

JULY 1980
\$1.60* NZ \$1.75



**ELECTRONICS
TODAY
INTERNATIONAL**

LASER

project to build

Teletext — what next ?
VIEWDATA !

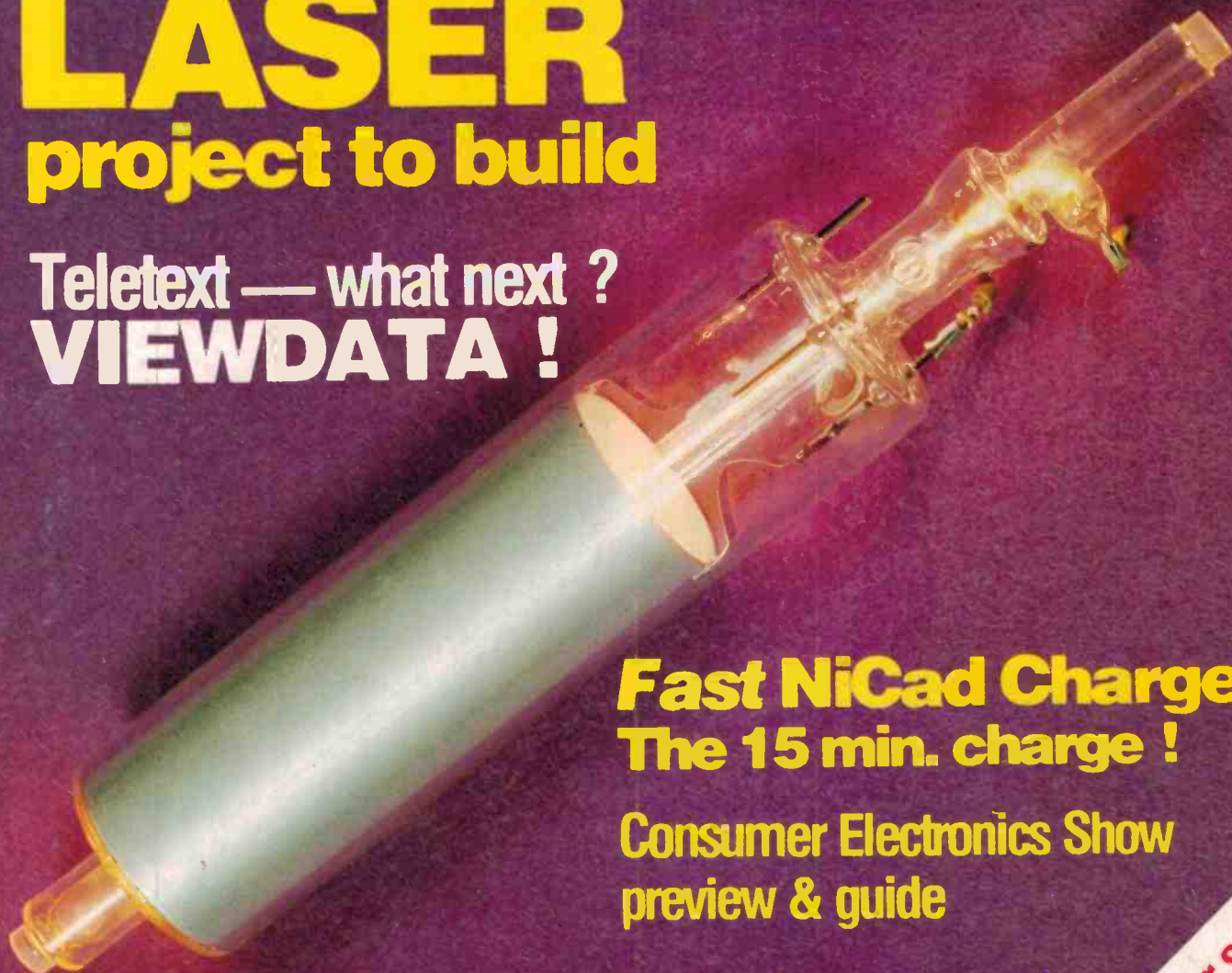

Fast NiCad Charger
The 15 min. charge !

Consumer Electronics Show
preview & guide

Hi-Fi: Optonica high-tech
cassette deck review

plus

Good car sound — how it's done

WIN — five Bose car sound
systems in our great
contest !

A new dynamic generation of Maxell tapes.

When Maxell announces an improvement in the quality of its tape, you can bet the improvement has to be pretty dynamic. In fact, we think our new generation has even gone beyond our own standards of superior sound reproduction.

Take our high level (CrO₂) position tape – the UD-XL II. Maxell engineers have succeeded in expanding its dynamic range in the middle-low frequency range by 1 dB, while also pushing its sensitivity by 1 dB in the high frequency range. Then look at our normal position UD-XL I, UD and LN tapes – our engineers expanded the dynamic range at all frequency points, while also boosting output in the high frequency range. The new dynamic range, of course, allows for better music reproduction even for LN-type tapes.

On the UD-XL I and II, we also added an exclusive shell stabilizer for significantly improved tape running and track positioning.

One thing hasn't changed on all Maxell tapes – our functional features like 4-function leader tape, replaceable index labels for UD-XL series tapes and Maxell's through-production system – your guarantee of quality and superior sound reproduction.

Tape selector position UD-XL I, UD, LN: Normal position (Normal bias/120 μsec. EQ)
UD-XL II: High level position (High level bias/70 μsec. EQ)



For details on all Maxell Recording Tape write to Maxell Advisory Service, P.O. Box 307, North Ryde, N.S.W. 2113 Available time length UD-XL I: 60, 90 min./UD-XL II: 60, 90 min. UD: 60, 90, 120 min./LN: 60, 90, 120 min.

Distributed by...
HAGEMEYER

WT126/79

maxell®
simply excellent



ELECTRONICS TODAY INTERNATIONAL

Registered for posting as a publication —
Category B

QUICK INDEX

FEATURES:

- 18 An Introduction to Lasers
- 81 Viewdata !
- 154 1980 Home Computer Show
- 67 CE Show Preview & Guide
- 108 CE Show Exhibitors' Guide
- 100 Contest — 5 Car Sound Systems to win !

PROJECT SECTION:

- 25 565: Build a helium-neon laser
- 33 563: NiCad Fast Charger
- 41 149: Two-tone Generator for SSB
- 47 466: Four-input Preamp to suit the ETI-466
- 55 Ideas for Experimenters
- 61 Shoparound
- 192 Kits for Projects

SOUND SECTION:

- 118 Sound News
- 92 Good Car Sound — How It's Done
- 132 Optonica RT7100 Cassette Deck Review
- 144 Audax Kit 51 Speaker Review

A "BLIND EYE" ON SPACE

THE AUSTRALIAN MEDIA seem to take little notice of NASA's successes, such as the Pioneer and Voyager planetary flybys, concentrating instead on the less glorious miscalculations — according to CAPCOM, a space news magazine put out by the Monash University Astronautical Society.

"The premature return to earth of Skylab received more attention than when that remarkable space station was actively advancing knowledge in the field of medicine, earth resources, solar physics, metallurgy and biology", CAPCOM say. They also charge the local media with being selective in what little coverage they do give to the successes of the various space agencies.

"NASA has been in the news to some degree but the USSR received only mild acclaim for her record space endurance flight and the Europeans' first successful rocket launch made only a tiny article in one Melbourne newspaper", they said.

We're proud of the fact that ETI cannot be included in that section of the Australian media ignoring the exciting events and achievements occurring in space research and exploration. We've covered the remarkable achievements of the Voyager and Pioneer missions twice each in the past year as well as giving previews to Spacelab (a multi-nation effort), Satellite Business Systems etc, as well as looking at the British Interplanetary Society's Daedalus Project. Reader reaction to our various 'space' features has been very favourable — showing that there is positive public interest in space matters.

This "blind eye" attitude of the Australian media is akin to the fifteenth century 'press' ignoring the voyages of Vasco da Gama or Christopher Columbus.

We trust ETI has played, and will continue to play, some part in redressing the imbalance.



Roger Harrison
Editor

advertisers

Advanced Electronics	139
Atram Electronics	110
Arena Distributors	124
Anderson Digital	117
Abacus Computer	32
Akai Aust.	128
AP Products	120, 121
AWA	135
Applied Technology	56
Audio Engineers	138
Ampec Engineering	99
A & R Soanar	88
Aust. General Electric	97
Audio Reflex	143
Audio Design	151
Australia Post/Telecom	189
AED	10
Audio Kits	142
Brian Bambach	141
Bose Aust.	66, 94
Barratt Lighting	114
Bell Instruments	104
BHO Control	178
Byte Shop	163
Bright Star Crystals	30
Convoy	70, 71, 82, 96, 106
Comp-Soft Micro	10
C.I.S.A.	60
Computerland	112
Cema	90, 172
Chadwick Audio	178
Christie Rand	146
Defense Recruiting	191
Dick Smith	16, 17, 46, 63, 136, 156, 157, 167, 170
Diggerman Electronics	98
Danish Hi Fi	134
David East	65
DSA Concert Systems	103
Delsound	140
Elmeasco Instruments	40
Emona Enterprises	62
Ellisronics	54
Electronic Circuit	162
Elect. Calculator Discounts	98
Electronic Agencies	142
Electrocraft	176
Embryonic Systems	146
Edible Electronics	179
Energy Control	142
Ferguson Transformers	187
Fairlight Instruments	142
G.E.S.	52
Goldring	96, 106, 148
Hitachi	116
Hagemeyer	2, 195
Hanimex	168
HF Coates	179
Holden Wasp	65
Insound	103
John F. Rose	12
JW Dicker	24
Jaycat	147
JP&A Electronics	73
Logic Shop	30
Laser Electronics	105
Looky Video	176
Leisure Sound	140
Magraths	14
Maruni Corp.	7
Microdot	31
Mitsui Computer	153
Micro 80	152
Maurice Chapman	180
Microtrix	10
National Panasonic Aust.	196
Northpoint Hi Fi	134
Overlander	187
Peterson Speaker Labs	130, 131
Parameters	6
Pre-Pak	107
Philips	140, 181
Plessey Components	179
Pitt St Micros	146
Radio Parts	76
Radio Despatch	176
Rod Irving	38, 39, 45, 61, 86, 164
Rank Electronics	158
Sevlen Lighting	184
Semis Unlimited	58, 59
Speedy Communications	190
Stewart Electronics	160, 167
Syntec	113
Stanton Magnetics	150
Sony	80
Sansul	125, 127, 129
Superscope	78, 79
Sharp	122
Sanyo	74, 75
SM Electronics	64, 65
Sigma International	151
Standard Components	15
Soundair	103
Tri-Kenwood	77
Tandy	174
TDK	91
Tasman Electronics	104
Video Classics	30
Zero One	166



ELECTRONICS TODAY INTERNATIONAL



COVER

Ivy Hansen's done it again — that's a real, live laser tube in operation on the cover, used for our initial development work on this month's feature project. Getting this picture was a delicate operation, what with that 1.5 kV supply hanging around . . .

features



AN INTRODUCTION TO LASERS 18

As a preface to our feature project, David Tilbrook gives a rundown on these fascinating devices and the physics behind their operation.

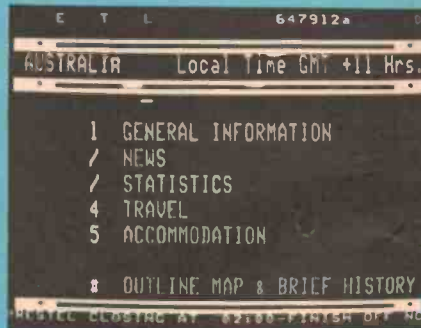

VIEWDATA! 81

Dubbed "the interactive Teletext", this electronic information system uses the telephone and the TV to give subscribers access to all sorts of information.

1980 HOME COMPUTER SHOW 154

We went for a stroll around the Sydney Home Computer Show . . . and what did we see?

CE SHOW PREVIEW & GUIDE 67

This year's Consumer Electronics Show will be much bigger than last year's, will run longer and . . . read all about it!

CE SHOW EXHIBITORS' GUIDE 108

Where to find all the pavilions and stands — where to find our stand!

CE SHOW EXHIBITORS' LIST 111

Alphabetical list of exhibitors and their stand numbers.

CONTEST — WIN FIVE BOSE CAR SOUND SYSTEMS 100

Over \$3000 in prizes in our great contest!

news

NEWS DIGEST 8

AM Stereo gets go ahead; October launch for SBS; Grant for solar research; We booted I, and more.

PRINTOUT 159

New generation micros; Farming computers?; Z8 single board micro; Updated club and user group listing.

COMMUNICATIONS NEWS 169

"State of the Art" contest revived; Heard Island dx-pedition; Icom WARC transceiver.

SHORTWAVE LOGGINGS 173

More power to Mongolia; Our Greek connection; Malta relays Libya; New programme for DXers.

projects

- 565: LASER** 25
This project is not just a "demonstration unit" but may form the basic component of a series of experiments and devices.



- 563: NICAD FAST CHARGER** 33
Don't be embarrassed by flat batteries — this charger will have them 'back to laws' in no time, er . . . flat.

- 149: TWO-TONE GENERATOR** 41
For testing or setting up singlesideband transmitters this is an essential piece of equipment.



- 467: FOUR-INPUT PREAMP** 47
Designed to team with our 300 W amp, this unit features high gain and bass/presence/treble controls with plenty of range.

sound

- SOUND NEWS** 118
Public demonstration of "Periphonic sound"; it's systems for the 80s; Sanyo's new cassettes.

- GOOD CAR SOUND — HOW IT'S DONE** 92
Getting good quality sound in a car seems difficult at first sight, harder when you look closer . . .



- OPTONICA RT7100 CASSETTE DECK** 132
More of an "electronic tape processor" than your common-or-garden variety cassette deck.

- AUDAX KIT 51 LOUDSPEAKERS** 144
A system that offers "... good performance at a reasonable price".

- AMPEX CASSETTE OFFER** 131
Superb offer of Ampex' "professional" series cassettes — repeated by reader demand.

- REEL-TO-REEL TAPE OFFER** 105

general

- LOGIC TESTER OFFER** 165
A very useful logic tester and frequency counter at around half the usual price.

- STOPWATCH OFFER** 185
Super Omron LCD stopwatch for school, club and other sporting events.

- MAIL ORDER BOOKS FROM ETI** 182
Beginners books, data books, circuit books etc.

- IDEAS FOR EXPERIMENTERS** 55
Circuit ideas, project modifications etc, etc.

- SHOPAROUND** 61
Latest news on sources for our projects, price estimates etc.

- LETTERS** 63
Have we forgotten how to design a good quality valve amp?

- IONOSPHERIC PREDICTIONS** 177

- MINI-MART** 188

- KITS FOR PROJECTS** 192

- ETI SERVICES** 193

- DREGS** 194

next month



- DIGITAL FREQ. METERS**
A guided tour inside this most useful item of test equipment, plus a buyers guide of what's available.

- LED TACHO FOR YOUR CAR**
Another project in our occasional series of "update your car electronically". This electronic tachometer features a 20 LED readout, switchable high and low ranges and selectable maximum speed.

- SIMPLE, RELIABLE HOUSE ALARM**
Whenever you hear a burglar alarm the chances are less than three in a hundred that the alarm has been set off by an intruder. The other 97 times it's been falsely triggered!
This project is adequate for the average household or small business and will provide years of reliable operation.



- TURNTABLE TECHNOLOGY**
This article had to be held over due to space problems, but it's worth waiting for — a fascinating insight into the problems involved in producing high quality turntables and how designers have surmounted the problems employing some of the 'new technology' that has emerged over the last decade.

Although these articles are in an advanced state of preparation, circumstances may affect the final content. However, we will make every attempt to include all features mentioned here.

"The bright clear trace makes the Trio CS1560AII easy for operators to use..." says John Shillabeer, Head of Test Equipment Engineering at S.T.C.



John Shillabeer's department is involved in the maintenance, calibration and servicing of all test equipment used within S.T.C. We asked him why S.T.C. used Trio CS1560A scopes.

"My department gets involved with all test gear purchases. As a general purpose scope we've found that the Trio provides excellent performance for its price. Being easy to trigger we find staff can readily get it up and going. On the production

15MHz Trio CS1560AII Dual Trace

line, the bright clear trace makes it an easy scope for operators to use.

"Over the past three or four years, S.T.C. has bought 8 Trio 1560s and we've had virtually no trouble from them. Any minor services have been easy to carry out. As you can see we even use one in our department in the development of our own digital test equipment."

30MHz Trio CS1577 Dual Trace



PARAMETERS^{PTY}LTD

"Perfection in Measurement"

Sydney 439 3288 Melbourne 90 7444

Available from selected dealers

N.S.W. Sydney Dick Smith Stores 888 3200; George Brown & Co 519 5855; Radio Despatch Service 211 0191. Newcastle D.G.E. Systems 69 1625; Elektron 2000 26 2644. Wollongong Hundell Engineering 74 0278; Macelec 29 1455; A.C.T. Canberra Electronic Components 80 4654. QLD Brisbane Audiotronics 44 7566; L.E. Boughen 36 1277; N.S. Electronics 36 5061. VIC Melbourne Browntronic 419 3986; Douglas Radio 211 1698; J.H. Magrath 663 3731; Radio Parts 329 7888; Tech Rentals 267 5877; G.B. Telespares 328 4301. Geelong Teleparts 21 7288. S.A. Adelaide K.D. Fisher & Co 269 2544; Gerard & Goodman 223 2222; Trio Electrix 51 6718. W.A. Perth Hinc Engineering 381 4477; W.J. Montcrieff 325 5722; Rablec Engineering 381 2866. TAS Hobart Imbros Surpath Systems 23 2892. Launceston W & G Genders 31 2511.

LISTED BELOW ARE THE
MAJOR HEADPHONES THAT OUTPERFORM
THE MARUNI HV3000R

N.B. MARUNI microphones take some beating too!!!

MARUNI

SUPERLATIVE HEADPHONES AND MICROPHONES

THE **MARUNI** CORPORATION

297 WILLIAMSTOWN ROAD, PORT MELBOURNE, 3207 • TELEPHONE, 645 2079 • TELEX 32571

AM stereo gets go-ahead

The US Federal Communications Commission has finally decided that AM stereo broadcasting can go ahead in the 'States and has endorsed the Magnavox system.

We reported in the May 1979 issue that the FCC were then about to make a 'definite ruling' on the system and standards to be implemented for stereo broadcasting in the AM broadcasting band, but it has taken them a further 12 months to bring down a ruling.

The Magnavox system, illustrated in the block diagram here, employs amplitude and phase modulation of the sum and difference products of the two stereo channels plus a pilot tone. The L + R signal is amplitude modulated onto the transmitter carrier while the L - R signal is phase modulated onto the transmitter carrier. In addition, a 5 Hz tone modulates the carrier to provide a reference for a wideband phase-locked loop which generates a phase-modulated signal. This signal is in turn modulated by the L + R signal before transmission.

The receiver consists of a single IF strip, the output of this being split and passed to an envelope detector — to recover the L + R signal — and to limiters and a phase-locked loop which demodulates the phase-modulated L - R signal.

The claimed advantages of the system include the simplicity of implementation, compatibility with existing transmission and reception systems that ensures no forced obsolescence (half the reception system already exists in current AM receivers — the rest may be "added on") and the low cost for manufacturers of adding stereo circuitry to existing receiver designs as it can be readily realised with existing IC technology.

The five competing schemes put up to the FCC were discussed in the July 1977 issue of ETI, pages 12 to 14.

We understand the decision to go with the Magnavox system

was a 4-to-2 vote, with one abstention, and that the decision has been disputed by Motorola (who proposed one of the competing schemes) in a petition to the FCC lodged early in May.

Motorola are seeking an oral hearing on the matter.

"There is a need to reach a decision on AM stereo without undue delay", Motorola said.

"However, the commission has an obligation to ensure that it makes available to broadcasters and consumers a system of AM stereo which performs well under various reception and transmission conditions.

"On the basis of the record in this proceeding, Motorola firmly believes the decision reached does not provide for such a system".

No schedule for the introduction of the stereo broadcasting system on the AM band has been circulated by the FCC to date.

Meanwhile, Magnavox Consumer Electronics, a subsidiary of North American Philips, has projected that broadcasters could begin to modify their transmitters to incorporate the AM stereo system within 6-9 months and that suitable receivers could be on the market within a year.

Robert Streeter, designer of the system for the Fort Wayne, Indiana, Magnavox division, said that existing AM receivers could be retrofitted for stereo reception but that it would possibly cost more than purchasing a new receiver incorporating stereo circuitry.

Kenneth Meinken Jr, president of Magnavox, said that several US firms, in addition to companies in Australia, Canada, Germany and Japan have contacted Magnavox about possibly manufacturing AM stereo receivers to the Magnavox design.

Potential sales for AM stereo receivers are estimated to be greater than 60 million units per year (for the US), split as follows — 20 million units for car radios, 35 million units for home stereos and seven million for modulator audio units.

Magnavox plan to hold a public demonstration "soon". Here's hoping they don't take as long to do it as the FCC took to decide on the system.

Whether or not we'll get AM stereo broadcasting in Australia remains "in the lap of the gods".

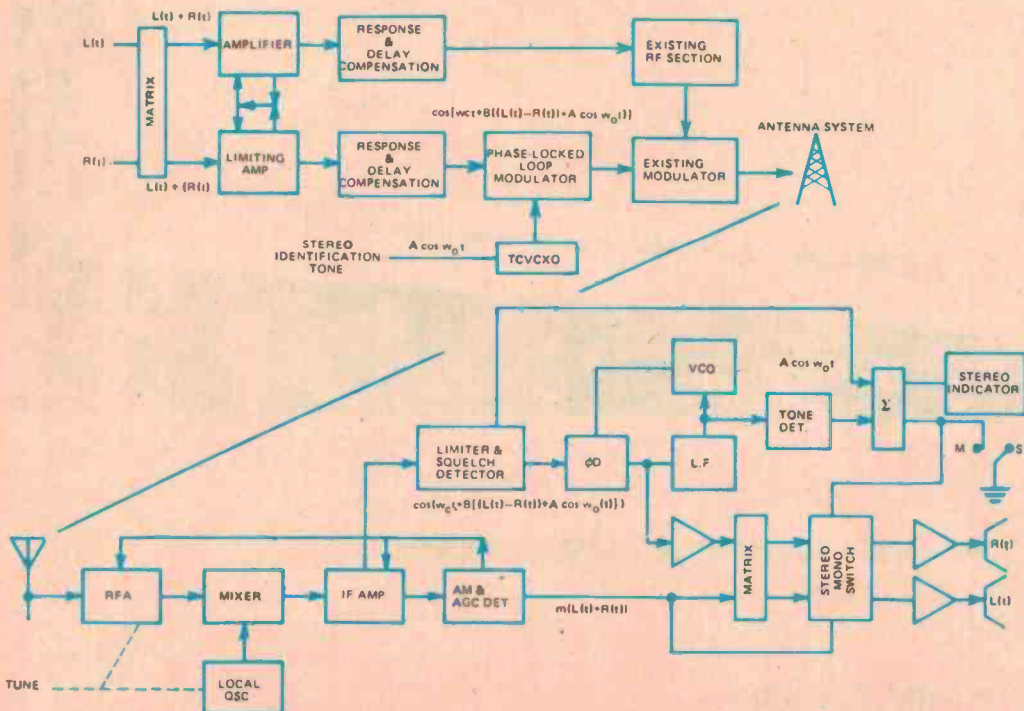

This block diagram shows both transmitter and receiver systems for Magnavox's AM stereo broadcasting system. The formulae detail the signal properties at various stages. Claimed advantages include the simplicity of implementation and compatibility with existing AM transmission and reception systems.

Briefs

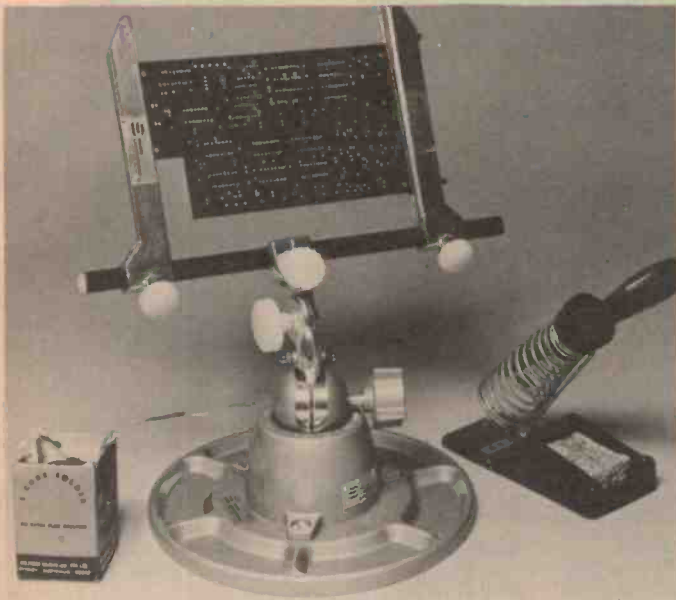

'Tilt, turn, lock' stand for pc boards

Scope Laboratories are now selling a pc board holder which enables a wide range of sizes and shapes of circuit boards to be held and locked in any position.

These holders allow the worker to construct or repair circuits at a convenient angle. The holder unit, called the Panavise™, is totally portable and the mounting base and gripping heads are easily separable. This means that a variety of heads can be attached to the swivel

base — for example: 152 mm variable jaws, a nylon spigot for screw mounting of items, or face plates with attachment slots.

Further information can be obtained from Scope Laboratories, P.O. Box 63, Niddrie Vic, 3042

NASA has developed a commutatorless ac/dc motor at their Pasadena, California, Jet Propulsion Labs. SCRs connected directly to the motor windings can be pulse-driven to provide the required current drive to the motor windings, a sensing transformer monitors load variations. The motors may be powered by solar energy, batteries and other dc sources.

Another of NASA's research facilities, the Goddard Space Flight Centre at Greenbelt, Maryland, has developed a tuned circuit using no inductors. The device can be used as an RF filter, amplifier or oscillator. Based on two directly-coupled transistor stages operated near their transition frequency, the inductorless tuned circuit can be fabricated as an IC on a single silicon chip. Near the transition frequency, the transistors' inductive and capacitive reactances allow them to function as active tuning elements.

LEDs having the brightness of subminiature incandescent lamps and a far longer life span than conventional LEDs have been developed by a US company. The developers, Opto-Electronics of Palo Alto, California, employ a gallium arsenide phosphide epitaxial structure on a gallium phosphide substrate. The company claims the LEDs have ten times the brightness of normal LEDs and an operating half-life of more than 100 000 hours.

A new quartz crystal 'cut' exhibits improved stability over the conventional AT-cut crystals widely used throughout the electronics and communications industry, according to a recent report from the UK. Philips Research Labs in Surrey and Cathodean Crystals Ltd have developed the crystals using the new 'cut' — dubbed "strain compensated" or SC-cut. They claim the advantages of the SC-cut crystals over AT-cut crystals are greater temperature stability, lower sensitivity to thermal and mechanical shock, slower ageing rates and higher Q values.

The three Laws of Industrial Robotics, to help ensure acceptance of industrial robot installations in the workplace, have been set down by the Block Petrella company in the US.

"Organisations may not install robots through devious or closed strategies which reflect distrust or disregard for the workforce, for surely they will fulfill their own prophecy.

"Organisations may only install robots on those tasks which, while currently performed by men, are tasks where the man is like a robot, and not the robot like a man."

The office of the future will be marked by slow progress, according to a study conducted by the UK Dept. of Industry. They conclude that economic limits on investment and social factors such as the lack of skilled electronics workers, union and management resistance and fear of trusting new, untried equipment will dictate the pace of change in the office, despite the advent of new technologies.

Optical fiber attenuation is getting so low it may cease to be cited as a significant parameter. Fiber optics is moving toward longer wavelengths and multi-band operation, prompted by recent technology breakthroughs, and lab findings will be translated into practical, cost-effective hardware in record time, according to L.C. Gundersen, director of Corning Glass Works' Optical Waveguide Technology R&D Lab.

An energy conserving device that cuts the power required for induction motors by 10-60%, has been developed by EnerCon Inc of Cleveland, Ohio. By plugging their Dr Watt unit into a wall socket and the appliance into Dr Watt, the unit measures the power needed to do the job and delivers only that amount to the appliance's motor. NASA developed the patented device used in Dr Watt to achieve the greatest possible efficiency from motors that operate via solar energy.

October launch for business satellite

October 23 this year is the date set for the Satellite Business System Inc.'s first satellite which will provide the world's first satellite-based business communications facility.

The system, featured in the March 1980 issue of ETI, will have customer-dedicated earth stations and such firms as Aetna Life & Casualty, Boeing Computer Services, IBM and the Travellers Insurance Company will enjoy the advantages of computer-to-computer communications, electronic mail and video conferencing, among other services.

The satellite system represents a US\$375 million investment for SBS Inc., even before

operational launch readiness is achieved. The company is a wholly owned subsidiary of Aetna Life & Casualty, Comsat General and IBM and is a successor to the CML Satellite Corporation.

It is understood the launch will be by conventional rocket (probably a Delta 3910 booster) as the Shuttle, dogged by problems, is too far behind schedule to be considered as a launch vehicle.



MICROCOMPUTER PRODUCTS

123 Military Road, Gullford,
NSW 2161. Phone (02) 632-6301
(02) 632-4966. Telex AA25958.

SORCERER OWNERS!

WE ARE NOW TAKING ORDERS FOR:

- Sorcerer Expansion S100 units from Exidy, \$420 with tax, \$390 excluding tax.
- Sorcerer to S100 Bus interface cards, price on application.
- 8" Disk System with many times the speed and data capacity of Micropolis and similar 5" disk systems. Plugs direct to Sorcerer without need for S100 Interface unit. Inbuilt intelligence allows disk to disk or file to file copy while DOS is used to do other things. CPM 2.1 available. Double density. One to four drives, single and double sided. Priced from \$1600.
- Discus 2D, requires S100 expansion interface. Complete package includes Diskate DOS, cables, cabinet, Interface card etc. Double Density single and double sided up to four 8" drives. Priced from \$1232. Why buy 5" when 8" is 3 times faster and has up to 5 times the capacity.
- Base 2 Printer. Yes, this is the printer all your mates are on about! The buy of the decade. You must talk to us about it. Priced from \$620!

Opening hours: Mon-Sat 9 to 6 and till 9pm Thur.
Shop closed during Home Computer Show.
Prices subject to change without notice.

Come and see the magnificent SSM VB3 Video Card running with Wordstar. We will be delighted to quote for a system to meet your requirements, be they wordprocessing, business, engineering or hobby.

microtrix



Microprocessor Systems,
Development,
Sales & Servicing.

S100 PRODUCTS

SBC 200 SINGLE BOARD COMPUTER

Z-80 based 4 MHz microcomputer with 1K RAM and sockets for 8K/16K PROM, synchronous or asynchronous serial I/O port with software programmable baud rate generator, RS232 and 20 mA interfaces, parallel ports, four channel counter/timer, power-on jump, and vectored interrupt operation. Kit with 2716 PROM \$360.

VERSAFLOPPY 1 DISK CONTROLLER

Low cost controller will operate with either mini or standard drives, single or double sided, in single density. Operates with CPM and is Shugart compatible. Kit \$258.

VERSAFLOPPY 2 DISC CONTROLLER

State-of-the-art controller operates with all combinations of drive types in single or double density modes, and has PLL data recovery circuit. SDOS compatible. Kit \$360.

EXPANDORAM 2 DYNAMIC RAM

A single dynamic RAM card that will hold 64K! Page mode operation allows the use of up to eight boards for multiuser

applications. Supplied with 200 nS 2116's for 4 MHz operation. Ideal for use with Versafloppy 2 and the SBC200. Kit: 32 K \$525, 48 K \$670, 64 K \$815.

MPB100 Z-80 CPU

Operation at 2 or 4 MHz, on-board PROM, power-on jump, can be used with or without front panel. Kit \$260.

PROM100 PROM PROGRAMMER

Capable of programming all popular EPROMs such as 2708, 2758, 2716, and 2732. Zero Insertion force socket is standard. Kit \$205.

MST 16 K STATIC RAM

Uses 2114's with bank select, addressable as 4 separate blocks on 4 K boundaries, wait states, fully buffered, phantom signal. Kit \$299.

VDB 8024 VIDEO DISPLAY BOARD

On-board Z-80 and CRT 5027 controller. 80 x 24 lines plus programmable characters. Kit \$380.

Z-80 Starter KitKit \$350
Ithaco Intersystems Z-80 CPU.....Kit \$156
Ithaco VDU 64 x 16Kit \$155
Ithaco 2708/2716 PROMKit \$115

MPR 16 2708 PROMKit \$95
VO card serial & parallel.....Kit \$189
Monitor for SBC 100.....\$60
CP/M Disc operating system\$145

Rack mount cabinet and mother board available soon. Some other cards in design stage. Add \$50 to prices for built and tested. For mail order add \$5 for reg. post. Please write for more info on any product.

MICROTRIX, PO Box 158 Hurstbridge, Vic., 3099. Ph. (03) 718-2581 AH.

COMP-SOFT

MICROCOMPUTER SERVICES

OHIO SCIENTIFIC (OSI) COMPUTERS

- Superboard and software
- C1P • C4P
- C4P MF

OPENING SALE

10% DISCOUNT ON ALL COMPUTERS

TRADING HOURS

Tuesday and Wednesday:
9.30 am-5.30 pm
Friday: 4.30 pm-8.30 pm
Saturday: 9.00 am-12.30 pm

235 SWAN STREET, RICHMOND. PHONE (03) 428-5267.

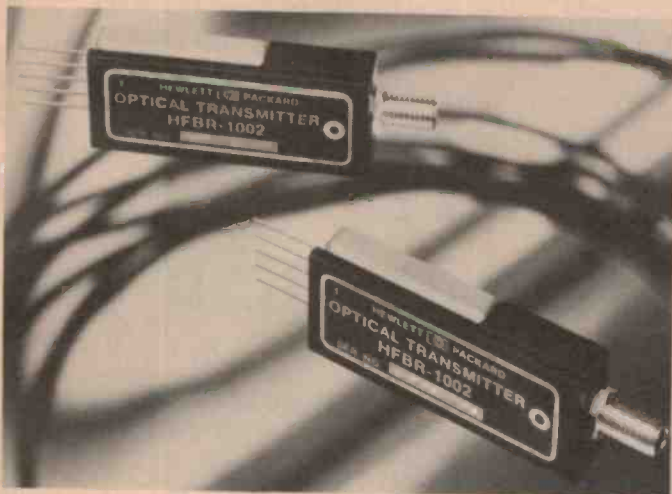

Digital Tx/Rx for 1 km fibre-optic link

A fibre-optic transmitter that can transmit data over 1000 metres with guaranteed performance specifications has been introduced by Hewlett-Packard.

The new HFBR-1002 fibre-optic digital transmitter is an integrated, electrical-to-optical transducer designed for digital-data transmission over single, optical-fibre channels. A bipolar, integrated circuit and a new high-efficiency GaAlAs infrared emitter convert TTL-level inputs to optical pulses at data rates from dc to Mbaud.

The new emitter is a Burrus diode specifically designed by HP for fibre-optic applications. The etched-well structure pro-

vides high-power output at 820 nm.

The HFBR-1002 (when used with HP's HFBR-2001 fibre-optic receiver and any HFBR-3000 series cable/connector assembly) guarantees system performance at 1000 metres, 10 Mbaud data rate, and 10^{-9} bit-error rate, with 2.6 dB flux margin, according to HP.

In quantities of one to nine the price of the HFBR-1002 is \$392. Available from franchised HP component distributors.

Versatile function generator

A maximum output of 30 V peak-to-peak and facilities for both internal and external sweep are just two of the features of a function generator being introduced by Philips Test and Measuring Instruments.

Designed for educational and general purpose applications, the PM5131 generator provides sine, triangular and square waves in three logarithmic sub ranges from 0.1 Hz to 2 MHz. A frequency offset vernier allows settings to be varied from minus 20% to plus 20%, say Philips.

Continuously variable output attenuation is provided up to 20 dB, in addition to fixed attenuation in 10 dB steps up to 60 dB. The main output has a 50 ohm impedance and there is a separate TTL output.

A three-and-one-third de-

cade internal sweep facility is provided with adjustable sweep range and period variable from 10 to 150 seconds. This allows the whole 20 Hz to 20 kHz audio band to be covered in a single sweep for example. External sweep is also possible, either up or down the frequency range.

Pushbutton selection is provided for the three waveforms as well as separate choice of dc voltage. The dc offset is variable from minus 10 to plus 10 V.

Power consumption is 21 W and the instrument runs on 115 or 230 Vac.

Function generator "gets smart"

The Krohn-Hite 5900 microprocessor-based function generator is the first to include 'intelligence' according to the manufacturers.

It features an "autoprogrammer" which can learn a procedure and repeat it at any given rate.

Covering the frequency range of 0.1 Hz to 5 MHz, the instrument produces the usual array of sine, square, triangle, pulse and sawtooth waveforms. Fully programmable modes include continuous, gate, triggered, digital lin/log sweep and triggered burst.

Rated output voltage is 30 V peak-to-peak with 10 mV reso-

lution. An adjustable offset of ± 15 V is provided.

The instrument is especially designed for automatic testing of instruments and components and includes nine storage registers for rapid retrieval of combinations of generator parameters and can be used in conjunction with computer systems if desired.

It is being distributed by Warburton Franki who would be happy to wise you up on further details.



\$1 billion for energy research

The European Community Commission (ECC) is to back energy research to the extent of more than \$1000 million over the next four years.

It means that Europe will match the efforts being made in the US, Russia and Japan to achieve nuclear fusion and so solve the world's power generation problems.

This figure represents more than a doubling of the investment in energy research and is seen by many as a big step forward for European ambitions of building an economically viable fusion reactor that could produce an abundance of electricity without the environmental problems of present day nuclear power stations. (Item courtesy "Briefings").

New catalogue

Tecnico Electronics have just published a 44 page catalogue containing information on the main products in electronic components and industrial instrumentation from 26 overseas companies.

The catalogue is intended firstly as a handy buyers guide for products such as resistors, capacitors, relays, potentiometers, fuses, switches, connectors, power supplies, recorders, meters, photo-electrics, etc.

Indexed and profusely illustrated the catalogue contains full technical details and where relevant, dimensional information to help design engineers.

Copies are available by forwarding a request on company letterhead to Tecnico Electron-

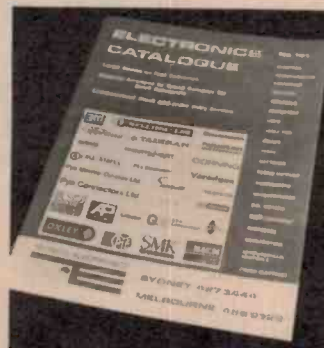

ics, P.O. Box 50, Lane Cove, NSW 2066.

N D K
< S - 4 0 0 0 >

JOHN F. ROSE COMPUTER SERVICES PTY. LTD.

PRINT SAMPLE SHEET

This is a printing sample by our newly developed matrix printer which has a 16 wire head designed for producing wordprocessing quality print at high speed.

17 x 16 matrix at the print speed of 75 cps is available for good printing quality, and 9 x 7 matrix at the print speed of 150 cps is available for high speed printing.
(Print speed can be increased by 20% by using the 12 cpi mode.)

The printer has 2 sets of dot matrix patterns in the character generator as standard (including JIS 8 bit-code)
This line is printed at 12 cpi.

!"#\$%&'()*+,-./0123456789:;<=>?
@ABCDEFGHIJKLMNPOQRSTUVWXYZ[^\`_~
'`abcdefghijklmnopqrstuvwxyz{|}~
。「」・ヲアイウエオカキクケコサシスセソ
タチツテトナニヌネノハヒフヘホマミムメモヤヨラリルレロワヅ

!"#\$%&'()*+,-./0123456789:;<=>?
@ABCDEFGHIJKLMNPOQRSTUVWXYZ[^\`_~
'`abcdefghijklmnopqrstuvwxyz{|}~
。「」・ヲアイウエオカキクケコサシスセソ
タチツテトナニヌネノハヒフヘホマミムメモヤヨラリルレロワヅ

Other type fonts can be specified by the user.
An important feature of the printer is the ability to define special characters under external software command. For example **NDK**.
Various patterns may be printed at rate of 900 dot-column per second and resolution of 120 dot per inch.

MANUFACTURED BY:

NIKKYO ELECTRIC INDUSTRY CO., LTD.
807 Futoo-cho, Kohoku-ku, Yokohama
222 Japan

DISTRIBUTED IN AUSTRALIA BY:

JOHN F. ROSE COMPUTER SERVICES PTY. LTD.
33-35 Atchison Street.,
St. Leonards. N.S.W. 2065
Telephone: (02) 439-1220 Telex: AA27901.

Price \$3,105 EXCLUDING
SALES TAX (15%)

Send \$1.00 to join our Mailing List Club
and receive our latest catalogue.

Australian energy for solar power

The Standards Association of Australia has taken the initiative in organising an international committee of over 30 countries to develop standards on solar power.

The SAA stated, "Increased use of solar energy for heating, cooling, and airconditioning offers worthwhile reductions in the rate of use of fossil fuels.

"Both developed and developing countries are pursuing development programmes related to solar heating and some significant standards are emerging.

"Australia has already produced an installation code for solar water heaters and is currently working on test methods together with a basic

specification for their construction. These standards will be taken by the international committee as a basis for discussion on their proposed international standards".

At present, the scope of the committee is restricted to thermal applications of solar energy, although it may expand its discussions at a future date to include electricity, water desalination and chemical reactions.

It is hoped that commercially viable systems could be compared all over the world.

US grant for solar research

CSIRO's Division of Mechanical Engineering is to receive a grant of more than US\$185 000 for research into solar powered air-conditioning systems.

The grant has been made by the US Department of Energy through the University of Wisconsin, Madison USA, and will enable the Division to carry out research on 'open cycle' cooling systems.

In these systems, special solids or liquids are used to dehumidify air and are then regenerated by solar energy.

Dr Don Close, a Principal Research Scientist with the Division, explained that these systems can supply cooling and dehumidification with moderate energy inputs provided each part of the system is highly effective.

These parts include heat ex-

changers and evaporative coolers.

"Different arrangements of these components produce different effects so what we aim to find is the most efficient arrangement," Dr Close said.

He said that while emphasis would be put on application for domestic cooling the system could be adapted easily for industrial use.

Mathematical models of the parts of the system will be made using experimental data and these will then be used to evaluate the effectiveness of various arrangements.

Both Australian and US climates will be used in these studies.

Power up

Warburton Franki are to distribute two new series of power devices — 150 A power Schottky diodes and high power bipolar transistors rated to 50 A collector current, both made by International Rectifier.

The Schottky diodes, designated 150 KQ Series, feature 175°C junction capability and very low reverse leakage (65 mA at 125°C). This means that savings in money, time and material can be achieved by using

one device instead of two 75 A diodes if you need this sort of forward current capability.

Voltage ratings on the NPN power transistors are 450 V, with $V_{ce(sat)}$ of 1 V maximum at the maximum continuous collector current rating of 50 A. Another marked quality of the devices is their switching fall times of only 200 ns from 50 A loads and claimed high efficiency at high frequency operation.

Full details of the new IR devices from Warburton Franki.



Get your seat into gear ! ... or something.

With the average electronics buff spending 15 000 hours seated on his dreary old office chair every 10 years, and then another 6000 hours seated in front of his latest piece of microprocessing wizardry on an old study chair, again every 10 years, those old chairs have had plenty of time to destroy his natural back posture.

While sports car enthusiasts the world over were being hugged and pampered by their Scheel seats, we lesser mortals have had to contend with our dreary chairs and bad backs. But no longer.

The Scheel Office Seat is fully reclining, has a tilt and locking lever, is pneumatically height adjustable, comes mounted on an attractive, five-pronged chrome base and runs on five matte black castors.

With the complete Scheel Office Seat available from \$400, there is no reason left for you to put off getting the seat your back deserves. Forget that extra disk drive/linear amp or whatever, get a good seat instead!

The Scheel Office Seat is available from Scheel Seats Pty Ltd, corner of Dickson Avenue and Pacific Highway, Artarmon NSW 2065. (02) 439-8308.

MAGRATHS

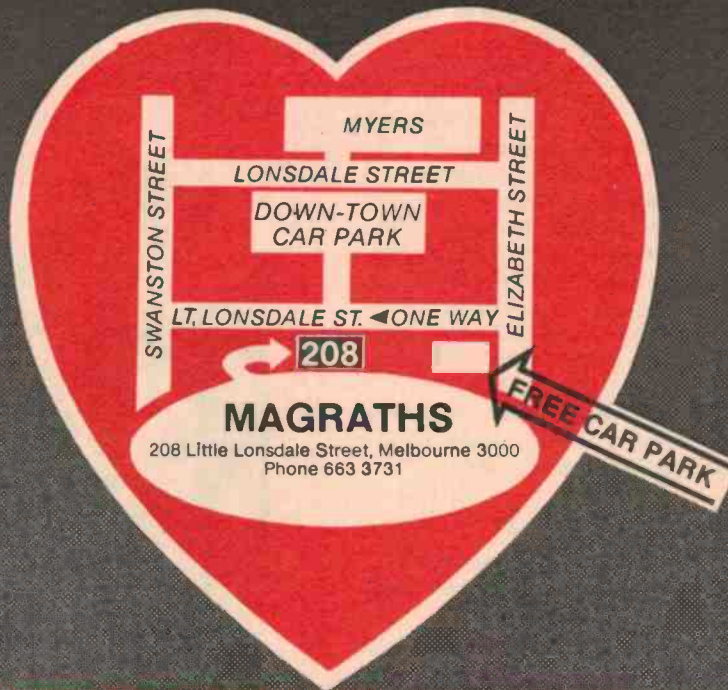

IN THE HEART OF MELBOURNE

NATIONAL

Full range of National Linears, CMOS, TTL etc. All current data books.

Even upside down



Sonnenschein batteries can be used upside down, sideways, anyway. Full range.

GI Diodes — Ex stock

1N 4001	1N 5061
1N 4002	1N 5626
1N 4004	GIG
1N 4006	GP30B
1N 4007	W02
1N 4145	W04

6800 9900

Microprocessor families from

AMI

OPTO'S GENERAL INSTRUMENT

RECTANGULAR*



MV52124
MV53124
MV57124

Green
Yellow
High Eff. Red

BAR GRAPH



MV57164

High Eff. Red

5" RECTANGULAR*



MV57173

High Eff. Red

*POP-INS AVAILABLE

Now available — 1980 Full Line Opto Catalogue

DIECAST BOXES

Full range from EDDYSTONE



TRIACS, SCR's

from TECCOR



BREADBOARDING, INTERCONNECTION & TESTING DEVICES

Full range on display from AP PRODUCTS INCORPORATED

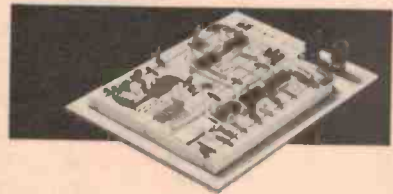

FLAT RIBBON CABLE ASSEMBLIES AT AFFORDABLE PRICES



FOR ALL YOUR ELECTRONIC COMPONENTS

Low cost CCTV camera



Dick Smith Electronics has announced the availability of a new, compact, monochrome, closed-circuit TV camera.

Designed for security and safety monitoring, for school and college dramatics, for use with video tape recorders, and for amateur TV enthusiasts, the Asaca Model ASA-500E is priced at \$299.

The camera features a modern 16 mm Vidicon tube, of the separate mesh type for improved picture quality; output switchable between video and modulated RF so that the camera may be used with either a CCTV monitor or a standard TV receiver (RF output is on Australian channel 1); video bandwidth of 7 MHz and video signal-to-noise ratio better than

40 dB, according to the specs.

The automatic light control circuit (ALC) has a wide range of control: 10 000 to 1. As the camera is supplied with a high quality "Tamron" f/1.8 lens with built-in iris diaphragm, the wide range ALC enables it to cope with widely varying ambient lighting situations.

A mechanical control on the rear of the camera case permits focussing down to less than 10 mm from the front of the lens.

The camera is listed as catalogue No. X-1195 and is available at all Dick Smith Electronics stores and dealers.

After the drought, it's raining in buckets

The CSIRO Division of Cloud Physics has developed a new type of rain gauge to measure the efficacy of their efforts to cause rainfall in drought-stricken areas through sowing crystals into clouds.

In a series of experiments of world significance, the Division is systematically sifting the weather patterns and comparing rainfall in "seeded" areas with that in similar "unseeded" areas.

This involves recording rain-falls in many remote areas.

The Division has evolved a "tipping bucket" rain gauge for use in remote recording sites for periods as long as three months at a time without attention. Rain fills the bucket after 1 mm has fallen, and tips it, bringing

another, empty, bucket into place.

The moment of tipping is recorded by a domestic tape recorder which is temporarily turned on when the bucket tips.

Having made 110 of these devices, and used them for six months or more, the Division has a good idea of how these recorders perform on lonely mountains.

Hopefully, some Australian firm will take them up and export like mad?

WE BOOBED I

March 1980 issue: The ETI-561 Metal Detector contains an error on the component overlay (p.33). R3 is shown as 1M when it should be 100k — as on the circuit and in the parts list. The Loudspeaker Protector, ETI-455, in the same issue has a comment on the circuit diagram relating to diodes D1-D4 and D5-D6. The comment is incorrect, trust the parts list instead. Turning to page 56 (Improvements to RTTY), Q1 and Q2 on the tuning CRO diagram are not listed. They are: BF338, 40327, 2N3440 or similar device with 300V Vce rating. On Figure 7 (p.57), all the transistors (Q1 - Q8) are small signal types, such as BC107, BC547, BC108, BC548, 2N3564 etc. The UART may be an MM5303N or equivalent, while IC1, IC2, IC4 and IC5 are all type 4001 and IC3 is a type 4000.

April 1980 issue: In the circuit diagram on page 39 (Project 566), Q6 was not given and is not listed in the parts list — it is a BC108, BC548 or similar type.

May 1980 issue: The 140W Valve Amplifier has several notation errors. On page 31, at the bottom of the power supply circuit, the note should read: "The power transformer . . .". In the parts list on page 35, D1-D10 and D11-D15 are listed incorrectly (! ! !). D1-D10 are A14Ps and D11-D15 are 1N4004s, as shown on the circuit diagrams.

See for yourself... **THE**
PORTABLE OSCILLOSCOPES by
Hitachi Denshi, Ltd. Japan

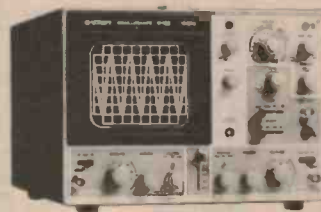

V152 15MHz DUAL TRACE
TV sync-separator circuit
High-sensitivity 1mV/div
(5MHz)
X-Y operation
Sweep time magnifier
(10 times)
Trace rotation
Z-axis input (intensity modulation)

5 great Oscilloscopes by Hitachi Denshi Ltd., Japan are now available in Australia from Standard Components. In addition to the V152 illustrated there are the V-151 15MHz single trace, V-301 30MHz single trace, V-302 30MHz dual trace and V-550 50MHz dual trace. Enquire about the great price and remember they are backed with good service and spare parts and are guaranteed for a full twelve months.

Also available from: Radio Parts Group, G.B. Telespares, Ellistronics (Melbourne); Audiotronics (Brisbane); David Reed, Radio Despatch (Sydney); Bee Jay (Adelaide) and other leading Electronic Shops.

Standard Components Pty. Ltd.

10 HILL ST., LEICHHARDT 2040. 660-6066

Don't miss our Giant Sale Mailer in July EA PARTS FOR NEW KITS

If a kit you want to build is not listed, the parts may be available anyway. Check the Dick Smith Catalogue or call in to your nearest Dick Smith store.

- FAST NICAD CHARGER** (See ETI July)
PCB only Cat H-8672 \$3.00
(All other components in this kit are normal stock lines)
- GUITAR/PA PREAMP** (See ETI July)
Short form kit (PCB & components, no transformer or case) Cat K-3035 \$29.50
Printed Circuit Board Only Cat H-8376 \$9.95
(Most other components are normal stock lines)
- 300 WATT AMPLIFIER** (See EA June)
Complete Kit Cat H-8376 \$9.95
Printed Circuit Board Cat H-8375 \$3.75
(Most other components are normal stock lines)
- TV CRO ADAPTOR** (See EA May)
Complete Kit Cat K-3060 \$29.95
Printed Circuit Board Cat H-8375 \$3.75
- CONTROL TIMER** (See EA April)
Printed Circuit Board Cat H-8374 \$2.50
Timer Module Cat X-1050 \$17.50
- OVER-REV ALARM** (See ETI March)
LM2917 IC Cat Z-6112 \$2.95
(This project is easily built on Matrix board or similar; all other components are normal stock lines.)
- ETI 466 300W AMPLIFIER** (See ETI Feb)
Complete kit Cat K-3444 \$69.00
Printed Circuit Board (f/less) Cat H-8696 \$7.60
MJ15003 O/P transistors Cat Z-1808 \$6.00
MJ15004 O/P transistor Cat Z-1810 \$6.00
- PLAYMASTER AUDIO ANALYSER** (See EA Feb)
Complete kit Cat K-3510 \$99.50
Printed Circuit Board Cat H-8373 \$8.50
4136 IC Cat Z-6105 \$1.88
- GUITAR PRACTICE AMPLIFIER** (See ETI Jan)
Printed Circuit Board Cat H-8625 \$4.60
(All other components are normal stock lines)
- ANALOGUE FREQUENCY METER** (See ETI December)
Printed Circuit Board Cat H-8642 \$1.95
CA3140 IC Cat Z-5417 \$1.48
NE555 Cat Z-6146 \$0.34

NEW TV CRO ADAPTOR

If you're like many people, the old b/w TV is sitting around doing nothing. And you're probably always wanted a CRO. Why not use your TV? This simple bit from Electronics Australia turns your TV set into an audio CRO which you'll find highly useful. The kit comes complete with instructions. Compare our price with others!

**PUT YOUR
OLD B&W TV
TO WORK!**



Cat K-3060
SEE EA MAY ISSUE
\$29.95

ETI 300W AMPLIFIER

Yes, there's a real massive 300W RMS. Build two amplifier modules and you've got a 600W music system! Or a guitar amplifier, public address amp, etc. This kit contains deluxe components and all on-board components (but not power transformer, case, etc.). A huge number of these kits have been made by enthusiastic constructors. It's a beauty. Transformer to suit Cat M-0150 @ \$32.50
Case to suit (15" rack size) Cat H-2480 @ 49.50
Cat K-3444

ETI MIXER/PREAMP

This is a perfect mate for the 300 watt guitar amplifier. You can build it into the same case as the main amp. It features 4 inputs, with level controls, master level and tone controls and is ideal for the guitarist or for PA work. Complete on a single PCB, it is very easy to build.
Cat K-3035

MAJOR DICK SMITH RESSELLERS

- ADVANCED ELECTRONICS**
56 The Quadrant, Launceston, Tas. (317 075)
- AERO ELECTRONICS**
1236 Bathurst Street, Hobart, Tas. (348 232)
- AMATEUR'S PARADISE**
121 Nerang Street, Southport, Qld. (322 644)
- A & M ELECTRONICS**
78a High Street, Wodonga, Vic. (244 588)
- COASTAL ELECTRONICS**
43 Vulcan Street, Moruya, NSW. (742 545)
- COFFS HARBOUR ELECTRONICS**
Shop 3, Coffs Harb. Plaza, Park Ave, Coffs Harbour, (528 684)
- CRYSTAL TV RENTALS PTY LTD**
65 Crystal Street, Broken Hill, NSW. (8897)
- DECRO ELECTRIC**
Cnr Magellan St & Brunner Hwy, Ullamore, NSW. (214 137)
- ELEKTRON 2000**
181 Wheel Road, Newcastle, NSW. (262 644)
- ELECTROFIX**
133 Malop Street, Geelong, Vic. (57 827)
- GOODWIN ELECTRONICS**
123 Station Street, Blackheath, NSW. (870 379)
- HAWKESBURY ELECTRONIC CENTRE**
111 George Street, Windsor, NSW. (773 441)
- HUNTS ELECTRONICS**
18 Hill Street, Toowoomba, Qld. (328 944)
- MUTHESSON'S COMMUNICATIONS CENTRE**
5 Elizabeth Street, Mt Gambier, SA. (258 404)
- KELLER ELECTRONICS**
218 Adelaide Street, Maryborough, Qld. (214 559)
- KINGSTON ELECTRONICS & RECORDS**
Channel Court, Kingston, Tas. (258 902)
- KB ELECTRONICS & MARINE**
361 Main Terrace, Geraldton, WA. (212 178)
- KENT ELECTRONICS**
42 Stuart Highway, Darwin, NT. (814 748)
- LYREBIRD ELECTRONICS**
50 Barry Street, Nowra, NSW. (25 626)
- MELLOR ENTERPRISES**
Shop 2, Foreythe St, Whyalla, Norria, SA. (854 744)
- M&W ELECTRONICS**
48 McNamee Street, Orange, NSW. (828 491)
- NAMBOUR ELECTRONIC SHOP**
Shop 4, Lewen House, Ann St, Nambour, Qld. (411 604)
- ODYSSEY ELECTRONICS**
101 Main Street, Burnside, Vic. (825 282)
- POWERNSOUND**
15 Franklin Street, Traralgon, Vic. (743 838)
- P.J. O'BRIEN ELECTRONICS**
62 Waa Waa Street, Wagait, NSW. (243)
- PURELY ELECTRONICS**
16 East St, Rockhampton, Qld. (21 058)
- SOUND COMPONENTS**
70 Brisbane Street, Tamworth, NSW. (661 383)
- SUNNER ELECTRONICS**
95 Mitchell Street, Bendigo, Vic. (431 977)
- STEVENS ELECTRONICS**
42 Victoria Street, Mackay, Qld. (511 723)
- SILICON CHIP ELECTRONICS**
Suite 3, 98 Bridge Street, Murrumbidgee, NSW.
- TABLELAND RADIO SERVICE**
2 Jack Street, Atherton, Qld. (912 017)
- TOMORROWS ELECTRONICS & HI FI**
82 Wilham Street, Gosford, NSW. (247 248)
- TRILOGY WHOLESALE ELECTRONICS**
40 Princeps Hwy, Fairy Meadow, NSW. (831 219)
- TRIPAL TV**
245 Fulham Road, VIC. (781 421)
- WAGGA WHOLESALE ELECTRONICS**
87 Foreytha Street, Wagga, NSW. (659)
- YKING ELECTRONICS PTY LTD**
3108 Gold Coast Hwy, Seaford Paradise, Qld. (388 260)

FM HAS ARRIVED!!!

At last there's a decent selection of stations on the FM bands. Most people have a tuner capable of receiving FM, all you need is an FM antenna to pick them up!

This FM antenna won't break the bank and you'll be able to listen to the latest stations on the dial. Very light, easy to erect. Comes complete with saddle clamp. 3 elements.

VALUE! \$14.90

Cat L-4064

300 OHM FLAT RIBBON 75 OHM COAXIAL CABLE

300/75 ohm BALUN

Use outside or inside. Convert 300 ohm to 75 ohm and vice versa.

Cat L-4452 \$2.50

Outside quality ribbon, suits FM antenna above. Cat W-2070 15¢/metre (10¢/m 100m up)

For problem areas. Use with balun for 300 ohms. W-2080 40¢/metre (30¢/m 100m up)

NOT ENOUGH SIGNAL IN YOUR AREA FOR GOOD FM RECEPTION? CHEAT... USE A TV MASTHEAD AMPLIFIER!

If you can't quite get enough signal for reliable FM reception, why not try one of these TV masthead amplifiers. They work beautifully on FM signals - fit one of these and it could be the difference between pleasant listening and static!

This masthead amplifier is easy to fit (all instructions supplied) and is NOT a kit. A separate plug-pack mains adaptor is included in the price: all you have to do is hook it up and you're away. You'll be so amazed at the improvement to your FM signal, you'll see for your TV set well!

\$39.50

INCLUDES POWER SUPPLY! Cat L-4200

TV & FM ANTENNA ACCESSORIES

- MAST SECTION** \$4.95
Great for mounting antenna just above the roof line. Use with mount below. Galvanneal.
Cat L-4158
- WALL-MOUNT** \$4.95
Use with vertical mast sections. Complete with saddle clamp. 85cm long. Cat L-4153
Also available: 28cm version L-4152 @ \$3.90
- CHIMNEY MOUNT** \$8.95
Straps securely to chimney, double arm with single strap. Complete assembly. Cat L-4154
- WALL PLUG** 80¢
For a professional job. Socket fits to starting board, plug takes ribbon to tuner or TV. P-2010
- Easy to fit, secure.** Cat L-4512
- Also Available: The ideal model for screwing into wood. Cat L-4510 @ 30¢ each (22¢ on 10 up)

DICK SMITH TAPES - A BARGAIN!

Thousands of happy customers can't be wrong! They're the ones who've tried Dick Smith Cassette Tapes! Try some, you won't be disappointed!

Buy ten or more tapes and also receive a free cassette recording guide!



- CRO LN: C-3350 \$1.50 ea (\$1.00 10 up)
CRO LN: C-3352 \$2.00 ea (\$1.20 10 up)
CRO EDR: C-3354 \$2.75 ea (\$1.90 10 up)

SAVE OVER \$15 ON 63 KEY KEYBOARD

Building computer oriented projects? You'll need a keyboard sooner or later. This deluxe keyboard features individually switched keys with removable taps (comes in standard QWERTY format) with gold plated contacts. Full 63 set ASCII characters. Cat X-1180

Quality USA manufacture was \$55.00.. **\$39.50**

NEW!!!

Yes, you haven't seen this before! It's in the same package as the Discote and Super-switch, but this one's a motor speed controller. Simple to use, just plug into power point, plug drill, mixer, etc into well. Suitable for all universal type motors up to 1000 watts (more or less than this). Rugged and reliable, too.

ARLEC SPEED-RIGHT:
Cat X-1110 **\$25.80**

NUMERIC KEYPAD TO BUILD:

A huge number of interesting projects can be made with a numeric keypad - here's one that you assemble yourself and no zero error moral high quality moulding, all parts supplied. Value! Cat K-2010 **\$3.75**

AND FOR THOSE COLD, COLD WINTER MORNINGS:

This must be the ultimate in comfort: imagine the coldest seat in the house becoming a beautifully warm place to relax your caros away! Seriously, you owe it to yourself and your family: the soothing comfort of a Dick Smith warmed toilet seat. It's heavenly!

Cat X-2000 **\$32.50**



MUSIC HATH CHARMS TO SOOTHE THE SAVAGE BEAST...

How do you like to be woken: a jangling jangling alarm or a soothing tune from your favourite AM or FM station? This modern digital clock radio features huge, bright fluoro display, with auto brightness control at night. Snooze sensor lets you snooze another few minutes shut-eye if you want it! Power failure indicator just in case. We've sold thousands of these!

Cat A-4444 **\$45.00**



BOOKS: GOOD ENOUGH TO GO TO BED WITH!

- 1980 ARRL HOOK**
The Amateur's Bible. Everything you need to know to pass your amateur theory exam. Used the world over. Cat B-2218... **\$19.95**
- ELECT. VEHICLES.**
They've got to be the way the auto world is heading, find out about this exciting field NOW. Cat B-2400... **\$8.95**
- DICK'S FUN WAY INTO ELECTRONICS**
Now in its third printing, thousands still find Great Introduction to Electronics for beginners from B to B0. Cat B-2600... **\$4.95**
- REFERENCE DATA FOR RADIO ENG.**
If this data you want, this book has it. One of the world's most respected sources of information. Huge! Cat B-1104... **\$35.00**
- INTRO. TO PASCAL**
Highly recommended! Says Jim Ross: A look at one of the newer and popular computer languages. Worthwhile! Cat B-2335... **\$13.95**
- THE BASIC HOOK**
- REFERENCE DATA FOR RADIO ENGINEERS**

INDY IGNITION: fit it yourself and save!

Because you're technical, why not fit an 'indy' electronic ignition to your car. With the price of fuel these days, you don't want to waste a drop! Indy will help get the most from your car! **\$29.95**

Cat A-8530

DICKTRACER Mk II: best value radar detector around!

Radar detectors come and go: the Dicktracer is still the best value around! Why pay top prices for extra performance you don't really need? The Dicktracer will give you enough warning in most instances, so save money!

Cat A-8500 **\$39.50**

MEASURE IT

ECONOMY MULTIMETERS FROM DICK...

What value! Simple, rugged & reliable with 11 ranges. 1000V AC & DC. 0-100mA DC and 0-150µA. Get one for the glovebox and one for the basement! Cat Q-1010 **\$12.50**

BACK IN STOCK!

Our very popular 3-way torch is now back in stock! If you missed out last time, hurry in. Features large fluoro tube for bright even light, plus spot and flashing amber light for safety. Comes complete with handy carry strap. Cat X-1084 **\$14.95**

Dear Customers...

Quite often, products we advertise are completely sold out within a few days. Or problems may hold up delivery of promised goods so they are not in the stores when the advert appears. Please don't blame the store manager or staff: they are powerless to do anything about it! What we are trying to say is that if you are about to drive across town to pick up a particular line, give the store a ring first: just in case!

Dick Smith and Staff

Our biggest selling multimeter. It has 20 ranges plus dB scale, with sensitivity of 20,000 ohms per volt. Large, unrolled scale for zero parallel error. Takes banana plugs. Q-1024 **\$15.95**

LOOK MUM: NO WIRES! FM WIRELESS MICS: GO ANYWHERE!

FM Wireless microphone that clips to your tie or shirt, tiny transmitter also included. Great for PA, etc.

ELECTRET CONDENSER QUALITY

C-1073 **\$29.95**

C-1070 **\$27.50**

Dr this one: the transmitter is completely wireless: the microphone case. Receive them on any 88-108MHz FM tuner. Incredible!

BUYING BY MAIL?

It's so easy! Simply list the items you want with their catalogue numbers and post it off with your cheque to our mail order centre (address at right). Don't forget to include post & packing charges (apply to total order value as per table at right). Then watch your letterbox!

ORDER VALUE:
\$5 (1 item) to \$9.99 \$1.00
\$10.00 to \$24.99 \$2.00
\$25.00 to \$49.99 \$3.00
\$50.00 to \$99.99 \$4.00
\$100 or more \$5.50

P&P
\$1.00
\$2.00
\$3.00
\$4.00
\$5.50

NOTE: These charges apply to goods sent by post in Australia only. Large and bulky items cannot be sent by post. If you prefer, we will dispatch your order by Comet Road Freight to anywhere in Australia for only \$6.00 (that's below what it costs us! Large and bulky items are normally sent by Comet unless you specify differently (eg by rail or air - you pay freight on delivery!)

YES! WE HAVE THE COMPUTER MAGS:

Uka Kloibaud, Byta, Creative Computing, Micro 80, etc (plus many of the overseas & Australian electronics mags which have computer sections!)
AND THE NEW: AUSTRALIAN PERSONAL COMPUTER \$220
 Cat B-5053
 Packed with the latest in hardware, software, new computer developments, people, contests, clinics, etc etc. Great value for the micro enthusiast!



IT'S JUST ARRIVED! THE NEW DICK SMITH SYSTEM 80 COMPUTER...
 See pages 156 & 157 for more details!

NEW! DICK SMITH GUIDE TO SORCERER BASIC

Still in the dark? This book will turn on the lights!
 Written exclusively for Dick Smith by computer programmers, this book really gets down to basics (no pun intended)! Like how to turn on your computer.

If you're buying a computer - or even thinking about one - this book is for you. While written with the Sorcerer Computer in mind, it's applicable to any computer using BASIC language.

EXCLUSIVE TO DICK

16K UPGRADE KIT: SAVE \$30!

SUITABLE FOR ALL COMPUTERS!
 Incredible bargain from Dick. Save a massive \$30.50 on this pack of 8 4116 RAMs for upgrading your computer memory. YES! These are top quality 250nS types which are suitable for ALL microcomputers. We're buying so many of these that we get huge bulk buy discounts - & our savings are passed on to you. You reap the benefit. X-1188

Also available: Individual 250nS 4116 RAMs, also at a huge saving. Buy at Dick's low bulk prices and save! Cat X-910

WORD PROCESSOR KEYS FOR SORCERER

11 special red keytops with word processor legends imbedded on them, to replace the numeric keypad keys when using the Sorcerer as a word processor. Makes remembering the word processor functions so much easier!

COMPUTER MAINS FILTER

Don't lose that important program through mains spikes! This filter removes the granules that cause down the power cord which causes programs to crash! A necessity for serious computer users! Cat M-8950

HOBBYISTS...Did you know?

WE STOCK A WIDE RANGE OF PARTS TO HELP YOU COPE WITH A VARIETY OF CONSTRUCTION PROBLEMS.

- VERNIER DIAL High quality for precision tuning... H-3900 \$4.90
- PLANETARY MECHANISM 5:1 Ratio... H-3945 \$4.50
- DIAL DRIVE SPINDLE Has 6.3mm shaft... H-3954 \$1.50
- EXTENSION SHAFTS 6.3mm to 51mm... H-3950 \$1.30
- DIAL DRUM 51mm diam. around dial drum... H-3926 90c
- BRASS DIAL PULLEYS 9.5mm dia. 3mm... H-3922 19c
- DIAL CORD Spool approx. 25 metres... H-3934 \$2.30
- DIAL SPRINGS RGS Universal... H-3940 20c



SAVE OVER 20% ON FAMOUS TRIO HOBBYIST CRO!

Full 5MHz bandwidth, 10mV per division sensitivity and a sweep frequency range from 10Hz to 100kHz in four ranges make this the ideal CRO for hobbyist use.
 But be quick, because we've only got a few of these left - so ring your nearest store to check stocks. Cat. Q-1230

WAS \$279.50
 NOW \$199.00
 SAVE \$80.50
 BELOW COST! LIMITED STOCKS!
 MODEL CO-13030



SPEAK'N'SPELL IS BACK!

A lot of customers have missed out on the Speak & Spell talking game. A lot of people have been disappointed! Now they're back, but hurry, stocks are still not as good as we would like them to be! The Speak & Spell is a great aid to teaching your children letter construction and spelling. It uses a special microprocessor IC to synthesise speech electronically. No tape recording!

NOW THE SPEAK & SPELL IS EVEN BETTER!
 Three new play-in modules to extend the Speak & Spell's vocabulary and give it more interesting variations:
 Vowell Power (X-1308) \$17.95 each
 Super Stumper 1 (X-1301) \$17.95 each
 Super Stumper 2 (X-1302) \$17.95 each

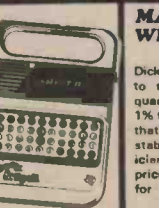

\$79.50
 Cat X-1300

MANUFACTURERS WHOLESALE USERS RETAILERS

Dick Smith Electronics is now able to supply OEM and wholesale quantities of professional quality 1% tolerance metal film resistors: that's right, 1% tolerance, high stability, low temperature coefficient metal film resistors. And the price is what you'd expect to pay for inferior carbon types: from

5c each
 In 100 up quantities! Want to know more? Give us a call on Sydney (02) 888 3200.

INTERCOM TELEPHONE PICKUP

Easily fits to your intercom, phone, etc by a suction pad. Inductive pickup allows sophisticated recording. Also compatible with 1 more lead and plug. Cat C-7300

\$1.50

ULTRASONICS

Need ultrasonic transducers for the magazine projects (see this month's ETI)? We've got em: matching ultrasonic transmitters and receivers for a huge range of projects. (They're fun to experiment with, too!)
 Transmitter: Cat L-7050
 Receiver: Cat L-7052

\$6.95 ea. \$99.00
 L-6108

DICK'S ZIPPYS ARE BEST

Dick Smith Zippy Boxes are unique: they're the ones with slotted sides allowing for easy mounting of PCB's, etc. Inset on them!

SIZE: Cat No: 1-9 Price
 150x90x50 H-2751 \$2.50 \$2.00
 190x113x60 H-2752 \$3.75 \$3.00
 130x68x41 H-2753 \$1.85 \$1.80
 85x44x28 H-2755 \$1.50 \$1.20

STEREO HEADPHONES

Comfortable fully padded phones at a true budget price. Adjustable headband and lightweight ensures hours of stereo listening pleasure.
 Completes with lead and plug.
 \$975
 C-4100

HI POWER HANDHELD!

Don't get caught in an emergency! This compact high power unit is ideal for hikers, fishermen, construction workers etc. Provides 6 channels (one fitted with marine emergency 27.800MHz). Maximum legal input is 5 watts - plenty of power for long distance communication! Comes complete with case, strap, earphone and instructions.

XTALS FOR ALL CHANNELS IN STOCK NOW!
 \$99.50
 Cat D-1120

HI SIDE XTALS FOR 27MHz TRANSCEIVERS

Eliminate 'image' interference on marine frequencies from CB radios & paging units etc. RECEIVE XTALS NEEDED ONLY:
 D-6120 27.24 27.895 ONLY
 D-6123 27.88 28.335 \$5.00 EACH!
 D-6124 27.89 28.345
 D-6125 27.90 28.335
 D-6126 27.91 28.385

NEW MARINE XTALS:
 Yes, we've got the crystals for the new 27MHz marine channels: receive/transmit pairs plug straight in!
 27.860 (Cat D-6088) \$5.00 pr.
 27.940 (Cat D-6084)
 27.95 (Cat D-6086)

HF & VHF ANTENNAS BY YAESU

How's this for a system? You buy the gutter mount & 2m stub and you're on the air on 2m. Then, as you want them, buy the HF band resonator/ whip and you're on HF! Incredible value from Yaesu!

- RSE-M-2 gutter MOUNT... \$32.50 D-4100
- RSE-2A 2m stub... \$10.95 D-4102
- RSL-145 8m/2m Antenna... \$23.95 D-4104
- RSL-3.6 80m Antenna... \$21.95 D-4110
- RSL-7 40m Antenna... \$20.95 D-4112
- RSL-14 20m Antenna... \$20.95 D-4114
- RSL-21 15m Antenna... \$20.95 D-4118
- RSL-28 10m Antenna... \$20.95 D-4116

WATCH IT! LCD WATCH KIT

Here's a liquid crystal display watch you can actually build yourself! Yes, incredible integrated circuit watch technology comes to the hobbyist. It's a great gift idea for anyone with a technical bent! function, complete with strap.
 \$17.50
 K-3457

SUPER CHRONO WATCH!

Compare our price! This incredible watch has the lot and it's under \$50.00! Alarm (all courses), stop watch with split & lap timing, day/date/month, seconds display. Almost forget it shows the time, too! Complete with attractive bracelet strap and presentation box.
 \$49.50
 Cat X-1044

SEE OUR HI FI SHOW: NOW ON AT YOUR NEAREST DICK SMITH STORE

DON'T WAIT FOR THE HI FI SHOWS: COME AND SEE DICK'S! ON 52 WEEKS OF EACH YEAR: NO ADMISSION CHARGE!

30W/CHANNEL TWIN VU METERS



Superb quality amplifier gives you performance at a budget price. Featuring twin VU meters and 30 watts per channel output, with complete facilities for the most discerning hi fi buff. Was selling for \$249.00 back in '78!
 \$199
 Cat A-1300

FM IS HERE! HOW ABOUT AN AM/FM TUNER?

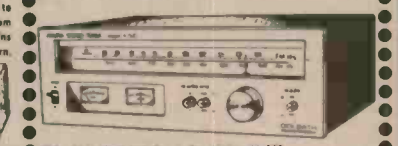

This tuner gives you the choice of the old AM stations or the brand new FM stations! Matches perfectly with the above amplifier to give you a system that's hard to beat. Large, illuminated meters give positive, accurate tuning indication. FM muting kills inter-station hash. Was selling for \$189.00 in 1979. New look!
 \$159
 Cat A-1500

AND A DOLBY DECK



Reviewed by Electronics Today magazine and rated as 'outstanding value for money...'. This model is the new, improved version with a damped cassette lid and auto stop. And, of course, Dolby™ noise reduction, giving you performance normally found only on decks costing much, much more! This superb deck makes the Dick Smith audio system the best deal in hi fi you're going to find!
 \$169
 Cat A-3500

TO FINISH YOUR SYSTEM PLAYMASTER SPEAKERS

Everyone - even you - can afford to have quality sound reproduction with superb Playmaster speakers. Why are they so economic? Because YOU supply the labour. And putting them together is child's play: just a couple of hours work, with full step-by-step instructions provided. You'll be proud to tell your friends: I built them myself!
 With Playmaster speaker kits from Dick Smith, you get the choice of three systems: 28 litre 3-way with 8 inch bass speaker, 53 litre 3-way with 10 inch bass speaker, and the superb 75 litre 3-way with a massive 12 inch bass speaker. Choose the system that best fits in with your requirements, your room size and your budget. There's something for everyone!

BUILD THEM YOURSELF AND SAVE!

8" system: \$150.50 pair
 10" system: \$248.00 pair
 12" system: \$298.00 pair
 (The 53 and 75 litre systems are also available in built up version for \$101 pair extra)

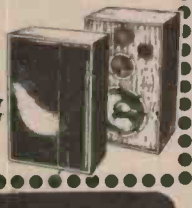

DICK SMITH ELECTRONICS

NSW 125 York Street, SYDNEY, Ph 290 3377
 147 Hume Highway, CHULLORA, Ph 642 8922
 162 Pacific Highway, GORE HILL, Ph 439 5311
 30 Grose Street, PARRAMATTA, Ph 683 1133
 613 Princes Highway, BLAKEHURST, Ph 546 7744
 263 Keira Street, WOLLONGONG, Ph 28 3800
 © 1980

VIC 399 Lonsdale Street, MELBOURNE, Ph 67 9834
 656 Bridge Road, RICHMOND, Ph 428 1614
 166 Logan Road, BURANDA, Ph 391 6233
 842 Gympie Road, CHERMSIDE, Ph 59 6255
 96 Gladstone Street, FYSHWICK, Ph 80 4944
 60 Wright Street, ADELAIDE, Ph 212 1962
 414 William Street, PERTH, Ph 328 6944

bankcard welcome here

SHOPS OPEN 9AM to 5.30PM (Saturday: 9am till 12 noon)
 BRISBANE: Half hour earlier.
 ANY TERMS OFFERED ARE TO APPROVED AGENTS ONLY
 RE-SELLERS OF DICK SMITH PRODUCTS IN MOST AREAS OF AUSTRALIA



MAIL ORDER CENTRE: PO Box 321, NORTH RYDE NSW 2113. Ph 888 3200. PACK & POST EXTRA.



An introduction to lasers

David Tilbrook

A fascinating rundown on these devices, the physics of their operation and the various types. This article prefaces a practical construction project which follows immediately.

THE FIRST LASER was built in 1960 by Theodore Maiman, a research scientist working for the Hughes Aircraft Corporation. His research paved the way for the development of a fantastic array of fascinating devices and very useful tools. Today, lasers are used in surveying, geophysical measurements, medical applications, electronic component manufacture, atomic fusion research, precise distance measurement and a host of other applications.

The word laser stands for *light amplification through stimulated emission of radiation*. Whilst this implies that lasers are amplifiers, they are generally configured as oscillators. The light radiation they produce is very 'pure' — occurring at a specific frequency (or frequencies) — and the beam is well collimated, that is, it diverges only a tiny amount rather than spreading as does the beam from a torch or spotlight.

The unique properties of laser light make the laser a prime candidate for wide application in technology and physical measurement. Many different types of laser have been developed but all employ the same basic principle of operation. All lasers have two fundamental components — a 'laser medium' and an energy source. The latter is used to excite the laser medium by a process called *pumping* — but I'll explain that further when I get into the physics be-

hind the laser. First, let's look at the various 'breeds'.

Solid-state lasers

In laser physics, solid-state does not refer to semiconductor lasers but to a breed having a laser medium that is formed by doping a crystalline or glass material with an impurity material which produces the laser action when pumped. The most common of these is the ruby laser.

This type of laser consists of a central, cylindrical synthetic ruby crystal made from aluminium oxide as a base material and doped with chromium as the impurity. The crystal is mounted with mirrors at each end and is surrounded by a xenon-filled flash tube (or tubes). These xenon tubes provide optical pumping — a requirement of all solid-state lasers. One of the mirrors is 100% reflective while the other is very slightly transmissive so that a small portion of the laser light produced within the crystal is tapped off.

When the xenon flash tube is fired, laser action occurs within the ruby and laser light travels back and forth down the crystal, exciting further laser action and generating an intense pulse of light that passes through the slightly transmissive mirror.

One of the early problems with solid-

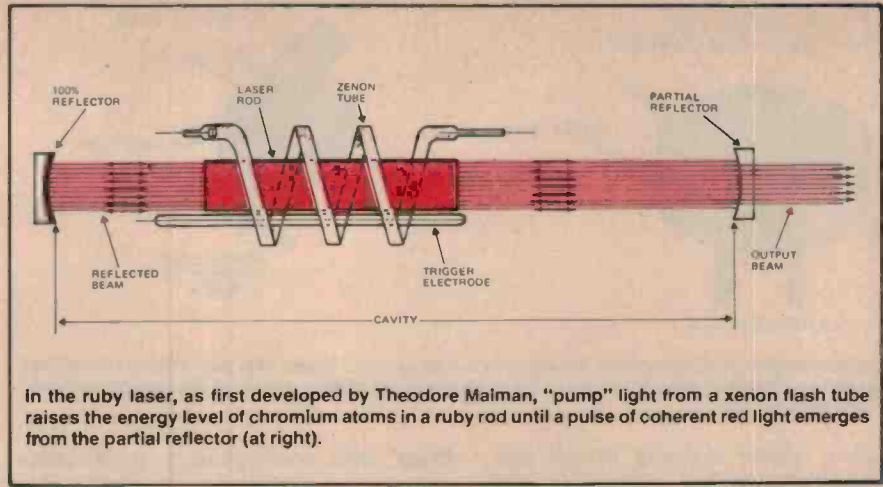

In the ruby laser, as first developed by Theodore Maiman, "pump" light from a xenon flash tube raises the energy level of chromium atoms in a ruby rod until a pulse of coherent red light emerges from the partial reflector (at right).

state lasers was to achieve a continuous output. In 1962 a solid-state laser was built at Bell Telephone Laboratories. It consisted of the base material calcium tungstate, impregnated with neodymium. More recently, solid-state lasers have been built with continuous outputs of over 1000 watts.

Much experimenting has been done to optimise the method of pumping solid-state lasers. One means developed by RCA in 1962 used a 300 mm hemispherical mirror to focus sunlight onto a laser crystal of calcium fluoride immersed in liquid helium. This laser produced a continuous output of 50 W, and

was the first laser to use sunlight to power the device directly.

Semiconductor lasers

Semiconductor lasers are relatives of the common light emitting diode, or LED. The most common of these is the gallium arsenide laser, and consists of a semiconductor diode junction formed by gallium arsenide doped with two different impurities to form the p and n materials. When forward bias is applied, a large number of electrons and holes move towards the junction where they recombine and generate laser light.

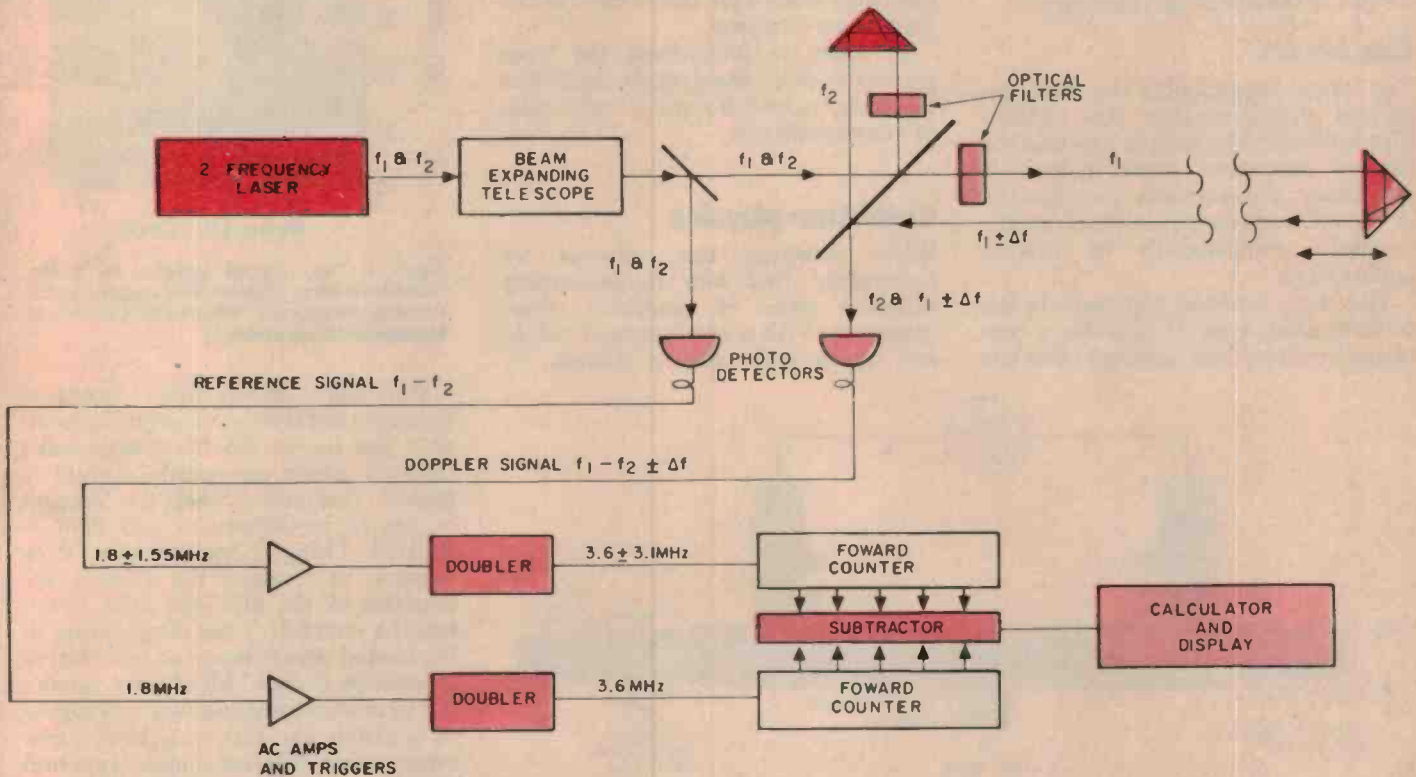

An important application of helium-neon lasers is in distance and velocity measurements using interferometric techniques. This block diagram shows a system devised by Hewlett-Packard for an instrument which has the ability to

measure length to an accuracy of 1 part in 10^6 over a distance of 60 metres (that's 1 mm in 1 km!).

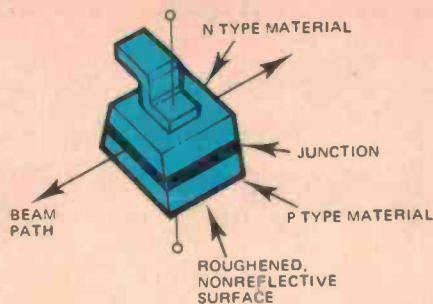
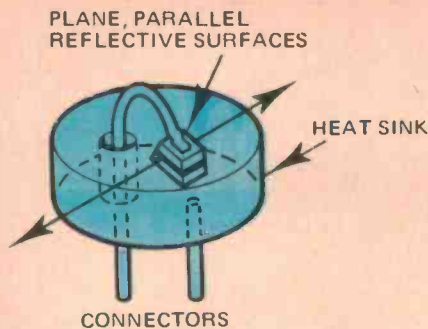

The semiconductor laser comprises a gallium arsenide junction doped with two different impurities. Construction of the junction is illustrated on the right, this is mounted on a heatsink header in the practical device, as shown at left.

Typical power outputs of gallium arsenide lasers are low, around one watt maximum, but efficiency is very high. Furthermore, they are easily modulated and for this reason should be of great importance in optical communications in the future.

Liquid lasers

Most liquid lasers use an organic dye as the laser medium and are optically pumped. Their big advantage over other types lies in the fact that the frequency of light generated can be varied. For this reason they are called **tunable lasers** and are being used experimentally to 'steer' chemical reactions.

Often the optical pumping of liquid dye lasers is done by other lasers, such as the nitrogen gas laser which has an output in the ultraviolet spectrum.

Gas lasers

Gas lasers are probably the most important single category. The **carbon dioxide laser** for example provides the highest continuous power outputs of any breed. Furthermore, its output is in the infra-red spectrum which makes it useful commercially for cutting applications.

The most common gas laser is the **helium-neon type**. It provides a continuous output of red laser light that has

been used commercially in distance measuring equipment as well as a general purpose "straight line". It is also used extensively in laboratories for diffraction, for general optical experiments and in interferometers. It has evolved into an inexpensive and reliable device and it was for this reason that we chose a HeNe laser tube for the project following this feature.

The HeNe laser consists of a mixture of the gases helium and neon, placed in a sealed tube at low pressure. Originally, HeNe lasers were excited by high frequency ac current (around 28 MHz) but these days high voltage dc is used. As in most other lasers, mirrors are used at each end of the tube, so that most of the light produced is trapped within the laser itself, maintaining a special condition needed for laser action called **population inversion**.

In order to understand the laser phenomenon in any greater depth it is necessary to look at some of the physics of atomic structure.

Quantum physics

When studying the universe we apparently find two fundamentally different types of quantities, those quantities with a continuum of values and those with only a discrete or

'quantised' number of values. For instance, the speed of an object can range from zero up to the speed of light and seems to consist of an infinite number of possibilities. Similarly, the set of all numbers is infinite. These are examples of continuous quantities, but not all quantities are continuous. A dice can only show 1, 2, 3, 4, 5 or 6 on its upper face and this is a quantised quantity.

Similarly, standing waves on a violin string, resonances of a quartz crystal, or harmonics of a square wave are all quantised — they occur only at fixed frequencies.

Quantum physics is based on the discovery that a large number of quantities involved with molecular, atomic and sub-atomic physics are quantised. Many of these quantities were assumed to be continuous in "classical physics" and it has only been through the recognition of their quantised nature that modern physics has been able to achieve a reasonably workable model of atomic structure.

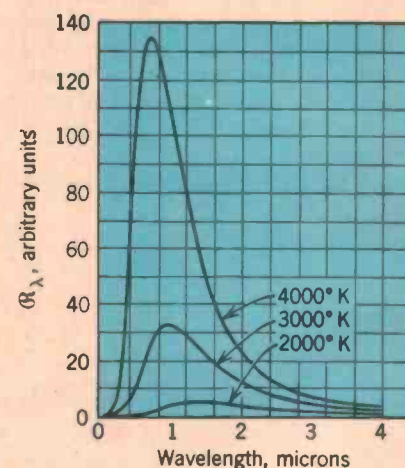
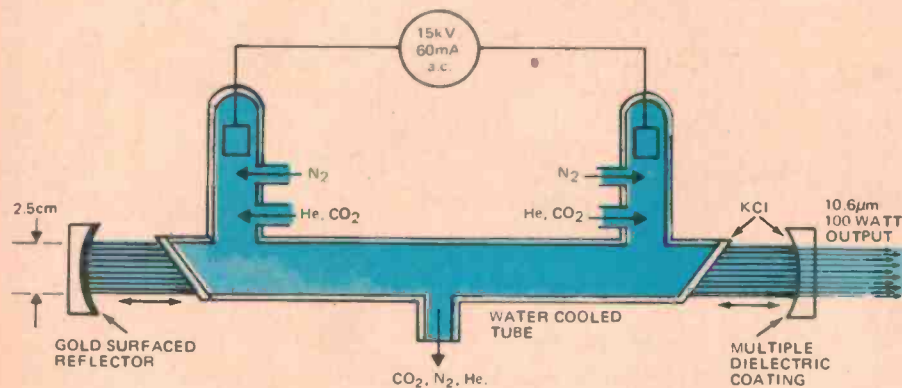

Figure 1. The spectral radiance for cavity radiation at three different temperatures. (After Halliday and Resnick, "Physics for Students of Science and Engineering".)

Most light sources today consist of either a solid (like a tungsten filament) or a gas (as in the fluorescent tube) through which an electric current is passed. This current heats the filament or gas to incandescence and light is emitted. Using a spectrometer, it is possible to measure the relative intensities of the different light wavelengths emitted. If the temperature of the heated objects is varied the relative intensities change. All of these results can be plotted to make a family of curves on a graph like Figure 1. Each curve represents a different temperature and the shape of these curves is related to the particular material that is being heated.



Some gas lasers can generate enormous output powers. This diagram illustrates the general construction of a carbon dioxide laser.

The number of variables in the case of a heated solid makes any mathematical analysis unnecessarily complicated so scientists sought an idealised heated solid. They called this a *cavity radiator*, and the light emitted proved to be largely independent of the material used to make the cavity radiator. Furthermore, the light emitted was found to vary in a fairly simple way as the temperature was varied.

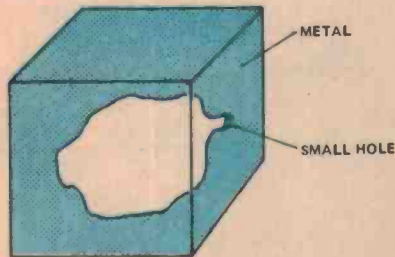

Figure 2. Representation of a cavity radiator. At a particular temperature, light emitted from the hole is brighter than that radiated by the body of the material.

Practical cavity radiators simply consist of a hollow container with a small hole drilled in one side (see Figure 2). If the cavity radiator is heated, more light is emitted from the hole than from the outside walls. The light emitted from the hole is called *cavity radiation* (sometimes called *black body radiation*) and was of intense interest in the later part of the nineteenth century.

The explanation of the related intensities of the various wavelengths emitted in cavity radiation was one of the outstanding problems for classical physics. Several attempts had been made but all of these had only fitted the experimental data partially.

In 1900, a German physicist, Max Planck, derived a formula that fitted cavity radiation perfectly. He was forced to the conclusion that the atoms inside the cavity radiator were acting like tiny electro-magnetic oscillators. They could emit light into the cavity and absorb light energy from it, but only at certain characteristic frequencies.

Planck was forced to make the radical assumption that an oscillator cannot have a continuum of different energies. These energies were quantised so that

the only possible values were given by the equation.

$$E = nh\nu$$

where 'E' is the energy
'n' is an integral number, i.e. 1, 2, 3, 4, 5, etc.

'h' is a constant (now called Planck's constant)

and 'ν' is the frequency of the oscillator.

The oscillators could not radiate light continuously but only in jumps, or 'quanta', and only when the atom jumped from a high energy state to a lower one. If the atom jumped just one energy state then 'n' in the above equation becomes equal to one, and the equation becomes:

$$E = h\nu$$

This is known as *Planck's equation* and is one of the more important equations in modern physics.

This was the start of quantum physics. A physical event could only be explained by assuming that atoms radiate integral amounts of energy.

Planck's ideas were reinforced several years later by Albert Einstein who applied the concepts of quantisation to another area of physics that was to revolutionise our understanding of the nature of light. Up to this time, light was thought of as an electromagnetic wave. Even though Planck had quantised the energies of atomic oscillators in the cavity walls, he still regarded the radiation within the cavity as a wave. This wave picture of light had been enormously successful in explaining light phenomena up to that time, but Einstein was to point out its inadequacy in some circumstances.

The Photo-electric Effect

This effect was another experiment which had not been satisfactorily explained in terms of classical physics. Figure 3 shows a circuit diagram for the apparatus used in the photo-electric experiment. If light is shone onto a clean metal surface some electrons are liberated from the metal. If the metal is placed in an evacuated glass cylinder,

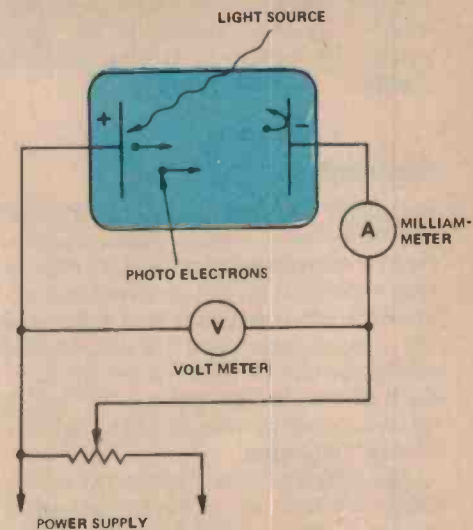

Figure 3. Circuit diagram of the apparatus used in the photo-electric experiment.

the liberated electrons (called *photo-electrons*) can be made to constitute a current flow, which will register on the meter. If the other electrode is now made negative with respect to the first, by connecting the two to a power supply, the negative electrode will tend to repel the photo-electrons and decrease current flow. When the voltage is great enough, the photo-electrons can be brought to a stop. If the voltage is increased even further the photo-electrons are turned back toward the anode. The voltage applied to the plates is called the retarding potential and can be used to measure the energy of the photo-electrons.

When the experiment is carried out it is found that photo-electrons are emitted almost instantaneously when the light is turned on. If the wavelength of the incident light and the retarding potential are kept constant, then the current flowing is found to be proportional to the intensity of the light beam. Furthermore, for any particular metal the energy of the photo-electrons is found to be independent of light intensity, but varies with the frequency of the light.

These results were difficult, if not impossible, to explain on the basis of the wave theory of light. Since light was thought of as a continuous wave, the energy absorbed on the photo-electric surface should have been proportional to the light intensity. If the intensity was decreased enough it should have taken a certain amount of time for sufficient energy to be absorbed by the electrons before any emission could start. So the wave theory of light could not explain why photo-electric emission starts instantaneously, even if the intensity of light is decreased.

Similarly, the fact that the energy of the photo-electrons varies with the

ELECTRIC FIELD

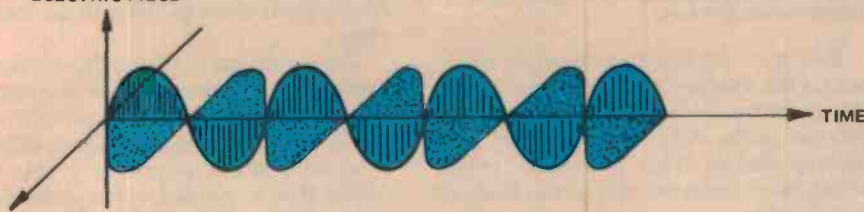

MAGNETIC FIELD

According to the electromagnetic wave theory, light is seen as a continuous wave of oscillating electric and magnetic fields.

frequency of the light and is in no way affected by the intensity of the light, cannot be explained by the classical theory.

A quantum approach

In 1905, Albert Einstein applied quantum theory to the problem of photo-electric emission and obtained a theory that explained all the observed characteristics. He postulated that light was not a continuous wave but consisted of small quanta of light called *photons*. Each photon has an energy, 'E', that is related to the wavelength of the light by Planck's equation.

Any single photon can interact with a single electron so the energy imparted to this electron will depend only on the energy of the photon. i.e: its frequency. Increasing the intensity of the light beam increases the number of photons and will only increase the number of photo-electrons emitted. Emission will start instantaneously, as all the energy needed for a photo-electron to escape the surface of the metal is contained in any single photon.

The photo-electric effect occurs because the energy imparted to the photo-electron by the photon has exceeded that needed by the electron to break bonds that normally bind it to the metal surface; but it is not the only example of electron-photon interactions. In the photo-electronic effect the electron struck is a bound electron, inside an atom. The photon disappears and the electron is dislodged. However if the electron is a free electron it will recoil and cause the generation of a second photon of lower energy. This is called *the Compton effect*.

Another set of electron-photon interactions are called *pair production* and *pair annihilation*. If a photon is given enough energy it can convert into an electron and a *positron* when passing another heavy particle. A positron is an antimatter electron. It has all the properties of a normal electron except that it has a positive instead of a negative charge. This process is called *pair production*. *Pair annihilation* occurs when a positron and an electron interact. Both are annihilated and two photons are generated.

All these electron-photon interactions are manifestations of a single process, the exchange of photons, called *virtual photons*, between charged particles. Indeed, it is this effect that gives rise to the attractive and repulsive forces between charged objects. The study of photo-electron interactions is called quantum electrodynamics and is one of the major fields of research in modern physics.

Spontaneous and stimulated emission

When a photon interacts with a bound electron it may not have sufficient energy to overcome the binding forces. In this case the photon is absorbed by the electron, as would happen in the photo-electric effect, but the electron is not liberated from the atom. Instead, it jumps up to a higher energy level or orbit. Quantum physics has determined that electrons cannot have a continuum of different energy levels, only energy levels that are integral multiples of a fixed amount. When the electrons of an atom are in their minimum energy states the atom is said to be in its ground state. If an atom is in its ground state, say with energy E_1 , it can be forced to a higher energy level, say E_2 , by absorption of a photon. If the photons absorbed have energy $E = h\nu$ then the increase in electron energy will be exactly $h\nu$, i.e: $E_2 - E_1 = h\nu$.

After a certain amount of time, approximately 10^{-8} seconds, the electron will drop back down to its lower energy level, automatically emitting a photon, again with energy $h\nu$.

The excited atom was initially at rest and has no preferred direction in space. As a result the photon can be radiated in any direction while the atom recoils in the opposite direction. This process is called *spontaneous emission*. If a group of atoms are excited in this way they will generate photons in all directions randomly, as excited atoms return to their ground states; see Figure 4.

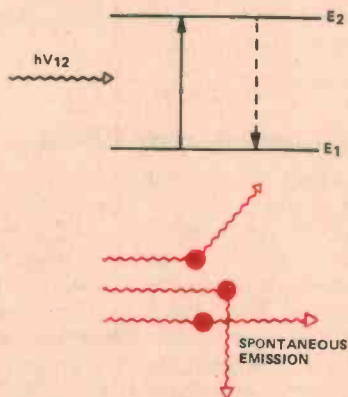

Figure 4. Energy level diagram for the process of spontaneous emission.

If an electron at energy level E_2 interacts with another photon of energy $h\nu$, the electron is forced to return to its ground state with the emission of a second photon. This process is called *stimulated emission* and is the basis of laser action.

The most important point about stimulated emission is that both photons leave the atom with the same phase and direction as the incoming

photon, see Figure 5. The two photons are said to be *coherent*. It is essential that the two photons be coherent. If they were even slightly out of phase cancellation would occur between them, violating the law of conservation of energy. If a group of atoms is excited in this way the initial beam of photons will be augmented by additional photons, so the beam is amplified.

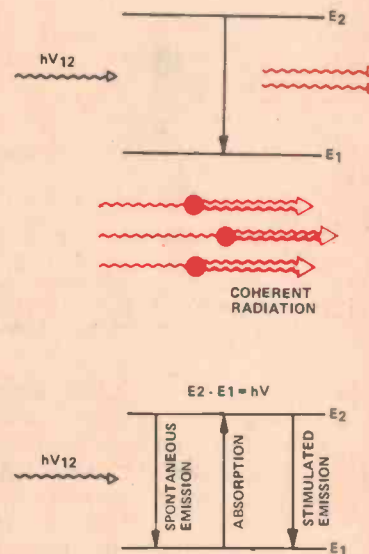

Figure 5. Energy level diagram for the process of stimulated emission.

Population inversion

If a material is in thermal equilibrium at a temperature T , the distribution of atoms in a lower energy state to those in a higher energy state is normally accented heavily toward the lower energy state. If N_1 is the density of atoms in the lower state and N_2 the density of atoms in the more excited state, then the ratio of N_2 to N_1 is given by the equation

$$\frac{N_2}{N_1} = \exp(-h\nu/kT)$$

where T is the temperature of the material in Kelvin and k is Boltzmann's constant. If the material is at 10^3 K, then:

$$\frac{N_2}{N_1} = 10^{-5} !$$

So, only one atom in 10^5 is in the excited state.

The condition in which the number of excited atoms exceeds the number of atoms at the ground state is a non-equilibrium condition called *population inversion*, but it is precisely this condition that is needed to maintain laser action. If the vast majority of atoms are in the non-excited state, only spontaneous absorption followed by spontaneous emission, can occur. If, on the other hand, a population inversion can be

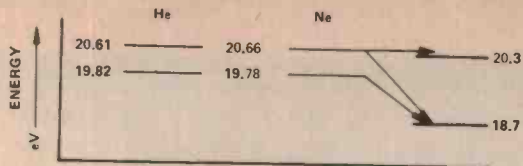

Figure 6. Energy level diagram for the helium-neon laser.

maintained then stimulated emission will occur leading to photon multiplication. *Pumping* is simply the process used to maintain the population inversion.

A closer look at the HeNe laser

In the helium-neon laser, population inversion is maintained by generating a glow discharge in a low pressure mixture of helium and neon gases. Figure 6 is a simplified energy diagram for a HeNe laser.

The helium energy levels at 20.61 and 19.82 electron volts (eV) are called *metastable levels*. Once at a metastable energy level an atom cannot move to a lower state by the emission of a photon. It can only be de-excited by some other process. A transition from a metastable level to a lower level is called a *forbidden transition* and the fact that these transitions are not permitted is predicted by quantum theory. So, once an atom has been excited to one of these energy levels it will stay at that energy level for a relatively long period of time, approximately 10^{-3} seconds, hence large metastable populations can exist.

Two of the energy levels of neon closely coincide with those of the metastable levels of helium, these are at

20.66 and 19.78 eV. An energy transfer will occur between helium metastable atoms and neon ground state atoms, exciting neon atoms to the 20.66 and 19.78 eV energy levels. As a result, very large populations of excited neon atoms are produced. The population of neon atoms in these energy levels vastly exceeds that achievable from direct excitation by the electric discharge. Below these two highly populated energy levels there are two lower neon levels that are only populated by direct excitation and consequently have much smaller populations, and this is a population inversion.

Whenever an excited neon atom jumps to one of these lower energy levels a photon is emitted, and the frequency of the photon will depend on the difference in energy between the two levels. The three possible transitions are shown in Figure 6 and are:

20.66 eV to 20.3 eV
(3391 nm in the far infrared)

19.78 eV to 18.7 eV
(1152 nm in the infrared)

20.66 eV to 18.7 eV
(633 nm in the visible spectrum)

Figure 7 shows the basic elements of a helium neon laser. The tube contains roughly 90% helium and 10% neon gas at a pressure of one to three Torr.

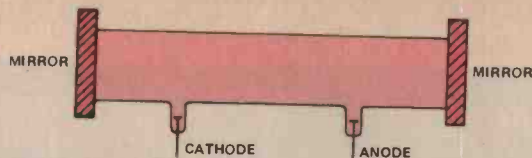
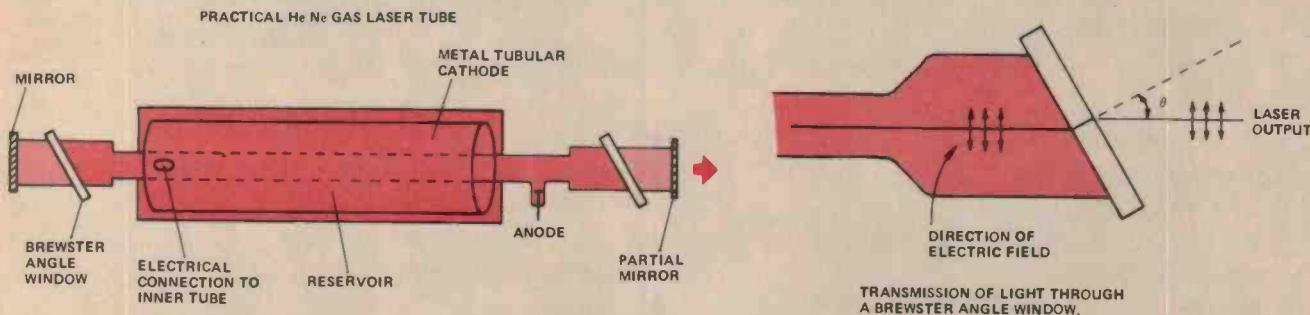

Figure 7. Basic construction of a gas laser. A glass cylinder, containing a gas at a low pressure, has two mirrors placed at either end — one is totally reflective, the other slightly transmissive. When current is passed through the gas, population inversions of the atoms occur and laser action results.

When a current is passed through the tube a variety of collision processes take place. Among these are the collisions that lead to population inversion. As neon and helium atoms jump between higher and lower energy levels, photons are emitted randomly in all directions. However, since there are large populations of neon atoms at the 20.66 and 19.78 eV energy levels, any photon with one of the above three wavelengths has a high probability of causing stimulated emission of a second, identical, photon. Those photons travelling parallel to the axis of tube are reflected back and forth between the two end mirrors, and each pass through the tube gives rise to further identical photons by the process of stimulated emission. A limit is finally reached when the rate of production of neon atoms at the higher energy levels equals the rate of stimulated emission.

If one of the mirrors is made a few percent transparent, (i.e. slightly transmissive) a portion of the coherent radiation can escape from the tube and this is the laser output. The word laser stands for *light amplification through stimulated emission of radiation*, but the helium neon laser is not really an amplifier, it's more of an oscillator generating coherent electromagnetic radiation at three distinct frequencies. ●

A practical HeNe laser tube



A practical HeNe laser tube is shown in the diagram. It features a number of improvements over the basic system. The cathode consists of a large metal cylinder instead of a single wire electrode. This decreases the current density around the cathode and increases the rate of excitation of helium atoms to metastable states. Plane mirrors are very difficult to align accurately and a common system used to overcome this difficulty is the use of slightly concave mirrors, separated

by their radius of curvature.

Another configuration employed, and the one used in the tube for the project, is referred to as a "hemispherical" configuration. This uses a totally reflective, flat-backed mirror and a concave front mirror with a radius of curvature of around 1.4 times the tube length. The mirrors used are designed specifically for laser use and constitute a significant portion of the cost of the device. The mirrors are used as bandpass filters to optimise the

particular output required. The tube specified for the project uses a system like this to enhance tube operation at the 633 nm emission wavelength and to suppress operation at the other two dominant wavelengths. The front mirror is approximately 0.9% transmissive at 633 nm but considerably less transmissive at the two longer wavelengths. The rear mirror is almost totally reflective at 633 nm, but more transmissive at longer wavelengths. HeNe tubes often employ

a "Brewster angle polarizing filter". This is a glass disc placed in the light beam at an angle determined by its refractive index. Light of the correct polarization is transmitted through the filter. All other polarizations suffer high reflections and are attenuated. This does not cause any loss in the light output of the laser since any one polarization will be amplified by stimulated emission to produce a full output intensity coherent laser beam with a single polarization.



All systems go!

VECTOR GRAPHIC SYSTEM B

VECTOR GRAPHIC is a leading American micro-computer manufacturer who has been producing reliable, quality products since 1976.

VECTOR GRAPHIC SYSTEM B offers enterprising companies the right hardware for the emerging micro-computer business market. More economical than "big" systems, yet offering wide ranging ability in their market sphere.

Whether you're looking for Hardware for your software products or you want a complete end user turn key system, Vector Graphic has the solution to your needs.

Fully supported in both Software and Hardware in Australia.

- 48K or 64K RAM
- 630K on dual floppy disk drives
- 24 x 80 video terminal
- Time-share multi-user — additional video terminals
- Microstor — extra on-line disk storage
- Vector Graphic DM printer
- Qume letter quality printer
- BASIC, Z80 assembler, debugger, editor
- The Industry standard — CP/M
- Optional languages include COBOL, FORTRAN, PASCAL, C etc.
- Accounts payable
- Accounts receivable
- General Ledger
- Inventory Management
- Word Processing

AUSTRALIAN DISTRIBUTOR

DEALER ENQUIRIES INVITED

AJ. & JW. DICKER

24 Woodfield Boulevard, Caringbah, NSW 2229. Phone (02) 524-5639. Telex 70182.

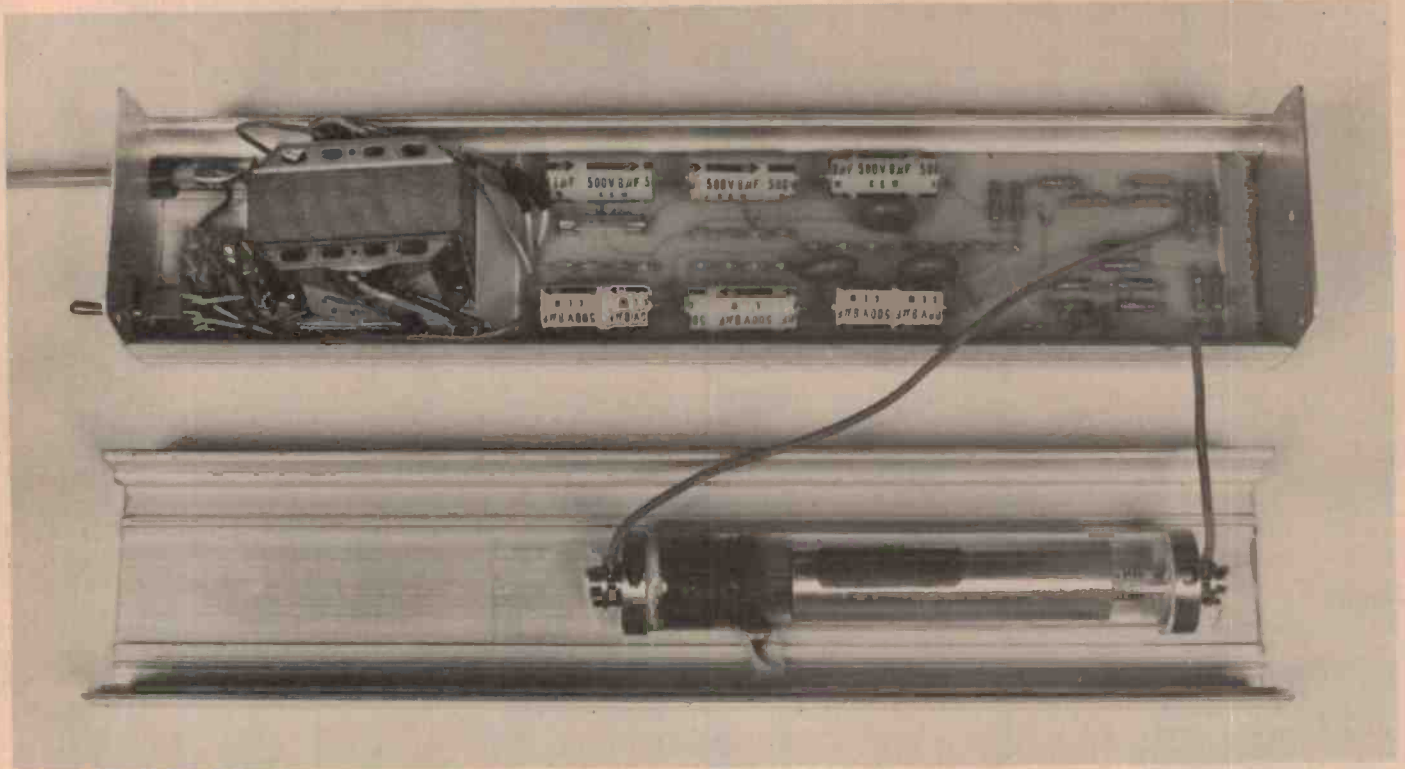

Build a helium-neon laser

David Tilbrook

This project has been designed around an Australian designed and manufactured laser tube having a 1 mW output at a wavelength of 633 nm in the red section of the visible spectrum.

THIS PROJECT, rather than serving just as a laser "demonstration" unit, has been designed with a view to using it as the primary component of a number of devices and experiments which we shall be describing in later issues of the magazine.

When we first considered doing a laser as a construction project we approached a Queensland company, Laser Electronics, for details about laser tubes presently available in Australia. Fortunately, at that time they had just embarked on the design of a helium-neon laser tube which they planned to manufacture here. They have subsequently achieved their aim and we decided to use their laser tube in our project. Laser Electronics has been of great assistance in supplying design ideas and information on lasers in general. The particular tube used in our

unit (as pictured) is a prototype only and some slight physical variations could be expected in the final production model. The laser tube used on the front cover is an imported model supplied by Laser Electronics for our experimentation.

To assist constructors, Laser Electronics have made arrangements to supply complete kits for this project, including metalwork. Their address appears at the end of this article.

Design factors

There are a number of design challenges involved in getting a helium-neon laser to operate correctly. The circuitry is really all power supply! — but it is called on to perform a number of tasks. Firstly, helium-neon laser tubes require a high voltage pulse of around 8 - 10 kV to start ionisation.

Thus, the power supply must provide a 'kick start' for the tube. Secondly, the tube requires a certain voltage supply to maintain operation once 'fired' and the current through it must be maintained at a constant value, both depending on the characteristics of the particular tube design. However, all gas-discharge tubes (and the helium-neon laser falls into this category) exhibit a *negative resistance characteristic* during operation. That is, an *increase* in the voltage applied between the anode and cathode will result in a *decrease* in current through the tube. Under certain circumstances, this property will cause the tube and surrounding circuitry to become an oscillator — an undesirable mode of operation, to say the least! To avoid this, the negative resistance of the tube is "swamped" with a large value series resistance. The value of this ►

Project 565

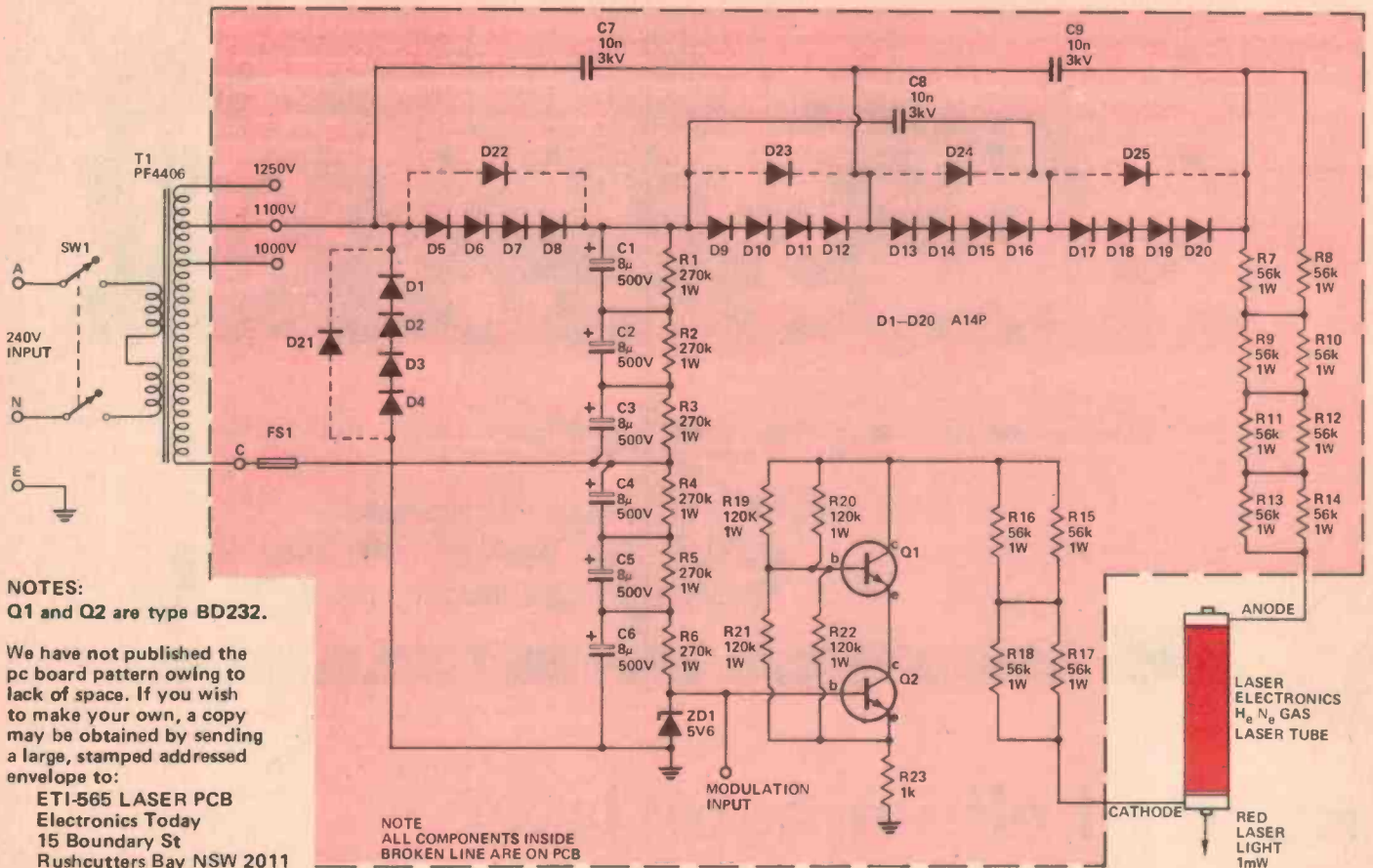

NOTES:
Q1 and Q2 are type BD232.

We have not published the pc board pattern owing to lack of space. If you wish to make your own, a copy may be obtained by sending a large, stamped addressed envelope to:

ETI-565 LASER PCB
Electronics Today
15 Boundary St
Rushcutters Bay NSW 2011

NOTE
ALL COMPONENTS INSIDE
BROKEN LINE ARE ON PCB

swamping resistance is determined from the particular tube's characteristics and, for this reason, laser tubes are supplied with details of the required minimum series anode resistance and our circuit adheres to the requirements of the tube supplied by Laser Electronics.

We have designed the power supply for this tube to deliver a constant current of 5 mA, which marginally decreases the output intensity of the laser beam, but ensures maximum tube life. At this current, the tube will maintain a voltage of around 1550 volts between anode and cathode. *A word of warning* — don't attempt to measure the voltage directly across the tube as the inherent capacitance of most high voltage probes will cause the laser action to stop, the power supply circuit will immediately ramp the tube voltage up in an attempt to re-start the tube and you'll have a 'relaxation oscillator' instead of a laser!

Physical construction of high voltage power supplies presents some unique problems. An obvious one is providing sufficient clearance between individual components having a high potential difference and between components at high voltages and conducting bodies nearby — the chassis, or whatever.

Components have to be chosen with care. Adequate voltage ratings have to be specified for diodes and capacitors, as well as allowing an adequate safety margin.

Resistors used in voltage divider strings etc need to be of a size and type such that their maximum working voltage is adequate for the job. Resistor construction needs to be considered

HOW IT WORKS — ETI 565

The circuit can be divided into five compartments: power transformer, voltage doubler rectifier, 'kick start' voltage multiplier, laser tube plus series resistance and constant current sink.

The power transformer has a secondary voltage of 1250 V, with taps at 1100 and 1000 volts. The 1100 volt tapping is used in this instance, the other two are provided to allow the power supply to operate different laser tubes (although we don't plan to do so).

The 1100 V transformer output drives a voltage doubler rectifier, involving diodes D1 to D8 and capacitors C1 to C6. The resistors across the latter capacitors serve as 'bleeders' to discharge the capacitors when the supply is turned off. They also serve to equalise the voltages across each capacitor. The output of the voltage doubler is around 2800 volts (cathode of D8). As two single diodes for this rectifier would be required to have a peak inverse voltage rating of at least 3 kV, we have used four diodes in series, each rated at 1 kV PIV. If suitable high voltage diodes can be found, you can substitute these as shown dotted on the circuit diagram.

The output of the voltage doubler drives the input of a three stage voltage multiplier involving diodes D9 to D20 and three 10n capacitors,

C7, C8 and C9. This provides the kick start for the tube, delivering somewhat in excess of 8 kV, but at a very low current (the impedance of the 10n capacitors at 50 Hz is rather high). Very quickly after turn on, the voltage at the cathode of D20 will rise to around 8 kV and the laser tube will 'fire'. When it does, the current drawn will be too great for the impedance of the voltage multiplier starting circuit to supply and the tube will be driven directly by the voltage doubler via the D9 — D20 diode string. The tube swamping resistance is provided by the series-parallel string of 1 W resistors, R7 to R18. The voltage at the anode of the laser tube is about 2240 volts during normal operation.

The constant current sink is formed by Q1 and Q2, plus associated components. It serves to regulate the current through the laser to the required 5 mA. The base of Q2 is clamped at 5.6 volts by the zener diode. This results in a voltage at the emitter of Q2 of 5 V, setting the current through the 1k resistor, R23, at 5 mA. Although the voltage across the two transistors will vary, the collector currents, and thus the current through the laser tube, will remain fixed at 5 mA. The worst-case power dissipation in these transistors is approximately 1.5 watts.

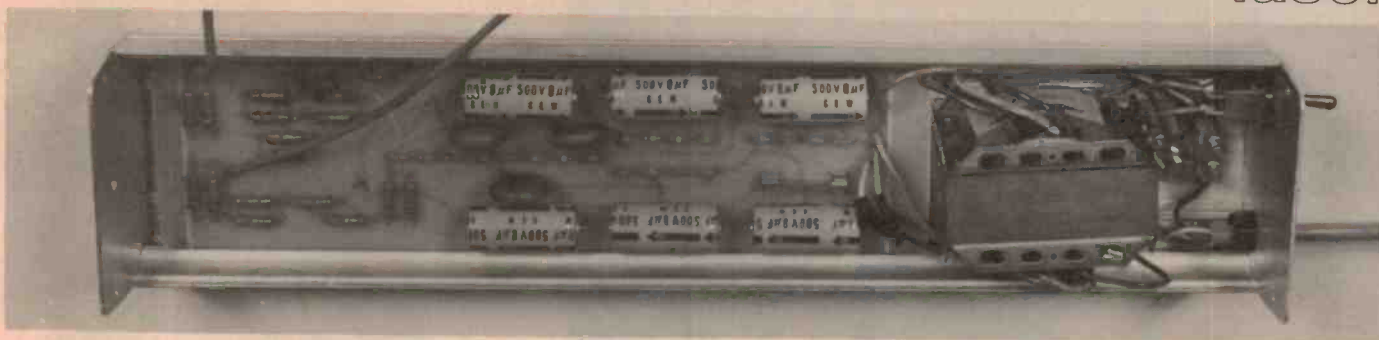

Interior view of the electronics for the laser, mounted in the case bottom. This case will be supplied by Laser Electronics with their kit for this unit.

here, too. Carbon composition resistors typically have a maximum working voltage rating of 700 V for half-watt types, 1000 V for 1 W types. Carbon film resistors, on the other hand, are only rated at 350 V for half-watt and 500 V for 1 W types. The project's power supply has been designed such that the individual resistors in the voltage divider strings have no more than 200 V across them. Although carbon composition types have been specified — as they will be the most reliable in these circumstances — carbon film types may be safely substituted.

Construction

You will notice construction is not difficult but care must be taken to ensure that adequate insulation exists between the tube, all high voltage points and the chassis. Make certain the chassis is correctly earthed to both the printed circuit board and the ground wire of the three-core mains cable, as shown in the wiring diagram.

Construction should commence with assembly of the components on the printed circuit board. Note that all the

diodes point in the same direction, with their *anodes* towards the *output* end of the pc board. Make sure the six electrolytic capacitors are inserted correctly.

Drill the bottom piece of the chassis to take a mains cable terminal block. Solder the wires from the power transformer onto the pc board. Solder two lengths of well insulated wire to the output of the pc board. These will go to the laser tube and should be kept as short as possible. The remaining pad on the board is the modulation input. This is not used in this project but will be used in subsequent articles. At this stage it is recommended that a pc board pin be soldered to this pad so that the board will not have to be removed from the chassis at a later date. The prototype laser has been constructed in a length of aluminium extrusion that we obtained from Laser Electronics. If you are not using this chassis, ensure that the chassis used is metal and well earthed. If you have purchased the kit from Laser Electronics, slide the pc board into the extrusion and mount the transformer and terminal block. Mount the power switch and finish the 240 V

wiring. Ensure that the connection between the chassis and the ground wire is secure, use a solder lug and lock washer, loop the ground wire through the lug and then solder.

Note that you can replace the strings of A14P diodes with single high-PIV rating types, as indicated by the diodes dotted in on the circuit diagram. They should have a PIV rating of at least 3 kV and have a low junction capacitance (under 150 pF). In general, diodes rated at 5 kV PIV and less than 1 A forward current will be OK. If you elect to replace the diode strings with single diodes, they should be connected from the anode pad of the first diode to the cathode pad of the fourth diode in each string.

If you have difficulty obtaining the BD232 transistors, you can substitute some other type providing they have a collector-emitter voltage rating of 300 V or more and can dissipate up to 1.5 W.

The laser tube has metal ends used as the anode and cathode connections to the tube, so it must be totally insulated from the case. In the prototype unit,

A close-up of the laser tube mounted in the case top (see text).

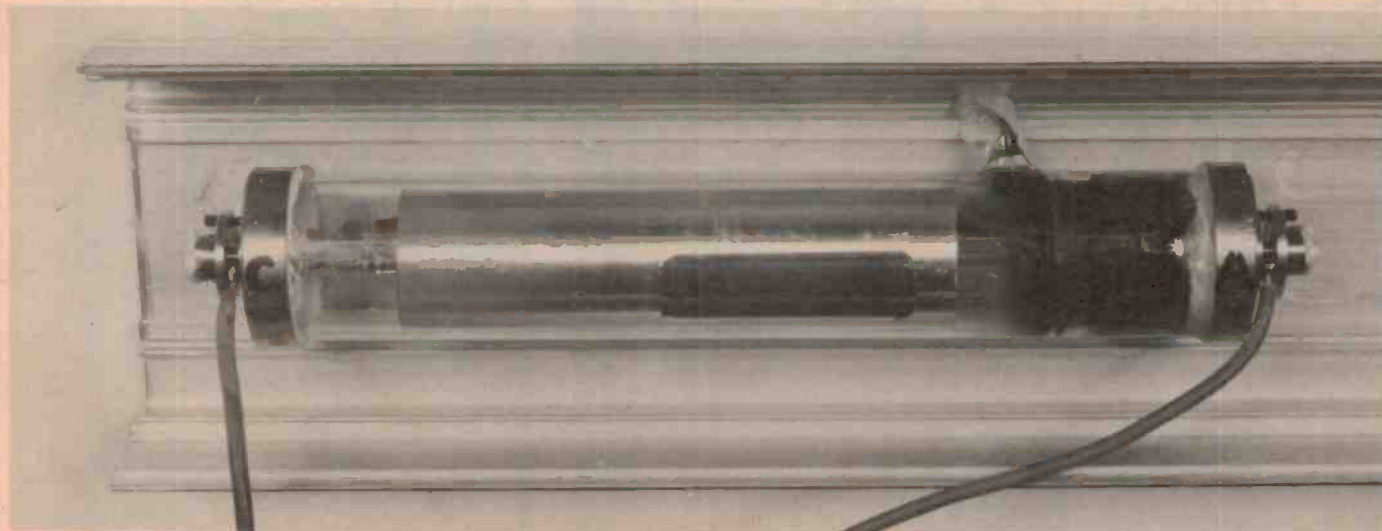

Project 565

perspex was slid into the extrusion and glued into place with Silastic. The laser tube was then glued to the perspex, again with Silastic. This provides a cheap and highly effective mounting method. Drill a small hole in the end plate through which the laser beam will pass. Connect the wires from the pc board to the laser tube, making absolutely certain they are the correct way around. Finally, push the two halves of the extrusion together and screw in the end plates.

Powering up

Do not apply power to the laser without the cabinet assembled. If the laser doesn't operate correctly when turned on, turn it OFF before opening the chassis and allow sufficient time for any high voltage that may be present on the anode, to discharge before reopening the chassis. This will take several minutes.

The output from this laser is rated at 1 mW and while this is not regarded as a dangerous level caution

The assembled unit, viewed from the rear.

should **ALWAYS** be taken when operating any laser. **DO NOT** look directly down the beam. Be careful also of reflections that may be able to enter the eye indirectly.

A complete kit of parts will be available from:

Laser Electronics Pty Ltd
PO Box 359
Southport QLD
(075) 32-1699

DON'T attempt to do any measurement on the power supply without a proper high voltage probe. The voltages present will break through the insulation on most standard multimeter cables.

The power supply is quite capable of delivering 2000 V at 20 mA and this could be LETHAL if touched.

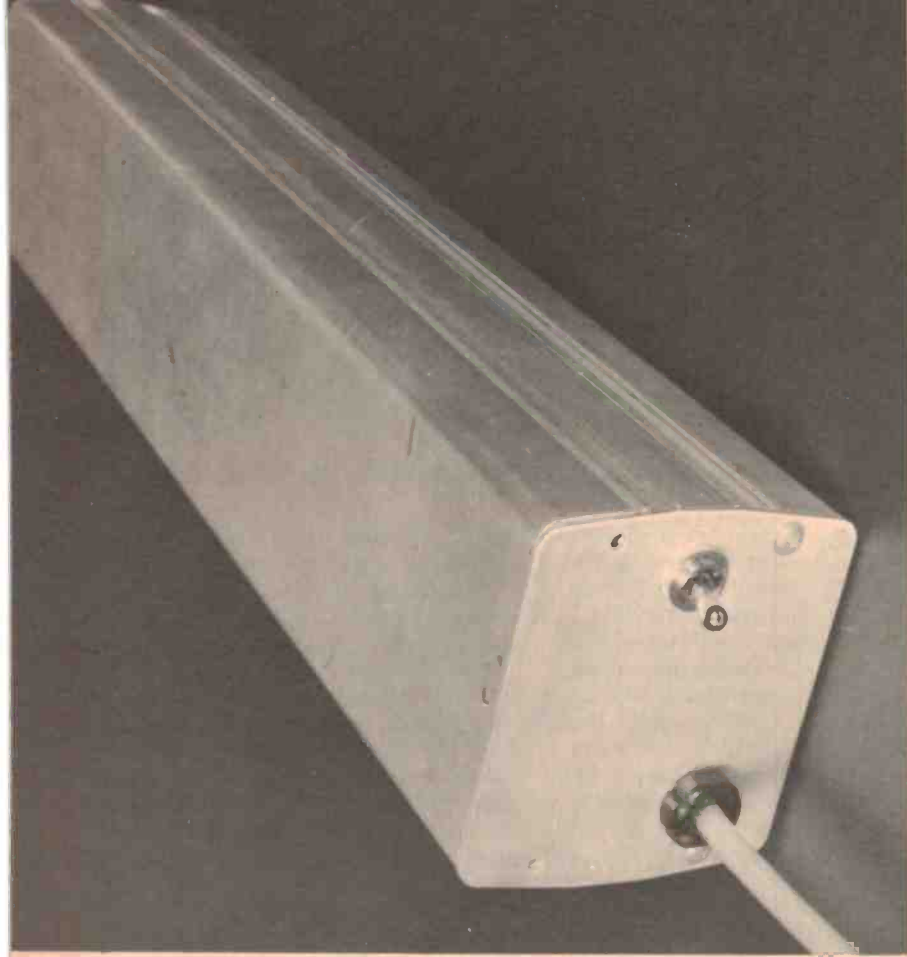

Component overlay for the underside of the pc board (copper side) showing placement of the resistors R1 to R6.

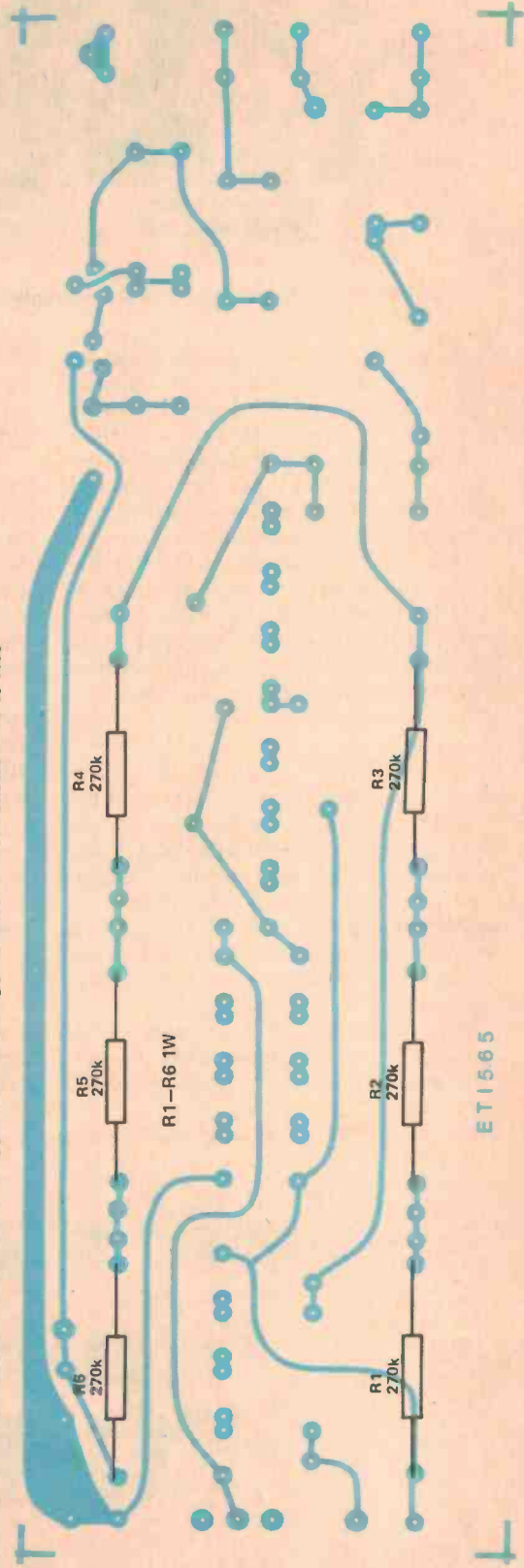

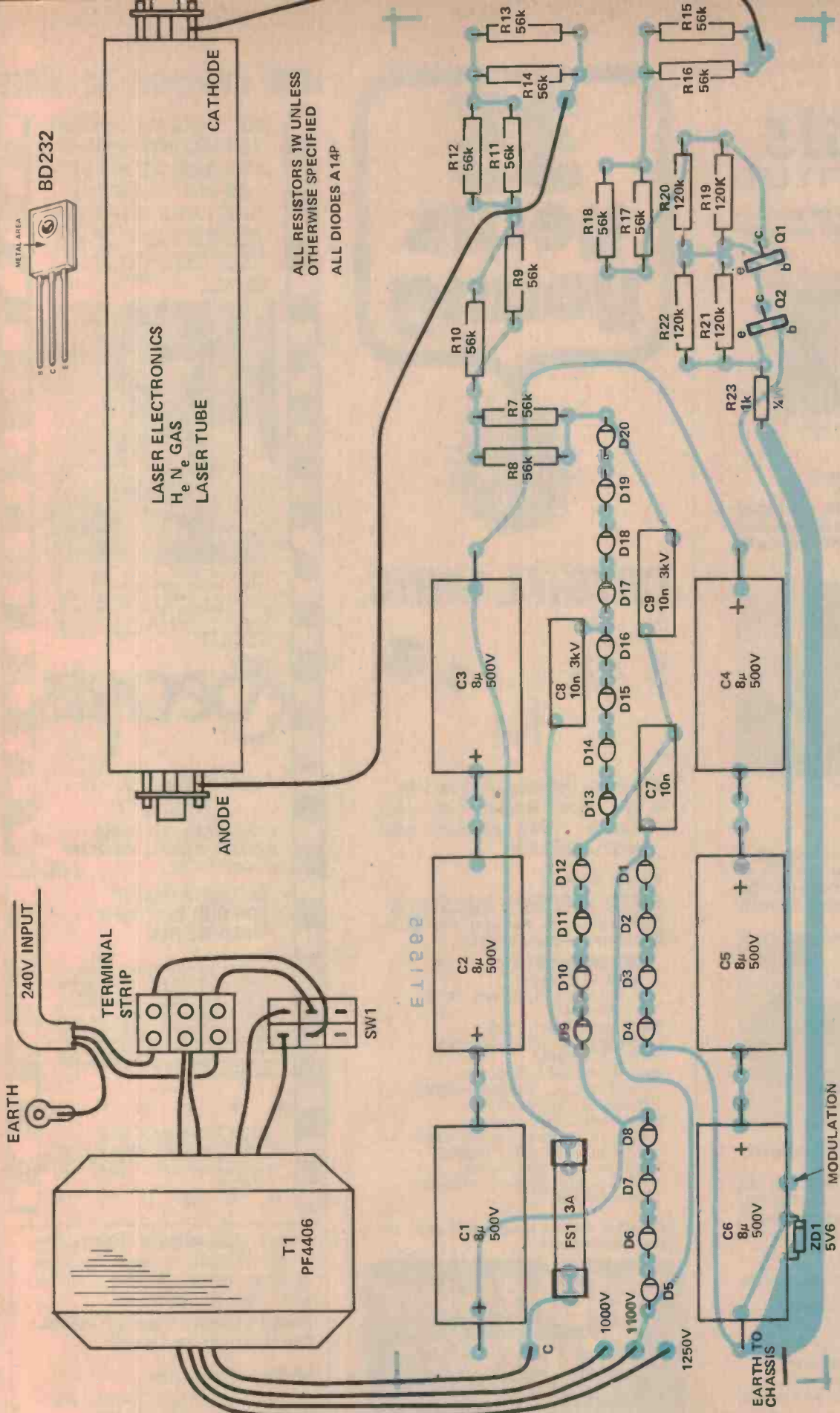

BD232



ALL RESISTORS 1W UNLESS OTHERWISE SPECIFIED
ALL DIODES A14P

PARTS LIST — ETI 565

Resistors		Capacitors		Semiconductors		Miscellaneous	
R1-R6	270k, 1W carbon	C1-C6	8u, 500 V electro	D1-D20	A14P 1000 V PIV diodes	HeNe Laser tube	Laser Electronics; pc board
R7-18	56k, 1W carbon	C7-C9	10n, 5 kV ceramic	ZD1	5V6 400 mW zener	— ETI 565; Power Transformer	— Ferguson PF4406 (240 Vac pri.) 0-1000/1100/1250 V
R19-R22	120k, 1W carbon			Q1, Q2	BD232 or equiv.	sec.) 240 Vac DPST switch, cable, cable clamp, 3-pin plug; chassis; assorted hardware, etc.	
R23	1k, 1/2W carbon						

\$ THE LOGIC SHOP PTY. LTD.

DISCOUNT SHOPPING for your professional Microcomputer and terminal requirements.



COMPUCOLOR II ex stock
From \$1970 including tax.

Features: ● up to 32K user RAM
● Eight colour display ● 32 lines of 64 characters ● 5" Mini disk drive ● 40 tracks, 48 TPI



TELEVIDEO TVI 912B DISPLAY UNIT ex stock
From \$1256 including tax.

Features: ● 24 lines at 80 characters per line ● Transmission rates 75 — 19,200 Bd. ● 96 character ASCII upper and lower case ● 12 inch monitor.



MICROLINE 80 PRINTER ex stock
From \$922 including tax.

Features: ● 80 char/sec ● 80 and 132 char/line ● 9 x 7 dot matrix ● Character or graphics printing ● Plug compatible to TRS-80. © Rgd. Tm. Tandy Corp.

SPECIAL

5¼ Diskettes — \$3.95 ea. Inc. tax.

\$ THE LOGIC SHOP PTY. LTD.

212 High St., PRAHRAN, VIC. 3181. Tel: 51-1950.
91 Regent St, CHIPPENDALE NSW. 2008
Tel: 699-4910

TRS-80® is a registered trade mark of Tandy Electronics.

35 years young

and still on top

CRYSTAL UNITS

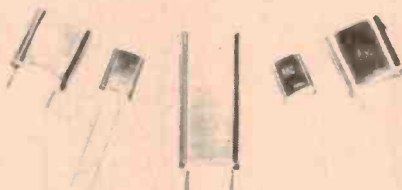

- Decade Counting Units to 1 Hz.
- Wide Band Amplifier for your counter, 1 MV sensitivity, band width 1-250 MHz.

Manufacturers of

PIEZO ELECTRIC CRYSTALS
Contractors to Federal and State Government Departments.

REPRESENTATIVES:

NSW: J. E. Waters,
11 Salisbury St, Botany. 2019.
Ph 666-8144.

SA: Rogers Electronics,
65 Magill Rd, Stepney. 5069.
Ph (08) 42-6666.

QLD: Fred Hoe & Sons P/L,
246 Evans Rd, Salisbury North.
Brisbane. Ph 277-4311.

WA: Westest Electronics,
71 Jean St, Hamilton Hill. 6161.
(Mail only) Ph (09) 337-6393.

TAS: Dilmond Instruments,
PO Box 219, Bellerive. Hobart.
Ph 479-47-9077.

Send SAE for new catalogue or quote for your requirements.

Bright Star Crystals Pty. Ltd.

PO Box 42, Springvale,
Ph (03) 546-5076 Telex AA36004

NOW AVAILABLE ON VIDEO

THE WHOLE COUNTRY IS WAITING TO SEE JACQUELINE BISSET AS YOU'VE NEVER SEEN HER BEFORE!

"Jacqueline Bisset is more stunning in 'Secrets' than in the 'Greek Tycoon' which hardly seems possible. Not only is La Bisset ravishing in 'Secrets', she is also nude . . ." — Bill Van Maurer, Miami News



"Jacqueline Bisset — This tantalizing beauty, usually mired in bad films, is here given a chance to evolve in a complex, intriguing fashion to create a woman very much the product of these confused times." — Candice Russell, Miami Herald

Secrets

STARRING
JACQUELINE BISSET

LONE STAR PICTURES
INTERNATIONAL RELEASE
COLOR BY CFI

BECOME A DEALER FOR OUR EXCLUSIVE VIDEO MOVIES

We are seeking dealers in the hi-fi and record retail trade for the sale and rental of "The Video Classics Movie Cassette Library". A range of 30 full-feature movies on video cassette. A Video Classics dealership offers high profit returns, excellent margins and full back-up with colour brochures, posters, window stickers, advertising and the opportunity to capitalise on the fastest growing section of the electrical trade.

* * * * *

Sneak Preview Cassette

Indicate format required. Send us \$25, and we'll send you a great in-store entertainment promotional video cassette of trailers of our best movies.

* * * * *

Visit our stand VIDEO IN THE 80's at the Consumer Electronic Show. Recorders, cassettes, movies, projectors, cameras — a total video presentation.

Bring a 1 hour blank tape and receive a free sneak preview cassette.

Video Classics

64 Arthur Street, North Sydney, 2060.
Phone (02) 92-6400, 92-6388.

FREE CATALOGUE

MICRODOT®



Instant Software™ New Releases

APPLE



SPACE WARS

SPACE WARS You must protect your planet against a wide variety of alien attacks. Included are:

- **Space War**—One or two players can pilot their saucers and duel with laser beams or shoot stars.
- **Star Ship Attack**—Your mission is to protect the food station satellites from destruction by the enemy star ship. You must capture, destroy, or drive off the attacking ship.
- **Battlefield**—Guess the location of the four enemy divisions and destroy them before your forces are wiped out.

Engaging in battle requires the Apple 8K and Integer BASIC. Order No. 0096A **11.95**

ACCOUNTING ASSISTANT

This package will help any businessman solve many of those day-to-day financial problems. Included are:

- **Loan Amortization Schedule**—This program will give you a complete breakdown of any loan or investment.
- **Depreciation Schedule**—You can get a depreciation schedule using any one of the following methods: straight line, sum of years-digits, declining balance, units of production, or machine hours.

This package requires the Apple 16K and Applesoft II BASIC. Order No. 0088A **11.95**

Featuring
SOUND EFFECTS

TRS-80™

BALL TURRET GUNNER

For years the Petro Resource Conglomerate has attacked our photon collection stations and strangled our deep-space trade routes. The PRC's Exonerators Class light fighters (code name: Gnat) have been their main weapon. Now you can strike back, by joining the Ball Turret Gunner Service.

Imagine yourself at the control console of the LW-1417 Stratoblazer (Type B Strategic Laser Weapon). Your Hindsight Director informs you that a Gnat fighter is coming in for an attack. You position your gigawatt laser turret until you can see the target on your monitor. The Range Indicator shows he's coming in fast. You center your target sights on his location. The Targeting Computer studies his course and speed as your finger tenses over the firing key. You know you'll have only a fraction of a second in which to react. The Gnat fighter's evasive maneuvers cause him to dance in your sights. Suddenly

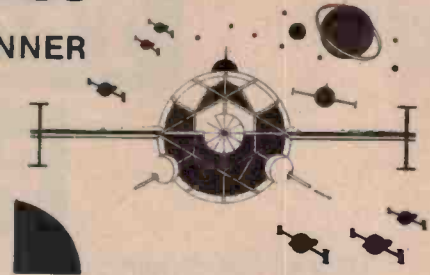

you see the fire command, and you instinctively react. Your Stratoblazer's laser beam lashes out and reduces the Gnat fighter to an expanding ball of ionized gas. Mission accomplished.

Ball Turret Gunner, with your choice of multiple levels of difficulty, optional sound effects programming, and superb graphics, is more than just a game. It's an adventure. Experience It!

Order No. 0051R **14.95**

PET™

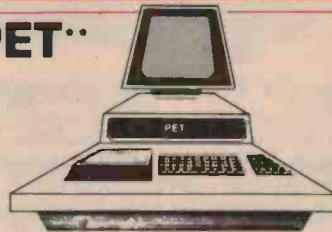

PET UTILITY I

You're working under a serious handicap if you can't write programs in machine language. The PET Utility I package gives you the tools you need:

- **Monitr**—The Monitr program lets you write, edit, save, and verify any machine language and/or BASIC program. Just load and run the Monitr program and then load the program you want to edit.

- **Programmer's Calculator**—This program will convert numbers into the binary, octal, decimal, and hexadecimal systems and function as a floating point calculator. It will also display all four numbering systems simultaneously and allow you to handle large numbers limited only by the size of your screen. For the 8K PET. Order No. 0105P. **14.95**

For a free catalog listing over 200 programs write: Instant Software Catalog

TRS — 80 DISK A/R A/P \$199.95
ENERGY AUDIT C A S S \$49.95
DISK \$75.00

HARDWARE

APPLE
SORCEROR
NORTH STAR

HORIZON II 32K QUAD	\$3056
HORIZON II, 64K QUAD	\$3683
HORIZON II, 64K 18M6	\$9329
DEC LA34 KSR	\$1435
NEC 5510	\$3219
S100 VIDEO 24 x 80	\$ 399

INSTANT SOFTWARE

PO BOX 420, HAWTHORN 3122.
PHONE (03) 819-2411.

Name
Address
..... P/Code.....

Phone
Quantity.....
Order No
Unit Cost
Total Cost
Handling.....\$1.00
Total Cost



Copy and complete: Please debit my Bankcard \$.....
Bankcard No..... Expiry Date.....

Now available for TRS-80, PET and Apple.

MIMIC

A fast-action memory game.

In Mimic, players are shown a sequence of graphic characters that appear in random locations within a 3x3 grid. You'll have to remember the order and location in which the characters were shown, and "mimic" that sequence on your keyboard.

With several levels of skill, it's not hard to see why people of all ages enjoy this exercise of concentration and dexterity.

TRS-80 Level II 16K, Order No. 0066R
PET 8K, Order No. 0039P **11.95**
Apple 24K (Integer), Order No. 0025A

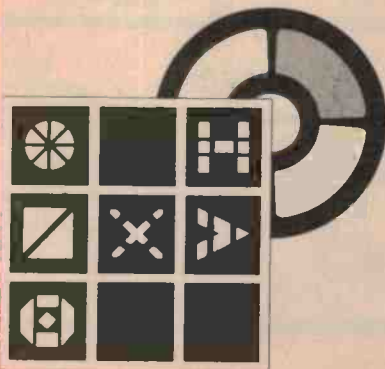



abacus

The new force in components

Due to the closing down of the Richmond Silicon Valley Store, Abacus has now been appointed a Silicon Valley Agent. We are stocking all Silicon Valley products and offering the full range of Cema Electronics products.

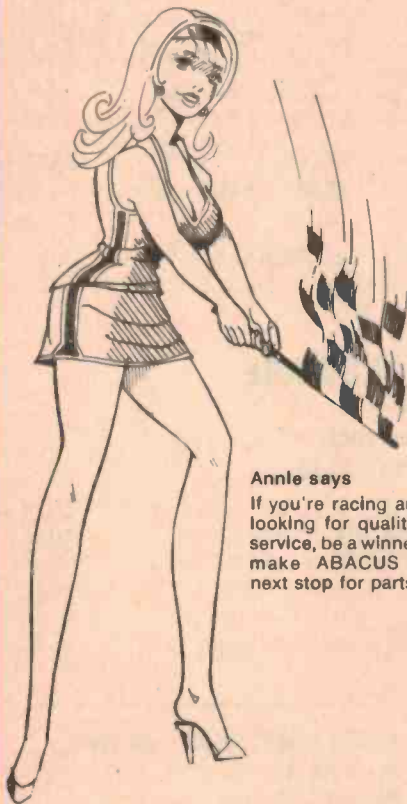

Anne says
If you're racing around looking for quality and service, be a winner and make ABACUS your next stop for parts.

BASE 2 MODEL 800 PRINTER



IN STOCK \$745
ALL OPTIONS INCLUDED

PRINT AREA: 8.0 Inches (203mm)
THROUGHPUT SPEED: 60 lines per minute

LINE SPACING: 6 lines per inch
COLUMN CAPACITY: 72, 80, 96, 120 or 132. Switch or program selectable

OPTIONS: "M" — 2K RAM buffer, "S" — high speed paper advance and graphics "T" — tractor feed.

INPUT/OUTPUT PROVISIONS: a) RS-232, b) 20 ma current loop, c) IEEE — 485 type, d) Centronics parallel.

In Sydney get your BASE 2 MODEL 800 from ALLIANCE DIGITAL CORPORATION PTY. LTD.
26th Floor, 100 Miller St,
Nth Sydney (02) 436-1600.

COMPUCOLOR II

Model 3, 8K \$1995
Model 4, 16K \$2295
Model 5, 32K \$2595
Prices include colour monitor, computer and one disc drive.



PET COMPUTER

With 8K & monitor, \$999 inc. tax plus \$150 free software.



\$100 BOARDS

- CPU CARDS
- MEMORY
- DISK CONTROLLER
- SERIAL & PARALLEL
- S100 FRONT PANEL

CONSUMABLES

in any quantity.
FLOPPY DISCS
5" \$3.75 ea.
FLOPPY DISCS
8" \$3.95 ea.



SOROC IQ120

- Cursor control keys
- Numeric key pad
- Line and page erase

- Addressable cursor
- Switch selectable transmission from 75 to 19,200 bps
- Communication mode MDX/FDX/Block
- Interfaces: Printer Interface/RS232 Extension
- RS232C Interface
- Non-glare read out screen
- Protect mode
- Tab

\$1295



SORD M100 ACE 1 \$2850

Price Includes:
• 48KB Memory
• 1 x 143KB Disc
• Monitor
• Printer Port
• Serial Port

All quoted prices are exclusive of 15 percent sales tax.
Prices valid to 31st July 1980.



Give name, number, expiry date and signature for mail order sales.



abacus

ABACUS COMPUTER STORE
512 Bridge Road, Richmond, Victoria 3121.
Phone (03) 429-5844 429-4780.

Switchmode charger delivers "fast charge" to NiCads

This project will charge your NiCad batteries to near rated capacity when you need them in a hurry. It can't overcharge either!

Jonathan Scott

HOW OFTEN have you suddenly needed a set of NiCads only to find that they have little or no charge left in them? Fuses always blow when torch batteries are at a minimum; events happen when flashgun batteries have been completely exhausted and the 6m band opens just as your rig's portable power pack is getting unusably weak.

These are basic corollaries of Murphy's Law.

NiCads are strange things. They have many wierd and wonderful habits, like the 1% per day (very approximately) self discharge rate. All these factors take some foresight to circumvent, since the recommended charging procedure is the 10 hour rate for 14 hours. But even this apparently elementary approach has drawbacks. The batteries must not be left on indefinitely at this rate. About 24 hours is the recommended maximum duration. It is safe to leave them on the 50 hour rate indefinitely, but here they suffer from even greater apparent capacity reduction than on the 10 hour rate! What's more, this is worsened if they are recharged before being substantially discharged! All in all, a steady discharge cycle followed by just the right amount of charge delivered at a moderate rate gives the healthiest cells. However, this leads us back to the problem of them not being always on hand at full capacity or being damaged by continuous overcharging.

This is where the *fast charger* comes in. It seems that flat NiCads will not only tolerate a controlled fast charge but actually benefit from it in terms of recovery of apparent capacity.

The ETI-563 not only charges "but quick", as the Americans say, but turns itself off preventing "cooking" that will surely follow your forgetting the job. In addition, it achieves this with the inherent efficiency of a switchmode supply. Imagine your flashgun rejuvenated to near full power in just 15



The completed project was housed in a smart PacTec case. Front panel is Scotchcal and will be available from the usual sources (see Shoparound on page 61).

minutes. The effective downtime of penlite cells is thus made bearable to all but the most impatient of persons. Finally the whole device runs so cool that the only heatsink is mounted internally, allowing the unit to fit in a space of only 80 x 150 x 150 mm — small enough for a camera bag or travelling case, at a pinch.

Operation

The device is basically a constant current source delivering about 2.4A, controlled by a timer. The timer is reset at turn-on and permits the current to flow for a period after that. The period is chosen by the capacity selector switch. Thus, the supply is always delivering the maximum current, and merely finishes when the current delivered should have charged the batteries in question.

It is relatively simple to use. Firstly, turn the unit off — this allows the timer

to reset. Connect the batteries — up to 12 volts of cells in series — across the terminals. If they are connected backwards they will see a very low impedance and may damage themselves discharging, or if flat they will be charged in the reverse direction, which is very unhealthy! The polarity LED will indicate if cells are connected correctly, but it will not detect voltage of less than two cells-worth. All of which adds up to saying that a double check is a good idea at this point. Next, select the capacity, setting the duration of the charge. Then, turn on. When the due time has elapsed the 'charge' LED will go out, indicating that the unit has shut off.

The charger delivers slightly more than the capacity of the battery. This is designed to allow for the inefficiency of the recharging process; i.e. it takes 14 hours at the 10 hour rate to fully charge up a cell under normal circumstances so ▶

Project 563

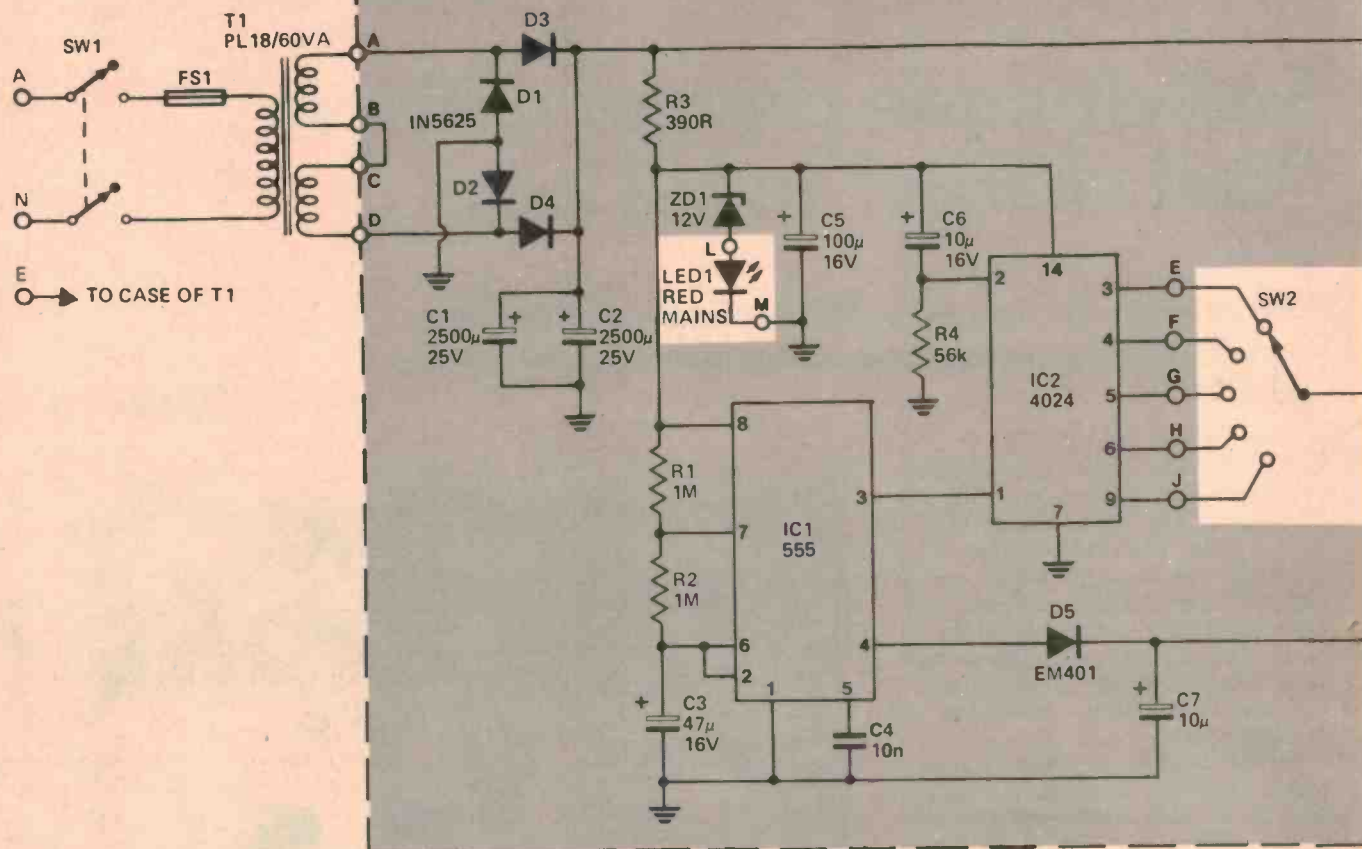

it will take more than an hour at the one hour rate — in fact, more like 1½ hours. The faster you go, the worse the efficiency. If you are not in too much of a hurry, it is a good idea to give a second burst at half capacity later on, to ensure complete charging; though *be careful*, as most NiCads will not like more of a burst at one time than the unit delivers.

For example, let us assume your 2 Ah NiCad torch is quite flat — you left it on last night (absent-minded twit!). So you hook it up and set for a 2 Ah charge. One hour later it turns off. About 2.4 Ah of charge has gone in in one hour, which is all that is likely not to upset the cells. You could pack it up in your camping bag now, as it will have something like 60% charge. However, if you aren't in a big hurry, when you come back two hours later, you put it on again for a 1 Ah (½ hr) charge. At worst, it will then be 90% or so charged, so that's OK.

As you can see, it is alright to give the batteries a second run provided it is spaced some time away from the first. It is alright also to charge batteries that are not fully exhausted. It is unwise to just regularly fast charge without any use in between, or to deliver more than the correct capacity charge in one hit. Similarly it is alright to deliver a half capacity charge to a cell you know to be

HOW IT WORKS

Looking at the circuit, it may be divided into several sections with simple discrete functions: An unregulated dc supply consisting of SW1, T1, D1-D4, C1 and C2; a timing circuit made up of IC1, IC2, Q1 and associated components; the actual switchmode circuit comprising Q4, D6, L1 and surrounding components; the supply controlling circuitry involving Q2, Q3, Q5 and R15. There are also three LED function indicators to give the user some idea of what is going on inside. Each of these sections will be treated in turn.

The unregulated supply is fairly conventional, delivering between 17 V and 25 V at a maximum of about 3 amps. It must be capable of briefly delivering the 2.5 amps starting current required by the regulator controller. Diodes D1 to D4 could in fact have been 1A types, but they would be slightly overtaxed at turnon and thus, in the interests of reliability, 3A types have been specified.

A regulated supply of about 13.7 V is provided for the ICs by R3, C5, ZD1 and LED 1. In this position, LED 1 serves to indicate that the mains voltage is applied and is sufficient to run the unit — if the line voltage falls, LED 1 will dim or go out, indicating an 'unhealthy' condition.

The electronics will withstand the situation indefinitely. However, if the line voltage is very low the current delivered may not reach the correct level for charging (2.4A) and the unit will consequently not be able to deliver the

correct charge to the cells being charged at the time.

IC1 is connected as an astable multivibrator with a period of around 110 seconds. IC2 is a seven-stage binary counter. C6 and R4 ensure that, at turnon, the counter is reset to zero. The five, more significant, outputs are made available on the five contacts of SW2. Due to the resetting, no matter which position SW2 is set to, the base of Q1 is initially held low and so it is turned off. However, C7 holds its collector low for a fraction of a second. This has the effect of momentarily holding Q2 on. The purpose of this will be pointed out later on.

Once C7 charges up to rail potential via R6, pin 4 of IC1 is no longer held low and so IC1 is free to commence oscillation. It oscillates until sufficient pulses are counted by IC2 to send high the output selected by SW2. Just how many pulses this represents is a function of which output was selected, and hence SW2 defines the duration of the timer interval.

When the selected output does go high, Q1 is turned on, Q2 is turned on and IC1's reset line is held low, inhibiting further clocking of the counter, IC2.

When Q2 is turned on, it diverts any possible drive current from the base of Q4, ensuring that it is held off and that no current is passed from the unregulated supply to the load. Q2 also holds Q4 off momentarily after initial power-up in order to give the transformer a chance to charge C1 and C2 without having to

fast nicad charger

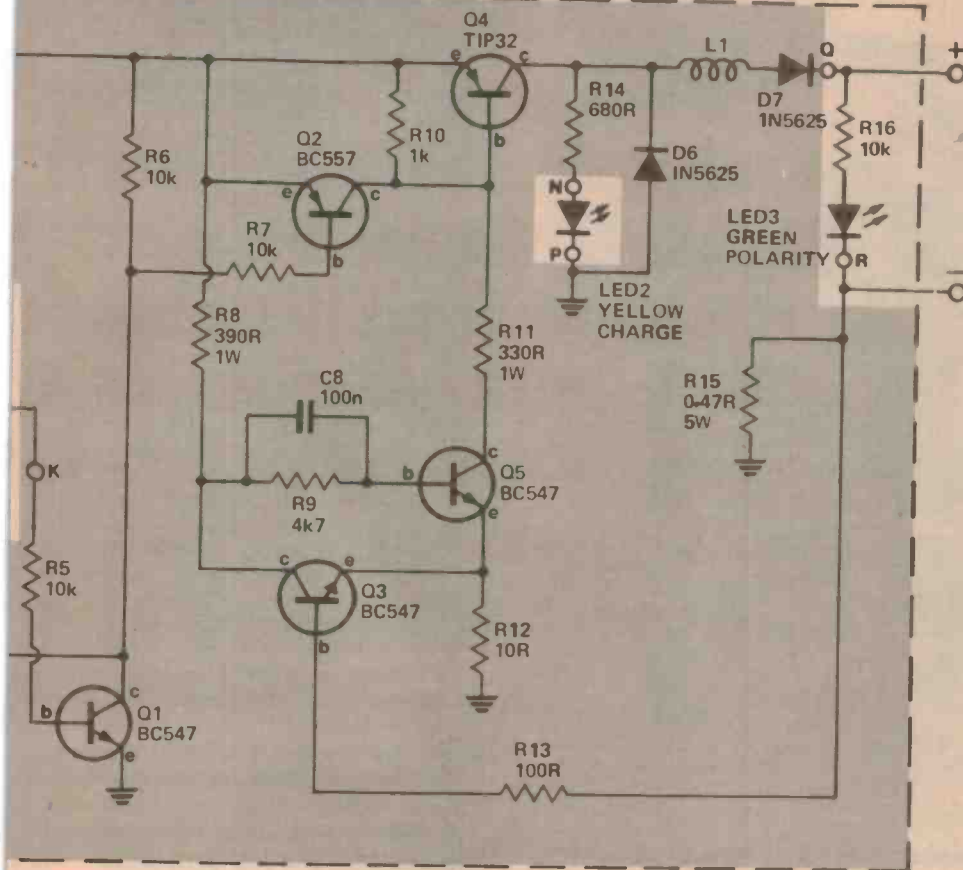

only half or slightly less used up — just don't overcharge badly or charge too long at the fast rate. The cells will get warm, but not burning hot, if all is well.

In fact, it's a good idea to have two chargers: a "standard" one, like the ETI-578 (June issue) for 'regular' use, and this one for "emergencies".

Construction

This project is relatively easy to construct if you follow the layout and wiring diagrams. It is best to commence construction by drilling and working the case. We housed the unit in a PacTec plastic case measuring 155 mm wide by 65 mm high by 160 mm deep. This case comes apart in four pieces — a top piece and a bottom piece plus front and rear panels. The rear panel was drilled to take a mains cable clamp and the mains fuse. The front panel contains the three LEDs, the capacity selector switch, the output terminals and the mains (labelled "START") switch. Take care with the placement of SW2 as it backs right onto the coil, L1, mounted on the pc board. Also, the bolt on one or both of the output terminals should be shortened to clear the components on the pc board. If you use a different mains switch to the one we selected, take care that it will clear the components on the pc board behind it. We chose a Dick Smith type, cat. no. S-1393, as it takes up little space behind the panel and is easy to operate.

Using the unloaded pc board as a template, mark the mounting hole positions on the bottom of the case and then drill them to size. Then, using the transformer as a template, mark and drill its mounting holes, and a hole for the mains input terminal block.

The printed circuit board may be assembled next. Using the component overlay as a guide, mount all the resistors and capacitors taking care that you have the electrolytics and tantalums correctly oriented. Next, mount the diodes. Make sure you have them correctly oriented, as well. The TIP32 and its heatsink may be mounted next. Smear a little silicone grease on the metal tab of the transistor case and on the heatsink. Put the transistor leads in place but don't solder them yet and place the heatsink in position on the pc board. Bend the transistor over such that the hole in its metal tab and the holes in the heatsink and pc board line up. Bolt them all together. The transistor leads may now be soldered.

The coil, L1, may be wound and mounted next. Coil winding details are ▶

— ETI 563

cope, at the same time, with the starting current of the main switching regulator circuitry.

Once the timer has run its course Q2 holds the regulator off, preventing any further charging of the connected cells. During charging (i.e. when Q4 is conducting) Q2 does not conduct and can be ignored.

When, a split second after turn on, Q2 isolates, Q3/Q4/Q5 are able to start regulating. Initially, Q3 will be held off via R13 and R15, and Q5 will be turned on by current flowing into its base via R8 and R9. Thus, it will draw current through R11 and turn Q4 on. Q4 will immediately saturate, raising its collector voltage to near rail potential. A current will build up through Q4, L1, D7 (the load (consisting of the cells to be charged) and R15). The rate of current build-up will be limited by the inductance of L1. When this current builds up to about 2.5 A, 1.2 V will be dropped across R15. The current Q5 is drawing via the base of Q4 will develop about 0.5 V across R12, and thus the 1.2 V across R15 will be enough to turn Q3 on. When Q3 turns on it removes drive from Q4's base, turning it off. Since the collector load of Q3 is higher than that of Q5 it draws less current and the voltage appearing on their common emitter resistor, R12, drops a small amount, turning Q3 on harder.

Transistors Q3 and Q5 actually form a Schmitt trigger. Q5 now having been turned off, Q4 also turns off. The collapsing field in L1

tries to maintain the output current and, having no other path, conducts via D6, referred to as the "freewheel" diode. When the current in L1 decays sufficiently for the voltage across the current sense resistor, R15, to fall to the lower 'Schmitt' level of Q3/Q4, both these transistors again change state, and the circuit returns to the initial conditions.

The whole cycle repeats and the average load current is held constant. LED 2 turns on whenever Q4 turns on, and will glow more brightly when the switchmode circuit is running at a higher duty cycle. For those interested, this gives an idea of how much power is being delivered by the supply.

The power dissipation of the electronics will be substantially independent of the load current/voltage product. i.e. unlike a conventional regulator, the switchmode device does not dissipate a significantly larger amount of power when the load drops less voltage.

R16 and LED3 simply detect correct voltage applied across the terminals. Owing to the voltage drop of the LED, it will not detect a voltage less than about 2 V.

Reverse-connected batteries will see a low impedance in the regulator circuitry via D7, L1, D6 and R15 — so quite a large current may flow from the batteries if they have some charge left and the voltage is above several volts. The POLARITY indicator (LED3) should light, if more than 2 V is left in the batteries, before power is applied.

Project 563

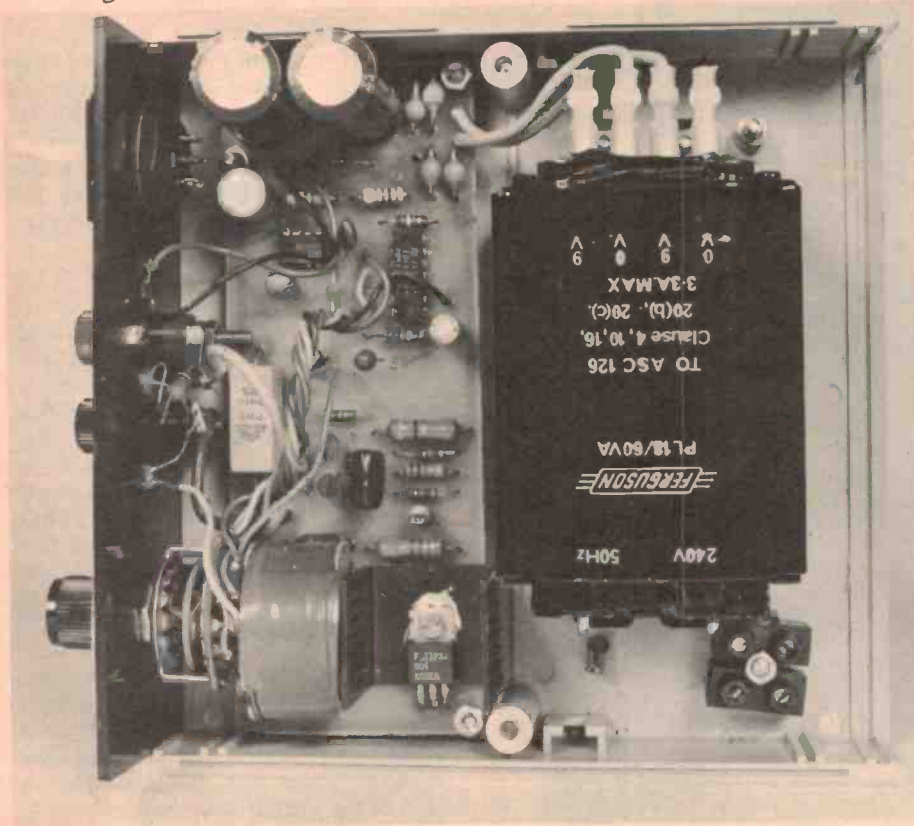

Internal view of the project, showing general placement of components. Mains wiring has been removed for the sake of clarity.

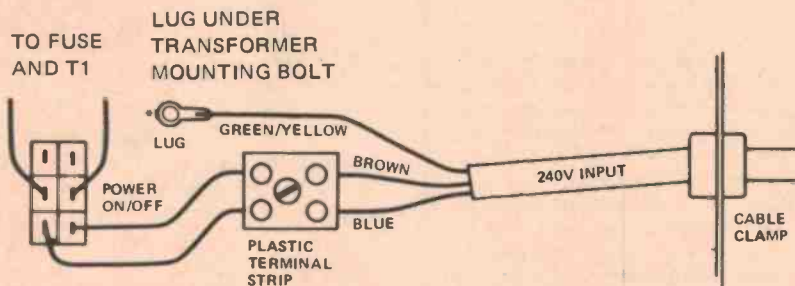

Mains wiring diagram

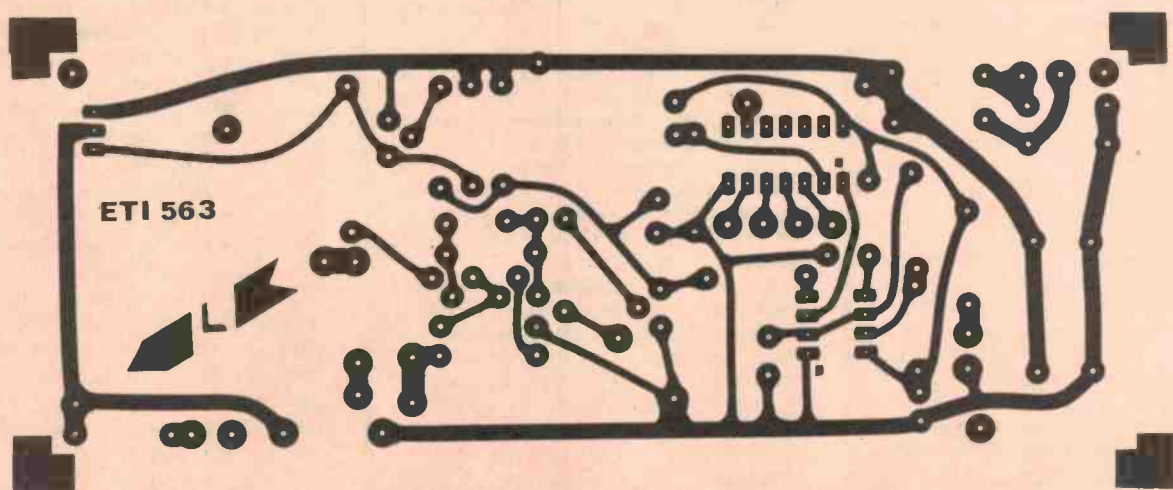

COIL DATA

The coil, L1, is not critical in value. It needs to have an inductance of at least 300 μ H and present a minimum of internal resistance. It should also be physically compatible so that it fits in the space between the rear of SW2 and the heatsink on Q4.

For the sake of simplicity, we wound ours on a standard Philips pot core former. The coil consists of about 120 turns of 1.0 mm diameter enamelled wire. The former has an internal diameter of 21 mm and is 19 mm deep. The internal resistance of the coil turned out to be about one ohm. This is really about the upper limit of internal resistance that the circuit will tolerate and no thinner gauge should be used. It gets quite hot, not surprisingly, as it dissipates more than Q4! Note that no core is used.

A free-wound coil wound with 1.25 mm diameter enamelled wire would doubtless run cooler. Inductors intended for use in loudspeaker crossover networks will also suffice, providing they have an internal resistance below one ohm.

given in the accompanying box. Whatever coil you use, make sure it will fit in the space between the heatsink and the rear of SW2 mounted on the front panel.

The two ICs should be mounted last. Again, ensure these are correctly oriented. After all the components are mounted, the external wiring from the pc board may be done. The connections to the transformer secondary are fortunately supplied with slide-on connectors. Cut two to length and attach them to their positions on the pc board. Note that, from the wiring diagram, the two *outer* terminals of the transformer secondary are bridged to connect the windings in series. Make up a short lead to effect this connection, as shown in the internal picture.

Wiring to SW2 is fairly straightforward. Refer to the overlay drawing for details. These wires may be colour-

fast nicad charger

coded to assist identification, or attached one at a time. Make sure they're all long enough. Wiring to the front panel components can only be done with the whole unit disassembled. The two wires from the pc board to the output terminals should be of a heavy gauge (10/010 as a minimum) as the output current is 2.4A. Note that R16 is mounted between the positive output terminal and the anode of LED3.

The mains wiring should be connected as shown in the wiring diagram. The rear of the mains switch should be protected by sleeving and/or a 'separator' made from heavy card. Mains wiring should be done in heavy gauge wire, such as 10/010, with suitably rated insulation. Some wires stripped from your mains cable would suffice. Make sure the earth lead to the transformer case is longer than the mains active and neutral input wires going to the terminal block. Sleeve the terminals of the fuse holder.

Check everything before you finally assemble the components into the case. Assemble the rubber feet before mounting the pc board and transformer to the bottom of the case.

Powering up

No electrical adjustment or alignment is necessary. Connect an ammeter in series with a discharged battery and connect to the output terminals — watch polarity. Select the minimum capacity (250 mAh). Plug in and turn the START switch on. The three LEDs should light and the ammeter should read close to 2.4 A. If all is not well, switch off and check your wiring again.

The charge times of the capacity selector switch should be checked. Should they be extremely short or long, this could be due to a large tolerance in C3. To compensate for this, R2 may be adjusted down to 560k or up to 1M5, say, to reduce or increase the time, respectively.

Using it

The unit should be switched OFF before connecting a battery. When you connect the battery, the green LED, marked POLARITY, should light if the battery has been correctly connected. If the battery is completely discharged, the LED will not light as it requires somewhat over 2 V to operate. In this case, carefully check the battery connections.

If all is well, turn the capacity selector switch to the appropriate position and operate the START switch. At the appropriate time later, the unit will switch off and your battery will be ready for use.

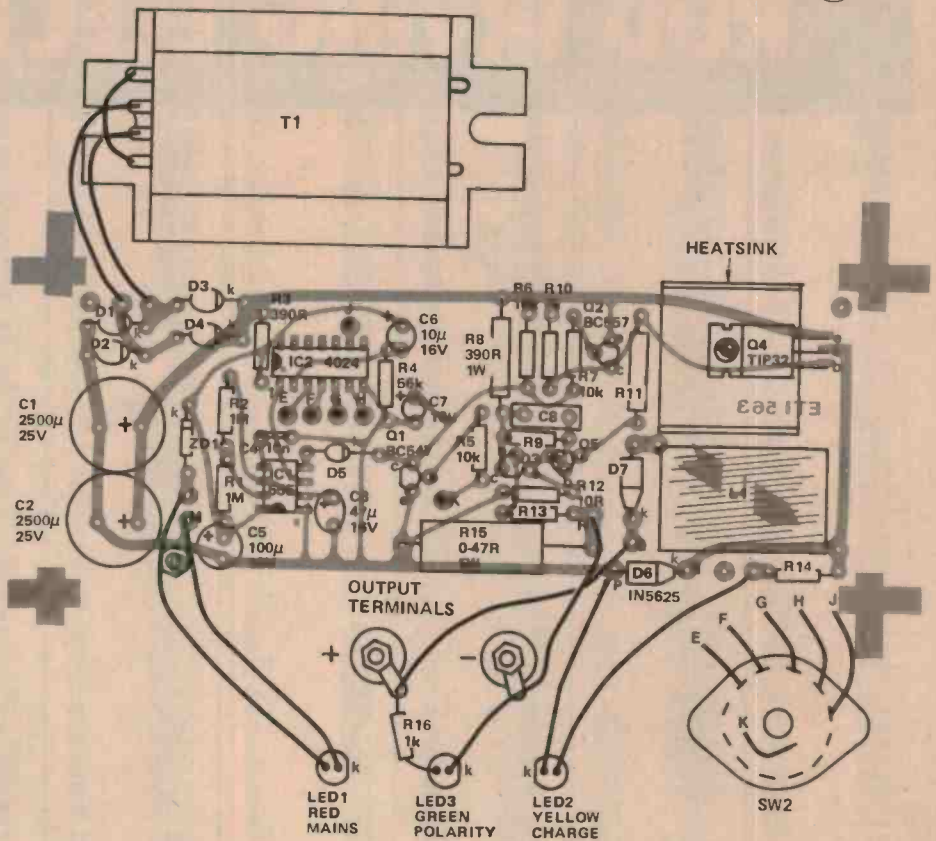

ICs viewed from top

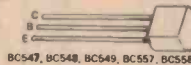
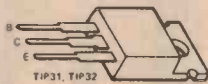
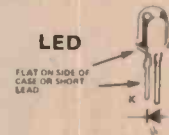

PARTS LIST — ETI 563

Resistors	all 1/2W, 5% unless noted	IC2	4024
R1,R2	1M	Q1,Q3,Q5	BC547 or similar
R3,R8	390R	Q2	BC557 or similar
R4	56k	Q4	TIP32
R5,6,7,16	10k	D1,2,3,4,6,7	1N5625, 3 A diodes
R9	4k7	D5	EM401 or similar
R10	1k	LED1	TIL220R, or sim. (red)
R11	330R	LED2	TIL220Y, or sim. (yellow)
R12	10R	LED3	TIL220G, or sim. (green)
R13	100R		
R14	680R		
R15	0R47 (0.5 ohm), 5W wirewound		
Capacitors		Miscellaneous	
C1,C2	2500u, 25 V electro	Case	PacTec 155 mm x 160 mm x 65 mm, plus four rubber feet to suit; Transformer PL18/60VA 2 x 9 V @ 3 A or similar; Fuse: 500 mA 3AG; Fuse holder to suit; DPDT switch (SW1): Dick Smith No. S-1393 or similar (see text) rated at 240 Vac, 1 A or more; Single-pole five position switch (SW2); Knob to suit SW2; Scotchcal front panel; one red and one black terminal; One two-way mains barrier strip connector; Mains cable clamp; Mains cable and three-pin plug; Heatsink: Dick Smith No. H-3402; Wire; Nuts, bolts etc
C3	47u, 16 V tantalum	Printed circuit board	— ETI-563
C4	10n greencap		
C5	100u, 16 V electro		
C6,C7	10u, 16 V tantalum		
C8	100n greencap		
Semiconductors			
IC1	555		

ROD IRVING ELECTRONICS

425 HIGH STREET, NORTHCOTE 3070. MELBOURNE. PH (03) 489-8131

CMOS	74C85	1.20	555	.30	7405	.30	74193	.80	74LS190	1.30	PN4121	.18	BFX85	.75
4000	74C86	.80	556	.70	7406	.30	74194	1.10	74LS191	1.10	2N4233	1.60	BFY50	.90
4001A	74C90	1.80	LM565	1.30	7407	.40	74195	.85	74LS192	.85	2N4235	1.90	BFY90	1.30
4001B	74C93	1.40	LM565CH	2.00	7408	.30	74196	.65	74LS193	.85	2N4236	2.20	BSV17	1.00
4002	74C95	.95	NE566	2.50	7409	.30	74197	1.10	74LS194	.70	2N4248	.30	BU126	3.00
4006	74C107	.70	LM567	1.50	7410	.30	74198	1.10	74LS195	.80	PN4249	.30	BU208	3.00
4007	74C150	3.40	NE571	6.50	7411	.30	74199	1.30	74LS196	1.25	2N4250	.15	BUX80	7.90
4008	74C151	1.00	TBA641B1X	2.50	7412	.30	74221	.90	74LS197	1.00	2N4258	.20	FT2955	1.40
4009	74C160	.90	TBA641BII	2.50	7413	.35	74290	.90	74LS221	1.10	2N4292	.70	FT3055	.75
4010	74C192	.90	LM709-14PIN	.70	7414	.35	74293	.90	74LS245	2.35	2N4354	.25	MEL12	.90
4011	74C164	1.10	UA710CA	.60	7416	.50	74365	.80	74LS247	.90	2N4355	.25	BU326A	3.40
4012	74C173	1.00	LM710-CH	.90	7417	.45	74366	.80	74LS249	1.30	2N4356	.20	MJ2955	.75
4013	74C174	.80	711	.80	7420	.40	74367	.80	74LS251	.80	2N4398	5.00	MJ4032	7.40
4014	74C175	1.00	UA711-H	.85	7421	.40	74368	.60	74LS253	.90	2N4401	.18	MJ802	3.40
4015	74C192	1.20	UA716HC	6.25	7423	.35	8T96	1.80	74LS257	.65	2N4402	.20	MJ4035	6.90
4016	74C195	1.00	723	.50	7425	.45	9314	1.30	74LS258	.50	2N4403	.18	MJ4502	3.70
4017	74C221	1.50	LM723CH	1.10	7426	.40	9368	1.75	74LS259	2.45	2N4416	1.00	MJE340	.90
4018	74C373	1.80	LM725	3.90	7427	.40	9370	2.00	74LS260	.40	2N4906	2.80	MJE350	1.20
4019	74C374	2.00	LM733	1.20	7430	.40			74LS266	.70	PN4868	.30	MJE7000	1.30
4020	74C901	.70	UA739	2.00	7432	.40			74LS273	1.60	MJE8000	1.00	MJE8000	1.00
4021	74C902	.70	741	.25	7437	.30			74LS279	.65	2N5089	.17	MJE1101	2.20
4022	74C905	11.20	LM741-H	1.20	7438	.40			74LS283	1.15	2N5179	1.90	MJE2955	.90
4023	74C906	.70	UA747	1.00	7440	.40			74LS283	1.15	2N5303	3.30	MJR3055	.90
4024	74C907	.80	UA747HC	2.20	7441	1.00			74LS293	1.15	2N5320	.80	MJE3521	.55
4025	74C915	1.50	UA748	.50	7442	.45			74LS295	1.60	2N5401	.25	MJ15003	4.00
4026	74C922	3.80	UA748HC	1.25	7443	1.40			74LS298	1.00	2N5458	.45	MJ15004	4.00
4027	74C923	5.00	UA753	1.80	7444	1.20			74LS352	1.30	2N5459	.45	MPE102	4.00
4028	74C925	5.50	UA760HC	4.10	7445	1.10			74LS353	1.30	2N5461	.70	MPE102	.40
4029	74C926	5.90	UA777	2.40	7446	1.00			74LS365	.50	2N5484	.55	MPE131	1.20
4030	74C927	5.90	UA777HC	2.65	7447	1.00			74LS366	.70	2N5485	.45	MPSA05	.20
4031	74C932	5.50	9334	1.70	7448	1.00			74LS367	.55	2N5486	.50	MPSA06	.60
4034			UA743	1.80	7450	.50			74LS368	.50	2N5769	.18	MPSA12	.60
4035	MM80C95	.90	UA760HC	4.10	7451	.50			74LS373	1.50	2N5770	.25	MPSA14	.30
4039	80C96	.90	UA777	2.40	7453	.40			74LS374	1.70	2N5830	.25	MPSA42	.60
4040	MM80C97	.90	UA777HC	2.65	8T26	1.80			74LS374	1.70	2N5831	.30	MPSA56	.80
4041	80C98	.90	UA796HC	1.70	9300	.60			74LS386	.50	2N5856	.30	MPSA92	.60
4042			LM802	1.10	9307	1.80			74L5670	2.70	2N5873	1.10	MRF475	4.40
4043			LM1310N	2.40	9308	1.20			81LS95	.80	2N5874	1.40	TIP318	.75
4044			1408	.60	7454	.40			11C90	12.50	2N5961	.18	TIP31C	.80
4046			LM1458	4.90	7472	.40			81LS96	2.10	2N5963	1.10	TIP328	.75
4047			UA1488	.90	7473	.40			81LS97	2.10	2N6027	.60	TIP32C	.75
4048			UA1489	.90	7474	.40					3N201	.90	TIP33A	1.10
4049			MC1495	7.30	7475	.30					AC127	.70	TIP34A	1.20
4050			MC1496L	11.40	7476	.30					AC128	.70	TIP24B	1.50
4051			LM1558	1.50	7480	.65					AC187	.70	TIP42B	1.10
4052			LM1596	1.40	7482	1.80					AC188	.70	TIP110	1.30
4053			LM1380	3.10	7483	.80					AD149	2.00	TIP210	1.30
4060			2T19	4.00	7485	.80					AD161	1.70	TIP2955	.90
4066			LM2902	1.40	7486	.40					AD162	1.70	TIP3055	.85
4068			UAA170	3.50	7489	1.60					BC318	.18	VMP4	28.00
4069			UAA180	3.50	7490	.60					BC319	.18	VN88AF	2.50
4070			TA220	2.20	CA3028	1.80					BC327	.15		
4071			LM301	.30	LM3039	.90					BC328	.17	MICRO CHIPS	
4072			LM301-H	.50	CA3046	1.70					BC337	.20	ADCO 800	12.00
4073			LM304-H	1.70	3065	.45					BC338	.20	DACO 808	2.00
4075			LM305-H	.80	LM3080	1.20					BC347	.12	2102 200 NS	2.00
4076			LM307-CN	.40	LM3089	3.90					BC547	.12	2101 350 NS	2.00
4077			LM307-H	.90	CA3130T	1.40					BC547B	.18	2102 450 NS	1.20
4078			LM308	.70	CA3130E	1.80					BC548	.12	2102 650 NS	1.20
4081			LM308-H	1.20	CA3140	1.40					BC548B	.18	2111	8.60
4082			LM310-N	2.20	3401	.70					BC549	.12	2114 150 NS	11.15
4089			LM310-H	2.60	3611	1.10					BC549C	.18	2114 300 NS	6.30
4093			311	.60	LM3900	.80					BC557	.16	2114 450 NS	5.30
4503			LM311	.60	LM3909	1.00					BC558	.16	8 - 31	4.90
4510			LM311-H	1.20	LM3914N	3.90					BC559	.16	32 up	4.65
4511			LM318	2.80	4136	1.40					BC637	.25	2513	12.40
4512			LM322	3.90	LM4250	1.75					BC638	.36	2516	55.00
4514			LM324	.70	UA4558TC	1.40					BC639	.30	2532	74.90
4516			LM325	3.10	MM5837	2.50					BC640	.30	2650	23.00
4518			LM329-DZ	1.40	LM7555	1.80					BCY70	.85	2708	8.50
4519			LM334-Z	1.30	Mc10116L	.95					BD115	1.50	2716	29.00
4520			LM335	12.40	LF13741	.60					BD135	.50	4116	10.00
4522			LM336-Z	3.20	LF13741-H	.70					BD136	.50	5101	9.00
4527			LM339	.60	DS75452	.50					BD137	.40	55101	9.00
4528			LM348	1.10	76477	4.20					BD138	.40	MM52030	14.50
4529			LM349	1.80	75451	.60					BD139	.25	MM5204	12.50
4539			LF351-N	.70	75491	1.40					BD140	.25	MM5220	7.20
4541			LF356-AN	1.10	75492	1.40					BD235	.65	MM5307	18.00
4543			LF357	1.10	TTL (\$)						BD236	.50	MM5309	6.50
4553			LM358	.70	74S00	.40					BD237	.50	MM5312	9.00
4555			LM373	4.10	74S02	.40					BD237	1.20	MM5369	2.60
40097			LM374	5.40	74S04	.80					BD301	.75	5387	8.50
40098			LM376	.70	74S10	.75					BD302	1.25	MM5395	6.50
40175			LM377	2.90	74S11	.75					BD363	.75	MM5740	15.60
74C SERIES	LM379	5.70	74S12	.75	74S11	.60					BD364	1.6	6502	10.50
74C00	LM308 8PIN	1.10	74S13	.75	74S12	1.00					BD365	1.50	6508	5.50
74C02	LM380 14PIN	2.40	74S14	1.20	74S13	.85					BD366	1.70	6520	5.50
74C04	LM381A-N	2.40	74S15	1.40	74S14	.60					BD367	1.80	6522	10.00
74C08	LM381N	1.80	74S16	1.40	74S15	.70								

FOR ALL YOUR ELECTRONIC COMPONENTS

<p>7106 12.90 7107 15.00 7210 13.20 LS7220 6.00 Z80 CPU 17.00 Z80A CPU 19.90 Z80 P10 13.80 Z80A P10 16.50 Z80 CTC 13.80 Z80A CTC 16.50 Z80 DMA 40.70 Z80 S10/0 56.90 Z80 S10/1 56.90 Z80 S10/2 56.90 Z80A S10/0 63.00 Z80A S10/1 63.00 Z80A S10/2 63.00 8035 27.00 INS8050 15.00 INS8080 8.00 P8085 25.00 8155 22.00 8165 22.00 8205 5.00 P8212 4.00 8214 8.00 8216 5.90 8224N 5.50 8224 7.50 8226 5.90 8228 9.50 8238 8.00 8243 8.00 8251 14.00 INS8251 6.50 8253 19.50 8255A 8.60 8257 99.00 8259 99.00 8275 99.00 8278 99.00 8295 25.00 DM8578 3.50 Ay-5-2376 19.56 MM5104N 10.00 MM55106N 10.00 MM57160 7.50 8748A 99.00 8755A 99.50 MCT2 .80 MCT6 3.30 MCT275 1.50 MCC671 3.00 4N28 .85 4N33 1.20 4N26 .85 MM80C95 .90 80C96 .90 MM80C97 .90 80C98 .90</p> <p>CAPACITORS 16V 33uf .15 330uf .40 25V 100uf .25 330uf .45 2500uf 1.00 50V 2500uf 2.15 63V 10uf .16 47uf .30 100uf .40 220uf .55 470uf .75 1000uf 1.65 RB. (PCB) 6.3V 470uf .20 1000uf .30 10V 4.7uf .10 100uf .10 16V 10uf .08 22uf .10 33/47uf .10 100uf .15 220uf .20 470uf .25 640uf .45 1000uf .40 2500uf .65 25V 2u2/3u3 .10 4u7/10u .10 25u/33u .12 47uf .13 100uf .15</p> <p>220uf .20 330uf .25 470uf .35 1000uf .50 2200uf .90 35V 2u2/3u3 .10 10uf .15 100uf .20 220uf .30 1000uf .70 2000uf .90 2200uf 1.10 50V 0.47uf .08 1u/2u2 .08 3.3uf .15 4.7uf .15 22u/33u .15 47u/100u .20 220uf .50 470uf .60 63V 0.47uf .10 1u/2u2 .10 3u3/4u7 .10 10u/25u .15 47uf .20 100uf .25 63V 220uf .40 330uf .45 470uf .80 160V 2.2uf .20 10uf .30 22uf .50 250V 2.2uf .25 350V 1uf .20</p> <p>CAN TYPE 35V 2500uf 1.95 40V 5600uf 1.90 50V 6800uf 4.50 63V 2500uf 3.25 75V 3300uf 5.90</p> <p>BIPOLAR 50V 1u/2u2 .25 3u3/4u7 .30 6.8uf .30 10/22uf .40 33uf .50 47uf .69 100uf .80</p> <p>POLYSTYRENE 125V 10pf to .45 680pf 1000pf to .55 10,000pf</p> <p>RESISTORS .33W .03 1W .07</p> <p>WINDING WIRE (B&S) 16.23 2.00 21.29 3.60 36.37 3.60 38.39 3.60 40 3.60 22 3.80 26 3.90 20.24 4.50 28 4.90 18.30 6.50 31.32 6.60 33.34 6.60</p> <p>FUSES 3AG 1-9 .09 10+ .08</p> <p>GREENCAPS 100V .001-.027 .09 .003-.056 .11 .068-1 .15 12-22 .25 0.27uf .30 0.33uf .30 0.39uf .45 0.47uf .40 .56, .68, .82 .50</p> <p>1.1, 2.1, 5 1.00 1.8uf 1.00 2.2uf 1.20 3.3uf 2.00 4.7uf 3.40</p> <p>ZENER DIODES E24 Range 400MW .12 1 Watt .23</p> <p>OPTOCOUPERS MCT2 .80</p> <p>MCT6 3.30 MCT275 1.50 MCC671 3.00 4N28 .85 4N33 1.20 4N26 .85</p> <p>AUDIO MODULES SI-1010 9.90 SI-1020 21.00 SI-1030 26.90 SI-1050 41.90 HY5 32.00</p> <p>HY50 41.00 HY120 93.00 HY200 132.00 HY400 175.00</p> <p>NEW PROJECT BOARDS ETI 263 \$1.80 ETI 151 \$2.20 ETI 152 \$2.00 ETI 261 \$1.50 ETI 264 \$1.50 ETI 321 \$3.90</p> <p>ETI 322 \$2.75 ETI 452 \$5.90 ETI 466 \$6.50 ETI 474 \$2.20 ETI 470 \$2.70 ETI 471 \$9.90 ETI 472 \$2.70 ETI 541 \$2.60 ETI 549A \$2.50 ETI 561 \$2.75 ETI 573 \$2.90 ETI 576 \$4.50 ETI 577 \$2.70</p> <p>ETI 606 \$2.30 ETI 726 \$3.30 80sa3 \$3.90 79FE11 \$2.50 79UPS6 \$2.90 79T111 \$2.20 79SF9 \$2.60 79PS11 \$2.90 79sa3 \$3.90 79md9 \$2.20 80au3 \$2.90 80cm3A \$2.40 80cm3B \$3.50</p> <p>DREAM 6800 \$10.90 DREAM 6802 \$11.90 (Redesigned board with notes to eliminate 6875 clock chip.) Please note boards are figerglass 1 oz copper precision drilled.</p>	<p>VOLTAGE REGULATORS 78L05 5V 100mA .40 LM341P-5 5V 500mA .80 7805 5V 1A 1.00 7905 5V 1A 1.70 LM309K 5V 1A 1.20 7805K 5V 1A 2.10 LM323-K 5V 3A 6.90 78H05KC 5V 5A 8.50 LM341p-8 8V 500mA .80 78L12CP 12V 100mA .40 79L12 12V 100mA .65 LM341P12 12V 500mA .75 7812 12V 1A 1.00 7912 12V 1A 1.90 7812KC 12V 1A 2.15 7912KC 12V 1A 2.60 79H12KC 12V 5A 8.00 78CBUC 13.8V 2A 3.50 78CBUC 13.8V 2A 6.00 78L15 15V 100mA .35 79L15 15V 100mA .65 LM341P15 15V 500mA .80 7815 15V 1A 1.00 7915CT 15V 1A 1.80 7915KC 15V 1A 2.60 78H15KC 15V 5A 6.50 78L18 18V 100mA .35 7818 18V 1A 1.40 78L24 24V 100mA .35 79L24 24V 100mA .65 7824 24V 1A 1.10 LM317T ADJ 1A 2.40 LM337T ADJ 1A 3.80 LM317K ADJ 2A 3.60 LM337K ADJ 2A 5.90 LM350K ADJ 3A 8.40 78BKCC ADJ 5A 10.50 78P05 5V 10A 10.50</p> <p>BRIDGES VM48 400V 1A DIL 1.50 W02 200V 1.5A .50 W04 400V 1.5A .50 W06 600V 1.5A .60 200V 3A 2.00 200V 6A 2.50 400V 6A 2.60 600V 6A 2.80 200V 10A 2.60 400V 10A 3.20 600V 10A 3.20 100V 35A 3.20 200V 35A 3.20 400V 35A 3.40</p> <p>DISPLAYS MAN2A 3" Red Alpha Num 6.30 MAN72A 3" CA Red 2.20 MAN74A 3" CC Red 2.20 MAN52A 3" CA Green 3.40 MAN82A 3" CC Green 3.40 MAN82A 3" CA Yellow 3.40 MAN84A 3" CC Yellow 3.40 MAN6740 56" 2 Digit CC Red 3.60 MAN8610 Red 3.30 MAN8640 Red 3.30 TIL306 12.00 DL704 3" CA Red 2.20 DL707 3" CA Red 3.40 DL750 63" CC Red 4.00 63" CC Red 4.00 FND357 362" CC Red 1.80 FND500 5" CC Red 1.80 FND507 5" CA Red 1.80 FND800 8" CC Red 3.00</p> <p>DIP SOCKETS 16 Pin Zip* Dip 11 \$1.50 24 Pin Zip* Dip 11 \$12.50 40 Pin Zip* Dip 11 \$17.50 *Zero Insertion Pressure</p> <p>DIP SWITCHES SPST P/N No. of Switches Price SD3 3 \$1.60 SD4 4 \$1.70 SD5 5 \$1.90 SD6 6 \$2.30 SD7 7 \$2.40 SD8 8 \$2.50 SD9 9 \$2.70 SD10 10 \$3.00</p> <p>WIRE WRAP 3-LEVEL 8 Pin 1-9 .75 .65 .50 14 Pin .90 .85 .80 16 Pin 1.00 .90 .85 18 Pin 1.20 1.10 1.00 20 Pin 1.40 1.30 1.20 22 Pin 1.60 1.40 1.30 24 Pin 1.90 1.80 1.70 28 Pin 2.20 2.10 2.00 36 Pin 2.60 2.40 2.30 40 Pin 2.90 2.70 2.50</p> <p>CANNON CONNECTORS XLP-3-11C 4.50 XLP-3-12C 4.50 XLP-3-13 4.20 XLP-3-14 3.60 XLP-LNE-31 4.50 XLP-LNE-32 4.60 XLP-LNE-12 5.50</p> <p>COMPUTER GRADE ELECTRO. 2900uf 40V 6.50 6800uf 16V 6.40 10,000uf 16V 9.00 10,000uf 25V 9.50 10,000uf 40V 11.90 15,000uf 40V 12.00 22,000uf 25V 12.90 22,000uf 40V 23.00 27,000uf 35V 23.50 33,000uf 16V 23.50 68,000uf 16V 21.50 100,000uf 10V 20.50</p> <p>MULTISTRAND RIBBON CABLE Price Per Meter: 1-9 10+ 10 Way .70 .60 12 Way .75 .65 16 Way 1.00 .90 20 Way 1.35 1.25 40 Way 2.70 2.50</p> <p>CRYSTALS freq. MHz. HOLDER PRICE 1 000 HC33 \$12.50 1.8432 HC33 \$10.50 2.000 HC33 \$6.90</p>	<p>2.097152 HC33 \$6.90 2.4576 HC33 \$6.90 2.500 HC33 \$6.90 3.000 HC33 \$7.90 3.000 HC33 \$7.90 3.2768 HC18 \$7.90 3.2768 HC33 \$7.90 3.330 HC33 \$7.90 3.330 HC18 \$7.90 3.579545 HC33 \$7.90 3.579545 HC18 \$4.90 3.6000 HC18 \$4.90 4.000 HC33 \$4.90 4.000 HC18 \$4.90 4.194304 HC18 \$6.90 4.33619 HC18 \$6.90 4.440 HC18 \$6.90 4.450 HC18 \$6.90 4.750 HC18 \$6.90 4.91520 HC18 \$6.90 4.9562 HC18 \$6.90 5.0688 HC18 \$6.90 5.185 HC18 \$6.90 5.585 HC18 \$6.90 5.585 HC18 \$6.90 5.587 HC18 \$6.90 5.7143 HC18 \$6.90 5.9904 HC18 \$6.90 5.000 HC18 \$4.90 6.000 HC18 \$4.90 6.1444 HC18 \$5.90 6.400 HC18 \$6.90 6.5536 HC18 \$6.90 6.6670 HC18 \$6.90 7.15900 HC18 \$6.90 8.000 HC18 \$4.90 8.330 HC18 \$6.90 9.304 HC18 \$6.90 10.000 HC18 \$4.90 10.73865 HC18 \$6.90 11.000 HC18 \$4.90 12.000 HC18 \$4.90 13.5168 HC18 \$6.90 14.31818 HC18 \$6.90 15.000 HC18 \$4.90 16.000 HC18 \$4.90 18.000 HC18 \$5.50 18.432 HC18 \$6.90 19.6608 HC18 \$7.50 20.000 HC18 \$5.50 23.400 HC18 \$7.50 23.684 HC18 \$7.50 24.000 HC18 \$5.50 27.000 HC18 \$5.50 32.000 HC18 \$5.50 36.000 HC18 \$5.50 48.000 HC18 \$5.50 100.00 HC18 \$15.00</p> <p>PLEASE NOTE: Not all crystals are in stock at present but are on order.</p> <p>SPECIALS: 2114 (450 ns) 8 for \$38.00 2114 (450 ns) 16 for \$75.00 2114 (450 ns) 32 for \$149.00 2114 (450 ns) 64 for \$293.00 2708 (450 ns) 1-8 for \$8.50 ea 2708 (450 ns) 16-32 for \$8.35 ea 4116 (200-250 ns) 1-7 \$10.00 ea 4116 (200-250 ns) 8-15 \$9.85 ea 4116 (200-250 ns) 16-31 \$9.68 ea 4116 (200-250 ns) 32+\$8.62 ea 10 BU208 \$25.00 100 BU208 \$200.00 10 BU126 \$28.00 10 BDx80 \$75.00 10 BD139 \$3.50 10 BD140 \$3.50 10 BD549 \$1.00 10 BC559 \$1.50 10 BC547 \$1.00 10 BC557 \$1.50 10 BC327 \$1.50 10 RL4136 \$13.00 10 2114 (450 ns) \$47.50 10 2708 \$84.00 10 Red Leds \$1.20 100 Red Leds \$10.00 10 Green Leds \$2.00 10 7447 \$6.00 10 7490 \$3.50</p>
---	--	---

All prices current only until 7th August, 1980.

For heavier items add additional postage. Extra heavy items sent Comet freight on. Prices subject to change without notice. Send 60c and SAE for free catalogues. Minimum pack and post \$1.25. Bankcard Mail Orders welcome.

Application

40MHz DUAL TRACE OSCILLOSCOPE

Model BS-615 15KV 40MHz & 1mV/div

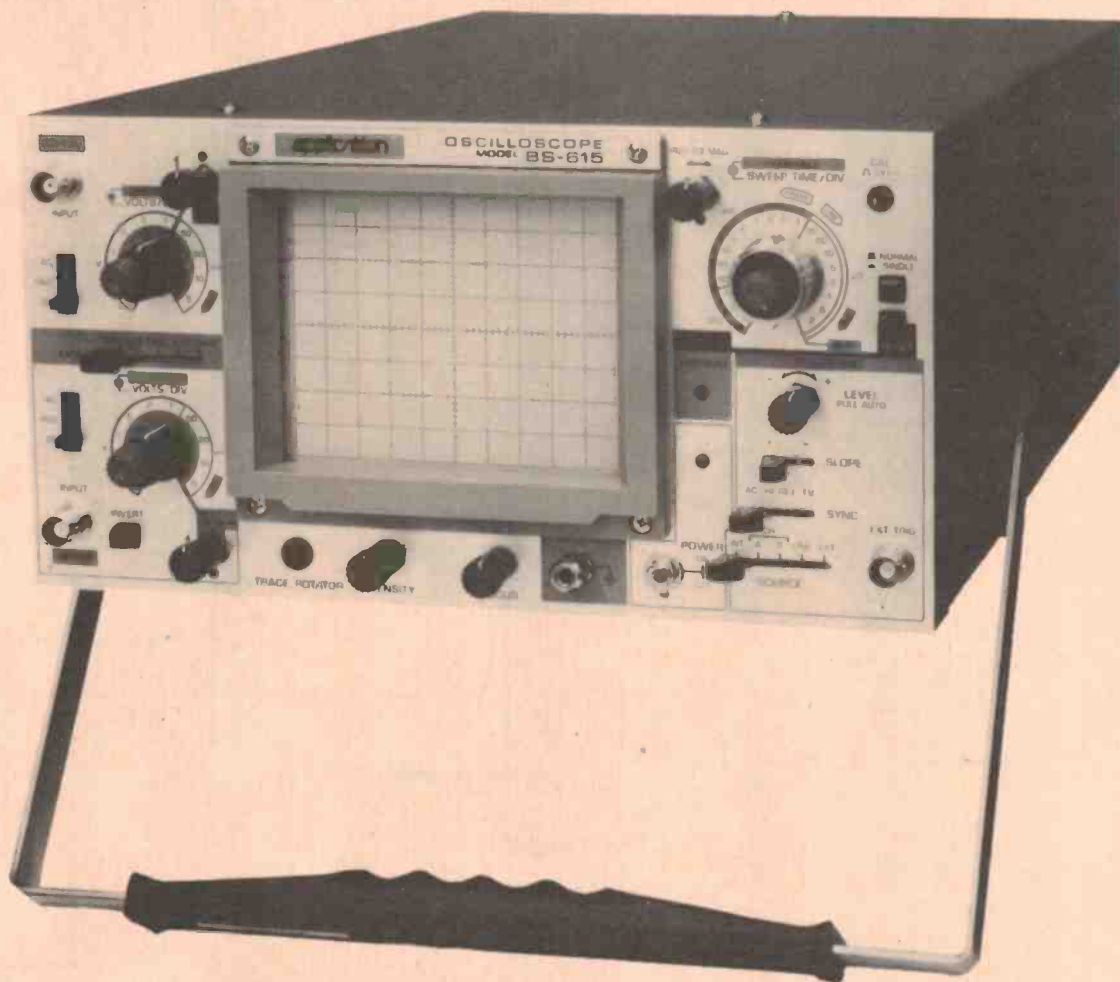

The new APPLICATION BS-615 oscilloscope offers these features:

40MHz bandwidth at 5mV/CM
10MHz bandwidth at 1mV/CM
15KV accelerating potential for a bright display
Inbuilt TV Sync Separator
Inbuilt delay line for rise time analysis

X-Y operation
Stable triggering
Internal graticule
Under \$1,000
(Including duty and excluding tax)

ELMEASCO Instruments Pty. Ltd.



SYDNEY

PO Box 30, Concord NSW
2137. 13-15 McDonald St,
Mortlake NSW. Phone
(02) 736-2888. Telex 25887.

MELBOURNE

PO Box 107, Mt. Waverley Vic,
3149. 21-23 Anthony Drive,
Mt. Waverley Vic. Phone
(03) 233-4044. Telex 36206.

ADELAIDE

Phone (08) 51-3521.

PERTH

Phone (09) 398-3362.

BRISBANE

Phone (07) 229-3161.

Two-tone generator for testing singlesideband systems

This project is an invaluable test instrument for the radio amateur or serviceman working with SSB transmitters.

WHEN SETTING UP a home-made SSB transmitter (such as one using our Project 725 Polyphase Generator, published in August 1979), testing a transceiver or setting up a homebrew linear amplifier, an appropriate audio signal source is absolutely essential. The most commonly used signal source for this sort of testing is a "two-tone" signal generator. Used in conjunction with even a simple oscilloscope, any single-sideband transmission system can be adjusted for best linearity — and thus, least distortion — eliminating "splatter" which can cause interference to other transmissions nearby. The two-tone generator is also invaluable for determining peak envelope power (PEP) of a transmitter.

Why?

The input-output relationship of a single-sideband transmitter must be reasonably linear or intermodulation will cause distortion products that can extend well outside the SSB channel. The amount of distortion tolerable in an SSB rig is difficult to estimate. Of course, it is important to ensure that products outside the channel are kept as low as possible, but distortion that occurs inside the channel is another matter. Gross distortion must be avoided — but often, changes in distortion level may make very little difference to the perceived transmission quality. Furthermore, in attempting to eliminate some small vestige of distortion inside the passband, other parameters may be degraded. Most likely to suffer will be efficiency, with an associated increase in current flowing in the output stage causing increased thermal dissipation, and possibly a shortening of the output device's lifespan.



The completed project was housed in a convenient 'zippy' box.

The major causes of distortion in output stages are clipping and cross-over distortion. Clipping occurs at high power levels. An increasing input voltage will eventually overdrive the amplifier, when it is not possible for the output voltage (or current) to follow the input accurately. It is easily cured by ensuring that the output stage is not overdriven. A two-tone generator is used to establish the maximum input level that will not produce clipping.

Cross-over distortion in push-pull designs is related to bias adjustment and becomes the dominant form of distortion at low signal levels. The cure is not as simple as is the cure for clipping. The output stage idle current can be increased but this will decrease efficiency. Often, filtering is used to reduce distortion products due to cross-over and here again, the two-tone generator is used to get an idea of the amount of cross-over distortion present.

The test generator is used with a CRO connected to the output of the transmitter, either directly or via an RF probe. The generator is connected to the microphone input and the resultant wave shape observed on the CRO. The presence of distortion products will change the waveform so that a clean sine wave shape will indicate a good clean transmitter. Increasing the input level until the output 'flattens' on the peaks will indicate the input level at which clipping occurs (this is called "flat-topping").

The generator

The generator simply mixes two sine waves together so that the transmitter is modulated by the beat frequency of the two tones. It is important that the tones are not harmonically related and that one of the tones can be adjusted slightly in frequency to make it easier for inexpensive CROs to sync on the ▶

Project 149

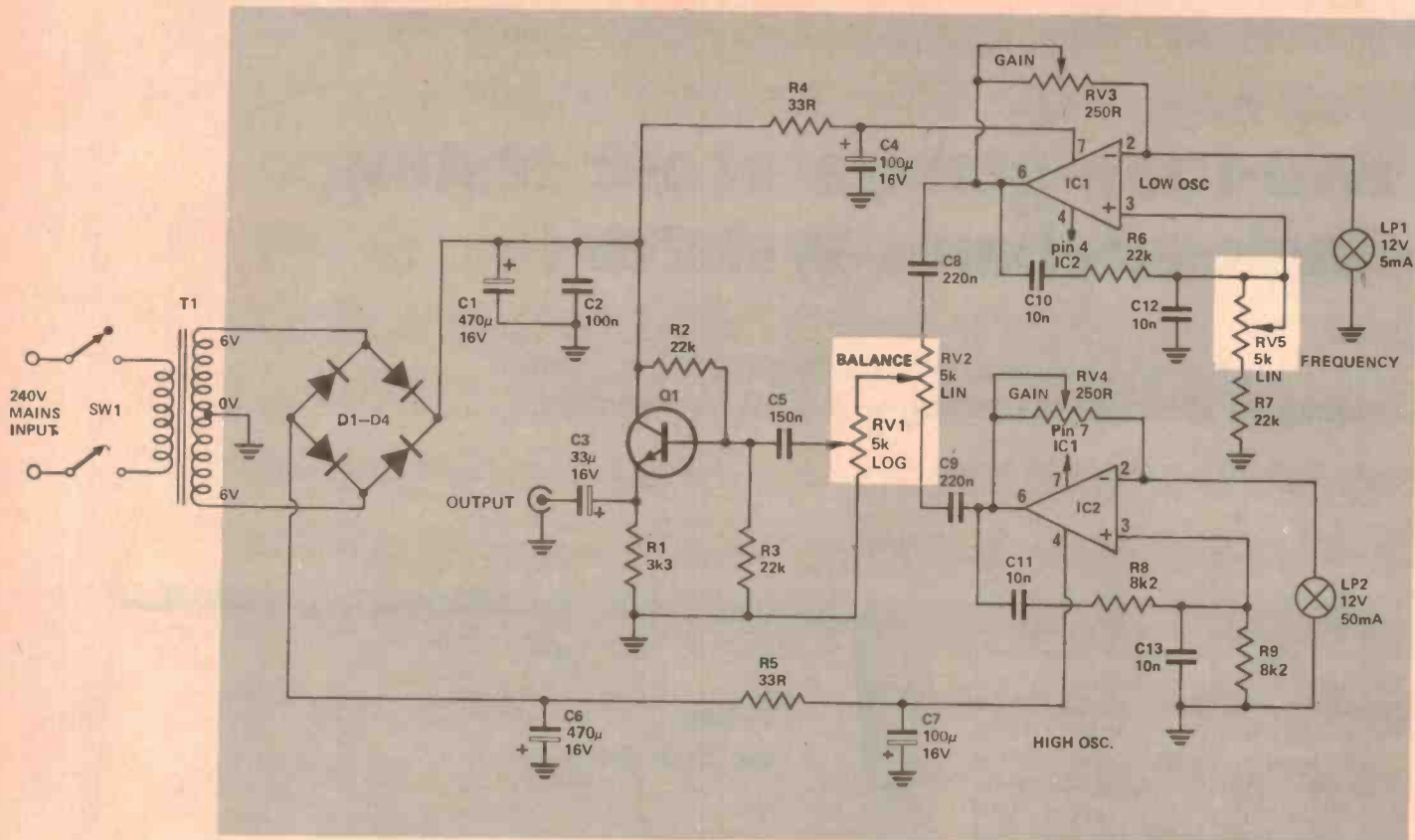

output waveform. A balance control has been fitted to the unit so that the level of the two tones can be made equal if filtering in the transmitter audio pre-amplifier attenuates one signal more than the other.

The sine wave oscillators consist of op-amps in a Wien Bridge circuit. (See 'Lab Notes', Dec. '79). The frequency of the basic oscillator is given by the equation:

$$f = \frac{1}{2\pi R_8 C_{11}} \text{ Hz. Where } R_8=R_9, \text{ and } C_{11}=C_{13}.$$

This gives frequencies of 1850 Hz for the fixed oscillator and 600 to 700 Hz for the variable frequency oscillator.

The problem with this type of circuit is that the gain must be closely maintained or the sine wave will be clipped severely. The necessary gain stability is achieved with the use of a light bulb in the negative feedback loop. The resistance of the light bulb varies with temperature, increasing with increasing temperature. If the oscillator amplitude were to increase, the larger current through the filament would increase its temperature, increasing its resistance, bringing about a rise in the amount of negative feedback and a consequent decrease in oscillator

HOW IT WORKS

IC1 and IC2 form Wien Bridge oscillators at the frequency determined by C10, C11, C12 and C13, R6, R7, R8, R9 and RV5. The potential dividers formed by RV3, RV4 and the two light bulbs maintain the amount of overall gain to prevent distortion. Capacitors C8 and C9 couple the outputs of the oscillators to the balance pot RV2. Capacitor C5 couples the output of the volume control to Q1. The bias for this stage is determined by the potential divider R2, R3. The output is taken across R1 via the 33µF tantalum capacitor. The power supply is constructed on the same printed circuit board, diode D1 to D4 forming a full wave bridge rectifier, C1 and C6 being smoothing capacitors.

amplitude. The circuit works very well and once the oscillators are set up, they will operate quite reliably. The light bulb used was a standard 12 volt "lilliput" bezel globe rated at 50 mA. A variety of globes can be used, although the value of the feedback presets might have to be changed, if the bulb chosen has a very different current rating from the one specified.

The outputs of the two oscillators are fed to either side of RV2 which serves as the 'balance' pot, and then via

RV1 to an emitter-follower stage around Q1. This provides the generator with the necessary low output impedance. If it is found that the output voltages are unnecessarily high a series resistor ($\approx 47k$) can be placed between the wiper of RV2 and the 'top' of RV1 - replace the link between the wiper of RV2 and the pc board with the resistor.

Construction

The construction is reasonably simple since it is mostly confined to the pc board. The order the components are placed on the board is not really critical, but it is probably wise to leave the ICs until last as they are the most difficult to unsolder should they be accidentally overheated while soldering other components around them. The light globes are soldered onto the pc board by first soldering wires to the globe. Short lengths of wire cut from the resistors already on the board are ideal for this. Care must be taken not to overheat the globe when soldering to the bottom connection, as the bulb is likely to unsolder itself internally with the heat applied from the soldering iron.

The prototype was constructed in a plastic 'zipper' box but any suitable

two-tone generator

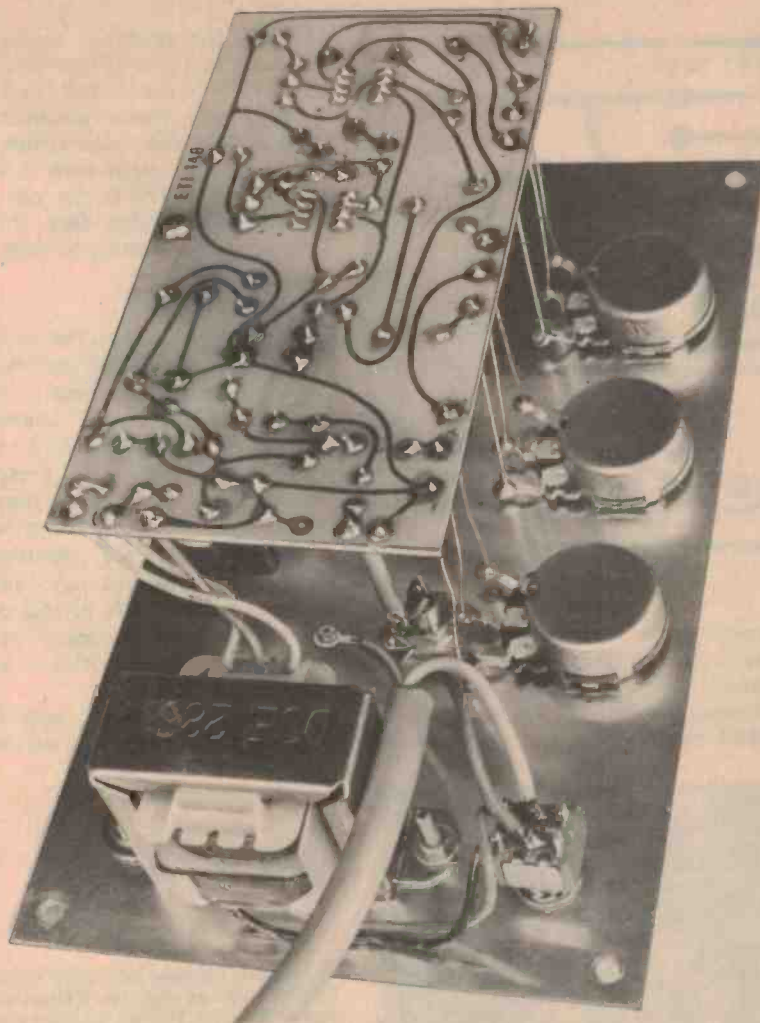

View of the internal construction showing placement of the major components and wiring to the potentiometers. The mains earth lead should be grounded to the front panel. Use a cable clamp where this lead enters the case.

PARTS LIST — ETI 149

Resistors

R1	3k3
R2,3,6,7	22k
R4,R5	33R
R8,R9	8k2

Potentiometers

RV1	5k log
RV2, RV5	5k lin
RV3, RV4	250 ohm vertical mounting mlni trimpots

Capacitors

C1, C6	470u, 16V electro
C2	100n greencap
C3	33u, 16V tantalum
C4, C7	100u, 16V electro
C5	150n greencap
C8, C9	220n greencap
C10, 11, 12, 13	10n greencap

Semiconductors

Q1	BC548, BC108 or similar
IC1, IC2	741 op-amp
D1-D4	EM401, 1N4001 or sim.

Miscellaneous

LP1, LP2	15 V/50 mA lght bulbs
T1	6.3 - 0 - 6.3 V, 150 mA transformer (M-2851 or similar)
SW1	DPST 240 Vac switch
		RCA phono output socket; zippy box — 200 x 115 x 60 mm; ETI-149 pc board; three knobs; Scotchcal front panel (see "Shoparound" this issue); power cable, cable clamp and plug.

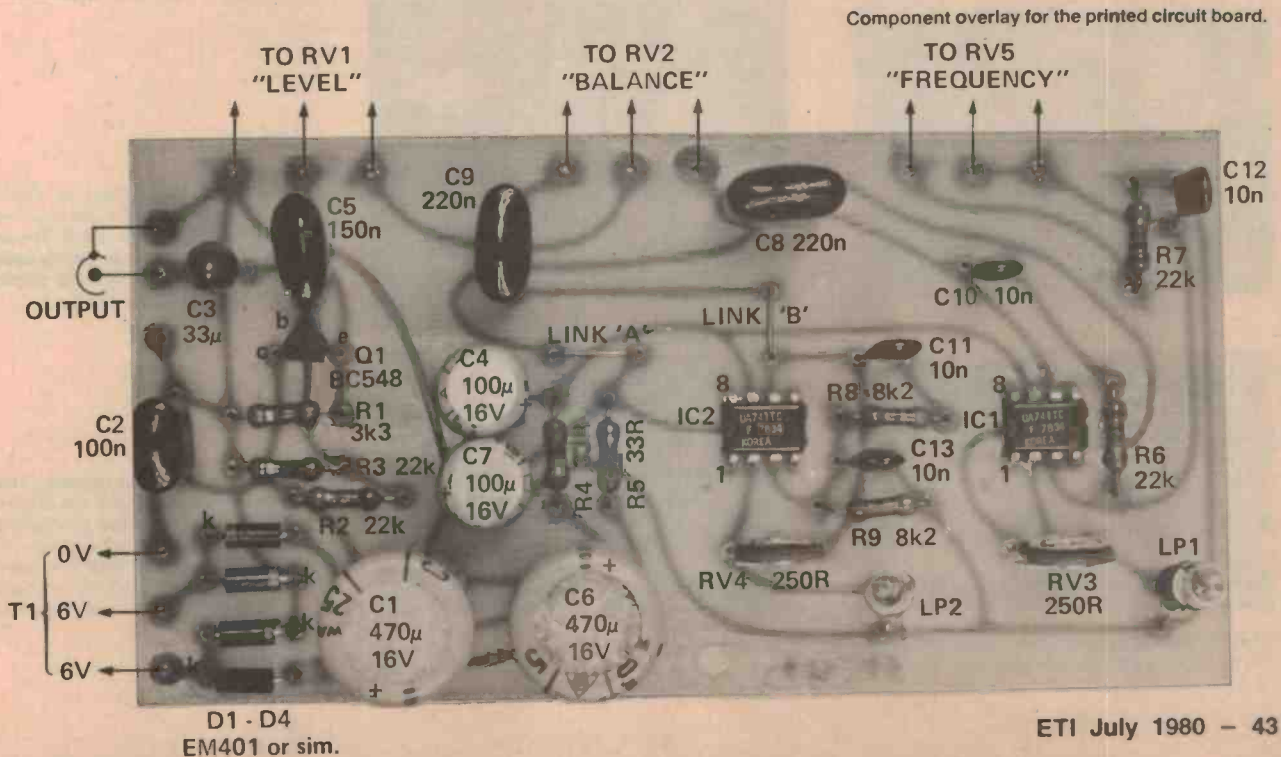

D1 - D4
EM401 or sim.

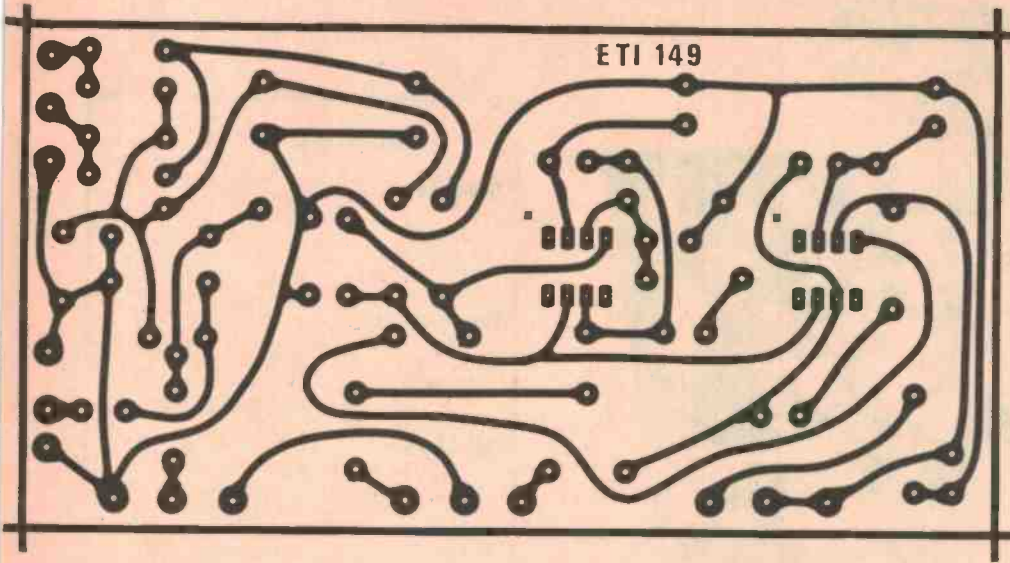

sized box could be used. The printed circuit board was mounted onto the front panel by one bracket bolted to the rear of the board (see photo) and the wire connections to the

potentiometers. If this method of construction is chosen it is necessary to ensure that the pots are mounted in the correct position on the front panel. Shielded cable should be used to

connect the output of the board to the RCA socket; this will prevent hum being induced into the output from the power transformer. Make absolutely certain that all 240 volt connections are secure and that the earth wire is soldered to a lug and bolted firmly onto the front panel. The mains flex should enter the case via a clamp grommet.

Powering up

Before connecting to the supply, check all the 240 Vac wiring and the pc board. If all is correct, connect a CRO to the output and turn the balance control fully to the side connected to the fixed oscillator. Adjust the preset control RV4 so that oscillation starts. Determine the range over which the circuit will oscillate, ensuring that the waveform does not clip, and set the preset in the middle of this range. Now wind the balance control to its other extreme and adjust RV3 in exactly the same way.

That's it! And may your extraneous sidebands be vanishingly small. ●

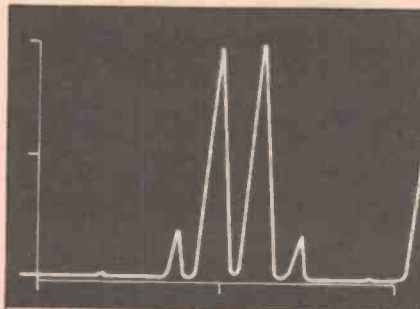
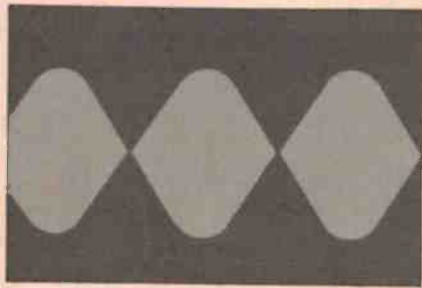

◀ A properly adjusted transmitter should produce a CRO pattern as at left and a clean analyser trace, as on the right. The two signal tones predominate and distortion products (the two small 'pips') are well down. Note the clean 'crossing points' on the CRO display.

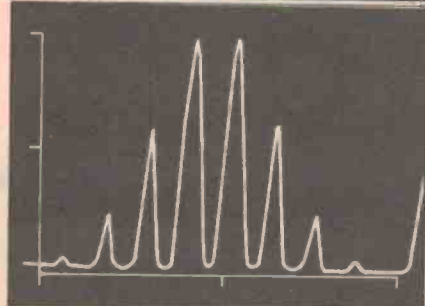
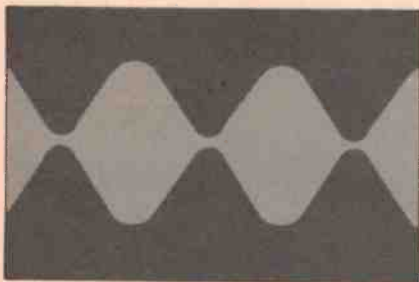

◀ If the bias on one stage of the linear amplifier system is set too low, particularly the PA bias, these sort of patterns result. The crossing points on the CRO pattern are clearly rounded while the analyser display shows the distortion products have increased dramatically.

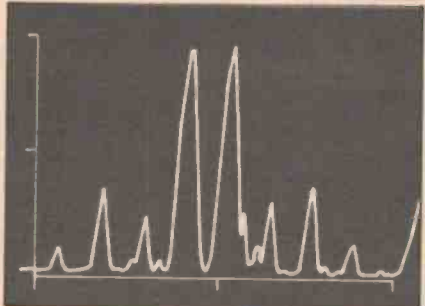
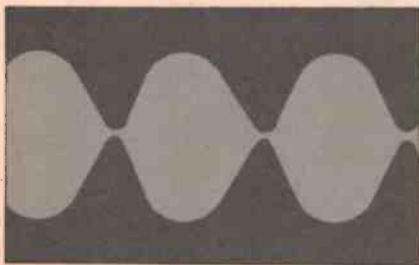

◀ A classic case of 'flat topping'. The CRO display has flattened peaks and the crossing points are obviously rounded. The analyser display shows the distortion products have moved away from the main signal. A signal like this causes 'splatter' well away from the transmitting frequency. In general, it is caused by overdriving linear amplifier stages.

Typical oscilloscope patterns you will obtain with corresponding spectrum analyser displays, when using the two-tone generator to adjust an SSB transmitter.

public apology

ROD IRVING ELECTRONICS AND STAFF WISH TO APOLOGISE FOR THE INCONVENIENCE CAUSED TO ITS MANY CUSTOMERS WHO ARE CONTINUALLY FORCED TO TRIP OVER EACH OTHER DUE TO OUR CRAMPED SHOP CONDITIONS. WE ARE PROUD TO ANOUNCE THAT FROM THE 1ST OF JULY WE HAVE MOVED TO LARGER PREMISES AT 425 HIGH ST NORTHCOTE JUST 2 BLOCKS TOWARDS THE CITY.

TO CELEBRATE: THE FIRST 200 HOBBYISTS TO PRESENT THIS AD WILL RECEIVE A FREE BAG OF ELECTRONIC GOODIES*****

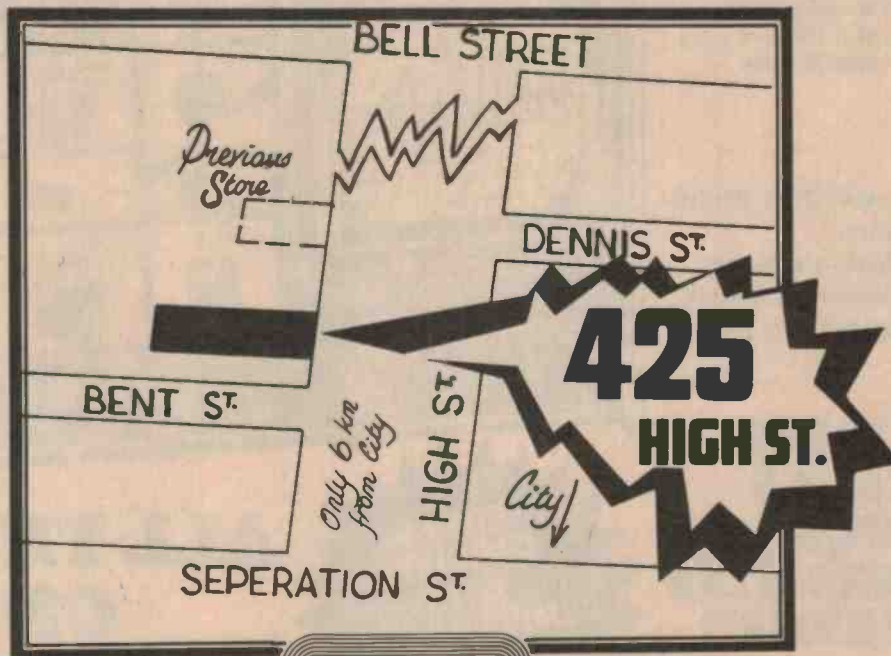

RIE ROD
IRVING
ELECTRONICS

425 HIGH ST., NORTHCOTE

PHONE (03) 489 8131 General Enquiries
(03) 481 1436 Mail Order Enquiries
(03) 489 7099 Ritronics Wholesale

MAIL ADDRESS P.O. BOX 235, NORTHCOTE VIC. 3070.

**AT
LAST!**

A LABORATORY QUALITY 6.5MHz CRO AT A HOBBYIST PRICE!

Here's what 'Electronics Australia' had to say:

... this neatly styled little oscilloscope should be just the shot for the hobbyist who cannot afford an expensive CRO ... now a CRO has been placed within the financial reach of most hobbyists ... our overall impression of the Q-1280 oscilloscope is that it represents good value for money.

This is it! The new Dick Smith Q-1280 laboratory oscilloscope. With a useable bandwidth to beyond 6.5MHz, it's the ideal budget cro for everyone!

- HOBBYISTS
- AMATEURS
- SCHOOLS
- UNIVERSITIES
- SERVICEMEN

SPECIFICATIONS:

Vertical Deflection Sensitivity: 10mV/DIV
 Horizontal Deflection Sensitivity: 500mV/DIV
 Time base - Sweep Frequency: 10Hz to 100KHz in 4 ranges
 Synchronising: Internal and external.
 Power Requirements: 100/234V, 50/60Hz, approximately 10W
 Dimensions: 202(w) x 160(h) x 306(d)mm. Weight: Approximately 3.8kg.

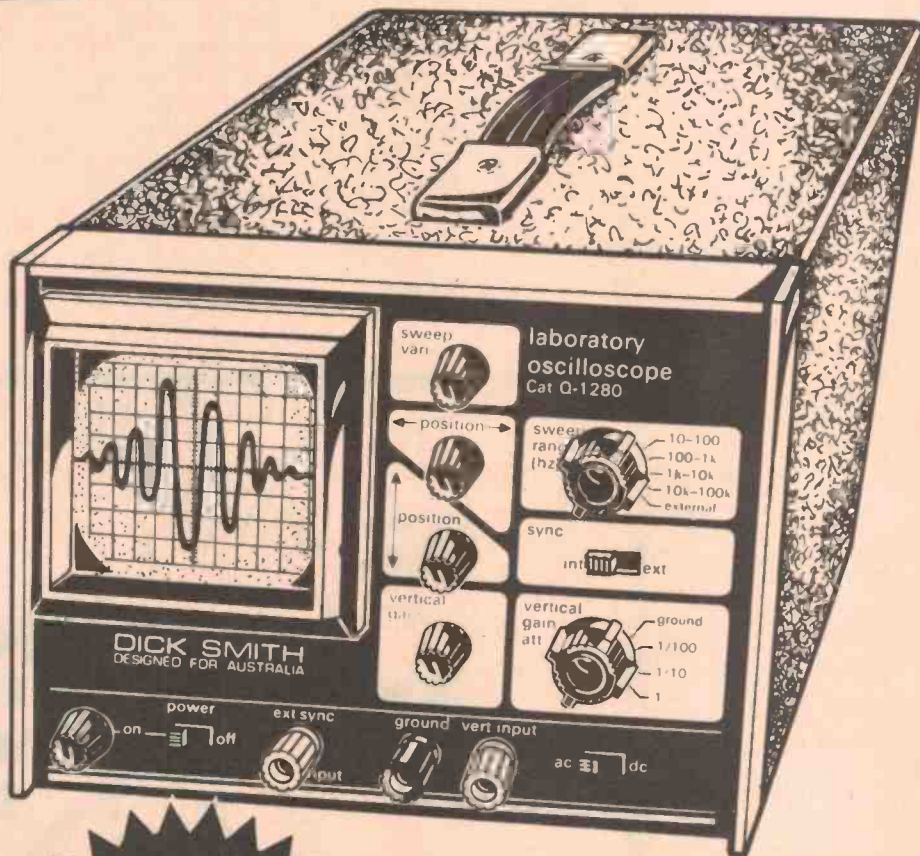

**COMES
COMPLETE
WITH
COMPREHENSIVE
USER'S
MANUAL**

**ALL THIS FOR
ONLY**

\$199⁰⁰ Cat. Q-1280

**\$6.00 Freight anywhere in Australia
THAT'S BELOW COST!**

DICK SMITH ELECTRONICS

NSW 125 York Street, SYDNEY, Ph 290 3377
 147 Hume Highway, CHULLORA, Ph 642 8922
 162 Pacific Highway, GORE HILL, Ph 439 5311
 30 Grose Street, PARRAMATTA Ph 683 1133
 613 Princes Highway, BLAKENURST Ph 546 7744
 263 Keira Street, WOLLONGONG, Ph 28 3800

VIC 399 Lonsdale Street, MELBOURNE, Ph 67 9834
 656 Bridge Road, RICHMOND, Ph 428 1614
 166 Logan Road, BURANDA, Ph 391 6233
 842 Gympie Road, CHERMSIDE, Ph 59 6255
QLD 96 Gladstone Street, FYSHWICK, Ph 80 4944
ACT 60 Wright Street, ADELAIDE, Ph 212 1962
SA 414 William Street, PERTH, Ph 328 6944
WA

bankcard
welcome here

SHOPS OPEN 9AM to 5.30PM
 (Saturday: 9am till 12 noon)
 BRISBANE: Half hour earlier.
 ANY TERMS OFFERED ARE TO
 APPROVED APPLICANTS ONLY
 RE-SELLERS OF DICK SMITH
 PRODUCTS IN MOST AREAS OF AUSTRALIA.



MAIL ORDER CENTRE: PO Box 321, NORTH RYDE NSW 2113. Ph 888 3200. PACK & POST EXTRA.

Four-input guitar/mic preamp to suit the ETI-466 module

Featuring simple construction and versatile operation, this preamp has been designed to mate with our 300 W 'Brute' power amp.

David Tilbrook

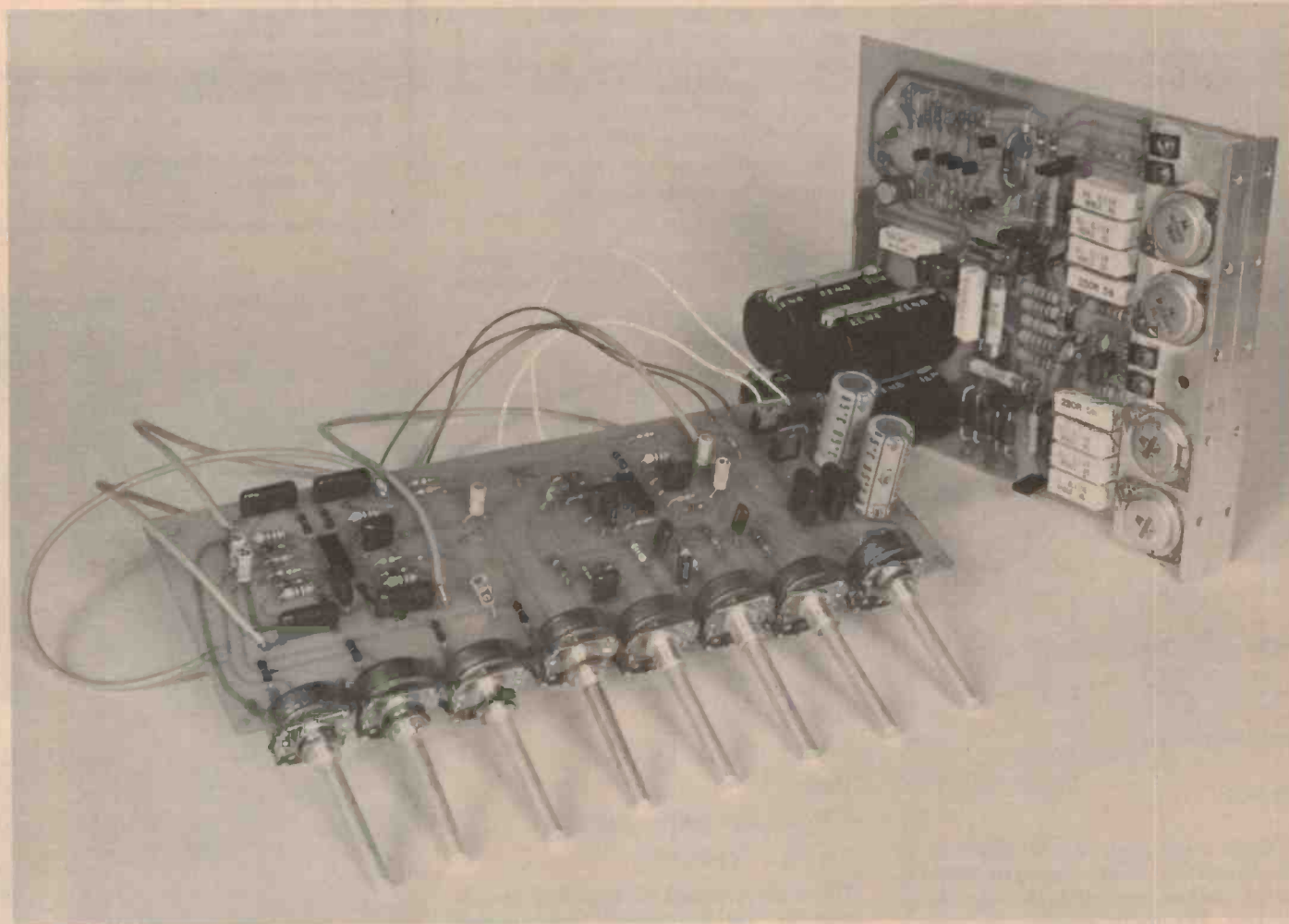

HAVING published the ETI-466 300 W power amplifier in February this year, we have had many requests for a guitar preamp capable of driving the module to full output. The biggest demand seems to be for a four-input preamp with bass, presence and treble controls followed by a master volume control. We are presenting the project as a printed circuit board rather than mounting the pc board in a chassis, as we feel most constructors will want to organise a chassis to meet their own requirements.

SPECIFICATIONS 4-INPUT PREAMP ETI-467

Hum and noise	76 dB below 50 mV Input signal (20 kHz bandwidth)
Frequency response	30 Hz to 30 kHz, ± 1 dB
Tone controls	Bass: ± 17 dB @ 50 Hz Presence: ± 22 dB @ 1.5 kHz Treble: ± 22 dB @ 10 kHz
Max. output before clipping	20 V peak to peak

Project 467

The power transformer recommended for use with the 466 power amp has an additional 15-0-15 volt winding that can be used to power this project if desired. For this reason we have included all the power supply components on the pc board, including voltage regulators. If the project is being constructed as a separate, stand-alone pre-amplifier, a small 12-0-12 volt power transformer can be used, such as the one specified in the parts list.

Design

The circuit consists of four input stages, followed by a mixing stage, tone control and output amplifier. The four input amplifiers drive the output of the mixing stage. This feeds the tone control circuit and then the final volume control and output amplifier. The 4136 quad operational amplifier IC was used throughout the project, mainly for the convenience of the quad package. One IC is used for the four input stages and the other for the mixing stage, tone control and output amplifier.

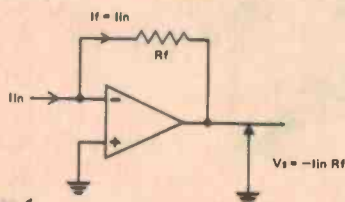

Figure 1.

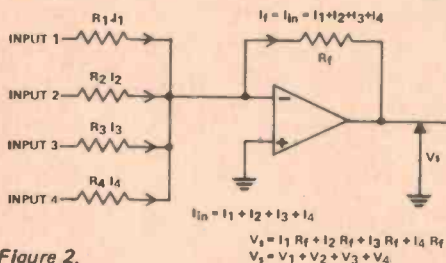

Figure 2.

Each input goes to one amplifier of the first 4136, where the input signal is amplified before going to the input level control. The input stages each have a gain of 20 dB, so a typical input level of around 50 mV will be amplified to 500 mV before being applied to the input level controls. With the input controls set at midway position the output from the potentiometers will be reduced to around 50 mV again. Without the input amplifiers, this signal voltage would be only 5 mV, causing a dramatic decrease in signal-to-noise ratio. The input amplifiers have an input impedance of 100k which should suit the vast majority of guitars. The

outputs of the input level controls are fed to a 'virtual earth' point formed by the feedback loop around another op-amp. This is probably the most common technique used for mixer stages at audio frequencies and allows signal voltages or currents to be added independently. Figure 1 shows the circuit of an ideal op-amp with negative feedback applied through resistor R_f . If a positive-going current is passed into the non-inverting (-ve) input, the output of the op-amp will swing negative, pulling current through the resistor R_f , until the voltage at the non-inverting input returns to zero. The output of the op-amp will always attempt to maintain the voltage on the non-inverting input at earth potential and for this reason it is referred to as a 'virtual earth' point. The output signal voltage from the op-amp is given by the equation,

$$V_s = -I_{in} R_f$$

Where: V_s is the signal output voltage
 I_{in} is the input signal current
 and R_f is the value of the feedback resistor.

If input resistors are added to the circuit as shown in Figure 2, the signal current from each input will be determined by the input signal voltage and the particular input resistor. Since the non-inverting input is a virtual earth point, the current through each input resistor will not be affected by the other input currents. The total input current simply becomes the sum of all the individual input currents. So,

$$I_{in} = I_1 + I_2 + I_3 + I_4$$

and since the output signal voltage is given by:

$$V_s = -I_{in} R_f$$

then

$$V_s = I_1 R_f + I_2 R_f + I_3 R_f + I_4 R_f \\ = V_1 + V_2 + V_3 + V_4.$$

The output signal voltage is thus the sum of the individual input signal voltages — exactly what is required of a mixing stage.

The output of the mixer is fed to the input of the tone control circuit. The bass, presence and treble controls are formed by including a potentiometer and a suitable R-C combination in the feedback loop of an op-amp. The potentiometer varies the amount of feedback around the op-amp and this has the effect of altering the frequency response of the circuit.

We judged that most guitarists would

HOW IT WORKS

The four input stages each use one section of a 4136 quad operational amplifier. These op-amps are internally compensated and require no external compensation capacitor. The input stages are configured as inverting amplifiers with a gain of 10 (20 dB) set by the ratio of the input resistor to the feedback resistor. The 100 ohm resistor in series with the output of each op-amp isolates any reactance on the output from the feedback loop, ensuring maximum freedom from instabilities that might otherwise cause oscillation.

Resistors R21 and R22, and capacitors C9 and C10 decouple the positive and negative supplies of the input amplifiers from all subsequent amplifier stages.

The outputs of the input stages are fed to the mixer input where they are summed as described in the text. The signal is then fed to the input of the tone control circuit, then through the master volume control to the last amplifier stage and finally to the output.

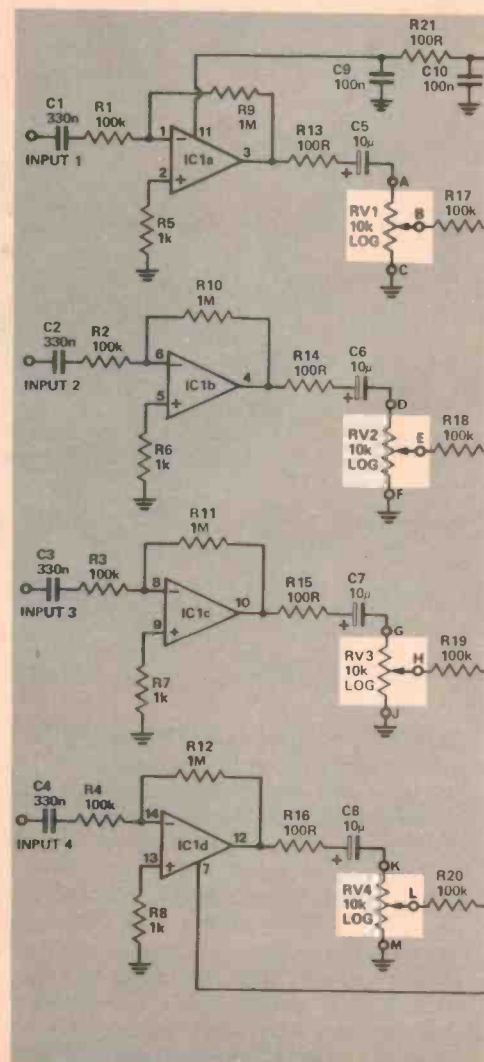

— ETI 467

The tone control stage works in a very similar way to the mixer stage. The signal currents in the bass, presence and treble circuits are summed at the non-inverting (-ve) input of the op-amp without interacting with one another, so the tone control really consists of three circuits operating simultaneously and these can be analysed separately. In each control, the potentiometer and the two resistors connected to each end of it, form the effective input and feedback resistance. The position of the wiper will determine the overall gain of the circuit. If a capacitor is now added, either across the potentiometer or in series with its wiper, a low pass or high pass frequency response, respectively, is obtained. The presence control simply consists of both a low pass and a high pass in the one circuit, forming a variable bandpass filter.

The power supply circuit is simple and uses commonly available IC voltage regulators to ensure stable voltage rails and minimise hum levels.

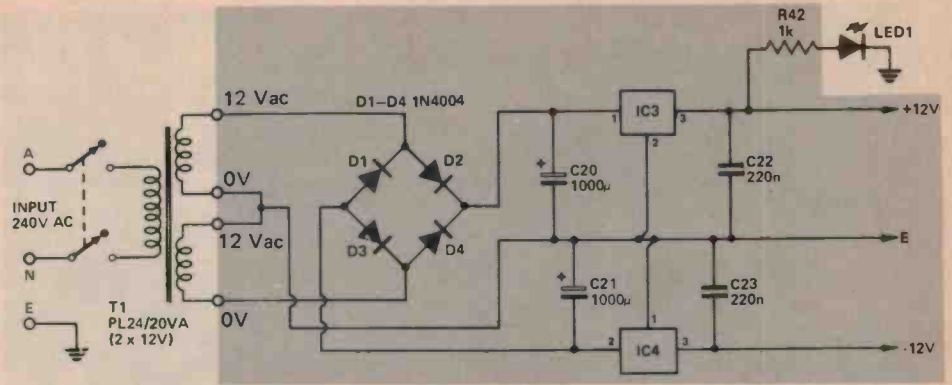

TANTALUM CAPACITOR

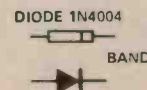
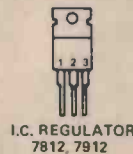
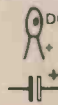

QUAD OP-AMP 4136
TOP VIEW

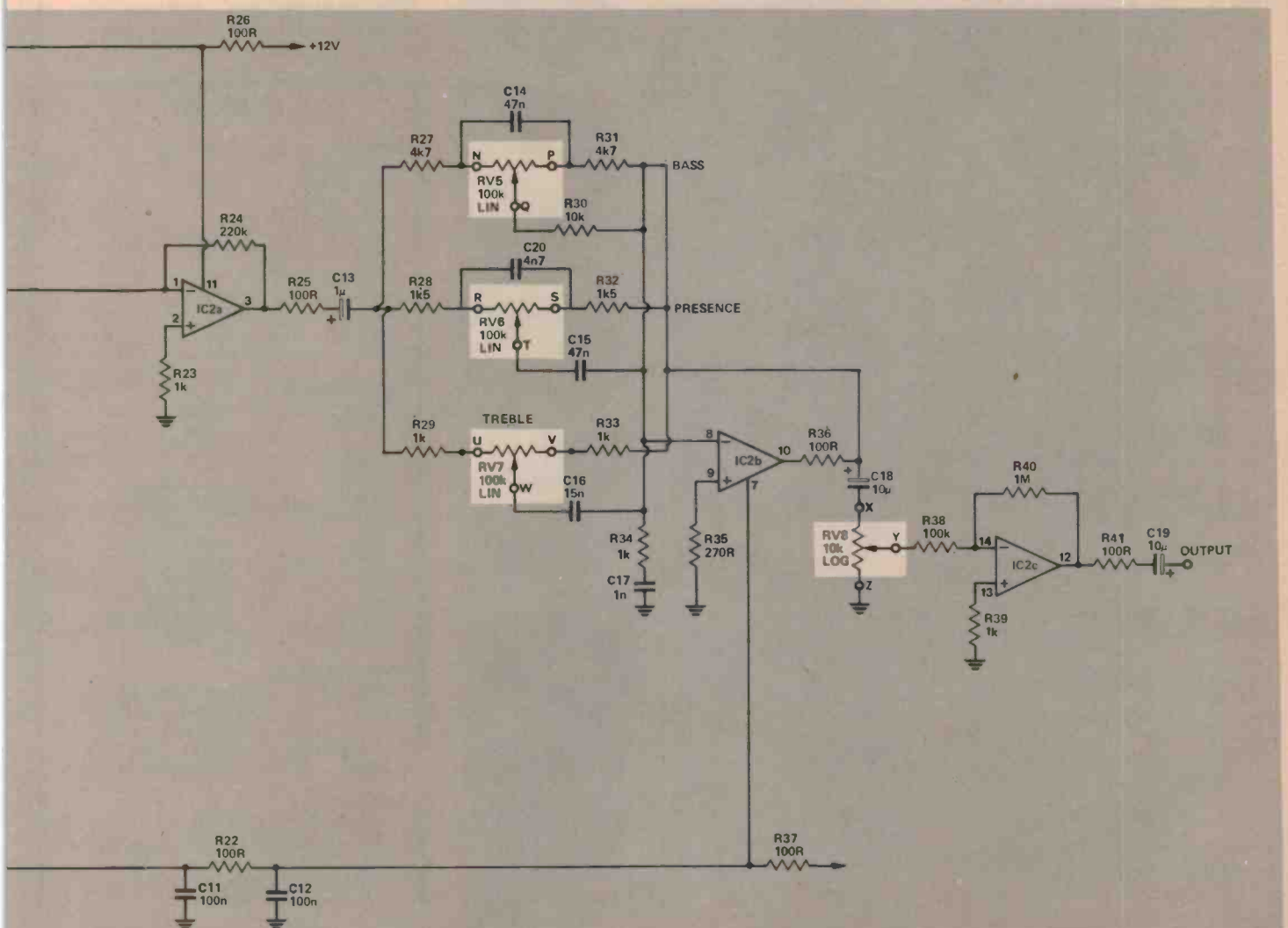
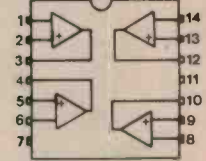

Project 467

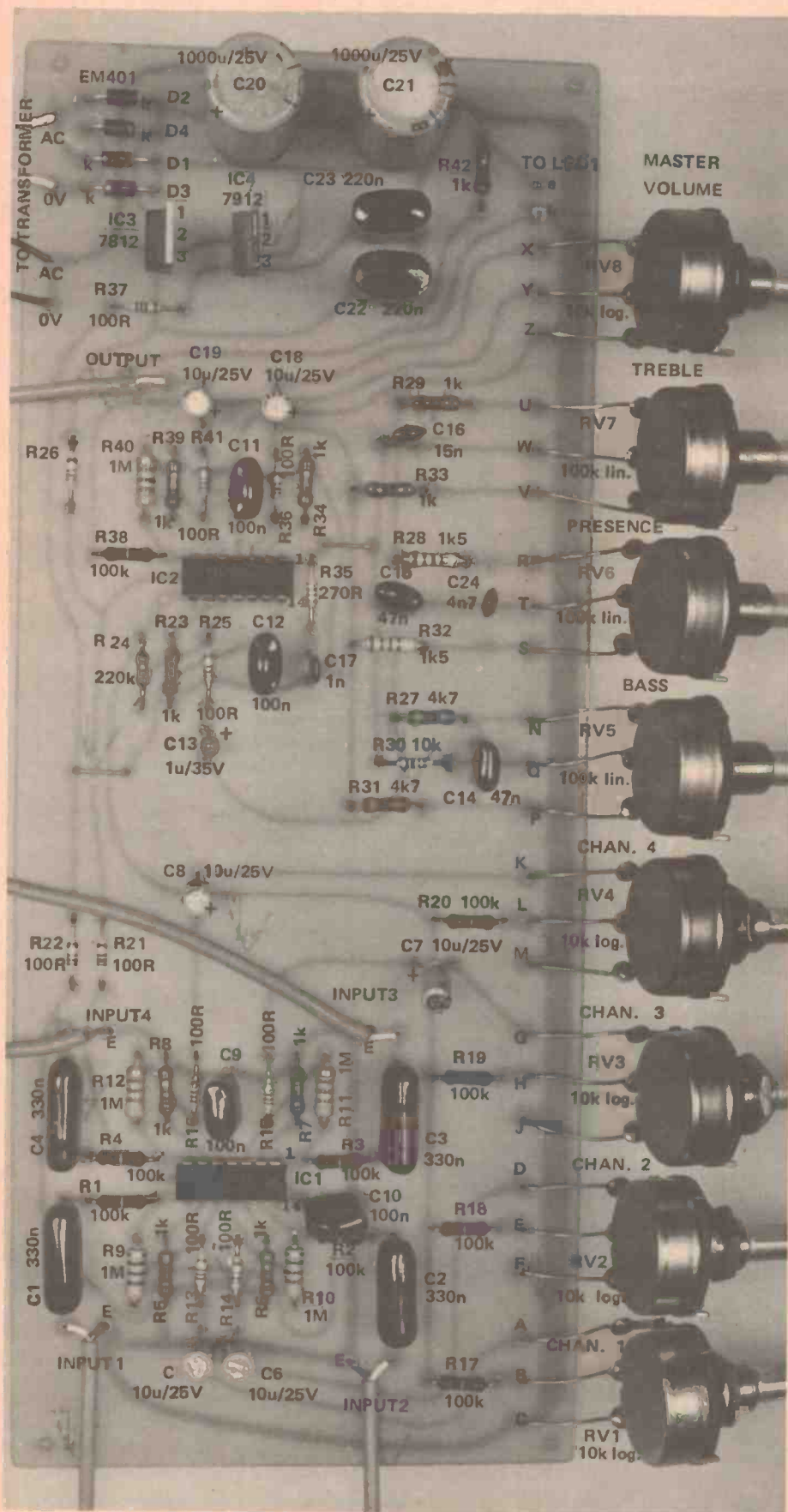

want a tone control that gives a relatively large amount of boost and cut, considerably larger than most hi-fi tone controls. The bass control has over 16 dB of boost and cut, while the presence and treble controls give over 20 dB.

The output of the tone control circuit goes to the master volume control and then to the final amplifier stage. The output impedance of the circuit is around 100 ohms and the maximum output voltage is 200 volts peak to peak, more than adequate to drive a power amplifier.

Construction

All the construction is restricted to the printed circuit board and so is relatively straightforward. We recommend you use our pc board, otherwise stability and ground-loop problems may occur.

Mount the resistors and non-polarised capacitors first. Next mount the tantalum and electrolytic capacitors, ensuring that they are inserted with the correct orientation. Most electrolytic capacitors have their negative

PARTS LIST

Resistors	all 1/4W, 5%
R1,2,3,4,17, 18,19,20,38	100k
R5,6,7,8,23,29, 33,34,39,42	1k
R9,10,11,12,40	1M
R13,14,15,16,21 22,25,26,36,37,41	100R
R24	220k
R27,31	4k7
R28,32	1k5
R30	10k
Potentiometers	
RV1,2,3,4,8	10k log.
RV5,6,7	100k lin.
Capacitors	
C1,2,3,4	330n greencap
C5,6,7,8,18,19	10u, 25 V electro
C9,10,11,12	100n greencap
C13	1u, 35 V tantalum
C14,15	47n greencap
C16	15n greencap
C17	1n greencap
C20,21	1000u/25 V electro
C22,C23	220n greencap
Semiconductors	
IC1,IC2	4136 quad op-amp
IC3	7812 +ve 12 V reg.
IC4	7912 -ve 12 V reg.
D1,D2,D3,D4	EM401, 1N4001 or sim.
LED1	TIL220 or similar LED
Miscellaneous	
Transformer (if required)	— 2 x 12 V, 0.8 A
Ferguson PL24/20 VA	(plus mains cord, cable clamp, plug etc); pc board — ETI 467; five phone jack sockets; eight knobs; DPST 240 Vac switch (if required).

4-input preamp

lead identified by a black arrow on the body of the capacitor. The polarity of tantalum capacitors is indicated by the position of the dot, as shown in the drawing accompanying the circuit diagram. Mount the power supply diodes and ICs next. Again, be certain these components are inserted with the correct orientation.

If the preamplifier is being constructed in a metal chassis, such as a 19-inch (483 mm) rack mounting cabinet for example, a separate power transformer is needed. This should be mounted on the chassis as far away from the pc board as possible. The input jacks will probably be mounted on the front panel and this will automatically connect the chassis to the signal earth at this point. If you experience any problems with hum in the finished unit this will probably be the cause. The solution is to try to obtain jack sockets that are insulated from the chassis, then experiment with the earthing arrangement. In most applications there should be no problems with hum, we have experimented by varying the position of the board with respect to its power transformer and it does not seem to be particularly sensitive.

Shielded cable should be used between the board and the input and output sockets. In the prototype unit the potentiometers are wired with short lengths of tinned copper wire. If the distance between the pc board and the pots is increased by more than a couple of centimetres, the connections to the pots should be made using shielded cable.

There is no special set-up procedure needed, but check all the components on the printed circuit board before applying power.

Using it

Turn all the input controls and the output volume control *fully counter-clockwise* and set the three tone controls to their mid positions. Connect the output of the preamplifier to the input of the ETI-466 (or what-have-you) power amplifier before turning the power amp on. This will prevent any momentary injection of hum into the power amp which could damage your loudspeakers. Plug in a guitar and turn up the input control for the channel you are using. Now, gradually increase the output volume control until the required volume is achieved. The tone controls may be adjusted to your liking, a bit of experimentation will show up what suits you and your system. ●

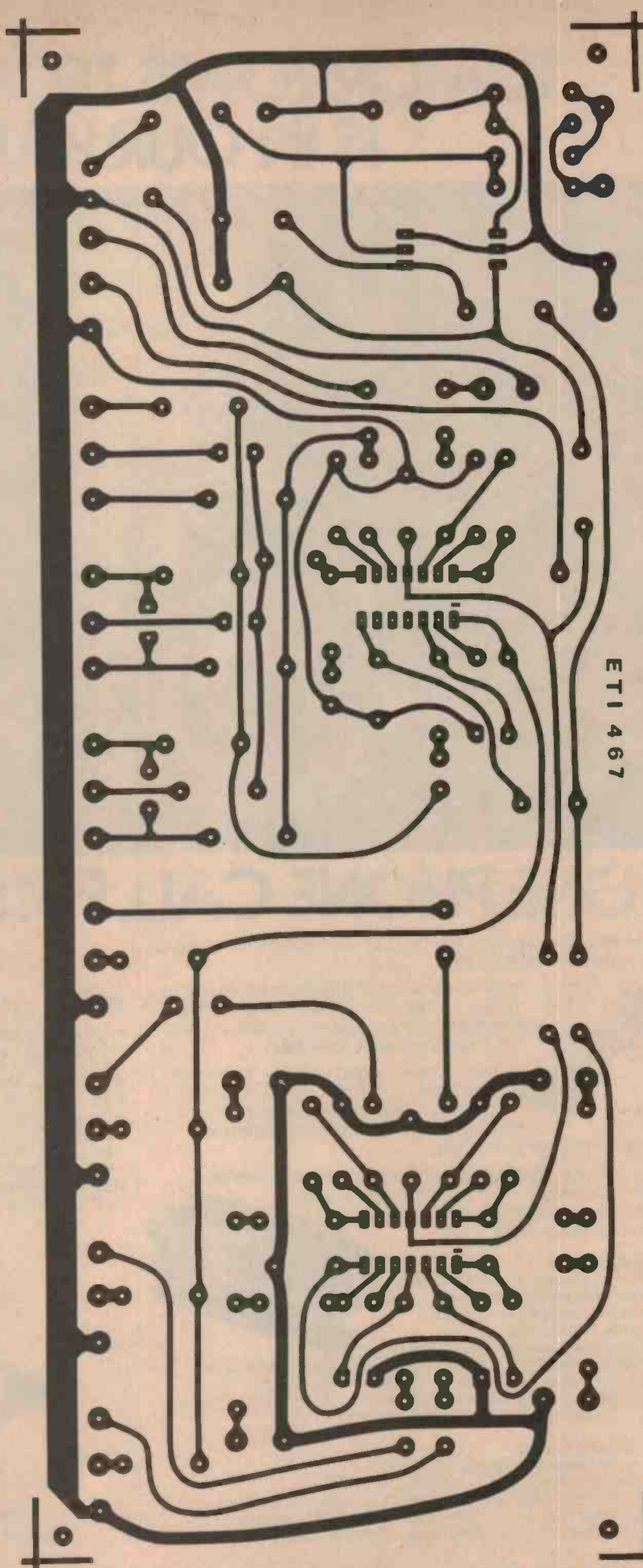

TOMORROW'S TECHNOLOGY IS IN OUR HANDS.



ONE PHONE CALL PUTS IT IN YOURS.

Whatever you want in the field of electronics, no doubt you want it to happen fast.



That, quite simply, is what GES is all about. We have the range. And we have the names. No problem is too large or too small. (And the same applies to orders).

We have world wide technical back-up, on-line stock control, an in-house engineer who is only too happy to offer technical advice and

fast service on indent orders.

Team this with large stocks on major lines and twenty years of business experience and you have the quickest, most efficient dealer in tomorrow's technology. GES.



Prime Agencies

- Robinson Nugent • Union Carbide
- Kemet Capacitors • Rockwell
- Microprocessors • E.F. Johnson
- Avantek • Redpoint
- Masterite Industries • Harwin Engineers
- E-Z Hook • Berk-Tek • Continental Specialties • Electrolube
- Erg • Lee Green Precision Instruments • Mini-Circuits
- Piezo Technology • Tecknit • Transco Products • Elu Elektro - Union GMBH • Compas Microsystems • OPCOA

Components Listing

- Microprocessors, Integrated Circuits
- I.C. Sockets - Production - MIL-SPEC Gold & Tin
- Ribbon Cable and Cable Connectors, Edge Connectors
- Kyna/Tefzel Wire 30 AWG, 26 AWG, 24 AWG, - 10 colours
- D.I.L. Switches colour coded. Keypatches and Keyboards



- Spacers, Terminals - feedthrough - stand-offs
- Heatsinks PCB type and extrusion
- Capacitors - solid tantalum - tag tants - ceramic and film

- E-Z Hooks and Test Leads, Circuit Hardware
- Fuses and Fuse Holders
- Crystal Oscillators, Crystal Ovens, Crystals, Monolithic Crystal Filters • L.E.D. Displays
- Antennas - Microwave
- Amplifiers, Attenuators, Oscillators, Transistors
- Double Balance Mixers, Power Splitter Combines
- Frequency Doublers, R/F Transformers, Coaxial Microwave Switches and Waveguide Switches
- EMI-RFI Shielding material, L.C.D. Connectors



439 2488

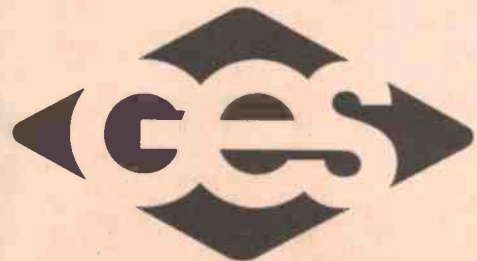

General Electronic Services Pty. Ltd.
99 Alexander Street, Crows Nest, NSW. 2065.

GES/001/CWA

Just starting out?

\$4.75*

PROJECT ELECTRONICS

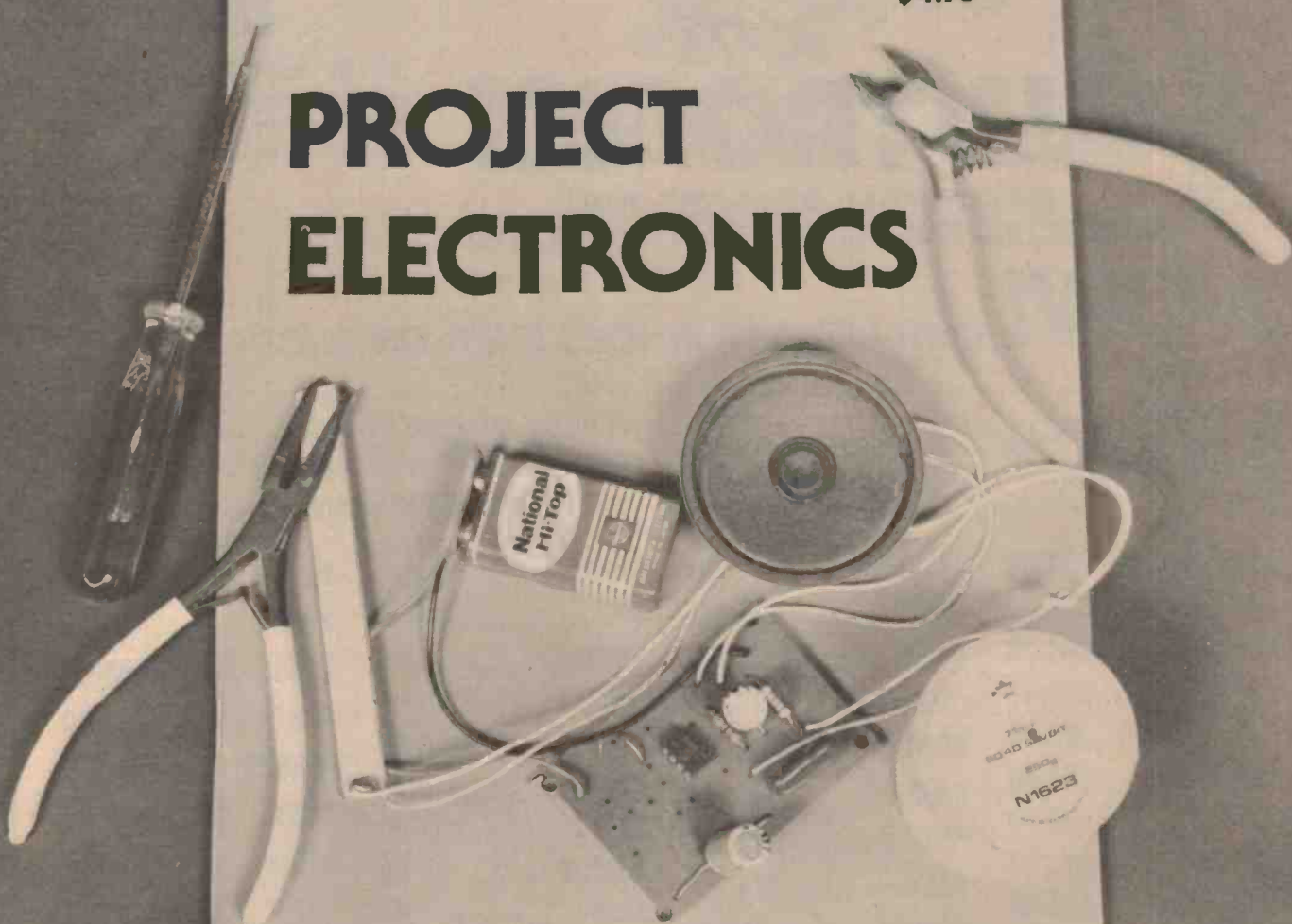

an **ELECTRONICS TODAY** publication

THIS BOOK has been specially designed and produced to meet the needs of newcomers to electronics. Students following the three-segment Industrial Arts syllabus at high school or embarking on the Electronics & Communications or a similar certificate course, will find the projects in this book an eminently practical introduction to the 'works' in electronics. Project Electronics has been a runaway success since it was first published. There are 26 projects included, many are readily available as inexpensive kits, and the book also provides advice on tools, identifying components, troubleshooting, how to solder etc. Available from specialist electronic suppliers or direct from the **ETI Subscription Department, 3rd Floor, 15 Boundary St, Rushcutters Bay NSW 2011** for \$4.75 plus 45 cents post and packing.



STRIKE IT RICH!

WITH

ELLISTRONICS

289 LATROBE ST. MELBOURNE. 3000
PHONE (03) 602-3282, 602-3836. TELEX AA37758 LSTRON

Ellistronics now stock in excess of 2000 different types of semiconductors plus computer components and systems. Altogether we have over 8000 various electronic components. The largest range available in Melbourne



YES! WE ACCEPT BANKCARD. All prices valid month of issue. Heavy items sent Comet freight forward. Minimum post \$3.00.

NOW! OUR LOWEST PRICES EVER ON MICRO CHIPS.

2114 450 NS.....	\$3.80	2708.....	\$6.50
2114 300 NS.....	\$4.50	2716 250 NS Single 5V Supply.....	\$22.00
2114 300 NS Low Power.....	\$5.95	2716 450 NS Single 5V Supply.....	\$16.50
2114 (8114) CMOS.....	\$21.80	2758 1K 8-bit PROM 5V Supply.....	\$12.50
2102.....	95		
2102 200 NS...\$1.50	MM5395.....\$5.60	6820.....\$4.70	8228.....\$8.20
2516.....\$22.00	6502.....\$9.10	6821.....\$4.60	8238.....\$6.50
2532.....\$64.00	6508.....\$4.75	6850.....\$4.20	8243.....\$6.90
2650.....\$23.48	MM5740.....\$10.10	6852.....\$5.10	8251 INTEL...\$12.10
4116 200 NS...\$6.95	6520.....\$4.78	7106.....\$10.50	INS8251.....\$5.60
5101 INTEL.....\$7.50	6522.....\$8.50	7107.....\$12.50	8253.....\$16.90
S5101.....\$4.50	6532.....\$14.70	7217.....\$11.00	8255A.....\$7.25
MM5203.....\$12.50	6551.....\$14.70	LS7220.....\$5.20	8295.....\$21.50
MM5204.....\$10.50	IM6561.....\$3.90	8035.....\$21.50	MM5104N.....\$9.70
MM5220.....\$5.50	MCM6574.....\$9.60	8155.....\$19.10	MM5106N.....\$8.50
MM5303N.....\$3.50	MCM6575.....\$7.90	8156.....\$19.10	MM55106N.....\$6.50
MM5307.....\$15.50	MC6800P.....\$7.50	8205.....\$4.35	MM57160.....\$6.50
MM5309.....\$5.65	MC6802.....\$11.80	P8212.....\$3.25	Z80 CTC.....\$9.49
MM5312.....\$7.80	MC6808.....\$10.50	8214.....\$6.90	Z80 CPU.....\$14.82
MM5369.....\$1.90	MC6808.....\$10.50	8224N.....\$2.70	
5387.....\$7.30	6810A.....\$4.25	8224 INTEL.....\$6.50	

**ALL PRICES PLUS 15 PERCENT SALES TAX IF APPLICABLE
QUANTITY DISCOUNTS ON APPLICATION**

Ideas for Experimenters

These pages are intended primarily as a source of ideas. As far as reasonably possible all material has been checked for feasibility, component availability etc, but the circuits have not necessarily been built and tested in our laboratory. Because of the nature of the information in this section we cannot enter into any correspondence about any of the circuits, nor can we produce constructional details.

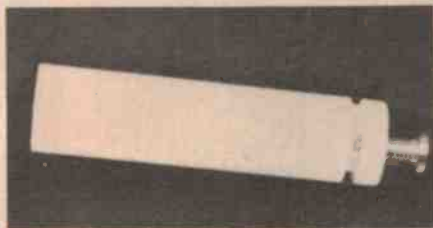

Extra hands !

This neat, nifty idea comes from Otto Patterson of Cammeray, NSW. Four rods of a suitable plastic are slotted at one end and a bolt inserted in a tapped hole such that it passes into the slot. The rods are slipped onto the pc board of the project you're about to build up and secured by tightening the bolts — with your fingers is enough. Load all the components on the upper side then slip the rods off the board, invert the board and slip them back on. Stand the board up and you're ready to solder everything !

The rods are made quite easily. Any suitable solid plastic rod material about 9 mm to 15 mm or so in diameter will suffice. Cut them about 60 - 80 mm long. Next drill and tap a hole in one end, a little off-centre. About 4 - 5 mm down

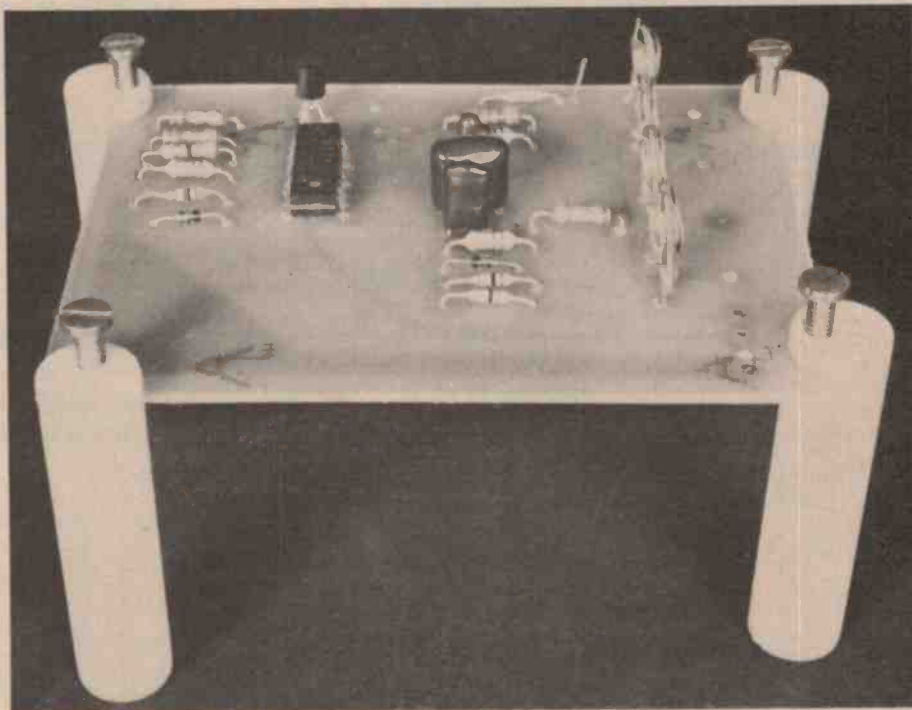

from this end cut a slot about 2/3 of the way through the rod. This slot should be about 2 mm wide to take pc boards of the usually-available thickness. The ac-

companying photographs tell most of the story.

That's it ! No more awkward juggling with that pc board on the bench.

Mods to the ETI-140 1 GHz frequency counter



The following modifications to the ETI-140, from Kit Scally of North Ryde NSW, will make it a little easier to use.

Firstly, an extra two decimal points on the display improves the appearance of the reading. Change R75 from 470R to 220R and common the decimal point on display 1 to displays 4 and 7 (pin 6 on each IC).

If the decimal point on display 5 lights dimly when using the "time with pre-scale", this can be cured by adding a 1N914 diode in series with pcb pin E and

SW5, anode to the switch.

To produce a MHz/kHz decimal point on the 0-50 MHz range, add the extra circuitry shown here. The components may be 'hung' off the board.

The PL18/20VA transformer in the power supply runs hot and this may be replaced by a PL18/40VA unit to reduce the temperature. A one amp, quick blow 3AG fuse placed in the primary circuit is also a good idea.

Erratic readings when measuring frequencies below 100 Hz can be cured by

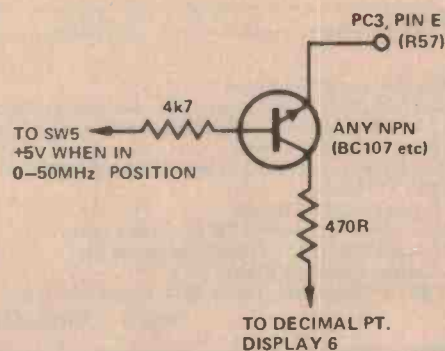

using a 1M resistor as a dc ground return. Place it from input to ground for these signals.

ETI S100/Z80 MICRO COMPUTER SYSTEM

- ★ LEARN AS YOU BUILD
- ★ START SMALL E·X·P·A·N·D LATER
- ★ AFFORDABLE - FLEXIBLE

Build up your own Z80 based home computer based on the DGZ80 described in ETI 1979. Designed by David Griffiths this is probably the most powerful S100/Z80 project described in the world to date. The big advantage of starting with the S100 bus is the flexibility. No need to pay \$400-500 for an expansion interface. Just plug in other boards to suit your requirements. A suggested starting system is described below and is supplied with sample programs and full documentation to enable you to learn the basics of microprocessors.

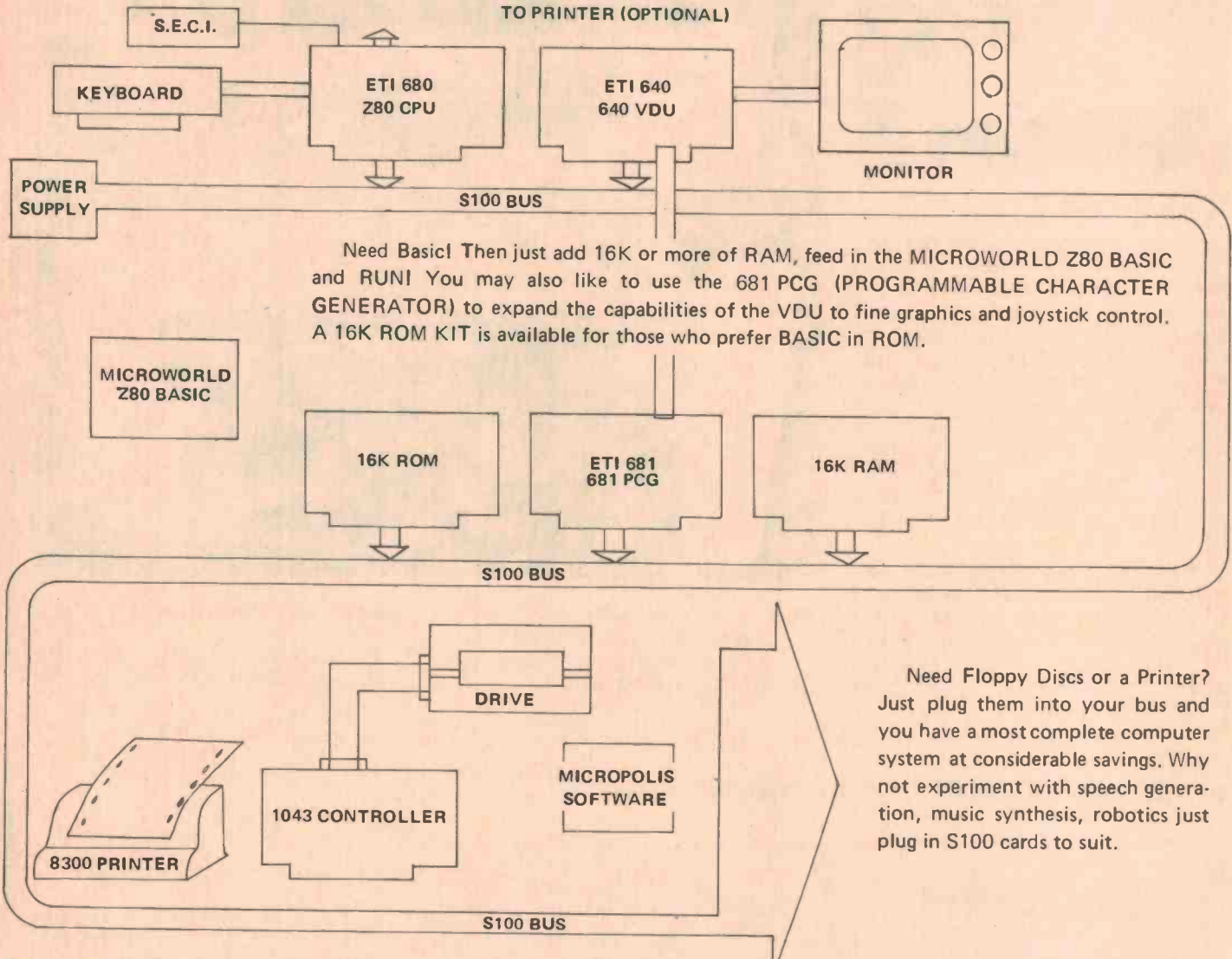

Need Basic! Then just add 16K or more of RAM, feed in the MICROWORLD Z80 BASIC and RUN! You may also like to use the 681 PCG (PROGRAMMABLE CHARACTER GENERATOR) to expand the capabilities of the VDU to fine graphics and joystick control. A 16K ROM KIT is available for those who prefer BASIC in ROM.

Need Floppy Discs or a Printer? Just plug them into your bus and you have a most complete computer system at considerable savings. Why not experiment with speech generation, music synthesis, robotics just plug in S100 cards to suit.

KB05 Economy Keyboard	\$89.50	TCT 16K ROM complete kit for up to 16K of EPROMS (less EPROMS)	\$105.00
CLARE. C70/MGP microprocessor controlled keyboard	\$165.00	Z80 BASIC - 11K Microworld basic on tape if purchased with DGZ80 (kit or assembled & tested)	\$10.00
DGZ80 S100 computer board complete kit (fully socketed)	\$199.25	If purchased separately	\$32.00
Assembled and Tested	\$240.00	8300 printer with RS232 connects direct to DGZ80	\$915.00
DGOS ROM - operating system, single 5v EPROM	\$40.00	MICROPOLIS 1043 QUAD DENSITY DISC CONTROLLER with drive, power supply and software package	\$1350.00
DG640 VDU Kit	\$139.50	SECI. Kansas City Cassette Interface Kit	\$24.50
Assembled and Tested	\$149.50	S100 Mother Board plated through with active termination Card Frame with professional finish	\$49.50
MONITOR - Converted TV for direct video	\$149.50		
TCT 16k RAM (2114 RAM) Complete kit	\$285.00		
Kit less RAMS/SOCKETS	\$100.00		
ETI 681 PCG as described in ETI June 1980 - kit	\$140.00		

NOTE - Prices include Sales Tax. Contact office for availability of Tax Exempt pricing.



MAIL ORDERS TO:
 PO Box 311, Hornsby 2077.
 Please add \$2.00 per order towards cost of post and packing.

OFFICE/SHOWROOM:
 1a Pattison Avenue, Waitara 2077.
 Hours: 9-5 Monday to Saturday.
 Telephone: 487-2711.

Ideas for Experimenters

The ubiquitous 555

These two circuits come from the pen of F. Zickar of East Corrimal NSW and illustrate some interesting applications of the ever-present 555 timer IC.

Circuit (1) shows a voltage doubling dc-to-dc inverter which consists of a 555 as an oscillator driving a complementary pair of transistors, Q1 and Q2, followed by a voltage-doubler rectifier.

When pin 3 of the 555 goes high, the collector of Q2 drops to near 0V as it turns on (Q1 is off) and the 10u capacitor charges through D1 and the collector-emitter of Q2, reaching a value almost equal to the supply voltage.

When pin 3 of the 555 goes to 0V, Q2 turns off and the collector of Q1 goes to the positive supply rail as it turns on. Now, the 10u capacitor discharges into the 200u capacitor through D2 and the process repeats with every cycle of IC1. After a few cycles, this latter capacitor is fully charged to a value equal to almost twice the supply rail voltage. If the supply is 12 V say, Vout will be about 22 V.

This can be used to supply an audio preamp, for example, in an amplifier that has low voltage supply rails, in order to improve overload margin etc. Load current may be about 10 - 15 mA.

The circuit in (2) is a suggestion for a voltage-controlled oscillator (VCO). Here, a FET (Q 1) is used as a voltage-variable resistance to control the voltage on pin 7 of the input 555 (IC2). As Q1 forms part of the CR timing network, this varies the frequency of the pulse from pin 3 of IC2.

IC2 can then be used to drive, for example, an LED (dotted circuit). Its brightness would vary with the

variation of the output frequency pulses from IC2. The gate of Q1 could be connected to the AGC line of a receiver and the LED used as a simple signal strength indicator in place of a more expensive 'S-meter'.

The rest of the circuit shows how to 'slave' another 555 (IC1) to provide an audio output.

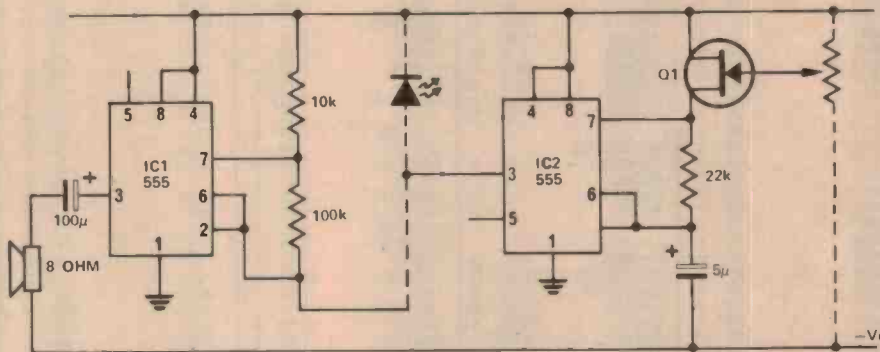
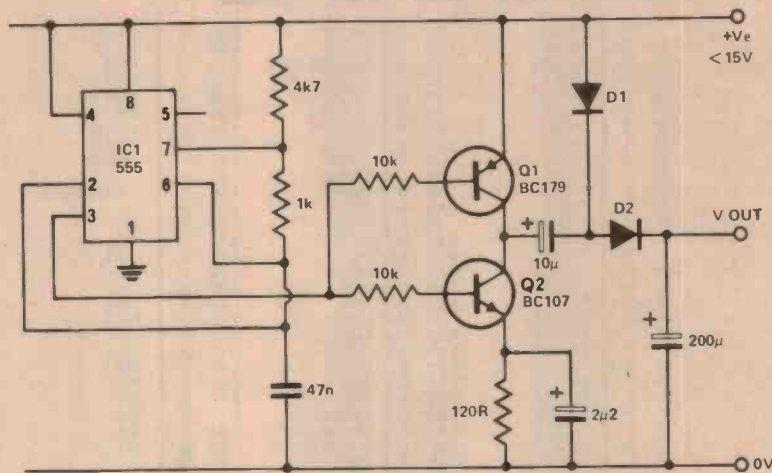

Incinerated ICs — stopped!

Now here's a good idea if your soldering iron is a bit too hot for soldering delicate components to a printed circuit board — why not use a standard light dimmer between the iron and the mains?

A reader from Pentland in Queensland, Mr B.D. Dever, found this an ideal solution to soldering-without-sizzling.

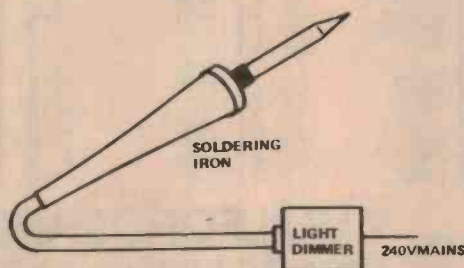

Any ideas?

Have you had a bright idea lately, or discovered an interesting circuit modification? We are always looking for items for these pages so naturally, we'd like to hear from you.

We pay between \$5 and \$10 per item — depending on how much work we have to do on it before we publish it.

The sort of items we are seeking, and the ones which other readers would like to see, are novel applications of existing devices, new ways of tackling old problems, hints and tips.

SEMIS

MAIL ORDER ONLY

UNLIMITED PH. (03) 602 3836

CMOS	TAX	74C32	30	B	LM377	2.30	A	74S51	53	B	9310	53	B	74LS26	29	B
4000	25	74C42	1.10	B	LM379	4.50	A	74S74	85	B	9311	79	B	74LS27	24	B
4001B	21	74C48	1.68	B	LM380 8 PIN	99	A	4586	43	B	9312	99	B	74LS28	40	B
4001A	21	74C73	75	B	LM380 14 PIN	1.10	A	74S112	95	B	74156	1.30	B	74LS30	25	B
4002	88	74C74	75	B	LM381A-N	2.55	A	74S135	1.29	B	74157	68	B	74LS32	29	B
4007	25	74C76	80	B	LM381N	1.69	A	74S138	2.60	B	74160	1.26	B	74LS33	35	B
4008	98	74C83	1.05	B	LM382N	1.21	A	74S157	2.42	B	74161	87	B	74LS37	29	B
4009	48	74C85	1.20	B	LM383	1.70	A	74S158	2.00	B	74162	87	B	74LS38	30	B
4010	48	74C86	45	B	LM384	1.66	A	74S182	2.60	B	74163	84	B	74LS40	22	B
4011	22	74C90	95	B	LM386	89	A	7400 SERIES			74164	91	B	74LS42	65	B
4012	26	74C93	1.25	B	LM387	1.00	A	7400	17	B	74165	91	B	74LS47	93	B
4013	35	74C95	1.05	B	LM391	1.15	A	7401	20	B	74166	1.31	B	74LS48	93	B
4014	99	74C107	63	B	LM393	66	B	7402	20	B	74167	2.44	B	74LS4	1.29	B
4015	99	74C150	2.63	B	LF398	3.43	A	7403	20	B	74170	2.88	B	74LS51	28	B
4016	41	74C151	1.95	B	456	1.29	A	7404	20	B	74173	1.39	B	74LS54	25	B
4017	1.04	74C154	2.40	B	NE530	79	A	7405	22	B	74174	1.35	B	74LS55	37	B
4018	1.13	74C160	1.30	B	550	22	B	7406	26	B	74175	78	B	74LS58	39	B
4019	52	74C192	1.10	B	556	68	B	7407	26	B	74176	96	B	74LS73	51	B
4020	81	74C164	99	B	LM565	1.10	B	7408	20	B	74177	96	B	74LS74	35	B
4021	81	74C173	1.05	B	LM565CH	1.35	B	7409	20	B	74180	78	B	74LS76	34	B
4022	91	74C174	1.05	B	NE566	2.10	B	7410	20	B	74181	1.76	B	74LS78	34	B
4023	25	74C175	1.00	B	LM567	1.25	B	7411	20	B	74182	88	B	74LS85	1.13	B
4024	69	74C192	1.10	B	NE571	6.50	B	7412	22	B	74184	1.50	B	74LS86	38	B
4025	25	74C193	1.10	B	TBA641BX1	2.17	B	7413	26	B	74185	1.50	B	74LS90	45	B
4026	1.81	74C195	1.00	B	TBA641B11	2.17	B	7414	38	B	74190	87	B	74LS92	81	B
4026	41	74C221	1.60	B	LM709-LN-8	54	B	7415	75	B	74191	87	B	74LS93	84	B
4028	78	74C373	1.80	B	LM709-14 PIN	60	B	7416	26	B	74192	87	B	74LS95	90	B
4029	1.06	74C374	2.10	B	UA710CA	49	B	7417	75	B	74193	87	B	74LS96	1.35	B
4030	34	74C901	60	B	LM710-CH	76	B	7420	19	B	74194	96	B	74LS107	40	B
4031	2.10	74C902	75	B	711	75	B	7421	20	B						
4034	3.20	74C905	8.50	B	UA711-H	75	B	7423	39	B						
4035	1.45	74C906	75	B	UA716HC	1.25	A	7425	39	B						
4039	78	74C907	75	B	723	38	B	7426	30	B						
4040	90	74C915	1.15	B	LM723CH	70	B	4427	35	B						
4041	90	74C922	3.30	B	LM725	3.30	B	7430	35	B						
4042	63	74C923	3.26	B	LM733	90	A	7432	29	B						
4043	63	74C925	4.70	B	UA739	1.48	A	7437	44	B						
4044	63	74C926	4.70	B	741	19	B	7438	39	B						
4046	1.04	74C927	6.20	B	LM741-H	43	B	7440	20	B						
4047	1.04	74C932	1.45	B	UA747	84	B	7441	85	B						
4048	45				UA747HC	1.82	B	7442	85	B						
4049	39				UA748	38	A	7443	1.56	B						
4050	39	80C SERIES			UA748HC	1.02	A	7444	1.03	B						
4050	39	MM80C95	75	B	UA753	1.80	B	7446	80	B						
4051	81	80C96	75	B	UA760HC	3.10	A	7477	93	B						
4052	69	MM80C97	75	B	UA777	1.60	A	7478	99	B						
4053	69	80C98	75	B	UA777HC	1.85	A	7450	20	B						
4060	1.25				UA796HC	1.35	A	7451	20	B						
4066	50	LINEAR			LM1310N	2.03	A	7453	20	B						
4068	26	LH0002	7.80	B	LM802	94	A	8T26	191	B						
4069	25	LH0022CD	13.15	B	1406	4.94	A	9300	60	B						
4070	34	LH0042CH	5.50	B	LM1458	64	A	9307	1.63	B						
4071	25	LH0070	11.80	B	UA1488	74	A	9308	99	B						
4072	26	LH071	10.80	B	UA1489	74	A	7454	20	B						
4073	26	REF02CJ	8.40	B	MC1495	5.38	A	7470	35	B						
4075	26	TL071	68	A	MC1496L	11.10	A	7472	35	B						
4076	94	TL072	1.10	A	LM1558	11.10	A	7473	35	B						
4077	26	TL082	89	A	LM1596	1.15	A	7474	29	B						
4078	26	LM0091CD	20.00	A	LM183	1.78	A	7475	44	B						
4081	26	LH0094CD	31.50	A	2719	3.50	A	7476	29	B						
4082	28	SAK140	1.90	B	LM2902	1.40	A	7480	63	B						
4089	86	UAA170	2.65	A	LM2917	2.20	A	7482	90	B						
4093	41	UAA180	2.70	A	CA3028	1.43	A	7483	94	B						
4503	59	TCA220	1.58	A	LM3039	91	A	7485	1.20	B						
4507	31	LM301	33	A	CA3046	1.38	A	7486	39	B						
4510	88	LM301-H	60	A	3065	40	A	7489	1.13	B						
4511	1.08	LM304-H	1.70	A	LM3080	85	A	7490	44	B						
4512	86	LM305-H	80	A	LM3089	3.13	A	7491	60	B						
4514	2.26	LM307-CN	40	A	CA3130T	90	A	7492	44	B						
4516	93	LM307-H	90	A	CA3130E	1.20	A	7493	44	B						
4518	93	LM308	53	A	CA3140	86	A	7494	91	B						
4519	31	LM308-H	84	A	3140	86	A	7495	54	B						
4520	93	LM310-N	1.78	A	3611	92	A	7496	92	B						
4522	1.13	LM310-H	1.85	A	LM3900	76	B	7497	2.44	B						
4527	93	3118PIN	54	A	LM3908	85	B	74107	44	B						
4528	1.20	LM311-14 PIN	1.25	A	LM3914N	3.20	B	74109	29	B						
4529	1.35	LM311-H	84	A	4136	1.20	A	74116	44	B						
4539	1.06	LM318	2.20	B	LM4250	1.45	A	74121	2.06	B						
4541	1.42	LM322	3.10	B	UA4558TC	1.08	A	74122	41	B						
4543	1.42	LM324	61	B	MM5837	1.18	A	74123	41	B						
4553	6.15	LM325	2.65	B	LM7555	1.50	B	74125	48	B						
4555	1.00	LM329-DZ	1.40	B	MC10116L	79	A	74126	43	B						
40097	75	LM334-Z	1.10	B	LF13741-H	45	A	74132	52	B						
40098	75	LM335	1.30	B	DS75452	45	A	74141	74	B						
40175	89	LM336-Z	3.20	B	76477	3.53	A	74145	94	B						
		LM339	61	A	TTL (S)			74147	1.74	B						
		LM348	1.18	B	74S00	43	B	74150	70	B						
		LM349	1.75	B	74S02	43	B	74151	70	B						

FREE GIFT PACK

SEMICONDUCTORS, ETC. WITH ORDERS OVER \$10

74LS181	2.50	B	2N3440	1.44	A
74LS189	3.14	B	2N3502	60	A
74LS190	1.00	B	243503	60	A
74LS191	1.10	B	243563	24	A
74LS192	85	B	2N3564	23	A
74LS193	85	B	2N3569	19	A
74LS194	70	B	PN3565	18	A
74LS195	80	B	PN3566	15	A
74LS197	1.00	B	PN3567	20	A
74LS211	1.10	B	PN3568	22	A
74LS245	1.95	B	2N3638	14	A
74LS247	1.08	B	2N3639	18	A
74LS249	1.30	B	2N3640	18	A
74LS251	65	B	2N3641	18	A
74LS253	88	B	2N3645	20	A
74LS257	65	B	PN3642	15	A
74LS258	60	B	PN3643	14	A
74LS259	2.45	B	PN3644	15	A
74LS260	40	B	2N3646	24	A
74LS266	70	B	2N3692	43	A
74LS273	1.40	B	243693	30	A
74LS279	65	B	2N3702	16	A
74LS283	1.15	B	PN3694	20	A
74LS290	94	B	2N3704	18	A
74LS293	1.15	B	2N3709	18	A
74LS295	1.40	B	2N3713	1.66	A
74LS298	90	B	2N3819	60	A
74LS352	1.30	B	2N3866	1.70	A
74LS353	1.16	B	2N3904	22	A

(450NS) **\$3.80** B
\$6.50 B
 (250NS) SINGLE SUPPLY **\$22.00** B
\$6.95 B
.95 B
\$5.35 A
.22 B
.03 B

74LS365	55	B	2N3906	14	A
74LS366	60	B	2N4030	90	A
74LS367	55	B	2N4032	78	A
74LS368	55	B	2N4033	78	A
74LS373	1.20	B	2N4036	82	A
74LS374	1.40	B	2N4037	73	A
74LS386	43	B	PN4121	14	A
74LS670	2.23	B	2N4233	1.30	A
81LS95	1.60	B	2N4235	1.55	A
95H90	7.90	B	2N4236	1.80	A
11C90	15.75	B	2N4248	16	A
81LS96	1.60	B	2N4249	29	A
81LS97	1.60	B	2N4250	11	A
81LS98	1.60	B	2N4258	18	A
			2N4292	60	A
			2N4354	20	A
TRANSISTORS					
2N301	1.80	A	2N4355	20	A
2N657	14	A	2N4356	16	A
2N930	51	A	2N4398	4.38	A
2N1613	90	A	2N4401	14	A
2N1711	81	A	2N4402	23	A
2N1893	86	A	2N4403	14	A
2N2219A	51	A	2N4416	80	A
PN2222	19	A	2N4906	2.45	A
2N2222	38	A	PN4868	30	A
2N2483	38	A	2N5088	14	A
2N2484	54	A	2N5089	14	A
2N2646	61	A	2N5179	1.50	A
2N2647	90	A	2N5303	2.65	A
2N2894	68	A	2N5320	68	A
2N2904	43	A	2N5401	14	A
2N2905	39	A	2N5458	34	A
2N2906	39	A	2N5459	35	A
2N2913	1.00	A	2N5461	39	A
PN2907	24	A	2N5484	38	A
2N3053	42	A	2N5485	44	A
2N3054	90	A	2N5486	42	A
2N3055	55	A	2N5789	14	A
2N3301	25	A	2N5770	18	A

22	A	TIP34A	94	A
25	A	TIP24B	1.18	B
27	A	TIP42B	79	A
94	A	TIP110	1.02	A
1.13	A	TIP120	1.02	A
14	A	TIP2955	63	A
90	A	TIP3055	63	A
32	A	VMP4	21.96	A
88	A	VN88AF	1.96	A
		ZENER DIODES		
		E23 Range		
		400MW	09	B
		1 Watt	18	B
		MICRO CHIPS		
		ADCCD 800	10.20	B
		DACO 808	1.74	B
		2102 200NS	1.50	B
		2101 350NS	1.50	B
		2102 450NS	1.05	B
		2102 650NS	95	B
		2111	7.48	B
		2114 300NS	4.50	B
		2114 450NS	3.80	B
		8to 31	3.70	B
		32 Up	3.60	B
		2516	22.00	B
		2532	64.00	B
		2650	23.48	B
		2708	7.20	B
		2716	22.00	B
		4116	7.30	B
		5101 INTEL	7.50	B
		SS101	4.40	B
		MM5203	12.50	B
		MM5204	10.50	B
		MM5220	5.50	B
		MM5303N	3.50	B
		MM5307	15.50	B
		MM5309	5.65	B
		MM5312	7.80	B
		MM5369	1.90	B
		5387	7.30	B
		MM5395	5.60	B
		MM5740	10.10	B
		6502	9.10	B
		6508	4.75	B
		6520	4.78	B
		6522	8.50	B
		6532	14.70	B
		IM6561	3.90	B
		MCM6574	9.60	B
		MCM6575	7.90	B
		MC6800P	7.50	B
		MC6802	11.80	B
		MC6808	10.50	B
		6810A	4.25	B
		6820	4.70	B
		6821	4.60	B
		6850	4.20	B
		6852	5.10	B
		7106	10.50	B
		7107	12.50	B
		7217	11.00	B
		LS7220	5.20	B
		8035	23.29	B
		INS8050	12.50	B
		INS8080	6.50	B
		P8085	21.50	B
		8155	19.10	B
		8205	19.10	B
		8205	4.35	B
		P8212	3.25	B
		8214	6.90	B
		8224N	2.70	B
		8224 INTEL	6.50	B
		8228	8.20	B
		8238	6.50	B
		8243	6.90	B
		8251 INTEL	12.10	B
		INS8251	5.60	B
		8255A	7.25	B
		8295	21.50	B
		DM8578	3.00	B
		AY-5-2376	17.00	B
		MM5204N	9.70	B
		MM55106N	8.80	B
		MM57160	6.50	B
		Z80CTC	9.49	B
		Z80CPU	14.82	B
		OPTOCOUPERS		
		MCT265	65	B
		MCT6	1.95	B
		MCT275	1.30	B
		MCC671	2.40	B
		4N28	70	B
		4N26	1.30	B
		4N26	70	B
		4N31	1.06	B
		CAPACITORS		
		Polyester		
		100V-250V		
		.01-.027	06	A
		.033-.056	07	A
		068-1	10	A
		12-22	15	A
		0.27uf	17	A
		0.33uf	22	A
		0.47uf	30	A
		56, 68, 82	35	A
		1, 2, 1.5	49	A
		1.8uf	55	A
		2.2uf	72	A
		3.3uf	1.05	A
		4.7uf	1.60	A
		6.8uf	2.40	A
		10uf	3.04	A
		I.C. SOCKETS		
		8Pin	16	B
		14Pin	18	B
		16Pin	23	B
		18Pin	25	B
		22Pin	28	B
		24Pin	30	B
		28Pin	34	B
		40Pin	43	B
		FUSES		
		3AG		
		1-9	08	B
		10+	07	B
		DISPLAYS		
		MAN2A	5.46	B
		MAN72A	1.30	B
		MAN74A	1.30	B
		MAN52A	2.80	B
		MAN82A	2.80	B
		MAN84A	2.80	B
		MAN6740	2.99	B
		MAN8610	2.80	B
		MAN8640	2.80	B
		TIL306	10.40	B
		DL704	1.80	B
		DL707	1.80	B
		DL747	2.96	B
		DL750	3.48	B
		FND357	1.40	B
		FND500	1.13	B
		FND507	1.30	B
		FND800	2.60	B
		FND807	2.96	B
		SEL521	2.40	B
		NSB7881	9.00	B
		NSN781	4.26	B
		FNA5220	2.96	B
		S.C.R.'s		
		T106B1	61	B
		C106B	61	B
		C106D1	68	B
		C106E	87	B
		C122D1	1.04	B
		C122E	1.30	B
		TRIACS & DIACS		
		2N6073	1.22	B
		SC141D	80	B
		SC146D	1.60	B
		ST2	26	B
		ST4	35	B
		SC151D	1.83	B

OPTO LEADS			
LED	Red Rectangle	19	B
LED	Green Rectangle	23	B
LED	Yellow Rectangle	23	B
133	Red Chrome	87	B
133	Amber Chrome	1.13	B
133	Green Chrome	1.13	B
LED	Red Standard	10	B
LED	Green Standard	17	B
LED	Yellow Standard	17	B
SAR3431	Red Miniature	14	B
CS205	Green Miniature	22	B
VOLTAGE REGULATORS			
78L05	.5V 100mA	30	B
LM341P-5	.5V 500mA	75	B
7805	.5V 1A	85	B
7905	.5V 1A	1.30	B
LM309K	.5V 1A	1.23	B
7805K	.5V 1A	1.23	B
LM323-K	.5V 3A	5.48	B
78H05KC	.5V 5A	5.20	B
LM31p-8	.8V 500mA	70	B
78L12CP	.12V 100mA	70	B
79L12	.12V 100mA	35	B
LM341P12	.12V 500mA	58	B
7812	.12V 1A	85	B
7912	.12V 1A	1.20	B
7812KC	.12V 1A	1.85	B
7912KC	.12V 1A	2.25	B
79H12KC	.12V 5A	5.22	B
78CUBUC	.13.8V 2A	1.90	B
78C8UC	.13.8V 2A	3.04	B
78L15	.15V 100mA	30	B
79L15	.15V 100mA	75	B
LM341P15	.15V 500mA	70	B
7815	.15V 1A	85	B
7915CT	.15V 1A	1.20	B
7915KC	.15V 5A	5.30	B
78L18	.18V 1A	30	B
7818	.18V 1A	85	B
78L24	.24V 100mA	30	B
79L24	.24V 100mA	75	B
7824	.24V 1A	85	B
LM317T	.ADJ 1A	85	B
LM337T	.ADJ 1A	2.05	B
LM317K	.ADJ 2A	4.56	B
LM333K	.ADJ 2A	4.30	B
LM350K	.ADJ 3A	6.34	B
78HGKC	.ADJ 5A	6.05	B
78P05	.5V 100mA	6.50	B
BRIDGES			
VM48	400V 1A DIL	85	B
W02	200V 1.5A	42	B
W04	400V 1.5A	43	B
W06	600V 1.5A	50	B
KPC02	200V 3A	1.10	B
KBP602	200V 1.5A	1.39	B
KBP604	400V 6A	1.65	B
KBP606	600V 6A	2.05	B
KHPC1002	200V 10A	2.26	B
KBPC1004	400V 10A	2.70	B
KBPC1006	600V 10A	2.75	B
MDA3501	100V 35A	2.70	B
MDA3502	200V 35A	2.70	B
MDA3504	400V 35A</		

The one-stop Microcomputer Shop providing a total service to TRS-80* and System 80 users

*TRS-80 is a registered Trademark of Tandy Radio-Shack

HARDWARE AND MODIFICATIONS

Having system crashes? Plug in our line filter and get mainframe stability.....\$55.00
Use your TRS-80 as a telephone book and automatic dialler. No hardware mods required. All software included.....\$59.50
LIGHT PEN with demonstration software and full programming instructions. **STILL ONLY**.....\$19.50
Lower case mod for **ELECTRIC PENCIL** and **SCRIPSI**. Fitted and 90 day guarantee.\$49.95
VIDEO STABILIZER CRYSTAL. Get professional stability on your VDU. **CRYSTAL** only \$19.95. Fitted and guaranteed.....\$39.00
16K MEMORY KITS \$85.00. We install \$105.00
RS-232 PRINTER DRIVER. Operates from cassette cable. Inc. software.....\$54.75
CISA DATA DIGITIZER. Our most popular hardware product. No hardware mods required. Reads and re-records tapes normally unreadable by any other method.....\$57.50
CASSETTE CABINET. Protect your valuable cassettes in this strong, handsome 36 cassette cabinet.....\$27.75
DIGITAL CASSETTES. Top quality.
C15's — 1 for \$1.65. 10 for.....\$14.85
C20's — 1 for \$1.85. 10 for.....\$16.85
C30's — 1 for \$1.99. 10 for.....\$18.50
This is an entirely new product. We are so confident of this product that we are now recording all our commercial software on it.
5 1/4" PRIME QUALITY DISKETTES
1 for \$4.95. 10 for.....\$45.00
All tracks guaranteed to load.
We are extending our range of computer paper and labels for the enthusiast and the business user.

BOOKS

We believe that we have the best and most comprehensive range of titles of interest to the TRS-80 owner/user. Over 200 titles presently in stock. **COME IN AND BROWSE AROUND!**
JUST A SELECTION

First Book of Microcomputers.....\$6.50

Pascal With Style.....\$8.50
Basis With Style.....\$8.00
TRS-80 Disk and Other Mysteries.....\$29.50
Level II ROM Reference Manual.....\$24.95
Basic and the Personal Computer (highly recommended).....\$15.95
Basic Programming for Scientists and Engineers.....\$15.50
The Incredible Secret Money Machine ..\$7.95
Z-80 Microcomputer Handbook.....\$11.95
Microcomputers for Business Applications.....\$11.95
Z-80 and 8080 Assembly Language Programming.....\$10.00
How to Profit from your Personal Computer.....\$12.00
Little Book of Basic Style.....\$7.95
Microcomputer Interfacing.....\$25.75
Microcomputers and the 3 R's (A Guide for Teachers).....\$10.00
COMPUTER CLASSICS
Wirth/Algorithms plus Data Structures equals Programs.....\$29.75
Tausworth/Standardized Development of Computer Software. Vol. I — Methods \$29.75. Vol. II — Standards.....\$29.75
Klingman/Microprocessor Systems Design.....\$30.50
Gilmour/Business Systems Handbook.....\$29.75
Gane/Structured Systems Analysis.....\$26.50
Garrett/Analog Systems for Microprocessors.....\$26.50
Rhyne/Fundamentals of Digital Systems Design.....\$26.95

TRS-80* AND SYSTEM 80 SOFTWARE

Ecology Simulations 1 and 2 (disk and lower case) each.....\$24.95
Mission Impossible and Voodoo Castle (disk).....\$24.95
Adventureland and Pirate Adventure (disk).....\$24.95
Investment Analysis (disk or L2 cassette).....\$49.95
Sargon II (cassette).....\$37.50

Strategy Games (5) (cassette).....\$7.95
Space Games (4) (cassette).....\$7.95
5 Adventures (cassette) each.....\$14.95
Advanced Statistics (disk or cassette).....\$24.95
U Boat (cassette).....\$8.50
Basic Monitor (cassette).....\$19.95
Micromazing (games cassette).....\$7.50
RPN Calculator (cassette).....\$14.95
PLUS MANY MORE

We stock and highly recommend all **RACET COMPUTES** professional standard system programs.

Infinite Basic.....\$49.95
Infinite Business.....\$29.95
Remodel.....\$24.95
Remodel plus Proload.....\$34.95
GSF.....\$24.95
DOSORT (sorts disk files).....\$34.95
COPSYS (copies system tapes).....\$34.95
NEW DOS FROM APPARAT

35 Track.....\$99.00
40 Track.....\$110.00

This DOS emulates many mainframe capabilities. Has features usually restricted to much larger systems.

TARANTO and ASSOCIATES

General Ledger.....\$155.00
Accounts Payable.....\$155.00
Accounts Receivable.....\$155.00
Print Invoice.....\$99.00
Complete Business System.....\$500.00

This is professional quality software and really provides a superb business system for the TRS-80. Software maintenance is available to purchasers of the complete system at \$15 per hour, to tailor the programs to your specific needs.

PLUS MANY MORE

We are the Australian agents for many first class U.S. software houses. Send for our full catalogue.



CISA

Remember, for all your TRS-80* and System 80 needs, phone, write or call
Showroom: Ground Floor, GIO Building, 159 Kent Street, Sydney 2000.
(Opposite IBM Building)
Phone (02) 241-1813
Trade enquiries welcome.



Shoparound

THIS PAGE is to assist readers in the continual search for components, kits and printed circuit boards for ETI projects. If you are looking for a particular component or project — check with our advertisers if it is not mentioned here. Also, for a list of suppliers who stock the ETI projects published over the last few years, our "Kits for Projects" page may generally be found on the page immediately before the DREGS page (inside the back cover).

This month's feature project, the ETI-565 Laser, will be available as a complete kit from:

Laser Electronics Pty Ltd
P.O. Box 359
Southport QLD
(075) 32-1699

However, for those wanting to construct the unit in a different configuration, just the laser tube and transformer will be available from them for around half the price of the complete kit. If you are attempting construction in a different manner to that described, the pc board will be available from the usual sources — Radio Despatch Service, R.C.S. Radio and Trilogy in NSW; All Electronic Components, Rod Irving Electronics and possibly a few others in Victoria. Refer to the "Kits for Projects" page (192 this month). The 10n, 5 kV ceramic capacitors used in the laser power supply are not common. Try David Reid Electronics, Radio Despatch Service and Martin de Launay in NSW, All Electronic Components and Ellistronics in Victoria. Other firms may carry these, so don't hesitate to phone around first. Note that carbon composition resistors are preferred for this project, but cracked carbon types may be used.

The ETI-563 NiCad Fast Charger is an excellent companion to the Simple NiCad Charger (ETI-578) described last month. There's nothing really special about the components in this project — all should be standard stock, available 'off the shelf' from many sources. There are quite a number of distributors of the PacTec case we used for this project and you can find the address of one near you by contacting Associated Controls P/L

at: 55 Fairford Rd
Padstow NSW 2211
(02)709-5700

or 214-224 Wellington Rd
Mulgrave Vic 3170
(03)561-2966

Scotchcal front panels to suit this project will be available from Radio Despatch Service in Sydney, plus All Electronic Components and Rod Irving Electronics in Melbourne.

Servicemen and radio amateurs will no doubt be interested in the **Two-tone Generator, ETI-149**. The project is simple to build and inexpensive and quite a useful test instrument if you are at all involved with singlesideband transmitters. All components should be available 'off the shelf'. The two "Lilliput" sub-miniature lamps used in this project we obtained from Dick Smith, cat. no. S-3842 (12 V, 50 mA version), although most stockists will have something similar, if not the same. The "zippy box" we used to house the project also came from Dick Smith's and it's cat. no. H-2752. As all the components mount on a panel roughly 195 x 110 mm, any housing having a panel this size would suit. Scotchcal front panels should be available from the above-mentioned sources (as for the NiCad Fast Charger).

Demand for a guitar/mic preamp to suit the ETI-466 300 W amplifier (February issue) has been quite high — hence the **Four-input Preamp, ETI-467**, this issue. This project is built around a commonly-available, high-performance quad op-amp, the 4136. As constructors will most likely want to suit themselves with regard to housing this project, we have not specified a case in the project description. However, note that the unit will fit nicely in a standard 19-inch wide (483 mm) by 1¾-inch high (45 mm) rack panel/cabinet. There are no special components associated with this project and, again, all components should be readily available off the shelf. Note that it may be powered by the extra winding (15 - 0 - 15 volts) on the PF4363 transformer specified for the ETI-466.

Announcements

Abacus Computer Store in Melbourne has taken over as Silicon Valley agents in Victoria following the gutting by fire of Silicon Valley's Richmond premises. You can get your ICs, resistors, capacitors and all the other Silicon Valley goodies from Abacus now; they're at:

512 Bridge Rd
Richmond 3121
(03)429-5844

Note also that they've just joined ETI's scheme for obtaining advance notice of projects so you might enquire about our latest projects from them in the future.

All Electronic Components at 118 Lonsdale St, Melbourne (not far from ETI's Melbourne "spy HQ") would like it known that they have many metal detector hardware items available. These range from handgrips and one-metre lengths of pvc suitable as shafts, to moulded fibreglass search heads, suitable for both the ETI-561 (March 1980 issue) and the still-popular ETI-549 (IB type — May 1977 issue) metal detector projects.

Price estimates

This may seem boring and repetitious, but . . . *these are estimated prices only*. This information is published as a guide and a variety of factors may affect the actual price of projects and/or kits. Generally, we hope it goes your way . . .

ETI-565 Laser	\$250 - 280 (complete kit)
ETI-563 Nicad Fast Charger	\$45-\$55
ETI-149 2-Tone Generator	\$28-\$35
ETI-467 4-Input Preamp	\$40-\$55 (depending on with/without T1)

ROD IRVING ELECTRONICS

499 High St, Northcote 3070. Ph (03) 489-8131.
Mail Orders: PO Box 135, Northcote 3070. Min P&P \$1.25. Heavier items add additional postage. Extra heavy items sent Comet freight on.

PRE STOCK TAKING SALE EXTRA SPECIALS

10 BU208	\$25.00
100 BU208	\$200.00
(While Stocks Last)	
10 BUX80	\$75.00
10 BU126	\$28.00
10 BD139	\$3.30
100 BD139	\$31.00
10 BD140	\$3.50
100 BD140	\$34.00
10 BC549	\$1.00
10 BC559	\$1.50
10 BC547	\$1.00
10 BC557	\$1.50
10 BC327	\$1.50
10 2114	\$47.50
10 4116	\$79.00
10 2708	\$84.00
10 Red Leds	\$1.20
100 Red Leds	\$11.00
10 GRN. Leds	\$2.00
10 YLW. Leds	\$2.10
10 7447	\$6.00
10 7490	\$3.50
10 RL4136	\$13.00

Prices current till 7th August, 1980
Bankcard Mail Orders Welcome

Please debit my Bankcard.

Bankcard No.

Expiry Date

Name

Signature

SEW**MEASURING INSTRUMENTS FROM "STANDARD"**

YN-360TR A reliable 20 000 ohm/V DC meter. Fully protected, dB readings & transistor checker.



ST-303TR A high sensitive meter with overload protection, minor scale, measuring up to 12A DC, dB readings & Transistor checker.



SP-10D A versatile pocket tester. Fully protected. Will measure dB and capacitance.



ST-350 A good performer, 10A DC, measuring dB, inductance & capacity.



ST-300. This CLAMPTESTER has fuse protection, shock proof movement & comes complete with Test Leads & carrying case.



ST-100



ST-80



ST-660



ST-45



ST-680



ST-160



ST-5 A mini tester, 4K ohm/V DC & dB range, provides satisfactory performance.

- * Full range of quality Multitesters, Panel Meters, Indicators.
- * Special meters to customer specifications.

**SOLE AUSTRALIAN AGENT:****EMONA ENTERPRISES Pty Ltd.** CBC Bank Building Suite 208/661 George St., SYDNEY, NSW, 2000. Telephone: 212 4815, 211 3038**DISTRIBUTORS**

N.S.W.
STANDARD COMPONENTS Pty Ltd.
 10 Hill St., Leichhardt, 660 6389

RADIO DESPATCH SERVICE,
 869 George St., Sydney, 211 0191

MARTIN de LAUNAY Pty. Ltd.
 King & Darby Sts, Newcastle, 2 4741
 270 Keira St, Wollongong, 28 6020

A.C.T.
ELECTRONIC COMPONENTS Pty. Ltd.
 29 Wollongong St. Fyshwick, 80 4654

VIC
RADIO PARTS GROUP
 562 Spencer St, West Melbourne, 329 7888
 1103 Dandenong Rd., East Malvern, 211 8122

S.A.
INTERNATIONAL COMMUNICATION
SYSTEMS Pty. Ltd.
 75 Dale St, Port Adelaide, 47 3688

W.A.
LETCO TRADING Co.
 45 Kirwan St, Floreat Park, 387 4966

QLD
AUDIOTRONICS
 396 Montague Rd,
 Westend, Brisbane, 44 7566



Introducing the NEW NO COMPROMISE JRC MODEL NRD-515 communications receiver.

This versatile high quality receiver covers 100KHz to 30MHz using a PLL and photo type rotary encoder to determine frequency setting.

With its continuous coverage and an optional 24 channel memory unit this receiver should meet the needs of professional and commercial services as well as sophisticated SWL, hams and others seeking excellence and quality.

This well made double super het has effective passband tuning, electronic switching and all solid state chassis. It features completely modular construction with all components mounted on plug in circuit boards for ease of servicing.

For further information write, phone or call in. Colour brochure and specifications available.



We also stock Australia's largest selection of scanning receivers! You can listen to aircraft, marine, police and other transmissions.

BEARCAT 210.
 BEARCAT 220FB.
 BEARCAT 250FB.
 BEARCAT POCKET
 SCANNERS.
 SX-100 etc.

Write for prices & specs.



WRITE FOR OUR 36-PAGE FREE CATALOGUE CONTAINING:

Send 50c stamp

- RECEIVERS
- TRANSCEIVERS
- LINEAR AMPLIFIERS
- RTTY EQUIPMENT
- SSTV EQUIPMENT
- TV CAMERAS & MONITORS
- COMPUTERS
- ANTENNAS
- ROTATORS
- ACCESSORIES

KENWOOD R-1000

Communications receiver of the year. Digital and analog dial, digital clock, automatic timer, three selectivity positions and many other features.



WRITE FOR SPECIFICATIONS

**emtronics**

CITY & SHOWROOM: 649 George St, Sydney, NSW. (02) 211-0531.
 POSTAL: PO Box K21, Haymarket, NSW 2000. Cable: Emtron Sydney.

LETTERS

Dear Sir

I have been waiting for you to publish your valve amplifier design for a while now, because I knew that it would make available hard to get parts such as transformers, etc. However, I am very disappointed with the design and concept of this amplifier, to the extent that I get the impression people have forgotten how to design high quality valve amplifiers. As I have several points to make I will list them below:

- The amplifier is a cross between a guitar amp and a hi-fi amp with the result that it does neither job well.
- Associated with this are high THD figures — even if it is valve distortion. The IMD must also be high.
- The power output is too high, and it would be better to sacrifice 3 dB of power for better linearity.
- The output stage is the worst part of the amplifier — running Class B and pentode connected is not the best way to achieve a linear stage.
- An ultra-linear output stage should be used (or even mode connected perhaps) with a quiescent current of 55-60 mA per tube (not 25 mA!). Use fixed bias as you have.
- Your output transformer has only a three-section winding, which is very sub-standard. At least five sections are required (as brought home in the power bandwidth figures). Note that D.T.N. Williamson had five primary sections and four secondary sections.
- The first three stages are quite good, but it is very easy to direct couple the first and second stages as in the "Williamson" amp.
- With the improved output transformer it should be possible to achieve at least 20 dB of negative feedback with a mode input stage as in the Williamson amplifier.
- The power output would be about 60W at approx. 0.1% THD.
- Also, the power supply is just not going to be stable enough for your Class B stage. Choke input filters or electronic regulation with another EL34 are recommended.

All this can be achieved without serious surgery on the circuit topology. However, my personal preference is for that shown in the circuit (supplied with letter . . . Ed.) which is based on a Mullard design,

except I have incorporated a low impedance driver stage, incorporating bias adjustments for each valve.

You'll probably say "we tried that", however these are just my thoughts on how a high quality amplifier should go.

J.S. Spicer

Monash Uni, Elec Eng, 4th Yr

Ref: Wireless World; April 1947 p.118 and May 1947 p.101; "High Quality Amp", D.T.N. Williamson.

Unfortunately, Mr Spicer, you have made an unwarranted assumption — or your reading comprehension was definitely at a low ebb when you read the May issue and wrote your letter. Firstly, the ETI-456 valve amplifier project was titled "The Rocker". Our intention with this title was to dispel any notion that we were presenting anything other than a guitar amplifier. The opening paragraph also contains a reference to musicians. Then again, surely the controls provided (the 'kill' and 'feedback in/out' switches) indicate that the project is aimed at the guitarist.

If we were to present a true "hi-fi" valve amp, it would definitely not be a mono unit.

Your points about a valve hi-fi amp are well taken, but in this area our conviction is that solid-state techniques are superior and that valve techniques remain but a curiosity.

**Roger Harrison,
Editor.**

Dear Sir,

I have been reading your magazine since I first became interested in electronics, about 12 months ago.

I was wondering if it was possible for you to design a 'low cost' interface for a cassette recorder to turn it into a video recorder. I feel a project like this would be very popular with readers.

**John Stevenson
Caulfield, Vic.**

We can only agree about such a project's popularity! However, were we to design such a unit, rest assured the last thing we'd do would be to publish it in the magazine — or anywhere! No way — we'd be out there making and selling the units as fast as could possibly be organised . . . and all retire as multi-millionaires next year.

You see, fundamentally, what you're asking is equivalent to attempting to fit, say, 50 litres of petrol into a 50 millilitre container — an extraordinarily difficult task!

A video signal has a bandwidth (the range of frequencies necessary for good reproduction) of about 3 MHz to as much as 5 MHz. The bandwidth of even the best audio cassette recorders is somewhat less than 20 kHz, and may be as little as 5 kHz for the cheaper models. At worst case, you're asking us to try and squeeze a signal 5 MHz wide into a 'space' (or bandwidth) only 5 kHz wide — hence the analogy with the 50 litre and 50 millilitre containers.

Whilst modern communications research has managed to do the seemingly impossible in developing a transmitting and receiving system that compresses the human voice into half the bandwidth previously required, one cannot expect such miracles to apply in this instance.

It's a good idea, but . . .

**Roger Harrison
Editor**



If you're an ASSEMBLY ARTIST

and you're reading this
magazine, WE WANT
YOU!



All the advertising you see for Dick Smith Electronics is done in-house. We have a very busy advertising department - and we're looking for a competent advertising assembly artist to help relieve the pressure.

- Check yourself against our requirements:
- At least 2 years experience.
 - Ability to type (we'll train you on a computerised phototypesetter).
 - A working knowledge of electronics.
 - Most of all, a proven self starter who doesn't need continual supervision.

Are we describing you? If so, how about working for us. An attractive salary is offered, you'll be working in a modern, air conditioned office at North Ryde with a pool and recreation facilities, and staff discounts on purchases will really help you if you're an electronics hobbyist.

Why not give us a call - as soon as possible. Call (02) 888 3200 and ask to speak to Mr Gary Johnston.

DICK SMITH ELECTRONICS
Cnr Lane Cove & Waterloo Rds,
NORTH RYDE, NSW, 2113.

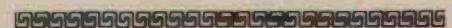

'THE S100 BUS STOP'TM

S-100 & 6800 CHASSIS



11 slot backplane, fully card guided. 15 amp power supply, fan, key switch, bench mount, rack mount, anodised aluminium. 5 edge connectors standard. S-100 Bench Kit \$345. S-100 Rack Kit \$306. 6800 Bench Kit \$370. 6800 Rack Kit \$330. Assembled prices add \$100.

ETI 642 S-100 16K STATIC RAM

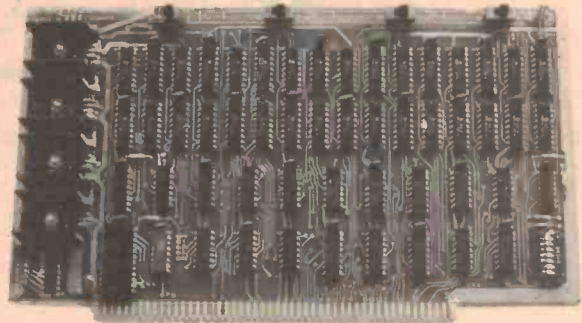

Features:- 2114 low power static RAM's, 4K addressing, 4K write protect, bank select, wait state gen., plated through hole, solder resist mask, 300 or 450 nS speed, ETI 642.
Kit \$315. Ass. \$380. Add \$32 for 300 nS.

2708/2716 EPROM CARD

Features:- holds up to 16 2708 or 2716 (single supply) EPROMS, on board wait state gen. Unused locations may be blanked. Plated through holes, solder resist mask.

PRICE:- Kit \$115. Ass \$155.

EPROM PROGRAMMING CARD

Features:- ability to programme triple supply 2708's and single supply 2508, 2716, 2732 etc. Zif. Socket. On board 26V generator. Port driven.

Price:- Kit \$175. Ass \$205.

Z-80 CPU CARD

Features:- 4 MHz operation, power on jump, wait state generators, provision for on board 1K EPROM, front panel socket for reset, and data lines etc.

Price:- Kit \$156. Ass \$196.

Z-80 SINGLE BOARD COMPUTER

Features:- 4 MHz operation, 1K static RAM, 8K/16K EPROM, serial/parallel ports, power on jump, timer, vectored interrupts, software selectable baud rates. With 2716 EPROM. Price:- Kit \$295. Ass \$370.

80 X 24 VIDEO DISPLAY CARD.

Features:- on board Z-80 and CRT 5027 controller chips, parallel keyboard interface, 2708 driver chip, and 2708 character generator chip, special effects and extended character set available.

Price:- Kit \$290. Ass \$370.

64 X 16 VIDEO DISPLAY CARD

Features:- memory mapped 1K board, with reverse video and cursor control. RCA video connector, plated through holes and solder resist mask.

PRICE:- Kit \$155. Ass. \$180.

64K DYNAMIC RAM CARD

200nS access time, bank select, wait states, 4116 RAMS.

32K — kit \$525. A&T \$605.

48K — kit \$670. A&T \$750.

64K — kit \$815. A&T \$895.

Z80 STARTER KIT

Hex key pad, hex address & data displays, 2 x S100 sockets, wire wrap area, PROM programmer, parallel port, Kansas City cassette interface, timer chip (Z80 CTC), 2K monitor PROM, monitor listing, 120 page manual, 2K RAM, 4K PROM.

KIT PRICE \$350. A&T \$420.

FLOPPY DISK CONTROLLER CARD

Features:- single density, mini or full size disk drives with FD 1771 controller chip, can be interrupt driven, syncs with CPU In data transfer, Shugart/Remex compatible.

Price:- Kit \$195 Ass \$235

DD FLOPPY DISK CONTROLLER CARD

Features:- controls mini and full size, single/double sided single/double density and all combinations of each. Crystal locked, PLL data recovery, Shugart/Remex compatible software (CP/M / SDOS) for above controllers available.

Price:- Kit \$285. Ass \$345

STANDARD EXTENDER CARD

Features:- double sided /glass board, numbered test points reflow soldered.

Price:- Kit \$33. Ass. \$48

WIRE WRAP CARD

Features:- double side /glass board, ground plane and supply rails run on both sides, 3M type connector patterns on top of board, provisions for regulators on all rails, holes are on .3" pitch, by .1" pitch.

Price:- Bare board \$26.50

6800 PRODUCTS

6800 Extender Board \$33. 6800 11-slot backplane \$36. 6800 11-slot chassis, rack mount \$330. 6800 Extender Terminator Board, Kit \$80. Ass \$105.

EPROMS AND RAM CHIPS

2708 450nS guaranteed \$12. 2716 450nS single supply ex-stock \$47.50. Hitachi 2114 low power 450nS \$7.50. Hitachi 2114 low power 300nS \$8.50.

DISK DRIVES

Shugart SA400 \$410. Shugart SA801 \$710. Remex 8-inch double sided \$795.

DUAL 8" DRIVE PACKAGE

Features:- contains dual 8" single or double sided disk drives either Remex or Shugart. Inbuilt power supply, cooling fan, modular construction, keyswitch, fused on mains, all aluminium 19" rack mount (10-1/2" high).

Price:- single sided \$1750. Double sided \$1950.

EPROM SOFTWARE

1. Z-80 monitor In 2708 EPROM, has 16 functions, three versions available to drive TTY, TTY/VDU, KBD/VDU. Price \$25. 2. ETI 640 video driver EPROM, makes the memory mapped video card look like a terminal, has XY cursor addressing, home clear screen. Price \$25. 3. 6.25K Basic Interpreter, In seven 2708 EPROMS, has trig functions, dimensions, command level input ability. EPROM resident at OC000 hex. Price \$180. 4. Disk control EPROMS, contain I/O routines to handle our disk controller with CP/M, 2 EPROM set with second EPROM containing inbuilt video driver and I/O routines for all external devices like printers, terminals etc. Price \$50.

Customised version available (I/O and relocation) for an additional charge depending on the programme.

DISK SOFTWARE

CP/M version 1.4 customised for our controller. \$145. CBASIC II \$125. Wordmaster, wordprocessing package \$140. TEX writer, letter and text formatter \$50. CP/M user group library (33 vols) at \$12 per vol. RAM Diagnostic, reports errors and likely causes \$25. Available on 8" and 5-1/4" single or double density. Above prices are for 8" disks.

MPB-100 CPU BOARD

Z80 CPU Board with 2K single supply EPROM provision, power on jump, 4 MHz, front panel socket, wait state.

KIT PRICE \$260. A&T \$310.

2708 EPROM CARD

16K of 2708, 4K address boundary, 8 or 16K area required, wait states, plated thru.

KIT PRICE \$98. A&T \$128.

LA34 DECWRITER PRINTER/TERMINAL

Desk Top printer, full 128 ASCII character set, switchable 110 and 300 baud rates, 30 cps speed, adjustable character widths, adjustable line spacing, 9 x 7 dot matrix printing.

PRICE \$1,545 ex stock.

Sm ELECTRONICS
MELBOURNE
Ph (03) 842-3666
Trading Hours: 10am-6pm Mon to Fri.

1096 Doncaster Rd, Doncaster East, Vic 3109.
PO Box 19, Doncaster East, 3109. Telex AA37213.
DEALER: Canberra - 81-5011, Sydney - 661-9237.

Send 60c in stamps for COMPUTER PRINTOUT CATALOGUE for more details.

ALL PRODUCTS AUSTRALIAN MADE AND EX STOCK (ALMOST). DEALER ENQUIRIES WELCOME.

Prices and specs. subject to change without notice.

All prices tax free, for retail prices add 15 percent.

bankcard

welcome here

Give name, number, expiry date and signature for mail order sales.

Trading Hours: 10am-6pm Mon to Fri.

S-100 I/O PORT BOARD



Now with dual serial ports

DUAL SERIAL I/O CARD Features:- dual independently controlled serial ports with TTY and RS232 outputs and inputs. Nine programmable parallel ports, crystal controlled baud rates fully buffered and address decoded. Plated through holes & solder resist mask.
Price:- Kit \$189. Ass. \$225.

UV EPROM ERASER



New product range. Model LEE/T 15W tube, 120 min timer, up to 40 EPROMS will erase in 10/15 mins. Model MEE/T 8W tube 120 min timer, up to 10 EPROMS will erase in 20/30 mins. Model MEE is same as MEE/T but with no timer. All erasers are fully assembled and have a safety switch. LEE/T \$105. MEE/T \$93.50. MEE \$74.

S-100 EXTENDER/TERMINATOR



EXTENDER TERMINATOR CARD — features:- true active termination of the bus with inbuilt extender connector on top of board, fused rails to extended board. Test points numbered, solder resist, plated through. Price:- Kit \$70. Ass. \$90.

TEXAS KSR 820 PRINTER/TERMINAL

Desk top printer with 150 cps printing speed, 9 x 7 dot matrix, numeric key pad, tractor feed, RS232 interface, 132 characters wide, 110 to 9600 baud rate, 640 character buffer. Price \$3,000.

TELEVIDEO TVI-912 TERMINAL

80 x 24 display, upper and lower case, 110 to 9600 baud rate, dual intensity, numeric pad, cursor controls, XY addressable cursor, block mode, self test, microprocessor controlled. Price \$1,295.

1096 Doncaster Rd, Doncaster East, Vic 3109.
PO Box 19, Doncaster East, 3109. Telex AA37213.
DEALER: Canberra - 81-5011, Sydney - 661-9237.

Send 60c in stamps for COMPUTER PRINTOUT CATALOGUE for more details.

ALL PRODUCTS AUSTRALIAN MADE AND EX STOCK (ALMOST). DEALER ENQUIRIES WELCOME. Prices and specs. subject to change without notice.

All prices tax free, for retail prices add 15 percent.

JACK SOCKETS FROM Re-an

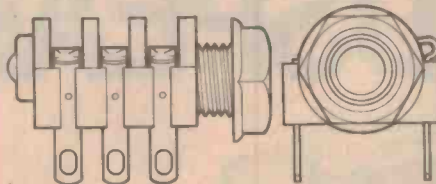

MONO

- M100 Plastic fixing nut single : single
- M101 Plastic fixing nut single : break
- M102 Plastic fixing nut break : break
- M120 Chrome fixing bush single : single
- M121 Chrome fixing bush single : break
- M123 Chrome fixing bush break : break

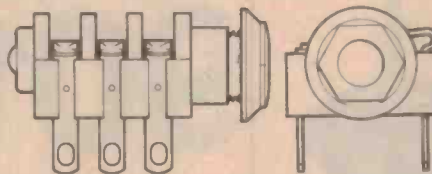

STEREO

- M200 Plastic fixing nut single : single
- M203 Plastic fixing nut break : break : break
- M220 Chrome fixing bush single : single : single
- M223 Chrome fixing bush break : break : break



Manufactured using gold-plated nickel silver spring contacts in a robust, high temperature nylon body. Our new range of sockets has been designed to allow speedy assembly on your production line together with excellent electrical performance backed by longlife reliability.

Brochures available on all products.

HOLDEN-WASP INTERNATIONAL

39 Chalder Street. PO Box 532, Marrickville 2204. Phone 560-3488.



DAVID EAST COMPONENT CENTRE

33A Regent Street, Kogarah NSW (Opposite Kogarah High School)
Phone 588-5172

RESISTORS

1/4W — 5c. 1 W — 8c. PW5's — 45c.

TRANSISTORS

BC 107, 108, 557, 558 — 33c. BC 559 — 30c. BC 547, 548 — 25c. BC 549 — 27c. BC 109 — 36c. BD 139, 140 — 95c. BC 639, 640 — 75c. 2N3055 (Motorola type) — \$1.30.

SEMICONDUCTORS

4001, 4011 — 40c. 4016 — \$1. 4017 — \$1.75. 7400, 7402 — 45c. 7490 — \$1. 74C00, C02 — 50c.

DIODES

IN914 — 5c. IN4004 — 8c. IN4007 — 18c.

REGULATORS

7805, 12, 15 — \$1.25. 7905, 12, 15 — \$1.75.

SCR's

C103B (200V, 800 mA) — \$1.16. C106DI (400V, 4A) — \$1.08. C106YI (30V, 4A) — 70c. C122E (500V, 8A) — \$2.56.

TRIACS

SC141D — \$1.28

DIACS

ST2 — 38c.

BRIDGE RECTIFIERS

All 400V, 1.5 amp to 30 amp.

POTS

Single gang log and linear: 500R-1M — 75c. Trim-pots — 39c. Cermet, Vert & Horiz — 42c.

LED's

5 mm Clear and Diffused Sankin Type. Red — 22c. Green and Amber — 31c.

Also a large range of capacitors, Electros, Greencaps, Tag Tantalums.

All first quality components at prices you CAN afford.

Listen to the worlds most highly reviewed LOUDSPEAKER



the
BOSE[®]
901

Stands 136-139 in the AMP
Pavilion at the 1980 CE Show

For a private showing contact your nearest Bose stockist:

Stereo Supplies

95 Turbot Street
Brisbane QLD.
Blackwood Sound
5 Corromandle Parade
Blackwood S.A.

The Audio Centre
883 Wellington Street
West Perth W.A.

Teak House
70 Liverpool Street
Hobart TAS.

Denman Audio
70 St Kilda Road
St Kilda VIC.

Duratone HI FI
3a Botany Street
Phillip A.C.T.

HI FI House

268 Keira Street
Wollongong N.S.W.

D.M.E. HI FI
599 George Street
Sydney N.S.W.

Apollo HI FI
283 Victoria Road
Marrickville N.S.W.

Audio Wholesalers
9 Wilson Street
Burnie TAS.

Belmont Stereo Systems
73 High street
Geelong Vic.

Northern Electronics
146 Gaffney Street
Coburg VIC.

Sound Factors

367 Lonsdale Street
Dandenong VIC.

Prouds Audio
89-100 Mitchell Street
Bendigo VIC.

HI FI Country
34 Statlon Street
Engadine N.S.W.

Haberechts
610 Deane Street
Albury

Nitronics
Centrepoint
9 Park Avenue
Coffs Harbour N.S.W.

Targa Electronics
Calrns

Russ Adam

Townsville

Stereo Sales

Mackay

Highway Sound Centre

Mt Isa

Premier Sound

Rockhampton

Bob Wilson

Bundaberg

Hoopers Sound Centre

Gympie

Custom Sound Centre

Nambour

DJL Electronics

Caloundra

Geoff Bradford

Towoomba

BOSE[®] AUSTRALIA INC. 11 Muriel Ave, Rydalmere 2116 Sydney NSW. Ph 684-1022.

Ladies and gentlemen, it's . . .

The 1980 Consumer Electronics Show !

Number five in a series, here's a preview and guide for your edification and enjoyment. The largest annual event of its type to be staged in Australia (insert orchestral crescendo here . . .).

THE FIFTH annual Consumer Electronics Show at the R.A.S. Showground in Sydney from July 14th to 20th will include a wider range of products than ever before, some of which are to be shown to the public for the first time. New ideas and new designs will be competing for your attention with old favourites that have stood the test of time.

Competition between manufacturers is as intense as ever. Amid the welter of attractions and distractions some companies will be trying extra hard to get your attention. Philips for example will be holding 'competitions with valuable prizes' and are giving away free sets of top quality recordings to anyone who buys one of their hi-fi systems.

But the prize for inventive publicity must go to Marantz, who'll be prominently displaying a surf life saving boat and an Escort rally car, both carrying the Marantz colours of course. They're also running a lottery with an audio system as first prize and to lure you into their listening room there's a lady representative from Penthouse magazine.

Yes folks ! All the "Mickey Mouse" gear at Australia's "Mickey Mouse" electronics show — even Mickey Mouse telephones !

But don't be a scruff when you meet her, get yourself a free trial of the latest Remington shaver at the Monier stand first!

TDK are screening what promises to be a fascinating 20 minute film that gives away some of the secrets of manufacturing top quality magnetic tape.

Some exhibitors have not yet finalised their plans as we go to press at the end of May, so there may be a few surprises in store that we haven't heard about. In the next few pages we aim to give you a good idea of what's on display.

Sound in the eighties

As you might expect, audio equipment features very strongly in this year's show. There's a strong emphasis on complete integrated systems, which make a lot of sense if you're not too sure about compatibility of components from different makers. The days when audio manufacturers were strong in some areas and weak in others are long past and some of today's package hi-fi systems are better than anything you could have mixed and matched a few years ago.

Mini systems have come on strong since they first appeared last year. Mini of course refers to size and weight, not power output which compares very favourably with full size equivalents. Most of the major manufacturers will be showing these mini (some call them micro) systems. The Uher Miniset, on display at the Atram Electronics stand, is billed as the smallest and most powerful system in the world. Uher also have a range of 'slim-line' modules mid-way in size and weight between minis and conventional components. Another top German mini maker, Körting, have their products on the same stand. ▶



Following their huge success with them last year, AIWA will be prominently featuring a range of updated minis this year too, and Marantz are launching a new slim-line range as well. JVC seem to be sticking to the standard size, but they're not just resting on their laurels. They plan to introduce no less than five all-new systems.

If you've been reading anything at all about hi-fi the past twelvemonth you'll have noticed the increasing prominence of graphic equalisers. You'll see plenty of them at this year's show. These complicated-looking units divide an audio signal into a dozen or more frequency bands, each of which can be independently boosted or attenuated to flatten out peaks and valleys in the frequency response caused by non-linearity of components or resonances in the listening room.

There's just one problem with this. How do you know when you've achieved a flat response or the closest you can get to it? If you use a microphone to measure frequency response, how can you be sure you're not just compensating for the inadequacies of the microphone? And if you just use your ears to judge then you'll probably end up, not with a flat response, but simply a pattern of distortion that you prefer to the original unequalised version.

Fortunately, there's an easy way out of this one and that is to buy your equaliser from a supplier who will install it for you in your home and use analysing equipment to make sure it's adjusted to optimise your system's response. One company who will do this for you is Audio Reflex, who'll be showing several equalisers at their stand.

Equalisers are all very well but you can't make a silk purse out of a sow's ear and to get a good system you still have to have good components all along the line. To help you pick and choose, here's a rundown of some of the new models. There just isn't space to list everything, but this will give you some idea.



Yamaha's top-line PX-2 turntable features a tangential-tracking tone arm — see Rose Music on Stands 11 & 12.



Systems will feature strongly amongst audio exhibitors this year. This Rank Arena 'Audio Plus, RA20T' system can be previewed on Rank's stands, Nos. 15 & 16.

Turntables and cartridges

Belt-driven turntables are still holding their own against the more expensive direct-drive types. Kenwood have a new model KD-1600 belt-drive turntable which is fully automatic. Times change, don't they? It's not so long since automatic tone arms were anathema to hi-fi buffs because of mechanical resonance problems. Not so now. Kenwood's two new quartz-locked direct-drive turntables also feature automatic operation.

Their KD-5100 has remote control terminals and for the top-of-the-range KD-850 they claim wow and flutter of less than 0.022%.

The Rega turntables at the Concept Audio stand should attract some attention, especially if they succeed in getting the Rega Planar 2 into Australia in time for the exhibition. The Planar 2 is a less expensive version of the Planar 3, an old favourite (for very good reasons) which will certainly be on display.

Tone arm design philosophy seems to change almost every year. The new Yamaha P-750 direct-drive turntable has a straight tone arm which the makers claim reduces torsional oscillations. Their top-line PX-2 does away with a pivoted tone arm altogether and tracks tangentially. Yamaha products will be at the Rose Music stand.

Maybe the days of the conventional record deck are numbered. Aiwa say they'll be showing "a revolutionary new turntable — a totally new concept in design". That's all they'll say about it in advance but they reckon it'll be a show-stopper.

Philips may be showing their digital disc and player. That's certainly a different approach — no grooves, no stylus, just a pattern of dark lines in digital code read by reflected laser light.

Moving-coil cartridges are now the most favoured type and every maker has at least one. Check out the Ortofon range at the Harman exhibit. Concept Audio's range of Dynavector cartridges are worth a look too. Audio Engineers and Syntec International will be showing the full range of Shure cartridges, including the M97 series which will be on display for the first time. Supporting these will be the world-renowned SME tone arms.

Cassettes and reel-to-reels

Audio cassette decks have come a long way since Philips invented them in the late sixties. Philips concentrate on other areas nowadays, but they still have a good range of portable and car radio-cassette systems. Akai will be showing strongly. Their model GX-M10 incorporates their exclusive twin field GX heads and like all top quality models



There'll be plenty of cassette decks out of wraps this year. Akai's GX-M10 features a programme memory and metal tape facility.

this year it's compatible with ferric, CrO₂ and metal tapes.

But competition is fierce. Yamaha's K-950 has a new version of the Sendust alloy head, which has been specially redesigned for metal tape. Kenwood's new KX600 has a fine bias adjustment in addition to the four preset tape selector positions, and JVC's KD A8 deck has automatic 'computerised' tape tuning.

No matter how high class your deck, it's essential to keep it in good nick and to use best quality tape. TDK, the tape specialists, aim to maintain their reputation with two new audio cassette tapes, the OD normal position and SA-X high position, which are both designed to handle the higher sound levels of some classical music, like the cannon in the 1812 Overture. (Warn the neighbours first!)

To keep your heads in good condition (and the capstan and pinchroller too), Communications Power Inc have the Allsop 3 cassette cleaner. This year they're introducing a video cassette cleaner, claimed to be unique.

Most manufacturers are offering a 'recording mute' facility which allows you to blank out commercials or commentary when recording off-air. In view of the copyright laws, this seems to be sailing close to the wind.

Reel-to-reel tape recorders are still in the doldrums. Only two makers think it worthwhile to mention them in their pre-show publicity. One is Akai of course, who made their name in this field and are still one of the leaders. The other is Revox, who are showing at the Audio Engineers stand.



Amongst a whole array of advanced tuners (should be a boom this year) you'll find JVC's R-S77 which features a digital synthesizer and a S.E.A. graphic equalizer.

Tuners and receivers

Demand for FM tuners and receivers is expected to rocket this year. Pioneer are gearing up for the boom and giving receivers and tuners the main emphasis on their stand. Their star receiver is the SX-D5000 which has an automatic station scan to find the nearest acceptable FM or AM broadcast, quartz-locked AFC to keep it in tune and a memory facility that can recall up to six stations on each band. Pioneer are proud of the external styling too, with its slider and pushbutton controls and all-digital indicators.

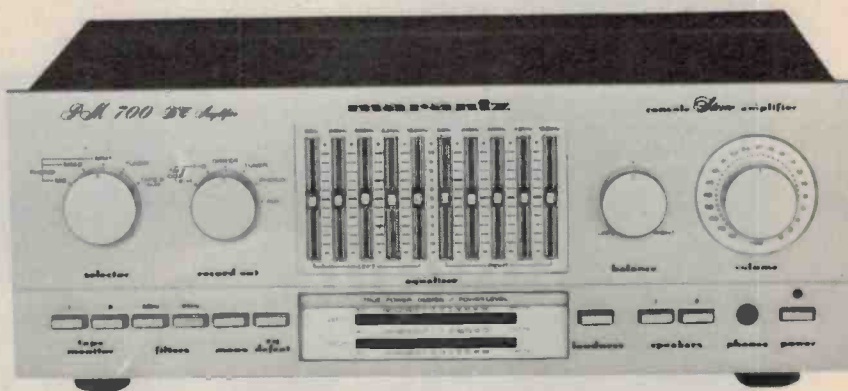

As always, there'll be plenty of rivalry amongst amplifier manufacturers. The Marantz PM700DC 'console' stereo amp features bargraph output meters and built-in graphic equalizer.

Strongest rival seems to be Marantz, whose ST500 Computuner boasts a microprocessor controlled quartz phase-lock-loop to hold the tuner on the station signal, automatic station search and memory recall of 14 stations.

Yamaha's T-550 tuner has a special multiplex demodulator which they say gives outstanding channel separation, and a built-in calibration oscillator to help set recording levels when you're taping FM broadcasts.

Amplifiers

If you can't find a preamp, power amp or integrated amp to suit your requirements at this exhibition then you're either not trying or you have impossibly high expectations. We can't possibly list every amplifier or even every new model on show. Manufacturers like Pioneer, JVC, Marantz and Kenwood are all showing a good range but so are many others. Happy hunting!

Loudspeakers

Choosing speakers is probably the most difficult decision for hi-fi buyers. When you may be spending \$1000 a pair you want to be sure of what you're getting. One leading company is doing its best to keep costs down. Acoustic Research reckon as much as 20% of the cost of speakers can be taken up by non-essentials like trims and veneers, and they think that money is better spent on improving performance. Among others, AR will be showing their AR93 and AR94 models which are liquid cooled and boast new computer-designed cross-over networks.

Professional sound engineers, oil millionaires and others who won't settle for

second best will also be interested in M & G Hoskins' display of Celestion speakers. These will be driven by the Luxman Laboratory Reference series of turntable, cassette deck and amplifier.

Another firm, Bose Australia Ltd, will be demonstrating a range of five different speaker systems, including the 802 professional models. Philips are still promoting their MFB (motional feedback) speakers. These have the power amp and transformers *inside* the speaker cabinet connected in a negative feedback loop with the drivers. A good idea, but so far they haven't really caught on. Maybe this year.

Audio sidelines

So far we've dealt with the more obvious categories of audio goodies but there's more, lots more. There's a smattering of microphones, notably at the Audio Engineers and Marantz exhibits, headphones to suit all pockets, car stereo systems and humble portable radios. And as mentioned before, almost everybody has a graphic equaliser.

Expo International Trading will be showing a range of small and portable radios, cassette recorders and digital clock/radios. At bargain basement level they have a stereo phonograph/radio system aimed at the teenage market and selling for just \$89. And guess what? Expo have graphic equalisers too.

If you can't make it round every audio stand you could do a lot worse than visit Tandy Electronics. They have a wide variety of hi-fi components and systems to suit most people's budgets, as well as a host of other electronic goodies. Tandy have more than 100 service centres throughout Australia, so if you live out in the sticks they could be your best bet. ▶



A dream come true
demands music
as true as the dream
- Nakamichi

Getting into moving pictures

In the beginning was the simple television receiver!... to parody a well-used quote. Most makers will have models on show but Kreisler Electronics are giving them a big emphasis and showing a complete range of colour models from 34 cm to 64 cm.

Two items at opposite ends of the TV size range are worth a mention. Hanimex have a portable 3-in-1 combination 12 cm (5") B & W television, cassette recorder and radio. This versatile little number will work off ac mains or 12 volt dc. If you like a bigger picture, check out K.C. Electronics. They'll be demonstrating a projection TV system which uses a portable receiver as the picture source. Screen size is 81 cm by 102 cm so you can't miss it.

VCRs and video discs

Three different systems are still struggling to dominate the video cassette recorder market. That's a pity because all three come from major innovators who spend fortunes on R & D and they all deserve to succeed.

Philips will probably be showing off their model N1700 which is one of the cheapest available. We've just heard too that you'll get a chance to see the new VR 2020, which Philips developed in

VCRs need head cleaning, just like any recorder — see the unique Allsop 3 VCR cleaner on the CPI stand, No. 57.

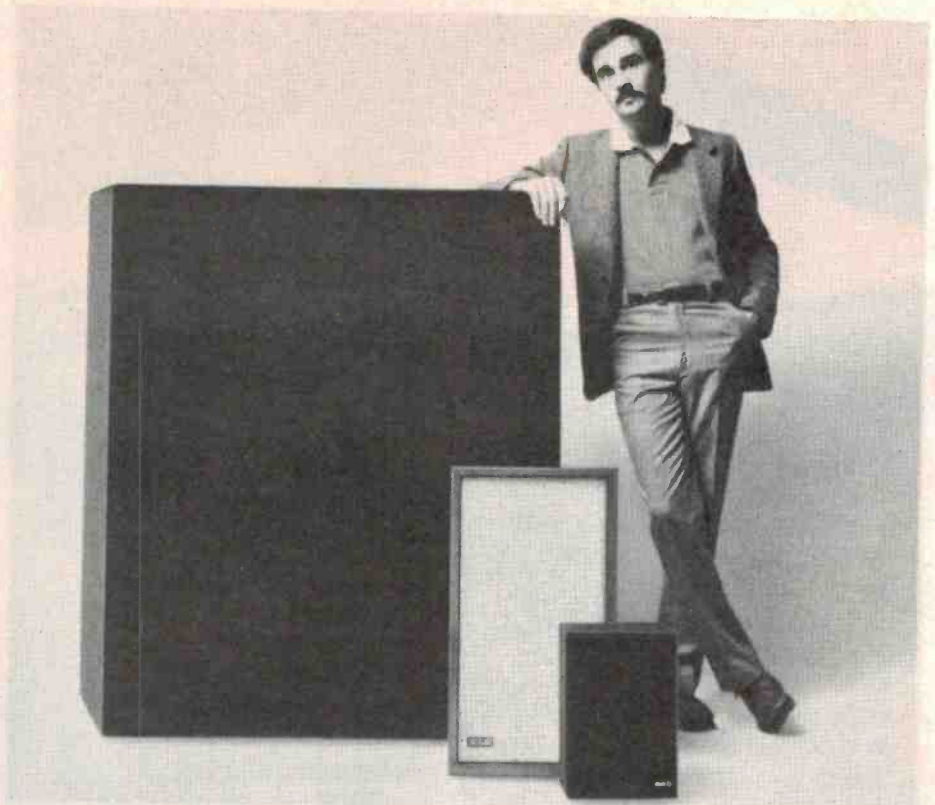

Once upon a time... big bass meant big speakers. These days, we have the "computer controlled loudspeaker" from KLH. Special electronics permits good bass from tiny boxes — see Concept Audio, Stand 6.

association with Grundig. It has a low tape speed and narrow track widths, giving a replay time of four hours for each side of a cassette, eight hours in all.

JVC are sure to be demonstrating a recorder using the VHS system which they developed. Akai and National Technics also make VHS recorders, and JVC have been using some of the money they got from licensing agreements with these companies to develop video discs. But at this stage we don't know if they'll be exhibiting them this year.

There will be at least two video disc systems on show, however. One is to be a prominent feature of the Pioneer stand; the other will be drawing the crowds at (yes, you guessed it) Philips.

Finally, we should mention the portable video camera and recorder that Hitachi are demonstrating. Video has at least two advantages over film for home movies. You don't have to wait while your pictures are processed and you can re-use the cassettes.

Study and recreation

Video software is a phrase you may not have heard before. It means pre-recorded cassettes and you can find a wide range of them at the exhibit of Video Programmes International. They have serious instructional material like 'Diagnosis of Occult Interabdominal Neoplasms' as well as more entertaining items like 'Nine Ages of Nakedness' or 'The Case of the Smiling Stiffs'. All



cassettes are available in Beta, VHS or Philips format.

Teletext, the 'TV Newspaper', which is carried by the previously unused line-synch portion of the normal TV signal, is sure to become increasingly popular. Hanimex will be showing their HTD101 Teletext Decoder, a moderately priced unit with remote controlled page selection.

Getting the message

Wonderful things are happening to the humble telephone. Manufacturers are talking about a "communications breakthrough" and saying telephones "will never be the same again". It seems the phones of the eighties will do everything but talk for you (but watch for developments in speech synthesis).

No kidding, some nifty gadgets will be on display. Computer Phones have developed the 'Royce Freedom Phone', a portable cordless device which works at anything up to 100 metres from the nearest normal phone terminal. A remote-controlled answering machine is a useful servant. Computer Phones have one called 'Elsie'. Ring up Elsie from anywhere and if you talk to her in the right tone she'll relay all your messages down the line to you.

For sheer versatility, how about a phone that stores 32 numbers in memory, displays any of them digitally incorporates a clock, a stopwatch and a calculator, automatically redials engaged numbers and has a loudspeaker so you can keep both hands free while you're talking? It's called the LR-707 Multi-function Phone and comes from the same family as 'Elsie'.

Pan Marketing are fostering the telephone revolution too. They have a whole range of products, all approved by Telecom. The STC teledialler takes the errors out of dialling. You just press a button and it automatically dials any of 32 numbers of up to 16 digits each. The Midland remote controlled answering machine will play back recorded calls down any phone line and also doubles as a cassette recorder/player when you are in the office.

Pan also have facsimile transmitters that send pictures along telephone wires and a portable data terminal to enable you to access your computer by phone.

For residential use, Answerex will be introducing the A-100 answering machine. This is a low-priced unit using a standard cassette which can be programmed to record outgoing and incoming messages of variable length.



Now we have Teletext, the "video page" comes to your TV screen — via the magic of a Teletext decoder such as Hanimex's HTD101. Check it out on Stand 52.

Ultraphone will be showing a wide range of telecommunications equipment. As well as devices to improve telephone message handling they have pocket pagers and two-way radio systems.

Radio communication gear isn't very strongly represented at the show, but Tandy will be displaying a selection from their wide range of static and portable transmitters and receivers, walkie-talkies and CB sets. Ten-Four.

Talk me into it

Apart from the increasing use of micro-processors to control almost anything more complicated than a light bulb, applications of digital electronics to consumer products are becoming ever more sophisticated. Texas Instruments, who started the whole thing back in 1958 with the first integrated circuit, are really showing off their expertise this year. 'Speak and Spell' is a learning aid that masquerades as a toy. Children will enjoy listening to its synthesised speech and at the same time develop their skills in reading, spelling and pronunciation, so Texas tell us. All the speech circuitry is on a single LSI chip so there's no tape or disc to break or slip in juvenile fingers.

TI have a machine that talks in foreign languages, too. Their handheld translator pronounces, displays and translates in German, French, Spanish and English. The same firm have recently entered the home computer market with the TI-99/4. They claim that its unique interchangeable software modules make it a cinch for any member of the family to use.

You can see one of the best-known personal computers at the Computerland Australia stand — the Apple II. Among the many possible applications of the renowned Apple II are colour graphics and music synthesis. An ▶

J.P. & A. ELECTRONICS

EVERYTHING FOR THE CONSTRUCTOR AT BUDGET PRICES

1/4W RESISTORS	.03 ea
GREENCAPS from	.10 ea
500V CERAMICS from	.10 ea
50V CERAMICS from	.10 ea
ELECTROS axial from	.15 ea
ELECTROS pcb from	.10 ea
LEDS RED 3/4	.14 ea
IC SOCKETS L/p from	.20 ea
LOW PROFILE TRANSFORMER PCB MOUNTING	\$6.00

SILICON VALLEY STOCKISTS

84 Ramsay Street, Haberfield 2045.
Telephone (02) 799-3331

Sanyo Plus Series pressed to find

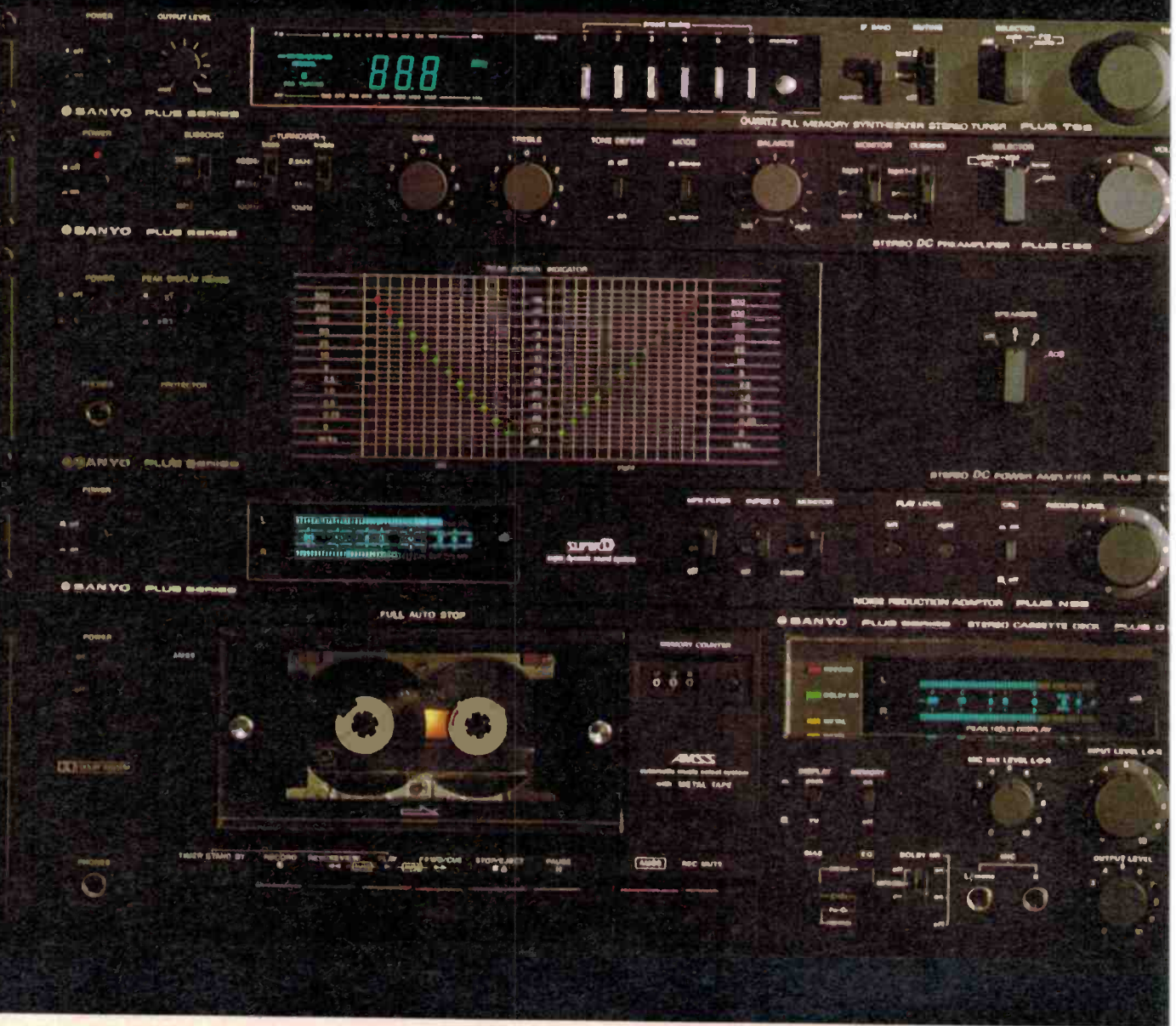

es. You'll be hard a single minus.

When we designed our new Plus Series hi-fi, we broke with tradition.

But we took care not to break one very important rule.

No compromise.

What we designed were receivers which correct themselves 100,000 times every second to make sure they are spot on your chosen FM station.

We designed a power amp able to unleash 100 watts of clean, clear sound per channel.

(Distortion less than 0.009%.)

Plus a cassette deck that's able to find individual pieces of music on a cassette.

And a turntable that lets you know when the stylus needs to be replaced.

We designed a tuner with a memory. Push a button and you

are listening to one of twelve pre-selected AM and FM stations.

Plus a noise reduction system that reduces tape noise around 8 times more than Dolby systems.

And increases dynamic range 100 times.

And a pre-amplifier with a built-in head amplifier for sensitive moving coil cartridges.

As you can see, all housed in stunning black cabinets.

As you'll discover, all capable of performance that's faithful to the original.

In summary, a series of high fidelity components that deserve to be auditioned.

Plus Series hi-fi.

Your reaction is bound to be positive.

 **SANYO**



The microprocessor revolution may come to your local school or corner business in the guise of an Apple II microcomputer. Computerland will tell you all about it on Stands 74 & 75.

optional (and very desirable) extra is a floppy disk drive which enables the Apple owner to rattle through complex iterative routines for such advanced mathematical manipulations as matrix inversion and numerical integration of differential equations. So if your kids are little Einsteins this should keep them quiet for hours... well, 30 minutes at least!

If you spend any time at all at a typewriter keyboard you'll appreciate the value of a word processor. You can clean up your errors, rearrange your sentences, centre the text and vary the spacing, automatically type the same letter to hundreds of people with the right name and address for each recipient and much more besides. We predict that within five years these devices will be almost as common as filing cabinets. Philips are just one of several firms who'll be putting them through their paces at the exhibition.

Household helpers

The exhibition organisers have adopted a very wide definition of 'consumer electronics'. The scope of the show this year has been widened to include all sorts of household equipment. If such items as electric irons turns you on, make sure you visit the Rank Industries stand. Their GE division are running an ironing competition would you believe? The same company are showing all kinds of other household equipment, ranging from small items like sandwich makers and food processors to heavy weights like washing machines and refrigerators. Most unusual item in the latter category is a dishwasher on wheels.

Monier have a lot of food preparation machines, a different gadget for every

possible process it seems. They've got one for making pizza, one for ice cream, and others for crepes, yoghurt, coffee and just plain boiling water.

Electronically assisted sewing machines aren't new, but Brother Industries claim their Computer Sew 1000 is the first in the world to be controlled by a microcomputer. It has 25 sewing patterns programmed in, including an automatic buttonhole maker. You just put the button into a gauge and the machine sews a buttonhole to the right size. Brother are showing eight other domestic sewing machines as well as an electronic knitting machine.

Sidelines

We haven't the space here to cover all the items you're likely to find tucked in between the more prominent displays, in any case it would be no fun if we told you everything would it? Among other things we feel we should mention are the vehicle anti-theft devices from Carguard International, Sanyo's solar energy display and the Mickey Mouse telephone. At the Goldring stand take a little time out from inspecting the excellent Nagoaka cartridges to look at the Discprotec record preservative. It's an aerosol that you spray directly onto the record surface. It's claimed to eliminate static charge and reduce wear on the record. Having seen that, you could pop across to the Concept Audio stand and ask Derek or Jackie Pugh to demonstrate their Permostat record preservative... could be interesting!

Whatever, make sure you get there and have fun! Don't miss us, though — we'll be there.

For a layout of the exhibition pavilions and an exhibitors list, turn to page 108.

VOXSON

Finest in Car Stereo



Nine superb models to choose from, many featuring ● AM-FM Radio ● Dolby, Loudness, Base and Treble Controls ● Auto Reverse ● Push-button tuning ● 20 watts per channel power output ● Auto seek and auto scan.



Hear the new range of Voxson car stereo units and high power Voxson speakers at any of these Voxson dealers:

John Thomas & Co — Ballarat.
Lang & Gleeson — Foster.
Webster's Electronics — Echuca.
Murray Roberts — Echuca.
Lou Simons — Shepparton.
Chris Berg Auto — Cobram.
Denillquin Elect Supplies.
Bryan Milner — Red Cliffs.
G. Beevers (Merben Appliance Service) — Civic Centre — Hamilton and Horsham.
Murlitt & Whiting — Terang.
H. Errey — Cobden.
A.C. Smith — Warrnambool.
Odyssey Electronics — Bairnsdale.
Bairnsdale Electrics — Bairnsdale.
Alecton T.V. Service — Warragul.
J.O.B. Electrics — Traralgon.
Teychenne Electronics — Traralgon.
Barham Radio & T.V. — Barham.
Lang & Gleeson — Foster.
McRae's Electrical — Horsham.
Loukes Radio — Lakes Entrance.
Bensl T.V. — Orbost.
Maryvale Electronics — Morwell.
Wright Bros — Ringwood.
Wonthaggi Radio.
Whartons Electrical — Swan Hill.
Mallester Auto — Kerang.
Len Day Car Radio — Geelong.
Fred Eva Car Radio — Ballarat.
A.G. Tulloh — Portland.
T. Wilson — Casterton.
W.G. Benson — Coleraine.
Harrap Electrics — Seymour.
Albury Audio — Lyvinton.
D & M Anderson — Woodonga.
G. Poldevin — Corowa.
John Barnes Auto — Yarrawonga.
Con Carr — Finlay.
Morrington Speed Shop.
Anderson's Electrical — Rochester.
Elliot Sound Equip — Mt Gambler.
Nyah & District T.V. — Nyah West.
Frank Day T.V. & Ass — Ballarat.
Thompson Ford — Mansfield.
Martins Garage — Mansfield.

Trade enquiries:

RADIO PARTS GROUP

562 Spencer St. Nth. Melbourne. Ph 329-7888.
1103. Dandenong Rd. East Malvern. Ph 211-8122.



You will catch more FM sound if
you use the right equipment . . .

KT-400

(FM-AM STEREO TUNER)

Exceptional sensitivity, selectivity and stability give hours
and hours of satisfying sound enjoyment.

As more FM stations go to air you'll really appreciate your KT-400 stereo tuner. Its sophisticated advanced design ensures you maximum broadcasting programme enjoyment. The tuner's keen sensitivity pulls in distant stations while its sharp selectivity separates powerful stations even when they are bunched together on the dial, and the FM stereo section is designed to provide good channel separation and low distortion. The KT-400 guarantees you optimum reception at all times.

**NEW MODEL
JUST ARRIVED!**



 **KENWOOD**

THE CHOICE OF CONNOISSEURS

TRIO-KENWOOD (AUSTRALIA) PTY. LTD. 30 Whiting St., Artarmon, N.S.W. 2064. Tel. 439 4322

RARE ADDITIONS



Marantz

FROM MARANTZ.

Rare: very valuable.

Additions: the things added.

Marantz: a range of ultra-high performance sophisticated components blending state-of-the-art engineering and operational versatility.

Marantz rare additions will add a new dimension to your musical enjoyment — so call on your local Marantz dealer and listen to our add-on or upgrade components outperform anything you've heard to date.

ST-500 AM/FM STEREO COMPUTUNER

features state-of-the-art electronic design. The quartz-locked synthesized tuning gives pinpoint tuning precision at the push of a button. The exact frequency locks in place with lowest possible distortion and no drift.

An advanced microprocessor works in conjunction with a quartz crystal and a phase-lock-loop circuit to accurately and instantaneously 'synthesize' any frequency on the bandwidth from a single quartz crystal reference source.

Simply push the tuning Up and Down Switch and you activate an automated bi-directional electronic search that scans the frequency band and automatically locks on the next station. In the manual mode, the ST-500 provides step-by-step tuning and permits pre-programming of station pre-sets.

Unlike other systems — you can pre-set as many as 14 stations, 7 AM and 7 FM.

The ST-500 also features a choice of Wide and Narrow positions which allows you to select the tuning bandwidth that best matches your reception area conditions, along with an LED Signal Strength/Multipath Indication Display.

PM-700 INTEGRATED AMPLIFIER

features Dual 5-band Graphic Equalizers and delivers 70 watts True Power per channel into 8 ohms — offering a seemingly infinite number of tone response changes. Its DC amplifier delivers a flat response all the way down to 0Hz, adding a full, live music sensation to recorded performances.

The PM-700 incorporates 2 bars of LED Indicators to register dynamic peak power levels on Left and Right channels allowing you to balance them perfectly.

The Independent Record Mode Selector and Tape Monitors enable you to listen to a record through your speaker system while recording off the air or dubbing between two tape decks.

The current interest in high-definition moving coil cartridges makes the built-in moving coil head-amp a plus — another of the reasons why the PM-700 was awarded the Decibel D'Honneur by the respected European sound magazine 'Revue du Son'. It offers the demanding audiophile a new concept in power, price and performance.

SD-8000 2-SPEED CASSETTE DECK

Audio engineers demonstrated long ago that by increasing tape speed, they could significantly improve high frequency response.

With the already wide frequency response of the SD-8000 at standard speed, 3¾ ips delivers both extended frequency response and increased dynamic range. That means that even high-energy, high-frequency musical segments are reproduced with incomparable accuracy and the distortion commonly caused by high frequency tape saturation is virtually eliminated.

The SD-8000 provides Normal, Special, Fe Cr plus Metal tape capability with an adjustable bias control to compensate for subtle variations in the bias requirements of different tape manufacturers.

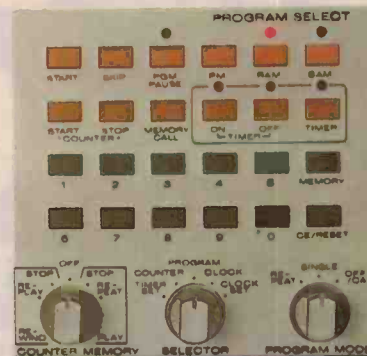

The SD-8000 Compudeck Control Centre

This model takes your system beyond the traditional limits of cassette deck technology. The Compudeck Feather-Touch control centre (inset) offers superior programming capability, with up to 19 replay selections in whatever order you wish. The sensitive electronic switching is smooth and quiet.

This blend of high performance engineering and operational versatility creates a cassette deck of remarkable value — add Dolby Noise Reduction; Sendust Alloy Head; digital display, including clock and LED meters... and the SD-8000 offers superior performance and reliability.

Marantz is renowned as one of the world's leading hi-fi component manufacturers and offers you one of the widest selections of truly sophisticated components in Australia. Marantz engineering skill promises you the complete musical experience.

Your Marantz stockist will happily demonstrate the unmatched quality of these components. If you demand critical performance standards — hear Marantz.



marantz.
Now you're listening.

For further information write to our Brookvale address or call any of the listed numbers.

Distributed by: MARANTZ (AUST.) PTY. LTD. 32 Cross St., Brookvale, NSW 2100, Telephone (02) 939 1900 Telex AA24121, Melbourne (03) 329 7655, Brisbane (07) 48 8266, Adelaide (08) 223 2699, Perth (09) 328 3874.

The Sony Casseiver.

A name like
no other for a system
like no other.

Never before has such a high quality system been so reasonably priced. The Casseiver by Sony. The Casseiver combines a front-loading Dolby* cassette deck, with twin LED displays and soft-eject mechanism; a built-in amplifier delivering 15 watts/channel RMS; a sensitive 4-band AM/FM/SW1/SW2 stereo tuner and a full-range speaker system with passive cone radiators. And with provision to add on other components, such as a turntable, the Sony Casseiver is truly a system like no other. Recommended retail price \$499.



*Dolby is a registered trademark of Dolby Laboratories.

The PS-212A turntable (pictured) is an optional extra. Recommended retail price \$210.00.



AP3412

SONY
AUDIO

Now we have Teletext, what next? . . .

Viewdata!

The telephone and the television changed people's lives. Now they're doing it all over again. Les Bell reports.

EASTEL 40842a 0p

EASTEL

WELCOMES TO PRESTEL

Australia

AND AUSTRALIAN TECHNOLOGY EXPORT PTY.LTD.

Press 0 For Main Index
Press 1 For a Prestel Test Match!
Press 9 For Details of Eastel Services

PRESTEL CLOSING AT 02:00-FINISH OFF NOW

THE LONDON public launching of Viewdata, in September 1979, has been followed by massive interests in this new information medium, and as the number of sets installed steadily increases the British Post Office's Prestel service looks set for success.

Viewdata has become a small but rapidly growing industry in Britain, as more and more companies become Information Providers on the system, set manufacturers announce TVs with built-in decoders and publishing companies vie in producing magazines and directories to the infant data bank.

But the British system is only one of several systems (albeit the first) which are now fighting it out for acceptance internationally. The next few years will undoubtedly see the introduction of a service in Australia; the question is, which will it be?

What is Viewdata?

In the early 1970s, British Post Office engineers saw the potential for linking together three technological products which, even separately, have had a profound influence on Western life — and business-styles. Using the telephone,

the television and the computer, the possibility existed to allow the individual access to vast amounts of information at comparatively low cost.

Most households own at least one television set, and many have a phone, so that the user did not have to invest heavily in new equipment. All that would be required was an add-on decoder which would receive signals over the phone line from a computer data base and display the information on the TV screen.

At the same time, engineers at the BCC and the IBA (Independent

For those who appreciate simple virtuosity

The 480 Series

With the 480 Series, Nakamichi again offers a more affordable cassette recorder – a deck that is simpler to operate, but that sacrifices neither Nakamichi sound nor Nakamichi excellence. The secret is simple. The Asymmetrical, Diffused-Resonance Transport – shared by all models and closely akin to that of the highly acclaimed 582 – is a 3-motor, dual-capstan drive so unique in its simplicity and elegance that it can be manufactured with virtually zero defects. Each 480 Series deck is factory calibrated to yield optimum performance with three types of tape – ferric, chrome-equivalent and metal. Use products of equivalent quality, and you can experience Nakamichi sound and Nakamichi specifications – response to 20 kHz – in your home.



480

The 2-Head Model 480 – fully metal-compatible thanks to our special, narrow-gap, Sendust R/P head and exclusive Direct-Flux erase head. Wide-range, peak responding meters, professional sliding record-level controls, Dolby, and defeatable MPX filter, of course! Even an optional remote control.



482

Step up to the 482, a 3-Head deck utilizing Nakamichi's exclusive "Crystalloy" cores and "Discrete-Head" technology. For those who demand "off-tape monitoring", the 482 incorporates two complete sets of electronics and Double-Dolby so you can hear exactly what has been recorded as it is being recorded.



For further information contact Convoy International Pty Ltd 4 Dowling Street Woolloomooloo NSW 2011 Telephone (02) 3582088

Broadcasting Authority) were working on the development of teletext — a method of transmitting digital information on the two unused lines of the TV picture during the line blanking period. The BBC and IBA agreed on a joint standard for the display and information format, and the BPO decided to make their system compatible so that the decoders could share common circuitry.

At this point some of the terminology in this field gets confusing, and definitions are necessary. M. Tyler, in a paper, 'Electronic Publishing: A Sketch of the European Experience', presented at the Institute for the Future's Teletext and Viewdata Workshop in California last year, defines Viewdata and Teletext this way: 'Systems for the widespread dissemination of textual and graphic information by wholly electronic means for display on low-cost terminals (often suitable control of the recipient, using control procedures easily understood by untrained users'.

The CCITT has proposed an alternative term to Viewdata, and the word "Videotex" is now gaining international acceptance. Ironically, the BPO was prevented from registering Viewdata as a trademark because of its widespread use as a generic term — which is why the trade-name for the BPO service is Prestel.

Teletext describes those systems in which information is inserted into a broadcast signal and there is no communication in the reverse direction, i.e. from the user to the information source.

Videotex, on the other hand, relies upon the user being able to specify, to the information-supplying computer, just which page of information he wants. The information is then sent in digital form down the phone line to the decoder and displayed on the TV screen.

Other arrangements are possible. For example, instead of allocating only two lines out of 625 to a teletext signal, an entire video channel could be dedicated to digital alphanumeric and graphic information. This would allow faster access time or higher resolution graphics. On North American cable TV networks, one channel often carries a computer-generated scrolling news run-down, together with weather information, distributed as video (not digital) information.

The wideband teletext concept can be expanded to include two-way operation on cable networks, although this is prohibitively expensive. A more feasible proposition is a hybrid scheme such as Qube in Columbus, Ohio, which broadcasts video downstream on a

Prestel

NOV 26 PRESTEL UPSIDE DOWN

Prestel is being shown to the people of Australia. Mike Ford, Prestel's deputy director, is down under demonstrating the system & has just sent back a message to tell us of 3 very successful presentations in Melbourne. Not only did the audience see Prestel live, but also got a look at the German & Dutch viewdata systems.
Mike Ford's next stop is Sydney.

Press 0 for earlier news items or
Press 2 for Prestel Gazette

Gazette

RESTEL CLOSING AT 02:00

Prestel even has its own magazine for users.

cable, and collects encoded digital responses from viewers in the upstream direction. This allows viewers to, for example, vote in televised beauty contests, or register interest in advertised products. Since the viewer cannot selectively access information, however, Qube is not a videotex system.

Some of these systems are already in existence or at an advanced stage of development. The Canadian Telidon system, for example, has been demonstrated in Australia and is a candidate for selection as an Australian standard.

Prestel

The only system that is past the trial stage and actually in public service however, is Prestel.

The Prestel display consists of 25 lines of 40 characters, in both upper and lower case. The character set is based on ASCII (ISO-7). Chunky

graphics can also be displayed, by breaking each character position up into a 2 x 3 matrix, each cell of which is individually controlled by a bit in the associated byte.

Sixteen colours are available, and as can be seen from the photographs, it is possible to make quite colourful and informative illustrations. In fact, one of the problems facing novice page or 'frame' designers is to exercise self-restraint and avoid garnish or dazzling pages.

The videotex, viewdata or Prestel (call it what you will!) decoder is built into the television and usually remotely controlled through an IR or ultrasonic keypad. Although external add-on decoders are available, they are not popular in Britain. The reason for this is economic — in the UK, the majority of colour TV sets are rented, and so people simply upgrade to a view-▶

Prestel provides useful information for the handicapped, too.

ResD.R18.1

640994k

0p

PRESTEL FOR THE

HANDICAPPED

Prestel has a team
dedicated to
applying
Prestel to
the needs
of the
handicapped.

CONTACT

DAVE
TOLCHER

Ipswich
643636

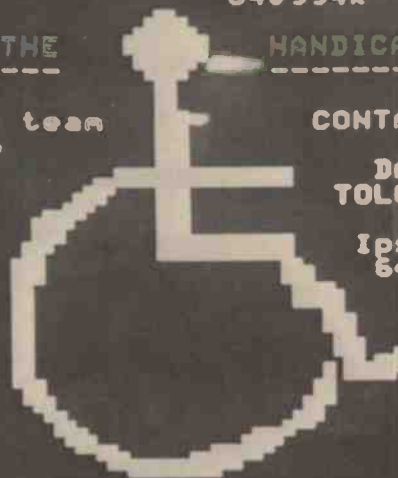

P R E S T E L
PRESTEL CLOSING AT 02:00

Export Technology Directory

THE RED CODE NUMBERS WHICH
APPEAR AFTER COMPANY NAMES
RELATE TO AUSTRALIAN TRADE
COMMISSIONERS DATA FILES

Press 0 for Main Index
Press 3 for Export Technology Directory
PRESTEL CLOSING AT 02:00-FINISH OFF NOW

An entry point to the ATEC Export Technology Directory.

data-equipped set from the same rental company.

Using Prestel is quite simple. After switching on the set, it is switched to viewdata operation, and an auto-dialler establishes communication on the phone line with one of the Prestel computers in London. The set then transmits the user's ID number to the computer which responds by sending a welcome frame to the user. This greets him by name, and indicates when he last used Prestel (in case little Johnny has been playing with the set). The user can optionally leave a password on the computer, which he must key in every time he attempts to enter the system.

From this point on, the user can proceed in a number of ways. Pressing the '#' symbol on the keyboard will bring up the main index on the screen. By pressing the numbers indicated opposite the index entries on successive

indices, the user will eventually arrive at the required section of the Prestel database.

For example, to find out what was showing at the West End cinemas, a user could go from Page 0 (the main index) to the general interest information index, just by pressing key 1. This index shows entertainment opposite 3, and by pressing 3, the user now accesses the entertainment index. This shows: 1) Games you can play on Prestel, 2) Media; Cinema, Theatre, Recorded Music, so the user presses 2. The Media index shows: 1) Cinema, 2) Theatre, 3) Recorded Music; so by pressing 1, the cinemas index is retrieved. This shows a choice of film reviews or 'What's on at the Cinema', so with one more button-push the viewer has his information.

Thus, by descending this inverted tree structure, the user has been guided

A page from the ATEC Export Technology Directory.

Export Technology Directory

ADVERTISING AGENCIES
E.G. HOLT AND ASSOC. PTY. LTD.
34 EASTERN RD, 8TH MELBOURNE, VIC 3205
TELEPHONE: (613) 6998622 (M3)

GEORGE PATTERSON PTY. LTD
252 GEORGE ST, SYDNEY, NSW 2000
TELEPHONE: 612 20571 (P1)

Press * to Continue
Press 0 for Main Index
Press 4 for NSW Dep. Mineral Resources
Press 6 for Australian Trade Commn.
PRESTEL CLOSING AT 02:00-FINISH OFF NOW

to the information required quite quickly. Prestel makes heavy use of indexing and cross-referencing techniques to guide the user to the information he requires, even if he may not know quite what he's after or where it is likely to be.

Alternatively, if the user knows the number of the page he needs, he can key it in directly in the format *PAGE NUMBER#, which will take him directly to the right page. For example, *1311# would go directly to the cinemas information index.

The keypad controller is very simple, using only the digits 0-9, *, and #. Nonetheless, it offers some useful facilities. For example, *# will recall the last page you saw (can be repeated up to three times in a row). *00 will retransmit a frame from the computer, free of charge, if interference on the line has spoiled the frame.

End of the line

The user's end of the telephone line is fairly simple, consisting of a telephone, modem and single-board Viewdata decoder and a fairly standard TV set. At the other end of the line, in London, is a pair of GEC 4000-series computers with four 70 Mbyte disk drives permanently attached and another two on standby. The machines are each equipped with 200 communications ports, so that with both machines running, up to 400 calls can be handled at a time.

The information on the computers is not supplied by the Post Office, The logistics of filling up that data base are beyond a single organisation. Instead, the database is rented out to approximately 170 Information Providers, who pay £4000 p.a. for their 'node' in the tree structure, and then pay £4 p.a. per page for a minimum of 100 pages.

So far, there are approximately 155 000 frames of information on Prestel, but this is expected to increase to 500 000 by the end of the year.

The Information Providers (IPs) are able to 'sub-let' the frames they have bought to other companies who want less than the PO's minimum 100 pages. This has given rise to the appearance of 'umbrella IPs' such as Business Transfer Viewdata, who will rent out a few pages at a time to small users.

Pan Am, for example, only have a single page on the system, giving details of the standby status of their trans-Atlantic flights. Incidentally, this page is a good example of one of the best uses of teletext, in providing frequently updated information to the travel industry.

The range of IPs is vast. Under 'D' alone in the Prestel Directory you find:

Dancing.....	133
Darts.....	121 91
Data Communications	175 2
Datastream International ..	535
Day Trips.....	142
Deafness	162 5
Debenhams	208
Degree Courses.....	165 1

and so on, through Discotheques, Dishwashers, Disposable Income (Statistics), Divorce, Dogs, etc.

The problem is that you have to pay for the information on Prestel, otherwise it would be tempting to browse through it all day. Three charges are involved; first, for a local telephone call to the computer, which goes onto the usual telephone bill; second, there's the connect time on the computer, reckoned at 2p per minute during the day and 3p per three minutes at night; and finally, there is any charge the IP may make for each frame of his information. This last is variable, with some frames being free (indexes, graphic introductory pages and timetables, for example), some 1p or 1½p (which seems to be the going rate) and some quite expensive (the Financial Times frames comparing the cost of living in various cities is 15p per frame). The connect time and IP charges are billed on your Prestel account. At any time you can see the state of your bill by selecting the appropriate page.

Other information on the system includes up-to-date information on the Stock Market, company reports, British Rail timetables, consumer information (the Consumers' Association runs TeleWhich, a Prestel equivalent to the Australian 'Choice' magazine), complete catalogues from major discount electrical stores and much, much more.

And this is where the story...

As well as allowing the user to access information, Prestel allows the user to act on it. For example, access frame 480 94. There you will find the Aramby Wine Club, offering sixteen personally selected wines. Eight are 'Interesting and Inexpensive', eight are 'Delicious'. Assuming that you are willing, taste untasted, to acquire a couple of cases of Aramby's potatoes. Do you hail a cab to Aramby's establishment in Piccadilly in order to complete the transaction?

No, sir, you do not. This is the push-button society, I keep telling you. Instead, you are invited to push a button to access a 'response frame'. When the frame is transmitted to you, the computer, knowing who you are, transmits a 'form' with your name, address and telephone number filled

QANTAS



PRESTEL CLOSING AT 02:00-FINISH OFF NOW to continue KEY 8

A QANTAS Index page.

in. You are then invited to fill in your order and your credit card number, using the keypad. After this is done, the computer will offer you the chance to have second thoughts and you can either cancel the frame, or send it, in which case the information will be stored in the computer until the gentlemen at Aramby's retrieve it and process your order.

There are safeguards built into the software to prevent little Johnny from having a lark by ordering 10 tons of nuts and bolts to be delivered to his best friend's house. Companies using the scheme will only deliver to the address which the computer has listed for the user, and many companies will ring the user to confirm the order before processing it.

The next stage in this scheme is for the Prestel computer to dial up the credit card company's computer and

establish the customer's credit-worthiness before finally accepting the order. Using the existing technology, it is possible to go beyond that and arrange for the actual transfer of funds between the customer's bank account to the supplier's - all electronically. The major problems here are not technical, but concern safeguards against fraud, privacy of computer data, and possible abuses of the system. These are policy issues which are probably the concern of governments, and which may well be the subject of heated public debate before long.

The Prestel computers can also play games. In fact, the computer is not 'playing' the game, in the sense that the CPU is not calculating the possibilities for the next move; in fact the response for each situation is predetermined and stored in a frame. For this reason, the system is best suited to games like ▶

Tourist Information on Australia.

PRE TEL Intl. 647912b 0p
 Key 1 for
 Outline Data

0 600 kilometres
 approx.
 0 300 miles

PRESTEL CLOSING AT 02:00-FINISH OFF NOW

ROD IRVING ELECTRONICS

499 HIGH STREET, NORTHCOTE 3070, MELBOURNE VICTORIA. Ph (03) 489-8131.

SCOTCHCAL

FRONT PANELS FOR ETI AND EA PROJECTS

ETI 452 Guitar Practice Amp	\$4.80
Series 4000 Any colour	\$12.50
Moving Coil Pre Amp	\$2.00
577 Power Supply	\$2.00
455 Loudspeaker Projector	\$2.70
Variable Power Supply	\$2.70
Linear Ohmmeter	\$2.50
Muscle Activity Meter Scale	\$1.40
ETI 576 Electromyogram	\$2.80
561 Metal Detector	\$2.50
EA Capacitance Meter	\$3.50
EA Flash Exposure Meter	\$4.25
EA Sound Triggered Flash	\$3.50
EA Slave Flash	\$1.20
EA Playmaster Graphic Analyser	\$8.50
EA Metal Detector 79md9	\$3.90
EA Pulse Generator	\$4.80
EA Square Wave Oscillator	\$2.50
EA RF Z Bridge	\$3.25
EA Thyristor Tester	\$2.40
EA Quartz Frequency Reference	\$2.70
EA Multi Monitor	\$1.90
EA Experimentors Supply	\$2.80
EA Quiz Master	\$3.70
EA Variable Wiper Delay	\$1.10
EA Playmate Stereo Amplifier	\$4.50

All front panels available from day of release of magazines. When ordering front panels, specify colour of lettering first, then colour of background.

10 TURN POTS

1/4" SHAFT. VALUES: 100, 500, 1K, 2K, 5K, 10K, 20K, 50K, 1M.

Inc tax \$6.50 ea.

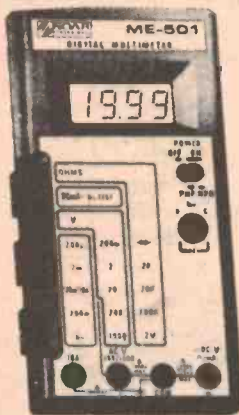

Soar Model 501A

4 digit LARGE LCD DISPLAY

Send for specs.

\$69.00

Add \$3 P&P and certified mail.

INTERSIL LCD 3½ DIGIT PANEL METER KITS

INTERSIL ICL7106 \$32.50

Build a working DPM in ½ hour with these complete evaluation kits.

Test these new parts for yourself with Intersil's low-cost prototyping kits, complete with A/D converter and LCD display (for the 7106) or LED display (for the 7107). Kits provide all materials including PC board, for a functioning panel meter. ICL7106EV (LCD)

KITS & CIRCUIT BOARDS



(Kits of parts including quality fibreglass boards)

ETI SERIES 4000 AMP

- Complete Kit, woodgrain sides \$179.00
- Rack Mounting \$185.00
- Quality front panel to suit above \$8.99
- ETI 470 kit of parts 19.90
- ETI 480 kit of parts 100w (incl. bracket) 19.75
- ETI 470 PS kit of parts (includes relay, not transformer) 19.50
- Transformer to suit 22.90
- ETI 471 pre-amp 45.50
- ETI 585R ultra sonic RX 15.95
- ETI 585T ultra sonic TX 8.95
- EA 79 SF9 sound flash trigger 15.00
- All parts available for DREAM computer project.
- P.C.B.'S (all quality fibreglass boards)
 - ETI 574 disco strobe 2.80
 - ETI 549A metal detector 2.75
 - DREAM circuit board 10.90

Project Boards (Fibreglass)

ETI 043	1.40	ETI 450B	1.90	EA 78N6	3.20	
ETI 044	1.30	ETI 480	2.40	EA 78NG4	2.50	
ETI 047	1.50	ETI 480PS	2.40	EA 78UT4	3.90	
ETI 051	1.40	ETI 481M	2.00	EA 78T3	4.20	
ETI 062	1.80	ETI 481PS	3.50	EA 78C5	3.90	
ETI 063	1.70	ETI 483	2.20	ETI 470	\$2.90	
ETI 064	1.70	ETI 484	3.90	ETI 741	\$9.90	
ETI 065	1.70	ETI 485	2.90	ETI 472	\$2.90	
ETI 067	1.80	ETI 486	2.90	ETI 576	\$4.90	
ETI 068	1.40	ETI 489A	2.50	ETI 474	\$2.80	
ETI 071	1.40	ETI 499	1.90	ETI 573	\$4.50	
ETI 072	1.80	ETI 528	2.20	ETI 577	\$2.90	
ETI 081	1.50	ETI 541	2.20	ETI 1118	\$2.30	
ETI 083	1.80	ETI 547	2.20	ETI 150S2.60	ETI 260	\$1.90
ETI 084	1.70	ETI 581	2.20	ETI 261	\$1.90	
ETI 085	1.30	ETI 583	2.20	ETI 262	\$1.80	
ETI 130	1.90	ETI 585R	1.60	ETI 263	\$2.20	
ETI 134	1.90	ETI 585T	1.40	ETI 606	\$2.90	
ETI 135	1.90	ETI 586	2.30	79se3	\$3.90	
ETI 136	1.80	ETI 603	2.50	Dream 6800	10.90	
ETI 137A	2.90	ETI 604	1.60	79s10	\$1.90	
ETI 137B	2.90	ETI 635	2.90	79md9	\$2.60	
ETI 139	1.90	ETI 638A	3.90	79pg9	\$2.90	
ETI 245	1.60	ETI 708	1.90	79ps11	\$2.90	
ETI 417	1.80	ETI 713	3.90	79T11	\$2.75	
ETI 445	1.50	ETI 714	1.90	79PC12	\$2.20	
ETI 446	1.90	ETI 717	2.90	79EB12	\$2.90	
ETI 449	1.50	EA 78A06	2.90			
ETI 450A	1.90	EA 78TMB	2.00			

Rod Irving Electronics Kits

Additional kits will be produced as new projects are available.

ETI 561 Metal Detector	\$29.90
ETI 041 continuity tester	3.90
ETI 043 heads and tails	3.50
ETI 044 2 tone door bell	4.10
ETI 046 500 second timer	3.90
ETI 047 simple morse, less key	3.90
ETI 048 buzz board	3.90
ETI 480 100w amp	19.50
ETI 063 electronic bongo	4.50
ETI 065 siren-less speaker	4.50
ETI 066 temp. alarm	3.90
ETI 068 LED dice	5.50
ETI 084 car alarm	10.00
ETI 470 60w amplifier	19.90
ETI 480 50w amplifier	16.00

(amplifier kits do not include heatsink)
Kits are complete with prime spec components and include assembly instructions, wire, solder, etc. All kit prices include sales tax, exempt prices on application.

NEW PRODUCTS



HEX KEY PAD \$24.90

63-key Keyboard \$55.00

RIE are now distributors for 3M Products, including SCOTCHCAL RANGE

- 8016 Blue on White Plastic \$4.10
 - 8018 Green on White Plastic \$4.10
 - 8011 Red on White Plastic \$4.60
 - 8012 Black on transparent Plastic \$4.10
 - 8013 Black on Yellow Plastic \$4.10
 - 8015 Black on White Plastic \$4.10
 - 8009 Light blue on aluminium \$4.10
 - 8001 Red on aluminium \$4.10
 - 8005 Black on aluminium \$4.60
 - 8007 Reversing film \$3.75
- NOTE: ALL ABOVE SHEETS 10" x 12"
8500 Photosensitive Developer \$4.40
3900 Clear Coating (Glossy Finish) \$9.30
3930 Clear Coating (Matte Finish) \$9.30
ML-3 Applicator block \$3.90
ML-4 Developer pads \$8.90
8002KA Evaluation Kit

Attention Sorcerer and TRS 80 owners - MEMORY EXPANSION KITS AVAILABLE

We also offer full service on the popular computer projects and systems.

SPECIAL 4116 RAM OFFER

- 8 of prime spec 4116 IC's \$79.00
- 16 of prime spec 4116 IC's \$155.00
- 32 of prime spec 4116 IC's \$276.00

STATIC RAM KIT 16K S-100

- Kit form \$239.00
- Ass & tested \$269.00

**Bankcard
Mail Orders
Welcome**

Please debit my Bankcard.

Bankcard No.

Expiry Date

Name

Signature

All prices current only until 7th August, 1980

HEAVIER ITEMS ADD ADDITIONAL POSTAGE. EXTRA HEAVY ITEMS SENT COMET FREIGHT ON PRICES SUBJECT TO CHANGE WITHOUT NOTICE. SEND 60c & SAE FOR FREE CATALOGUES.

MAIL ORDERS: PO BOX 235, NORTHCOTE, VICTORIA 3070.
PHONE (03) 489 8131. MINIMUM PACK and POST \$1.00.

noughts and crosses, in which the graphics show up well, and the rules of the game are simple. The Prestel noughts and crosses game can always be beaten by a fairly simple strategy.

For the best in games using the Prestel system, an experiment called Telesoftware holds more promise. Prestel have asked computer consultants CAP-CPP to report on the practicality of distributing computer software through Prestel, and there are now several pages of machine-executable software on the database. The trouble is that it is written in CAP-CPP's MicroCobol, which although it will run on the 8080 microprocessor, is not a very common language. Since the pilot study only involves CAP-CPP, it is reasonable to expect them to use their own language, but if the Telesoftware becomes a public service, one would expect the software to be distributed in Microsoft BASIC, CBASIC2 or Microsoft FORTRAN, which are much more common in the microcomputer world.

Hard copy units for Viewdata are now becoming available in Britain. Most are based on thermal or electrostatic printers, but one of the cheapest, which also offers full colour capability, is a polaroid camera, mounted in a framework which resembles a giant oscilloscope camera.

Two magazines (printed) have already started, devoted exclusively to Prestel. Both are published by companies who also have 'magazines' on Prestel — IPC and Eastern Counties Newspaper Group. IPC have in fact got several 'magazines' on Prestel — for example, the electronics trade weekly 'Electron' has supplied a list of component suppliers who meet the QA standard B.S.9000, while Farmer's Weekly contributes the latest livestock prices and market trends.

Goes international

The significance of Prestel to Australia is more immediate than at first seems the case. During 1980, a small group of commercial users in Australia (as well as other countries) will collaborate with the British Post Office in the first market trials of International Prestel, a new service which, although fundamentally the same as the British national Prestel service, is not connected to it.

International Prestel is primarily a commercial service for multi-national or international companies, or those with many international dealings. The database will be contributed by these users themselves as well as other IP's such as various national trade and export ministries, banks, airlines, travel and tour operators and so on. Several of the

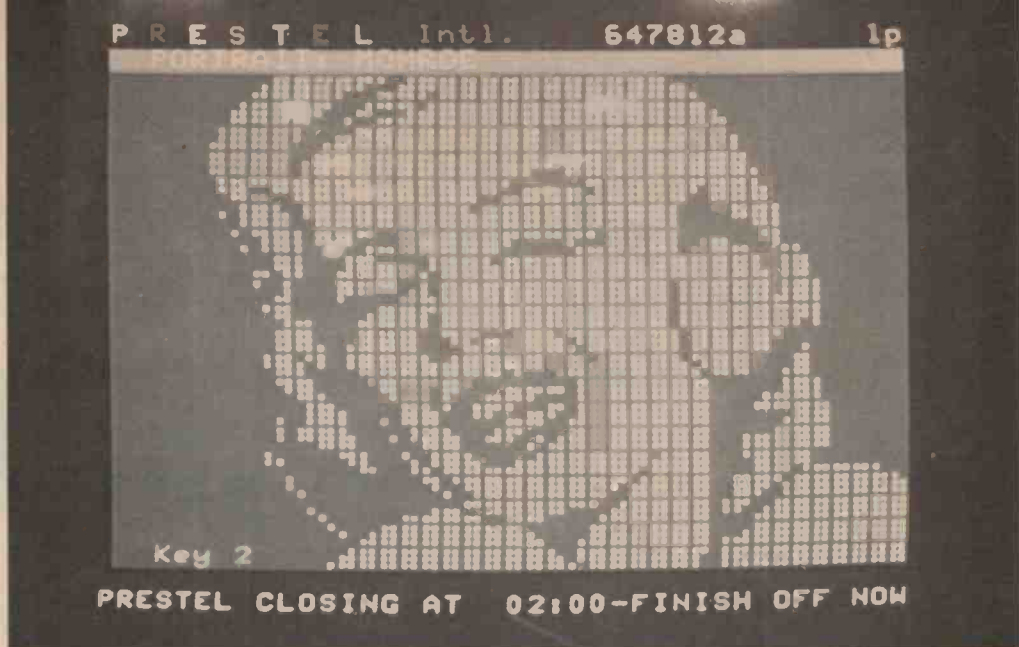

Quite complex effects are possible with the graphics — note the 1p charge for this page (in the top right corner).

access restriction facilities on Prestel have special significance for the international users.

On Prestel, there is unlimited access to the bulk of the frames. However, the Prestel computer may sometimes refuse a user access to certain frames. This is because the pages belong to a Closed User Group (CUG). There are two types of CUG — conventional CUGs generally consist of offices of a single organisation. For example, ETI being an international publication, could form a CUG of international offices, and use pages on Prestel to communicate between them. These pages would be inaccessible to other users.

Syndicated CUGs, on the other hand, are typically open to members of associations, or to users who are willing to pay for the privilege of joining them.

Again, to use ETI as an example, details of forthcoming projects could be placed on frames available only to retailers and stores who have previously paid for that information, and any who don't pay could be easily refused access to the frames. Members can be admitted to, or removed from CUGs virtually instantaneously, and of course, the information is secure from unauthorised users.

Another example of a syndicated CUG might be run by a consortium of hotels, for example, who might allow travel agents (the members of the CUG) to get information hotels and place bookings through the response frame facility mentioned earlier.

International Prestel is primarily a business tool, and will probably be used mainly by companies involved in import/export. For example, suppose ▶

The pistons and clouds move in this graphics frame.

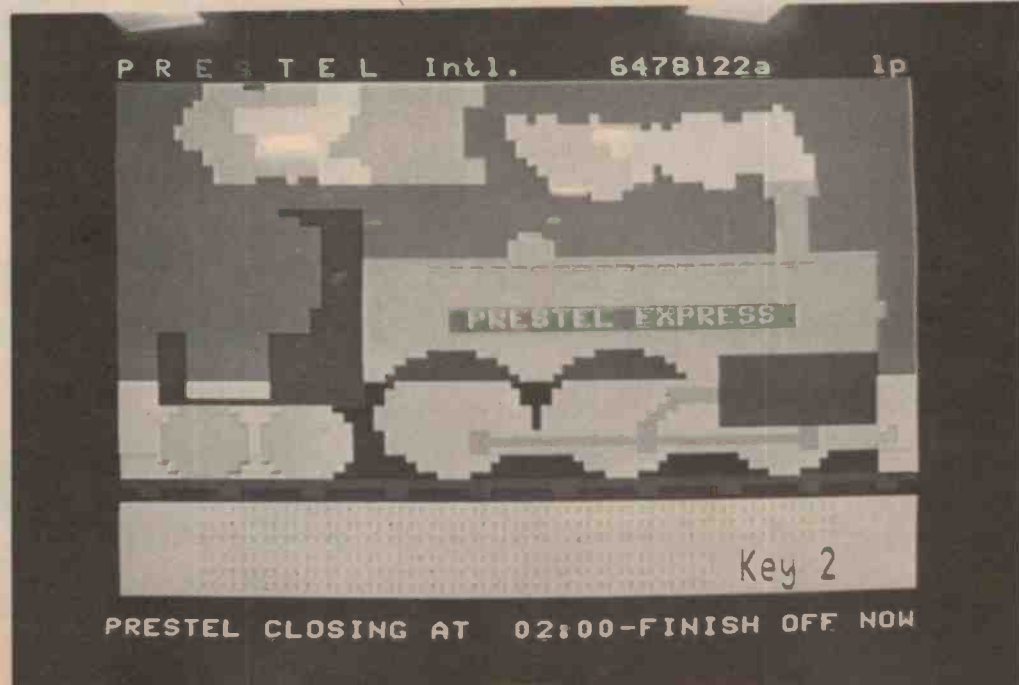

ONE-STOP SHOPPING FOR ALL THE BEST BUYS IN SEMICONDUCTORS & PASSIVES



SOANAR

THE POWER DISTRIBUTOR

Comprehensive Stocks readily
available in all States throughout Australia

SOANAR

SOANAR ELECTRONICS PTY. LTD.

A MEMBER OF THE A+R-SOANAR ELECTRONICS GROUP
30 Lexton Road, Box Hill, Vic., 3128, Australia. ☎ 890661

VICTORIA: 89 0661
N.S.W.: 789 6733
S.H. AUSTR.: 51 6981
QUEENSLAND: 52 5421
WEST AUSTR.: 381 9522

you are the export director of the XYZ Furklewangler Manufacturing Company, and you wish to find an agent for your product in Argentina. By checking through the information stored on Prestel by the Argentinian Government, you can find a list of Argentinian companies which have English-speaking directors, together with background information on each company, such as their primary business, number of offices and where they are located, etc.

Australian companies are being represented on Prestel (both British and International) by a company called Australian Technology Export Pty. Ltd. who are using a combination of Prestel, colour microfiche and video disc technology to provide information on Australian companies and products to interested companies overseas. The Prestel information can be updated instantly for distribution throughout the world on the Prestel system.

Future developments

In Britain, plans are well advanced for the expansion of the Prestel service into all of the major cities by the mid-80's. This will provide the service to about 90% of the population for the price of a local phone call; those in rural areas will have to pay STD rates for their phone calls.

At present the system is updated every night for those IPs who edit their frames off-line using a minicomputer (one company, Cherry Leisure, report considerable success in creating and editing frames on an Apple II micro-computer), but other editing and updating arrangements are possible. For example, the Stock Exchange information is updated three times a day directly by the Stock Exchange computer. BPO engineers are working in collaboration with GEC on an interface for the GEC computers to match the X.25 and X.75 asynchronous protocols, which would allow the Prestel system to communicate with other computers on the Post Office's packet switching data communications network.

At this stage, all kinds of exciting possibilities open up. Computers at different locations around the country could maintain their local data base, as well as specialised data on scientific subjects, for example. If the user requests that information, his local computer could establish a link with the distant computer and request the appropriate frame. All this process would, of course, be transparent to the user.

Interestingly, although Prestel is owned by the British Post Office, the Prestel company is separate, and is not party to the BPO's monopoly on

communications. The BPO acts purely as a common carrier. This means that anyone can set up and operate a private viewdata service, with adequate funding, of course. And that's the problem; viewdata is tremendously expensive to set up.

In Australia

A similar situation exists here in Australia, according to a Telecom spokesman. Although Telecom is performing a feasibility study, and have a small-scale Viewdata service running in-house, they are not racing ahead to set up a full-scale service to the public. There are major policy decisions to be made regarding standards and system choice, as well as major social and policy issues to be resolved.

For example, should the more profitable areas of the viewdata system, i.e: the frequently accessed pages, be used to subsidise less profitable, but important, information in the areas of education and consumer assistance? What is the situation regarding copyright? Who is liable for the accuracy of the information on the database (the BPO have a contract with IPs which places liability on the IPs)?

Since the Prestel system only went public a few months ago, there is still a lack of clear market research information on the system, and Telecom is waiting for this information

to become available before acting. During 1980 Telecom will offer seminars, run a studio in which potential users can gain hands-on experience, and generally encourage informed debate on some of these issues. This means that it is unlikely that we shall see a fully operational service in Australia before 1982.

However, there is not complete agreement within Telecom itself that it is the right organisation to run a Videotex service. Accordingly, the field may be open for private enterprise to inaugurate a system - and you can bet that Messrs. Packer and Murdoch are already considering the possibilities of electronic publishing.

In conclusion, then, it seems that computers, which for a long time have been regarded as 'number-crunchers' are going to change their role in society - and quite probably change society. We are entering the information age - already more than half the workers in the USA do not directly produce, but instead, manipulate information. Videotex has been greeted with open arms by the BPO's unions (although door-to-door encyclopedia salesmen face a rather bleak future), but the introduction of this comparatively 'friendly' technology can be expected to cause many changes in the way we view information.

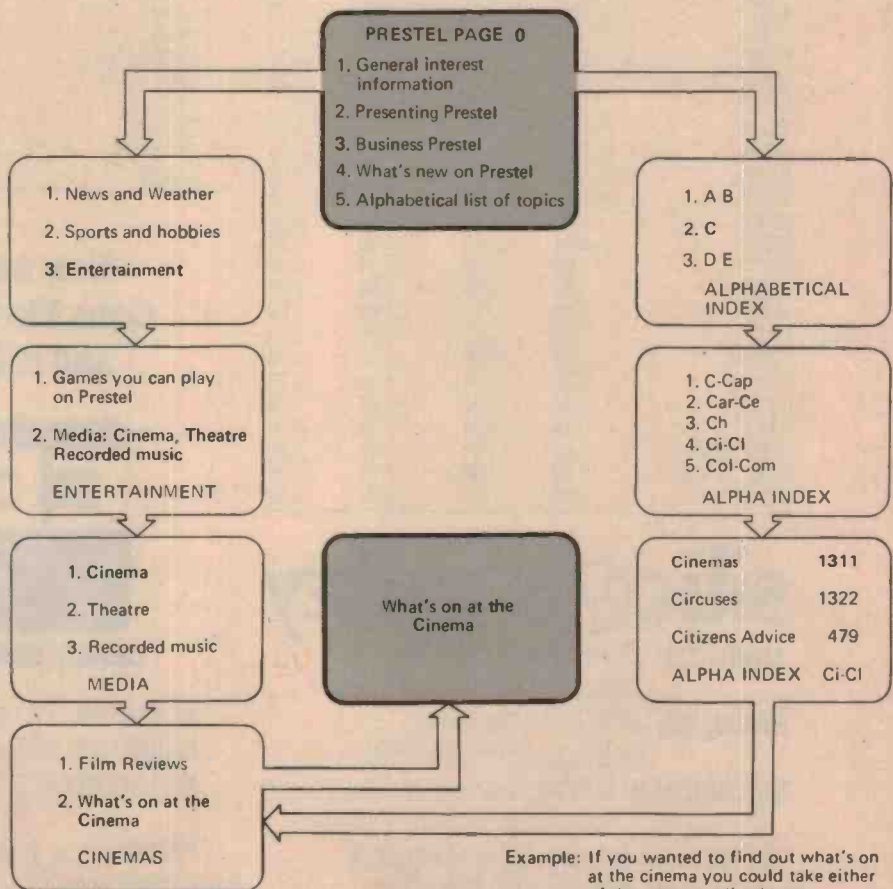

Save a bundle on Philips components from Cema.

Cema now offers you a new deal on Philips Components. Through joint effort with Philips we have indentified approximately 40 semiconductor devices or ranges of product that are in substantial and regular demand. These products are available through both Cema distribution sales offices and now also over the counter from any of our **Silicon Valley** retail stores. What's more they are available in our **Silicon Valley** stores in virtually any quantity and at prices that our distribution competitors will find hard to match.

Cema makes it easier for you to obtain these Philips components.



— save a bundle.

No minimum quantity for cash sale through Silicon Valley.
No minimum value for cash sale through Silicon Valley.
\$5.00 minimum Bankcard transaction.
\$25.00 minimum normal charge account transaction.
\$2.00 packing and delivery if goods not picked up.

TRANSISTORS TYPE	1 - 99		100 +	
	TAX EXEMPT	TAX INCL.	TAX EXEMPT	TAX INCL.
AC128	0.50	0.64	0.44	0.56
AD149	1.55	1.98	1.45	1.85
BAV21	0.13	0.16	0.11	0.14
BC107, 108, 109	0.20	0.26	0.18	0.23
BC177	0.20	0.26	0.18	0.23
BC327	0.14	0.18	0.12	0.15
BC337	0.14	0.18	0.12	0.15
BC547, 548, 549	0.09	0.11	0.08	0.10
BC559	0.09	0.11	0.08	0.10
BC639	0.20	0.26	0.18	0.23
BC640	0.20	0.26	0.18	0.23
BD135	0.26	0.33	0.24	0.31
BD136	0.26	0.33	0.24	0.31
BD233	0.34	0.43	0.30	0.38
BD234	0.34	0.43	0.30	0.38
BD677	0.50	0.64	0.44	0.56
BD678	0.50	0.64	0.45	0.57
BF337	0.47	0.60	0.42	0.54
BU126	1.80	2.30	1.65	2.10
BU208A	2.25	2.87	2.15	2.74
BU326A	2.30	2.93	2.18	2.78
BUX80	5.35	6.82	4.85	6.18
BY406	0.15	0.19	0.14	0.18
BYX2IL-200	0.84	1.07	0.76	0.97
BYX2IL-200R	0.84	1.07	0.76	0.97
BYX55-350	0.30	0.38	0.27	0.34

DIODES TYPE	1 - 99		100 +	
	TAX EXEMPT	TAX INCL.	TAX EXEMPT	TAX INCL.
400m W Zener (BZX79 Series)	0.09	0.10	0.08	0.09
1W Zener (BZX61 Series)	0.16	0.18	0.13	0.15
OA 90	0.10	0.13	0.09	0.11
OA 95	0.11	0.14	0.10	0.13
OA 636-1000 (BVY 96E)	0.39	0.50	0.36	0.46
IN 4148	0.04	0.05	0.036	0.05
IN 4004	0.06	0.07	0.058	0.07
IN 4007	0.10	0.12	0.09	0.10
IN 5060	0.22	0.25	0.19	0.22

Now available from both
Cema Electronics Sales offices
and Silicon Valley shops.



CEMA ELECTRONICS PTY LTD

silicon valley

ADELAIDE: 170 Sturt St, Adelaide
Telephone: (08) 51.4080
BRISBANE: 22 Ross St, Newstead
Telephone: (07) 52.1339
MELBOURNE: 208 Whitehorse Rd, Blackburn
Telephone: (03) 877.5311
SYDNEY: 23 Chandos St, St. Leonards
Telephone: (02) 439.2965

ADELAIDE: 170 Sturt St, Adelaide, SA 51.6483
BRISBANE: 22 Ross St, Newstead, Qld 52.4261
MELBOURNE: 208 Whitehorse Rd, Blackburn,
Vic 877.5311
PERTH: Unit 1, 25 Brisbane St, East Perth 328.8091
SYDNEY: 21 Chandos St, St. Leonards 439.8622

Seven great tapes from TDK.

Now you can get the best from your hi-fi. With the new SA-X and OD you can choose the right tape from TDK's range of seven improved cassettes.

Metal Position tapes

MA-R Metal alloy tape in a diecast metal frame cassette. To make full use of TDK's metal tape technology they designed a "Reference Standard" cassette mechanism. High precision assures complete stability and constantly accurate orientation. Available in 60 and 90 minute tapes.

MA TDK's metal alloy tape with a much higher maximum output level (MOL) outperforms high bias tapes and compares in reproduction with open reel. Metal's high coercivity and remanence has revolutionised the quality of sound recording. Metal bias position switch required, now found on top of the range decks. Available in 60 and 90 minute tapes.

High (CrO₂) Position tapes

SA-X Super Avilyn tape, a new addition to the TDK range, featuring a dual coating that improves the characteristics of its MOL and coercivity. A high position tape in a "Laboratory Standard" cassette mechanism.

The dual coating of Super Avilyn gives a notable improvement across the bandwidth. Available in 60 and 90 minute tapes.

SA Super Avilyn, TDK's famous high quality, high position tape.

A sophisticated cobalt enriched ferric oxide coating that gave a new dimension to cassette recording. Now improved in quality. Available in 60 and 90 minute tapes.

OD Optimum Dynamic, the second new tape to be added to TDK's range. The top of the dynamic series of tapes for Normal Switch position. This tape promises to become the reference for all low-noise high-output tapes. Available in 60 and 90 minute tapes.

AD Acoustic Dynamic. This tape is just right for quality cassette recorders, cassette radios and home music centres. Available in 46, 60, 90, 120 minute tapes.

D Dynamic. A quality tape specially designed and coated for the wide selection of popular priced cassette recorders. It has a wide dynamic range. Available in 46, 60, 90, 120 minute tapes.



Write or phone TDK for detailed information on their two new tapes SA-X and OD and get a free copy of TDK's "Guide to better recording."

Note: Any person practising tape recording should observe the provision of the Copyright Act 1968.

TDK

TDK (AUSTRALIA) PTY. LTD.
4 Dowling Street, Woolloomooloo, NSW 2011
Phone: (02) 358 1877 Telex: AA 70174

Good car sound — how it's done

On the face of it, attempting to obtain good quality sound in a car would seem fraught with difficulties. And when you look closely at the problem — it gets worse! However, there are solutions it seems.

THE INTERIOR of a car can really be regarded as a "hostile environment" when you look at it acoustically. The problem has been thrown into sharp relief in the past few years as the demand and availability of quality car sound systems has increased. A host of factors combine to make life subtly unpleasant inside the passenger compartment of a car. A great deal of interest has been shown in their acoustic characteristics and the effects on occupants, in recent years.

When considering the problems of reproduction of sound inside a car, the first limitation one comes across is the interior dimensions. Acoustic "standing waves" are set up inside any confined space, affecting the realistic reproduction of low frequencies. For most cars, an acoustic half wavelength inside

the passenger compartment is around two metres (corresponding to a frequency of about 85 Hz), causing some limitations below that. Further, there are many cavities, angles and objects inside a car which resonate at specific frequencies ranging up to a few kilohertz or so. These resonances greatly affect the perceived sound quality as music, speech and vibration will set the objects and cavities resonating in sympathy with particular frequency sounds, producing effects which are generally undesirable.

Thirdly, the content inside the vehicle — passengers, cushions, felt lining, carpets and suchlike, absorb specific audio frequencies, or frequency bands, unbalancing the general response of the environment. In other words, it's not "flat", or as flat as good reproduction

requires.

Apart from all this, the sound quality is affected by the opening of windows or ventilation systems, poor sealing etc.

The audio interference from noise sources generated by the motion of the car, the engine etc, can be very severe — as high as 75 - 85 dB. Many scientific studies of the effect of these on passengers' health have been made in recent years. These noise sources include: the carburettor air intake, tyres, transmission, engine, cooling fan, suspension and air rushing past open windows.

The spectrum of this audio interference ranges across the whole audio band and is particularly severe in intensity below 500 Hz and extending below the generally accepted audible limit of 20 Hz. It is these low and sub-



Speakers are best positioned so that sound output is not obscured to any great extent by seats or passenger's legs — or obstructing window winders etc.



Chipboard is secured to the door panel and the speaker mounts on this. The door cavity may be stuffed with sound absorbent material to improve results.

sonic frequencies that have concerned health specialists because they give rise to such effects as dizziness, fatigue and "audio hypnotism" where the brain suppresses auditory sensitivity of a particular audio band where a constant, high level of sound persists over a period.

One interesting and little known phenomenon is that air rushing past a partially open window or sunroof will cause the car's interior to act as a low frequency Helmholtz resonator — resonating at 2 - 5 Hz at very high levels.

It is perhaps partially as a reaction to the medical disaffects of driving large distances that increasing numbers of Australian drivers are fitting high quality sound systems to their vehicles. In general, they are seeking to avoid the hypnotic rhythms, set up by the vehicle's motion, through pleasurable listening. It makes sense — why not enjoy the same music in your car as you listen to on your home hi-fi system?

But, with all those factors to consider, is it possible to achieve quality sound inside a car? Well, there's a strong market demand and that provides the will — and where there's a will, there's a way (as the saying goes ...).

How it's done

While there are many companies providing products for the car sound marketplace, there aren't too many paying attention to the details of making the environment match the capabilities of a quality car sound system.

Bose Australia are one such company, and they invited us to take a look at the techniques they employ when installing one of their car sound systems.

The first thing they pointed out was that, after spending \$600 or \$700 (or more) on a good quality car stereo system, it's no good just 'banging the bits where they'll fit', plugging it in and expecting to get the full response the system is capable of providing.

Speakers need to be mounted on a solid base that will not vibrate. The average door panel or rear window shelf is just not rigid enough on its own. These are generally stabilised by securing chipboard to them.

When mounting speakers in a door panel, they are positioned such that the sound will not be absorbed by the seat or the passenger. This can be tricky as the rear of the speaker has to avoid fouling window glass and the winder mechanism. The door panel is damped

by securing as large a piece of chipboard to it as can be fitted, screwed securely to the panel.

The cavity behind the door trim is sealed using silicone-based sealing compound. The hole for the speaker is often cut directly through the trim, metal and wood together. Metal and sawdust inside the door cavity is cleaned out to avoid the possibility of it getting into the speaker and fouling the voice-coil gap, possibly damaging the speaker.

Whilst the door cavity cannot be completely airtight, it has been found that the better sealed this cavity is, the better the result. Sound absorbent material may be stuffed into door cavities also, to further improve the sound. However, if this material retains water, rust may become a problem in the future. Naturally, care is taken to avoid fouling window glass and winder mechanisms.

Those doors not having speakers mounted in them are treated in the same general manner. Chipboard is secured to the inside panel, the trim sealed, plus as many other orifices as possible, and the cavities stuffed with sound absorbent material.

Similar principles are employed



It is important to seal the door cavity as much as possible, particularly around the inside trim. Silastic is recommended for this job.



The Bose 1401 booster/equaliser is extraordinarily slim and mounts easily under a dashboard without being at all obtrusive.



If you're considering
car hi fi, why not have the
best money can buy?
In my opinion the new 1401
100 watt BOSE direct/reflecting
system is without doubt
the finest car stereo
available!

David
Manning

NEW

**100 WATT
CAR STEREO FROM
BOSE®**

AVAILABLE NOW FROM

DME HI FI

599 George Street, Sydney. Phone 61-3189.

Australasian Distributors: BOSE AUST. 11 Muriel Ave, Rydalmere 2116, Sydney NSW. Phone 684-1022.

when mounting speakers on the rear window shelf. The cavity behind these speakers is the boot — and this can be effectively sealed, in fact it *must* be, to produce the desired acoustic result. Soft luggage in the boot aids the overall sound also.

The sound equipment itself is installed in a position generally convenient to both the driver and front seat passenger. Wires to the speakers and dc power take-off that are routed through metal panels are always passed through grommetted holes — to avoid chafing the wire and producing possible short circuits, a disaster in anybody's book. Any holes where wires pass through into the boot and door cavities are sealed too.

Bose recommend that the dc power wiring to the equipment should be run straight from the battery terminations and not from the ignition switch. A car sound system may draw as much as 15 amps peak, which is quite a heavy load on the ignition switch — in addition to the load it may be carrying already — and any switch contact resistance (due to corrosion or whatever) can give rise to problems. Bose systems incorporate a heavy duty on/off switch and a suitable line fuse.

Having worked on the vehicle itself, what else can be done? Well, plenty of carpets and cushions scattered about the passenger compartment, whilst increasing sound absorption, reduce reflections and damp resonances. The effect of these can be surprising.

How does it sound ?

Remarkable! Subjectively, we have never heard a better car sound system.

With careful adjustment of the controls and the direct/reflecting speaker grilles, one can produce quite a 'spacious' sound with acceptable treble response and dispersion and bass that has to be heard to be believed. Some resonance of the door panels was detectable on heavily modulated passages, but it's not too obtrusive. The 'spatial' control is remarkably effective, quite unlike the familiar 'fader' control one finds on car sound systems. It can be adjusted such that, sitting in the front seats, one gets the impression of sitting in the orchestra pit. It's a little unnerving however, when a vocalist "pops up" over the gear shift! Enough range is provided on all the controls to allow adjustment of the sound for a wide variety of situations and personal preferences, according to Bose, and our experience seems to back that up.

Only one thing really needs be said in summary — you've got to hear it to believe it!

The Bose Model 1401 stereo car sound system

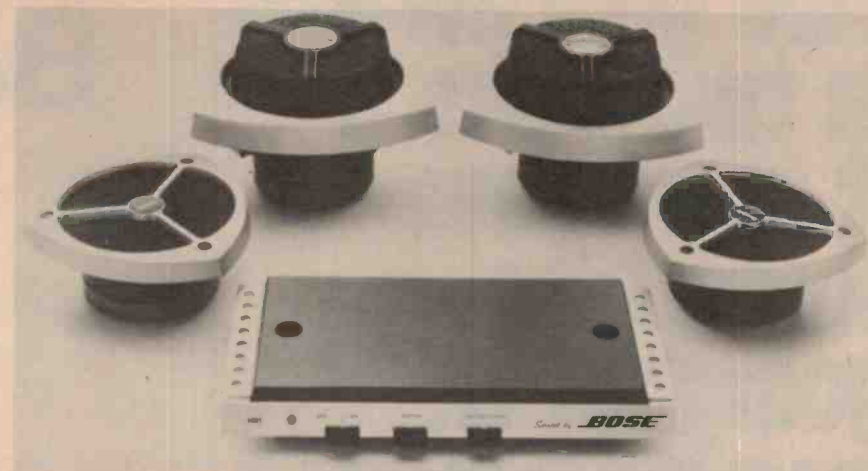

THE BOSE MODEL 1401 system comprises a booster/equaliser unit and two or four speakers — one pair is supplied with special direct/reflecting grilles. Input to the system may be from any good quality car stereo cassette player or receiver/cassette deck. The system is supplied complete down to every last nut, bolt, washer and cable. For those tackling the installation themselves, a detailed and very clearly written instruction book, complete with troubleshooting chart, comes with the unit. The speakers use the same drivers featured in the well-known Bose 901 loud-speaker system, but for this application the cones have been specially treated with a water-repellent coating. The voice-coils are specially wound and have a characteristic impedance of only half an ohm! The direct/reflecting grilles on one pair of speakers serve to reflect the high frequencies off hard surfaces, to distribute them throughout the car — the direct/reflecting principle is the cornerstone of Dr Bose's philosophy of sound reproduction.

The booster/equaliser unit is quite unconventional as car sound systems go. Firstly, the complete unit measures about 250 mm wide by 125 mm deep and just under 65 mm high! Compact, indeed. The unit has just two controls, besides the on/off switch — a "spatial" control and "low frequency" control. Before explaining their functions, the operation of the

booster/equaliser needs explaining. The unit incorporates four independent channels rated at 25 watts each. The system may be wired for two-speaker or four-speaker operation. The latter is the preferred arrangement. Bose recommend the speakers mounted in the front of the car should have the direct/reflecting grilles installed. The system reviewed in the accompanying article was a four speaker system.

The spatial control allows adjustment of the front-rear balance in a four-speaker system where two speakers are mounted in the front of the car and two in the rear. In a two-speaker system, it is simply left at one extreme or the other of its range. This control adjusts levels to all four amplifiers of the mid-range and treble frequencies. Equal drive at low frequencies is applied to all four amplifiers continuously. The low frequency control permits adjustment of the overall low frequency level. In addition, a "treble boost" switch is provided on the rear of the unit to boost the highs in situations where the speakers may be somewhat obscured by the seats.

Complete installation takes the Bose technicians about a day, depending on the vehicle, if you aren't inclined to do it yourself. Further information on Bose car sound systems can be obtained from Bose Australia Inc, 11 Muriel Ave, Rydalmere NSW 2116.

Model 1401 Booster/Equalizer Unit Specifications

Power Output	100 watts total power (4 speakers); 25 watts continuous average sine wave power per channel into 0.45 ohm resistive load with either two channels (front left, right or rear left, right) or four channels operating from 40 Hz to 17 kHz at less than .09% harmonic distortion with 13.8 Vdc power supply.
Frequency Response	+/- 1 dB from nominal equalization curve with bass control centered and spatial control electrically centered from 125 Hz to 10 kHz.
Separation	Not less than 40 dB above 500 Hz spatial slide control centered.
Signal-To-Noise-Ratio	Greater than 70 dB A-weighted with complementary filter, referenced to full output 25 watts.
Sensitivity	Low-level input 0.25 Vrms input for 25 watts output at 1 kHz. High-level Input 1.5 Vrms input for 25 watts output at 1 kHz.
Power Supply Tolerance	Unit will operate without notable performance defects over a power supply range of 10.5 V to 16.5 V dc.
Size	254 mm wide x 125 mm deep x 64 mm high.

**Two gold awards
in two years...
it must have
something
going for it!
DISCPROTEC
RECORD PRESERVATIVE**



Discprotec in fact has a lot going for it. In 1978 Discprotec won the coveted Grand Prix Gold Award in Tokyo, the only product in it's field to receive such an award, and in 1979 it was awarded the 'Audio-Video' Hi-Fi Grand Prix Award by retailers and critics in the U.S.A. Discprotec, (marketed as 'Lifesaver' in the U.S.A.) was tested by the critics panel for the 'Audio-Video' Grand Prix Award and they found that it could bring the static charge on a record down to 300-500 volts - not bad when you consider that voltage figures on records can be as high as 30,000.

The advantages of it's dual function of preservative and anti-static compound and the resulting savings to users was also stressed by the panel. The Discprotec formula is unique, and offers benefits not available from other record preservatives. Surely your records deserve the Best!

Available through all leading record bars, Hi-Fi shops and department stores.

DISCPROTEC is distributed throughout Australia by Goldring Audio Industries.



HO1 721

B&W 801

**TO CREATE OUR
SERIES 801
WE BROKE THE RULES**

With the B & W 801, the design brief was brief. In fact, the required performance was summarised in just four telling words; full professional monitor requirements.

To qualify as a monitor by B & W standards, a system must have linear free-field amplitude response from 30Hz to 20kHz, with minimal deviation horizontally and vertically. It must be free from distortion and colouration and have an audio-powered overload circuit to protect against accidental damage or overload.

This is the Series 80 concept in a nutshell.

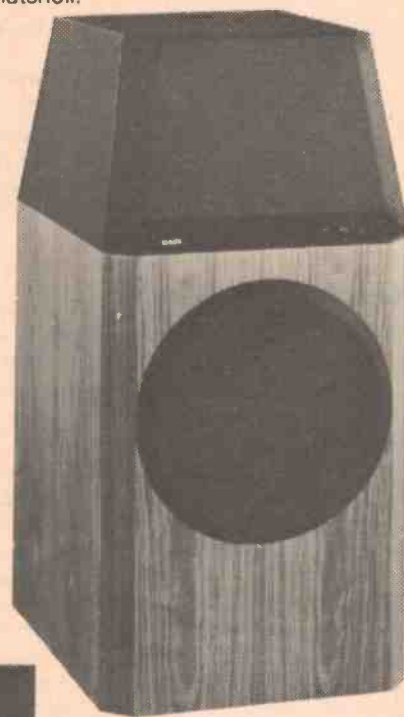

B&W

LOUDSPEAKERS

For further information see your B & W dealer or contact
Convoy International Pty Ltd
4 Dowling Street
Woolloomooloo NSW 2011
Telephone (02) 3582088

Have you joined the Wonderful World of General Electric

GE Ni Cad Rechargeable Batteries



General Electric have reorganised their sales and distribution for their successful rechargeable battery systems.



If you would like to join the General Electric selling force, or if you require information on General Electric rechargeable battery systems, then your enquiries are welcome at:

Australian General Electric (Sales) Limited,
86-90 Bay Street,
Ultimo, N.S.W. 2007.

C.G.F. Marketing Services,
117 Burnley Street,
Richmond, Victoria 3121.

Products from the Wonderful World of General Electric

GENERAL  ELECTRIC *

*Trademark General Electric Company U.S.A.
World's Largest Electrical Enterprise



HEWLETT-PACKARD

Count on quality — use HP's
 HP41C Calculator \$359.90 (\$323)
 HP41C Accessories:
 Card Reader \$237 (\$213)
 Printer/Plotter \$425 (\$382)
 Memory Modules \$56.40 (\$49.10)
 Application Packs \$56.40 (\$49.10)
 Solution Books \$15.70 (\$13.63)
 Thermal Paper \$7.50 (\$6.50)
 40 Mag Cards \$25.10 (\$21.80)
 HP34C, 210 steps \$184.50 (\$165.50)
 HP33C, 49 steps \$148 (\$133)
 HP33E, 49 steps \$111 (\$99.75)
 HP33E Scrf/Stats \$17 (\$78)
 HP31E Scientific \$63 (\$56.50)
 Also HP97 HP29C, HP38C, HP39E, HP37E

HP ONLY — POST FREE

HP41C

ASK OUR PRICES LAST — WE ARE NEVER KNOWINGLY UNDERSOLD

The CBM™ Computer Business System

New 3000 Series now available 2001-16/32
 2023 Friction feed 2022



COMPUTERS — HARDWARE — SOFTWARE —

AUTHORISED DEALER
commodore
 Dual Drive Floppy Disk



CASIO • fx502P/FAI LCD PROGRAMMABLE



256 steps, 22 memories. FAI adaptor interfaces an ordinary cassette for program storage. Manual and huge book of programs. Continuous memory.

FX502P \$149 (\$135)
 FAI \$43.50 (\$39)

A.P.F. LCD

M5602, 40 functions ..\$23 (\$20.50)
 M8602, 60 functions ..\$29.30 (\$26)

Pack and Post — all LCD models \$1.50 anywhere in Australia (except Casio fx502p). Otherwise \$4 for registered post in NSW. \$5 elsewhere.

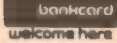

Copy and complete

Please debit my Bankcard \$.....
 No..... Expiry Date.....
 Signature.....
 Name.....
 Address.....

TEXAS PROGRAMMABLE SYSTEMS

GREATEST PACKAGE DEAL EVER!!!



Ti59 and PC100C PRINTER

\$510 (\$450)

- Modules 58C/59 \$34.50 (\$30.50)
- Pakettes 58C/59 \$9 (\$8)
- 3 Rolls Therm Paper \$12 (\$10.50)
- 40 Mag Cards \$15 (\$13.50)

NEW Intertec Computer System

- 32K/64K RAM
- 350K/800K Disks
- 20Mb Fixed Disk
- Multi-user unit up to 16 terminals
- Full range of printers
- 7 languages avail.
- Superb business software

CALCULATOR AND COMPUTER DISTRIBUTORS

INCORPORATING ELECTRONIC CALCULATOR DISCOUNTS

PHONE (02) 624-8849
 PO BOX 106, BAULKHAM HILLS 2153

Some of AUSTRALIA'S LOWEST COMPONENT PRICES (Now Lower STILL!)

Note: Regular Prices not temporary specials — keep us in mind for that next order.



POTS 40c
 (LINEAR 1/4" ALUM. SHAFT)

Linear potentiometers rotary carbon
 500 Ohm, 1K, 5K, 50K, 100K, 250K, 500K, 1M, 2M.

Quality Large red LEDs well diffused wide viewing angle.
 15c each, \$1.40 per 10, \$110/K.
 Quality MOUNTING CLIPS 3c ea. ea. \$2.70/100

LEDS
 \$12 a 100
 15c each



Best value
 No brag
 Just fact



TRIMPOTS 14c
 \$12 a 100 (10mm)

Values: 100, 500 Ohm, 1K, 2K, 5K, 10K, 50K, 100K, 250K, 500K, 1M, 2M.

Trade/govt./S.T. exempt: welcome.
 Send for special lists (e.g. \$29 a 100 pots and \$99 a 1000 LEDs plus tax if applicable. Small quantities also.

← TRADE ENTRANCE

13c



METAL CAN TRANSISTOR
BC 107 BC 108 BC 109
13c
 10 for \$1.20 100 for \$11
 Epoxy BC178 BC109 same price

1 Amp. DIODES
 50V 1N4001 - 6c
 100V 1N4002 - 7c
 400V 1N4004 - 8c
 1000V 1N4007 - 11c
 10% off 100 SAME

\$3½ a 100 SIGNAL DIODE IN4148
\$29 a 1000 4c each



4c ELECTROS
 (UPRIGHT)

Cap.	(per 100 prices in brackets)			
	16V	25V	50V	50V
0.47uF	4c(\$3½)	5c(\$3¾)	6c(\$4)	
1, 2.2, 3.3, 4.7, 10uF	5c(\$3½)	6c(\$3¾)	7c(\$4)	
22uF	6c(\$3¾)	7c(\$4)	8c(\$5)	
33uF	8c(\$4)	9c(\$5)	10c(\$6)	
47uF	9c(\$5)	10c(\$6)	11c(\$7)	
100uF	10c(\$6)	12c(\$7)	14c(\$11)	
220uF	12c(\$8)	16c(\$10)	35c(\$17)	
470uF	16c(\$12)	22c(\$16)	45c(\$30)	
1000uF	22c(\$18)	30c(\$25)	75c(\$50)	

4c POLYESTER FILM CAPS

E12 10% 100V

.001 - 4c	.01 - 5c	.1 - 10c
.0012 - 5c	.012 - 6c	.12 - 11c
.0015 - 5c	.015 - 6c	.15 - 12c
.0018 - 5c	.018 - 6c	.18 - 14c
.0022 - 5c	.022 - 6c	.22 - 15c
.0027 - 5c	.027 - 6c	.27 - 16c
.0033 - 5c	.033 - 7c	.33 - 18c
.0039 - 5c	.039 - 7c	.39 - 19c
.0047 - 5c	.047 - 7c	.47 - 20c
.0056 - 5c	.056 - 8c	
.0068 - 5c	.068 - 8c	All values
.0082 - 5c	.082 - 9c	in uF
	10uF off 100	same uF

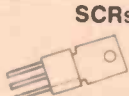

SCRs
C106Y1
40c
C122E
\$1.20

SCRs:
 0.8A 30V C103Y — 35
 0.8A 200V C103B — 60
 4A 30V C108Y1 — 40
 4A 400V C108D1 — 75
 8A 400V C122D — \$1.05
 8A 500V C122E — \$1.20

TRIACS:
 6A 400V SC141D — \$1.30
 10A 400V SC146D — \$1.50
 — 35
 DIAC ST2 — 75
 Chart to identify leads — 10c
 Plus trigger info.

25 A 400V
SC260D TRIAC
C37D SCR
 EA. **\$2.50**



1½c

RESISTORS

NEW TOP QUALITY CARBON FILM PERFECTS ONLY

5% E12,2.2 Ohm to 4M7
 1½c each ¼w or
 90c a 100 same Ohms
 2c each ¼w or
 \$1.40 a 100 same Ohms

Keep electronics a hobby and not a luxury, compare our prices and buy from us. Same day turnaround service (unless swamped). All goods top quality and new. No minimum order. One P/P charge of 45c regardless of quantity. Advert current 3 months for late readers

CONSTANTLY LOW PRICES

DIGGERMAN ELECTRONICS

P.O. BOX 33, CORAMBA, N.S.W. 2466

CONSTANTLY BETTER SERVICE



JUST WRAP™ WIRE WRAPPING TOOL

WHY CUT? WHY STRIP? WHY SLIT?
WHY NOT JUST WRAP?

JW-1-B	BLUE WIRE
JW-1-W	WHITE WIRE
JW-1-Y	YELLOW WIRE
JW-1-R	RED WIRE

JUST WRAP REPLACEMENT ROLLS

R-JW-B	BLUE WIRE	50 ft. Roll
R-JW-W	WHITE WIRE	50 ft. Roll
R-JW-Y	YELLOW WIRE	50 ft. Roll
R-JW-R	RED WIRE	50 ft. Roll

UNWRAP TOOL FOR JUST WRAP

JUW-1	UNWRAPPING TOOL
-------	-----------------

JUST WRAP KIT

JWK-6	JUST WRAP KIT
-------	---------------

"HOBBY" WIRE WRAPPING TOOL BATTERY POWERED

BW-2630	FOR AWG 26-30
---------	---------------

Use "C" size NICAD Batteries, not included. Bits not included.

BT-30	BIT FOR AWG 30
BT-2628	BIT FOR AWG 26-28

HOBBY WRAP TOOLS

WSU-30	REGULAR WRAP
WSU-30M	MODIFIED WRAP

30 B 50-010	30 AWG Blue Wire 1' Long
30 Y 50-010	30 AWG Yellow Wire 1' Long
30 W 50-010	30 AWG White Wire 1' Long
30 R 50-010	30 AWG Red Wire 1' Long
30 B 50-020	30 AWG Blue Wire 2' Long
30 Y 50-020	30 AWG Yellow Wire 2' Long
30 W 50-020	30 AWG White Wire 2' Long
30 R 50-020	30 AWG Red Wire 2' Long
30 B 50-030	30 AWG Blue Wire 3' Long
30 Y 50-030	30 AWG Yellow Wire 3' Long
30 W 50-030	30 AWG White Wire 3' Long
30 R 50-030	30 AWG Red Wire 3' Long
30 B 50-040	30 AWG Blue Wire 4' Long
30 Y 50-040	30 AWG Yellow Wire 4' Long
30 W 50-040	30 AWG White Wire 4' Long
30 R 50-040	30 AWG Red Wire 4' Long
30 B 50-050	30 AWG Blue Wire 5' Long
30 Y 50-050	30 AWG Yellow Wire 5' Long
30 W 50-050	30 AWG White Wire 5' Long
30 R 50-050	30 AWG Red Wire 5' Long
30 B 50-060	30 AWG Blue Wire 6' Long
30 Y 50-060	30 AWG Yellow Wire 6' Long
30 W 50-060	30 AWG White Wire 6' Long
30 R 50-060	30 AWG Red Wire 6' Long

PRE-STRIPPED WIRE WRAPPING WIRE

Wire for wire wrapping.
AWG-30 (0.25mm)
KYMAR® wire, 50 wires
per package stripped
1" both ends.

© KYMAR PENNVALT

TRI-COLOR DISPENSER

WD-30-TRI	TRI-COLOR DISPENSER
-----------	---------------------

R-30-TRI	REPLACEMENT ROLLS
----------	-------------------

WIRE DISPENSER

WD-30-B	BLUE WIRE
WD-30-Y	YELLOW WIRE
WD-30-W	WHITE WIRE
WD-30-R	RED WIRE

DISPENSER REPLACEMENT ROLLS

R-30B-0050	30-AWG BLUE 50 FT. ROLL
R-30Y-0050	30-AWG YELLOW 50 FT. ROLL
R-30W-0050	30-AWG WHITE 50 FT. ROLL
R-30R-0050	30-AWG RED 50 FT. ROLL

HOOK-UP WIRE

HK-18	18 AWG 25 FT.	SOLID CONDUCTOR
HK-20	20 AWG 25 FT.	SOLID CONDUCTOR
HK-22	22 AWG 50 FT.	SOLID CONDUCTOR
HK-24	24 AWG 50 FT.	SOLID CONDUCTOR
HK-26	26 AWG 50 FT.	SOLID CONDUCTOR
SHK-18	18 AWG 25 FT.	STRANDED CONDUCTOR
SHK-20	20 AWG 25 FT.	STRANDED CONDUCTOR
SHK-22	22 AWG 50 FT.	STRANDED CONDUCTOR
SHK-24	24 AWG 50 FT.	STRANDED CONDUCTOR
SHK-26	26 AWG 50 FT.	STRANDED CONDUCTOR

PRB-1 DIGITAL LOGIC PROBE

- DC to > 50 MHz
- 10 nsec. pulse response
- 120 K Ω impedance
- Automatic pulse stretching to 50 Msec.
- Automatic resetting memory
- Open circuit detection
- Automatic threshold resetting
- Compatible with all logic families 4-15 VDC
- Range extended to 15-25 VDC with optional PA-1 adapter
- Supply 0 V.P. to ± 70 VDC
- No switches/no calibration

PRB-1	DIGITAL LOGIC PROBE
-------	---------------------

PROTOTYPE BOARD (CM-100)

TERMINALS: 1,020 TEST POINTS. 188 separate 5 point terminals, plus 2 horizontal bus lines of 40 common test points each.

SIZE: 6½" Wide, 5" Long.

CM-100	MODULAR PROTOTYPE BOARD
--------	-------------------------

PROTOTYPE BOARD (CM-200)

TERMINALS: 630 TEST POINTS. 94 separate 5 point terminals, plus 4 bus lines of 40 common test points each.

SIZE: 6" Wide, 3½" Long.

CM-200	MODULAR PROTOTYPE BOARD
--------	-------------------------

PROTOTYPE BOARD (CM-300, CM-400)

CM-300 and CM-400 have two separated rows of five interconnected contacts each. Each pin of a DIP inserted in the strip will have four additional tie-points per pin to insert connecting wires. They accept leads and components up to .032 in. diameter. Interconnections are readily made with RW-50 Jumper Wire. All contact sockets are on a .100 in. square grid (1¼ in. wide).

CM-300	MODULAR PROTOTYPE BOARD
--------	-------------------------

CM-400	MODULAR PROTOTYPE BOARD
--------	-------------------------

MODULAR BUS STRIP

CM-500 is a bus strip to be used in conjunction with CM-300 and CM-400 for distribution of power and common signed lines. Two separate rows of common terminals, grouped into clusters of five. All contact sockets are on a .100 in. square grid.

CM-500	MODULAR BUS STRIP
--------	-------------------

DIP IC INSERTION TOOLS WITH PIN STRAIGHTNER

Narrow profile. Pin straightener built into tool. Automatic ejector.

INS-1416	14-16 PIN DIP/IC INSERTER
----------	------------------------------

MOS, CMOS-SAFE

GROUND STRAP NOT INCLUDED

MOS-1416	14-16 PIN, MOS CMOS SAFE INSERTER
----------	--------------------------------------

MOS-2428	24-28 PIN, MOS CMOS SAFE INSERTER
----------	--------------------------------------

36-40 PIN CMOS-SAFE IC INSERTION TOOL

Aligns bent out pins. Includes terminal lug for attachment of ground strap.

GROUND STRAP NOT INCLUDED

MOS-40	36-40 PIN CMOS SAFE INSERTION TOOL
--------	---------------------------------------

DIP IC EXTRACTOR TOOL

Extracts all LSI, MSI and SSI devices of from 8 to 24 pins.

EX-1	EXTRACTOR TOOL
------	----------------

24-40 CMOS-SAFE EXTRACTOR TOOL

Removes 24-40 pin IC's, .600" centers. CMOS safe. Includes terminal lug for attachment of ground strap.

GROUND STRAP NOT INCLUDED

EX-2	CMOS SAFE EXTRACTOR TOOL
------	--------------------------

**Over \$3000
in prizes!**

5 BOSE CAR



Each system, WORTH \$650, contains everything you see here — amplifier/equalizer, four speakers with grilles (two with the direct/reflecting grille), all the cables, mounting brackets, nuts, bolts and connectors you need to install your Bose stereo car sound system . . . you could be lucky to win one !

RULES

HERE ARE FIVE chances to win a superb, top-line 100 watt Bose car stereo system. Each system consists of a booster-equaliser capable of driving four separate Bose 901 design speakers at 25 watts each.

These systems normally sell for over \$650 each.

Here's an excellent chance of obtaining one for nothing!!!!

This contest is sponsored jointly by ETI and Bose Australia — who have generously donated the prizes.

NOTE: Please read contest rules very carefully if sending in multiple entries.

This contest is open to all persons normally resident in Australia with the exception of members of the staff of Modern Magazines (Holdings) Ltd, K.G.Murray Ltd, Australian Consolidated Press, Wilkes Pty Ltd and/or associated companies.

Entries should be addressed to **ETI/Bose Contest, Electronics Today Int., 15 Boundary St, Rushcutters Bay, NSW 2011.**

Closing date for the contest is August 29th 1980. Entries received within seven days of that date will be accepted if postmarked prior to and including August 29.

The contest will be judged by the Managing Editor and Editor of ETI whose decisions will be final. No correspondence can be entered into regarding their decisions.

In the event of one or more tied results the finalists' entries will be thoroughly mixed and then drawn by the Managing Editor.

Winners will be advised by telegrams the same day the results are declared. The names of the winners, together with the winning answers will be published in the next possible issue of ETI.

Contestants *must* enter their names and address where indicated on each entry form. Photostats or clearly written copies will be accepted but if sending copies you must cut out and include with *each entry* the month and page number from bottom of the right hand page of the contest. In other words you can send in multiple entries but you will need extra copies of the magazine so that you send an original page number with each entry.

This contest is invalid in States where local laws prohibit entries.

Entrants must sign the declaration, accompanying this contest, that they have read the above rules and agree to abide by their conditions. **PERMIT NUMBER: TC80/622.**

STEREOS TO WIN

ENTRY FORM

Here are ten questions, each having multiple-choice answers, with the tenth question further seeking a few words from a not-so-well-known quotation.

If you can't find out the answers to some of the questions then just have a guess — you could well be right!

Needless to say, the readers having the highest marks are the lucky (or studious) winners. In the event of a tie the conditions outlined in the contest rules shall apply.

1. To double the maximum perceived sound level obtainable from a 10 watt car stereo what power would you need?
 - 15 watts
 - 25 watts
 - 50 watts
 - 100 watts
 - none of the above
2. What is the approximate peak power in watts generated by a one metre diameter bass drum?
 - 5 watts
 - 25 watts
 - 50 watts
 - 100 watts
 - none of the above
3. Two cars are standing side by side with their engines revving hard. Do they make twice as much noise as one car . . . or?
 - More than twice
 - Twice
 - One and three quarters
 - One and a half
 - Less than one and a half
4. Some problems occur in reproducing music below certain limiting frequencies in small areas — such as a car interior. Which of the following is the *primary* problem?
 - Sounds bounce around so much they all become mixed
 - Sounds reflecting off far surfaces cancel those heard directly
 - Sounds reflecting off far surfaces reinforce those heard directly
 - External and internal noises prevent the desired sound being heard
5. Bose's fundamental speaker design concept is that only a small part of the sound in a concert hall is perceived directly — most is reflected. So they design their speakers to work in the same way. What percentage of sound does Bose feel is direct?
 - 98%
 - 89%
 - 21%
 - 11%
6. What is the model number of Bose's best-known domestic speaker?
 - 901
 - 910
 - 911
 - 919
7. What total harmonic distortion level do Bose claim for their 1401 car stereo?
 - 0.9%
 - 0.09%
 - 0.009%
8. What was a 'Housekeeper seal'?
 - A design award
 - A method of sealing base metals through glass used in early valve technology
 - A car radio locking device
 - A technique for protecting radio equipment against deterioration during WWII
 - None of the above
9. This measuring device was in use during the very early days of electromagnetic communications. What was it called?



- Faraday's loop
 - Hertzian loop
 - Inductor
 - Cymoscope
 - Oscycoscope
10. Music has charms to sooth the savage breast — but . . . "
 - Who said the above?
 - Bob Dylan
 - William Congreve
 - Alexander Chase
 - Ronald Keeley

What are the next few words

Name

Address

Postcode

I have read the Contest Rules and agree to abide by their conditions.

Signed

Date



SONICS

the Australian
magazine
dedicated to
the art and
craft of sound

Available late June

Sonics is a magazine for everyone who has an interest or involvement in music or musical electronics. Published quarterly, in March, June, September and December, each issue contains features, equipment reviews, construction projects, distributor and brand index and much, much more.

Sonics June 1980 line-up:

FEATURE — Ibanez MC-500 guitar reviewed

RIGS — Fleetwood Mac: the sound of the band

HOMEGROWN — Jands: how a small lighting company became one of Australia's biggest PA system operators.

SOUNDPROOF — Mediasound studios: improving the style of a sound reputation

HARDWARE — Yamaha's CS-20M and Roland's Promars Compuphonic synthesizers reviewed

PROFILE — Charles Fisher of Trafalgar studio

SHINE ON — Latest products and news in the lighting game

PLUS — extra features, a B.I.Y. project or two, and all the news, views and happenings in music and electronics. Rendezvous with Sonics in June!

Also available Sonics 1980 Yearbook is Australia's first comprehensive directory of electronic musical equipment, featuring articles on keyboards, guitar pick-ups, amplifiers, speaker systems and microphones. The Yearbook is still available from most newsagents, or direct from Sonics, 4th Floor, 15 Boundary St, Rushcutters Bay, NSW 2011 — Price \$4.35 plus 75 cents post and packaging.

DSA

concert systems

SOUND HIRE
SALES & INSTALLATION
DESIGN & CONSULTATION

JBL

Beyer Dynamic

Jands

WHITE
EQUALIZERS

CEITEX
LIGHTING &
DISCO EQUIPMENT

CABINETS
MADE TO
ORDER

MXR

SHURE/SENNHEISSER

BANDS: Talk to us
about our equipment
management scheme!

MISCELLANEOUS:

- ★ GAFF TAPE
- ★ SESSION HARDWARE
- ★ CANNONS-JACKS
- ★ MIC, SPK CABLE
- ★ MULTICORE
- ★ PIEZO TWEETERS
- ★ MUFFIN FANS

SHOWROOM:
156 GIVEN TCE.
PADDINGTON QLD.
PH. (07) 366 367

JBL's 4311 STUDIO MONITOR.

NOW IT'S NOT FOR STUDIOS ONLY.



FIRST WITH THE
PROS.

JBL is making its most popular studio monitor available to everyone.

It's a 3-way, high-efficiency system that gives you wide range response. And, because it's compact for use in small studios, and is finished in hand-rubbed walnut, it's perfect for your living room or den. The JBL 4311 compact studio monitor.

For details and demonstrations visit us
THE PROFESSIONALS IN JBL

insound

PTY. LTD.

108 WEST ST., CROWS NEST
929 2714 92 1498

SPECIALISTS IN HOME INSTALLATIONS
AND BUILT-IN SOUND SYSTEMS.

CHEAP TAPES!

BULK TAPES DISCOUNTED

MAXELL

LN C60	ULTRA LOW NOISE	Box of 12	\$ 18.00
LN C90	ULTRA LOW NOISE	Box of 12	25.00
LN C120	ULTRA LOW NOISE	Box of 12	37.00
UD C60	ULTRA DYNAMIC	Box of 12	29.00
UD C90	ULTRA DYNAMIC	Box of 12	35.00
UDXLI C60	EPITAXIAL	Box of 12	38.00
UDXLI C90	EPITAXIAL	Box of 12	48.00
UDXL II C60	EPITAXIAL	Box of 12	40.00
UDXL II C90	EPITAXIAL	Box of 12	50.00

TDK

D-C60	DYNAMIC	Box of 10	\$ 18.00
D-C90	DYNAMIC	Box of 10	23.00
AD-C60	ACOUSTIC DYNAMIC	Box of 10	28.00
AD-C90	ACOUSTIC DYNAMIC	Box of 10	33.00
SA-C60	SUPER AVILYN	Box of 10	34.00
SA-C90	SUPER AVILYN	Box of 10	43.00
MAR-C60	METAL (METAL CASE)	Each	14.00
MA-C60	METAL	Each	11.00

SONY

CHF C60	ORANGE CASE	Box of 10	\$ 18.00
CHF C90	ORANGE CASE	Box of 10	24.00
BHF C60	GREEN CASE	Box of 10	24.00
BHF C90	GREEN CASE	Box of 10	28.00
AHF C60	BLUE CASE	Box of 10	29.00
AHF C90	BLUE CASE	Box of 10	39.00

FUJI

FL C60	SUPER LOW NOISE	Box of 10	\$ 17.00
FL C90	SUPER LOW NOISE	Box of 10	23.00
FXI C60	PURE FERRIX	Box of 10	26.00
FXI C90	PURE FERRIX	Box of 10	31.00
FXII C60	BERIDOX	Box of 10	32.00
FXII C90	BERIDOX	Box of 10	41.00
MC 60	METAL	Each	11.00
MC 90	METAL	Each	14.50

OPUS

UD C90	EXT. RESPONSE	Box of 12	\$ 25.00
G-C90	G-TAPE LOW NOISE	Box of 20	19.00

FURTHER DISCOUNTS AVAILABLE
ON PURCHASE OF 10 BOXES
OR MORE

ADD: PACK & POST —

	VIC.	TAS/S/NSW	WA/NT/QLD
1 - 2 Boxes	\$1.00	\$2.00	\$3.00
3 - 4 Boxes	\$1.50	\$3.00	\$3.50
5 + Boxes	\$2.00	\$4.00	\$5.00

STOCK AT PRICES SHOWN AVAILABLE
AT TIME OF GOING TO PRESS

TO:
MAIL ORDER CENTRE
A.M.S. SYSTEMS,
135 Hawthorn Road,
CAULFIELD. VIC. 3162.
PHONE (03) 523-7145.



KYORITSU TEST INSTRUMENTS

— designed for safety

- No exposed metal parts
- Overload protection
- Threaded lead sockets
- Functional compact designs
- Proven field performance
- 3000V AC with stand
- Low battery consumption
- 13MM L.C.D. Display

ANALOGUE MULTIMETERS FOR INDUSTRIAL USE

TS-1100 (illustrated)
TS-1101

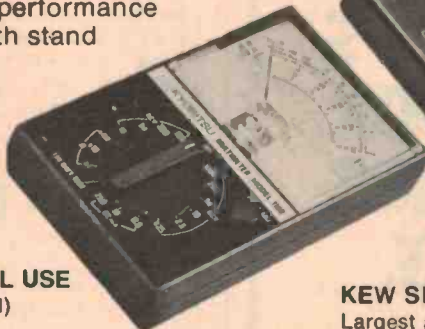

- TS-2000 (above)**
- 300 VAC with stand
 - 13 mm LCD display
 - Low Battery Consumption

KEW SNAP CLAMP METERS

Largest available range.
From 100 MA F.S.D. through to 1000 Amps.
DC and digital models also.



Available from Electrical Wholesalers throughout Australia.

BELL

BELL INSTRUMENTS PTY. LIMITED

Garema Circuit, Kingsgrove 2208 NSW.
PO Box 154, Tel (02) 750-6000.

74 Raglan Street, Preston 3072 Vic.
Tel (03) 44-5021.

TASMAN ELECTRONICS

12 Victoria Street,
Coburg 3058.
Phone (03) 354-5062.

Special Offers for the month of July.

BC548.....10	7405.....20	74LS03.....20	2708.....8.50
BC549.....10	7406.....20	74LS04.....20	2716.....31.50
BC558.....12	7408.....20	74LS20.....20	4116.....12.00
BDV64B.....2.50	7410.....20	74LS28.....25	6810P.....4.90
BDV65B.....2.50	7413.....35	74LS38.....30	6821.....5.90
2N3055.....65	7420.....20	74LS93.....60	6850.....5.50
MJ2955.....75	7430.....20	74LS95.....70	6800P.....9.50
MJE2955.....90	7432.....20	74LS109.....35	8085.....22.00
uA741.....20	7440.....20	74LS113.....45	Z80P10.....10.00
LM3914.....3.50	7442.....45	74LS151.....75	Z80CTC.....10.00
RC4136.....1.10	7447.....70	74LS155.....55	
4520.....1.00	7448.....80	74LS157.....70	
	7453.....20	74LS163.....75	
	7460.....20	74LS165.....90	
	7470.....30	74LS193.....80	
	7473.....30	74LS251.....75	
	7474.....25	74LS253.....80	
	7475.....25	74LS367.....60	
	7483.....80	74LS368.....50	
	74100.....1.50		
	74107......45		
	74123......60		
	74145......85		
	74150......85		
	74151......70		
	74154......70		
	74160.....1.00		
	74172......95		
	74192......80		
	74193......80		
	74367......60		

MAIL ORDERS -- \$1.00 minimum post & pack please.

LASER

From Australia's only manufacturer of over eighty lasers and laser systems with 14 years' research, design and manufacturing experience.

STOCK PRODUCTS INCLUDE:

- Education and research lasers.
- Medical lasers for surgery and acupuncture.
- Alignment and control for civil engineering.
- Tunneling, mining and flameproof lasers.
- Lasers for cutting, welding and drilling.
- Marine navigation and survey lasers.
- Light show and entertainment lasers.

AND NOW . . .

The laser kit as illustrated in this issue. Complete with all components and alloy case — ex stock at \$250 plus tax (ex factory).

From the all-Australian laser manufacturer

Laser Electronics Pty Ltd

216 Sea World Drive, Southport, QLD. 4215.
Phone: (075) 32-1699. Telex. AA41225.

**"Laser Electronics~
making light work"**

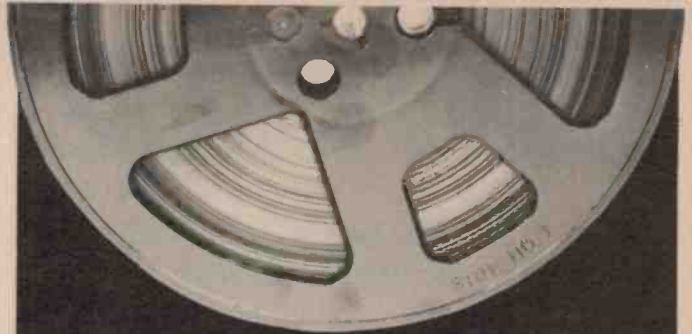

Top AMPEX REEL to REEL TAPE $\frac{1}{3}$ normal price!

THE USA AMPEX CORPORATION has made available a substantial quantity of 'off-cut' tapes from their highest grade material. All tapes are 1800 ft (549 m) by $\frac{1}{4}$ ", 1 mil ferric oxide on standard 7" reels.

There's a slight gamble involved — but one in which you either win a lot — or a hell of a lot!

Here's why:

The tapes offered are of differing types and you take pot luck on which you receive.

BUT, The lowest quality is Ampex' superb Ampex Plus series! The highest is Ampex' Grand Master series!

SO. If you draw the Ampex Plus you'll be paying about one-third the usual price. If you score the Grand Masters you'll be paying about a quarter usual price.

YOU CANNOT LOSE. If you are not totally and completely satisfied with your purchase, Dindy guarantee to return the full purchase price without question provided the tapes are returned within 14 days in the original packing.

Identical tapes to those offered are marketed in the USA by Ampex, using the trade name 'Shamrock'. This trade name is also used for those offered here.

NOTE: This offer is made by Dindy Marketing (Aust.) Pty Ltd and this publication is acting as a clearing house only. Cheques should be made payable to 'Ampex Tape Offer', ETI Magazine, 15 Boundary Street, Rushcutters Bay NSW 2011. We will then process your order and pass it on to Dindy, who will send you the goods. Please allow up to four weeks for delivery.

Owing to the exceptionally low offer price the minimum ordering quantity is ten tapes (total \$39).

\$39 for 10 reels

AMPEX TAPE OFFER

Please supply tapes at \$39 for ten \$

Plus post and packing, any quantity:— \$2.50

TOTAL \$

Name

Address

.

. Post Code

B&W DM12

THE UNOBTRUSIVE REVOLUTIONARY

We could have built something smaller, but we were determined to build a miniature speaker that rises way above the limitations hitherto imposed by a small enclosure. In particular, we wanted to achieve wider response and more realistic sound levels in the low frequency range. We also wanted safe power-handling capacity. Thanks to our unique resources in computer and laser technology and the sheer creativity of our design team, DM12 achieves all this and more.



B&W
LOUDSPEAKERS



It's certainly small.
Just 355mm (14 in) high x 220mm (8¾ in) wide x 270mm (10½ in) deep.

106dB.
That's the surprising peak sound pressure level DM12 produces from its 12 litre enclosure.

Monitor standard.
Frequency linearity + 2 dB 85 Hz to 20kHz.

APOC-protected.
B & W's exclusive audio-powered overload circuit protects against accidental damage or overload.

For further information see your B & W dealer or contact
Convoy International Pty Ltd
4 Dowling Street Woolloomooloo NSW 2011
Telephone (02) 3582088

LABORATORY TESTS PROVE DISCPROTEC RECORD PRESERVATIVE IS THE BEST!

Why use anything else?



In a comparison test of DISCPROTEC and SOUND GUARD conducted by Mr. Kazuko Ohta, manager of Technology Section of Victor Co. (Japan) Ltd., Tokyo, Japan and published in the monthly magazine 'Radio Technology' Discprotec was clearly the superior product. Mr. Ohta stated in his report: "upon using Discprotec he was entirely captivated by the fascinating effect of it. The sound became quite fresh and alive. The building-up of the direct sound and the trailing of the indirect sound were clear and dynamic, just like coming from a brand new laquer disc." He went on to say: "In the Discprotec instructions

the description is rather conservative. It is written that 'quality of sound is maintained without deterioration,' but actually it is a vivid fact that the sound is reproduced almost similar to that of a master type."

"For testing, many kinds of cartridges of moving magnet and moving coil types were used and in conclusion, Discprotec produced a significant improvement in audition better than Sound Guard by presenting utmostly fine sound."

As we said before, "why use anything else!"

Available through all leading record bars, Hi-Fi shops and department stores.

DISCPROTEC is distributed throughout Australia by Goldring Audio Industries.

(Copies of report and test procedures available from Goldring Audio Industries, 69 Clarence St., Sydney 2000)



HO1 723

DOLLAR SAVING

SAVE

THE BEST VALUE IN ELECTRONICS

JULY MONEY SAVERS

*** NEW BIG POWER Speaker Systems**

PHILIPS/ETI 4000/2 KITS
JUNE ETI p51 3 WAY
SPEAKERS and X'OVERS
\$360 PR.
do-it-yourself

100 WATTS NEW
ETI 4000/2

PHILIPS/ETI SERIES 4000/1 KITS
FEBRUARY ETI 4 WAY
SPEAKERS and X'OVERS
\$460 PR. \$698 PR.
All speakers sent 'FREIGHT-ON'

DIGITAL WATCH

LCD QUARTZ
HOURS, MINS, SECS, DAY, DATE, BACK LIGHT AND AUTO CALENDAR.
Stainless Steel or Gold Finish. Please advise.

NEW CRAZY LOW PRICE!
6 Months Guarantee
With instructions and display case!
\$14.99

ULTRA-THIN POCKET-SIZE LCD DISPLAY CALCULATORS
With Memory, $\frac{1}{2}$ %, auto shut-off etc!
90x55x5mm size
\$12.99

WHOLESALE PRICES DIGITAL LED CAR CLOCKS
12:10

\$16.99
12v Thin-line auto Quartz -70x45x20mm
•Self-adhesive back sticks to car dash
•Automatic night dimmer
12v DIGITAL CAR CLOCKS
•ALARM •GREEN DISPLAY
•AM/PM •ABOVE/BELOW DASH
•QUARTZ CRYSTAL ACCUR.
•AUTOMATIC NIGHT DIMMER
•24HR ALARM SYSTEM
•REV. POLARITY PROTECT.

NEW, ECONOMY FM WIRELESS MIKE
Range to 300ft, use FM radio, size 103x34x25mm
\$10
ELECTRICAL TERMINAL BLOCKS EA
(12 FOR 50c) MULTIPLES OF 12
50c

ORDER NOW BY... bankcard
24 HOUR TELEPHONE ANSWERING SERVICE!
Order on Bankcard, we'll send it out, usually the next day!

welcome here **ROCKING ARMATURE MICROPHONES**
EXTREMELY RUGGED LOW IMPED.
79c

Jackpot No 4
OVER 160 PARTS FOR \$15
over 5kgm
Our latest assortment of over 100's of specials, samples, and off-line clearouts, manufacturers over-runs etc. Jackpot No 4 has all new items - contents vary but contain val. less than 3kgm weight - 900 worth for \$15

U-BEAT POWER TRANSFORMER
240v Input OUTPUTS
26v 1/2A
26v 1A
BRAND NEW AC TESTED WITH SHIELD.
Lots of Uses eg: Amplifiers, Power supplies, Test equipment etc. Ask our price for quantity - total 800 available.

MAL'S VALU-PACKS
LUCKY DIP ASSORTMENTS FOR VALUE CONSCIOUS EXPERIMENTERS
500 1/2W 200 1W 250 MIXED 40 5W RESISTORS
\$2 \$2 \$2 \$2
25 NEW PRESET POTS \$2
12 NEW SLIDER POTS \$2
40 RADIO TV KNOBS \$2
20 ASST POTS \$2
100 CAPS CERAMIC \$2
45 CAPS ELECTROS \$2
20 8F 1K OSC COILS \$2
20 ASST VOR3 0-100 \$2
50 ASST TAGSTRIPS \$2
20 ASST. LOW VOLTAGE SWITCH TI TUBING \$2
30 6 RES. SMD TI TUBING \$2
20 MINI POTS \$2

BUY 10 PACKS + EXTRA ONE FREE!

SUPER SAVING!
12v CAR CASSETTE TAPE HEAD DEMAG. PROBE
RESTORES OUTPUT AND H.F. RESPONSE.
\$1.99
SCOOP! Save \$5 were \$6.99

LOWEST PRICED SWITCHES SALE
B ON-(ON) SPDT 80¢ 10 FOR \$7
D ON-OFF-(ON) (3P)
E (ON)-OFF-(ON)
G ON-(ON) DPDT 1.00 EA 10 FOR \$9
I ON-OFF-(ON) (6P)
J (ON)-OFF-(ON)

New dialer

•GENTLE TOUCH DIALER
•LAST NUMBER RE-DIAL
•FLASHING LED INDIC.

\$29.99
AUTO DIALER TELEPHONES

Using Dialer as above!
DESK MODEL \$75.00
WALL MODEL \$69.95
(not illustrated)
NOT APPROVED BY TELECOM RINGING WITH FEATURES

AM/FM CAR RADIO CASSETTE
3 MTH G'TEE
\$79 WERE \$89 SAVE \$10
AM Manual CAR RADIOS With Speaker \$19.95

SPECIALS

ENGINE ANALYZER
MEASURE VOLTS 0-16, AMPS 0-60 RPM 0-12,000/160 100 POINTS TEST, DWELL ANGLE etc.
\$14
TEST 4, 6 OR 8 CYLINDER MOTOR S
WITH FULL INSTRUCTIONS
Usually \$10 Around \$25

POPULAR REPLACEMENT CERAMIC STEREO CARTRIDGES
LOOK! \$2.50 EA OR 5 FOR \$10
ON SV PATENT

PL-259 PLUGS
with in-built reducer etc
NEW, TOP QUALITY PUSH ON TYPE
40¢ EA FOR \$3.50
Importor sacrifices stock!

TWIN BLOWER
USA made 110v, \$10 ea
use 2 in series or 260 to 110v transformer - \$7.99

\$10
WERE \$12
100,000uF 16vW ELECTROS
New Siemens \$9 EA
DPDT MINI 10+ SLIDE SWITCH DE-LUXE BATTIN CHROME \$20

SAVE OVER \$4 SOLAR PANEL
WITH REFLECTORS
R.R.P. \$24.50
3v, 6v, 9v 50mA out
Size 104x144x10mm without reflectors!

UNIVERSAL CABLE KIT
Suit Car Stereo, CB cables etc.
5 PIN with fuseholder
\$1.95
Interchangeable pins, colour coded leads, with instructions
PANEL SOCKET 90c

*** Power Transformers**
Input- 200 to 250v in 10v steps.
Output- 110v
2A Cont. rating 4A Intermittent.
\$19

SOCKET SPECIAL
14 PIN 16 PIN
5 for \$1 4 for \$1

DE-SOLDERING WICK
1m
WAS \$2.25
SAVE \$1
\$1.25
5 METRES ONLY
5m Speaker Cable
COLOUR-CODED!

MAD MAL

PRE-PAK electronics
P.O. Box 43, CROYDON 2132
1a West St, Lewisham, N. S.W.
Ph: 569-9797 P/POST 10% GROSS VALUE

OPEN FOR BUSINESS

WE HAVE MOVED
1a WEST ST LEWISHAM
N.S.W. PH: 569-9797

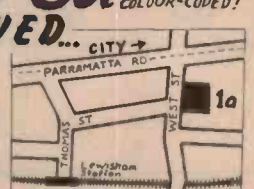

MANUFACTURER'S PAVILION

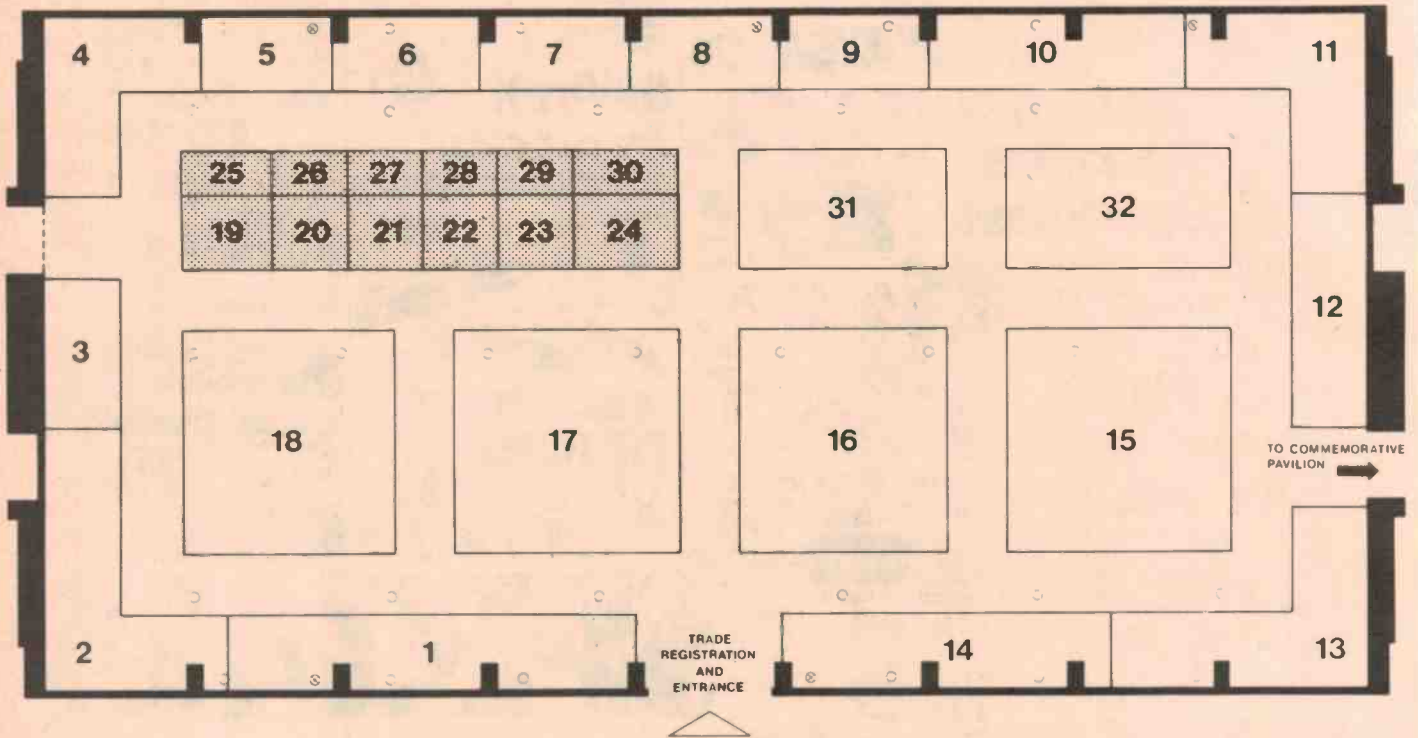

AMP PAVILION

GROUND FLOOR

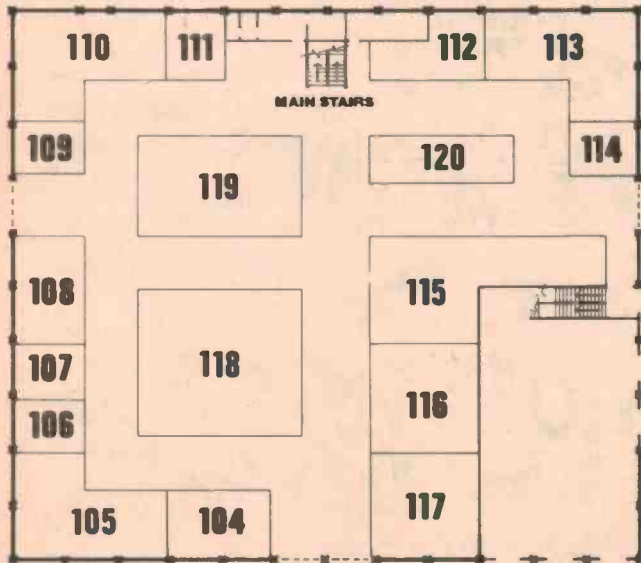

FIRST FLOOR

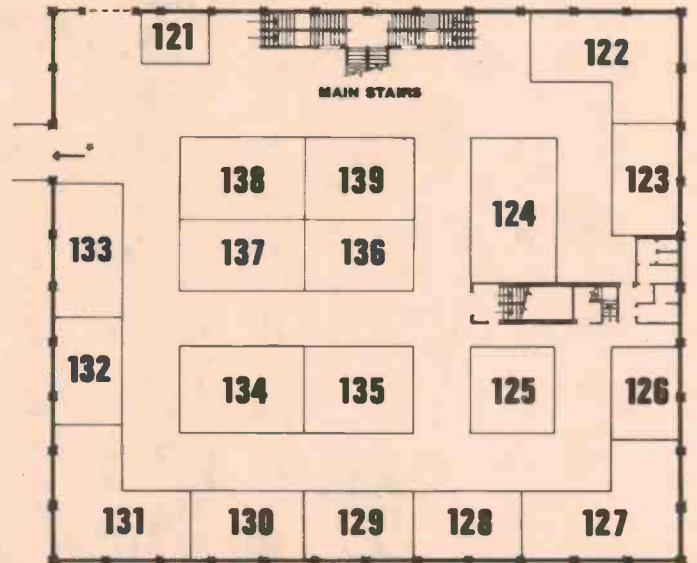

COMMEMORATIVE PAVILION

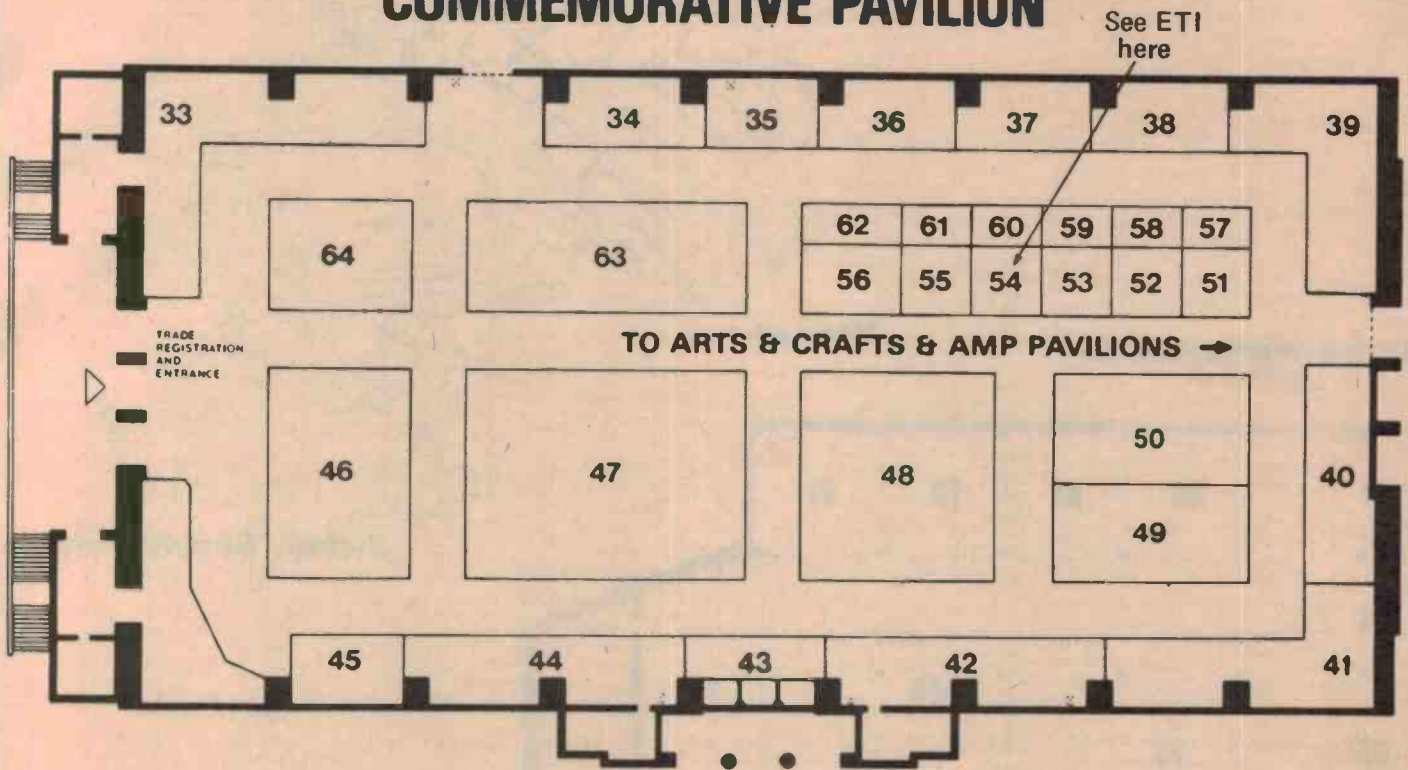

ARTS & CRAFTS PAVILION

FIRST FLOOR

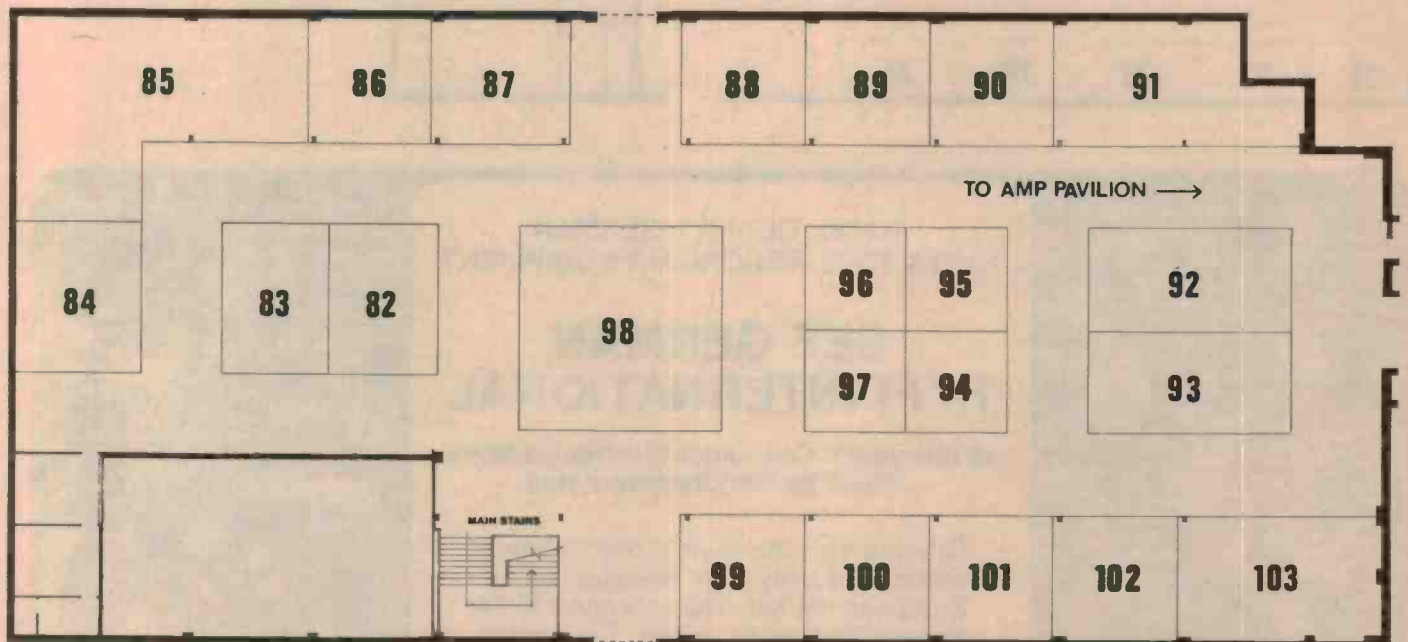

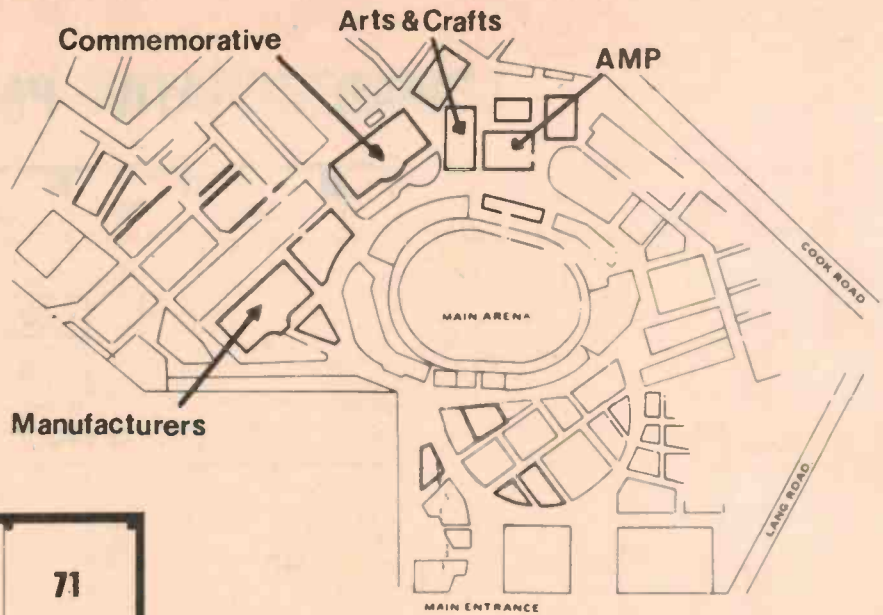

ARTS & CRAFTS PAVILION
GROUND FLOOR



Sydney Showgrounds

The Kortling Mini Tower on castors. Clean, modern design to match your European or Scandinavian decor. 2 x 50 W



Available from:
German Hi Fi International Pty. Ltd., 5 McLaren Street, North Sydney, NSW 2060. Phone: 92-4177.

TOTAL QUALITY GERMAN
HI FI & TAPE RECORDING EQUIPMENT

**SEE GERMAN
HI FI INTERNATIONAL**

at this year's Consumer Electronics Show,
Stand 25 Manufacturers Hall

Offering you this year a new range of equipment only just released on the European market. The very latest in FM Tuners, Receivers, Amps, Loudspeakers etc. from

UHER, KORTING, ELAC, HECO, WHD, ISOPHON

The Uher Hi Fi Miniset. Smallest and most powerful in the world market. 2 x 65 W.



Sole Australian
Importer and Distributors:
ATRAM ELECTRONICS, 5 McLaren Street, North Sydney, NSW 2060. Phone: 92-4178.

Exhibitors

CES

ACCESS COMMUNICATIONS

147 Sailors Bay Road, Northbridge, 2063
Stand 98

ACOUSTIC RESEARCH AUSTRALIA

7 Ford Street, Greenacre, 2180
Stand 3

AIWA AUSTRALIA PTY LTD

14 Gertrude Street, Arncliffe, 2205
Stand 13

AKAI MARKETING SERVICES AUST. PTY LTD

P.O. Box 309, North Ryde, 2113
Stands 24, 30 & 31

ATRAM ELECTRONICS and GERMAN HI FI INTERNATIONAL P/L

5 McLaren Street, North Sydney, 2060
Stand 25

AUDIO ENGINEERS PTY LTD

342-344 Kent Street, Sydney, 2000
Stand 44

BOSE AUSTRALIA INCORPORATED

11 Muriel Avenue, Rydalmere, 2116
Stands 136, 137, 138 & 139

BREWO ELECTRONICS

104 Bathurst Street, Sydney 2000
Stand 56

BROTHER INDUSTRIES (AUST.) PTY LTD

49 Herbert Street, Artamon, 2064
Stand 92

CARGUARD INTERNATIONAL

77 Military Road, Dover Heights, 2030
Stand 60

CELESTION INTERNATIONAL (M & G HOSKINS PTY LTD)

268 Princes Highway, Arncliffe, 2205
Stand 34

COMMUNICATIONS POWER PTY LTD

P.O. Box 246, Double Bay, 2028
Stands 51 & 57

COMPUTERLAND AUSTRALIA PTY LTD

55 Clarence Street, Sydney, 2000
Stands 74 & 75

COMPUTER PHONES PTY LTD

22 Wattle Road, Brookvale, 2100
Stand 6

CONVOY INTERNATIONAL PTY LTD

4 Dowling Street, Woolloomooloo, 2011
Stand 45

R.H. CUNNINGHAM PTY LTD

493 Victoria Street, West Melbourne, 3003
Stand 5

EXPO INTERNATIONAL TRADING P/L

P.O. Box 272, St Marys, 2760
Stand 14

HAGEMEYER (AUSTRALASIA) B.V.

Unit C, 25-27 Paul Street, North Ryde, 2113
Stand 32

HANIMEX PTY LTD

108 Old Pittwater Road, Brookvale, 2100
Stand 52

HARMAN AUSTRALIA PTY LTD

P.O. Box 6, Brookvale, 2100
Stand 42

HITACHI SALES AUST. PTY LTD

153 Keys Road, Moorabbin, 3189
Stands 63 & 64

HOME VIDEO SALES

2 Guilfoyle Avenue, Double Bay, 2028
Stand 7

K.C. ELECTRONICS PTY LTD

239 Scenic Drive, Merewether, 2291
Stand 109

KRIESLER ELECTRONICS

12-30 Cawarra Road, Carlingbah, 2229
Stand 39

MARANTZ AUSTRALIA PTY LTD

32 Cross Street, Brookvale, 2067
Stand 18

MONIER CONSUMER PRODUCTS

Cnr Ferndell & Everley Sts, Granville, 2142
Stand 36

PAN MARKETING

11 Hay Street, Vaucluse, 2030
Stand 88

PHILIPS CONSUMER PRODUCTS

1092 Centre Road, Clayton, 3168
Stands 46 & 47

PIONEER ELECTRONICS AUSTRALIA P/L

178 Boundary Road, Braeside, 3195
Stands 49 & 50

PROFESSIONAL ACOUSTICS PTY LTD

268 Princes Highway, Arncliffe, 2205
Stand 35

RANK INDUSTRIES AUSTRALIA PTY LTD

P.O. Box 632, Chatswood, 2067
Stands 15 & 16

ROSE MUSIC PTY LTD

17-33 Market Street, South Melbourne, 3205
Stands 11 & 12

SANYO AUSTRALIA PTY LTD

225 Miller Street, North Sydney, 2060
Stands 1 & 17

SUNBEAM CORPORATION LTD

Wade Street, Campsie, 2194
Stand 48

TANDY CORPORATION

280-316 Victoria Road, Rydalmere, 2116
Stand 37

TDK (AUSTRALIA) PTY LTD

4 Dowling Street, Woolloomooloo, 2011
Stand 40

TEXAS INSTRUMENTS AUST. LTD

9 Byfield Street, North Ryde, 2113
Stand 8

TRIO-KENWOOD (AUSTRALIA) PTY LTD

P.O. Box 425, Artamon, 2064
Stands 24 & 30

ULTRAPHONE

Suite 7, 1st Floor, Centrepont, Sydney, 2000
Stand 53

VAN FI (AUST.) PTY LTD

162 ASlibert Road, South Melbourne, 3205
Stand 33

VIDEO PROGRAMMES INTERNATIONAL P/L

Level 4, 140 Arthur Street, North Sydney, 2060
Stand 62

VOXSON (AUSTRALIA)

109-113 Keilor Road, Essendon, 3041
Stand 41

SEE ETI — STAND 54



What kind of man owns his own computer?

Rather revolutionary, the idea of owning your own computer? Not if your time means money. Because an Apple personal computer can help you make more of it.

Just like big computers, Apple manages data, crunches numbers, keeps records, processes information and prints reports. And it has three programming

languages, including Pascal.

Not only that, Apple is less expensive than timesharing. More dependable than distributed processing. Far more flexible than centralized EDP. And, at less than \$2500 (as shown), downright affordable.

Why not join the personal computer revolution by visiting us today?



YOUR NEAREST 'COMPUTERLAND' STORE

SYDNEY:	Ground Floor, 55 Clarence St, Telephone 29 3753
MELBOURNE:	555 Collins St, Telephone 62 5581
BRISBANE:	127 Creek St, Telephone 221 9777
ADELAIDE:	131 Pirie St, Telephone 223 5083
PERTH:	City Mutual Place, 197 St. Georges Trc. Telephone 321 4671

OR SPECIALLY APPOINTED DEALERS
See us on Stands 74 and 75 at the CES.

REVOX B795 Turntable.

The tonearm that isn't.



Touch button operation and Linatrack tangential tonearm mean scratch-free records for years to come.

The traditional tone arm has been replaced. By Linatrack. A revolutionary tracking system developed by Revox.

This sophisticated and highly refined electronic servo-system ensures that your records are played just the way they were cut, with perfect tangential tracking.

We've eliminated the causes of distortion inherent in conventional tone arm design. There's no need for an anti-skating device because there is no skating force. Our unique LED/photo diode array monitors the stylus angle and makes instant corrections to keep the tip absolutely perpendicular.

Pivot friction has also been dramatically reduced by our unique single-point jewelled pivot/magnetic support and suspension system.

With Linatrack, tracking error is reduced to a phenomenal 0.5 degree or less, virtually eliminating distortion and protecting your records from excessive wear.

The high torque direct drive motor of the Revox B795 uses Hall-Effect magnetic sensors tied to a quartz crystal to

constantly read and instantly correct rotational speed. This eliminates the moment-to-moment deviations found on even the most expensive conventional direct drive motors.

Even with its advanced features, the Revox B795 is a pleasure to operate with safe and convenient automation. It works with virtually every cartridge and is ruggedly built to stand up to years of daily operation.

SYNTEC

INTERNATIONAL PTY LTD

53 Victoria Ave, Chatswood NSW 2067. (02) 406-4557.

VIC (03) 419-4644
QLD (07) 268-6082

SA (08) 278-6888
WA (09) 325-7811

STAGE & EFFECTS LIGHTING

ALL YOUR REQUIREMENTS AUSTRALIA WIDE

FINDING IT HARD TO KEEP UP WITH US?

THESE ARE JUST SOME OF OUR MOST RECENT NEW PRODUCTS!

FROM CEITEX:

8 Channel Memory Chaser



The ultimate lighting controller. 8 channels, 8 functions, re-programmable! Accepts any input voltage from 24V, perfect for Pin Spots, Tubelite — or up to 20 amps/240V output for big systems! Add on up to 10 slave units. Sensational.

ROCK INDUSTRIES:

POLE FOCUS SYSTEM



NEW
NOW
FITTED
TO ALL NEW
● PAR 56
● PAR 64
● ROCKBEAM
LANTERNS!

With new Rock Industries Pole Focus System simple pole adjustments can be made from ground or stage level. No more ladders! Conversion kits and poles available now.

TUBELITE

This amazing 24V lighting tube can be run in, over, under or around almost anything! Great for architecture or even in the pool! 25,000 hour lamps mean no maintenance — drive Tubelite from a single transformer or the 3 channel version from a Flowbox or Snake Chaser.

FLOWBOX

The budget controller for Snakelite and Tubelite. Perfect for window displays, discos, promotions, anywhere high impact lighting is needed! Snakelites need NOT be plugged into a Snakelite Audio Chaser — The Flowbox Basic 24V Chaser is here!

CHASER FOUR



- 4 channel Audio Chaser and Colour Organ.
- Accepts mic or speaker input (selectable).
- Will drive inductive loads (Pin Spots etc).

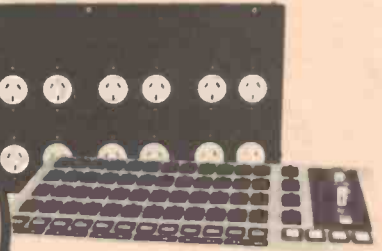

The Remote Switchboard that's taking Australia by storm! Now there's no need for an expensive dimmer system, the Access Remote Switchboard offers amazing versatility.

STROBE PULSER

- 4 channel Rain-box Strobe Controller.
- Built-in mic for audio chaser!
- Can be used with up to 32 strobes.

PAR 36 PINSPOT SPECIAL!

We have packaged 4 systems of "Solo" Par 36 lamphousings & transformers — and you save heaps! The Solo is our basic, Par 36 Lamphousing. Up to 8 Solos may be driven from 1 transformer — offering normally large savings compared to Hotspots — now we have slashed prices, and whole Solo Systems are cheap! Get it while it lasts! (*Offer limited to first 6,000 Solos)

SAVE UP TO 20%

SYDNEY: Ceitex 2/33 College St, Gladesville (02) 896-2900
WOLLONGONG: Trilogy Electronics 40 Princes Hwy, Fairy Meadow (042) 83-1219

NEWCASTLE: Your Move Lighting 37a Beaumont St, Hamilton (043) 69-3560

BRISBANE: Harvey Theatrical Lighting 21 Crosby Rd, Albion (07) 262-4622

BRISBANE: Mothers Lightworks 624 Brunswick St, New Farm (07) 358-2210

GOLD COAST: Rave Audio Visual 2388 Gold Coast Hwy, Mermaid Beach (075) 38-3331

MELBOURNE: Clearlight Shows 17 Alex Ave, Moorabbin (03) 553-1446

MELBOURNE: Lighting Corporation 131 Brighton St, Richmond (03) 429-5122

ADELAIDE: Hiwatt Lighting 37 Angus St, Nth Adelaide 5006 (08) 212-2033

ADELAIDE: Optical Acoustics 22 Finnis St, Nth Adelaide 5006 (08) 267-2049

ACT: Topstage Productions 12/4 Ipswich St, Fyshwick ACT 2609 (082) 80-6940

PERTH: Kosmic Sound 1074 Albany Hwy, Bentley (09) 361-8981

HOBART: Good Oil Sound 310 Liverpool St, Hobart (002) 23-5151

Also available Australia-wide at Strand/Rank Electronic outlets.

DISTRIBUTED
NATIONALLY BY

BARRATT LIGHTING

PTY
LTD

140 MYRTLE STREET,
CHIPPENDALE NSW 2008.

PHONE (02) 699-7963.
TELEX AA25298.



OSOUND

NEWS:	● PERIPHONIC SOUND DEMO.	118
REVIEWS:	● OPTONICA RT7100 CASSETTE DECK	132
	● AUDAX KIT 51 LOUDSPEAKERS	144

With our tapes we've reached a new high.

At Hitachi we aim for pure, distortion-free sound, not only in our Hi-Fi components but in the recording medium itself. Our UD-ER and UD-EX tapes prove it. We've literally reached a new high in recording superiority with these two tapes. The reason lies in the use of a unique surface coating developed by us. This EPITAXIAL coating is applied to the tape in one uniform application. It consists of gamma-hematite for high sensitivity in the low and mid frequency ranges, and cobalt-ferrite for the same characteristics in the high frequency ranges.

UD-EX is a ferric oxide tape specially formulated for use with the tape selector switch in the chrome position (70 microsecond equalization and high-level bias). It offers the low noise advantages of chrome without the disadvantages.

Its performance characteristics include extremely low modulation noise; an improvement in sensitivity by 2 dB or more over most chrome tape; and a 5 dB signal-to-noise ratio improvement over ordinary premium tapes.

UD-ER is a ferric oxide tape designed for

use with the tape selector switch in the normal position (120 microsecond equalization and standard bias).

It offers an unbelievably low harmonic distortion level.

It also improves sensitivity by 2.5 dB over the entire frequency range when compared to conventional low noise tapes.

The maximum output level is improved by 5.5 dB.

Both cassette tapes feature super precision shells to ensure outstanding head azimuth, accurate tracking position and the smoothest possible tape travel without jamming.

Our UD-EX and UD-ER tapes are a real breakthrough in cassette recording. And like everything we make at Hitachi they are manufactured with uncompromising quality. Try our tapes now. Your sound equipment will reach a new high too.

 **HITACHI**

With Hitachi tape there's no room for compromise.

UD-ER MOL/Frequency Response/Noise Spectrum

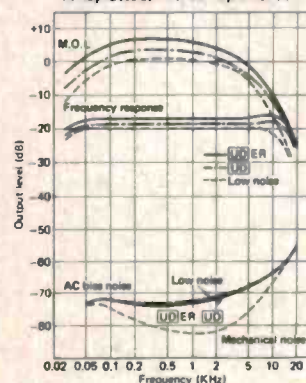

UD-EX MOL/Frequency Response/Noise Spectrum

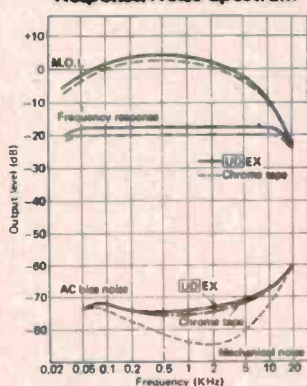

"ULTRA DYNAMIC" is a registered trademark of Hitachi Limited (A 273,012)

Color your thinking with CompuColor 11



- Color Graphics Display
- Tutorial Software
- Financial Software
- Computer Games
- Personal Data Base
- Fortran, Basic, Assembler
- Text Editor, Utilities

The Renaissance Machine is a "one-of-a-kind" system for the "one-of-a-kind" person who demands, and will not settle for anything less than, the best.

The color machine with the black and white price

Available from

ANDERSON DIGITAL EQUIPMENT PTY. LTD.

MELBOURNE: 1 Expo Court, Mt. Waverley, (03) 543-2077.

SYDNEY: 9 Pioneer Ave, Thornleigh. PO Box 341, Thornleigh, NSW 2120. (02) 848-8533.

Your local dealer:

Melbourne: Logic Shop (03) 51-1950. Sydney: Logic Shop (02) 699-4910.

Newcastle: DGE Systems Pty Ltd (049) 69-1625. Canberra: ADE (062) 58-1811.

Brisbane: ADE (07) 59-6436. Adelaide: Applied Data Control Pty Ltd (08) 79-9211.

Perth: WJ Moncreff Pty Ltd (09) 325-5722. Hobart: Management Technology (002) 34-4522.

Darwin: Direct TV and Electronic Services (089) 81-9313.

NEW ZEALAND:

Wellington: ADE 64-4585. Auckland: ADE 87-6570. Christchurch: ADE 79-0210.

NEW GUINEA: Komputel Systems 42-3924.



DEALER ENQUIRIES
WELCOME

“Periphonic sound” demonstrated publicly

A ‘periphonic sound’ system, which permits reproduction of recorded sound in three dimensions, was publicly demonstrated at the UK Audio Engineering Society’s Convention in London a few months back.

Britain’s National Research and Development Council sponsored the development of the system by Ambisonic, who will continue with further development.

The system was dreamed up back in 1970 by Michael Gerzon, a mathematical researcher at Oxford University. He was experimenting with “tetrahedral recording” using four, almost coincident microphones angled for spherical sound pickup, with playback over four loudspeakers arranged in a tetrahedral array.

It was discovered that there was actually redundancy in the system and that the minimum number of non-redundant channels was three. Gerzon got a system working, not perfectly, but in 1972 he said, “Those who have had the opportunity of hearing periphony at its best can have no doubt that the height effect is important in the reproduction of sound and in the enjoyment of music.”

It’s taken Gerzon a decade to develop a system to the stage where he could confidently give public demonstrations. Until now, only ambisonic equipment, which provides ‘horizontal’ (or two-dimensional) surround sound has been available, although the general theory of the system is just as applicable to the third dimension of height.

Whilst the market place may not yet be ready for six or eight loudspeaker sound systems interest in periphony is steadily

increasing. The development of the periphonic or soundfield microphone was a necessary condition for this.

Many recording engineers are now aware that together with its signal processing circuitry it offers mono, stereo and two and three-channel horizontal surround, as well as periphonic options, at the touch of a few control knobs. And this at a time when digital systems are promising the audio world access to a greater number of high quality audio channels.

Progress in periphony, and in periphonic decoder design in particular, became possible due to the development of a fairly comprehensive theory of the psychoacoustics of directional reproduction which helped to unravel just why periphony didn’t work perfectly the first time. Equipment design is greatly simplified and subjective results readily optimised using the results of this work, some aspects of which were summarised in a lecture by Michael Gerzon at the convention.

Requirements for accurate periphonic sound, according to the two main theories are neatly summed up in Gerzon’s diametric decoder theorem, which says that

- (a) all loudspeakers must be the same distance from the centre
- (b) speakers must be diametrically opposite pairs
- (c) the sum of two signals fed to a pair must be the same for all pairs

(Gerzon has also shown that such layouts can be fed by $p + 1$ channels, where ‘p’ is the number of speaker pairs, so four speakers need three channels, six speakers need four channels.)

One of the most convenient speaker arrays that meets these requirements is a birectangular type because it also provides conventional stereo speaker placement. Speakers are at the corners of two rectangles, one horizontal, one vertical.

This was the arrangement

used in the recent AES demonstration which produced what was reported as “a satisfying result”.

The demonstrators explain that what is lost in image precision is gained in stability. “Full sphere” sound was judged to be ‘distinctly more satisfying’ than that from a horizontal rectangle of speakers.

But will it go the way of other ‘surround sound’ systems?

A statistical assessment comparing stereo and multi-channel horizontal surround sound systems carried out by NHK some years back, showed that the square speaker array of the quad system had a rating of +0.9, +0.5 and +0.3 for non-experts, audio enthusiasts and acoustic engineers respectively, where a rating of 1.0 meant “slightly better” than conventional stereo.

No wonder quad bombed.

From the results of the first public showing of periphonic sound, it seems to offer something beyond conventional stereo... at long last.

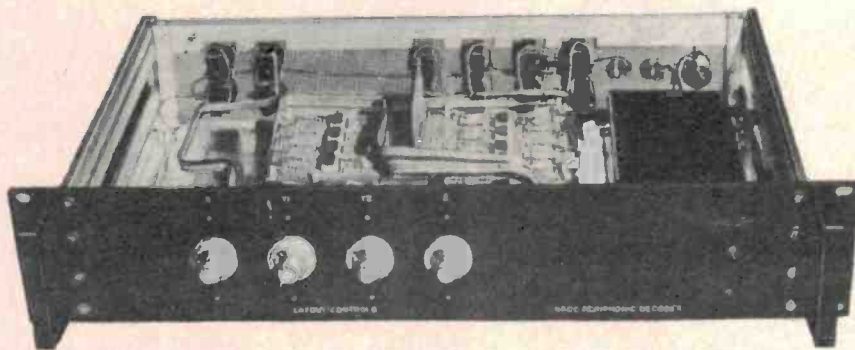

The periphonic decoder produced by Ambisonic for Britain’s NRDC — used in the public demonstrations at the UK Audio Engineering Society’s Convention.

Noisy car sound system?

The most annoying problem that arises when one installs a good quality sound system in a vehicle is that of spurious noises coming from the car's electrical system.

Noise from the ignition, the battery charge regulator and other equipment is the culprit.

Unlikely though it may seem, most often this is conducted up the sound system's power cable, and as the dc supply has quite a low impedance, conventional filtering schemes often fail.



The most effective remedy devised to date is to insert a "toroidal filter inductor" in series with the main power lead.

Result: noise vanishes! However, as Murphy's law would have it, such beasts are often hard to obtain.

Leading US car sound system manufacturer, Fosgate, tackled the problem and have come up with their Noise Suppression Choke, model FA-505. They are marketed here through the Fosgate agents, CPI (Australia) Pty Ltd. Details on where to lay your hands on them can be obtained from CPI at P.O. Box 246, Double Bay NSW



Compressor-expander

New to the range of Audio Reflex products is the CE431 Compressor-Expander.

A 20 dB dynamic range improvement is something which, once heard, changes almost everyone's attitudes to the real potential of noise reduction while taping.

The CE431 features a stepped control on both compression and expansion. The precision of these settings allows an exact duplication of the compression-expansion ratios, difficult with variable control.

Another useful feature is the provision of individual input level controls and meters which

allow proper input matching to get optimum results from the unit.

Signal to noise ratio is specified as 66 dB and distortion figures in the expansion mode are given as 0.12%.

This unit has been designed to match the styling of most stereo componentry and would be at home in most systems. Recommended retail is \$299.

Available from Audio Reflex (Australia) Pty Ltd, 7 Orchard Road, Brookvale NSW 2100. (02) 938-4188.



Graphic equaliser in car stereo

Ferris Audio Products has launched a new car stereo/radio that incorporates a graphic equaliser yet takes up no more space than a conventional car cassette.

The Ferris JMPA-5020 is an in-dash AM/FM/stereo cassette tape player with an output of six watts per channel. Ferris say it is capable of 20 watts per channel with the graphic equaliser switched in.

It will retail for just under \$200.

The graphic equaliser allows the bass and treble to be altered by plus/minus 12db in five

bands from 60 Hz to 10 kHz, say Ferris.

Special features of the Ferris JMPA-5020 are FM muting, an equaliser by-pass switch, auto stop and lock-in fast forward on the cassette section plus balance and fader controls.

Ferris recommended a tri-axial (three way) speaker system for the JMPA-5020.



Sanyo cassette decks

Sanyo has two new Dolby tape decks, models RD5030 and RD5008.

Both have dc motors with electronic control for low wow and flutter — quoted as 0.08% for the RD5030, and for the RD5008, less than 0.1% WRMS.

Using Dolby, the RD5030's signal to noise ratio is given as 62 dB, 54 dB without Dolby.

Both units have ac erase and bias, and fast forward and rewind each take 90 seconds for a C60 tape. Frequency response in the RD5030 is specified as 30 Hz to 16 kHz (FeCr and CrO2) and 30 Hz to 13 kHz normal tape.

The RD5008 gives a response of 30 Hz to 14 kHz on

CrO2 and 30 Hz to 10 kHz on normal tape, say Sanyo.

The RD5030 has a super-hard permalloy head, and the RD5008 features instant read-out LED VU meters replacing conventional needle types and a permalloy head. Both have demonstration tapes and patch cords among their accessories.

Recommended retail prices are: RD5030 — \$189.00, RD5008 — \$165.00.

Further details from Sanyo Australia Pty Ltd, 225 Miller Street, North Sydney, NSW 2060. (02) 436-1122.

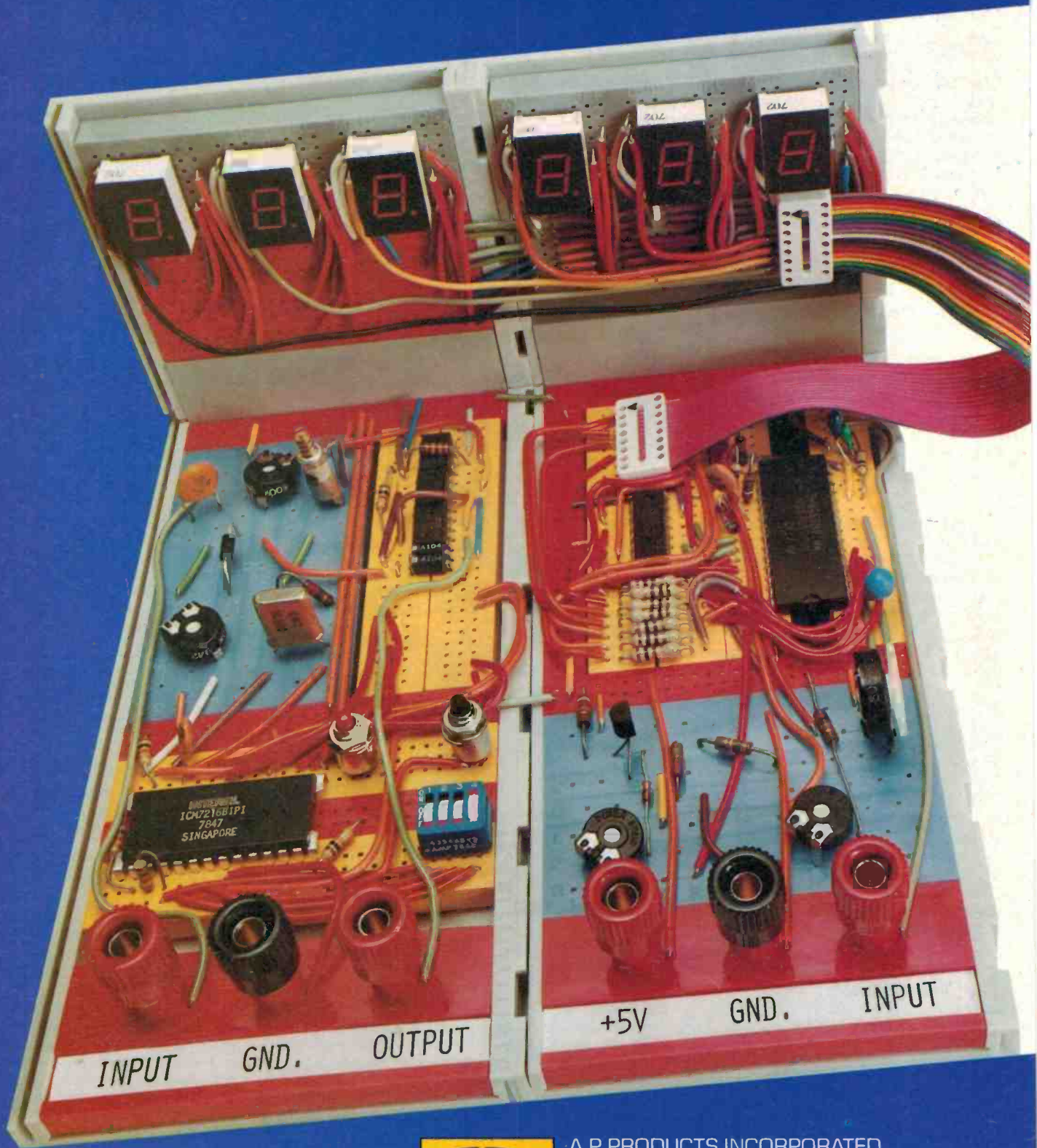

A P PRODUCTS INCORPORATED
1359 West Jackson Street
Painesville, Ohio 44077
(216) 354-2101

INTRODUCING THE NEW HOBBY-BLOX™ SYSTEM.

HOBBY-BLOX™. The new modular circuit building system designed especially for electronic hobbyists.

Until now, hobbyists had to buy "professional" solderless breadboards for their projects and pay "professional" prices. But now there's Hobby-Blox™ a brand new solderless breadboarding system that's not only economically priced but offers far more advantages to the hobbyist.

At the core of the system are two starter packs, one for discrete component projects, the other for integrated circuit projects. Each comes with a number of Hobby-Blox system modules that fit into a tray and an illustrated project booklet which shows you step-by-step how to build ten projects with the existing modules of each pack.

You can add modules at any time to build new projects or expand on existing ones. The Hobby-Blox system includes 14 separate module packs that can be purchased individually.

Modules include Tray, Terminal Strip Pack, Distribution Strips, Bus Strip, 3 x 16 Terminal Strip, Discrete Component Strip, L.E.D. Strip, Vertical Tray Pack, Speaker Panel Pack, Control Panel Pack, Blank

Panel Pack, Battery Holder Pack, Binding Post Strip, Tray Extender Clips.

All modules are color-keyed and letter-number indexed to make circuit building even easier.

The Hobby-Blox system is compatible with DIPs of all sizes and a wide variety of discrete components. Simply plug in your components and interconnect with hookup wire. No soldering, and all components can be used again and again.

How far can you go with the Hobby-Blox system? Take a look at the example on the page to the left and see for yourself. Then you'll know why we say, "with Hobby-Blox, your only limit is your imagination!"



Patents Pending
©A P PRODUCTS
INCORPORATED 1980

For a free catalog, contact your local HOBBY-BLOX™ dealer:

N.E.T. PTY. LTD.
92 Woodfield Boulevard
Caringbah, N.S.W. 2229
TEL: 525-6090

RIFA PTY. LTD.
P.O. Box 485
Cross House, 2 Cross Street
Hurstville, N.S.W. 2220
TEL: 570-8122

RIFA PTY. LTD.
P.O. Box 95
202 Bell Street
Preston, Victoria 3072
TEL: [03] 480-1211

OPTONICA

revolutionise Hi Fi with ultra-slim advanced digital technology

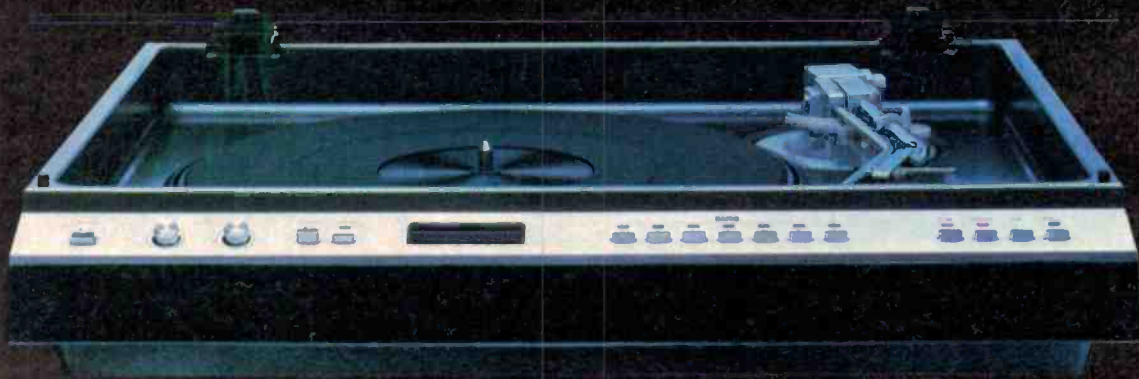

SHARP revolutionise Hi-Fi with new ultra-slim OPTONICA.
Performance is smoother, components are slimmer.



Micro-computer for smoother performance and sophisticated operation.
The sweet sounds of success are now slimmer, sleeker, smoother.

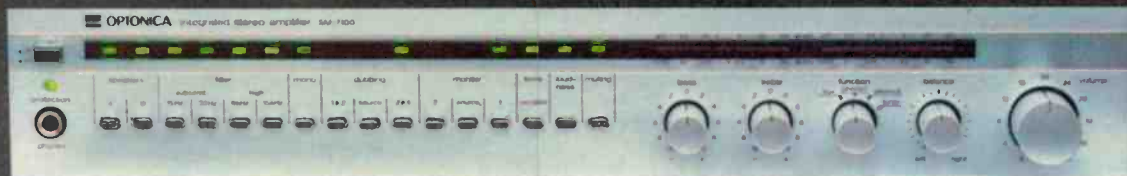

Greater sound from brilliant compact Optonica's
Toroidal power transformer within these new slim amplifiers.

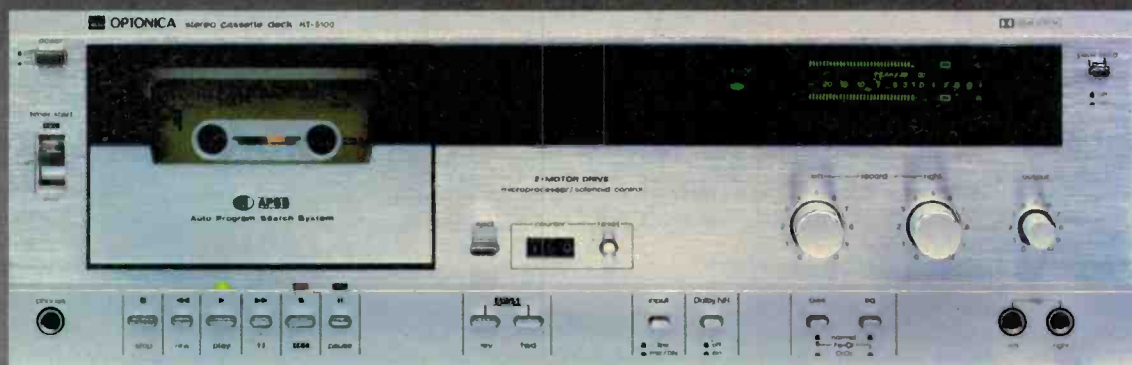

Advanced digital technology brings this major innovative breakthrough - and Sharp leads the way.

Think Slim, Think Sharp, Think Optonica

OPTONICA by SHARP

For technical specifications, brochures and your nearest Optonica retailer, please write to:
Sharp Corporation of Australia, 64 Seville Street, Fairfield, N.S.W. Phone 02 728-9111

SHA82E

It's systems for the 80s

Just about every major manufacturer of hi-fi equipment is offering a variety of complete systems in their model range this year, a trend we saw starting to emerge barely 12 months ago.

The systems include everything from the cartridge to the loudspeakers — even cabinets to match! The concept is aimed at the mass market, home furnishings purchaser, in particular that sector often identified as the "female market" — It seems women these days represent a strong group involved in purchasing sound equipment for the home.

It seems the practice of 'mixing and matching' — buying one type of amplifier and a different cassette deck, a particular turntable but an arm and

280 mm across and only 65 mm high, or thereabouts.

Teamed with it is a stereo preamp/control unit, the UC-A5, and FM/AM quartz-synthesised tuner, the UC-S5, and you can add an optional infra-red remote control unit — all having the same dimensions. The UC-F5 cassette deck does not skimp on features while skimping on the space it occupies. It measures 280 mm wide and stands around 160 mm tall.

A pair of two-way mini speakers having matching styling go with the system,



The remarkable SL-10 tangential tracking turntable dominates Technics' Concise Components system built around the SU-C03 40 W/channel integrated stereo amp.

cartridge of differing makes etc — is becoming more and more the province of the 'buff', though they still represent a large market force.

Systems are generally assembled and priced to appeal to a defined market level or area. "Mini systems" have proliferated of late — tiny, but nonetheless high performance, components designed for those with a premium on space. Aiwa were an early contender in this market, now followed by Technics and Akai.

Akai's UC-5 mini components system has a 35 W/channel amplifier as its foundation measuring a mere

standing around 320 mm high and taking up only 190 mm of shelf space. There's no two ways about it — that's a truly compact system.

Technics' recently-released "Concise Component" series is a little different to other mini systems being offered. The anchor for this system is their SU-C03 integrated amp rated at 40 W/channel. It measures around 300 mm wide and stands about 100 mm high. Smallest component in the system is the ST-C03 quartz-synthesised AM/FM stereo tuner. It's the same width as the other components but stands just 49 mm high. Featherlight



Akai's UC-5 mini components system, released a few months back, features a 35W/channel amp, stereo preamp/control unit, the latest technology in tuner and cassette deck, plus the option of an infra-red wireless remote control unit.

touch controls are featured along with an eight-channel memory for each band.

The RS-M02 cassette deck will accept metal tapes and features a direct-drive motor plus fluorescent bargraph meters. Another model, the RS-M04, is also offered in this series.

The most interesting component is the remarkable SL-10 phase-locked, direct-drive turntable that features a moving-coil cartridge and built-in head amp and the capability of being operated in any position. The system is topped-off with the SB-F2 two-way, linear phase speaker system.

The long-established three-in-one system, it seems, has seen better days and consumers have become more 'sound quality' and feature conscious and demand true

hi-fi performance from compact systems.

Whilst Akai have opted for just the single line of mini components, Technics have made provision to mix-and-match some of the components in the system, offering alternative tuners and cassette decks.

Naturally, the separate components may be bought individually to suit your own requirements.

In the larger, more conventionally-sized systems, a very wide range is available from nearly all the major manufacturers.

Sanyo's System 2 Hi-Fi Package, for example, consists of their DCA 311 integrated stereo amp (45 W/channel), TP 1012 semi-automatic direct-drive turntable, RD 5250 cassette deck with Dolby nr and

— to page 126. ▶



Technics' "deck 'n receiver" from their Sigma range comprises an integrated cassette deck with FM/AM tuner/amp plus a pair of SB-F2 two-way speakers.

THE NEW ACCUPHASE E303 MOSFET AMPLIFIER



After intensive research and development, Accuphase proudly announce the release of the most advanced amplifier ever to be released in Australia — the new E303 Power MOSFET Integrated Amplifier.

The E303 is the result of many years of amplifier design experience. The E303 fulfills Accuphase's objective to produce an outstanding integrated amplifier with the same high quality performance of high quality separate amplifiers.

The E303 features an exciting new development in Hi-Fi — THE MOSFET POWER OUTPUT DEVICE. The MOSFET will ultimately replace the current transistor and valve designs of today in high quality amplifiers. It has far better sonic qualities than both without the inherent limitations of either.

The Accuphase E303 produces a very conservative 130 watts RMS/channel with less than 0.02% distortion and is designed for optimum performance with any loudspeaker load. Its quality and design are, of course, in keeping with the Accuphase "Grand Prix" award winning tradition.

The advanced specification of the E303 includes a Head-Amplifier with impedance matching facilities so that any moving coil cartridge can be used directly without the need for noisy external transformers or head amps. There is also a versatile tone adjustment system with variable loudness and turnover points.

For the technically inclined, some of the advantages of Accuphase's Power MOSFET are:

- Less active components, minimising phase shift.
- Extremely fast switching characteristics and negative temperature coefficient resulting in far less distortion.
- Less distortion in the extreme high and low frequencies due to an increased power bandwidth.
- Instant switch on efficiency peak. Normal amplifiers take up to fifteen minutes to reach their peak efficiency.

RECOMMENDED PRICE \$1698

**Latest release! Model E203 70 watts a side
Almost identical features and Mosfet
circuits all for \$898**

WEST AUSTRALIA

Alberts, Perth
Vic. Park
Balga, Fremantle.
Leslie Leonards,
Perth.

N.S.W.

Douglas Hi Fi,
430 George Street,
Sydney 233 3922
Allied Hi Fi
330 Pacific Hwy.,
Crows Nest. 439 1072

Authorised Dealers:

QUEENSLAND
John Gipps Stereo,
12 Douglas Street,
Milton 36 0080

TASMANIA
Wills Hi Fi Centre,
11 Quadrant,
Launceston

STH. AUST.

Cheshers Pty. Ltd.
38 Liverpool Street,
Pt. Lincoln 82 1166
For Adelaide Dealer
Phone Arena.

VICTORIA

Douglas Hi Fi
202 Bourke Street,
Melb. 663 2211

arena
DISTRIBUTORS
AUSTRALASIA PTY. LTD.
(09) 361 5422

Accuphase



Only hi-fi, everything hi-fi.

Sansui



The putative straight wire with gain.



The design of all Sansui power amplifier sections mark a straight line toward that ideal of amplification: a straight wire with gain. And now, drawing on its priceless experience as a hi-fi specialist, Sansui presents its R-70 stereo receiver and A-80 integrated amplifier.

DC (direct coupling) circuitry is closest to our ideal of pure amplification. DC power amplifier stages are directly coupled and all capacitors

are eliminated. And Sansui's DC-Servo configuration prevents subsonic signals from reaching your speakers so the music you hear is purer and free from coloration.

Both power amplifier sections feature Sansui's original DC-Servo amplification. When you hear how accurately recorded music is reproduced, you may well wonder how Sansui achieved such an audible miracle.

Advanced technology includes the special microelectronic devices in the FM/AM tuner section of the R-70 and the OCL output of the A-80. Advanced features include LED peak power level displays for both units and a built-in MC pre-amplifier for the A-80.

But the real secret is that Sansui does not make a fetish of advanced technology. Instead, it is the application of that technology continuously

monitored by that sensitive instrument — the human ear — that receives the highest priority. Our dedication, in the final analysis, is to faithful reproduction of the actual musical performance.

- R-70 DC-Servo Receiver:**
65 RMS watts x 2. THD: 0.08%
- A-80 DC-Servo Integrated Amplifier:**
65 RMS watts x 2. THD: 0.05%

SANSUI R-70/A-80

SANSUI ELECTRIC CO., LTD.
14-1 Izumi 2-chome, Suginami-ku, Tokyo 168, Japan
VANFI (AUST.) PTY. LTD.
297, City Road, South Melbourne, Victoria 3205,
Australia Tel: 690-6200
283 Alfred Street, North Sydney, N.S.W. 2060,
Australia Tel: 929-0293

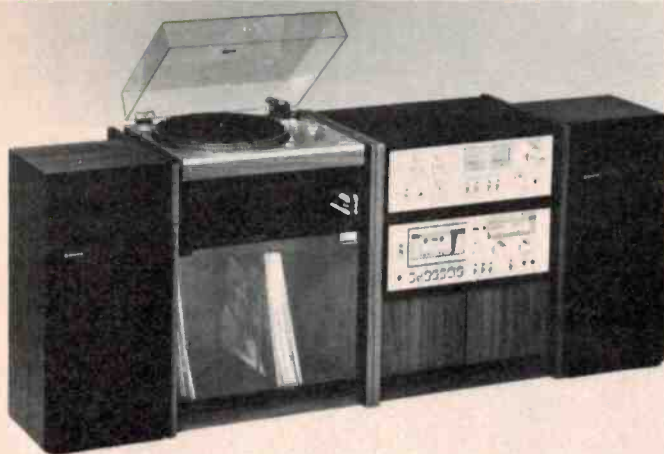

This hi-fi package is Sanyo's System 2, consisting of their DCA 311 integrated amp which puts out 45 W/channel, TP 1012 direct-drive turntable, RD 5250 Dolby cassette deck and JSX 225 linear phase speakers.

JSX 225 two-way linear phase, bass reflex speakers with 200 mm woofers and 60 mm cone tweeters.

The ST 10WB stand supplied with the System 2 may be arranged horizontally or vertically. The System retails for around \$1000.

The Audio Reflex Lab 65 system is in the same price bracket and is comprised of an integrated stereo amp rated at 65 W/channel teamed with a semi-automatic belt-drive turntable and a pair of 380 mm three-way speakers rated at 100 W. These employ 125 mm mid-range drivers and 50 mm cone tweeters. For an extra \$400-odd you can option-up the system to include their EQ1 graphic equaliser and a vertical

cabinet with four shelves and glass front doors.

Audio Reflex's Lab 80 system is another step up. It includes an 80 W/channel integrated amp, cassette deck with Dolby nr, stereo FM/AM tuner, direct-drive turntable, EQ1 graphic equaliser and a pair of SB485 transmission line speakers with 380 mm bass drivers — plus the cabinet. The Lab 80 system retails for around \$1700.

Technics are currently marketing the widest range of systems. They released their "Sigma" series — identifiable by the distinctive Greek symbol of the same name — last March.

There are seven systems in the Sigma range. Smallest is the Sigma-3705 "deck 'n receiver". As the name implies, the

heart — indeed, just about the whole — of this system is an integrated cassette deck-receiver amplifier. The previously-mentioned SB-F2 speakers make up the rest!

Big gun of the range is the Sigma-V4. The line-up includes: the SL-Q3 fully automatic 'front control' direct-drive turntable; the SU-V4 55 W/channel integrated amp featuring "new Class A" power amp design; the SH-8010 graphic equaliser; the ST-S1 tuner; the RS-M24 metal

tape compatible cassette deck with FL metering; the SB-1990 three-way linear phase speaker system and the SH-528 audio rack with glass doors. An impressive line-up, by any standards.

So, it seems 'systems' are the in thing for the 80s, and those described have been just a few examples of the sort of thing available in this area of the market. It's going to be interesting to see how the consumer reacts.



An unusual option you can add to the Audio Reflex Lab 65 system is the EQ1 graphic equaliser — which Audio Reflex offer to set up for you!

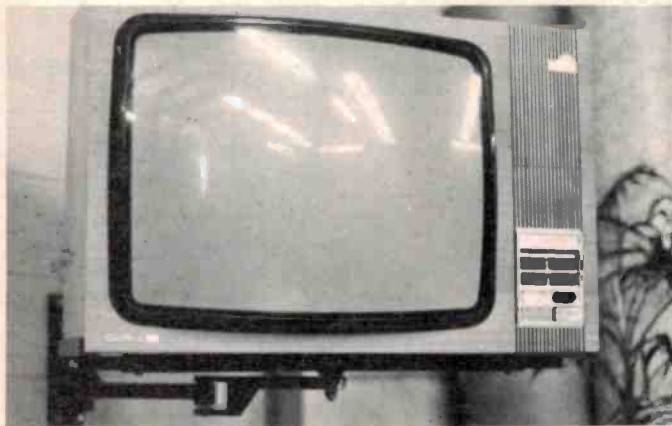

Equipment wall brackets

Don't put it down just anywhere — get it out of the way, like on the wall.

That's the message one gets with a recently released series of brackets designed to carry equipment suitable for wall mounting — which could mean anything, from a television set, to stereo equipment to test equipment perhaps!

Marketed under the name of "Pivotelli", the brackets feature a swivel action permitting the wall-mounted equipment to be

viewed from a convenient angle. The brackets will hold up to 110 kg, according to the literature supplied and are available with horizontal and vertical tilt facilities.

Australian agent for the Pivotelli wall brackets is Associated Steel Equipment P/L, 11 Horscroft Ave, Moorabbin Vic 3189. (03) 95-9921.

Sansui

Only hi-fi, every thing hi-fi.



The warmth of metal.

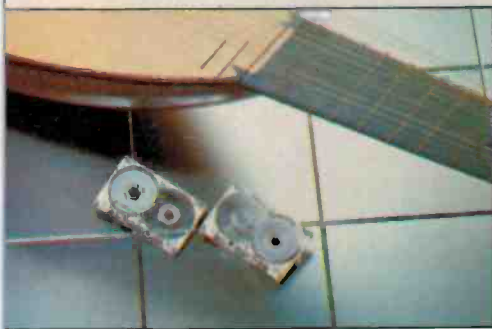

New metal tape promises purer music. But it depends on the tape deck if that promise becomes real.

Pure iron particles explain the superior performance of metal tape. Greatly improved dynamic range, far higher S/N, wider frequency response, and radically reduced distortion mean purer music.

Sansui's new SC-3330 brings that purer music to life. All the subtle nuances of recorded sound, from the

metallic overtones of a piccolo to the warm resonance of an old lute are breathtakingly reproduced.

Particularly critical for smooth Debussy or Fleetwood Mac on metal is Sansui's exclusive FH head (FeAlSi alloy head). Advantages include extra-long life, ultra-high MFD (maximum flux density) to prevent high bias saturation, and a special hyperbolic head. Sansui developed that head shape to minimize the contour effect for a wide-range *Pelléas* or *Tusk*.

Keep in mind, too, that our special head formulation isn't superficial — it's throughout the head, from surface to core. And 200% more erase current means our erase head does a clean job indeed.

Front-loading, two DC motors and feather-touch controls with full logic for a host of automatic functions are other refinements. The

16 LED Bar-Graph Meter makes recording exceptionally accurate. Wow & flutter: 0.04%. Frequency response: 20 — 18kHz (metal). Erasure factor: 70dB. Special features: too many to list. Performance: brilliant.

Sansui's SC-3330: the new deck everyone feels passionate about!

SANSUI SC-3330

SANSUI ELECTRIC CO., LTD.
14-1 Izumi 2-chome, Suginami-ku, Tokyo 168, Japan
VANFI (AUST.) PTY. LTD.
297, City Road, South Melbourne, Victoria 3205,
Australia Tel: 699-5473
283 Alfred Street, North Sydney, N.S.W. 2060,
Australia Tel: 929-0293

YOU CAN'T BEAT THE SYSTEM



Illustrated systems include graphic equalisers, audio timers and metal audio racks – all optional extras.

AKAI's expertise and reputation in quality audio products is now exemplified in a new series of integrated sound systems – the Pro Series.

AKAI Pro Series combine the latest developments in every area. DC Amplifiers with up to 48W per channel minimum output. Turntables with quartz lock direct drive and AKAI's discolith motor. Cassette decks with AKAI'S unique Super GX head and metal tape capable.

FM/AM Tuners with digital display, auto scan and preset facilities. Pre and Power amplifiers, three way speaker systems and optional graphic equalisers and audio tuners head a formidable line up of hi-fi engineering. AKAI Pro-Series – they're the systems you just can't beat.

Akai Marketing Services Australia Pty. Ltd
Unit 11, Eden Park, Waterloo Road, North Ryde, NSW 2113. Tel 887 2311

PRO-601

Separate pre and power amplifier system with 48 watts per channel output. Features a digital synthesiser FM/AM tuner with preset facilities; front loading, metal tape capable cassette deck with AKAI's exclusive Super GX head and auto return, quartz lock, direct drive turntable all matched with a 3 way, 3 speaker system.

PRO-501

Integrated amplifier system with 23 watts per channel output. Features FM/AM tuner; Dolby NR cassette deck and auto return, belt drive turntable all coupled with a 2 way, 2 speaker system.

PRO-502

Integrated amplifier system with 28 watts per channel output. Features FM/AM tuner; metal tape capable cassette deck and auto return, direct drive turntable all coupled with a 2 way, 2 speaker system.

AKAI
YOU'VE NEVER HEARD IT SO GOOD

Only hi-fi, everything hi-fi.

Sansui

Sansui Super Integrated Amplifier AU-X1 ULTRA HIGH SPEED DD/DC

Saturation impossible.

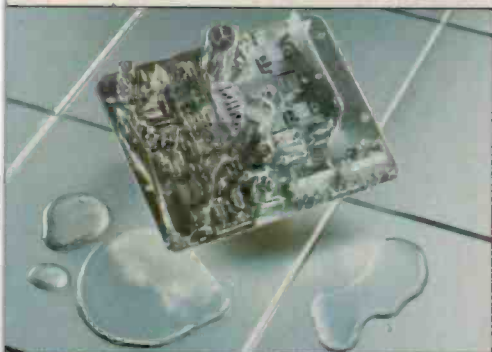

Sansui's AU-X1 is the DC amplifier in which current saturation is impossible. So TIM and envelope distortion are virtually nil. And accurate reproduction of musical signals reaches new levels.

THD and TIM

You're probably aware that THD specs only indicate an amplifier's response to simple steady state signals.

But dynamic musical signals may generate music-smearing TIM.

TIM, transient intermodulation distortion, can be caused by pulsive musical signals which make ordinary amplifiers cry out in distress. And that means distressful music.

Sansui's powerful solution: the DD/DC circuit

The beauty of Sansui's exclusive DD/DC (Diamond Differential DC) circuit is it allows sufficient NFB for an ultra-low THD and — at the same time — stamps out TIM. The secret of DD/DC (PAT. PEND.) is driving power so powerful that current saturation is impossible. Slew rate: $\pm 260V/\mu\text{Sec}$; Rise/fall time: $0.5\mu\text{Sec}$. THD: under 0.007% at full rated 160 RMS watts $\times 2$ output. You hear unprecedented clarity and precision of detail.

Now look closely at the photo. What you thought were bass and treble controls, aren't. They are simply level controls. We admit the AU-X1 integrated amplifier is relatively austere. Because purity in reproducing the most demanding musical signals requires discipline.

SANSUI AU-X1

SANSUI ELECTRIC CO., LTD.

14-1 Izumi 2-chome, Suginami-ku, Tokyo 168, Japan

VANFI (AUST.) PTY. LTD.

162, Albert Road, South Melbourne, Victoria 3205,

Australia Tel: 699-5473

283 Alfred Street, North Sydney, N.S.W. 2060,

Australia Tel: 929-0293

"The sound of the Sixes' was very impressive, it was clear, live and very real."



We played a selection of Jazz pieces and were surprised just how good they sounded. Overall definition was excellent while the stereo image was precise and stable."

Extract from 'Australian HI-FI Stereo Buyers Guide Manual' 1979

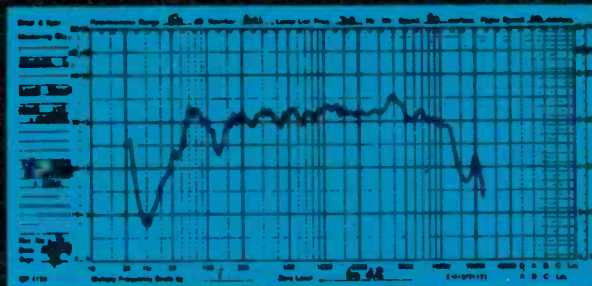

Handles 100 watts RMS per channel.

"the heart of every good stereo system"

MODEL SIX MONITOR
Suggested retail price, \$658 pair.



Peterson SPEAKER LABORATORIES Pty Ltd

4 Walter Street, Moorabbin, 3189. Tel: (03) 553-1055.





Peterson **SPEAKER LABORATORIES Pty Ltd**

Distributors:

Victoria

Dandy Sound

Dandenong

Clive Peters

Ringwood, Mt Waverley,

Dandenong

Northern Electronics

Gaffney Street

Coburg

Paul Phillips

Flinders Street

Flinders Fair, City

Brystan

Ryrie Street, Geelong

Prouds Audio World

100 Mitchell Street

Bendigo

Frank Day & Associates

121 Doveton Street

Nth. Ballarat

John Lewis Audio Division

729 Sturt Street

Nth. Ballarat

Federal Benefit Wireless

Nth. Melbourne

Frankston Sound Centre

Belmoral Centre

Frankston

South Australia

Jim Ryan

2c Eyron Street

Glenelg

Spartan Electronics

Main North East Rd

Campbelltown

Savorys Hi Fi

Kurralt Park

Track Hi Fi

9 Gawler Place

Adelaide

Tasmania

Wills & Co

4 The Quadrant

Launceston

New South Wales

Soundex

(Agent) Ph. 487-2543

Wahroonga

Sydney Hi Fi

83-87 York Street

Sydney

Hi Fi House

268 Keira Street

Wollongong

Queensland

Nth. NSW

Northern Territory

Stereo Supplies

(Agents) Ph. 221-3623

Brisbane



**AMPEX
CASSETTES
SPECIAL READER OFFER!**

AMPEX

360 Professional Series Cassettes

- Low noise/high output
- Wide dynamic range
- Ferrosheen (TM) polished oxide surface
- Superior quality shell and components

HERE IS A UNIQUE OPPORTUNITY to obtain world-famous AMPEX tape cassettes at truly bargain prices.

The AMPEX 360 series are standard tape cassettes but made to professional standards using professional grade materials. They are made specifically for applications in which consistent and reliable performance is as essential as top quality electromagnetic properties. The tapes are of course completely suitable for all general purposes — the main difference between AMPEX 360's and many other tape cassettes is that these are made properly!

Each cassette is packaged in a transparent "Norelco" container. The insert label is reversible, providing space for programme contents and title to be written or typed.

Dindy Marketing has arranged with Ampex for Dindy to offer these tapes to our readers for a limited period of time, and at genuinely bargain prices. Electronics Today International has tested these tapes and supports Ampex's claims for performance and quality.

If demand exceeds Dindy's stock, Ampex has agreed to make further supplies available to Dindy within two weeks notice.

Due to the extreme care taken in manufacture, it is extremely unlikely that any faulty cassettes will be found — in the improbable event that you receive a faulty cassette, Dindy guarantee to replace it (at their discretion) within 30 days.

SPECIAL PRICES

Quantity	1-29	30-99	100+
C45	\$1.49	\$1.41	\$1.34
C60	\$1.69	\$1.61	\$1.56
C90	\$1.99	\$1.89	\$1.84

You may mix quantities of tapes of different lengths to make up an order in the quantity breaks given above to take advantage of the discount available.

AMPEX OFFER

Please make cheques/postal notes payable to 'Ampex Cassette Offer' and send together with this order to Ampex Cassette Offer, Electronics Today International, 15 Boundary St, Rushcutters Bay NSW 2011. This offer is made by Dindy Marketing and this magazine is acting as a clearing house for orders only. We do not stock tapes. ETI will process the orders and pass them to Dindy who will send out the goods by road transport or certified mail. Please allow about four weeks for delivery.

Please supply: Quantity C45 \$
 C60 \$
 C90 \$

Postage (any quantity) \$2.50

TOTAL:

Name

Address

Postcode

The Optonica RT7100 'electronic tape processor'



"... this machine is an obvious must for those who want an exceptional unit with performance to match".

TO CALL the new Optonica RT7100 cassette deck an "electronic tape processor" is most probably nearer the truth than to call it a cassette deck. The last Optonica unit we reviewed was the model TR3535H, for the now demised Hi-Fi Review in 1977. It was conceptually a market leader at that time.

From the outset there could be no denying that this latest unit is far more advanced and offers more frills, flashing lights, digital displays and features than virtually any other cassette deck on the market at the moment. It exemplifies one of the directions towards which the computer and microprocessor revolution is dragging us at the moment.

The unit examined

The frontal appearance of the deck is particularly striking and unusually attractive. The front panel is arranged with three separate and distinct levels of controls with the top level being dominated by a dark, smoked-plastic inset which contains the liquid crystal display for the programming sequences, the digital tape counter, counter memory and next address for the programme memory. These are fully controlled by a microprocessor.

The upper centre section of the fascia is dominated by the cassette well, while the right hand side of the display is dominated by the fluoroscan peak level display covering the range of -23 dB to $+8$ dB. This uses a green bar display for

the levels from -1 dB to -23 dB and red rectangles for 0 dB to $+8$ dB. These displays are flanked on the left hand side by the power switch and on the right hand side by a peak hold selector switch. This holds the highest signal recorded on the fluoroscan display of the previous section of the programme and modulates the display level corresponding to the transient signal level actually occurring at any time. Immediately below this peak hold switch is an auto reset switch which, when activated, maintains the peak hold function for three seconds instead of continuously.

In the central area of controls on the left hand side of the panel is a timer switch which controls an external timer unit for which a DIN socket is provided

on the back panel. Next to this are the APMS controls. These letters stand for "automatic programmable music selector" and consist of an array of controls for activation of control function and the associated directory buttons. The APMS automatic programme music selector is more sci-fi than hi-fi. Utilising an array of 20 push buttons it is possible to programme the microprocessor to do things that no other cassette recorder can currently do. Whilst there are some recorders that do some of the things that this machine does, we don't know of any other that does them all. These controls allow one to locate two three-digit counter numbers and organise the cassette recorder to play from the start of the tape to one of those numbers (either singularly or repetitively) from one of these numbers to another counter number and play (either singularly or repetitively) or from one of those numbers to the end of tape and play (singularly or repetitively). If that were not enough, the microprocessor will allow you to play from any segment of tape which is initiated and finished by a three second gap, to any other segment of tape with up to 15 segments being played sequentially with random orders like 1 3 8 4 7 3, by programming the APMS switch to follow those instructions. Why anybody should want to organise a programme in such a manner remains to be seen, but nonetheless the RT7100 can do so on command. This is simply utilising the power of a computer to perform tasks that cannot normally be performed because the facilities are lacking.

On the left hand side of the deck are the coaxial microphone and line input level controls. On their left are the line output control, two microphone tip and sleeve sockets and an eject button which activates the pneumatically damped cassette well which is located in the centre of the panel.

The bottom row of controls is arranged as a neat linear array with 17 touch switches and a tip-ring-and-sleeve headphone socket providing the following functions. The first grouping

of three buttons are the autoplay, repeat and cue which allow automatic playing or repeating of the automatic programmable music selector functions and automatic stopping after the sequence of preprogrammed commands has been completed. If the repeat button is selected the music will play over and over again, automatically, until the stop key is pressed. The third of these controls, the cue control, allows operation of the automatic programmable music selector at some later time, determined by the external timer, and if the APMS button is pushed after such programme the unit locates the beginning of the memorised programme and stops at that point. Thereafter it is only necessary to press the play button to allow the recorded programme to be played through in the complete sequence. If the unit is already in a search mode then touching the cue button stops the cassette player at the start of the next recorded programme content and it plays until the commencement of the following selection point on the tape.

The next nine controls, all of which have bezel lights immediately above them, are (with three exceptions) conventional and of the type found in most other cassette recorders. These include stop, rewind, play, fast forward, record and pause. The three exceptions are the APSS automatic reverse and forward controls and the auto spacing button. Activation of the APSS reverse button, with the unit either stopped or playing back in the manual mode, triggers the unit into the fast rewind mode. It finds the start of the previous recorded section and then automatically reverses into the playback mode. The APSS forward button with the unit operating in either the manual playback, fast forward, rewind or stop mode automatically triggers the fast forward wind which it follows until the end of the recorded material is detected. At that point the unit starts playing back. If the APSS in the forward mode does not detect recorded content it goes to the end of the cassette and switches off. The third unusual control is the auto

spacing. This provides a blank space segment of about four seconds between recorded sections of the tape. If the four seconds of blank spacing has been inserted, the machine automatically switches itself into the pause mode awaiting the reactivation of the play button before proceeding with the next segment of the recording. The other controls provided on the right hand side of the bottom of the deck, all of which have bezel indicating lights, are the Dolby noise reduction switch, the multiplex filter switch and three mutually exclusive tape selector switches for normal, ferrichrome and chromium dioxide tapes.

The rear panel of the unit contains coaxial line input and line output sockets flanking a DIN socket for combined record/playback, selection of which is sensibly effected by means of a changeover switch located nearby. The unit has a voltage selector indication at the top right hand corner, a twin lead (no earth) mains lead and a synchro connector designed for exclusive use with the Optonica's own external electronic timer.

The inside of the unit is a delight. The circuitry is divided up by printed circuit cards and partially encapsulated into a series of separate modules. These are: respectively, the main power supply transformer at the left hand rear corner, with the microprocessor board immediately in front of it; the power supply and regulator cards, centrally located at the rear of the unit adjacent to the shielded transformer; the tape transport mechanism and part of its equalisation circuitry, located centrally at the front; and the tape record and replay amplifiers located on two boards, one horizontal and one vertical, on the right hand side of the deck. The wiring is carried by means of conventional harnesses making extensive use of plugs and sockets rather than hard wiring to interconnect the various sections. The things that catch one's eye are the clear colour coding and component designation and the extent to which the number of components used is reduced by the use of large scale ▶

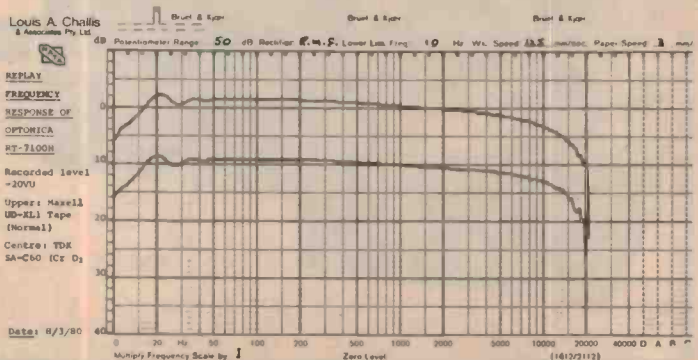
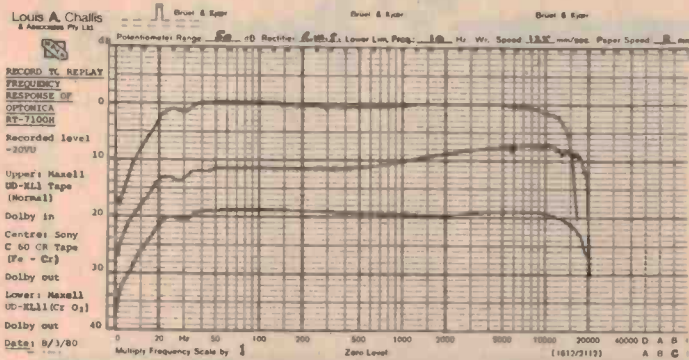

PHILIPS LOUDSPEAKERS

Why spend a fortune on imported loudspeakers?

You can build your own for a fraction of the cost! We stock a wide range of European-made Philips loudspeaker components and matching cross-over networks.

We also have the range of Philips speaker kits and the new Philips/ETI 4000 series loudspeakers, with or without enclosures.

Don't worry about your skills; we will show you how easy they are to construct. For a modest charge we will even assemble them for you!



northpoint hi-fi

100 Miller St, North Sydney. Ph 922-7780.

 **WAGNER** ELECTRONICS
SALES & SERVICE

305 Liverpool Rd, Ashfield. Ph 798-9147.

Danish design. Peerless precision.



Loudspeakers from Peerless make your present system sound like new.

Not only will the new precision-built Peerless PAS series improve the sound from your present system, but the beautiful Danish designed natural wood-veneer cabinets complement any interior.

Now you can enjoy tight clean bass responses, with accurate mid-range and crisply defined treble notes.

The new mini Peerless models PAS 20 and 30 are designed for shelf use (upright or horizontally) while models PAS 40, 50 and 80 are floor standing speaker systems. All models handle up to 100 watts RMS inputs.

Contact us now and discover where you can hear Peerless loudspeakers — then let your ears make up your mind.

G.R.D. GROUP Pty. Ltd.

698 Burke Rd, Camberwell, Victoria 3124.
Telephone: (03)82 1256 Telex 31712



Peerless

P1380

.....
Please send me literature and dealer list on the PAS Loudspeakers.

NAME _____

ADDRESS _____

POSTCODE _____

SOUND PROFESSIONALS

DP-1200

DENON



- * Direct Drive system * Smooth AC Servo motor
- * Record-end detection employs non-contact system — tonearm velocity is optically detected when it moves from sound groove to lead-out groove
 - * Anti-vibration construction of lower portion of tonearm and turntable feet
- * Magnetic Pulse Signal speed control system
- * Oil-damped, automatic arm lifter
- * Adjustable tonearm height
- * Cueing and Stand-by switch
- * Wow and flutter of 0.018% Wrms (as measured by Denon with magnetic pulse wheel)

SPECIFICATIONS

Model DP-1200

Phono motor	
Drive system	Direct drive by AC servo motor
Speed control	Frequency detection servo system
Speed	33 1/3 rpm, 45 rpm
Speed adjustable range	over ±3%
S/N ratio	over 75 dB (DIN-B)
Starting time	less than 1.5 sec (33 1/3 rpm)
Turntable	Aluminum alloy diecast, 30 cm diam.
Tonearm	
Type	Static balance type (automatic arm lifter)

Effective length	244 mm
Overhang	14 mm
Tracking error	less than 2.5°
Stylus pressure adjustable range	0 — 2.5 g
Acceptable weight of cartridge	5 g — 11 g
Height adjustment range	39 — 43 mm
Cueing	oil damped system
General	
Power consumption	17W
Dimensions	485(W) x 163(H) x 396(D) mm
Weight	Aprox. 11 kg

DENON

PROFESSIONAL AUDIO BRAND

For the location of your nearest Denon dealer, please contact

Canberra 80 5915	Melbourne 560 4533	Launceston 44 5155	Hobart 72 4366
Adelaide 272 2366	Perth 271 0888	Townsville 79 6155	Brisbane 44 1631

Hi-Fi Audio Equipment
AMALGAMATED WIRELESS (AUSTRALASIA) LIMITED
 554 Parramatta Road, Ashfield, NSW 2131 Phone 797 5757



Ross and Sandra were feeling down. They wanted a good sound system but thought they couldn't afford one



until they visited their nearest **DICK SMITH STORE**

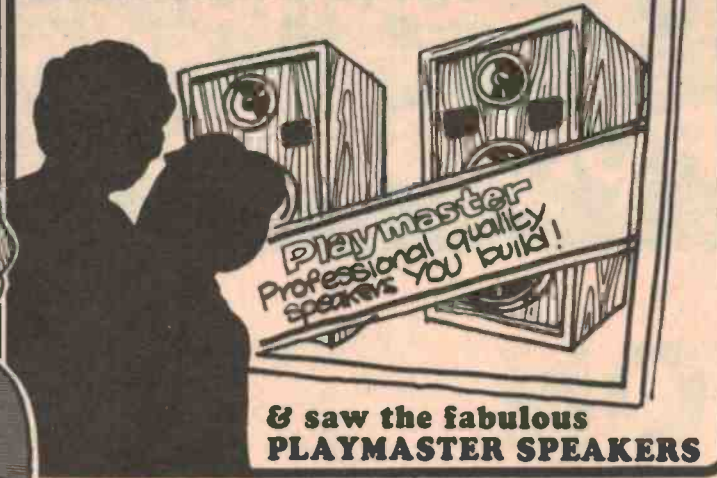

& saw the fabulous **PLAYMASTER SPEAKERS**

Ross worked out how much they would save and decided Playmasters were for them.



next saturday morning they collected their **PLAYMASTERS**



assembly was a cinch.



Saturday evening, Sally & George called

Look at those speakers!

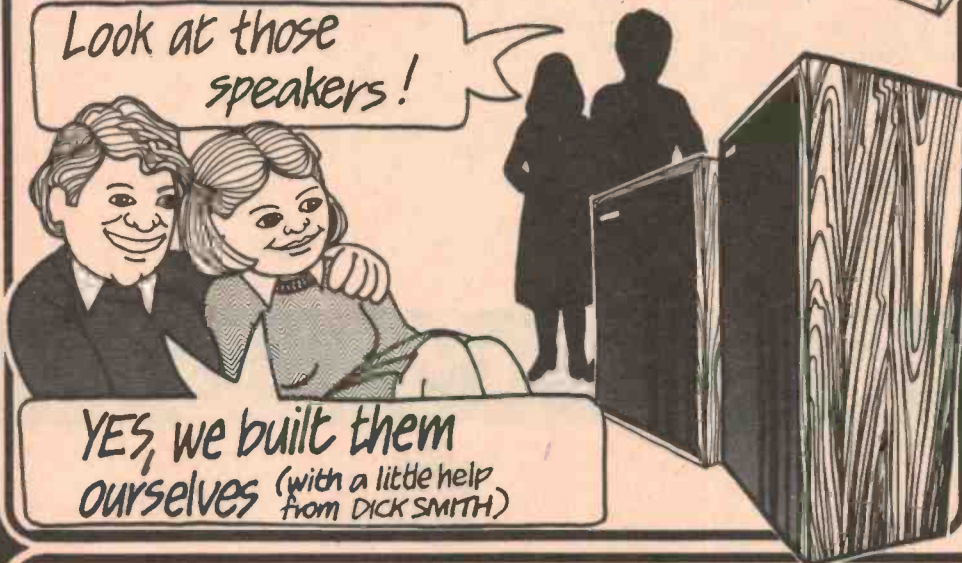

YES, we built them ourselves (with a little help from DICK SMITH)

PLAYMASTERS ARE RIGHT FOR YOU!

- 8" SYSTEM**
26 litre infinite baffle system with 8 ohms impedance and 40 watts max power handling.
SAVE \$101* \$159.50 pair
- 10" SYSTEM**
53 litre infinite baffle system with 8 ohms impedance and 60 watts max power handling.
SAVE \$101* \$248.00 pair
- 12" SYSTEM**
75 litre infinite baffle system with 8 ohms impedance and 80 watts max power handling. Also has mid-range and tweeter control networks.
\$298.00 pair

*Saving based on the same speakers in made up form (also available from Dick Smith)

DICK SMITH ELECTRONICS

SEE OUR OTHER ADVERTS IN THIS MAGAZINE FOR OUR STORE ADDRESSES AND RESELLERS

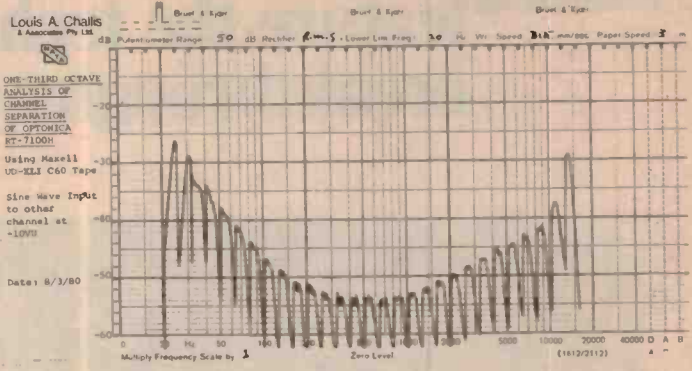
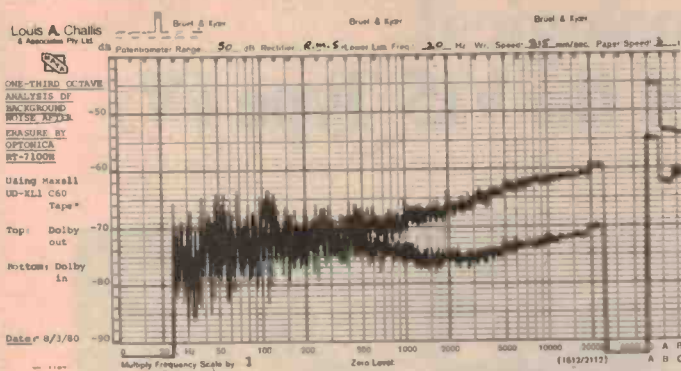

integrated circuits in the microprocessor section.

The unit is ruggedly constructed with galvanised steel sections and chassis.

On test

The conventional performance characteristics of this unit are interesting. First, the replay response of the unit, which extends from 15 Hz to 10 kHz, is independent of the type of recording tape used. It is quite apparent that the head azimuth alignment is not optimally aligned and has been adjusted with an azimuth alignment tape differing slightly to that used by us. Correctly aligned in accordance with either JIS standard tape or an IEC standard tape, it is apparent from the shape of the response that the machine could provide a replay frequency response extending to at least 18 kHz

and possibly beyond. The low frequency capabilities of the machine on replay are outstanding and better than any other machine we have recently seen. The record-to-replay frequency response is substantially better than the replay response, extending from 18 Hz to 15 kHz with Maxell UDXL I, 22 Hz to 20 kHz with Sonychrome and 18 Hz to 17 kHz with Maxell UDXL II — which is a good performance.

This is achieved with a flatness of response which is so smooth as to be reminiscent of the best reel-to-reel recorders.

The dynamic range of the machine with Dolby out is 58 dB(A) and Dolby in, 67 dB which is particularly good. The maximum input limit for 3% harmonic distortion is +5 VU, which also is good, and the harmonic distortion test at 0 VU and -6 VU showed less than 1% distortion at the three test frequencies.

The erasure ratio is better than 84 dB for a 1 kHz signal recorded at 0 VU and both the wow and flutter figures are above average. The channel separation is very much a function of frequency, extending from 26 dB at approximately 20 Hz and 20 kHz, down to 53 dB between 300 Hz and 1200 Hz. The objective testing shows the unit to have performance figures that are, in the main, exemplary although the replay frequency response is not as broad as we would like but is nonetheless very smooth.

In the home

When we said that this unit was more sci-fi than hi-fi we possibly created a wrong impression for once you spend a few minutes to become familiar with the APMS and APSS system, you can use them or forget them at your will. We

p.137 ▶

MEASURED PERFORMANCE OF OPTONICA RT-7100 H ELECTRONIC TAPE PROCESSOR

SERIAL NO. 91104749

RECORD TO REPLAY FREQUENCY RESPONSE AT -20VU:

Tape	Dolby	Lower -3dB Point	Max. Point and Frequency	Upper -3dB Point
Maxell UDXL 1	In	20Hz	-	13kHz
Sony C60CR	Out	22Hz	+3dB @ 12kHz	20kHz
Maxell UDXL 11	Out	18Hz	+1dB @ 6kHz	17kHz

SPEED ACCURACY: 0.3%

WOW AND FLUTTER:

WOW: Average 0.5 % P-P
 FLUTTER: Unweighted 0.29 % RMS
 Weighted 0.25 % RMS

MAXIMUM INPUT LEVEL:

(for 3% third harmonic distortion at 1kHz)
 Tape: Maxell UDXL 1 +5 VU

DYNAMIC RANGE:

Tape: Maxell UDXL 1
 Dolby Out 56dB(Lin) 58dB(A)
 Dolby In 63dB(Lin) 67dB(A)

ERASURE RATIO:

(for 1kHz signal recorded at 0VU)
 Tape: Maxell UDXL 1 84 dB
 Tape: Sony C 60 CR 85 dB

HARMONIC DISTORTION:

Tape: Maxell UDXL 1	OVU:	2nd	100Hz	1kHz	6.3kHz
		3rd	-44	-44.2	-41.5 dB
		4th	-65.7	-65.1	- dB
		5th	-52.4	-55.5	- dB
		THD	0.7	0.66	0.86 %
	-6VU:	2nd	-	-	-51.5 dB
		3rd	-50.3	-50	-44.7 dB
		4th	-	-	- dB
		5th	-56	-62.9	- dB
		THD	0.35	0.32	0.63 %



fact: five new Shure Cartridges feature the technological breakthroughs of the V15 Type IV

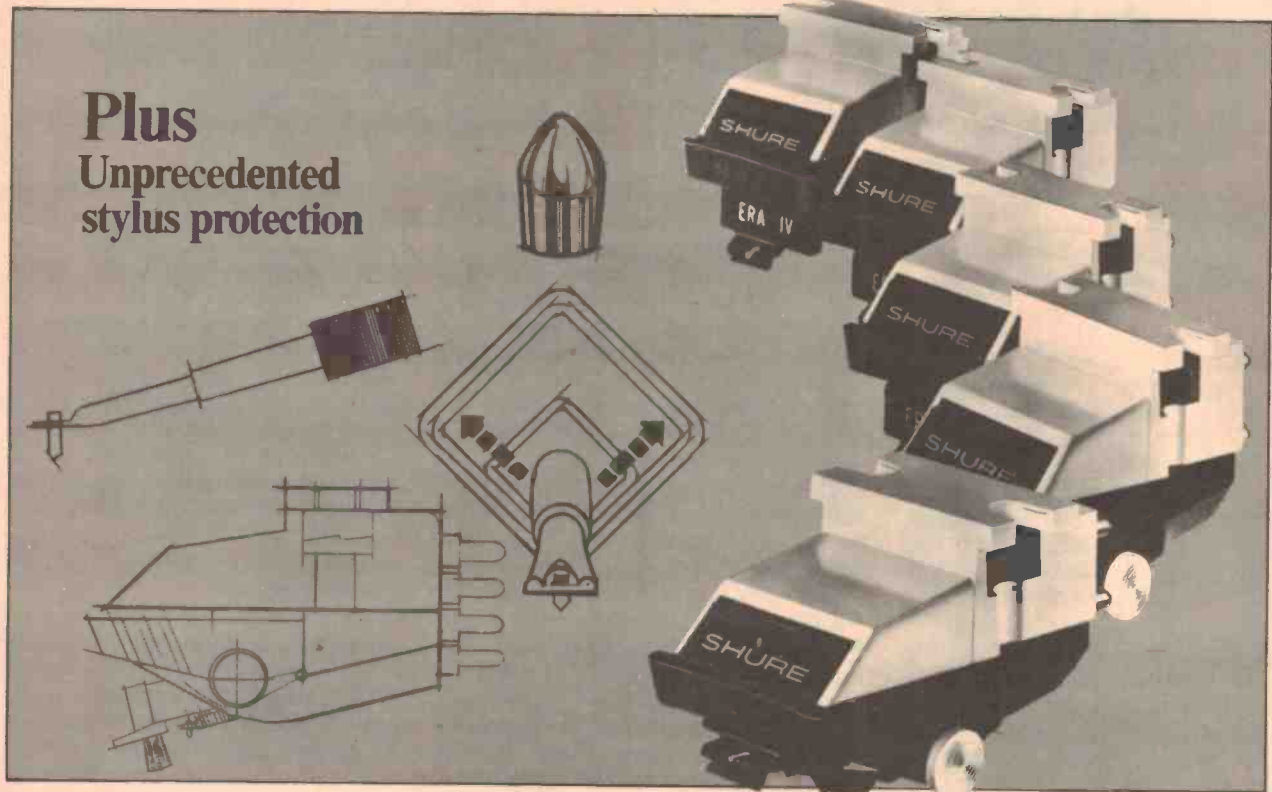

**Plus
Unprecedented
stylus protection**

the M97 Era IV Series phono cartridges

Model	Stylus Configuration	Tip Tracking Force	Applications
M97HE	Nude Hyperelliptical	¾ to 1½ grams	Highest fidelity where light tracking forces are essential.
M97ED	Nude Biradial (Elliptical)	¾ to 1½ grams	
M97GD	Nude Spherical	¾ to 1½ grams	
M97EJ	Biradial (Elliptical)	1½ to 3 grams	Where slightly heavier tracking forces are required.
M97B	Spherical	1½ to 3 grams	
78 rpm Stylus for all M97's	Biradial (Elliptical)	1½ to 3 grams	For 78 rpm records.

Shure has written a new chapter in the history of affordable hi-fi by making the space-age technological breakthroughs of the incomparable V15 Type IV available in a complete line of high-performance, moderately-priced cartridges: the M97 Era IV Series Phono Cartridges, available with five different interchangeable stylus configurations to fit every system and every budget.

The critically acclaimed V15 Type IV is the cartridge that astonished audiophiles with such vanguard features as the Dynamic Stabilizer—which simultaneously overcomes record-warp caused problems, provides electrostatic neutralization of the record surface, and effectively removes dust and lint from the record—and, the unique telescoped stylus assembly which results in lower effective stylus mass and dramatically improved trackability.

Each of these features... and more... has been incorporated in the five cartridges in the M97 Series—there is even an M97 cartridge that offers the low distortion Hyperelliptical stylus! What's more, every M97 cartridge features a unique lateral deflection assembly, called the SIDE-GUARD, which responds to side thrusts on the stylus by withdrawing the entire stylus shank and tip safely into the stylus housing before it can bend.

**NEW! M97 Series Era IV Phono Cartridges...
Five new invitations to the new era in hi-fi.**



AUDIO ENGINEERS P/L
342 Kent Street.
SYDNEY 2000 N.S.W.

AUDIO ENGINEERS (Vic.)
2A Hill Street.
THORNBURY 3071 Vic.

AUDIO ENGINEERS (Qld.)
51a Castlemaine Street.
MILTON 4064 Qld.

AE 151/FP
ATHOL M. HILL P/L
33 Wittenoom Street.
EAST PERTH 6000 W.A.

— from p. 137.

proved that the APMS system works and that it is possible to select various unorganised musical passages on a tape and play them sequentially. This of course occurs with the significant time gaps that may result between widely spaced sections on a tape.

Obviously, if one was recording these sections on to another machine, the APMS control could prove a marvellous advantage but leaving that possibility aside, this feature of the unit is once again the sort of thing you show off to your friends but don't often use. By contrast, the direct memory or counter memory function is the sort of feature you could be expected to use quite often, if for no other reason than that you like the piece of music and want to play it over and over. In practical usage it is possible to fool the APMS system if there are sections of noise immediately before or immediately after a recorded section of music. Again, I found it possible to fool if there were unusually quiet passages within a piece of music. Obviously this doesn't happen on rock, but often happens with classical music. Notwithstanding, the APMS system, together with the ability to programme and re-programme it, is exciting and may well be the manner in which all expensive cassette recorders are designed to operate in the future. Even leaving these features aside, the quality of reproduction of the RT7100 is excellent and is extremely impressive, even without the APMS and APSS systems.

The RT7100 is obviously a moderately expensive machine but with frequency responses extending from 20 Hz to 17 kHz and matched by distortion figures that are remarkably low, this is already a particularly difficult machine to beat. Given the frills and associated thrills of a control system which is head and shoulders above anything else currently available, this machine is an obvious must for consideration for the intending purchaser who wants an exceptional unit with performance to match. ●

OPTONICA RT7100 ELECTRONIC TAPE PROCESSOR

Dimensions: Width 730 mm; Height 144 mm;
Depth 371 mm; Weight 11.5 kg
Manufactured by Sharp Corporation, Osaka, Japan.
Price: \$539

Absolute copyright in this review and accompanying measurements is owned by Electronics Today International. Under no circumstances may any review or part thereof be reprinted or incorporated in any reprint or used in any advertising or promotion without the express written agreement of the Managing Editor.

ENTER THE 80's NOW WITH

UNI-BOARD

THE "UNIVERSAL" CIRCUIT BOARD

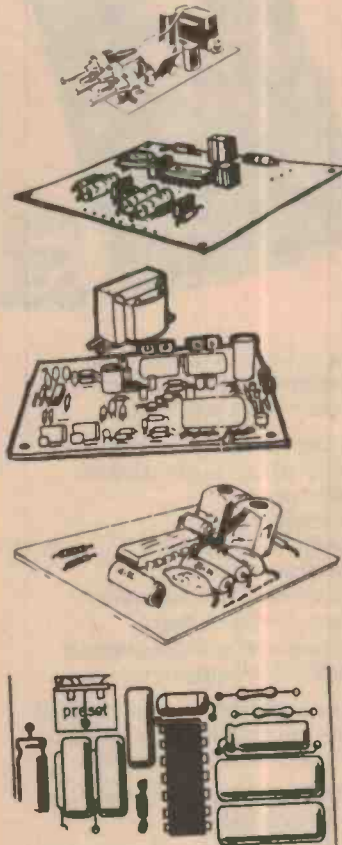

BUILD ALMOST ANY CIRCUIT —

- AMPLIFIERS
- REGULATED POWER SUPPLIES
- LINEAR IC CIRCUITS
- DIGITAL IC CIRCUITS
- PRE-AMPS, TONE CONTROLS
- MANY, MANY, MORE!

ECONOMY PLUS!

UNIBOARD WILL SAVE YOU MONEY.

- NO WASTE — SURPLUS BOARD CAN BE USED ON ANOTHER PROJECT
- USE AGAIN & AGAIN
- LOW COST "BREAD BOARDING"
- PROTOTYPE LAYOUTS CAN ALSO BE USED FOR YOUR "UNI-BOARD" PRODUCTION RUN
- BOARD EASILY CUT OR TRIMMED TO SUIT THE SIZE OF YOUR PROJECT.

NOW YOU CAN BUILD CIRCUIT AFTER CIRCUIT WITH THIS SPECIAL OFFER.

INTRODUCTORY KIT INCLUDES:

- APPLICATION MANUAL
- ONE UNI-BOARD TWIN PACK
- ONE UNI-BOARD SIX PACK

REMEMBER: UNIBOARD SIX PACK IS ONE LARGE CIRCUIT BOARD WITH 6 LAYOUT "MODULES" (SUFFICIENT FOR MANY PROJECTS).



TO: ADVANCED ELECTRONIC SYSTEMS PTY LTD
3 STANILAND GROVE, ELSTERNWICK 3185

PLEASE SUPPLY.....UNI-BOARD INTRODUCTORY KITS AT \$9.95 EA
(INCL. P&P)

NAME.....
ADDRESS.....
POSTCODE.....

— PTY. LTD —
DELSOUND

BRISBANE
NEW QUALITY
PRODUCTS FROM
CLIFF

V.U. PANEL

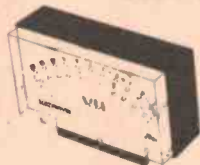

METER

MONO
\$28zea.
STEREO
\$49 ea.



BARGRAPH

MONO
\$49 ea.

TO 3 INSULATOR PADS

20c ea. \$15/100

JACK SOCKETS

INSULATED



MONO
\$40/100
S1-SS

COLOURS: RED,
BLACK, WHITE,
GREY



JACK PLUGS

MONO \$70/100 P2

COLOURS:
RED, YELLOW,
BLACK, GREEN,
WHITE, GREY



**PLASTIC
FEET**

\$30/100 PFI

For further information, local agents and
wholesale prices, write to the Australian
Importers:

DELSOUND PTY. LTD.
1 Wickham Tce. (Cnr. Wharf St.)
Brisbane. Phone 229-6155.
Wholesale and Retail suppliers of
Electronic Hardware and
Components.

**The definitive
book on speaker
enclosure design
and construction.**

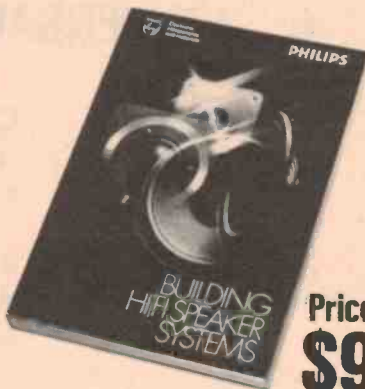

Price:
\$9.

Since its first publication in 1969
"Building Hi-Fi Speaker Systems" has
become a classic in its field.

And now, in a completely updated
seventh edition, this book contains
chapters on:

- the nature of sound
- high fidelity and realism
- power considerations
- loudspeaker & enclosure theory
- crossover network theory
- listening room acoustics and room
placement of loudspeakers

And it includes constructional details of
19 new enclosure designs which can be
built using Philips quality speakers.

All this in plain language for the
non-technical layman.

This book is a definite must for anyone
who wants a superior sound system at
less cost and, at \$9.00*, you have
nothing to lose, and a new fund of
knowledge to gain, even if you have no
plans to get into home construction.

Philips Electronic Components and Materials

P.O. Box 50
LANE COVE, N.S.W. 2066

Please send me a list of Philips dealers where I
may purchase this book and further
information on Philips loudspeakers.

*suggested retail price only

NAME _____

Please Print

ADDRESS _____

STATE _____ P'CODE _____



Electronic
Components
and Materials

PHILIPS

ETI

**LOST IN THE
HI FI JUNGLE?**



LEISURE SOUND CAN HELP

At our impressive North Shore
Showroom, or at our exciting
new city location we have
friendly, expert staff who will
help you solve the confusion.
We believe that Hi-Fi is more
than a means to an end. Total
satisfaction is the ultimate goal.

We stock a range of quality
Hi-Fi to suit most needs.

- NAKAMICHI
- YAMAHA
- MERIDIAN
- B&W
- S.T.D.
- ROGERS
- REGA
- J.B.L.
- GRADO
- DYNAVECTOR
- dbx
- HADCOCK
- GRACE
- ARISTON
- MISSION.
- FIDELITY RESEARCH

**Leisure
Sound**

401 Pacific Hwy., ARTARMON, N.S.W.
(Near Epping Hwy.)

Open all day Saturday.
Phone 438 4166

387 George St., CITY. Phone 290 1533
NEW CITY ADDRESS FROM MID
JULY — 38 York St., (Near King St.)



OPTONICA

RT-7100H

\$539



Optonica RT-7100H Cassette Deck. Starts where the others leave off! This fully computerised tape deck will play up to 15 songs in any order you wish and then turn itself off. Or it can repeat those selected songs indefinitely! It features two computer controlled motors to eliminate tape stretch and solid state VU meters for recording ease. This is the most advanced tape deck available, its built-in microprocessor system giving unprecedented handling ease. Come and see it now!

SM-5100H

\$369



Sharp SM-5100H Amplifier to suit RT-7100H and RT-5100H Tape Decks. Huge 40 plus 40 RMS per channel. Frequency response of 10Hz to 100kHz plus 1dB minus 3dB. Hum and noise level .3mV (shortest). Takes up to two sets of speakers from 4 to 16 ohms. All stages are direct coupled pure complementary TTL/OTL/OCL circuitry. Chadwick 3-way (mirror matched) speakers to suit SM-5100H Amp with 20 to 20,000 KHz response at 50 watts and 5 year written guarantee, \$299. In black or walnut finish.

RP-7100H

\$499



Top of the line Sharp RP-7100H direct drive turntable with Quartz Motor Speed Lock. You can select any song and the infrared sensor will play it for you. The automatic record-size detector will adjust tone arm action without you lifting a finger! With rumble better than 68dB, wow and flutter at .03 percent and a DC core-less motor using a Frequency Generator servo control system, the RP-7100H will deliver the sound you want!

RT-5100H

\$309



The little brother to the RT-7100H, this deck uses the latest in microprocessor technology and solid state techniques. It has two computer controlled motors to ensure long tape life and solenoid switching controls for operational ease (levers are old hat!). Dolby noise reduction and Auto Program Search System with the famous Sharp 2 year warranty complete the package.

Send cheque or money order to:

BRIAN BAMBACH ELECTRONICS
670 Hunter Street, Newcastle 2302.
Phone (049) 24996. Telex AA28708.

Send 40c stamp for colour catalogue (includes postage).
No-deposit finance for approved applicants.

We also stock CB accessories, electronic kits & parts, and a wide range of electronic components (4,000 lines).
Importers, wholesale and retail.

BRIAN BAMBACH ELECTRONICS

Bill Edge's

ELECTRONIC AGENCIES

115-117 PARRAMATTA ROAD
CONCORD, 2137. Tel: 745-3077
(Corner Parramatta Rd & Lloyd George Ave)

TRADING HOURS:

9am-5.30pm Monday-Friday
9am-NOON Saturday
10am-2pm SUNDAY

Why not buy your Dick Smith Electronic products on a Sunday — we have a great range.

As our range of electronic products and kits has reached astronomical proportions we have decided to give a complete list below of our kits.

SPEAKER KITS:

1. Coral 12SA-1 30cm (12") 3-way 4-speaker system kit. ONLY \$129 pair. Box kit to suit 12SA-1 \$89 pair.
2. Coral 10SA-1 25 cm (10") 3-way 3-speaker system kit. ONLY \$95 pair (Woodwork not supplied).
3. Coral 8SA-1 20cm (8") 3-way 3-speaker system kit. ONLY \$58 pair. (Woodwork not supplied).
4. Philips ET4000-1 4-way 4-speaker 100 watt system (see ETI Feb. '80). ONLY \$459 pair. Completely assembled boxes to suit, \$300 pair.
5. Philips ET4000-2 3-way 3-speaker 100 watt system (see ETI June '80). ONLY \$360 pair. Full range of separate speakers available. (Woodwork not included).

AUDIO KITS:

1. ET1466 300 watt amp module (less heatsink & power supply). ONLY \$63.50.
2. ET14000 amplifier (see ETI May, June, July '79). ONLY \$179.00 (with wooden sided case); \$189 (with rack mounting case). \$10 extra with 'C' core transformer.
3. ET1470 60 watt low distortion amplifier module \$29.90.
4. ET1471 Pre-amp control unit \$45.90.
5. ET1472 power supply kit \$42.90, with 'C' core \$52.90.
6. All New EA 300 watt amp module \$75.00.
7. 10 watts RMS per channel amplifier module (completely assembled). Just add transformer and case and you have a complete amp. ONLY \$24.50. Transformer \$9.50.
8. Famous Mini-Color (similar to Musicolor, only PC board is pre-wired & tested) STILL ONLY \$49.90.
9. Playmaster stereo graphic equaliser (complete kit) ONLY \$99.50.
10. Playmaster AM/FM digital tuner (complete kit) ONLY \$129.50.
11. Playmaster Forty Forty stereo amp. (complete kit) ONLY \$129.50.

MISCELLANEOUS KITS:

1. Masthead Amplifier for TV & FM (EA Aug. '79) STILL ONLY \$28.50.
2. LED Level Meter (EA June '76) \$14.50.
3. Impedance Bridge (EA Aug. '79) short form kit \$37.50.
4. Sine & Square Wave Oscillator 15Hz to 150kHz \$36.50.
5. CRO Adaptor — use your TV as a large screen oscilloscope (see EA May '80) ONLY \$29.40. Power adaptor extra 9 volts \$6.50.
6. Transistor Assisted Ignition (EA Dec. '79) with dwell extension & full protection. ONLY \$32.50 with genuine diecast box.
7. MK 3 Drill Speed Control — a must for the handyman \$13.50.
8. Transistor Tester (EA July '78) \$19.75.
9. Radar Intruder Alarm — 10GHz microwave — \$69.00.
10. Capacitor Discharge Ignition — over 8000 sold — ONLY \$32.50.
11. Disco-Strobe 1 to 20 flashes/sec. extremely easy to build, for parties etc. ONLY \$34.50.
12. Car Alarm short form kit, ONLY \$11.50.
13. Digital Capacitance Meter measure from 1pf to 99.99uF. ONLY \$59.90 (EA project).
14. Sound Triggered Photo Flash (EA Sept '79) Short Form Kit. \$17.44.
15. Induction Balance Metal Detector the best of all metal detectors ONLY \$32.50.
16. D7-Digit Frequency Meter to 40MHz \$99.50, to 200MHz \$112.00.
17. RLC Bridge measures unknown components ONLY \$36.50.

FOR THIS MONTH, Bill presents the
4-INPUT GUITAR/MIC PREAMP
to suit 466 300W Amp (ETI July '80)
ONLY \$29.50 complete kit.

MAIL ORDER: \$1.00 plus 5 percent of order value up to \$80.00 thence a flat \$4.00. Heavy items sent "freight on"

AIM, SYM, KIM OWNERS

KIM 4 Bus compatible products.
Same shape and size as KIM, SYM.

MEMORY PLUS \$225 A&T

8K low power RAM. All IC's socketed. 8K EPROM sockets and programmer for Intel 2716, 6522 I/O and plus 5V and plus 25V regulators.

VIDEO PLUS \$293 A&T

Upper/lower ASCII. 80 characters by 24 lines. 128 additional user programmable characters. Keyboard and Lightpen interfaces. 2K display RAM, expansion to 4K. On-board regulators, provision for 6502. All IC's socketed.

DRAM PLUS \$353

Complete with 16K of 4116 socketed and tested to 32K.

PROTO PLUS \$47

Double sided, plated through holes, professional quality. Provision for 40 off 14/16 sockets, 4 off 24/40 sockets, 3 off voltage regulators.

MOTHER PLUS \$98 A&T.

Fully buffered and decoded. Add up to 5 additional boards.

CARD CAGE PLUS \$28

Compatible with Mother Plus.

PROTO PLUS \$48

Transparent Refresh with 4K segment addressing. 4 sockets for 16K or 32K bit ROMS. 4K memory segment addressing. EPROM programmer to suit. 2 off I/O for 32 I/O lines and 4 off 16 bit times proto type area.

P&P \$3.50. Prices plus sales tax if applicable.



PO BOX 31, GOODNA 4300

PHONE (07) 288-2757

Prices subject to change without notice.

SAE for Datasheet

computer components

We have a small number of quality computer peripherals and components to clear.

Main Items are:

- Shugart 801 8" Floppy Drives, slightly used but will guarantee them 6 weeks — \$495 plus 15 percent Sales Tax.
- FD1791 Floppy Controller Chip, double density, new — \$45.00 each plus 15 percent Sales Tax.
- MC6809 M.P.U. New — \$30 each plus 15 percent Sales Tax.
- Teletype Model 33 RO Printer, working — \$150.
- Teletype Model 43 KSR with paper tape, working, with transformer — \$400.
- MCM4416 16K x 1 dynamic RAMS, new — \$5 each plus 15 percent Sales Tax.
- 6" CRT with Yoke — \$25 each.
- Various Alphanumeric Keyboards, new ICS, P.C. boards crammed with useful parts, make us an offer of these.

PERSONAL SHOPPERS ONLY

Fairlight Instruments Pty. Ltd.

Ground Floor, 15 Boundary Street,
Rushcutters Bay, N.S.W.
(Same building as E.T.I.)



Mail Order KEF Drivers & Kits

CERTIFIED MAIL
DELIVERY THROUGHOUT
AUSTRALIA
& NEW ZEALAND
Bankcard accepted

KEF B139

Superb 30 x 21cm bass driver, with solid flat diaphragm of unique construction, acting as a perfect rigid piston, to give clean, distortion-free bass over the frequency range 20-1,000Hz. The KEF range also includes mid range and high frequency units, with dividing networks designed to link them into compatible systems.



...the no-compromise approach to uncoloured sound

For full information, write to:
AUDIOKITS
PO BOX 553
BROOKVALE NSW 2100



OUR ELECTRONIC EAR



OUR EQUALIZER

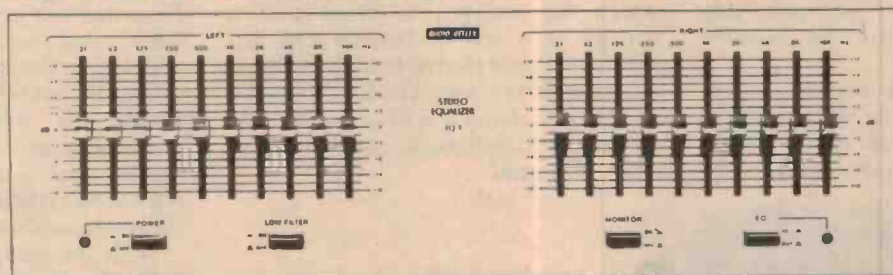

Together they can improve the sound of your system by 50%-150%

No matter what system you own, no matter what speakers, you are probably only hearing about half of the information on your records.

You see, the room you are listening in is as much a part of sound, as the rest of the system.

For years, the world's authorities on hi fi have recommended careful placement of speakers, and have extolled the virtues of well designed listening rooms.

Unfortunately, most of us do not have a perfect room . . . and can not always place speakers in the optimum listening position . . . and even if we could . . . problems would still exist.

Now, with today's technology, it is possible to overcome these problems, and hear as

near to perfect sound as is possible from your system.

If your room is accentuating certain sounds, we can now measure it . . . and adjust accordingly.

If some sounds are lost in the background . . . we can bring them back up to where they belong.

When you buy an Audio Reflex equalizer, a factory trained technician will come to your home, and, using sophisticated electronic measuring equipment, will tailor the acoustics of your room so you hear a nearly perfect flat response.

The difference is amazing, and the service is available only from your Audio Reflex dealer. See him before you spend another cent on your hi fi . . . it's a big improvement for a small price.

Installation service available in capital cities only.

AUDIO REFLEX

The Audax Kit 51 bass reflex speaker system

An unusual system which has been designed to either be a sealed or a vented enclosure. The Kit 51 "... offers good performance at a reasonable price."

AUDAX is a new name on the local scene. Even in Europe they are not as well known as many of the other big brand names because they fall in the category of being an OEM speaker manufacturer whose products are mainly incorporated in other people's systems.

The Kit 51 system is unusual in that it is a system which has been designed to either be a sealed or a vented enclosure. This, for a start, was the first

eye-opener in that the basic low frequency drive parameters for the sealed enclosure are almost as a general rule very different from those required as a vented enclosure. The system which we received is fitted with a venting port and we believe that this would be the preferred configuration to optimise this system. The Kit 51 is not a small system and is a little larger than the conventional bookcase speaker so often favoured.

The appearance of the unit is not really striking and is a little different from what we have grown accustomed to expect from other manufacturers. Firstly, the enclosure is veneered on all faces and not just on the four sides and front, and secondly the method of clipping on the speaker grille also uses a different retention system to that chosen by the majority of other manufacturers. The metal press-stud system that is utilised is effective but not necessarily as utilitarian as some of the other options available.

With dimensions of 600 mm high x 370 mm wide it does not fit too easily on a book shelf and so should be considered as a floor mounting system. The manufacturer provides a very well written sixteen page book providing details of construction and technical data on the level recordings of the base driver, mid-range speaker and tweeter whose responses are a little different than those measured by us in the anechoic chamber. The difference between their responses and ours are most probably readily explicable and are not a bone of contention. Even the impedance curve looks a little different although this is primarily as a result of our using a linear scale for impedance whereas Audax have presented theirs on a logarithmic scale.

The system

The heart of the system is obviously a well designed vented enclosure and a 300 mm dia. driver with a free-air resonance of 20 Hz, a 37 mm diameter mid-range driver with a soft dome and a 25 mm diameter dome tweeter designed to give good high frequency dispersion extending beyond 20 kHz.

The local agents, Audax Loudspeakers, quote kit prices which are reasonably attractive and do not really frighten us when compared with



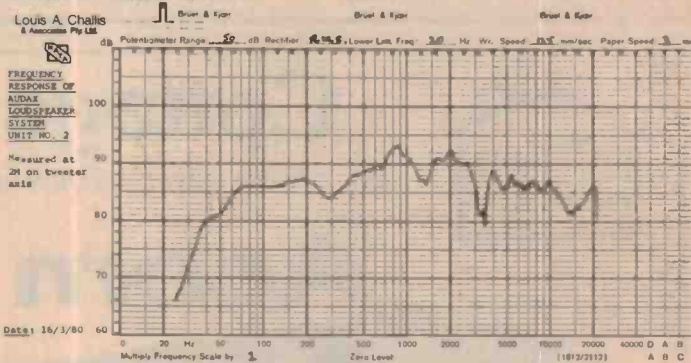
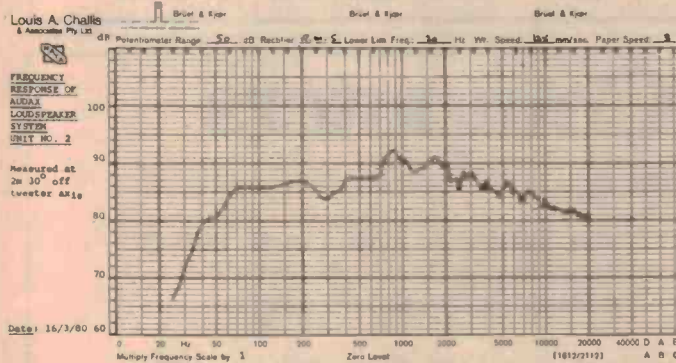
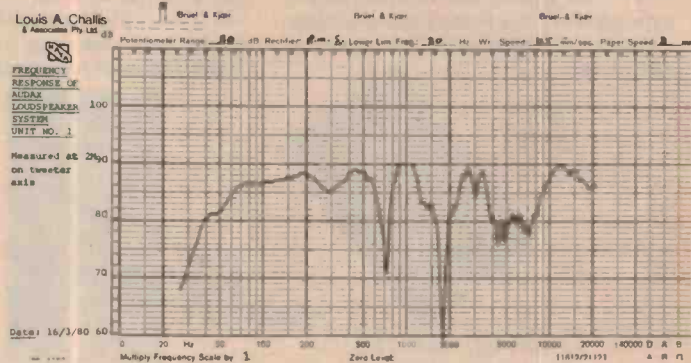
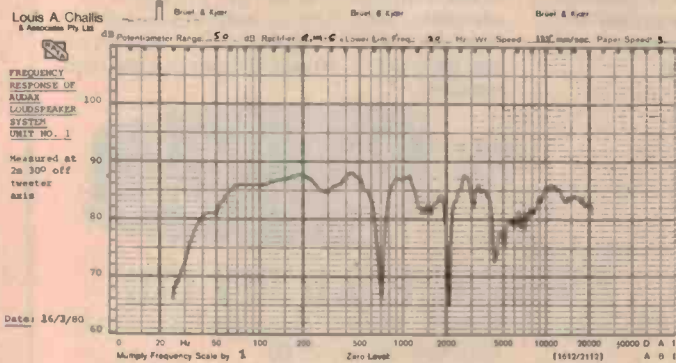

comparable speakers in the marketplace.

On test

Our first series of tests in the anechoic room were to measure the frequency response of the speakers on-axis and off-axis and apart from a minor problem with one of the speakers whose mid-range connections had been inadvertently wired in reverse phase, showed that the overall response on-axis was quite smooth and extended from 50 Hz to well beyond 20 kHz.

When correctly wired, the crossover frequency points are indistinguishable and the off-axis response at 30° to the main axis is just as flat and if anything more impressive than the on-axis

response. The polar response of the speaker over a 45° angle is exceptionally good and the designers have performed eminently in achieving an objective response which is particularly good.

The phase response of the unit is also exceptionally good and is right up in the class leaders that we have seen over the last year. The crossovers are sensibly located at 700 Hz and 5 kHz and it is apparent that the combination of drivers and crossovers are as close to optimum as one could reasonably ask for.

With a sensitivity of 3.8 watts into nominally 8 ohms for 90 dB at two metres, the speakers are also efficient and consequently the manufacturer's recommendation of a 50 watt amplifier

would provide the ability to develop healthy sound pressure levels in excess of 100 decibels in an average living room without any gross problems.

The distortion level for a 90 dB output at 2 metres is moderately low at 1.1% at 100 Hz, 0.3% at 1 kHz and 0.5% at 6.3 kHz. The tone-burst testing showed a response that is not as clean as the other speakers we have tested, either at the 100 Hz level or at the 1 kHz level and whilst at the 6.3 kHz level, the performance was acceptable but not outstanding.

Overall, the objective testing of the unit illustrated basically good performance whose best characteristics were dominated by the phase response and the above average frequency linearity. ▶

— to page 149. ▶

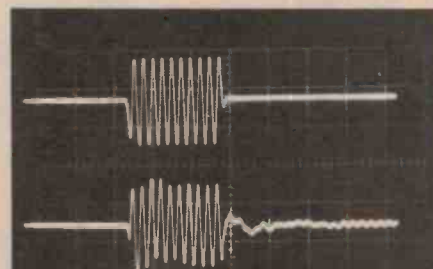
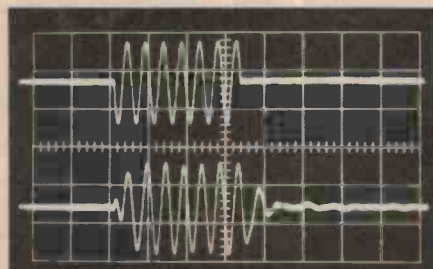
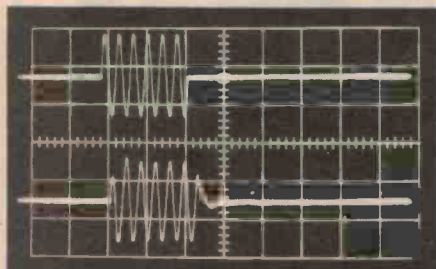

Tone burst response oscillographs of the Audax Kit 51 system, measured with respect to 90 dB steady-state spl at 2m on axis. LEFT: at 100 Hz (25 ms/div sweep); CENTRE: at 1 kHz (2 ms/div) and RIGHT: at 6.3 kHz (0.7 ms/div).

NEW INSTRUMENTS FROM CHRISTIE RAND PTY LTD

'SANSEI' 2200A DIGITAL MULTIMETER, with a 3½ digit LCD display. This new Multimeter has now been released, with an accuracy of 0.1% fs for under \$100. Other features include auto polarity, low battery and overrange indication. Supplied with Test Leads and spare fuse.

ONLY
\$95
+\$14.25 S.T.



MONEY BACK GUARANTEE

'SANSEI' 2000A DIGITAL MULTIMETER, with a 3½ digit LCD display. We are now able to offer an AUTO RANGING D.M.M. for the price of a normal D.M.M.. It has an accuracy of 0.1% fs and features low battery warning, and overrange indication. Test leads and spare fuse supplied.

ONLY
\$138
+\$20.70 S.T.



SABTRONICS 8610 FREQUENCY COUNTER gives you a first class high stability instrument at the hobbyists price, for a 8 digit counter. FREQUENCY RANGE guaranteed 10Hz to 600MHz (typical 5Hz to 750Mhz) with a good sensitivity. Measurement accuracy 1 ppm + 1 digit or 0.0001%. Ageing rate + 5ppm/year, gate times 0.1, 1, 10 secs, Battery operated (not supplied).

ONLY
\$181
+\$27.15 S.T.



SEND TO:

CHRISTIE RAND PTY LTD
P.O. BOX 48, EPPING, 2121. Phone (02) 477-5494.
Packing & delivery \$2.00

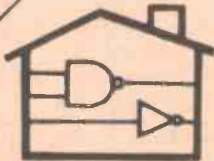

Cottage Computers

386 QUEENS Pde., FITZROY NORTH Victoria 3068 (03)481 1975

Acorn

****The EUROCARD 6502 Based system from England.....Expandable.... Convenient Modular parts.....



µControllers from \$110, Memory Cards, Software, and User Manuals available

System 2 from \$954,
Systems also available
Fully Assembled & Tested

ACORN System 3
With F/Disk
Kit: \$2199.40+S/Tax(15%)



TRS-80 OWNERS!

CASSETTE (Level 11)	Adventure (Scot Adams).....16.00	Newdos plus 40 track.....110.00
Cribbage.....9.00	Electric Pencil Word Processor...105.00	Renumbar 4, 16, 32, 48k.....26.00
Checkers.....8.00	Racet Remodel.....25.00	ST 80-D Smart terminal.....80.00
Fastgammon.....16.00	GSF Soft.....25.00	Electric Pencil Word Processor...155.00
Galactic Blockade.....9.00	Copy System Tape.....15.00	
Pork Barrel.....11.00	Autoloader.....20.00	OSBORNE & ASSOCIATES
Round The Horn.....11.00	Fargone One.....25.00	COMPLETE BUSINESS SYSTEM
Santa Paravia.....9.00	Fargone Two.....37.50	LINKED.....450.00
Talpan.....11.00		Accounts Receivable/Payable
Accounts Receivable.....26.00	DISK	General Ledger/Cash Book
General Accounting.....16.00	Accounts Receivable 11.....80.00	Individually/Invoicing.....100.00
Personal Finance.....11.00	Advanced Pers Finance.....26.00	
Mortgage Calculator.....9.00	Amateur Radio System.....26.00	BOOKS
Inventory Control.....13.00	General Ledger 11.....80.00	TRS-80 Disc — other mysteries.....30.00
Basis Statistics.....21.00	Inventory 23.....80.00	Osborne Accts Rec/Accts Pay.....20.00
Ham Radio.....11.00	Inventory 11.....99.00	Osborne Gen Ledger.....20.00
Electronics Asst.....11.00	Level in lev 11 Ram.....26.00	HARDWARE (prices inc. s/t)
	Mall List 11.....99.00	10 Verbatim Discs.....46.00

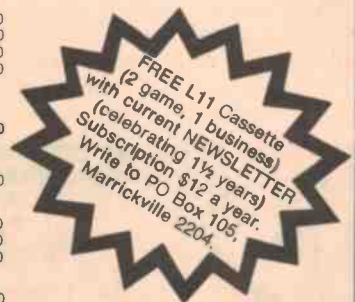

Many other programs available.

PITT ST MICROCOMPUTERS

Box A344, Sydney South 2000. Phone 569-8228.

PROFESSIONAL AUDIO EQUIPMENT

MODEL 3002 — 2 CHANNEL POWER AMPLIFIER

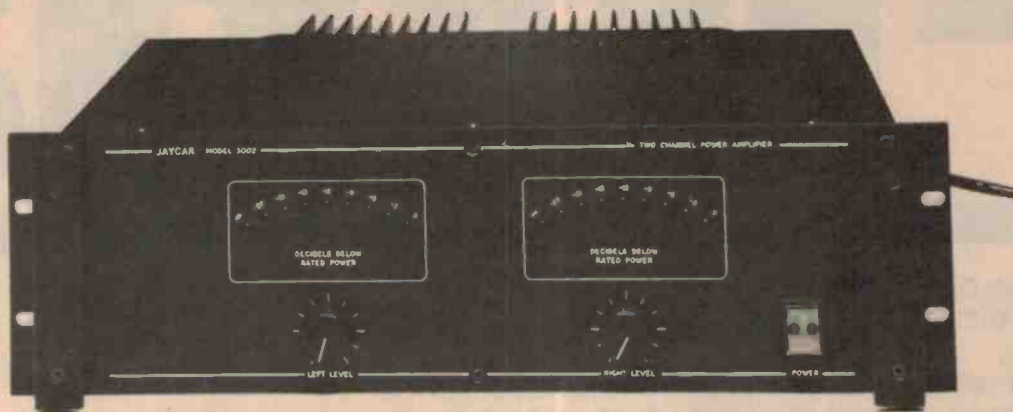

FEATURES

- 300 Watts per channel.
- Massive rear mounted heatsinks.
- Multiple speaker protection circuits.
- Peak output power meters.
- Constructed to withstand the tortures of 'On the road' use.
- Standard 19" rack mounting.
- Separate power supplies for each channel.
- Dual RCA input sockets to allow bridging to other amplifiers.
- Equally suited to Hi Fi use or P.A./Disco situations.

BRIEF SPECIFICATIONS

Output Power — 300 watts/channel into 8 ohms.
200 watts/channel into 4 ohms.
Frequency Response — 20Hz to 20kHz ± 0.5 dB.
Hum and Noise — 105dB below rated output.
Harmonic Distortion — Less than 0.05% to 80 watts.
Less than 0.15% at rated power.
Input Sensitivity — 1.0 volts for rated output.
Dimensions — 482mm x 133mm x 340mm.
Weight — 20 kgs.



MODEL 2801 — 1/3 OCTAVE EQUALISER

The 2801 is a single channel graphic equaliser that divides the audio spectrum into twenty-eight one third octave bands. Each frequency segment is controlled by a slider that provides up to ± 10 dB of adjustment in standard ISO steps.

The 2810 was designed primarily to compensate for any deficiencies in the linearity of speaker systems, acoustic peculiarities of the hall or listening room, and inadequacies of program source quality. In P.A. application the equaliser may be used to improve sound quality and increase intelligibility by attenuating problem frequencies that cause ringing, boominess, or other disruptive resonances that occur in acoustically difficult rooms. The 2801 allows sound systems to be "tuned" according to the special acoustics of a room, to maximise output and minimise feedback. As a creative tool in sound recording or re-recording the 2801 allows complete freedom in contouring response over the complete audio spectrum from 31.5 Hz to 16 KHz.



MODEL 2021 — 2 CHANNEL EQUALISER

The 2021 is a two channel graphic equaliser featuring ten adjustable controls on octave centre frequencies (independent for each channel). Each control provides up to ± 14 dB of adjustment. Each channel is also equipped with a level match control giving an overall gain of adjustment of ± 14 dB.

The functional versatility of the 2021 equaliser is unsurpassed. Eight modes of operation are available from the push button switches on the front panel.

Included amongst these are the ability to equalise both recording and playback when dubbing tapes.

The 2021 has been designed to be compatible with all commercially available equipment and is ideal for use in a Hi Fi system or P.A. system.

*For further information, please send a 35c stamp
for full specification sheets, or call at our showroom for a demonstration.*

jaycar
PTY LTD

380 SUSSEX STREET, SYDNEY, NSW
P.O. BOX K39, HAYMARKET 2000
TEL: (02) 211-5077

Filth!

What you see on your records as just a few specks of dust and dirt, your expensive stylus sees as more of a rockery.

The greatest enemies of good record reproduction are static electricity and the gritty dust and grime which it attracts.

This dirt chews up the groove walls of your records and friction heat causes dirt to become burnt on to your stylus tip.

Now, Nagaoka, Japan's No.1 record-care and hi-fi accessory company, are making their entire range of scientifically conceived products available in Australia.

The whole range, from the unique Nagaoka rolling cleaner to the brand new anti-static record sleeves, has been introduced to allow your expensive hi-fi equipment to reproduce pure power sound free from annoying dust and static noise.

Nagaoka products are solely distributed throughout Australia by Goldring Audio Industries.

NAGAOKA
 HI-FI ACCESSORIES
 FROM LEADING
 HI-FI & DEPARTMENT
 STORES &
 ALL BRASH'S &
 ALLAN'S RETAIL
 STORES.

GOLDRING 



Crystal Turntable Mat GL602, Rolling Record Cleaner RC200, Crystal Stabilizer GL601, Stylus Cleaner/Stabilizer RC40L, Crystal Stabilizer GL603J, Anti-static Record Sleeves 102, Kilovolt Anti-static Gun 103, Anti-static Tissues 101.



Louis A Chellis and Associates Pty Ltd

**MEASURED PERFORMANCE OF
AUDAX MODEL 51 BASS REFLEX
SERIAL NO. SAMPLE 5958**

FREQUENCY RESPONSE: 40Hz to 20kHz

CROSSOVER FREQUENCIES: 700Hz and 5kHz

SENSITIVITY:
(for 90dB average at 2m) 5.5 VRMS = 3.8 Watts (nominal into 8Ω)

HARMONIC DISTORTION:

(for 90dB at 2m)	100Hz	1kHz	6.3kHz
2nd	-39.5	-50	-45.5 dB
3rd	-52	-65.3	-
4th	-69.3	-	-
5th	-	-	-
THD	1.1 %	0.32 %	0.53 %

INPUT IMPEDANCE:

100Hz	9.5 Ω
1kHz	15 Ω
6.3kHz	12 Ω
Minimum at	2.8kHz 7 Ω

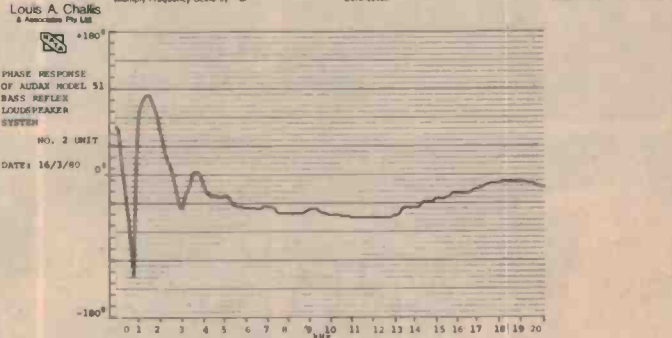
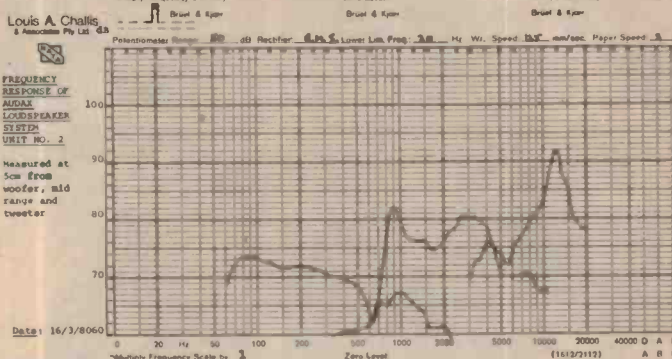
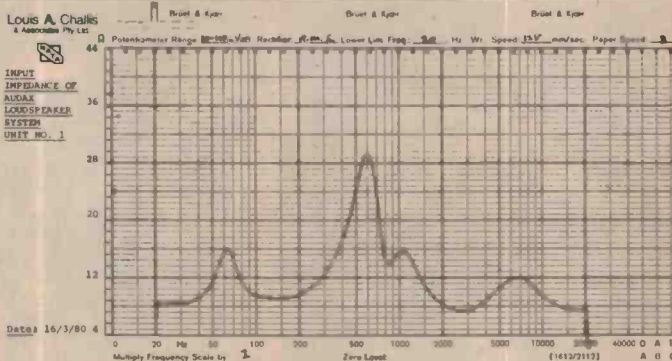

To the ear

The subjective evaluation of the speakers presented no real surprises. The first and most favourable feature is the audible broadband frequency response with only moderate colouration on most instrumental music. Percussion, drums, piano, harpsichord, viola, cello and most classical instruments come through with reasonable fidelity and very little detectable distortion. Even at power levels resulting in outputs over 100 dB SPL the unit exhibits very little frequency doubling except at the very lowest frequencies, in the range 20 to 40 Hz. Under severe drive conditions below 30 Hz frequency doubling is pronounced but it should be noted that most records and virtually all pre-recorded tapes are carefully tailored to attenuate significant outputs below 30 Hz. Two of our test records, designed for subjective evaluation, differ

substantially from the norm as they provide a very effective way of evaluating the frequency response of such speakers. One of them, made by a well known American speaker manufacturer, showed up particularly well in this test whilst a second, manufactured by the Swedish High Fidelity Institute, demonstrated that the Audax system does not produce much output below 50 Hz.

When fed with prerecorded speech from the Shure test record and the IEC TC29B working group 8 listening test tapes, it was obvious that this speaker system does not provide as natural a reproduction on speech and tympany as many people would desire. When playing rock music, including moderately hard rock, at levels over 100 dB SPL, they performed reasonably well and cope with high levels of drum beats better than would be expected from a speaker system of this size.

Summary

The Audax Kit 51 speaker is a well designed system. It achieves reasonable performance in terms of basic fidelity and its ability to deliver high level signals without substantially compromising the resulting quality.

At a recommended retail price of \$739 per pair it offers good performance at a reasonable price.

THE AUDAX MODEL 51 BASS REFLEX ENCLOSURE SPEAKER SYSTEM

Dimensions: 660mm high x 430mm wide x 330mm deep

Price: \$739

Manufactured by: Audax Loudspeakers, Oakleigh, Victoria

Absolute copyright in this review and accompanying measurements is owned by Electronics Today International. Under no circumstances may any review or part thereof be reprinted or incorporated in any reprint or used in any advertising or promotion without the express written agreement of the Managing Editor.



Get The Professional Disco Sound!

Three great reasons why a recent survey published by Billboard Magazine reveals that for the third year in a row Stanton has increased its share of the Disco phonograph cartridge market. The Stanton share has grown to an impressive 55.8%... a full 24 percentage points more than its nearest competitor.

The 500AL, known as the workhorse of the broadcast industry, meets the extremely rugged requirements of live application without sacrificing performance quality.

The 680EL is designed to deliver sound excellence and at the same time stand up to back cueing, vibrations and mishandling.

For home Disco, the 680SL is the perfect choice. It features the patented Stereohedron™ stylus tip assuring longer life for record collections.

From Disc cutting to Disco... to home entertainment... your choice should be the Choice of the Professionals... Stanton cartridges.

© 1979 STANTON MAGNETICS



STANTON #1 in DISCO

THE CHOICE OF THE PROFESSIONALS™

Sole Australian Distributors:
LEROY INDUSTRIES PTY LTD

Head Office: 156 Railway Pde, Leederville, Western Australia, 6007. Phone 81 2930
NSW Office: 7 Jordan Rd., Wahroonga, 2076. Phone 487-2543

Available at quality conscious Hi-Fi dealers throughout Australia!

AUDIO DESIGN professional audio products



REFERENCE PREAMPLIFIER

This new class A preamplifier eliminates cartridge interaction common mode and slewing induced distortions, and provides accurate and extended bass response with 18dB/octave subsonic filtering below 15Hz. Noise reduction unit links and record/playback/copy facilities for two tape decks are provided. 20Hz-20KHz ± 0.25 dB(RIAA); <0.01% THD at 1V out (20Hz-20KHz) 10V/ μ s phono slewing rate; 90dB signal/noise below 10mV in 40dB overload margin (20Hz-20KHz) \$395



OCTAVE BAND GRAPHIC EQUALIZER

A high slewing rate, ultra low noise, wide bandwidth design. 20Hz-20KHz ± 0.25 dB; <0.01% THD at 1V out; 100dB signal/noise ± 15 dB control range (adjacent filters at $\frac{1}{2}$) \$395

Please contact

AUDIO DESIGN

3/7 Harvton Street, Stafford 4053. Phone (07) 356-9191 or Sydney 597-3492, Adelaide 272-6606, Perth 322-4606.



4 POWER AMPLIFIERS

The amplifiers all feature high slewing rates and will drive 8 ohms $\pm 40^\circ$ load phase angles to full output. Avoidance of output coupling zobel networks eliminates frequency response aberrations with reactive loading. 20Hz-20KHz ± 0.25 dB; <0.05% THD at 1dB below clipping (typically 0.02% 1KHz).
 25 Watts/channel into 8 ohms CLASS A \$395
 50/75 Watts/channel into 8/4ohms class AB1 \$350
 100/150 Watts/channel into 8/4ohms class AB1 \$550
 200/300 Watts/channel into 8/4ohms class AB1 \$750



ACTIVE CROSSOVER UNIT

This 2/3 way unit features a phase and amplitude coherent class A design. Variable 100Hz-1KHz, 8Hz-8KHz crossover frequencies. 5V/ μ s slewing rate; 100dB signal/noise ratio; <0.01% THD at 1V out; 26dB gain range \$395
 NEW SUBWOOFER CROSSOVER 18dB/octave; 150Hz nominal \$250

OTHER PRODUCTS INCLUDE compander, active crossover/amplifier combination, moving coil amplifier, disco mixer, 12 into 2 microphone mixer, loudspeaker systems, passive Crossovers.



Telephone (02) 231-4091
232-6804

INTERNATIONAL
PTY. LTD.

GPO BOX 72, SYDNEY 2001



Yes at last! These fantastic NORTH STAR Horizon Computer systems are so popular in America that until now it was virtually impossible to obtain them in Australia. They feature an S-100 12 slot bus, dual or quad capacity 5" disk drives, RS232 (serial) and parallel ports, multi tasking multi user expandability, North Star Basic, Pascal and a host of other features. Call us or our dealers for details.

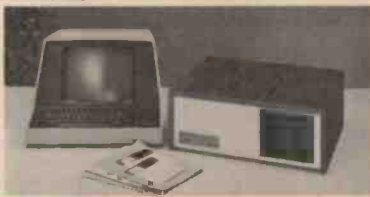

RESEARCH — UNIVERSITY — COMMERCIAL/INDUSTRIAL

We have the terminals, printers and multitasking micro mainframes to suit your needs for word processing, data processing and research work.

HOME AND SMALL BUSINESS:

If you are looking for a whole system or just one printer, talk to us or one of our dealers before you buy because we offer the best selection to suit your needs. For example, we can supply products from the following manufacturers:

- | | | | | | | | | | | | | | | | |
|--|---|---|---|--|---|---|---|--|------------------------------------|--|---|---------------------------|---|---|---|
| COMPUTER GAMES
Alter Ego
Cralg
Fidelity Electronics
Texas Instruments | DISK CONTROLLERS
Cromemco
Konan
Northstar | ENVIRONMENT CONTROL
Mountain Hardware | FLOPPY DISK SYSTEMS
North Star
Percitar
Shugart | HARD DISK DRIVES
Century Data
Control Data Corp.
Cromemco
Fujitsu | INDUSTRIAL PROCESS CONTROL
D.A.I.
Ecotronics | SOFTWARE
Cromemco
Digital Research
Lifeboat Associates
Micro Pro
Microsoft
Microsource
Software Works | SPEECH SYNTHESISERS/ ANALYSERS
Computalk
Heuristics Speechlabs | TELECOMMUNICATIONS
D.C. Hayes
Teletype
Texas Instruments | MEDIA
Scotch
Verbatim | MEMORY
Cromemco
Industrial Micro
Northstar
Vector Graphic | MICROCOMPUTER SYSTEMS
Commodore
Cromemco
Datapoint
DEC
Exidy
Industrial Micro
Intelligent Systems Corp
Intertec
Microcomputer Systems
Northstar
Ohio Scientific
Vector Graphic | PRINTERS
Base 2 | Centronics
D.E.C.
Diablo
Dip
Impact Data
Integral Data Systems
I P S I
LRC
MPI
N E C
Qume
Super-Brain
Teletype
Texas Instruments | VIDEO TERMINALS/ MONITORS
Beehive
Hazeltine
Intertube
Micro-term
Soric
Tec
Televideo
Visual Technology | MISCELLANEOUS
Electrolabs
Houston Instruments
Mullen
Rochester Data
Spectronics |
|--|---|---|---|--|---|---|---|--|------------------------------------|--|---|---------------------------|---|---|---|

DEALER AND WHOLESALE ENQUIRIES INVITED:

Distribution Manager,
GPO Box 72, Sydney 2001.

MICRO-80

P.O. BOX 213, GOODWOOD, S.A. 5034 AUSTRALIA. TELEPHONE (08) 71-9683

MICRO-80 is Australia's only monthly microcomputing journal devoted exclusively to the TANDY T.R.S. 80. With software listings, articles on both BASIC and Machine Language programming, hardware (both add-on and modifications), problem solving columns, readers letters and hints, club notices, etc, etc. Each edition will keep you entertained at your micro's keyboard until the next arrives. For those with less time, we also offer a monthly cassette containing all that month's software.

U-BOAT — \$15.00 plus 50c p&p

With Real Time Simulation at its best! Comes with working sonar — screen and periscope, a full rack of torpedoes, plenty of targets, working fuel and battery meters. Has a helpful mother-ship for high seas re-provisioning and even an emergency radio for that terrible moment when the depth charges put you and your crew at risk. Required level 2/16K.

BMON — THE ULTIMATE HIGH MEMORY BASIC MONITOR — (L2/16K & up) — (not suitable for use with Disk Basic) \$19.95 plus 50c p&p.

Our own personnel refuse to write BASIC without first loading this amazing machine language utility program into high mem-

ory! BMON Renumbers; Displays Basic programs on the screen while they are still loading; Tells you the memory locations of the program just loaded; Lets you stop a load part-way through; Merges two programs; with automatic renumbering of the second so as to prevent any clashes of line numbers; Recovers your program even though you did type NEW; Makes one program invisible while you work on a second (saves hours of cassette time!); Lists all the variables used in the program; Makes SYSTEM tapes; Lets you Edit memory directly . . . the list goes on and on. Cassette comes with 16K, 32K, and 48K versions, ready to load. Can anyone afford NOT to have BMON?

TOUCHTYPE (L2/4K) \$19.95 plus 50c p&p

An Interactive, 22 lesson typing course which uses the computer's keyboard and screen to teach you to type rapidly and accurately. The computer checks for accuracy, and sets timed exercises to check your progress. If you have to look at each key before you press it, or only use two fingers, then this program, plus a little perseverance will do some amazing things to your typing speed.

FREE

\$40 WORTH OF T.R.S. — 80 SOFTWARE WITH EVERY NEW SUBSCRIPTION TO MICRO-80.

Every new subscriber will receive, on cassette, ready to LOAD, 2 x Level 1 and 2 x Level 2 programs, with a regular retail value of at least \$40.

RPN CALCULATOR (L2/16K & L2/32K) \$24.95 plus 50c p&p

Give your computer the power of a \$400 reverse polish notation calculator with 45 functions and selectable accuracy of 8 or 16 digits. The main stack and registers are continuously displayed, whilst the menu is always instantly accessible without disturbing any calculations or register values. The cassette comes with both the 16K and 32K versions, the latter giving you the additional power of a programmable calculator. Comes with a comprehensive 15 page manual. Whether for everyday or occasional use, this package will prove invaluable, and turn your '80 into a very powerful instrument.

LEVEL II ROM MAP (book) \$24.95 plus \$1.20 p&p

All the secrets of the Level II ROM are revealed at last! If you're an assembly language programmer, or if you just want to know what goes on inside that BASIC INTERPRETER, then this is just what you've been waiting for. ROM-MAP tells you what every significant routine in the ROM does, how to use it, and how to escape from it. This will save you hours of tedious programming re-inventing Microsoft's wheel!

DALEK CHASE (L2/16K & up) \$15.00 plus 50c p&p

An absorbing game in which you save Dr Who from pursuing Daleks. The better you play, the harder it gets (and vice versa). Infinite range of play levels from HARD to UTTERLY IMPOSSIBLE, and comes complete with messages of praise and mediocre insults. Fun for all ages 15 to 150!

These items represent only a selection of our AUSTRALIAN PRODUCED software and TRS 80 support lines. Send an A4 size SAE for a free software catalogue, or order from this listing, and we'll send the catalogue anyway.

DEALER ENQUIRIES ATTENDED TO PROMPTLY.

ATTENTION amateur programmers. We are always looking for quality software.

To: MICRO-80,
P.O. Box 213, Goodwood, S.A. 5034.

Please rush me the items checked below.

- 12 month subscription to MICRO-80 and my free software cassette \$24.00
- 12 month subscription to MICRO-80 and the cassette edition, plus my free software cassette \$60.00
- The latest issue of MICRO-80 \$2.50
- Touchtype \$20.45
- RPN Calculator \$25.45
- BMON \$20.45
- Dalek Chase \$15.50
- Level II ROM MAP \$26.15
- U-Boat \$15.50
- Your FREE Software Catalogue

TOTAL ENCLOSED \$.....

NAME.....

ADDRESS.....

..... Post Code.....

bankcard No Expiry Date.....
welcome here

Please debit my Bankcard \$.....

Signature.....

Micro 80 and Micro 80 software also available from: C.I.S.A., 159 Kent Street, Sydney NSW (opposite IBM building). Rymac, 2 Balanda Street, Jindalee QLD. Conquest Electronics, 212 Katoomba Street, Katoomba NSW.

OEM's and Systems Builders from Sorcerer and Tandy all the way to main frame.

You too can make like the big boys with the Mitsui 1300 Series range of intelligent interfaces.

From Sorcerer Mk II and Tandy TRS80 through Apple, DEC, Hewlett Packard and all the way to most main frames Mitsui have designed and successfully installed interfaces to enable your micro or mini to deliver what you need. There is a full range of buffered intelligent interfaces for RS232c, I.E.E. and 8 bit Parallel, Centronics compatible, all simply and speedily fitted with plug-in printed circuit boards and custom control panels.

Front - HyType II with metal print wheel for 'camera-ready' copy.

Rear - HyType II with wide-bed printer for forms up to 762mm wide.

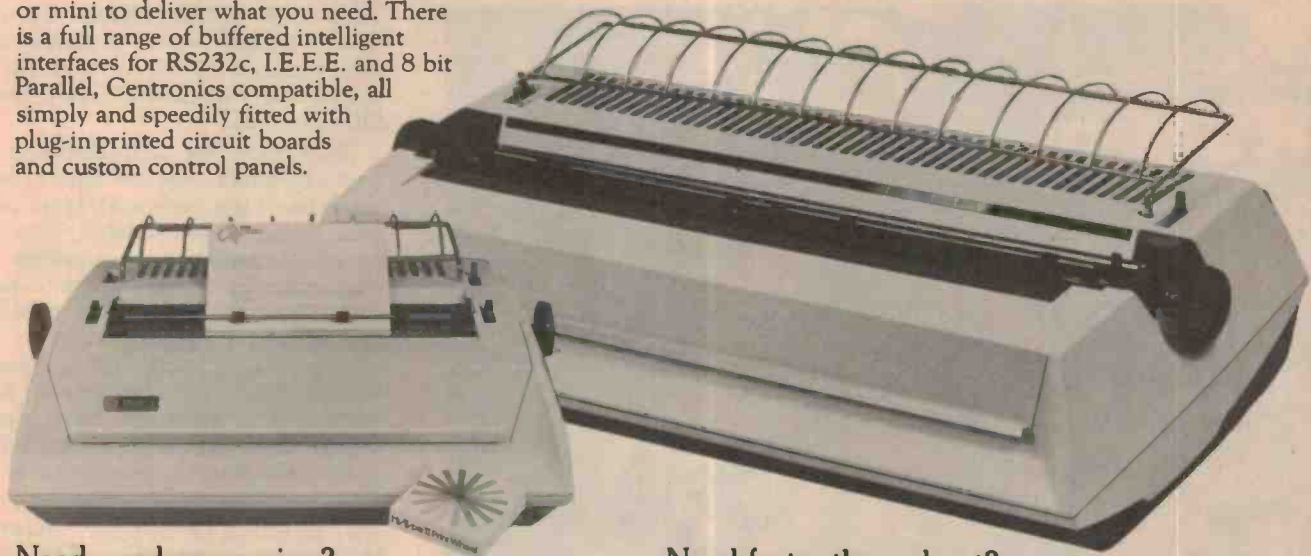

Need word processing?

Certainly. Diablo HyType II 1345 prints up to 45 characters per second with excellent character definition and quality. Diablo's Daisy Wheel printer gives you the industry's largest range of type styles, reproduced on forms up to 393mm wide.

Need 'Camera-ready' copy?

No problem with HyType II 1355 WP and its exclusive metal Daisy Wheel printer. Offering true proportional spaced printing and a denser, blacker character impression than can be provided by the less durable plastic wheel. Diablo's metal wheel has an expected space life of about 16 million characters - field experience indicates 30 to 50 million are possible.

Need faster throughput?

Diablo HyType II 1355 HS is specifically designed for those applications which require faster output without sacrificing print quality. Printing up to 60 characters per second. Diablo 1355 HS uses the interface that has become the industry standard for fully formed character serial printers, the HyType II. In addition, Mitsui Computer Systems have developed a range of serial and parallel interfaces which suit most current systems.

Need wide-bed printing (to 762mm)?

Diablo HyType II 1380 WB is the first wide-bed printer to offer excellent print quality. Handles accounting ledger sheets and legal forms up to 30 inches (762 mm) wide with uniform character density. Features Diablo exclusive metal Daisy Wheel to combine high quality and high volume printing.

To find out what Diablo can do for you just phone Sydney (02) 929 9921 or Melbourne (03) 690 6722 or mail the coupon. Trade enquires are welcome.



**MITSUI
COMPUTER SYSTEMS
(Australasia) Pty. Ltd.**

7 West Street, North
Sydney, N.S.W. 2060

Yes, I'd like to know more what Diablo can do for me. I am especially interested in (tick box)

- Word Processing Camera-Ready Copy Faster Throughput
 Wide-Bed Printing Special Interface Other (please specify)

Name: _____

Company: _____

Address: _____

Postcode: _____ Phone: _____

That was the 1980 Home Computer Show, that was . . .

'Twas in the merry month of May, when 64K RAMS were sweetly bloomin...' to parody an old folk song. Impressions from this now established, annual event.

John Pollard



"Melody", the Cyber robot . . . Dick Smith's crowd-puller for the show.

THE 1980 Sydney Home Computer Show was held over 22 to 25 May when an estimated 10 000 visitors 'hit' the stands at the Westco Pavilion in Sydney Showgrounds.

Show organiser, John Kennedy, said that exhibitors were extremely pleased with the high technical level of the enquiries and the increasing number of small businessmen who realise that they must be conversant with micro-computers. He said those exhibitors selling books, magazines and software were especially happy with the show. It seems the large numbers of school parties who arranged visits demonstrated that the next generation is going to take computers seriously indeed.

Visiting the show, I was amazed at the technical knowledge shown by the many young visitors of both sexes eagerly crowding the stands. The computer games on show at the Computerland, Chelsea, Tandy, Hanimex and Dick Smith stands were popular amongst youngsters and 'old hands' alike and one could detect many a heated discussion about the merits and faults of *this* games program compared to *that*.

A few exhibitors put on crowd-catching "drawcards". Tandy's stand was dominated by a huge projection-TV VDU, one Computerland stand (they had three!) was doing computer portraits on aluminised printed paper while Dick Smith had Melody, the Cyber robot — an attractive lady in a silver lame suit who acted convincingly like a robot, creating great amusement amongst the visitors.

Quite a number of complete systems and peripherals were on show, some for the first time. Tandy had their Model II, along with an array of the familiar TRS80s; Dick Smith exposed his System 80 (at long last . . .); Computerland had



Bird's-eye view from the middle of the Westco Pavilion — and this pic was taken on a 'slack' day!

their Apple II Plus with some interesting new software additions; Hanimex put their CBM system through its word processing paces and T.C.G. showed off their Ohio machines with some attractive and spectacular colour graphics. Acoustic Electronic Developments had an unusual stand. Along with systems to suit the businessman and the hobbyist, they demonstrated some marvellous computer music software and had a range of the famous 'blue boards' and kits (including the ETI-643 EPROM Programmer) for the hard-bitten hobbyist.

Another unusual exhibitor was Sigma International. Their range of products was dominated by peripherals,

though they had a system on display as well.

The US Fourth West Coast Computer Faire last year highlighted the rise in software production and distribution. It seems that trend has spread to Australia as there were quite a number of software peddlers in evidence at the Sydney Home Computer Show this year. Of the big guns, Tandy, Dick Smith, Hanimex and Computerland had a lot of software on offer. A number of specialist companies have sprung up and we noted Datasoft and Seahorse Computer Services both selling software for the PET, Micro-80 with programs (and a magazine!) for TRS80 and System 80 users and M.S.C.O. with

Cromemco software (and hardware too!).

Other exhibitors included Electron Computer with the Data General commercial mini systems (*that's the top end...*), The Logic Shop with a Compucolor II and an interesting acoustic coupler (interesting possibilities...) and Rank demonstrating their Motorola systems (6800 ways to...).

One of the major problems in the present fast-moving developments in the computer field is that of obtaining information. Businessmen need to know objective comparisons of available equipment, hobbyists need more technical literature, and more inexperienced computer enthusiasts need introductory material. The Technical Bookshop provided a large (like 10⁴ or 64K...) selection of written information and the Australian Computer Society provided pointers to people contemplating a career in computing. Both the Apple Users Group and the Microcomputers Enthusiasts' Group of Sydney were busy distributing pamphlets on their activities to eager hordes.

I felt the show was a very informative experience and absolutely essential for anyone getting into micros for the first time. The next one will be held in Melbourne at the Kew Civic Centre over September 11-14. If you're down that way don't miss it!



David Begg (centre, in the tie) and Duncan Craven (In glasses) talking turkey with customers on the Sigma International stand.

IT HAD TO HAPPEN AND IT HAS!



SAVE OVER

32% ON TANDY & FULLY COMPATIBLE

Easy terms available!

HUGE PRICE BREAKTHROUGH!

ONLY \$595!
WITH LEVEL II BASIC!

DICK SMITH SYSTEM 80 - THIRD GENERATION COMPUTER SYSTEM - THE COMPUTER OF THE DECADE!

**COMPLETE
WITH TANDY COMPATIBLE
LEVEL II BASIC
SO ALL TANDY PROGRAMS ARE
FULLY USABLE**

**IT ALLOWS YOU TO MAKE USE OF THE
LARGEST RANGE OF COMPUTER
SOFTWARE IN THE WORLD!**

AND MORE!

* **THE SYSTEM 80 EXPANSION UNIT IS
S-100 BUS COMPATIBLE - NOW
TANDY SOFTWARE WITH AN S-100
BUS - AT A HUGE SAVING.**

WHEN WILL IT END?

* **AND EVEN MORE,
VIDEO MONITOR NOT
NECESSARY!**

**THIS UNIT SIMPLY PLUGS INTO
YOUR STANDARD TV SET (SAVE UP
TO AN ADDITIONAL \$250!)**

Yes, we agree, the Tandy TRS-80 HAS BEEN the best selling microcomputer in the world. The original TRS-80 design is now over 2 years old, and in the microcomputer industry 2 years is a long time.

THE DICK SMITH SYSTEM 80 is fresh from the design laboratory and features latest **"STATE OF THE ART"** techniques.



**INBUILT
CASSETTE
DECK**

**AND PROVISION
FOR AN
ADDITIONAL UNIT.
(TANDY ONLY
ALLOWS THE USE
OF ONE!)**

PRICE PLUMMETED and features have been added. In our opinion, the greatest disadvantage of the TRS-80 is the fact that it is not S-100 Bus compatible, meaning that the fantastic range of S-100 products (speech synthesizers, disk controllers etc.) are not readily usable. This problem has now been solved with the

**DICK SMITH
SYSTEM 80**

Over 500 sold
in 10 days:
Australia's
fastest selling
microcomputer



BASIC SPECS:

- ★ Z-80 microprocessor
- ★ Takes two cassette players – one is built in!
- ★ RF output direct to TV set (video output as well!)
- ★ 12k Tandy compatible BASIC
- ★ 16 lines of 64 characters or 32 characters
- ★ 128 x 48 graphics matrix
- ★ Dick Smith backup
- ★ Expansion with S-100 system

When comparing Tandy TRS-80 with level II BASIC, 16k RAM and cassette recorder (\$1019.50) with System 80 16k (\$695.00),

YOU SAVE 32%

SYSTEM 80

With Level II BASIC
(12k); Inbuilt recorder;
Demonstration tape;
Inbuilt TV modulator;
4k RAM:

\$595

Cat. X-4003

SYSTEM 80

As
described
16k RAM:

\$695

Cat. X-4005

DICK SMITH ELECTRONICS

NSW 125 York Street, SYDNEY, Ph 290 3377
147 Hume Highway, CHULLORA, Ph 642 8922
162 Pacific Highway, GORE HILL, Ph 439 5311
30 Grose Street, PARRAMATTA, Ph 683 1133
813 Princes Highway, BLAKEHURST, Ph 546 7744
263 Kairs Street, WOLLONGONG, Ph 28 3800

VIC 399 Lonsdale Street, MELBOURNE, Ph 67 9834
656 Bridge Road, RICHMOND, Ph 428 1614
166 Logan Road, BURANDA, Ph 391 6233
842 Gympie Road, CHERMSIDE, Ph 59 6255
ACT 96 Gladstone Street, Fyshwick, Ph 80 4944
SA 60 Wright Street, ADELAIDE, Ph 212 1962
WA 414 William Street, PERTH, Ph 328 6944

bankcard
welcome here

SHOPS OPEN 9AM to 5.30PM
(Saturday: 9am till 12 noon)
BRISBANE Half hour earlier
ANY TERMS OFFERED ARE TO
APPROVED APPLICANTS ONLY
RE-SELLERS OF DICK SMITH
PRODUCTS IN MOST AREAS OF AUSTRALIA.



MAIL ORDER CENTRE: PO Box 321, NORTH RYDE NSW 2113, Ph 888 3200, PACK & POST EXTRA.

"Where you reap the benefit!"

MC68000

Break away from
the past.



Motorola's MC68000 sets new MPU system performance standards for the '80s. Now.

Motorola announces a new microprocessor so advanced in concept it offers the designer virtually unlimited freedom of system design. Advanced technologies provide it with a speed/power product four times that of standard NMOS. Break away from the past and step into the new era of microprocessors.

Everything you need for system design is available now—a Design Module for evaluating the MC68000, development hardware and software, full documentation and training. In addition, the MC68000 interfaces directly and easily with existing M6800 Family peripherals, MPUs, and MCUs.

The MC68000 is, by design, perfect for an easy-to-handle, block-structured, high-level language like PASCAL. It simplifies modern programming techniques like modular programming.

Complete M68000 design support available now. Concurrent with introduction of the MC68000, the design tools to help you break away from the past are now available.

A major commitment to development of timely and effective M68000 hardware and software has been part of the program from the beginning. The results, part innovation and part evolution, give you a choice among Motorola's EXORciser®, the

IBM 370 and the PDP*-11 for system hardware and software development.

Motorola offers the total range of microcomponents for your advanced systems.

Motorola's original M6800 Family pioneered the concept of the fully-compatible, matched set microprocessor plus I/O, peripheral controller and memory family, complete with support hardware, software and training.

The MC68000 springs from a rich tradition in both microcomponents and MOS technology and is designed to develop in the same total family way as the M6800 Family.

Pace-setting products like the MCM6664 64K dynamic RAM, the MC6809 super 8-bit microprocessor, and the definitive MC6801 and M6805 Family one-chip MCUs have firmly established Motorola's capability.

For further details and application form please contact:



**RANK
ELECTRONICS**
PTY LIMITED
INDUSTRIAL SYSTEMS

12 Barcoo Street, East Roseville NSW 2069. Phone: 406 5666
60 Rosebank Avenue, Clayton South Vic 3169. Phone: 541 8444
299 Montague Road, West End, Brisbane 4101. Phone 44 2851
101-105 Mooringe Avenue, Camden Park SA 5038. Phone 294 6555
430 Newcastle Street, Perth WA 6000. Phone: 328 3933
120 Parry Street, Newcastle NSW 2300. Phone: 26 2466

*Trademark of Digital Equipment Corporation.

MAS5694

Print-out

New generation of micro computers announced

The US Computer Conference in May saw the introduction of the 'third generation' of microcomputers, aimed at the small business user.

It was reported that the under \$10 000 sector will be the most explosive section of the total computer market for the next few years.

Both personal and main-frame computer manufacturers are looking at the opportunities in this market area. Massive advertising campaigns are being launched in the US by companies such as IBM, Hewlett-Packard, Apple, Commodore and Tandy.

The machines being promoted are geared for use with high quality printers for word processing, vastly improved computational performance and flexibility to allow applications in education, laboratory, office and industry.

An example of the machines whose details are to be announced in the next few months is the Apple III. This machine will sell for US\$4300 to US\$7800, depending on the peripherals. It contains up to 128 K of RAM, a built-in disk drive, and a professionally oriented software operating system.

At the moment, personal

computers are differentiated more by the available software than by the hardware and this is expected to be reflected in the small commercial systems now being offered. The best value for money will depend on the software support offered by the manufacturer and independent companies.

The Microprocessor systems are now grouped in three price brackets. At the low price end available machines cost around \$700-\$1200. For the more serious hobbyist, the microprocessor plus peripherals costs in the range \$1200-\$2500.

At the top end, the price range is \$4000-\$9000 depending mostly on the cost of peripherals required for a particular application rather than the processor itself.

"These are professional tools and sell for professional prices", said Steven Jobs of Apple Computer at the US Computer Conference. He predicted that a truly mass consumer market for personal computers would not emerge before the end of the decade.



The new Sord M200 Mark VI is based on the Z80A CPU, comes with 64K of RAM and 8K of ROM plus Winchester-type disk controller. See Mitsui, 7 West St, North Sydney NSW for details.

New small business computer

The Sord M200 Mark VI is a computer that should be of special interest to teachers in technical institutions as well as accountants, solicitors, insurance sales offices, and other small businesses.

The computer is based on the Z80A Central Processing Unit with its 4 MHz operation, large instruction set and software backup. In addition, the M200 Mk VI has a separate Arithmetic Processing Unit, the AMD9511, which speeds up arithmetic calculations dramatically.

Another Z80 CPU is incorporated in the Winchester-type disc controller which the makers claim increases the pro-

cessing speed by three to six times. Standard configuration includes 64K of RAM and 8K of ROM. It contains a minifloppy disk drive with 350K of back-up memory.

IBM format 200 mm (8") floppy disks are used for compatibility with other systems.

Large data storage capacity is provided by a Winchester-type hard disk system with 8M of formatted information per disk.

Z8-based single board micro

Zilog have announced a new single board system based on the Z8 single chip microcomputer, which has an on-board Basic/Debug interpreter.

The board features two counter/timers, five parallel I/O ports, 124 general purpose registers and three levels of interrupts.

The board is the first of a series which will include a floppy disc controller, universal mem-

ory plus D/A and A/D input and output. These boards will interface with a bus structure specifically designed by Zilog.

For more information, telephone Sydney (02) 438-4533, Melbourne (03) 497-2181 or Brisbane (07) 36-3396.

Farming computers ?

No, not mooring micros — just farm planning!

The UK Ministry of Agriculture, Fisheries and Food has held the most comprehensive demonstration of the agricultural use of computers ever organised in that country, they say.

The event was held near Winchester in Southern England and the use of computer-controlled harvesting, spraying and other equipment was shown over a two day period in May. Electronics illuminated the improvement possible in farm productivity by efficient computer control of planning, investment and monitoring of all aspects of farm business.

Here in Australia it is a far cry from the halcyon days of John MacArthur when he was starting the wool trade, but who knows... perhaps even now someone in Parramatta is planning Australia's second agricultural revolution with that micro he is developing?

Computer Books



OSBORNE/McGraw-Hill, Inc.

INTRODUCTION SERIES

AN INTRODUCTION TO MICROCOMPUTERS: Volume 0.

The Beginners Book by Adam Osborne. 300 pages \$9.50
If you are not familiar with computers but would like to be, then this is the book for you.

AN INTRODUCTION TO MICROCOMPUTERS: Volume 1.

Basic Concepts by Adam Osborne. 300 pages \$11.95
A must for anyone in the computer field, this best-selling text explains hardware and programming concepts common to all microprocessors on the market today.

AN INTRODUCTION TO MICROCOMPUTERS: Volume 2.

Some Real Microprocessors.
New enlarged 1978 edition, loose leaf \$30.00
Binding Cover to suit \$6.00
Provides objective, commercial-free descriptions of virtually every microprocessor on the market today.

AN INTRODUCTION TO MICROCOMPUTERS: Volume 3.

Some Real Support Devices.
New enlarged September 1978 edition, loose leaf \$18.50
Binding Cover to suit \$6.00
Same objective, in-depth coverage as Volume 2, but applied to support devices that might be used in any microprocessor system. Note: Update series for Volumes 2 and 3 are published every 2 months. They are available ex-stock at \$6.95 each. Send for details.

PROGRAMMING FOR LOGIC DESIGN SERIES

8080 Programming for Logic Design, 6800 Programming for Logic Design, Z80 Programming for Logic Design, by Adam Osborne and co-authors. List price \$11.50 ea.

ASSEMBLY LANGUAGE PROGRAMMING SERIES

8080A/8085 Assembly Language Programming, 6800 Assembly Language Programming, Z80 Assembly Language Programming, 6502 Assembly Language Programming, by Lance Leventhal. List price \$15.00 ea.

SOME COMMON BASIC PROGRAMS

By Lon Poole and Mary Borchers
This book includes BASIC listings for 76 short programs covering financial, math, statistics and general interest subjects. Every program has been tested, examples and sample program runs are published, as are source listings. List price \$16.50 per book.
Note: Some Common BASIC Programs are available on cassette for the Commodore PET and Radio Shack TRS-80 at a list price of \$18.00 per cassette.

E&L TECHNIBOOK SERIES

555 TIMER APPLICATIONS SOURCE BOOK With experiments H. Berlin 168 pages \$8.00
THE DESIGN OF ACTIVE FILTERS. With experiments H. Berlin 288 pages \$10.00
THE DESIGN OF OPERATIONAL AMPLIFIERS CIRCUITS, With experiments H. Berlin 280 pages \$10.00
PHASE LOCK LOOPS: With experiments H. Berlin 263 pages \$10.50
NCR BASIC ELECTRONICS COURSE, With experiments: Edited by C. Titus, J. Titus, P. Rony and D. Larsen 440 pages \$11.00
NCR DATA COMMUNICATIONS CONCEPTS: Edited as above 220 pages \$11.00
DBUG: AN INTERPRETIVE DEBUGGER: Describes DEBUG, a 1K program that simplifies the programmers task in creating, debugging, or editing 8080 programs J. Titus 64 pages \$6.00
CMOS-M: CMOS DESIGNER'S PRIMER AND HANDBOOK R. Giroloso and J. Streator 8080/8085 SOFTWARE DESIGN: WITH 190 SOFTWARE SOLUTIONS BBB-C. Titus 228 pages \$11.00

MICROCOMPUTER-ANALOG CONVERTER SOFTWARE AND HARDWARE INTERFACING: BB7 J. Titus, C. Titus, P. Rony and D. Larsen 248 pages \$11.00
BASIC BASIC: An Introduction to Computer Programming in Basic Language. Second Edition. (James S. Coan) 288 pages \$12.00
110 BASIC COMPUTER PROGRAMS: 110 Ready to run Basic programs for hobbyist and engineer (Jules H. Gilder) 60 pages \$8.00
APL: AN INTRODUCTION — This combination workbook/text book offers a problem-solving approach to learning computer programming in Basic (Howard A. Peelle) 256 pages \$11.50
PROGRAMMING STYLE GUIDES: These six short style guides offer short rules or guidelines, for writing more accurate, error-free programs with minimum sweat and struggle. (Henry F. Ledgard)
BASIC WITH STYLE 144 pages \$8.00. COBOL WITH STYLE 160 pages \$9.50. FORTRAN WITH STYLE 176 pages \$9.50. PASCAL WITH STYLE 144 pages \$8.50. PROGRAMMING PROVERBS 144 pages \$9.50. PROGRAMMING PROVERBS FOR FORTRAN PROGRAMMERS 144 pages \$9.50.
DISCOVERING BASIC: A PROBLEM SOLVING APPROACH. (Robert E. Smith, Control Data Corp.) 224 pages \$9.50
ADVANCED BASIC: Applications and Problems (James S. Coan) 192 pages. \$12.00
SARGON: A computer program, written in Z80 Assembly Language (Dan and Kathie Spracklen) 120 pages \$20.00
I/O DESIGN: DATA MANAGEMENT IN OPERATING SYSTEMS. (D.E. Freeman, IBM and O.R. Perry) 384 pages \$23.50
FUNDAMENTALS AND APPLICATIONS OF DIGITAL LOGIC CIRCUITS: Second Edition (Sol Libes) 208 pages \$9.00
MINICOMPUTERS: STRUCTURE AND PROGRAMMING, It thoroughly introduces the reader to MINI hardware, covers all the essentials needed to program minicomputers, uses the PDP-11 for examples (T.G. Lewis and J.W. Doerr) 288 pages \$18.50
THE 6800 MICROPROCESSOR: A SELF STUDY COURSE WITH APPLICATIONS (Lance A. Leventhal) 112 pages \$11.00
BASIC MICROPROCESSORS AND THE 6800 (Ron Bishop, Motorola Semiconductor Group) 176 pages \$16.00
MICROPROCESSOR BASICS: A COLLECTION OF ARTICLES FROM "ELECTRONIC DESIGN" Magazine, Specific models covered include the 8080, F8, 6800, 2650, 6100, 1802, and PACE (Michael Elphick) 224 pages \$16.00
S-100 BUS BOOK HANDBOOK: by Dave Bursky 128 pages \$10.00 DIGITAL EXPERIMENTS: WORKBOOK OF IC EXPERIMENTS Guides you through the hands on verification of the practical theory and trouble-shooting techniques in digital trouble-shooting (Richard Gasperini) 192 pages \$11.00
DIGITAL SIGNAL ANALYSIS: (Samuel D. Stearns, Sandia Laboratories) 228 pages \$27.00
MINI-MICRO SOLDERING AND WIRE WRAPPING: FOR THE HOBBYIST AND TECHNICIAN. Here is the first book devoted entirely to electronic soldering/desoldering and wirewrapping techniques. (Murray P. Rosenthal) 128 pages \$5.50
400 IDEAS FOR DESIGN, Volume 3: taken from Electronic Designs "IDEAS FOR DESIGN" Column 352 pages \$18.50
400 IDEAS FOR DESIGN, Volume 4 352 pages \$18.50

LEADER IN MICROCOMPUTER EDUCATION



STEWART ELECTRONICS

44 Stafford Street, Huntingdale. Vic 3166.
Phone (03) 543-3733. Telex 36908.
Mon-Fri 8.30am to 5.30pm. Sat 9am to 12 noon.
Bankcard accepted.
All books plus \$2.00 pack and post. Tax ex.
Prices subject to change without notice.

- 6502 APPLICATIONS BOOK (for SYM and KIM)
A series of practical (hardware and software) applications for a 6502 board (SYM preferred or KIM) which can be used as experiments, or implemented at minimal cost \$14.95
- MICROCOMPUTER PROGRAMMING: 6502 by Rodney Zaks.
This text will teach you how to program with the 6502, from ground zero if necessary; arithmetic, input-output including polling and interrupts, addressing techniques \$13.95
- MICROPROCESSORS: From Chips to Systems by Rodney Zaks.
An educational text, used world-wide at universities and in industry. 420 pages \$12.95
- PROGRAMMING THE Z80: 330 pages.
The basic introductory text on programming the Z80 \$13.95
- MICROPROCESSOR INTERFACING TECHNIQUES: 416 pages.
By Austin Lesea and Rodney Zaks. All the basic interfacing techniques from keyboard to floppy disk, including the standard busses (S100 to IEEE488) \$15.95

New publication "Computers and Computing"

Computers and Computing — Yearbook 1980, published by the Electronics Group of Modern Magazines (who bring you ETI), has just been released.

This book is absolutely essential for the hobbyist and small business user who wants to know what is happening on the microprocessor scene in Australia right now.

It contains: an armchair guide to microcomputers, a beginners buying guide, reviews of commonly available microcomputers in the country, an introduction to programming in Basic, an explanation of the new IEEE standardised S-100 bus, and a collection of ETI computer projects plus a complete glossary.

The Yearbook has two aims — to help the person who regards a microprocessor or

microcomputer as a tool, albeit a wonderfully flexible one, and also to provide circuit diagrams, printed circuit board layouts, instructions and trouble shooting help for the hobbyist who wants to construct his own computer.

It is packed with information and at \$4.95 for 156 pages it's a real bargain, though we say it ourselves. It is available at newsagents and specialist suppliers or direct, from ETI Subscriptions Department, 3rd Floor, 15 Boundary St, Rushcutters Bay, NSW 2011 (please add 45¢ post and handling if ordering direct).

Printers with impact

AED of Guildford, NSW displayed the Base 2 Model 800 impact printer at the Sydney Home Computer Show. This printer sells for \$828 and offers 64, 72, 80, 96, 120 or 132 characters per line and churns out paper at 60 lines per minute. The character font is a standard 5x7, 96 character ASCII set with the facility to have expanded characters and a user-defined set. Baud rates from 75 to 19 200 can be selected.

The printer is designed for use in small business applications and at its price should find wide acceptance. Enquiries to

A.E.D. on (02) 632-6301.

A more expensive printer, the NDK model S-4000, has been introduced to Australia by **John F. Rose of St. Leonards, NSW**. This impact printer has a 17x16 matrix for high quality printing at 75 characters per second and a 9x7 matrix for high speed printing at 150 characters per second. The printer has two standard fonts and others can be specified by the user. Special characters can be defined in software. Phone John F. Rose on (02) 439-1220 for an audition.

Speech synthesis

Texas Instruments views speech technology as the next major growth area in electronics and are predicting a world wide market of US\$3 billion by the end of the 1980s.

They predict that more and more machines will communicate to people using the spoken word, especially in the areas of computer operating instructions, medical and accident warnings as well as military operations where rapid human action is required.

TI have announced a massive investment in this new technology and are setting up regional centres dedicated to help custo-

mers develop quality speech for their product vocabularies.

The mechanism of speed production was modelled and implemented using digital signal processing techniques for the "Speak and Spell" learning aid sold by TI. The same approach will be used to assist original equipment manufacturers develop speech modules to their own specifications.

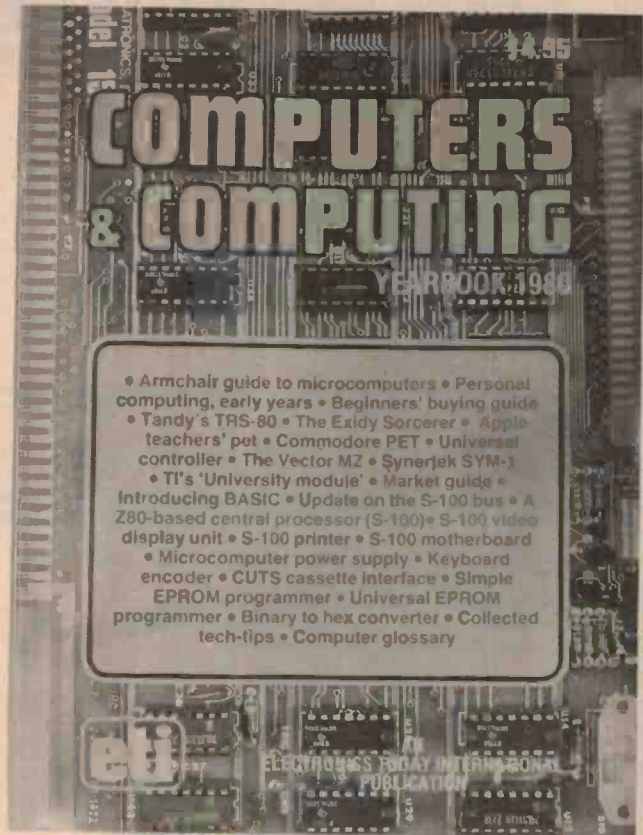

1M minifloppy !

MPI of California have just released their Model 92 minifloppy disk drive which has an unformatted capacity of one megabyte.

This is achieved by using a 96 track-per-inch format, giving 80 usable tracks on both sides of the media, accessible via a double-headed mechanism controlled by a split head positioner.

For further details contact the Australian distributors, Zero One Electronics of Brisbane, (07) 371-6707.

Enthusiasts' News

A minicomputer interest group has been formed in **Gosford, NSW** and their first meeting on May 21st attracted 21 people who exchanged information and interests. Quite a surprising amount of hardware and sophisticated applications were revealed to exist in the central coast area of NSW. Plans for the future include regular meetings, demonstrations, lectures and program exchange and development. Details of the group and the dates of future meetings may be obtained from P.O. Box 525, Gosford NSW.

User groups for the Compucolor II have been formed in Sydney and Mel-

bourne. Meetings will be held on the first Monday of each month in both cities. Details can be obtained from The Logic Shop (02) 699-4919 or (03) 51-1950.

The Commodore Computer Users Association held their first Annual General Meeting on 26 March in the Sydney Science Centre and decided to have monthly meetings on the Wednesday nearest to the 25th of each month at 8:00 pm. The regular meeting place has yet to be decided and further information can be obtained from the Secretary, P.O. Box 4721, Sydney NSW.

Buy OHIO SCIENTIFIC Direct From the INDEPENDENT IMPORTER

PERSONAL COMPUTERS



CIP: \$459 A dramatic breakthrough in price and performance. Features OSI's ultra-fast BASIC-in-ROM, full graphics display capability, and large library of software on cassette and disk, including entertainment programs, personal finance, small business, and home appliances. It's a complete programmable computer system ready to go. Just plug-in a video monitor or TV through an RF converter, and be up and running. 15K total memory including 8K BASIC and 4K RAM — expandable to 8K.

CIP MF: \$1657 First floppy disk based computer for under \$1700! Same great features as the CIP plus more memory and instant program and data retrieval. Can be expanded to 32K static RAM and a second mini-floppy. It also supports a printer, modem, real time clock, and AC remote interface, as well as OS-65D V3.0 development disk operating system.

PROFESSIONAL PORTABLES

C4P: \$849 The professional portable that has over three times the display capability of CIPs. Features 32 x 64 character display in up to 16 colors, graphics, audio output, a DAC for voice and music generation, key pad and joystick interfaces, AC remote control interface and much more. Utilizes a 4-slot BUS (2 used in base machine), 8K BASIC-in-ROM, 8K of static RAM and audio cassette interface. Can be directly expanded to 32K static RAM and two mini-floppy disks.

C4P MF: \$1999 The ultimate portable computer has all the features of the C4P plus real time clock, home security system interface, modem interface, printer interface, 16 parallel lines and an accessory BUS. The standard machine operates at twice the speed of currently available personal computers (with GT option it runs even faster!) The C4P MF starts with 24K RAM and a single mini-floppy and can be directly expanded to 48K and two mini-floppies. Available software includes games, personal, business, educational and home control applications programs as well as a real time operating system, word processor and a data base management system.

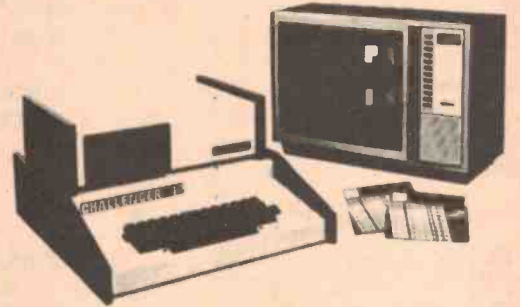

HOME/SMALL BUSINESS SYSTEMS

C8P: \$1099 Same great features as the C4P in a tremendously expandable "main-frame package." Features over three times the expansion capability of the C4P for advanced home and demanding business applications. Can be expanded to 48K RAM, dual 8" floppies, hard (Winchester) disks and multiple I/O devices such as Voice I/O and a universal telephone interface.



C8P DF: From \$3149 The ultimate Home/Very Small Business Computer at a personal computer price. Features 32K RAM (expandable to 48K) and dual 8" floppy disks (stores eight times as much information as a mini-floppy). Has all personal computer capabilities including 32 x 64 display, color graphics, sound, DAC, joystick interfaces, home features including real time clock, AC remote interface, home security and fire detection interface and can be expanded to include voice I/O and a universal telephone system for answering and initiating calls! Its large memory capability and 8" floppies allow it to run most Ohio Scientific business system software including a complete accounting system, word processor and information management system.

OHIO SCIENTIFIC

All Prices ex-tax and subject to change without notice.

ALL OHIO SCIENTIFIC INTERNATIONAL MODELS AVAILABLE FROM
SUPERBOARD TO HARD DISK

DEALERS - Add OHIO SCIENTIFIC to your Line

All enquiries to:

THE ELECTRONIC CIRCUIT

SUITE 414, 4th FLOOR, 20 DUNCAN STREET, FORTITUDE VALLEY — 528455
BRISBANE'S CALCULATOR/MICRO-MINI COMPUTER CENTRE

Print-out

COMPUTER CLUB AND USER GROUPS DIRECTORY

SECTION 1 — arranged by districts

Adelaide

South Australian Microprocessor Group Inc, P.O. Box 113, Plympton, SA 5038. (08) 278-7288. Meets at 7.30pm on the second Friday of each month at Thebarton High School, Ashley St., Thebarton.

Armidale

New England Computer Hobbyists Club, c/- Union, University of New England, Armidale, 2351.

Brisbane

IREE Microcomputer Interest Group, P.O. Box 81, Albion, QLD 4010. (07) 356-6176.

Brisbane Youth Computer Group, 14 Cupania St., Algester, QLD 4115.

Canberra

Microprocessor Special Interest Group (MICSIG), P.O. Box 446, Canberra City ACT 2601, (062) 72-2237.

Geelong

Geelong Computer Club, c/- Ian Stacey, (052) 22-1455 (business hours). Meets 2nd Thursday of each month at Tybar Engineering, Hampton St., Newtown, Geelong Vic 3220.

Gosford

Minicomputer Interest Group, P.O. Box 525, Gosford NSW.

Hobart

Tasmanian Amateur Computer Society, P.O. Box 474, Sandy Bay, Tas. 7005.

Melbourne

Microcomputer Club of Melbourne (MICOM), P.O. Box 60, Canterbury Vic 3126. Meets on third Sunday of every month at AMRA Hall, Willis St., Glen Iris, opposite Glen Iris Railway Station, at 2 pm.

Melbourne

Monash Personal Computing Club, c/- Union Building, Monash University, Clayton Vic 3168.

Newcastle

Newcastle Microcomputer Club, c/- Dr. Peter Moyland, Dept. of Electrical Engineering, University of Newcastle, Newcastle NSW 2308. (049) 68-5256 (office), (049) 52-3267 (home).

Orange

Bruce Carroll, (063) 62-8703 or Neville Wilde (063) 31-5809 or write c/- P.O. Box 1117, Orange 2800.

Perth

Western Australian Computer Enthusiasts Group, c/- R. Langlois, Memorex Pty Ltd, 49 Haty St., Subiaco WA 6008. Meets last Monday of each month at 7.30pm at Taimac Video Corporation, 1st floor, Cnr Newcastle and William Streets, Perth.

University Computer Club, Room 217, Guild Building, Guild of Undergraduates of WA, Crawley, WA 6008. (09) 380-2297.

Sydney

Microcomputer Enthusiasts' Group, P.O. Box 3, St. Leonards NSW 2065. Meets at WIA Hall, 14 Atchison St, St. Leonards, on the first and third Mondays of the month at 8pm.

IREE Microprocessor Group, c/- Dr. Barry Madden, School of Chemical Technology, University of NSW, P.O. Box 1, Kensington NSW 2033. (02) 662-2423.

Marrickville Microcomputer Society, c/- 26 Malakoff St., Marrickville NSW 2204. (02) 569-5689.

Manly Micro Interest Group, c/- Lionel Hirning, (02) 98-7338 or Ron Bloom (02) 938-1476. Meets 2nd Monday of each month at Manly Youth Centre, Kangaroo St, Manly NSW.

Tasmania

Darth Amateur Computer (and electronics) Society, 4 Melling Place, Tarooma, TAS 7006.

Wagga Wagga

c/- David Aleksic, P.O. Box 186, Wagga Wagga NSW 2650.

Wollongong

Wollongong Computer Club, c/- Gary Nelson, 220 Farmborough Road, Farmborough Heights, NSW 2526. (042) 71-4054.

NEW ZEALAND

Auckland

The NZ Microcomputer Club, P.O. Box 6210, Auckland 1, NZ.

Christchurch

c/- Paul Campbell, 50 Francis Ave, Christchurch, NZ.

Wellington

Wellington Microcomputer Club, P.O. Box 1581, Wellington, NZ.

SECTION 2 — arranged by processor or computer

Apple II

Apple II Users Club, c/- Computerland Australia Pty Ltd, 55 Clarence St, Sydney 2000.

CompuColor II

CompuColor II Users Group, c/- The Logic Shop, 91 Regent St, Chippendale, NSW 2008. (02) 699-4919.

CompuColor II Users Group, c/- The Logic Shop, 212 High St, Prahran, Vic 3181. (03) 51-1950.

Commodore

Commodore Computer Users Association, P.O. Box 4721, Sydney NSW 2001.

Exidy Sorcerer

Exidy Sorcerer Users Group, c/- Frank Schuffelen, 66 Porter St, Templestone Vic 3106.

Sorcerer Users' Group, P.O. Box 43, Peakhurst NSW 2211. Meets at WIA Hall, 14 Atchison St, St Leonards, 4th Monday of every month. Workshops on 1st Friday of odd months, 2nd Friday of even months.

North Star

North Star Users Group, P.O. Box 156, Carnegie, Vic 3163.

T159

T159 User Exchange Service, c/- Serge Petelin, 95 Gerler St, Bardon QLD 4065. (07) 450-2026.

TMS9900

Australian 9900 Users Group, P.O. Box 835, Melbourne Vic 3001. Barry Day, (03) 661-2523 (business hours).

TRS-80

TRS-80 Users Group, c/- G.F. Stevenson, 34-36 Sturt St, Adelaide, SA 5000. (08) 51-5241. Meetings 1st Thursday of every month at address available from the above.

TRS-80 Users Group, c/- Les Kinch VK2BBD 128A Booralie Duffys Forest NSW 2084. (02) 450-2026.

2650

Australian 2650 Users Group, c/- Applied Technology, 1A Paterson Ave, Waitara, NSW 2077.

8080/8085/Z-80

AT-80, c/- Rod Whitworth, Planet Three Systems, 47 Birch St, Bankstown NSW 2200.

HARDWARE

S100

SM Electronics
Teletek
BETSI interface for PET
Thinker Toys

6800 (Exorciser bus)

SM Electronics
Pennywise Peripherals

PET

Commodore
NEECO
GPA Electronics Inc

TRS-80

Small Systems Hardware

SYSTEMS

SM Electronics
Pennywise Peripherals
Commodore Business Machines
ASP Microcomputers

PERIPHERALS

PRINTERS

DOT MATRIX
— Anadex DP8000/DP9500
— C.I.TOH D8300
— Paper Tiger
— CBM 2022 & 2023
— Mallbu 160 & 165
— DEC LA34
DAISY WHEEL
— IPSI 1622 & 1650

DISK UNITS

Discus
Shugart
Remex
CBM 2040

TERMINALS

SM — WF402
Telaray 1061
IDS Intertube 11
TEC Series 500

SOFTWARE

8K PET
16/32K CBM
TRS-80
APPLE
5 1/4" x 8" CP/M
CP/M Users Library

MAGNETIC MEDIA

Cassettes
3M 8" Floppies
Verbatim Mini Floppies

MANUALS

6502, Z80 and BASIC

THE BYTE SHOP

Telephone (062) 81-5011
PO Box 118, Mawson ACT 2607
29 Colbee Court, Phillip



ROD IRVING ELECTRONICS

425 HIGH STREET, NORTHCOTE 3070, MELBOURNE VICTORIA. Ph (03) 489-8131.

\$100 COMPUTER PRODUCTS

16K EPROM CARD-S 100 BUSS



\$89.50
KIT

FIRST TIME OFFERED!
BLANK PC BOARD - \$39

USES 2708's!

Thousands of personal and business systems around the world use this board with complete satisfaction. Puts 16K of software on line at **ALL TIMES!** Kit features a top quality soldermasked and silk-screened PC board and first run parts and sockets. Any number of EPROM locations may be disabled to avoid any memory conflicts. Fully buffered and has WAIT STATE capabilities.

OUR 450 NS 2708'S
ARE \$8.95 EA. WITH
PURCHASE OF KIT

ASSEMBLED
AND FULLY TESTED
ADD \$36

8K LOW POWER RAM KIT-S 100 BUSS SALE

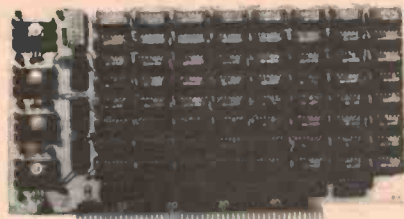

PRICE
CUT!

\$159.50

21L02
(450 NS RAMS!)

Thousands of computer systems rely on this rugged, work horse, RAM board. Designed for error-free NO HASSLE systems use.

Blank PC Board w/Documentation
\$44

Low Profile Socket Set.. 13.50
Support IC's (TTL & Regulators)

\$13
Bypass CAP's (Disc & Tantalums)
\$7

ASSEMBLED AND FULLY
BURNED IN ADD \$45

ALL ASSEMBLED BOARDS
ARE TESTED AT 4MHZ.

16K STATIC RAM KIT-S 100 BUSS

KIT \$249
A&T \$279

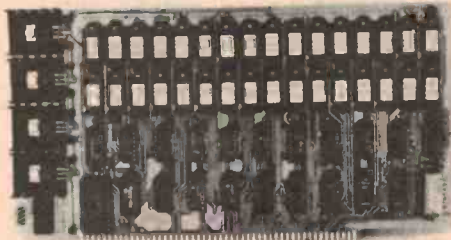

KIT FEATURES:

1. Addressable as four separate 4K Blocks.
2. ON BOARD BANK SELECT circuitry. (Cromemco Standard). Allows up to 512K on line!
3. Uses 2114 (450NS) 4K Static Rams.
4. ON BOARD SELECTABLE WAIT STATES.
5. Double sided PC Board, with solder mask and silk screened layout. Gold plated contact fingers
6. All address and data lines fully buffered.
7. Kit includes ALL parts and sockets.
8. PHANTOM Is jumpered to PIN 67.
9. LOW POWER: under 1.5 amps TYPICAL from the +8 Volt Buss
10. Blank PC Board can be populated as any multiple of 4K.

BLANK PC BOARD W/DATA \$49
LOW PROFILE SOCKET SET \$19
SUPPORT IC'S & CAPS \$27
ASSEMBLED & TESTED-ADD \$30

OUR #1 SELLING
RAM BOARD!

16K STATIC RAM SS-50 BUSS

PRICE CUT!

\$279

FULLY STATIC
AT DYNAMIC
PRICES

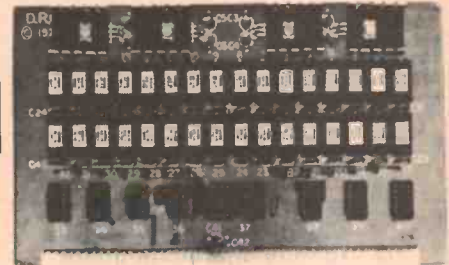

KIT FEATURES

1. Addressable on 16K Boundaries
2. Uses 2114 Static Ram
3. Runs at Full Speed
4. Double sided PC Board Solder mask and silk screened layout Gold fingers
5. A'l Parts and Sockets included
6. Low Power: Under 1.5 Amps Typical

BLANK PC BOARD— \$39 **COMPLETE SOCKET SET— \$19**
SUPPORT IC'S AND CAPS— \$45

FOR SWTPC
6800 BUSS!

ASSEMBLED AND
TESTED - \$30

ITOH Model 8300 PRINTER. \$770 plus 15% sales tax.

This 80-column printer provides quiet operation, making it suitable for use in offices, classrooms and homes. Specifications include 125 cps, 60 lines per minute, paper loading from bottom or rear and Centronics-compatible, parallel interface.

A bidirectional, dot matrix impact printer with a print head designed for 100 percent duty operation, assuring a print life that exceeds 100 million characters. The precision sprocket-feed mechanism permits printing forms from 4½ to 9½ inches wide. A 96 ASCII character set prints in upper and lowercase with the added capability of producing double-width fonts in boldface. The vertical format unit provides preprogrammed/ programmable tab positions, top of form and bottom of form for complete formatting capabilities.

RITRON 8 SLOT MOTHERBOARD: KIT \$65.90 inc. tax.
BUILT & TESTED \$80.00 inc. tax.

RITRON COMPUTER GRADE POWER SUPPLY: +5V Reg, 10A,
+16V Unreg. Kit of parts \$79.95 inc. tax. A&T \$99.95 inc. tax.

Write for list of other power supplies. Tax free prices also available.

JUST WRAP KIT - JWK-6 \$39.50

● 50ft ea. blue, white, red, yellow wire ● Just Wrap Tool ● Unwrap Tool

S-100 Z80 CPU CARD

Perfect for
OEM's

\$199.00
Wired &
Tested

4 MHZ



ASSEMBLED AND TESTED! READY TO USE! Over 3 years of design efforts were required to produce a TRUE S-100 Z80 CPU at a genuinely bargain price!

BRAND NEW!

FEATURES:

- ★ 2 or 4 MHZ Operation
- ★ Generates MWRITE, so no front panel required,
- ★ Jump on reset capability
- ★ 8080 Signals emulated for S-100 compatibility
- ★ Top Quality PCB. Silk Screened. Solder Masked. Gold Plated Contact Fingers

SHUGART 5" MINI FLOPPY DRIVE: \$379.50 inc. tax.
\$330.00 ex tax.

Verbatim Products available. Please write for price lists.

Prices current till 7th August, 1980. Heavier items add additional postage. Extra heavy items sent Comet freight on. Prices subject to change without notice. Send 60c and SAE for free catalogues. MAIL ORDERS: PO Box 235, Northcote, Vic 3070. Minimum pack and post \$1.00. Phone (03) 489 8131.

Bankcard
Mail Order's
Welcome

Please debit my Bankcard.

Bankcard No.

Expiry Date.....

Name.....

Signature.....

HOW TO BUILD PROJECTS. CRYSTAL
RADIO. ONE-TRANSISTOR RADIO.
KILL THAT GHOST. TV MASTHEAD
AMPLIFIER. FM ANTENNA. SIMPLE
SPEAKER. SIMPLE AMP.

SIMPLE PROJECTS

from electronics today \$2.00

UNIT. SIMPLE
LOUDHAILER. BASIC POWER SUPPLY.
FET DC VOLTMETER. LIGHT DIMMER.
DRILL SPEED CONTROLLER. TWO
SIREN CIRCUITS. HI-POWER STROBE
LIGHT OPERATED SWITCH. CAR
ALARM. AUTO-AMP. FOUR-CHANNEL
FOR \$10. BUYING COMPONENTS.
TRANSISTOR TESTER. COURTESY
LIGHT EXTENDER. BETTER SOUND
FOR \$5. ETI UTILIBOARD. SIMPLE
INTERCOMS. MONOPHONIC ORGAN

SIMPLE PROJECTS, VOLUME 1.

Every beginner has to start somewhere, and this book sure is a good place to start! Projects include: Crystal Radio, FM, Antenna, Car Alarm, Basic Power Supply, Siren Circuits, Electronic Flash Trigger, Pool Alarm, Hi-Power Strobe, Simple Speaker, Auto-Amp, Simple Amplifier, Monophonic Organ etc.

\$2.00 plus 65 cents post and handling.

metal detector
train controller
telephone bell extender
photographic strobe
transistor tester
selecta-game
breakdown beacon
loudness control
touch switch
courtesy light extender
rev monitor counter
auto amp
car alarm
three receivers
code practice oscillator
emergency flash
drill speed controller
active antenna
one transistor radio
mini-organ
accentuated beat metronome
power supply
simple intercoms

SIMPLE PROJECTS, VOLUME 2.

Even more projects for the beginner! This book includes many of the most popular simple projects we have published. Contents include: Induction Balance Metal Detector, Train Controller, Telephone Bell, Extender, Drill Speed Controller, Emergency Flash, Loudness Control, Breakdown Beacon, Active Antenna.

\$2.95 plus 65 cents post and handling.

Available by mail order from:

"Subscriptions Dept., Electronics Today International"
15 Boundary St, Rushcutters Bay NSW 2011

Special reader offer!



Logic tester \$150! freq. counter (inc. S/T) post and handling: \$2.50

It normally retails at around twice this price.

The Colrose Logic Tester Model CLT001 allows accurate functional tests to be made on logic equipment whilst the equipment is operating at its normal speed. It was developed to perform the functions usually provided by most logic testers, plus the functional tests which would normally be carried out using a dual trace CRO, including output duty cycle measurements, without the bulk, cost, and setup times required with such instruments. The CLT001 is a combination of three instruments; LOGIC PERFORMANCE INDICATOR; LOGIC STATE INDICATOR; LOGIC FREQUENCY COUNTER. The unit is compact, very versatile, accurate, easy to use and requires no calibration or setup procedure. Power for the Tester is obtained from the supply of the device under test, and is polarity protected. The three inputs are protected to 20 volts above Vcc/Vdd and 20 volts below Gnd/Vss. This unit normally retails at around twice the offer price and comes complete with all test leads, instructions and a vinyl carry pouch.

The Logic Tester comes with a 6 month guarantee against defects in material and workmanship, excluding 2 MHz crystal, leads and carry pouch.

SPECIFICATIONS —

SUPPLY VOLTAGE: 4.5 volts to maximum of 15.5 volts DC.

POWER CONSUMPTION: 40 mA at 5 volts; 100 mA at 15.5 volts.

DIMENSIONS: Length 91 mm; Width 65 mm; Depth 54 mm.

WEIGHT: 190 grams.

INPUT IMPEDANCE: 100 kohm or greater.

INPUT THRESHOLD LEVELS: Alters with supply voltage to suit device under test.

FREQUENCY COUNTER CRYSTAL: 2,000 KHz. Calibration tolerance .0025%

X1 INPUT, TYPICAL FREQUENCY RESPONSE: DC to 2.5 MHz at 5v VCC; DC to 6 MHz at

10-15.5v VDD.

X10 INPUT, TYPICAL FREQUENCY RESPONSE: 10 Hz to 5 MHz at 5v VCC; 10 Hz to 15 MHz at 10v VDD; 10 Hz to 20 MHz at 15.5v VDD.

IC OUTPUT, TYPICAL FREQUENCY RESPONSE: DC to 1.5 MHz.

MAXIMUM DISPLAY FREQUENCY: X1 input 999,999 Hz. X10 input 9,999,999 Hz.

This offer is made by General Electronic Services Pty Ltd and ETI is acting as a clearing house only. Cheques or money orders should be made out to 'Logic Tester Offer', and sent to ETI Magazine, 15 Boundary St, Rushcutters Bay NSW 2011. We will then process your order and pass it on to GES who will send you the goods. Please allow up to four weeks for delivery.

Please supply . . . Logic Testers at \$150 each \$. . .

Plus post and handling; \$. . .

TOTAL \$. . .

Name . . .

Address . . .

Postcode

(Logic Tester Offer)

MINI-FLOPPY DRIVES FROM MPI!

THE WORLD'S SECOND LARGEST MANUFACTURER OF MINI-FLOPPY DRIVES THE DRIVES WITH FEATURES COMPARABLE TO 8" DRIVES

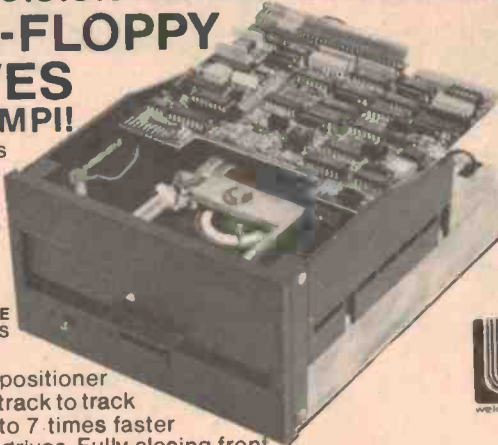

Head band positioner gives 5 ms track to track access - 5 to 7 times faster than other drives, Fully closing front door and 1/2" Clutch Cone for media protection, Double Density Heads, Shugart Compatible, only 10 moving parts due to non-mechanical switching.

TWO MODELS AVAILABLE

- Model 51 Single Head 250k Bytes DD
- Model 52 Double Head 500k Bytes DD

PRICING: 51 \$350.00 (402.50) Inc. tax. 52 \$450.00 (517.50) Inc. tax

Write or call for technical description. Power supply/case available May. Since we are the Australian Distributors OEM discounts are available.



GET INTO MICROPROCESSORS WITH THE S100 BUS FOR EASY EXPANDABILITY

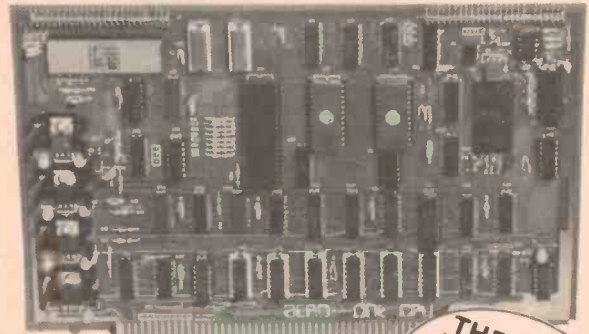

CHEAPER THAN THE USA

THE FIRST AUSTRALIAN DEVELOPED Z80 S100 BUS SYSTEM

SOFTWARE (on cassette)
 Z80 8k Basic to suit our CPU Card \$19.95
 12k Basic etc \$35.00
 Z80 Assembler/Editor/Debugger \$19.95
GAMES PACKAGE 8 large games \$9.95
 And more to come!

SUPPORT DEVICES

Mother Board —

- 8/Slot
 - 7.5a SCR preregulated supply for 5v lines + 16v. 75a - 16v. 75a
 - Actively Terminated
 - Comes complete including all edge connectors and power supply components
 - All Components excepting power transformer and main filter Capacitor mounted on Mother Card
- Price \$159.50 kit

CARD FRAME/CASE

To accept S100 or EXORCISER mother board/power supply and has provision for Fan and 19" rack mounting
 Price: \$105.00
 Freight: \$10.00

S100 MEMORY CARDS

16k Static —

- Access time 450 ns (2MHZ only) 2114
- 16k Bytes organised in 2 x 8k Blocks Individually selected to any 8k Boundary

Price kit \$299.00. All sockets supplied. Assembled and tested add \$40.00

64k DYNAMIC

THE ZERO ONE DYNARAM II

- Access time 250 ns (2MHZ or 4MHZ) 4116
 - 64k Bytes organised in 4 x 16k Blocks
 - Refresh completely transparent using bus signals to derive refresh allowing processor to run at full speed without wait states
 - Supplied on minimum of 1 x 16k Blocks expandable by merely plugging in extra rams.
- Price 16k kit \$255.00 All sockets supplied. each 16k add \$100.00
 Assembled and tested add \$60.00

ETI 640 VDU kit fully socketed \$139

Please note that 200ns memories are required for VDU 4MHZ operation at \$6.00 extra or 10 x 21L02-2 for \$26.00 separately.

Z80 CPU CARD FEATURES —

- Comes with full assembly instructions and card documents.
- Power on jump for automatic execution of monitor program on startup.
- Front panel-less operation allowed by on board 2k monitor which is too good to explain here; 19 commands all unique abbreviations allowed.
- Full S100 DMA Capabilities.
- Sockets supplied for all major devices.
- Clock speed, 2MHZ Standard, 4MHZ Option.
- 1/0 Z80 P10 2 x 8 bit programmable parallel 1/0.
- RAM 256 Bytes scratch pad (Monitor).
- Onboard 2100 baud Tarbell Cassette Interface (Software Controlled) with cassette recorder remote motor control Test Cassette supplied with CPU Kit contains set up procedures for cassette interface as well as software to allow the cassette interface to read and dump 300 baud CUTS (Kansas City) format.
- Keyboard input direct onto card in parallel ASCII.
- Monitor performs all functions to drive ET1640 VDU as an ASCII terminal. Entry points for cursor control etc.
- The spare socket onboard is to allow the National MM57109 to be fitted which works in conjunction with the CPU to give a full floating point RPN arithmetic unit.
- Functions as a general purpose Z80 single board computer or as the heart of a fully expanded system to 64k Bytes of memory and a multitude of 1/0 devices.
- Plated thru solder masked printed circuit board with components screened overlay.
- Description Manual Construction manual \$1.00 refundable with purchase.

PRICE KIT \$199.50 2MHZ

\$225.00 4 MHZ
 \$22.50 Number Cruncher Option
 Assembled and tested add \$50.00

BOOKS

Z80 CPU Technical Description \$10.00 posted
 Z80 P10 Technical Description \$6.50 posted
 Z80 CTC Technical Description \$6.50 posted
 Z80 CPU Programming and Assembly Language Manual \$10.00 posted

CARDS IN DEVELOPMENT

1/0 Card; with serial parallel ports, extra ROM etc.
 Eprom Card; Holds 8 ROMS with Eprom Programmer
 Floppy Control; Minifloppy or Floppy, CP/M Compatible
 Exorciser Mother Board/Power Supply
 Stand alone 80 column 125 CPS Tractor Feed Plain Paper Printer

6809 Exorciser CPU 10k Eprom — 4k ram — Serial/Parallel 1/0 — Dual Baudrate — 9511 NCU
 TRS80 to S100 Interface
 Exorciser 32/16 channel A/D Converter 2650 users! 24k static card bus compatible KT9500
 Exorciser 8 channel Asynchronous — 1 channel synchronous communications interface

DARTBAUD

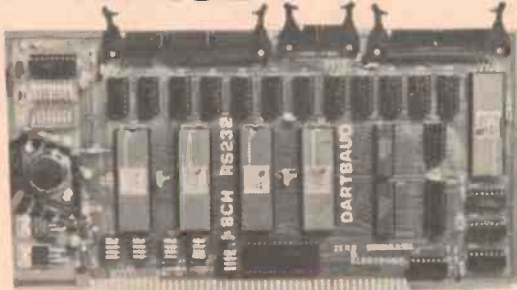

FEATURES:

- 8 Independently selectable 1/0 channels
- 2 Eight bit parallel ports
- RS-232 interface levels
- Async or optional synchronous channels
- Baud rates 50-19, 200 Independently selected for each channel

SPECIFICATION:

Serial Ports: 8 Independent ports using Zilog D/ARTs (sync) or optionally S10/0 (may be retrofitted for synchronous parts, for any pair (S10 and DART are dual devices).

Baud Rates: 8 Independent, crystal-controlled, software selectable rates for each port selected from the 16 standard rates between 50 and 19,200 baud.

Parallel Ports: 2 Independent ports using Zilog P10, selectable as either input or output.

Interrupts: Full on-board interrupt control provided. On-board devices daisy chained. Rotating priority control provided for running multiple boards (through top connector). Jumper selection of interrupt control (local, rotating, vectored). **PRICE: POA & MANUAL AVAILABLE**

KEYBOARDS!

THE CLARE MODEL C70/MGP — by far the best value in keyboards we have seen to date.

- 70 key full upper and lower case with non mechanical Capacitive Keyswitch — fully encoded Microprocessor control with RS232 or 20ma serial options — parallel output standard single 5V Supply, Serial baud rate jumper from 110 to 9600 baud.

PRICE \$160 ea Connector \$3.00 MOULDED ABS plastic case to suit \$26.00

Prices are inclusive of sales tax, tax exempt institutions deduct six percent.

ZERO
 200 MOGGIL ROAD,
 TARINGA, 4068,
 BRISBANE,
 AUSTRALIA.

All prices include freight anywhere in Australia.
 Allow 10 days for despatch.
 Hours of business: Mon. to Fri.: 9am to 5pm. Sat.: 8.30am to 12 noon.

PHONE 371 6707

ELECTRONICS

SELF-STUDY COURSES ON CASSETTES

"The time-efficient way to learn"™

Self-study courses include two to eight audio-cassettes and a special book. They offer the fastest way to learn the topic covered (from ½ to two days). Highly effective.

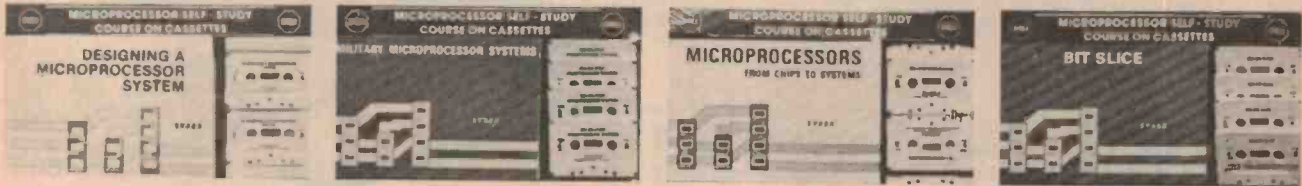

1. INTRODUCTORY-SHORT (2.5 hrs ea)

- S1 — Introduction to Microprocessors \$35.94
- S2 — Programming Microprocessors \$35.94
- S3 — Designing a Microprocessor System \$35.94
- S10B — Introduction to Personal and Business Computing \$26.23.

2. INTRODUCTORY-COMPREHENSIVE (10 to 12 hrs ea)

- SB1 — Microprocessors \$71.94
- SB2 — Microcomputer Programming \$71.94

3. SPECIALISED (4.5 to 6 hrs ea)

- SB3 — Military Microprocessor Systems \$59.95
- SB5 — Bit-Slice \$59.95
- SB6 — Industrial Microprocessor Systems \$59.95
- SB7 — Microprocessor Interfacing \$59.95

A more detailed catalogue on the above courses is available. All courses plus \$4 pack and post tax exempt. Also send for our free up-to-date Book Catalogue.

STEWART ELECTRONICS

44 Stafford Street, Huntingdale, Vic. 3166.
Phone (03) 543-3733. Telex 36908.
Open Mon-Fri 8.30am to 5.30pm. Sat 9am to 12 noon.
Bankcard accepted.

\$9.95

introduction to
**Sorcerer
BASIC**
by John & Judy Deane

A specially prepared guide to BASIC. The language which makes programming fun & easily understood by the beginner.

Cat. B-6103

MAIL ORDER CUSTOMERS:
PACK AND POST FREE!!!

OWN A MICROCOMPUTER... OR THINKING ABOUT ONE?

Here's a superb new book that will take the mysteries out of microcomputers. It is:

DICK SMITH'S INTRODUCTION TO SORCERER BASIC

It's the ideal introduction to computers in general and BASIC in particular. While written with the Sorcerer computer in mind, the contents apply to ANY microcomputer using the BASIC language - which doesn't leave out many! Each chapter includes exercises - with solutions at the back so you can find out where you went wrong.

It includes:

- How to turn on a computer
- What programming is all about
- Storing your programmes on cassette
- Summary of BASIC language & commands
- Glossary of computer terms
- Error messages: and what to do about them

WHERE ELSE BUT . . .

**DICK SMITH
ELECTRONICS**

SEE OUR OTHER ADS FOR STORE AND
RESELLER ADDRESSES



DSE773

commodore

the PET computer

The Pet has a television screen, a keyboard as simple to use as a typewriter and a self-contained cassette recorder which is the source for programmes and for storing data in connection with these programmes. And it has, in its standard configuration, an 8K user memory. (This is in addition to the 14K operating system resident in the computer).

SPECIAL AT NO EXTRA COST
\$200 value of programmes will be provided with each PET purchased



2001-16/32



The CBM Computer is now a truly sophisticated Business System with the announcement of these Peripherals.

The CBM incorporated with the Floppy Disk and Printer makes an ideal business system for most professional and specialized fields, medicine, law, dental, research, engineering, toolmaking, printing, education, energy conservation etc . . . The CBM Business System as a management tool, delivers information to all levels of Business previously attainable only with equipment many times more expensive, the CBM Business system is one of the most cost efficient business tools today. It offers a wide range

of applications from logging management strategy in major corporations to organizing accounts and inventory control of small businesses. Here are just a few of the cost saving uses in the corporation, professional office or small business stock control, purchasing, forecasting, manufacturing, costing, customer records, mailing list, etc. The CBM Floppy Disk and Printer, a compatible business system at a reasonable price — Take a closer look at these Peripherals.

Dual Drive Floppy Disk

The Dual Drive Floppy is the latest in Disk technology with extremely large storage capability and excellent file management. As the Commodore disk is an "Intelligent" peripheral, it uses none of the RAM (user) memory of the CBM. The Floppy Disk operating system used with the CBM computer enables a programme to read or write data in the background while simultaneously transferring data over the IEEE to the CBM. The Floppy Disk is a reliable

low cost unit, and is convenient for high speed data transfer. Due to the latest technological advances incorporated in this disk, a total of 340K bytes are available in the two standard 5 1/4" disks, without the problems of double tracking or double density. This is achieved by the use of two microprocessors and memory I.C.s built into the disk unit. Only two connections are necessary — an A/C cord and CBM Interface cord.



2040

Tractor Feed Printer

The Tractor Feed Printer is a high specification printer that can print onto paper (multiple copies) all the CBM characters — letters (upper and lower case), numbers and graphics available in the CBM. The tractor feed capability has the advantage of accepting mailing labels, using standard preprinted forms (customized), cheque printing for salaries, payables, etc. Again, the only

connections required are an A/C cord and CBM connecting cord. The CBM is programmable, allowing the printer to format print for: width, decimal position, leading and trailing zero's, left margin justified, lines per page, etc. It accepts 8 1/2" paper giving up to four copies. Bidirectional printing enables increased speed of printing.

2022

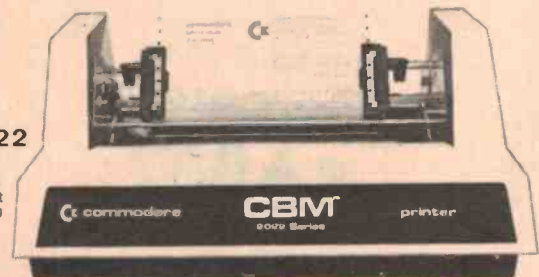

Distributed by

HANIMEX PTY. LTD.
Commodore Business Machines Division.

CONTACT YOUR LOCAL DEALER FOR FURTHER INFORMATION, PRICING AND DEMONSTRATION.



“State of the Art” contest revived

The NSW VHF & TV Group has revived the “State of the Art” contest sponsored and run in the early 1970s by the now demised 6UP Magazine.

Originated by David Tanner, VK3AUU, in 1971 an attempt to run the contest in 1972 by the NSW VHF & TV Group produced no result. In 1973, the event was revived by 6UP — an independant magazine for amateurs interested in VHF and UHF techniques, published by Roger Harrison VK2ZTB (now editor of ETI) and his wife.

Winner of that contest was Wally Watkins, VK5ZWW (now VK2NOW/VK2ZNW). Winner of the 1974 contest was the late Ron Wilkinson, VK3AKC, who also won the original event run by VK3AUU.

The 1980/81 NSW VHF & TV Group committee has revived the contest which will run over the period 19 July to 3 August. It

is open to all amateurs and the aim is to contact as many other stations on any of the available VHF/UHF/SHF bands — with the idea of promoting the more ‘difficult’ scatter techniques and fostering UHF/SHF activity. The contest period includes the Group’s mid-winter field day contest to be held over the weekend 26 - 27 July, to encourage portable operation.

General rules appear in the accompanying box.

Prizes are yet to be announced. Listen to the NSW WIA Sunday morning and evening broadcasts for details. A copy of the rules and full details of the State of the Art contest may be obtained from the Secretary, NSW VHF & TV Group, 14 Atchison St, Crows Nest 2065 NSW.

Heard Island DX Association to mount dx-pedition

An association has been formed with the view to activating this currently uninhabited sub-antarctic island, much sought after as a ‘rare one’ on the DX countries list.

Anybody who followed the recent activation of Heard Island will be disappointed in the misfortune suffered by the people involved. Even if all had gone well, the size and duration of the operation (interspersed as it was with the requirements of a scientific expedition) meant that the total of anticipated contacts would not exceed around 1000 QSOs.

Prior to VK0RM, Heard Island had not been activated for 8-10 years and has never been the subject of a full blown dx-pedition. It is intended to try and change this situation within the next 10 months.

A considerable amount of research has already been done in conjunction with the scientific expedition which took place in March this year. During the

coming months further work involving the necessary logistics to support a serious amateur dx-pedition to Heard Island will continue.

The Australian authorities concerned have indicated that there would be no serious objection to a well planned, well founded and good intentioned amateur dx-pedition. It is intended that the association will offer a place in the team to a professional scientist to carry out research on Heard Island over the duration of the dx-pedition.

The financing of any major operation invariably creates problems; the costs of mounting this dx-pedition will be considerable. Many people and DX groups have indicated a tremendous interest in the

STATE OF THE ART CONTEST RULES

1. Duration 0001 EAST 19 July to 2359 EAST 3 August 1980.
2. The operating period for scoring purposes will be any 10 days in the above period.
3. There is one division — transmitting, open.
4. Entrants must operate within the terms of their licence.
5. All amateur stations may enter whether fixed, portable or mobile.
6. All VHF/UHF/SHF bands, including ‘net’ frequencies, may be used. Cross-band contacts are not permitted for scoring purposes (**Exception:** Oscar satellites); cross-mode contacts are permitted.
7. Contacts via terrestrial and satellite repeaters are permitted as are EME contacts.
8. Only one contact per band per station per day is acceptable for scoring purposes (**exceptions:** Oscar, SHF stations and UHF/SHF field stations).
- 8a. A station working through an Oscar satellite may work the same station on not more than two different orbits/day.
- 8b. A station operating on an SHF band may work the same station on the same band twice in one day provided that two clock hours have elapsed from the start of the first to the start of the second contact (Bands 2.3 GHz and above are deemed SHF).
- 8c. A UHF/SHF field station is defined as a station operating with a portable power supply and antenna systems and would not be considered to be a mobile station as normally construed. Scoring as in 8b for two contacts/day.
9. The usual RS/RST report followed by a three digit number is to be used. Serial numbers **NEED NOT** commence at 001 and **NEED NOT BE CONSECUTIVE**. The usual method of starting at 001 and increasing by one/contact may be used, or a non-consecutive system, at the operator’s discretion.
10. Contacts via Sporadic-E & Tropospheric duct propagation will be disallowed. Judges’ decision is final.
11. Clock times to be in EAST or GMT and distances to be in km.
12. All logs to contain the following information: date & time of contact, band, emission, call sign of station worked, report and serial number sent and received, distance, points claimed. (A comment on antenna/power/field-QTH would be of interest).

Scoring for all contacts above the minimum distance appropriate to the band, with the exception of repeaters, will be based on the distance between stations multiplied by a band factor.

Where the stations (not using a repeater) are within the minimum distance contacts score at the numerical value of the band factor, no distance multiplier.

Terrestrial repeaters: the minimum distance station-to-repeater-to-station to be three times the minimum scoring distance for a direct contact. Contacts not satisfying this constraint score at the band factor per contact, no distance multiplier.

Oscar satellites: scoring is based on geographically adjacent and non-adjacent call areas. VK7 and VK3 are considered to be adjacent; VK9, VK0 and all other prefixes except ZL are all considered mutually non-adjacent. VK to ZL and vice versa are non-adjacent.

Band	Minimum distance	Band factor
52 MHz	80	1
144 MHz	80 (240)	2
432 MHz	40 (120)	8
576 MHz	40	16
1215 MHz	40	24
bands above 1200 MHz	15	50

Oscar adjacent call areas: 100 pts/contact
 non-adjacent call areas: 200 pts/contact
 Others: 500 pts/contact

EME
 3000 pts/contact regardless of distance or band.

Entries
 To be delivered (or postmarked) no later than September 3rd, 1980 to The Secretary, NSW VHF & TV Group, 14 Atchison St, Crows Nest, NSW 2065.

activation of Heard Island and offers of assistance have been numerous.

Funding of the 1980-81 dx-pedition will be based on the

following criteria:-

- (a) Each member of the amateur team will be required to contribute to the expedition fund.

WOULD YOU BUY A TRANSCEIVER THAT IS ALREADY OBSOLETE?

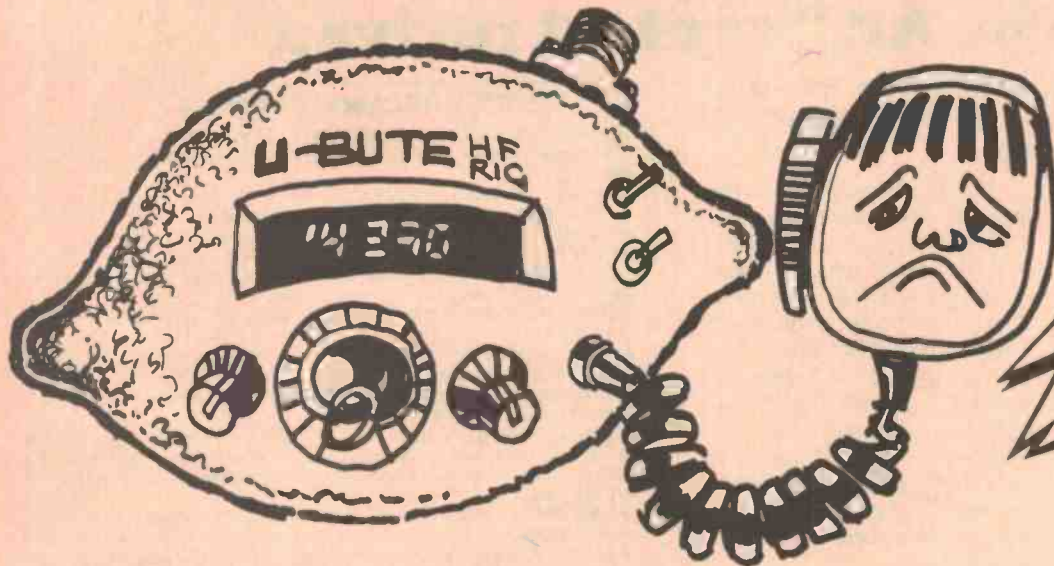

STOP PRESS!!!
 A BRAND NEW CONTEST FOR
 AMATEURS — WIN A TRIP
 TO HONG KONG — DETAILS NEXT MONTH!
 OR FROM YOUR DICK SMITH STORE
 (DON'T BUY A TRANSCEIVER ELSEWHERE UNTIL
 YOU FIND OUT ABOUT THIS CONTEST!)

Let's face it: a modern transceiver is quite an investment. Are you prepared to buy a transceiver which would let you down in years to come?

The new Yaesu FT-707 HF transceiver is, as far as we know, the only transceiver on the market with the new HF amateur bands already included. Its modern circuitry represents the 'state-of-the-art' in communications technology. And the really good news: the FT-707 actually costs LESS than many of the superseded transceivers it is replacing. Shouldn't your next transceiver be a Yaesu FT-707?

'PLANNING AHEAD' was Amateur Radio Action's introduction (review in June issue).

Here's some more of what they said:

... physically very attractive ... one of the finest velvet smooth tuning arrangements on any transceiver in the world ... VFO stability is superb ... receiver performance is excellent ... sensitivity is very good ... audio output is clean ... performance (of the noise blanker rated 'great' on the FT101Z) if anything is better ... the transceiver is well laid out and simple to operate ... makes an ideal mobile rig ... expected to retail for around \$850 and therefore on present standards represents good value ...

One minor discrepancy: our price for the FT-707 is over \$100 less than the price quoted above. This must mean it is far and away the best value transceiver on the market in Australia!!!



ACCESSORIES:
 FC-707 Antenna Tuner (D-2875) \$146.00
 FP-707 Base Power Supply (D-2895) \$170.00

© 1980

Cat D-2869

FREIGHT: \$6.00 ANYWHERE
 in Australia (that's below cost!)

**COMPARE OUR
 PRICE:**

\$735⁰⁰ INC TAX

EASY TERMS AVAILABLE TO APPROVED APPLICANTS!

NOVICES:

You can legally use this transceiver on the Novice bands — then when you get your full ticket, it's ready for you! Why buy a 'Novice Only' rig now and be disappointed later???

DICK SMITH ELECTRONICS

NSW 125 York Street, SYDNEY, Ph 290 3377
 147 Hume Highway, CHUMORA, Ph 642 8922
 162 Pacific Highway, GORE HILL, Ph 439 5311
 30 Grose Street, PARRAMATTA, Ph 683 1133
 613 Princes Highway, BLAKEHURST, Ph 546 7744
 263 Keira Street, WOLLONGONG, Ph 28 3800

VIC 399 Lonsdale Street, MELBOURNE, Ph 67 9834
 656 Bridge Road, RICHMOND, Ph 428 1614
 166 Logan Road, BURANDA, Ph 391 6233
QLD 842 Gympie Road, CHERMSIDE, Ph 59 6255
ACT 96 Gladstone Street, Fyshwick, Ph 80 4944
SA 60 Wright Street, ADELAIDE, Ph 212 1962
WA 414 William Street, PERTH, Ph 328 6944

bankcard
 welcome here

SHOPS OPEN 9AM to 5.30PM
 (Saturday: 9am till 12 noon)
 BRISBANE: Half hour earlier.
 ANY TERMS OFFERED ARE TO
 APPROVED APPLICANTS ONLY
 RE-SELLERS OF DICK SMITH
 PRODUCTS IN MOST AREAS OF AUSTRALIA.



MAIL ORDER CENTRE: PO Box 321, NORTH RYDE NSW 2113. Ph 888 3200. PACK & POST EXTRA.

COMMUNICATIONS

(b) Individual donations will be accepted.

(c) Offers of financial assistance from the various amateur radio societies, radio clubs and DX groups will be accepted.

(d) Residue of funds accrued after completion of QSL commitments.

A trust account has been established by the founder members of the Heard Island DX Association to account for the funds received, and receipts will be issued for all contributions.

Firm offers of radio equip-

ment have already been received, but no offers of ancillary equipment, antennas or power supplies etc. have yet been solicited.

Owing to weather conditions the time slot available is mid-December to mid-February.

The association seeks your help.

Write to:
Jim Smith
Heard Island DX Association,
c/o P.O. Box 2053,
Konedobu,
Papua New Guinea.

Intelligent receiver

The new NRD-515 receiver doesn't quite think for itself — but it sure comes close.

Featuring continuous coverage from 100 kHz to 30 MHz, the NRD-515, just released here by Emtronics, is a top-line unit for the well-heeled amateur or professional involved in HF communications.

The receiver incorporates a PLL synthesizer, with digital readout to 100 Hz and you get a selection of six IF filter bandwidths (two filters provided), rapid up/down auto tuning at the flick of a switch beside the conventional-type dial, five reception modes — AM, LSB, USB, CW and RTTY, selectable AGC decay (fast/slow) plus facility to turn the AGC off, variable BFO and passband tuning and a dial lock.

In addition, you can obtain a

Memory Unit which permits the storing of up to 24 different frequencies with instant recall at the flick of a switch.

The specifications — and performance — are quite impressive. We were fortunate enough to have one for a few days and were most impressed with the unit. It flies like a dream and is one of the **very few** receivers I have ever used that has what could be regarded as a "genuine" S-meter. We'll get one back for a full review in a later issue. Until then, get Emtronics to send you a brochure to drool over; they're at 649 George St, Sydney 2000. (02) 211 0531.

VK2ZTB

Icom's new WARC transceiver



ICOM of Japan have released their latest HF Amateur transceiver, the Model IC720.

The newcomer to the Icom stable incorporates a general coverage receiver (100 kHz - 30 MHz) and all the new bands approved at WARC 79.

In common with most other Icom transceivers, the nucleus of the unit is a microprocessor. Tuning is accomplished by the successful "optical chopper" VFO which means better linearity, no backlash and no variable capacitors, giving problem free use.

Naturally, the IC720 has features like speech processor, band-pass tuning and an effective noise blanker as standard. To enhance the IC720 a new range of options will be released, including an automatically-tuned HF mobile an-

tenna system covering all HF bands.

The Icom range of transceivers are distributed in Australia by Vicom and can also be obtained from any of their large number of authorised dealers scattered throughout Australia.

Principal specifications are as follows: Frequency Coverage: receive 100 kHz to 30 MHz; Tx/Rx-160m, 80m, 40m, 20m, 15m and 10m plus WARC 10/18/24 MHz. Modes: SSB/RTTY/CW/AM; Output Power: (SSB) 10 - 100 W, variable; Spurious Emissions: better than 60 dB below full output; Sensitivity: better than 0.25 uV for 10 dB S+N/N.

The Brisbane VHF Group

At a meeting of the Brisbane VHF Group earlier this year it was decided to launch a publicity drive to promote the group and further the VHF-UHF cause in Queensland.

The Brisbane VHF Group consists of amateurs with a special interest in the world above 50 MHz. The group meets at the Newmarket High School on the fourth Wednesday of every month and welcomes new members and visitors.

Its current office bearers are: Pres. — Bill McDermott, VK4AZM; V.Pres. — George McLucas and Sec. — Ross Marren, VK4AMJ.

The group owns and maintains the 2m chan. 7000 repeater, VK4RBN Brisbane, the 70cm repeater, VK4RBC Brisbane, the

2m beacon, VK4RTT Mt Mow-bullan, and the 70cm repeater, VK4RBB Brisbane.

The group has used its knowledge and technical expertise to develop various projects such as VHF-UHF aerials and amplifiers etc and has information available on other projects available for clubs and individuals.

All enquiries to the group, about membership or its activities, should be addressed to the Secretary, Brisbane VHF Group, P.O. Box 911, Fortitude Valley, Brisbane Qld 4006.



for service...

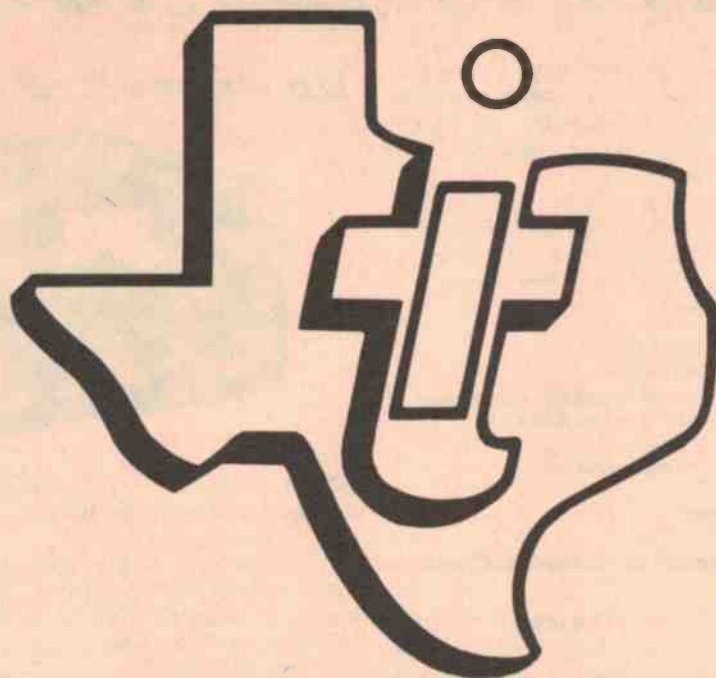

...on Texas Instruments

MEMORIES:

4K, 16K and 64K Dynamic RAM
4K Static RAM

8K, 16K and 32K EAROM

INTERFACE CIRCUITS:

Drivers, Receivers,
Transceivers in Dual,
Quad, Hex and Octal
configuration

VOLTAGE REGULATORS
AND POWER

CONTROL CIRCUITS

OP. AMPS

Single Dual and Quad

Bi-Polar and Bi Fet

— at the new low prices

AND 74 LIKE NEVER BEFORE

74 Standard TTL

74 Low Power Schottky TTL

and 74 Schottky TTL

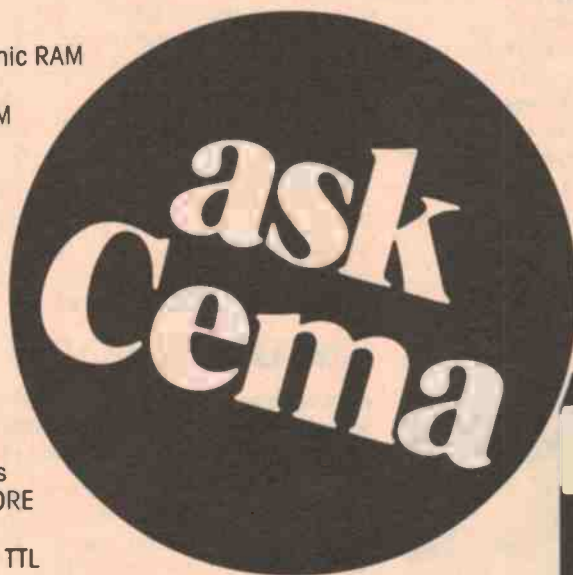

CEMA ELECTRONICS PTY. LTD.

ADELAIDE

170 Sturt Street, Adelaide, S.A. 51 6483

BRISBANE

22 Ross Street, Newstead, Qld 52 4261

MELBOURNE

208 Whitehorse Road, Blackburn, Vic 877 5311

PERTH

Unit 1, 25 Brisbane Street, East Perth 328 8091

SYDNEY

21 Chandos Street, St. Leonards 439 8622

NEW ZEALAND

7-9 Kirk Street, Grey Lynn, Auckland 76 1169

World Trade Centre Building, Wellington 848 922

More power to Mongolia!

With the introduction of a high powered shortwave transmitter recently, Radio Ulan Bator's signal into Australia has shown a dramatic improvement.

For many years, it has been difficult to tune in to Radio Ulan Bator's broadcasts as they used transmitters of fairly low power by international standards (no more than about 50 kilowatt).

The Mongolian station was notorious among DXers as usually being very badly undermodulated. One DXer even remarked that Ulan Bator's transmitters had so little punch that they sounded like they were made out of cardboard!

All this has now dramatically changed. Radio Ulan Bator's external service in English is

now audible at very fine level during our evenings at 1220 until 1250, with frequencies currently used being 12 070 and 6383.

There is also an English broadcast at 1715-1745 on 11 850 and 6383, according to on-air announcements by the station. These two English programmes are on air daily, except on Sundays.

The latest edition of the World Radio and Television Handbook mentions Radio Ulan Bator planned to introduce four new shortwave transmitters, and it seems Mongolia has now introduced at least two of these transmitters, using them for the English language services.

Some time ago, Ulan Bator tested one new transmitter for broadcasts of the Home Service in Mongolian on 11 855 during our local evenings. You would have read about these earlier tests in ETI last year.

If you pick up one of Radio Ulan Bator's broadcasts, why not advise them how well the signal is being heard at your location? You can send reception reports, all of which will be answered with a very attractive verification card, to: Radio Ulan Bator, C.P.O. Box 365, Ulan Bator, Mongolia.



New programme for DXers!

Radio station KTWR at Agana, on the island of Guam, in the Pacific, has recently introduced a special programme for DXers.

Called "DX Listener's Log" the programme began at the end of May and is heard weekly at three different times to ensure world-wide coverage.

"DX Listener's Log" is devoted entirely to information for the DXer, including station interval signal identification, technical information, propagation data, latest DX tips and much more.

Altogether, the active DXer will find the programme of great value and interest. Current times and frequencies for "DX Listener's Log" are: Thursdays at 0100 on 17 855; Fridays at 0915 on 11 840; and Fridays at 1445 on 15 365.

These times and frequencies will be current until early in September.

Our Greek connection

The Voice of Greece in Athens puts a good deal of emphasis on broadcasting to Australia.

Until early in September, Greek Radio will broadcast at these times to our area: 0900 to 0950 in Greek and English on 17 830 and 21 455; 2100-2150 in Greek and English on 9530, 9640 and 11 730; and finally

from 2200 to 2250 in Greek only, using 9640.

The English segments of these broadcasts consist of news bulletins, and may be heard at 0915 and 2115, usually for about 10 minutes.

Malta relays Libya

The Libyan radio's Overseas Broadcasting service is one of the latest stations to make use of the shortwave relay facilities located at Cyclops on the island of Malta in the Mediterranean.

A schedule recently received direct from the Libyan Radio's Overseas service indicates relays via the Malta transmitters are currently broadcast as follows:

0600-0800 daily in Arabic, for the Mediterranean and Africa on 5980.
0600-0800 on Fridays in Arabic, for the Mediterranean and Africa on 7135.
0700-0800 daily in Arabic, for the central Mediterranean and Africa on 5960.
1000-1045 on Saturdays and Sundays in Italian, directed to Europe on 5960.
1500-1530 daily in English, directed to Europe on 7120.
1800-2000 daily in Arabic, directed to Europe on 5960.

The broadcast in English at 1500 on 7120 is currently well heard in Australia, and the station verifies reports of reception with a fully detailed letter in English. Send reports to: PO Box 17, Hamrun, Malta. Note that the station requests reports be sent to this Malta address for the above broadcasts, rather than to the Tripoli address of the Libyan radio.

Kiwi land changes

Radio New Zealand has made some changes to their broadcast schedule recently.

RNZ is using a new out-of-band frequency of 15 485, between 1800 and 2150, beamed to the Pacific Islands. This outlet replaces 15 345 which had been suffering much interference from other stations until the frequency switch occurred early in May.

A new programme from Radio New Zealand is "New Zealand Calling", broadcast on the first and third Mondays from 0530 to 0600, on 17 860 and 15 345. "New Zealand Calling" includes a mailbox programme and DX tips.

This 0530 session is beamed for North American reception, but the programme is also broadcast for Australia and the north-west Pacific at 0845 on 11 945, also on the first and

third Mondays.

Most of Radio New Zealand's other programmes on shortwave consist of relays of the National (domestic) service, with identification announcements for the overseas service being inserted periodically between programmes.

NOTE! All times are given in Greenwich Mean Time (GMT). To convert to Australian Eastern Standard Time, add 10 hours (11 hours for Daylight Saving Time). To convert to Central Time, add 9.5 hours and for Western Time add 8 hours. All frequencies are in kHz.

Shortwave Loggings is compiled by Peter Bunn on behalf of the Australian Radio DX Club (ARDXC). Further information on DXing or the activities of ARDXC may be obtained from PO Box 79, Narrabeen NSW 2101, for a 30c stamp.

REALISTIC®

**Save
\$25**



FM 2-STATION INTERCOM SYSTEM

•“Beep” call tone •Adjustable squelch •Lighted talk bar

Great for family or business use. Easy to use — just press the talk-bar to speak, and the lock-bar for hands-free talking or monitoring. FM reduces noise from dimmer switches, fluorescent lights and appliance motors. FM and adjustable squelch combine to reduce “hash” and static. Plus, the lighted talk-bar doubles as a night light! The two units are smartly styled with no ugly connecting wires. Plug each station into any AC outlet and they’re ready to use. Move stations easily and add as many pairs as needed, with wireless intercom. 43-212

44⁹⁵
Pair

Regular Retail Price
69.95 Pair

Available at all Tandy Stores
and participating Dealers
around Australia

**TANDY
ELECTRONICS**

Sale Ends August 2nd, 1980

Mail Order Department
P.O. Box 229, Rydalmere,
N.S.W. 2116, or any store.

shortwave loggings

Belgium in English.

Brussels has rescheduled some of the English broadcasts, according to their published guide which will be current until September 27th.

There is a Monday-to-Friday English segment 1330-1345 for Africa and South East Asia on 17 730 and 21 475.

English for East Africa and Southern Europe is broadcast daily on 17 730 and 6010 from 1605 to 1650.

English for the Americas is broadcast 0015-0100 daily on

15 380 and 15 175.

There is a DX programme on Sundays, called "DX Corner", which is broadcast during the 1605 and the 0015 programmes.

Best reception of Brussel's English programmes is currently noted on 21 475 at 1330, and at 0015 on 15 175.

Costa Rica

Shortwave broadcasting in Costa Rica has seen quite a boost in the last year or so, and another new station from this small central American country can now be picked up in Australia.

Radio Rumbo, located at Cartago, is currently heard on 6075 between approximately 0730 and 1030. The station has been active on mediumwave for many years, but has only recently acquired shortwave facilities.

The current broadcasts appear to be test transmissions,

as there are no commercial announcements and the station makes periodic calls of their operating frequencies.

The Radio Rumbo address is also often given on air — Apartado postal 140, Cartago, Costa Rica.

Programmes are in Spanish, with mostly local ballads and instrumentals being aired. A strong Colombian station, Radio Sutatenza in Bogota, opens transmission on 6075 at about 1030, so don't confuse this signal with the new Costa Rican station.

Montreal calling

Radio Canada International's current schedule for broadcasts up to 7 September shows many adjustments of frequencies in line with the northern summer months. Generally higher frequencies are currently in use.

Montreal currently has English programmes:

Daily: 1800-1830 on 15 260, 17 280, 21 630; **1900-1930** on 15 260, 17 820, 21 630, 7130, 9555, 15 235 and 17 875; **2000-2030** on 7295, 9555, 15 325, 17 820 and 17 875; **2130-2200** on 11 945, 15 150, 17 820. This session is also aired on 15 325 and 17 875 on weekends only.

Monday to Friday: 0615-0630, and **0645-0700** on 9590, 11 775, 11 960, 15 440, 17 860, 6140, 7155, 9760 and 11 825; **2100-2300** on 6170, 15 325 and 17 875. This programme is a must for those who wish to keep up with latest news world-wide, as it features "The World at Six" as well as "As it Happens".

Zambia back

Following some months silence on shortwave due to lack of spare parts for run-down equipment, Zambia Broadcasting Services have returned to the air.

Lusaka's Home Service programmes can regularly be heard in our mornings, on 4911, up to sign-off at 2104, and even later on weekends. Also, recently noted active for the first time in some months are 6060 and 6165, both frequencies also closing at 2104 most days.

Overseas reports further suggest that the External Services have been re-activated, with the Sunday programme on 17 895 being noted from sign-on at 1050.

It is some years since Zambia used this 16 metre band outlet.

Poland in English

Polish Radio has advised that their schedule for English programmes current until November includes these broadcasts at convenient times for reception in Australia:

0630-0700 on 9675, 7270 and 6135.

2030-2100 on 7285 and 6095.

2230-2300 using 7270, 7125, 6135 and 5995.

Polish radio has recently expressed interest in how well signals from Poland are being heard here in Australia.

Of special interest to DXers is Polish Radio's DX Club. To become a member, you send 12 reception reports to Polish Radio, and in return the DXer will receive a membership card and a Polish Radio pennant.

There is a special feature for DX Club members broadcast every second and fourth Sunday in the programmes in English starting on 0630 and 2230. The station's address is: Polish Radio, English Section, PO Box 46, 00-950 Warsaw.

New Cameroon station

The town of Bafoussam in central Cameroon is the newest location in Africa to add a shortwave transmitter.

This new provincial station broadcasts on 4000, and has local programmes in both French and English from 1700 to 1800 daily, followed by relays of the National station located in Yaounde.

Sign-off time is currently listed as 2230, but fade out of the signal occurs well before then in east Australia due to local sunrise.

Dubai continues tests.

Radio and Colour TV Dubai, in the United Arab Emirates, continues with test transmissions from their new 300 kilowatt shortwave transmitters.

A verification card for a recent test transmission report, received by the writer, was accompanied by a note from Dubai's Chief Engineer, Mr. Harold Robin, indicating current test broadcasts.

Test transmissions are presently being directed to the United Kingdom, using 21 485, with transmissions spanning the period 0600 to 1000 every day except Friday. Most programmes consist of a relay of the Home Service programme in Arabic, but there are occasional announcements in English.

Latest Latin rhythms

It's the time of year again to note good reception of stations in central and South America. A good hunting ground for these stations is the 49 metre band during our local evenings.

With a largely darkness path across the Pacific Ocean between about 0700 and 1200, listeners in east Australia should be able to hear many of the fairly low powered commercial broadcasters in Latin America which operate on 49 metres. Signals tend to fade from about 1200, due to approaching sunrise in Latin American locations.

Some of the latest signals heard include: **On 6010, Radio America** in Lima is heard between 1130 and 1230 and the station gives identification plus call signs and frequencies at 1200.

Radio Victoria in Lima is currently active on 6020, with

pleasant Peruvian music at 1030, together with occasional announcements in Spanish.

Radio Continental in Arequipa has recently been operating throughout the Peruvian night, and is noted from about 0730 to past 0830 on 6056. The station plays a good deal of American disco music!

Radio Tawantinsuyo in Cuzco, high in the Andes, is currently active from sign-on at 0930 on 6175. A feature of programming is some distinctive music of the Andes with flutes and accordions. Get it before Malaysia opens on this same frequency at 1030.

"BUGS"



When recording video or sound tapes (FM-AM or TV), the performance is largely dependent on the level and quality of the signal being fed into the tuner or video cassette.

You could be plagued with the same bugs, (ghosting-snow-poor sound) that you encounter with TV reception.

Regardless of how much you spend on your video cassette or FM & AM tuner, your equipment will only perform as well as your aerial system will allow.

However, a good antenna installation will rectify these problems and let the tuner or video cassette prove how good they can be.

FM AERIALS

- Hills FM1 2EL 300ohm\$12.54
- Hills FM3 3EL 300ohm\$24.61
- Hills do-it-yourself Kit,
75 ohm Cable, Brackets, Mast, Screws
etc.....\$38.90
- Channel Master 700 FM 4EL
300ohm\$26.53
- Matchmaster FMG 300 ohm ...\$16.81
- Matchmaster FMG2 Semi Fringe\$27.25
- Matchmaster FMG6 Fringe\$51.47
- Many others in stock.

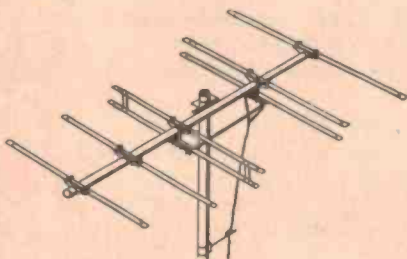

If you have recording bugs
our staff have the cure.

ELECTROCRAFT PTY LTD

68 Whiting Street, Artarmon NSW
Telephone 438-4308 ext. 6
or 438-3266 ext. 6

WE ARE SPECIALISTS
30 years in the antenna business.
Hours: 8am to 5pm.

Prices subject to alteration without notice.

LOOKY VIDEO

INDEPENDENT
IMPORTER/MANUFACTURER

OHIO SCIENTIFIC COMPUTERS

HARDWARE

1. Memory Expansion Board, 8K. The double sided, printed through board has 8K of wired sockets with driver and buffer IC's and RF filters. Add 2114's as you require RAM. Kit \$120. Fully assembled and tested, extra \$15. FREE 40 wire lead included (value \$19.95).
2. 4K RAM Memory Expansion Chips, 2114 450nS, \$52.
3. RF Modulator, 5 to 9 volt, all channels, \$19.95.
4. Superboard 11 Cover/VDU Stand, \$18.95.
5. Superboard 11 Computer, 8K ROM, 4K RAM, \$389.
6. Challenger C1P Computer, 8K ROM, 4K RAM, \$489.
7. Challenger C4P Computer, Sound/Colour, \$946.20.

SOFTWARE

We regret PRICE RISE due to shipping costs. All previous (54) advertised Cassette Software up \$2.00. Instructions (14 sets) are still the same price. O1 is now replaced by an updated and enlarged C1 at \$2.95.

New Programs for Ohio Software

UTILITIES

- U.15. Dissassembler — 4K.....\$10.95
- U.16. Filename, for cassettes.....\$8.95
- U.17 Trace.....\$12.95
- U.18 Packer — (K saver).....\$14.95
- U.19. Cursor — C2/4.....\$13.95

INSTRUCTIONS

- I.11. Dissassembled ROM, with Comments.....\$12.95
- I.12. 32 x 64 Character Display.....\$12.95
- I.13. Wp 6502 Word Processor Book.....\$3.95
- I.14. Dissassembled ROM, with Inbuilt References \$13.95
- I.15. Sound — S I/C1P.....\$6.95
- I.16. G.T. Conversion, X2.....\$2.95
- I.17. Saving Data on Tape.....\$6.95
- I.18. C1P Tape Control.....\$6.95
- I.19. C1P Beeper.....\$5.95
- I.20. C1P/ Base 2 Printer.....\$6.95
- I.21. Morse Code Converter with tape.....\$16.95
- I.22. 32X64 Character, 100 percent hardware.....\$13.95

BUSINESS

- B.4. Savings & Loan Package.....\$14.95

DISPLAY

- D.2. Flashboard, your advert.....\$10.95

GAMES

- G.25. Alien Invaders/Space Invaders.....\$10.95
- G.26. Orbital Lander.....\$11.95
- G.27. Escape from Mars, 2 tapes.....\$18.95
- G.28. Death Ship, 2 tapes.....\$18.95
- G.29. Startrek.....\$7.95
- G.30. Air — Sea Battle.....\$7.95

BOOKS/MAGAZINES/CATALOGUE

- T.1. The First Book of OSI.....\$19.95
- T.2. Aardvark Journal (6 Issues).....\$12.95
- T.3. Basic Handbook, David Lien.....\$15.95
- T.4. Personal Computing, Monthly.....\$2.20
- C.1. Catalogue describes all software and hints plus free programs.....\$2.95

- Postage: 1 or 2 \$1.00
(Software) 3 — 5 \$1.50
6 — 9 \$2.00
10 or more \$2.50

MAIL ORDER: Cheque or Bankcard.

Looky Video: PO Box 347, Richmond Vic.
3121. Shop, 418 Brldge Road, Richmond.
Ph (03) 429-5674.

All prices subject to change without notice. All prices INCLUDE sales tax.

RADIO DESPATCH SERVICE

869 George Street,
Sydney, NSW. 2000.
(Near Harris Street)
Phone 211-0816, 211-0191.

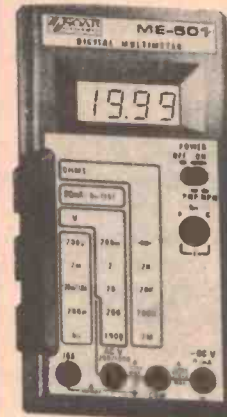

Soar Model
501

14 digit
LARGE
LCD
DISPLAY

Price
\$70

INTERSIL ICL7106
LCD Evaluation Kits \$39.10

INTERSIL LCD 3½ DIGIT
PANEL METER KITS

Build a working DPM in ½ hour with
these complete evaluation kits.

BUY THE BEST!
Buy TEXAS Calculators

Ti-59 Calculator, Ti-PC100 Printer, Ti-30
Student Pack, Ti-58C, Ti-5025, Little Profes-
sor, Data Man.

PRICES ON APPLICATION

SPECIAL BUY:

Philips AV, LN, C-10 Computer Cassette
Tapes. While they last.

- 1 off\$1 ea. 24 off65c ea.
- 12 off70c ea. 48 off61c ea.

WE SPECIALISE IN:

PC boards for ETI & EA projects, Logic
Probes, Leader oscilloscopes and signal
generators, Soar and Fluke DVM's, Univer-
sity meters and multimeters, Weller solder-
ing stations, Scope and Adcola irons, the
famous Jostykits, boxes and cases — Hor-
wood, Jiffy and die cast, distributors for Xce-
lite tools.

WRITE TO US FOR SPECIAL PRICES

MAIL ORDER CUSTOMERS

\$1.00 packing plus 5 percent of order value
up to \$80.00, thence a flat \$4.00 for postal
items. Carrier — freight on.

OPEN: Mon-Fri 8 am to 5.30 pm.
Thursday night late shopping till
8.30 pm. Saturday 8 am to
11.45 am.

PREDICTIONS AUGUST 1980

Covering 3 to 40 MHz, these predictions show the times radio contact is possible between the areas designated beneath each graph, as well as the possible 'mode' and reliability. Vertical columns indicate time — commencing at 0000 UT on the left, to 2300 UT at right. For reliable predictions follow the times and frequencies indicated by the F character.

Complete information on using these predictions can be obtained by sending a stamped, self-addressed envelope to:-

ETI — Predictions
3rd floor 15 Boundary St
RUSHCUTTERS BAY NSW 2011.

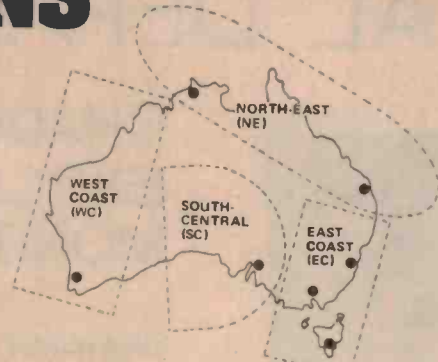

These GRAFEX style computer generated predictions are provided courtesy of the Australian Ionospheric Prediction Service.

KEY TO SYMBOLS

- A blank area means no normal propagation is possible.
- % path open 50 - 90% of days in month.
- F path open at least 90% of days in month.
- B propagation possible via E and F layers over 90% of days. Overrides 'F'.
- M propagation possible by both 1st and 2nd F-layer modes. Expect strong fading.
- S propagation possible by 2nd mode (also 3rd and mixed E and F modes). Expect strong fading, weak signals.
- A High absorption indicated. Expect weak signals.

40	40
39	39
38	38
37	37
36	36
35	35
34	34
33	33
32	32
31	31
30	30
29	29
28	28
27	27
26	26
25	25
24	24
23	23
22	22
21	21
20	20
19	19
18	18
17	17
16	16
15	15
14	14
13	13
12	12
11	11
10	10
9	9
8	8
7	7
6	6
5	5
4	4
3	3

40	40
39	39
38	38
37	37
36	36
35	35
34	34
33	33
32	32
31	31
30	30
29	29
28	28
27	27
26	26
25	25
24	24
23	23
22	22
21	21
20	20
19	19
18	18
17	17
16	16
15	15
14	14
13	13
12	12
11	11
10	10
9	9
8	8
7	7
6	6
5	5
4	4
3	3

40	40
39	39
38	38
37	37
36	36
35	35
34	34
33	33
32	32
31	31
30	30
29	29
28	28
27	27
26	26
25	25
24	24
23	23
22	22
21	21
20	20
19	19
18	18
17	17
16	16
15	15
14	14
13	13
12	12
11	11
10	10
9	9
8	8
7	7
6	6
5	5
4	4
3	3

40	40
39	39
38	38
37	37
36	36
35	35
34	34
33	33
32	32
31	31
30	30
29	29
28	28
27	27
26	26
25	25
24	24
23	23
22	22
21	21
20	20
19	19
18	18
17	17
16	16
15	15
14	14
13	13
12	12
11	11
10	10
9	9
8	8
7	7
6	6
5	5
4	4
3	3

East Coast to Japan (Also serves N.E. and S.C.)

40
39
38
37
36
35
34
33
32
31
30
29
28
27
26
25
24
23
22
21
20
19
18
17
16
15
14
13
12
11
10
9
8
7
6
5
4
3

East Coast to South Pacific

40
39
38
37
36
35
34
33
32
31
30
29
28
27
26
25
24
23
22
21
20
19
18
17
16
15
14
13
12
11
10
9
8
7
6
5
4
3

East Coast to North America (Also serves N.E. and S.C.)

40
39
38
37
36
35
34
33
32
31
30
29
28
27
26
25
24
23
22
21
20
19
18
17
16
15
14
13
12
11
10
9
8
7
6
5
4
3

East Coast to South America (Also serves S.C.)

40
39
38
37
36
35
34
33
32
31
30
29
28
27
26
25
24
23
22
21
20
19
18
17
16
15
14
13
12
11
10
9
8
7
6
5
4
3

East Coast to North Africa (Also serves S.C.)

40
39
38
37
36
35
34
33
32
31
30
29
28
27
26
25
24
23
22
21
20
19
18
17
16
15
14
13
12
11
10
9
8
7
6
5
4
3

East Coast to South Africa (Also serves S.C.)

40
39
38
37
36
35
34
33
32
31
30
29
28
27
26
25
24
23
22
21
20
19
18
17
16
15
14
13
12
11
10
9
8
7
6
5
4
3

East Coast to Europe (Short Path)

40
39
38
37
36
35
34
33
32
31
30
29
28
27
26
25
24
23
22
21
20
19
18
17
16
15
14
13
12
11
10
9
8
7
6
5
4
3

E.C. and S.C. to Europe (Long Path)

40
39
38
37
36
35
34
33
32
31
30
29
28
27
26
25
24
23
22
21
20
19
18
17
16
15
14
13
12
11
10
9
8
7
6
5
4
3

East Coast and S.C. to Persia

40
39
38
37
36
35
34
33
32
31
30
29
28
27
26
25
24
23
22
21
20
19
18
17
16
15
14
13
12
11
10
9
8
7
6
5
4
3

A TOTAL DEPARTURE



CHADWICK EXECUTIVE MONITOR ME 12

SPECIFICATION

ENCLOSURE	: Bass reflex.
FREQUENCY RES	: 25 Hz — 22 kHz.
IMPEDANCE	: 8 ohms.
SENSITIVITY	: 91 dB.
POWER RATING	: 120 Watts RMS.
CROSSOVER	: 480Hz, 3.5kHz, 10 kHz.
DIMENSIONS	: 816 x 400 x 430 mm.
WEIGHT	: 35 kg.

WHEN LISTENING BECOMES PARAMOUNT. HEAR THE EXCEPTIONAL CLARITY AND DETAIL OF THE EXECUTIVE MONITOR ME.12.



CHADWICK AUDIO FURNISHINGS PTY. LTD.
89 CARNARVON ST. SILVERWATER. 2141 PH. (02) 647-1103

MICROBITS

FLOPPY DISCS

5" soft sectored standard version	\$4.50
5" soft sectored 77 track	\$6.10
8" soft sectored single or double density	\$6.50

MOLEX CONNECTORS

10 pin point 1 pitch pc mount	\$1.30
10 pin point 1 pitch pc right angle	\$1.35
10 pin point 1 pitch pc top entry	\$1.35
10 pin point 156 pitch pc mount	\$1.10
10 pin point 156 pitch pc right angle	\$1.27
10 pin point 156 pitch pc top entry	\$1.30

PENNYWISE PERIPHERALS PRODUCTS

STATIC RAM BOARDS
• 8k 450ns \$249. • 8k 300ns \$268. • 16k 450ns \$359. • 16k 300ns \$397.

EPROM BOARDS
16/32/64k with Bank Select feature. Takes 2708/2758/2716/2516/2732/2532 or any mixture. \$176.

16k EPROM BOARD
Features: On board programming, to program and run Intel 2716, Texas 2516 up to 16k. Zero IF sockets \$253. Low IF sockets \$198.

2708 EPROM PROGRAMMER
Reads and writes, Z.I.F. Sockets included \$139.

The 6809 Microprocessor Board

The 6809 is the most advanced 8 bit microprocessor with many 16 bit operations. It deserves more than just being plonked on a PCB with the usual RAM, PROM, I/O and standard Monitor.

PP's 6809 Card has advanced memory mapping and protection hardware with a powerful Monitor to match.

- Increased addressing capability — up to 256K.
- Memory protection hardware — 4K pages can be individually write-protected or marked absent by software. Any violation causes an immediate interrupt to the monitor which prints diagnostics.
- No more worn out edge connectors — reconfiguration of hardware is done by software, not by switching switches or swapping cards.
- Cassette or Disk-based software available including — operating system, macroassembler and linking loader, higher level languages and application programs.
- Software controlled baud rates — the monitor determines the speed or any terminal connected and configures the UART for the observed baud rate (up to 9600) and parity.
- Supports proper operating system — system has privileged control of memory map and I/O.
- Motorola Exorciser compatible.

EVER HAD TROUBLE CONNECTING YOUR COMPUTER TO THE REAL WORLD?

Our 2111C-A Controller lets you connect to a.c. supplies from 12v to 240v and control on-off or variable 0 to Max volts.

The 2111C-A is plug in, connects direct to opto couplers, 0-10v or Potentiometer and can control loads from resistive to heavy inductive (transformers etc.). The standard kit delivers 1A and up to 5A with heatsink attached. (For loads up to 40A the triac has to be mounted off board.) On board pots limit minimum and maximum voltages to the desired level. Built and tested. \$28.00 Professional Ver. \$35.00 Edge connector P.C.B., Transformer, opto to suit 2111C-A \$7.50. Base Board takes 4 units. Built and tested \$32.00.

280 VICTORIA ROAD, GLADESVILLE N.S.W.

TELEPHONE 89 3145. Quantity discounts avail. ADD 15% sales tax where applic. FREIGHT FORWARD ON ALL ITEMS.



PLESSEY COMPONENTS

PO Box 2, Villawood, NSW 2163
Telephone 72-0133

NI-CAD PACKS

Plessey SAFT present high-reliability Ni-Cad Battery Packs.

- 1.2V to 24V (1.2V steps)
- 100 mA to 10 AH
- Long life of over 2,000 charge/discharge cycles.
- Rapid recharge capability fully recharge — 3.5 hours

Available ex stock:

- 5V 500 mA Standard package 5/500 28 mm x 28 mm x 50 mm
- 6V 500 mA Standard package 6/500 42 mm x 28 mm x 50 mm
- 9V 500 mA Standard package 9/500 55 mm x 28 mm x 50 mm
- 12V 500 mA Standard package 12/500 85 mm x 28 mm x 50 mm

These standard packages are supplied in insulated packages with fly leads 0.3 metre long. Other package configurations available.

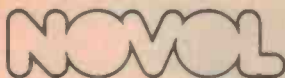

NON VOLATILE LOGIC

Features

- Data retention for one year in the absence of applied power
- Simple to use
- Standard power supplies only (plus 5V, minus 12V)
- CMOS/TTL compatible
- 14-lead DIL package
- Typically ten million SAVE operations

DEVICES AVAILABLE

MN9102

The MN9102 is a non-volatile 4-bit data latch which uses MNOS* transistors as memory.

MN9105

The MN9105 is a 4-decade BCD counter which counts up or down on negative transitions of the Clock input. In parallel with the counter is a 16-bit non-volatile MNOS memory into which the contents of the counter can be written. When data has been written into the memory it can be retained in the absence of applied power, and subsequently be recalled from the memory to preset the counter.

MN9106

The MN9106 is a six-decade up counter in parallel with a twenty-four-bit MNOS memory which can provide non-volatile data storage of the current count position.

MN9107, MN9108

The MN9107 will count up to 99 hours, 59 minutes, 59 seconds, while the MN9108 counts up to 9999 hours, 59 minutes or 9999 minutes, 59 seconds.

APPLICATIONS

Applications for NOVOL are found in all forms of metering, security code storage, back-up storage for microprocessor-based systems, elapsed time indicators, electronic counters, latching relays and many other general industrial areas.

Plessey Agents and Distributors:

SYDNEY	
Martin De Launay	29-1066
MELBOURNE	
Zephyr Products	568-2922
BRISBANE	
L.E. Bougmen	36-1277
ADELAIDE	
K.D. Fisher & Co.	269-2544
TOWNSVILLE	
Electronic Communications	72-3450
PERTH	
H.J. McQuillan Pty. Ltd.	458-7111

- SYN-1 Single Board Computer \$210.00
- KTM-2 CRT/TV Keyboard terminal module \$349.00
- BAS-1 8K BASIC ROM for SYN-1 \$149.00
- BUFFERED MOTHERboard for SYN-1, KIM-1 or AIM-65 systems \$179.00

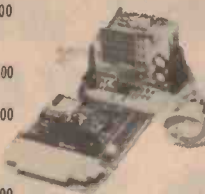

16K-8 fully tested memory board WRITE PROTECT and BANK switching for SYN-1, KIM-1 or AIM-65 systems . . . \$360.00

EPROM Programmer and EPROM/ROM Board MEMORY mapped EPROM programming will program up to 16K per command firmware in PROM included. For SYN-1, KIM-1 or AIM-65 systems \$345.00

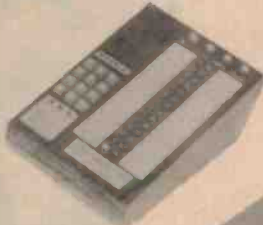
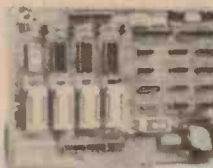

AUTOMATIC TELEPHONE DIALER PROM dialling 32 numbers plus other options \$180.00

PRESETTABLE COUNTER 5 digits suitable for counting, batching and numerical control \$150.00



DIGITAL TACHOMETER \$120.00

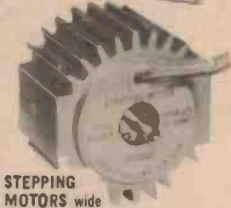

STEPPING MOTORS wide range for N.C. Control, Plotters, Variable speed, Servo Control etc. From \$49.50



HAND HELD TACHOMETER \$180

STEPPING MOTOR DRIVING CIRCUITS for 3 or 4 phase in Mode 1 phase 2 phase 1-2 phase excitation. From \$12.00

- THUMB WHEEL SWITCHES — \$2.20ea.
- TROXINITY TRANSDUCERS — \$15.00ea.

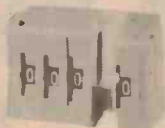

Mail orders add \$3.50 for postage and packaging

67 Blackshaw Avenue, MORTDALE 2223.
G.C.S. Telephone: 570 1225

(Trade enquiries invited)

EDIBLE ELECTRONICS

P.O. BOX 1053,
RICHMOND NORTH, 3121.
PH. (03) 415708

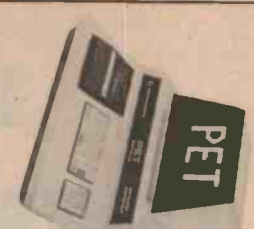

Space invaders have arrived, get the game of the century. It's free with every 8K PET sold this month, along with a package of other programs and a book on programming. Super! Special \$999 complete.

The Commodore PET is a completely self-contained personal computer. Just plug in, and within a few short hours even the complete novice will be amazed at what can be done. The 8K model shown, 16K & 32K models are now available. Options available are External Cassette Decks, Dual Drive Intelligent Mini-Floppies and Printers. The 8K, 16K & 32K models are expandable up to 40K of RAM via plug-in memory boards.

Trendcom Printers. We now have available these high performance thermal printers. These print the full set of alphanumeric characters at a rate of 40 characters per second. The Trendcom 100 is a 40 character-per-line printer, and the Trendcom 200 is an 80 character per line printer which also prints graphics.

Analog to Digital Conversion System. We will soon be offering a 16 channel analog to digital conversion system to enable your PET (Interfaces for other computers will be available later) to sense temp., velocity, pressure, light level, fluid level, etc. — Just think of the possibilities.

We handle a wide range of speaker components including RCF, Plessey, Foster and Motorola. Two of the Motor's KSN1001 which will handle 100W with a response from 4K to 30 KHz, and KSN1025 which will handle 100W with a 2K to 30KHz response. These speakers feature excellent transient response, high reliability and high impedance. Both KSN1001 & KSN1025 are only \$21.00 (no close over is required).



CHEAP LIFE INSURANCE
EARTH LEAKAGE PROTECTED POWER OUTLETS. These units detect leakage of current out of the circuit (possibly through your body!) and cut off power before a fatal can occur. If you have ever received an electric shock you must realize the worth of these units.
THE CHEAPEST LIFE INSURANCE YOU HAVE EVER BOUGHT!

SHOW SPECIALS

- TRIO CS-1560A II including probes \$660.00
- Telephone Press Burton Dialer insert with memory \$45.00.
- Wireless Telephones, Memory Dialers and Hands off telephones — prices on application.
- Ask about our special on the Commodore PET.

TRIO SG-402 R.F. OSCILLATOR — 100KHZ-30MHz — \$111



here's what the laboratory says about audio technica

"The Audio Technica AT-12E, although very modestly priced, features one of the flattest responses provided by any of the cartridges we have reviewed over the last 15 years . . . this cartridge performed as well as many cartridges selling at five times the price . . ."

Reproduced from a review in ETI Feb. 1980, by Louis A. Challis & Associates Pty. Ltd.

AT-12E



AT-11



AT-11E



AT-10

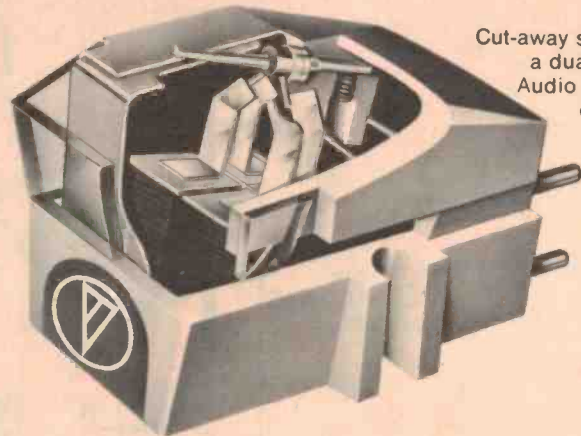

Cut-away section of a dual magnet Audio Technica cartridge.

To obtain top performance you must look for a cartridge with a dual magnet system, as perfected by Audio Technica.

AT 12E

Value leader among elliptical stylus models. Employs finely-crafted 0.4 x 0.7 mil bonded diamond mounted to thin-wall cantilever. Dual Magnet design assures flat response and excellent stereo separation. For all modern record changers and turntables.

•AT-12E technical data
Frequency Response: 15 ~ 26,000 Hz
Tracking Force: 1.0 ~ 2.0 g (Optimal Force 1.5 g)
Output Voltage: 4.2 mV (1 kHz 5 cm/sec)
Channel Separation: Minimum 23 dB (1 kHz)
Static Compliance: 25×10^{-6} cm/dyne
Load Resistance: 47 k Ω

Replacement Stylus ATS-12

AT 11

Flat response and remarkable tracking ability distinguish this Dual Magnet cartridge. Spherical bonded tip is best for use with older or budget record changers. High output matches moderately-priced systems.

•AT-11 technical data
Frequency Response: 15 ~ 22,000 Hz
Tracking Force: 1.5 ~ 2.5 g (Optimal Force 2.0 g)
Output Voltage: 4.8 mV (1 kHz 5 cm/sec)
Channel Separation: Minimum 21 dB (1 kHz)
Static Compliance: 22×10^{-6} cm/dyne
Load Resistance: 47 k Ω

Replacement Stylus ATS-11

AT 11E

Our lowest cost elliptical stylus cartridge yet built to high Audio Technica standards. Bonded 0.4 x 0.7 mil elliptical tip and thin-wall cantilever combine to offer unusual high frequency tracking ability in this price category. Excellent replacement for older cartridges to improve your system.

•AT-11E technical data
Frequency Response: 15 ~ 25,000 Hz
Tracking Force: 1.5 ~ 2.5 g (Optimal Force 2.0 g)
Output Voltage: 4.8 mV (1 kHz 5 cm/sec)
Channel Separation: Minimum 21 dB (1 kHz)
Static Compliance: 22×10^{-6} cm/dyne
Load Resistance: 47 k Ω

Replacement Stylus: ATS-11E

AT 10

Almost identical to the AT-11, the AT-10's flat response and remarkable tracking ability enables high quality stereo sound reproduction. Uses bonded spherical stylus. Has same characteristics that fit moderately priced systems so well.

•AT-10 technical data
Frequency Response: 20 ~ 20,000 Hz
Tracking Force: 2.0 ~ 3.0 g (Optimal Force 2.5 g)
Output Voltage: 4.8 mV (1 kHz 5 cm/sec)
Channel Separation: Minimum 20 dB (1 kHz)
Static Compliance: 20×10^{-6} cm/dyne
Load Resistance: 47 k Ω

Replacement Stylus ATS-10

audio technica

available at all quality hi fi dealers

If you have any supply problems however, please contact the nearest Maurice Chapman outlet to ascertain your closest supply source.

THE MAURICE CHAPMAN GROUP PTY. LIMITED

44 Dickson Ave, Artarmon, NSW. 2064. Phone 438-3111 • 150 Burwood Rd, Hawthorn, Vic. 3122. Phone 818-1730.

• Perth 446-5679 • Brisbane 44-7566 • Adelaide 272-8011

"I have always wanted a really good loudspeaker system."



Today the cost of excellent turntables, cartridges, tape decks and amplifiers has fallen to the point where the average family man can afford equipment of a quality and performance-level that was impossible ten years ago.

But good loudspeakers have remained extremely expensive and, in most domestic hi-fi systems, the rest of the equipment can dramatically outperform the speaker.

Philips have set out to correct this imbalance.

In co-operation with a leading electronics magazine, the Philips Elcoma Division has developed the Series 4000/1 speaker system.

The Series 4000/1 is available in kit form which means you save money by assembling it yourself.

A total kit, including:

- 8 loudspeaker drivers (4 per box)
 - 22 element crossover networks
 - pre-assembled boxes.
- For around \$798.00 per pair. (\$300.00 less, if you build your own boxes!)

The Series 4000/1 is comparable to systems selling for twice the price.

See your Philips dealer today or send for complete details including a free reprint of the original construction article. Further information on Philips loudspeakers; a list of Philips dealers and a free 4-speed stroboscope card for checking the speed accuracy of your turntable.

Philips Electronic Components and Materials
P.O. Box 50
LANE COVE, N.S.W. 2066

Please send me complete information on the Series 4000/1 loudspeaker system plus my free 4-speed stroboscope card and further information on loudspeakers.

NAME _____
Please Print

ADDRESS _____

STATE _____ P'CODE _____

ETI



**Electronic
Components
and Materials**

PHILIPS

AHEARN EL 29

Radio & Electronics Books

BERNARD BABANI (publishing) LTD

160: COIL DESIGN & CONSTRUCTION MANUAL B.B. Babani

• Complete book on how to design and make RF, IF, audio and power coils, chokes and transformers. Every type is discussed and calculations given. Covers AM and FM radio and TV.
96 pages Price \$2.25

202: HANDBOOK OF ICs EQUIVALENTS AND SUBSTITUTES. B.B. Babani

• One of the most complete IC equivalent and substitute guides yet published. Full data on over 9500 ICs. Covers digital and linear of all types from UK, USA, Japan, Germany, France, Czechoslovakia etc.
128 pages Price \$3.00

221: 28 TESTED TRANSISTOR PROJECTS R. Torrens

• Some circuits are completely new — others are more familiar designs. The projects can be split into simple building blocks to enable readers to combine circuits for specialised needs.
96 pages Price \$3.75

224: 50 CMOS IC PROJECTS R.A. Penfold

• CMOS ICs are suitable for an extraordinarily wide range of applications, are cheap and easy to obtain. Here are a number of interesting and useful projects in four general categories: (1) Multivibrators, (2) Amplifiers and oscillators, (3) Trigger devices, (4) Special devices.
112 pages Price \$2.85

225: PRACTICAL INTRO TO DIGITAL ICs D.W. Easterling

• This book introduces the reader to digital ICs (mainly TTL 7400 series). Besides a number of simple projects, contents include details of a Logic Test Set which enables constructors to identify and test digital ICs. Also includes digital counter-timer.
80 pages Price \$2.85

227: BEGINNERS GUIDE TO BUILDING ELECTRONIC PROJECTS R.A. Penfold

• Enables total beginners to tackle practical electronic so he or she can confidently build electronics projects such as published in ETI and other magazines and books. Subjects include component identification, tools, soldering, various building methods, cases, legends etc. Practical basic projects are also included.
112 pages Price \$3.75

BP1: 1ST BOOK OF TRANSISTOR EQUIVALENTS AND SUBSTITUTES B.B. Babani

• Complete transistor equivalents guide. More than 25 000 transistors with alternatives and equivalents. Covers devices made in UK, USA, Japan, Germany, France, Europe, Hong Kong etc. See also BP 14 (below).
80 pages Price \$2.25

BP 14: 2ND BOOK OF TRANSISTOR EQUIVALENTS AND SUBSTITUTES B.B. Babani

• The second book contains data on devices not included in the first. This book supplements BP1, no data is duplicated.
208 pages Price \$3.50

BP 24: 52 PROJECTS USING IC 741 Rudi & Uwe Redmer

• Originally published in German, this book achieved huge European sales. Now translated into English with copious notes, data and circuits, this book is a must for those interested in any way in this inexpensive and most versatile IC.
80 pages Price: \$2.85

BP 33: ELECTRONIC CALCULATOR USERS HANDBOOK M.H. Babani

• An invaluable book for all calculator users. Presents formulae, data, methods of calculation, conversion factors etc, often with examples. Includes way to use simple four-function calculator for Trig functions (sin, cos, tan); Hyperbolic functions (sinh, cosh, tanh), Logs, Square Roots & Powers.

Comprehensive conversion factors incorporated, including length, area, volume & weight through specialised conversions such as viscosity, illumination, cargo shipping measures etc. Also formulae for discounts and mark-up, currency conversions, interest, solutions of equations, binary and octal numbers, areas and volumes, stats and maths etc.

208 pages Price \$2.85

BP 36: 50 CIRCUITS USING GERMANIUM, SILICON, ZENER DIODES R.N. Soar

• Contains 50 interesting and useful circuits and applications in many different branches of electronics.
64 pages Price \$2.25

BP 37: 50 PROJECTS USING RELAYS, SCRs & TRIACs F.G. Rayer

• Relays, SCRs and Triacs have a wide range of applications — from motor speed control, dimming, heating, timers, light-sensitive circuits, warning devices, light modulators, priority indicators, circuit breakers etc. Book gives tried and proven circuits which will tolerate wide latitude of components and values allowing easy modification to suit special needs.
112 pages Price \$3.75

BP 39: 50 (FET) FIELD EFFECT TRANSISTOR PROJECTS F.G. Rayer

• Field effect transistors are used in many circuits. The projects here include amplifiers and converters, test equipment and receiver aids, tuners, receivers, mixers and tone controls, plus miscellaneous devices. The FET used is not critical and many other types will work as well. This book will be of interest to all enthusiasts, shortwave listener, radio amateur, hi-fi buff or general electronics experimenter.
112 pages Price \$3.75

BP 40: DIGITAL ICs AND PIN CONNECTIONS Adrian Michaels

• Equivalents and pin connections of a popular user-orientated selection of digital ICs. Shows details of packaging, families, functions, manufacturer and country of origin. Includes devices by Fairchild, Ferranti, Harris, ITT, Motorola, National, Philips, RCA, Signetics, Sencocem, SGS-Ates, Siemens, SSSI, Stewart Warner, AEG-Telefunken, Texas, Teledyne. Companion volume to BP 41 — Linear ICs.

320 pages Price \$7.50

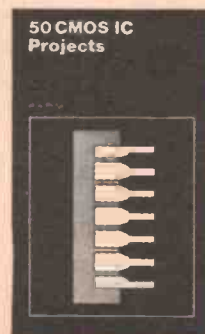
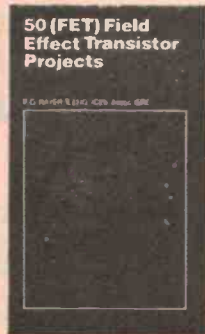

BP 41: LINEAR IC EQUIVALENTS AND PIN CONNECTIONS
Adrian Michaels

• Essentially similar in concept to above but deals with linear integrated circuits.
320 pages Price \$8.25

BP 42: 50 SIMPLE LED CIRCUITS
R.N.Soar

• 50 Interesting and useful circuits and applications using LEDs. A useful book for beginner and advanced enthusiast alike.
64 pages Price \$2.25

BP 44: IC 555 PROJECTS
E.A.Parr

• Every so often a device is made that is so useful one wonders how life went on before it! The 555 IC is one such. First made by Signetics it is now manufactured by almost everyone in the business. It is very cheap and readily obtainable.
Included in this book are basic and general circuits, motor car and model railway circuits, alarms and noise makers plus a section on the subsequent 556, 558 and 559 devices.
160 pages Price \$5.25

BP 45: PROJECTS IN OPTO-ELECTRONICS
R.A.Penfold

• Opto-electronic projects of interest to all electronics enthusiasts. Included are simple circuits using ordinary LEDs as well as more sophisticated designs such as infra-red transmitters and receivers, modulated light transmission and photographic projects.
112 pages Price \$3.75

BP 47: MOBILE DISCO HANDBOOK
Colin Carson

• Most people who start mobile discos know little about equipment or what to buy. This book assumes no preliminary knowledge and gives enough info to enable you to have a reasonable understanding of disco gear.
128 pages Price \$4.15

BP 48: ELECTRONIC PROJECTS FOR BEGINNERS
F.G.Rayer

• This book gives the newcomer to electronics a wide range of easily built projects. Actual component and wiring layouts aid the beginner. Some of the projects may be built without using soldering techniques.
128 pages Price \$4.15

BP 49: POPULAR ELECTRONIC PROJECTS
R.A.Penfold

• A collection of the most popular types of circuits and projects covering radio, audio, household and test equipment.
144 pages Price \$4.35

BP 51: ELECTRONIC MUSIC AND CREATIVE TAPE RECORDING
M.K.Berry

• This book shows how electronic music can be made at home with simple and inexpensive equipment. It describes how sounds are created and recorded to build up a final composition. It shows how to build a small studio including mixer and various sound effects units.
96 pages Price \$3.75

BP 53: PRACTICAL ELECTRONIC CALCULATIONS AND FORMULAE
F.A.Wilson

• This book is for the practical person's workshop bench. It bridges the gap between technical theory and cut-and-ried methods which may work but leave the experimenter unfulfilled. There's a strong practical bias. Tedious and higher maths has been avoided where possible. Many tables are included. This one's a beauty!
256 pages Price \$6.75

BP 56: ELECTRONIC SECURITY DEVICES
R.A.Penfold

• Simple and more sophisticated burglar alarms using light, infra-red and ultrasonics; also other types of alarm such as gas and smoke detectors, flood alarms, doorphone and baby alarms etc.
112 pages Price \$4.35

ELEMENTS OF ELECTRONICS
F.A.Wilaon

BP 62 — Book 1

BP 63 — Book 2

BP 64 — Book 3

• This series provides an inexpensive intro to modern electronics. Although written for readers with no more than basic arithmetic skills, the use of maths is not avoided — all the maths is taught as the reader progresses.

The course concentrates on the understanding of concepts central to electronics rather than continually digressing over the whole field — on the basis that once the fundamentals are mastered, the workings of most other things are soon revealed. The author anticipates where the difficulties lie and guides the reader through them.

Book 1 . . . All the fundamental theory necessary to a full understanding of simple electronic circuits and main components.

Book 2 . . . Alternating current theory.

Book 3 . . . Semiconductor technology leading to transistors and ICs.

These three books constitute a complete, inexpensive electronics theory course of inestimable value in either hobby or career.

224 pages Price \$6.75 (each volume)

BP 65: SINGLE IC PROJECTS
R.A.Penfold

• All projects in this book are simple to build and are based on a single IC. A few projects use one or two transistors in addition. A strip board layout is provided for each project together with special constructional points and setting up info. The five chapters are: Low level audio, Audio power amps, Timers, Op-amps, Miscellaneous circuits.
128 pages Price \$4.50

BP 66: BEGINNERS GUIDE TO MICROPROCESSORS AND COMPUTING
E.F.Scott

• An introduction to basic theory and concepts of binary arithmetic, microprocessor operation and machine language programming. The only prior knowledge assumed is very basic arithmetic and an understanding of indices.
128 pages Price \$5.25

BABANI BOOKS — MAIL ORDER, DIRECT FROM ETI !

Please send me:

Book	Qty.	
160	...	BP41
202	...	BP42
221	...	BP44
224	...	BP45
225	...	BP47
227	...	BP48
BP1	...	BP49
BP14	...	BP51
BP24	...	BP53
BP33	...	BP56
BP36	...	BP62
BP37	...	BP63
BP39	...	BP64
BP40	...	BP65
	...	BP66

Post & handling:

1 - 4 books:	\$1.10
5 - 10 books:	\$2.70
11 - 20 books:	\$3.50
over 20 books:	\$5.00

I enclose \$ (inc. p & h.)

Name

Address

. postcode

Send to: ETI 'Book Sales', 3rd Floor,
15 Boundary St, Rushcutters Bay NSW 2011.
Please allow 4 - 5 weeks for delivery.

SEVLEN LIGHTING

MANUFACTURERS OF LIGHTING CONTROL SYSTEMS
Office: 4 Weldon St., Burwood. 2134 N.S.W.
Tel. (02) 74 8905

PTY. LTD.

TECHNICAL SPECIFICATIONS

- **STANDARDS COMPLIANCE**
ENERGY AUTHORITY APPROVAL N/1385
- **OPERATION**
FULL LOGIC INTERGRATED CIRCUITRY
WITH ISOLATION PROTECTION.
- **ISOLATION FREQ. RESPONSE**
0dbm 30 Hz to 25KHz less than 1 db
18dbm 50 Hz to 25KHz less than 1 db
- **INPUT INSERTION LOSS**
.6db at 0dbm
- **SOUND INPUT**
SWITCHED MASTER CONTROL FOR
SOUND OPERATION FROM 1watt to 120watts
- **LOAD CAPACITY**
4 CHANNEL - 1,000 watts per channel
5amps only on full load on mains
- **VOLTAGE SUPPLY**
240 volts ac 50Hz
- **SIZE**
27.7 x 15 x 45 cm

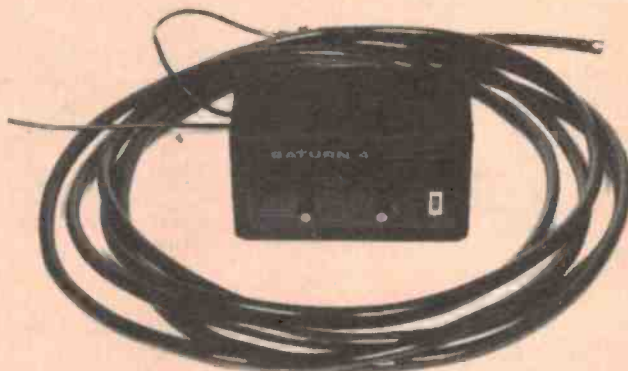

The most portable, economical and adaptable low priced lighting system ever invented, a must for clubs, displays, windows and dance venues.

Connected to the STARCHASER controller, an amazing sequence is produced all within a tube.

Up to 300 metres of scintillating, pulsating chase.

No complicated connections, bend it, shape it, take it anywhere, anytime.

SEE US AT THE CES'80 Show

STAND 58 in the COMMEMORATIVE PAVILION

DISTRIBUTOR AND TRADE ENQUIRIES WELCOME

STOPWATCH OFFER!

Quality LCD stopwatch by Omron

Features:

- Wristwatch or handheld use
- Remote-control switch
- Displays to 0.1 second
- Times up to 59 mins 59.9 secs
- Measures effective time and lap time
- Easily read LCD display

This Omron stopwatch has been promoted and sold as a "jogging watch" but is, in fact, a general-purpose stopwatch and can be used in all applications where conventional stopwatches are employed. e.g.: swim race timing; car and motorbike hill climb events; running track events, etc. This stopwatch could be especially valuable at school and club sporting events.

Tax free price: \$39.17 — for schools, colleges etc who supply us with a valid sales tax exemption certificate.

Post and handling: \$2.50



**Special price:
\$49.95 (incl. S/T)**

(Offer closes 31 August 1980)



LAP Switch is used in measuring lap time.

ON/OFF RESET Switch is used when turning on or off the power or clearing the time displayed.

START/STOP Switch is used when starting or stopping time measurement.

Display
The time measured is displayed every 1/10 second. The display is reset to 0 to 59 minutes and 59.9 seconds and continues measuring in succession.

Remote-Control Jack
Insert the remote-control switch connector into this jack.

EFFECTIVE TIME

For example, in a 1,500-meter run, you can measure 500-meter or 1,000-meter lap times by depressing the LAP switch repeatedly.

Example: Measurement of 500-meter and 1,000-meter lap times as well as the final time in the 1,500-meter run.

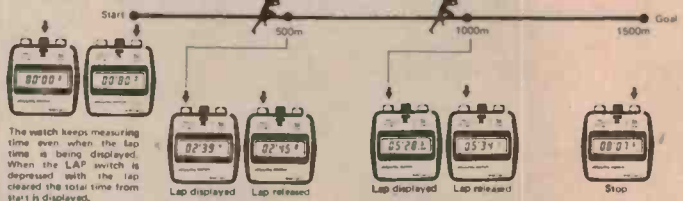

The watch keeps measuring time even when the lap time is being displayed. When the LAP switch is depressed with the lap cleared the total time from start is displayed.

SPECIFICATIONS

Power source Alkaline battery 1.5 V (G13 Type)
 Battery life Approx. 6 months
 Display Liquid Crystal Display
 Main device C.MOS-LSI
 Crystal frequency 32,768 kHz

Usable ambient temperature 0° C to 45° C
 Time accuracy ±1.5 second per day
 Dimensions Main body: 250 x 50 x 23 mm
 Weight 70g (Included band, remote switch, battery)
 Accessories Instruction manual
 Model 3T5-JM4

WINNER AND RUNNER-UP TIME

For example, in a 100-meter run, you can measure the time of the winner and the runner-up by depressing the LAP Switch and START/STOP switch.

Example: Measurement of the time used by the winner and the runner-up in 100-meter run.

When the winner reaches the goal, depress the LAP switch. Then, the winner's time is displayed.

When the runner-up reaches the goal next, depress the START/STOP switch and then the LAP switch. The runner-up's time will be displayed.

Remote-Control Switch Connector
When using the remote-control switch, connect the remote-control switch connector to the switch.

Remote-Control Switch
You can start or stop the watch by holding the remote-control switch on the palm of your hand.



be accomplished only by depressing the START/STOP switch repeatedly.
 Example: Measurement of the 20-minutes half time in a game of basketball.

LAP TIME

For example, when a game of basketball is interrupted due to a foul, stop the measuring. When the game is resumed, start the measurement again. Thus, you can measure the effective time only. These operations can

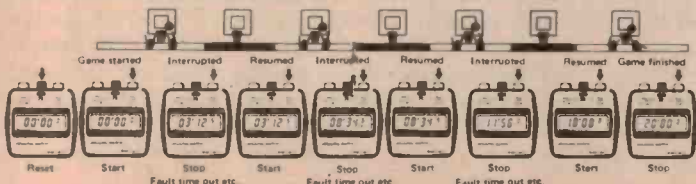

Stopwatch Offer

Please supply Omron stopwatches, model 3T5-JM4 at

\$49.95 or \$39.17 (S/T exempt) each \$

Post and handling; any quantity: \$2.50

TOTAL: \$

Sales Tax Certificate No. (if applicable)

Name

Address

Postcode

NOTE: This offer is made by Caldor Pty Ltd and this publication is acting as a clearing house only. Payment should be made by cheque or money order, made out to 'Stopwatch Offer', and sent together with the order form or accompanying letter to Stopwatch Offer, c/o ETI Magazine, 15 Boundary St, Rushcutters Bay NSW 2011. We will then process your order and pass it on to Caldor who will send you the goods. Please allow at least four weeks for delivery.

**OUT
NOW**

eti

**ELECTRONICS
TODAY
INTERNATIONAL**

\$3.95

TEST GEAR VOL. 2

PROJECTS INCLUDE:

AUDIO OSCILLATOR
SWR/POWER METER
TRANSISTOR TESTER
SOUND LEVEL METER
AUDIO POWER METER
TRUE RMS VOLTMETER
RF SIGNAL GENERATOR
CROSSHATCH GENERATOR
AUDIO SPECTRUM ANALYSER
DIGITAL TEMPERATURE METER
VERSATILE LOGIC TEST PROBE
10 MHz FREQUENCY METER-TIMER
FIELD STRENGTH/POWER METER
UP/DOWN PRESETTABLE COUNTER
MICROWAVE OVEN LEAK DETECTOR
LINEAR-SCALE CAPACITANCE METER

Project construction and debugging is so much easier if you have the appropriate test equipment. The same applies when servicing manufactured electronic equipment. Our first Test Gear book was extraordinarily popular. Test Gear 2, assembles 27 of our test instrument projects published over the last few years in one handy volume, including: 487 Audio Spectrum Analyser, 320 Battery Condition Indicator, 717 Crosshatch Generator, 135 Digital Panel Meter, 132 Experimenter's Power Supply, 719 Field Strength/Power Meter, 140 1GHz Frequency Meter, 141 Logic Trigger, 129 RF Signal Generator, 139 SWR/Power Meter, 222 Transistor Tester, 148 Versatile Logic Probe – and more. Price: \$3.95 plus 55 cents postage and handling, from ETI, Subscription Department, 15 Boundary St, Rushcutters Bay NSW 2011. Also available from newsagents and selected electronics suppliers.

POWER SUPPLIES

Fixed Voltage for Battery Operated Equipment

- Fully protected against sustained short circuits
- Rugged, attractive steel case
- Suitable for continuous operation in high ambient temperatures.
- On-off switch with separate L.E.D. indicator
- Overload Indicator on ECA143 and ECA144



ECA140 ECA143 ECA144

OUTPUT	13.8V 2 A	13.8V 3 A	13.8V 4 A
RIPPLE & NOISE:	0.75mV/Volt at rated output		
PROTECTION:	Fold back current limiting		

Variable Voltage for Bench Use

The "ECA160" series are low cost power supplies designed for laboratory, factory test and systems applications. They are equipped with a front panel mounted 10 turn voltage control, combination ammeter/voltmeter and binding posts. Output is continuously variable from zero to 8% above the maximum rated voltage.

FEATURES:

- Linear series regulator
- Automatic short circuit protection
- Low drift
- Fast transient response
- Electricity authority approved



VOLTAGE CONTROL :
10 turn 5mV resolution
RIPPLE : 2mV RMS
LOAD REGULATION :
0.04% or 10mV

TYPE NO.	VOLTS	AMPS
ECA160-12/3	0-12	3.0
ECA160-24/1.5	0-24	1.5
ECA160-35/1	0-35	1.0

Made in Australia and Guaranteed by:



FERGUSON

FERGUSON TRANSFORMERS PTY.LTD.
31 HIGH STREET, CHATSWOOD. N.S.W. 2067.

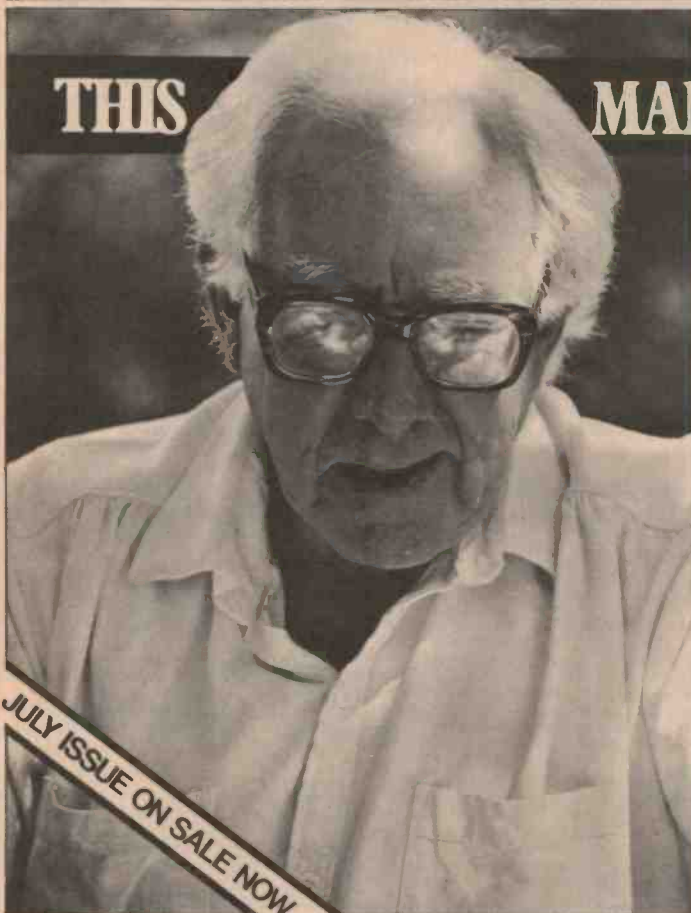

THIS

MAN IS ABOUT TO DRIVE

THE CANNING STOCK ROUTE

Billy Wentworth is as unorthodox in retirement as he was in Parliament. He's the great-grandson of the first man to cross the Blue Mountains. Now, at 72, he's about to tackle the longest, most difficult stock route in the world.

The Canning. A thousand miles of sand dunes, spinifex and desert.

What makes Billy Wentworth tick?

Michael Richardson provides the answers in July OVERLANDER.

Also in this issue:

THE SHOALHAVEN RIVER:
Sydney's newest water supply.

BIRD PHOTOGRAPHY:
By Australia's leading expert.

PORTABLE WELDERS:
Do They Work?

overlander

AUSTRALIA'S OUTBACK MAGAZINE

MINI-MART

Where readers can advertise — For Sale/Wanted/Swap/Join.

• We'll publish up to 24 words (maximum) totally free of charge for you, your club or your association. Copy must be with us by the 1st of the month preceding the month of issue. Please — please — print or type adverts clearly, otherwise it may not turn out as you intended! Every effort will be made to publish all adverts received however, no responsibility for so doing is accepted or implied. Private adverts only will be accepted. We reserve the right to refuse adverts considered unsuitable.

• Conditions: Name and address plus phone number (if required) must be included within the 24 words. Reasonable abbreviations, such as 25 W RMS or 240 Vac, count as one word. Adverts must relate to electronics, audio, communications, computing etc — general adverts cannot be accepted. Send your advert to:

ETI Mini-Mart, Modern Magazines
15 Boundary St,
Rushcutters Bay NSW 2011

AUDIO

WANTED: Full service manual *(buy or borrow) for **Wattmaster Stereo (Dolby) Cassette Deck Model CSD-2**. Post details to **B.D. Connors, 72 View St., Gunnedah, NSW 2380**.

MANUAL STEREO record player (less amp) with crystal cartridge, diamond stylus, three speeds and plastic dustcover. **27 Badminton Rd, Croydon NSW. (02) 747-1702**.

SELL: Ex studio equipment. **Ampex MM1000 8 track recorder, \$400 o.n.o.** Two **S.A.E. 400 w/ channel amplifiers, excellent condition, \$1000 each o.n.o.** Phone (08) 270-1241.

STEREO receiver **35 W RMS** Korean **Samsung** left channel reduced power cassette inoperative due failing friction disk \$220 circuit manual included. **Gronlund (02) 871-7582 a.h.**

WANTED: Circuit diagrams and/or manual of **National Panasonic RQ-444S AM-FM radio cassette**. **C. Pavan, 291 Annandale St, Annandale 2058. (02) 821825**.

WANTED: **Byen or Royce Disc Recorder** not professional models. **A. Goodwin, Bogdad, Tas 7407**

PRO 9TL transmission-line speakers. Custom built to **Chris Rogers** specifications, immaculate finish. Sound quality is extremely accurate and musical. **\$950. E. Lusins, (07) 372-3380**.

COMMUNICATIONS

FOR SALE: **Yaesu FT-310** all solid state MF/HF transceiver. 160 to 10 metres including 11m; approx 200W input. As new condition (approx 20 hours use since new). Complete with manual. \$650 (no offers). **Ross VK2ZVO. Phone (02) 982-9624 a.h.**

SELL: Mobile transceivers with power supplies — **Yaesu FT125c, two SSB220s — \$200 each o.n.o.** Also **SWR meter, antenna tuner and high power antenna tuner parts — cheap.** Phone **Andrew (02) 858-3517**.

KENWOOD TS 180 (DFC). New, inc w/shop man. \$1000. **TV 502 2m t/verter. mod to suit TS 180 complete inc. cables \$120. (02) 57-4648**.

HIGH TENSION R.F. parts: Tubes: **3J160E, 813, 2500/1250 Philips, 125A. Buf 4kv, 1uf 25kv oil caps. Rheostats 25 watt to (2kW 250 v) 0.5 , 2, 4, 250, 1k plus huge assortment power resistors 10W up to 100W mainly vitreous. (02) 887-1338**.

TRS-80 L2 16K system including L3, clone and hundreds of games on tapes, \$1000 complete. (063) 82-3344 or write to **Box 480, Young, NSW 2594**.

SELL Mostek 4015J dynamic RAMS 4K x 1 bit \$150 for sixteen. **C. Nielsen, P.O. Box 68, Aspley, Qld 4034**.

SELL: TI59 calculator complete with manuals master library module etc \$210 including airfreight, **Peter Cooper, 25 Bruce St, Alice Springs, NT 5750. (089) 52-4686**.

SELL: Chess Challenger 10 w/carrying case, owner's manual, etc. Excellent condition, \$199 o.n.o. **35 Tweed St, Ashgrove, 4060. (07) 38-5691 after 6 p.m.**

SELL: Colour super video game (channel F) 6 game cartridges incl pinball challenge, maze. Worth \$380, sell \$230. **K. Jackson, Perth (09) 339-3833**.

SELL: EA 2650 computer. 4K memory. Full system all working. Assembler, micro basic plus much more. \$384. All offers considered. Phone **Tony (02) 449-4163**.

SELL 6800D2 based system. 8½ RAM, 2K ROM ASCII keyboard, video board, cardcage and power supply, \$400. Also 8/16K EPROM board, 1200 baud cassette interface, 2708 EPROM programmer and assort. software. \$100 each. **W. Geary, Koolan Island, WA 6733**.

TRS-80 level 2 software (on cassette) full documentation, 39 prog's incl games, teaching aids, mathematics, etc. \$9 + \$1 p&p. **J. Anderson, 225 Ocean Beach Rd, Sorrento, Vic 3943**.

WANTED: Listing of game of dominoes in Basic to suit OSI micro computer, also to correspond with owners of C1P superboard computers. Phone **Paul (042) 61-5451**.

TRS-80 L1 games pack + personal finance programs. Cost over \$57, sell \$40. Hardly used. Phone **Frank (03) 318-4297**. Will separate if necessary.

SELL: 16K Sorcerer with video monitor cassette recorder. Technical manuals, plus some software. \$1200. Contact **Chris Hanley, 38 North Av, Bullsbrook East, WA 6084**.

TANDY TRS-80 with 4 disc drives. Best offer. (02) 30-7706 or (02) 358-2655 b.hrs. **Paul Rawnsley**.

TRS-80 input/output controller — control virtually anything using the TRS-80. Cct diag shows how to control 8 I/O devices, can be expanded to 255. Cct diag. & info \$10. **R. Gareb, 17/37 O'Donnell St, Bondi, NSW 2026. (02) 30-8261**.

OSI C2/4/8 owners. Let's form a club, start a library of original software etc. case. **Peter Meulman, 4 Halsmere St, Geebung 4034. Phone (07) 59-0017**.

FOR SALE: Realistic DX-160, in very good condition, set of headphones included, only \$100. **Adrian (02) 46-1848 after 5 p.m.**

AUSTRALIAN Radio DX club for shortwave, mediumwave Dxers. For a sample copy send one 22c stamp to **P.O. Box 79, Narrabeen, NSW 2101**, mentioning this ad.

KENWOOD TS120-V. Perfect condition. Complete with microphone, instruction manual and accessories. \$500. **Sydney area sale preferred. W.H.R. Treloar. (02) 239-5267 office hours**.

COMPUTERS

SELL: Motorola D2 kit in cardcage, 5V@10A, +/-12V@1A power supply, 2K RAM in 16K pennywise board, manuals, software — ideal intro to micros. \$285. **Geoff (02) 922-5088 ext 14, (02) 92-5377 a.h.**

FRIDEN ASCII teleprinter with tape-punch, reader, \$280. Non-ASCII \$160. **SCM optical tape-reader, punch, \$150. John Monro, 16 Gourlay St, Balaclava. (03) 527-1075**.

TRENDCOM 100 high speed thermal printer with Apple II interface, \$400. **Ross Lambert, 34 Carrington Av, Caringbah, NSW 2229. (02) 524-7096 a.h.**

RAM 16K dynamic TRS-80 conversion instructions provided. **Peter Bladwell, 27 York St., Beecroft, 2114. (02) 84-1114 after 5.30 p.m.**

VDU (EME-1) plus encoded keyboard with p/s in f/glass case. Assembled and working, \$220 o.n.o. Phone **Herbie Prause (08) 256-2666 w.h. (08) 258-1184 a.h.**

MEK6800D2, with cassette interface, assembled and tested. \$150. **SWTP intelligent VDU terminal with ASCII keyboard (CT64) partly built (no monitor) \$150. (02) 622-4388 or (047) 39-1348 a.h.**

COPYRIGHT: The contents of *Electronics Today International* and associated publications is fully protected by the Commonwealth Copyright Act (1968).

Copyright extends to all written material, photographs, drawings, circuit diagrams and printed circuit boards. Although any form of reproduction is a breach of copyright, we are not concerned about individuals constructing projects for their own private use, nor by pop groups (for example) constructing one or more items for use in connection with their performances.

Commercial organisations should note that no project or part project described in *Electronics Today International* or associated publications may be offered for sale, or sold, in substantially or fully assembled form, unless a licence has been specifically obtained so to do from the publishers, *Modern Magazines (Holdings) Ltd* or from the copyright holders.

LIABILITY: Comments and test results on equipment reviewed refer to the particular item submitted for review and may not necessarily pertain to other units of the same make or model number. Whilst every effort has been made to ensure that all constructional projects referred to in this edition will operate as indicated efficiently and properly and that all necessary components to manufacture the same will be available no responsibility whatsoever is accepted in respect of the failure for any reason at all of the project to operate effectively or at all whether due to any fault in design or otherwise and no responsibility is accepted for the failure to obtain any components parts in respect of any such project. Further, no responsibility is accepted in respect of any injury or damage caused by any fault in the design of any such project as aforesaid.

68XX Flex users: I have large wide-interest software library. Will exchange. Greg Wilson, P.O. Box 504, Potts Point 2011.

SELL: Resident editor/assembler for 2650 computer systems. Pipbug format 110 baud k.c. cassette only \$20. P. Clemence, Sheldon Caravan Park, Upper Mt. Gravatt, 4122.

WANTED: Exidy Sorcerer MKI or MKII. Also APPLE II, preferably 16K. Phone (02) 816-2292 after 4pm.

SELL MEK6800D2 working. 1/2k RAM, documentation, extra books. Editor assembler software. \$175 o.n.o. Phone Mark (03) 749-2627 after 7pm.

SELL quality C10 computer cassettes. 99¢ each. ten for \$8.99. p&p 50¢ per order. J. Cummings, P.O. Box 9, South Mackay, Qld 4740.

SELL: HMI-6504-9, TMS 4044-45NL, TMS4060, memory chips; also 4520A, 4500, TIL305, FND500, 7 segment displays, 6871A clock and SN76477, CA3130 can chips. For prices ring Armen (02) 888-5074 a.h.

COMPUTER Cromenco Z2D, 32K RAM, software \$3500; VDU Soroc IQ120 \$1000; Teletype 43 \$1000. John Kearney, 54 Mont-Albert Rd, Canterbury Vic 3126. (03) 818-0321 ext 137.

CROMEMCO Z2D, 48K, 2x5 1/4" Wangco drvs \$4500. 2x8" Persci drvs \$1500. Tuart board \$150. D+7Z board \$95. (07) 273-1102.

ASCII keyboard for sale. 53 keys fully encoded and assembled, upper/lower case with mounting frame. \$75. Phone Alec (02) 46-1976.

MISCELLANEOUS

SELL: Electronic gadgets, components, radios, turntables, hi-fi gear etc. Send 22¢ stamp for complete list and prices. R. Stockburger, 6 Seaview Av, Port Macquarie, NSW 2444.

FOR SALE: C.R.O. Tektronix 545B Lab, 4 trace, DC-30mHz, dual time base, many features, workshop manuals, probes, \$850 o.n.o. with trolley. (08) 356-9859. H. Grandsden, 9 Downer St, Kilkenny, SA 5009.

B/W video recorder t.v. set/monitor nine x 1 1/4 hr tapes. Lot \$199. Colour recorder Philips type 1500 by Luxor with perfect still frame incl 15 x 1 hr tapes \$399. M. Dobbin, 60 Smith St, Manly, NSW 2095. (02) 977-5533 night or w/end.

CRO: Leader LBO510 5" transistorised. 4 MHz bandwidth. Mint condition. \$160. D. Johnson, 2/13a Aberfeldy Av, Edwardstown, 5039. (08) 293-5605.

WANTED: Oscilloscope BWD 539D. Also HP-35 calculator parts. phone Brian after 8 pm (03) 565478.

SELL: Small 6 digit electro-mechanical counters, non-resettable \$6. Also DPDT cradle relays and pc mount sockets 15V coil. \$2.50. (02) 78-6249.

TRIO 15 MHz Oscilloscope — CS-1560A hardly used, as new, normally sells for over \$600, must sell now \$490. Leon (062) 54-2662, 73 Bambridge St, Weetangera, ACT 2614.

Eight power supply units comprising of two sections: a 2A 240 Vac stabiliser (usable) and a 10A dc 30-70 V adj. regulator (1 sq.ft. heatsink with 4xTO3's) with 50 amp bridge rect. All on common chassis. \$175 or \$75 minus transformers. (02) 887-1338.

WANTED: "Radiotron Designer's Handbook" in good condition, must be complete. Will pay \$20 min for reasonable copy. F.Stulner, Melbourne 82-6804 (after work).

SELL: Electronic parts. Capacitors, diodes, IC's, POT's, switches, transistors, trim pots and many more, all separate prices. M. Sully, 61 Newman St, Niddrie, Vic 3042.

WANTED: Photoelectric valve, 1P37, 1P39 or comparable type for student project. M. Bernard, C/- Physics Dept, B.C.A.E., Ballarat, Vic.

WANTED: Circuit and wiring diagram of metal detector with discriminator plus parts list, pcb layout, instructions if possible. K. Westhead, 692 Gloucester St, Christchurch, New Zealand.

GEIGER tubes. Brand new 20th century electronics professional sizes at fraction of current price. R. Long, 151a George St, Sydney.

MUSICOLOUR: Built up and tested, just add controls and switches, manual as well, \$50. Also built and tested cassette interface (Dick Smith type) \$50. (02) 798-4831 John.

POSTAL & TELECOMMUNICATIONS DEPT.



CB RADIO WHAT CHANNELS? PUBLIC COMMENT WANTED

Radio frequency arrangements and regulations for CB radio are to be reviewed.

The Postal and Telecommunications Department is conducting a public inquiry with the following terms of reference.

To report to the Minister for Post and Telecommunications as soon as possible on whether the present 18 channel 27 MHz Citizens Band Radio Service, which was established on 2 June 1977, should be retained after June 1982.

In considering this issue regard should be had to:

- (1) all matters associated with the technical operating conditions, regulations, frequencies, channel allocations and procedures governing the Citizens Band Radio Service in both the HF (27 MHz) and UHF (477 MHz) bands;
- (2) the need to utilise and manage the radio frequency spectrum for the maximum overall benefit to the Australian community;
- (3) Australia's international obligations in radio frequency management; and
- (4) the need to minimise interference to other services.

The Department is seeking written submissions on these issues from interested individuals and organisations.

Submissions should be sent to:

**First Assistant Secretary
Radio Frequency Management Division
Postal and Telecommunications Department
PO Box 5412CC
MELBOURNE VIC. 3001**

**CLOSING DATE FOR SUBMISSIONS:
15 AUGUST 1980**

**TELEPHONE INQUIRIES:
MR. J. KENNEDY (03) 609 1512**

OUT NOW

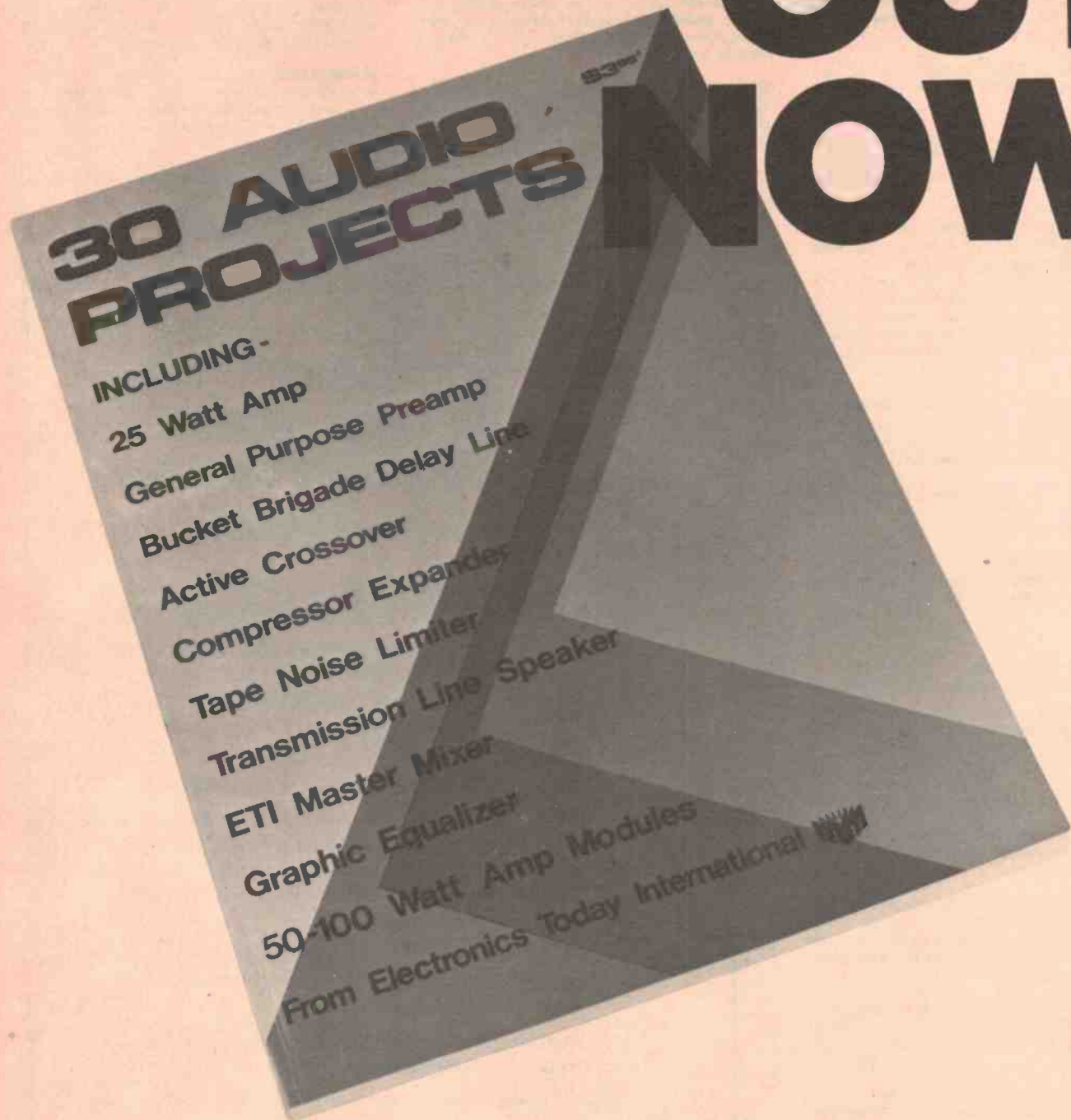

Thirty Audio Projects is the latest in our line of books designed especially with the serious constructor in mind. Ever found yourself leafing through back-issues of ETI for the circuit of a low-noise input stage? Or looking for some information on bucket brigade devices? Or do you need to know that the design you're using has been checked and re-checked for circuit errors and built by people all over the world before it is published? Thirty Audio Projects contains just that — thirty projects of the highest ETI standard, checked and re-checked and then presented in a compact and complete form.

The price is \$3.95 — that's under fifteen cents per full project design — and they're *all* audio projects, thirty of our most sought-after designs. Projects include: Simple 25 watt amp; Bucket brigade delay line, Active crossover; Compressor/expander; Tape noise limiter; ETI speaker system; Professional-feature mixer; Howl-round suppressor; the ever-popular 50/100 watt amp modules, Graphic equaliser; Spectrum analyser; Audio millivoltmeter.

A blueprint for your success.

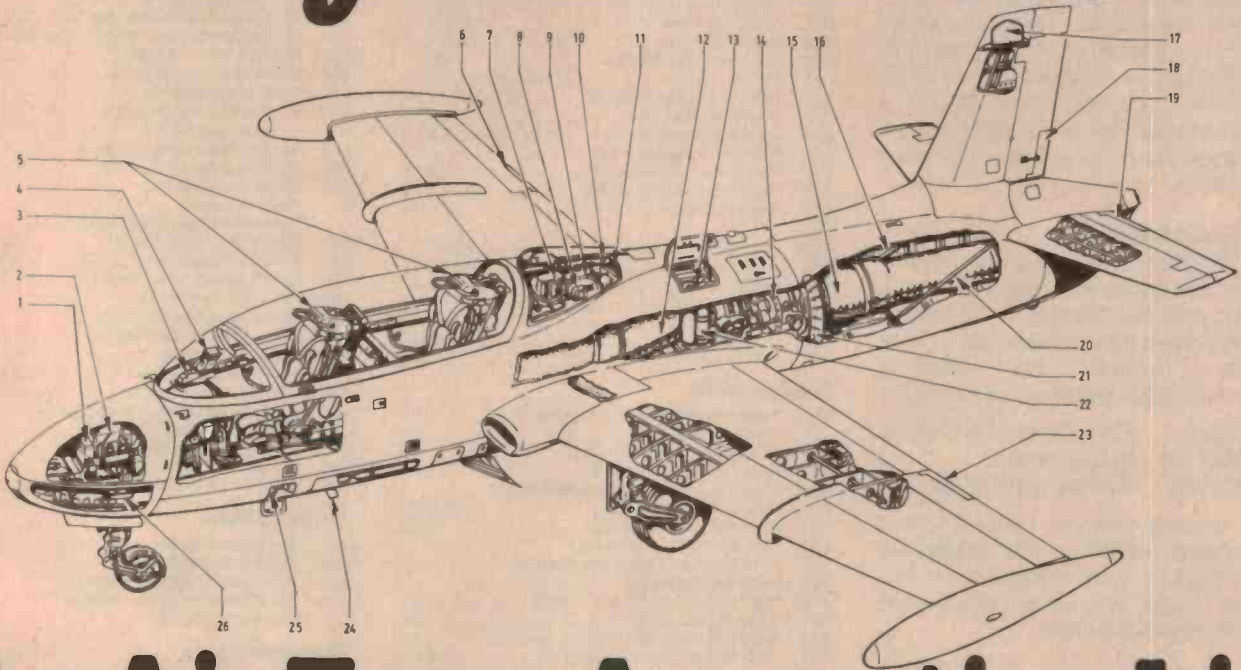

An Air Force Apprenticeship.

Opportunities no shop floor Apprenticeship can offer.

Right now, you can take an Air Force Apprenticeship and become a specialist in Airframes, Armaments, Radar, Communications, Propulsion Systems, Flight Systems or Motor Transport.

Full time training recognised and respected by Australian employers.

For the first 2½ years, you will be taught on some of the most up-to-the-minute equipment under the expert guidance of professional instructors. In modern laboratories, classrooms and workshops.

Understandably, when you have completed your initial training we expect you to spend another 6½ years working for us. On full adult pay of course.

It's not easy!

Success demands application. And a disciplined approach to work. As an Air Force Apprentice you'll be required to study in your own time. And regularly sit for exams. The rewards are there. Many Apprentices go on to become Officers.

It's not all work.

You will have stacks of time to relax provided you're on top of your studies. At both training bases (Wagga Wagga and Laverton) excellent sports facilities abound. Gyms, football grounds, golf courses, swimming pools, tennis courts and many clubs.

What about entry qualifications?

You need to be 15 and under 17 years at time of entry, an Australian citizen or able to meet our nationality requirements. We also expect you to have passed (or be in the process of passing) your *10th year of formal schooling with above-average marks in maths and science with a physics content. And be reasonably fit.

The scope for the future is enormous.

On completion of your Apprenticeship, you'll be part of a team servicing, repairing and testing some of the most advanced and sophisticated aircraft and equipment in the country. The technology of the future will be in your everyday working life.

Apply now!

Air Force Apprenticeships are very popular. So the sooner you have a chat

with a Careers Officer the better. The address is in the phone book and there's no obligation.

Alternatively send or phone for the facts:

Brisbane:	Townsville:	Sydney:	Newcastle:
226 2626	71 3191	212 1011	2 5476
Wollongong:	Wagga:	Canberra:	Melbourne:
28 6492	21 1100	82 2333	61 3731
Hobart:	Adelaide:	Perth:	
34 7077	223 2891	325 6222	

* 11th year will be required for 1982 entry for Certificate of Technology Scheme.

To:
AIR FORCE CAREERS OFFICER, C-20, Box XYZ
in the capital city nearest you.

Yes! I am interested in an Air Force Apprenticeship. Please send me full details.

Name: _____
Mr: _____

Address: _____

State: _____ Postcode: _____

Date of Birth: ____/____/____

AFAP230.FP.30

You're somebody in Today's Air Force

Authorised by Director-General Recruiting Dept. Defence

KITS for projects

WE GET MANY enquiries from readers wanting to know where they can get kits for the projects we publish. This list is a guide to suppliers of kits and components for ETI projects.

We have listed here most of the projects published over the last few years which are either available as kits or can still be made up by shopping around for components. Suppliers listed against a particular project will either stock it as a kit or stock the pc board plus the other components.

Printed circuit boards

Those suppliers listed against specific projects here are able to supply pc boards for those projects. Printed circuit boards for every project ever published in ETI are available through the following companies (to the best of our knowledge):

RCS Radio Radio Despatch Service
651 Forest Rd 869 George St
Bexley NSW Sydney NSW 2000

For current projects and a more comprehensive list of pc board suppliers refer to the Shoparound page in this and previous issues. This list will be updated roughly every four months.

Key to Companies

- A Applied Technology Pty Ltd, 1A Pattison Avenue, Waitara, NSW 2077. Ph. (02) 487-2711.
- B Bill Edge Electronic Agencies, 115 Parramatta Road, Concord (PO Box 1005, Burwood North 2134). Ph. (02) 747-6472.
- C J.R. Components, PO Box 128, Eastwood, NSW 2122. Ph. (02) 85-3976.
- D Dick Smith Electronics P/L, Cnr Waterloo & Lane Cove Roads, North Ryde, 2113. Ph. (02) 888-3200.
- E All Electronic Components, 118 Lonsdale Street, Melbourne, Vic 3000. Ph. (03) 662-3506.
- F Tasman Electronics, 12 Victoria Street, Coburg, Vic 3058. Ph. (03) 354-5062.
- J Jaycar Pty Ltd, PO Box K39, Haymarket, NSW 2000. Ph. (02) 211-5077.
- K S M Electronics, 10 Stafford Court, Doncaster East, Vic 3109. Ph. (03) 842-3950.
- L Ellistrionics, 289 Latrobe Street, Melbourne, Vic 3000. Ph. (03) 602-3282.
- M Mode Electronics, PO Box 365, Mascot, NSW 2020. Ph. (02) 666-6324.
- N Nebula Electronics Pty Ltd, 15 Boundary Street, Rushcutters Bay, NSW 2011. Ph. (02) 33-5850.
- O Orbit Electronics, PO Box 7176, Auckland, New Zealand.
- P Pre-Pak Electronics, 718 Parramatta Road, Croydon, NSW 2132. Ph. (02) 797-6144.
- R Rod Irving, PO Box 135, Northcote, Vic 3070. Ph. (03) 489-8131.
- V Silicon Valley, 23 Chandos Street, St Leonards, NSW 2065. Ph. (02) 439-4655.
- W Willis Electronics, 993 Hay Street, Perth, WA 6000. Ph. (09) 321-7609.
- Y Tnlogy, 40 Princes Highway, Fairy Meadow, NSW 2519.

Project Electronics

- 041 Continuity Tester W,R,D,B,Y,L
- 042 Soil Moisture Indicator R,B
- 043 Heads or Tails Circuit (Oct 76) . . . W,R,D,E,A,F,B,Y,L
- 044 Two Tone Door Bell (Oct 76) . . . W,R,D,E,O,A,F,B,Y,L
- 045 500 Second Timer W,D,E,A,B,Y,L
- 047 Morse Practice Set W,D,O,A,B,Y,L
- 048 Buzz Board W,D,A,B,Y,L
- 061 Simple Amplifier (Oct 76) W,R,D,E,A,B,Y,L
- 062 Simple AM Tuner (Mar 77) W,D,E,B,Y
- 063 Electronic Bongos R,D,A,B,Y,L
- 064 Simple Intercom (Nov 76) W,A
- 065 Electronic Siren W,R,D,E,O,A,B,Y,L
- 066 Temperature Alarm (Dec 76) W,D,E,A,B,Y,L
- 067 Singing Moisture Meter D,B,Y
- 068 LED Dice Circuit (Oct 76) Y,W,R,D,E,A,B,L
- 070 Electronic Tie Breaker (Jan 77) W,A
- 071 Tape Noise Limiter (Jun 78) R,E,F
- 072 Two-Octave Organ (Jun 78) W,D,B,Y
- 081 Tachometer (Mar 77) W,E,O
- 082/
- 528 Intruder Alarm W,R,E,A
- 083 Train Controller Y,W,R,E,L
- 084 Car Alarm W,R,D,E,A,B,Y,L
- 085 Over-rev Alarm W
- 086 FM Antenna W
- 087 Over-LED Y,W,E
- 088 Hi-Fi Speaker W

Test Equipment

- 132 Experimenters' Power Supply (Feb 77) E,O
- 133 Phase Meter (Apr 77) E
- 134 True RMS Voltmeter (Aug 77) E
- 135 Digital Panel Meter (Oct 77) E
- 136 Linear Scale Capacitance Meter (Mar 78) W
- 137 Audio Oscillator (May 78) W,D,E
- 138 Audio Wattmeter (Nov 78) E,B
- 139 SWR/Power Meter (May 78) W
- 140 1GHz Frequency Meter-timer (Mar 78) C
- 141 Logic Trigger (Jan 79) E
- 142 High Current Power Supply (Feb 79) W,E
- 143 Curve Tracer (Jan 79) W
- 144 Expanded-scale RMS Voltmeter (Jun 79) E
- 148 Versatile Logic Test Probe (Jul 79) E,L

Simple Projects

- 243 Bip Beacon (Apr 77) F
- 244 Alarm Alarm (Feb 77) F
- 245 White Line Follower (Nov 77) F
- 246 Rain Alarm (Apr 78) F
- 248 Simple 12V to 22V Converter (Jul 78) W
- 249 Electronic Combination Lock (Apr 79) E
- 252 The Passionmeter (Aug 79) W
- 253 Electronic Grenade (Hot Potato) (May 79) W
- 254 Egg Timer (Jun 79) Y,W

Motorists' Projects

- 316 Transistor Assisted Ignition (May 77) W,E,O,K
- 317 Rev. Monitor Counter (Jul 77) E
- 318 Digital Car Tacho (Jul 78) W,E,K
- 319 Vanwiper MK II (Sep 78) W,E,O
- 320 Battery Condition Indicator (Apr 79) Y,E,L

Audio Projects

- 448 Disco Mixer (Nov 76) W
- 449 Balanced Microphone Amp (Nov 76) . . . W,D,E,J,F,Y
- 450 Bucket Brigade Audio Delay Line (Dec 77) . . . W,E
- 451 Hum Filter (Jul 79) D,E,F
- 455 Class A Headphone Amp (Nov 78)
- 470 60 W Amp Module (May 79) . . . Y,W,R,E,F,B,P,L,A,V
- 471 High Performance Stereo Preamp Control Unit (Jun 79) W,R,E,F,B,P,A,V,L
- 472 Power Supply — the Series 4000 Stereo Amp (Jul 79) W,R,E,F,B,V,L
- 473 Series 4000 Moving-coil Cartridge Pre-amplifier F,J
- 480 50-100 Watt Amp Modules (Dec 76) W,R,D,E,J,O,Y,L
- 481 12V 100 Watt Audio Amp (May 77) R,E
- 481 High Power PA/Guitar Amp (Jun 77) W
- 482 Stereo Amp (Jan 77) O,E
- 482 Stereo Amp Part 2 (Feb 77) O,E
- 483 Sound Level Meter (Feb 78) E
- 484 Simple Compressor Expander (Jul 77) E
- 485 Graphic Equaliser (Jun 77) Y,W,E,J,O
- 486 Howl-round Stabiliser (Nov 77) J
- 487 Audio Spectrum Analyser (Feb 78) E
- 489 Audio Spectrum Analyser 2 (Apr 78) E,J
- 490 Audio Compressor (Dec 78)
- 491 Simple Graphic Equaliser (Mar 79) W,E
- 495 Transmission Line Speakers (Aug 77)

Miscellaneous

- 546 GSR Monitor (Mar 77) W,E
- 547 Telephone Bell Extender (Jun 77) E
- 548 Photographic Strobe (May 77) W,E
- 549 Induction Balance Metal Detector (May 77) Y,W,D,E,L
- 550 Digital Dial (Aug 78) E,O
- 551 Light Chaser (Sep 78) W,E,O
- 552 LED Pendant (Sep 78)
- 553 Tape/Slide Synchroniser (Oct 78) E
- 556 Wind Speed/Direction Indicator (Dec 78)
- 557 Reaction Timer (Feb 79) E
- 558 Mast-head Strobe (Feb 79) E
- 559 Cable Tester (Mar 79)
- 575 Portable Fluorescent Light Wand for Car, Camping (Aug 79) W
- 577 General Purpose Power Supply J
- 581 Dual Power Supply (Jan 77) W,E,Y
- 582 House Alarm (Jul 77) W,E,O,A, House Alarm — Installation Instructions (Aug 77) W
- 583 Marine Gas Alarm (Aug 77) D,E,M
- 585 Ultrasonic Switch (Sep 77) R,D,E,O,F
- 586 Shutter Speed Timer (Oct 77) E
- 587 UFO Detector (May 78)
- 588 Theatrical Lighting Controller (Nov & Dec 77 Jan & Mar 78) N
- 589 Digital Temperature Meter (PCB135) (Dec 77) E
- 590 LCD Stopwatch (Oct 78) O,N
- 591 Up/Down Presettable Counter (Jul 78) D,E
- 592 Light Show Controller (Aug 78) E
- 593 Colour Sequencer (Dec 78)
- 594 Development Timer (Apr 79) E
- 595 Aquarium Lamp Controller (May 79)

Electronic Music

- 602 Mini Organ (Aug 76) W,D,E,Y
- 603 Sequencer (Aug 77) W
- 604 Accented Beat Metronome (Sep 77) E
- 605 Temp Stabilized Log-exponential Converter (Sep 78)

Computer Projects

- 630 Hex Display (Dec 76) E,A
- 631 ASCII Keyboard (Dec 76) W,E,O,A
- 631 Keyboard Encoder (Apr 77) W,E,O,A
- 632 Video Display Unit (Jan 77) E,O
- 633 TV Sync Generator (Jan 77) E
- 634 8080 Educational/Prototyping Interface (Jul, Aug 78)
- 635 Microcomputer Power Supply (Sep 77) O
- 637 Cuts Cassette Interface (Jun 78) V,E,A
- 638 Eprom Programmer (Jul 78) W,E
- 639 Computerised Musical Doorbell (Mar 78) A
- 640 S100 VDU (Apr, May, Jun 78) W,O,A,V
- 641 S100 Printer (Sep 78) O
- 642 16k S100 RAM Card (Feb 79) K
- 650 STAC Timer (Nov 78) E,L
- 651 Binary to Hex Number Converter (Jun 79) E
- 680 Z-80 based CPU (Nov, 79) A

Radio Projects

- 712 CB Power Supply (Jun 77) W,E
- 713 Add-on FM Tuner (Sep 77)
- 714 VHF-Log-Periodic Antenna (Feb, Mar 78)
- 715 VHF Power Amplifiers (Nov 77)
- 716 VHF Power Amplifiers (Jan, Feb 78)
- 717 Crosshatch Generator (May 78) W,D,E,A,Y
- 718 SW Radio (Oct 78) E
- 719 RF Field Strength Indicator (Nov 78)
- 720 2m VMOS Power Amp (Jan 79)
- 721 Aircraft Band Converter (Mar 79) W,E
- 722 Antenna for Aircraft Band Converter (May 79)
- 724 Microwave Oven Leak Detector (Jul 79) D,E,B
- 725 Simple SSB Generator employs Polyphase Network using Standard Components (Aug 79) . . . E,L
- 730 Get Going on Radioteletype (Aug 79) E,L

Electronic Games

- 804 Selectagame (Nov 76) O
- 804 Selectagame (Rifle Project) (Mar 77) O
- 805 Puzzle of the Drunken Sailor (Oct 77)
- 806 Skeet (Jan 78) O
- 810 Stunt Cycle TV Game (Jun 78) D,O
- 811 TV Tank Game (Oct 78) O
- 812 Wheel of Fortune (Dec 78)
- 813 Race Track Game (Jan 79) O
- 814 The 'Dinky-Die' (Aug 79)



Editor
Roger Harrison VK2ZTB

Project Manager
Phil Wait VK2DKN

Editorial Staff
John Pollard M.A., Ph.D.
Jonathon Scott B.Sc. (Hons)
David Tilbrook VK2YMI
Jan Vernon B.A.

Art Direction and
technical photography
Ivy Hansen

Layout
Bill Crump

Reader Services
Jan Collins

Managing Editor
Collyn Rivers

Acoustical Consultants
Louis Challis & Associates

Editorial and Sales Office
4th Floor, 15 Boundary St
Rushcutters Bay NSW 2011
Ph: 33-4282; Tlx: 27243

Sales Manager: Bob Taylor
Sales Admin: Jan Collins
(address as above)

Melbourne
Tom Bray
150 Lonsdale St
Melbourne Vic 3000
Ph: 662-1222; Tlx AA34543

Auckland
Geoff Collins
Catalyst Ltd
Cnr, Pauls & Airedale Sts
Auckland NZ
Ph: 79-4168

Adelaide
Admedia Group
24 Kensington Rd
Rose Park SA 5067
Ph: 332-8144; Tlx AA82182

London
Australian Consolidated Press
Ludgate House
107 Fleet St
London EC4A 2AL
Ph: 353-1040; Tlx: 267163

Brisbane
Geoff Horne Agencies
60 Montanus Drive
Bellbowrie QLD 4070
Ph: 202-6229

Tokyo
Genzo Uchida
Bancho Media Services
15 Sanyocho
Shinjuku-Ku
Tokyo 160
Ph: 359-8866
Cable: Elbanchorito

Hobart
H.W. Lincolne
23 Lord St
Sandy Bay Tas 7005
Ph: 34-2630

New York
George McGann
Australian Consolidated Press
444 Madison Avenue
New York NY 10022
Ph: 751-3383; Tlx: 620892

Perth
Aubrey Barker
133 St Georges Terrace
Perth WA 6000
Ph: 322-3184; Tlx: AA93810

Electronics Today International is published by Modern Magazines (Holdings) Ltd, 15 Boundary St, Rushcutters Bay, NSW 2011. It is printed (in 1980) by Wilke & Co, Browns Rd, Clayton, Victoria and distributed by Gordon and Gotch. Recommended retail price only.

Reader Enquiries

By Mail: There is no charge for replies but a foolscap-size stamped addressed envelope must be enclosed. Queries relating to projects can only be answered if related to the item as published. We cannot advise on modifications to projects, other than errata or addenda, nor if a project has been modified or if components are otherwise than specified. We try to answer letters as soon as possible. Difficult questions may take time to answer.

By phone: We can only answer readers' technical enquiries by telephone after 4.30 pm. In enquiring by telephone about back issues or photosats, please ask for the "Subscriptions Department". **33-4282**

Microfilm

Microfiche editions of this publication are available by annual subscription from Microsystems Pty Ltd, P.O. Box 188, North Sydney, NSW 2060.

ORDER FORM

I enclose \$ for (tick appropriate box/es):

NAME

ADDRESS

. POSTCODE

Subscriptions \$21.50 per year within Australia \$
\$27.00 overseas (surface mail) \$
Airmail rates on application.

Back issues (\$2.50 from April 1977 on)

or photocopies (\$2.50 per article per issue)

Project No. Month Year \$

Project No. Month Year \$

Project No. Month Year \$

Project No. Month Year \$

* Please attach a list if more than four required.

Binders No. @ \$6.10 each in NSW \$
No. @ \$7.50 each other states \$

ALL PRICES INCLUDE POSTAGE

Send orders to: **ETI, 4th Floor, 15 Boundary St,
RUSHCUTTERS BAY NSW 2011 Phone: (02)33-4282**



"... and when I typed in GOTO: JMP20,
it said - GO JUMP, YOURSELF!"

FOLLOWING what was described by Managing Editor, Collyn Rivers, as "arguably the worst pun we have ever published in ETI", which appeared on this page in the June issue ("...Descartes before the morse"), the Editor has decided to institute "The Great Dregs Awful Puns Competition".

The rules are as follows: submit an original pun which incorporates an electronics/communications/audio theme, preferably using some jargon or the odd acronym. Each month we will publish the one we adjudge the best, along with the winner's name (or just your initials, if you feel that bad about it) and city/suburb/town. Each month's winner will receive a free copy of Test Gear 2/30 Audio Projects/Computers & Computing (nominate your preference). You may send as many entries as you wish.



DREGS

Send entries to: The Great Dregs Awful Puns Competition, ETI Magazine, 3rd Floor, 15 Boundary Street, Rushcutters Bay, NSW 2011.

Just to kick things off to a good start, here's Collyn Rivers' own entry —

"What with the information explosion and the microprocessor revolution, will the future be nothing but a load of fiche and chips?"

What is a robot

According to the Robot Institute of America (RIA), who formed an industry-wide panel of robot users, manufacturers and researchers charged with the weighty responsibility of defining what a robot **really** is, a robot is:

"A reprogrammable, multifunctional manipulator designed to move parts, tools, or specialised devices through variable programmed motions for the performance of a variety of tasks."

You thought it was going to be something simple, didn't you?

REAL HI-FI

AND IT'S ALL IN OUR COLOUR CATALOGUE

The truth is, JVC have always produced real hi-fi components and we believe this current range represents JVC's finest range ever. Here are some real innovations and performance features to whet your appetite:— Quartz locked turntables with uncanny accuracy; Receivers/Amplifiers, some with built-in SEA Graphic Equaliser and DC, class A/B amplification; Cassette deck with JVC automatic computerised tape tuning; Computer designed

speaker systems; Separate but matching JVC components designed to compliment one another, perfectly. And all this real hi-fi know-how is yours ...merely for the asking.



**If you think they look different,
wait till you've heard them!**

FREE OFFER COLOUR HI-FI CATALOGUE

Just fill out this coupon and we'll fill you in on what's available and new in terms of JVC hi-fi entertainment...and it's all FREE!

Name _____

Address _____

_____ Postcode _____

WT1323/ETI/79

I am especially interested in...

- Cassette Decks
- Matching Systems Amplifiers
- Speakers
- Turntables
- Receivers

Just address your envelope to...
JVC Hi-Fi Advisory
Service,
Post Office Box 307,
North Ryde,
N.S.W. 2113

JVC

the right choice

The revolutionary Honeycomb Disc Speaker System!



Another Technics
'first' that brings...

Sounds
Alive



Cross Sectional View of the SB-10

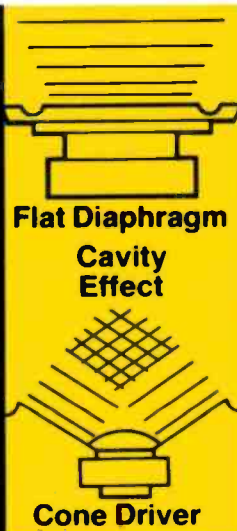

The most obvious difference... between the new Technics honeycomb disc speaker system and conventional speaker systems is that the speaker units are flat instead of conical. This flat sound radiating surface at last puts an end to all of the distortions inherent in the traditional cone-shaped design. Cone shaped drivers suffer from something called the 'cavity effect' which causes peaks and dips in the upper end of the driver's frequency range.

But cone shaped drivers do have their advantages, namely a combination of low mass and high rigidity which contributes to pistonic motion. In designing this new Technics honeycomb speaker system we were faced with the problem of retaining or improving upon the cone-shaped speaker's low-mass, high-rigidity characteristics while developing a flat speaker surface. We found the answer in the 'axially symmetric honeycomb diaphragm.' It is well known that honeycomb structures are very light and strong, which is why they are extensively used in aircraft construction. In spite of the honeycomb's low mass, it is very rigid and difficult to bend.

Technics