

Feb. 1980  
\$1.60\* NZ \$1.75

**eti**

**ELECTRONICS  
TODAY  
INTERNATIONAL**

**300 W AMP.  
to build**

**'Series 4000'  
4-way speaker**

**Over-rev alarm  
for your car**



**Hi-Fi. Updating your system;  
Special emphasis on turntables  
- with top models reviewed.**

# A new dynamic generation of Maxell tapes.

When Maxell announces an improvement in the quality of its tape, you can bet the improvement has to be pretty dynamic. In fact, we think our new generation has even gone beyond our own standards of superior sound reproduction.

Take our high level (CrO<sub>2</sub>) position tape – the UD-XL II. Maxell engineers have succeeded in expanding its dynamic range in the middle-low frequency range by 1 dB, while also pushing its sensitivity by 1 dB in the high frequency range. Then look at our normal position UD-XL I, UD and LN tapes – our engineers expanded the dynamic range at all frequency points, while also boosting output in the high frequency range. The new dynamic range, of course, allows for better music reproduction even for LN-type tapes.

On the UD-XL I and II, we also added an exclusive shell stabilizer for significantly improved tape running and track positioning.

One thing hasn't changed on all Maxell tapes – our functional features like 4-function leader tape, replaceable index labels for UD-XL series tapes and Maxell's through-production system – your guarantee of quality and superior sound reproduction.

Tape selector position UD-XL I, UD, LN: Normal position (Normal bias/120 μsec. EQ)  
UD-XL II: High level position (High level bias/70 μsec. EQ)



For details on all Maxell Recording Tape write to Maxell Advisory Service, P.O. Box 307, North Ryde, N.S.W. 2113 Available time length UD-XL I: 60, 90 min./UD-XL II: 60, 90 min. UD: 60, 90, 120 min./LN: 60, 90, 120 min.

Distributed by...  
**HAGEMEYER**

**maxell**®  
simply excellent



# ELECTRONICS TODAY INTERNATIONAL

Registered for posting as a publication -  
Category B

## QUICK INDEX

### FEATURES:

- 16 Through the Multimeter Maze
- 27 The Saturn Flyby
- 34 Courses and Careers in Electronics
- 153 Leading Ferrite Researcher Visits Australia

### SOUND SECTION:

- 125 Upgrading Your Hi-Fi
- 136 Loudspeaker Design, Principles and Problems
- 144 Pioneer PL-L1000 Turntable Review
- 150 Audio Reflex MR-130/140 Turntable Review
- 154 Hafler Preamp and Amp Review

### PROJECT SECTION:

- 44 466: 300 Watt Power Amplifier Module
- 57 152: Linear Scale Capacitance Meter
- 65 726: 70 Watt Booster Amp for 6m and 10m
- 74 496: Series 4000 Four-way Loudspeaker
- 87 Ideas for Experimenters
- 93 Shoparound
- 161 Kits for Projects

NO DOUBT you have already noticed a number of changes in this issue. First, the price increase. Over the past year we have experienced a number of substantial increases in the price of the paper as well as a steep rise in the cost of printing. Most other general costs have increased as well. We elected to absorb the increases at the time, partly because circulation showed a healthy increase (. . . thank you, readers) and mainly because our last price increase was in January 1979. Considering the way most commodities are heading pricewise these days, our 20c increase is quite modest by comparison.

Secondly, with this issue we have changed to a very much better grade of paper throughout the magazine. Trusting the printers to do a good job, this paper will significantly improve clarity of reproduction, with photographs in particular as well as with the texts and drawings. Along with the improvements in content and presentation we have made over the last year, we feel the magazine represents excellent value for money at a cover price of \$1.60. Progress and continual improvement are our aims, the results you can judge for yourself.

Talking of 'progress', the relentless advance of electronic technology has engaged the close attention of both the captains of industry and union leaders. Everybody in Australia is doubtless aware of Mr Bob Hawke. He is shortly to vacate his seat at the head of the powerful Australian Council of Trade Unions to start a career in Federal politics. The man slated to step into the void is Mr Cliff Dolan, National Secretary of the Electrical Trades Union and an ACTU Vice President. In a recent interview reported in the Sydney Morning Herald (14-1-80), Cliff Dolan made plain his concern over the possible effects of the 'technological revolution'. He believes that this technology is destroying jobs "en masse", that the public is too little aware of this, that government policies - particularly taxation policies - actually fuel the problem and "massive unemployment" is staring us in the face. According to the SMH report, Cliff Dolan says it is not possible to resist unemployment-creating technology, but he challenges the Federal Government's policy of encouraging it through tax concessions. It may be necessary, he says, to tax job-destroying technological equipment to finance new jobs. The new technology, especially the "micro-chip", is pushing us to the point of having to consider radical new ways of distributing wealth.

A view espoused in different circles holds that new technology actually redistributes the *type* of jobs people do, rather than reducing the number of jobs available (on a per capita basis), and that unemployment 'created' by technological advances is a result of a phase lag in the education system. . . .

Which view reflects the real situation remains to be seen as technology progresses. Nonetheless, the seriousness of the situation, in human terms, demands a thorough investigation and plenty of public debate.

Roger Harrison, Editor



# advertisers

Adaptive Electronics	12
AED	63
All Electronic Components	62
Ampec Engineering	32
Anderson Digital	128
Applied Technology	90
Arena Distributors	124,156
A & R Soanar	10,26,47
Associated Services	72
Audio Engineers	132
Audio Reflex	116
Audioson	148
Auditec	63
Audio 2000	134
AWA	114
Barratt Lighting	135
Bell Instruments	14
Calculator Supermarket	92
Cema	102
Chadwick Audio	134
Christie Rand	69
C & K Electronics	14
Collingwood Tech.	39
Computer Ware	69
Concept Audio	140
Convoy International	146
Daneva Control	101
David Reid	43
Deisound	158
Defence Recruiting	36
Dick Smith	20,24-25,33,60,100,104
Diggerman Electronics	39
Douglas (BJD) HI-FI	111
Edible Electronics	95
Electrocraft	108
Electronic Agencies	73
Elect. Calculator Discounts	18
Electronic Circuit	108
Ellstronics Wholesale	98
Emac Industries	158
Embryonic Services	46
Emona Enterprises	31
Ferguson Transformers	79
GLW	101
Hagemeyer	2,163
Hanlimex	82
HF Coates	72
Hitachi	118-119
Holden Wasp	148
H Rowe & Co	26,56
IFTA Aust	106
Insound	148
Jaycar	138
John F Rose	15
JW Dicker	79
JW Haymes	42
Kenelec	64
LE Chapman	40
Logic Shop	17
Looky Video	42
Magraths	11
Mauri Corp	7
McGills	10
Microprocessor Applications	64
Micro Pro Design	46
Microtrix	46
Modern Boating	101
Modern Fishing	111
National Panasonic	164
Phillips Elcoma	78
Plessey Components	72
Pre-Pak	89
Radio Despatch	42
Radio Parts	95
Rank Australia	149
Rod Irving	54-55,83
Rose Music	143
Scope Labs	6
Semcon	86
SM Electronics	88
Sony	120
Speedy Communications	126-127
Stanton Magnetics	158
Stewart Electronics	96
Stotts Correspondence	33
Systems Automation	94,95
Tandy	22,153
Tasman Electronics	71
Texas Instruments	130
Time Life Int	122-123
Vicom	110
Wheels	33
Willis Electronics	108



# ELECTRONICS TODAY INTERNATIONAL

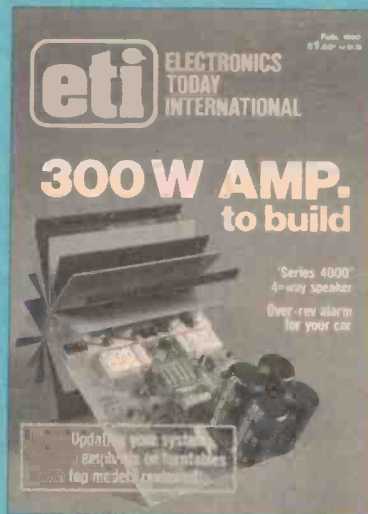

## COVER

As we said: you asked for it — here it is! A high power amplifier. We 'dressed up' the heatsink for this shot, and Ivy Hansen did the rest.

## features



## MULTIMETERS

16

Through the multimeter maze — how to choose and how to use.

## THE SATURN FLYBY

27

Pioneer 11's mission to Saturn was a remarkable success.

## COURSES AND CAREERS IN ELECTRONICS

34

Concluding part of our look into the tertiary education system for electronics people.

## projects

## news

### NEWS DIGEST

8

Australian made metal detector; Gold fever; Video disc gear up; Flashers etc.

### PRINTOUT

97

Apple — teacher's pet; Microtrix expand; Pascal microengine; New clubs and user groups; Releases.

### COMMUNICATIONS NEWS

103

Amateurs score at WARC1; New walkie-talkie; Swan and Cubic re-organise; 23rd field day for club.

### SHORTWAVE LOGGINGS

107

English broadcasts beamed to Australia; Chinese regional; Tunisia on move.



### 466: 300 WATT POWER AMP

44

This lusty fella sure packs a punch! If you want to hear those peaks unclipped or like your sound loud — this is what you need.

**152: LINEAR SCALE CAPACITANCE METER 57**

Third in our series of low-cost, look-alike test instruments.

**726: BOOSTER AMP FOR SIX AND TEN METRE HAM BANDS 65**

Get amongst the DX on the 'hot' bands with this 70 W linear.

**496: SERIES 4000 FOUR-WAY LOUDSPEAKER 74**

Top of the line in a new series of quality loudspeakers designed and developed in our own laboratories.

## sound

**SOUND NEWS 117**

AR verticals; Signal split; New Chartwell speakers; TDK accessories; Super discs.



**UPGRADING YOUR HI-FI 125**  
Climbing the ladder to sound perfection.

**LOUDSPEAKER DESIGN 136**  
Concluding part of the principles and problems encountered in loudspeaker design.

**FERRITE RESEARCHER VISITS 153**

Dr Takei, consultant to TDK, and the story of his devotion to the development of ferrites.

**PIONEER PL-L1000 TURNTABLE 144**  
Elegant design, top class performance, but . . . . .

**AUDIO REFLEX TURNTABLE 150**  
The MR-130/140 is a recent release and not bad, not bad.



**HAFLE AMP AND PREAMP 154**  
Can you build top specification gear to match the professionals?

**REEL-TO-REEL TAPE OFFER 91**  
**SUPER CASSETTE OFFER 112**

## general

**IDEAS FOR EXPERIMENTERS 87**  
Flip-flop flasher; Keyboard encoder; Oscillator for ETI-551;

**SHOPAROUND 93**  
Where to get kits, components and pc boards for our projects, sources for scarce components etc.

**LETTERS 41**  
**IONOSPHERIC PREDICTIONS 109**  
**MINI-MART 159**  
**ETI SERVICES 160**  
**KITS FOR PROJECTS 161**  
**DREGS 162**

## next month



### METAL DETECTOR

With gold at more than \$600 an ounce and old pennies fetching \$50, there's strong incentive to turn one's hobby into a more profitable pastime. Join the metal detecting boom with our new metal detector for a fraction of the cost of the imported models — and get the satisfaction of having built it yourself!



### TECHNICS RS-M63 CASSETTE DECK

Louis Challis reviews Technics' cassette deck with metal tape facility that was released last year.

### SATELLITE BUSINESS SYSTEMS

Business communications have become so complex and reached such enormous volumes that a satellite system is the only solution. It seems the USA will have it within twelve months. . . .

### CAR OVER-REV ALARM



With many modern high-revving engines it is remarkably easy for the engine to exceed its 'red line' limit when changing gears at highway speeds. This unit lets you know *before* you do some damage. This project was held over to ensure parts availability.

Although these articles are in an advanced state of preparation, circumstances may affect the final content. However, we will make every attempt to include all features mentioned here.

# SERVICE TECHNICIANS!

## Specialised Soldering Tools from...

# SCOPE

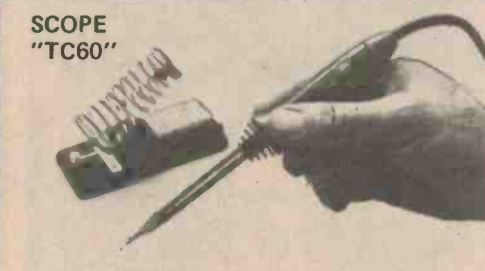
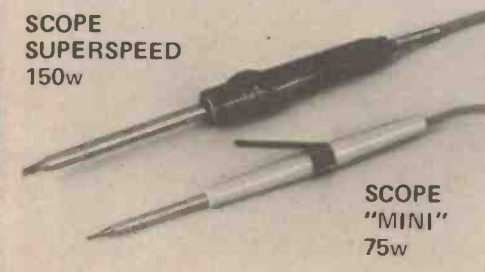
SERVICE SITUATION	TAKE THIS TOOL	GET THIS USER ADVANTAGE
<ul style="list-style-type: none"> <li>● No power</li> <li>● No time to get power</li> <li>● Must work on live gear</li> </ul>	<p>SCOPE "CORDLESS"</p> 	<ol style="list-style-type: none"> <li>1. 40-200 Terminations depending on conductor size.</li> <li>2. Recharges overnight.</li> <li>3. Heats in 6 seconds.</li> <li>4. 60 watts - Controllable temperature.</li> </ol>
<ul style="list-style-type: none"> <li>● 12 volt. Battery power available only.</li> <li>● Outdoor and bad weather expected.</li> <li>● Service vehicle can get within 6 metres.</li> </ul>	 <p>SCOPE "12VOLT SUPERSPEED"</p>	<ol style="list-style-type: none"> <li>1. 5 Second heating.</li> <li>2. 200 watts if needed.</li> <li>3. Controllable temperature.</li> <li>4. You can replace tip or element anywhere in minutes.</li> </ol>
<ul style="list-style-type: none"> <li>● Modern sophisticated PCB equipment.</li> <li>● Accurate &amp; automatic temp. control wanted.</li> <li>● Components are heat critical.</li> </ul>	<p>SCOPE "TC60"</p> 	<ol style="list-style-type: none"> <li>1. Heats in 45 seconds.</li> <li>2. Dial any temp. 200°-400°</li> <li>3. Plugs direct to mains. No transformer needed.</li> <li>4. Accept iron plated tips from 0.8mm to 6.4mm.</li> </ol>
<ul style="list-style-type: none"> <li>● Unpredictable soldering situation.</li> <li>● Maybe electrical or electronic or mechanical.</li> <li>● You can't come back to base for a bigger or smaller iron.</li> </ul>	<p>SCOPE SUPERSPEED 150w</p>  <p>SCOPE "MINI" 75w</p>	<ol style="list-style-type: none"> <li>1. 5 second heat up.</li> <li>2. Controllable temperature.</li> <li>3. Reserve heat for any normal job.</li> <li>4. 4 volt safety in the hand.</li> </ol>

For further information telephone your nearest Scope agent:  
 NSW (02) 546-6144. QLD (07) 221-1933. SA (08) 223-2261. WA (09) 381-4155.  
 TAS (003) 31-5545, (002) 34-2811. NZ (4) 85-9578, (9) 54-6029.

### SCOPE LABORATORIES

Box 63 Niddrie Vic., 3042.  
 Phone: (03) 338 1566. TLX 34382.

LISTED BELOW ARE THE  
MAJOR HEADPHONES THAT OUTPERFORM  
**THE MARUNI HV3000R**

*N.B. MARUNI microphones take some beating too!!!*

# **MARUNI**

SUPERLATIVE HEADPHONES AND MICROPHONES

THE **MARUNI** CORPORATION

297 WILLIAMSTOWN ROAD, PORT MELBOURNE, 3207 • TELEPHONE, 645 2079 • TELEX 32571



## Metal/mineral detector is locally built

Amongst the plethora of imported metal detectors currently vying for attention on the market it is rare to find a locally-made model, but Melbourne manufacturer Aegis Pty Ltd has produced a unique unit claiming remarkable performance.

**Employing an induction balance technique, the Aegis model CZ6000 consists of separate transmitter and receiver units placed at either end of a carrying handle.**

A conductive loop around the rim of each box acts as the antenna for each unit and the boxes are aligned to 'balance' the signal induced into the receiver from the transmitter before searching. A 'target' will disturb the balance and the transmitter signal will be heard in the receiver. A knob on the receiver end of the handle facilitates aligning the unit to get a null.

Claimed penetration is remarkable. For example, Aegis quote that, under average soil condition, the CZ6000 may be expected to find an object of 2580 sq. mm (4 sq. inches) that has been buried to a depth of 355 mm (14 inches) below

the soil surface for up to two years. Larger objects may be found at considerable depths, they say.

The unit has a built-in speaker or may be used with headphones. A sensitivity control allows you to adjust the unit for a wide variety of field conditions. A meter is also provided to aid accurate nulling and indication of the position of a target object. Condensed operating instructions are printed on the front panel — a thoughtful, and very handy, inclusion.

The instrument is powered by two 9 V batteries, one each for the receiver and transmitter. The two boxes detach from the handle and clip together for transportation.

Further information, brochures etc available from Aegis Pty Ltd, P.O. Box 49, Thornbury 3071 Vic; (03) 49-1017 or 49-6792.

## Remote programmable high voltage supply

**A new modular high voltage power supply from Pacific Precision Instruments features remote programming and 0.01% stability for use in sensitive applications, such as photomultiplier excitation.**

AC powered, it is ideal for the system designer or OEM user and is less than a third the size of comparable rack mounted models.

Designated Model 230, it is available with positive or negative output voltages, adjustable from 0 to 2000 volts using an on-board screwdriver control, or remote programming. Output current is from 0 to 4 milliamperes with no external heat sinking required, according to the data supplied. An auxiliary output provides one volt per 1 kV for external monitoring.

With 10 millisecond transient response the 230 finds applications in high voltage control loops and computer programmable power supplies — as



well as fixed voltage requirements.

For further information, contact: John Morris Pty Ltd, PO Box 80, Chatswood, NSW, 2067. (02) 407-0206.

## Voltage tester: unique advantages

**This inexpensive voltage tester can be used to check ac or dc voltages from 6 to 415 volts, indicate polarity of dc voltages and has probe tips that can be safely inserted into a power socket.**



Unique to the Australian market, this German-made instrument is highly portable — designed to be carried in the pocket, and is made from impact-resistant plastic.

Called the 'Master Check' it is being distributed by Bell Instruments Pty Ltd, P.O. Box S2, Homebush NSW 2140. (02) 764-3733, telex AA22540.





## Frequency synthesizer

A high accuracy microprocessor-controlled frequency synthesizer covering the 0.001 Hz to 2 MHz range has been introduced by Philips Test and Measuring Instruments.

The PM 5190 offers sine, triangular and square wave signals with keyboard setting of parameters on LED display. An IEC bus interface is standard for complete remote control.

Frequency setting is accurate to plus/minus one part per million, according to Philips. A crystal-controlled oscillator ensures high short and long term stability — ageing is quoted as less than 1.5 parts per million per year. Maximum output is 19.9 V peak to peak with dc offset possible up to plus or minus 9.9 V. A separate TTL output is also provided.

## Gold fever got you?

"You too can join the ranks of the rich — just go out and dig up some gold.", says the Dick Smith advertisement.

If you're into the treasure hunting scene — be it gold, precious metals or whatever, then two books recently released by Dick Smith should take your interest.

'Metal Detecting in Australia' by Colin Webster is a \$4.50 paperback that covers all the techniques of using an electronic metal detector to search out metals buried in the ground. It covers the subject in exhaustive detail, including the various types of detector currently available and how they are used.

'The Australian Goldfinder', written by Gerry Nolan, an electronic technician who has worked for many years in geophysics, searching for gold, copper, uranium, nickel etc. Specifically pitched at the gold prospector, it goes into gold

finding in great detail, including the use of metal detectors, panning techniques etc. Quite instructive for \$1.95.

Both books available at booksellers, newsagents and Dick Smith Stores.

The PM 5190 is a compact portable instrument measuring 140x310x365 mm and weighing only 6 kg. It will run on 110, 128, 220 and 238 Vac supplies at 50 to 60 Hz. Power consumption is 47 W.

Frequency readout is shown on a six digit LED display with separate displays of ac and dc output values and dc polarity. External amplitude modulation is possible with modulation depth up to 90 percent.

All functions are fully programmable through the built-in IEC bus interface. This allows use with automatic test systems without modification.

All functions are fully programmable through the built-in IEC bus interface. This allows use with automatic test systems without modification.

All functions are fully programmable through the built-in IEC bus interface. This allows use with automatic test systems without modification.

All functions are fully programmable through the built-in IEC bus interface. This allows use with automatic test systems without modification.



## Briefs

Conventional carbon brushes on electric motors will be a thing of the past if an invention by E. Wilcox of the Isle of Man gets off the ground. He has replaced the brushes on an electric motor with a liquid metal slip ring formed from an alloy of 50% bismuth, 31.2% lead and 18.8% tin.

Japan's semiconductor technology development expertise has almost caught up with the US, which used to be able to count on a two-year lead time. Japan's co-operative government R & D push is cracking the US' world-wide hold on LSI and VLSI technology in their effort to build domestic LSI expertise.

Non-corroding iron, discovered on the surface of the moon, has been reproduced on Earth by Russian scientists. A sample of non-corroding iron was picked up by USSR's Luna 16 unmanned earth-moon-earth probe in 1970. The non-oxidising form of iron was produced by the solar wind which removes oxygen from the iron to form a pure metal. Soviet scientists duplicated lunar surface conditions in the laboratory to produce a sample and have registered the process with the Soviet Committee for Inventions and Discoveries.

Cathodeon Crystals of Cambridge, UK, claim to have produced high-stability TTC-cut crystals and is offering production samples of 10 MHz units. These new crystals are said to be less sensitive to mechanical and thermal stress than conventional types as well as offering superior aging characteristics.

An experimental voice-input typewriter, developed by Toshiba, can potentially type any one of the 100 000 to 200 000 Japanese words by recognising the language's 68 basic syllables. It is not well-suited to English because of the irregularities and the number of syllables. Toshiba say a commercial product is only two or three years away.

An optical detector device that incorporates a voltage regulator, Schmitt trigger, differential amp and a photodiode on the same substrate has been developed by Spectronics, the Texas(US)-based division of Honeywell Inc. Expected applications include replacement of discrete and hybrid photo-transistor arrays in existing equipment, specialised industrial counting etc.

The Silicon Transistor Corp of Massachusetts USA has developed a transistor for switching circuit and power amplifier applications having a collector-emitter sustaining voltage of 325 V, a minimum gain of 15 at 2.5 A and a saturation voltage of 0.7 V at 2.5 A. Type number is 2N5241 and it comes in a TO-3 package.

The first commercially available 500 volt MOSFET will be offered by International Rectifier Corp's semiconductor division. Based on their recently-introduced HEXFET technology, the device is expected to have a pulsed-current rating greater than 6 A, the company says. It should find immediate applications in motor drives and switched-mode converters.

Meanwhile, VFET market leader Siliconix, has slashed prices on several devices in their VMOS line. The VN64GA price has been cut in half, for example, and is now listed at US\$6.88 in 1000-off quantities.

Centronics has introduced a new typewriter technology featuring low cost, hard copy output and unlimited fonts — aimed at the office environment. The system uses a stylus controlled by miniature solenoids in the X, Y, and Z axes to press on and through a carbon typewriter ribbon. Thus, while it writes silently like non-impact printers it can make multiple copies which the latter can't. This approach offers the ability to print any programmed font, including cursive script simulating handwriting. Having seen the editor's handwriting, he could certainly do with one!

# ARLEC



**NEW**

## LOW PROFILE TRANSFORMERS

**with 40% Extra Power**

AL 7VA/6	6V C.T. or 3V
AL 7VA/9	9V C.T. or 4.5V
AL 7VA/12	12V C.T. or 6V
AL 7VA/15	15V C.T. or 7.5V
AL 7VA/18	18V C.T. or 9V
AL 7VA/24	24V C.T. or 12V
AL 7VA/30	30V C.T. or 15V

**All Models Rated At 7 VA.**

### Features:

- Insulated to AS C126
- PCB Mounting Pins
- Pin Compatible with other Current Models
- Mounting Clamps available for non PCB applications
- Modern Welded Stack
- Fully enclosed windings
- Size L.49mm, W.35mm, H.34mm.
- Weight 0.23 Kg

Also available in 10VA with similar dimensions for O.E.M. Quantities.

S.E.C. certificate of suitability to ASC126.

**ARLEC**

**A+R Electronics Pty Ltd**

30-32 Lexton Road, Box Hill, Vic., 3128, Australia. Telex: 32286.

A MEMBER OF  
THE A+R SOANAR  
ELECTRONICS  
GROUP

VICTORIA: 89 0661  
N.S.W.: 789 6733  
S.T.H. AUST.: 51 6981

QUEENSLAND: 52 5421  
WEST AUST.: 381 9522  
HONG KONG: (3) 89 1271

# BOOKS

Just some of the books from the biggest range of radio and electronics books in Australia. If the book you require is not listed below, it can be ordered from us.

**NEW - NEW - NEW** Latest editions of some of the most popular books on the subject:

Basic Computer Games — Microcomputer Edn. (David H. Ahl, Ed.)	\$11.75
More Basic Computer Games (David H. Ahl)	\$11.75
ARRL Handbook 1980 (now available)	\$14.95
Australian Radio Amateur Callbook 1979	\$2.95
World Radio and TV Handbook	\$15.95
World DX Guide — 1st Edition (Ed. J.M. Frost)	\$9.95
R.S.G.B. Handbook — Volume 1	\$21.95
R.S.G.B. Handbook — Volume 2	\$18.90
R.S.G.B. Test Equipment for the Radio Amateur	\$19.55
R.S.G.B. VHF-UHF Manual	\$17.70
R.S.G.B. Radio Amateur's Examination Questions and Answers	\$5.50
The World In My Ears (Cushen)	\$13.35
Radio Handbook — 21st Edition (New Edition) (William Orr)	\$26.50

### ADAM OSBORNE BOOKS:

An Introduction to Microcomputers — Volume 0 — The Beginner's Book	\$11.50
An Introduction to Microcomputers — Volume 1 — Basic Concepts	\$13.50
An Introduction to Microcomputers — Volume 2 — Some Real Microprocessors	\$29.00
An Introduction to Microcomputers — Volume 3 — Some Real Support Devices	\$19.00
Some Common Basic Programmes	\$13.00
Accounts Payable and Accounts Receivable	\$18.60
Payroll with Cost Accounting in Basic	\$18.60
General Ledger	\$18.60
Z80 Assembly Language Programming	\$13.50
Z80 Programming for Logic Design	\$13.50
8080A/8085 Assembly Language Programming	\$13.50
6800 Programming for Logic Design	\$13.50
6800 Assembly Language Programming	\$13.50
8080 Programming for Logic Design	\$13.50
6502 Assembly Language Programming	\$13.50

### AMERICAN RADIO RELAY LEAGUE PUBLICATIONS:

All New A.R.R.L. Code Kit	\$14.50
Hints and Kinks for the Radio Amateur	\$7.20
The Radio Amateur's VHF Manual	\$7.20
A.R.R.L. Antenna Handbook	\$8.80
Understanding Amateur Radio	\$8.80
The Radio Amateur's License Manual	\$7.20
A Course in Radio Fundamentals	\$7.20
Specialized Communications Techniques for the Radio Amateur	\$7.20
FM & Repeater for the Radio Amateur	\$12.80
Single Sideband for the Radio Amateur	\$7.20
Ham Radio Operating Guide	\$7.20
Electronics Data Book	\$7.20
Solid State Design for the Radio Amateur	\$12.80
Learning to Work with Integrated Circuits	\$4.00
Getting to Know Oscar from the Ground Up	\$6.20
Tune in the World with Ham Radio	\$13.25

### MICROCOMPUTERS/MICROPROCESSORS BOOKS:

Microprocessors/Microprogramming Handbook (Brice Ward)	\$9.80
Basic Microprocessors and the 6800 (Ron Bishop)	\$15.00
Programming Microprocessors (M.W. McMurrin)	\$9.25
The Complete Motorola Microcomputer Data Library	\$12.50
M6800 Microprocessor Applications Manual (Motorola)	\$12.50
Microcomputer Primer (Walte & Pardee)	\$10.75
How to Buy and Use Minicomputers and Microcomputers (W. Barden, Jr.)	\$13.50
6502 Applications Book (Zaks)	\$17.80
Z80 Microcomputer Handbook (Barden)	\$11.95
Getting Acquainted with Microcomputers (Lou Frenzel)	\$11.95
Understanding Microcomputers and Small Computer Systems (Scebel Publication)	\$15.40

### OTHER TITLES:

IC OP-AMP Cookbook (Walter C Jung)	\$17.50
IC Converter Cookbook (Walter C. Jung)	\$18.95
TTL Cookbook (Lancaster)	\$12.95
TV Typewriter Cookbook (Lancaster)	\$13.50
CMOS Cookbook (Lancaster) 1st Edition 1977	\$14.25
Active Filter Cookbook (Lancaster)	\$19.95
IC Timer Cookbook (Jung)	\$13.50
The Cheap Video Cookbook (Lancaster)	\$7.95
VHF Handbook for Radio Amateurs (Brier & Orr)	\$9.40
Amateur Radio Techniques — 6th Edition (P. Hawker)	\$9.35
RCA Receiving Tube Manual	\$5.10
Beam Antenna Handbook — New 5th Edition (William I. Orr & Stuart D. Cowan)	\$7.80
The Beginner's Handbook of Amateur Radio (Clay Laster)	\$14.20
Getting Acquainted with the IC (Rufus P. Turner)	\$7.00
Towers' International Transistor Selector 2nd Edition (T.D. Towers)	\$9.80
Motorola Low-power Schottky TTL (Motorola)	\$8.20

For mail orders please add: \$1.40 Local \$1.75 Interstate

**McGILL'S AUTHORISED NEWSAGENCY PTY. LTD.**

187 Elizabeth Street, Melbourne. Phone: 60-1475-6-7

Prices Subject to Alteration

# MAGRATHS

FOR ALL YOUR ELECTRONIC COMPONENTS

FULL RANGE OF  
PLESSEY-FOSTER  
MAGNAVOX  
& PHILIPS SPEAKERS  
IN STOCK.

SOFTWARE  
IN STOCK FOR  
TSC 6800 & 6809  
TRS 80 PET AND  
APPLE  
ETC.

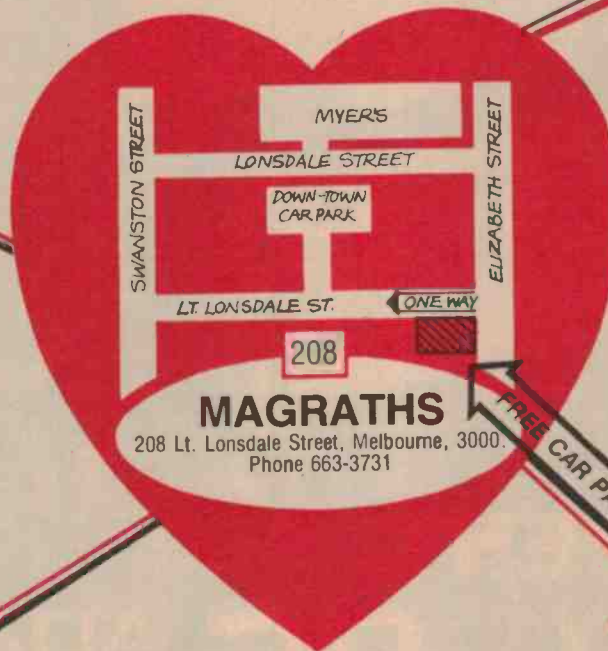

## PUBLICATIONS (Including postage)

### E&L BUG BOOKS

• IV: Using the 8255-type programmable interface chip, \$10.50 • V & VI: A combined approach to digital electronics and micro-computer interfacing, \$11.50 e.a. • VII: Microcomputer — Analog Converter Software and Hardware Interfacing, \$10.50 • VIII: Assembly language programming for 8080 processors, \$11.00

### E&L BUG BOOK REFERENCE SERIES

• BRS-1: 555 Timer Applications with experiments, \$8.50 • BRS-2: Design of Active Filters with experiments, \$10.50 • BRS-4: Design of Operational Circuits with experiments, \$11.50 • BRS-6: NCR Data Communications Concepts, \$11.50 • BRS-7: Phase-Locked Loop Book with experiments, \$11.00

Also a full range  
of H.S. Books  
available at  
\$4.50 ea.

IN THE HEART OF MELBOURNE

A MICROSCOPE THAT FITS INTO  
YOUR POCKET — MANY USES

Gives unparalleled sharp and brilliant vision with 30X magnification. Unique built-in light and easy focusing system.

To: J.H. MAGRATH & CO. P/L,  
208 Lt. Lonsdale Street, Melbourne, 3000.

Please send me by return mail  
 SCOPE MK. III MICROSCOPE  
at \$29.50 ea. (Post Free)

Name .....

Address .....

.....Postcode.....

Cheque for \$ ..... is enclosed.

For Designers  
Printers  
Watchmakers  
Photographers  
Jewellers  
Beauticians  
Students

FULL RANGE OF COMPONENTS, PC BOARDS, ETC, FOR ETI AND OTHER PROJECTS

# ADAPTABOX

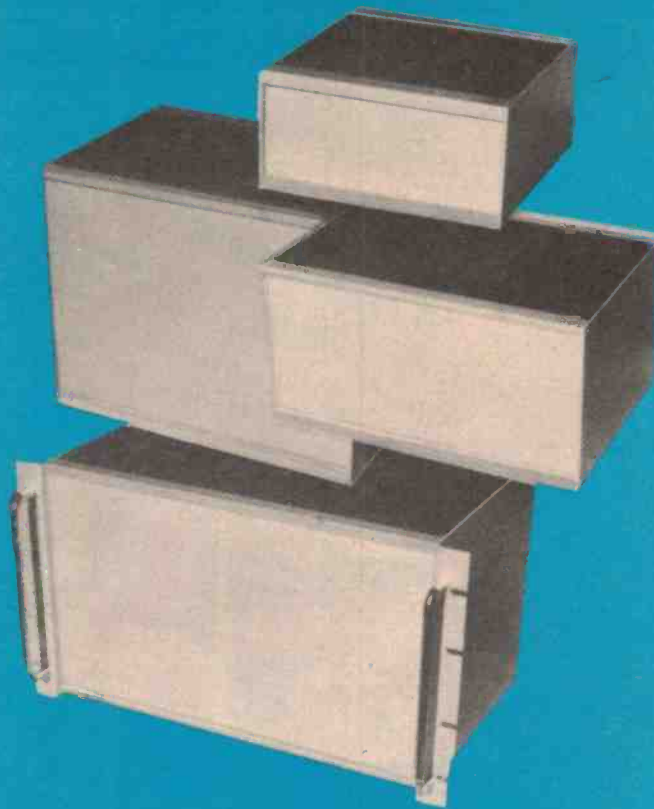

## INSTRUMENT CASES BY

**AE ADAPTIVE  
ELECTRONICS P/L**

GIVE A PROFESSIONAL APPEARANCE  
TO THAT SPECIAL PIECE OF  
EQUIPMENT YOU ARE BUILDING.

77 BEACH ROAD, SANDRINGHAM, VICTORIA, AUSTRALIA. 3191.  
TELEPHONE: (03) 598-4422. TELEX: 35666.

*The standard cabinet comes in a kit containing:*

- A. Satin anodised aluminium front and back panel.
- B. Top and bottom panels of hard wearing "Marviplate".
- C. Side panels of satin anodised aluminium or timber.
- D. Four specially designed extrusions to hold the assembly together, with provision for mounting a metal chassis, circuit board or edge connectors.

*Options available are:*

- 1. The front and rear panels can be replaced with anodised aluminium.
- 2. The bottom panel can be replaced with aluminium.
- 3. The side panels can be of rack mounting type, with handles provided.

*For further details and prices contact:*

VICTORIA: TASMAN ELECTRONICS, 12 Victoria Street, Coburg, 354-5062. ALL ELECTRONIC COMPONENTS, 118 Lonsdale Street, Melbourne, Neville Foley, 662-3506. ELLISTRONICS, 289 Latrobe Street, Melbourne, 3000. JOCK ELLIS, 502-3282. J. H. McGRATH AND CO PTY LTD, 208 Lt. Lonsdale Street, Melbourne, 3000. J. H. GUNN, 663-3731. RADIO PARTS GROUP, 562 Spencer Street, West Melbourne, 3003. C. THOMPSON, 329-7888. ROD IRVING ELECTRONICS, 499 High Street, Northcote, 3070. Rod Irving, 489-8131. RADIO PARTS SOUTHERN DEPOT, 1403 Dandenong Road, East Malvern, 3145. 211-8122. STEWART ELECTRONIC COMPONENTS PTY LTD, 33 Sunhill Road, Mount Waverley, 3149. Stewart Day, 277-0600, 277-0622. NEW SOUTH WALES: MARTIN DE LAUNAY PTY LTD, Cnr King and Darby Streets, Newcastle, 2300. 2-4741. DAVE RYALL ELECTRONICS, 657 Pittwater Road, Dee Why, 982-7500. APPLIED TECHNOLOGY PTY LTD, 1A Pattison Ave, Waitara, 2077. Owen Hill, 487-2711. WESTERN AUSTRALIA: MICRO-DATA P/L, 25 Brisbane Street, East Perth. ALTRONICS, 105 Stirling Street, Perth, 6000. (09) 328-1599. SOUTH AUSTRALIA: N.S. ELECTRONICS PTY LTD, 59 Wood Avenue, Ridleyton, 5007. (08) 46-3928. QUEENSLAND: BALTEC SYSTEMS, 27 Carrol Street, Bardonia, 4065. (07) 36-5183.

## Versatile case is a local product



The Amtex-case range has been designed to provide an inexpensive housing for the smaller type of instrument.

It features rugged construction, good quality, versatility and attractive looks, ideal for control instruments, digital clocks,

measuring instruments, power supplies etc.

Made of 2 mm thick extruded aluminium, the body incorporates grooves for mounting printed circuit boards, and is black anodised. The side plates are made of clear-anodised 3 mm thick aluminium. The front panel is 18 g aluminium in natural finish which can be anodised, etched or painted.

The case is designed in such a way that two cases will interlock by sliding, thereby creating a rectangular case of twice the original depth.

Designed and produced by Amtex Electronics, P.O. Box 285, Chatswood 2067. (02) 411-1323.

## Frequency sensitive ICs

Consumer Microcircuits Limited have developed a duo-datum frequency sensitive switch design for high/in-limit/low frequency monitoring systems.

Designated FX701P, the MOS device is used in a 14-pin plastic DIP package and operates from a single 8-15 V power supply. Current drain is around 3.5 mA.

Typical applications for the FX701P are for tachometry, flow rate and frequency alarms.

The two set point frequencies may be adjusted up to 10 kHz by means of external resistors

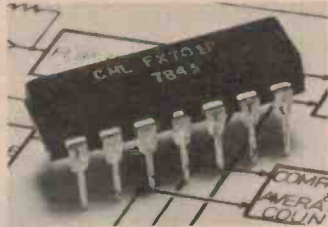

and capacitors. Latching and inverse functions are available in conjunction with the three output switches which correspond to the high, in limit and low frequency bands.

Available from Daneva Control Pty Ltd, 70 Bay Rd, Sandringham, Vic 3191. (03) 598-5622.

## Solder sucker

The solder tool shown here is Swiss-made, hand-size and economically priced.

The nozzle is made of heat-resistant teflon (PTFE) plastic and replacements are available at \$2.25 each.

The tool costs \$11.90 complete and is available through Semiconductors Imports, P.O. Box 43 Croydon 2132 or through Pre-Pak Electro electronics at 718 Parramatta Rd, Croydon NSW.

Invaluable for the experimenter or serviceman - Swiss-made solder sucker from Pre-Pak.



## Compact 100 MHz logic analyzer

Both timing and logic state checking is much simplified by a compact easy-to-use 100 MHz logic analyzer from Philips Test and Measuring Instruments.

The PM 3500 displays up to 16 channels on a built-in cathode ray tube display and has a 505 word memory depth and fixed or variable thresholds to match any logic family.

Comprehensive triggering facilities are provided including delay. Sampling can be either at an internal clock rate variable from 20 ms to 10 ns or at the clock rate of the circuit under test. A glitch-catching mode allows detection of and triggering on spikes and transients as short as 3 ns.

A wide range of triggering facilities is provided. Internal triggering is from a word preset on front panel selector switches. A separate connector provides external triggering. This also provides effectively a 17th channel to expand the trigger word and provide trigger qual-

ification using trigger probes.

Triggering can be delayed by up to 9999 clock pulses. The various trigger modes can be set by one simple control. All trigger information, including delay, and other relevant status information such as mode, compare, expand and cursor word and position is indicated on a continuously-displayed summary. Additional information provided includes a number of counts and no trigger, inequality and no/slow clock messages.

Tests at every power-on ensure maximum reliability. Maintenance has been simplified by building-in service tests to check all circuitry. The instrument operates from 80 to 270 Vac at 48 to 440 Hz, measures 200 x 386 x 470 mm and weighs only 14 kg.

## Oscilloscopes simplified

Two 10 MHz oscilloscopes recently introduced by Leader combine high performance at low cost by means of a simplified design which uses integrated circuits for many functions.

The LBO-513 single trace and LBO-514 dual trace oscilloscopes feature sensitivity to 1 mV, a capability not usually available in low cost instruments. Both are equipped with

80 x 100 mm displays, Z-axis modulation, x5 magnifier and complete trigger controls. The dual trace unit also provides front panel x-y operation, Ch-1/Ch-2 trigger selection and alternate or chopped display modes.

Leader oscilloscopes are distributed in Australia by Vicom of 68 Eastern Rd, South Melbourne Vic 3205, (03) 699-6700.

# LORLIN supa-switches from C&K

## MAINS SWITCHES

Type MS — Rotary action DPST, suitable for inductive circuits.

Type PBMS — Pushbutton (push on / push off). Ideal for TV industry. Both types 4A at 250V, 80A. surge.

## PRINTED TRACK SWITCH

Type PT — Offering outstanding, cost saving design — multibank.

## ROTARY WAFER SWITCHES

Type CK — Inexpensive totally enclosed, single bank 12 position, 1, 2, 3 & 4 pole.

## MINIATURE ROTARY SWITCH

Type RA — 1" diameter. Up to 12 position — multibank.

## SECURITY KEY SWITCHES

Types KMS and KRA — Random or common keys, key trapping facility. Mains switch at 4A, 250V, 80A. surge or RA rotary wafer, multi position.

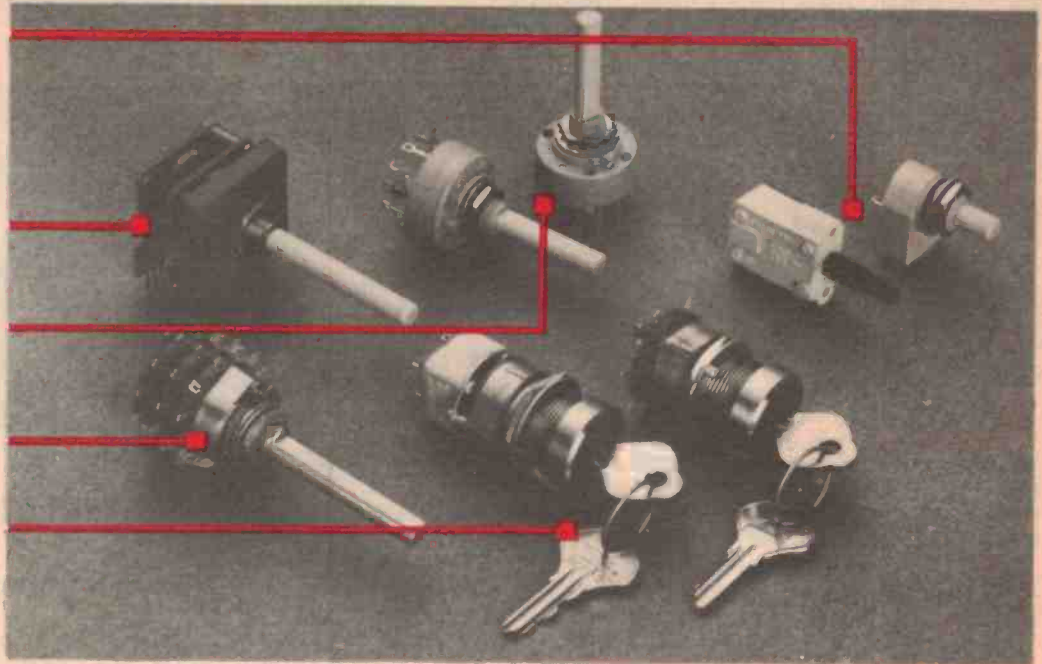

**C&K**  
COMPONENTS

**C&K Electronics (Aust.) Pty Limited**

Office 2/6 McFarlane Street Merrylands NSW 2160

PO Box 101 Merrylands 2160 Telephone 682 3144 Telex AA23404

Agents Melb. 598 2333/Adel. 269 2544/Bris. 36 1277/Perth 458 7111

Obligation free and comprehensive data is yours for the asking.

# MASTER CHECK

## VOLTAGE ANALYSER

Voltage Indicated:  
6, 12, 24, 50, 110,  
240, 415 V ≈



**NEW**  
**\$24** Plus 15% sales tax  
P & P \$2.00

### MASTER CHECK

- Cannot be over ranged.
- Indicates AC or DC Voltage.
- Automatic Voltage indication.
- Read off polarity at a glance.
- Designed for Australian conditions.
- 7 Voltage Indication steps by L.E.D.'s
- Robust lightweight plastic construction.
- AC or DC Voltage Check from 6 to 415 Volts.
- Useable on battery operated devices to three phase AC.
- Available from Electrical Wholesalers throughout Australia.

**ALSO AVAILABLE Multi-Check** — Handy solid state continuity checker. Will check AC or DC Voltages from 4.5 to 415 Volts.

**BELL**

**BELL INSTRUMENTS PTY. LIMITED**

Garema Circuit, Kingsgrove 2208 NSW.  
PO Box 154. Tel (02) 750-6000.

74 Raglan Street, Preston 3072 Vic.  
Tel (03) 44-5021.

# **NDK**

## **SERIAL PRINTER**

# **S-2000**

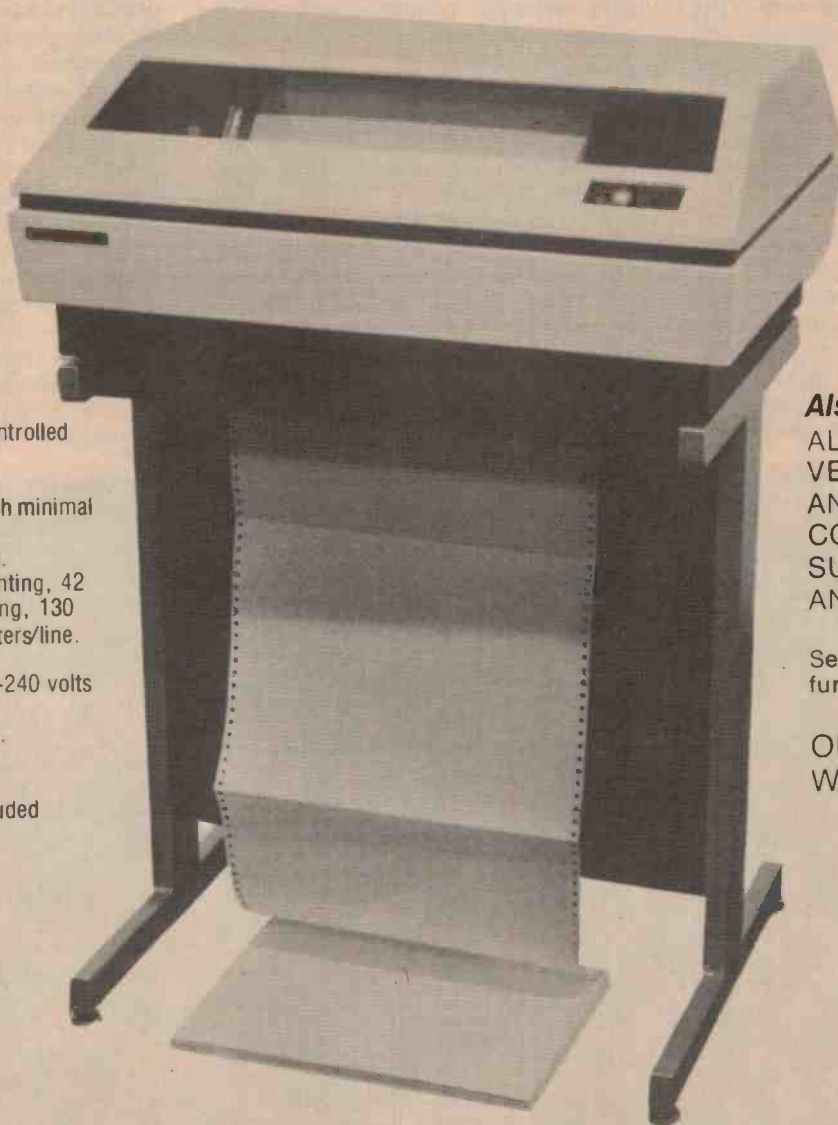

- 8085 Microprocessor controlled single board electronics.
- Quiet operation.
- Simplified mechanism with minimal moving parts.
- Front or back paper feed.
- 170 cps bidirectional printing, 42 ips automatic space skipping, 130 lines/minute at 136 characters/line.
- 4 inch to 15 inch paper.
- AC voltage selector, 100-240 volts AC.
- 10 CPI, 11.7 CPI, 5 CPI.
- 9 x 7 dot matrix.
- 6 months warranty.
- Stand and interface included in price.

**Also available:**

ALTOS, CROMEMCO  
VECTOR GRAPHICS  
AND OMEGA  
COMPUTER SYSTEMS,  
SUB-ASSEMBLIES  
AND COMPONENTS.

Send 2 x 20c stamps for  
further information.

OEM ENQUIRIES  
WELCOME.

Sole Australian distributor:

**JOHN F. ROSE** COMPUTER SERVICES PTY. LTD.

AMA House, 33-35 Atchison Street, St. Leonards. Tel: (02) 439-1220. After Hours: (02) 328-6683. Telex: AA27901.

# Through the multimeter maze

The basic test instrument — for hobbyist and professional alike — is the multimeter. Here's a look inside the commonest electronic instrument, how to choose one and how to use one.

Roger Harrison

THE MULTIMETER would be just about the most versatile piece of electronic equipment available. Cost-effective too, fortunately for the hobbyist. For developing, building and trouble-shooting projects or other electronic equipment, a multimeter is *indispensable*. For checking voltages around a circuit, supply or device currents and resistors values — no other single item of test equipment will suffice. Every hobbyist, technician or engineer will purchase — *need* to purchase — a multimeter sooner or later. Generally sooner than later, though.

## Types

There are two basic types of multimeter — analogue and digital. The analogue type is built around a moving-coil meter, the operation of which is explained in the accompanying box. Digital multimeters, as the title implies, employ a digital counting technique and incorporate a digital readout to

display the quantity being measured. The operation of digital type multimeters is explained in a separate box.

Each type has individual merits and disadvantages and what separated them principally in the past was price. Recently, however, the cost of the smaller general purpose digital multimeters has fallen to a level where they now seriously compete with many analogue multimeters.

## Accuracy

Multimeters of either type will have a certain accuracy specified by the manufacturer. For an analogue type, this may typically be “ $\pm 3\%$  of full scale” for popular types. This means that on, say, the 100 volt range, the meter reading will be accurate to three volts at any part of the scale. Thus, if you connect the meter to a power supply delivering exactly 100 volts it may read somewhere between 97 volts and 103 volts (over scale) when set on the 100 volt range — an error of only 3%

maximum. If you connect it to a power supply set to exactly 30 volts, say, whilst still set to the 100 volt range, it may read somewhere between 27 volts and 33 volts — an error of up to 10%. If measuring 10 volts on the 100 volt range the error may thus be as great as 30%! The lesson to be learned here is to make your measurement with the instrument switched to a range where the reading is towards the full-scale end of the meter.

Most popular analogue multimeters have an accuracy of  $\pm 3\%$  on the dc ranges and  $\pm 4\%$  on the ac ranges. The higher cost top-line models typically have an accuracy of  $\pm 1\%$ . For improved reading accuracy, most analogue meters currently available have what is called a “mirror scale”. When the needle of the meter movement is viewed at an angle other than directly overhead a small, but significant, error will be apparent as the scale marking viewed will not be that immediately beneath the needle — this is called “parallax

## THE MOVING-COIL METER

THE ‘HEART’ of the common multi-meter is a moving-coil, or D’Arsonval, type meter. It works as follows: When electricity flows through a wire, a magnetic field is produced in a plane perpendicular to the wire. This magnetic field may be concentrated by winding the wire to form a coil of many turns, and still further by winding the coil around a soft-iron core. If this coil is suspended in a magnetic field (from a permanent magnet) and a current passed through the coil, it will rotate. The force of rotation will be proportional to the current passed through the coil.

In the moving-coil type of meter, the coil is suspended around a cylinder of soft iron located in a permanent magnetic field. This ensures a magnetic field which is always perpendicular to the

plane of the coil. A fine spiral tension-spring restrains the rotation of the coil, providing a linearly increasing restraining torque as the coil rotates when current is passed through it. The coil pivots

on two diamond bearings above and below the magnet assembly.

A pointer is attached to the coil so that, when the coil rotates as a current passes through it, the pointer in-

dicates the value of the current on a calibrated scale.

Moving-coil meters are generally delicate and will change calibration or sustain permanent damage if jarred. Generally it is the fine spiral tension spring that suffers from shock so another suspension torque-restraint system was devised using a thin ribbon or band, called the “taut-band” suspension system. A flat ribbon will provide a restoring torque that increases linearly as the ribbon is twisted. The taut-band replaces the spiral spring and diamond bearings and is considerably more robust, though more costly to manufacture. The taut-band system is also inherently more accurate as there is no ‘stiction’ — caused by friction in the bearing/suspension system, which results in inaccurate readings on conventional meters.

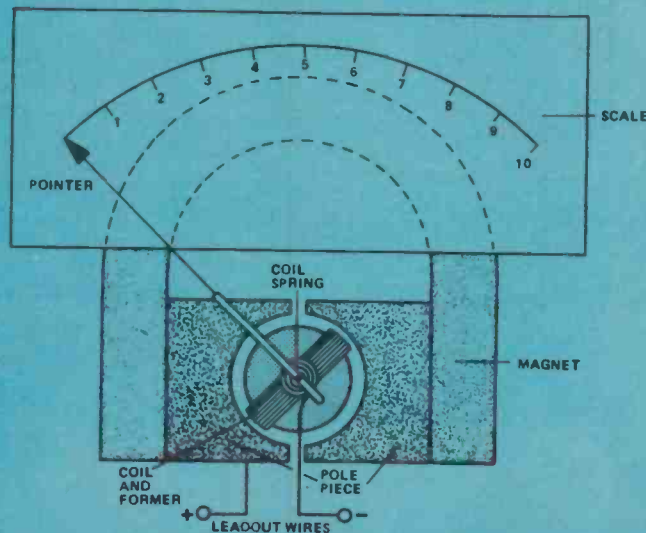

Inside the moving-coil meter.





A multitude of multimeters! Analogue types lined up at the rear: from left to right, Avometer 8, Dick Smith's Q1140 and the Sanwa N-501. Front row digitals: from left to right, the Fluke 8600A portable bench DMM, Data Precision 935, Fluke 8020A and Tandy's Micronta 22-197. The latter three are low cost hand held models featuring liquid crystal displays.

error". To assist viewing the meter needle from directly overhead a strip of reflecting material is placed between the scales. When the needle and its image are lined up then the meter is being viewed from the correct angle and any parallax error is eliminated.

Digital multimeters are inherently more accurate than analogue types — but that's not necessarily a reason to exclude analogue types when considering the purchase of an instrument! Typically a digital multimeter may be quoted to have an accuracy of "+/- 0.3% of the reading, +/- 0.1% of full scale, +/- one digit", on the dc ranges, slightly worse (big deal!) on the ac ranges. They're not separate accuracy specifications, that's a *complete* specification. It works out like this: say you've selected the 100 volt dc range — if you connect the unit to a power supply of exactly 100 volts, the reading will be within +/- 0.1 volt, plus or minus the last digit. That is, if the unit could resolve down to 0.1 volt the display could indicate "99.9", "100.0" or "100.1", and you couldn't take the last digit as 'gospel'. If the supply you were measuring were set to 30 volts and the multimeter to the 100 volt scale, then the display might read "30.1", "30.0" or "29.9"; and you couldn't trust the last digit, as before.

As with analogue units, you get better accuracy when the reading is made somewhere towards the full scale end of the range selected.

## Ranges

As the term 'multimeter' implies, the instrument is designed to measure a multitude of electrical quantities, generally in convenient ranges or steps.

The number of ranges provided on a multimeter depends largely on its price.

Typically, the dc voltage ranges will go in decade steps on the cheaper units — 2, 20, 200 volts etc; more expensive units will have anything from five to eight overlapping ranges starting at 2.5 volts (or lower) going to 10, 50, 250 etc. Top-line analogue types may commence as low as 0.3 volts on the dc voltage range, going to 1.2 volts, 3, 12, 30 etc up to 1.2 kV or more. There are usually fewer ac voltage ranges, the lowest being usually two or three volts.

Current ranges on most instruments generally have similar progressions with fewer ranges provided.

Digital instruments almost universally have a full scale reading based on '2' — 2, 20, 200 etc, as the display will only read up to 1.99, 19.9, etc (depending on resolution). The leading digit of the display (most significant digit) can either be '1' or '0' (the latter is generally suppressed for the sake of clarity) as this turns out to be an economical way to arrange a digital display.

Resistance ranges generally go in decade steps: the less expensive units will typically have a lower resistance range of 1k (analogue types) or 2k (digital types) full scale going to 1M or 2M (respectively) in four ranges altogether. More expensive models may have a lower resistance range of 10 ohms (analogue) or 20 ohms (digital) full scale with decade steps to 100M or 200M (respectively).

## Sensitivity

The sensitivity of analogue multimeters is expressed in "ohms/volt" and for a typical popular type this may be "20 000 ohms/volt". This means that whenever a voltage reading is being made, the meter resistance will be 20 000 ohms times the full-scale voltage of the range selected. Say you select

# THE LOGIC SHOP PTY. LTD.

DISCOUNT SHOPPING for your professional Microcomputer and terminal requirements.

FROM \$2065



## COMPUCOLOR II

Features: ● up to 32K user RAM ● Eight colour display ● 32 lines of 64 characters ● 5" Mini disk drive ● 40 tracks, 48 TPI

FROM \$1415



## LOW COST LOGIC TLS 900 VIDEO DISPLAY UNIT

Features: ● 24 lines at 80 characters per line ● Transmission rates 75 — 19,200 Bd. ● 96 character ASCII upper and lower case ● 12 inch monitor.

FROM \$960



## MICROLINE 80 PRINTER

Features: ● 80 char/sec ● 80 and 132 char/line ● 9 x 7 dot matrix ● Character or graphics printing ● Plug compatible to TRS-80.

"The professional computer shop" where you SAVE-SAVE-SAVE

THE LOGIC SHOP PTY. LTD.

212 High St., PRAHRAN, VIC. 3181. Tel: 51-1950.  
91 Regent St., CHIPPENDALE NSW. 2008  
Tel: 699-4910

**Hewlett-Packard** You'll never know how good HP's are till you own one.

**NEW!** FANTASTIC SYSTEM  
LCD ALPHA-NUMERIC

- **HP41C** — over 400 steps, up to 64 data registers (continuous) \$359.90 (\$323)
- The 41C has 4 Interface ports for:
- Card Reader \$237 (\$213)
  - Printer/Plotter \$425 (\$382)
  - Extra memory modules each with capacity of basic 41C \$56.40 (\$49.10)
  - Plus 16 application pacs (plug-in modules) \$56.40 (\$49.10) ea.
  - And 24 solution books \$15.70 (\$13.60) ea.
  - Also HP67/97 software compatible.



HP41C

**NEW!** ALL WITH  
CONTINUOUS MEMORY

- **HP34C** Scientific Programmable, 210 steps \$184.50 (\$165.50)
- **HP33C** Scientific Programmable, 49 steps \$148 (\$133)
- **HP38C** Financial Programmable, 99 steps \$184.50 (\$165.50)

(Prices in brackets exclude sales tax)

**HP's ONLY POST FREE! For February/March.**

- **HP31E** Scientific \$63 (\$56.50)
- **HP32E** Advanced Scientific Statistical \$87 (\$78)
- **HP33E** Advanced Scientific Programmable, 49 steps \$111 (\$99.75)
- **HP29C** Scientific Programmable 98 steps, continuous \$202.50 (\$182)
- **HP19C** same as 29C but with Printer \$251.50 (\$225)
- **HP97** Card Programmable, printing, 224 steps \$913 (\$820)
- **HP37E** Business \$93.50 (\$84)
- **HP38E** Financial \$148 (\$133)
- **HP92A** "The Investor" Financial Printing \$530 (\$476)

PLUS ALL ACCESSORIES

ASK OUR PRICES LAST — WE ARE NEVER KNOWINGLY UNDERSOLD

**COMPUTERS** HARDWARE — SOFTWARE — ACCESSORIES

**The CBM™ Computer Business System**



AUTHORISED DEALER:  
**commodore**  
Dual Drive Floppy Disk

COMMODORE SALES TOP \$71,000,000  
Fantastic additions coming 1980,  
watch our ads for details.

**C. ITOH 8300 IMPACT  
PRINTER \$970**  
Free delivery in Aust.

TRENDCOM THERMAL PRINTERS  
Model 100 (40 char. wide) POA.  
Model 200 (40 char. wide) POA.  
Free delivery in Aust.  
We have Interfaces too!

**SOFTWARE FOR CBM and PET**

16/32K CBM Word Processor.....\$150	Accounts.....\$25
8K PET Word Processor.....\$90	Address Book.....\$15
Creditors/General Ledger.....POA	Frame Pack.....\$100
Debtors Ledger.....POA	Taxi Management.....\$500
Stock Control.....\$100	Roof Master.....\$48
Super Stock Control.....\$400	Sales Analysis.....\$22
Percentage Costing.....\$110	Real Estate Agent.....\$55
Payroll.....\$55	House Finder.....\$55
Payroll — up to 400 (Disk).....\$110	Job Evaluation.....\$50
Mailing List.....\$30	Profit and Loss.....\$25
Invoicing.....\$40	Debtors Letter.....\$25
Service Station/Garage.....POA	

PLUS  
DOZENS OF  
PROGRAMMES  
ON GAMES,  
EDUCATIONAL,  
MATHS,  
PROGRAMMING  
AIDS.

**CANON AX1 and BX1**

Self-contained desk computers with fantastic programmes for business, farming, etc.



Expandable to  
impact printers,  
extra disks, etc.  
  
Very  
powerful  
symbolic  
algebraic  
language.

**TEXAS PROGRAMMABLE SYSTEMS**

STILL ON! The greatest package offer ever!  
A Ti-59 and PC100C printer \$835



**\$530 (\$470)**  
ONLY WHILE STOCKS LAST  
**HURRY!!**  
PRICES HAVE  
INCREASED

- **TI58C** \$127 (\$112)
- **TI59** \$299.90 (\$265)
- **PC100C** \$237 (\$210)
- **TI55** \$61.50 (\$54)

- **Modules 58C/59** \$34.50 (\$30.50)
- **Pakettes 58C/59** \$9 (\$8)
- **3 Rolls Therm Paper** \$12 (\$10.50)
- **40 Mag Cards** \$15 (\$13.50)

**NEW!** CASIO  
● **FX502P/FAI**  
LCD PROGRAMMABLE



**FX502P** \$149 (\$135)  
**FAI** \$43.50 (\$39)  
P&P: NSW \$3.50, Elsewhere \$4.50.

256 steps, 22 memories, FAI adaptor  
Interfaces an ordinary cassette for program storage. Manual and huge book of programs. Continuous memory.

**SCHOOL AND COLLEGE SPECIALS**

Wholesale prices on bulk orders.

**PRICE LIST AVAILABLE**

Prices in brackets exclude sales tax.

- **Texas TI25** \$35 (\$31)
- **Texas TI50** \$39.50 (\$35)
- **CASIO FX510** \$41 (\$36)
- **CASIO FX310** \$31.50 (\$28)
- **CASIO FX80** \$28.50 (\$25)
- **GE LCS 500** \$36 (\$31.90)
- **NS108** \$41 (\$36)

**Pack and Post** — All LCD models \$1.50 anywhere in Australia. Otherwise \$2.50 for NSW, elsewhere \$3.50 per order. (Extra \$1.50 for registered). Sales Tax Forms must be duly signed and stamped (Forms available).

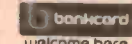

**LEASING  
ARRANGED**  
welcome here  
Copy and complete.  
Please debit my Bankcard \$.....  
No ..... Expiry Date.....  
Signature .....  
Name & Address .....

**ELECTRONIC CALCULATOR DISCOUNTS**

Phone (02) 624-8849 (8am till 3pm) PO Box 106, Baulkham Hills, NSW. 2153.

the 10 volt range; the resistance across the input terminals of the multimeter will be 200 000 ohms (200k). This is a point to watch when making measurements — and when purchasing a multimeter. The instrument may “load” the circuit you are testing and a false reading will result as you will disturb the operating conditions of the circuit. To take a simple example, say we have a multimeter having a sensitivity of 1000 ohms/volt, and we wish to measure the voltage across R2 in the circuit here with the meter set to the one volt range. By Ohm’s law we know the voltage across R2 will be 0.75 volts. Now, the meter will have a resistance of 1000 ohms on the one volt range and this will be in parallel with R2 when we

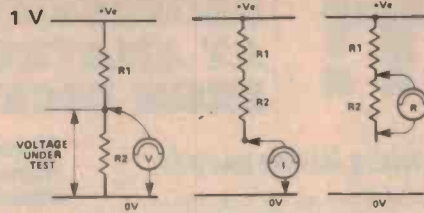

The correct way to use a multimeter to measure in-circuit quantities. From left to right: voltage, current and resistance. The internal impedance of the meter is an important consideration, as explained in the text.

connect the meter, the combined resistance then being 500 ohms. Thus, the

voltage read by the meter will be 0.5 volt instead of 0.75 volt — an error of 33%!

It is the *degree* of this shunting, or loading, effect that is important. In theory, it can never be completely avoided as some current must flow into the measuring system from the circuit being measured. However, this can be made vanishingly small by using an instrument having a very high input resistance — or a high sensitivity specification. As a general rule the instrument’s resistance should be ten times, or more, than the circuit resistance.

Digital multimeters have a constant input impedance — generally 10M, which rarely presents any loading prob-

## RANGE EXTENSION

A MOVING-COIL METER is a dc current-indicating device. They are made with full-scale deflection currents at convenient values, such as 1 mA, 100  $\mu$ A etc. The current range can be extended by adding a ‘shunt’ resistor in parallel with the meter, so that most of the current to be measured flows through the shunt and a small amount through the meter.

To measure **dc voltage**, a ‘multiplier’ resistor is placed in series with the meter so that, at the voltage to be measured, the full-scale current passes through the resistor and the meter. Various switching schemes are arranged so that a number of voltage and current ranges can be covered.

To measure **ac voltage** a rectifier is usually incorporated into the circuit, along with range switching and multiplier resistors. **AC current** is measured usually via a transformer which ‘steps-up’ the current flowing in a primary winding, the secondary voltage being rectified and applied to the meter. Taps on the transformer primary winding provide different current ranges.

**Resistance** may be measured by a simple extension of the voltage — or current-measuring principles. The ‘series-connected’ ohmmeter is the most common type. The ‘range’ resistor determines the centre-scale current through the meter. The ‘un-

known’ resistor is connected in series with the range resistor (hence ‘series-connected’).

The ‘set zero’ control is adjusted for full-scale deflection of the meter with the X-X terminals shorted together. The unknown resistor is then connected to the X-X terminals and the current through the meter will be directly proportional to the value of the unknown resistor.

The meter scale is calibrated in resistance, low values to the right — high values to the left, the scale being logarithmic (see diagram), generally covering four decades. Calibration accuracy is not influenced by minor changes in battery voltage (since you can compensate with the ‘set zero’ control) and the ranges covered are readily changed by selecting different range resistors.

The ‘parallel-connected’ or ‘shunt’ ohmmeter is used for measuring low and very low values of resistance. The ‘set zero’ control on this type is adjusted for full-scale deflection on the meter with the switch (SW1) closed and the X-X terminals open circuit. The unknown resistor is then connected across the X-X terminals. The reading obtained will be, again, directly proportional to the value of the unknown resistance.

The scale is reverse-reading; that is, lowest values to the left, higher values to the right.

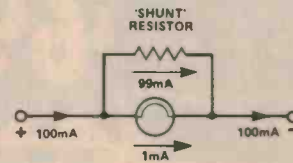

Extending the current range of a meter with a ‘shunt’ resistor.

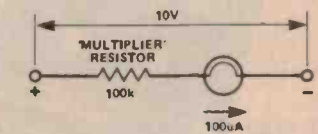

A meter can indicate voltage by adding a ‘multiplier’.

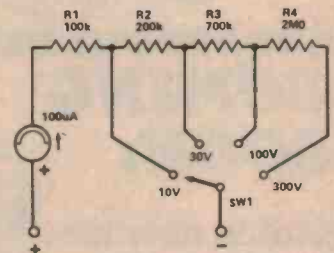

Typical range switching for the voltage ranges in a multimeter. Note how the ‘intervals’ overlap.

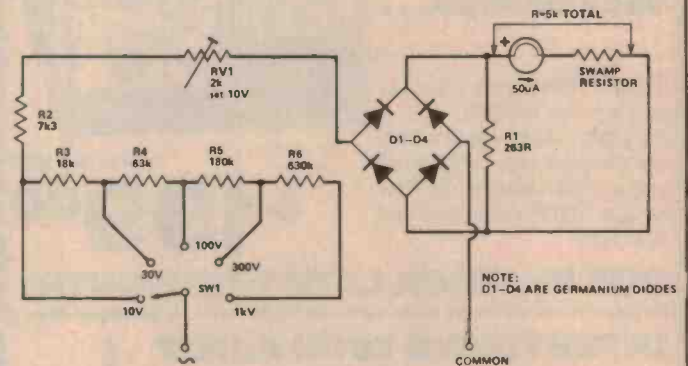

Practical example of an ac voltmeter covering 10 V to 1 kV in five ranges. Note that R1 reduces the sensitivity to 1k/V.

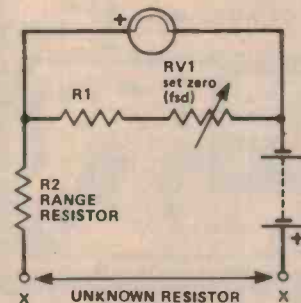

Basic circuit of a ‘series-connected’ ohmmeter.

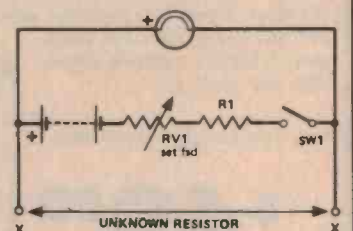

Parallel-connected type of ohmmeter is used to measure low and very low values of resistance.

# TEST IT!

## PROFESSIONAL TEST GEAR AT AMATEUR PRICES — FROM DICK SMITH



### LOOK AT THESE HANDY RANGES:

DC Volts: 0.25, 2.5, 10, 50, 250, 1000 (100kV)  
 AC Volts: 5, 10, 50, 250, 1000  
 DC Current: 10uA, 25uA, 0.5mA, 5mA, 50mA, 500mA,  
 & 10A. AC current: 10A.  
 Resistance: 20, 200, 20k & 200k centre scale  
 Decibels: -10 to -62.  
 Transistor:  $h_{FE}$  0-500;  $I_C$  0-50uA  
 Capacitance: 50pF to 3uF; 0.01uF to 50uF

ONLY  
**\$69<sup>50</sup>**

Q-1140

See the review in February  
 Electronics Today Intl.

**YES!** We have many other feature-packed multimeters in stock, from a low \$12.50. Call in and see our superb range soon — along with a host of other test gear!

More than a multimeter. More than a transistor checker. This one measures capacitance, too!!!

Incredible value! This superb 100,000 ohm per volt multimeter is probably the handiest instrument you will ever own. For with its 36 ranges, you can not only measure voltages, currents, resistances, etc like most other multimeters, you can actually check transistors and capacitors! And with the optional RF probe, you can extend the range of your meter up to 30MHz — ideal for trouble-shooting RF circuits too!

Whether you're a hobbyist, amateur, service technician, or engineer you'll find this meter will give years of accurate, reliable service. It's fully protected (internal fuse protection); has large, mirrored scale for accurate reading and even has a polarity reversal switch. Supplied complete with instruction manual, test leads and transistor connection leads.

## COMING SOON:

### Dick's new lab. oscilloscope ...

A bargain! 5MHz bandwidth; 10mV/div (vert) and under \$200.00! That's right — it's the new Dick Smith Laboratory Oscilloscope; just right for the amateur, hobbyist or service desk. Why pay up to \$100.00 more for a CRO and do no better?

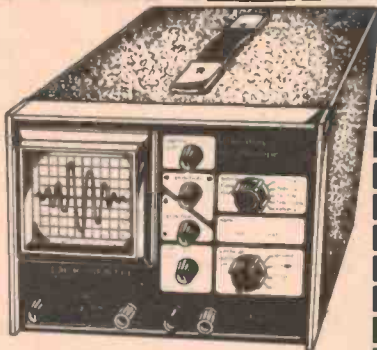

Cat Q-1280

**\$199<sup>00</sup>**

## DUE IN STOCK LATE THIS MONTH!

### IS SERVICING YOUR GAME?

Make some money out of CBI! Yes, there are a lot of opportunities for CB repairers: if your forte is servicing, why not cash in on it? This deluxe CB test set, in conjunction with your other test gear (cro, dmm, etc) is all you really need. Checks power, modulation, oscillators, antenna SWR, xtal activity, etc.

Ideal for the test bench or service vehicle.

**\$49<sup>50</sup>**

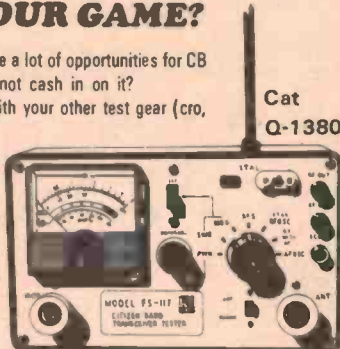

Cat Q-1380

## WANT TO GO DIGITAL?



Cat Q-1440

**\$145<sup>00</sup>**

For accuracy and speed you can't go past a digital multimeter. This budget priced 3½ digit model offers better accuracy than others in similar price range, plus huge digits for high visibility.

Battery operated, or mains operation with optional 'plug-pack' adaptor (M-9525 @ \$6.90).

High impedance input — 10Mohm AC & DC; ranges 200mV — 1kV DC, 200mV — 700V AC, 200uA — 2A AC & DC, 2k to 20M ohms. Better than 0.1% accuracy on DC!

## THE DIPPER...



Cat Q-1322

Ask an amateur how handy his 'dipper' is! He'll tell you he wouldn't be without one. For circuit checking, signal generation, as an absorption wavemeter, modulation checker... the list of uses for this incredible instrument goes on and on. There are a lot of 'cheapie' dippers on the market: this is one of the top models available.

Recommended.

**\$99<sup>50</sup>**

## INCREDIBLY HANDY...

Think of how many times you've wondered if a battery is ok! You've probably just measured it with a meter for a voltage check. Wrong! You need to properly load batteries when checking them — this checker does that, with virtually every type of battery. Gives a go/maybe/no go reading. Also checks lamps and fuses.

Cat Q-1525

**\$9<sup>95</sup>**

# DICK SMITH ELECTRONICS

SEE OUR OTHER ADVERTS IN THIS MAGAZINE FOR OUR STORE ADDRESSES AND RESELLERS



lems, as they employ electronic amplification between the input and the analogue-to-digital conversion.

There are a range of analogue meters available that incorporate electronic amplification — generally using a FET or FET-input op-amp. These have a high input impedance, generally 10M, and similar ranges to other types available. Naturally, they cost more and digital instruments now seriously compete with them.

When measuring current, the internal resistance of the meter is also important. The resistance of the meter, connected in series with the circuit being measured, may introduce an undesirable voltage drop upsetting the circuit operation and resulting in an erroneous reading. In this case, the internal resistance of the meter on the range selected should be one-tenth, or preferably less, than the series circuit resistance.

## Protection

No . . . you won't need to pay \$100 to the little man who comes around every

week so your multimeter will not suffer a terminal fate! Most multimeters include one or more devices to protect the meter movement (at least) and perhaps the internal circuitry from damage in the event of an overload being applied to the input terminals and/or mechanical shock.

Moving-coil meters are delicate instruments and may easily be damaged by overload currents exceeding the full-scale deflection value of the movement by 50% or more. The simplest protection method employed uses two germanium diodes wired 'back-to-back' across the meter terminals. The diodes will conduct when the voltage across the meter terminals rises above about 200-300 millivolts (in either direction), effectively placing a shunt across the meter. Hence, it is called 'shunt diode protection'. Most analogue multimeters incorporate this form of meter movement protection. However, a sufficiently large overload will almost certainly damage the diodes — resulting in damage to the meter. For example: if you have the meter set to the 1 mA

range and inadvertently connect it across the 240 Vac mains . . . I recommend you give the instrument an honest burial for it will be *your* fault that the ensuing explosion brought about the instrument's demise.

The more expensive analogue instruments may include a device that senses an overload condition and operates a 'cutout' — a device that latches out, disconnecting the input terminals. The famous "AVO" series of multimeters incorporate 'cutout' protection. When an overload occurs, a button on the front panel pops up and the device can only be reset once the overload is removed.

Some manufacturers include an "OFF" position on the range switch of their instruments. This disconnects the input terminals and places a short across the meter. This is to protect the unit against damage from mechanical shock while it is being transported. It works like this: if the meter is jerked suddenly, the meter coil will tend to rotate. As it is suspended in a magnetic field, any movement will generate a ▶

## THE DIGITAL MULTIMETER

THE MAJORITY of currently available digital multimeters employ an analogue-to-digital conversion technique called "dual-slope integration".

In this method, the analogue input voltage is first converted to a time period which in turn is converted into a binary number by a timer/counting system. Referring to the block diagram here, and the associated timing diagram, the system commences the measurement when the switch connects the analogue signal input to the integrator which commences to 'ramp up'. At the same time the counter begins, from zero, to count the clock pulses. When a predetermined number of pulses (1000 is usually convenient) appear in the counter, the integrator is electronically switched over to the reference voltage. At this point, the integration capacitor, C, has then charged linearly from the input, rising as a ramp voltage to a level decided by the average input signal value over the counter time period (T). As the switch changes to the reference, the counter is reset to zero and commences

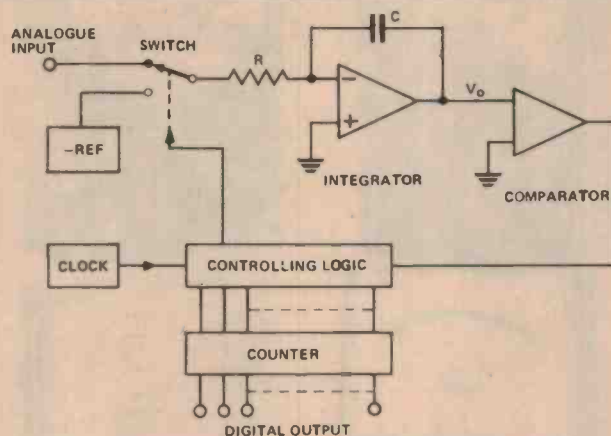

Block diagram of the 'dual-slope integration' technique of analogue-to-digital conversion commonly used in digital meters.

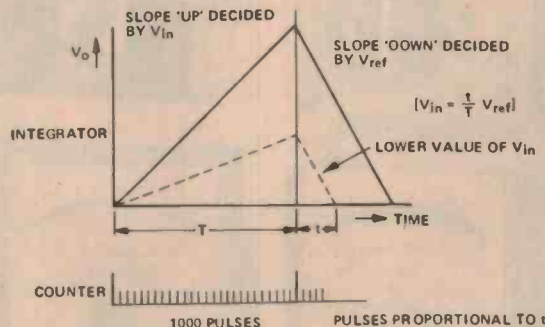

Timing diagram for the dual-slope A/D conversion technique.

counting again. The reference, chosen to be of opposite polarity to the input signal, now causes the charged integration capacitor, (C) to ramp downward with a fixed

slope. When the output of the integrator reaches the zero threshold the counter is stopped and its contents displayed on the digital readout. The count displayed is the

ratio of the counts during the 'downward' ramp (over time 't') to the counts during the upward ramp. Thus, when a limit of 1000 counts is chosen for the upward ramp duration a direct reading of input voltage is obtained if the reference voltage is chosen appropriately.

The absolute value of the integration capacitor and the clock frequency are of little significance provided they are stable for the duration of the conversion period.

The relatively long analogue-to-digital (A/D) conversion period has an inherent advantage in that it ignores noise. When noise is integrated over an extended period, its amplitude tends to zero. Thus, dual-slope integration results in excellent accuracy.

Most modern digital multimeters — particularly handheld types — have most of their internal circuitry located within a single integrated circuit. Range switching is provided in a conventional manner, similar to moving-coil instruments. The more expensive 'top-line' instruments may incorporate input amplifiers to improve sensitivity and provide high constant input impedance.

# ANNOUNCING PRECISION YOU CAN COUNT ON!

## MICRONTA MULTITESTERS

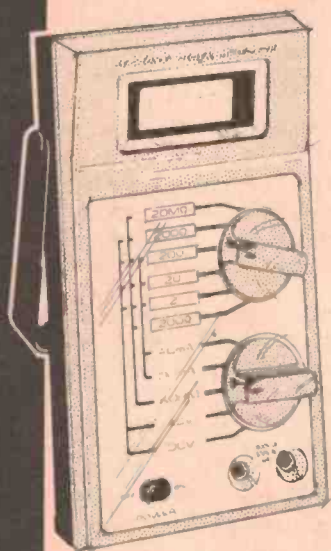

**MICRONTA**  
20 Range, 3½ Digit  
LCD Multitester

**79<sup>95</sup>**

Big 1.0cm digits, 10 meg Input, automatic polarity, automatic zero adjust and overrange indication. 9V battery or AC adapter required to provide power. Comes complete with carry handle, test leads. 22-198

**MICRONTA**  
13 Range, 3½ Digit  
LCD Multitester

**59<sup>95</sup>**

Has 0.6cm digits, 10 meg Input, automatic polarity and zero adjust plus overrange indicator. 9V battery or AC adapter required to provide power. Comes complete with leads, vinyl pouch. 22-197

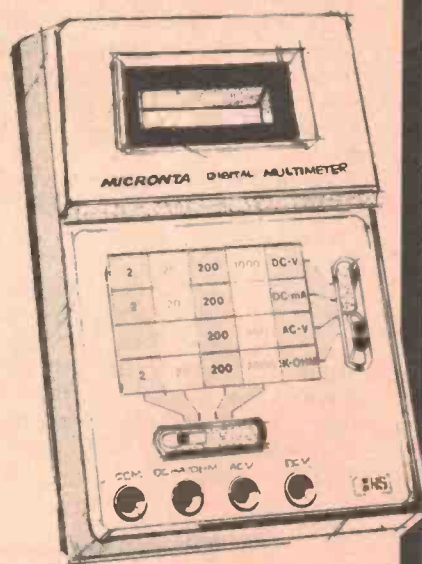

**8 Ranges, 1000  
Ohms per Volt**

**9<sup>95</sup>**

2-colour 5.0cm meter, pln jacks for all 8 ranges. Thumbset zero adjust. Mirrored scale prevents parallax. Requires "AA" battery for power. Comes with leads. 22-027

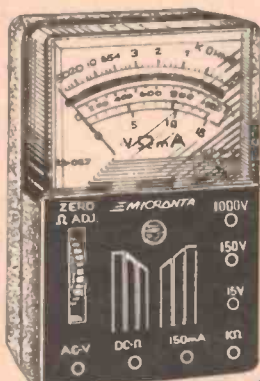

**18 Ranges, 20,000 Ohms  
per Volt**

**19<sup>95</sup>**

Range selector with "off" position. 7.6cm meter, 4 pin jack connections including output jack, zero adjust. Requires "AA" battery to provide power. Comes with leads. 22-201

**25 Ranges, 20,000 Ohms  
per Volt**

**26<sup>95</sup>**

Single-knob range selector, 10.1cm meter, mirrored scale. Six-pln jack connections including output jack. Requires "AA" battery to provide power. Comes with leads. 22-202

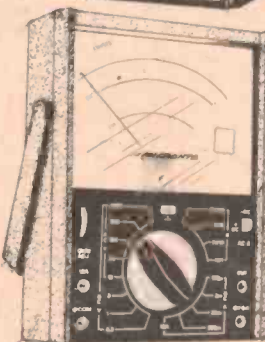
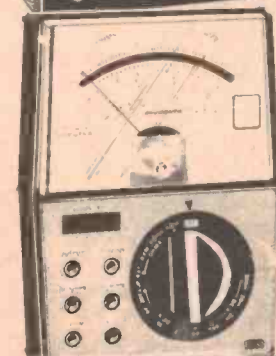

**27 Ranges, 30,000 Ohms  
per Volt**

**32<sup>95</sup>**

Super-sensitive multitester has colour-coded meter. 4 banana jacks including output jack, polarity reverse switch, zero adjust. Requires 1 9V, 1 "AA" battery to provide power. Comes with leads. 22-203

**43 Ranges, 50,000 Ohms  
per Volt**

**39<sup>95</sup>**

Features versatile "Volts/Amps Range Doubler". 11.4cm mirrored scale, single-knob function switch. Overload protected meter movement. Requires 1 "AA", 1 9V battery to provide power. Comes with instructions and leads.

22-204

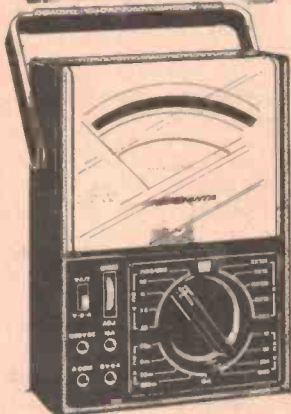

**26 Ranges, 10-Megohm  
Input**

**49<sup>95</sup>**

Dual-FET input for high-accuracy. Single-knob range selector, mirrored 11.4cm scale, overload-protected meter movement. Requires 9V battery to provide power. Comes with leads.

22-209

**TANDY**  
ELECTRONICS

Available at all 210 Tandy Stores and Participating Tandy Dealers around Australia or Mail Order Department, P.O. Box 229, Rydalmere, N.S.W. 2116. (Bankcard Mail Order facilities available on receipt of signed letter quoting Bankcard number)

Tandy Electronics offer service at over 200 locations across Australia

current in the coil. This current will flow through any load connected to the meter terminals. That current will also set up a magnetic field around the meter's coil that will react with the permanent magnetic field, generating a 'restoring' force that opposes the movement of the meter's coil. A short-circuit across the coil ensures maximum current due to the meter coil's movement and thus maximum restoring force, heavily damping any violent motion of the meter movement due to mechanical shock.

Most popular instruments include a fuse in series with one input terminal to protect the unit from gross overloads.

## Choosing

Analogue types range in price from under \$10 to over \$100. Undoubtedly, price will be the first consideration for the hobbyist. You need to first assess how much money you can afford, or wish to lay out, and then get the meter that best suits your needs or applications from that price range.

The next consideration should be sensitivity. For most hobby applications a sensitivity of 20 000 ohms/volt dc is generally adequate. However, if you intend working with high impedance devices such as MOSFETs and CMOS ICs, then something with a sensitivity of at least 50 000 ohms/volt dc, preferably 100 000 ohms/volt or one of the 500k to 1M ohms/volt types, if you can afford it.

"Run-of-the-mill" 20 k/V dc sensitivity multimeters range in price from a little under \$20 to a little over \$30. Models having a sensitivity of 50 k/V or 100 k/V dc range from about \$25 up to \$50. The more expensive types will include more ranges and perhaps have additional features such as transistor testing and/or capacitance measurement. Seek out a model having a large scale and good meter protection. A large scale makes for easy reading and good protection is wise insurance. The more expensive models often include an "OFF" position on the range switch that puts a short-circuit across the meter movement to protect it from shock damage. Models incorporating a taut-band suspension meter are less prone to shock and overload damage.

As a minimum requirement, the voltage ranges on your instrument should be from about one volt to at least 300 volts dc, and 10 to 300 volts ac. Resistance measurements should have at least four ranges, preferably more, covering ohms 'X1', 'X10', 'X100' and 'X1000'. The dc current ranges should go down to at least 100  $\mu$ A and up to 200 mA or more, preferably with an extra input socket providing measurement up to 10A.

You'll rarely use the ac current ranges so this is not of too much importance.

Accuracy is not of great importance to the average hobbyist as measurement to better than  $\pm 5\%$  is rarely required and even the cheapest multimeters advertised quote accuracies these days of  $\pm 3\%$  on the dc ranges and  $\pm 4\%$  on the ac ranges. If you envisage a requirement for greater accuracy then go for the higher-priced taut-band suspension models or start looking amongst the digital instruments.

Always look carefully at the construction of an instrument. Seek an instrument with rugged construction as a multimeter is a valuable tool that should remain serviceable for many years.

It can be a waste of money to buy something 'too fancy' for your needs so think carefully beforehand. It is often possible to make test instruments to supplement your multimeter's capabilities for less than the difference in cost between a unit with straightforward ranges and features and a higher cost type with many 'extras'. You also get the satisfaction of building such projects yourself — and there's no price on that!

Digital instruments have to be considered in something of a different fashion to analogue types. Again, price is generally your first consideration. The cheapest digital instruments available at present cost around \$70 to \$80... and the competition at this end of the market is fierce!

Sensitivity and accuracy are unimportant: resolution and the number of ranges are the two basic deciding factors. Instruments in this price range generally have a  $3\frac{1}{2}$ -digit display (1999 full-scale reading). Unless you are looking for a mains-operated, bench instrument, the portable models having a liquid crystal display (LCD) have a considerably longer battery life, larger display size and are consequently more practical than those having LED displays — the latter are rapidly disappearing from the market as a result. However, LCD displays have a limited life — generally around five years.

The general comments on ranges that I made with regard to analogue instruments also apply to digital instruments. Maximum input voltages and currents are generally given on the front panel of digital instruments and should be heeded. Most units provide overload protection — a fuse on all the models the author has seen to date. A spare fuse is handy — particularly if one is provided stored in the instrument case.

Most digital instruments will generally provide as many ranges and features as analogue instruments costing about 25-30% less. The chief advantages

of digital instruments over analogue instruments are: direct readout (no interpretation of a meter scale required, with the chance of error), better resolution and constant input impedance on the ac and dc voltage ranges. However, an analogue instrument can indicate varying quantities — when adjusting a circuit to provide a "peak" or "minimum" reading where the exact value is not required. You cannot tell on a digital display which way a quantity is changing, unless the change is very slow.

The final choice is up to you — but the author has noted a growing tendency among 'serious' enthusiasts, engineering labs and servicemen to purchase at least one multimeter of each type to take advantage of the special features unique to each!

## Using

A multimeter is not only an easy instrument to use but will serve you well for many years if you stick to the following basic rules:

- 1) Most moving-coil multimeters are designed to operate accurately only when the face of the meter is in one specific orientation — usually horizontal. Digital instruments are not affected this way.
- 2) When measuring an unknown current or voltage always set the meter to its highest range and switch down through the ranges until the correct range is found — try to obtain a reading that is nearest full scale, switch up one range as a check on accuracy (this also reduces loading problems with analogue meters).
- 3) When measuring an in-circuit voltage, always connect the meter *across* the voltage source.
- 4) When measuring an in-circuit current always connect the meter *in series* with the current source.
- 5) When measuring an in-circuit resistance always disconnect one lead and then connect the meter across the resistance. Always 'zero' an analogue meter on the selected range before making a measurement.
- 6) When measuring continuity in semiconductors (diodes, transistors etc) always remember that the meter's internal battery has the *positive* connected to the *common* (black lead) terminal.
- 7) With analogue instruments ensure that, on dc and ac voltage measurements, the input impedance (ohms/V sensitivity multiplied by the voltage range) is at least ten times the circuit impedance being measured. ●







# HIOKI

Illustrated is the Model 3133 Power Meter (bottom) Model 3141 Integrator, and Model 8701 Recorder.



## SERIES 3130 CLAMP-ON POWER HI-TESTERS

Clamp type power meters that enable readings to be taken without any interruption to supply.

- Four models:- two for single-phase and two for 3-phase measurements
- Also measures voltage, current and reactive power
- Ideal for energy saving power supervision and electrical appliance testing.
- Output terminal for recorder connection.
- Optional accessories, Model 3141 Integrator for watt-hour measurement and Model 8701 Continuous Roll Chart Recorder.

All models feature a clamp-on power sensor, making it possible to take readings without power line interruption. Model 3131 features 3 voltage ranges from 100V to 500V, 5 current ranges from 10A to 250A, and 5 power ranges from 5kW to 100kW. A companion model, Model 3132, measures up to 1000A and 500kW.

Model 3133 is somewhat more elaborate. It has a 3½-digit LED readout and measures voltage to 500V in 2 ranges, current to 200A in 2 ranges, power to 200kW, and reactive power to 200kvar. It, too, has a companion model (Model 3134), and this measures current to 1000A, power to 1000kW, and reactive power to 1000kvar.

### H. ROWE & CO. PTY. LTD.

54 Racecourse Road, North Melbourne, Vic. 3051.  
127 Newbridge Road, Moorebank, N.S.W. 2170.  
37b Manton Street, Hindmarsh, S.A. 5007.  
8 Allison Street, Mayne, QLD. 4006.  
Unit 6, 34 Hector St, Osborne Park, W.A. 6017.

# SOANAR

PW SERIES



## COMPUTER GRADE ELECTROLYTICS

PW Series Capacitors are particularly suitable as power source filters for computers, inverters, high current power supplies, high output power amplifiers and control equipment.

Despite their small size, these capacitors have exceptionally large capacity and are capable of handling high ripple currents. Miniaturisation has been achieved by the use of new electrode foils developed from a technique of high magnification etching.

Construction includes an aluminium can which is sealed with a long life, heat resistant resin and heavy duty screw terminals for handling the high currents involved. Mounting clamps are supplied as standard equipment.

**2,900 $\mu$ F TO 100,000 $\mu$ F**  
**16 Volt TO 40 Volt DCW**

Available ex stock all States

### SOANAR ELECTRONICS PTY. LTD.

A MEMBER OF THE A+R-SOANAR ELECTRONICS GROUP

30 Lexton Road, Box Hill, Vic., 3128.  
Australia. Telex: 32286.

SALES OFFICES: VICTORIA 89 0061  
NSW 789 6233  
Sth AUSTR 51 6981  
QUEENSLAND 52 5421  
WEST AUSTR 3819522



# The Saturn flyby

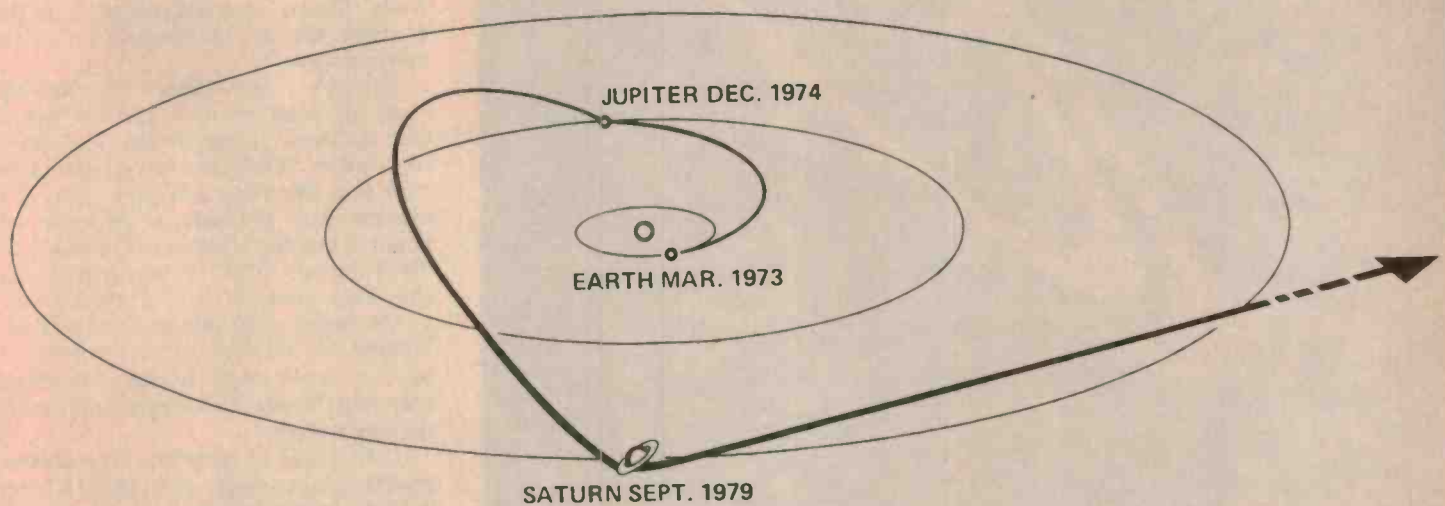

The story of Pioneer 11's successful mission to Saturn and some of the surprising results obtained.

## Brian Dance

THE PIONEER 11 craft was launched as long ago as April 5th, 1973 on a highly successful mission to a Jupiter encounter on December 2nd, 1974. Before the launch this spacecraft was named Pioneer G, and was specifically intended only for a follow up to its sister craft Pioneer 10's encounter with Jupiter. However, it is interesting to note that a NASA press release dated April 1st, 1973 casually states "After flyby (of Jupiter), it may follow Pioneer 10 and become the second man-made object to escape the solar system, or mission directors may choose a solar orbit near Jupiter's orbit. One possible trajectory could take it to Saturn in 1980."

It is very fortunate that mission control was able to use the huge gravitational field of Jupiter, together with the motion of this planet, almost like a sling, to swing the path of Pioneer 11 on its very long journey to a Saturn encounter. As indicated in Figure 1, the trajectory from Jupiter to Saturn was about three times as great as the path from the Earth to Jupiter. The Pioneer craft passed high above the plane of the earth's orbit (or the plane of the ecliptic) and reached a maximum height of 164 million km about the end of 1976.

The project scientists decided to use the gas jets carried by Pioneer to aim

the spacecraft in such a direction that it would fly by Saturn just outside the outermost ring, crossing the magnificent ring system of this planet. The closest approach to Saturn took place when Pioneer was below the plane of the rings on September 1st, 1979, the distance of nearest approach being about 21 400 km above the cloud tops of the second largest planet in the solar system.

### Pioneer 11

Pioneer 11 is a 260 kg spacecraft using nuclear powered thermo-electric generators as its source of power, since the intensity of sunlight is inadequate at great distances from the sun to enable solar cells to be used for this purpose. This craft is identical to the earlier Pioneer 10 except that it carries a second magnetometer. It was designed specifically to investigate the Jovian system together with the inter-planetary gas, cosmic rays, asteroids and meteoroids between the Earth and Jupiter. Thus the Saturn encounter has been a great bonus which makes the spacecraft's work much more cost effective.

A particular feature of Pioneer 11 is that it is a spin-stabilised spacecraft, rotating in a full circle 4.8 times per minute. It employs a 2.75 metre (9 feet) diameter dish antenna reflector for

communications with the US Deep Space Network Earth stations. This dish antenna must be kept so that it points to the Earth at all times, so the axis of the reflector is also the axis of rotation.

Pioneer 11 also has an aft-facing omnidirectional spiral antenna, so that if the main antenna is not directed towards the earth at any time, signals can still be sent to orientate the main reflector to face the earth. The omnidirectional antenna provides low gain, the high gain antenna employing the 2.75 metre reflector. A medium gain horn antenna is also incorporated into the craft. The spacecraft equipment is housed in a box of hexagonal cross section. This box is 355 mm deep with each of its 6 sides 710 mm in length.

Pioneer 11 receives signals at 2110 MHz from earth and transmits at 2292 MHz. Its travelling wave tubes provide an output of 8 W at the S-band frequency. When the high gain antenna (gain: 33 dB) is employed, the maximum data rate from the region of Saturn is 1024 bits/second to one of the huge 64 metre diameter antennas on Earth. A maximum of 128 bits/second can be sent to the 26 metre Earth antennae which can also be used to return commands in the event of the 64 metre facility not being ►



The rings of Saturn as seen by Pioneer 11 shortly before its closest approach. The bright object at about 4 o'clock is the moon Tethys, whilst there is a faint extra moon at about 7 o'clock (now identified as 1979S2) just off the tip of the bright A ring. The newly-discovered F ring is just visible outside the A ring. The two white bars at the top are due to missing data. This photograph has been especially processed to show faint detail.

available. The Pioneer 11 high gain antenna has a  $3.3^\circ$  beam width, whereas the medium gain antenna has a  $32^\circ$  beam width and 12 dB gain.

It must be made quite clear that Pioneer 11 was designed a long time before the more advanced Voyager spacecraft. The communications facilities at its Jupiter encounter in 1974 were much inferior to those of the two Voyager craft (which are now on their way towards Saturn). In addition, the much greater distance of Saturn has made communications with the craft more difficult than for the Jupiter encounter. Thus there could be no question of the images from Saturn being of the quality of those we have recently seen from the Voyager Jupiter encounter or even equal to those of the earlier Pioneer Jupiter encounter.

A further difficulty arose because Pioneer 11 was not originally intended to make a Saturn encounter, and at the time, Saturn was in the general direction of the Sun as viewed from the Earth. As the sun is the most intense source of radio noise in the sky as seen from the Earth, communications quality was further impaired by this unfortunate occurrence.

Nevertheless, the images returned at the closest approach to Saturn were about 20 times better than we can

obtain with the best of our huge earth-based optical telescopes. Cloud features down to about 50 km on the planet were satisfactorily resolved by Pioneer's imaging equipment. Even on August 31st, 1979, the last day on which Saturn was far enough away for a complete image of the planet to be obtained in a single photograph, image resolution was about five times better than that of earth-based photographs.

The one major disappointment of the Saturn encounter was the loss of data about Saturn's largest moon, Titan, which is particularly interesting because it has an atmosphere of a density comparable to that of the earth's atmosphere, although of very different composition. The size of this satellite is between that of the planet Mercury and the somewhat larger planet Mars, about 5000 km in diameter.

The other satellites of Saturn are much smaller, Rhea having a diameter of some 1500 km and Iapetus about 1200 km, with numerous other satellites of diameter less than 1000 m. These values may be compared with the mean diameter of Saturn itself of 120 800 km, about  $9\frac{1}{2}$  times that of the Earth.

### The rings

Saturn appears to the unaided eye as a somewhat yellowish star of the first

magnitude. However, it becomes considerably brighter about every fourteen years when its ring system attains maximum angle of inclination to the Earth-Saturn line and thus reflects more light towards the Earth. At such times Saturn is a magnificent object to view through a telescope of even moderate size.

Saturn's rings consist of relatively small particles of rock and ice which cast shadows on Saturn and thus affect its weather. It has been known for some time that the rings are quite thin, and Pioneer data indicates a thickness of about 1 km and a temperature of about 70 K (about  $-200^\circ$  C). The particles in the rings seem to have a typical size of the order of 10 mm in cross section. Pioneer 11 travelled within 21 000 km of the visible rings. It was not known how near Pioneer could safely approach the ring system.

Earth-based observations have shown several distinct rings. The outer 'A' ring is fairly bright and is divided into two rings of approximately equal size by a narrow zone of minimum brightness known as Encke's division. The innermost of the two 'A' rings is brighter than the outer one. This dual-ring extends from a distance of 139 200 km to 119 900 km from the centre of the planet. A dark region, called Cassini's Division, about 2800 km across, separates this dual-ring from the brightest 'B' ring which extends from 117 000 km to 90 520 km from the centre of Saturn. As one moves nearer to the planet, one encounters a narrow dark gap of some 500 km breadth before coming to a much fainter 'C' ring (the Crepe ring) extending from 90 000 km to 74 800 km from the centre of the planet. This is about 14 000 km above its cloud tops. A still fainter ring 'D' may be present inside the Crepe ring.

Pioneer 11 has found at least two more rings ('F' and 'G') outside the rings visible from the Earth. It is interesting to note that the presence of the ring system of Saturn makes the formation of radiation belts difficult. The magnetic field of Saturn was found to be much weaker than expected, being about the same value as that of the Earth and only about 1/20 Jupiter's.

Pioneer 11 has sent us views of Saturn's rings which can never be obtained from Earth. Views of the rings not illuminated by the Sun have been obtained in which one sees the light shining through the gaps in the rings and through the rings. This view is like a photographic negative in which the brightest rings are opaque and the normally dark areas (such as the Cassini Division) are very bright.

At one time the ring system of

Saturn was believed to be unique, but both Voyager spacecraft have found rings around Jupiter and a careful search has also shown rings around Uranus. However, Saturn's rings are far, far brighter than those of any other planet. Jupiter's rings may not be stable over a period of time and extend right down to the clouds above the planet, whereas Saturn's rings are believed to terminate far above the clouds.

## Saturn

Unlike Jupiter, only a few spots have been seen in the clouds of Saturn and it seems to have a very stable environment. As in the case of Jupiter, Saturn emits more radiant energy than it receives from the sun. It is believed to be a gas, presumably hydrogen and helium, perhaps with some form of rocky core or a core of liquid hydrogen. It spins quite rapidly with a period of about 10 hours.

Saturn has definite belts or zones, but they are not so prominent as in the case of Jupiter. In general, Saturn has less colouration and is less dynamic and colder than Jupiter. However, Saturn may have a simpler weather system on which we shall be able to test our models for Jupiter's weather, and which may even eventually help us to understand our own weather.

## Images

As the Pioneer spacecraft spun on its axis, it built up the images line-by-line. The craft was moving at a high speed and therefore this imaging process resulted in some jagged edges, but the images were re-constructed as far as possible by computer techniques. The images could be made only in red or blue light, although some images in these two colours could be superimposed to produce a kind of colour image.

The imaging produced by the 4.8 revolution per minute spacecraft may be far from ideal, but it is the best available with the communications systems of the Pioneer craft. At each revolution of the craft a strip of the image 0.03 degrees in width was scanned. A complete picture was built up in about an hour, while the image data was converted into digital form by Pioneer's electronic equipment and returned to Earth by telemetry.

The viewing angle of the 864 mm focal length telescope could be varied by about 160 degrees relative to the spacecraft's spin axis. The telescope could be directed to within 10 degrees of the spin axis looking away from Earth. The aperture of the telescope is 250 mm and the incoming light was split into two beams polarised at right angles to one another.

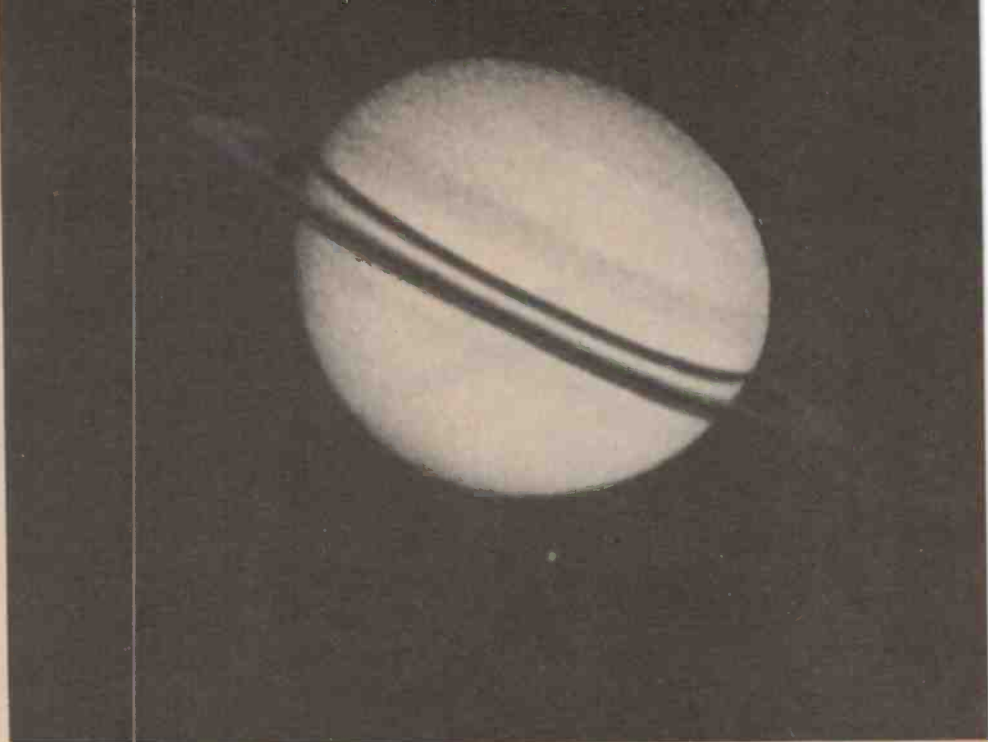

Saturn with the moon Rhea beneath it. This computer-processed image was taken on 29 August 1979, 58 hours before encounter. The greater brightness of the rings on the right hand side and the somewhat distorted shape of the planet are instrumental effects. Note the shadow of the rings on the surface of the clouds and the banded cloud structure.

Each beam was further split by passing it through a red filter which passed wavelengths from 580 to 700 nm and through a blue filter passing 390 to 490 nm. The resulting beams of light were passed to Channeltron detectors for conversion to electrical signals.

Although the images returned to Earth by this imaging photopolarimeter instrument are one of the most striking results of the Pioneer Saturn encounter, they are by no means the only important results obtained.

Cells to detect micrometeoroid impacts recorded about one small impact per month as it passed from Jupiter to Saturn, but this impact rate increased to about six per hour in the region of the planet. There are 234 of these impact cells which could detect particles weighing as little as  $10^{-8}$  gramme. Such particles can penetrate the cell walls of 0.05 mm stainless steel and allow the escape of a gas mixture (75% argon and 25% nitrogen). A transducer notes this escape of gas and records the impact. The total area of this micrometeoroid detector is about a half square metre.

Other instruments on board Pioneer (designed for its Jupiter encounter) include two magnetometers and an instrument to determine the composition of charged particles, Geiger tube telescopes for various energy bands, ultra-violet photometers for wavelengths of 121.6 nm and 58.4 nm and the infra-red radiometer which provided a measurement of the incoming and outgoing energy of Saturn.

As an example of the uses of one of these instruments, one may mention that Pioneer's instruments detected levels of charged hydrogen particles and electrons which almost certainly show the presence of an unknown satellite of the planet. Indeed, it seems likely that Saturn has a very large number of small moons and it is to be expected that in due course the Voyager encounters will produce evidence of many more moons than are known at present.

One of the peculiarities of Saturn is that the equatorial clouds are higher and colder than the clouds over the remainder of the planet. (One would never think of the earth's clouds as being colder at the equator than at the poles!) As it is believed that this planet, like the other outer planets, consists mainly of gas, there is probably not much point at our present state of knowledge in thinking about a possible surface temperature. If a solid surface exists, it is probably only small and deep inside the atmosphere under conditions of fantastically high pressure.

As one moves out towards the edges of the solar system, the increasing distance not only renders communications more difficult (owing to the inverse square law applying to the reduction of the signal intensity with increasing distance), but the time for the radio waves to reach the spacecraft increases. At the Pioneer 11 encounter with Saturn, the time taken for the radio waves to travel to or from the spacecraft was about one hour and 25 ▶

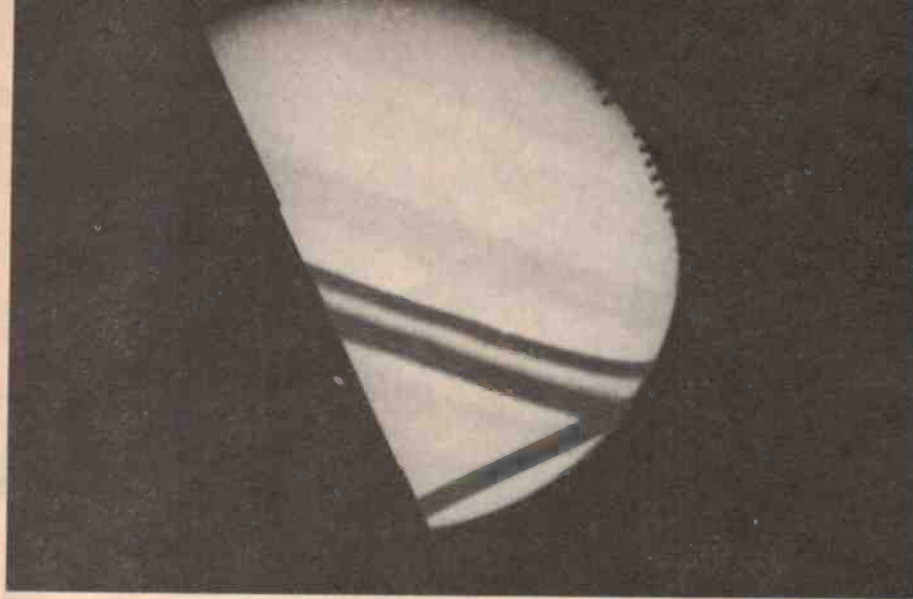

Part of the image of Saturn and its rings from 1.5 million km distance. The north pole of the planet is in the 2 o'clock position, but the left hand part was not imaged. The shadow of the rings can be seen on the disc but the sloping horizontal dark band on the lower right part of the disc is due to instrumental effects.

minutes. Thus any command signal sent to the craft from one of the US Deep Space Network stations took 85 minutes to reach the craft and even if a signal was immediately emitted by the craft to signify that the command signal had been safely received and the command executed, another 85 minutes elapsed before this second signal could be received by an Earth station.

Apart from the expenses involved in sending Pioneer 11 to Jupiter and Saturn, if the mission failed because of a transmitter failure, it would be some years before scientists would have the opportunity of repeating the work. The Saturn data has been returned from a distance of about 1.5 thousand million kilometres from the Earth!

Further communications problems in planetary exploration include the passage of the spacecraft through the radio shadow of the planet. One minute after its closest approach to Saturn, Pioneer disappeared from radio view from the earth for 78 minutes, behind the giant planet. During this time no radio contact was possible. After it came out from the shadow of Saturn, it made a second hazardous crossing of the planet's ring plane on its journey away from the planet on September 1st, again at a distance of 112 000 km above the planet. Pioneer is now moving out of the solar system. Pioneer 10 and 11 both carry a plaque showing a pictorial message (including a drawing of a man and a woman) which it is just possible some intelligent being from outer space may find at some remote future date. This plaque, designed by Dr Carl Sagan of Cornell University, his wife and Dr Frank Drake, Director of the National Astronomy and Ionospheric Centre, Cornell, shows the location of the sun as an intersection point of the

signals from 14 pulsars (pulsating neutron stars). The frequencies of pulsation are shown in binary notation so that the time of launch could be calculated even in a million year's time. The sun and nine planets are shown on this plaque with the Pioneer craft leaving the third planet (Earth), passing Mars and swinging by Jupiter. (Saturn encounter was not planned when the plaque was designed).

### Conclusions

Pioneer 11 has provided us with our first close up look at Saturn and its ring system. The two Pioneer craft built at a cost of some  $10^8$  US dollars (this figure includes instruments, but excludes launch costs, tracking and data recovery) have been mainly controlled by commands from the Earth rather than from on-board computer-stored commands. Nevertheless, they can store up to five commands for later execution and 222 different commands are possible. An on-board 49 192 data bit store enabled information to be temporarily stored so that it could be later transmitted at the data rate possible; this enables data to be accumulated faster than it can be transmitted. It is interesting to note that Pioneer 11 is expected to provide us with signals until 1987, yet in 1974 it moved past Jupiter at 171 000 km/hour — the fastest object ever made by man.

The data returned by Pioneer 11 will greatly help scientists to choose the best trajectory for the two much more sophisticated Voyager craft which are now on their way to Saturn. For example, we now have much more information about Saturn's ring system and this will guide us in placing the Voyager craft close enough to obtain the required information, with a

minimum risk for the destruction of the craft as they pass through the ring plane. Pioneer 11, travelling at some 85 000 km/hour, passed through the ring plane in much less than a second.

Voyager's imaging and communications systems are far more sophisticated than those aboard Pioneer 11, so we are virtually certain to obtain far better pictures from these craft. Pioneer 11 took nearly five years to move right across the solar system from Jupiter to Saturn, but the Voyager craft will reach Saturn in November 1980 and in August 1981 — less than two years after their Jupiter encounter. The reason for this shorter time interval is the alignment of the outer planets at the present time which enables the journey to be far shorter. Pioneer 11 has lived up to its name in carrying out the pioneering work, but much more detailed work remains to be done. In particular, there is much speculation as to whether Titan's dense atmosphere (possibly methane) contains the type of molecules from which life evolved on earth.

Apart from the Voyager Saturn encounters in the not too distant future, one of these craft should visit Uranus and Neptune. Project Galileo (launch date 1982) plans to send probes into the atmosphere of Jupiter and to put an Orbiter vehicle into orbit around Jupiter to watch its cloud formations over an extended period and to survey its Great Red Spot and its moons. Thus the early 1980s will be of great significance for space exploration.

Man is not only tackling the problem of obtaining good images by his use of inter-planetary probes. In the early 1980s a multi-national space telescope will be launched which will enable us to view objects from which we receive only 1/50 of the light of the faintest object visible from our largest Earth telescopes. In addition, this orbiting space telescope will enable us to look at astronomical objects over a much greater range of wavelengths, from the far infra-red through the visible to the far ultra-violet and X ray regions. Not only will the image resolution be improved, but far more information will be obtained from the use of wavelengths which are absorbed by the Earth's atmosphere if one attempts to use an Earth-based telescope.

The future of astronomy is certainly going to be fascinating! ●

### Acknowledgement

The author gratefully acknowledges the help of Ms Kit Weinrichter of NASA's Ames Research Centre, California for the provision of Pioneer Saturn photographs and of detailed information about the Pioneer Saturn encounter.

# MOVE OUT AHEAD WITH MEASURING INSTRUMENTS FROM STANDARD

SEW

**NEW!**

YN-360TR

ST-303TR

ST-350

ST-300

SP-10D

ST-5

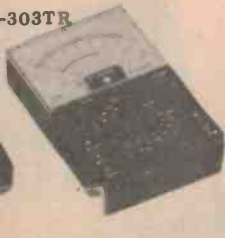

## YN - 360 TR SPECIFICATIONS

### Measurement Ranges:

DC V 0-0.1V-0.5V-2.5V-10V-50V-250V-1000V (20KΩ/V)  
AC V 0-10V-50V-250V-1000V (8KΩ/V)  
DCmA 0-50mA-2.5mA-25mA-100mA-1A-0.25A  
50μA at 0.1V DC position

Resistance Range	X1	X10	X1K	X10K
Minimum	0.2	2	200	200K
Midscale	20	200	20K	200K
Maximum	2K	20K	2M	20M

Volume level: 20 ~ +22dB for 10V AC  
dB-10dB ~ +22dB for 10V AC  
Battery: 1.5 X 2, 9V X 1  
Accuracy:  
DC V & mA: within ± 3% F.S.  
AC V: within ± 4% F.S.  
ohm: within ± 3% Arc  
Dimensions & weight 147 x 100 x 45mm 430g

## ST-303TR SPECIFICATIONS:

DC Voltage: 0.0.3, 1.5, 3, 12, 30, 120, 300, 1200 Volts 20k Ω/V  
AC Voltage: 0.6, 30, 120, 300, 1200, 8k Ω/V  
DC Current: 0.006, 3, 30, 300mA, 12A  
Ohms: 0.20 Megohms in 4 Ranges ± 3%. 20 ohms center Scale  
Decibels: -10 to +17  
Transistor checker: Ico (L1) 0-150μA on x 1KΩ Range;  
0-15mA on x 10Ω Range; 0-150mA on x 1Ω Range; hfe  
0-1000 on x 10Ω Range 1C/1B

## ST-350 SPECIFICATIONS.

Range of Measurement  
DC Voltages: 10V 50V 250V 500V 1000V (2KΩ/V)  
AC Voltages: 10V 50V 250V 500V 1000V (2KΩ/V)  
DC Current: 0.5mA 25mA 500mA 10A  
Resistance:  
Range X1 X10 X1000  
Midscale 20Ω 200Ω 10KΩ  
Maximum 500Ω 5KΩ 1MΩ  
Minimum 0.2Ω 2Ω 200Ω  
Volume level: 20 ~ +22dB & +20 ~ +38dB  
Capacity: 0.0001 ~ 0.03μF & 0.01 ~ 0.5μF  
Inductance: 10~1000H  
High resistance: 0.~50MΩ use external power  
Batteries: Two 1.5V dry cells (UM-3 or equivalent)  
Allowance: DC Voltage % Current: Within ± 3% f.s.  
AC Voltage: Within ± 4% f.s.  
Resistance: Within ± 3% of scale length  
Size & weight: 138x96x51/mm 480g

## ST-300 SPECIFICATIONS:

Range of Measurement:  
AC Amperes (AC A): 6A 15A 60A 150A 300A  
AC Voltages (AC V): 150V 300V 600V  
Resistance ( ): 1kK (centre: 30 )  
Tolerance:  
AC Ampere: 3% of maximum graduation.  
AC Voltage: 3% of maximum graduation  
Resistance: 3% of Scale length.  
Inside Battery and fuses of Resistance Range 1 piece UM-3 Battery, 1.5 Volts 3 piece 0.1A Fuses in a Glass Tube (9.5-11.5 )

## SP-10D SPECIFICATIONS

Measurement ranges.  
DCV 0.25 10 50 250 500 1000 (4KΩ/V)  
DCmA 0.25 25 500 (250mV drop)  
ACV 10 20 250 500 1000 (4KΩ/V) 50  
Ω Range X1 X10 KΩ  
Midscale -20 200 10K  
Maximum -500 5K 1M  
Minimum -0.2 2 200  
Battery - 1.5VX1  
dB -20 ~ +22 +20 ~ +36 ~ +62  
MΩ 0.1 ~ 50 using external  
μF 0.000 ~ 0.02 0.01-0.3 power  
Accuracy: Within ± 2.5% for DCV & mA; Within ± 3.5% for ACV; Within ± 3% of arc for Ω  
Dimensions & weight 140x95x44mm & 310g.

## ST-5 SPECIFICATION

Range of measurement  
DC Voltages: 5V 25V 250V 500V (4KΩ/V)  
AC Voltages: 10V 50V 500V 1000V (2KΩ/V)  
DC Current: 250μA 250mA  
Resistance: 0 ~ 600K (7000 ohm center)  
Allowance:  
DCV and DCA: within ± 3% f.s.  
ACV: within ± 4% f.s.  
ohm: within ± 3% arc  
Size and weight: 90x60x28/mm-120g.

# NEW ARRIVAL GOODWILL TEST INSTRUMENTS

## AUDIO GENERATOR

Model: GAG 808A

### SPECIFICATION

• SINE WAVE CHARACTERISTICS  
Output Voltage: 7V rms or more (when no load)  
Frequency Characteristic: 10 Hz to 1 MHz ± 0.5 dB (reference frequency: 1 KHz)  
Distortion Factor: 400Hz to 20KHz 0.1% or less; 100Hz to 100KHz 0.3% or less 50Hz to 200KHz 0.5% or less; 20Hz to 500KHz 1% or less; 10Hz to 1MHz 1.5% or less  
• SQUARE WAVE CHARACTERISTICS  
Output Voltage: More than 10V P-P (when no load)  
SAG: 5% or less (at 50 Hz)  
Rise & Fall Times: Less than 200 nS  
Overshoot: Less than 2%  
Duty Ratio: 50% ± 5%

### EXTERNAL SYNCHRONIZATION CHARACTERISTICS

Synchronizing Range: More than 1V ± 1%  
Max Allowable Input: 10V RMS  
Input Impedance: 10K Ohm  
Output Impedance: 600 Ohm ± 10%  
Output Attenuator: D to 50 dB, 6 steps, each step decrease 10 db. (less than ± 1 dB)  
Frequency Variation: Less than ± 0.5% AT 110V ± 10%  
Operation Temperature: 0-50C (relative humidity: less than 90%)  
Power Source: 110V/220V ± 10% (AC) 50Hz/60Hz  
Dimension: 142 (W) x 240 (D) x 197 (H) mm  
Weight: 4.5 kg



## AC MILLIVOLT METER

Models: GUT-708 A & GVT-708B

HIGH SENSITIVITY  
RMS Scale: 1mV-300V (Full Scale) in 12 Ranges. (GVT-708A); 1.5mV-500V (Full Scale) in 12 Ranges. (GVT-708B)  
dBM Scale: -60db ~ +50db in 12 Ranges  
Input Impedance: 10M Ω on all Ranges.  
Accuracy: ± 3% of Full Scale at 1KHz  
Frequency: 10Hz-500KHz ± 3%  
Response: 5Hz - 1MHz ± 5%  
Output: About 1V at Full Scale Indication  
Distortion: Less Than 2%  
Dimension: 142 (W)x205 (H) x 230 (D) (mm)  
Weight: 3kg

Frequency Range: x 1 range 10Hz to 100Hz; x 10 range - 100Hz to 1KHz; x 100 range - 1KHz to 10KHz; x 1K range - 10KHz to 100KHz; x 10K range - 100KHz to 1MHz (5 Ranges)  
Frequency Accuracy: ± (3% + 1Hz)



## OSCILLOSCOPE

Models: GOS-935 & GOS-955

GOS-935  
Vertical Deflection: Sensitivity: 10mV/DIV  
Attenuator: 1/1, 1/10, 1/100, and GND.  
Bandwidth: DC-DC-5MHz (-3dB)  
AC: 2Hz-5MHz (-3dB). Input Impedance: 1MΩ ± 5% Within 35PF. Max Input Voltage: 600VP-P or 300V(DC + ac peak).

Horizontal Deflection: Sensitivity: 250mV/DIV. Bandwidth: DC-500KHz (-3dB). Input Impedance: 1M Ω ± 10% Within 35PF  
Time Base: Sweep Frequency: 10Hz-100KHz in 4 ranges and fine control. Linearity: Less than 5% Synchronizing: Internal and external  
Synchronization: Type of sync: INT. EXT. Sync Amplitude: INT: more than 1 DIV on the screen. EXT: more than 2VP-P

GOS-955  
Vertical Deflection: Sensitivity: 10mV/DIV. Attenuator: 1/1, 1/10, 1/100, and GND. Bandwidth: DC-DC-5MHz (-3dB); AC: 2Hz-5MHz (-3dB). Input Impedance: 1M Ω ± 5% Within 35PF  
Max Input Voltage: 600VP-P or 300V(DC + ac peak).

Horizontal Deflection: Sensitivity: 250mV/DIV or better Bandwidth: DC-500KHz (-3dB) Input Impedance: 1M Ω ± 10% Within 35PF



## FREQUENCY COUNTER

Model: GFC - 876

### SPECIFICATIONS

Frequency Range: 10Hz-70MHz  
Input Sensitivity: 20mV, 200mV rms selected by sensitivity switch.  
Input Impedance: Approx 1 M Ohm, under 25 pF.  
Input Destroyed Voltage: 150V rms.  
Coupling System: AC Coupling  
Oscillation Frequency: 10 MHz  
Aging Rate: 1x10<sup>-6</sup> week  
Temperature Stability: 5x10<sup>-6</sup> (25 + 5°C) 4x10<sup>-6</sup> (Calibration ambient temperature 0-40°C)  
Measurement Accuracy: ± 1 count ± standard time base accuracy  
Counting Capacity: 6 digital decimal.  
Counting speed: Max 70 MHz  
Display system: Digital display LED, display storage with overflow indication.  
Resolution: 100Hz (10 ms) or 1Hz (1S)  
Operating temperature range: 10 - +45°C  
Power Consumption: Approx 15VA  
Power Requirement: AC 110V/220V, 50/60Hz  
Dimensions: Approx 175 (W) x 75 (H) x 260 (D)mm  
Weight: Approx 2.5kg

Time Base  
Sweep Frequency: 10Hz to 100KHz in 4 ranges and the fine control. Linearity: Less than 5%. Synchronizing: Internal and external  
Synchronization: Internal - & +; external: line 0-140 for line frequency sweep.



# EMONA ENTERPRISES Pty. Ltd.

Suite 208/661 GEORGE ST., SYDNEY, NSW

PHONE: (02) 212 4815, 211 3038  
CABLE: EMONA SYDNEY

# DIGITAL MULTIMETER AT AN ANALOG PRICE!

## ME-501A SPECIFICATIONS



### DC Voltage

Ranges: 200 mV, 2V, 20V, 200V, 1000V  
 Input R: 10 M Ohm  
 Accuracy: 1 (0.8 percent of rdg plus 1 dgt)  
 Overload protection: 100V dc/peak

### AC Voltage

Range: 1000V  
 Input R: 10 M Ohm  
 Accuracy: 1 (1 percent of rdg plus 5 dgt)  
 Overload protection: 1200 Vrms

### DCmA:

Ranges: 200 uA, 2mA, 200 mA, 10A  
 Voltage Burden: 250mV maximum at F.S.  
 except 10A range, 5.00 mV  
 Accuracy: 1 (1.2 percent of rdg plus 2 dgt)  
 Overload protection: 0.5A/25DV Fuse

### Resistance:

Ranges: 2k, 20k, 200k, 2M, Diode test  
 Accuracy: 1 (1 percent of rdg plus 2 dgt)  
 Overload protection: 250 Vdc/rms

### Transistor Hfe Checker:

Range: 0 — 100 (IB 10 ma)  
 Accuracy: 1 (10 percent of rdg plus 2 dgt)



4 models available from

**\$ 78.00**

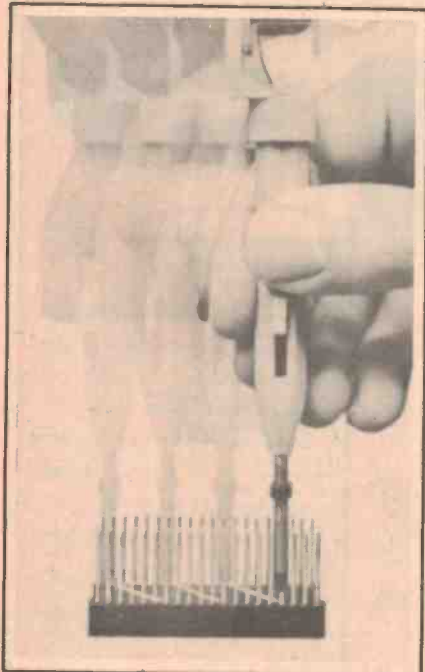

U.S.A.  
 FOREIGN  
 PATENTS  
 PENDING

# NEW!

**WHY CUT?  
 WHY STRIP?  
 WHY SLIT?**



**WHY NOT...**

# JUST WRAP™

- AWG 30 Wire
- .025" Square Posts
- Daisy Chain or Point To Point
- No Stripping or Slitting Required
- JUST WRAP™
- Built In Cut Off
- Easy Loading of Wire
- Available Wire Colors:  
 Blue, White, Red & Yellow

## AMPEC ENGINEERING CO. PTY. LTD.

1 Wellington St, Rozelle, 2039. PO Box 132, Rozelle, 2039. Ph (02) 818-1166.

Available from: NSW David Reid Electronics, 29-6601. Radio Despatch Service, 211-0191. Electronics (Distributors), 636-6052. Martin De Launay, 29-5834. Applied Technology, 487-2711. Vic. Radio Parts, 329-7888. Stewart Electronics, 534-3733. Arlin Instruments, 569-6984. Ellistrionics, 602-3282. S. Aust. Protronics, 212-3111. W. Aust. Reserve Electronics, 328-3116. Qld. Wilber Sales, 391-5136.



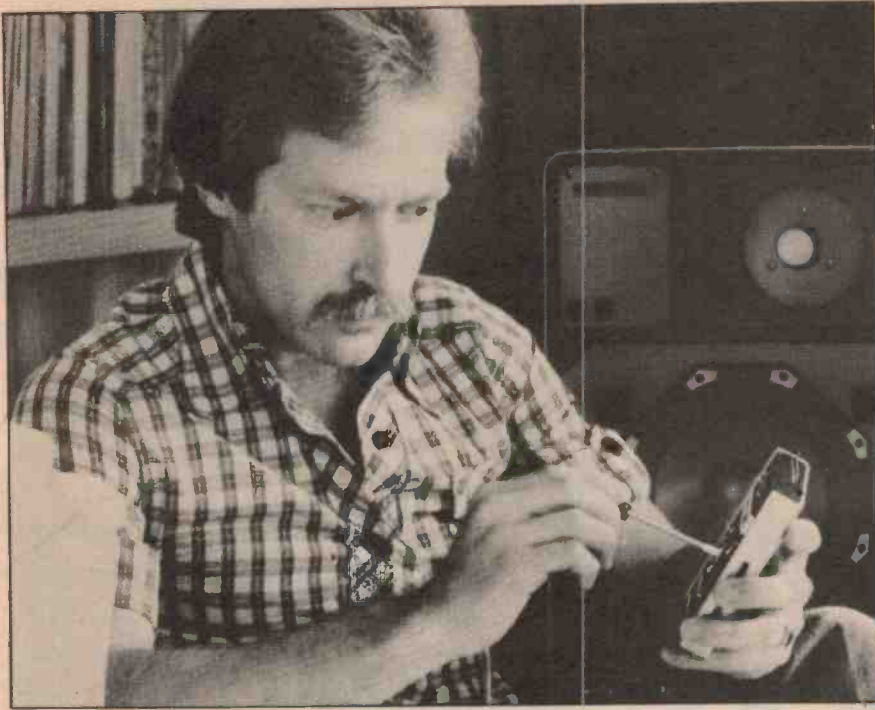

## “HOW TO TURN ELECTRONIC THEORY INTO PRACTICE AND MAKE IT PAY...”

“If you understand and enjoy radio and electronics and want to extend your knowledge and experience, then we at Stott's can help you.

Stott's have home-study courses for complete beginners in Radio theory and basic Electronics through to the standards needed to maintain and service Colour Television.

Anyone who has these skills at their fingertips can make it pay by turning a fascinating hobby into a lucrative part or full time profession.”

*Athol H. Kelly*

Athol H. Kelly B. Com. (Hons.), A.A.S.A., F.C.I.S.  
Principal, Stott's Technical Correspondence College



**Stotts**



The name to trust in correspondence education.

TECHNICAL CORRESPONDENCE COLLEGE

Melbourne, 159 Flinders Lane, 3000. Tel: 63 6212  
Sydney, 383 George Street, 2000. Tel: 29 2445  
Brisbane, 290 Adelaide Street, 4000. Tel: 31 1627  
Adelaide, 85 Pirie Street, 5000. Tel: 223 3700  
Perth, 140 St. Georges Terrace, 6000. Tel: 322 5481  
Hobart, 1st Fl. 29 Argyle Street, 7000. Tel: 34 2399  
Singapore, P.O. Box 3396, Singapore 1.

Please send me free, and without obligation, full details of the following courses:

(PLEASE PRINT)

MR. MRS. MISS \_\_\_\_\_ AGE \_\_\_\_\_

ADDRESS \_\_\_\_\_

POSTCODE \_\_\_\_\_

Stott's undertake that no sales counsellor will visit you.

ALA/ST1482/ET180

The Stott's range of courses in Electronics is:

Intro. to Electronics  
Digital Electronics for Technicians/Service-men  
Microprocessors  
AM Radio Receivers  
Radio/TV Servicing  
Colour Television  
Radio for Amateurs  
Amateur and Novice Radio Operators' Certs.  
Electrical Mechanics

A full range of Hobby and Business courses also available.

# SAVE \$\$\$ ON BATTERIES!

3 ● 6 ● 9V  
at 200mA!

WAS \$9.50  
NOW \$6.90

(SAVE NEAR 30%!) Cat M-9525



Why waste money on batteries? This superb 'plug-pack' battery eliminator suits most small battery operated appliances with its 3, 6 and 9 volts output – radios, cassettes, toys, calculators, etc etc. At our budget price, it will pay for itself in no time at all! Fully approved; comes with 4-way power plug and reversible polarity. Ideal for the home, office, shack, etc. Start saving money today!

**DICK SMITH ELECTRONICS**



SYDNEY 439 5311 MELBOURNE 67 9834 CANBERRA 80 4944  
ADELAIDE 212 1967 BRISBANE 391 6233  
PERTH 378 6944 WOLLONGONG 28 3800

MAIL ORDERS PO Box 321, North Ryde, NSW 2113

(Please include \$1 00 extra for packing & postage)



# WHEELS CAR OF THE YEAR SHOCK!

MARCH ISSUE OUT NOW

# TERTIARY EDUCATION: The System Explained.....

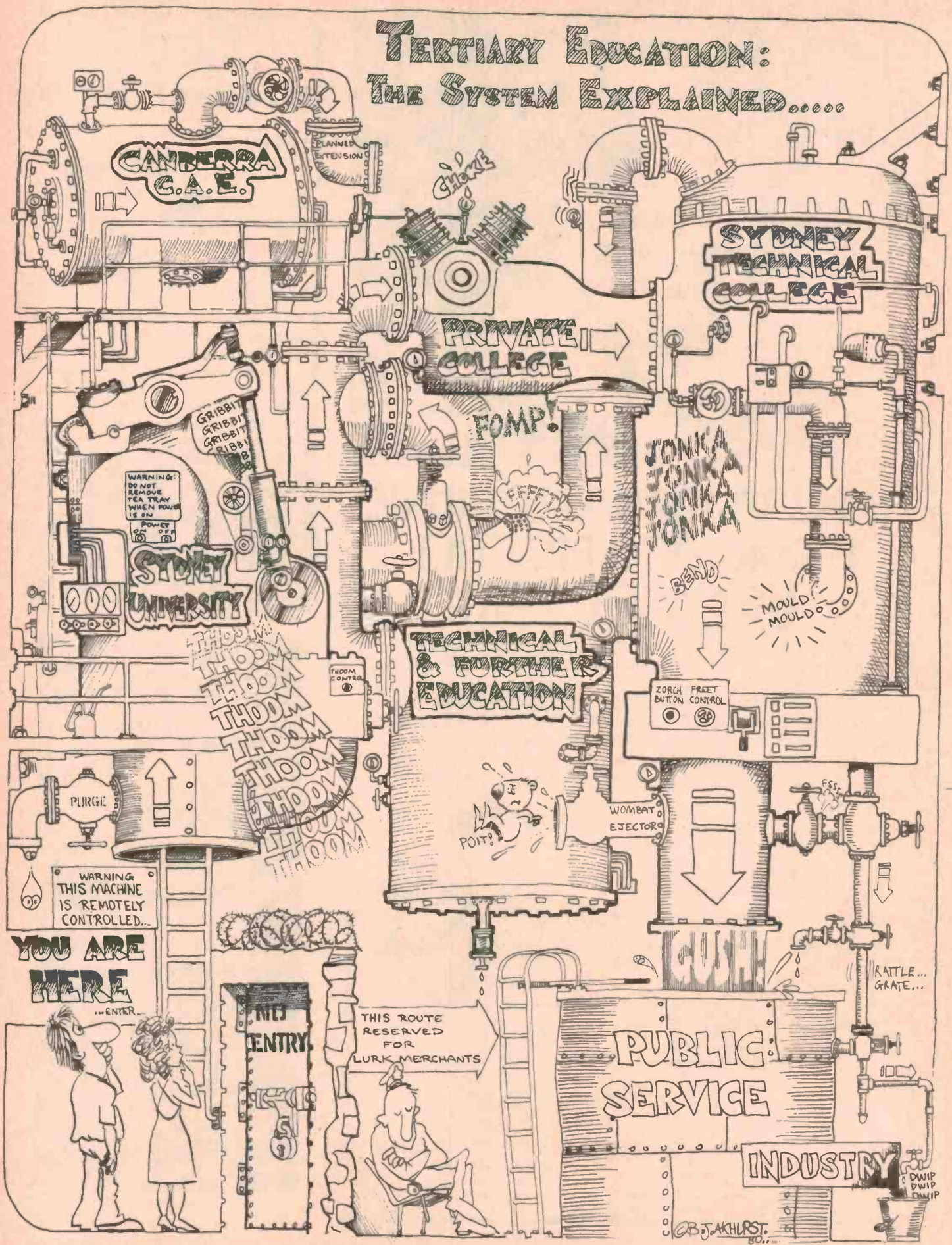

© B. J. AKHURST 80...

# Courses and careers in electronics

**Roberta Kennedy**

Concluding part of our feature on the electronics education and employment scene in Australia.

## Universities CAEs and ITs

The admission requirements and standards of universities, CAEs and ITs are basically the same. All stress the need for physics, maths and english at Year 12 (sixth form) level, and the HSC is essential except for mature age students who must show that they have reached an equivalent standard. Some colleges also require chemistry at HSC level.

Bridging courses in the above subjects are available at NSW University, Caulfield IT and Swinburne College of Technology.

At Sydney University you can study electronics as part of a B.E. (Bachelor of Engineering) degree, which is four years full time. The first two years cover general engineering subjects, with a choice in year three of Electrical, Civil, Mining or whatever specialisation you require. In addition, students are expected to acquire twelve weeks practical experience during vacations.

The course is strongly science based, and students should have above average ability in maths, chemistry and physics at HSC level. It is possible to obtain a double BSc, BE degree after five years full time study, which gives a broader scientific basis to the engineering studies.

At the University of NSW there are two degree courses available - BE (four years full-time) or BSc (Eng), which is three years full-time or six years part-time. Part-time students must do three years appropriate industrial training concurrently, while BE students need at

least 12 weeks practical experience which can be done during vacations. The BSc course is the more computer-oriented of the two.

The first year of the NSW degree course covers general science and engineering, with electrical engineering specialisation starting in Year 2.

For those who want a combined BE/BSc degree, there is also a five year full-time course.

Newcastle Uni also concentrates on general science and engineering fundamentals for the first year of their B.Eng course. This is a four year course which includes a certain number of Arts faculty units and 20 weeks industrial experience. Subjects such as industrial law, economics and accounting are available in the final year.

NSW Institute of Technology has a BE degree course which can be taken either part-time or 'sandwich', The latter means that students alternate between full-time working in the industry and study at the college. In either case the course duration is six years, and requires 144 weeks of industrial training. This training can either be sponsored by a particular company, or on a flexible basis where students move to a different company each semester.

Requirements for NSWIT are five units in maths and science plus english at HSC level, or the TAFE certificate in Electrical Engineering or Electronics and Communications.

Canberra College of Advanced Education offers a one year course in

electronics engineering as part of their two-year Associate Diploma or three-year Bachelor of Applied Physics course. After the first year, students go on to complete one of the above courses. Those who want to specialise in electronics have to transfer to an EE degree course at another university or college.

A graduate diploma course is also available on a two year part-time basis. This provides a basic grounding in electronics, communications and computer science, but entry is restricted to graduates only.

The B Eng degree course at Caulfield IT provides three years of common core subjects followed by one year in which specialist elective units can be taken.

For those who want to move into the administrative or management side of the industry, an engineering/business studies stream has been established through co-operation between the Dept. of Electrical and Electronic Engineering and the David Syme Business School at Caulfield. This enables a Bachelor of Business degree to be gained with one year of equivalent full-time study on top of the four year B.Eng course.

A three-year diploma course is also available at Caulfield. This non-professional course is integrated with the degree course and provides for specialisation in power or communications engineering. Students who have done the diploma course can continue their studies through to degree level if they wish.

Admission requirements for both degree and diploma courses are the ►

# How to crack a highly paid job as an electronics technician.



We'll give you excellent training - as good as you'll get anywhere in Australia.

We'll give you free medical, dental and hospital treatment.

We'll provide plenty of good tucker and a comfortable place to stay.

We'll give you substantial leave, and on top of all that, we'll pay you well while you're training.

On your side, you'll give us a period of hard, but interesting and rewarding work. And, when eventually you leave us, you'll find yourself a fully qualified and experienced Electronics Technician. Not a bad thing to be, these days.

So, if electronics is your idea of a great career and you are (at time of entry) approx. 15 to 17 for apprenticeship

and over 17 for an Adult Trainee, join the Navy, Army or Air Force.

Phone us at:

Adelaide 223 2891. Brisbane 226 2626.

Canberra 822 333 Hobart 34 7077.

Melbourne 61 3731. Perth 325 6222.

Sydney 212 1011.

Write to either the Navy, Army or Air Force Electronics Technician Counsellor, GPO Box XYZ in your nearest State Capital City (please

include your date of birth).

**Learn  
Electronics  
with us.**

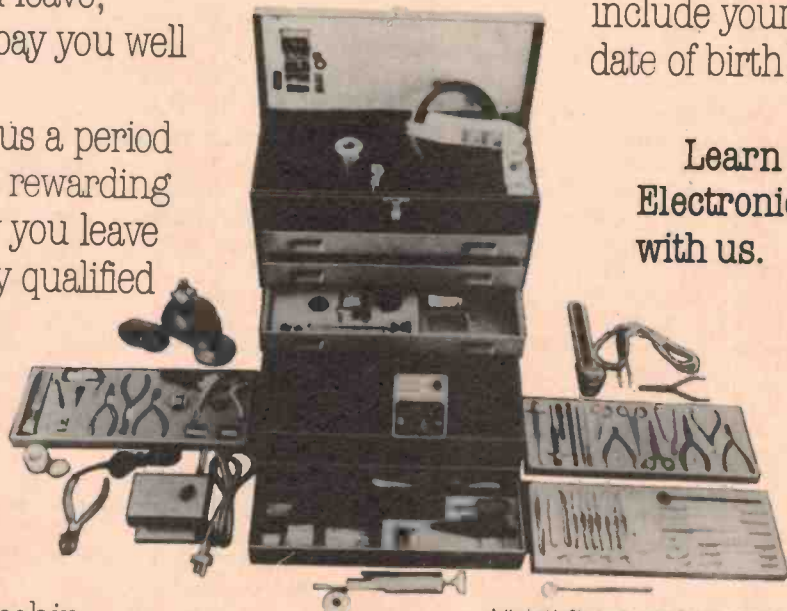

Authorised by Director-General of Recruiting, Dept. Defence.  
TSAP15.FP.48



One of the more interesting applications of electronics is in the recording industry, a field of employment that is still expanding. Photo courtesy of the School of Electronics, North Sydney.

same, being HSC with chemistry, maths, physics and english. A Tertiary Orientation Programme is available for students without Year 12 qualifications.

La Trobe University has a B.Sc. course in electronics and computing, and a two-year post-B.Sc. degree in communication engineering.

Deakin University (Vic) offers a four-year B.Eng, a B.Sc. and a Diploma of Technology, with an emphasis on mathematics.

Monash University also has a four-year B. Eng degree course. First year studies in general engineering principles are common to all engineering students, and some Arts or Humanities units must also be covered in Year 3 or 4.

The University of Western Australia has a four-year full-time B. Eng degree course with specialisation in EE from Year 3. They require proven ability in chemistry, maths, physics and english as well as prior completion of a tertiary course for admission.

Adelaide University has a BE in Electrical Engineering with basic science studies in the first year and mathematics units through to fourth year. Students must gain 16 weeks practical experience during vacations.

Queensland's James Cook University provides a B. Eng with first year studies in engineering and applied mechanics as well as the basic sciences - 24 weeks minimum industrial experience is required.

### Private courses

In addition to the universities, colleges and techs, there are a number of private electronics schools which offer worthwhile courses.

One of these is the School of Electronics at Milsons Pt, Sydney, which has been going for two years. The course involves three two-hour lectures per week, for a period of 40 weeks.

Of course, private schools don't come cheaply - and this one will set you back \$1200 (\$30 per week).

There are no absolute prerequisites for the course, although students are carefully screened for aptitude and great emphasis is placed on emotional maturity - without this, you don't get in.

The school enrolls a maximum of 60 students per year, and competition for these places is quite strong. The course caters for students from a variety of backgrounds, including those engaged in degree or diploma courses elsewhere, roadies and others working in the industry, young people with no previous experience and anyone who specifically wants studio recording experience.

The school does not aim at turning out technicians for specific jobs, but instead emphasises self-motivation and productiveness, in the belief that what the industry really needs are more freelance operators and technical consultants.

The course is oriented to audio engineering and sound production, rather than pure electronics, and emphasises practical studio experience. This is provided through the school's association with Tin Pan Alley Studios, where students have access to full professional facilities and the opportunity to work with session musicians, bands, orchestras and advertising teams.

Assessment is based on attendance of lectures and practical sessions, as well as assignments. On completion of the course students receive a certificate and a personal reference from the school, this qualification being quite well recognised in the television, radio and sound recording industries.

**International Correspondence Schools (ICS)** have a wide range of courses in electronics which enable students to pursue specialist subjects or general studies as required. The Electronic Technicians Programme is designed for those with little or no experience other than mathematical ability. Phase 1 covers the fundamentals of electronics, electricity amplifiers and radio receivers, while Phase 2 provides a choice between audio, radio and hi-fi systems, industrial electronics, communications and broadcasting and computer servicing.

Selected programmes in radio theory and industrial applications of electronics are also available. ICS courses are well ▶

recognised in the industry.

Private correspondence courses are also available through the Collier MacMillan Schools. They have a general Electrical Engineering Certificate course and an Electrical Technicians Certificate for qualified technicians. In addition, there are special courses in electronics design, radio and TV, and telecommunications. CMS charges between \$400 and \$500 for a course, which can be paid in installments.

## Employment

So you've done the electronics course of your choice, and there's the certificate/diploma/degree in a nice frame on the wall. Now it's time to start scanning the employment pages for that wonderful rewarding job that you've spent all this time working towards.

Commonwealth and State Government departments and agencies have always been a major source of employment for engineers, technicians and technical officers, in fact the more cynical among us would say that many of the above courses exist purely to staff the Public Service.

The Department of Transport (Civil Aviation) employs about 700 technicians/technical officers, working on radar, air communications, navigational aids, message switching and a host of computer equipment.

OTC has around 600 trained personnel who are involved with computer control, telephones, telex data, satellite Earth stations, cable stations and international transmitting and receiving stations, while Telecom is the biggest employer of all, with approximately 10 000 technicians and technical officers working on domestic telephone and Telex services, maintenance of ABC radio and television transmitters etc.

Other government departments which employ skilled electronics staff are the Department of Post and Telecommunications, the Bureau of Meteorology and the Department of the Navy. All the above departments supplement certificate courses with two to four years of in-house training.

Many government departments offer four-year traineeships for school leavers, which require them to attend tech part-time during working hours (usually one day per week). Additional in-house training and practical field work is supplementary to the course taken.

In recent years, government staff ceilings have severely restricted the number of traineeships available, and this is one of the reasons for the current shortage of trained technicians.

While Public Service jobs offer a high degree of security, the promotional

prospects are fairly limited. If you started off as a trainee and steadily worked your way up the ladder, it would take up to seven years to reach Technical Officer grade 1 with a salary of \$11 972. Beyond this point the number of jobs available diminishes rapidly, with less than five percent of Public Service Staff reaching Senior TO level or beyond.

The situation in the private sector is quite different, with promotional prospects and salaries being far greater. On average, the salaries now being offered in private industry are about 15 percent higher than in the Public Service. This leads to a "brain drain" of trained public servants to the private sector, who benefit in two ways, since they do not have to bear the cost of training these employees in the first place.

Salaries being offered at the time of writing (November 79) clearly showed

just how keenly the private industries are recruiting electronics staff. At the senior engineer or management level the range was from \$18 000 to \$25 000 plus package, and higher.

Engineers with two or more year's experience can expect to earn between \$15 000 to \$18 000 plus package, while technicians with the same amount of experience are looking at between \$13 000 to \$17 000.

While the Public Service, in order to maintain its own hierarchy, insists on the appropriate tertiary qualifications for employment, it seems that the private sector can do without formal qualifications, which are usually described as *desirable* but not essential.

Ultimately, and despite whatever the piece of paper says you are trained to do, *experience* is the single most important qualification you can have — after all, the whole point is "Can you do the job?"

### A Guide to Public Service Salary Scales.

Add 5.7% for Telecom and about 15% for private industry.

<b>Trainee T.O.</b>		
under 18 .....	\$ 5626	\$12987
at 18 .....	\$ 6563	\$13323
at 19 .....	\$ 7595	
at 20 .....	\$ 8532	<b>T.O.2</b> .....
adult (21) .....	\$ 9376	\$13661
	\$ 9921	\$14032
	\$10457	\$14401
<b>T.A.2</b> .....	\$10490	<b>Senior T.O.1</b> .....
	\$10724	\$14773
	\$10962	\$15139
	\$11200	\$15510
	\$11441	<b>S.T.O.2</b> .....
<b>Tradesman (Radio)</b>	\$ 9823	\$15914
	\$ 9990	\$16321
	\$10159	\$16727
	\$10325	<b>S.T.O.3</b> .....
	\$10493	\$17160
	\$10664	\$17590
	\$10829	<b>S.T.I.2</b> .....
<b>Radio Assistant</b>	\$ 9139	\$16001
	\$ 9309	<b>S.T.I.3</b> .....
	\$ 9481	\$16631
<b>Radio Technician</b>	\$10941	<b>P.T.O.</b> .....
	\$11284	\$18038
	\$11625	\$18493
	\$11972	<b>Controller</b> .....
<b>Technical Officer</b>		\$21101
<b>Grade 1</b> .....	\$11972	<b>Supervisor</b> .....
	\$12310	(workshops) .....
	\$12648	\$14672
		\$14961
		<b>T.O.</b> — Technical Officer
		<b>T.A.</b> — Technical Assistant
		<b>S.T.O.</b> — Senior Technical Officer
		<b>S.T.I.</b> — Senior Technical Inspector
		<b>P.T.O.</b> — Principal Technical Officer



# Collingwood Technical College

# IMPROVE YOUR SKILLS

## SPECIAL SHORT COURSES OFFERED 1980

### Amateur Television for the radio amateur.

### Slow Scan Television for the radio amateur.

These two courses are short practical classes catering for those who wish to build either an A.T.V. transmitter, linear and power amplifier or slow scan digital scan-converter with memory. If you do not have the skills or equipment to tackle such a project at home — then these courses are for you.

## OTHER SHORT COURSES ARE (5-30 WEEKS)

- 16mm Projector Training
- Basic Television Techniques
- Advanced Television Techniques
- Film and Animation
- Basic Photography
- Script Writing for A.V. Programmes
- Amateur Radio Operators Certificate of Proficiency

- Digital Techniques
- Introduction to Microprocessors
- Hobby Electronics
- Wiring and Assembly Methods
- Advanced Microprocessors
- Advanced Electronics
- Portable Electric Tools — Repair and Rewiring

## CERTIFICATE OF TECHNOLOGY COURSES

- Cartography
- Civil Design Drafting
- Electrical
- Electronics
- Mechanical Design Drafting
- Mechanical Engineering
- Structural Design Drafting
- Surveying
- Surveying Drafting

For further information contact Collingwood Technical College,  
35 Johnston Street, Collingwood, 3066. Phone (03) 419-6666.



## Some of AUSTRALIA'S LOWEST COMPONENT PRICES (Now Lower STILL!)

Note: Regular Prices not temporary specials — keep us in mind for that next order.



**POTS 40c**  
(LINEAR 1/4" ALUM. SHAFT)

Linear potentiometers rotary carbon 38c ea. 500 Ohm, 1K, 5K, 50K, 100K, 250K, 500K, 1M, 2M.

Quality Large red LEDs well diffused wide viewing angle. 15c each, \$1.40 per 10, \$110/K. Quality MOUNTING CLIPS 3c ea. ea. \$2.70/100

**LEDs**  
\$12 a 100  
15c each



Best value  
No brag  
Just fact



**TRIMPOTS 14c**  
\$12 a 100 (10mm)

Values: 100, 500 Ohm, 1K, 2K, 5K, 10K, 50K, 100K, 250K, 500K, 1M, 2M

Trade/govt./S.T. exempt: welcome. Send for special lists (e.g. \$29 a 100 pots and \$99 a 1000 LEDs plus tax if applicable. Small quantities also.

**TRADE ENTRANCE**

13c  
**BC 108**



METAL CAN TRANSISTOR  
**BC 107 BC 108**  
13c  
10 for \$1.20 100 for \$11  
Epoxy BC178, BC109 same price

1 Amp. DIODES  
50V 1N4001 - 6c  
100V 1N4002 - 7c  
400V 1N4004 - 8c  
1000V 1N4007 - 11c  
10% off 100 SAME

\$3 1/2 a 100 SIGNAL DIODE **IN4148**  
\$29 a 1000 4c each



**4c ELECTROS**  
(UPRIGHT)

(per 100 Cap.	prices in brackets		
	16V	25V	50V
0.47uF	4c(\$3 1/2)	5c(\$3 3/4)	6c(\$4)
1, 2.2, 3.3, 4.7, 10uF	5c(\$3 1/2)	6c(\$3 3/4)	7c(\$4)
22uF	6c(\$3 3/4)	7c(\$4)	8c(\$5)
33uF	8c(\$4)	9c(\$5)	10c(\$6)
47uF	9c(\$5)	10c(\$6)	11c(\$7)
100uF	10c(\$6)	12c(\$7)	14c(\$11)
220uF	12c(\$8)	16c(\$10)	35c(\$17)
470uF	16c(\$12)	22c(\$16)	45c(\$30)
1000uF	22c(\$18)	30c(\$25)	75c(\$50)



**4c POLYESTER**  
FILM CAPS  
E12 10% 100V

.001 - 4c	.01 - 5c	.1 - 10c
.0012 - 5c	.012 - 6c	.12 - 11c
.0015 - 5c	.015 - 6c	.15 - 12c
.0018 - 5c	.018 - 6c	.18 - 14c
.0022 - 5c	.022 - 6c	.22 - 15c
.0027 - 5c	.027 - 6c	.27 - 16c
.0033 - 5c	.033 - 7c	.33 - 18c
.0039 - 5c	.039 - 7c	.39 - 19c
.0047 - 5c	.047 - 7c	.47 - 20c
.0056 - 5c	.056 - 8c	
.0068 - 5c	.068 - 8c	All values
.0082 - 5c	.082 - 9c	in uF
		10% off 100 same uF

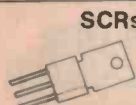

**SCRs**  
**C106Y1**  
40c  
**C122E**  
\$1.20

SCRs:  
0.8A 30V C103Y — 35  
0.8A 200V C103B — 60  
4A 30V C106Y1 — 40  
4A 400V C106D1 — 75  
8A 400V C122D — \$1.05  
8A 500V C122E — \$1.20

TRIACS:  
6A 400V SC141D — \$1.30  
10A 400V SC146D — \$1.50  
DIAC ST2 — 35  
Chart to identify leads — 10c  
Plus trigger info.

25 A 400V  
**SC260D** TRIAC  
**C37D** SCR  
EA. \$2.50



**RESISTORS 1/4 & 1/2 W**  
NEW STOCKS COMING AT MUCH LOWER PRICES.  
Keep a close eye on this area for arrival and new prices.

Keep electronics a hobby and not a luxury, compare our prices and buy from us. Same day turnaround! service (unless swamped). All goods top quality and new. No minimum order. One P/P charge of 45c regardless of quantity. Advert current 3 months for late readers

CONSISTANTLY  
LOW PRICES

**DIGGERMAN ELECTRONICS**

P.O. BOX 33, CORAMBA, N.S.W. 2466

CONSISTANTLY  
BETTER SERVICE

## RESISTORS

150 ohm, 5W	20c
10 ohm, 5W	20c
47 ohm, 5W	20c
12 ohm, 5W	20c
2.5 ohm, 3W	20c
33 ohm, 3W	20c
8 ohm, 10W	25c
4000 ohm, 10W	25c
100 ohm, 5W	20c
330 ohm, 10W	25c
220 ohm, 5W	20c
5 ohm, 5W	20c
220 ohm, 10W	25c
950 ohm, 3W	20c
115 ohm, 5W	20c
10 ohm, 5W	20c
1k ohm, 5W	20c
5000 ohm, 5W	20c
6.8k ohm, 3W	20c
330 ohm, 10W	25c
6800 ohm, 10W	25c
1500 ohm DUAL, 21W	50c
50 ohm, 5W	20c
330 ohm, 5W	20c
1k ohm, 5W	20c
820 ohm, 5W	20c
12 ohm, 10W	25c
470 ohm, 7W	20c
4700 ohm, 4.5W	20c
5000 ohm, 10W	25c

## ELECTROS

470uF, 25V	5 for \$1
400uF, 10V	5 for \$1
47uF, 63V	5 for \$1
350uF, 16V	2 for \$1
27uF, 160V	5 for \$1
25uF, 63V	10 for \$1
22uF, 160V	10 for \$1
47uF, 16V	5 for \$1
47uF, 200V	5 for \$1
2200uF, 10V	10 for \$1
68uF, 16V	10 for \$1
1000uF, 25V	5 for \$1

## CAPACITORS

0.0039uF, 1500V	20c ea.
6N8, 1500V	20c ea.
0.0068uF, 1500V	20c ea.
1200PF, 400V	10 for \$1
0.068uF, 400V	5 for \$1
2200PF, 630V	10 for \$1
0.47uF, 250V	10 for \$1
0.10uF, 400V	5 for \$1
0.082uF, 160V	10 for \$1
26k, 250V	10 for \$1
0.041uF, 400V	10 for \$1
0.033uF, 250V	5 for \$1
0.027uF, 100V	20 for \$1
220uF, 10V	10 for \$1

Power leads 240 volt, suit most tape recorders, radios, etc. \$1 each.

TV Stick Rectifiers 20SC, \$1.00.

Phillips Colour TV Convergence Boards, \$3 each.

455KC IF Transformers for valve radios, \$1 each. Also aerial and OSC coils, 75 cents each.

<b>Slide Pots</b>	
250K-50K	3 for \$1
Dual 500K	3 for \$1
1 Meg	3 for \$1
2 Meg	3 for \$1
Including Fancy Gold Knobs	

**SPECIAL**  
100 mixed resistors, all useful \$2.  
100 mixed capacitors, fresh stock \$2.

<b>AUDIO LEADS</b>	
3.5m to 3.5m, 7ft	.75c
3.5m to 6.5m, 7ft	.75c
6.5, 7ft	.50c

**MICRO SWITCH**  
5A, 250V AC .75c ea.

**TUNING CAPS**  
2 and 3 gang \$1 ea.  
Min 2 gang .50c

**FUSES**  
0.5A, 2A, 3.25 10 for \$1  
In line fuse holders .30c  
RCA jack plugs and sockets .40c pair

# L. E. CHAPMAN

122 PITT ROAD, NTH CURL CURL.  
MAIL ORDERS: BOX 156, DEE WHY, NSW. 2099.  
TELEPHONE 93-1848.

## SPECIAL TRANSISTORS

AD161-162	\$2.50 pair
2SC 901A	\$1.50 each
BC 548	10 for \$1
AC 187	.50c
BD 262	.50c
OC 955	.50c
OC 957	.50c
OC 2N1111	.25c
OC 944	.50c
OC 9304	.25c
OC 9524	.50c
C 106F1	.50c
OC 967	.50c
OC 968	.50c
C 10480 SANYO	.75c
2SA 246	.50c
2SC 1548	.75c
AT 350A	.50c
AT 473	.50c
2SB 77	.50c
2SB 186	.50c
2SB 303	.50c
2SB 407 SANYO	\$1.50
OC 9554	.50c
DELCO 2N174	\$3.00
DELCO DTS 105	\$2.00
2SB 405	.50c
BD 139	.50c
B 324	.50c
A 436	.50c
AT 324	.25c
AT 341	.25c
AT 322	.25c
2SA 101	.50c
2SB 186	.50c
AT 473	.50c
AD 149	\$3.00 pair
IS 309	.75c

## DIODES

OA 626	4 for \$1.00
OA 662	4 for \$1.00
EM 410C	4 for \$1.00
DS 150A	.50c
DSY 130YO	.50c
OA 636	.50c
HR 15	.50c

## POTS ROTARY

1/2 Meg	.30c
1 Meg	.30c
100K	.30c
100K Switch	.50c
50K Double Pole Switch	.50c
7.500	.30c
10K Switch	.50c
250K	.30c
50K	.30c
20K	.30c
10K Min Pots	.25c
50/Ohm	.50c
1/2 or 1 Meg Switch	.50c

## SPEAKER SPECIALS

6 x 9	\$6.00
7 x 5	\$4.50
5 inch 3.5/ohm	\$3.50
5 x 3	\$1.50
2 1/2 inch	\$1.50
2 1/2 inch	2 for \$1.00
6 x 9 27/ohm	\$6.00
6 x 9 47/ohm	\$6.00

## PILOT LIGHTS

Screw in 6.3V	10 for \$10.50
12V	10 for \$1.00
24V	10 for \$1.00

- Car radio suppressors, 3 for \$1
- 3 position slide switch, 50c
- Toggle switches, 25c
- 2 position push button switch, 50c
- 6 position push button switch, \$1
- 4 position push button switch, 75c
- Transistor ear plugs & leads, 3 for \$1
- In-line fuse holders, 4 for \$1
- 4 pole 2 position rotary switches, 50c

**Special:** 100 mixed capacitors, fresh stock, all useful. \$2.00

- Telescopic aerials, \$1.50
- Top quality, low impedance microphones, \$3.50
- 6 Inch ferrite rods, 75c
- Rainbow lead, 5 strand, 20c per metre
- Line output transformers, 600 ohm, to 15 ohm, 20 watts, \$5
- Line output transformers, 1200 to 3/ohm, 5 watt, \$1
- Power supply units, filtered, 240 to 20 volt, \$12
- 240 to 15 volt transformers, \$3.50.

## POWER TRANSFORMERS

240V pri; two x 25V, 117V & 6.3V sec. windings, \$7. P&P NSW \$1.50, Interstate \$2.50.



## EX-LAB AUDIO OUTPUT METERS

3 scale, \$15.00

## SUPER SPECIAL



BSR RECORD CHANGER, cueing device, 11 inch turntable, brand new. \$35. P&P: NSW \$2.50, Interstate \$3.50, WA \$4.50.

## 24V MOTORS

Reversible

Only \$2.50 ea.



## SPEAKER SYSTEMS



Inc. two 5 x 3 speakers, 5W RMS, \$7 ea. P&P NSW \$1.50, Interstate \$2.50 (For singles or pairs).

## TV TUNER VALVE TYPE

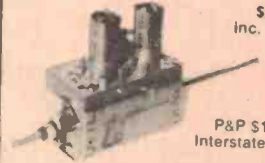

\$2.50  
Inc. valves.

P&P \$1.00  
Interstate \$2.50

## SUPER SPECIALS

### FM STEREO TUNER KITS

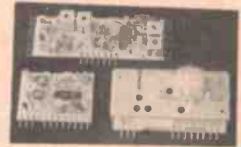

Sets of 3 modules include FM tuner, decoder and IF detector. Circuit diagram supplied. Can be used with amp modules.

ONLY \$18.00  
P&P \$1.00

## VU & BALANCE METERS



STEREO VU \$3.00



12Kn 100uA \$2.00

## PHILIPS TV TUNERS

Transistor NT3024, NT3030, NT3032, Colour — P&P \$1.



\$10 ea.



Dear Sir

I refer to your note headed "Are Scanners Legal?" in November ETI.

The problem is basically a constitutional one. The Commonwealth Parliament has power to make laws about "telegraphic, telephonic and other like services". The key word is "services"; there is no power to make laws about communications unless a service is involved. A power to make laws about bus services would not authorise a law about buses generally, i.e. one that extended to buses not engaged in a service.

Thus, people who use electrical means of communication for their own purposes, without providing a service, are outside Commonwealth power. A telephone, whether wired or wireless, installed within one's own home, does not involve a service and is outside the power of the Commonwealth.

There is no magic in the use of "wireless" instead of "wired": the constitution makes no such distinction.

The foregoing deals with the problem generally. There are other points too detailed to go into in a short letter.

By the way, it follows from the above that a person using a "wireless" purely for experimental purposes is not providing a service and is outside power.

The trouble is that the Wireless Telegraphy Act, 1905, copied identically the English Act, where constitutional problems of this kind don't exist.

(Name and address supplied, but withheld by request. The author is a practicing barrister.)

Dear Sir

I have been using Ampex tapes for a few years and have found the quality of tape and of reproduction to be excellent. I previously used the Ampex Plus Series in my cassette decks but have since moved on to the relatively new Ampex Grand Master Series in cassette format.

My reason for changing tapes (so to speak) was that I have always used the Grand Master tapes on my open reel tape deck. It is a Teac 10½ inch compatible machine that accepts the Grand Master tapes beautifully. To be quite honest, I wouldn't use any other brand of tape as I have been told many times, and also found out for myself, that they are the best currently available.

When I received the November issue of ETI and read of your tape offer I automatically jumped at the idea of taking full advantage of the offer in question. I find Ampex tapes quite useful in the seven inch reel format,

# LETTERS

for the sound effect collection that I am currently establishing.

Anyway, I would like to thank you very much for making this tape offer available.

Ivan Roberts  
Mt Kurring-gai  
NSW

Dear ETI

Since the tender age of seven I have had the pleasurable misfortune of being an avid, but alas entranced, patron of the humble pinball parlour. After ten years of monetary sacrifice to the demogorgon (namely pinball machines), I am elated to discover that the microprocessor has found its way to my "Machineries of Joy".

Would you be so kind as to elaborate upon the hardware employed, i.e. memory, chips and so on? More specifically, as I have single handedly financed the proliferation of "Space Invaders", it would be more than gratifying to know how to "tamper" with them (purely theoretically of course), incitement laws pending.

David Goldfayl  
Canterbury  
Vic

*Electronic games technology — hmm, sounds interesting. No promises, but we'll look into it and see what pops up.*

Dear Sir

As of late I have become an ardent reader of your magazine. I enjoy the modern format, which leaves your competitors for dead, and the choice of articles, especially technical articles explaining the basics of electronics.

One point I find annoying is that you don't state an approximate price for your projects, as we on strict budgets have to plan what we can spend (I have a car and music system to support!).

If you could include a rough estimate of the price for each project it would help, especially in comparison with other similar projects.

One final request: I know you've probably had numerous requests for these projects, but would it be possible to design projects on:

(a) an oscilloscope which has medium to high performance, and

(b) a multichannel (say six), radio control transmitter and receiver which would be used in model aeroplanes and boats.

I know you may encounter problems with these, but these are the two most wanted projects I wish to construct, and the numerous plans I have seen don't really come up to scratch.

In closing, I would like to say that I really enjoy your magazine, and will continue to do so for some time.

Brad Hopkins

*Thanks for the encouragement! Sorry about the lack of approximate price on projects, though. It is something we have closely considered for some time. Whilst we agree that it would help greatly in budgeting, at the same time it may be misleading. For example, with a project we ran last year, and it is still current, price ranges between about \$17 minimum and \$26 maximum amongst the various suppliers listing the kit. The variation exceeds 50%! Our estimate at the time placed it at around \$25, perhaps as low as about \$20 from competitive suppliers. What actually happened was a completely different story! Certainly, with quite a few projects our estimates would not be too far wrong. We've tested it on occasion and come reasonably close.*

*The big problem is that some suppliers can buy components at very advantageous prices and undercut our estimate by a large factor. Then again, if we do not anticipate a price variation, our estimate may be grossly low. Either way, suppliers and readers would be 'down' on us — and justifiably so.*

*As we have received many letters like this recently it seems a moot time to grasp the nettle, bite the bullet, put the nose to the grindstone . . . and suck it and seal! Starting next month.*

*With regard to the projects, an oscilloscope is fraught with difficulties and expensive for the home constructor and is not something we've seriously considered for these reasons. We described an eight channel radio control system back in the July to October, 1976 issues (ETI-711) which could be used on model boats — or a large model plane. We might look at that topic again, though.*

# RADIO DESPATCH SERVICE

869 George Street,  
Sydney, NSW. 2000.  
(Near Harris Street)  
Phone 211-0816, 211-0191.

## FOR THE 1980's

REMEMBER, we can supply all the electronic parts that other stores are too tired to stock.

### We specialise in:

- PC boards for ETI and EA projects.
- Scotchcal labels made under order for ETI and EA projects 1979 and onwards.
- Edge Connectors — .1" and .15" up to 85 way, single or double, solder lug or wire wrap.
- Canon Plugs and Sockets — see us before you order elsewhere.
- A full range of Transistors and IC's — if we cannot supply them then they are hard to get.

### TEXAS INSTRUMENTS

TI 59 Calculator.....	\$247.00 plus s/tax.		
TI PC100 Printer.....	\$213.57 plus s/tax.		
	<b>Excl.</b>	<b>Incl.</b>	
	<b>S/tax</b>	<b>S/tax</b>	
TI-30 Student Pack.....	20.00	22.10	
TI-58C.....	109.00	120.70	
TI-5025.....	73.85	81.76	
Little Professor.....	15.00	16.57	
Data Man.....	25.65	27.90	

● Logic Probes ● Leader Oscilloscopes and Signal Generators ● Soar and Fluke DVM's ● University Meters and Multimeters ● Weller Soldering Stations ● Scope and Adcola Irons ● The famous Jostykits ● For boxes and cases — Horwood, Jiffy and Die Cast ● Distributors for Xcelite Tools.

### WRITE TO US FOR SPECIAL PRICES

#### MAIL ORDER CUSTOMERS

\$1.00 packing plus 5 percent of order value up to \$80.00, thence a flat \$4.00 for postal items. Carrier — freight on.

**OPEN: Mon-Fri 8am to 5.30pm.  
Thursday night late shopping till  
8.30pm. Saturday 8am to 11.45am.**

# LOOKY VIDEO

### OSI (OHIO) COMPUTERS

SUPERBOARD 11.....4K \$360, 8K \$425  
CHALLENGER 1P.....4K \$449, 8K \$514  
Expansion Boards, Expansion Kits, Power Supplies & Kits.

**PET**  
Sound Interfaces — \$29, Educational Programmes, Dust Covers.

**TRS-80**  
Library 100 — \$72, Business Programmes, Trendcom Printers — \$443, Interfaces; Pet, Apple II, Sorcerer, TRS-80, etc., Video Recorders; Video Portapacks, Video U-Matic & Open Reel, Recorders & Tapes.

Games: Machine Language 4K

G.1. Chess.....\$19.95

Games: Basic Language 8K

G.2. Backgammon.....\$15.95

G.3. Super Doodler.....\$7.95

G.4. Blackjack.....\$9.95

Games: Basic Language 4K

G.5. Ten Tank Blitz.....\$9.95

G.6. Star Fighter.....\$7.95

G.7. Seawolf.....\$7.95

G.8. Tank for Two.....\$7.95

G.9. Fighter Pilot.....\$7.95

G.10. Killerbot.....\$7.95

G.11. Barrier Ball.....\$7.95

G.12. Battle Fleet.....\$7.95

G.13. Slash Ball.....\$7.95

G.14. Break Thru.....\$7.95

G.15. Bomber.....\$7.95

G.16. Awarl.....\$7.95

G.17. Robotank.....\$7.95

G.18. Lunar Lander.....\$6.95

G.19. Tankkanna.....\$6.95

G.20. Gobbler.....\$6.95

G.21. Bowling.....\$5.95

G.22. Teen Age Driver.....\$6.95

G.23. Battle Ground.....\$6.95

Education: Basic Language 4K

E.1. Math Practice.....\$6.95

E.2. Master Mind/Gieep.....\$6.95

E.3. Master Mind II.....\$6.95

E.4. Concentration.....\$6.95

E.5. Biorhythm.....\$5.95

Utility: Basic Language 4K

U.1. Line Renumberer.....\$6.95

U.2. Variable Table Maker.....\$6.95

U.3. Search.....\$6.95

U.4. Branch Finder.....\$5.00

U.5. Super Utilities Pack.....\$19.95

U.7. Poker Routine Maker.....\$5.95

U.8. Cursor Control.....\$5.95

U.9. Flashboard — Merry Xmas.....\$5.95

Utility: Machine Language 4K

U.6. Auto Loader.....\$7.95

Utility: Basic Language 6K

U.10. Disassembler.....\$7.95

Instructions:

I.1. Graphics Instructions.....\$4.95

I.2. How to read a line of microsoft.....\$1.95

I.3. 600 Baud/Printer Interface.....\$1.95

I.4. Joy Stick Instructions.....\$3.95

I.5. RS — 232 Conversion.....\$4.95

I.6. OSI ROM Basic.....\$9.95

I.7. How to Write Professional Programs.....\$1.95

I.8. Disassembled ROM Listing.....\$9.95

I.9. Tokens & Basic Storage.....\$2.95

W.P. 6502 — Word Processor.....\$99

Also Business Programmes.....\$14.95

Monitor/T.V.'s Switchball from.....\$129

Second-hand  
recorders and  
video tapes — cheap  
TV Games —  
Programmable.

MAIL ORDER:  
LOOKY VIDEO,  
PO Box 347,  
Richmond, Vic. 3121.  
Allow postage,  
eg OSI Software  
1 or 2 \$1; 3-5 \$1.50,  
6-10 \$2; 10 or  
more \$2.50.

**LOOKY VIDEO**  
418 Bridge Road, Richmond.  
Phone (03) 429-5674

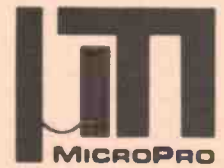

## PROFESSIONAL QUALITY SOFTWARE

from

### MICROPRO INTERNATIONAL CORPORATION

**WORD=STAR™**

Complete, totally  
integrated word  
processing software

### WORD-MASTER®

The last word in  
text editing

### SUPER-SORT®

The ultimate in high  
performance sort/merge

RUN UNDER CP/M ON ANY  
8080/8085/Z80 SYSTEM  
USING ANY PRINTER AND  
VDU OF YOUR CHOICE

**02-412 2409**

BOX 155, P.O.  
ROSEVILLE 2069

© 1978, MicroPro International Corporation.

All rights reserved.

YOU SEE US FIRST!

WE ARE THE HEART OF ELECTRONICS IN AUSTRALIA

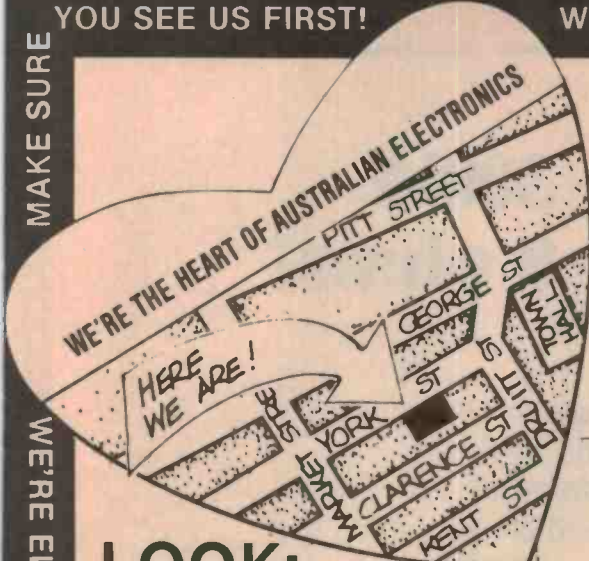

# SENSIBLY PRICED COMMUNICATION

Ralmar Intercoms Now In Stock

- 2 way system only \$14.35
- 3 way system only \$25.50
- 4 way system only \$35.00



## The Complete Electronic Tool Kit

WELLER-XCELITE — JUST \$48.95

Here's great value — contains SPI-25D soldering iron and 2 extra tips, soldering aid tool, rosin core solder, long nose plier, diagonal cutter, wire stripper, nutdriver, slotted screwdriver, No. 1 Phillips head screwdriver.

**LOOK: off the shelf!**

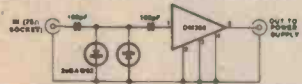

OM 350 Hybrid I.C. as used in August E.A. at \$11.30. PLUS we also have the 79 M8 PC Board for this project.

**BE QUICK!**

Don't miss out — only while stocks last.

**FLUKE 8022A LCD MULTIMETER**

\$165.60 includes tax



## DO IT YOURSELF . . . Copper Laminate



**PAPER PHENOLIC**  
152 x 76mm 50c  
305 x 152mm \$1.60

**EPOXY GLASS**  
152 x 127mm \$1.75  
305 x 127mm \$3.25

**FERRIC CHLORIDE PELLETS**  
An etching solution only \$3.95 565g jar

**Personal Shoppers Only:**  
625 x 625mm \$9.75  
625 x 450mm \$17.75

We are stockists of Sound Barrier Hi-Fi Car Stereo — eg Model F104 \$129.50

## SUPER PRICES Low Profile IC Sockets

ULJ063N 6 pin low profile DIL 20c	SI-2443 24 pin low profile DIL 60c
ULJ083N 8 pin low profile DIL 20c	SI-2444 28 pin low profile DIL 70c
SI-2441 14 pin low profile DIL 25c	SI-2445 40 pin low profile DIL 80c
SI-2442 16 pin low profile DIL 30c	

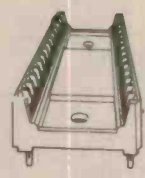

## SEE US FIRST! For Soldering Equipment



250g, 20 or 22 gauge \$5.25

We have a full range of accessories.



\$8.75

**Look: Zenor Diodes**  
Special savings on our comprehensive range.

.5 Watt	volts	1 Watt	volts
BZXB3C-3V0	3	IS3009A	6.1
BZXB3C-3V2	3.3	IS3007A	6.8
BZXB3C-3V6	3.6	IS3008A	6.2
BZXB3C-4V7	4.7	IS3009A	8.1
BZXB3C-5V1	5.1	IS3010A	10
BZXB3C-5V6	5.6	IS3012A	12
BZXB3C-6V2	6.2	IS3015A	15
BZXB3C-6V8	6.8	IS3016A	18
BZXB3C-7V5	7.5	IS3020A	20
BZXB3C-8V1	8.2	IS3024A	24
BZXB3C-9V1	9.1	IS3027A	27
BZXB3C-10	10	IS3030A	30
BZXB3C-12	12	IS3033A	33
BZXB3C-13	13	IS3036A	36
BZXB3C-15	15	IS3039A	39
BZXB3C-16	16	IS3047A	47
BZXB3C-18	18	IS3051A	51
BZXB3C-20	20	IS3058A	58
BZXB3C-22	22	IS3062A	62
BZXB3C-24	24	IS3068A	68
BZXB3C-27	27	IS3075A	75
BZXB3C-30	30	IS3100A	100
BZXB3C-33	33	IS3150A	150
BZXB3C-37	37	IS3180A	180
BZXB3C-47	47	IS3200A	200

All 5W only 25c ea.  
All 1W only 75c ea.

## In Stock Again

**\$110.40**  
PS 384 5amp Regulated Power Supply



A fixed voltage electronically regulated power supply ideally suited for two-way radio and security systems having 12V DC supply requirements.

NDTE: We have a wide range of supplies to suit nearly every application. Nosey on in and see 'em soon!

## February Special: DON'T MISS OUT!

Instrument cabinets ideal for instrument cases, power supplies or bench test instruments

- IC1 norm \$4.95
- Feb only \$3.95
- IC2 norm \$14.50
- Feb only \$10.50



## SOLDER SUCKER

A must for IC's!

Ideal Brand — Great buying at \$13.20



## STRIKE IT RICH!

We have a wide range of renowned Bounty Hunter metal detectors. Now you can get out prospecting for gold or treasure. Our models range from the inexpensive for those making a start, to professional models for big paydirt — eg Model 840



\$269.00



# DAVID REID ELECTRONICS PTY LTD

P.O. Box Q103 Sydney 2000  
127 York St Sydney Phone 296601

WE TAKE **BANKCARD**



WE HAVE YOUR GOODIES — COME ON IN TODAY — DON'T MISS CALLING IN ON US

MAKE SURE YOU SEE US FIRST! — WE'RE ELECTRONICS IN SYDNEY — MAKE SURE YOU SEE US FIRST! — DON'T MISS CALLING

WE ARE THE HEART OF ELECTRONICS IN AUSTRALIA — MAKE SURE YOU SEE US FIRST! — WE'RE ELECTRONICS

# 'The Brute' — develops 300W into 4 ohms, 200W into 8 ohms!

**Barry Wilkinson**

For many audio applications there's no substitute for sheer power — low efficiency speakers, outdoor sound systems, or maybe you like the full flavour of the dynamic range afforded by a high power amp. Whatever your requirement — this 'super power' module should fill the bill.

**START HERE**

**Do not pass 'go', do not spend \$200**

THIS IS a relatively expensive project, compared to our previous amplifier modules, the ETI-480 and the more recent ETI-470. It is not recommended for beginners or inexperienced constructors. Although we have included protection for the output devices in the design it is obviously impossible to protect against circumstances which we cannot foresee. Follow the assembly and advice given in this article — especially regarding heatsinks and power supplies etc, and you'll be well assured of success. We must *stress* that any deviation from this design, other than the variations suggested, you do at your own risk.

If this is your first experience with such high power don't be embarrassed to follow the instructions slavishly until you are familiar with the unit and the get 'feel' of the technology. Check *everything* as failures can be disastrous, not to mention spectacular, if something goes wrong.

If we haven't put you off by this stage — read on!

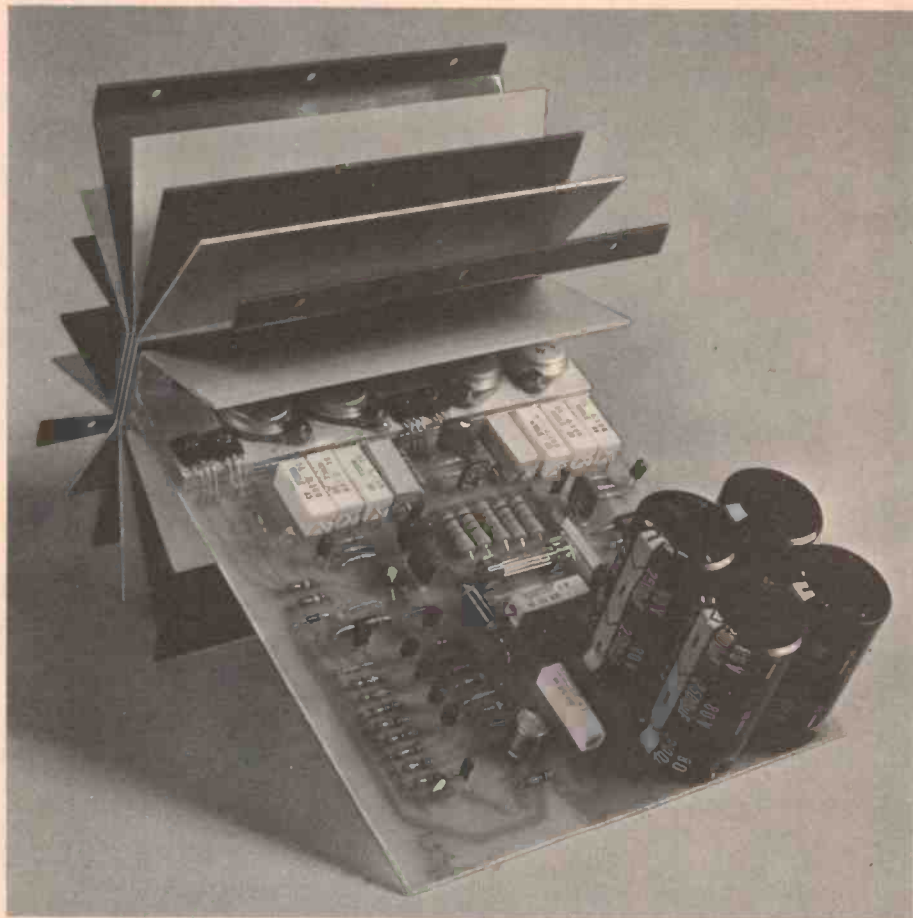

**SPECIFICATIONS — ETI 466**

**Power output**  
8 ohm load  
4 ohm load

200 watts RMS  
310 watts RMS

**Frequency response**  
20 Hz to 20 kHz

+/- 0.5 dB

**Hum and noise**  
re 200 W into 8 ohm

- 105 dB

**Input sensitivity**  
8 ohm load  
4 ohm load

1 V for 200 W output  
1 V for 300 W output

**Total harmonic distortion**

see graph

**Damping factor**  
20 Hz - 3 kHz

65

5 kHz  
10 kHz  
20 kHz

55  
45  
35

# 300 watt amplifier

HI-FI AMPLIFIERS are becoming more and more powerful, and with good reason. Modern recordings, especially direct cut discs, have a useful dynamic range approaching 40 dB between the quieter musical passages and the peaks of the crescendos. If the quieter passages are played at a power output of 100 mW, which is not untypical in a domestic environment, to faithfully reproduce the full recorded dynamic range of a good record without clipping the peaks would require an amplifier capable of delivering 1000 watts! This, coupled with the current trend amongst some manufacturers to build speakers having quite low efficiency, plus the number of people who like their music loud (and undistorted) makes the case for high power amplifiers very strong indeed.

Past amplifier projects have generally been limited to output powers of 50 watts or so. Designed around cheap, readily available transistors, they have proved very popular. We have done the occasional 100 watt amplifier and once described a 'bridge' amplifier capable of delivering 200 watts into an eight ohm load, rather than design an amplifier using expensive, hard to get transistors for that power level.

To gain a worthwhile improvement in subjective performance over an amplifier of 50 watts output, we must go for a four times increase at least, to 200 watts, as the ear has a logarithmic response, and anything less is barely noticeable. That might be stating the case a little simply, but it conveys the general idea.

Over the past six or seven years we've had many requests for a high power amplifier, but for the reasons stated previously, we have decided against it. It would have been possible to design a unit using a large number of readily available power transistors in the output — in fact, one design we have seen used a total of 24 devices in the output stage! Difficulties for the home constructor in this approach are obvious, regardless of expense.

For various reasons, a bridge amplifier was ruled out when the design of this amplifier was considered. Hence, a plentiful source of suitable output transistors was first sought.

There are really not too many transistors available that meet the requirements. Firstly, adequate safe operating area (SOAR) is of prime importance. Next, and probably of equal importance, is availability. Let's have a look at the SOAR problem first. Some high power transistors don't compare too well with the ubiquitous 2N3055

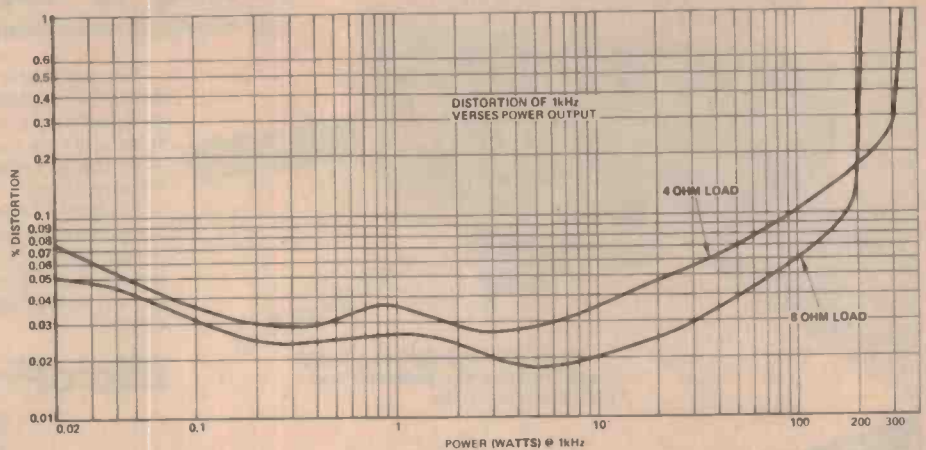

Total harmonic distortion versus power output at 1 kHz. The 'bump' at around 1 W is due to the output stage changing from Class A operation to Class AB operation.

(and its complement, the MJ2955) when operated as an amplifier. Take a look at the set of curves plotted on the accompanying diagram. This compares the safe operating area curves of a number of power transistors. Operation of any power device must be confined to the area inside the device's curve at worst case. If the current/voltage operating point is allowed to fall outside the area of the SOAR curve during any part of the operating cycle for the device, it will be destroyed — with amazing rapidity. Now, the 2N3773 and MJ802 transistors have been around for some time and at first glance would seem good choices for a high power amp, but note that their SOAR characteristics are not much better than the 2N3055. In fact, at 40 V (Vcc) the MJ802 is actually worse. In contrast, the MJ15003 is quite a long way outside the curve for the 2N3055 and therefore has a much higher power rating when used in an amplifier. Hence, the MJ15003 and its complement — the MJ15004, were chosen as the output devices for this design. Secondly, these transistors are widely used in industrial applications and are available from a number of sources, thus they meet the availability requirement. See Shoparound on page 93 for more information.

Another problem that arises with a design such as this is protection for the output devices. Amplifiers using transistors such as the 2N3055/MJ2955 can easily be protected with a fuse. In high power amplifiers where supply rails of 60 – 70 volts are necessary, the energy available (from the filter capacitors) will easily destroy the transistor and the fuse — in that order. The answer is to use electronic current limiting in the output. This adds complexity, but is cheap insurance against accidental (or deliberate!) abuse. The curve showing the limiting effect on the SOAR charac-

teristics of the MJ15003 for the protection network used in this amplifier is shown on the diagram with the other SOAR curves.

The main cost of the amplifier is in the output stage, transformer and heat-sink. We therefore decided to go to a slightly more complex input stage to improve the performance. This type of amplifier usually uses a Class A driver which introduces second harmonic distortion. By using a complementary-differential input circuit we have been able to eliminate the Class A driver and therefore kept the second harmonic distortion very low indeed. The distortion curve shows the distortion is well under 0.1% until almost full power output. The 'bump' in the curve around one watt is the point where the output stage changes from Class A (peak output being less than the bias current) to Class AB operation.

Comparison between the Safe Operating Area characteristics of a variety of transistors, including the MJ15003 used in the output stage of this amplifier.

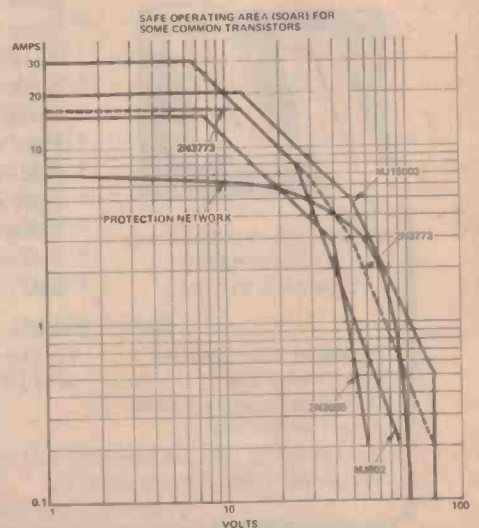



# Micro Con ... the easily applied and economical microcomputer for people with imagination

Do useful and interesting things with your computer. MicroCon makes it possible and not just because it is easily programmed and operated. A host of optional plug-in interfaces are available which let you 'talk' to the real world. Virtually no knowledge of computers or electronics is required for you to put MicroCon to effective use.

Existing Interfaces allow you to monitor variable inputs like temperature, humidity and position. Also they let you control motor speed, or switch lights and solenoids. Maybe you already have a computer system. If so, then MicroCon could act as an intelligent controller taking commands from your computer.

Tell us your interest and we will send you our free brochure and relevant information.

## MicroPro Design Pty.Ltd.

PO Box 153, North Sydney, NSW 2060.

Phone: (02) 438-1220

Dealer enquiries welcome.

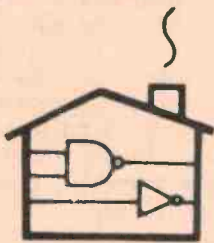

PERSONAL & DOMESTIC COMPUTERS, PARTS & ACCESSORIES

386 QUEENS PARADE FITZROY NORTH Victoria 3068 Tel:(03)481 1975

# Cottage Computers

a division of Embryonic Systems Pty. Ltd.

**3M**  
**Central Data**  
**NPC**

Now in stock: Clare C70/MGP ASCII Keyboards

RAYDATA 2KD2 Addon Memory for 6800D2

D2C1 Game Cassettefor 6800D2

GREENCORP C10 Computer Cassettes

Ring or call in for our BLUE STAR Specials

We are an INDEPENDENT Computer Shop and want your custom to remain so....

Science of Cambridge



**microtrix**



Microprocessor Systems,  
Development,  
Sales & Servicing.

## SBC100 SINGLE BOARD COMPUTER

- \* Fully self contained microprocessor system
- \* Based on the powerful Z-80
- \* 1K RAM
- \* Sockets for 8K or 16K PROM
- \* Serial port - synchronous or asynchronous
- \* Parallel input & output port
- \* RS232 and 20mA interfaces
- \* Four channel counter/timer with vectored interrupt
- \* Software programmable baud rate
- \* Power-on jump
- \* S100 bus, plus many more features

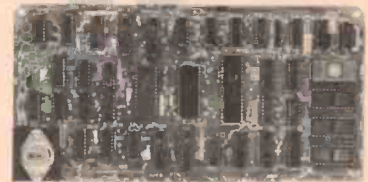

Excellent value at \$260 kit,  
\$325 assembled & tested.

### Also Available.

Versafloppy Disc Controller	\$175 kit	\$230 built & tested
Video Display Board	\$319 kit	\$390 built & tested
CP/M Disc Operating System		\$125 built & tested
Monitor for SBC100		\$ 50

Prices plus 15% sales tax where applicable and postage (\$5 max).  
Send for more details on any product.

### RS232 to 20mA CONVERTER

Allows any two pieces of computer equipment with differing interface requirements to be connected together. Built in an attractive, hard wearing ABS plastic case, it has 3 DB25 connectors, one being a switchable RS232 printer output. LEDs indicate data transfer information. Designed and built by MICROTRIX. Trade enquiries welcome.

\$135 built & tested.

MICROTRIX PO Box 29 Essendon, 3040 or Lot 4 Bingley Ave, Hurstbridge, 3099. AH (03) 718 2581.

what Australia needs in electronics

# SOANAR PROVIDES

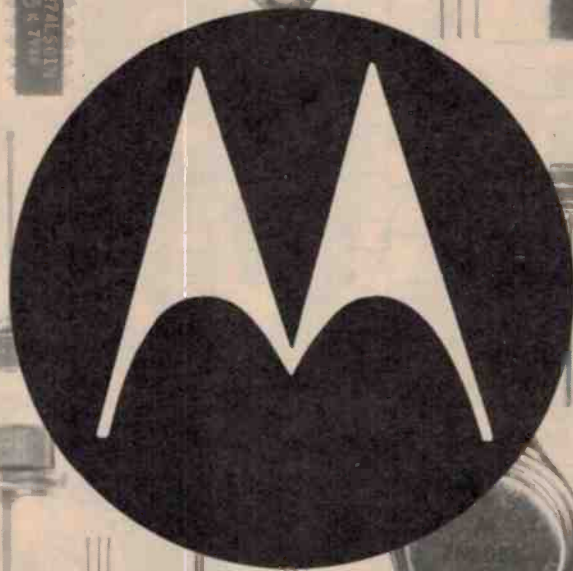

Motorola semiconductors

**SOANAR**

**SOANAR ELECTRONICS PTY. LTD.**

A MEMBER OF THE A+R-SOANAR ELECTRONICS GROUP  
30 Lexton Road, Box Hill, Vic., 3128, Australia. ☎890 661

VICTORIA: 89 0661  
N.S.W: 789 6733  
Sth. AUST: 51 6981  
QUEENSLAND: 52 5421  
WEST. AUST: 3819522

# Project 466

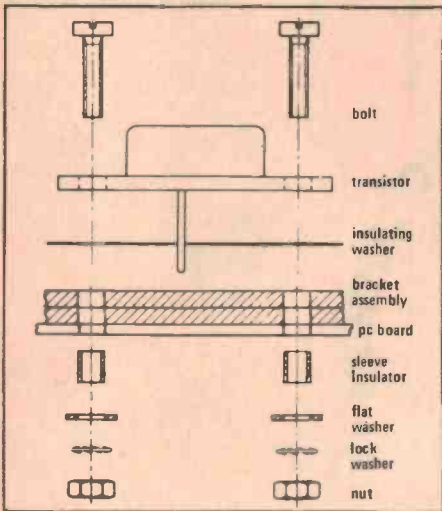

Exploded view of how the TO3 output transistors are assembled to the angle brackets and pc board.

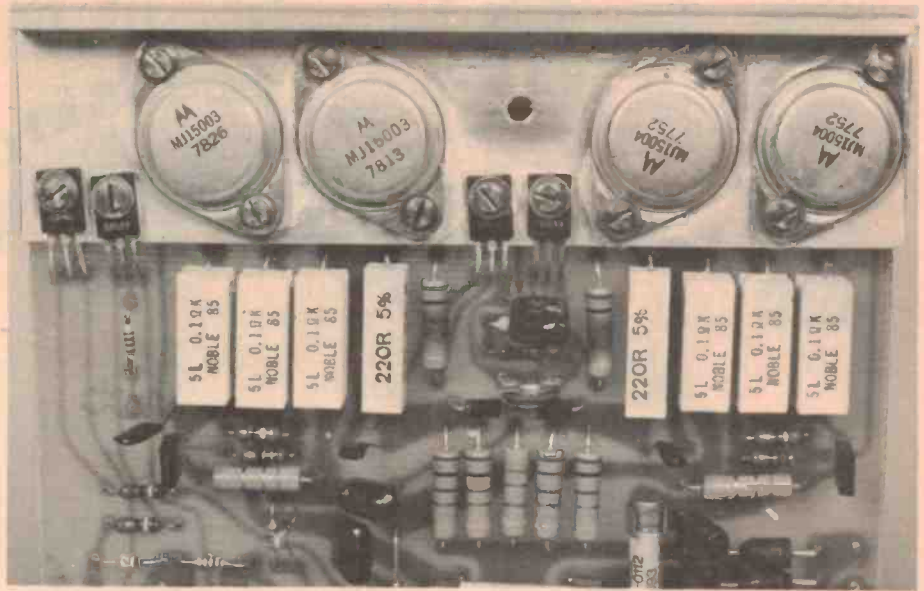

Photograph of the completed output stage, prior to mounting to the heatsink assembly.

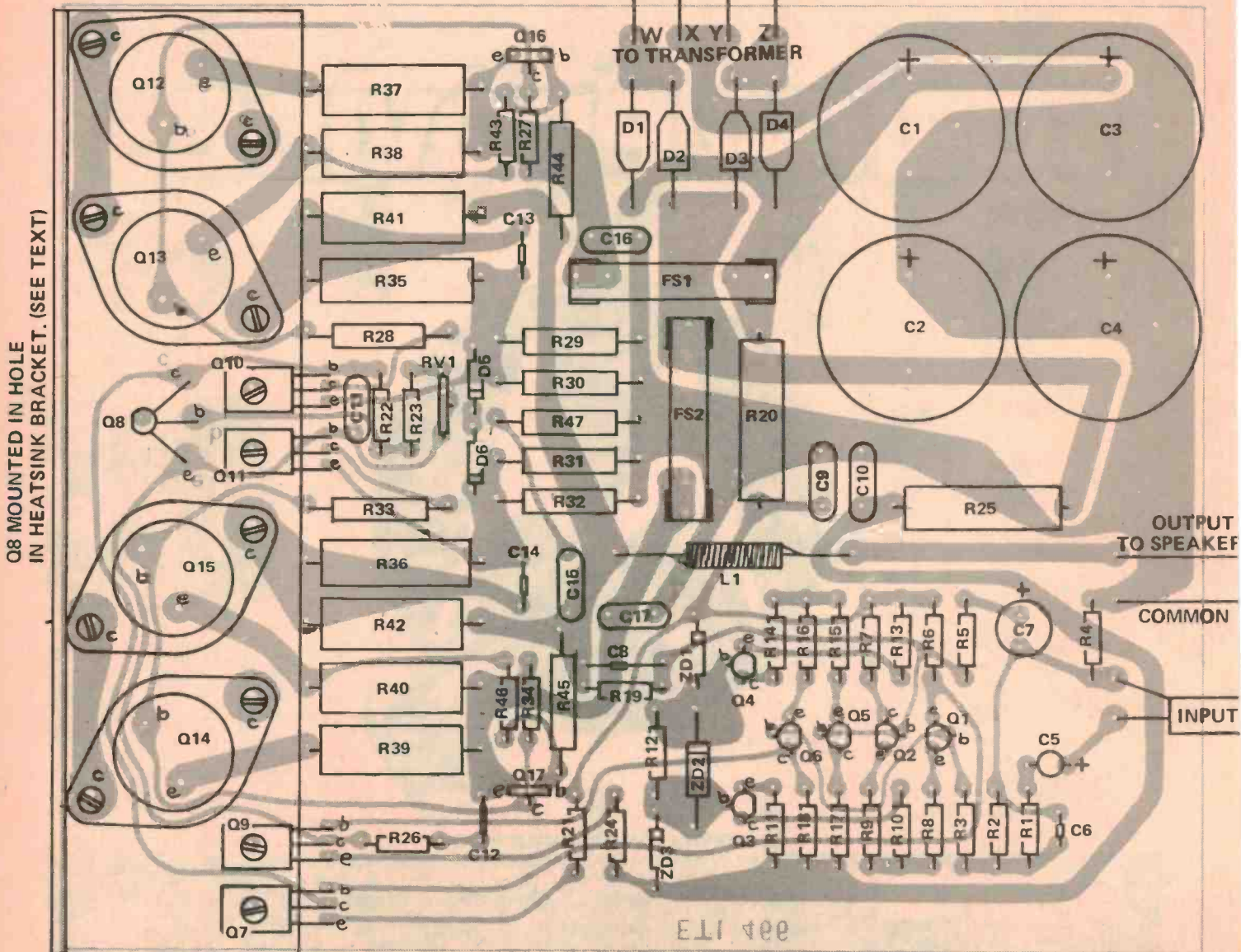



# 300 watt amplifier

The complete amplifier, including the power supply components and output transistors, is assembled on a single pc board. An aluminium bracket holds the output transistors conducting heat from the output stage to the heatsink. Only three sets of external connections are made to the pc board; input, output and power supply ac input from the transformer.

Start the construction by making the aluminium bracket shown on page 53. We used two lengths of 3 mm angle which may be purchased from Alcan Handyman stores. This bracket is 3 mm thick and two must be placed back to back to make the required 6 mm thickness for adequate thermal conduction to the heatsink assembly. If you elect to use a Philips 65D6CB heatsink (see the box on 'Heatsinks'), a single 6 mm thick angle extrusion can be used, fixed to the flat side of this heatsink.

The easiest way to make the bracket assembly and ensure correct alignment of all the holes is to cut the two lengths of angle somewhat longer than necessary. The extra length will be cut off later. Clamp the two pieces back to back and drill a small hole at each end so that they can be clamped together with nuts and bolts through this excess. This allows you to shift the bracket assembly in a vice or what have you without getting them out of alignment. Next, mark out the position of the transistor holes (use the pc board as a guide if you have it to hand already) on the broad side of one bracket and then the holes in the narrow side — the latter secure the bracket assembly to the heatsink. Use a scribe or other sharp-pointed instrument. Then drill the holes.

The hole for the thermal feedback transistor (Q8) must be a neat fit. The best way to accomplish this is to drill a slightly smaller hole and carefully enlarge it with the correct size drill. A reamer gives a conical hole and is not really suitable. Those holes marked 'C' on the bracket drawings can be tapped to take a 4 BA bolt if you plan on using the sheet metal heatsink described later.

Once you have drilled all the holes in the bracket assembly, cut off the excess at each end and file the edges smooth. Also, ensure that no 'burrs' are left on the lips of each hole. Chamfer then with a large drill held in your hand.

The next step is to make the heatsink assembly — that is, if you're not using one of the commercially-made alternatives suggested.

If you have access to a sheet metal

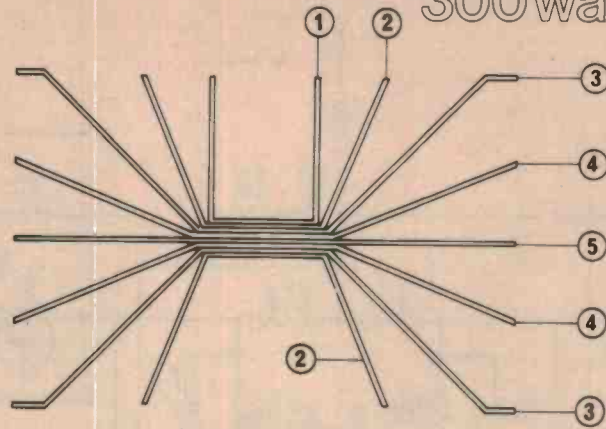

Dimensions and bending details for the sheet metal heatsink assembly we used.

MATERIAL 1.6mm ALUMINIUM  
FINISH BLACK ANODISED  
ALL DIMENSIONS IN MILLIMETRES

ITEMS					
	1	2	3	4	5
A	58	65	95	80	75
B	15	17	19	21	—
C	90°	87.5°	45°	22.5°	0°
D	0°	0°	45°	0°	0°

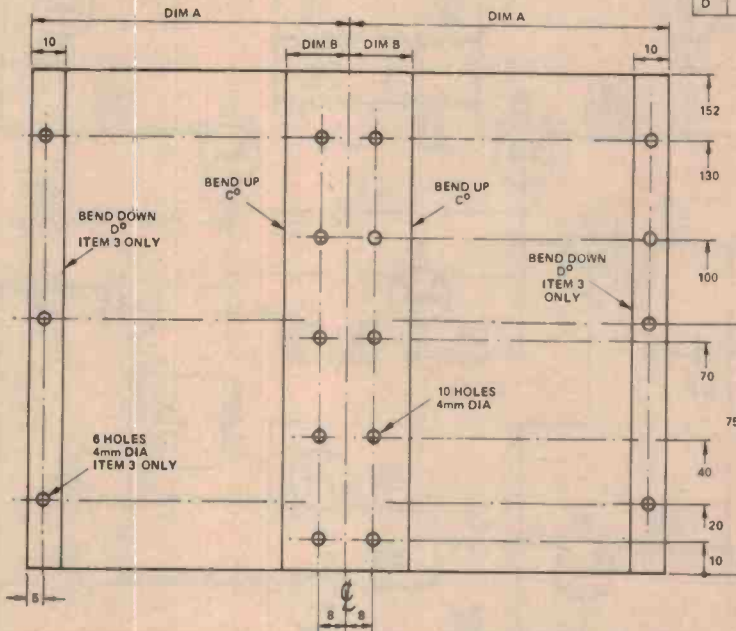

## HEATSINKS

There are several alternatives you can choose from for heatsinking the amplifier output stage. The heatsink described, and shown in the front cover photograph, was made from sheet aluminium and has a thermal rating of 0.55°C/watt. This is the rating we recommend for any heatsink if the amplifier is to drive a four ohm load, particularly for pop group use. If it is driving an eight ohm load in typical domestic use, half the fins may be left out (every second one — the yellow ones!) resulting in a thermal rating for this heatsink arrangement of 0.75°C/watt.

The nearest equivalent in a commercially-made heatsink is a 140 mm length of Redpoint R type — which nobody (to our knowledge) has had the foresight to stock in this

country. Tch, tch.

The Philips 65D6CB heatsink has a rating of 0.65°C/watt and would be suitable for this amplifier in most applications, except for a pop group with four ohm loudspeakers, unless fan cooling is added.

A heatsink with about 1°C/watt rating and substantial fan cooling is another alternative.

Remember that dissipation in the heatsink will be about 200 watts at full power output. That means a temperature rise of 110°C above ambient if the amplifier is run continuously. Poached eggs anyone? Temperature rise with music or intermittent use is considerably less, of course, as average power dissipated is much lower.

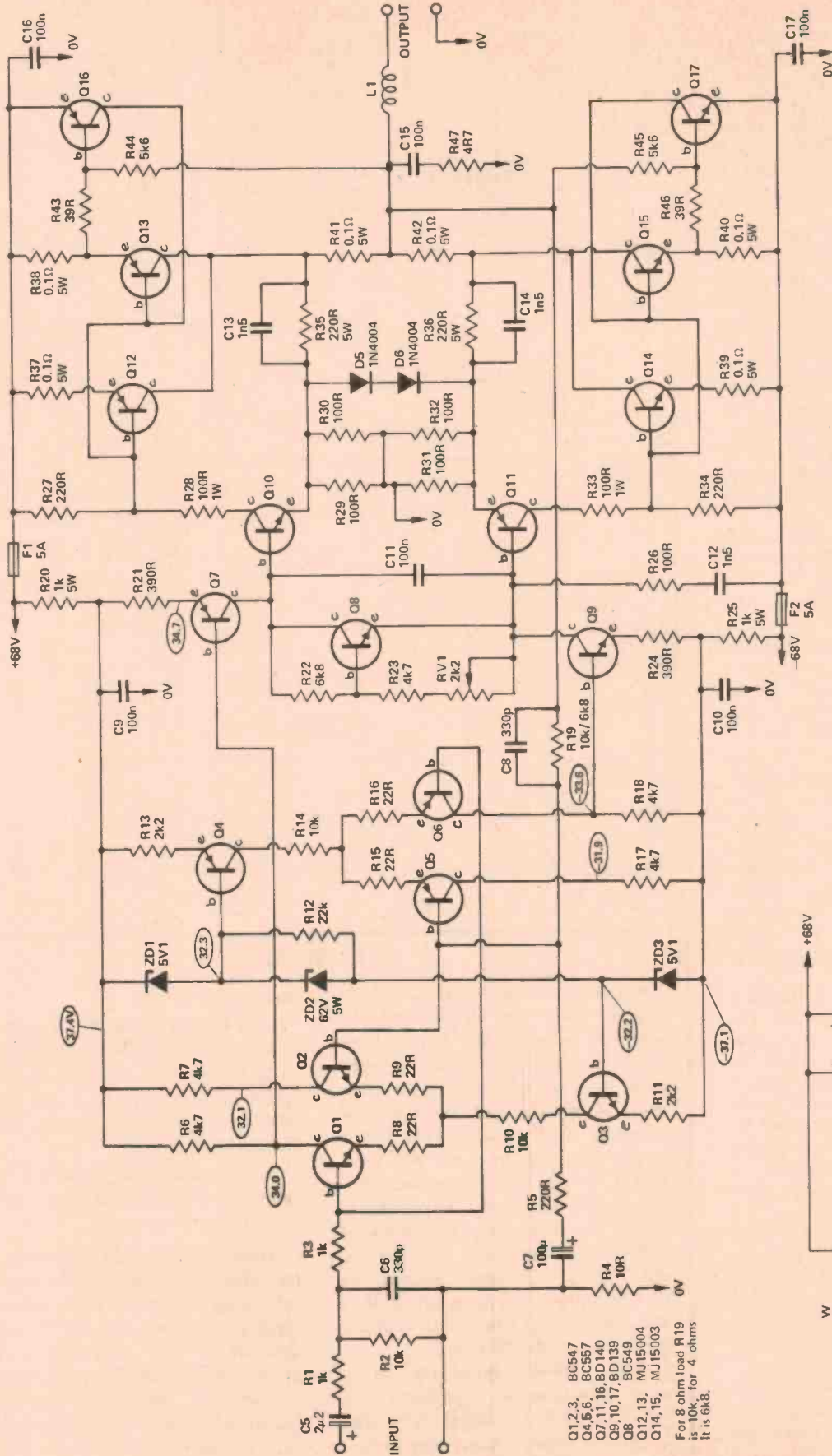

- O1,2,3, BC547
  - O4,5,6, BC557
  - O7,11,16, BD140
  - O8,9,10,17, BD139
  - O8, BC549
  - O12,13, MJ15004
  - O14,15, MJ15003
- For 8 ohm load R19 is 10k, for 4 ohms it is 6k8.

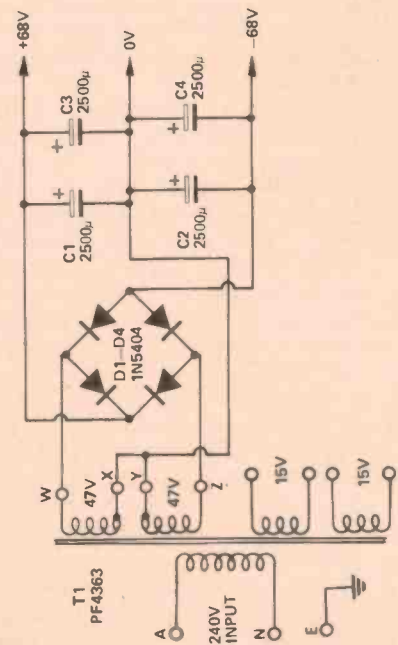

Complete circuit diagram of the amplifier. Note that L1, not listed in the parts list below, is wound on a 1 W resistor - see text. Voltage readings are included as a guide. The power transformer shown will power a pair of amplifiers (stereo) driving 8 ohm loads in typical domestic situations, but only a single module under other circumstances, particularly if driving a 4 ohm load. When supplying two modules from a single transformer simply parallel W, X, Y and Z on each pc board and connect these to

the transformer. For stereo applications use separate earth returns for each speaker to the common on the pc board and separately join the two commons. If the module is to be used in applications other than a domestic hi-fi set up and driving a 4 ohm load, we recommend you add another MJ15003/MJ15004 pair and associated components. The angle bracket and heat-sink assembly will need to be extended.

bender, making your own heatsink is certainly the cheapest way out. The complete drawings are given back on page 49. Referring to these, note that dimension 'A' and dimension 'B' varies for each fin, the appropriate measurements being given in the table accompanying the drawings together with the angle of bend for each fin. Don't forget to allow a small angle for the 'spring' in the metal. Angles can be within a few degrees as they aren't that critical to heatsink efficiency. Don't be too sloppy though.

We used 1.6 mm thick aluminium sheet to construct the heatsink — do not substitute a thinner gauge. The bolts which secure the heatsink assembly to the bracket assembly also hold the whole heatsink assembly together.

It is easiest to drill the heatsink fins before bending them up, but you must mark out and drill the holes accurately. Mark one outer fin very carefully. Assemble the fins in order, making sure they are carefully aligned, then clamp the whole assembly and drill right through. Carefully de-burr all the holes.

At this stage you can do a trial assembly of the heatsink and bracket or not. If you have taken care with the drilling, then all should be well. Having confidence in your ability, we shall press on.

If you decide to paint the heatsink as we have (see the front cover!), rather than having it anodised black, the mating surfaces should all be masked before spraying.

If you intend to use a Philips 65D6CB heatsink, the bracket holes may be marked on the heatsink using the already-drilled 6 mm thick bracket as a template. The holes can be drilled to the root diameter of a 4 BA bolt and suitably tapped.

The whole heatsink 'business' is not assembled at this stage, final assembly comes later. Be patient my little chickens!

The next part is the easy part (Ed.). Having got the mechanics off your chest, the electronics needs attention.

The components may be assembled to the pc board starting with the smaller resistors and capacitors. Carefully follow the overlay drawing. When you come to the 0.1 ohm, 5 W resistors note that they should be mounted about 2 - 3 mm off the board to allow a free air flow around them. Next mount the power supply electrolytics. Note that the recommended types have three pins projecting from the base. This is to provide mechanical rigidity. All three pins are soldered to the board and the capacitors can only be inserted one way round. The inductor L1 is made by winding a layer of 26 swg enamelled wire (or the nearest equivalent gauge) along the body of a 1 W resistor. The number of turns is not critical, just wind enough wire on the resistor to cover the body with one layer. The value of this resistor may be anything over 100 ohms. Two 5 A fuses are mounted on the pc board, held in place with fuse clips.

Next comes the semiconductors.

## HOW IT WORKS — ETI 466

The amplifier can be divided into three separate parts. These are: the input stage — which consists of Q1 - Q9, a high gain, low power driver; the output or power stage — which only has a voltage gain of four but enormous power gain; and the power supply.

The input stage is a complementary-differential network, each 'side' with its own current source. Each transistor in this stage is run at a collector current of about 0.7 mA. Emitter resistors are employed to stabilize the gain and improve linearity. The output of Q1 - Q6 drives Q7 and Q9. The latter are virtually two constant-current sources run at about 7 mA collector current. With an input signal these 'current' sources are modulated out of phase — the collector current of one decreases while the other increases. This configuration provides quite an amount of gain.

In between the bases of these two transistors is Q8, the thermal sensing bias transistor. The voltage across Q8 may be adjusted by RV1, thus setting the quiescent bias current for the output stage.

The output stage, Q10 - Q15, has a gain of about five, set by R39 and R29 plus R30. Diodes D5 and D6 prevent reverse biasing of Q10 and Q11 (otherwise the output would be limited).

Protection of the output transistors is provided by Q16 and Q17 which monitor both current and voltage in the output transistors and bypass the base current if the limit is exceeded.

The power supply is a full-wave rectifier, with a centre-tap on the transformer giving the 0 V rail, providing +/- 68 volts. A total of 5000 uF is used across each supply rail for filtering. The amplifier input stage works on a reduced supply rail, derived from ZD1-ZD3 via R20 and R25.

Frequency stabilisation is provided by capacitors C8, 13, 14 and the RC networks R26/C12 plus R47/C15. Frequency response of the amplifier is set by C5 and C7 (lower limit), C8 sets the upper frequency limit.

The transformer has two additional windings of 15 Vac each. These are not used here but are suitable for powering a preamplifier.

## PARTS LIST - ETI 466

Resistors	all ½W, 5% unless noted
R1	10k
R2	10k
R3	1k
R4	10R
R5	220R
R6, R7	4k7
R8, R9	22R
R10	10k
R11	2k2
R12	22k
R13	2k2
R14	10k
R15, R16	22R
R17, R18	4k7
R19	10k(6k8 for 4 ohm loads)
R20	1k 5W
R21	390R
R22	6k8
R23	4k7
R24	390R
R25	1k 5W

Semiconductors	
Q1-Q3	BC547
Q4-Q6	BC557
Q7	BD140
Q8	BC549
Q9, Q10	BD139
Q11	BD140
Q12, Q13	MJ15004
Q14, Q15	MJ15003
Q16	BD140 or BC640
Q17	BD139 or BC639
D1-D4	1N5404
D5, D6	1N4004
ZD1	5V1 300 mW (IN751A)
ZD2	62V 5W (IN5372B)
ZD3	5V1 300 mW (IN751A)
Miscellaneous	
ETI 466	pc board
Heatsink	see text
Transformer	PF4363 (47 + 47V - 300 W)
	4 fuse clips, 2 x 5A fuses

R26	100R
R27	220R
R28-R33	100R 1W
R34	220R
R35, R36	220R 5W
R37-R42	0.1 ohm, 5W
R43	39R
R44, R45	5k6 1W
R46	39R
R47	4R7 1W
Potentiometers	
RV1	2k2 trim
Capacitors	
C1-C4	2500µ 80V RTP electro
C5	2µ2 35V tantalum
C6	330p ceramic
C7	100µ 25V RB electro
C8	330p ceramic
C9-C11	100n polyester
C12-C14	1n5 polyester
C15-C17	100n polyester

# Project 466

## 30 AUDIO PROJECTS

INCLUDING:

25 Watt Amp

General Purpose Preamp

Bucket Brigade Delay Line

Active Crossover

Compressor Expander

Tape Noise Limiter

Transmission Line

ETI Master Mixer

Graphic Equalizer

50 Watt Amp

## Inside

Simple 25 watt amplifier

General purpose preamplifier

Bucket brigade audio delay line

Stereo rumble filter

Over led

Active crossover

Silent A-B switch

Simple compressor expander

Din connectors

Tape noise limiter

Audio Limiter

ETI master mixer

High power PA/guitar amplifier

Line amplifier

Stage mixer

Audio spectrum analyser

### AND MORE !

A collection of the top audio projects from Electronics Today for the audiophile who wants good sound at a good price plus the satisfaction of having built it himself.

\$3.95 plus 70 cents post and packing in NSW (80 cents in other states).

Order from:—  
Electronics Today International  
Subscriptions Department  
15 Boundary St  
Rushcutters Bay NSW 2011

Also available in newsagents and selected electronics suppliers.

Leave Q7, 8, 9, 10 and Q11 plus the output stage devices Q12, 13, 14 and Q15 until last. Be *careful* with the orientation of the diodes.

Now you can assemble the heatsink bracket to the pc board, plus Q7 to Q15 inclusive.

First smear heatsink compound on the two mating surfaces of the bracket assembly. Note that insulating washers are used on all the transistors, Q7 to Q15, mounted on the bracket assembly (except Q8 of course). Smear both sides of each washer with heatsink compound. Place the bracket pieces on the board — component side — and secure Q7, Q9, Q10 and Q11 with nuts and bolts. Only tighten the nuts finger tight at this stage. Now, take the whole board and place the bracket ends against a flat surface — such as the flat heatsink fin — and juggle the brackets until the end faces are flush. Check that all holes line up and then tighten the nuts and bolts.

The TO3 power transistors Q12, 13, 14 and Q15 may now be assembled to the bracket and pc board using the accompanying assembly diagram as a guide. We used spaghetti insulation to sleeve the bolts but pieces of heat-shrink tubing would be better.

*Don't solder any leads yet.*

Allow time for the heatsink compound to spread under compression and finally tighten all nuts. Last of all insert Q8. Smear the inside of the hole it sits in with heatsink compound to ensure good thermal contact.

Now you can solder all the transistor leads.

Check the component placement against the overlay now, just to ensure all is in order. If you wish, you can test the amplifier up to the driver stages for correct operation before assembling the unit to the heatsink. Remove the fuses before applying ac input from the transformer. Refer to the 'powering up' procedure. If there are any problems, look for errors in component placement or orientation — particularly with diodes. If all is well, assemble the module to the heatsink and you're ready for the big test.

### Powering up

The set of output transistors are expensive to replace, therefore we recommend you follow this test procedure in the interest of conserving supplies of same.

The power supply ac input should be connected to the transformer (see the overlay) but no power applied.

You'll need a multimeter of at least 20k ohms/V sensitivity.

- 1) Remove the two fuses.
- 2) Solder a small link across C11.
- 3) Solder a wire between this link and the output pad.
- 4) With no load connected and no input signal, switch the power on.
- 5) Check the supply rail voltages. These should be about 68 volts each (plus and minus).
- 6) Check the voltages on the cathode of ZD1 (should be about +37 V) and the anode of ZD3 (about -37 V) with respect to 0 V.
- 7) If these two voltages differ with respect to each other by a volt or so, check other voltages around the input stage to determine the reason.
- 8) Check the dc voltage on the output (with respect to 0 V). It should be within 20 mV of zero.
- 9) Inject a sinewave signal into the input at a level of about 20 mV (RMS). Don't use a higher input level. Output should be 1 V RMS.
- 10) Switch off the main power and allow the filter capacitors to discharge. Remove the input signal.
- 11) Solder a 10 ohm ½W resistor across each fuse holder. Rotate the trimpot RV1 such that it is set at maximum resistance. Remove the short across C11 and the link from there to the output pad.
- 12) Switch on. . . . . if the 10 ohm resistors immediately vaporise you either have a short or some fault in the output stage!
- 13) If all is well, check the dc output voltage. It should be near zero.
- 14) Measure the voltage drop across one of the 10 ohm resistors placed across the fuse holders and adjust RV1 to give a reading of 1.0 V.
- 15) Switch off, allow the filter capacitors to discharge and remove the two 10 ohm resistors. Replace the fuses.
- 16) Connect suitably rated loudspeakers, warn the neighbours, connect a signal source to the input (turn down the volume), switch on the power and put the amp through its paces.

At this stage we'll leave the applications of this module up to you. No doubt you have plenty in mind already.

We are preparing a follow-up article for a later issue in which we may cover such things as preamps, bridge operation, design parameters and variations etc. For the moment, our existing preamp designs, such as the ETI-422 and ETI-471 will drive this module quite well.

Keep reading. ●

# 300 watt amplifier

HOLES MARKED A 4.5mm DIA  
HOLES MARKED B 3mm DIA  
HOLES MARKED C TAP 4BA OR 4mm DIA  
ALL OTHERS 4mm DIA

MATERIAL 40 x 12 x 3 ALUMINIUM ANGLE EXTRUSION

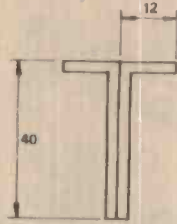
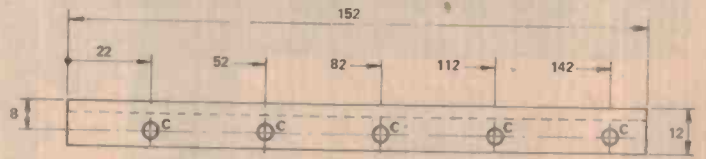

Drilling details for the heatsink bracket assembly. All dimensions are in millimetres. Suitable aluminium angle stock is available from Alcan Handyman stores.

MAKE 2 OPPOSITE HANDS

## ETI 466

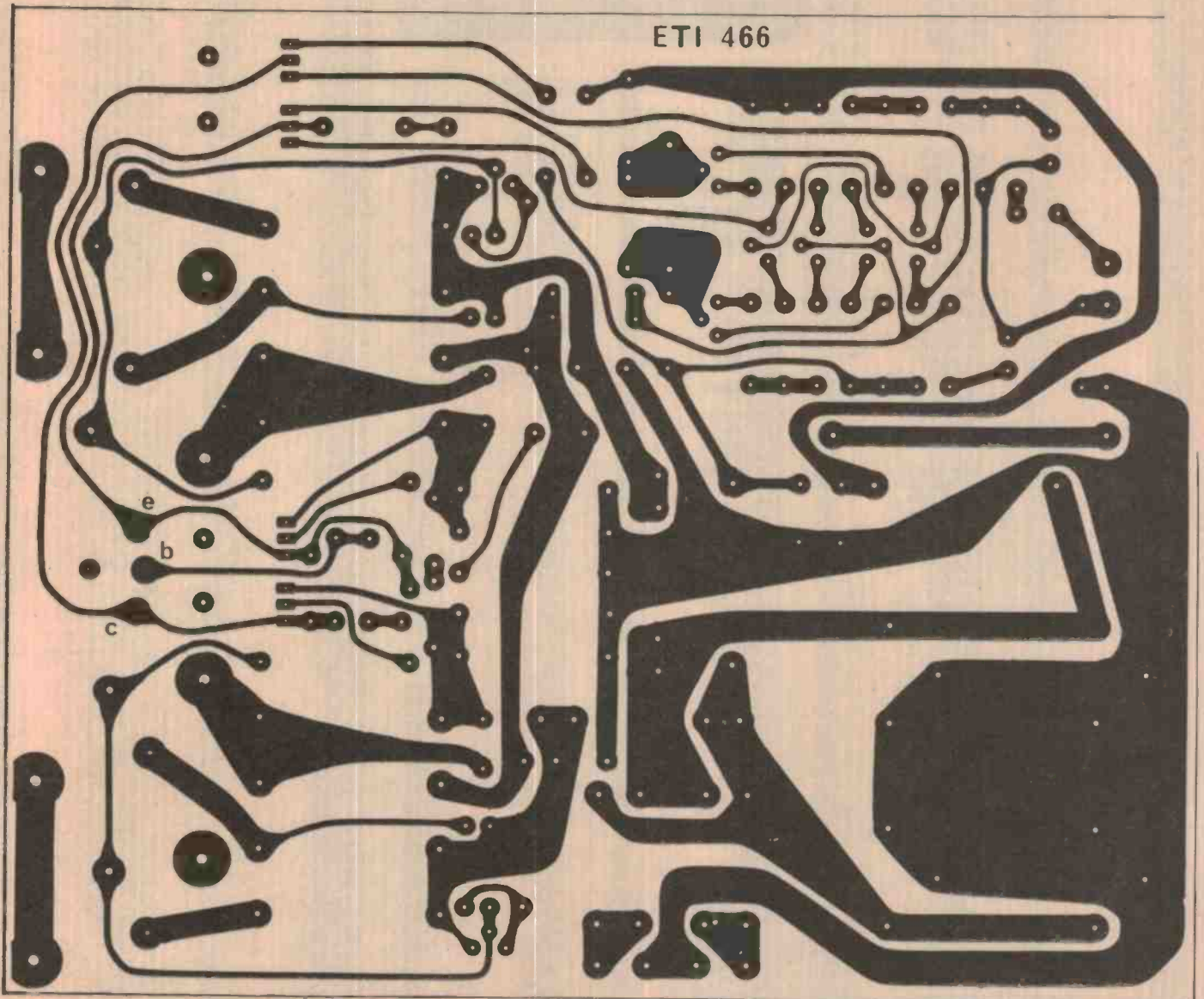

# ROD IRVING ELECTRONICS

*Birthday  
Sale*

<b>CMOS</b>	
4000	.25
4001B	.25
4001A	.25
4002	.25
4006	1.10
4007	.25
4008	1.00
4009	.46
4010	.46
4011	.25
4012	.22
4013	.37
4014	1.10
4015	.90
4016	.45
4017	.90
4018	1.10
4019	.60
4020	1.10
4021	1.10
4022	1.05
4023	.25
4024	.72
4025	.25
4026	1.60
4027	.48
4028	.90
4029	1.20
4030	.40
4031	2.20
4034	3.00
4035	1.30
4039	.70
4040	1.05
4041	1.05
4042	.70
4043	.70
4044	.70
4046	1.20
4047	1.20
4048	.50
4049	.40
4050	.45
4051	.90
4052	.80
4053	.80
5060	1.20
4066	.60
4068	.35
4069	.25
4070	.35
4071	.25
4072	.35
4073	.30
4075	.30
4076	1.20
4077	.35
4078	.40
4081	.30
4082	.40
4089	1.00
4093	.60
4503	.60
5407	.60
5410	1.10
4511	1.00
4512	1.10
4514	2.50
4516	1.40
4518	1.00
4519	.55
4520	1.10
4522	1.25
4527	1.20
4528	1.25
4529	1.60
4539	1.60
4541	1.60
5443	2.00
4553	5.50
4555	1.00
40097	.95
40098	.95
40175	1.00
<b>74C SERIES</b>	
74C00	.25
74C02	.25
74C04	.25
74C08	.25
74C10	.25
74C14	.50
74C20	.30
74C30	.30
74C32	.30
74C42	1.10
74C48	1.55
74C73	.75
74C74	.60
74C76	.75
74C83	1.40

74C85	1.20
74C86	.50
74C90	.60
74C93	1.40
74C95	.95
74C107	.70
74C150	3.40
74C151	1.00
74C154	2.90
74C160	.90
74C192	.90
74C164	1.10
74C173	1.00
74C174	.80
74C175	1.00
74C192	1.20
74C193	1.10
74C195	1.00
74C221	1.50
74C373	1.80
74C374	2.00
74C901	.60
74C902	.60
74C905	11.20
74C906	.50
74C907	.60
74C915	1.00
74C922	3.80
74C923	4.00
74C925	4.70
74C926	4.70
74C927	4.70
74C932	1.20

<b>80C SERIES</b>	
MM80C95	.90
80C96	.90
MM80C97	.90
80C98	.90

<b>LINEAR</b>	
LH0002	9.50
LH0022CD	16.60
LH0042CH	5.60
LH0070	12.70
LH0071	12.70
REF02CJ	8.40
TL071	.80
TL072	1.50
TL082	1.10
LM0091CD	26.40
LH0094CD	37.60
SAK140	2.20
UAA170	3.50
UAA180	3.50
TCA220	2.20
LM301	.30
LM301-H	.50
LM304-H	1.70
LM305-H	.80
LM307-CN	.40
LM307-H	.90
LM308	.70
LM308-H	1.20
LM310-N	2.20
LM310-H	2.60
311	.60
LM311	.60
LM311-H	1.20
LM318	2.80
LM322	3.90
LM324	.70
LM325	3.10
LM329-DZ	1.40
LM334-Z	1.30
LM335	12.40
LM336-Z	3.20
LM339	.60
LM348	1.10
LM349	1.80
LF351-N	.70
LF356-AN	1.10
LF357	1.10
LM358	.70
LM374	4.10
LM376	5.40
LM377	.70
LM379	5.70
LM308 8 PIN	1.00
LM380 14 PIN	1.20
LM381A-N	2.40
LM381N	1.80
LM382N	1.60
LM383	2.70
LM384	2.40
LM386	1.00
LM387	1.30
LM391	1.80
LM393	.80
LF398	5.00
465P	1.60
NE530	1.10

555	.30
556	.70
LM565	1.30
LM565CH	2.00
NE566	2.50
LM567	1.50
NE571	6.50
TBA641BX1	2.50
TBA641B11	2.50
LM709-LN-8	.60
LM709-14PIN	.70
UA710CA	.60
LM710-CH	.90
711	.80
UA711-H	.85
UA716HC	6.25
723	.45
LM723CH	1.10
LM725	3.90
LM733	1.20
UA739	2.00
741	.25
LM741-H	.55
UA747	1.00
UA747HC	2.20
UA748	.50
UA748HC	1.25
UA753	1.80
UA760HC	4.10
UA777	2.40
UA777HC	2.65
UA796HC	1.70
LM802	1.10
LM1310N	2.40
1408	4.90
LM1458	.60
UA1488	.90
UA1489	.90
MC1495	7.30
MC1496L	1.40
LM1558	1.50
LM1596	1.40
LM1380	3.10
2719	4.00
LM2902	1.40
LM2917 8 Pin	2.80
LM2917	3.10
CA3028	1.80
LM3039	.90
CA3046	1.70
3065	.45
LM3080	1.20
LM3089	3.90
CA3130T	1.20
CA3130E	1.80
CA3140	1.20
3401	.70
3611	1.10
LM3900	.80
LM3909	1.00
LM3914N	3.90
4136	1.20
LM4250	1.75
UAA558TC	1.40
MM5837	1.45
LM7555	1.80
MC10116L	.95
LF13741	.60

LF13741-H	.70
DS75452	.50
76477	4.20

<b>TTL (S)</b>	
74500	.30
74502	.30
74504	.80
74510	.75
74511	.75
74532	.75
74551	.75
74574	1.20
74586	1.40
745112	1.20
745135	2.20
745138	3.20
745157	2.95
745158	2.95
745182	3.30

<b>7400 SERIES</b>	
7400	.20
7401	.20
7402	.20
7403	.20
7404	.20
7405	.25
7406	.20
7407	.30
7408	.20
7409	.20
7410	.20
7411	.25
7412	.30
7413	.35
7414	.35
7416	.30
7417	.45
7420	.20
7421	.20
7423	.35
7425	.45
7426	.30
7427	.30
7430	.20
7432	.25
7437	.30
7438	.35
7440	.25
7441	1.00
7442	.45
7443	1.40
7444	1.20
7445	1.10
7446	.90
7447	.70
7448	.90
7450	.22
7451	.22
7453	.20
8T26	1.80
9300	.60
9307	1.80
9308	1.20
7454	.20
7470	.35
7427	.35

7473	.35
7474	.30
7475	.25
7476	.30
7480	.65
7482	1.80
7483	.80
7485	.80
7486	.40
7489	1.60
7490	.28
7491	.55
7492	.35
7493	.30
7494	.90
7495	.45
7496	.80
7497	2.50
74107	.45
74109	.35
74116	2.20
74121	.45
74122	.65
74123	.60
74125	.55
74126	.60
74132	.80
74141	1.10
74145	.85
74147	2.00
74148	1.40
74150	.70
74151	.40
74152	4.90
74153	.70
74154	.70
74155	.90
8T28	1.60
9310	.65
9311	1.00
9312	1.35
9315	1.50
74156	.60
74157	.60
74160	1.00
74161	1.00
74162	1.00
74163	.85
74164	.60
74165	.60
74166	1.40
74167	2.50
74170	2.10
74173	1.60
74174	.50
74175	.90
74176	1.10
74177	1.10
74180	.90
74181	2.30
74182	.90
74184	1.20
74185	1.20
74190	1.00
74191	.90
74192	.70
74193	.80
74194	.80
74195	1.10
74196	.65
74199	.85
74197	1.10
74198	1.10
74199	1.30
74221	.90
74290	.90
74293	.90
74365	.80
74366	.80
74367	.60
74368	.80
8T96	1.80
9314	1.30
9368	1.75
9370	2.00
74LS00	.20
74LS01	.20
74LS02	.20
74LS03	.20
74LS04	.20
74LS05	.20
74LS08	.20
74LS09	.20
74LS10	.20
74LS11	.20
74LS13	.45
74LS14	.65
74LS15	.25
74LS20	.25
74LS21	.25
74LS22	.20
74LS26	.20
74LS27	.20
74LS28	.30
74LS30	.25

74LS32	.25
74LS33	.35
74LS37	.35
74LS38	.30
74LS40	.25
74LS42	.75
74LS47	.85
74LS48	1.00
74LS49	1.00
74LS51	.25
74LS54	.25
74LS55	.55
74LS58	.65
74LS73	.55
74LS74	.35
74LS75	.45
74LS76	.40
74LS78	.40
74LS83	1.00
74LS85	1.00
74LS86	.30
74LS90	.45
74LS92	.90
74LS93	.60
74LS95	.65
74LS96	1.55
74LS107	.35
74LS109	.35
74LS112	.35
74LS113	.65
74LS114	.50
74LS122	.45
74LS123	.75
74LS125	.50
74LS126	.70
74LS132	.80
74LS133	.35
74LS136	.35
74LS138	.70
74LS139	.85
74LS151	.75
74LS153	.60
74LS154	1.50
74LS155	1.00
74LS156	1.00
74LS157	.90
74LS158	.70
74LS160	.85
74LS161	.85
74LS162	1.00
74LS163	.85
74LS164	1.30
74LS165	.50
74LS168	1.90
74LS169	1.90
74LS170	2.80
74LS173	.70
74LS174	.70
74LS175	.70
74LS181	2.50
74LS189	3.80
74LS190	1.30
74LS191	1.10
74LS192	.85
74LS193	.85
74LS194	.70
74LS195	.80
74LS196	1.25
74LS197	1.00
74LS221	1.10
74LS245	2.35
74LS247	.90
74LS249	1.30
74LS251	.80
74LS253	.90
74LS257	.65
74LS258	.50
74LS259	2.45
74LS260	.40
74LS266	.70
74LS273	1.60
74LS279	.65
74LS283	1.15
74LS290	1.10
74LS2	

TRANSISTORS

Table listing various transistor models and their prices, including BC548, BC548B, BC549, BC549C, BC557, BC558, BC559, BC637, BC638, BC639, BC640, BCY70, BCY71, BD115, BD135, BD136, BD137, BD138, BD139, BD140, BD235, BD234, BD237, BD262, BD301, BD302, BD303, BD435, BD646, BD647, BD675, BDV64B, BDV65B, BF115, BF173, BF180, BF195, BF198, BF199, BF336, BF337, BF458, BF494, BFX85, BFY50, BFY90, BSV17, BU126, BU208, BUX80, FT2955, FT3055, MEL12, MJ326A, MJ2955, MJ4032, MJ802, MJ4035, MJ4502, MJE340, MJE350, MJE700, MJE800, MJE1101, MJE2955, MJE3055, MJE3521, MPPF102, MPPF131, MP5A05, MP5A14, MRF475, MPSA92, TIP31B, TIP31C, TIP32B, TIP32C, TIP33A, TIP34A, TIP24B, TIP42B, TIP110, TIP120, TIP2955, TIP3055, VMP4, VN88AF.

MICRO CHIPS

Table listing microchip models and prices, including ADCC 800, DACO 808, 2102 200NS, 2101 350NS, 2102 450NS, 2102 650NS, 2111, 2114 150NS, 2113 300NS, 2114 450NS, 8 to 31, 32 Up, 2513, 2516, 2532, 2650, 2708, 2716, 4116, 5101, 55101, MM52030, MM5204, MM5220, MM5303N, MM5307.

Table listing various transistor models and their prices, including MM5309, MM5312, MM5369, 5387, MM5395, MM5740, 6502, 6508, 6520, 6522, 6532, 6551, IM6561, MCM6574, MCM6575, MC6800P, MC6802, MC6808, 6810A, 6820, 6821, 6850, 6852, 7106, 7107, 7210, LS7220, 8035, INS8050, INS8080, P8085, 8156, 8205, P8212, 8214, 8224N, 8224, 8228, 8238, 8243, 8251 INTEL, INS8251, 8253, 8255A, 8295, DM8578, AY-5-2376, MM5104N, MM55106N, MM57160.

OPTOCOUPLERS

Table listing optocoupler models and prices, including MCT2, MCT6, MCT275, MCC671, 4N28, 4N33, 4N26.

ZENER DIODES

Table listing zener diode models and prices, including E23 Range, 400MW, 1 Watt.

CAPACITORS

Table listing capacitor models and prices, including Polyester 100V-250V, .001-027, .033-056, .068-1, .12-22, 0.27uf, 0.33uf, 0.39uf, 0.47uf, .56, .68, .82, 1.1, 1.2, 1.5, 1.8uf, 2.2uf, 3.3uf, 4.7uf.

I.C. SOCKETS

Table listing IC socket models and prices, including 8 Pin, 14 Pin, 16 Pin, 18 Pin, 22 Pin, 24 Pin, 28 Pin, 40 Pin.

FUSES

Table listing fuse models and prices, including 3AG, 1-9, 10+.

VOLTAGE REGULATORS

Table listing voltage regulator models and prices, including 78L05, LM341P-5, 7805, 7905, LM309K, 7805K, LM323-K, 78H05KC, LM341P-8, 78L12CP, 79L12, LM341P12, 7812, 7912, 7812KC, 7912KC, 79H12KC, 78CBUC, 78CBUC, 79L15, 79L15, LM341P15, 7815, 7915CT, 7915KC, 78H15KC, 78L18, 7818, 78L24, 79L24, 7824, LM317T, LM337T, LM317K, LM337K, LM350K, 78HCKC, 78P05.

BRIDGES

Table listing bridge models and prices, including VM48, W02, W04, W06, KHPC02, KBP602, KBP604, KBP606, KHPC1002, KBPC1004, KBPC1006, MDA3501, MDA3502, MDA3504.

DISPLAYS

Table listing display models and prices, including MAN2A, MAN72A.

Table listing various LED and diode models and prices, including MAN74A, MAN52A, MAN82A, MAN82A, MAN84A, MAN6740, MAN8610 Red, MAN8640 Red, TIL306, DL704, DL707, DL747, DL750, FND357, FND507, FND507, FND800, FND807, SEL521, NSB7881, NSN781, FNA5220.

S.C.R.'s

Table listing S.C.R. models and prices, including T10681, C106B, C106D1, C106E, C122D1, C122E.

TRIACS & DIACS

Table listing triac and diac models and prices, including 2N6073, SC141D, SC146D, ST2, ST4, SC151D.

OPTO LEDS

Table listing opto LED models and prices, including LED Red Rectangle, LED Green Rectangle, LED Yellow Rectangle, 133 Red Chrome, 133 Amber Chrome, 133 Green Chrome, LED Red Standard, LED Green Standard, LED Yellow Standard, SAR3431, CS205.



FREE PACK OF ASSORTED PARTS WITH ORDERS OVER \$20,000 (Including IF Coils, Switches, Resistors, Variable Capacitors, Coils, etc.)

Please note: All prices include sales tax; offer is current till 7th of March, 1980; backorders will be accepted if stock is not available at time of ordering; all prices are correct at time of printing; E&OE.

SHOP HOURS: Mon-Thur, 8am to 6.30pm, Fri, 8am to 8.30pm, Sat, 8.30am to 12.30pm

MAIL ORDERS: PO Box 135, Northcote, Vic. 3070. Minimum pack and post \$1.00. Send 50c stamp for catalogues and other specials.

499 HIGH STREET, NORTHCOTE 3070

PHONE (03) 489-8131



## MULTIMETERS



**3001** A competitive meter with fuse protection and an additional Battery Test Calibration facility for speedy checking of small batteries (calculators etc.). A temperature probe is available as an optional extra with a range of  $-50^{\circ}\text{C}$  to  $+200^{\circ}\text{C}$ .

**D.C. VOLTAGE**  
Full Scale Value 0.25/2.5/10/50/250/1000V  
Accuracy  $\pm 3\%$  of rated value  
Internal Resistance 20000 $\Omega$ /V

**D.C. AMPERAGE**  
Full Scale Value 0.5/10/250mA  
Accuracy  $\pm 3\%$  of rated value  
Voltage Drop 250mV

**A.C. VOLTAGE**  
Full Scale Value 10/50/250/1000V

**RESISTANCE (OHMS)**  
Full Scale Value 3k/30k/300k $\Omega$  (Rc 26 $\Omega$ )

**DIMENSIONS**  
130 mm H. x 90 mm W. x 53 mm D. Weight 305g

**ACCESSORIES**  
Carry case, test leads, spare fuse



**3010** An ultra sensitive meter—100,000 $\Omega$ /V (Max). Includes D.C. polarity selector switch, relay and fuse protection, a taut band movement plus an output terminal for dB readings.

**D.C. VOLTAGE**  
Full Scale Value 0.1/1/2.5/10/50/250/1000V  
Accuracy  $\pm 3\%$  of rated value  
Internal Resistance 100,000 $\Omega$ /V

**D.C. AMPERAGE**  
Full Scale Value 10 $\mu$ /100 $\mu$ /1/10/100/500 mA #10A  
Accuracy  $\pm 3\%$  of rated value  
Voltage Drop 100 mV, 250 mV

**A.C. VOLTAGE**  
Full Scale Value 10/50/250/500/1000V  
Accuracy  $\pm 3\%$  of rated value  
Internal Resistance 10,000 $\Omega$ /V

**A.C. AMPERAGE**  
Full Scale Value 10A  
Accuracy  $\pm 4\%$  of rated value

**RESISTANCE (OHMS)**  
Full Scale Value 2k/200k/2m/20m $\Omega$  (Rc 200)  
Accuracy  $\pm 3\%$  of scale length

**LOW FREQUENCY OUTPUT (DECIBELS)**  
20 +36 dB

**DIMENSIONS**  
170 mm H. x 126 mm W. x 70 mm D. Weight—690g

# HIOKI TESTERS

all with the backing of  
**H. ROWE & CO.**



**3003** A high sensitivity meter with fuse protection, taut band movement and mirror scale. A.C. current measurement up to 10A, and output terminal for dB readings.

**D.C. VOLTAGE**  
Full Scale Value 0.25/2.5/10/50/250/1000V  
Accuracy  $\pm 3\%$  of rated value  
Internal Resistance 30,000 $\Omega$ /V

**D.C. AMPERAGE**  
Full Scale Value 50 $\mu$ A/2.5/25/250mA/10A  
Accuracy  $\pm 3\%$  of rated value

**A.C. VOLTAGE**  
Full Scale Value 10/50/250/1000V  
Accuracy  $\pm 3\%$  of rated value  
Internal Resistance 13,500 $\Omega$ /V

**A.C. AMPERAGE**  
Full Scale Value 10A  
Accuracy  $\pm 4\%$  of rated value

**RESISTANCE (OHMS)**  
Full Scale Value 5k/50k/500k/5m $\Omega$  (Rc50 $\Omega$ )  
Accuracy  $\pm 3\%$  of scale length

**LOW FREQUENCY OUTPUT (DECIBELS)**  
Full Scale Value 20 +36 dB  
Accuracy  $\pm 4\%$  of rated value

**DIMENSIONS**  
150 mm H. x 109 mm W. x 60 mm D. Weight 380g  
**ACCESSORIES INCLUDED**  
Carry case, test leads, spare fuse, alligator clip



## 3205 DIGITAL MULTIMETER

A "Field Effect" liquid crystal display ensures good contrast. Approx. 40 hours continuous use with alkaline batteries. Features include—automatic and fuse overload protection and semi automatic range selection.

**D.C. VOLTAGE** 5 ranges. With auto facility 200 & 2000 mV ranges. acc.  $\pm 0.3\%$ rdg  $\pm 0.1\%$ fs.  $\pm 1$ dg. 20-200 Volts range. acc.  $\pm 0.5\%$ rdg  $\pm 0.1\%$ fs.  $\pm 1$ dg. 200 & 1000 V ranges. acc.  $\pm 1.5\%$ rdg  $\pm 0.1\%$ fs.  $\pm 1$ dg.  
**D.C. AMPERAGE** 4 ranges. With auto facility 200 & 2000  $\mu$ A ranges. acc.  $\pm 1.0\%$ rdg  $\pm 0.1\%$ fs.  $\pm 1$ dg. 20 & 200 mA ranges. acc.  $\pm 1.0\%$ rdg  $\pm 0.1\%$ fs.  $\pm 1$ dg.  
**A.C. VOLTAGE** 5 ranges. With auto facility 2000 mV range. acc.  $\pm 0.3\%$ rdg  $\pm 0.2\%$ fs.  $\pm 1$ dg. 20-200 Volts range. acc.  $\pm 0.8\%$ rdg  $\pm 0.7\%$ fs.  $\pm 1$ dg. 200 Volts range. acc.  $\pm 1.7\%$ rdg  $\pm 0.8\%$ fs.  $\pm 1$ dg. 1000 Volts range. acc.  $\pm 1.7\%$ rdg  $\pm 0.3\%$ fs.  $\pm 1$ dg.

**A.C. AMPERAGE** 4 ranges. With auto facility 2000  $\mu$ A acc.  $\pm 1.3\%$ rdg  $\pm 1.0\%$ fs.  $\pm 1$ dg. 20 & 200 mA ranges. acc.  $\pm 1.3\%$ rdg  $\pm 0.7\%$ fs.  $\pm 1$ dg.

**RESISTANCE (OHMS)** 6 ranges. With auto facility 200 & 2000 $\Omega$  ranges. acc.  $\pm 0.5\%$ rdg  $\pm 0.1\%$ fs.  $\pm 1$ dg. 20 & 2000k $\Omega$  ranges. acc.  $\pm 0.5\%$ rdg  $\pm 0.1\%$ fs.  $\pm 1$ dg. 2-20m $\Omega$  acc.  $\pm 0.7\%$ rdg  $\pm 0.2\%$ fs.  $\pm 1$ dg.

**DIMENSIONS (Approx)**  
151 mm H. x 100 mm W. x 36 mm D. Weight 470g

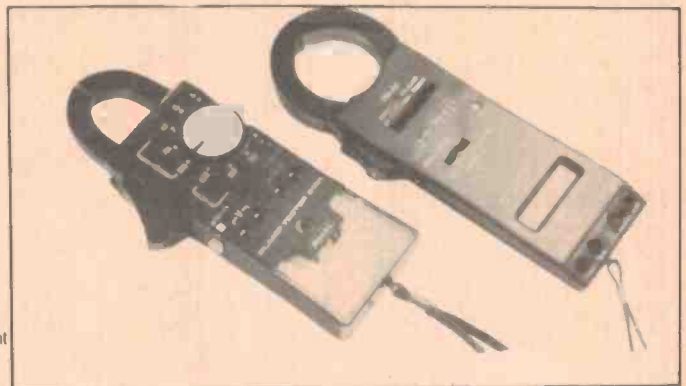

## CLAMPTESTERS

**3101** Dustproof case, circuit protection fuse and convenient meter lock. Incorporates the advanced, shock-resisting core magnet taut band movement.

**A.C. AMPERAGE**  
6/15/60/150/300A  
Accuracy  $\pm 3\%$  of rated value

**A.C. VOLTAGE**  
150/300/600 V  
Accuracy  $\pm 3\%$  of rated value

**RESISTANCE (OHMS)**  
0-1 k $\Omega$  (Centre 30 $\Omega$ )  
Accuracy  $\pm 3\%$  of scale length

**DIMENSIONS**  
210 mm H. 86 mm W. 42 mm D. Weight 400 g

**ACCESSORIES INCLUDED**  
Carry case, test leads, spare fuses, alligator clip,

## 3206 DIGITAL CLAMP TESTER

A "Field Effect" type liquid crystal display ensures good contrast for low power consumption—approx. 100 hours continuous use with alkaline batteries. Features include auto range selection, peak hold and display hold facilities.

**READING RANGE**  
**A.C. AMPERAGE**  
0-20 amp range, 200 and 1000 amps max.

**A.C. VOLTAGE**  
0-1000 volts.

**RESISTANCE (OHMS)** 0-2000 $\Omega$

**DIMENSIONS (Approx)**  
230 mm H. x 80 mm W. x 38 mm D. Weight 450g

**ACCESSORIES INCLUDED**  
Carry case, test leads, spare fuse, alligator clip.



# H. ROWE & CO. PTY. LTD.

54 Racecourse Road, North Melbourne. Ph. 329 6511

SOLE AUSTRALIAN AGENTS

adelaide  
melbourne

brisbane  
perth

sydney



# Capacitance meter features linear scale and low cost

This is the third instrument in our series of simple, inexpensive, look-alike test gear projects.

Roger Harrison

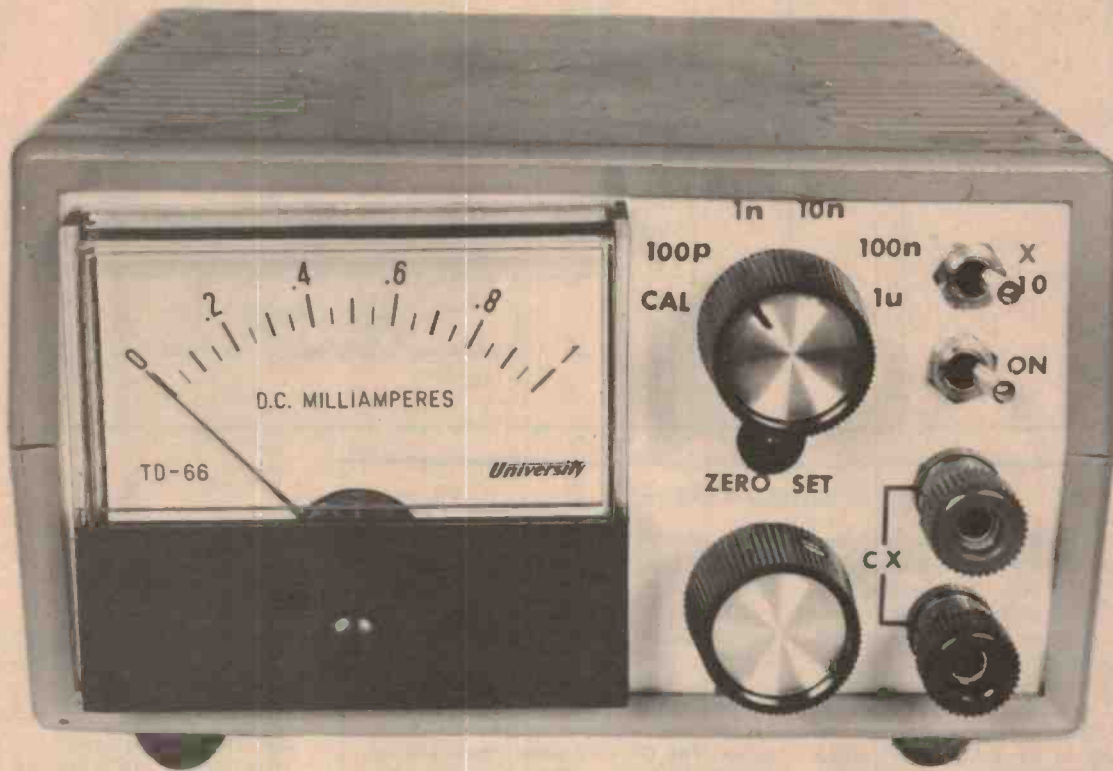

WE FIRST published a capacitance meter project almost two years ago. The Linear Scale Capacitance Meter, Project 136, (ETI, March 1978) enjoyed a certain amount of popularity at the time it was published, but ran into a few snags. Unfortunately the edgewise mounting meter became difficult to procure as did, later, the case. Also, the meter required calibration by hand. Correspondence from a number of readers also suggested extending the range of the instrument to enable capacitors up to 10 uF to be measured.

So, when we were considering our current range of simple, inexpensive test gear projects, the old linear scale capacitance meter was an obvious candidate for revamping to include in

the series. Phil Wait took it in hand and here it is — the all-new, singing-dancing, lemon-fresh Linear Scale Capacitance Meter!

This unit has been constructed using the same type case, meter and range switch as the two previous projects in the series: the frequency meter, ETI-150, and linear scale ohmmeter, ETI-151. It can be powered from

internal batteries or a small plugpack.

Since constructing the original project, the writer has been consistently amazed at how often it has been used. When considering the purchase or construction of test instruments, most people take resistance measurement for granted — but, in so many applications, capacitance measurement comes a good second. ▶

## SPECIFICATIONS — ETI 152

Capacitance ranges (full scale)	100p, 1n, 10n, 100, 1u — to 10u on x10
Accuracy	5%, estimate to 2% on meter scale
Calibration	from internal capacitor, 2%
Supply voltage	9 Vdc from battery or plugpack

# Project 152

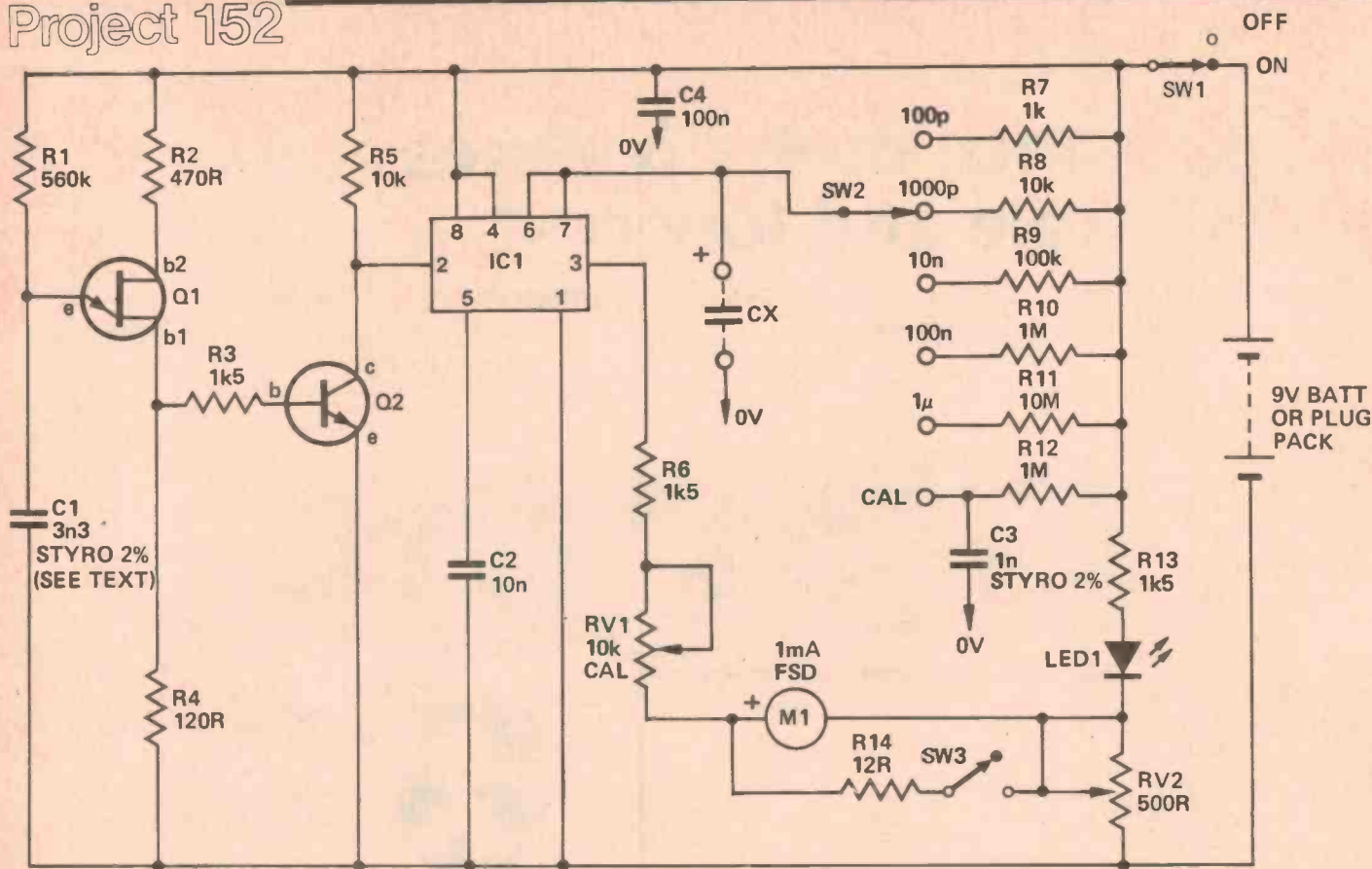

## HOW IT WORKS - ETI 152

A unijunction transistor, Q1, is connected as a relaxation oscillator with a frequency determined by R1-C1. The frequency of oscillation in this instance is about 1 kHz.

Pulses of about 1  $\mu$ s duration are produced across R4 each time the UJT "fires". The resistance between b2 and b1 of the UJT reduces to a low value each time the emitter conducts. Much of the charge stored in C1 is "dumped" across R4 for the short duration that the e-b1 junction of Q1 conducts.

The narrow pulses across R4 drive the base of Q2 via R3, which serves as a base-current limiting resistor. The pulses cause Q2 to conduct for the same duration, that is, about 1  $\mu$ s, and negative-going pulses from the collector of Q2 drive the "TRIGGER" input of the 555 timer, IC1. This is connected to operate as a monostable in this circuit.

When IC1 receives a trigger pulse at pin 2, the flip-flop is set, releasing the short circuit across Cx and driving the output, pin 3, high. The voltage across the capacitor then increases exponentially for a period that depends on the value of the unknown capacitance Cx. The period is determined according to the formula:

$$t = 1.1 RrCx$$

— where 'Rr' is the range resistor, and 'Cx' the capacitor being measured.

At the end of the period, the comparator inside the 555 resets the flip-flop

which in turn discharges the unknown capacitor, Cx, and drives the output to its low state.

This cycle is repeated each time a negative-going trigger pulse appears at pin 2 of IC1.

Thus, as the range resistor value (Rr) is fixed, the ON/OFF ratio of the output voltage will be determined by the value of Cx. The ON/OFF ratio is independent of the relaxation oscillator frequency and trigger pulse duration.

The current measured through the 'load' resistor on the output (R6) of IC1 will thus be directly proportional to the value of the unknown capacitor Cx.

The meter, M1, measures the current through R6, the meter inertia 'averaging' the current.

As the voltage at the output pin swings between about 2/3 of the supply voltage and less than 1/3 of the supply in its 'high' and 'low' states respectively, the dc offset is compensated for by returning the 'load' current through an offset voltage developed across RV2 via R13 from the supply rail.

Zero-setting is accomplished by making RV2 variable. A calibration control is provided by making a portion of the 'load' resistance variable — RV1 here.

The 'X10' switch simply reduces the sensitivity of the meter, allowing measurement of a high output pulse-on to pulse-off ratio.

## Ranges

The unit will measure capacitance from 5 pF up to 1  $\mu$ F in five ranges with a x10 facility to extend the top range to 10  $\mu$ F. Full-scale values for each range are: 100 pF; 1 nF (1000 pF or 0.001  $\mu$ F); 10 nF (0.01  $\mu$ F); 100 nF (0.1  $\mu$ F) and 1  $\mu$ F — extended to 10  $\mu$ F with the x10 switch.

The x10 switch actually works on all ranges and is handy when checking capacitors that over-range when a particular range is selected, so that the appropriate range can be readily found.

Different ranges can be provided by selecting different values for the range resistors R7 to R11. For example 47 pF to 0.47  $\mu$ F (in five ranges), 4.7  $\mu$ F with the x10 in, could be obtained by changing R7 to 470R, R8 to 4k7 etc. However, the meter scale would need to be recalibrated. As it stands, the scale reads capacitance directly.

The meter scale provides divisions of 5% and the actual capacitance value can be estimated to about 2% or so, once the unit is calibrated. Overall accuracy will depend on the meter and the calibration capacitor accuracy.

# linear scale capacitance meter

## PARTS LIST - ETI 152

<b>Resistors</b>	all ½W, 5% (except R7-R12)
R1	560k
R2	470R
R3	1k5
R4	120R
R5	10k
R6	1k5
R7	1k 2%
R8	10k 2%
R9	100k 2%
R10	1M 2%
R11	10M 2%
R12	1M 2%
R13	1k5
R14	12R
<b>Potentiometers</b>	
RV1	10k min vert mounting trim pot
RV2	500R lin pot
<b>Capacitors</b>	
C1	3n3 2% tolerance - see text
C2	10n greencap
C3	1n 2% tolerance - see text
C4	100n greencap
<b>Semiconductors</b>	
LED1	TIL220R or similar LED
Q1	2N2646, 2N2647 uni-junction
Q2	BC548, BC108
IC1	555 timer
<b>Miscellaneous</b>	
M1	1mA FSD meter 60 mm square, University TD66 or similar
SW1	SPST miniature toggle switch
SW2	one pole six pos wafer switch
SW3	SPST miniature toggle switch
SK1, SK2	screw terminals

ETI 152 pc board, 9V battery (type 216) and battery clips, plastic case 130 mm x 130 mm x 75 mm, knobs.

## Design

A pulse oscillator, Q1, running at a pulse repetition frequency of about 1 kHz, triggers a 555 timer IC which is connected as a monostable multivibrator. The 555 in this configuration will produce a pulse at its output, pin 3, having a period determined by the values of the range resistor selected and the unknown capacitance. The lower the value of the unknown capacitance, the shorter the duration of the output pulse from the 555. Conversely, the higher the value of the unknown capacitance, the longer the duration of the output pulse.

The output pulse is passed through a moving-coil meter which will integrate the pulse waveform. The reading on the

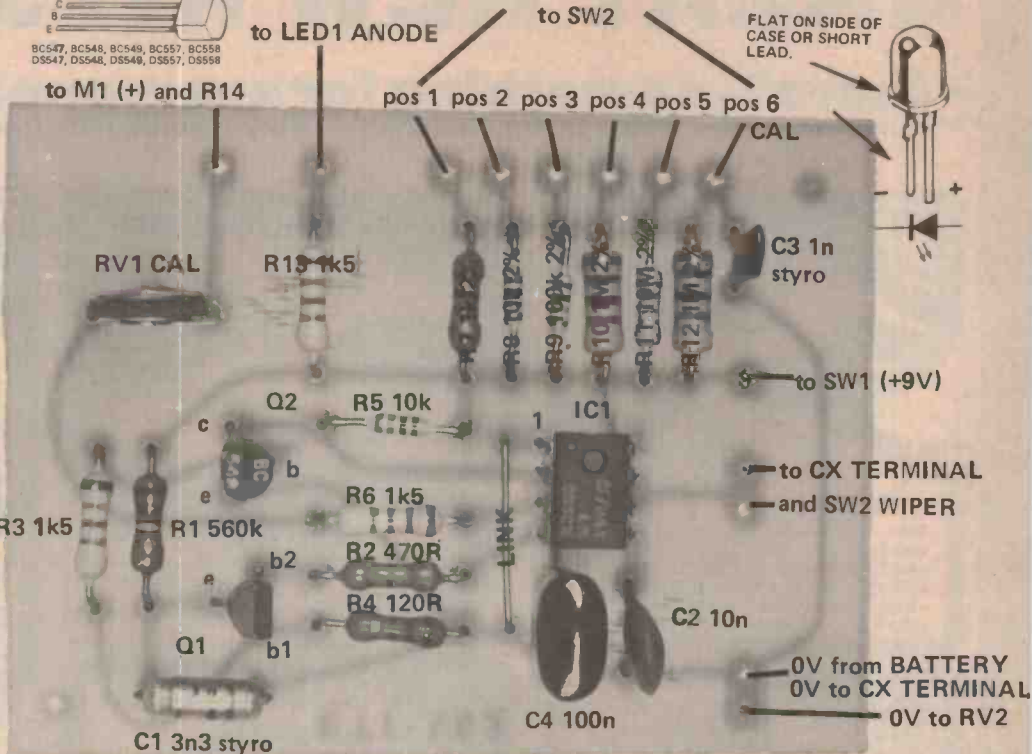
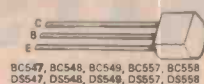

meter will thus be directly proportional to the ratio of the time the output pulse is on to the time it is off, resulting in a linear relationship of capacitance to meter reading. A low value of capacitance connected to the 'CX' terminals will produce a short duration pulse and thus a low meter reading; a high value of capacitance will produce a long duration pulse and a high meter reading, as illustrated on the accompanying diagram.

The output pulse of the 555 swings between values of about 2/3 of the supply voltage ('high') and 1/3 of the supply voltage ('low'). Thus, the meter needs to be returned to a voltage of about 1/3 of the supply, otherwise current would flow through it continuously. Conveniently, this voltage is set by a pot on the front panel which serves as a 'zero set' control. The meter is calibrated by varying the resistance in series with the meter, rather than having preset range resistors. This results in better accuracy and requires only one preset control. The CAL. position on the range switch is for occasional checking. Any significant variation in the calibration will generally indicate a low battery.

## Construction

We mounted our meter in a matching case to our Linear Scale Ohm meter and Frequency Meter. The front panel layout is a little cramped but all switch-

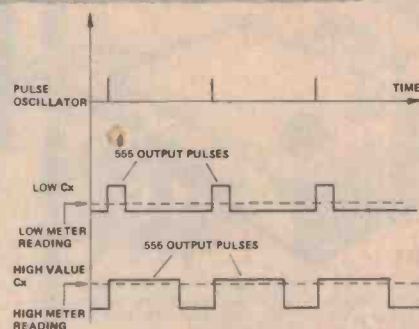

The unknown capacitance, C<sub>x</sub>, determines the width of the output pulses from the 555 monostable. The meter integrates these pulses to produce a reading which is directly proportional to the unknown capacitor's value.

es and terminals are easy to use with plenty of finger room.

Start your construction with the pc board making sure that the integrated circuit is the right way around. Take care also with the transistor and UJT orientation. Capacitors C1 and C3 determine the overall accuracy of the instrument and should be close tolerance types. Some suppliers carry a range of close tolerance silver mica or styroseal capacitors. Alternatively, if you have a friend or employer with a capacitance bridge you can select one close to the required value (1n) from standard tolerance types. See Shop-around on page 93 for suppliers that stock suitable capacitors. The range resistors R7 to R12 should also be close tolerance (2%) types.

All other components, including ▶

# GREAT NEW KITS

- there's something for everyone!

Why buy foreign kits when you can get Australian kits with Australian components from Dick?



**SEE EA DEC '79**

**TRANSISTOR ASSISTED IGNITION**

**NEW**

**\$32<sup>50</sup>**

K-3300

This transistor assisted ignition kit uses your standard car coil and points and is delightfully easy to build and install. No coil winding or setting up required; also has built-in dwell extension for optimum performance. Your car will stay in tune longer and you'll save!

**SEE EA SEPT '79**

**AUTOCHIME**

**\$29<sup>75</sup>**

**NEW**

K-3502

This simple to build kit utilizes a microprocessor with a repertoire of 24 tunes. Each time the doorbell is pushed it will automatically move on to the next tune! Full instructions supplied.

**SEE ETI SEPT '79**

**MARK II DISCO-STROBE**

K-3152

**\$34<sup>50</sup>**

**NEW UPDATED KIT**

The ever popular ETI Disco Strobe has been updated - improvements in the electronics necessitated a new PCB and this plus the all new case makes this an essential kit for parties. The kit comes complete with instructions and these instructions include details on extending the kit to include two flash tubes.

**SEE EA NOV '79**

**METAL DETECTOR**

**NEW**

**\$19<sup>50</sup>**

K-3504

Economy PLUS! Latest digital IC circuitry for top performance from a budget kit. Easy to make and get going - you could find a fortune. (Note: does not include dowel rod or coil former).

**SEE EA DEC '79**

**FAN SPEED CONTROL**

**\$11<sup>50</sup>**

K-3090

This is a shortform kit (does not include case etc) for use with fans or other 'squirrel type' motors which are unsuitable for normal speed controllers. Build this kit into the appliance itself! Not illustrated

**SEE EA AUG '79**

**MAST HEAD AMP**

**\$29<sup>50</sup>**

K-3232

Not Illustrated

If you are plagued with TV reception problems then this masthead kit could solve them for you! Designed for TV plus FM and UHF, it is simple to build and includes power supply and full instructions.

**C.D.I. SAVES ON PETROL**

This kit will pay for itself over and over. Installed in your car, it will give easier starting from cold, keep your points & plugs in better condition thereby keeping your car in tune for a longer time.

**\$32<sup>50</sup>**

K-3280

**DRILL SPEED CONTROLLER**

Thousands of these simple to build kits have been sold. Use with your 240V 'universal' brush type motor drill to give speeds down to near zero.

**\$13<sup>50</sup>**

E.A. July '78

K-3080

- PLAYMASTER 40/40 STEREO AMPLIFIER**  
(E.A. December '76)  
Our most popular kit ever. Thousands sold.  
Cat. K-3411.....\$129.50
- PLAYMASTER TWIN 25 AMPLIFIER**  
(E.A. May '76)  
Similar to above, but less power. A great kit.  
Cat. K-3410.....\$105.00
- PLAYMASTER AM/FM TUNER**  
(E.A. Nov/Dec '78)  
Matches Playmaster amplifiers - with in-built digital clock.  
Cat. K-3494.....\$129.50
- PLAYMASTER GRAPHIC EQUALIZER**  
(E.A. May '79)  
Adds depth and dimension to your Hi Fi system.  
Cat. K-3500.....\$99.50
- LED LEVEL METER**  
(E.A. June '76)  
Easy to make, fully solid state.  
Cat. K-3370.....\$13.50
- CAR STEREO BOOSTER**  
(E.A. January '79)  
Boosts power output of your car stereo to 12 watts per channel.  
Cat. K-3493.....\$29.50
- MUSICOLOR Mk111 COLOUR ORGAN**  
(E.A. September '76)  
Turns your music into light! Just add the lights.  
Cat. K-3140.....\$65.00
- ETI601 MINI ORGAN**  
(E.T.I. August '76)  
YOU can play your favourite tune in style.  
Cat. K-3430.....\$26.50
- LOUDSPEAKER PROTECTOR**  
(E.A. June '76)  
Eliminates turn-on and turn-off surges from most amplifiers.  
Cat. K-3425.....\$13.50

- WHISTLE FILTER**  
(E.A. Feb '79)  
Rid your tuner of heterodyne whistles.  
Cat. K-3496.....\$19.75
- 45 WATT VHF AMPLIFIER**  
Fibreglass PCB. 13.8V operation. Requires 8-12W drive.  
Cat. K-3132.....\$29.50
- 30 WATT 80 METRE AMPLIFIER**  
Ideal for the novice. 13.8V. Adaptable to 50W output.  
Cat. K-3133.....\$35.75
- CAR ALARM**  
Easy to build and protects your investment.  
Cat. K-3250.....\$11.50
- LOW COST VIDEO DISPLAY UNIT**  
(E.A. February '78)  
Communicate with a computer.  
Cat. K-3460.....\$97.50
- VIDEO MODULATOR for use with VDU**  
(E.A. April '78)  
Allows above VDU to be used with any TV set.  
Cat. K-3462.....\$4.50
- ASCII KEYBOARD ENCODER**  
(E.A. April '78)  
Uses our standard keyboard (Cat. X-1180).  
Cat. K-3464.....\$39.50
- CASSETTE INTERFACE**  
(E.A. April '77)  
Use any cassette to communicate with a computer.  
Cat. K-3465.....\$24.50
- 40MHz DIGITAL FREQUENCY COUNTER**  
(E.A. August/September '78)  
Versatile piece of test gear. Easily upgraded to 200MHz by adding 95H90 Pre-scaler IC.  
(Cat. Z-5360.....\$12.50)  
Cat. K-3437.....\$99.50
- TRANSISTOR TESTER**  
(E.A. July '78)  
Checks most transistors and FETs quickly and easily.  
Cat. K-3052.....\$19.75
- R-C-L BRIDGE**  
(E.A. March '78)  
Ideal project for the beginner or enthusiast.  
Cat. K-3468.....\$34.50
- AUDIO OSCILLATOR**  
(E.A. June '78)  
Outstanding value for a service aid.  
Cat. K-3469.....\$32.00

PRICES CORRECT AND STOCK AVAILABLE AT TIME OF GOING TO PRESS

# DICK SMITH ELECTRONICS



SEE OUR OTHER ADVERTS IN THIS MAGAZINE FOR OUR STORE ADDRESSES AND RESELLERS

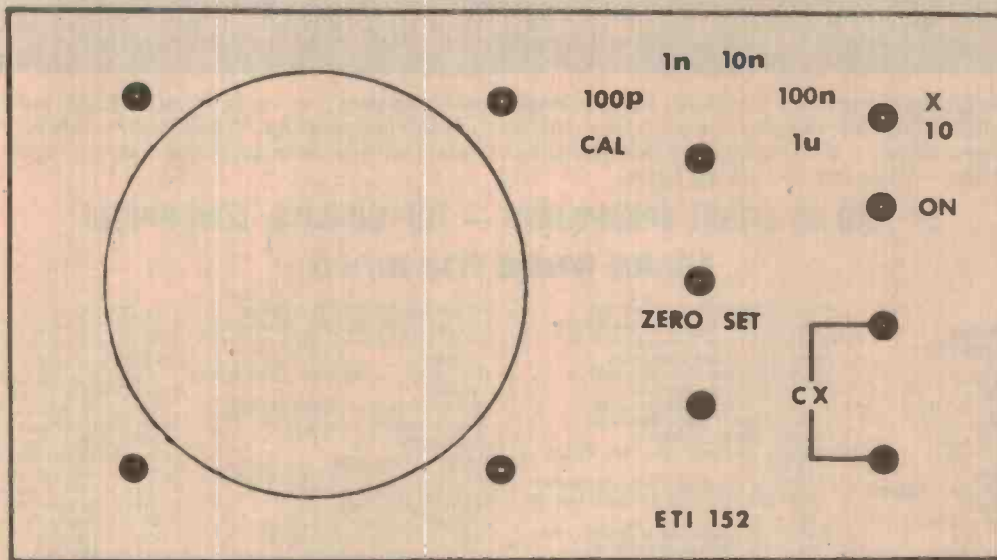

the x10 range resistor, are mounted on the front panel. Mount the smaller switches and terminals first, followed by the potentiometers and last of all the meter. The resistor R14 is wired from the positive meter terminal to one of the contacts on the range switch, SW3.

The printed circuit must be mounted so the lead length from the Cx terminals is as short as possible to avoid stray capacitance. Mount the pc board to the bottom of the case just behind the terminals and use tinned copper wire to make the connections making sure that the wires are well spaced from each other and well away from the rest of the circuit. Wire each connection from the board to the components on the front panel carefully to avoid errors.

When the construction is complete check all the wiring but don't assemble the lid to the box yet. Switch to the 1n range and turn the instrument on. Adjust the ZERO SET pot and see that the meter pointer varies about the zero scale marking. If it doesn't, check the pc board and panel wiring. If all is well, set the control so the meter pointer is on the scale zero mark. Then, switch to the CAL position and the meter pointer should move up the scale. Adjust the CAL trimpot on the pc board, RV1, so that the meter reads '1'. Switch to any range and you're ready to go!

You will find that stray capaci-

tance affects the meter zero reading on the 100p scale. Simply adjust the ZERO SET control so that the meter reads zero before taking a measurement on this range. You'll find that once the instrument is zeroed on the 1n range, the higher ranges will not require further adjustment of the zero set.

In use, occasionally check the calibration. If grossly in error, your battery is about to go flat. A No.216 battery should give quite a long life as the unit draws 50-60 mA. For longer life a No.2362 battery is recommended. If you operate the unit from a plug-pack, one rated at 6 Vdc output should deliver more than 8V at this low load, which is perfectly adequate.

Remember that any devices used to grip the leads of capacitors being measured will add stray capacitance and you will need to compensate for this by readjusting the zero set control. However, this will only have to be done on the 100p and 1n ranges as the added capacitance will be negligible on the higher ranges.

The 'x10' switch is primarily intended to extend the 1u range to 10u, although it is useful on the other ranges - when a capacitor being measured over-ranges you can assess whether it is just above the range selected or many ranges up in value.

Well, there you go! I hope you find this instrument as useful as I have. ●

Above is a full-size reproduction of the front panel artwork. You may cut it from the magazine if you wish and use it directly. Alternatively, Scotchcal reproductions will be available from Radio Despatch Service in Sydney.

Same-size reproduction of the pc board artwork. See Shoparound on page 93 for details on pc board suppliers.

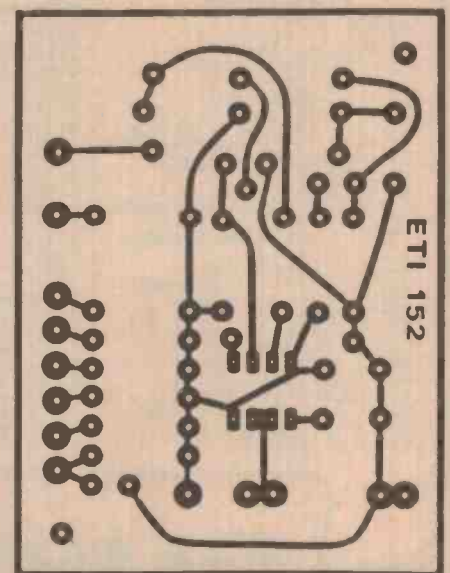

# ALL ELECTRONIC COMPONENTS

That's our name . . . that's our game!!!

MAJOR STOCKISTS OF ALL GENERAL RADIO AND ELECTRONIC COMPONENTS

Only "recognised brands" and top-quality components stocked. Resistors (incl. large industrial types) capacitors, semi-conductor devices, switches, meters, valves, metalwork, front panels, plugs, sockets, cable connectors, transformers, speakers, etc. Prompt and efficient attention through our mail order department. Major stockist of all ETI & EA kits — you name it — we will quote.

ETI AND EA KITSET SPECIALISTS — TOP QUALITY, LOW PRICES

LEARN WHILE YOU BUILD

## STEREO UNITS

S1 ETI 484. Compressor Expander  
S2 ETI 482. 50 watt per channel Amp.  
S3 ETI 482A. Preamp Board  
S4 ETI 482B. Tone Control Board  
S5 ETI 485. Graphic Equalizer  
S6 ETI 480. 50 watt Amplifier less H/s  
S7 ETI 480. 100 watt Amplifier less H/s  
S8 ETI 480. Power Supply for above  
S9 ETI 443. Expander Compressor  
S10 ETI 444. Five Watt Stereo  
S11 ETI 422B. Booster Amplifier Incl. metalwork  
S12 ETI 438. Audio Level Meter  
S13 ETI 440. 25 watt Stereo Amp. Incl. metalwork

S14 ETI 420. Four channel Amplifier  
S16 ETI 423. Add-on Decoder Amplifier  
S17 ETI 422. 50 watt per channel Amplifier  
S18 ETI 426. Rumble Filter  
S19 ETI 429. Simple Stereo Amplifier  
S21 ETI 417. Over Ired Distortion Monitor  
S22 ETI 410. Stereo Width Control  
S24 ETI 427. Graphic Equalizer  
S25 E.A. Playmaster 10 plus 10  
S26 E.A. Playmaster 128 40 watt  
S27 E.A. Playmaster 132 40 watt  
S28 E.A. Playmaster 136 13 watt  
S29 E.A. Playmaster 137 3 watt  
S30 E.A. Playmaster 143 12.5 watt  
S31 E.A. Playmaster Twin 25 watt  
S32 E.A. Musicolour II 1000 w/ch  
S33 E.A. Musicolour III 1000 w/ch  
S34 E.A. Stereo Dynamic Noise Filter  
S35 ETI. 60 watt Audio Amp. Module  
S36 ETI 4000 Series 60W Amplifier  
S37 E.A. Stereo Infrared Remote Control

## AUDIO TEST UNITS

AT1 ETI 441. Audio Noise Generator  
AT2 ETI 128. Audio Millivolt Meter  
AT3 ETI 112. Audio Attenuator  
AT4 ETI 102. Audio Signal Generator  
AT5 E.A. A.F. Tone Burst Generator  
AT6 E.A. Laboratory Solid State A.F. Generator  
AT7 ETI 137. Audio Oscillator

## TEST EQUIPMENT

TE1 ETI 134. True PMS Voltmeter  
TE2 ETI 133. Phase Meter  
TE3 ETI 533c. Digital Display  
TE4 ETI 129. R.F. Signal Generator  
TE5 ETI 130. Temperature Meter  
TE6 ETI 706. Marker Generator  
TE7 ETI 709. R.F. Attenuator  
TE8 ETI 122. Logic Tester  
TE9 ETI 124. Tone Burst Generator  
TE10 ETI 123. C Mos Tester  
TE11 ETI 116. Impedance Meter  
TE12 ETI 533. Digital Display  
TE13 ETI 117. Digital Voltmeter 1975 Display  
TE14 ETI 117. Digital Voltmeter 1976 Display  
TE15 ETI 704. Cross Hatch Dot Generator  
TE16 ETI 120. Logic Probe  
TE17 ETI 121. Logic Pulser  
TE18 ETI 118. Digital Frequency Meter 1975 Display  
TE19 ETI 118. Digital Frequency Meter 1976 Display  
TE20 ETI 222. Transistor Tester  
TE21 ETI 113. 7 Input Thermocouple Meter  
TE22 ETI 107. Wide Range Voltmeter  
TE23 ETI 108. Decade Resistance Box  
TE24 ETI 109. Digital Frequency Meter  
TE25 E.A. SWR Reflectometer  
TE26 E.A. R.F. Impedance Meter  
TE27 E.A. Antenna Noise Bridge  
TE28 E.A. 1968 Transistor Test Set  
TE29 E.A. 1971 Transistor (F.E.T.) Tester  
TE30 E.A. 1977 Digital Logic Trainer  
TE31 E.A. 2 1/2 Digit Volt Ohm Meter

TE32 E.A. Simple Function Generator

TE33 E.A. Direct Reading Capacitance Meter  
TE34 ETI 487. Real Time Audio Analyser  
TE35 ETI 483. Sound Level Meter  
TE36 ETI 489. Real Time Audio Analyser  
TE37 ETI 717. Cross Hatch Gen.  
TE38 E.A. 3 Mhz Frequency Counter  
TE40 E.A. Direct Reading Ohm Meter  
TE41 E.A. Function Generator  
TE42 E.A. Transistor Tester Incl. BiPolar & F.E.T.S.

TE43 ETI 591. Up Down Pre-settable Counter  
TE44 ETI 550. Digital Dial (less case) includes ETI 591  
TE45 ETI 150 Simple Analog Frequency Meter  
TE46 ETI 151 Linear Scale Ohmmeter

## WARNING SYSTEMS

WS1 ETI 583. Gas Alarm  
WS2 ETI 066. Temperature Alarm  
WS3 ETI 528. Home Burglar Alarm  
WS4 ETI 702. Radar Intruder Alarm  
WS5 ETI 220. Walling Siren  
WS6 ETI 219. Hee Haw Siren  
WS7 ETI 313. Car Alarm  
WS9 ETI 503. Electronic Thief Trap  
WS10 ETI 506. Infra Red Intruder Alarm  
WS11 ETI 305. Automatic Car Alarm System  
WS12 ETI 582. House Alarm  
WS13 E.A. Electronic Siren  
WS14 E.A. 1976 Car Alarm  
WS15 E.A. 10 Ghz Radar Alarm

## PHOTOGRAPHIC

PH1 ETI 586. Shutter Speed Timer  
PH2 ETI 548. Photographic Strobe (less reflector)  
PH3 ETI 514B. Sound Light Flash Trigger  
PH4 ETI 532. Photo Timer  
PH6 ETI 505. High Powered Strobe (less reflector)  
PH7 ETI 513. Tape Slide Synchronizer  
PH8 ETI 512. Photographic Process Timer  
PH9 ETI 515. Slave Flash  
PH10 ETI 540. Universal Timer  
PH11 E.A. 1970 Stroboscope Unit (less reflector)  
PH12 E.A. Sync-A-Slide  
PH13 E.A. Auto Trigger for Time Lapse Movies  
PH17 ETI 558. Mast Head Strobe  
PH15 ETI 553. Tape Slide Synchronizer  
PH17 E.A. Digital Photo Timer  
PH17 ETI 594. Development Timer

## MODEL TRAIN UNITS

MT1 ETI 541. Model Train Control  
MT2 E.A. 1974 Model Train Control  
MT3 E.A. 1971 S.C.R. P.U.T. Control Unit  
MT4 E.A. Electronic Steam Whistle  
MT5 E.A. Electronic Chuffer  
MT6 E.A. 1978 Train Control

## AUTOMOTIVE UNITS

A1 ETI 317. Rev. Monitor  
A2 ETI 081. Tachometer  
A3 ETI 316. Transistor Assisted Ignition  
A4 ETI 240. High Power Emergency Flasher  
A5 ETI 239. Break Down Beacon  
A6 ETI 312. Electronic Ignition System  
A7 ETI 301. Vari-Wiper  
A8 ETI 502. Emergency Flasher  
A9 ETI 302. Tacho and Dwell Meter  
A10 ETI 303. Brake Light Indicator  
A11 ETI 309. Battery Charger  
A12 E.A. 1970 C.D.I.  
A13 E.A. High Efficiency Flasher  
A14 E.A. Dwell Meter  
A15 E.A. Variwiper  
A16 E.A. Tacho for Tune-ups  
A17 E.A. Ignition Analyser & Tacho  
A18 E.A. Strobe Adapter for Above  
A19 E.A. 1975 C.D.I.  
A20 E.A. Mains P.S. for Car Cass

A21 E.A. Automatic H.D. Batt. Charger

A22 ETI 318. Digital Car Tacho. (less metalwork)  
A23 ETI 319A. Variwiper Mk. 2 (No dynamic braking)  
A24 ETI 319B. Variwiper Mk. 2 (For dynamic braking)  
A25 ETI 320. Battery Condition Indicator  
A26 E.A. Transistor Assisted Ignition

## GUITAR UNITS

G1 ETI 447. Audio Phaser  
G2 ETI 413. 2 x 200 watt Bridge Amplifier  
G3 ETI 424. Spring Reverb Mixer  
G4 ETI 408. Reverberation Unit  
G5 ETI 413. 100 watt Guitar Amplifier  
G6 ETI 410. A.D.U. for your Guitar  
G7 E.A. PM 125 50 watt Guitar Amplifier  
G8 E.A. PM 134 21 watt Guitar Amplifier  
G9 E.A. PM 138 20 watt Guitar Amplifier  
G10 E.A. Waa Waa Unit  
G11 E.A. Fuzz Box  
G12 E.A. Sustain Unit  
G13 E.A. PM 135 12 watt Guitar Amplifier  
G14 ETI 452 Guitar Practice Amp.

## PRE-AMPLIFIERS AND MIXER

P1 ETI 445. Stereo Pre-amplifier  
P2 ETI 449. Balance Mic Pre-amplifier  
P5 ETI 444. Master Mixer 8 channel  
P6 ETI 419. Mixer Pre-amplifier — 4 ch; Mixer Pre-amplifier — 2 ch  
P7 ETI 401. F.E.T. 4 Input Mixer  
P8 E.A. Playmaster 127 Control Unit  
P9 E.A. Simple Mixer for Pick up & Mic  
P10 E.A. Playmaster 145 Mixer  
P11 ETI 446. Audio Limiter  
P13 ETI 477 Series 4000 Moving Coil Cartridge Pre Amplifier  
P14 ETI 471 Pre Amplifier  
P15 ETI 474 High to Low Impedance Interface

## TUNERS

T1 ETI 062. A.M. Tuner  
T2 ETI 740. F.M. Tuner  
T4 E.A. Playmaster 146 AM-FM Tuner

## VOLTAGE/CURRENT CONTROLS

V ETI 481. 12 volt to — 40V D.C. 100 watt Inverter  
V2 ETI 525. Drill Speed Controller  
V3 E.A. S.C.R. Speed Controller  
V4 E.A. Stage (etc.) Auto Dimmer 2 K.W.  
V5 E.A. Stage (etc.) Auto Dimmer 4 K.W. & 6 K.W. add on for above  
V6 E.A. 1976 Speed Control  
V7 ETI 592. Light Show Controller (3 ch.) (1000 w/ch)  
V8 E.A. Inverter 12V D/C Input 230V 50hz 300VA output

## POWER SUPPLIES

PS1 ETI 132. Experimenters Power Supply  
PS2 ETI 581. Dual Power Supply (High Powered Version)  
PS3 ETI 712. CB Power Supply  
PS4 ETI 131. Power Supply  
PS5 ETI 119. 5 volt Switching Regulator Supply  
PS6 ETI 105. Laboratory Power Supply  
PS7 ETI 111. I/C Power Supply  
PS8 E.A. D.C. Voltage Reference  
PS9 E.A. 1976 Regulated Power Supply  
PS10 E.A. Dual 20-2-0-30V at 2A or 0-60V at 2A or Dual Pos and Neg 30V at 2A  
PS11 E.A. C.B. Power Supply  
PS12 ETI 142. Power Supply 0-30V 0-15A (fully protected)  
PS13 E.A. Dream 6800

## RECEIVERS/TRANSMITTERS

R1 ETI 711. Remote Control T/X Switch  
R2 ETI 711R. Remote Control Receiver  
R3 ETI 711D. Remote Control Decoder  
R4 ETI 711B. Single Control

R5 ETI 711C. Double Control  
R6 ETI 711P. Power Supply  
R7 ETI 707A. 144 Mhz Converter  
R8 ETI 707B. 52 Mhz Converter  
R9 ETI 708. Active Antenna  
R10 ETI 710. R.F. Power Amplifier  
R11 ETI 780. Novice Transmitter  
R12 ETI 703. Antenna Matching Unit  
R14 E.A. 240 Communications Receiver  
R15 E.A. 110 Communications Receiver  
R16 E.A. 160 Communications Receiver  
R17 E.A. 130 Communications Receiver  
R18 E.A. All Wave I/C2  
R20 E.A. Fremodyne 4 Complete Kit  
R21 E.A. Fremodyne 4 RF Section  
R22 E.A. PM 138 Tuner Receiver  
R23 E.A. Mos Fet 52 Mhz Converter  
R24 E.A. 2-6 Mhz Converter  
R25 E.A. 6-19 Mhz Converter  
R29 E.A. Short Wave Converter for 27 Mhz  
R30 E.A. Simple S.W.R. Meter  
R31 E.A. 27 Mhz Pre-Amp  
R32 E.A. 10-30 Mhz Pre-Amp  
R33 ETI. Aircraft Band Converter

## COMPUTER AND DIGITAL UNITS

C1 ETI 633. Video Synch Board  
C2 ETI 632M. Part 1 Memory Board V.D.U.  
C3 ETI 632P. Part 1 Power Supply V.D.U.  
C4 ETI 632A. Part 2 Control Logic V.D.U.  
C5 ETI 632B. Part 2 Control Logic V.D.U.  
C6 ETI 632C. Part 2 Character Generator V.D.U.  
C7 ETI 632. Mother Board including P/S  
C8 ETI 632. U.A.R.T. Board  
C9 ETI 631-2. Keyboard Encoder  
C10 ETI 631. A. Sch. Keyboard Encoder (less keyboard)

## MISCELLANEOUS KITS

M1 ETI 604. Accented Beat Metronome  
M2 ETI 546. C.S.R. Monitor (less probes)  
M3 ETI 549. Induction Balance Metal Locator less Search Head  
M4 ETI 547. Telephone Bell Extender  
M5 ETI 602. Mini Organ (less case)  
M6 ETI 544. Heart Rate Monitor  
M7 ETI 044. Two Tone Doorbell  
M8 ETI 043. Heads and Tails  
M9 ETI 068. L.E.D. Dice Circuit  
M10 ETI 539. Touch Switch  
M11 ETI 529. Electronic Poker Machine  
M12 ETI 236. Code Practice Oscillator  
M14 ETI 701. Masthead Amplifier  
M15 E.A. I/C Volume Compressor  
M18 E.A. 240 volt Lamp Flasher  
M19 E.A. A/C Line Filter  
M20 E.A. Bongo Drums  
M21 E.A. Keyless Organ  
M22 E.A. Auto Drums  
M23 E.A. Electronic Roulette Wheel  
M25 E.A. Digital Metronome  
M26 E.A. Voice Operated Relay  
M27 E.A. Gas Detector Car; Boat  
M28 E.A. Led Chaser  
M29 E.A. Sound Effects Generator  
M30 ETI 551. Light Chaser 3 channel 1000 watt/ ch.  
M31 E.A. Electronic Poker Machine  
M32 E.A. Remote TV Headphone  
M34 ETI 650 STAC Timer  
M35 ETI 557. Reaction Timer  
M36 ETI 249. Combination Lock (less lock)  
M37 E.A. Combination Lock (including lock)  
M38 E.T.I. 576 Electromyogram  
M39 E.A. Prospector Metal Locator

E. D. & E. (SALES) PTY. LTD., NOW

# ALL ELECTRONIC COMPONENTS

118 LONSDALE STREET, MELBOURNE, VIC. 3000. TEL: 662-3506.



# MICROCOMPUTER PRODUCTS

123 Military Road,  
Guildford. Ph 632-6301.

Some of our fine range of products.

## MORROW (THINKER TOYS) PRODUCTS:

SuperRam: 16K Static RAM in KIT form for \$299.  
Discus 2D: Sorcerer Compatible 8" Floppy Disc System.  
Switchboard: Extended VO facilities for \$199 the Kit.  
Memory Master: 16K and 24K RAM with Bank Select from \$349.

Wunderbuss: Actively terminated ultra low noise S100 bus cards from \$54.

## Some of the SSM BLUE BOARDS:

VB3 80: 80 x 24 or 80 x 51 Video display board, graphics up to 160 x 204, up to 256 user defined symbols, full interface and memory mapped from \$375.

104: 2 parallel and 2 serial ports: RS232, current loop, 55 to 9600 baud for \$159.

SB1: Music Synthesiser card: Turn your computer into a musical instrument for \$179. Can be banked for multipart harmony. Provides wide range of waveform and envelope control.

MB8A: 1K to 16K EPROM card: \$145 plus 2708's Includes power on jump circuit, facility to disable any 1K chunk.

## PRINTERS:

Base 2 Dot Matrix for up to 132 characters per line from \$600. Can provide high resolution graphics and tractor feed.

Diablo Wordprocessing daisy wheel printing from \$2800. Other Printers available to special order.

## PROTOTYPING:

Solder, Soldering Irons, Tools, Wire Wrap materials and tools.

\$100 Wire wrap or solder card: \$18.50.

\$100 Extender with Logic probe, pulse catcher. A surprisingly powerful de-bugging tool for \$49.

## INTEL and ZILOG:

A full range of Intel and Zilog microprocessor and support chips.

**Opening Hours: Mon-Sat 9 to 6 and till 9pm Thur.**

Prices subject to change without notice.

## SOFTWARE:

CP/M, Microsoft Disc Basic, Tarbell Cassette Basic, Disc Fortran, Cobol, Pascal, Structured Systems' completely integrated Business Software, WordStar for Ultimate Word Processing, CP/M utility to use the ETI 643 EPROM Programmer to its fullest!

## BASIC HOME, HOBBY COMPUTER SYSTEM:

Includes the famous CMS-01 cabinet, containing the MPS-01X power supply, a fully terminated and shielded Wunderbuss, DG680 Z80 CPU card with Monitor VO and cassette interface, DG640 64 x 16 video card with graphics, 16K Morrow static RAM, 14" video monitor, ASR37 keyboard with upper and lower case. Priced from \$1595 including Sales Tax. Compare with about \$1900 for similarly optioned Sorcerer; with the added advantages of IEEE specifications. Expandable to the largest imaginable microcomputer system with floppy and/or hard disc drives.

## MOST POWERFUL BUSINESS SYSTEM:

We can provide one of the most powerful fully integrated business systems available. Standard Features: Most Rugged construction (engineered in sheet steel and cast aluminium), S100 from the ground up, without the add-on apologies often required by other systems. High resolution, green phosphor 80 x 24 character video display. Full word processing keyboard. Fast Z80 CPU, up to 64K of memory, all required input/output facilities. High speed, superior quality PerSci dual 8" floppy disc drive, running true IBM compatible Single and Double Density formats. Software: CP/M Disc Operating System, CBASIC2, Accounts receivable, accounts payable, general ledger, WordStar word processor, Mailing list, file Sort and Merge. Printer: Diablo word processing daisy wheel printer. See us and discuss your particular requirements, so that we can advise you on the best combination to meet them.

For a full range of AED's own products see ETI Dec '79 and Jan '80 advertisements and press releases.

**GET YOUR ETI 643 EPROM PROGRAMMER  
KIT FROM US FOR \$115.**

# AUDITEC POWER 25-250 WATTS

001 Mk.2 30 Watts R.M.S. Power Amplifier Module. Load 8 ohms. Less than 0.05 percent T.H.D. Fully short-circuit protected.

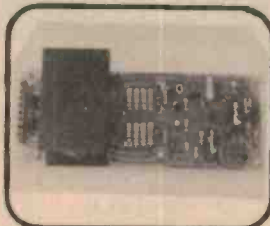

033 Very high quality 100 Watts R.M.S. Power Amplifier for studio work etc. Distortion almost unmeasurable. T.I. distortion almost nil. Produces a subtle difference in sound which has to be heard to be appreciated.

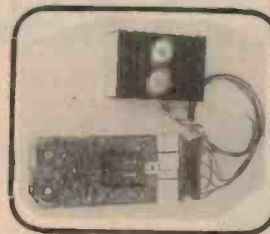

018 60 Watts R.M.S. at less than 0.1 percent T.H.D. Load 4 ohms. Fully short-circuit protected.

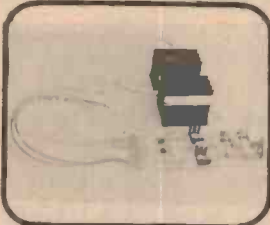

027 250 Watts R.M.S. power amplifier module at less than 0.2 percent T.H.D. Fully short-circuit protected. 8 ohm balanced output.

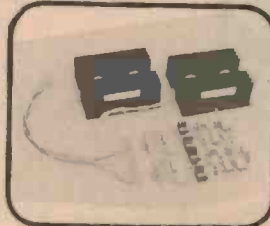

009 120 Watts R.M.S. at less than 0.1 percent T.H.D. Load 4 ohms. Fully short-circuit protected.

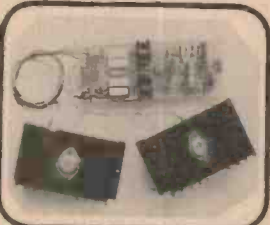

For descriptive leaflets on these models call phone or write to:

**AUDITEC AUSTRALIA  
PTY. LTD.**  
10 Waitara Avenue,  
WAITARA, NSW. 2077.  
Phone 48-4116.

(Pacific Highway side of Waitara Station)

## AUDITEC MAJOR STOCKISTS:

VIC: Zephyr Products, (03) 568-2922

QLD: Deisound Pty. Ltd. (07) 229-6155

SA: Neil Muller Pty. Ltd. (08) 272-8011

WA: Willis Trading Co. Pty. Ltd.

(092) 321-7609

ACT: Musique Boutique (062) 81-5255

NT: Darwin Communications Systems

(089) 85-3184

Farmer & Davies Electronics-Alice

Springs 52-2967

## OTHER AGENTS:

NSW: Hi-Fi Gallery, Tamworth,

(067) 66-2525

Ray Walsh Sound Systems, Albury,

(060) 21-1502

President Sound, Wentworthville,

(02) 631-6689

W.M.R. Electronics. (02) 605-1203

Dawes Sound Systems. (047) 39-4421

D.R. Hi-Fi & Electronics. Dee Why,

(02) 982-7500

Landers Music Centre Pty. Ltd. Orange,

(063) 62-6515

QLD: Bundaberg Hi-Fi. Bundaberg,

(071) 71-3176

Keller Electronics, Maryborough,

(071) 21-4559

R.A.V.E. Mermaid Beach,

(075) 38-3331

A FULL RANGE OF PREAMPLIFIERS, MIXERS AND COMPLETE AMPLIFIERS  
FOR PUBLIC ADDRESS, STUDIO AND HI-FI IS ALSO AVAILABLE

It's what you expect from Data Precision.  
 Our 3 1/2 digit Model 935 full function DMM gives you  
 0.1% accuracy on DC volts, as good as many lab/bench  
 instruments, and equally high accuracy on all of its 29 ranges.  
 All this comes in a palm-sized, lightweight package that goes  
 anywhere to solve your measurement problems.  
 It stays accurate too. Guaranteed for a full year  
 between calibrations (by only one adjustment!). And even if  
 you bang it around or subject it to large overloads —  
 the 935 is designed to take it.

**MODEL 935. Unmatched performance  
 at an unmatched price: \$149.00\***

Available from stock at all Data Precision  
 representatives.  
 \*Plus sales tax



# ACCURACY

Where you need it.

**DATA PRECISION**  
 Performance in the field.

Kenelec (Aust.) Pty. Ltd.

48 Henderson Rd, Clayton, Vic. 3168. Tel. (03) 560-1011. NSW (02) 439-3954. SA (08) 223-2420. QLD (07) 262-2223. WA (09) 444-5826.

## PRICE BREAKTHROUGH

A complete S100 BUS Dual Disk computer for :- **\$4950** \* Complete



THIS IS IT!

The amazing NEW dual processor Versatile 4 with an 8085 and Z80.

The system with 630K of disk storage and 32K of RAM. Expandable to 96 Megabytes!

Full business software, Word Processing, CPM, CBASIC, Burroughs polling capability and more also available.

DEALER ENQUIRES WELCOME



**MICROPROCESSOR  
 APPLICATIONS PTY. LTD.**  
 (03) 754 5108

MASKELL'S HILL RD, SELBY, 3159

\*unit quantity  
 plus tax if applic

small computers  
 solving large problems



# 70W booster amplifier for 28 and 52 MHz

Design: Rex Pearson, VK2AIP

Article: Roger Harrison, VK2ZTB

NOW THAT OLD SOL is at the peak of his/her/its 11-year activity cycle, interest in the DX opportunities available on the amateur 'six' and 'ten' metre bands (28 MHz and 52 MHz respectively) has also 'peaked'. Most of the popular commercial transceivers available for six metre operation have an output around 10-15 watts, PEP - SSB being the popular mode on this band. Homebrew transmitters for this band, too, generally put out about 10-20 watts as it is relatively easy to generate this sort of power using components widely available. Many designs have been presented in the wide-circulation amateur publications like QST, 73 and Ham Radio.

Whenever the six metre band 'opens', especially to one of the rarer areas, one can observe about four layers in the

ensuing 'dog piles' of calling stations. The first - and strongest - stations in the pile are those running high power linears, known as "the big boys" for most of them run 300-400 watts PEP output (the legal limit). The next layer consists of a large number of operators running around 50-60 watts output, generally from a transverter driven by a HF transceiver. They are known as "the transverter brigade". The third layer consists of those operators running 'barefoot' transceivers, either homebrew or commercial systems, with around 10-20 watts output. They are known as "the barefoot boys". The bottom of the pile is occupied by stations running low power commercial transceivers (such as the popular Icom IC501) or homebrew rigs - known as "the QRP brigade". This classification is

remarkably reminiscent of class stratification in Victorian England...

On six metres many of the anomalous propagation modes that provide the DX opportunities so many VHF enthusiasts delight in exploiting are often-times marginal and results depend a lot on the amount of power you run. And if you want to explore meteor scatter (popular during the previous solar minima), a power output of at least 50-60 watts minimum is required for reasonable results.

This booster amplifier will move you up one rung in the dog pile layers.

Similarly, on the ten metre amateur band, one can have a lot of fun with a converted CB rig. They have an output of 10-12 watts PEP, and can be 'coaxed' a little further, but not a significant amount. This booster amp should put you into much the same power bracket as most of the all-band transceivers.

## Circuit features

The design is very straightforward, centred on a Philips RF power transistor - the DX542CF, a fairly recent release. It has been carefully chosen for optimum linearity and performance in the 30-50 MHz region.

Automatic, signal-sensed antenna changeover is provided and the bias network has been arranged to turn off when the amplifier is not in-circuit, thus the booster does not draw current during receive - an important consideration for mobile or portable operation.

Apart from the RF power transistor, no specialised components have been used. When we published the series of ETI-715/716 VHF power amplifiers about two years ago, special mica compression trimmers were specified - expensive, and now difficult to get. This design uses inexpensive, commonly-available Philips film trimmers. The amplifier may be mounted onto a variety of available heatsinks, a special single-sided heatsink is not necessary. ▶



### DX542CF RF POWER TRANSISTOR - TYPICAL CHARACTERISTICS

F (MHz)	G (dB)	Input Z (series)	Output Z (parallel)	IMD (dB)
30	13	R1.47 - j0.3	1170pF & 1.2 ohms	>30
50	9.3	R1.36 - j0.3	937pF & 1.56 ohms	>30

# Project 726

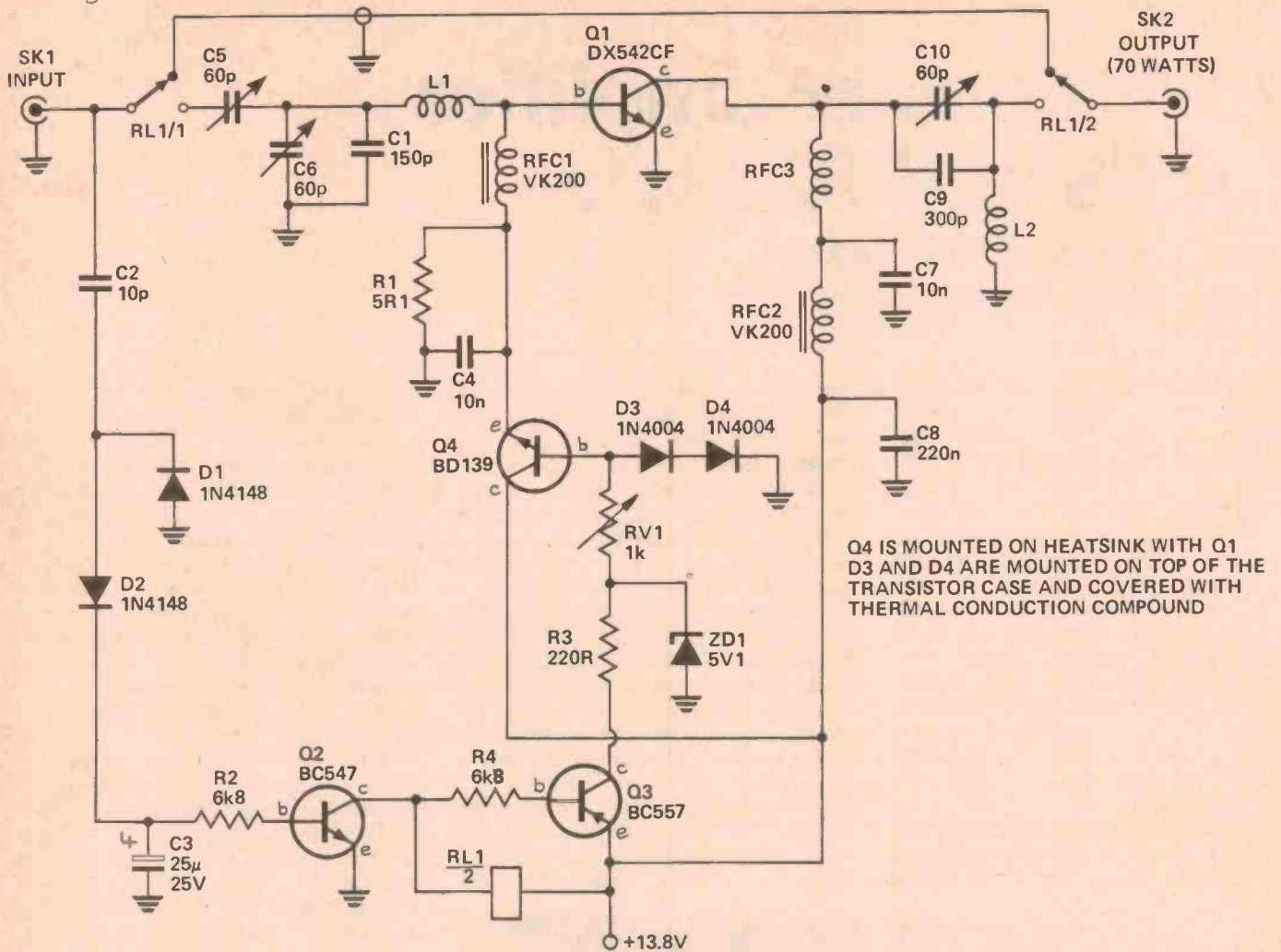

Q4 IS MOUNTED ON HEATSINK WITH Q1  
D3 AND D4 ARE MOUNTED ON TOP OF THE  
TRANSISTOR CASE AND COVERED WITH  
THERMAL CONDUCTION COMPOUND

## Construction

A double-sided printed circuit board is used. The underside, in contact with the heatsink, is unetched copper which provides a healthy 'ground plane'. The 'top' side is etched and the components mounted directly between the pads (take a close look at the photograph). There are two cutouts required in the board, one for the RF power transistor, Q1, and one for the bias transistor, Q4. Make sure that each device clears the edges of the cutouts. There should be about 1-2 mm clearance all round.

Two shim straps, each about 3-4 mm wide and about 10 mm long, should be soldered from each emitter pad of Q1 on the top of the pc board to the ground plane underneath. This should be done first thing. Ensure that Q1 still passes through the cutout and does not foul the shim straps. Two other shim straps are required - one adjacent to

## HOW IT WORKS - ET1726

The amplifier employs a single RF power transistor operated in Class B. The bias network and antenna changeover are operated by a circuit which senses the presence of input signal.

Taking the amplifier itself: the input is via SK1 and the antenna changeover is operated as soon as a very small amount of input signal from the transceiver is present. With RL1/1 operated, input is applied to the base of Q1 via an impedance matching network consisting of C5, C6 and C1 with L1. Bias is applied to the base of Q1 via RFC1. Output from the collector of Q1 is passed to the output socket, SK2, via another impedance matching network consisting of C9, C10 and L2, thence via RL1/2. Collector supply for Q1 is shunt fed via RFC2 and RFC3. The RF power transistor, Q1, has a power gain of around 8.5 - 9.5 dB so an input of about 10 W PEP will result in an output of 70 W PEP or more.

The input signal-operated bias and antenna changeover circuit operates as follows: a small amount of input signal is bled off by C2 and is rectified by a

voltage doubler consisting of D1 and D2. This will charge C3, applying forward bias to the base of Q2 via R2. When Q2 conducts, RL1 will operate, diverting the transmit signal from the transceiver via the amplifier. At the same time, base-emitter current will flow in Q3, via R4, turning Q3 on. It will draw collector current via ZD1 and R3. Thus, Q4 will be forward-biased from ZD1 via RV1, diodes D3 and D4 clamping the voltage on the base to about 1.2 - 1.4 volts. The base of Q1 will be forward-biased via the emitter of Q4, the base-emitter drop of Q4 allowing only about 0.6 volts to appear on the base of Q1. RF and dc earth-return for the base-emitter of Q1 is provided by R1 and RFC3.

When the input signal disappears, C3 will discharge via R2 and the base-emitter of Q2. When the voltage on the base of Q2 falls below about 0.5 V, about half a second after the input ceases, Q2, along with Q3, Q4 and thus Q1, will turn off and RL1 will release, returning the booster amp to the 'receive' condition.

# 6 or 10 metre power amplifier

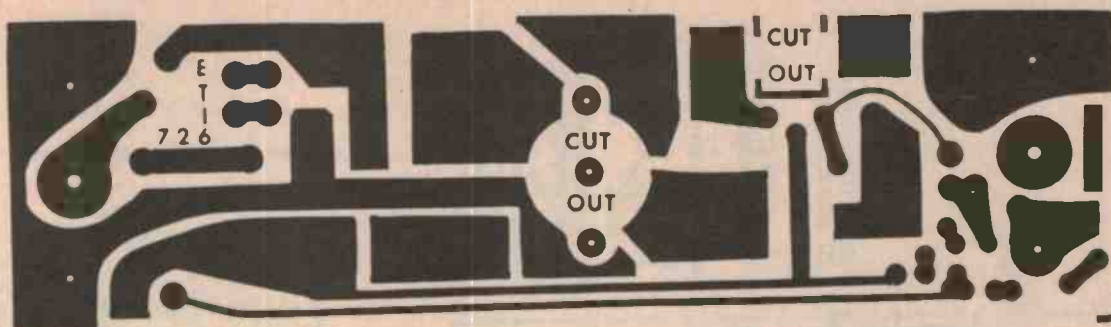

the input socket, and one adjacent to the output socket.

Next, mount the three trimmer capacitors. Bend their leads out from the component's case at a right angle. The fixed plates in these Philips trimmers have two connection leads, the fixed plates having only one. You can check this quite simply by examination of the trimmer. The fixed leads of C6 should be soldered to the ground pad (see pc board overlay) while the single moving plate lead of C5 should be soldered to the input pad (connected by coax to RL1 — see the overlay again). This avoids one of the leads of C5 fouling Q4. All the resistors and capacitors can then be mounted — save C2, which is left until after the pc board is assembled to the heatsink. Note that C9 on the 52 MHz model is actually three 100 pF ceramic capacitors in parallel (refer to the pc board overlay). Note also that the resistors are all stood on end. In the 28 MHz model, C7 consists of two 150 pF capacitors in parallel, while C9 is five 100 pF capacitors in parallel.

Now you can mount diodes D1, D2 and ZD1 — watch the polarity of these components. Follow this by mounting the two transistors Q2 and Q3. You can also solder the leads of Q4 to the board at this stage. Prior to soldering, bend a “U” in each lead, fairly close to the body of the transistor. The “U” will be about 1-2 mm across and about 2-3 mm high and on the plastic side of the transistor body. Cut each lead at the end of the U and bend a small bit out away from the body — this part solders to the pc board (the shape of each lead should look like an  $\Omega$  symbol). This bend provides some resilience in the leads to prevent damage to the transistor when it is screwed down to the heatsink later.

Note that diodes D3 and D4 are left until the pc board and Q1 are mounted to the heatsink.

The two ferrite RF chokes, RFC1 and RFC2, consist of a length of 22 gauge tinned copper wire passed

through five holes in a Philips six-hole ferrite bead — type 4312-020-31550. These can actually be obtained from a number of suppliers already wound and are known as “VK200” RF chokes. Alternatively, you can buy the beads separately (they are widely available) and wind them yourself.

The input and output coils, L1 and L2 may now be wound and mounted. They are constructed of 18 gauge tinned copper wire. The collector decoupling choke, RFC3, may be wound and mounted next. It is constructed of 20 gauge enamelled copper wire.

The antenna changeover relay, RL1 is the next item to attend to. Whilst holding it above the position it will occupy on the pc board, carefully bend each lead out so that it matches the corresponding pad on the board. Then solder it in place. Take a look at the photograph to check orientation.

At this point in the construction the board may be placed on the heatsink and used as a template to mark the hole drilling positions for the input and output coax sockets. Drill the holes to suit. Then, temporarily secure the board to the heatsink with the coax socket mounting bolts and mark the position of the hole required for the securing bolt for Q4. Also, carefully place the RF power transistor in the pc board cutout — correctly oriented — and mark the position of the two mounting bolt holes it requires. Disassemble the pc board and coax sockets from the heatsink and drill the latter.

Small self-tapping “PK” screws can be used to secure Q1 and Q4 so the heatsink need not be drilled right through. Drill a hole in each marked position using a drill which is the root diameter of suitable PK screws — a 1.5 — 2.0 mm diameter drill should be fine. Alternatively, you can tap the hole to take an appropriate screw, if you have the tools. Then again, you can drill right through and use a bolt, nut and washer. Whatever suits you and is mechanically suitable is fine.

Now, Q4 needs to be insulated from the heatsink as the metal area on the device is connected to the collector which is connected to the positive supply rail. Thus, an insulating washer is required. Smear both sides of the washer with silicone thermal compound (such as Bevaloid GS13 or other proprietary silicone heatsink paste).

Assemble the pc board and coax sockets to the heatsink once again, placing Q4's insulating washer over the bolt hole first. Tighten the nuts and bolts securing the coax sockets and solder the centre pins of the coax sockets to their pads — make sure you get a good joint. Now bolt down Q4.

Next, smear the bottom side of Q1's header with heatsink compound and place it in the pc board cutout being careful to orient it correctly. Refer to the transistor package diagram and pc board overlay to assist you. Bolt it in place then carefully bend down the leads and solder them to the pads on the pc board, being careful not to strain the leads. The bias network diodes, D3 and

## COIL AND CAPACITOR DATA

Coil	52 MHz	28 MHz
Input, L1	2 turns, 6 mm i.d.	3 turns, 6 mm i.d.
Output, L2	1 turn, 9.5 mm i.d.	3 turns, 9.5 mm i.d.
C1	150 pF ceramic	2 x 150 pF ceramic
C9	3 x 100 pF ceramic	5 x 100 pF ceramic

RFC3                                      7 turns, 6 mm i.d.                                      9 turns, 6 mm i.d.

Wire gauge: Coils L1 and L2 use 18 gauge B & S tinned copper wire; RFC3 uses 20 gauge enamelled copper wire.

# 6 or 10 metre power amplifier

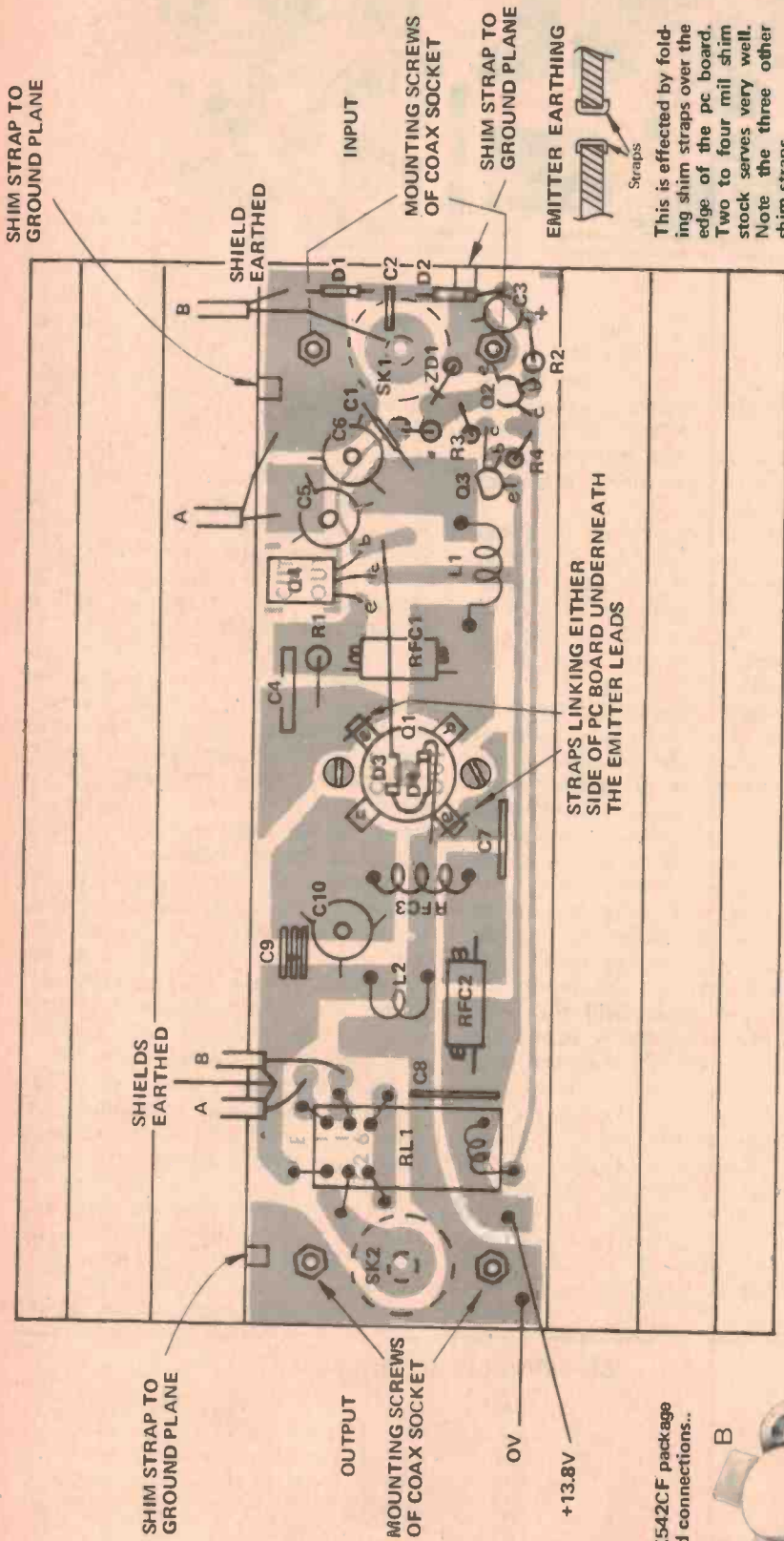

The DX542CF package and lead connections.



This is effected by folding shim straps over the edge of the pc board. Two to four mil shim stock serves very well. Note the three other shim straps.

SK1 and SK2 mounted on heatsink with centre pin soldered onto pc board. Q1 and Q4 are mounted onto heatsink through cutouts in pc board. RL1 has pins bent to allow soldering to the pc board. All resistors are stood on end. The base lead of Q2 must be slightly bent to fit correctly. \*RV1 used to set bias and can be replaced with a fixed resistor (shown).

## PARTS LIST - ETI 726

Resistors	all 1/2W, 5%	Miscellaneous
R1	5R1	RFC1, RFC2
R2	6k8	RFC3
R3	220R	L1, L2
R4	6k8	RL1
RV1	1k (vert mounting min trim pot (can be replaced with fixed resistor))	SK1, SK2
Capacitors		ETI 726 pc board, thermal conduction compound, minifin heatsink (see text), miniature 50 Ω coax, tinned copper wire.
C1	see coil table	
C2	10p disc ceramic	
C3	25μ 25V electro	
C4	10n disc ceramic	
C5, C6	60p trimmer - see text	
C7	10n disc ceramic	
C8	220n disc ceramic	
Semiconductors		
D1, D2	IN914, IN4148, etc.	
D3, D4	IN4004	
ZD1	5V1, 400 mW zener diode	
Q1	DX542CF Philips power transistor - see text	
Q2	BC547	
Q3	BC557	
Q4	BD139	

# NEW INSTRUMENTS from Christie Rand Pty. Ltd.

The SABTRONICS Type 8610 A Frequency Counter, gives you a first class, high stability instrument at the hobbyists price, for an 8 digit counter. Frequency Range guaranteed 10 Hz to 600 MHz (typically 5 Hz to 750 MHz) with a good sensitivity which holds over the whole range. Measurement accuracy of 1ppm plus 1 digit or 0.0001 percent. Ageing Rate: plus/minus 5ppm/yr. Gate Times, 0.1, 1, 10 secs. Battery Operated (not with unit). Size only 8"x6.5"x3". Weight 0.54kg (less battery)

**ONLY \$289 incl S.T.  
KIT \$250 Incl S.T.**

SCOPEX from England offer — a new lightweight dual trace, D.C. to 10 MHz oscilloscope with a 3 percent accuracy for the amplifiers and timebase. The Scopex 4D-10B is sold by Christie Rand Pty Ltd. Other features are: Y Amplifiers 10mV/cm to 50V/cm Timebase speeds 100ms/cm to 1us/cm Times 5 magnifier. Alternative channel & Chop Trigger Normal/TV field (TV line on Normal). AC switch for Amp to 3Hz. Z Modulation.

**ONLY \$550  
Plus 15 percent S.T.**

A NEW 0.1 PERCENT DIGITAL MULTIMETER BY SABTRONICS, U.S.A. is now available in KIT form. The price is lower than other comparable DMMs on the market The SABTRONICS model 2010A is obtainable from Christie Rand Pty Ltd. The specification of this 3½ Digit multimeter is:- D.C and A.C Volts 100uV to 1000V from 0.1 percent accuracy DC & 0.5 percent A.C. D.C and A.C Current 0.1uA to 10 Amp from 0.1 accuracy DC & 0.5 A.C. Resistance 100mΩ to 20MΩ from 0.1 percent accuracy. Diode Test 1mA, 10uA, 0.1uA Temp Range OC — 55C. Dry cells not included. Size only 8"x6.5"x3".

**ONLY \$159 Incl S.T. KIT \$142 Incl S.T.**

To compliment the dual trace oscilloscope by SCOPEX the D.C. to 25 MHz 4D-25 is now available. Again with all of the features listed in the 4D-10B including an accuracy of 3 percent for Amps and Timebase. Timebase speed 200ns/cm to 200ms/cm

**ONLY \$853  
Plus 15 percent Sales Tax.**

Switchable Probes for the above Attenuation x 1, x 10, and earth.

**ONLY \$48 each.  
Plus 15 percent Sales Tax.**

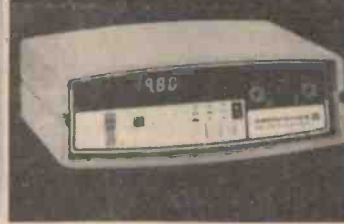

## MONEY BACK GUARANTEE IF NOT SATISFIED

NAME ..... Please send me .....  
 COMPANY if applicable ..... Cheque enclosed for \$ .....  
 ADDRESS ..... Or charge to my Bankcard, Expiry date .....  
 POSTCODE ..... PHONE ..... Signature .....

Send to:  
**CHRISTIE RAND PTY. LTD.**  
 PO Box 48, Epping, 2121.  
 Tel (02) 868-1209.



**\* Trendcom 100 \$395\***

**\* Trendcom 200 \$610\***

Word Processing from:

**COMPUTERWARE**

63 Paisley Street, Footscray. Vic. 3011.  
 (03) 68-4200

\*Plus sales tax

# Project 726

D4 can now be mounted. Place the diodes parallel to one another so that you can twist the anode lead of one diode together with the cathode lead of the other, and then solder them together. Smear the top of Q1 and the two diodes with silicone heatsink compound and put the two diodes on top of Q1. The spare anode lead (from what is now D3) goes to the base lead of Q4, over the top of RFC1 (refer to the pc board overlay). The remaining lead is bent back so that it may be soldered to the emitter (ground) pad adjacent to the grounded end of C7 (refer to the overlay again).

Last of all, solder C2 in place and add the two coax leads, A and B. Use RG174 3 mm diameter coax for these leads. Take care not to melt the insulation of the cables causing a possible short to the shield braid. These cables do not have to be any specific length — just allow enough to reach without the cables being crowded down on the pc board. The supply connections can then be made. This booster may draw 10 A on peaks, so use appropriately rated leads — 23/0076 is a suggested minimum. These leads should be colour-coded to avoid reverse connection, otherwise connect a power diode in reverse across the supply rail as 'idiot' protection.

At this stage, check *everything*. Having satisfied yourself that all is in order, you are ready for test.

## Powering up

You will need a 50 ohm, 50 or 100 watt dummy load, an SWR/power meter, a dc power supply that will deliver 12-14 volts at 10 amps and a 1½ V battery with clip leads attached. A low resistance ammeter to read 10 amps should be connected in series with the dc power supply.

First, connect the SWR/power meter and dummy load to the booster amp's output. No drive should be applied until much later. Connect the dc power supply and check to see that the amplifier draws no current. Taking your 1½ V battery, connect the *negative* terminal to a ground point and then the *positive* terminal to the junction of D1, D2 and C2 — this pad is immediately in front of the input coax socket centre terminal pad. The relay, RL1, should operate and the amplifier should draw around 200-300 mA of current if all is well. Now, lift the end of RFC2 that connects to the power supply rail on the pc board and connect a 0-100 mA meter in series (disconnect the dc power supply first!). With the power supply connected and the 1½ V

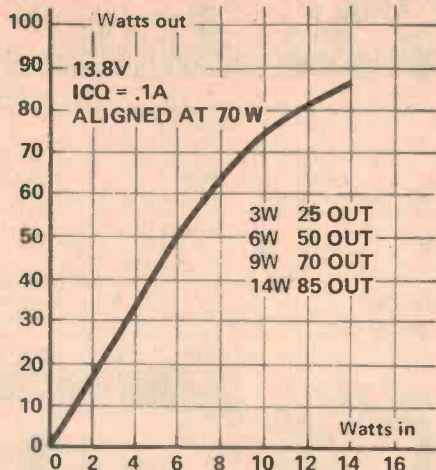

Output versus input power. This applies when the linear is aligned at 70 W out. With 3 W in, the amp can be aligned to give 32 W out.

battery reapplied to the junction of D1, D2 and C2, adjust the trimpot RV1 so that the collector current of Q1, as indicated on the milliammeter you just inserted, is 100 mA. Having done that, remove the milliammeter, restore RFC2 to its rightful position and you can move on to tune-up.

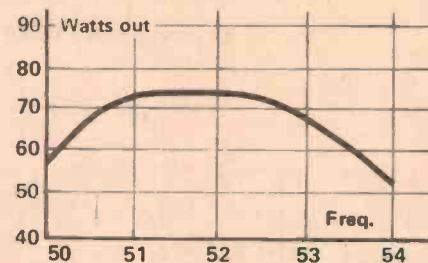

Bandwidth with the unit aligned at 52 MHz

## Heatsinks

The peak dissipation of the RF power transistor is about 50 W, about 20 W average for SSB operation during transmit periods. A heatsink rated between 1°C/watt and 1.5°C/watt should be used to give adequate heat dissipation. The one used on the prototype shown in the picture is a 147 mm length of "Minifin". In fact, the pc board has been designed to drop into this particular heatsink. There are several alternatives. A 152 mm length of Redpoint Q-type or L-type should be suitable. Dick Smith has a 225 mm length of single-sided heatsink that should be more than adequate — it's a little big but is OK if space is not a problem. The pc board would need to be mounted on the flat side.

Whatever heatsink you select you will need a space between the inner fins of at least 33 mm on the side the coax sockets mount and 40 mm on the side the pc board is mounted.

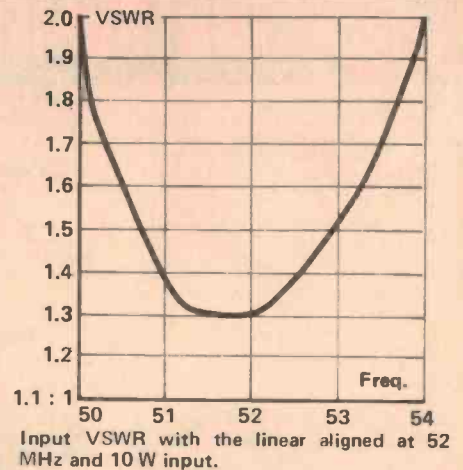

Input VSWR with the linear aligned at 52 MHz and 10 W input.

If you have, or can obtain, another in-line power meter, it would be a wise idea to connect it between your transceiver and the booster amp's input. First adjust your transceiver (into a dummy load) to give an output of 3-4 watts on carrier, or apply a single tone to the mic input and adjust the level to provide a similar power output.

With the transceiver and booster amplifier all connected up, apply drive and tune the trimmers C5, C6 and C10 for maximum power output. If all goes well at this stage, increase the drive to the 10 W level (or peak output of the transceiver, providing it's no greater than 15 W) and peak all the trimmers for maximum output. Check the input SWR.

That's the simplest tune-up method. By far the best method is to use a two-tone test generator and a spectrum analyser — but not every shack has these items!

Now you can give the amp an on-air test.

## Performance

Performance graphs for one prototype on 52 MHz are reproduced here. Output linearity and overall gain is dependent on the level at which the unit is aligned. If aligned at 10 W drive you'll get around 75 W output, but at 3 W drive you'll get about 30 W output. Intermod distortion on prototypes has been measured at better than 30 dB down on PEP output (two-tone). On 28 MHz the DX542CF has more gain than at 50 MHz so you'll get somewhat higher output for less drive.

Bandwidth of the unit, when aligned at one frequency, is flat within 1 dB over more than 2 MHz for power output, input VSWR being less than 1.5:1 over the same range.

This amplifier will provide more than adequate drive to a subsequent high power linear amplifier designed to deliver the legal limit of 400 W PEP output.

# TASMAN ELECTRONICS

12 Victoria St, Coburg, Vic. 3058. Ph 354-5062.

Minimum postage \$1.00.

TRANSISTORS	2N2646	1.00	78P05	8.00	74LS28	.35	74123	.85	TRIACS		2500uf	1.00	MINIATURE TRIMPOTS	
AC127	2N2647	1.20	78L05	.40	74LS30	.30	74132	1.30	SC141D	1.30	50V		100 to	
AC128	2N2904	.50	78L09	.40	74LS32	.30	74145	1.50	O4015L5	2.80	2500uf	2.15	1M OHM	.20
AD149	2N2905	.50	78L12	.40	74LS37	.40	74150	1.50	BT139	2.80	63V			
AD161	2N2905A	.50	78L15	.40	74LS38	.40	74151	1.40			10uf	.16		
AD162	2N2906A	.50	78L18	.40	74LS40	.30	74153	1.40	TRIGGER DIODES		47uf	.30	MINIATURE MULTITURN	
BC107	2N2907	.50	78L24	.40	74LS42	.45	74154	1.40	ST2	.55	100uf	.40	10 to	
BC108	2N2907A	.50	78L24	.40	74LS43	.60	74157	1.40	ST4	.80	220uf	.65	2M OHM	1.45
BC108C	2N3053	.55	78CB	2.40	74LS44	.40	74160	1.70	LED's		470uf	.75	POTENTIOMET.	
BC109	2N3054	.90	7905	1.85	74LS45	.40	74165	1.70	RED	.18	1000uf	1.65	SINGLE	.70
BC109C	2N3055	.75	7905K	2.95	74LS47	.60	74172	1.40	GREEN	.30			DUAL	1.60
BC177	2N3107	1.20	7906	1.85	74LS48	.40	74175	1.20	YELLOW	.30	RB. (PCB)		+ switch	1.80
BC177B	2N3300	.85	7908	1.85	74LS50	.40	74180	1.50	CLEAR	.25	6.3V		SLIDER	1.10
BC178	2N3302	.60	7912	1.85	74LS51	.40	74188	3.00	TIL209	.18	470uf	.20	CERMET TRIMPOT	
BC179	2N3638	.55	7912K	2.95	74LS52	.40	74192	1.80	FRD(f)	2.30	100uf	.10	100 to	
BC318	2N3638A	.59	7915	1.85	74LS53	.40	74193	1.80	SEL102S	.30	100uf	.10	1M OHM	.52
BC319	2N3638A	.59	7918	1.85	74LS54	.40	74367	.90	SEL103S	.30	16V		FUSEHOLDERS	
BC320	2N3702	.20	7924	1.85	74LS55	.40	4000	.30	SEL302E	.40	10uf	.08	3AG	
BC182B	2N3703	.30	79HG	10.80	74LS56	.40	4001	.38	SEL303E	.40	22uf	.10	502	.99
BC286	2N3704	.30	79L03	.95	74LS57	.40	4002	.40	SKNR	1.20	33/47uf	.10	504 (box)	.58
BC287	2N3819	.40	79L05	.95	74LS58	.40	4007	.30	SKNG	1.70	100uf	.15	830 line	.28
BC327	2N3904	.25	79L12	.95	74LS59	.40	4008	1.20	SKNY	1.80	220uf	.20	PCB CLIPS	.06
BC337	2N3906	.20	79L15	.95	74LS60	.40	4011	.38	LD271A	.80	330uf	.20	2AG	
BC338	2N4030	1.00	79L18	.95	74LS61	.40	4012	.30	ZENERS		470uf	.25	506	.75
BC547	2N4032	.80	79L24	.95	74LS62	.40	4013	.65	1/2 WATT	.19	1000uf	.40	FUSES	
BC548	2N4033	1.00	78MGT2C	1.80	74LS63	.40	4014	1.40	1 WATT	.30	2500uf	.65	25-75A	.20
BC549	2N4033	1.00	79MGT2C	1.80	74LS64	.40	4015	1.20	2 1/2 WATT	.65	25V		1-5A	.15
BC549C	2N4036	1.20	LINEAR		74LS65	.40	4016	.60	5 WATT	1.20	2u2/3u3	.10	2AG	
BC557	2N4037	1.30	301	.40	74LS66	.40	4017	1.30	MICROS		4u7/10u	.10	2-5A	.30
BC558	2N4231	1.20	307	.70	74LS67	.40	4018	1.30	6800P	11.50	25u/33u	.12	63-4A	.20
BC559	2N4234	2.10	308	1.20	74LS68	.40	4021	1.30	6821	6.50	47uf	.13	WINDING WIRE (B&S)	
BC639	2N4235	1.70	310	2.60	74LS69	.40	4022	1.30	6850	6.50	100uf	.15	16.23	2.00
BC640	2N4238	1.90	311	.70	74LS70	.40	4023	.30	TMS1000	7.95	220uf	.20	21.29	3.60
BCY71	2N4401	.20	318	3.20	74LS71	.40	4024	1.00	TANTALUM		330uf	.25	36.37	3.60
BD131	2N4403	.20	324	1.00	74LS72	.40	4025	.30	35v		470uf	.35	36.37	3.60
BD139	2N5086	.25	329	.90	74LS73	.40	4027	.70	u1-u68	.25	1000uf	.50	38.39	3.60
BD140	2N5087	.25	339	.90	74LS74	.40	4028	1.00	1u-10u	.30	2200uf	.90	40	3.60
BD262	2N5088	.30	377	2.70	74LS75	.40	4029	1.60	15uF	.55	22uf	.10	22	3.80
BD263	2N5089	.25	378	4.20	74LS76	.40	4035	1.20	22uF	.74	2u2/3u3	.10	26	3.90
BD647	2N5210	.50	379S	6.90	74LS77	.40	4040	1.40	10uF/25V	.25	10uf	.15	20,24	4.50
BD648	2N5458	.50	380-8	1.50	74LS78	.40	4042	1.20	4u7	.20	100uf	.20	28	4.90
BDV64B	2N5459	.55	380N14	1.50	74LS79	.40	4043	1.00	22uF	.30	220uf	.30	18,30	6.50
BDV65B	2N5461	.90	381	2.30	74LS80	.40	4044	1.00	47uF	1.30	1000uf	.70	31,32	6.60
BF115	2N5462	.90	381AN	3.96	74LS81	.40	4046	2.20	6.3V		220uf	1.10	33,34	6.60
BF338	2N5485	.65	382	2.00	74LS82	.40	4049	.70	47uF	.40	50V		IC SOCKETS	
BFW10	2N5871	1.70	388	1.38	74LS83	.40	4050	.75	100uF	1.10	47uf	.08	8 pin	.20
BFX84	2N5872	2.25	388	1.38	74LS84	.40	4051	1.20	47uF	.40	1u/2u2	.08	14 pin	.25
BFY50	2N5873	1.70	555	.35	74LS85	.40	4052	1.20	100uF		3.3uf	.15	16 pin	.28
BFY51	2N5874	1.85	556	1.20	74LS86	.40	4053	1.20	CERAMICS		4.7uf	.15	18 pin	.65
BFY90	2N6027	1.00	565CH	3.30	74LS87	.40	4060	1.50	1P-u01	.06	10uf	.15	24 pin	.80
BU126	2N6124	1.20	566	3.10	74LS88	.40	4066	.90	.0056uF	.10	22u/33u	.20	8 W/W	.33
BUX80	2N6126	1.30	567CH	3.00	74LS89	.40	4068	.45	.0068uF	.12	47u/100u	.20	16 W/W	.90
MJ802	2N6129	1.40	709	.80	74LS90	.40	4069	.30	.0082uF	.20	220uf	.50	EDGE CONN.	
MJ2955	2N6130	1.30	710	.80	74LS91	.40	4070	.30	.047uF	.08	470uf	.60	8 WAY	1.10
MJ4502	2N6132	1.60	711	.80	74LS92	.40	4071	.30	.1uF	.12	220uf	.50	16 WAY	1.85
MJE340	2N6134	1.70	741	.30	74LS93	.40	4072	.30	22uF	.22	470uf	.60	24 WAY	2.95
MJE2955	2N6134	1.70	747	1.00	74LS94	.40	4076	1.75	47uF	.25	63V		32 WAY	3.80
MPF102	3N140	1.70	748	.60	74LS95	.40	4077	.30	GREENCAPS		1u/2u2	.10	AUDIO MOD.	
MPS3565	3N201	1.60	771	.70	74LS96	.40	4078	.60	100V		3u3/4u7	.10	SI-1010	10.80
MPS3565	3N210	1.70	771	.70	74LS97	.40	4078	.60	.001uF to	.10	10u/25u	.15	SI-1020	21.90
MPS3538	40673	1.40	1458	.60	74LS98	.40	4082	.30	.027uF	.10	47uf	.20	SI-1030	27.75
MPSA05	DIODES		1558	.90	74LS99	.40	4093	.70	.033uF to	.10	100uf	.25	SI-1050	42.38
MPSA06	AA30	.40	2917	3.20	74LS100	.40	4441	.95	.056uF	.12	220uf	.40	HY5	33.00
MPSA12	AA24	.22	3089	4.20	74LS101	.40	4502	1.40	.068uF to	.12	330uf	.45	HY50	42.00
MPSA14	BP104	2.80	3914	4.50	74LS102	.40	4506	.70	1uF	.16	470uf	.80	HY120	95.00
MPSA15	BYX71	1.20	7392	3.30	74LS103	.40	4510	1.50	.12uF to	.30	160V		HY200	133.00
MPSA55	HP5082		CA3046	1.65	74LS104	.40	4511	1.30	22uF	.30	2.2uf	.20	HY400	188.00
MPSA92	2800	2.50	CA3086	.65	74LS105	.40	4518	1.80	250V		10uf	.30	JOSTY KITS	
MPSA93	OA47	.40	CA3130	1.50	74LS106	.40	4520	1.40	.33uF	.34	22uf	.50	as per JOSTY adverts.	
PN3564	OA90	.20	CA3140	1.50	74LS107	.40	4528	1.40	.39uF	.48	250V	.25	CABLE TIES	
PN3565	OA91	.20	CA3302	.70	74LS108	.40	4553	6.90	47uF	.50	350V	.20	3 1/2 Inch	.06
PN3566	OA636	.70	CA3401	.80	74LS109	.40	4581	3.50	.56uF to	.60	1uf	.20	5 1/2 Inch	.07
PN3567	P600G	.90	MC1494L	6.65	74LS110	.40	4582	1.40	82uF		CAN TYPE		SWITCHES	
PN3568	1N3493	1.70	OM350	7.90	74LS111	.40	4584	1.00	1uF to		35V		C&K	
PN3569	1N3493R	1.70	RC4136	1.45	74LS112	.40	40014	.90	1.5uF	1.00	2500uf	1.60	'7101	1.40
PN3638	1N4001	.08	PROMS		74LS113	.40	40097	1.00	1.8uF	1.20	2500uf	1.95	7201	1.90
PN3638A	1N4002	.10	93448	10.50	74LS114	.40	40098	1.20	2.2uF	1.40	40V		7301	2.95
PN3641	1N4004	.20	2708	12.00	74LS115	.40	74C02	.35	3.3uF	2.10	5600uf	2.40	7401	3.75
PN3642	1N4007	.10	1488	1.00	74LS116	.40	74C04	.35	4.7uF	3.50	50V		7201L40	2.15
PN3643	1N4148	.06	9368	2.30	74LS117	.40	74C08	.35	.001uF to		6800uf	5.20	7203	2.30
PN3644	1N5404	.40	8T24	2.20	74LS118	.40	74C10	.35	.0082uF	.20	63V		7301R	2.45
PN3645	1N5408	.80	RAMS		74LS119	.40	74C20	.35	0.1uF to		2500uf	3.25	8531	1.06
PN3646	BRID. RECT.		2102A-4	1.90	74LS									

• FAST • CLEAN • EFFICIENT

# SOLDAVAC DESOLDERING TOOL

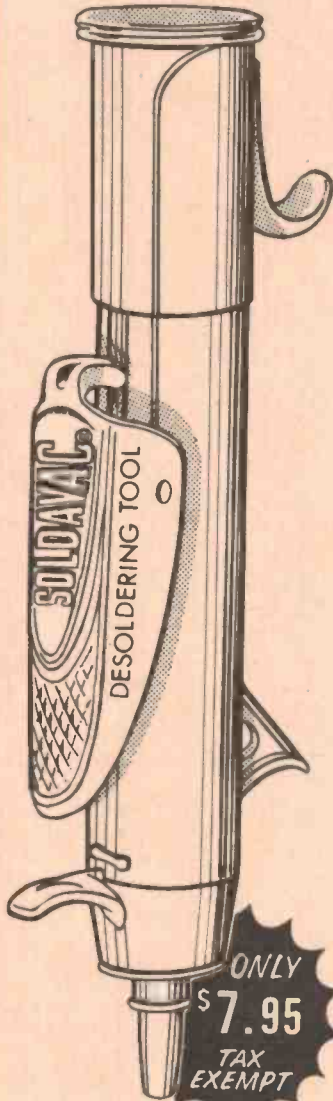

**ONLY  
\$7.95  
TAX  
EXEMPT**

Constructed of tough, shatter-proof plastic with a heatproof tip, SOLDAVAC desoldering tool is lightweight and its spring operated suction is designed for one hand operation.

Look for  
**SOLDAVAC**  
at your regular suppliers.

Or write for further details to:  
**ASSOCIATED SERVICES PTY. LTD.**  
110 Tynte St., North Adelaide  
South Australia 5006  
Phone: (08) 267 2246  
Mail Order, add 55c P&P

SYN-1 Single Board Computer \$210.00  
KTM-2 CRT/TV Keyboard terminal module \$349.00  
BAS-1 8K BASIC ROM for SYN-1 \$149.00  
BUFFERED MOTHERboard for SYN-1, KIM-1 or AIM-65 systems .. \$179.00

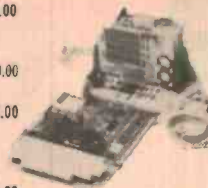

16K-8 fully tested memory board WRITE PROTECT and BANK switching for SYN-1, KIM-1 or AIM-65 systems .. \$360.00

EPROM Programmer and EPROM/ROM Board MEMORY mapped EPROM programming will program up to 16K per command firmware in PROM included. For SYN-1, KIM-1 or AIM-65 systems .....

\$345.00

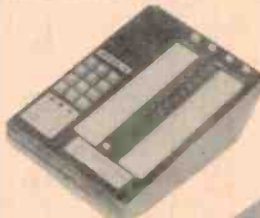

AUTOMATIC TELEPHONE DIALER PROM dialling 32 numbers plus other options

\$180.00

PRESETABLE COUNTER 5 digits suitable for counting, batching and numerical control

\$150.00



DIGITAL TACHOMETER

\$120.00

STEPPING MOTORS wide range for M.C. Control, Plotters, Variable speed, Servo Control etc. From

\$49.50



STEPPING MOTOR DRIVING CIRCUITS for 3 or 4 phase in Mode 1 phase 2 phase 1-2 phase excitation. From .....

\$12.00

THUMB WHEEL SWITCHES \$2.20 ea.  
PROXIMITY TRANSDUCERS \$15.00 ea.  
HAND HELD TACHOMETERS \$160.00 ea.

Mail orders add \$3.50 for postage and packaging

**G.C.S.**  
67 Blackshaw Avenue.  
MORTDALE 2223.  
Telephone: 570 1225  
(Trade enquiries invited)

# PLESSEY COMPONENTS

Australian distributors for



- IC MEMORIES
- MOS FET Audio Power Amplifier  
2SJ48-2SK133  
Complementary Pair

## GENERAL COMPONENTS Stocks held of ...

- Connectors
- Rotary Switches
- Lever Keys
- Reed Relays
- Neon Lamps
- Panel Lamps
- Switches
- Potentiometers
- Integrated Circuits
- Sonalert Devices
- Indicator Tubes
- Photodiodes
- Photo Voltaic Cells
- Nickel Cadmium Batteries
- Loudspeakers

Try us for hard-to-get components such as:-

SILVER MICA  
TRANSMISSION MICA  
TRANSMISSION CERAMICS  
COMPUTER GRADE ELECTROLYTICS



PO Box 2 Villawood, NSW. 2163  
Telephone 72-0133

Adelaide 269-2544 • Melbourne 329-0044  
Brisbane 36-1277 • Perth 458-7111



**Bill Edge's**

We stock all Dick Smith Electronics kits and some products plus an exclusive range of our own kits (See details EA Sept '79).

# ELECTRONIC AGENCIES

115-117 PARRAMATTA ROAD, CONCORD, 2137. TEL: 747-6472.  
(Corner Parramatta Rd and Lloyd George Ave)

## ELECTRONIC AND SPEAKER KITS FOR EVERYONE

A spectacular range is always available from Electronic Agencies. A free pamphlet outlining all our fantastic kits is yours on request.

# PHILIPS/ETI 4-WAY SPEAKER SYSTEM

(See ETI Feb '80)

This is really a superb system for the 1980's. Using the latest Philips speakers and a marvellous design by David Tilbrook, it is as modern as tomorrow. Not only will you have the ultimate in sound,

YOU COULD ALSO BE SAVING UP TO \$1,000,

as these speaker boxes are rivalling commercial units in the \$1,000-\$1,800 price bracket.



AD12250/W8  
300mm (12")  
Woofer, 100 watts  
RMS \$78.50

AD70601/W8  
178mm (7") Lower  
Midrange \$19.95

ADO2160/SQ8 Squawker  
(ADO2161/SQ8) 50mm (2")  
Midrange \$31.99

ADO1605/T8 25mm (1") Dome  
Tweeter \$15.99

## COMPLETE SPEAKER KIT

Including 2 only AD12250/W8, 2 only AD70601/W8, 2 only ADO2160/SQ8 (ADO2161/SQ8), 2 only AD10605/T8, 2 only 4-Way crossovers

ONLY \$377

(Boxes not included)

Box kits (Woodwork) will be available within the next few weeks. All speakers available separately (See box at left)



## 60 WATT LOW DISTORTION AMPLIFIER MODULE ETI 470

Complete 60 watt amplifier kit (as used in ETI 4000 kit). Absolutely everything including heatsinks and all hardware as per May '79 ETI. Features very low distortion and very simple mechanical construction (replaces ETI 480). Can be used to replace existing amplifier modules and bring your present system up to scratch.



ETI 470 KIT ONLY \$29.90

## FANTASTIC ETI "SERIES 4000" AMPLIFIER



Series 4000 Amp: with rack mount metal case as used by ETI — only \$189; with wooden sided case (same as metal but no flange or handles) — only \$179. If special "C" core transformer required add extra \$10.

This kit contains absolutely everything to build this high performance amplifier (equal to some commercial amps around \$600). All that's required is your labour and time and you could be saving up to \$400 or more!

This kit includes the two ETI 470 modules, ETI 471 high performance stereo preamp control unit, ETI 472 power supply case, front panel and all necessary wiring and hardware to make this kit the most professional you have ever built. We can say this with complete honesty as we have made up a kit to demonstrate.

With each set of instructions for the ETI 4000 we have included a two page insert on "How we constructed our ETI 4000" with hints and advice you wouldn't normally find in kit instructions.

## ETI 471 HIGH PERFORMANCE STEREO PRE-AMP CONTROL UNIT KIT

Designed to complement 60 watt ETI 470 modules, but is such an exceptional design it can be used to update existing systems or incorporate in new designs, as it has features unheard of in other pre-amp designs, eg all connections through RCA sockets and controls going direct to PCB. Everything designed for very very low distortion (Details see ETI June '79).



KIT incl hardware etc. (Front panel included — only in complete kit)

\$45.90

## ETI 472 POWER SUPPLY KIT

Complete set of parts, including all hardware, as per ETI July '79, for this exceptional power supply. With standard power transformer, \$42.90. With special "C" core transformer, \$52.90.

All components are available separately for the ETI 4000 Amplifier:

• ETI 470 PCB \$3.50 • ETI 471 PCB \$6.90 • ETI 472 PCB \$3.00 • BDV64B \$3.56 • BDV65B \$3.56 • Washers and brushes for BDV64/65B (set of 4) \$1.45 • Wooden sided case \$45.00 • Metal case \$55.00 • Silk screened front panel \$10.00.

MAIL ORDER: \$1.00 plus 5 percent of order value up to \$80, thence a flat \$4. Heavy items sent "freight-on" through carrier

# Series 4000 four-way loudspeaker

David Tilbrook

This project is the first in a series of loudspeaker projects designed to complement our Series 4000 range of quality hi-fi projects.

LOUDSPEAKERS still remain the weakest link in the hi-fi chain and the total sound of any system will depend more on the loudspeakers than any other single hi-fi component. So it is important to get the best loudspeakers, even if this means accepting a slightly lower performance amplifier or turntable. In most systems the performance of the cartridge, turntable and amplifier greatly exceeds that of the loudspeakers so an improvement in the loudspeaker department will often yield a radically improved system.

Unfortunately, there are very few really good kit loudspeakers. This project is an attempt to rectify that situation by providing a loudspeaker suitable for home construction that rates amongst the best available. This is not an inexpensive project – the driver and crossover cost being around \$400 – but the finished project will rival commercial units at three times the price.

## Choosing the drivers

In order to build a good loudspeaker it is obviously important to use good drivers, but availability is just as important a criterion as performance. For this reason we had a close look at the drivers commonly available in Australia and finally decided to use drivers from the huge range of Philips loudspeakers, some of which were not available in this country at that time. Philips agreed to stock the drivers we decided on and these form the basis of the 4000 series of loudspeakers.

The 4000/1 is a four-way sealed enclosure loudspeaker using 12 dB/octave crossover slopes. The original design for our prototype used an 18 dB/octave M-derived crossover (see 'Principles and problems in loudspeaker design' in last month's and this month's issues) but it was enormously expensive and complex and would have contributed little to the overall sound finally achieved with the 12 dB/octave cross-

over. The four-way approach allows closer control over the final frequency response than does a three-way. More importantly a major part of the mid-range normally handled by the woofer can be dedicated to a separate mid-range driver. The basic design idea was to use the woofer only up to 150 Hz. A separate mid-range driver would then take over up to 750 Hz where a second mid-range would come in. The lower mid-range driver, crossing in at 150 Hz needs a usable response down to around 60 Hz (i.e. one octave) so that the crossover region will have a reasonably flat response. Similarly, the woofer crossing out at 150 Hz needs to have a usable response to at least 300 Hz.

After a great deal of testing it was finally decided to use the Philips AD12250/W8 unit for the woofer. This is a 100 watt driver with a free air resonance of 26 Hz. When mounted in the enclosure the fundamental resonance rises to around 31 Hz, an excellent figure. This driver seems to have a bad hole in its response at 350 Hz but this is unimportant in this loudspeaker.

The AD70601/W8 unit was chosen as the lower mid-range as it has a free air resonant frequency at 45 Hz. This driver is actually a woofer and does not have the integral sealed enclosure common to many mid-range drivers. The enclosure must be provided by the cabinet construction and the volume chosen in the 4000/1 increases the 45 Hz fundamental resonance of this driver to around 55 Hz, which is ample.

The response between 750 Hz and 3 kHz, where the tweeter takes over, is handled by the latest Philips dome (AD02161/SQ8) mid-range. This driver has a 50 mm textile dome giving a good frequency response and wide dispersion at higher mid-range frequencies.

Above 3 kHz the AD01610/T8 tweeter is used. We tested a large range of Philips tweeters and this was the best, followed closely by the AD01605/T8,



The 4000/1 loudspeaker, without the front grille, showing the drivers. It stands about one metre tall.

which suffered a little from roll-off of the frequencies above 10 kHz.

## Construction

If you are constructing the boxes yourself start by assembling the sides, top, bottom and back of the cabinet. The bottom panel is placed 100 mm above the bottom of the box and the cavity formed under the box can be used to mount the crossover instead of putting it inside the box as is the usual practice. Now insert the two pieces of timber that form the mid-range enclosure. It is essential that there is a perfect seal between the bass and mid-range chambers, as well as between these two chambers and the outside air. Line every joint carefully with caulking compound

# 4000/1 4-way speaker system

## HOW IT WORKS.

The input signal from the output of the amplifier is fed to the 4 way crossover that divides the signal into the different frequency bands covered by each of the drivers. The loudspeaker cabinet is divided into two sections, the larger one forming the bass chamber for the woofer and the smaller one forming the midrange chamber. These two chambers are sealed from each other so that interactions cannot occur between the back radiations of the woofer and lower midrange. The other two drivers have their own enclosures as an integral part of the driver. For a detailed account of the design approach and the problems that occur in loudspeaker design read 'Principles and problems in loudspeaker design' in this month's and last month's issues.

or glue so that no possibility of an air leak exists. This is probably the best stage of the construction to drill the holes for the wiring to the loudspeakers. I used two cores of 240 volt three-core mains cable for this purpose, mainly because a round hole could be drilled and the cable squeezed through it to make a reasonable seal. Three holes need to be drilled in the bottom of the midrange chamber to allow for cables for the two midrange drivers and the tweeter. Cut suitable lengths of 240 V mains cable and insert these through the holes. Seal between the cables and the holes with sealing compound or a glue like Silastic. If the crossover is to be mounted under the loudspeaker, drill four holes through the bottom of the box and run the cables exactly as with the mid-range enclosure. Drill the holes so that they are closer to the rear of the box to allow ample room for mounting of the crossover. The input terminals should be mounted on the back of the enclosure, below the bottom panel if the crossover is mounted under the loudspeaker.

It is not necessary to have the front baffle removable since the drivers are external mounting types. It is probably easier to cut the holes for the drivers before mounting the baffle onto the front of the cabinet. The base panel and midrange enclosure panel should have been cut so that 38 mm remains between these and the front edge of the side and top panels. When the front panel is fitted, 19 mm should remain between the front of the baffle and the front edge of the sides and top.

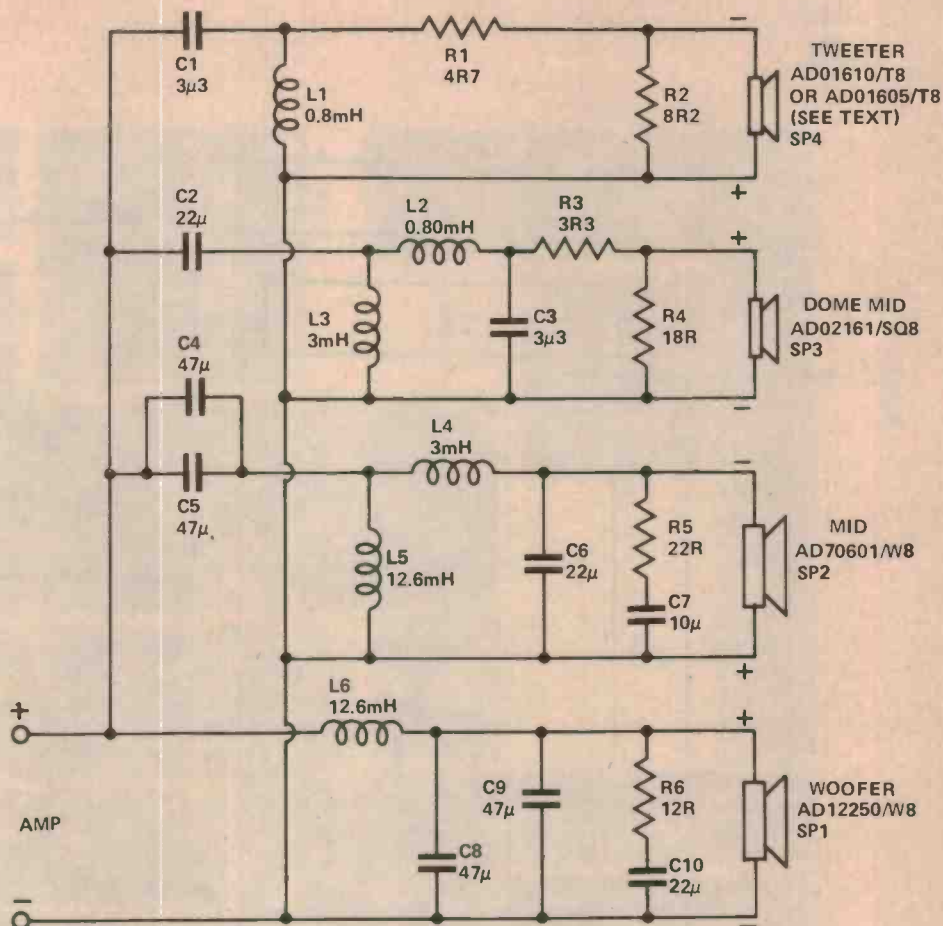

Circuit diagram for the four-way system. Driver polarity is important. Note that the "dome mid" driver, AD02161/SQ8, is available in two models, the other being AD02160/SQ8, which is different in appearance but electrically equivalent.

This space will be taken up by the grill cloth frame. Seal the remaining joints between the front baffle and the rest of the box. The only remaining part of the box construction is to attach the small 100 mm high wooden panel to the bottom of the box. The front grill is made by constructing a rectangular frame that fits into the remaining cavity on the front of the baffle. Stretch the grill cloth (use proper speaker grill material to avoid absorption of the treble) tightly over the frame.

If you have purchased a kit of ready made boxes it will still be necessary to drill the holes for the cables and to seal the box thoroughly with some sealing compound. If the slightest leak exists between the bass and mid-range chambers the large pressure increases created in the bass chamber will force the mid-range to vibrate, causing distortion.

The last stage before mounting the drivers is to line the box with 25 mm thick loudspeaker innerbond. Line the

back, sides, top and bottom of both the bass and mid-range chambers. Attach the innerbond firmly to the sides of the box using tacks or thin nails and glue.

The tweeter and dome mid-range drivers are supplied with mounting washers so that good seals can be made between the drivers and the baffle. Use adhesive foam tape available from most hardware stores, to make a good seal around the lower mid-range unit and the woofer. Stick the tape to the front of the baffle around the edge of the holes cut for the woofer and mid-range so that when the drivers are mounted a good seal results.

Solder the wires to each of the drivers making sure you know which wire is connected to the positive terminal on the loudspeaker. This terminal is marked on the driver either by a red terminal or a red dot near one of the terminals. Mark the other ends of the cables so that it is clear which cables connect to which drivers. *This is important*; if the outputs of the crossover are connected to the wrong drivers ▶

1-0004173

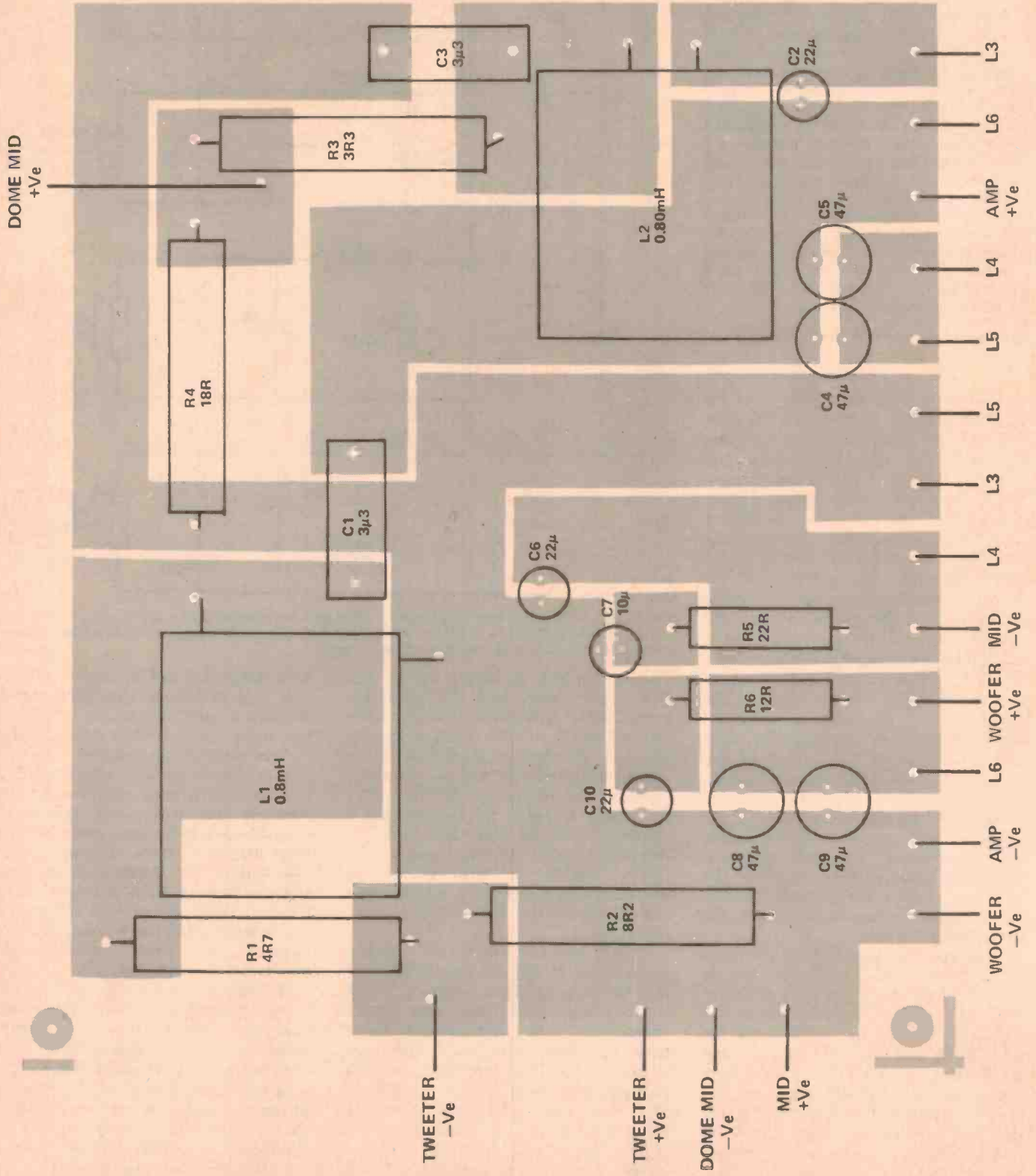

# 4000/1 4-way speaker system

this could result in damage to the drivers.

Once all of the drivers are mounted the final stage is the construction and mounting of the crossover. If the crossover is mounted inside, instead of under the box it will be necessary to leave mounting of the woofer until last. After all of the drivers have been mounted connect a 1.5 volt battery to the woofer wires and watch the lower mid-range cone. If it moves, the seal between the bass and mid-range chambers is not complete.

The inductors used in the crossover are too big to be mounted on the pc board. All the other crossover components are on the pc board. Start construction of the crossover by

## PARTS LIST - ETI 496

The following is a parts list for one only loudspeaker so two of every component will be needed for a stereo pair.

### Drivers

SP1 . . . . .	Philips AD12250/W8
SP2 . . . . .	Philips AD70601/W8
SP3 . . . . .	Philips AD02161/SQ8
	Philips AD02161/SQ8 or
	AD02160/SQ8
SP4 . . . . .	Philips AD01610/T8 or
	AD01605/T8, see text.

### Inductors

L1, L2 . . . . .	0.8 mH max dc resistance
	0.5 R
L3, L4 . . . . .	3.0 mH max dc resistance
	0.5 R
L5, L6 . . . . .	12.6 mH max dc resistance
	0.7 R

### Capacitors

C1 . . . . .	3 $\mu$ 3 polycarbonate
C2 . . . . .	22 $\mu$ bipolar electrolytic 50 V
C3 . . . . .	3 $\mu$ 3 polycarbonate
C4, C5 . . . . .	47 $\mu$ bipolar electrolytic 50 V
C6 . . . . .	22 $\mu$ bipolar electrolytic 50 V
C7 . . . . .	10 $\mu$ bipolar electrolytic 50 V
C8, C9 . . . . .	47 $\mu$ bipolar electrolytic 50 V
C10 . . . . .	22 $\mu$ bipolar electrolytic 50 V

### Resistors

R1 . . . . .	4R7 10 W 5%
R2 . . . . .	8R2 10 W 5%
R3 . . . . .	3R3 10 W 5%
R4 . . . . .	18R 10 W 5%
R5 . . . . .	22R 5 W 5%
R6 . . . . .	12R 5 W 5%

### Miscellaneous

pc board . . . . .	ETI 496
Wire, one pair of spring terminals, particle board, screws, glue, etc.	
Speaker grill cloth, innerbond.	

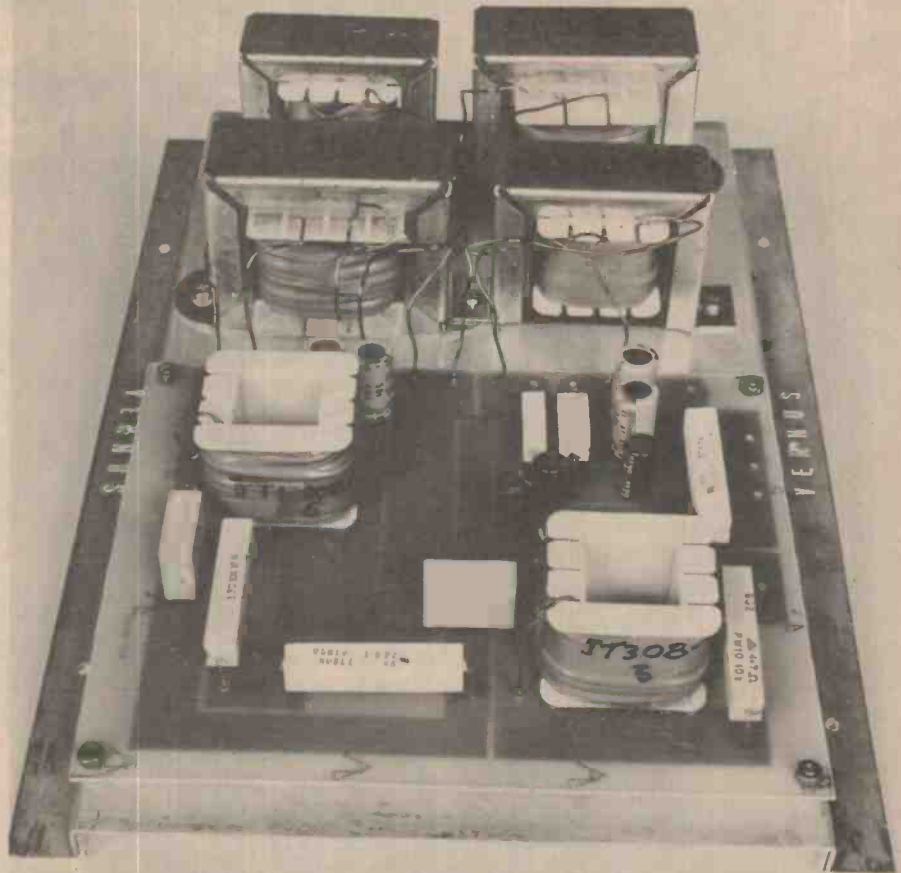

We mounted the crossover network assembly on an aluminium plate, bent as shown. The whole assembly was then screwed to the bottom of the loudspeaker and each driver connected as per the overlay.

mounting and soldering the capacitors to the pc board. Next solder the resistors into place spacing them approximately 10 mm off the board. This is necessary to prevent charring the pc board should these resistors get hot when the speaker is used with high power amplifiers. The remaining two inductors should be glued onto the pc board and then the leads soldered.

The prototype crossover was mounted on a sheet of aluminium 200 mm by 330 mm, but this is optional. If you elect to use this method of construction screw the remaining four inductors onto the aluminium sheet and solder the leads from these onto the pc board. Solder the leads from the drivers and input terminals onto the pc board and mount the pc board onto the aluminium base using 6 mm spacers. Finally, the whole crossover can be screwed to the bottom of the loudspeaker box. If you are not using the aluminium base the pc board and inductors are mounted directly

to the bottom of the loudspeaker box. The advantage of using the aluminium base is so that the crossover can be handled as one complete unit.

## Powering up

Before connecting the loudspeaker to an amplifier touch the input of the loudspeaker to a single 1½ volt penlight battery. With the positive of the battery connected to the positive input (red terminal) of the loudspeaker the woofer cone should move forward and the loudspeaker should make a loud thump. Listen to all the drivers separately while connecting and disconnecting the battery to check that all of the drivers are operating. Don't use a battery any bigger than 1½ volts for this test or you could damage the woofer.

If all is well, connect the speakers to an amplifier and turn the volume up slowly.

## Performance

Power handling figures for loudspeakers ►

# Philips introduce their new loudspeakers designed for the 80's

## High power - High fidelity to Din 45 500

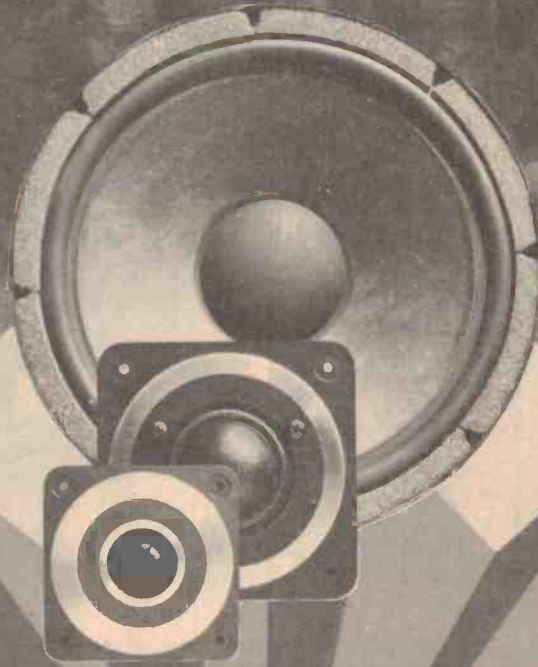

Introducing the new range of Philips loudspeakers, developed out of 50 years experience in loudspeaker research and production. And they're here before the '80s. Select now from our wide range of fine quality, high performance Woofers, tweeters and squawkers. To get more information, talk to your nearest Philips distributor or dealer, or write to Philips direct at P.O. Box 50, Lane Cove, N.S.W. 2066.

#### **Tweeters — 25 mm Dome High Power**

Incisive AD 0140/T8 40W RMS Polycarb Non Exposed Dome  
Incisive AD 0162/T8 or T1550W RMS Polycarb Non Exposed Dome  
New Smooth AD 01605/T8 50W RMS Textile Exposed Dome  
New Smooth AD 01631/T8 50W RMS Textile Non Exposed Dome

#### **Woofers — 300 mm High Power.**

New AD 12650/W8 60W RMS  
New AD 12200/W8 80W RMS  
New AD 12250/W8 100W RMS

#### **Squawkers — High Power**

AD 5060/SQ8 40W RMS 125 mm Cone Sealed Back  
AD 0210/SQ8 60W RMS 50 mm Dome Sealed Back  
New AD 02160/SQ8 80W RMS 50 mm Dome Sealed Back

Don't forget to ask your Philips distributor/dealer about:  
● these & other drivers; ● recommended enclosure designs from 10W- 100W RMS; ● loudspeaker kits.

#### **Philips Hi-Fi Speaker System Kits SYDNEY**

**Dee Why:** D.R. Hi-Fi & Electronics, 657 Pittwater Road, North Sydney;  
**North Point Hi-Fi:** Shop P23, Northpoint Building, 100 Miller Street, Redfern;  
**Sheridan Electronics,** 164-166 Redfern Street, Concord; **Electronic Agencies,** 115-117 Parramatta Road, Pendle Hill; **Electronic Distributors,** Shops 2, 3, 4, Post Office Arcade, Joyce Street, City; **Magnetic Sound,** 32 York Street.

#### **Philips Hi-Fi Loudspeakers and Loudspeaker Kits Distributed by:**

**Queensland:** Audiotronics Pty. Ltd., 396 Montague Rd., West End, Brisbane. Phone: 44.7566. **Victoria:** Systems Reliability Pty. Limited, 49 Tope Street, South Melbourne. Phone: 699.8433. **South Australia:** World Imports, 232 Rundle Street, Adelaide. Phone: 223.6539. **Western Australia:** Electro Acoustic Co. Pty. Ltd., 55 Froblsher Street, Osborne Park. Phone: 444.8688.



**Electronic  
Components  
and Materials**

# PHILIPS

# 48K DYNAMIC RAM

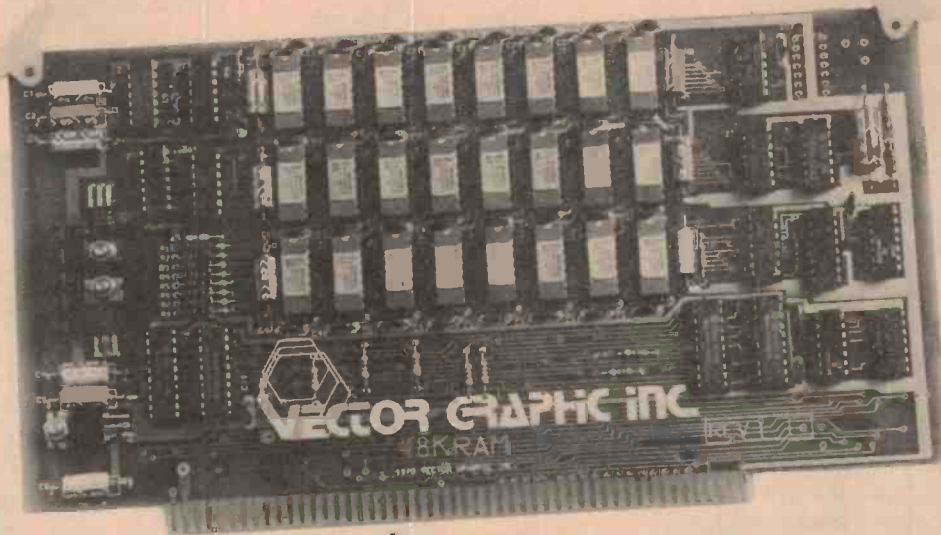

**\$750**

**AJ. & JW. DICKER**

24 Woodfield Boulevard, Caringbah, NSW. (02) 524-5639.

## POWER SUPPLIES

### Fixed Voltage for Battery Operated Equipment

- Fully protected against sustained short circuits
- Rugged, attractive steel case
- Suitable for continuous operation in high ambient temperatures
- On-off switch with separate L.E.D. indicator
- Overload Indicator on ECA143 and ECA144



	ECA140	ECA143	ECA144
--	--------	--------	--------

OUTPUT	13.8V 2 A	13.8V 3 A	13.8V 4 A
--------	--------------	--------------	--------------

RIPPLE & NOISE: 0.75mV/Volt at rated output

PROTECTION: Fold back current limiting

### Variable Voltage for Bench Use

The "ECA160" series are low cost power supplies designed for laboratory, factory test and systems applications. They are equipped with a front panel mounted 10 turn voltage control, combination ammeter/voltmeter and binding posts. Output is continuously variable from zero to 8% above the maximum rated voltage.

#### FEATURES:

- Linear series regulator
- Automatic short circuit protection
- Low drift
- Fast transient response
- Electricity authority approved



VOLTAGE CONTROL :  
10 turn 5mV resolution  
RIPPLE : 2mV RMS  
LOAD REGULATION :  
0.04% or 10mV

TYPE NO.	VOLTS	AMPS
ECA160-12/3	0-12	3.0
ECA160-24/1.5	0-24	1.5
ECA160-35/1	0-35	1.0

Made in Australia and Guaranteed by:



# FERGUSON

FERGUSON TRANSFORMERS PTY. LTD.  
31 HIGH STREET, CHATSWOOD, N.S.W. 2067.

# Project 496

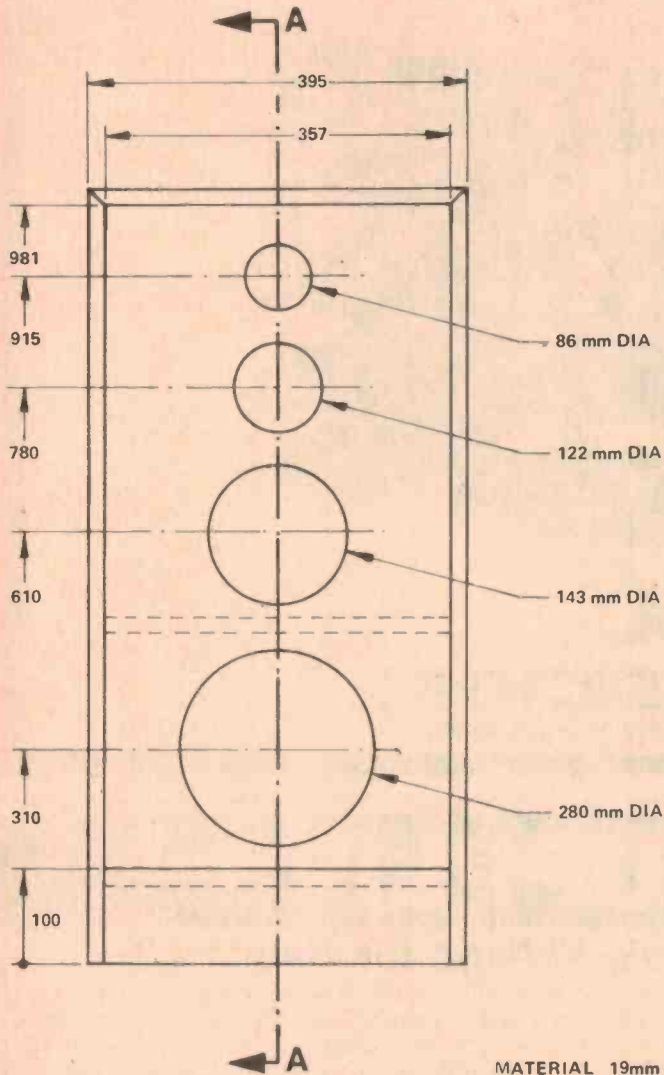

Complete cutting and assembly details for the four-way loudspeaker box. It is important that all joints be well sealed.

MATERIAL 19mm PARTICLE BOARD

ALL DIMENSIONS ARE IN MILLIMETRES

NOT TO SCALE

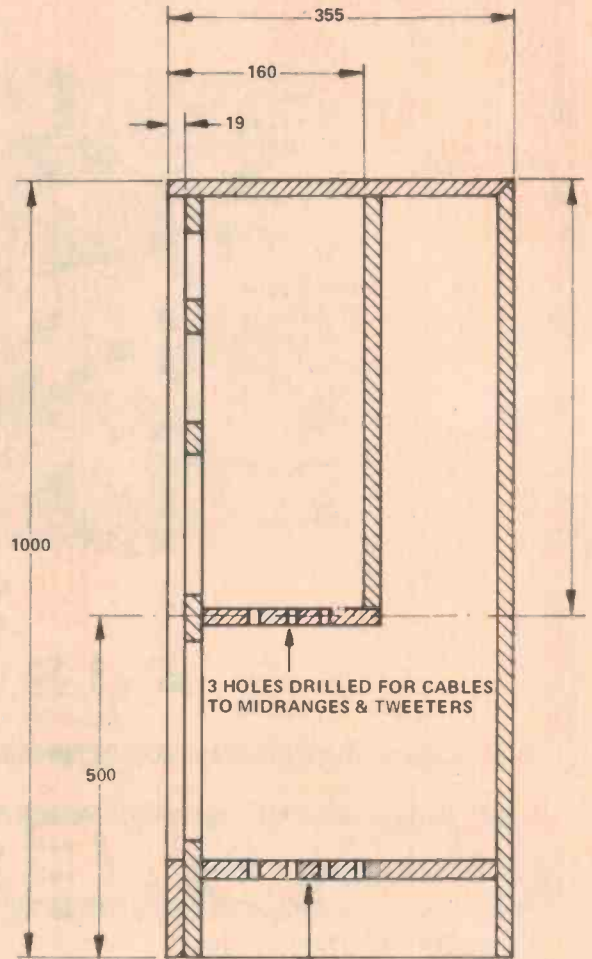

3 HOLES DRILLED FOR CABLES TO MIDRANGES & TWEETERS

4 HOLES DRILLED TO ALLOW CABLES TO BE BROUGHT OUT THE BOTTOM OF THE BOX IF CROSSOVER IS TO BE MOUNTED IN THE BASE.

SECTION AA

are a very dubious quantity. Some manufacturers (not many) quote continuous sine wave power handling at a particular frequency, but it is doubtful that this is a really meaningful figure. Probably the best way of measuring power handling is with pink noise. This is a type of noise which contains equal energy per octave over the entire audio range. Using this technique, these loudspeakers are rated at 100 watt power handling. The bipolar electrolytic capacitors used in the crossover are rated at 50 volts. This corresponds to 156 watts into an 8 ohm load so this should be considered the *absolute maximum* power for the loudspeaker. It is sometimes mistakenly thought that

the power handling figure represents the power below which the loudspeaker cannot be damaged. The most dangerous condition for any loudspeaker is a heavily clipping amplifier. In this state the output of the amplifier approaches dc and even a 20 watt amplifier can do irreparable damage if operated incorrectly.

Your ears are the best indication that the loudspeakers are operating safely. If the sound becomes distorted or unpleasant at higher power levels, turn down your amplifier. Nine times out of ten it will be the amplifier and not the loudspeaker that is running out of power.

The 4000/1 loudspeaker has been

designed in accordance with extensive tests that reveal the "ideal" frequency response characteristics for most listening environments. This response is not flat but has a tapered top end, so that the extreme treble is attenuated slightly with respect to the mid-range and bass.

The subjective test revealed just how good the loudspeakers are. The frequency response is smooth and extended and the bass and treble are present only when they should be!

Above all, the sound is clean and easy to listen to for extended periods, even at very high listening levels. I hope you get as much enjoyment from your 4000/1 speakers as I have. ●



4000/1 4-way speaker system

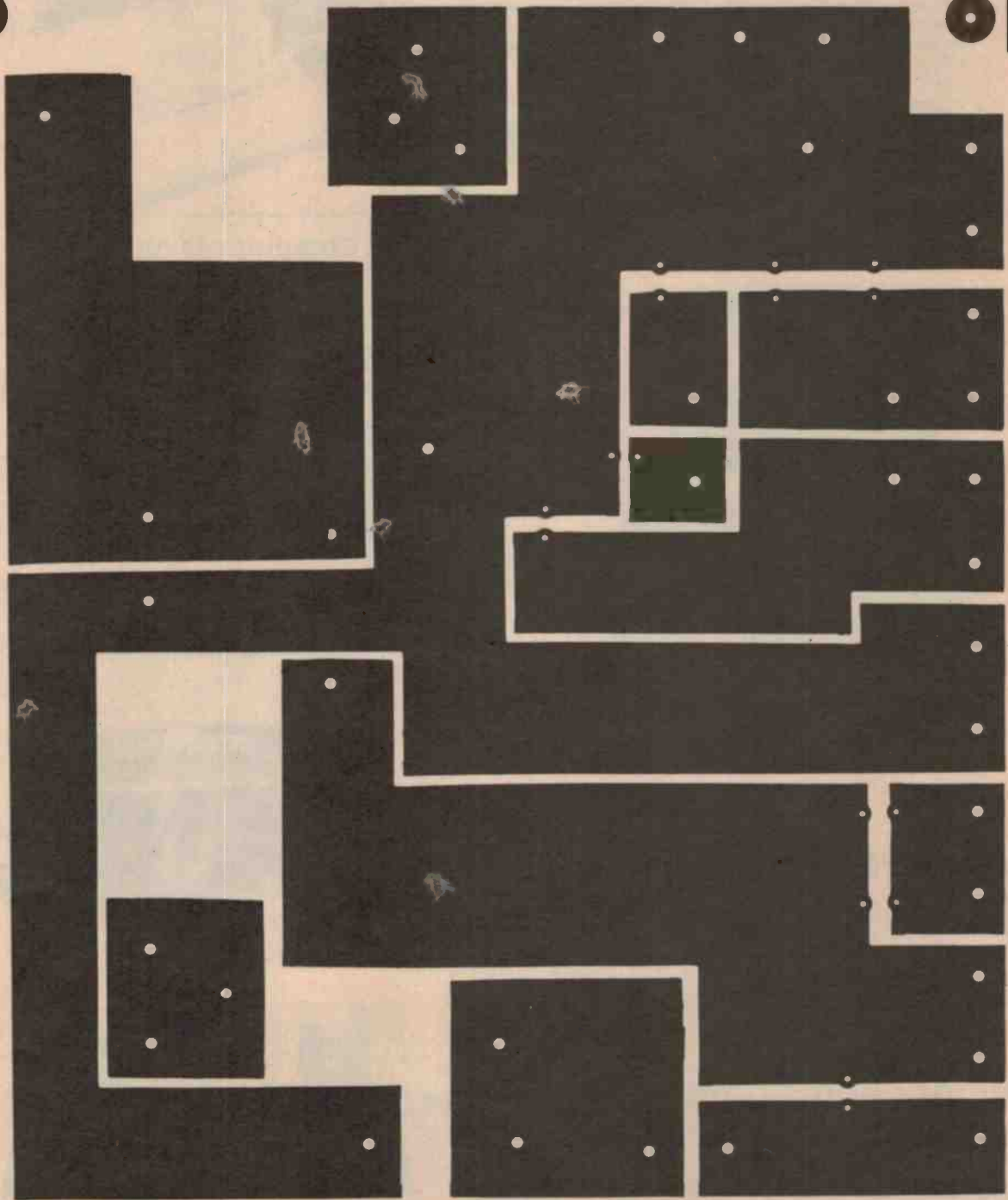

ETI 496 ETI 4000 - 1



# commodore

## the PET computer

The Pet has a television screen, a keyboard as simple to use as a typewriter and a self-contained cassette recorder which is the source for programmes and for storing data in connection with these programmes. And it has, in its standard configuration, an 8K user memory. (This is in addition to the 14K operating system memory in the computer).



### **SPECIAL** AT NO EXTRA COST

\$200 value of programmes will be provided with each PET purchased prior to December, 31st, 1979.

2001-16/32



**The CBM Computer is now a truly sophisticated Business System with the announcement of these Peripherals.**

The CBM incorporated with the Floppy Disk and Printer makes an ideal business system for most professional and specialized fields, medicine, law, dental, research, engineering, toolmaking, printing, education, energy conservation etc. . . . The CBM Business System as a management tool, delivers information to all levels of Business previously attainable only with equipment many times more expensive, the CBM Business system is one of the most cost efficient business tools today. It offers a wide range

of applications from logging management strategy in major corporations, to organizing accounts and inventory control of small businesses. Here are just a few of the cost saving uses in the corporation, professional office or small business stock control, purchasing, forecasting, manufacturing, costing, customer records, mailing list, etc. The CBM Floppy Disk and Printer, a compatible business system at a reasonable price — Take a closer look at these Peripherals.

### Dual Drive Floppy Disk

The Dual Drive Floppy is the latest in Disk technology with extremely large storage capability and excellent file management. As the Commodore disk is an "intelligent" peripheral, it uses none of the RAM (user) memory of the CBM. The Floppy Disk operating system used with the CBM computer enables a programme to read or write data in the background while simultaneously transferring data over the IEEE to the CBM. The Floppy Disk is a reliable

low cost unit, and is convenient for high speed data transfer. Due to the latest technological advances incorporated in this disk, a total of 340K bytes are available in the two standard 5 1/4" disks, without the problems of double tracking or double density. This is achieved by the use of two microprocessors and memory I.C.s built into the disk unit. Only two connections are necessary — an A/C cord and CBM interface cord.



2040

### Tractor Feed Printer

The Tractor Feed Printer is a high specification printer that can print onto paper (multiple copies) all the CBM characters — letters (upper and lower case), numbers and graphics available in the CBM. The tractor feed capability has the advantage of accepting mailing labels, using standard preprinted forms (customized), cheque printing for salaries, payables, etc. Again, the only

connections required are an A/C cord and CBM connecting cord. The CBM is programmable, allowing the printer to format print for: width, decimal position, leading and trailing zero's, left margin justified, lines per page, etc. It accepts 8 1/2" paper giving up to four copies. Bidirectional printing enables increased speed of printing.

2022



Distributed by

**HANIMEX LTD.**  
Commodore Business Machines Division.

CONTACT YOUR LOCAL DEALER FOR FURTHER INFORMATION, PRICING AND DEMONSTRATION.

# ROD IRVING

## COMPONENTS

2114 RAMS .....	\$6.25
2708 EPROM .....	9.50
741's 10 up .....	2.50
555's 10 up .....	2.90
BD139 10 up .....	4.50
BD140 10 up .....	4.50
SC141D 10 up .....	10.10
SC151D 10 up .....	21.10
RED LEDS 10 up .....	1.40
RED LEDS 100 up .....	11.00
YELLOW LEDS 10 up .....	2.90
8 PIN I/C SKTS 10 up .....	2.00
BC547 10 up .....	1.00
BC548 .....	0.15 ea.
BC549 .....	0.19 ea.
MJ802 .....	3.60
6,800/50V CAPS (LUG) .....	4.50
5,600/40V CAPS (PCB) .....	1.90

## 10 TURN POTS

1/4" SHAFT. VALUES: 100, 500, 1K, 2K, 5K, 10K, 20K, 50K, 1M.

Inc. tax \$6.25 ea.

## MAXELL UDC 90 TAPES,

3 for \$9.00

Shop customers only (No mail order).

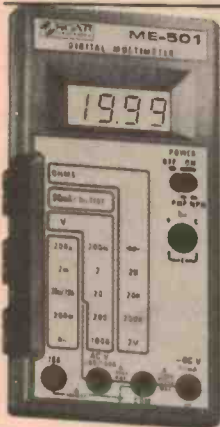

**4 digit  
LARGE  
LCD  
DISPLAY**

Send for  
specs.

**\$69.95**

Add \$3 P&P  
and certified  
mail.

## INTERSIL ICL7106 LCD EVALUATION KIT \$32.50

## INTERSIL LCD 3 1/2 DIGIT PANEL METER KITS

Build a working DPM in 1/2 hour with these complete evaluation kits. Test these new parts for yourself with Intersil's low-cost prototyping kits, complete with A/D converter and LCD display (for the 7106) or LED display (for the 7107). Kits provide all materials including PC board, for a functioning panel meter. ICL7106EV (LCD)

## KITS & CIRCUIT BOARDS



(Kits of parts including quality fibreglass boards)

## ETI SERIES 4000 AMP

- Complete Kit .....\$175.00
- Quality front panel to suit above...\$7.99
- ETI 470 kit of parts.....\$19.90
- ETI 480 kit of parts 100w (Incl. bracket).....19.75
- ETI 470 PS kit of parts.....19.50 (Includes relay, not transformer)
- Transformer to suit .....22.90
- ETI 471 pre-amp.....45.50
- ETI 585R ultra sonic RX.....15.95
- ETI 585T ultra sonic TX.....8.95
- EA 79 SF9 sound flash trigger.....15.00
- All parts available for DREAM computer project.
- P.C.B.'S (all quality fibreglass boards)
- ETI 574 disco strobe.....2.80
- ETI 549A metal detector.....2.75
- DREAM circuit board.....9.90

## Project Boards (Fibreglass)

ETI 043.....1.40	ETI 450B.....1.90	EA 78N6.....3.20
ETI 044.....1.30	ETI 480.....2.40	EA 78NG4.....2.50
ETI 047.....1.50	ETI 480PS.....2.40	EA 78UT4.....3.90
ETI 051.....1.40	ETI 481M.....2.00	EA 78T3.....4.20
ETI 062.....1.80	ETI 481PS.....3.50	EA 78C5.....3.90
ETI 063.....1.70	ETI 483.....2.20	ETI 470.....\$2.90
ETI 064.....1.70	ETI 484.....3.90	ETI 741.....\$9.90
ETI 065.....1.70	ETI 485.....2.90	ETI 472.....\$2.90
ETI 067.....1.80	ETI 486.....2.90	ETI 576.....\$4.90
ETI 068.....1.40	ETI 489A.....2.50	ETI 574.....\$2.80
ETI 071.....1.40	ETI 499.....1.90	ETI 473.....\$4.50
ETI 072.....1.80	ETI 528.....2.20	ETI 573.....\$2.90
ETI 081.....1.50	ETI 541.....2.20	ETI 577.....\$2.90
ETI 083.....1.80	ETI 547.....2.20	ETI 111B.....\$2.30
ETI 084.....1.70	ETI 581.....2.20	ETI 150S2.60 ETI 260.....\$1.90
ETI 085.....1.30	ETI 583.....2.20	ETI 261.....\$1.90
ETI 130.....1.90	ETI 585R.....1.60	ETI 262.....\$1.80
ETI 134.....1.90	ETI 585T.....1.40	ETI 263.....\$2.20
ETI 135.....1.90	ETI 586.....2.30	ETI 606.....\$2.90
ETI 136.....1.80	ETI 603.....2.50	79se3.....\$3.90
ETI 137A.....2.90	ETI 604.....1.60	Dream 6800S9.90
ETI 137B.....2.90	ETI 635.....2.90	79sf10.....\$1.90
ETI 139.....1.90	ETI 638A.....3.90	79md9.....\$2.60
ETI 245.....1.60	ETI 708.....1.90	79pg9.....\$2.90
ETI 417.....1.80	ETI 713.....3.90	79ps11.....\$2.90
ETI 445.....1.50	ETI 714.....1.90	79T11.....\$2.75
ETI 446.....1.90	ETI 717.....2.90	79PC12.....\$2.20
ETI 449.....1.50	EA 78A06.....2.90	79EB12.....\$2.90
ETI 450A.....1.90	EA 78TM8.....2.00	

## Rod Irving Electronics Kits

Additional kits will be produced as new projects are available.

ETI 041 continuity tester .....	3.65
ETI 043 heads and tails.....	3.15
ETI 044 2 tone door bell.....	3.90
ETI 046 500 second timer.....	3.45
ETI 047 simple morse, less key.....	3.05
ETI 048 buzz board.....	3.45
ETI 480 100w amp.....	17.45
ETI 063 electronic bong.....	4.20
ETI 065 siren-less speaker.....	4.20
ETI 066 temp. alarm.....	3.65
ETI 068 LED dice.....	4.90
ETI 084 car alarm.....	9.45
ETI 470 80w amplifier.....	19.45
ETI 480 50w amplifier.....	14.70

(amplifier kits do not include heatsink)  
Kits are complete with prime spec components and include assembly instructions, wire, solder, etc. All kit prices include sales tax, exempt prices on application.

## NEW PRODUCTS



## HEX KEY PAD

**\$17.90**

## RIE are now distributors for 3M Products, including SCOTCHAL RANGE

- 8016 Blue on White Plastic
  - 8018 Green on White Plastic
  - 8011 Red on White Plastic
  - 8012 Black on transparent Plastic
  - 8013 Black on Yellow Plastic
  - 8015 Black on White Plastic
  - 8009 Light blue on aluminium
  - 8001 Red on aluminium
  - 8005 Black on aluminium
  - 8007 Reversing film
- NOTE: ALL ABOVE SHEETS 10" x 12"
- 8500 Photosensitive Developer
  - 3900 Clear Coating (Glossy Finish)
  - 3930 Clear Coating (Matte Finish)
  - ML-3 Applicator block
  - ML-4 Developer pads
  - 8002KA Evaluation Kit

## Attention Sorcerer and TRS 80 owners - MEMORY EXPANSION KITS AVAILABLE

We also offer full service on the popular computer projects and systems.

**SPECIAL 4116 RAM OFFER**  
8 off prime spec 4116 IC's .....\$88.00

**STATIC RAM KIT 16K S-100**  
Kit form .....\$269.00  
Ass & tested .....\$299.00

ALL FRONT PANELS AVAILABLE FOR  
ETI & EA PROJECTS IN SCOTCHAL.  
PHONE FOR DETAILS.

## SHOP 499, HIGH STREET, NORTHCOTE, VIC. 3070

Open: Mon-Thur 8am to 6.30pm. Fri 8am to 8.30pm. Sat 8.30am to 12.30pm.

Mail Orders: PO Box 135, Northcote, Vic. 3070. Minimum \$1.00 P&P.

Send 30c stamp for free condensed catalogue.

# THE ETI COLLECTION

30 Audio Projects \$3.95    Top Projects Vol.4. \$3    3600/4600 Synthesizers \$12.50    Simple Projects Vol.2. \$2.95  
 Project Electronics \$4.75    Top Projects Vol.5. \$3  
 Australian CB \$3.95    Circuits No.2. \$2.95  
 Test Gear \$3



HERE  
 THEY ARE!  
 COLLECTIONS OF  
 THE 'BEST FROM ETI'

Forget leather-cased editions of Moby Dick, papyrus printings of ancient classics and first editions of Gone With the Wind! The dedicated electronics enthusiast puts an investment on his bookshelf with the ETI Collection – an investment in hours of pleasure in building and using projects that are backed by one of the world's largest electronics magazines.

From electronic music, through audio, to CB radio, the ETI Collection ranges the whole field of electronics.

Please send me:     Test Gear.     3600/4600 Synthesizers.  
 30 Audio Projects.     Circuits 2.     Project Electronics.  
 Top Projects Vol.4.     Top Projects Vol.5.     Aust. CB.

I enclose \$ . . . . . (inc. postage).

Name. . . . .

Address. . . . .

. . . . . Post Code . . . . .

#### HOW TO ORDER

The books in this collection are available from most newsagents or directly from ETI. The only exception is the International Synthesizer book which is only available from us and a limited number of specialist suppliers – it is not sold by newsagents. Send your order, enclosing a cheque or money order (and including postage where appropriate), to:

**Electronics Today International  
 Subscriptions Department  
 15 Boundary St  
 Rushcutters Bay NSW 2011**

### ● **Test Gear**

Your confidence to tackle more complex projects will increase dramatically if you have the right test equipment to troubleshoot, fault-find and generally understand the operation of the circuits you build. Why not build your own test equipment, saving money and learning as you go?

Contents include: Audio Level Meter, Impedance Meter, Audio Millivoltmeter, Simple Frequency Counter, Phase Meter, Temperature Meter, Audio Signal Generator, Audio Noise Generator, and many more.

**Price: \$3.00 plus 45 cents post and packing.**

### ● **ETI Circuits No. 2**

This giant compendium of circuits has been assembled from the 'Ideas for Experimenters' section of Electronics Today and is packed full of ideas and suggestions for the experimenter. The chapter headings cover Alarms, Amplifiers, Automobile, Batteries, Comparators, Conversion Tables, Crossovers, Crystal Oscillators, Detectors, Digital, Filters and so on. Whenever you're looking for a circuit, this is the book to turn to.

**Price: \$2.95 plus 45 cents post and packing.**

### ● **30 Audio Projects**

For the Audiophile who wants good sound at a good price plus the satisfaction of having built it himself, 30 Audio Projects is required reading. The contents include our most popular audio projects: 25 watt Amp, General Purpose Preamp, Bucket Brigade Delay Line, Active Crossover, Compressor Expander, Tape Noise Limiter, Transmission Line Speaker System, Master Mixer, Graphic Equalizer and the 50/100 Watt Amp Modules.

**Price: \$3.95 plus 70 cents postage and packing in NSW (80 cents in other states).**

### ● **Project Electronics**

Specially designed to meet the needs of newcomers to electronics, and in particular school students following the three-segment Industrial Arts syllabus in electronics, this book has been a runaway success! Twenty-six projects (many easily available in kit form) are completely described along with hints on troubleshooting, components, how to solder, etc. None of the projects is expensive and all are satisfying to build.

Available in newsagents, component stores or directly from ETI.

**Price: \$4.75 plus 45 cents post and packing.**

### ● **International 3600 and 4600 Synthesizers**

A completely revised and updated reprint of ETI's phenomenally successful music synthesizer designs.

This book has been beautifully printed on heavy art paper and has a sturdy cover varnished for protection.

Available from some kit suppliers.

**Price: \$12.50 including post and packing.**

### ● **Top Projects Vol. 4**

Available from newsagents or directly from Electronics Today International this book, published in June 1977, contains the following projects: Audio Expander/Compressor, 50/100 Watt Amp Modules, Stereo Amplifier, Dynamic Noise Filter, Audio Phaser, Audio Limiter, TV Game, Swimming Pool Alarm, Temperature Alarm, Active Antenna, GSR Monitor, Universal Timer, Mini-Organ, GP Power Supply, Temperature Meter, Train Controller, Car 'Scope Testing.

**Price: \$3.00 plus 45 cents postage and packing.**

### ● **Top Projects Vol. 5**

Once again, this 'Best of ETI' publication is available from many newsagents or directly from ETI. Published in 1978 it is crammed with projects: Shutter Speed Timer, Ultrasonic Switch, Accentuated Beat Metronome, Marine Gas Alarm, House Alarm, White Line Follower, Induction Balance Metal Detector, Photographic Strobe, Simple Compressor/expander and CB Power Supply.

**Price: \$3.00 plus 45 cents post and packing.**

## NEW! 6809 EXORCISER COMPATIBLE MODULE

Designed and manufactured  
locally for Semcon

### Features:

- MC6809 1 MHz CPU
- Fully buffered bus
- Two 6821 PIA's
- Two 6850 ACIA's with RS232 interface (One ACIA may be replaced with a 6852 S.S.D.A.)
- 4K static RAM accessible by external devices
- 4 sockets for up to 16K of EPROM (accepts 2708, 2716, 2516, 2532)
- O.S.9 in EPROM — this Unix based operating system written

- by Microware comes supplied with each module
- Programmable timer
- Supports D.M.A. channel
- Capable of tristating module bus buffers when external access is not required
- Break detect
- Power on reset
- 14411 baud rate generator

**\$950 plus tax**  
(\$799 if purchased without O.S.9)

## SOFTWARE SUPPORT

The following software for the 6809 should be available early November

- Macroassembler
- Editor
- C-Compiler

Prices on application

## 7932A 32K STATIC RAM MODULE

- Now outline compatible with Motorola Exorciser cards
- Only available assembled and tested
- Includes 100 hour burn-in and 12 months warranty

**Features:** ● Page mode operation — allows system expansion to 1 Megabyte  
● Quality PCB with solder resist  
● Motorola bus compatible ● Low power — 2.5 amps typical ● 300nS access

- Fully static operation
- Buffered address, data and control lines
- Power rails in grid network for improved noise immunity
- 4 x 8K blocks — Individually addressable, each write protectable, may be removed from address space if not required
- Multi-phase operation — the module allows access during phase one and phase two — Ideal for multiprocessing or DMA channels

32K .....	\$650.00	16K .....	\$430.00
24K .....	\$540.00	8K .....	\$320.00

### Attention users of Motorola, Southwest Technical and Smoke Signal Hardware

Send large SAE with 50c stamp plus \$2.00 for our latest catalogue. This includes detailed information on:

- Microware Software
- Microware SS50 Development System, including 2 MHz CPU and dual floppies.
- 6800 Macroassembler
- 6800 Assembler
- Sembug — Our new video orientated DeBug package.
- New 6809 Software.
- 6809 CPU Module.
- 32 K RAM Module.
- CRT02 Video Interface.
- 7908 EPROM Module.
- S-Bug Module.
- 10 Amp Switching P/s.
- 6802 CPU Module.
- ACIA Module.
- PIA Module.
- Timer Module.
- 32/32 I/O Module.
- Contact Closure Module.
- Wire wrap board.
- Extender card.
- A/D & D/A for SS50.

## 6800 SOFTWARE FROM MICROWARE

SEMCON is now the Australian distributor of Microware Software. It is available in the following formats:

- MIKBUG compatible cassette.
- SOUTH WEST TECHNICAL Diskette.
- SMOKE SIGNAL Diskette.
- MOTOROLA M-DOS.
- TEKTRONIX 8002.

**(A) A/BASIC COMPILER** — This is a true 6800 Basic Compiler that converts programs written in BASIC, into fast, efficient machine language programs. Its output runs without a run-time package and is directly ROMable according to user defined memory assignments. It requires 8K of RAM and permits the user to call up and incorporate his own machine language subroutines. **CASSETTE \$85. SWT \$175. SSB \$175. M-DOS \$500.**

**(B) A/BASIC INTERPRETER** — This is a source compatible, extremely fast, Basic Interpreter implemented as an incremental compiler. Its specially extended syntax and memory assignment features make it especially suited to process control and systems programming. It may also be used as an alternative to the text editor to prepare input for the Compiler. **CASSETTE \$85. SWT \$95. SSB \$95. M-DOS \$300.**

**(C) A-BASIC SOURCE GENERATOR** — This optional extra to the compiler disc versions, results in the production of a complete assembly listing from the object code produced by the compiler. **SWT \$65. SSB \$65. M-DOS \$175.**

**(D) CHESS PROGRAM** — **CASSETTE \$65. SWT \$65.**

**(E) LISP INTERPRETER** — This list orientated language, featured in the August 1979 BYTE, is ideally suited to computer aided design, decisional logic and artificial intelligence. LISP programs have the capability of dynamically altering themselves making it an ideal language for programs that learn. **CASSETTE \$90. SWT \$95. M-DOS \$275.**

**(F) D2 UPGRADE KIT** — This enables the D2 to communicate with an RS232 interface. **\$45.**

**(G) RT/68** — Supplied in a 2708 ROM, this monitor normally looks like MIKBUG to most programs. Its real power lies in its multitasking capabilities. When the system command is executed, it can supervise the execution of from one to sixteen tasks. Each task may be assigned a priority, time slice and state indicator. **\$65.**

## NEW! CRT02 VIDEO INTERFACE

Memory mapped with a difference!

Our versatile CRT01 video interface has been modified to enable simple installation in existing systems along with the addition of several new features:

- 2K page of on board RAM — the new module now looks like a 2K memory board, and plugs directly into any exorciser bus.
- A 2716 is used as the character generator — up to 160 user defined characters may be programmed into the ROM — ideal for those languages requiring special symbols or In graphics applications.
- Dual Intensity (or optional flashing characters) for 96 of the 160 available characters. The inverse video is only available if programmed as special characters.
- Character font now 12 rows of 8 dots.
- Multiple CRT02's can be plugged into the bus.
- Retains all the versatility of display formats of the CRT01 as well as the logic to provide a stable flicker free display.

Price \$350.

## WIRE WRAP BOARD

- Double-sided ground & plus 5V
- plus/minus 12V on card
- Plated holes
- Gold edge connector



\$47

## CMS 9600 MC6802 CPU MODULE



\$565

- 6802 CPU
- 1.1K Static Ram with battery back-up
- 6K Eprom
- Programmable timer
- 2 PIA's
- 2 ACIA's — RS232
- Priority interrupt
- Address and data buffers
- Power failure protect/restart
- MC14411 Baud rate generator (One ACIA may be replaced with SSDA)



## SEMCON RACKING SYSTEM \$153

(\$94 for rack without connectors)

- Sturdy aluminium construction
- Blue anodised finish
- Accommodates 8 Motorola Bus compatible cards
- Tin plated backplane with ground plane on one side
- 8 43x2x0.156" edge connectors.

**SEMCON MICROCOMPUTERS** PO Box 61, Pennant Hills, 2120. Tel (02) 848-0800  
Add 15 percent tax where applicable. P&P: \$2.50 Sydney Area. \$3.50 elsewhere

# Ideas for Experimenters

These pages are intended primarily as a source of ideas. As far as reasonably possible all material has been checked for feasibility, component availability etc, but the circuits have not necessarily been built and tested in our laboratory. Because of the nature of the information in this section we cannot enter into any correspondence about any of the circuits, nor can we produce constructional details.

## Synchrodyne tuner

The main component of this design, from H. Lee of Vacluse NSW, is the integrated circuit which can be any of the many types of FM detector and limiter chips such as LM 1351, MC 1351, LM 1841, ULN 2136A, LM 2111, ULN 2111A, LM 2113 and ULN 2113A. There is very little difference among these ICs, except the pin connections. The detection of the AM signal takes place when two synchronous signals are fed into the balanced product detector (or multiplier) section of the chip. The two signals are obtained from the same RF amplifier, MOSFET-PNP combination, Q1 and Q2 (hence the name synchrodyne). The de-emphasising capacitor, C2 at pin 14 of the LM 2111 IC smooths the audio output at pin 1. The author does not find it necessary to incorporate a 10 kHz whistle filter.

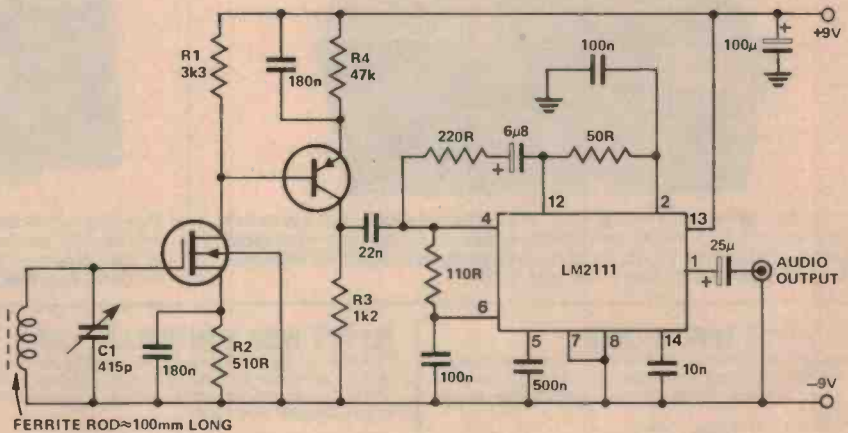

The selectivity is rated fair for the high frequency end of the AM band but stations like 2FC Sydney on the lower end are entirely satisfactory. However at a small increase in cost and a little effort of alignment, selectivity can be increased greatly if R3 is replaced by

another LC tuned circuit similar to L1 C1. This was not used since the author is a 2FC fan most of the listening time! If a replacement is used for Q2 then it must be a high fT variety and R4 can be trimmed for the required gain of the RF stage.

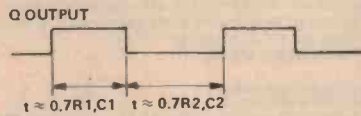
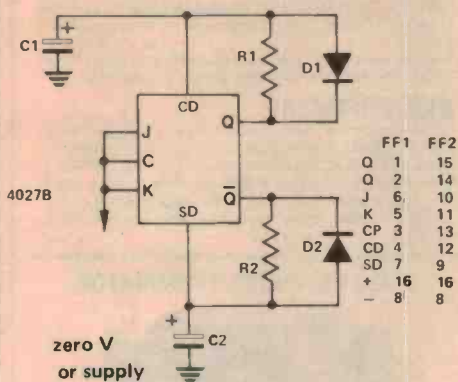

## Oscillator has variable mark/space ratio

This oscillator allows the period of each half-cycle of the output wave form to be independently set by the RC networks R1C1 and R2C2. D1 is only

necessary if  $t_2 < 5t_1$  while D2 is necessary if  $t_1 < 5t_2$  approximately. This is to speed the discharge of the associated capacitors. R1 may be any value in the range 1k to 22M, while C1 should be between 10p and 100µ.

The circuit may latch up with both outputs high if the power supply rises slowly at power-up or if the outputs are shorted to the positive supply, according to its designer, Barry Wilkinson, of Nebula Electronics.

## Sound-modulated light source

This circuit, submitted by Michael Thong of Crawley WA, modulates a light beam with voice or music from the output of an amplifier. If the 10k pot is adjusted to slightly less than the Vbe

of the transistor, the circuit forms a peak detector.

This drives the gate of the SCR, lighting the globe, the brightness of which will vary as the sound level varies. C2 may be removed for a faster response.

Michael used his original circuit for a low cost colour organ from his amplifier.

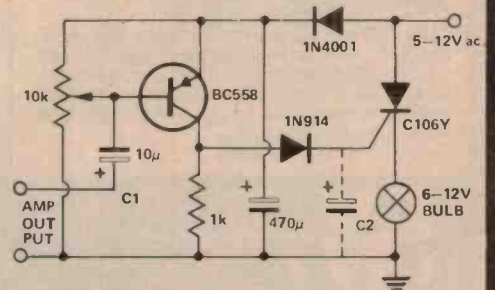

# 'THE \$100 BUS STOP'<sup>TM</sup>

## S-100 & 6800 CHASSIS



11 slot backplane, fully card guided. 15 amp power supply, fan, key switch, bench mount, rack mount, anodised aluminium. 5 edge connectors standard. S-100 Bench Kit \$345. S-100 Rack Kit \$306. 6800 Bench Kit \$370. 6800 Rack Kit \$330. Assembled prices add \$100.

## ETI 642 S-100 16K STATIC RAM

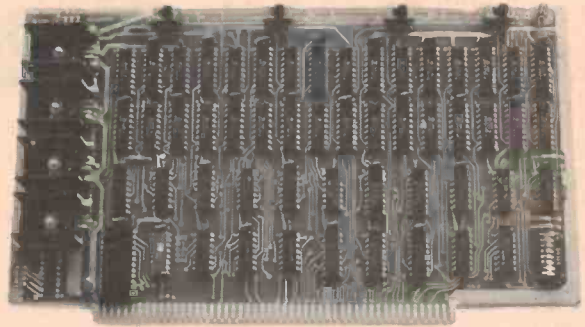

Features:- 2114 low power static RAM's, 4K addressing, 4K write protect, bank select, wait state gen., plated through hole, solder resist mask, 300 or 450 nS speed, ETI 642.  
Kit \$315. Ass. \$380. Add \$32 for 300 nS.

### 2708/2716 EPROM CARD

Features:- holds up to 16 2708 or 2716 (single supply) EPROMS, on board wait state gen. Unused locations may be blanked. Plated through holes, solder resist mask.

PRICE:- Kit \$115. Ass \$155.

### EPROM PROGRAMMING CARD

Features:- ability to programme triple supply 2708's and single supply 2508, 2716, 2732 etc. ZIF Socket. On board 26V generator. Port driven.

Price:- Kit \$175. Ass \$205.

### Z-80 CPU CARD

Features:- 4 MHz operation, power on jump, wait state generators, provision for on board 1K EPROM, front panel socket for reset, and data lines etc.

Price:- Kit \$156. Ass \$196.

### Z-80 SINGLE BOARD COMPUTER

Features:- 2 MHz operation, 1K static RAM, 8K/16K EPROM, serial/parallel ports, power on jump, timer, vectored interrupts, software selectable baud rates.

Price:- Kit \$260. Ass \$326.

### 80 X 24 VIDEO DISPLAY CARD.

Features:- on board Z-80 and CRT 5027 controller chips, parallel keyboard interface, 2708 driver chip, and 2708 character generator chip, special effects and extended character set available.

Price:- Kit \$330. Ass. \$395

### 64 X 16 VIDEO DISPLAY CARD

Features:- memory mapped 1K board, with reverse video and cursor control. RCA video connector, plated through holes and solder resist mask.

PRICE:- Kit \$155. Ass. \$180.

### FLOPPY DISK CONTROLLER CARD

Features:- single density, mini or full size disk drives with FD 1771 controller chip, can be interrupt driven, syncs with CPU in data transfer, Shugart/Remex compatible.

Price:- Kit \$165. Ass. \$210.

### DD FLOPPY DISK CONTROLLER CARD

Features:- controls mini and full size, single/double sided single/double density and all combinations of each. Crystal locked, PLL data recovery, Shugart/Remex compatible software (CP/M / SDOS) for above controllers available.

Price:- Kit \$325. Ass. \$385.

### STANDARD EXTENDER CARD

Features:- double sided f/glass board, numbered test points reflow soldered.

Price:- Kit \$33. Ass. \$48

### WIRE WRAP CARD

Features:- double sided f/glass board, ground plane and supply rails run on both sides, 3M type connector patterns on top of board, provisions for regulators on all rails, holes are on .3" pitch, by .1" pitch.

Price:- Bare board \$28.50

### 6800 PRODUCTS

6800 Extender Board \$33. 6800 11 slot backplane \$36. 6800 11 slot chassis, rack mount \$330.

### EPROMS AND RAM CHIPS

2708 450nS guaranteed \$12. 2716 450nS single supply ex-stock \$47.50. Hitachi 2114 low power 450nS \$7.50. Hitachi 2114 low power 300nS \$8.50.

### DISK DRIVES

Shugart SA400 \$375. Shugart SA801 \$650. Remex 8" double sided \$750.

### DUAL 8" DRIVE PACKAGE

Features:- contains dual 8" single or double sided disk drives either Remex or Shugart. Inbuilt power supply, cooling fan, modular construction, keyswitch, fused on mains, all aluminium 19" rack mount (10-1/2" high).

Price:- single sided \$1750. Double sided \$1950.

### EPROM SOFTWARE

1. Z-80 monitor in 2708 EPROM, has 16 functions, three versions available to drive TTY, TTY/VDU, KBD/VDU. Price \$25. 2. ETI 640 video driver EPROM, makes the memory mapped video card look like a terminal, has XY cursor addressing, home clear screen. Price \$25. 3. 6.25K Basic Interpreter, in seven 2708 EPROMS, has trig functions, dimensions, command level input ability. EPROM resident at OC000 hex. Price \$180. 4. Disk control EPROMS, contain I/O routines to handle our disk controller with CP/M, 2 EPROM set with second EPROM containing inbuilt video driver and I/O routines for all external devices like printers, terminals etc. Price \$50.

Customised version available (I/O and relocation) for an additional charge depending on the programme.

### DISK SOFTWARE

CP/M version 1.4, customised for our controller, \$130. CBASICII \$100. Wordmaster, word processing package \$140. TEX writer, letter and text formatter \$50. CP/M user group library (33 volts) at \$12 per volt. RAM Diagnostic, reports errors and likely causes \$25. Available on 8" and 5-1/4" single or double density. Above prices are for 8" disks.

### S-100 I/O PORT BOARD



Now with dual serial ports

DUAL SERIAL I/O CARD Features:- dual independently controlled serial ports with TTY and RS232 outputs and inputs. Nine programmable parallel ports, crystal controlled baud rates fully buffered and address decoded. Plated through holes & solder resist mask.  
Price:- Kit \$189. Ass. \$225.

### UV EPROM ERASER



New product range. Model LEE/T 15W tube, 120 min timer, up to 40 EPROMS will erase in 10/15 mins. Model MEE/T 8W tube 120 min timer, up to 10 EPROMS will erase in 20/30 mins. Model MEE is same as MEE/T but with no timer. All erasers are fully assembled and have a safety switch. LEE/T \$105. MEE/T \$93.50. MEE \$74.

### S-100 EXTENDER/TERMINATOR

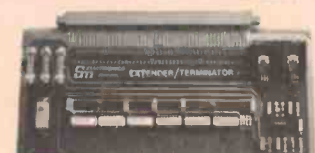

EXTENDER TERMINATOR CARD — features:- true active termination of the bus with inbuilt extender connector on top of board, fused rails to extended board. Test points numbered, solder resist, plated through. Price:- Kit \$70. Ass. \$90.

**Sm ELECTRONICS**  
MELBOURNE  
Ph (03) 842-3666  
Trading Hours 10am — 6pm.

1096 Doncaster Rd, Doncaster East, Vic 3109.  
PO Box 19, Doncaster East, 3109. Telex AA37213.  
DEALER: Canberra — 81-5011, Sydney — 661-9237.

Send 60c in stamps for COMPUTER PRINTOUT CATALOGUE for more details.

ALL PRODUCTS AUSTRALIAN MADE AND EX STOCK (ALMOST).  
DEALER ENQUIRIES WELCOME.  
Prices and specs. subject to change without notice.

All prices add 15 percent S.T. if applicable.

**bankcard**  
welcome here

Give name, number, expiry date and signature for mail order sales.



**MAD MAL**

# THE DEAL YOU DIDN'T

## PRICES SLASHED! THINK POSSIBLE

**BUY AND SELL**  
 • ALL TEST GEAR  
 • Elect. Parts  
 • Elect. MAGAZINES  
 BACK ISSUES 1970 ON  
 EA, £71 £1 ea Most months  
 available, also English, American mags!  
 wanted to buy same for each, any quantity!

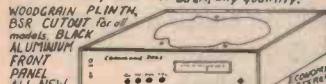

**6watt TUNER-AMPLIFIER**  
 from bankrupt company production line, PCBs  
 wired but needing final assembly. All parts ex  
 transformer, power heat etc supplied and circuit  
 diagram includes plinth but not turntable.  
 Features: AM tuner, Volume, Bass, Treble, Balance  
 controls, Din (face) socket, N Phone socket etc.  
 TO CLEAR AT LESS THAN PARTS COST!  
 SORTLY NO WARRANTY AT THIS PRICE  
 ADD ONLY TURNABLE AND SPEAKERS only

**BSR CHANGERS-NEW,**  
 COMPLETE, WITH STEREO CAR,  
 Huge Purchase - full size  
 3 speed, 11" platter only

**1 Watt 2 Channel**  
**TRANSCEIVERS**  
 • ADJUSTABLE SQUELCH CONTROL  
 • AUTOMATIC GAIN CONTROL  
 • SIGNAL CALL SYSTEM  
 Famous make, with  
 RF stage, 1V sens.,  
 27-80 KHz fitted, circuit incl. ea

**5 METRE 5m Speaker**  
**ONLY 50c** COLOUR-CODED TOOLS

**Speakers**  
 2 1/2" 33-14" 15m 5" 3-5 15" 15" 6 1/2" 15"  
 \$1 \$1.50 \$2 \$1.50 \$1.95

**20w POWER**  
**BOOSTER FOR**  
 NEW AT THIS PRICE!  
 AMPLIFY YOUR CAR RADIO/  
 STEREO - 2x10W RMS POWER  
 4 TO 8m INPUT AND OUTPUT.  
 Distortion 0.2%, 17-16v Oper.  
 Easy to install, under dash, out  
 of sight - Full rect & supplied.

**9x6" COAXIAL**  
**SPEAKERS**  
 Popular design,  
 heavy duty,  
 4m, 25W \$45 PR  
 SAVE 620m

**CANNON PLUGS & SOCKETS**  
 LOOK!  
 XLP-3-11 PLUG \$4.20  
 XLP-3-32 SOCKET \$3  
 XLP-3-31 PLUG \$6.45  
 XLP-3-12 SOCKET \$2.80

**KEYBOARD KITS**  
 German "Rati" high quality  
 Ideal for keyless  
 entry lock systems,  
 burglar alarms, all  
 microprocessor uses  
 0-9 and CLR keys 18x18mm

**PRE-PAK electronics**  
 P.O. Box 43, CROYDON 2132  
 718 Parramatta Rd, Croydon N. S.W.  
 Ph: 797-6144 Pack/Post: Add 10%

## New 'ONE CENTERS'

- 1 SALE BUY 1 AT REGULAR PRICE GET 2nd ONE OF SAME NUMBER FOR ONLY 1c**
- 1 12 POT-NUTS and WASHERS Handy to have 24 for \$1.00
  - 2 20 ASST. POTS Syd volume, ganged, switched, dual etc. 40 for \$2.00
  - 3 4mm Stacking BANANA PLUG spring-loaded terminal 2 for \$0.75
  - 4 10 NE-2 NEONS 90v strike, 60v operation 20 for \$1.00
  - 5 1000uf 63v w Pigtail ELECTROS New Elna caps 2 for \$1.30
  - 6 45 ASST. ELECTROLYTICS Pigtail and single-ended 90 for \$2.00
  - 7 Honeywell MICROSWITCH 250v 2A changeover 2 for \$0.90
  - 8 SPEAKERS 5x3" 27m or 5" round 33m 2 for \$3.00
  - 9 5xTO-3 MOUNTING KITS Comprise mic washer, 10 for \$1.00
  - 10 In-Dash Car Speaker FADER Dash mounting front, back stereo balancer 2 for \$2.00
  - 11 10 COMPUTER BOARDS Over 600 parts incl. caps, 20 for \$5.00
  - 12 20v 1A BRIDGE RECTIFIERS Selenium type 4 for \$1.00
  - 13 50 ASST. TAGSTRIPS Terminal strips 1 PACK 2 for \$2.00
  - 14 25CT92 TO-3 TRANSISTOR Ideal for TVs etc. 2 for \$2.50
  - 15 RELAY 110v DC 15KA coil, 5A contacts 2 for \$1.50
  - 16 3P2T de-luxe ROCKER SWITCH Black rocker, high quality 2 for \$1.50
  - 17 PVC CABLE CLAMPS for 3 core cable 10 for \$1.00
  - 18 3-5mm to 3-5mm AUDIO CABLE 1metre long 2 for \$1.50
  - 19 6-5mm Gold-Plated PHONE PLUGS (mono) 2 for \$1.25
  - 20 5WATT W.W. RESISTORS 0.5, 0.68, 0.75, 1.5, 1.8, 2.2, 2.7, 3.9, 4.7, 27, 47, 56, 68, 82 OHMS 2 for \$1.00
  - 21 DUAL-GANG POTS 10K, 25K, 50K, 100K, 200K 2 for \$1.00
  - 22 20 RF, IF, OSC COILS Asst. types Handy for all 40 for \$2.00
  - 23 2 Pin POWER LEADS Suit most Jap. type recorders and radios 6 for \$1.40
  - 24 CAR RADIO SUPPRESSORS for Hitachi 3 for \$1.00
  - 25 20 ASST LOW VOLTAGE LAMPS General purpose 40 for \$2.00
  - 26 VALVE OUTPUT TRANSFORMER replacement 2 for \$2.00
  - 27 100 x 1/2 W RESISTOR Pack Assorted values 2 for \$1.75
  - 28 RCA twin panel SOCKETS Ideal for amps etc 2 for \$4.00
  - 29 200 ASST HARDWARE PACK Screws, nuts, washers etc 2 for \$2.00
  - 30 20 x 0.5" Plastic SPACERS Handy to keep 1 PACK 2 for \$1.00
  - 31 3 POLE 3 POSITION ONK Rotary Switch type 'H' 2 for \$1.50
  - 32 40 RADIO & TV KNOBS Assorted types suit servicemen etc 1 PACK 2 for \$2.00

**PHILIPS TRIPLERS**  
 FOR COLOUR TV 425 \$12 EA  
 71m, 641, 444  
 As used in Pvc, Philips, Kriesler etc and most German colour TVs. 10 x \$10 EA

**EHT TRANS.**  
 NT3100 AU \$4.50 EA  
 NT3101 NEW \$4.50  
 NT3122 ONLY \$4.50

**ASST. YOKES**  
 Clearance of all \$4 EA  
 models - too many to list all, sorry.

**5" TV TUBE**  
 150CB4 \$5.95 EA  
 NEW! LAST NEW. 2 FOR \$11 ea

**FERRITE ROD AERIALS**  
 200mm long x 9mm diam \$1.25 EA  
 128mm x 9mm  
 142mm x 16mm x 3mm  
 126mm x 13mm x 5mm  
 55mm x 13mm x 5mm  
 COMPLETE WITH COILS  
 STEAL AT 10 for \$10

**HEAVY DUTY RELAYS**  
 10A 4 CHANGEOVER CONTACTS  
 Take your pick:  
 AC: 12, 24, 50, 115, 220v  
 DC: 6, 12, 24, 48, 110, 220volts  
 STEAL AT \$4.50 EA

**TRANSFORMERS**  
 All new, 240v input, guaranteed by Mail  
 No 82 0-6V-18v 1A 4.50  
 103 0-15V 1A x 2 windings 6.50  
 81 26v 1A, 6-3v 1A 4.90  
 70 31v 1A, 6-3v 1A 4.90  
 101 50v 1A x 2 windings, 6-3v 5.50  
 110 110v -3A, 26v 1A 5.90  
 112 200v CT. 15A, 6-3v 5A 6.00  
 185 12v -5A, 26v 1A 3.95

**SUPER CARTRIDGES...**  
 MAD BARGAINS  
 A STEREO CERAMIC \$1.80  
 B MONO CRYSTAL 90c

**Jackpot No 4**  
 OVER \$60 WORTH PARTS FOR 15c  
 Over 5 Kgms  
 Our latest assortment of over 1000 of specials, samples, out-of-line clearouts, manufacturers over-runs etc. Jackpot No 4 has all new items - contents vary, but contain no less than 3 Kgms worth of 15c items  
**ELECTRICAL TERMINAL BLOCKS** 50c EA (12 FOR 50c) MULTIPLES OF 12

**NEW, ECONOMY FM WIRELESS MIKE**  
 Range to 300ft, use FM Radio, size 103x34 x25mm \$14

**FM SNEAKY\* SUPER-MICRO TRANSMITTER**  
 Not toys, but highly sophisticated sensitive 'BUGS'  
 USE YOUR FM RADIO TO RECEIVE IC-8 87-92MHz 1,500m \$73.50

**LATEST 1979 JAPANESE SEMICONDUCTOR MANUALS** ea.  
 1. TRANSISTOR SUBSTITUTION MANUAL LIMITED QUANTITIES  
 2. TRANSISTOR MANUAL  
 3. LINEAR IC MANUAL  
 4. DIODE MANUAL 15 Series  
 5. FET MANUAL 25, 25K, 25K

**SWISS MADE DESOLDER TOOL**  
 New, best quality aluminium alloy Maximum suction Minimum backstroke Replaceable Teflon Tip • Self-cleaning  
 ONLY \$11.90  
 2 METRES DE-LUXE SOLDER-WICK in handy dispenser  
 ONLY \$3.50  
 • 2m twice as long as most  
 • Fast, simple solder removal  
 • Best quality gum-impregnated  
 BE QUICK - LIMITED STOCK

**OPEN 7 DAYS** 9:00 to 5:30

**TELESCOPIC AERIALS**  
 Pivots survive! Six portable TV's etc. to 180m  
 \$1.75  
**CAR AERIAL**  
 Beauty \$4.50  
 NOW \$3

**\*LIGHT DIMMER KITS**  
 or motor speed control  
 Great Value!  
 700 WATT Capability, With RFI OR Suppression 2 for \$9

**TV TUNER**  
 made by SHARP  
 \$5 EA or 2 \$9 Fully  
 12 Channels, 9 with biscuits.

**VORTEX cassette mechanisms**  
 Missing only record/playback head and piano-key knobs  
 Ideal for experimenters, etc.  
 \$10 ea

**VEEDED-ROOT 5 DIGIT RESETTABLE COUNTER**  
 24VDC 150m coil  
 Resets to 0, also manually presettable to any No.  
 \$15

**BU-126 300v 3A 30W 240v SOLDERING IRON**  
 15w \$13.50 TIPS \$1 ea  
 30w \$12.50  
 Quality make and fully guaranteed

**COMPUTER-GRADE ELECTROS**  
 SPECIAL OF THE MONTH

24,000uF	30v	\$12 EA	84,000uF	15v	\$11 EA
32,000uF	40v	\$14 EA	100,000uF	16v	\$12 EA
37,000uF	30v	\$14 EA	100,000uF	30v	\$18 EA
46,000uF	20v	\$15 EA	120,000uF	15v	\$15 EA
54,000uF	30v	\$17 EA	145,000uF	15v	\$15 EA
55,000uF	25v	\$16 EA	240,000uF	17v	\$20 EA
58,000uF	20v	\$15 EA	300,000uF	7.5v	\$15 EA
77,000uF	30v	\$18 EA	Mounting Clamps to suit 50uF ea		

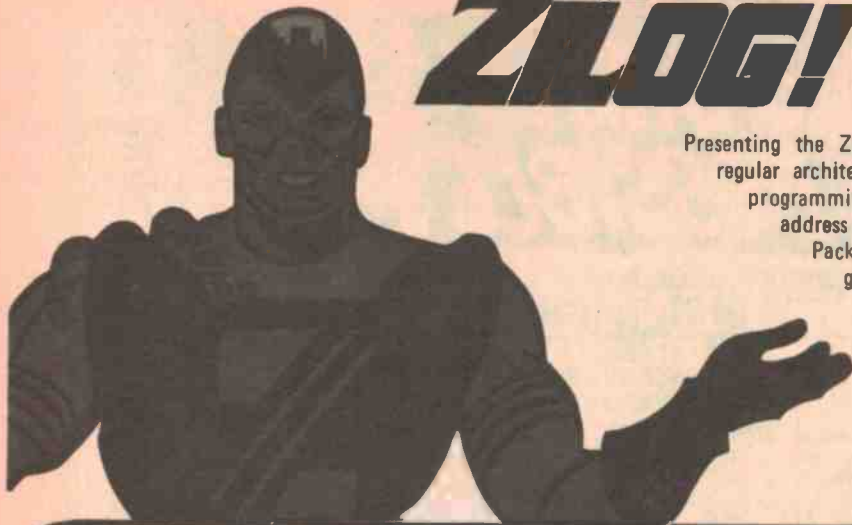

# CAPTAIN ZLOG!

—THE FIREWORKS HAVE  
JUST BEGUN!!

Presenting the Z8000 Microprocessor for the 1980's. The Z8000 has regular architecture to simplify design, 418 OP codes for incredible programming power, can perform 32 Bit operations and even address 8M bytes directly. Want to know more? Z8000 data Pack 1 includes complete technical data on Z8000 and its growing family of peripherals, development systems and software.

## Z8000 TECHNICAL PROGRAM

Z8000 Data Pack . . . . .	\$ 3.50
Z80 CPU Technical Manual . . . .	\$10.00
Z80 CPU Programming Manual . .	\$10.00
ZILOG Data Book . . . . .	\$ 5.00

### DGZ-80 HOME COMPUTER ON S100 BUS. AFFORDABLE — EXPANDABLE — POWERFUL



Build your own Z80 based computer using the DGZ 80 (ETI 680) as described in ETI November, 1979, designed by David Griffiths this is probably the most powerful Z80 project described in the world to date. Features include on board PIO (dual 8 bit INPUT OUTPUT), CTC (Programming Counter Timer) power on Jump, software write protect, cassette interface, option 2K monitor, on board RAM for stack, scratchpad etc. sockets for all IC's, top quality solder masked, plated through PCB and comprehensive owners manual.  
 DGZ80 (Kit) . . \$199.25 (\$175.00 Sales Tax exempt)  
 (Assembled) . . . \$240.00 (\$215.00 Sales Tax exempt)  
*Optional—but strongly recommended . . .*  
 DGOS Monitor ROM 2716 . . . . . \$ 48.00



### DG640—VDU

Designed by David Griffiths this is an Ideal support for the DGZ 80. Just add a keyboard with power supply to the DGZ 80 and DG 640 and you have a 4K Z80 system. Described in ETI March, 1978 the DG 640 features 16 lines of 64 characters, upper, lower case with graphics, crystal locked self-contained TV scan circuitry, top quality plated through PCB with solder mask, sockets for all IC's and comprehensive owners manual.  
 DG 640 (Kit) . . \$139.50 (\$125.70 Sales Tax exempt)  
 (Assembled) . . . \$149.50 (\$134.25 Sales Tax exempt)

### DREAM 6802—HAVE FUN WHILE LEARNING ABOUT MICRO COMPUTERS

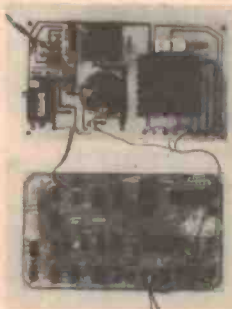

Learn as you build this fascinating microprocessor project designed by Michael Bauer and published in Electronics Australia, May, 1979.

We have designed the PCB to use the latest 6802 chip which has a self contained clock driver (eliminates 6875 problem) and is fully 6800 compatible. A separate PCB is also supplied containing an 18 key keyboard, power supply and modulator.

All components are supplied including top quality fibreglass PCB's, keyboard, modulator, chips in 2708, 6802 and full data sheets. Also included is a detailed operators manual with construction notes and exciting programs for you to run.

Dream 6802 (Kit) . . . . . \$149.50

### COMPONENT SPECIALS

Z80 CPU . . . . .	\$16.50
Z80 PIO . . . . .	\$ 9.75
Z80 CTC . . . . .	\$ 9.75
6802 CPU . . . . .	\$15.50
6821 PIO . . . . .	\$ 5.75
6810 RAM . . . . .	\$ 3.75
2708 EPROMS . . . . .	\$14.50
2114 4K RAMS . . . . .	\$ 6.75
555 TIMERS—4 for . . . .	\$ 1.00

### NEW PRODUCTS

#### RECTANGULAR LEDS

Red . . . . .	20¢
Yellow . . . . .	35¢
Green . . . . .	35¢

#### 1W ZENERS

Full Range 3.3v to 30v . . . 25¢ each

#### 5V RELAYS

FIT IN DIP SOCKET . . . . \$ 2.25  
*Ideal for microprocessor outputs SPST*

#### COMPUTER FANS

3" square 240V . . . . . \$24.50

#### RS232 "D" TYPE

#### CONNECTORS

DB25S Socket . . . . .	\$ 8.75
DB25P Plug . . . . .	\$ 5.25
DB25H Hood . . . . .	\$ 2.75

ALL ADVERTISED ITEMS IN STOCK AT TIME OF GOING TO PRESS (3/11/79)



**APPLIED  
TECHNOLOGY  
PTY. LTD.**

MAIL ORDERS TO:  
 P.O. Box 311, HORNSBY 2077

Please add \$2.00 per order towards cost  
 of post and packaging.

OFFICE/SHOWROOM:  
 1A Pattison Ave., WAITARA 2077  
 Hours 9—5 Monday to Saturday.  
 Telephone: 487-2711

# Top AMPEX REEL to REEL TAPE at one-third normal price!

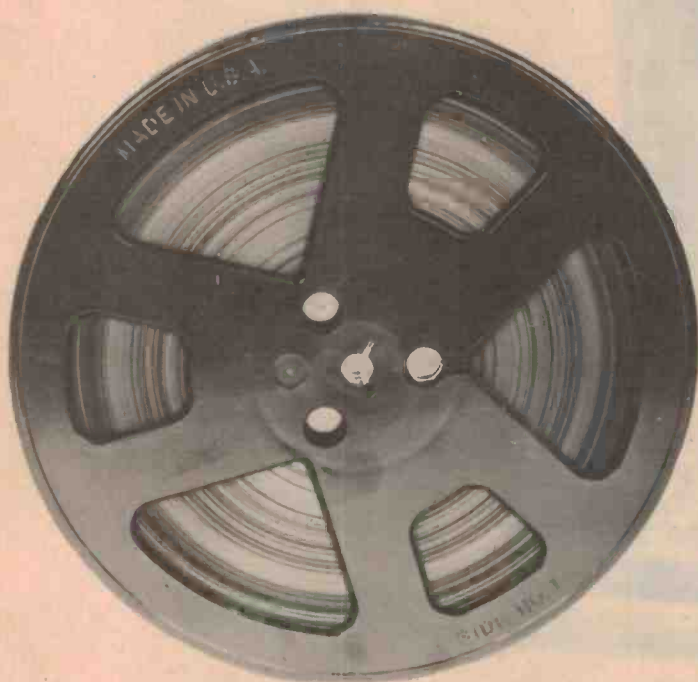

The USA Ampex Corporation has made available a substantial quantity of 'off-cut' tapes from their highest grade material. All tapes are 1800 ft (549 m) by 1/4", 1 mil ferric oxide on standard 7" reels.

There's a slight gamble involved — but one in which you either win a lot — or a hell of a lot!

Here's why:

The tapes offered are of differing types and you take pot luck on which you receive.

**BUT**, The lowest quality is Ampex' superb Ampex Plus series! The highest is Ampex' Grand Master series!

**SO**. If you draw the Ampex Plus' you'll be paying about one-third the usual price. If you score the Grand Masters you'll be paying about a quarter usual price.

**YOU CANNOT LOSE**. If you are not totally and completely satisfied with your purchase, Dindy guarantee to return the full purchase price without question provided the tapes are returned within 14 days in the original packing.

Identical tapes to those offered are marketed in the USA by Ampex, using the trade name 'Shamrock'. This trade name is also used for those offered here.

*NOTE: This offer is made by Dindy Marketing (Aust.) Pty Ltd and this publication is acting as a clearing house only. Cheques should be made payable to 'Ampex Tape Offer' and sent, together with the order form or accompanying letter, to 'Ampex Tape Offer', c/o ETI Magazine, 15 Boundary Street, Rushcutters Bay NSW 2011. We will then process your order and pass it on to Dindy, who will send you the goods. Please allow up to four weeks for delivery.*

*Owing to the exceptionally low offer price, the minimum ordering quantity is ten tapes (total \$39).*

## \$39 for 10 reels

Plus \$2.00 for post and packing.

AMPEX TAPE OFFER	Please supply . . . . . tapes at \$39 for ten \$ . . . . .
	Plus post and packing, any quantity:— \$2.00
	TOTAL \$ . . . . .
	Name . . . . .
Address . . . . .	
. . . . .	
. . . . . Post Code . . . . .	

# The Imagination Machine



**APF APF APF APF**

- IM-1** Your Life Will Never Be The Same — Two great achievements — a powerful state-of-the-art personal computer and a thrilling home entertainment center in one single package
- User-programmable in BASIC
  - With loads of pre-programmed software for educational entertainment and home and personal management
  - Features — 9K RAM, 10K ROM
  - 53 key typewriter-style

- keyboard • 32 characters x 16 line screen format • Alpha numerics in 3 color modes with up to 8 colors • Built-in sound synthesizer with a range of 3 octaves including flats and sharps
  - Six function built-in cassette tape deck • 2 game-style hand-held controllers • Unique shift key for "BASIC keywords"
  - Expandable for floppy disk, printers and more.
- \$995 inc. colour monitor. Tax paid.

## **CALCULATOR SUPERMARKET**

435 Bourke Street, Melbourne. (03) 67-6412.

## **RADIO PARTS GROUP**

562 Spencer Street, Nth. Melbourne. (03) 329-7888. 1103 Dandenong Road, East Malvern. (03) 211-8122.

# Shoparound

WHAT WITH an increasing pile of letters demanding we publish a *really* high power amplifier and the number of readers we've heard about bridging a couple of ETI-480 amp modules to get several hundred watts power output, it didn't take much to convince us that the ETI-466 300 W power amp module would be popular with readers.

We didn't quite know whether the kit and component suppliers would take to the idea of a very high power, build-it-yourself amplifier module though. However, the response has been startling! At least five firms have indicated they will be stocking the full kit and most of the other suppliers we contacted indicated they will be stocking the special components.

Publication of this amplifier was made possible by the availability of suitable high current transistors and power transformer. The latter, a type PF4363, is a new stock line being manufactured by Ferguson Transformers. The output transistors, type MJ15003 and MJ15004, are made by Motorola and distributed in Australia by A&R Soanar, Cema and Total Electronics. These transistors will be available through most outlets (they are widely used in industrial applications) as will the 0.1 ohm, 5 W resistors, the 2500u, 80 V RPT pc-mounting electrolytics, the 62 V, 5 W zener diode and the Philips heatsink (or equivalent).

We have recommended two different types of heatsink: one, a homemade style constructed from sheet aluminium, the other a Philips 65D6C. Dick Smith Electronics tell us they plan to sell a lower capacity heatsink than that recommended, together with a small fan. This should be a satisfactory arrangement.

Suppliers who have indicated they will stock the complete kit for the ETI-466 amp are:

Jaycar, Haymarket, Sydney NSW  
Electronic Agencies, Concord NSW  
Dick Smith stores  
All Electronic Components, Melb.  
Rod Irving Electronics, Northcote

In addition, Electronic(distributors) of Shops 2-3, 7/10 Joyce St, Pendle Hill NSW will be stocking a 'semiconductor kit' and possibly the other components. Any other suppliers who wish to kit up for this project please phone Phil Wait.

The 4000/1 four-way speaker system featured this month is the 'top of the line' in a new range of speakers based on recently released Philips drivers. The 4000/1 system we expect to cost around \$500-odd all up, but for that you get truly superlative sound — equal to a commercial system around three times the price.

Complete kits, including all drivers, boxes and crossover components, will be sold through Philips retail dealer outlets and Philips Service Centres throughout the country — but there may be some delay while they arrange stocks and distribution. Kits and individual components will be available from a number of other suppliers — right now, try All Electronic Components in Melbourne or Electronic Agencies of Concord, Sydney NSW.

The Linear Scale Capacitance Meter (ETI-152) is another in our range of look-alike simple test instruments and should prove a most useful piece of equipment around the workshop, or kitchen table. All components in this project are readily available, with the exception of the close tolerance capacitors, C1 and C3 (1n each). Since these two components determine the overall accuracy of the instrument, it is worthwhile hunting around to get them. All Electronic Components in Melbourne said they have some, while Radio Despatch Service in Sydney are selecting capacitors to the required tolerance from their standard range exclusively for this project. Ask for them.

While we're on the subject of capacitors, we have received quite a number of enquiries about TAG tantalums — they're apparently getting as scarce as rocking horse droppings. However, Electronic(distributors) of Pendle Hill — address elsewhere in this column — advised us that they now have ex-stock the 20% tolerance range of Nichicon-Sprague resin-dipped tantalums. They have hermetic sealed axial types too. Values stocked range from 4n7 (0.0047 uF) to 330 uF, 6 Vdc to 125 Vdc ratings. Others on request.

Right now, 6m is the excitement band for amateurs. DX opportunities currently available have not been seen for 20 years past. To get amongst it

you need a respectable signal. The ETI-726 booster amp will deliver around 70-80 W PEP from 10 W drive. For novices or the 10m enthusiast, it will also work on 28 MHz with minor changes. A complete kit of parts is available from BEN Industries, P.O. Box 34, Winmalee 2777 NSW. Individual parts will be available through Radio Despatch of Broadway, Sydney, while the DX542CF transistor and Philips trimmers will also be available through Cema Distributors.

Some readers have reported a slight hum problem in their Series 4000 stereo amplifier. This is caused by field leakage from the transformer being induced into the sensitive preamp, either directly or via the case panels. This may be improved by putting a few small washers over the transformer mounting bolts, between the tranny and the chassis. Further improvement will only come through using a transformer with less leakage. Applied Technology of Hornsby NSW have a transformer specially made for the Series 4000 stereo which largely eliminates residual hum problems. It is a specially-constructed C-core with performance approaching that of the toroidal type, without the prohibitive cost.

Once again, it seems a good time to update the list of suppliers who carry pc boards for our projects as we have been receiving quite a few enquiries of late — don't forget to look up the 'Kits for Projects' page when you're searching out suppliers for projects. This page is normally located immediately before the DREGS page which is always just inside the back cover.

There are two sources for *every pc board we have ever published*. If these people don't have what you want in stock, they'll get it for you in a few days. They are:

Radio Despatch Service  
869 George St, Broadway NSW

RCS Radio  
651 Forest Rd, Bexley NSW

For Victorian readers (and surrounding states) All Electronic Components of 180 Lonsdale St, Melbourne keep stocks of *almost every pc board we've ever published*.

A number of suppliers stock most boards for projects published in the last few years. In Melbourne, try Rod Irving Electronics in Northcote and Ellistronics in the city. In Sydney, try Electronic Agencies in Concord. ●

# At Last A Computer We Can All Afford

## CHALLENGER I SERIES

Economical computer systems, ideal for personal use.

**Superboard II** – a complete system on a board requires a 5 volt supply to be up and running.

**Challenger 1P** – fully packaged Superboard II with power supply.

Both systems feature a 24 x 32 character display, 4K RAM (8K on C1) on the board, Keyboard and ready-to-run Basic-in-ROM.

Challenger's I's are expandable up to 32K of RAM, dual mini-floppies, and printer.



**\$489\***

Now in  
stock at  
these  
dealers

**\$360\***



## CHALLENGER IV SERIES

**C-4P** – a high performance BUS oriented modular microprocessor system easily expandable. The back-plane construction allows any of Ohio's 50 boards to be readily added, such as memory expansion options, A/D converters, Voice I/O, printer, sound output, disk controllers and many more.

The C-4P has a software selectable 32 x 32 and 32 x 64 character display, and a programmable keyboard for real time interactive use. The C2 is the choice for the serious computer owner planning on expansion.



**\$837\***

TV set and cassette recorder not included.

All systems include 4K RAM, a typewriter style keyboard, video output suitable for use with an RF convertor (not supplied) to a standard TV set, and the reliable Kansas City standard cassette system. Microsoft's 8K BASIC-in-ROM avoids lengthy loading from cassette and features full string manipulation, floating point and trigonometric capabilities. A machine code monitor in ROM, plus an Assembler allow access to machine code programming. A large range of programs are available for education and entertainment. Contact us for further details.

# OHIO SCIENTIFIC TCG

Australian Dealer: **Systems Automation Pty. Ltd.**  
31 Hume Street, Crows Nest, NSW. 2065. Tel: 439-6477

Dealer enquiries invited

*\*Plus sales tax if applicable.*

# AUTHORISED OHIO DEALERS

**N.S.W.**  
Trevor Burton Pty Ltd  
93 Beatrice Street,  
BALGOWLAH, NSW 2093  
Phone: 94-3861  
Manly Stationary Supplies  
15a The Corso,  
MANLY, NSW 2095  
Phone: 977-2316  
**Compuwest**  
P.O. Box 603  
BATHURST, NSW 2795  
Phone: (063) 375-235  
**Dwell Electronics**  
77 Edgeworth-David Ave.  
HORNSBY, NSW 2077  
Phone: 487-3111

**Softech**  
33 Hume St,  
CROWS NEST, 2065  
Phone (02) 438-3113.

**Compuserve Newcastle P/L**  
Suite 31, 301 Tudor St,  
HAMILTON, NSW 2303  
Phone: (049) 612-579

**VIC**  
**Looky Video**  
418 Bridge Road,  
RICHMOND, VIC 3121  
Phone: (03) 429-5674

**Computer Co-Ordination Services**  
22 Golden Grove,  
THE BASIN, VIC. 3154.  
Phone (03) 762-5937.

**Computerware**  
63 Palsley St,  
FOOTSCRAY, VIC. 3011.  
Phone (03) 68-4200.

**W.A.**  
**Micro Data Pty Ltd**  
25 Brisbane Street,  
EAST PERTH, WA 6000  
Phone: (09) 328-1179  
**Micro Solutions**  
322 Hay Street,  
SUBIACO, WA 6008  
Phone: (09) 381-8372  
**Compulator Australia,**  
Cloisters Square,  
863 Hay Street,  
PERTH, WA 6000  
Phone: (09) 321-9232

**S.A.**  
**Applied Data Control,**  
244 Glen Osmond Road,  
FULLARTON, SA 5065  
Phone: (08) 79-9211  
Neil Pollard

**TAS**  
**J. Walch & Co.,**  
130 Macquarie Street,  
HOBART, TAS 7000  
Phone: (002) 34-7511  
James Powell-Davies

**A.C.T.**  
**Minicomputer & Electronic Services**  
Suite 2, 46 Colbee Court,  
PHILLIP, A.C.T. 2606  
Phone: (062) 82-1774  
Cliff Beechey

**N.T.**  
**Gem Electronics,**  
82 Bradshaw Drive,  
ALICE SPRINGS, N.T.  
Phone: (011) 52-4820  
Graham Langsford

## SPECIAL OFFER TO ETI READERS \$5.00 OFF THESE APF SCIENTIFIC CALCULATORS

### MODEL 8601 ADVANCED SCIENTIFIC

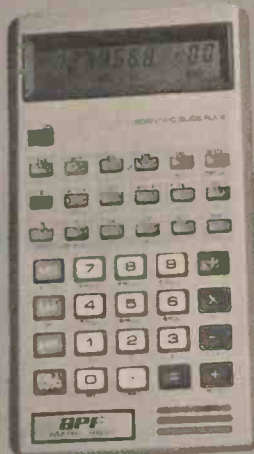

Normal price  
\$37.95  
Special price  
\$32.95

- 10 digit with sign, or 8 digit mantissa + 2 digit exponent display.
- 1 independent memory.
- Calculator range:  $10^{-106}$  ~  $10^{107}$
- Mode key for Degree/Radian/Grad/Statistical function selection.
- Two level parenthesis.
- Long battery life — over 2000 hours' operation.
- Super thin size with deluxe aluminium case.

**Scientific functions:**  
 $x^2$ ,  $\sqrt{x}$ ,  $1/x$ ,  $\pi$ ,  $x!$ ,  
 $10^x$ ,  $e^x$ ,  $\ln$ ,  $\log$ ,  $y^x$ ,  $x\sqrt{y}$ ,  
 $nPr$ ,  $nCr$ ,  
 $\sin$ ,  $\cos$ ,  $\tan$ ,  $\sin^{-1}$ ,  $\cos^{-1}$ ,  $\tan^{-1}$ ,  
 $\sinh$ ,  $\cosh$ ,  $\tanh$ ,  $\sinh^{-1}$ ,  $\cosh^{-1}$ ,  
 $\tanh^{-1}$

**Exchange functions:**  
CN, PaR, R+P,  $\circ$ ,  $\circ$ ,  $\circ$ ,  $\circ$ ,  $\circ$ ,  $\circ$ ,  $\circ$ ,  $\circ$ ,  $\circ$ ,  $\circ$ ,  
D=R, R=G, G=D, R=D, G=R,  
D=G.

### MODEL 5602 FUL SCIENTIFIC

Normal Price  
\$29.95  
Special price  
\$24.95

- 8-digit display in two forms: a. 8 digit floating point number with sign, b. 5-digit mantissa with sign, plus 2-digit exponent with sign.
- 35 key operation with four-mode select switch.
- Calculation range:  $10^{-103}$  to  $10^{103}$
- Number entry in either floating point or scientific notation.
- Constant and repeat operation.
- Degree/Radian/Grad/SD switch for trigonometric functions and statistical functions.

**Scientific functions:**  
 $\sin$ ,  $\cos$ ,  $\tan$ ,  $\sin^{-1}$ ,  $\cos^{-1}$ ,  
 $\tan^{-1}$ ,  $e^x$ ,  $10^x$ ,  $\log$ ,  $\ln$ ,  $y^x$ ,  
 $x\sqrt{y}$ ,  $x^2$ ,  $\sqrt{x}$ ,  $1/x$ ,  $x!$ , degree-minute-second to degree, degree to degree-minute-second,  $\{(),\}$ .

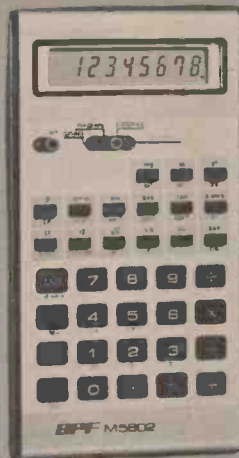

Produce a copy of this advert for special price.  
Offer open for February 1980 only.

## RADIO PARTS GROUP

562 Spencer St, Nth Melbourne. Ph 329-7888.  
1103 Dandenong Rd, East Malvern. Ph 211-8122.

## CALCULATOR SUPERMARKET

435 Bourke St, Melbourne. Ph 67-6412.



TRIO SG-402 R.F.  
OSCILLATOR — \$111  
100KHz-30MHz

We handle the complete range of TRIO test equipment. The GS-1572 is a 30MHz dual trace oscilloscope. This CRD is ideally suited for use in all aspects of the I.V. industry and features a "video delayed trigger". This enables delayed sweep action to be started from any desired point in any single video frame. This CRD has a 5mV/div sensitivity and sweep time of 0.2  $\mu$ s to 0.5 S/div. All this for only \$1095.00. Probes to suit (PC-28) \$47.70 each.



We handle a wide range of speaker components including RCF, Plessey, Foster and Motorola. Two of the Motorola Piezo-Ceramic tweeters are the KSN1001, which will handle 100W, with a response from 4K to 30 KHz, and KSN1025 which will handle 150W with a 2K to 30KHz response. These tweeters feature excellent transient response, low distortion, high impedance, high reliability and light weight. The KSN1001 is only \$11.00 and the KSN1025 is only \$21.00 (no cross-over is required).

The Commodore Pet is a completely self-contained personal computer. Just plug in, and within a few short hours even the complete novice will be amazed at what can be done. The 8K model shown, 16K & 32K models are now available. Options available are External Cassette Decks, Dual Drive Intelligent Mini-Floppies and Printers. The 8K, 16K & 32K models are expandable up to 40K of RAM via plug-in memory boards. For a review of the PET see May 1979 ETI.

Pet Food A large range of programs including games, business applications, and even a program to teach yourself Basic, are now available.

Trendcom Printers. We now have available these high performance thermal printers. These print the full set of alpha-numeric characters at a rate of 40 characters per second. The Trendcom 100 is a 40 character per-line printer, and the Trendcom 200 is an 80 character per line printer which also prints graphics. Interfaces are available for the PET, TRS-80, APPLE II and SORCERER.

Analog to Digital Conversion System. We will soon be offering a 16 channel analog to digital conversion system to enable your PET (interfaces for other computers will be available later) to sense temp, velocity, pressure, light level, fluid level, etc. — just think of the possibilities.



P.O. BOX 1053,  
RICHMOND NORTH, 3121.  
PH. (03) 415708

# EDIBLE ELECTRONICS

# Computer Books



OSBORNE/McGraw-Hill, Inc.

## INTRODUCTION SERIES

### AN INTRODUCTION TO MICROCOMPUTERS: Volume 0

**The Beginner's Book**  
by Adam Osborne

300 pages — \$9.50

If you are not familiar with computers but would like to be, then this is the book for you.

### AN INTRODUCTION TO MICROCOMPUTERS: Volume 1

**Basic Concepts**  
by Adam Osborne

300 pages — \$11.95

A must for anyone in the computer field, this best-selling text explains hardware and programming concepts common to all microprocessors on the market today.

### AN INTRODUCTION TO MICROCOMPUTERS: Volume 2

**Some Real Microprocessors**

New enlarged 1978 edition — loose leaf — \$25.00  
Binding cover to suit — \$5.50

Provides objective, commercial-free descriptions of virtually every microprocessor on the market today.

### AN INTRODUCTION TO MICROCOMPUTERS: Volume 3

**Some Real Support Devices**

New enlarged September 1978 edition — loose lead — \$25.00  
Blinding cover to suit — \$5.50

Same objective, in-depth coverage as Volume 2, but applied to support devices that might be used in any microprocessor system. Memory, data communication devices, data converters, direct memory access controllers, busses and much more.

**Note:** Update series for Volumes 2 and 3 are published every 2 months. They are available ex stock at \$6.95 each. Send for full details.

## PROGRAMMING FOR LOGIC DESIGN SERIES

8080 Programming for Logic Design  
6800 Programming for Logic Design  
Z80 Programming for Logic Design  
by Adam Osborne and co-authors

List price — \$11.50 each.

## ASSEMBLY LANGUAGE PROGRAMMING SERIES

8080A / 8085 Assembly Language Programming  
6800 Assembly Language Programming  
Z80 Assembly Language Programming  
6502 Assembly Language Programming  
by Lance Leventhal

List price — \$11.50 each

## SOME COMMON BASIC PROGRAMS

by Lon Poole and Mary Borchers

This book includes BASIC listings for 76 short programs covering financial, math, statistics and general interest subjects. Every program has been tested, examples and sample program runs are published, as are source listings. Some changes that you may wish to make to the programs are also described.

List price — \$16.50 per book.

**Note:** Some Common BASIC Programs are available on cassette for the Commodore PET and Radio Shack TRS-80 at a list price of \$15.00 per cassette.



LEADER IN  
MICROCOMPUTER EDUCATION

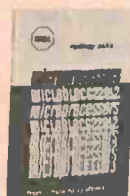

## STEWART ELECTRONICS

44 Stafford Street, Huntingdale. Vic 3166.  
Phone (03) 543-3733. Telex 36908.  
Mon-Fri 8.30am to 5.30pm. Sat 9am to 12 noon.  
Bankcard accepted.

All books plus \$2 pack and post. Tax ex.

### ● 6502 APPLICATIONS BOOK (for SYM and KIM)

A series of practical (hardware and software) applications for a 6502 board (SYM preferred or KIM) which can be used as experiments, or implemented at minimal cost. Examples are: morse generator, electronic piano, digital clock, home alarm system, traffic controller. \$13.95.

● **MICROCOMPUTER PROGRAMMING: 6502.** by Rodney Zaks  
This text will teach you how to program with the 6502, from ground zero if necessary: arithmetic, input-output including polling and interrupts, addressing techniques. Complete, self-contained, it can be used by the novice to learn programming or by anyone who wants to learn about basic techniques using the 6502. \$11.95.

● **MICROPROCESSORS: From Chips to Systems.** by Rodney Zaks.  
An educational text, used worldwide at universities and in industry. Designed to teach all the fundamentals of microprocessors, the assembly of a system, and its use. 420 pages. \$11.95.

● **PROGRAMMING THE Z80.** 330 pages.  
The basic introductory text on programming the Z80. \$11.95.

● **MICROPROCESSOR INTERFACING TECHNIQUES.** Austin Lesea & Rodney Zaks.

All the basic interfacing techniques, from keyboard to floppy disk, including the standard busses (S-100 to IEEE488). 416 pages. \$14.95.



# Print-out



## Apple, the teachers' pet!

The Apple, following its enormous success amongst education establishments in the US, has won acceptance from the NSW Education Department and will be supplied under contract to the State's public schools embarking on computer studies.

A locally-designed and produced machine has also made it to the State Education Department's contracts list as we foreshadowed in last month's 'Rumours'. The Mini-Map from B & S Micro Applications, a 2650-based microcomputer, was specifically designed for school and classroom use. The Sydney-based manufacturers claim the Mini-Map is easy to use and is ideal for student applications.

Computerland Australia Pty Ltd will be supplying Apples to the NSW Education Department (the micros that is... Ed). The Apple II will run BASIC (10K Applesoft Extend Basic — an Apple development) and PASCAL. Software is available for education applications and the basic machine costs around \$1600. The 16K machine can

be expanded to 48K, colour graphic is supplied as standard and it will drive the usual range of peripherals.

The Mini-Map is a smaller capacity machine, available with 5K, 9K or 17K of RAM. It is specifically graphics oriented — split screen operation is possible with text on the top half and graphics on the bottom as well as full-screen graphics availability or full-screen text over full-screen graphics. The Mini-Map is priced at \$650 for the basic machine.

Computerland Australia may be contacted for further information on the Apple at 55 Clarence St, Sydney 2000; (02) 29-3753. Information on the Mini-Map (which missed last month's market guide) may be obtained from B & S Micro Applications, P.O. Box 118 Miller NSW 2168; (02) 607-7674.

## Microtrix expand

A Melbourne-based electronic consulting firm, Microtrix, is expanding its operations to include sales of S100 bus compatible boards and systems.

Various computer-related products designed by Microtrix will also be marketed.

Through its consulting and design activities, Microtrix has gained special knowledge on the operation and use of a number of microprocessor system cards, and only these will be offered for sale. They are able to offer advice on the possible applications of their products or to design systems around them.

Their experience has also led them to design some specialised products of interest to the computer user.

Of particular interest to both hobbyists and industrial applications engineers is the SBC100 single board computer. Based on the powerful Z80 microprocessor, it is a fully self-contained microcomputer system. Its attributes make it ideal for stand-alone applications such as small personal systems or industrial controllers, or as the basis for a larger

processing system according to Microtrix.

It features 1K of on-board RAM and provision for 8K (2716) or 16K of PROM. A parallel input port and a parallel output port, both with handshaking, allow easy interfacing to peripherals or processes. A serial port capable of asynchronous and synchronous operation with software programmable baud rate generation is also provided. Both RS232 and 20 mA interfaces are standard. Further features include a four channel counter/timer with vectored interrupt capability, power-on jump, and board addressing selection.

The SBC100 is fully S100 bus compatible on a high quality printed circuit board with plated through holes and silkscreen layout diagram.

For further information contact Microtrix, PO Box 29 Essendon, 3040 or Lot 4, Bingley Ave, Hurstbridge, 3099. AH: 718-2581.

## Pascal Microengine

Talking about the Pascal Microengine, Daneva Control Pty Ltd, of 70 Bay Road, Sandringham, Vic 3191, tell us they've recently got their first Pascal Microengine from Western Digital.

The Microengine is rather unusual in that the machine's instruction set is in fact the p-code produced as the output of the UCSD Pascal compiler.

While all other computers require an interpreter program to run the p-code, the Microengine executes it directly with a several-fold increase in speed over conventional micros.

The machine comes complete with 32 Kwords (64 Kbytes) of RAM, two RS-232 ports, two 8-bit parallel ports, and a DMA-type floppy disk controller which can handle up to four drives.

Western Digital claim the Pascal Microengine offers considerable advantages over conventional processors, such as

software portability, lower software development costs and efficient memory utilization. The software support for the Microengine is the UCSD Pascal Operating System Version III.O, which includes a Pascal compiler, BASIC compiler, File Manager, Screen Oriented Editor and a Pascal Oriented Debugger.

\* \* \*

The new HP-34C calculator from Hewlett-Packard offers two new functions at a single keystroke. The calculator will integrate a function between two limits, and also has a key marked SOLVE, which will find real roots of an equation . . .

# ELLISTRONICS

289 LATROBE ST. MELBOURNE, 3000  
PHONE (03) 602-3282, 602-3836

## AIM 65 BY ROCKWELL INTERNATIONAL

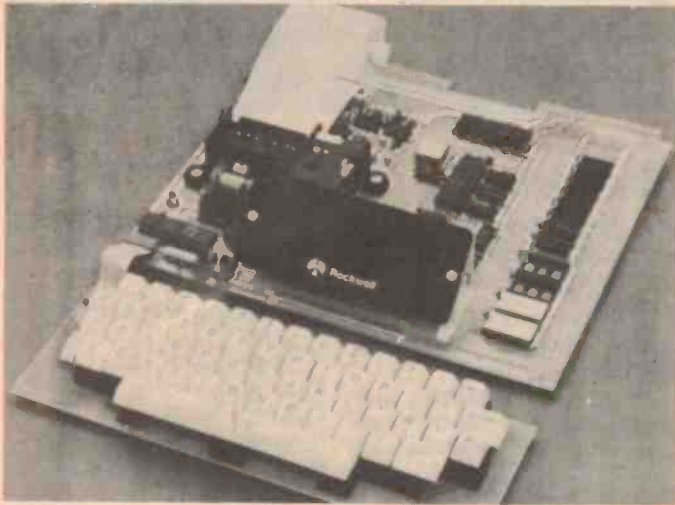

AIM 65 is fully assembled, tested and warranted. With the addition of a low cost, readily available power supply, it's ready to start working for you. AT ONLY \$450 PLUS 15 percent SALES TAX.

### SUPER SPECIALS — LOWEST PRICES EVER

	TRADE	INC TAX
2708 E. PROM .....	8.20	9.43
2114 450nS .....	4.60	5.29
2114 8 for .....	36.00	41.40
2114 32 for .....	136.00	156.40
2716 SINGLE SUPPLY .....	25.00	28.75
MJE 3055 .....	.60	.77
MJE 2955 .....	.60	.77
LM555 timer .....	.20	.26
LM741 op amp .....	.16	.19
BC547-BC548-BC549 .....	.09	.12
BC557-BC558-BC559 .....	.09	.12
Red Leds .....	.10	.12
Green or yellow Leds .....	.20	.23

### SYM-1, 6502-BASED MICROCOMPUTER

- ★ FULLY-ASSEMBLED AND COMPLETELY INTEGRATED SYSTEM that's ready-to-use
- ★ ALL LSI IC'S ARE IN SOCKETS
- ★ 28 DOUBLE-FUNCTION KEYPAD INCLUDING UP TO 24 "SPECIAL" FUNCTIONS
- ★ EASY-TO-VIEW 6-DIGIT HEX LED DISPLAY
- ★ KIM-1\* HARDWARE COMPATIBILITY
- The powerful 6502 8-Bit MICROPROCESSOR whose advanced architectural features have made it one of the largest selling "micros" on the market today
- ★ THREE ON-BOARD PROGRAMMABLE INTERVAL TIMERS available to the user, expandable to five on-board
- ★ 4K BYTE ROM RESIDENT MONITOR and Operating Programs
- ★ Single 5 Volt power supply is all that is required
- ★ 1K BYTES of 2114 STATIC RAM onboard with sockets provided for immediate expansion to 4K bytes onboard, with total memory expansion to 65, 536 bytes
- ★ USER PROM/ROM: The system is equipped with 3 PROM/ROM expansion sockets for 2316/2332 ROMs or 2716 EPROMs
- ★ ENHANCED SOFTWARE with simplified user interface
- ★ STANDARD INTERFACES INCLUDE:
  - Audio Cassette Recorder Interface with Remote Control (Two modes: 135 Baud KIM-1\* compatible, Hi-Speed 1500 Baud)
  - Full duplex 20mA Teletype Interface
  - System Expansion Bus Interface
  - TV Controller Board Interface
  - CRT Compatible Interface (RS-232)
- ★ APPLICATION PORT: 15 Bi-directional TTL Lines for user applications with expansion capability for added lines.
- ★ EXPANSION PORT FOR ADD-ON MODULES (51 I/O Lines included in the basic system)
- ★ SEPARATE POWER SUPPLY connector for easy disconnect of the d-c power.

### PROVEN R6500 MICROCOMPUTER SYSTEM DEVICES

- Reliable, high performance NMOS technology . . .
- ★ R6502 Central Processing Unit (CPU), operating at 1 MHz. Has 65K address capability, 13 addressing modes and true Index capability. Simple but powerful 56 instructions.
- ★ Read/Write Memory, using R2114 Static RAM devices. Available in 1K byte and 4K byte versions.
- ★ 8K Monitor Program Memory, using R2332 Static ROM devices. Has sockets to accept additional 2332 ROM or 2532 PROM devices, to expand on-board Program memory up to 20K bytes.
- ★ R6532 RAM-Input/Output-Timer (RIOT) combination device. Multipurpose circuit for AIM 65 Monitor functions.
- ★ Two R6522 Versatile Interface Adapter (VIA) devices, which support AIM 65 and user functions. Each VIA has two parallel and one serial 8-bit, bidirectional I/O ports, two 2-bit peripheral handshake control lines and two fully-programmable 16-bit interval timer/event counters.

### BUILT-IN EXPANSION CAPABILITY

- ★ 44-Pin Application Connector for peripheral add-ons
- ★ 44-Pin Expansion Connector has full system bus
- ★ Both connectors are KIM-1 compatible

### TTY AND AUDIO CASSETTE INTERFACES

- Standard interface to low-cost peripherals . . .
- ★ 20 ma. current loop TTY interface
- ★ Interface for two audio cassette recorders
- Two audio cassette formats: ASCII KIM-1 compatible and binary, blocked file assembler compatible

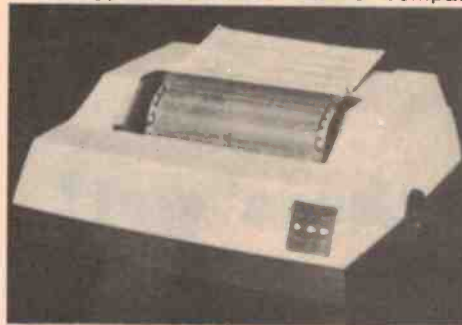

ITO MODEL  
8300  
\$785 PLUS 15%  
SALES TAX

This 80-column printer provides quiet operation, making it suitable for use in offices, classrooms and homes. Specifications include 125 cps, 60 lines per minute, paper loading from bottom or rear and Centronics-compatible, parallel interface.

A bidirectional, dot matrix printer with a print head designed for 100 percent duty operation, assuring a print life that exceeds 100 million characters. The precision sprocket-feed mechanism permits printing forms from 4½ to 9½ inches wide. A 96 ASCII character set prints in upper and lowercase with the added capability of producing double-width fonts in boldface. The vertical format unit provides preprogrammed/programmable tab positions, top of form and bottom of form for complete formatting capabilities.

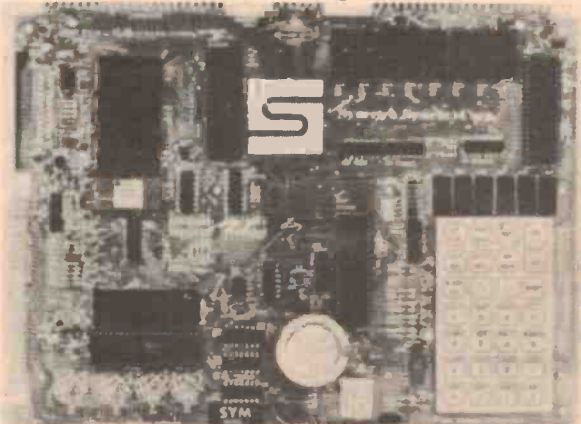

SYM I \$195.00 PLUS 15% SALES TAX  
MINIMUM PACK AND POSTAGE \$3 HEAVY ITEMS COMET  
FREIGHT FORWARD  
SEND 40c STAMP FOR CATALOGUE

IF YOU ARE A RETAILER — SEND FOR ELLISTRONIC DISTRIBUTORS WHOLESALe PRICE LIST.

## New clubs and user groups

The Brisbane Youth Computer Group was formed to enable those people under 18 years of age, who cannot afford their own, to have the opportunity of using (or learning to use) a computer. To raise funds so that the group can construct their own computer, they are selling microprocessor programming sheets at \$10 for 500, \$2.50 for 100 or a minimum order of 50 for \$1.30. Also available, at the same prices, are subroutine function sheets and quick-lookup 2650 microprocessor mnemonic sheets. The minimum order of 50 sheets may be made up of a mixture of three types if you wish. The Brisbane Youth Computer Group may be contacted c/- 14 Cupania St, Algester 4115 QLD.

The Mahly Micro Interest Group of Sydney meets on the second Monday of each month

at the Manly Youth Centre, Kangaroo Street, Manly (behind the Manly War Memorial Club). The Club invites all people interested in Microcomputers, both hardware and software. All age groups are catered for. More information is available from Lionel Hirning on (02) 98-7338, or Ron Bloom on (02) 938-1476.

A North Star Users Group is to be formed in Melbourne. Those interested are invited to attend a meeting on Tuesday 3 March at 7.00 pm at the premises of Sontron Instruments, 17 Arawatta St, Carnegie 3163 Vic. A questionnaire has been prepared to enable information to be exchanged, such as system configuration, particulars and interests etc. You can write to P.O. Box 156 Carnegie 3163 Vic, enclosing \$2 (to cover costs) and a questionnaire will be sent to you.

## Personal Computing for the 80s

MICSIG (Canberra) will be sponsoring a National Microcomputer Conference on 'Personal Computing for the Eighties' to be held over 9-11 July this year in Canberra.

The group have put out a "Call for Papers", seeking speakers to present papers on topics relevant to the micro scene over the next decade. Papers will be particularly welcome, they say, on forward-looking work in progress aimed at extensible systems with easy hardware or software interfaces to systems or subsystems of different manufacturers.

You can obtain a Call for Papers brochure from MICSIG c/- Canberra Branch A.C.S., P.O. Box 446, Canberra City ACT 2601.

## JMP-80 S100 CPU Card

Acoustic Electronic Developments, of Guildford, NSW, have recently announced the release of their 8080A S100 CPU card.

This product has been especially developed for high reliability and completely complies with the proposed IEEE bus standard according to AED.

The special feature of this design is the provision of a jump starter circuit, which enables a power on jump to any address in memory on single byte boundaries. This design re-

quires no special features, such as the Phantom control, on any other card in the bus. Similarly there are no software prerequisites, such as a jump instruction at the right memory location.

The board also provides a socket for the connection of a front panel, such as that by Im-sai, Altair, etc. The MEMR signal is generated, but may be disabled if not required.

For further information, Contact AED at their Shop, 123 Military Rd, Guildford, NSW, 2161. Telephone: (02) 632-6301.



## Releases, releases

● National's new family of A/D converters easily interfaces with microprocessors — according to N.S. Electronics' latest release. They have a range of four 20-pin DIL 8-bit CMOS successive approximation converters which use a modified potentiometric ladder similar to the 256R approach, and require no external interface logic.

Designated ADC0801, ADC0802, ADC0803 and ADC0804, the family is confi-

● Melbourne-based component and computer marketers, R & D Electronics, will be handling the AmZ8000 Evaluation Board from Advanced Micro Computers of Santa Clara, California.

The board is a fully assembled and tested unit that integrates the necessary on-board software and hardware resources to explore and use the exceptional features of the AmZ8000. In its basic config-

gured to allow operation with the standard control bus of the 8080 microprocessor derivatives. The chips appear like memory locations or I/O ports to the microprocessor, hence no necessity for interface logic.

All the good oil on the ADC0801 family can be obtained from Jack Rutherford at N.S. Electronics, PO Box 89, Bayswater 3153 Vic; (03) 729-6333.

uration, the AMC 96/4016 incorporates the 16-bit CPU, 8K of RAM, 24 parallel I/O lines, two RS232C serial ports, 12K of EPROM/ROM sockets, a system clock and resident monitor.

Its complete features are too long to go into here, but you can get full information from R & D Electronics at 247 Burwood Highway, Burwood 3125 Vic; (03) 288-8232, 288-8262.

## Alpha Micro move in

The move of micros into commercial systems has taken another step with the formation of Australian Alpha Micro to market the well-known Alpha Micro range of small business computers.

The Alpha Micro is based on the same chip set as the LSI-11 and the Western Digital Pascal Microengine, but it obeys a different instruction set which has been specifically optimised to run a multi-user, multi-tasking operating system. The AM-100's designer, Dick Wilcox, got the idea when he read an article suggesting that someone should interface the LSI-11 chip set to the S-100 bus; so he went ahead and did it, redesigning the instruction set and adding a few frills as he went. The five-chip CPU set is mounted on two

S-100 cards, and provides prioritised interrupts, a real time clock and an awful lot of computer power.

Since the CPU was designed, Alpha Micro have added a lot of peripherals, including both floppy and hard disk interfaces and a software package that makes other micro suppliers turn green with envy, including Pascal, LISP, and a BASIC compiler. Is this a micro or a mini?

Australian Alpha Micro can be contacted at 247 Pacific Highway, North Sydney 2060. Tel: (02) 929 0685.

# ENTER THE WORLD OF COMPUTERS — WHEN YOU ENTER A DICK SMITH STORE!

## CASSETTES FOR USE WITH YOUR SORCERER —



**GRAPHIC GAMES** (X-3631 - \$14.95)  
The most fantastic games - the ultimate game is to land on the moon with a LEM. Also includes pie lob, nuclear reaction, bounce checkers and dodgem.

**SMART ALEC** (X-3632 - \$14.95)  
Over 200 questions on seven subjects. The computer can certify you a genius!

**MAGIC MAZE** (X-3620 - \$14.95)  
Ten levels of play - how good are you at getting out?

**PLOT** (X-3621 - \$17.95)  
High resolution mode for superior graphics or low resolution mode for ultra fast graphics, all on one cassette.

**Z-80 DISASSEMBLER** (X-3622 - \$17.95)  
Decode machine language programs, including the Sorcerer's monitor and ROM PACs. Or use in ASCII mode which converts machine language to ASCII.

**SHAPE MAKER** (X-3623 - \$17.95)  
Detailed 12 page book explains how you can construct special characters and fancy shapes with this on-screen editor.

**OEBUG** (X-3624 - \$17.95)  
Debug machine language programs by stepping through one instruction at a time - has several display options.

**FASTGAMMON** (X-3625 - \$22.95)  
A skillful opponent for backgammon players - includes an 8 page instruction manual with rules.

## MICROPOLIS™ FLOPPY DISC DRIVES

Top quality drive systems without the expense!  
**DUAL DENSITY - SINGLE DRIVE**  
A massive 143k storage with a transfer rate of 1/4 million bits/sec recording density of 5162bpi and improved drive system for accurate location.

X-3200 ..... \$875

**DUAL DENSITY - DUAL DRIVE**  
The same top quality as the single drive plus 630k storage.  
X-3210 ..... \$1950

Both systems are supplied with \$100 controllers, Interconnect cable, 2 diskettes, one of the MICROPOLIS™ BASIC, a compatible DOS, assembler, editor and user's manual.

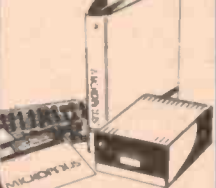

## FOR LESS THAN \$1,000! A TOP MODEL PRINTER



This is a superior dot matrix impact printer that uses inexpensive fan fold paper. It has a print speed of 125 characters per sec. with a 1 line data buffer. Interface is 8 bit parallel standard and the code is ASCII (96 characters). If you are after a printer then the CITOH is an absolute must!

X-3255 ..... \$970

Computers for the enthusiast is an ever expanding hobby. Dick Smith is constantly expanding his range of products so when you are next in a Dick Smith store why not ask about our latest products in this fascinating hobby.

## COMPUTER MONITOR



You don't have to spend a fortune on a video monitor. This famous mark unit can be used with the Sorcerer, TRS80, Apple etc. It has a large 30cm diagonal screen and gives jitter free characters. Connection to your computer is via an RCA plug and the unit can be used on 240V AC mains or 12V DC.

X-1196 ..... \$149.50

## LIMITED STOCKS VIDEO BRAIN KEYBOARD

Scoop purchase from manufacturer who has gone broke! This is a full function keyboard with 37 keys on a silver plated double sided PCB. Connections are made through a double sided edge connector (0.1"). All keys can be individually accessed by cutting the PCB tracks. Keys contain all alphabet letters, 0-9 numerals, shift, %, etc. etc.

X-1182 ..... \$17.50



## PERTEC POWER SUPPLY

If you wish to increase the number of disc drives to your computer and you are using the superb PERTEC then you will require a suitable power supply. This unit has dual voltage (+5V & +12V) and special connector

X-3234 ..... \$60.00

Supply powers TWO disc drives.

## THE NEW SORCERER II The BEST is now even BETTER!



As part of their on-going research and development, Exidy have made some changes giving the Sorcerer on-board capability of up to 48k RAM plus even greater reliability. You still get a complete stand alone computer that only needs a video monitor to be up and running in BASIC. The Sorcerer has built-in flexibility; there are other computers BUT there is only one Sorcerer.

SORCERER II (8k RAM) Cat. X-3000 ..... \$1095.00  
SORCERER II (16k RAM) Cat. X-3001 ..... \$1250.00

## SORCERER S-100 EXPANSION

Opens the way to almost unlimited expansion of your Sorcerer. Use memory modules speech synthesizers etc. etc. Complete with power supply ribbon cable & connector.

X-3010 ..... \$499

Use other manufacturer's peripherals with your Sorcerer.

## ASCII KEYBOARD

This standard ASCII 63-key keyboard array comes as a one piece unit that can be easily soldered directly to a PCB without the need for subpanels or other additional hardware. Keys have gold alloy inlaid to give long life, low bounce and low contact resistance. If you are considering making up your own keyboard assembly then this is the unit for your project.

X-1180 ..... \$55

## SUPER SPECIAL 16k EXPANSION KIT FOR TRS 80 AND APPLE

Increase your 4k up to 16k and if you have expansion interface you can increase the memory to 32k or even 48k!!

SAVE A MASSIVE \$40!!

Limited stocks at only \$109.50

Cat. X-1186  
Also available 16k expansion kit for the Sorcerer. X-1185 ..... \$149.50



## DISKETTES

133mm HARD SECTOR BLANK DISKETTE  
Made by a leading US manufacturer for the Micropolis drive systems.

X-3505 1-9 \$5.95 ea  
10 up \$5.00 ea

133mm SOFT SECTOR BLANK DISKETTE  
Made for the Shugart drive systems.  
X-3510 1-9 \$5.95 ea  
10 up \$5.00 ea

## PERTEC DISC DRIVE FOR TRS80 OWNERS

More features for your dollar:  
● 133.4mm minifloppy ● 40 tracks ● soft sectored ● dual sensors for recording both sides ● recording density (inside track) 2768bpi ● 1 million bits/side/disc ● power harness and power supply available (see this page).

X-3230 ..... \$379  
Don't pay \$689!!!

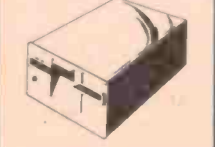

We have limited stocks of this superb disc drive - call in now before we sell out!

## NEW "TINY" PASCAL FOR TRS 80

Cassette tape with "Tiny" Pascal for developing, debugging and running programs on your TRS80. Provides powerful subset of standard Pascal statements, including recursive procedure/functions, global & local variables, If-then-else-then, peek & poke, while, for, repeat/until case & complete TRS80 graphics.

X-3670 ..... \$49.50

Comes complete with comprehensive easy to read manual.

## C10 TAPE

High grade personal computer programming cassette tape in standard cassette case. Five minutes per side giving 38k capacity per side.

X-3500 ..... \$1.95

## CONNECTION CABLES

34 way daisy-chain cable for connecting 4 disc drives to your computer for use with PERTEC drives & TRS80 expansion interface.

X-3232 ..... \$49.50

Serial interface cable for the Sorcerer - connect 2 cassette recorders to the Sorcerer with motor control for both.

X-3110 ..... \$34.50

Printer cable for Sorcerer - connects CITOH or any Centronics compatible printer to the Sorcerer.

X-3112 ..... \$49.50

## LIGHT PEN

Scoop purchase of incredible light pens, direct from the USA. Now you can 'draw' on your computer monitor - it's fun, it's educational and it's simple to use!

● Use your cassette recorder as a pre-amp ● Comes complete with cassette containing two application programs tic-tac-toe and menu display routine ● Give your TRS80 an 'eye' ● Only a fraction of the cost of other light pens

## COMPUTER BOOKS

We stock a huge range of books - call in and browse!

## INTRODUCTION TO PASCAL

By Welsh & Elder  
'Highly recommended' says Jim Rowe. Pascal is the latest 'state of the art' computer language - if you're a computer enthusiast, this 282 page reference will tell you what you want to know.

B-2368 ..... \$13.95

## BASIC AND THE PERSONAL COMPUTER

Dwyer & Critchfield  
This book does not require you to have a University degree! It has 438 pages of superb information on BASIC written for the novice or advanced computer man. Covers games, art, graphics, business and much more as well. A highly recommended book that not only educates but is a lot of fun as well.

B-2330 ..... \$14.95

## GAMES FOR TRS80

Special absorbing program cassettes for TRS 80 owners. TIME TREK (X-3650 - \$17.95) A version of the popular Star Trek. Level I & II 4k RAM.

STIMULATING SIMULATIONS (X-3652 - \$17.95) 10 games on one cassette, all original - art auction, forest fire, monster chase, nautical navigation, lost treasure, business management, gone fishing, rare birds, space flight and diamond thief. Level I & II 4k RAM.

ELECTRIC PAINTBRUSH (X-3654 - \$17.95) Paint patterns on your monitor at machine language speeds. Level I & II 4k RAM.

BRIDGE CHALLENGER (X-3656 - \$17.95) Practice and improve your play - whether you're expert or novice. Level II 16k RAM.

MICROCHESS (X-3658 - \$22.95) Think out your moves because the computer is out to beat you!



# DICK SMITH ELECTRONICS

SEE OUR OTHER ADVERTS IN THIS MAGAZINE FOR OUR STORE ADDRESSES AND RESELLERS



# BUSINESS BUILDER CHIPS



## HOTSHOT STANDARD CIRCUITS TO USE RIGHT NOW:

### KEYLESS DIGITAL LOCK

**The first!** Now you can make a digital lock as tiny as the digital keyboard.

**LS7220:** 14-pin DIP. 5,040 4-digit combinations; out-of-sequence detection logic; 25  $\mu$ A standby; "Save" mode for valet parking, settable in "Unlock"; built-in convenience delay.

### COUNTERS

**For DC to 5MHz counting applications.**

**LS7030:** DC to 5MHz eight decade MOS up counter with 8 decade latch and multiplexer.

Multiplexed BCD and 7 segment outputs. Single power supply +4.75 to +15 VDC (full frequency range over full voltage range). Compatible with CMOS logic. Counter output latches. Leading zero blanking. 40 pin DIP

**For 5MHz to 500MHz counting applications.**

**LS7031:** DC to 5MHz six decade MOS up counter with 8 decade latch and multiplexer.

Multiplexed BCD outputs. Access to LSD latches allows attachment of pre-scalers for counting to 500 MHz. Leading zero blanking. Single power supply operation +4.75 to +15VDC (full frequency range over full voltage range) Compatible with CMOS logic. 40 pin DIP

**For multi-comparison applications where parallel outputs are required**

**LS7040:** Dual 3 decade up/down counter with parallel BCD outputs.

Selectable as 6 decade or dual 3 decade up/down counter. DC to 350KHz count frequency at +5 volts. Fully synchronous operation. Inputs CMOS, TTL, and DTL compatible at +5V operation. Reset. Count enable. Power-on-reset. 40 pin DIP

**For counting applications requiring presignalling and recycling.**

**LS 7050:** DC to 50 KHz six decade up/down counter.

Counting down: 2 signals, optional recycling; counting up: 2 signals, optional recycling, zero detect output. Divide by 5 or 6 inputs. 7-segment output. Latches.

Leading zero blanking. High noise immunity. All outputs CMOS compatible over entire power supply range (+5V to +15V) 40-pin DIP.

### COMPARATOR

**For multicomparison applications; to be used with LS7040.**

**LS7240:** 7 level comparator/multiplexer with parallel BCD inputs. Seven comparators can be loaded with one set of thumbwheel switches. Contents of any comparator constantly available for 7-segment display. Two or more 7240s can be used with one 7040, offering as many levels as needed. 40-pin DIP.

### NUMERIC DISPLAY DRIVER

**For liquid crystal or gas discharge displays requiring up to 60V**

**LS7100:** BCD to 7 segment latch/decoder/driver.

Ion-implanted P Channel MOS circuit compatible with CMOS and TTL systems. Drive voltages up to 60V. 16 pin DIP

**For timing applications requiring keyboard control.**

**LS7090:** 9 decade keyboard controlled Up/Down timer or counter with memory providing 7 segment display, comparator and tone outputs.

Interfaces directly with key switches of standard keyboard. Automatic or keyboard-controlled reset. Divide by 5 or 6 inputs. Contents of memory counter can be displayed at any time. Schmitt trigger count input. Leading zero blanking. Single pin scan oscillator controls. CMOS type noise immunity. All inputs protected, and CMOS, TTL, and DTL compatible at 5V operation. 40-pin DIP.



**daneva control  
pty. ltd.,**

70 bay road, sandringham, victoria, 3191.  
phone: (03) 598 5622, 598 9207 tlx 34439  
Sydney 51 5880. Brisbane 36 5183  
Hobart 44 1337. Perth 326 2444  
Adelaide 42 6666

## TRS-80, APPLE & SORCERER

16K, 200ns, MEMORY  
EXPANSION KITS \$85

Z80A \$17; Z80 P10 \$12  
Z80 CTC \$12; 6875 \$10.75  
6820 \$5; 6821 \$6  
4MHZ Crystals \$4  
s100 Connectors \$4.25  
6800 \$8.50; 8080A \$8.50

**Other microprocessors &  
peripheral ICs available**

Send 20¢ stamp for list

# G.L.W.

4 Pryton Court, Balwyn,  
VIC. 3103.

Phone

**AH (03) 89 6918.**

## THE SYDNEY TO HOBART

SPECTACULAR IN-DEPTH COVERAGE.

• THE SENSATIONAL  
MAXI RACE —

The world's biggest and  
fastest ocean racing yachts  
in battle.

• SOUTHERN CROSS  
SERIES —  
Australia's own  
Admiral's Cup.

FEBRUARY ISSUE,  
ON SALE NOW.



Modern  
**boating**  
& Seacraft

# Professional Calculators

These calculators are not toys. They are professional equipment from the USA's foremost manufacturer of electronic equipment designed to increase business efficiency.

## Data Card

A handsome little package, not much larger than a credit card, a true pocket portable calculator, super slimline styling, packs the power of calculators far greater in size. Basic functions plus 4 key memory. Easy to read 8 digit liquid crystal display. (LCD)

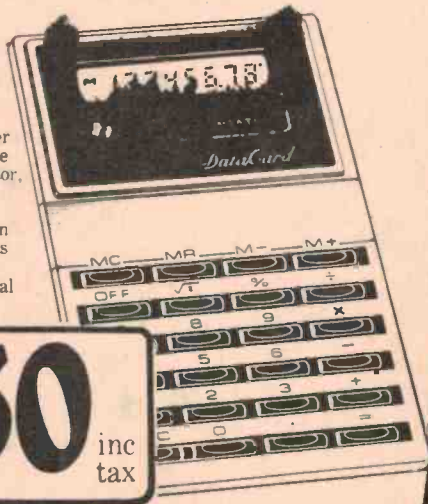

**\$30** inc tax

## Slimline T.I. 50

Super powerful scientific calculator with over 60 functions. T.I.'s new constant memory full statistical function. Algebraic operation function, automatic power down, and AOS entry system. Liquid digital crystal display shows 8-digit or 5-digit mantissa and 2-digit exponent in scientific rotation.



**\$46** inc tax

**TEXAS INSTRUMENTS**  
AUSTRALIA LIMITED

## The T.I. Programmable 59

A revolutionary new personal programmable calculator. 960 programme steps or 100 memories. Master library module plug in feature. 25 different programmes in key areas. Four types of display, up to 10 additional test registers. 72 useful labels. Up to 6 levels of sub routines. Complete programme editing. Operates with PC-100C printer. Optional solid state software libraries.



**\$ 349.50**  
including tax

## PC-100C

The PC-100C printer plotter turns your programmable T.I. 59 into a high speed quiet printer calculator that prints, lists and traces your programme.



Printer plus  
**\$ 284.00**  
including tax.

# silicon VALLEY

**Sydney:** 23 Chandos Street, St. Leonards. Telephone: (02) 439 2965.

**Brisbane:** 22 Ross Street, Newstead. Telephone: (07) 52 1339.

**Melbourne:** 208 Whitehorse Road, Blackburn. Telephone: (03) 877 5311.  
380 Bridge Road, Richmond. Telephone: (03) 429 4780.

**Adelaide:** 170 Sturt Street, Adelaide. Telephone: (08) 51 4080.



## Amateurs gain new bands, lose little at WARC 79!

Amateurs gained three new HF bands and five new EHF (above 30 GHz) bands and extended satellite service privileges out of the World Administrative Radio Conference late last year, but lost portions of the 420-450 MHz and 1215-1300 MHz bands.

**Held in Geneva between 24 September and 6 December 1979, it was the most important radio conference ever organised by the ITU. Following is a preliminary statement by David Wardlaw, VK3ADW, the W.I.A. President, who attended the Conference, with Michael Owen, VK3K1, as part of the Australian delegation:**

"The final news is good news. Firstly, our hopes of new HF bands were fulfilled with no losses of existing HF bands. Secondly, the Amateur Satellite Service now has access to frequencies in all amateur bands above 1 GHz and, finally, four new amateur bands have been allocated above 40 GHz.

"Other aspects of amateur radio were dealt with including Article N30 in which, although the Morse qualification was retained, the lower frequency limit was reduced to 30 MHz. Also, a resolution of considerable significance to the amateur satellite service was passed, removing the necessity of the majority

of amateur earth stations being involved in the notification procedures mentioned in Article N11.

"The new HF bands are: 10.100-10.150 MHz amateur secondary with fixed as primary; 18.068-18.168 MHz and 24.890-24.990 MHz both amateur and amateur satellite primary.

"There have been some changes in the sharing arrangements for the existing HF bands in some regions. Region 1 now has a small table allocation in the 1800 kHz area. In Region 2, 7.100-7.300 MHz remains an amateur allocation although protection from Region 1 and Region 3 broadcasting has been removed.

"In the VHF range 50-54 MHz remains in the table as exclusive amateur in Regions 2 and 3 with many Region 3 countries footnoting broadcasting. 144-146 MHz remains world-wide amateur and amateur satellite but in Region 3 146-148 MHz is now shared with fixed and mobile services on an equal basis. Thus this band was main-

tained, despite extreme pressure, by accepting sharing. This sharing does not mean Australia will assign frequencies to the other services in this band, but we know other countries will.

"In UHF the amateur service had the most problems. On 70 cm both Regions 2 and 3 were aligned with the Region 1 table which included the removal of amateurs from the table between 420-430 MHz and 440-450 MHz only leaving 430-440 MHz as before. However, Australia and a number of other countries, including USA, have retained the amateur service between 420-430 MHz and 440-450 MHz by way of a footnote to the table thus, in Australia, we have lost nothing.

"On the 23 cm band, as expected, the segment 1215-1240 MHz was lost to the amateur service to make way for a Global Positioning Radio Navigation Service. Amateur satellite was footnoted on 1260-1270 MHz in an earth to space direction only.

"The 2300-2450 MHz amateur allocation remains with amateur satellite footnoted 2400-2450 MHz both directions.

"In Region 2 and 3 the 3300-3500 MHz amateur allo-

cation remains with amateur satellite 3400-3410 MHz both directions Regions 2 and 3 only.

"In the worldwide 5650-5850 MHz amateur band there are two satellite segments: 5650-5670 MHz earth to space and 5830-5850 MHz space to earth.

"The 10-10.5 GHz band has amateur satellite in 10.45-10.50 GHz both directions; 24.00-24.05 GHz remains exclusive amateur and amateur satellite, and 24.05-24.250 amateur shared.

"In all the bands between 1 GHz and 40 GHz there have been changes in the services sharing with the Amateur Service.

"Above 40 GHz prior to this Conference there were no table allocations to the amateur or amateur satellite service. There are now four new exclusive bands, some with shared extensions. Also a separate shared band by footnote. The new bands are 47-47.2 GHz, 75.5-76 GHz, 142-144 GHz and 248-250 GHz amateur and amateur satellite primary; 76-81 GHz, 144-149 GHz and 241-248 GHz Radio location primary amateur and amateur satellite secondary; 119.98-120.02 GHz allocated to the amateur service on secondary basis by footnote. ▶



## Walkie-talkie is a versatile unit

**The National Panasonic transceiver, Model RJ-380, is a 6-channel 27 MHz unit which incorporates a number of advanced features including:**

Squelch control to eliminate background noise.

Three-way meter to indicate signal strength, mod. and battery level. An LED on-air indicator.

Earphone, external antenna and microphone terminals.

The units are small, (82 x 282 x 90 mm), light weight (1.1 kg without batteries) and will operate effectively over 2 km in the city, 8 km in country areas and up to 100 km over water, National claim.

The six channels allow use for marine or rescue operations as well as for citizens band use.

Recommended retail price per unit is \$145. More details are available from National Panasonic, 57-69 Anzac Pde, Kensington NSW 2033.

# THIS IS A YAESU PRICE TICKET.

## Notice the price?

There isn't one! Or if there is, it represents only the **maximum** you will have to pay. If anyone advertises, in Australia, a lower price than we show, we will guarantee to beat it! Our list prices are very competitive as they are – but we will guarantee to lower them if our prices are undercut!



Please take these prices with a grain of salt . . .



**WHY TAKE CHANCES?  
BUY YOUR YAESU GEAR  
FROM THE AUTHORISED  
AUSTRALIAN YAESU  
AGENTS!**

### HF TRANSCEIVERS:

- FT-901D: Superb all-mode HF transceiver with digital readout. 6146B finals; 180 watts. The ham's dream! . . . . . CatD-2854 **\$1266.00**  
 FT-101Z: Up-graded version of the famous FT-101E. Suits the FT-901 accessories, same smart styling . . . . . CatD-2862 **\$849.00**  
 FT-7B: Mobile or base, all HF bands. AM/SSB/CW, 12 volt operation. Easy controls for safer mobbling, too. . . . . CatD-2868 **\$649.00**

### LINEAR AMPLIFIERS:

- FL-2100B: 1.2kW of muscle (drive it at 400 and it's coasting!) Tunes all HF bands; 240 volt operated. . . . . CatD-2546 **\$599.00**

### VHF TRANSCEIVERS:

- FT-625R: The new all mode 6m rig for DX chasers. . . . . CatD-2886 **\$795.00**  
 FT-207R: The 21st century microprocessor-controlled hand held for 2 metre operation. Complete with NiCads. . . . . CatD-2888 **\$358.00**  
 CPU-2500RK: 800 channels from 144-148; 25 watts. . . . . CatD-2889 **\$549.00**  
 FT-227RB: 2 metre mobile, dual power out, built-in memorizer. . . . . CatD-2891 **\$399.00**

### RECEIVERS:

- FRG-7: Probably the most popular receiver in the world! ) 0.5 to 30MHz, famous Wadley Loop circuit. Mains or 12V. . . . . CatD-2850 **\$395.00**  
 FRG-7000: Up-graded FRG-7, with digital readout, dual clocks & timer, etc. A superb receiver for the serious listener. . . . . CatD-2848 **\$625.00**

### ACCESSORIES:

- AC-901 Antenna tuner: Suits most transceivers; tunes into virtually any load (almost a wet piece of string) . . . . . CatD-2855 **\$265.00**  
 DC/DC Converter: Suits both the 901 & 101Z. . . . . CatD-2856 **\$75.00**  
 MEMORY UNIT: For both the 901 & 101Z. . . . . CatD-2858 **\$149.50**  
 YE7A Mic: 500 ohms imp; with p.t.t. Suits most transceivers. . . . . CatD-2863 **\$14.50**  
 Cooling Fan: For the 101Z (or replacement on 901) . . . . . CatD-2865 **\$39.00**

### TEST EQUIPMENT:

- YC-500S Digital Frequency Counter: 1ppm accuracy, 500MHz. . . . . CatD-2892 **\$475.00**

**WE OFFER EASY TERMS THROUGH BFC FINANCE \***

For us to better any price, simply show us the advertisement from an Australian company. After checking that they have stocks available at that price, we will sell it for a lower price. Offer open while stocks last.

## DICK SMITH ELECTRONICS

<b>NSW</b> 125 York Street, 147 Hume Highway, 162 Pacific Highway, 30 Grosse Street, 263 Keira Street.	<b>SYDNEY.</b> Phone 290 3377 <b>CHULLORA.</b> Phone 642 8922 <b>GORE HILL.</b> Phone 439 5311 <b>PARRAMATTA</b> Phone 683 1133 <b>WOLLONGONG</b> Phone 28 3800	<b>ACT</b> 96-98 Gladstone Street, <b>VIC</b> 399 Lonsdale Street, 656 Bridge Road, <b>QLD</b> 166 Logan Road, <b>SA</b> 203 Wright Street, <b>WA</b> 414 William Street,	<b>FYSHWICK.</b> Phone 80 4944 <b>MELBOURNE.</b> Phone 67 9834 <b>RICHMOND.</b> Phone 428 1614 <b>BURANDA.</b> Phone 391 6233 <b>ADELAIDE.</b> Phone 212 1962 <b>PERTH.</b> Phone 328 6944
--	---	--	---

EXCEPT WHERE NOTED ALL ITEMS SHOWN IN STOCK AT PRICES GIVEN AT TIME OF GOING TO PRESS.

**MAIL ORDER CENTRE: PO Box 321, NORTH RYDE NSW 2113. Ph 888 3200. PACK & POST EXTRA.**

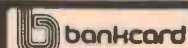

**SHOPS OPEN 9AM to 5.30PM**  
(Saturday: 9am till 12 noon)  
**BRISBANE:** Half hour earlier.  
ANY TERMS OFFERED ARE TO  
APPROVED APPLICANTS ONLY  
RE-SELLERS OF DICK SMITH  
PRODUCTS IN MOST AREAS OF AUSTRALIA.







"The date of release of the new HF bands is dependent on procedures for the relocation of existing stations; this applies to all services, not just amateurs."

Michael Owen, dealing with regulatory matters, added (in brief): (1) The new Radio Regulations come into force on 1.1.1982; (2) The definition of Amateur Service becomes "a radio communication service" which will affect harmful inter-

ference rights to our benefit; (3) Red Cross fixed links are to be in fixed, not amateur, bands; (4) By resolution, natural disaster communications will have priority on amateur bands for the declared duration of disasters; (5) The formation of an Australian national frequency table is the next step in procedure; (6) The new bands will not necessarily become available from 1-1-1982.

## Swan and Cubic re-organise

**Sam Arn, head of Swan Electronics, the Californian amateur equipment manufacturer, will head up a new company manufacturing transceivers for the commercial radio communications market.**

To be called Cubic Communications Inc., it will be operated as a wholly-owned subsidiary of the existing Cubic Corp. In addition, Cubic Corp. said Swan Electronics will become a division of the new company, but "will continue to expand its present amateur radio operations with no change in personnel."

The new company, according to Cubic Corp., "will have a broad product line of professional communications equipment, including commercial land mobile, point-to-point and

special military equipment and systems for domestic and international applications."

A company spokesman said Cubic Communications will employ about 150 people and be located in the same facility now used by Swan Electronics, which employs about 100 people.

Some commercial equipment currently made by Swan for export markets, as well as Swan-developed technologies, will now be handled by the new subsidiary, according to the spokesman.

## 1980 annual field day will be club's twenty-third

The Central Coast Amateur Radio Club will hold their 23rd Annual Field Day on Sunday 17 February. The 'Gosford Field Day', as it is known, is Australia's biggest annual amateur radio event.

**All amateur operators, their families, friends and anyone interested in amateur radio, are invited to attend. Venue for the event will be the usual place — Gosford Showground, Showground Road, Gosford NSW.**

The day's programme will open at 8.00 am, registration will run until 12.00 noon. Registration costs \$4 for men, \$3 for women, children 16 years and under — \$1. The fee includes morning and afternoon tea, subsidised outings and entry to the contest events. A pensioner concession of 50 percent is available.

You can take a picnic lunch — popular with families, or a take-away food bar will gladly accept your patronage between 10.00 am and 3.00 pm.

The Gosford Field Day popularity is built around three major attractions: The contests, the equipment market — trade display, and the disposals market.

Contests consist of a series of on-air 'scrambles' — where stations attempt to contact as many other stations as possible in a given time; vehicular 'fox hunts' — finding a transmitter hidden several miles away, and pedestrian fox hunts — finding, on foot, a transmitter hidden within the showground area.

Contest operation this year will be co-ordinated using a

computer. Contestants are requested to drive to the event recording area immediately after registering, before parking their cars.

If you want to get rid of the existing junk cluttering up your shack and buy some more to replace it (1), the Gosford Disposals Market is second to none. You must register your equipment for sale by 9.30 am on the day, the Club advises. Cataloguing forms and lot numbers must be obtained in advance — contact Bill Smith VK2TS at RMB 4525, Gosford 2250 NSW, or phone (043) 74-1207.

If you haven't got wheels you can travel by train; the trains arriving in Gosford at 8.45 am and 10.09 am from Sydney and 9.20 am from Newcastle will be met by a Club representative and transport will be provided to the grounds.

The NSW Division WIA Sunday morning broadcast will be from the Gosford Showground, between 11 and 11.30 am. Apart from the usual HF and VHF bands, the broadcast will be televised from the grounds, transmitted on one of the UHF amateur bands (420 or 576 MHz).

For bumper fun, frolics, fox hunts and fizzy drinks with your big amateur radio blowout of the year — it's Gosford, Sunday 17 February!

## Clubs

If you live on the eastern side of Port Phillip Bay, in the very southern suburbs of Melbourne, you might like to pop along to the **Southern Peninsula Amateur Radio Club** and see what they're all about. Meetings are on the first and third Monday of each month at the Rosebud Primary School. Club call signs are VK3BSP and VK3VKR. The Secretary is Bob Whitehead VK3NHA who may be contacted at 7 Spensely St, Rosebud 3939 Vic.

**The Coffs Harbour and District Amateur Radio Club** is one of northern NSW's active amateur groups. At their AGM late last year the 1980 executive were elected, being: President — Max Francis VK2BMK; Secretary — Paul Ireland VK2VQI and Treasurer — Norm Napper VK2VMP, plus a committee of five members.

The Club conducts classes for prospective amateurs to Novice standard, including morse.

The Club will be hosting the **1980 URUNGA Convention** commencing at 8.00 pm on Good Friday 4 April. Registration is \$5.00 per competitor. Programme includes popular

fox hunts and on-air contests.

The Club is contactable through P.O. Box 655 Coffs Harbour 2450 NSW, or you can phone Paul Ireland VK2VQI on (066) 52-4389.

**The Liverpool and Districts Amateur Radio Club** will hold their 1980 Field Day on Sunday 23 March at Catherine Fields west of Sydney.

Programme commences at 8.30 am (an ungodly hour for Sunday! ... Ed.) and all the popular events are listed — fox hunts, scrambles etc plus an observation trial, a 'meet the people' contest and a 'find-the-beeper' scramble for the kids. Venue is the Catherine Fields Hall on the corner of Catherine Fields Road and Chisholm Road (opposite the Catherine Fields Post Office). Bring your own lunch or purchase at the shop opposite.

Trade displays and a disposal market will also be featured.

Registration costs \$4 for adults, \$6 for a family, children under 16 years and pensioners — \$2. Further information is available from Lloyd Anderson at 105 William Drive, Cartwright 2168 NSW or on (02) 72-1107, (02) 605-4461.

# jackson

## TWO-WAY RADIO COMMUNICATION MICROPHONES & ACCESSORIES

**NEW  
RELEASE**



**LESON  
DT 251**

Cat. No.  
7-102

- Locking device
- External and battery power source
- Compression pre-amp
- Volume control
- Tone control
- Built-in meter
- Universal wiring
- Rugged construction



**LESON  
DH233**

Hand held power mic.  
Cat. No. 7-105



**LESON  
CH 229**

Hand held compression  
and noise cancelling mic.  
Cat. No. 7-104

**LESON TW 232**

Cat. No. 7-101

- Base station mic
- Speech compression amplifier
- Variable gain control
- Electronic or relay switching
- Complete with curly cord



**LESON DESK  
MIC DT 252**

Cat. No. 7-109



# jackson

**TAPE RECORDING  
MICROPHONE**

Cat. No. 7-107



**TRANSCIVER  
DYNAMIC  
MICROPHONE**

Cat. No. 7-103



## ACCESSORIES

Cat. No. 7-202



**MAGNETIC  
MIC CLIP**

Cat. No. 7-201



**SCREW-ON  
MIC CLIP**

Cat. No. 7-203



**ADHESIVE  
MIC CLIP**



**EXT. & REPLACEMENT MIC  
LEADS with 4-pin plugs.**  
6' and 12'. Cat. No. 5-321.



**MIC PLUG**

Cat. No. 4-132

**RECEPTACLE**



Cat. No.  
4-133

**ALSO**

Replacement inserts,  
switches and PC  
boards for many other  
microphones.

### OTHER PRODUCTS IN OUR RANGE

**CABLES:** RF military spec co-axial cables • RG 58A/U, RG 58C/U RG 8/U  
• Teflon Dielectric and insulated wires and cables • Speaker  
**ACCESSORIES:** • Power supplies • Electro-Lock, Standard lock mounts  
• Hand held & base station mics • Pre amplifiers • HF-UHF RF amplifiers

• Extension speakers and PA horns • Co-axial connectors • Microphone  
plugs and sockets • Fuses and fuse holders • Filters and noise suppressors  
• Transistors and IC's • Quartz crystals.

**ANTENNA:** HF-VHF-UHF mobile, marine and base station.

**ANTENNA MOUNTINGS:** • Gutter grip • Roof bar • Trunk/lip • Springs  
• Layover • Quick release • Slope adjustable bases:



IMPORT - EXPORT

## I.F.T.A. AUSTRALIA

International Foreign Trading  
Agency of Australasia

1 Greville Street,  
Randwick, N.S.W. 2031  
Sydney, Australia  
Telephone: (02) 665-8211

Telegrams: IFTAA - SYDNEY  
Telex: AA20181 IFTAUS  
Mail: P.O. Box 21,  
Bondi Beach, N.S.W. 2026

# shortwave loggings

## English broadcasts beamed to Australia

A complete listing for the Transmission Period 4 November 1979 through to 1 March 1980. Times are in Greenwich Mean Time, frequencies are in kilohertz. Frequencies in brackets refer to alternative channels not beamed specifically to Australia, but to the Asian area in general, which provide useful secondary coverage.

**ALBANIA.** Radio Tirana. English 0700-0730 and 0900-0930 on 11 985 and 9500.

**AUSTRIA.** Austrian Radio, Vienna. 0700-0900 on 21 735(15 410) 0400-0600 on 17 745 0600-0700 21 500 (15 410); 1100-1300 21 725; 0900-1100 21 585; German 0400-0430, English 0430-0500, German 0500-0800, French 0800-0830, English 0830-0900, German 0900-1230, English 1230-1300.

**CHINA — PEOPLES REPUBLIC.** Radio Peking. English 0830-1030 on 17 635, 15 125, 12 450, 11 725, 11 600, 9460, 8425, 6995. Cantonese 1000-1100 15 200, 12 080, 10 865, 8240.

**CHINA - REPUBLIC (TAIWAN).** Voice of Free China, Taipei. Mandarin 0000-0100, English 0100-0200, Cantonese 0200-0300, English 0300-0400, Mandarin 2040-2140, English 2140-2240, all transmissions on 17 890.

**CZECHOSLOVAKIA.** Radio Prague. English 0730-0800, Czech and Slovak 0800-0830, English 0830-0900 (Saturdays and Sundays English extended to 0925) all services on 21 700, 17 775, 11 855.

**DENMARK.** Voice of Denmark, Copenhagen. Danish 1200-1255 on 15 165.

**ECUADOR.** "The Voice of the Andes", station HCJB, Quito. English 0600-0700 on 6130, 11 900; 0700-1030 on 6130, 9745, 11 900; 1030-1130 on 6130, 11 900.

**FINLAND.** "Radio Finland", Helsinki. English 0930-1000; Finnish 1000-1105; Swedish 1105-1130; English (Sundays only) 0800-0930; Finnish (Saturdays only) 0800-0930. All transmissions on 21 465.

**GERMAN FEDERAL REPUBLIC.** "The Voice of Germany", Cologne. German 0600-0950 on 7285, 9735, 11 795, 17 845, 21 560; relayed on 11 705 (Montserrat), 11 785 and 9690 (Antigua). German 2300-2320 on 7235, 9690, 11 705. English 0930-1030 on 9650, 11 850, 15 275, 17 780, 21 680 and relayed on 17 800 and 21 540 (Rwanda, Africa). English 2200-2300 on 7130, 9765.

**GREECE.** "The Voice of Greece", Athens. 0900-0950 on 9760, 9655 (Greek, including English 0915-0925); 2100-2150 on 9760, 9640, 7205 (Greek, including English 2115-2130; 2200-2250 on 9640 (entirely in Greek).

**HOLLAND.** "Radio Nederland", Hilversum. English 0730-0825 on 9770, 9715 (both via the Netherlands Antilles relay centre at Bonaire); English 0830-0925 on 9715 (via Bonaire); Dutch 0830-0925 on 9770 (via Bonaire); Dutch 1030-1125 on 21 490 & 17 810 (both frequencies via the relay station at Talata, on the island of Madagascar).

**HUNGARY.** "Radio Budapest". Hungarian 1000-1030, English 1030-1100. Both services on 21 525, 17 785, 17 710, 15 220, 11 910, and 9835.

**INDIA.** "All India Radio", New Delhi. General Overseas Service (English): 2045-2230 on 11 755, 15 110; 1000-1100 on 11 935, 15 205, 17 875 (15 300, 17 387, 21 695 for East Asia).

**INDONESIA.** "Voice of Indonesia" at Jakarta. English 0100-0200, Indonesian 0200-0300, English 0800-0900, all services on 15 200, intended for the Pacific area generally.

**ISRAEL.** "Voice of Israel", Jerusalem. English 0500-0515, French 0515-0530. Both services on 11 637, 21 500, English 1200-1230, French 1230-1300. Both services on 17 560.

**ITALY.** "Radio Television Italiana", Rome. Italian 2050-2130 on 11 800, 9575, 7290. Italian 0830-0930 on 21 690, 17 780, 15 330, 11 810, 9580. Italian - special sports programmes on Sundays 1410-1730 on 15 340.

**JAPAN.** "Radio Japan", Tokyo. English 0930-1030 on 11 875, 15 235.

**NEW ZEALAND.** "Radio New Zealand", Wellington. English 0730-1115 on 11 945; English 0945-1115 on 6105.

**NORWAY.** "Radio Norway", Oslo. Norwegian 0700-0830 on 9500, 11 850, 21 730; Norwegian 1100-1230 on 15 345, 21 730; Norwegian 1900-2030 on 9590, 11 850; Norwegian 0300-0430 on 9550. Special English segments are carried on Sundays 0800-0830, 1200-1230, 2000-2030, and on Mondays 0400-0430.

**PHILIPPINES.** "Far East Broadcasting Company", Manila. English: 2300-0500 on 21 515, 2300-0000 on 15 450, 0000-0500 on 17 810, 2300-0100 on 11 890, 0800-1000 on 11 705, 0100-0500 on 15 305.

**RUMANIA.** "Radio Bucharest". English: 0645-0715 on 11 805, 15 335, 15 255, 11 940.

**SPAIN.** "Radio Exterior de Espana", Madrid. Spanish: 0730-1000 on 9520, 11 730, 15 405. (On Sundays, the broadcast opens earlier at 0700).

**SRI LANKA.** "Sri Lanka Broadcasting Corporation", Colombo. English: 1030-1130 on 11 835 (15

120, 17 850 for South Asia). On Sundays, the DX session "RADIO MONITORS INTERNATIONAL" is broadcast.

**SWEDEN.** "Radio Sweden", Stockholm. English: 1100-1130 on 21 690. (DX session "SWEDEN CALLING DXERS" Tuesday).

**SWITZERLAND.** "Swiss Radio International", Berne. 0700-0930, English/Italian/French/German, 21 520, 9560, 15 305 (also on 21 695 to Asia). (DX session "Swiss Shortwave Merrygoround", 2nd and 4th Saturdays).

**UNITED KINGDOM.** BBC "World Service", English. 0900-1130 on 25 650; 0900-1330 on 21 550; 0545-0730 on 15 070; 0600-0915 on 11 955; 0545-0915 on 9640, 7150; 1030-1515 on 15 070; 1100-1515 on 9740; 2000-2245 on 11 750, 9410; 2000-2115 on 7120. 0900-1115 on 15 280 (Far Eastern Relay Station); 0900-1515 on 11 750 (Far Eastern Relay Station); 0730-0915 on 21 660 (Ascension Island Relay Station); 0545-0915 on 9510 (Antigua Relay Station). DX program "WORLD RADIO CLUB" on Sundays 0745 and 2100, Mondays 1115, Wednesdays 2315.

**USA.** Voice of America, Washington, DC. English: 1100-1400 on 15 425 (Philippines relay). Other frequencies beamed to Asia are: 9545, 9760, 6110, 11 715, 21 615, 15 160 (all Philippines); 9565 (via Delano, California); English: 2200-0000 on 26 000 (Philippines relay); Other frequencies for Asia are: 17 820, 15 290, 17 740, 11 760, 15 185, 9770 (all Phils.), 21 460 (via Delano, California).

**VATICAN CITY.** Vatican Radio. English: 2210-2225 9615, 11 830, 15 120.

**USSR.** "Radio Moscow": broadcasts its "World Service" throughout the day, with no specific target areas. Best reception is during the period 0800-1000 on 21 530, 21 645, 17 775, 15 140, 15 130.

**ADDITIONAL:** Many international broadcasters beam programmes for the Asian area generally, and not specifically to Australia. Some of these broadcasts give reliable reception in Australia.

**KUWAIT:** "Radio Kuwait", English 0500-0800 on 21 545.

**PAKISTAN:** "Radio Pakistan", World Service, 0130-0245, English, 17 830, 21 590.

**MALAYSIA:** "Voice of Malaysia", English, 0625-0855 on 15 295.

**MONGOLIA:** "Radio Ulan Bator", English 1220-1250 (Mondays through Sats) 12 070, 9575.

**TURKEY:** "Voice of Turkey", Ankara, English 1200-1300 on 17 775.

**NETHERLANDS ANTILLES:** "Trans World Radio", Bonaire, English 0050-0135 on 11 925.

**EGYPT:** "Radio Cairo", English, 1215-1330 on 17 920.

**BANGLADESH:** "Radio Bangladesh", Dacca, English, 0445-0515 on 15 400, 17 890, 21 685; English 1230-1300 on 21 670, 15 285.

**GERMAN DEMOCRATIC REPUBLIC:** "Radio Berlin International", English 0645-0730 on 15 100, 21 465, 17 740; 1200-1245 on 21 540, 21 465, 17 880, 15 115.

**KOREA (South):** "Radio Korea", Seoul, English 1000-1030 on 11 725, 9580, 9525; 0730-0800 on 15 570, 11 810.

## Chinese Regional Station in English

The Heilongjiang People's Broadcasting Station, at Harbin, has lately been noted with daily English language lessons.

Harbin broadcasts on 5950, with the English lessons being aired from 0930 until 1000. These broadcasts provide DXers with an opportunity to gather enough programme details for the submission of reception reports to this regional Chinese station, located in the area formerly known as Manchuria.

## Tunisia on the Move

Tunisian Radio and TV at Tunis has moved to the clear channel of 11 965, replacing 11 970, for the overseas service.

This new frequency avoids the jamming interference suffered by transmissions on 11 970, and carries programmes in Arabic from sign-on at 0430. The same programme is also broadcast on 15 225.

**NOTE!** All times are given in Greenwich Mean Time (GMT). To convert to Australian Eastern Standard Time, add 10 hours (11 hours for Daylight Saving Time). To convert to Central Time, add 9.5 hours and for Western Time add 8 hours. All frequencies are in kHz.

Shortwave Loggings is compiled by Peter Bunn on behalf of the Australian Radio DX Club (ARDXC). Further information on DXing or the activities of ARDXC may be obtained from either PO Box 67, Highett Vic 3190, or from PO Box 79, Narrabeen NSW 2101, for a 30c stamp.

# AMPLIFIED ANTENNA FOR VHF-UHF-TELEVISION -FM-AM-RADIO

*new!* **SENSAR**

Ultra compact 82-channel TV antennas provide perfect colour and black and white reception in most viewing areas. Sensor antennas have elegant modern styling which blends with the decor of any home setting. Compact unobtrusive design makes it ideal for homes, camper trailers, mobile homes, cruisers, houseboats and yachts. The rugged construction, super strong anodized elements and weather tight Cyclac housing makes it durable in all kinds of weather. Does not require elaborate mounting hardware, yet Sensor installations are stronger than that of conventional antennas with comparable performance. Unique bi-directional characteristics of Sensor antennas provide excellent reception in areas where stations are in different directions . . . eliminates the need for an antenna rotor in most locations. Reception is excellent . . . up to 40 miles over land . . . much, much farther over water. Provides VHF/UHF/FM-AM reception. 240 Volts AC power supply available.

● Please include postage with all orders. Trade enquiries welcome.



**KIT INCLUDES:**  
SR-20M for 12-volt operation. Includes antenna with built-in solid-state preamplifier and anodized aluminium elements, SBP-20 12-volt battery adaptor, MSJ-5 band separator with TV set cord, 15ft 75ohm coaxial cable with connectors. Push up antenna mast, mast brackets, clamps, screws, instruction sheet supplied.

## ELECTRORAFT MANUFACTURING PTY. LTD.

68 Whiting Street, Artarmon, NSW. 2064. Tel: 438-3266.  
We are specialists — 30 years in the antenna business.  
Hours: Mon-Fri 8am to 5pm. Sat 9am to 12 noon.

PEPKEL PTY. LTD. TRADING AS

# WILLIS ELECTRONICS

ELECTRONIC PARTS AND EQUIPMENT



993 HAY STREET, PERTH, W.A. 6000  
TELEPHONES: 321 7609, 321 3047

ALL MAIL TO  
P.O. BOX 7024, CLOISTERS SQUARE,  
PERTH, W.A. 6000

AUTHORIZED  
DEALER

**VICOM**



**DAIWA**

## *hy-gain.*

# NOW OPEN

## DATA ENTRY MADE EASY . . . . MR - 500

NOW ALL YOU NEED IS A STANDARD  
#2 PENCIL, A CARD, AND THE LOW-COST  
MR - 500 MARK SENSE CARD READER TO  
ENTER DATA INTO YOUR MICROCOMPUTER

MARK SENSE CARD READER

- READER AND INTERFACES FOR
- APPLE II, TRS-80 & PET \$825.00.
  - S-100 AND RS232C \$985.00.
- (ALL PRICES EX TAX)

\*IDEAL FOR EDUCATION AND SMALL BUSINESS APPLICATIONS

For more details contact:

## THE ELECTRONIC CIRCUIT

SUIT 414, 4th FLOOR, 20 DUNCAN ST., FORTITUDE VALLEY, QLD. 4006.  
P.O. BOX 2, BROADWAY, Q. 4000. Telephone (07) 52-8455



# PREDICTIONS

MARCH 1980

These GRAFEX style computer generated predictions are provided courtesy of the Australian Ionospheric Prediction Service.

Covering 3 to 40 MHz, these predictions show the times radio contact is possible between the areas designated beneath each graph, as well as the possible 'mode' and reliability. Vertical columns indicate time - commencing at 0000 UT on the left, to 2300 UT at right. For reliable predictions follow the times and frequencies indicated by the F character.

Complete information on using these predictions can be obtained by sending a stamped, self-addressed envelope to:-

ETI - Predictions  
3rd floor 15 Boundary St  
RUSHCUTTERS BAY NSW 2011.



## KEY TO SYMBOLS

- A blank area means no normal propagation is possible.
- % ..... path open 50 - 90% of days in month.
- F ..... path open at least 90% of days in month.
- B ..... propagation possible via E and F layers over 90% of days. Overrides 'F'.
- M ..... propagation possible by both 1st and 2nd F-layer modes. Expect strong fading.
- S ..... propagation possible by 2nd mode (also 3rd and mixed E and F modes). Expect strong fading, weak signals.
- A ..... High absorption indicated. Expect weak signals.

40	.....	33
39	.....	32
38	.....	31
37	.....	30
36	.....	29
35	.....	28
34	.....	27
33	.....	26
32	.....	25
31	.....	24
30	.....	23
29	.....	22
28	.....	21
27	.....	20
26	.....	19
25	.....	18
24	.....	17
23	.....	16
22	.....	15
21	.....	14
20	.....	13
19	.....	12
18	.....	11
17	.....	10
16	.....	9
15	.....	8
14	.....	7
13	.....	6
12	.....	5
11	.....	4
10	.....	3
9	.....	2
8	.....	1

East Coast to Japan  
(Also serves N.E. and S.C.)

East Coast to South Pacific

East Coast to North America  
(Also serves N.E. and S.C.)

East Coast to South America  
(Also serves S.C.)

East Coast to North Africa  
(Also serves S.C.)

East Coast to South Africa  
(Also serves S.C.)

40	.....	33
39	.....	32
38	.....	31
37	.....	30
36	.....	29
35	.....	28
34	.....	27
33	.....	26
32	.....	25
31	.....	24
30	.....	23
29	.....	22
28	.....	21
27	.....	20
26	.....	19
25	.....	18
24	.....	17
23	.....	16
22	.....	15
21	.....	14
20	.....	13
19	.....	12
18	.....	11
17	.....	10
16	.....	9
15	.....	8
14	.....	7
13	.....	6
12	.....	5
11	.....	4
10	.....	3
9	.....	2
8	.....	1

East Coast to Europe  
(Short Path)

E.C. and S.C. to Europe  
(Long Path)

East Coast and S.C. to Persia

North East to South Pacific  
(Also serves S.E.)

North East to North Africa

North East to South Africa

40	.....	33
39	.....	32
38	.....	31
37	.....	30
36	.....	29
35	.....	28
34	.....	27
33	.....	26
32	.....	25
31	.....	24
30	.....	23
29	.....	22
28	.....	21
27	.....	20
26	.....	19
25	.....	18
24	.....	17
23	.....	16
22	.....	15
21	.....	14
20	.....	13
19	.....	12
18	.....	11
17	.....	10
16	.....	9
15	.....	8
14	.....	7
13	.....	6
12	.....	5
11	.....	4
10	.....	3
9	.....	2
8	.....	1

North East to Europe  
(Short Path)

S. Central & W.C. to Europe  
(Short Path)

West Coast to North America

West Coast to Japan

West Coast to North Africa

West Coast to South Africa

# MAKE ONE OF THESE EASILY ASSEMBLED KITS FROM DENMARK.

JostyKits ... Denmark's finest, offer the kind of innovative design inside and outside that you'd expect from Scandinavia. Created by qualified electronic engineers, they feature solid-state space age technology advanced enough for the most

demanding kit builder. Each comes with a comprehensive instruction booklet. Whether you're a novice or experienced builder — JostyKits will give you hours of satisfaction in construction and performance!

## Audio

### AF300 AUDIO AMPLIFIER

A real work-horse, this universal power amp has a wide range of applications such as car radio, record players and small receivers.

Due to its well designed electronic circuit, the AF300 can be used over wide voltage ranges without deterioration of the specification parameters.

Kit AF300 — \$25.00

### AF340 40 WATT AUDIO AMPLIFIER MODULE

High quality 20-20,000 Hz, 37w RMS with low distortion.

Kit AG340 — \$35.00

## FM Tuners

### HF325-2 QUALITY FM TUNER MODULE

The HF325 is a complete high quality FM tuner of professional standing. The tuner unit is ready-made and pretrimmed, making it child's play to assemble. Tuning range 88-108 MHz, operating voltage 12-55 ac. Kit HF325 — \$79.00

Stereo decoder HF 310

### HF310 FM RECEIVER

The HF310 is a very reasonable priced HF FM tuner. Fully trimmed, the sensitivity according to IHF standards is better than 10uV. Features 60 dB S/N ratio and low harmonic distortion.

Kit HF310 — \$49.00

### HF330 STEREO DECODER

Gives 40-45 dB channel separation, just add to a good quality FM receiver. Kit HF330 — \$24.00

## Pre-amps (RF)

### HF395 RF PREAMPLIFIER

Gain 30dB to 20 MHz, 10 dB to 100 MHz and 5 dB to 226 MHz. Ideal to boost reception on short-wave receivers. Kit HF 395 — \$6.00

### HF385 VHF/UHF ANTENNA PREAMP

Superb quality with two aerial inputs and one down lead which simultaneously supplies current from the power supply. Frequency range 40-250 MHz and 400-820 MHz. Gain 9-18 dB, depending on frequency. Kit 385 — \$30.00. Box B850 — \$6.00.



## Light Shows

### AT465 LIGHT SHOW

Turn your music into light. Simply connect this 3 channel light show to the audio terminals of your amplifier and this quality kit does the rest for you!

Kit AT465 — \$64.00

Attractive box and knobs B6065 — \$25.00

### AT468 4 CHANNEL LIGHT SHOW

This superb kit drives 4 lights (400w per channel) from the audio amplifier output. Kit AT468 — \$75.00. Attractive box and knobs B3265 — \$48.00

### AT365 LIGHT SHOW

This quality kit uses microphone input instead of connection to the audio output. 1599w max.

Kit AT365 — \$69.00

Box and knobs B3265 — \$48.00

## FM Transmitter

### HF65 FM TRANSMITTER 60-148 MHz

Will run 5w output with heat sink. Ideal for signal testing of for a miniature transmitter which could be received on a standard FM receiver. Kit HF65 — \$9.00.

## Receiver Converter

### HF305 VHF CONVERTER

Converts FM 105-148 MHz to 105 MHz.

Kit HF305 — \$28.00

Box B3405 attractive chassis kit — \$24.00

## AM Receiver

### HF61 MEDIUM WAVE

### RECEIVER

receiver complete with ferrite coil antenna. Kit HF61 — \$9.00

## Power Supplies

NT415 LAB POWER SUPPLY 0-30V 1 amp well-regulated supply for professional use.

Complete with box and transformer. Kit NT415 — \$128.00

### NT300 LABORATORY POWER SUPPLY

2-30V High quality supply, regulated 2-30V dc at 2 amps with overload protection. Complete with box and transformer. Kit NT300 — \$110.00

## Quick assembly kits

JK01	GENERAL PURPOSE AMP 0.5w	\$18.00
JK02	MICROPHONE AMPLIFIER	\$18.00
JK03	SINE WAVE GENERATOR 20-20,000 Hz	\$30.00
JK04	FM TUNER 88-108 MHz	\$30.00
JK05	27 MHz RECEIVER	\$33.00
JK06	27 MHz TRANSMITTER	\$29.00
JK07	DUAL TONE DECODER FOR R/C MODELS	\$43.00
JK08	330Vac LIGHT OPERATED RELAY	\$19.00
JK09	SIREN KIT inc. SPEAKER	\$19.00
JK10	PHOTOGRAPHIC TIMER 240 Vac	\$23.00
JK101	CAR BURGLAR ALARM KIT	\$55.00

## New Kits

AT347	Electronic Roulette	\$54.00
AT350	2 amp triac light controller	\$12.00
AT357	Touch-control light dimmer	\$33.00
AT356	6 amp AC regulator	\$27.00
MI-360	Multivibrator, sq. wave to 10MHz	\$6.00
SY-310	15w stereo amplifier kit	\$230.00
SY-340	37W stereo amplifier kit	\$289.00



Mail Orders: Direct to VICOM, 68 Eastern Rd., Sth. Melbourne, Vic. 3205. Enclose \$1 extra for handling and postage costs.

JostyKits are available now from:

**Sydney:** Custom Communications, 6 Orchardleigh St Yennora. Ph. 631-3544.

Radio Despatch Service  
869 George St  
Sydney Ph. 211 0816

Vicom International Pty Limited  
339 Pacific Hwy.,  
Crows Nest  
(02) 436 2766

**Adelaide:** Hamtronics,  
Goodwood Rd, Kingspark,  
Ph. 272-8417. Port Adelaide.

International Communications Systems, 75-77 Dale St,  
Port Adelaide. Ph. 47-3688.

**Melbourne:** Eastern Communications, 898 Riversdale Rd  
Camberwell. Ph. 836 8635.

Tasman Electronics,  
12 Victoria St, Coburg.  
Ph. 354 5062.  
J.H. Magraths & Co. P/L,  
208 Little Lonsdale St,  
Ph. 663 3736.

**Brisbane:** Delsound,  
1 Wickham Tce.  
Ph. 229 6155.  
**Launceston:** Advanced Electronics, 5A Quadrant,  
Ph. 31 7075, Tasmanian  
Hi-Fi Company, 87A Brisbane St,  
Ph. 31 5815.

Sydney 681 3544  
Adelaide 43 7981  
Gold Coast 32 2644  
Melbourne 836 8635  
Perth 321 3047  
Geelong 78 9660  
Rockhampton 28 2843  
Wagga 21 2125

Hobart 43 6337  
Cairns 54 1035  
Launceston 44 3882  
Brisbane 38 4480  
Wellington (N.Z.) 28 7946

# The Amcron PSA-2 – A significant advance along the road to perfection.

The name Amcron needs no introduction to seasoned audiophiles. Respected the world over for laboratory standard components of the highest quality and durability, few people would argue that "Nobody does it better than Amcron".

Nearly 30 years of engineering excellence and design innovation is reflected in this new addition to the Amcron range.

The Amcron PSA-2 produces 220 watts RMS per channel at 8 ohm or over 350 at 4 ohms, and features I.O.C. which compares the input signal with the output signal and indicates more than 0.05% distortion via LED lights.

10 years of specialised research has resulted in a new and unique feature: Analog computers within the PSA-2 constantly analyse each

output device. If an output transistor approaches its Safe Operating Area limit (SOA), the self analysing circuits limit output, thus preventing damage. Until the SOA limit is reached, no power limiting takes place at all.

No other amplifier offers this safe, uniquely accurate, yet unobtrusive protection system.

The Amcron PSA-2 can drive speakers harder yet remains a completely safe amplifier.

With the release of the PSA-2, Amcron must surely have raised the standard by which all other amps are judged.

For more information, contact the sole importers:



**B.J.D. ELECTRONICS P/L**  
 202 BOURKE ST MELBOURNE 663 2210  
 430 GEORGE ST SYDNEY 231 2149

# Modern fishing



*It's the new look  
 bigger, brighter, better  
 Modern Fishing!*

116 feature-packed pages, over 50 in colour, a brilliant mix of entertainment and information for Ocean, Rock, Beach, and Stream fishermen!

**Sea Mite Saga** — Epic struggle for mastery over a half-ton Black Marlin — from a 16ft open boat off Cairns!

**New Feature Writers** — Tall Tales and True from Australia's best-known fishing writers!

**How to Win Australia's most Renowned Fishing Competition.**

**FEBRUARY ISSUE ON SALE NOW!**

**AMPEX****360****Professional Series  
Cassettes**

Low noise/high output

Wide dynamic range

Ferrosheen™ polished oxide surface

Superior quality shell and components

HERE IS A UNIQUE OPPORTUNITY to obtain world-famous AMPEX tape cassettes at truly bargain prices.

The AMPEX 360 series are standard tape cassettes but made to professional standards using professional grade materials. They are made specifically for applications in which consistent and reliable performance is as essential as top quality electromagnetic properties. The tapes are of course completely suitable for all general purposes — the main difference between AMPEX 360's and many other tape cassettes is that these are made properly!

The Ampex Professional Series cassette has a wide dynamic range due to its low noise/high output oxide formulation, providing clean, well defined response across the spectrum.

The recording surface is polished by the exclusive Ampex Ferrosheen™ process to produce a glass-slick oxide surface that achieves close tape-to-head contact, maintaining sound fidelity.

The shell, and its internal components, are precision products designed for the highest mechanical reliability. The pressure pad system is a felt/beryllium copper spring assembly. Rotating guide rollers run on lubricated stainless steel pins.

A special formulation in the interior top and bottom liners reduces tape edge friction and minimises possible wow and

flutter. The cushioning effect created by the liners helps to reduce mechanical noise to a practically inaudible level. The convex shape of the liners causes a spring-like action which controls tape torque and tape alignment and helps in forming a uniform tape pack for smooth, jam-free operation.

The cassette shells are assembled with five screws to maintain precise internal dimensional uniformity. The shell may be dis-assembled for editing or splicing if required.

Windows, which allow visual inspection of the tape packs, are made of solid transparent polystyrene to protect the tape from dust.

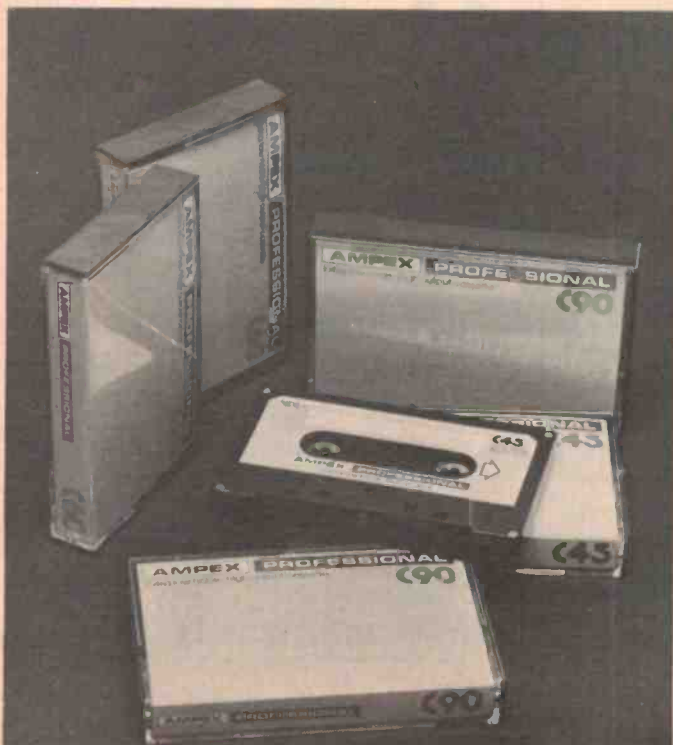
**CHARACTERISTICS****SPECIFICATION****CASSETTE TAPE SYSTEM****PLASTIC SHELL**

Dimensions:	Manufactured in conformance to Philips Dimensional Standards.
Materials of Construction:	High heat, medium impact polystyrene.
Torque Control Liners:	Graphite coated, pretensioned polyester.
Pressure Pad Assembly:	Felt/Beryllium copper spring.
Magnetic Shielding:	Full-width steel.
Closure Method:	5-screw assembly.
Tape position Windows:	Rigid polystyrene. Welded.
Tape Guide System:	Rotating guide rollers operating on lubricating stainless steel pins.

**SYSTEM PERFORMANCE**

Rotating Torque:	Less than 25gm/cm without hold-back.
Wow and Flutter:	Less than 0.10% DIN weighted.

**INTRINSIC MAGNETIC OXIDE PROPERTIES**

Coercivity (Hci) in oersteds	290	290
Retentivity (Brs) in gauss	1100	1100
Erasure (1000 oersted field) in db	-60	-60

**PHYSICAL PROPERTIES**

Base film thickness in mils	0.50	0.30
Base film type	Tensitized polyester	Tensitized polyester
Oxide coating thickness in mils	0.20	0.17
Total thickness in mils	0.70	0.47



# AMPEX CASSETTES SPECIAL READER OFFER!

## Offer repeated by reader request

Each cassette is packaged in a transparent "Norelco" container. The insert label is reversible, providing space for programme contents and title to be written or typed.

Dindy Marketing has arranged with Ampex for Dindy to offer these tapes to our readers for a limited period of time, and at genuinely bargain prices. Electronics Today International has tested these tapes and supports Ampex's claims for performance and quality.

NOTE: Dindy has available ex-stock — 10,000 C45s; 30,000 C60s; and 20,000 C90s. If demand exceeds Dindy's stock, Ampex has agreed to make further supplies available to Dindy within two weeks notice.

*Due to the extreme care taken in manufacture, it is extremely unlikely that any faulty cassettes will be found — in the improbable event that you receive a faulty cassette, Dindy guarantee to replace it (at their discretion) within 30 days.*

Organisations able to purchase at sales-tax free prices should enclose a valid sales-tax certificate and deduct C45 (11c); C60 (12c); C90 (15c) for each cassette.

Offer closes March 15.

This offer is made by Dindy Marketing and this magazine is acting as a clearing house for orders only. Cheques should be made out to 'Ampex Offer' and sent together with the order form to 'Dindy Offer', Electronics Today Int., 15 Boundary Street, Rushcutters Bay, NSW, 2011. ETI will process the orders and pass them on to Dindy who will send out the goods by IPEC or certified mail. Please allow approximately four weeks for delivery.

### SPECIAL BARGAIN PRICES

Quantity	1 - 99	100 - 199	200+
C45	\$1.39	\$1.35	\$1.30
C60	\$1.49	\$1.45	\$1.40
C90	\$1.89	\$1.80	\$1.70

Plus postage — \$2.00 (any quantity).

If valid sales tax certificate enclosed deduct 11 cents — C45s, 12 cents — C60s, 15 cents — C90s.

### AMPEX OFFER

Send to: Electronics Today International  
15 Boundary Street  
Rushcutters Bay, NSW 2011

Please supply:

Quantity

.....C45 ..... \$ .....

.....C60 ..... \$ .....

.....C90 ..... \$ .....

Postage (any quantity) ..... \$2.00

TOTAL:

Name .....

Address .....

.....Postcode .....

Please make cheques/postal notes payable to 'Ampex Offer' and send together with the order to 'Ampex Offer', Electronics Today International, 15 Boundary Street, Rushcutters Bay, NSW 2011. Offer closes March 15.

# AKG



### The AKG Transversal Suspension System

The solution to the pivot problem is relatively simple: a single-suspension element comprises both the spring (suspension and restoring force) and frictional (damping) functions. This results in a pivot point "drift zone" which is limited to a small, practical dimension. The tracking force of the cartridge is transferred to the stylus tip through torque forces created at the suspension element. To be more specific, as the stylus tip rests in the record groove, the cantilever will swing up at the stylus end until the torque-generated force reaches equilibrium with the tracking force. By minimizing the length of the lever over which this torque is generated, the chance of dynamic shifting of the pivot point is greatly reduced. Further, placing the plane of the suspension force perpendicular to the cantilever axis and directly through the pivot point concentrates all forces essentially at one point. In conventional designs, the plane of the suspension force (wire) is parallel to the cantilever, and therefore, not clearly defined as a single-point force.

now offers you the  
major advancement in  
phonocartridge design

## transversal suspension

#### MODEL P8E

Stylus: 0.2 x 0.7 mil nude  
Frequency Range: 10-23,000 Hz  
Tracking Force Range: 0.75-1.25 grams  
Channel Separation: 1kHz 30dB

#### MODEL P7E

Stylus: 0.3 x 0.7 mil  
Frequency Range: 10-21,500 Hz  
Tracking Force Range: 1.25-2.5 grams  
Channel Separation: 1kHz 25dB

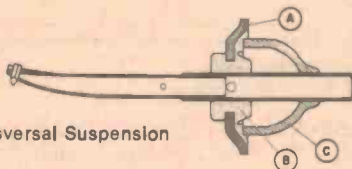

AKG Transversal Suspension

The cantilever is centered symmetrically in a small hole in a very thin, gold-plated metal plate (a). The hole is only marginally larger in diameter than is the cantilever assembly. The plate and the gold-plated cantilever assembly are connected to each other by a newly developed

#### MODEL P8ES

Stylus: 0.2 x 0.7 mil nude  
Frequency Range: 10-28,000 Hz  
Tracking Force Range: 0.75-1.25 grams  
Channel Separation: 1kHz 30dB



#### MODEL P6R

Stylus: 0.7 mil  
Frequency Range: 20-20,000 Hz  
Tracking Force Range: 2-4 grams  
Channel Separation: 1kHz 25dB

#### MODEL P6E

Stylus: 0.3 x 0.7 mil  
Frequency Range: 20-20,000 Hz  
Tracking Force Range: 1.5-3 grams  
Channel Separation: 1kHz 25dB

rubber element (b) which is vulcanized to both metal parts via a special process. The gauge of the suspension plate is quite small in comparison to the diameter of the cantilever assembly. The result is a knife-edge bearing of incredibly small size. When transverse force is applied to the stylus, the cantilever assembly "rolls" back and forth over the knife-edge. Due to the design's complete symmetry, the same mechanical conditions exist for transverse excitation in all directions. Essentially attributable to the extremely small distance between the cantilever assembly and the edge of the hole, the knife-edge effect virtually eliminates dynamic shifting of the pivot point. Variation of the shape of the rubber element allows control of the dynamic forces and torque distribution free from any effects on the pivot point. By tailoring the shape of the rubber element, or by combining two rubber elements, it is possible to control the damping. If two rubber elements are used, a hard rubber may be used in the vicinity of the pivot point (where forces are large) while a softer rubber (c) may be used at greater distances for damping control. This has the advantage of maintaining the desired firm, small, fixed pivot point, and eliminates one of the basic reasons for inclusion of the support or tie-back wire characteristic of traditional designs: i.e. hysteresis or sagging of the soft-rubber element due to the large static suspension (tracking) forces.



Hi-Fi Audio Equipment  
**AMALGAMATED WIRELESS**  
**(AUSTRALASIA) LIMITED**

554 Parramatta Road, Ashfield, NSW 2131 Phone 797 5757

Canberra  
80 5915

Melbourne  
560 4533

Launceston  
44 5155

Hobart  
72 4366

Adelaide  
272 2366

Perth  
271 0888

Townsville  
79 6155

Brisbane  
44 1631

The logo for 'SOUND' is rendered in a stylized, multi-lined font. To the left of the word is a circular icon consisting of concentric lines, resembling a speaker or a sound wave. The entire logo is set against a light grey horizontal band.

# SOUND

<b>FEATURES:</b>	•UPGRADING YOUR HI-FI	125
	•LOUDSPEAKER DESIGN PRINCIPLES	136
	•FERRITE RESEARCHER VISITS US	153

<b>REVIEWS:</b>	•PIONEER PL-L1000 TURNTABLE	144
	•AUDIO REFLEX TURNTABLE	150
	•HAFLER PREAMP & AMP	154



# CLEAR WINNER.



## Our remarkable new amplifier . . . UNCHALLENGABLE!!

Another outstanding Hi-Fi value from Canada's Audio Reflex!  
A powerhouse at 70 Watts RMS per channel, with exceptionally low distortion (0.05% THD) and so many facilities - mic mixing, separate pre/main amp operation, tone control defeat switch, double phono & double auxiliary, & tape dubbing facility.

Electronics Today Intl. says ...  
"harmonic performance...excellent, hum & noise level ... excellent, TID performance ... excellent."  
"In all tests it either equals or exceeds all of the manufacturer's specifications."  
... excellent performance...reasonable price!! Exceptional 3 year warranty!

Available either with perspex cover as illustrated or conventional metal cover. \*Suggested retail \$399



## AUDIO REFLEX

Australian Distributor: Audio Reflex (AUSTRALIA) PTY. LTD.

You'll hear more from us .....

● SYDNEY

7 Orchard Road, Brookvale 2100  
(P.O. Box 208, Brookvale 2100)  
Telephone: (02) 938 4188

● N.S.W.

NEWCASTLE (049) 69 2733  
WOLLONGONG (042) 29 3762

● INTERSTATE

MELBOURNE (03) 572-1419  
BRISBANE (07) 52 4074  
ADELAIDE (08) 264 7266  
PERTH (09) 271 0262  
LAUNCESTON (003) 31 7188

GEELONG (052) 21 6934

# AR adopts vertical stance

Teledyne Acoustic Research, makers of the AR range of loudspeakers, have adopted a policy of 'vertical' placement of driver units in designs for their latest range of loudspeakers — the AR9, AR90, AR91 and AR92.

**Called the "AR Verticals", the new family feature "woofer placement and enclosure shapes designed to eliminate or render inconsequential the 'wall dip' in response that occurs when a speaker is placed in a room". All mid-range and tweeter drive units use 'liquid magnet' cooling for improved power handling capacity and each speaker uses the AR 'Acoustic Blanket' to reduce or eliminate cabinet reflections.**

Top of the line is the AR9, a four-way system using five drivers. Designed to handle high power, but being a high efficiency design, the AR9 will produce high sound pressure levels even from an amplifier of average power, according to AR. Two 300 mm woofers are located on either side of bottom of the enclosure. AR claim this placement prevents reflected-wave cancellation below 200 Hz. A lower mid-range driver comes into play at this frequency, preventing the 'wall dip' in response which would otherwise occur, they say. The crossover network allows for maximum damping at the system's resonant frequency while maintaining bass output.

The vertical array of mid-range and high frequency drivers is surrounded by the AR 'Acoustic Blanket' which is said to aid precise stereo imaging.

The AR9 will deliver 87 dB SPL at one meter on axis, low frequency response is down 3 dB at 28 Hz and cabinet volume is 12 litres. Nominal impedance for the range of AR Verticals is four ohms.

The AR90 is a smaller four-way system, again with five driv-

ers, incorporating most of the important design features of its big brother. AR say it can be placed only 50 mm from the side wall of a room without any appreciable compromise in response. Cabinet volume is 90 litres and it stands 1102 mm tall, whereas the AR9 stands 1340 mm tall. Efficiency of the AR90 is quoted the same as the AR9 and low frequency roll-off is -3 dB at 32 Hz.

The AR91 is a three-way system designed for floor use. The enclosure volume, at 47 litres, is somewhat larger than previous AR three-ways. It has a crossover network designed specifically for the system. Drive units are: one 300 mm acoustic suspension woofer, one 38 mm liquid-magnet cooled dome mid-range with semi-horn and one 19 mm liquid-magnet cooled dome tweeter. Efficiency is quoted as 87 dB SPL from one watt drive at one metre on axis. Low frequency response is down 3 dB at 35 Hz and the system is rated to 300 watts continuous, according to AR's specs. The cabinet has chamfered top corners.

The AR92 is a very similar three-way system. It has a 250 mm bass drive unit and the same cabinet volume but low frequency response is 3 dB down at 44 Hz. Both the AR91 and AR92 stand around 800 mm tall.

All the speakers in the AR Verticals range are covered by a full five-year warranty.

Prices are: AR9 — \$2700, AR90 — \$1645, AR91 — \$1145 and the AR92 — \$935.

For more information, contact Acoustic Research Australia, P.O. Box 21, Greenacre, NSW 2190.



## Signal split

**Direct Injection units (DI's) are used in professional audio applications to obtain a feed from an electronic instrument or its associated amplifier, as an alternative to deriving the signal from a microphone placed in front of a loudspeaker.**

In most cases, the signal is 'split' from the instrument. However this technique bypasses the tonal colourations, effects, and so on, which may be introduced by an amplifier.

Music and Audio Consultants' DLU-1 is designed to take an audio feed from an amplifier output, where the signal is virtually the same as that which would be 'heard' by a microphone, but is free from 'spill' (from adjacent instruments / amplifiers), and from undesirable acoustic noises.

The DLU-1 is a passive device, designed to connect bet-

ween amplifier and speakers. The split feed output is low impedance, at either line level (33 dB attenuation) or mic level (63 dB), floating, and electrically isolated (rated to 400 Vdc) from the input. All connections are via 6.5 mm phone jacks (a connector cable is supplied with the unit), and the maximum input, allowing a 10 dB overload margin, is 945 Watts RMS.

Distributed by Music and Audio Consultants, 212 Hindley St, Adelaide, S.A. 5000, and available from most music accessory stores. Recommended retail price — \$86.67.

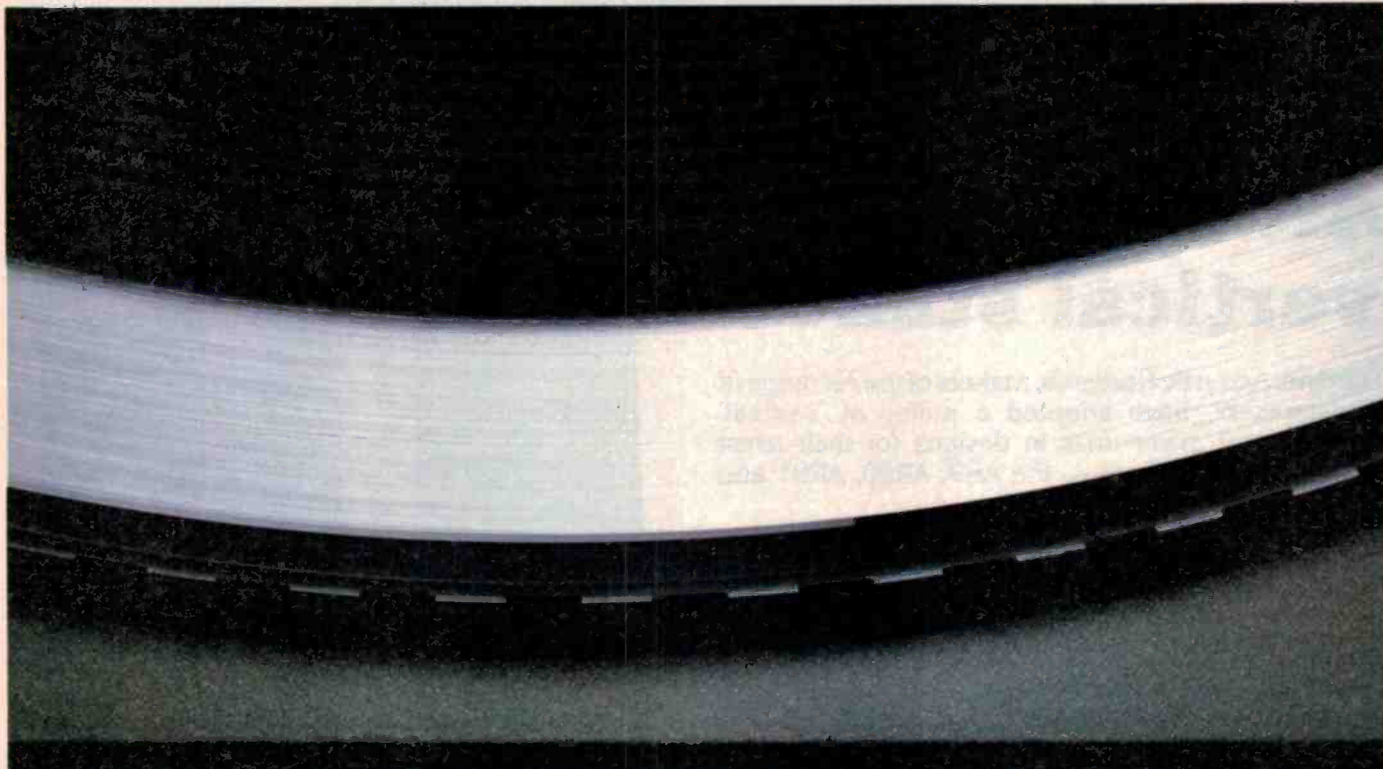

**UNITORQUE**  
QUARTZ LOCK

**CHI** DIRECT DRIVE AUTOMATIC TURNTABLE mode

**sound  
engineering**

## Hitachi's Unitorque Motor with Quartz Lock

### It gives the HT-660 Turntable its all-around precision.

Unitorque direct drive is sound engineering. Precision engineering. Every revolution is perfectly smooth. The balance is as true as the music you hear. Temperature rise is low.

In the HT-660 Turntable, this Unitorque precision is teamed-up with Quartz. Together they provide stable, accurate performance. Platter speed is free from deviation and drift, no matter what the room temperature, the load or the variations in line voltage.

Of course, the HT-660 is fully automatic. But all auto functions are independently powered so there's no drain on the main drive motor. That's why wow and flutter is an incredibly low 0.025% WRMS. Photo-sensor arm return eliminates many mechanical parts. Sensing is all done with light beams, so side force doesn't exist. There's also electronic braking to stop the platter in just three seconds. And all controls are right up front, so you never have to lift the dust cover to get to them.

Hitachi technology is at work to deliver unparalleled turntable accuracy. The HT-660 Turntable with Unitorque and Quartz Lock is the result of those efforts. Listen to the soundness of Hitachi engineering today.

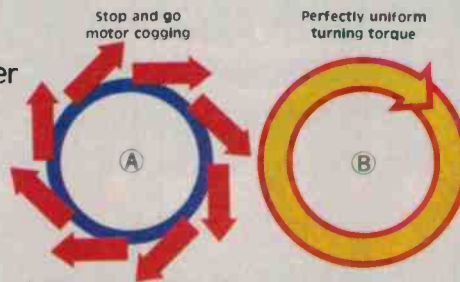

(A) Conventional DC direct drive response  
(B) Hitachi's Unitorque drive

Graphic illustrations are reconstructed from Hitachi Toyokawa audio laboratory data.

Professional sound through sound engineering

# HT-660



# SONY®

## SONY BETAMAX

### PRESENTS

### MOVIES SPORTS

### DOCUMENTARIES

### FAMILY ENTERTAINMENT

## Now playing in your home.

With a Sony Betamax, you can watch programmes you never thought you'd see on your own TV.

Great films, sports and the best TV specials are now available, pre-recorded, on compact video cassettes.

Betamax can also record anything on TV. So besides showing you professionally recorded entertainment, you'll never have to miss another favourite TV broadcast either. You could be watching one channel, for example, while Betamax simultaneously records another. It will even record programmes automatically in your absence and have them waiting when you return.

Over 20 years of Sony video experience goes into every Betamax, more than any other maker of home video recorders. No wonder the world's smallest and most economical cassette format was another of Sony's breakthroughs. And despite the small size, Betamax cassettes can still hold over three hours of video programming.

That's plenty of time for a full, feature length film or a ball game or whatever you please.

## Sony Betamax

See what you've been missing.

TV picture simulated.



KV 2000AS



SL-8000AS

Unauthorised recording of recorded works may be contrary to the provisions of the copyright laws

AP3271F



## New Chartwell speakers feature poly cones

British speaker manufacturers, Chartwell, have recently released a range of speakers using their newly-developed drivers with polypropylene cones.

Because of its physical properties polypropylene is an almost ideal material for loudspeaker cones offering an overall improvement in reproduction and performance characteristics, according to Chartwell.

Prices on the various models have not yet been finalised. However, they are expected to be approximately the same as the models they have replaced. The enclosure sizes will remain the same as the previous model range. The legendary LS3/5A has not been re-designed to include the new drivers.

Full information on the new Chartwell range is available from the sole Australian distributor, Audio 2000, P.O. Box 107, Brookvale NSW 2100. (02) 939-2159.



## TDK tape accessories

These accessories are very handy for the keen tape enthusiast.

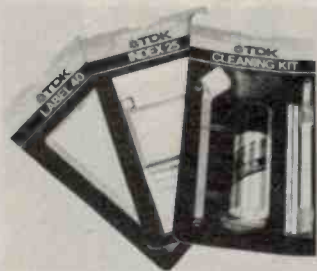

The TDK tape cleaning kit contains head cleaning fluid, pads and applicators and a small mirror. Heads should be cleaned quite frequently, around 10 hours of use when recording, or 20 hours when playing pre-recorded tapes.

When updating your cassette library, or just cleaning up the

files, the "Index 25" kit contains a handy set of 25 labels and cards. One set goes in your cassette case, the other in your index library. You haven't got an index library? There's another good reason for getting a TDK Index 25 kit.

To label your individual cassettes, TDK's "Label 40" pack contains 40 sets of stick-on labels which can be written on with either ink or felt-tip pens without blurring or running. The labels completely cover any existing writing or marking and do not affect azimuth alignment.

For more information, contact TDK (Australia), 4 Dowling St, Woolloomooloo NSW 2011; (02) 358-2088.



## New technics turntables

Three new Technics Quartz Synthesizer direct-drive turntables are now available here. They are:

- The Model SL-1600 Mk2 fully automatic
- The Model SL-1700 Mk2 semi-automatic
- The Model SL-1800 Mk2 manual

All three have many advanced features, including: micro-computer control of all tonearm functions in the SL-1600 Mk2 (this model also has automatic disc-size sensing and repeat-play control through an infra-red sensor and will automatically play discs of different diameters); quartz-locked continuous 6 percent pitch adjustment; all controls located on the front panel, so the turntables can be operated with the dust cover down, plus double-isolated suspension system to drastically reduce the chance of acoustic feedback.

These Technics models are available from selected hi-fi specialists. Recommended retail prices for the new models are: SL-1600 Mk2 \$469; SL-1700 Mk2 \$439; SL-1800 Mk2 \$399.

More information is available from National Panasonic, 57-69 Anzac Pde., Kensington, NSW 2033.

## Super discs from Discwasher

If you're interested in direct-to-disc recordings, Discwasher have released seven recently, covering jazz, rock and orchestral music.

Four are jazz: "Intensive Care" features Paul Smith on piano, Ray Brown on bass and Louie Bellson on drums; "Note Smoking" features Louie Bellson and his Explosion Band (big band jazz); for something different in the jazz line there's "Nostalgia Suite" from Roger Kellaway's group with cello, piano, bass, percussion and drums, and to round out the selection there's "Climax" with the Climax Jazz Band playing their New Orleans style traditional jazz.

For the rock fan there's "Head Room" from the Canadian trio of Ben Mink, Martin Deller and Cameron Hawkins. "Overholt, Tate and Phillips" is a femal vocal group working in the contemporary rock idiom.

For the orchestral fan there's "Direct from Cleveland" featuring Lorin Maazel conducting the Cleveland Orchestra.

All except the "Nostalgia Suite" are available from Arena Distributors, P.O. Box 178, East Victoria Park, W.A. 6101; (09) 361-5422.

# Return to the days of canvas and cannon... great ships and the men who sailed them...

Start with 'The Pirates' your introductory volume to Time Life Books brilliant new series, THE SEAFARERS.



Built for speed, every inch of canvas catching the wind, the huge clippers race against time to claim huge bounties for their cargo.



The Jolly Roger struck terror into the hearts of honest seafaring men. Pirates like Vane slaughtered their captives without mercy. Blackbeard often turned his vicious humour on his own men. He malmed Israel Hands for life as an object lesson to keep the rest of the crew in line. The infamous Bartholomew Roberts captured a staggering total of 400 vessels in just 4 years. You can read the incredible adventures of these blood thirsty sea-dogs in "The Pirates", your exciting introduction to Time-Life Books' brilliant new series, THE SEAFARERS.

**Treasure Islands, murder, torture and plunder.**

Through extensive research into old records, ships' logs and naval reports, we can take you back to those lawless days on the high seas. You'll find out how a regular seaman can turn pirate... how much treasure he captured and his secret hiding places. Why so many captains surrendered without firing a single shot at attacking brigands... and why only death could keep the secret of a pirate's hidden treasure.

**A rich haul of paintings, prints and historic photography.**

Each volume in THE SEAFARERS series contains a rich haul of paintings by naval artists, old prints, maps and historic photographs. Many of the illustrations are in stunning full colour. Each volume comes in a beautiful rich

Pirates attack a merchant ship off New Providence.



logbook-style hard bound cover, inset with a full colour illustration.

**Free 10 day examination**

As your Introduction to adventure on the high seas, we would like you to examine "The Pirates" free for 10 days... return with us to the days of canvas and cannon... great ships and the men who sailed them. As the series continues you'll plunge into fiery battles that changed history, such as Trafalgar and Chesapeake Bay in the volume "Fighting Sall". You'll work beside hardy sailors as they pile on canvas for the last grain races in "The Windjammers". You'll cross the Atlantic in the sumptuous splendour of "The Great Liners". From "The Explorers" to "The Dreadnoughts", each volume offers magnificent illustrations and a wealth of seagoing lore. Begin your adventure right here, simply complete and post the coupon today.



**TIME LIFE BOOKS** **THE** Volume after volume—

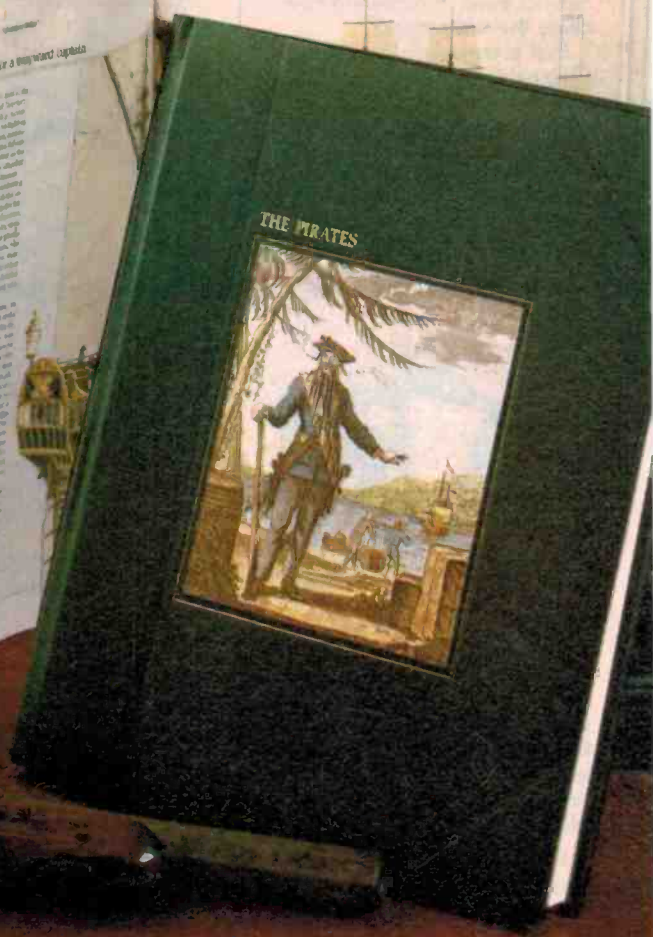
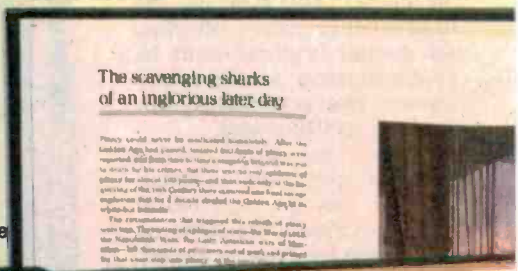



English and Dutch look broadside in the Four Days' Fight of 1666. Roaring cannons spew death and destruction, while the cries of men are silenced by a watery grave.

Workmen seal the planking with a mixture of pitch and horsehair, while yardmen hoist a new rudder into place on "that unique, that most famous ship, the Victoria".

A beehive of power and precision, The Normandie was by far the largest ship afloat. Shown here in minute detail on a magnificent double-fold-out section in the volume "The Great Liners".

# SEAFARERS

packed with beautiful full colour illustrations.

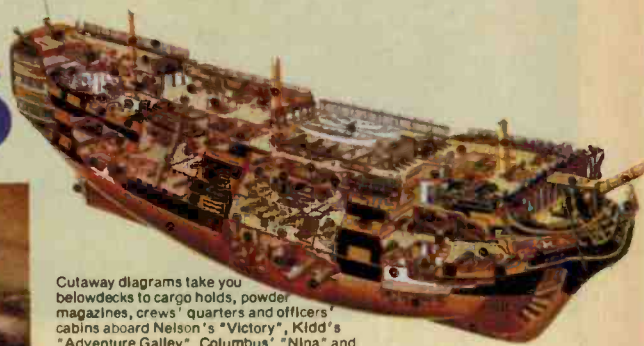

Cutaway diagrams take you belowdecks to cargo holds, powder magazines, crews' quarters and officers' cabins aboard Nelson's "Victory", Kidd's "Adventure Galley", Columbus' "Niña" and other vessels.

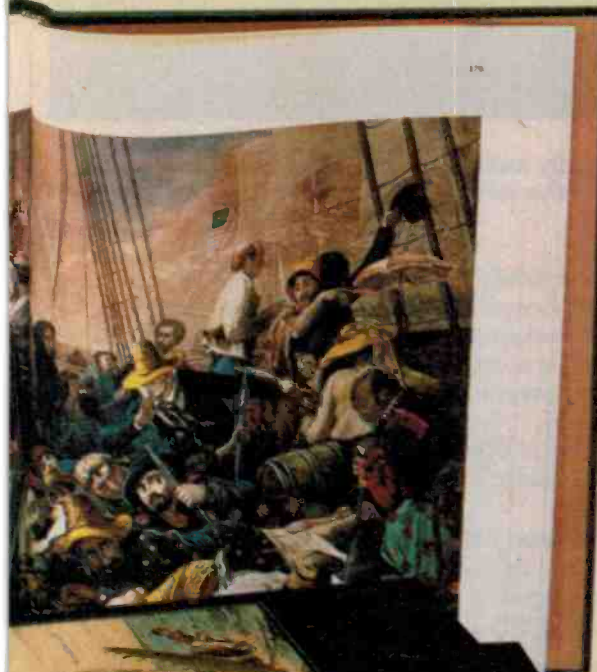

Exciting paintings and rare 19th Century photographs help tell of days when men sailed into the southern oceans in search of the great whales.



"It felt like a shudder", one soldier recalled as the Queen Mary slammed into her own escort vessel at more than 28 knots.

## Yours FREE

A superb Portfolio of Sailing Ships of the High Seas, beautifully reproduced in full colour, each print is a perfect example of naval art. Accept this Portfolio as a free gift, simply for agreeing to examine "The Pirates".



From 16th Century shipbuilding methods to daily routine aboard a "Frisco-bound clipper like the Sovereign of the Seas". It all comes alive in THE SEAFARERS.

Time-Life Books, Blue Street, North Sydney.

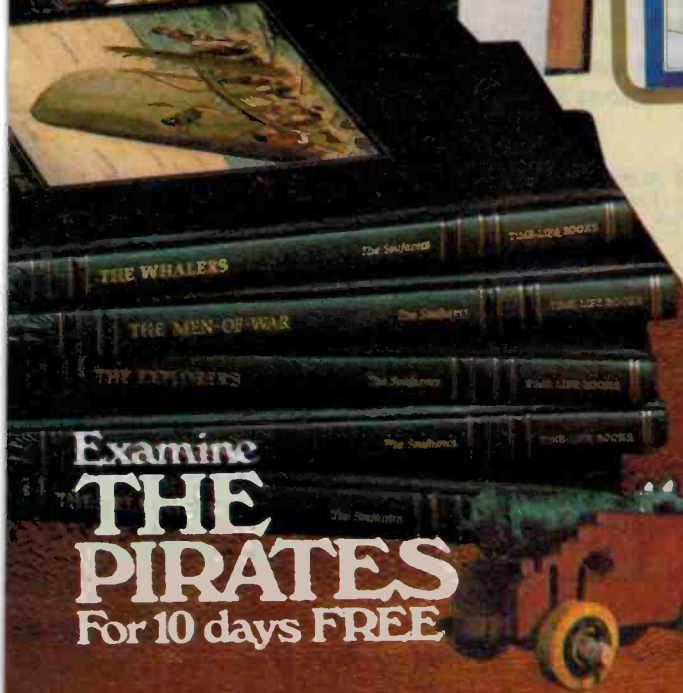

Examine  
**THE PIRATES**  
For 10 days FREE

## FREE EXAMINATION COUPON

**TIME LIFE BOOKS** MAIL TO: FREEPOST 4\*  
Time-Life Books, Box 3814  
G.P.O., SYDNEY 2001.



**YES** You don't need a postage stamp when mailing Freepost. I would like to examine "The Pirates" for 10 days free. Please send it, together with my free Portfolio of Sailing Ships, and enter my subscription to the Time-Life THE SEAFARERS series. I needn't send any money now. Only if I decide to keep "The Pirates" will I pay just \$14.95 plus \$1.50 postage and handling. I will receive further volumes in THE SEAFARERS series, approximately every second month, for 10 days free examination and for the same low price. I don't have to buy a minimum number of books and may cancel my subscription at any time simply by notifying you. If I return "The Pirates" within 10 days, my subscription will be cancelled and I will owe nothing. I may keep my Portfolio of Sailing Ships whatever I decide.

PLEASE PRINT

7996-06

Name: \_\_\_\_\_

Address: \_\_\_\_\_

State: \_\_\_\_\_

Postcode: \_\_\_\_\_ Telephone No.: \_\_\_\_\_

Signature: \_\_\_\_\_  
(Your order won't be accepted without a signature)

**FILL IN AND POST THIS CARD TODAY  
NO POSTAGE STAMP NECESSARY**



# THE NEW ACCUPHASE E303 MOSFET AMPLIFIER



After intensive research and development, Accuphase proudly announce the release of the most advanced amplifier ever to be released in Australia — the new E303 Power MOSFET Integrated Amplifier.

The E303 is the result of many years of amplifier design experience. The E303 fulfills Accuphase's objective to produce an outstanding integrated amplifier with the same high quality performance of high quality separate amplifiers.

The E303 features an exciting new development in Hi-Fi — THE MOSFET POWER OUTPUT DEVICE. The MOSFET will ultimately replace the current transistor and valve designs of today in high quality amplifiers. It has far better sonic qualities than both without the inherent limitations of either.

The Accuphase E303 produces a very conservative 130 watts RMS/channel with less than 0.02% distortion and is designed for optimum performance with any loudspeaker load. Its quality and design are, of course, in keeping with the Accuphase "Grand Prix" award winning tradition.

The advanced specification of the E303 includes a Head-Amplifier with impedance matching facilities so that any moving coil cartridge can be used directly without the need for noisy external transformers or head amps. There is also a versatile tone adjustment system with variable loudness and turnover points.

For the technically inclined, some of the advantages of Accuphase's Power MOSFET are:

- Less active components, minimising phase shift.
- Extremely fast switching characteristics and negative temperature coefficient resulting in far less distortion.
- Less distortion in the extreme high and low frequencies due to an increased power band width.
- Instant switch on efficiency peak. Normal amplifiers take up to fifteen minutes to reach their peak efficiency.

RECOMMENDED PRICE \$1698

**Latest release! Model E203 70 watts a side  
Almost identical features and Mosfet  
circuits all for \$898**

**WEST AUSTRALIA**  
Alberts, Perth  
Vic. Park  
Balga, Fremantle.  
Leslie Leonards,  
Perth.  
**N.S.W.**  
Douglas Hi Fi,  
430 George Street,  
Sydney 233 3922  
Allied Hi Fi  
330 Pacific Hwy.,  
Crows Nest. 439 1072

**Authorised  
Dealers:**

**QUEENSLAND**  
John Gipps Stereo,  
12 Douglas Street,  
Milton 36 0080

**TASMANIA**  
Wills Hi Fi Centre,  
11 Quadrant,  
Launceston

**STH. AUST.**  
Cheshers Pty. Ltd.  
38 Liverpool Street,  
Pt. Lincoln 82 1166  
For Adelaide Dealer  
Phone Arena.

**VICTORIA**  
Douglas Hi Fi  
202 Bourke Street,  
Melb. 663 2211

**arena**  
**DISTRIBUTORS**  
AUSTRALASIA PTY. LTD.  
(09) 361 5422

Accuphase



# Upgrading your hi-fi system

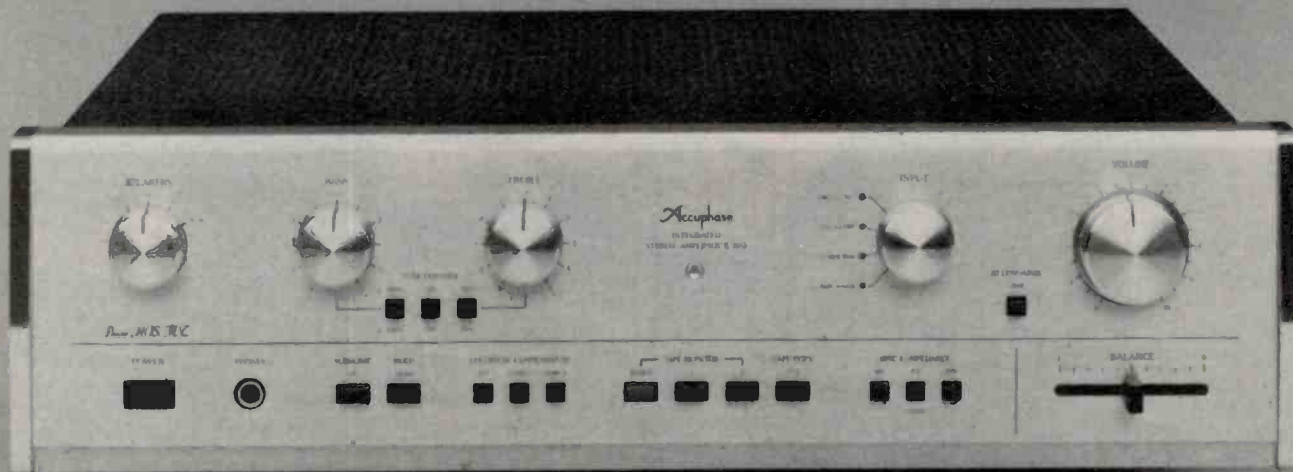

## Richard Timmins

You've progressed to a 'good' system and have enjoyed the equipment for some time — but you'd like to go further. Here's a guide to assist your selection, with a special emphasis on the turntable system.

THE LOGICAL way of upgrading is to begin at the beginning, and with hi-fi that still means the turntable.

Digital techniques, despite their already obvious superiority to current analogue systems, still seem destined for the distant future, that is, a good ten years or more from now, which means nobody should be wondering if it's worth holding off buying a new turntable to replace an old and deficient one. Disc records will be with us for a good while yet and it's interesting to note that there is lots of evidence to suggest the disc isn't exploited to the full. Which is to say even the best modern record playing equipment doesn't extract anything like one hundred percent of the information from a disc recording.

### The turntable etc

Turntables and pickups will continue to improve, and in the next ten years it's likely they will improve by the same magnitude that they did in the last. The standard-setting Linn-Sondek, way ahead of its competition five years

The latest amp from Accuphase, the E 203, features MOSFET output devices and superlative specifications.

ago, now has strong competition in the form of new belt-drive designs like the STD 305 M and 305 D and, believe it or not, direct-drive models like the JMB (British) and Technics. A very old design, the splendid Connoisseur DB1 can, if set up on a very solid and heavy base, give results equally satisfying as those of the Linn. Although the latter sounds definitely quite different to any other turntable, it is now not necessarily better!

Upgrading your turntable doesn't always mean buying a more expensive one. The BD1, for example, equipped with a mid-price arm such as the Haddock GH228 or SME II and an appropriate cartridge — say a Decca Gold, a Grado or Ortofon MC for the Haddock and a fairly compliant model — (a good choice would be an Ortofon moving magnet, a top grade ADC or Shure) for the SME — could still leave you with lots of change from \$700 and

give you top-notch sound as well. Down the price scale there is the unbeatable AR, simplicity personified. The main drawback with this design is its arm, which accepts only a very restricted range of cartridges, although with the trend toward very low effective tip mass but reduced compliance in the best cartridges, the AR arm becomes a more reasonable choice than it was a couple of years ago. Nevertheless it suffers from a poor headshell which is frustratingly non-standard in the sense that it can be substituted physically by any EIA-standard (SME-type) model. This substitution can well result in trouble because the arm has unsprung electrical contacts, unlike EIA-standard arms; it is the AR *headshell* terminals that are sprung.

The AR arm bearings are also a little flimsy, but by and large this turntable is a very good choice for those who want top sound with economy.

Automatic turntables in general still don't appear to offer the performance of manuals, although a couple of designs

*Continued on page 129* ▶



**Pack it. Wrap it. Seal it. Tie it.**



## Or bag it.

The best ideas are always simple. Like TNT Courier Overnight Satchels. For \$8.75 you can send anything that fits inside, to almost anywhere in Australia door to door. Overnight. Just call before 6 p.m. and we'll get it there, usually by 10 a.m. the next morning.

Don't be fooled by appearances. The bag is tough, waterproof and tear resistant.

Get TNT Courier Overnight Satchels from TNT Courier offices around Australia. Or from most newsagents.

**TNT Courier Overnight Satchels. Anything, anywhere, overnight.**



A Speedy Communications product. \*Anything which fits inside the satchel may be sent almost anywhere in Australia, overnight.

# Color your thinking with CompuColor 11

...The Renaissance Machine

- Color Graphics Display
- Tutorial Software
- Financial Software
- Computer Games
- Personal Data Base
- Fortran, Basic, Assembler
- Text Editor, Utilities

The Renaissance Machine is a "one-of-a-kind" system for the "one-of-a-kind" person who demands, and will not settle for anything less than, the best.

The color machine with the black and white price

Available from

**ANDERSON DIGITAL EQUIPMENT PTY. LTD.**

MELBOURNE: 1 Expo Court, Mt. Waverley, (03) 543 2077.

SYDNEY: (02) 808 1444.

Your local dealer:

Newcastle: D.G.E. Systems Pty. Ltd. (049) 69 1625 • Canberra: A.D.E. (062) 58 1811

Brisbane: A.D.E. (07) 59 6436 • Adelaide: Applied Data Control Pty. Ltd. (08) 79 9211

Perth: W. J. Moncrieff Pty. Ltd. (09) 325 5722 • Hobart: Management Technology, (002) 34 4522

Darwin: Direct T.V. and Electronic Services (089) 81 9313

NEW ZEALAND:

Wellington: A.D.E. 64 4585 • Auckland: A.D.E. 87 6570 • Christchurch: A.D.E. 79 0210 — 89 7598

NEW GUINEA: Komputel Systems. 42 3924

Also Sydney — Logic Shop 699 4910. Melbourne — Logic Shop 51 1950



DEALER ENQUIRIES  
WELCOME



Continued from page 125

have separate motors to drive the arm whilst it performs its automatic functions. But no automatic turntable can offer the performance of a manual at the same price, so be prepared to spend more for convenience!

Cartridges have improved almost out of recognition in the past few years, and the most significant shift has been towards low-output moving coils.

Most moving coil cartridges have low-medium compliance which means, in effect, that they will not track at very low downforces. Most of them require at least 1.5 g and the majority sound best at about 2 g. This seems retrograde compared with the tracking forces of 0.75 and 1 g of many popular cartridges a few years ago, but record wear isn't necessarily increased. This is because the latest generation of cartridges has significantly lower tip mass than before, and the inertia of the stylus as it moves within the groove is significantly lower. The reduction of this inertia is an important factor in the reduction of record wear, and the higher tracking forces serve to reduce surface noise (because the stylus has better and more consistent contact with the groove walls) with greater overall stability. In general, heavier arms can be used — an advantage in most ways because a heavy arm will normally have fewer structural resonances than a very light arm.

An arm with reasonably low effective mass, few structural resonances and genuine flexibility is the Hadcock GH228. This gives excellent results with most moving-coil cartridges and

Philips' top-of-the-range turntable is their model AF 977. This unit features a servo-controlled motor for the platter with speed referenced to an accurate quartz crystal oscillator.



The PL-L1000 turntable from Pioneer, reviewed in this issue, features a tangential tracking tone-arm system, an unusual feature amongst top-line turntables these days.

will also accept the finicky Decca with its curious requirement of a low-mass arm that is also very rigid. The Hadcock unipivot bearing is surprisingly free of resonance and other losses, due probably to its use of only four ball-bearings which, due to the high pressure they impose on the bearing shaft, are less prone to vibration than more bearings, with reduced pressure on each.

Another arm worthy of attention despite its high price is the Mission, a low-mass but highly rigid design with

gimbal bearings and viscous damping arrangements.

When selecting a new pickup, due care must be taken to ensure that all performance parameters are carefully matched. It is woeful to hear a combination such as the Stax UA-7 with an expensive Fidelity Research moving-coil cartridge being trounced by the combination of a humble Grace 707 with the cheapest of Fidelity Research moving-magnets! The inferiority of the vastly more expensive combination arises simply because of a poor match, while the Grace and the budget FR moving-magnet come together as an excellent compromise.

Any self-respecting turntable should rarely give trouble in terms of wow and flutter, and rumble will be reduced using a good arm-cartridge system (provided the turntable is well set up) because spurious resonances will be suppressed. When you choose a new turntable, listen with particular care to the clarity of all frequencies. Rumble and other forms of noise will obscure details in music, resulting in a flat, thick sound. A good turntable system will, on the other hand, produce a fine, textured delicacy.

## Amplifiers

There has been some considerable controversy of late concerning amplifier sound, Messrs Acoustical Manufacturing (Quad), represented by Mr Peter Walker, having instituted last year some pretty convincing 'blind' tests with some 'golden ears' of the UK hi-fi press to demonstrate that the differences between competently-designed power amplifiers

Continued on page 131 ▶

New TI Programmable 58C with Constant Memory™ feature: now \$165\*



## If you enter a 480-step program today, the new TI Programmable 58C will remember it tomorrow...even if you turn it off overnight!

Now you can hold the power of a computer in the palm of your hand. Power that can dramatically increase your productivity. Provide the answers you need for rapid, accurate decision making. For exploring hypothetical "what if" situations. It's part of what the new era of "Personal Electronics" is all about.

The TI Programmable 58C, with plug-in application libraries and more than 170 functions and operations in scientific, engineering, and statistical fields ... now an even greater value with Constant Memory feature.

### More easy-to-use software.

Take advantage of the versatility of the new TI Programmable 58C and new software. Twelve optional *Solid State Software™* libraries are now available. Each plug-in library module contains dozens of prewritten programs. Solid-state libraries are available in a variety of fields including engineering, science, sta-

tistics, and business. From \$36\*

The *Professional Program Exchange* lets you exchange programs with members. Over 1,500 programs are already available.

*Specialty Pakettes* are conveniently formatted program listings available in 16 subject areas. Just follow the program listings and tackle a wide variety of problems without the need to do any conventional programming. With the TI Programmable 58C's Constant Memory feature, you won't lose your program if you have to turn the calculator off. \$9.10\* per subject.



In addition, *Custom Software Modules* can be developed for specialized applications and a unique *Professional Productivity Program* is available for corporate use.

### Printing and plotting capability.

Add the PC-100C printer/plotter to your TI Programmable 58C and you can plot, prompt, and print inputs and outputs automatically. \$285\*



### Free literature.

Please call or write to your Texas Instruments Calculator Distributor.



NSW; A.J.F. Systems & Components, 808-2555. Email Ltd (Metering Div.), 699-0033. Silicon Valley, 439-2965. VIC; A.J.F. Systems & Components, 67-9702. Delta Scientific Product Distributors, 366-3742. Email Ltd, 557-2944. Silicon Valley, 429-4780. S.A.; A.J.F. Systems & Components, 269-1244. Email Ltd, 51-0411. Silicon Valley, 51-4080. W.A.; Esdailes of Cloisters, 321-9232. QLD; Email Ltd, 44-0281. Silicon Valley, 52-1339. TAS; J. Walch & Sons, 34-7511. N.Z.; David Reid Data Products, 49-9197.

*Texas Instruments technology - bringing affordable electronics to your fingertips.*

**TEXAS INSTRUMENTS**  
AUSTRALIA LIMITED

\* Suggested retail price.

Continued from page 129

are negligible. Whilst this is no doubt true, I believe a great many listeners stretch their amplification beyond the fundamental design limits and the behaviour of an amplifier when clipping or operating into a 'difficult' loudspeaker load is really what one hears a great deal of the time. So the power amp with 'soft' clipping characteristics might well sound smoother and more expansive than one which clips 'spikily' but is otherwise more accurate and real-sounding. One of Mr Walker's provisos during his tests was that all amplifiers should be working within their limits (i.e. not clipping). But this, one feels, is out of touch with reality. The best power amplifiers seem to be those with good current drive ability, and these can almost invariably be recognised by their use of huge mains transformers and large filter capacitor complements. It is interesting to compare the Phase



Ortofon's top-class Concorde and LM series cartridges feature a patented transducer system, top performance specifications and extremely light weight.

them and the power transformer is fairly substantial (and toroidal transformers are far smaller than conventional ones) then the amplifier is almost certain to sound good. Perhaps the best way to choose between two power amps of the same rating is to check their weights; the heavier one will almost

characteristic of records in which bass is attenuated and treble boosted. Correspondingly, the preamp needs to provide bass boost and treble cut, and the accuracy of this characteristic is important. Even a deviation of as little as 1 dB or 0.5 dB can give serious colouration to sound from records, and so those preamps with highly accurate RIAA are obvious starters when you're upgrading. About the most accurate RIAA of any commercial preamp is the Meridian 101. This model has the advantages of plug-in input modules optimising signal-to-noise ratio for a very wide range of cartridges by giving the correct load impedance and appropriate gain characteristics to avoid overload. Moving-coil cartridges can be connected directly to the 101 without need for head amplifiers or transformers.

Another first-class preamp is the locally made HSA which achieves level matching for high-output cartridges by using input level controls. This preamp doesn't have sufficient gain for moving coils but HSA market a good head amplifier. Other preamps worth considering are the local Audiolab and the American Hafler designs. In integrated amps, several excellent new models are available from Japan and the United States and of particular interest are the MOSFET types using state-of-the-art semiconductor devices.

Continued on page 133 ▶

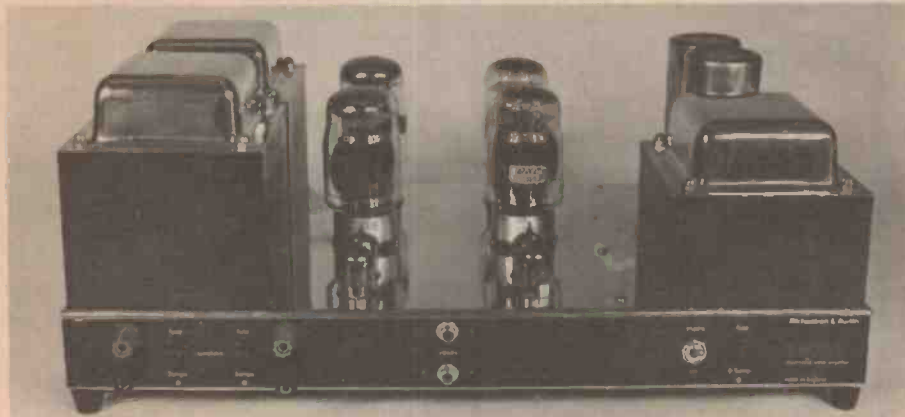

The British-made Michaelson & Austin TVA-1 amplifier — for those who like the 'valve sound'

Linear 700B rated at 350 watts per channel with such amplifiers as the TVA-1 (90 W), the ME-100 (rated 100 W), the ME-50 (50 W), the Naims, Meridians and Sugdens etc., operating into real loudspeaker loads. It is under these circumstances that the now obsolete mono Quad 2, rated at 15 watts, reveals itself as a surprisingly powerful amplifier!

The first thing to check when you buy your new amplifier is that it has an adequate power supply. If you compare two amplifiers each with the same power output rating but one with a larger power supply and transformer, it can be predicted that invariably the unit with the bigger power supply will sound better. It's not enough to judge an amplifier by the size of its cabinet of course; in this context, the Meridian 105 would pale into insignificance against the average Oriental 100 watt amplifier. The power supply capacitors are a good guide, generally speaking. If they're big and there are plenty of

certainly sound better! All of this applies regardless of price range.





The part of the amplifier that is generally regarded as having greatest influence on sound quality is the preamp. The most critical part of the preamp is the circuitry for amplification and equalisation of the incoming signal from a pickup cartridge. Here, the preamp must compensate for the RIAA

Low transient intermodulation distortion (TIM) is considered highly desirable in an amplifier and Sansul's TUX-1 has been designed with this parameter specifically in mind.

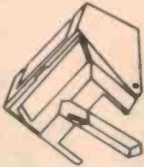

# fact: a Genuine Shure upgrade stylus is unquestionably the biggest bargain in hi-fi

We strongly urge you to check your stylus for wear at least once a year to protect your records and maintain the highest standards of listening pleasure. Regardless of when (or where) you purchased your Shure cartridge, there is a Genuine Shure replacement stylus available which will bring your cartridge right back to its original specifications. Even better, *you may actually be able to improve its performance significantly over the original* with a Genuine Shure upgrade stylus... at surprisingly low cost! For example:

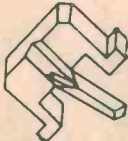
IF YOU OWN:	UPGRADE WITH:	THIS IS THE RESULT:
 <p><b>V15 Type III SERIES</b></p>  <p><b>M95 SERIES</b></p>	<p><b>VN35HE</b> Hyperelliptical stylus</p>  <p><b>N95HE*</b> Hyperelliptical stylus</p> 	<p>A dramatic reduction of harmonic and intermodulation distortion (formerly available only to owners of the incomparable V15 Type IV) is now possible with the V15 Type III and the M95 Series of cartridges simply by replacing the stylus. The Hyperelliptical stylus configuration contacts the record groove in a "footprint" that is longer and narrower than the popular Biradial tip design, making it pre-eminent for reproduction of the stereo-cut groove.</p>
 <p><b>M70 SERIES</b></p>	<p><b>N72EJ</b> Biradial (Elliptical) stylus <b>N72B</b> Spherical stylus</p> 	<p>Improved trackability, especially at high frequencies, due to a new, redesigned low-mass N72 stylus assembly.</p>
<p><b>ANY M91, M92, M93</b></p>	<p><b>N91ED*</b> stylus</p>	<p>Much improved trackability due to the lower effective tip mass of the nude Biradial (Elliptical) stylus tip. Less tracing distortion compared with a Spherical stylus tip.</p>
<p><b>ANY M71, M73, M75</b></p>	<p><b>N75 TYPE 2*</b> Series styli</p>	<p>Improved trackability at higher frequencies due to a stylus assembly with a lower effective tip mass.</p>
<p><b>ANY M44 Series</b></p>	<p><b>N55E*</b> stylus</p>	<p>Lower tracking force with a Biradial (Elliptical) stylus, lower distortion, lower effective tip mass.</p>
<p><b>M3D, M7D</b></p>	<p><b>N21D*</b> stylus</p>	<p>Improved performance at lower tracking forces.</p>

\* Before purchasing any replacement stylus be certain your turntable is compatible with the tracking force of the stylus you select.

**Always insist on a Genuine Shure replacement stylus.  
Look for the name "Shure" on the stylus grip.**

**Genuine Shure upgrade styli by**

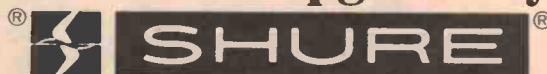

**AUDIO ENGINEERS P/L**  
342 Kent Street,  
SYDNEY 2000 N.S.W.

**AUDIO ENGINEERS (Vic.)**  
2A Hill Street,  
THORNBURY 3071 Vic.

**AUDIO ENGINEERS (Qld.)**  
51A Castlemaine Street,  
MILTON 4064 Qld.

**ATHOL M. HILL P/L**  
33 Wittenoom Street,  
EAST PERTH 6000 W.A.

Continued from page 131

Basically, you should choose any new amplifier by ensuring it sounds acceptable into the speakers you intend using — provided those speakers can accept the power output.

## Speakers

Talking of speakers, this is probably the most difficult area of all to upgrade, not because there's any shortage of variety, but because of individual characteristics being marked. Recent trends in speaker design are toward increased efficiency and power handling without a size penalty, although the best of the latest generation tend to be very expensive but very good. Those of you bent on minimum compromise performance may well be tempted by systems like the magnificent Meridian M1s, the price of which appears outrageous at first until you realise all power amplification is built in. In this context the price of a complete system based on the M1s becomes much more reasonable and compares more than favourably with



The Australian-made Otoscan 1 — considered a top performer in its class.

similarly-priced competition. As always there are plenty of speaker bargains to be had, and the best policy is to persuade an obliging dealer to allow you to try a few at home before choosing. The thing to avoid like the plague is spectacular-sounding speakers, for this points to peaky frequency response and colouration. Listen instead for clean, effortless dynamics and a firmly defined bass line with crisp but not over-stated treble.



Nakamichi's brilliant 582 cassette deck represents the state of the art (see July '79 ETI).

In general the better a speaker, regardless of size, the simpler it will appear to be. Monstrosities with dozens of drive units look exciting but normally don't sound good, unless those drive units are very carefully positioned for a specific radiation pattern. A very valid test, even now, is weight. The heavier the better. The little BBC-designed LS3/5A is a fine example of advanced speaker design and is surprisingly heavy. Used with suitable ancillaries (and with its complex crossover the LS3/5A needs a well-behaved power amplifier) the loudspeaker gives remarkably natural results despite its lack of deep bass. Other BBC-based designs worth checking out are the Rogers Export Monitors and Spender BC1's — now showing some signs of old age but nevertheless a cut above many similarly-priced competitors.

The name of the upgrading game is compromise. It's surprising just how good a system based on fairly ordinary components can sound if each part is suitably matched to the rest. The most expensive components in the world simply won't give good results if they're not an adequate match and if you're upgrading piece by piece, it's advisable to check the compatibility of the new equipment not only with existing gear but with whatever you're likely to be using in the future.

A quick final word about tape. The new metal tape cassettes demand very special bias and equalisation arrangements and if you're planning to replace an existing cassette machine it would be wise to select one with metal tape capability, even if you don't feel you'll be able to afford the vastly superior new tapes which are, admittedly, very dear indeed. The indications are that the new machinery gives improved results with more conventional tapes, and in any event the metal formulations are certain to become cheaper within a fairly short time.

The natural complement to tape recorders is the FM tuner and here there is a very wide selection. Sound, once again, is the chief reason for selecting any particular model, but as Australian cities gain more FM broadcasts, such performance features as selectivity and capture ratio (the ability of the tuner to reject unwanted broadcasts on different or similar broadcast frequencies) will become increasingly important, especially with the existence of high power TV broadcasts adjacent to and within the normal radio range.

Approach upgrading with a straightforward attitude and don't believe that the most expensive will be the best. Try the new equipment with your existing system if you can, and only settle for those items which show considerably more potential than your present ones. And, begin at the beginning . . .

The famous KEF Model 105.

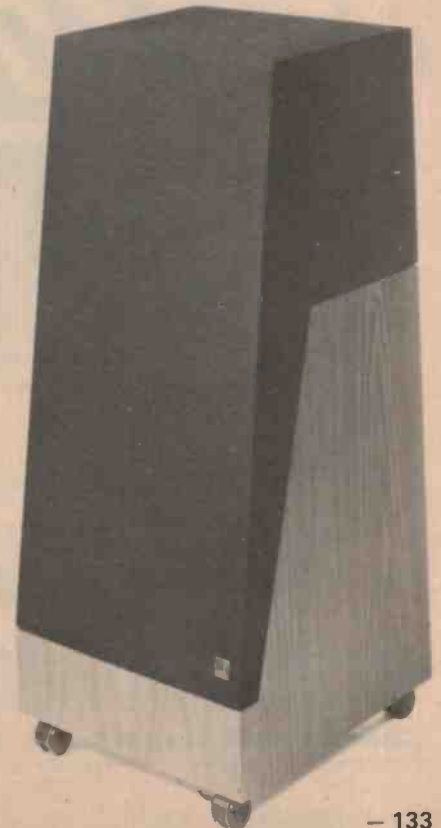

# MERIDIAN



103D Amplifier System  
(45w/45w)

105 Amplifier System  
(2 x 100w mono)

The Boothroyd Stuart Meridian range of amplifiers combines acknowledged state of the art performance with award winning appearance design. Modular construction allows flexibility which, backed by our commitment to produce the finest equipment, offers the unique possibility of periodic up grading or extension with perfectly matched products.

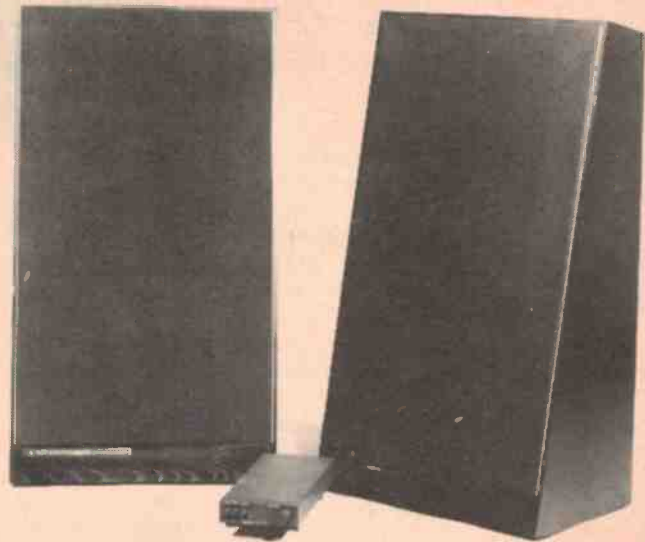

M1 Tri-amplified Active Speaker System.

from **AUDIO 2000**

for the best of British  Hi-Fi  
P.O. BOX 107, BROOKVALE 2100. TEL: (02) 939-2159

SYDNEY: LEISURE SOUND, City & Artarmon; RUSSIN HI-FI, Ashfield.  
N.S.W.: HAMILTON HI-FI, Newcastle; SPRINGWOOD HI-FI Blue Mountains.  
MELBOURNE: NATSOUND City.

BRISBANE: REG MILLS, City; IPSWICH HI-FI Ipswich.  
QLD: CHEVRON SOUND, Gold Coast; HUNTS, Toowoomba.  
ADELAIDE: GRENFELL PLAZA HI-FI, City; SOUNDCRAFTSMEN, Hawthorn.  
TAS: UNITED AUDIO, HOBART; UNITED ELECTRONICS, Launceston.

we have a



for you

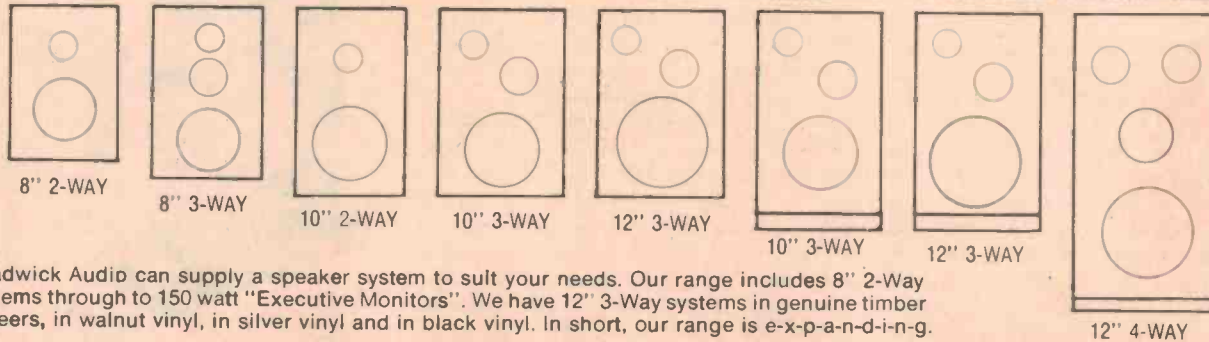

Chadwick Audio can supply a speaker system to suit your needs. Our range includes 8" 2-Way systems through to 150 watt "Executive Monitors". We have 12" 3-Way systems in genuine timber veneers, in walnut vinyl, in silver vinyl and in black vinyl. In short, our range is e-x-p-a-n-d-i-n-g.

Chadwick Audio Services Pty. Ltd. 89 Carnarvon Street, Silverwater. 2141. Phone (02) 647-1103, 647-1198.

**MONSTER  
1980  
SALE!**

# STAGE & EFFECTS LIGHTING

ALL YOUR REQUIREMENTS AUSTRALIA WIDE

SALE OF THE DECADE  
ENDS FEBRUARY 28th!  
EVERYTHING REDUCED BY UP TO 40%!

## TRUSS SECTIONS

**SAVE 20%!**



**WINCH-UP  
STANDS  
SAVE 30%!**

12' and 18' maximum height-  
The WINCHUP stand is the only  
portable, compact method of rigging stage  
lighting equipment- and we invented it!  
With folding legs, the Winchup stand packs up tight for  
travel- winds up high for lighting equipment! Up to 20 Par-  
64 or similar spotlights can be used on one stand! Our  
Winchup stands feature cast pulley heads, rugged Nylon  
finish, and STRONG sturdy construction- complete with three  
months guarantee on winch, and one year guarantee on workmanship!

These 2 metre long  
Truss Sections bolt  
together to form a  
portable lighting  
bridge across a stage.  
The complete truss is  
then either suspended,  
or winched up using  
our Winchup stands.  
Up to six sections can  
be used, giving a  
maximum width of 12m.  
Par 64 spotlights, or  
any other similar  
lanterns are hooked directly onto  
the truss once rigged in either a  
Par frame, or on a bar of four  
lanterns. Using our S. Hook, the  
actual rigging time is about half  
that of conventional systems!  
We designed and developed this  
system to suit Australian require-  
ments and conditions.

**space  
beacon**  
4,8,&16 lamp  
**SAVE 10%!**

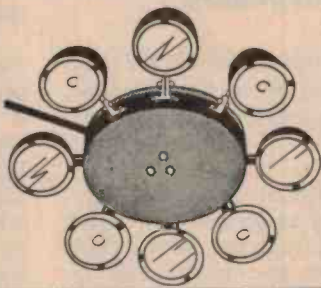

**EVERY ITEM  
REDUCED!**

ALL ROCK INDUSTRIES AND  
CEITEX PRODUCTS,  
LASERS, LAMPS,  
& ACCESSORIES

PRICES MAY VARY, AND SOME AGENTS MAY NOT PARTICIPATE IN THIS SALE. FREIGHT EXTRA.

Nationwide distribution by

# Barratt Lighting

PTY. LTD.

140 MYRTLE STREET  
CHIPPENDALE NSW 2008  
02 699 7963

SYDNEY:  
Strand Electric  
8/11 Barcoo St  
East Roseville  
(02) 406-6176

Ceutex Industries  
2/33 College St  
Glaesville  
(02) 896-2900  
WOLLONGONG:

Trilogy Lights & Sound  
40 Princes Hwy  
Fairy Meadow  
(042) 83-1219  
NEWCASTLE:

Your Move Lighting  
37a Beaumont St  
Hamilton  
(043) 69-3560

BRISBANE:  
Harvey Theatrical  
Lighting  
21 Crosby Rd  
Albion  
(07) 262-4622

EDA Sound  
10 Ross St  
Newstead  
(07) 52-8694

GOLD COAST:  
Rave Light & Sound  
2388 Gold Coast Hwy  
Mermaid Beach  
(075) 38-3331

MELBOURNE:  
Clearlight P/L  
17 Alex Ave  
Moorabbin  
(03) 553-1446  
Strand Electric  
60 Rosebank Ave  
Clayton  
(03) 541-8502  
Lighting Corporation  
131 Brighton Rd  
Richmond  
(03) 429-5122

ADELAIDE:  
Hiwatt Lighting  
37 Angus St  
Aueisbaue  
(08) 212-2033

Psycho Lites  
PO Box 291  
North Adelaide  
(08) 47-1874

PERTH:  
Western Strobe Lighting  
1142 Hav St  
East Perth  
(09) 321-9369  
Kosmic Sound  
1074 Albany Hwy  
Bentley  
(09) 361-8981  
MOBART:  
Good Oil Sound  
25 Castray Esplanade  
Battery Point  
(002) 23-5150  
Strand Electric  
430 Newcastle St  
Perth 6000  
(09) 328-3933

# Principles and problems in loudspeaker design

David Tilbrook

This month's article concludes with a discussion on crossovers. The first of the Series 4000 speaker designs you'll find in the project section this issue!

LAST MONTH'S article dealt with the characteristics of a typical moving-coil direct-radiating loudspeaker and the interactions that are likely to occur with the loudspeaker enclosure. Once these problems are understood and the bass performance has been optimised, we are in a position to finish the design. I have discussed the bass end of the audio spectrum first not because it is the most important, but simply because it is the most difficult to optimise. The mid-range is by far the most critical part of the audio spectrum since it is midrange distortion that the ear objects to more than any other.

It was shown last month that drivers have limited frequency responses and that it is therefore necessary to use several drivers, each covering its own frequency range. By far the most common arrangement is the three-way, so called because it uses three drivers to cover the audio range. A woofer covers the bass end, crossing over to a midrange driver somewhere between 400 Hz and 1 kHz. The midrange driver, sometimes called a 'squawker', carries the frequency range from this crossover point up to where the tweeter takes over, usually around 3 kHz to 5 kHz. The tweeter covers the remainder of the audio spectrum up to around 18 kHz, about the limit of human hearing. A crossover

is used to separate the input signal from the output of the power amplifier into the three frequency bands.

## Passive loudspeaker crossovers

The design of the crossover for any particular group of drivers must be done only after a thorough investigation into the characteristics of the drivers has been carried out. It is essential to choose drivers with an adequate overlap in their frequency responses, or a 'hole' will result in the response of the final loudspeaker. The amount of overlap needed depends on the slope of the filters used in the crossover. If a fast slope is used a smaller overlap is required, but filters with very fast slopes are complicated and expensive.

The basic crossover filter consists of a low pass and a high pass section. In a two way loudspeaker only one of these sections would be used, while in a three way loudspeaker two sections are used, one for the bass-mid crossover and the other for the mid-treble crossover. The simplest crossover is called a first-order crossover and has a slope in its attenuating region of 6 dB/octave. An octave is a range of frequency such that the highest frequency in the band is double the lowest frequency; for

instance, an octave above 50 Hz is the frequency range 50 Hz to 100 Hz, while an octave above 5 kHz is 5 kHz to 10 kHz. This is not a precise definition of an octave but is essentially correct and is adequate for loudspeaker analysis.

Figures 2 and 3 show circuit diagrams for series and parallel first-order crossovers. The series configuration is less commonly used since it is only applicable to two-way loudspeakers and has no advantages over the parallel type. If the first-order crossover is terminated with ideal resistive loads, the two slopes will add to give a linear response with the phase response perfectly preserved. In this respect it is fairly unusual since no other simple passive crossover will give a response that is linear in both frequency and phase. Unfortunately 6 dB/octave slopes require a choice of drivers with very broad overlapping frequency responses. Generally it is necessary to have a usable response from a driver to a frequency where the crossover is giving about 12 dB of attenuation. For a 6 dB/octave low pass crossover this would be two octaves above the crossover point. A woofer crossing out at 500 Hz would be very unlikely to have a response to 2 kHz, so a 6 dB/octave filter could not be used.

The most common crossover is the



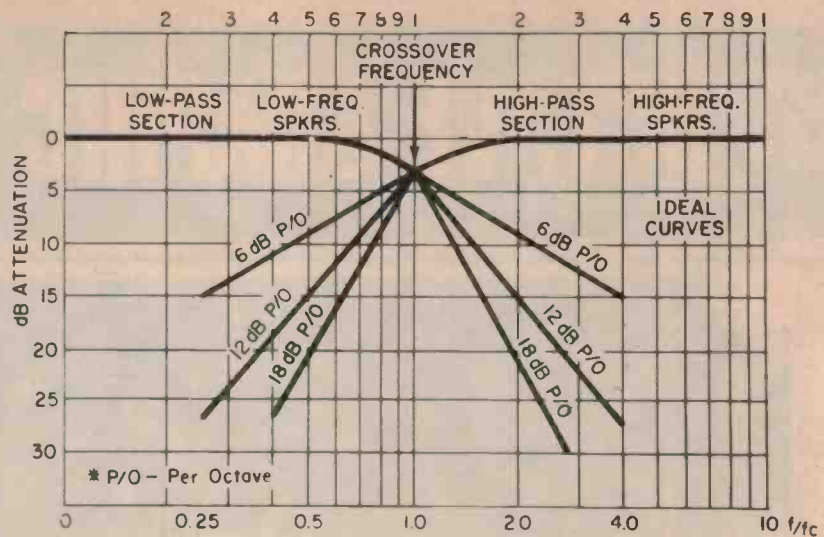

Figure 1. Typical frequency response curves of a two-way crossover network. The graph shows three different pairs of filters, each having a different rate of attenuation.

second order crossover, having a slope of 12 dB/octave. Figures 4 and 5 show the circuit diagrams for series and parallel second-order crossovers. Once again the series configuration is less commonly used. When terminated with ideal resistive loads the second-order crossover does not give an overall flat response. The phase characteristic causes the outputs of each half of the crossover to approach a 180 degree phase difference at the crossover point. The two outputs cancel each other, leaving a massive hole in the frequency response of the system. The 'cure' is to invert one of the drivers so that it is driven out of phase normally. The phase inversion around the crossover point brings the two drivers in phase again and the two outputs add, instead of cancelling. Unfortunately they still don't add perfectly and the result is an overall response that has a slight hump in the frequency response of around 2 dB. This is not really noticeable, as few drivers have responses that are flat to this degree.

At the present time there is a great deal of discussion as to whether this non-idealistic phase response is audible. Some manufacturers insist that it is audible and design their loudspeakers accordingly, while others are most emphatic that it is not audible. The first work that I know of that was done on the subject was by Helmholtz, in his "Sensations of Tone". The quality of any sound was said to be a result only of the relative intensities of the component sine waves and not their phase relationships. The waveshape could therefore be totally different but they would sound the same.

There is another source of phase error caused by the misalignment of the acoustic centres of the drivers. The conventional way to mount the drivers

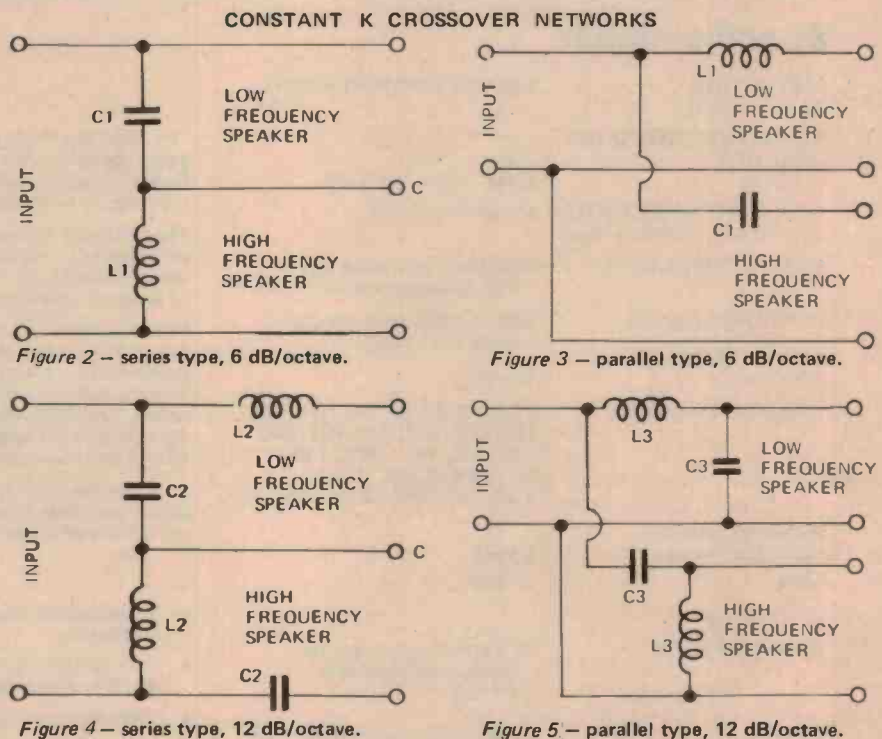

Figure 2 - series type, 6 dB/octave.

Figure 3 - parallel type, 6 dB/octave.

Figure 4 - series type, 12 dB/octave.

Figure 5 - parallel type, 12 dB/octave.

FREQ.	C1	C2	C3	L1	L2	L3
100	199	28.1	141	12.7	9	18
150	133	188	93.8	8.49	6	12
200	99.5	141	70.3	6.37	4.5	9
250	79.6	113	56.3	5.09	3.6	7.2
300	66.3	93.8	46.9	4.24	3	6
350	56.8	80.4	40.2	3.64	2.57	5.14
400	49.7	70.3	35.2	3.18	2.25	4.5
500	39.8	56.3	28.1	2.55	1.8	3.6
600	33.2	46.9	23.4	2.12	1.5	3
750	26.5	37.5	18.8	1.7	1.2	2.4
1000	19.9	28.1	14.1	1.27	.9	1.8
1250	15.9	22.5	11.3	1.02	.72	1.44
1500	13.3	18.8	9.38	.849	.6	1.2
2000	9.95	14.1	7.03	.637	.45	.9
2500	7.96	11.3	5.63	.509	.36	.72
3000	6.63	9.38	4.69	.424	.3	.6
3500	5.68	8.04	4.02	.364	.257	.514
4000	4.97	7.03	3.52	.318	.225	.45
5000	3.98	5.63	2.81	.255	.18	.36
6000	3.32	4.69	2.34	.212	.15	.3
7500	2.65	3.75	1.88	.17	.12	.24
10000	1.99	2.81	1.41	.127	.09	.18

Table 1: Component values for constant K loudspeaker crossover networks. Inductance in millihenries, capacitance in microfarads, speaker impedance = 8 ohms.

# 1/3 OCTAVE GRAPHIC EQUALISER

MODEL 2801



## Specifications:

DISTORTION (@ 2 volts out)	Less than .05% 20Hz–20kHz
FREQUENCY RESPONSE – EQ. OUT – EQ. IN	Flat 20Hz – 20kHz $\pm \frac{1}{2}$ dB
SIGNAL TO NOISE RATIO (@ 2 volts out, controls flat)	greater than 82dB
OUTPUT IMPEDANCE:	100 Ohms (will drive low or high impedance equipment)
INPUT IMPEDANCE:	50K to 100K depending on input configuration.
MAXIMUM INPUT VOLTAGE:	10 volts
EQ, centre frequencies:	31.5, 40, 50, 63, 80, 100, 125, 160, 200, 250, 315, 400, 500, 630, 800, 1K, 1.25K, 1.6K, 2K, 2.5K, 3.15K, 4K, 5K, 6.3K, 8K, 10K, 12.5K, 16K, Hz
Range of Controls: Individual Filters: Level	$\pm 10$ dB $\pm 15$ dB
CONTROLS EQUALISATION:	28 Vertical potentiometers continuously variable $\pm 10$ dB
LEVEL:	Rotary potentiometer variable $\pm 15$ dB
EQ BYPASS:	Toggle Switch
POWER:	" "
Terminations:	Rear panel cannon sockets & P.M.G. sockets for input and output.
PHYSICAL Size	19" x 3½" x 4" (Standard rack mount size)
Weight	4 kg
Finish	Front & rear panel brushed & anodised black with white lettering, black Marvplate cover

The 2801 is a single channel graphic equaliser that divides the audio spectrum into twenty-eight one third octave bands. Each frequency segment is controlled by a slider that provides up to  $\pm 10$ dB of adjustment in standard ISO steps.

The 2801 was designed primarily to compensate for any deficiencies in the linearity of speaker systems, acoustic peculiarities of the hall or listening room, and inadequacies of program source quality.

In P.A. application the equaliser may be used to improve sound quality and increase intelligibility by attenuating problem frequencies that cause ringing, boominess or other disruptive resonances that occur in acoustically difficult rooms. The 2801 allows sound systems to be "tuned" according to the special acoustics of a room, to maximize output and minimize feedback.

As a creative tool in sound recording or re-recording the 2801 allows complete freedom in contouring response over the complete audio spectrum from 31.5Hz to 16KHz.

- 28 adjustable controls on 1/3 octave ISO centre frequencies
- Vertical slide controls give a graphic representation of the resulting response curve.
- 10dB boost or 10dB cut at any centre frequency.
- Gain control giving  $\pm 15$  dB operating range.
- Balanced or unbalanced input.
- Equaliser bypass switch.
- Standard rack mounting – only 3½" high.

Available as a complete kit for \$198.00.

Post and pack \$3.00

Construction notes \$1.00, refundable on kit price.

**jaycar**  
PTY. LTD.

380 SUSSEX STREET, SYDNEY

PO Box K39, Haymarket, 2000. Tel: 211-5077.

is to simply bolt them to the front panel. This lines up the chassis of the drivers, but since different drivers have different depths, the voice coils of the drivers are all at different distance from the listener. If two notes are sent simultaneously to both the woofer and the tweeter for example, the note sent to the tweeter will get to the listener momentarily before the note from the woofer. Furthermore, the woofer cone is heavier than the tweeter or midrange cones and this combined with the effect of the air load on the drivers moves their actual acoustic centres even further away from the chassis. Manufacturers concerned with this effect mount the drivers on a multi-level front panel so that the tweeter is further away from the listener than the midrange. Similarly, the midrange is mounted on a plane that is further away from the listener than the woofer. This gives the sound from the midrange and woofers a head start over the tweeter, and attempts to correct for the differences in their acoustic centres.

Both types of phase errors need to be recognised and dealt with independently if a meaningful analysis of the audibility of phase errors in loudspeakers is to be carried out. Even if phase errors of this magnitude are audible (and only experiment can tell us), an extremely good loudspeaker can still be constructed along the more conventional techniques using second-order crossovers with drivers mounted on a plane baffle.

The 4000 Series of loudspeaker projects commencing in this issue use the more conventional approach to driver mounting and crossover design to simplify construction and decrease cost. If you choose to experiment with the audibility of phase in loudspeakers, and construct a Series 4000 loudspeaker with a stepped front panel, the best way to establish the correct distance between the panels is by experiment. The drivers should be connected to the crossover and mounted in separate enclosures. The size of these enclosures is not critical.

Supply the power amp driving the loudspeaker with a source of low repetition pulses (or a low frequency square wave around 20 Hz). If the loudspeaker is now monitored with a microphone and the output of the mic amplifier fed to an oscilloscope, the transient performance of the loudspeaker can be determined.

When the front baffles of the enclosures are aligned, as would be the case in a conventional loudspeaker, the input pulses will be seen to be converted into a series of pulses. Each pulse corresponds to one of the drivers. If the enclosures are moved slowly back with respect to the woofer enclosure these pulses will merge into a single pulse. This is the



correct position for the baffles, and using these measurements the final enclosure can be built. If you have the necessary equipment to do this experiment we would be interested in hearing about your results.

The crossovers described so far belong to a class of filters called constant-K filters. These filters are designed on the assumption that the product of the impedances of the capacitor and the inductor in the stage is equal to the square of its characteristic resistance, i.e.

$$Z_C \times Z_L = R_0^2$$

The characteristic resistance of a

filter is that resistance into which there is maximum power transfer. Originally, 'K' was used instead of the now more common symbol  $R_0$  for the characteristic resistance, hence the name constant K. Table 1 gives values for constant-K filters for a variety of crossover points assuming an 8 ohm resistive load.

### M-derived filter sections

The assumptions made to simplify the design of the constant-K filters lead to some non-ideal characteristics. It is sometimes mistakenly thought that constant-K implies constant impedance. This is not the case and the impedance is a variable with the effect occurring ▶

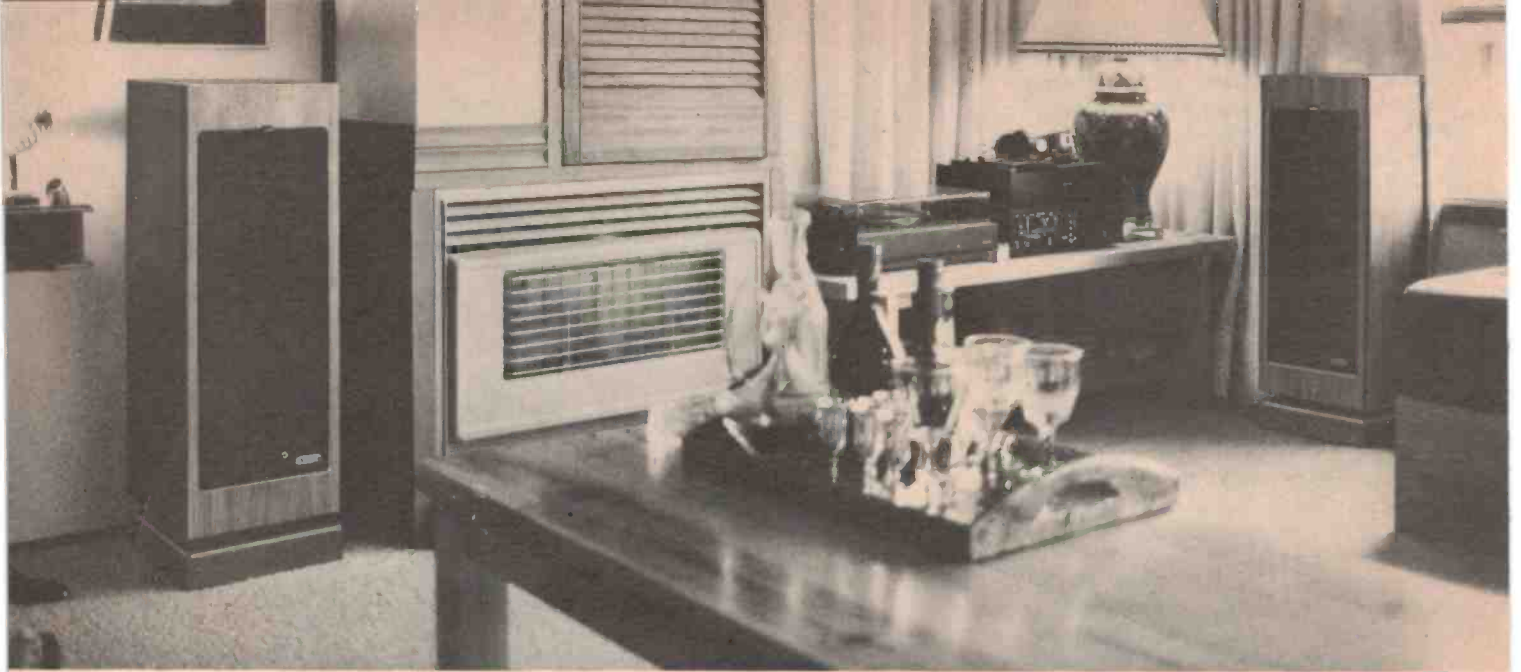

## Honestly. How much time do you spend listening to Hi-Fi?

Even the most ardent hi-fi purist won't spend more than a couple or three hours at a stretch listening to hi-fi. The rest of the time the system just sits there. Not listened to. But looked at.

The Jennings Research Company of Los Angeles design and manufacture a range of superb sounding speakers. They do however have a major added benefit. They are, as you can see, quite simply very beautiful to look at.

As "Stereo World" puts it, "Jennings Research must be the first speaker manufacturer in the world to realise that speakers are off more than they're on. It was clever making speakers that sound this good. And it was cleverer still to make them look as beautiful as they are".

For more information on the Jennings Research beautiful sounding, beautiful looking range of speakers, fill in the coupon below.

### Jennings

Dear Concept Audio. I'm sick of ugly speakers. Tell me more about Jennings Research's beautiful looking, beautiful sounding speakers.

Name \_\_\_\_\_

Address \_\_\_\_\_

Postcode \_\_\_\_\_

Concept Audio Pty. Ltd., 22 Wattle Road, Brookvale,  
N.S.W. 2101. Tel: (02) 938 3700.

Concept Audio

CA 407

Brand Management

## Where only the very best is good enough.

# ...loudspeaker design

mostly around the crossover point. The other problem with constant-K filters is that the slopes are slowest near the crossover point. The solution to these problems has been known since 1923, when Zobel proposed that other sections could be used to flatten the response within the passband and sharpen the roll-off point. These stages are called M-derived sections, since the values of inductance and capacitance used in the filter are obtained by first deriving them for a constant-K type filter and then converting these values into M-derived values with the use of a mathematical equation that contains the term M. M is simply a number between 0 and 1, usually around 0.6 for crossover applications. Either the phase or frequency characteristics may be optimized but not both at once; 0.6 is a good compromise. Table 2 and Figures 6 to 9 give values for inductors and capacitors for M-derived crossovers with  $M = 0.6$ .

The other major advantage of this filter is that it allows a third-order or 18 dB/octave filter to be built. Third-order filters can be made to have a linear frequency characteristic when the outputs of the two channels are summed, but like the second-order filters described before, suffer from a very non-linear phase response. Each filter shifts the phase at the crossover point by 180 degrees, so there is a 360 degree phase shift between the two outputs.

## Loudspeaker impedance

So far I have assumed that the loudspeakers connected to the crossover are fixed 8 ohm loads, but as was seen in last month's article, this is most definitely not the case. Most drivers have an impedance characteristic that presents maximum impedance at their resonant frequency, dropping to the nominal dc resistance of the driver at a frequency above this, followed by a generally increasing impedance as frequency rises (see Figure 2 in last month's issue). Provided the driver is not being used near its resonant frequency, which should always be the case with midranges and tweeters, this impedance variation can be corrected by a series capacitor-resistor network placed in parallel with the loudspeaker. Figure 10 shows a typical circuit. This network has an impedance that decreases with increasing frequency, tending to cancel the increasing impedance of the driver. The component values shown are applicable to an average woofer, although the actual values in any specific application

are best established by experiment. This works very well and it is not difficult to obtain an impedance response that is flat within one ohm over most of the driver's operating range.

## Matching sensitivities

Once the crossover points have been established from an analysis of the driver's best operating regions, the final step is to equalise the various sensitivities

of the different drivers. This is done by a resistor divider network as shown in Figure 11. A simple resistor placed in series with the driver would of course decrease the power in the loudspeaker for a given signal voltage, but this increases the impedance seen by the rest of the crossover altering the crossover frequency point. The resistive divider network shown in Figure 11 can be set to represent a fairly constant 8 ohm

### M-DERIVED CROSSOVER NETWORKS

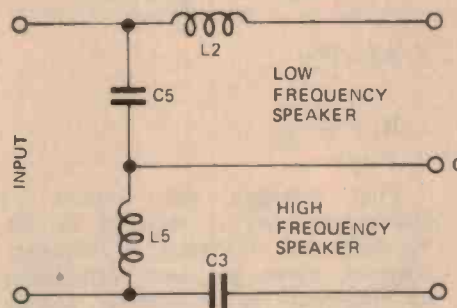

Figure 6—series type, 12 dB/octave.

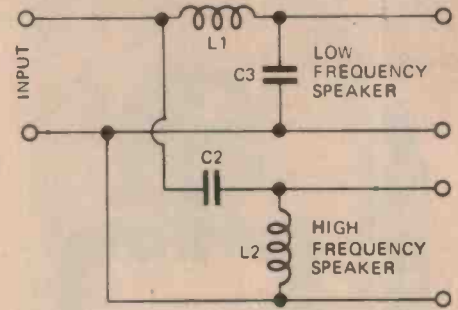

Figure 7—parallel type, 12 dB/octave.

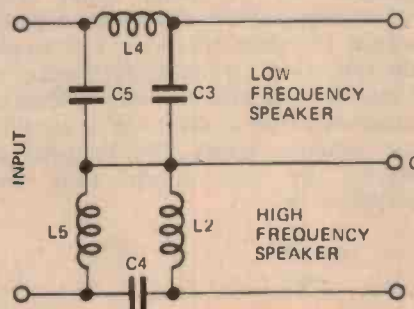

Figure 8—series type, 18 dB/octave.

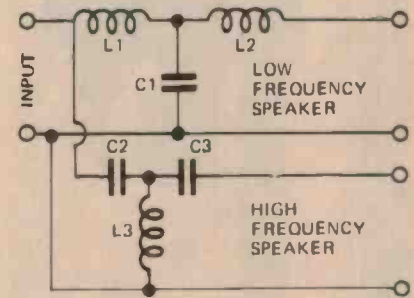
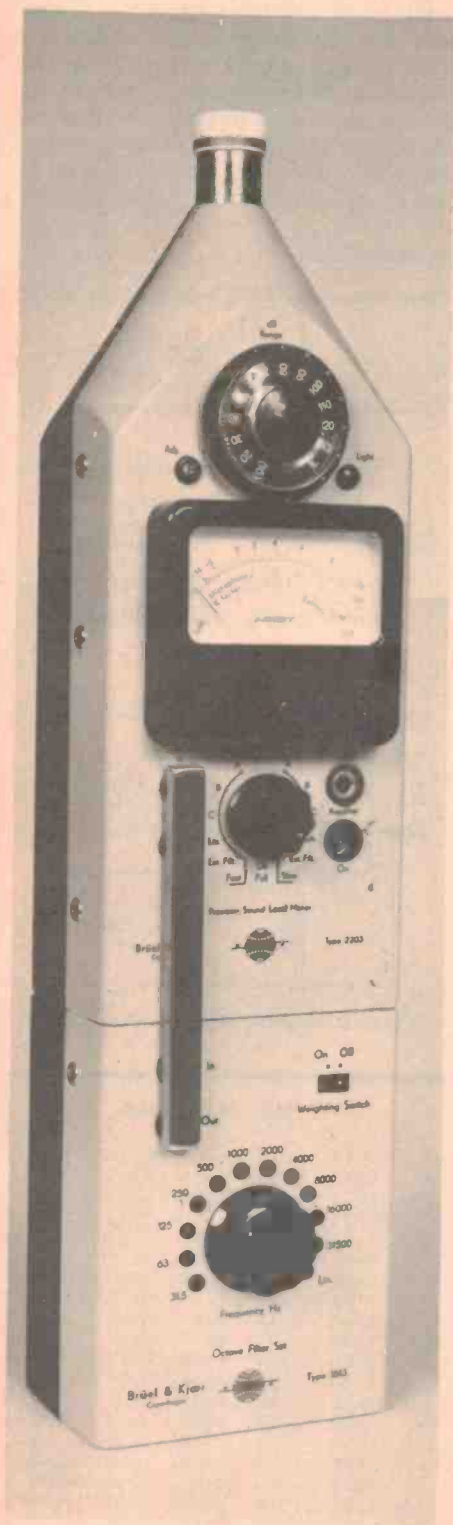

Figure 9—parallel type, 18 dB/octave.

FREQ.	C1	C2	C3	C4	C5	L1	L2	L3	L4	L5
100	398	124	199	99.4	318	20.3	12.7	6.37	25.4	7.96
150	265	82.9	133	66.3	212	13.5	8.49	4.24	16.9	5.31
200	199	62.1	99.4	49.7	159	10.1	6.37	3.18	12.7	3.98
250	159	49.7	79.5	39.7	127	8.15	5.09	2.55	10.1	3.18
300	133	41.4	66.3	33.1	106	6.79	4.24	2.12	8.49	2.65
350	114	35.5	56.8	28.4	90.9	5.82	3.64	1.82	7.28	2.27
400	99.4	31	49.7	24.8	79.5	5.09	3.18	1.59	6.37	1.99
500	79.5	24.8	39.7	19.9	63.6	4.07	2.55	1.27	5.09	1.59
600	66.3	20.7	33.1	16.5	53	3.4	2.12	1.06	4.24	1.33
750	53	16.5	26.5	13.2	42.4	2.72	1.7	.849	3.4	1.06
1000	39.7	12.4	19.9	9.95	31.8	2.04	1.27	.637	2.55	.796
1250	31.8	9.95	15.9	7.96	25.4	1.63	1.02	.509	2.04	.637
1500	26.5	8.29	13.2	6.63	21.2	1.36	.849	.424	1.7	.531
2000	19.9	6.22	9.95	4.97	15.9	1.02	.637	.318	1.27	.398
2500	15.9	4.97	7.96	3.98	12.7	.815	.509	.255	1.02	.318
3000	13.2	4.14	6.63	3.32	10.6	.679	.424	.212	.849	.265
3500	11.4	3.55	5.68	2.84	9.09	.582	.364	.182	.728	.227
4000	9.95	3.11	4.97	2.49	7.96	.509	.318	.159	.637	.199
5000	7.96	2.49	3.98	1.99	6.37	.407	.255	.127	.509	.159
6000	6.63	2.07	3.32	1.66	5.31	.34	.212	.106	.424	.133
7500	5.31	1.66	2.65	1.33	4.24	.272	.17	.085	.34	.106
10000	3.98	1.24	1.99	.995	3.18	.204	.127	.064	.255	.08

Table 2: Component values for M-derived loudspeaker crossover networks. Inductance in millihenries, capacitance in microfarads,  $M = 0.6$ , speaker impedance = 8 ohms.

# ...loudspeaker design



A Brüel and Kjær sound level meter. Instruments like this are used to determine the frequency response of a loudspeaker. This instrument has several weighting curves built in as well as a one octave filter set to allow pink noise analysis.

load. Resistor R2 is placed in parallel with the driver, resulting in a decreased total impedance. This impedance is then brought back up to the desired impedance by placing R1 in series. The correct values for R1 and R2, assuming an 8 ohm loudspeaker system, are given by the following three simple equations.

1.  $d = \text{antilog} \frac{-\text{signal drop in dB}}{20}$
2.  $R2 = \frac{8d}{1-d}$
3.  $R1 = \frac{64}{8 + R2}$

First establish the amount of attenuation that is required in dB. Normally by this stage a frequency response curve has been established by measuring the loudspeaker, and an estimate of the required attenuation can be obtained from this. Now use equation 1 above. The antilog of a number can be found either using log/antilog tables or the inverse log key on any scientific calculator. I have used the symbol 'd' for the result of equation 1 mainly to simplify the written form of equation 2, but in reality 'd' is equal to the voltage across the loudspeaker divided by the voltage from the amplifier. i.e.

$$d = \frac{V_s}{V_i}$$

where 'V' is the signal voltage across the loudspeaker and 'V<sub>i</sub>' is the applied signal voltage from the amplifier.

The result of equation 1 is plugged into equation 2, which yields the correct value for R2. The value of R2 is then used in equation 3 to obtain the value of R1. For example, if a midrange is to be decreased in sensitivity by 3 dB, equation 1 becomes:

$$d = \text{antilog} \frac{-3}{20}$$

$$d = \text{antilog} -0.15 = 0.7079$$

So a 3 dB drop in output signal level is equivalent to decreasing the signal voltage across the loudspeaker to 0.7079V<sub>i</sub>. Plugging this into equation 2 gives

$$R2 = \frac{8 \times 0.7079}{1 - 0.7079} = 19.4 \text{ ohms.}$$

Using this result in equation 2 gives

$$R1 = \frac{64}{8 + 19.4} = 2.3 \text{ ohms.}$$

The nearest value resistors to these would be 18R and 2.2R, and with these resistors the impedance presented to the remainder of the crossover would be approximately 7.7 ohms which is close enough in practice.

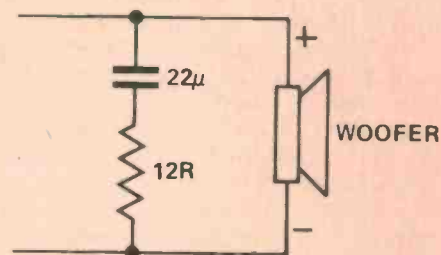

Figure 10. Circuit to improve the apparent impedance of a loudspeaker.

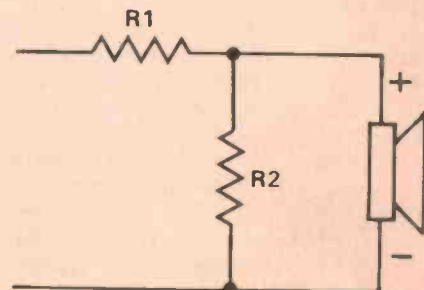

Figure 11. Potential divider used to compensate for different loudspeaker sensitivities.

## The final test

Now that the bass performance has been optimised through a suitable choice of enclosure size and damping, the crossover points and slopes have been established, and the impedance and sensitivities of the various drivers corrected, the final subjective tests can begin. The importance of good subjective testing in loudspeaker design cannot be overestimated. The most common form of subjective analysis, other than simply listening to some good records, is an A-B test with other loudspeakers. Although this method can give some meaningful results, its validity is generally overestimated in my opinion. The best form of subjective testing is comparison to the original live performance. Simply recording a voice onto high quality recording equipment with a good microphone will tell you more about a loudspeaker than any amount of A-B testing. ●

# The head we guarantee for life.

For our new Yamaha TC 920 cassette deck, our very finest head.

Pure Plasma Process Sendust-Alloy.

The hardest material we know.

It's been specially designed for the new breed of highly sensitive, but highly abrasive, recording tape.

But we're so confident in the hardness of Pure Plasma Process Sendust-Alloy that we guarantee it for life.

We're pretty pleased with the deck, too.

Tone and balance controls are hidden behind a hinged panel.

Mechanical memory, which enables you to replay a favourite track as often as you like.

And feather-touch solenoid tape transport controls with built-in logic sequence.

Then there's the peak LED meters.

They react so much faster than VU meters, they just have to be seen to be believed.

For component-matching, it's available in silver or in black.

Audition the Yamaha TC 920 soon.

And let our head rule your heart.

\*excludes erase head.

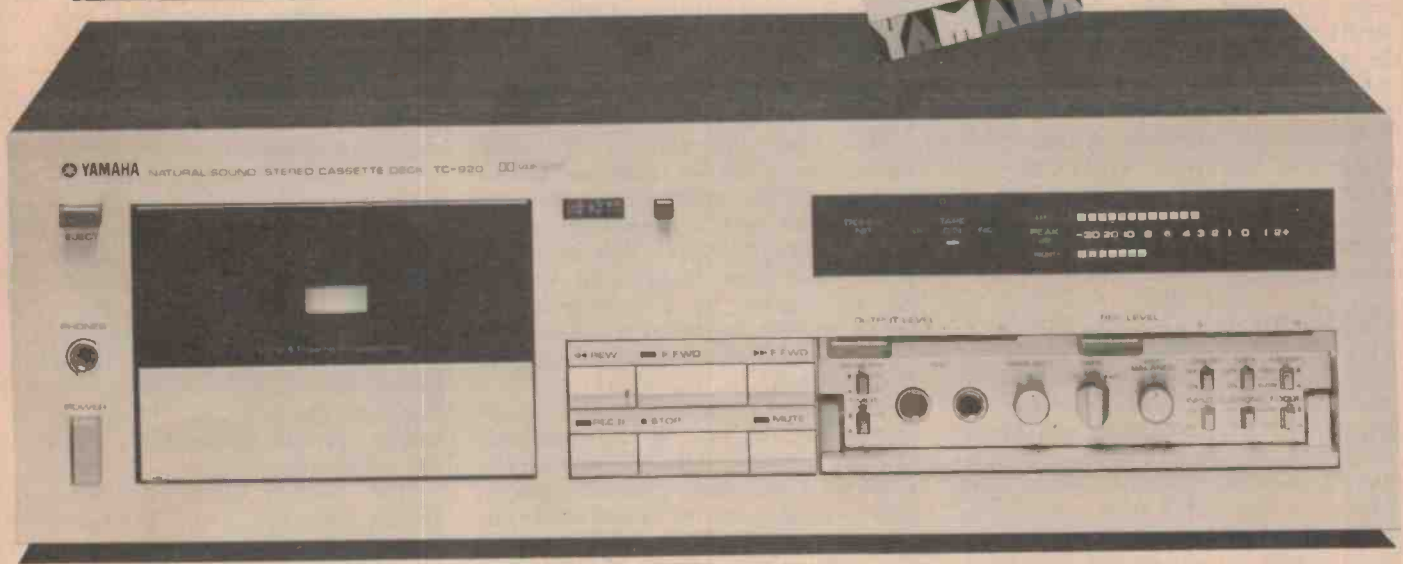

**New South Wales:** Allied HiFi, Crows Nest; Audiocom Stereo HiFi Sales, Eastwood; Miranda HiFi & Stereo Centre Pty Ltd, Parramatta; Miranda HiFi Gosford Pty Ltd, Gosford; Newcastle HiFi, Newcastle; HiFi House, Wollongong; Kolrano Pty Ltd, Hurstville; Leisure Sound, Sydney; Leisure Sound, Chatswood; Len Wallis Audio, Lane Cove; Miranda HiFi & Stereo Centre Pty Ltd, Taren Point; Miranda HiFi Roselands, Roselands; Miranda HiFi & Stereo Centre Pty Ltd, Miranda; Wroth HiFi, Bathurst; Audiocom Stereo HiFi, North Rocks; Springwood HiFi, Springwood; Russin Electronics, Ashfield; Park HiFi, Sydney; Warringah HiFi, Mona Vale; Forster Colour Television, Forster; Greigs Music House, Goulburn; Buckleys Music Centre, Grafton; Lismore HiFi, Lismore; Melody Music, Dubbo; Melody Village, Port Macquarie; Newells Music Centre, Armidale; Music Centre, Murwillumbah; Ted Lumbewes, Inverell. **A.C.T.:** Duratone HiFi, Phillip. **Victoria:** Tivoli HiFi Pty Ltd, Hawthorn; Selim Electronics, Camberwell; Soundair Centre, Caulfield; Sound Factors, Dandenong; Denman Audio Pty Ltd, St Kilda; Beland Electronics, Cheltenham; Belmont Stereo Systems, Belmont; Steve Bennet Audio, Geelong; The Soundcraftsman, North Caulfield; Radio Parts Group, East Malvern; Radio Parts Group, West Melbourne; Natsound Pty Ltd, Melbourne; A.G. Smith & Co., Warrnambool; Prouds Audio World, Bendigo; Audio Control (Aust) Pty Ltd., Shepparton; John Martin Music Studio, Swan Hill; George Hawthorn Electronics, Armadale. **South Australia:** Sound Dynamics, Adelaide; Revolver HiFi, Goodwood; Blackwood Sound Centre, Blackwood; Blackwood Sound Centre, North Adelaide; Country Music Sales, Berri; Chessers, Port Lincoln. **Queensland:** Stereo FM Centre, Brisbane; Reg Mills Stereo, Brisbane; Living Sound Centre, Ashgrove; HiFi Sales, Kipparing; Ken A. Elborne & Assoc., Toowoomba; Gold Coast HiFi, Southport; Mackay Audio Centre, Mackay; Premier Sound, North Rockhampton; Adcocks Agencies, Ayr; Andersens Music Store, Bundaberg; The Sound Centre, Coolangatta; Custom Sound Centre, Nambour; D.J.L. Electronics, Caloundra; Disco & Stereo Supplies, Townsville; Hoopers Music Centre, Gympie; Keller Electronics, Maryborough. **Western Australia:** Audio Centre Pty Ltd, West Perth; Audio Centre Pty Ltd, Victoria Park; Denham HiFi, Albany; Park Music, Rockingham; Wickham Sound Lounge, Wickham; Western Amplification, Nedlands; PF & JE Collins, Bunbury; Audio Lane, Geraldton. **Tasmania:** Teak House Pty Ltd, Hobart; Begent McGuire, Launceston; James Loughran & Sons Pty Ltd, Burnie; Downtown HiFi, Devonport. **Northern Territory:** Pfitzners Music House, Darwin; Mr Murray Neck Pty Ltd., Alice Springs.



RM 769

# Pioneer PL-L1000 tangential tracking record player

Pioneer has employed an ingenious linear motor to drive the tangential tracking tone arm on their top-line turntable. Performance is superlative — but first change the cartridge.

OVER THE last 80 years, there have been many ingenious attempts by designers to produce parallel- or tangential-tracking record players. Most of the designs have been innovative, some of them technically successful, but few of them practical or effective from a commercial standpoint. In the last 10 years we have reviewed four different units, all of which were technically innovative. Each of these units exhibited various limitations in terms of channel balance, crosstalk, and in one case other mechanical problems which we pointed out in no uncertain terms.

There are currently at least five tangential tracking record players available with prices ranging as high as \$1600. Because of this it was with more than some interest that we received the Pioneer PL-L1000.

## Features

This unit is without a doubt one of the most attractive record players on the market at the moment. It features a large plinth with all the main controls located on the front of a raised slanting section positioned in front of the clear plastic, spring-loaded dust cover. This cover is asymmetric with an unusual semi-circular cut-out on the right hand side.

The main controls are grouped in two sections. The power switch is located at the left hand end with a light emitting diode recessed immediately next to it. This light only illuminates when the unit is operating exactly at correct speed. Next to this control is a speed control switch which is touched to select either 33 RPM or 45 RPM, the selected speed again being indicated by one of two light emitting diodes. To the right of this is a record size selector

switch which is again touched to sequentially select 17mm (7 inch), 25mm (10 inch) or 30mm (12 inch) record sizes.

On the right hand side of the plinth is a repeat switch and adjacent to it an arm elevation switch with light emitting diodes indicating which function is selected (up or down). On the right of this is a start/stop switch. At the extreme right hand side of the record player is an unusual control wheel with a finger hole recessed into it. This is used to position the tangential tracking arm electronically and remotely when the tone arm is in the elevated position.

The tone arm and its traversing mechanism is located at the rear of the turntable. The system runs on two parallel bars and is connected to the main electronics by a "thin umbilical cord". The arm is balanced in the normal manner by a counter-weight on its rear but thereafter any similarity between it and other record players virtually ends.

Like most conventional record players this unit must be horizontal and to make sure that it is, Pioneer provides a beautiful disk shaped levelling gauge. This is intended to be placed either on the two parallel rails on which the tone arm runs or alternatively on the plinth surface, which appears to be parallel, in both planes, to the two rails.

To set the unit up only involved the fitting of the head shell, the counterweights, unscrewing the locking mechanism and screwed sections from underneath and releasing the arm clamp switch at the right hand side of the tone arm carriage.

To achieve what we regard as a state-of-the-art unit, Pioneer have gone past the previous tangential design approach of other manufacturers. Some of these

other units have utilised worm drives, belts and rollers. In almost every case, the mechanical connections required by the drive system have resulted in sufficient noise and motor vibration being fed through to the tone arm for these components to be audible in the electrical output signal.

Pioneer have solved this problem with an ingenious linear motor. The tone arm base is a permanently magnetic armature that glides along the two guide bar rails supported above electro-magnetic coils. The arm moves by direct induction instead of by a normal mechanical connection. The result is a *virtually noise-free supporting system* that overcomes the limits of most of the previous parallel tracking systems that we have evaluated. The tone arm maintains its position by means of an optical electronic detector built inside the arm. It senses the tracking angle error and by means of a feedback network, provides a traversing signal to keep the arm correctly tracking. The arm itself is light, short and an excellent example of a precision servo-feedback system.

The record player drive motor system incorporates a slotless, coreless hanging rotor dc motor. This features an extremely rapid start with an extremely high torque and achieves a very small speed deviation.

The cartridge fitted under the head shell is a Pioneer Model 600 moving magnet cartridge, for which the manufacturers have provided no data. The turntable is a large diecast construction, featuring a heavy rubber mat which adds to the turntable inertia and assists in providing a stable rotational speed. The underside of the turntable plinth, together with the drive mechanism and tone arm assembly, is spring



mounted as a single assembly underneath the main cover. The unit appears to be primarily fabricated from plastic mouldings (with the exception of the drive system).

### On test

We have tended to be sceptical of the various manufacturers' claims for tangential arm record player systems and so we proceeded with our objective testing ready to put the manufacturer to the test (and to task) if the many claims made could not be substantiated.

We recorded the frequency response of the cartridge fitted to the unit and were a little disappointed. We feel that Pioneer do themselves a disservice in fitting the 600 moving magnet cartridge to this record player. As the results show, the frequency response of this cartridge rises rapidly above 8 kHz to peak at 17 kHz. Whilst the cartridge has a good channel separation, being typically 30 dB at 1 kHz, the channel separation in the 10 kHz to 20 kHz region falls off rapidly.

It has generally been our experience that cartridges with poor high frequency performance also tend to have poor transient and often poor trackability performance as well. This proved to be the case with the 600 cartridge which tracks well at velocity levels up to 24 cm per second but mistracks badly at velocity levels exceeding that figure. At 300 cm/sec the degree of mistracking is pronounced and on the Shure TTR103 Test Record, the tracking performance is particularly poor.

The wow is moderately high at 0.5% peak to peak, whilst the flutter is very low at 0.03% weighted RMS (or 0.042% unweighted RMS). The rumble is particularly low at -78 dB weighted



which is a very commendable performance. The time to achieve full speed from an initial start is less than a second and the developed torque is so high that cleaning a record on the turntable with a Decca carbon filament brush causes *no perceptible change in the playing speed.*

The tone arm resonance occurs at 6.6 Hz and exhibits a particularly sharp response. The rumble testing showed that the only significant component of rumble was associated with the tone arm's resonance and a narrow band analysis in the range dc to 1000 Hz showed no other significant components.

The evaluation of the isolation of external vibration showed that the spring mounts resonate at 21 Hz but offer reasonable isolation at other frequencies. We would have preferred better isolation performance but few manufacturers pay much attention to this problem.

### Subjectively

Our subjective evaluation of the PL-L1000 actually preceded the laboratory testing by some two weeks and we were fully aware of many of the characteristics and attributes before we started on the laboratory testing. ▶

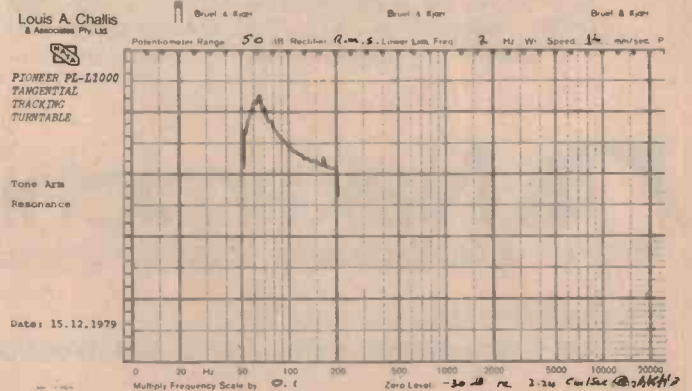
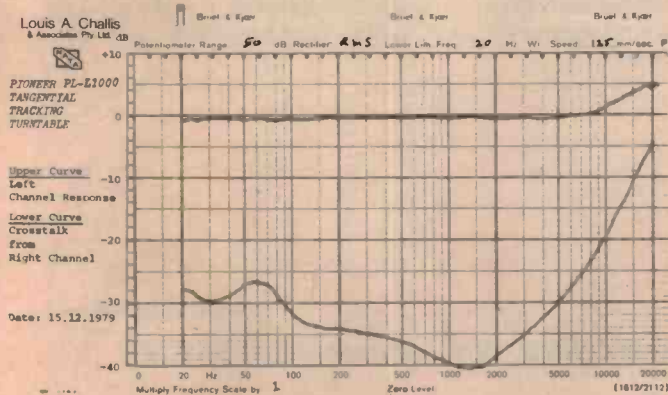

# The \$399\* Nakamichi



New Nakamichi 480 metal compatible 2 head cassette deck.

If you know Nakamichi products, you'll know \$399\* sounds too cheap for real Nakamichi quality. But if you know Nakamichi, the man, you won't be that surprised.

Nakamichi's genius for innovation has created a new Nakamichi range that makes brilliant reproduction at incredibly reasonable prices a reality.

Take the new 480. It is the personification of Professor Nakamichi's latest technology and his policy of producing components with an excellent performance/cost ratio.

Nakamichi 480 can play and record conventional and the new metal tapes and is available with an optional remote control unit. It has a frequency response of 20Hz-20KHz (-20dB Rec. level), wow and flutter less than 0.11 percent WTD peak, 0.06 percent WTD rms, signal to noise ratio (Dolby NR In, 70us) — better than 62dB at 400 Hz, 3 percent THD WTD rms, cross-talk better than 60dB at 1 KHz, 0dB, erasure better than 60dB below saturation level at 1 KHz and total

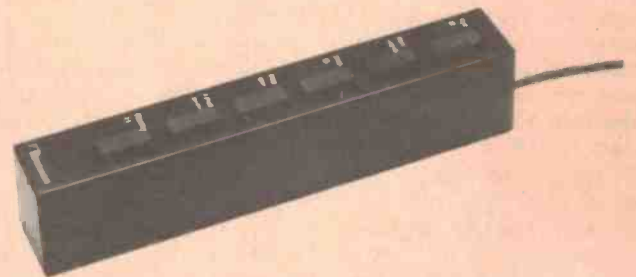

harmonic distortion less than 1.0 percent at 400Hz, 0dB (ZX, EXII tapes) and less than 1.2 percent at 400 Hz, 0dB (SX tape).

And if you're not sure about all that technical jargon, it means, quite simply, that the Nakamichi 480 performs brilliantly. But don't take our word for it. Experience the difference Nakamichi technology makes to high fidelity sound reproduction by visiting your nearest Nakamichi dealer.

## Nakamichi

Products of unusual creativity and competence.

**For further information contact:**

**Convoy International, 4 Dowling Street, Woolloomooloo, NSW. 2011. Phone (02) 358-2088.**

\*Recommended retail price

We had already decided that the PL-L1000 was, without a doubt, the most attractive and ergonomically advanced record player that we have yet seen. More important, it is *without a doubt the most delightful record player that we have had the pleasure to use.*

In use it is only necessary to place a record on the plinth and clean the record (if necessary) before lowering the lid. After selecting the speed and size of the record it is only necessary to press the start button and the record player will literally do everything else with a gratifying ease and simplicity.

To move the tone arm to a different part of the record it is only necessary to press the arm elevation button and, after an inexplicable delay of approximately three seconds, the arm will lift. The arm can then be moved to the required position by means of the large knob outside the main cover section. This knob, as we soon discovered, is not mechanically connected to the drive mechanism but features an electrical connection which is not potentiometric but apparently generates some velocity-type signal to which the linear drive motor, under the tone arm, responds.

The arm can be moved right through to the centre of the spindle; i.e. across the label of the record, and this of course does not provide protection of

the cartridge. In such a position the stylus could be readily damaged or prematurely worn by lowering it onto the record. Under normal use, a velocity sensing mechanism within the tone arm assembly responds to the increase in velocity experienced at the run-out groove. Where no groove exists it does not respond, and consequently does not return the arm automatically to the rest position. This possible problem is an unusual one and should not be regarded as a condemnation of the system.

The slow time of response for the arm to lift and drop is a little disconcerting, although practically, does not constitute a real problem.

### Summary

Our only real criticism of the PL-L1000 is in the choice of cartridge that Pioneer have made for the format as it is sold to the public. In practical terms this cartridge is a very weak link in the system. Most people spending \$600 or more on a record player could be excused for believing that the cartridge forms part of the original system and would thus compare in quality. The 600 cartridge is, without a doubt, one of the worst that we have seen in the last two years in terms of both frequency response and trackability. The audible results consequently show up badly on most of the high quality recorded material and, most particularly, the

directly recorded records with high velocities that we attempted to play.

Any person considering the purchase of the PL-L1000 record player would be well advised to immediately remove the cartridge supplied and replace it with one of the better cartridges available.

Our overall impression of the Pioneer PL-L1000 record player is that it comes closer to perfection than almost any other record player we have seen. It features a functionality and performance which is, in most respects, exciting. Fitted with a decent cartridge offering a flat frequency response and above average trackability we would not hesitate to recommend this unit to any well heeled audiophile. ●

### PIONEER TANGENTIAL TRACKING PL-L1000 FULLY AUTOMATIC RECORD PLAYER

Dimensions: 494mm wide x 153mm high x 450mm deep

Weight: 9.5kg Price: \$699  
Manufactured by Pioneer Electric Corporation, Japan.

Absolute copyright in this review and accompanying measurements is owned by Electronics Today International. Under no circumstances may any review or part thereof be reprinted or incorporated in any reprint or used in any advertising or promotion without the express written agreement of the Managing Editor.

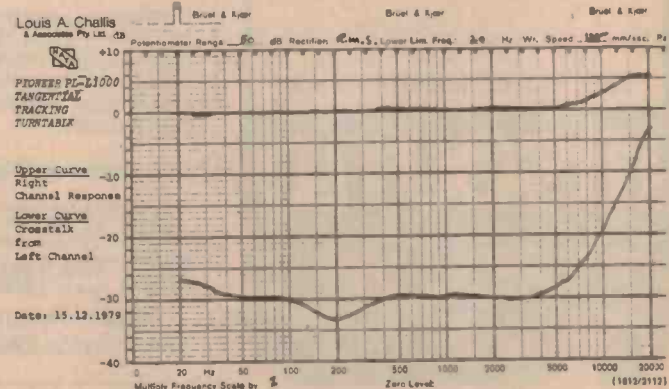
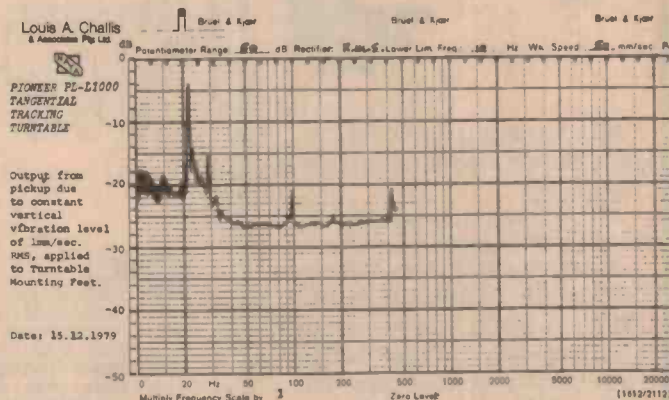
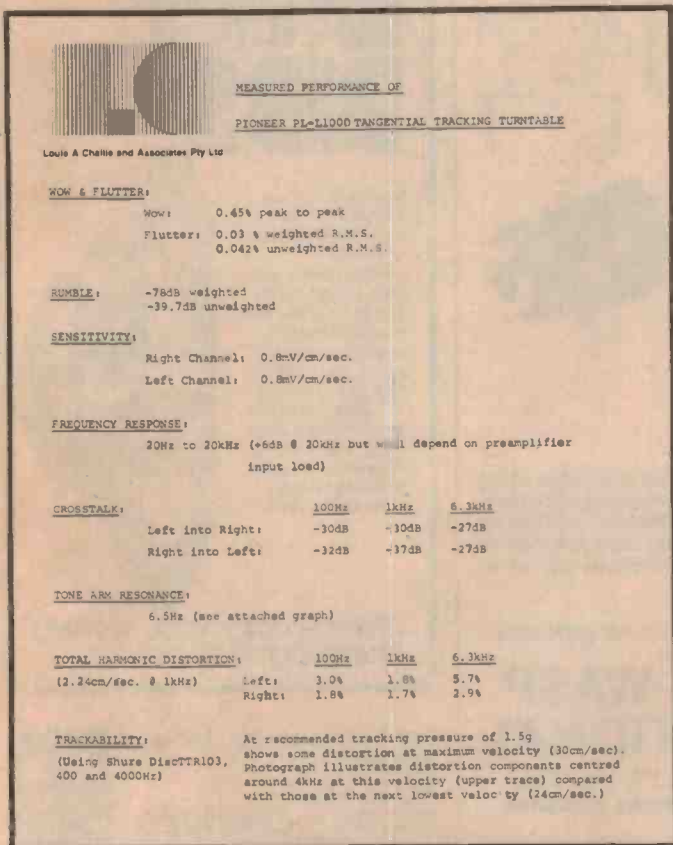

# JBL's 4311 STUDIO MONITOR.

## NOW IT'S NOT FOR STUDIOS ONLY.



**FIRST**  
WITH THE  
**PROS.**

JBL, is making its most popular studio monitor available to everyone.

It's a 3-way, high-efficiency system that gives you wide range response. And, because it's compact for use in small studios, and is finished in hand-rubbed walnut, it's perfect for your living room or den. The JBL 4311 compact studio monitor.

For details and demonstrations visit us  
**THE PROFESSIONALS IN JBL**

# insound

PTY. LTD.

108 WEST ST., CROWS NEST  
929 2714 92 1498

SPECIALISTS IN HOME INSTALLATIONS  
AND BUILT-IN SOUND SYSTEMS.

# JACK SOCKETS FROM Re-an

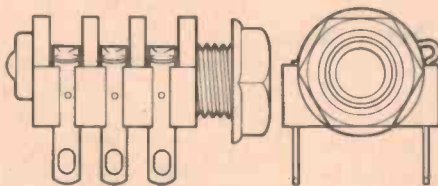

## MONO

- M100 Plastic fixing nut  
single : single
- M101 Plastic fixing nut  
single : break
- M102 Plastic fixing nut  
break : break
- M120 Chrome fixing bush  
single : single
- M121 Chrome fixing bush  
single : break
- M123 Chrome fixing bush  
break : break

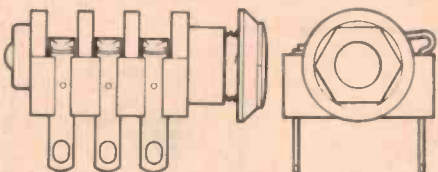

## STEREO

- M200 Plastic fixing nut  
single : single : single
- M203 Plastic fixing nut  
break : break : break
- M220 Chrome fixing bush  
single : single : single
- M223 Chrome fixing bush  
break : break : break



Manufactured using gold-plated nickel silver spring contacts in a robust, high temperature nylon body. Our new range of sockets has been designed to allow speedy assembly on your production line together with excellent electrical performance backed by longlife reliability.

Brochures available on all products.

## HOLDEN-WASP INTERNATIONAL

39 Chalder Street. PO Box 532,  
Marrickville 2204. Phone 560-3488.



# Mail Order KEF Drivers & Kits

CERTIFIED MAIL  
DELIVERY THROUGHOUT  
AUSTRALIA  
& NEW ZEALAND  
Bankcard accepted

# KEF B139

Superb 30 x 21cm  
bass driver, with  
solid flat diaphragm  
of unique  
construction, acting  
as a perfect rigid  
piston, to give clean,  
distortion-free bass  
over the frequency  
range 20-1,000Hz.  
The KEF range also  
includes mid range  
and high frequency  
units, with dividing  
networks designed  
to link them into  
compatible systems.



*...the no-compromise approach  
to uncoloured sound*

For full information, write to:  
AUDIOKITS  
PO BOX 553  
BROOKVALE NSW 2100

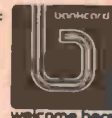

# The best is worth the little extra.



Forty years experience has produced a range of speaker components unmatched in sensitivity and long-term acoustic output, offering a robustness that is hard to equal.

Altec Lansing is the choice of professionals world-wide.

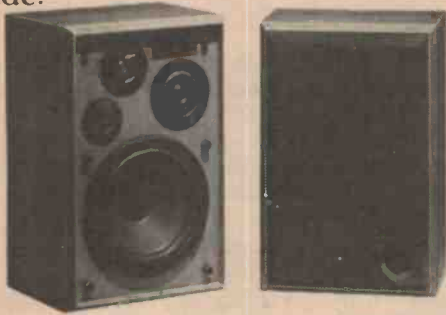

## THORENS

Every Thorens Transcription turntable is a

technical masterpiece designed to reproduce the most sensitive sound performances. Rumble figures are among the best in the world, some say the best. Thorens has achieved an effective tone arm mass of 7.5 g which is comparable to the best available.



*Cecil & Watts Ltd*

## The Dust Bug<sup>®</sup>

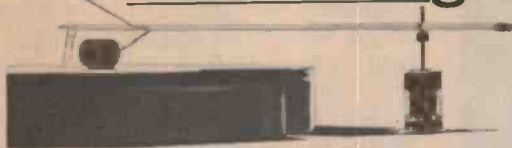

The original Dust Bug collects particles of destructive dust, discharges residual static leaving a perfectly clean recording groove for the stylus to trace. Reproduction improves, records last longer.

Wharfedale 'E' Series Hi-Fi speakers will amplify your amplifier. Make 20 watts sound like 200. That's because their generous performance characteristics give you power-plus, when the



sound pressure level is 94 db and above (SPL @ 1 watt @ 1 metre).

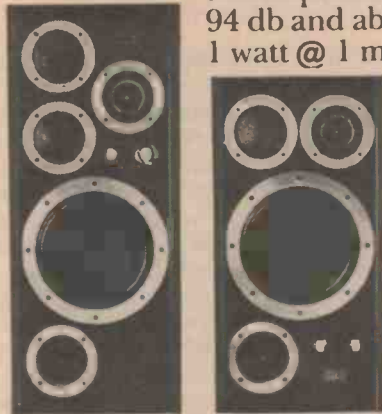

## BEYER DYNAMIC

The lightweight padded headband offers the best possible wearing comfort. The inbuilt wideband transducer system supplies impulse fidelity and true sound reproduction even at the highest levels. A truly professional product.



Distributed by

## RANK AUSTRALIA

Sydney 406 5666, Melbourne 541 8441, Brisbane 44 2851, Adelaide 294 6555, Perth 328 3933, Newcastle 26 2466, Townsville 72 2547.

.....  
 Rank Australia P/L, 12 Barcoo St., E. Roseville 2069.  
 Please send me more information on Altec   
 Wharfedale  Thorens  Watts  Beyer   
 Name \_\_\_\_\_  
 Address \_\_\_\_\_  
 Postcode \_\_\_\_\_

CU416/79

# Audio Reflex MR-130/140 auto-return record player

This mid-priced unit from Audio Reflex features belt-drive, comes fitted with an Audio Technica AT-12E cartridge and provides "... a good compromise between price and performance".

IN AN AGE of direct drive turntables whose prices range from reasonable to ridiculous, there is still a great demand for rim drive and belt drive turntables. Whilst direct drive turntables are capable of offering exemplary wow and reasonable flutter figures, belt drive turntables generally offer a lower rumble figure but a very much higher wow. This wow, which is the low frequency fluctuation in speed stability, comes as a result of the belt drive acting like a great big rubber band which cyclically expands and contracts under the influence of the drive motor pulley. This produces a measurable and sometimes audible modulation of the recorded signal.

## The unit

The Audio Reflex MR130/140 Belt Drive Turntable is a good example of an economical belt drive system, supplied for evaluation with an Audio Technica AT-12E Moving Magnet Cartridge. The unit is reasonably attractive, featuring a simulated wooden veneer plinth with a spring isolated turntable mounted neatly inside. The unit is a practical but rather modestly

finished acrylic cover which is removable and is spring loaded for convenience.

The plinth has the minimum number of controls. These consist of a speed control lever on the left hand side for changing from 33 RPM to 45 RPM (which certainly leaves for dead the old fashioned requirement of pulling off the platter to get at the pulley) and an S-shaped tone arm which accepts universal head shells.

The tone arm is simply but effectively counter-balanced with a balance weight covering the range zero to four grams. The anti-skating control and counter balance weight are pre-set and according to the manufacturer, optimally so. The tone arm rests on a hydraulically damped cueing bar which is controlled by a cueing lever. This is particularly smooth in its characteristics and is as good as any we have seen. The cueing lever has a down-turn at the inboard end which allows the tone arm to traverse into an arm rest. This incorporates a sensible locking lever for storage, removal or transportation.

Whilst the tone arm does not automatically advance onto the turn-

table, it is provided with an automatic return. We consider that this is more important than an automatic play function. The only other control of any significance is the reject button which facilitates automatic return of the tone arm from the rest position during normal playing.

The turntable is a heavyweight 1.2 kg platten on which is mounted a non-skid ribbed rubber mat. The gimbal configuration is rigidly constructed but in the unit evaluated the two bearings did not lie exactly on the same plane. As a consequence, there was an approximate 3° error in the azimuth angle and this also showed up in the final position of the cartridge and its vertical angle to the record groove.

## Performance

The objective testing of the record player commenced with an evaluation of the cartridge fitted in the head shell. The Audio Technica AT-12E, although very modestly priced, features one of the flattest responses provided by any of the cartridges we have reviewed over the last 15 years. Both the left hand and right hand channels were within  $\pm 1$  dB from 20 Hz to 20 kHz and featured a smooth drop off in frequency response above 20 kHz. Whilst the channel separation is modest, being only 20 dB from 20 Hz to 10 kHz, the channel separation in the 5 kHz to 16 kHz range is better than most other cartridges we have evaluated. Even at 20 kHz the channel separation is still superior to the majority of high priced cartridges on the market.

If we were satisfied with the frequency response, we were much more satisfied with the distortion and transient performance of this cartridge.



Second harmonic distortion performance as shown by the spectrum analyser.

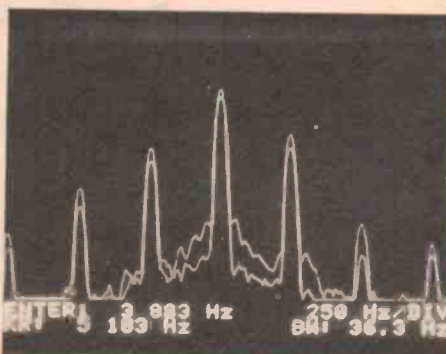

Spectrum analyser picture of tracking performance at 1.7 gram and 24 and 30 cm/sec.



At 1.7 grams tracking weight, the cartridge tracks remarkably well at velocity levels up to and including 30cm/sec, whilst simultaneously providing distortion components that are generally low and relatively inaudible. Whilst the channel separation between left and right channel was 2.1 dB this did not greatly concern us and was compensated by the excellent tracking performance which the cartridge exhibits.

The tone arm, which is simple and rugged, exhibits a smooth and relatively unobtrusive resonance at 6.2 Hz, and with the exception of the machining alignment between the two bearings, constitutes a well designed and otherwise well manufactured system.

The turntable flutter is low but not superlative at 0.07% weighted RMS, whilst the rumble is very low, being -60 dB which is an excellent performance. By contrast, the wow is relatively high

at 2.8% peak to peak which is bordering on the audible, particularly on sustained notes from singers and some musical instruments.

### To the ear

The subjective performance of this unit was generally above average. The most pleasing feature was the performance of the Audio Technica cartridge which exemplifies the extent to which cartridge designers have advanced the

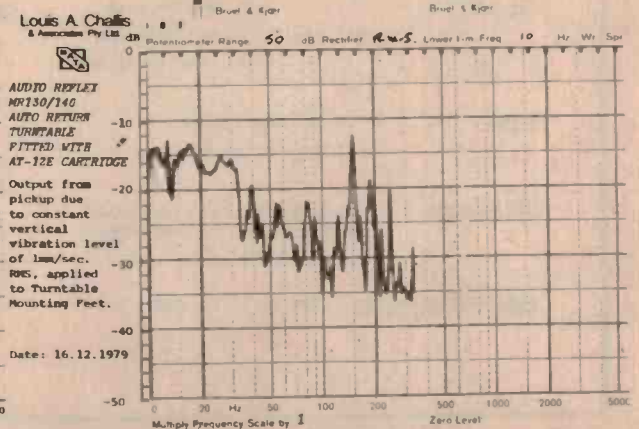
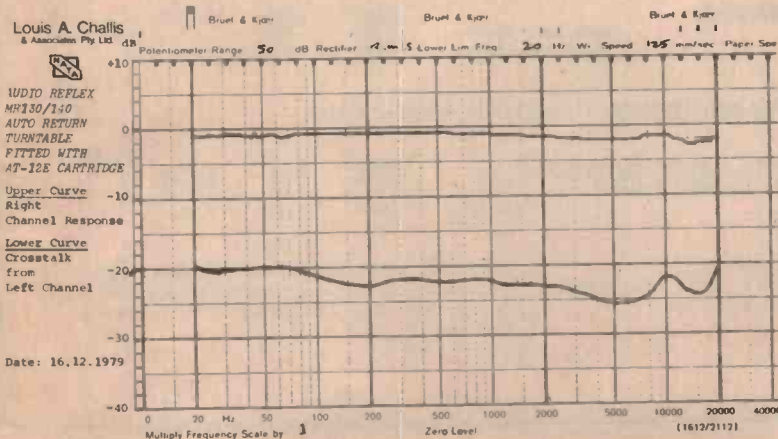

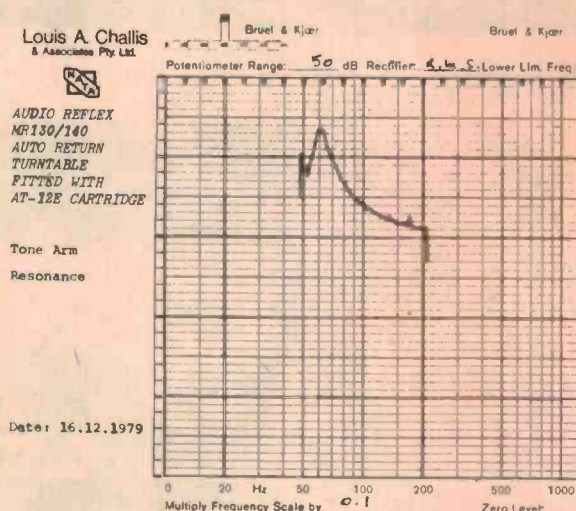
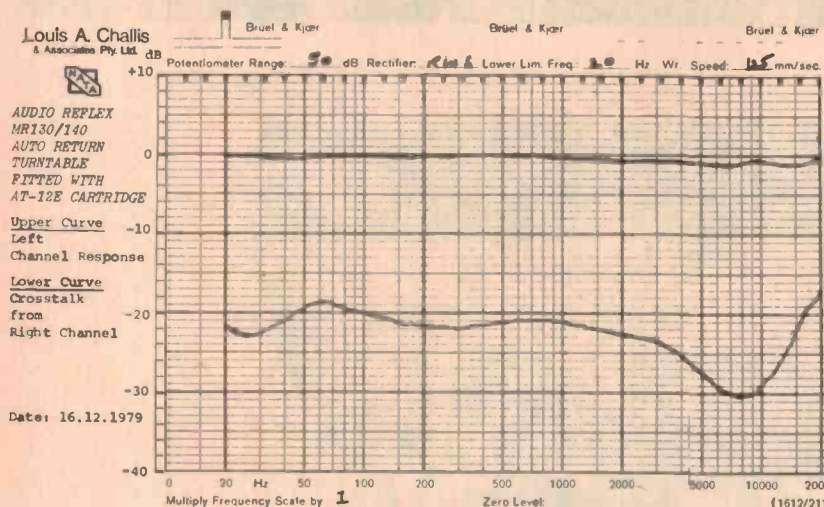

state-of-the-art in the last few years. In general terms, this cartridge performed as well as many cartridges selling at five times the price, and definitely does show the record player up to advantage.

The major performance attributes of this turntable are its simplicity of operation and general ruggedness, which are only slightly detracted from by the reasonably high wow produced by the belt drive.

Whilst the unit performs well at 1.7 grams with the automatic anti-skate control device in use, we found that it tracks even better at 1.5 grams without

anti-skating control. When coupled to a high quality amplifier and our normal monitoring speakers, we were impressed that this unit, with the cartridge supplied, constitutes a good system which belies its price.

## Summary

The MR-130/140 Turntable constitutes a good compromise between price and performance, and with the AT-12E Cartridge provided is well worth considering for inclusion in your hi-fidelity system.

## THE AUDIO REFLEX MODEL MR-130/140 AUTO-RETURN STEREO PLAYER FITTED WITH AUDIO TECHNICA AT-12E MOVING MAGNET CARTRIDGE

Dimensions: 455mm wide x 150mm high x 370 mm deep

Weight: 6kg Price: \$180  
Manufactured by Audio Reflex in Taiwan.

Absolute copyright in this review and accompanying measurements is owned by Electronics Today International. Under no circumstances may any review or part thereof be reprinted or incorporated in any reprint or used in any advertising or promotion without the express written agreement of the Managing Editor.



Louis A Challis and Associates Pty Ltd

### MEASURED PERFORMANCE OF

AUDIO REFLEX MODEL MR-130/140 AUTO RETURN STEREO PLAYER (SERIAL NO. 9074845)

**WOW & FLUTTER:**  
Wow: 2.8% peak to peak  
Flutter: 0.07% weighted RMS  
0.12% unweighted RMS

**CROSSTALK:**

	100Hz	1kHz	6.3kHz
Left into Right:	-24dB	-23dB	-30dB
Right into Left:	-22dB	-20dB	-29dB

**RUMBLE:**  
-26.3dB unweighted  
-51.5dB weighted

**TONE ARM RESONANCE:** 6.1Hz (see attached graph)

**SENSITIVITY:**  
Right Channel: 1.3mV/cm/sec.  
Left Channel: 1.0mV/cm/sec.  
Channel difference: 2.1dB

**TOTAL HARMONIC DISTORTION:**  
(2.24cm/sec. @ 1kHz)

	100Hz	1kHz	6.3kHz
Left:	1.9%	0.9%	2.6%
Right:	1.9%	1.7%	3.0%

**FREQUENCY RESPONSE:** 20Hz to 20kHz  $\pm$ 1dB

**TRACKABILITY:**  
(Using Shure Disc TTR103, 400 and 4000Hz)  
Tracks all levels satisfactorily at 1.7 grams. Photo shows distortion components (including those of disc) at two highest levels (24 and 30cm/sec.)



# Leading ferrite researcher visits Australia

Late last year, Australia was honoured by the visit of Dr Takeshi Takei. Dr Takei has spent most of his academic life devoted to research on ferrites and would be recognised as the world's leading authority on the subject.

FERRITES HAVE HAD far-reaching influences on many fields — such as the development of better permanent magnets for loudspeakers, cores for inductors, as insoluble anodes in electrolytic processes (such as electroplating), in PTC thermistors, piezoceramic materials — even in agriculture!

The most important single use of ferrite is probably in the manufacture of recording tape. Prior to this major development (of ferrites), magnetic recording was restricted to wire records with very limited bandwidths.

Dr Takei graduated from Tohoku University and four years later, in 1932, obtained his Doctor of Science degree. His subsequent research into ferrites quickly resulted in industrial applications of the material.

The biggest boom in research into the nature and properties of ferrite occurred in the 1950s. The end of World War II saw a growth in consumer applications and ferrite was an essential material in inductors of many different types for widely differing applications.

Parallel developments occurred with the chemistry of ferrites so that the number of different ferrites increased dramatically over that period. The chemical and structural properties could be tailored to suit almost any application. For instance: ferrite was synthesised with extremely low loss at radio frequencies, allowing the construction of the sensitive and compact ferrite rod antenna so common these days in portable transistor radios. Ferrites these days are used at frequencies well into the microwave region — in waveguide components, travelling wave structures etc.

Another special application of a highly developed form of ferrite is the ceramic magnet, without which high quality permanent magnet loudspeakers would be impossible.

One of the most recent developments, and one which is deemed to be amongst the most important,

Ferrite can be made in all sorts of shapes, sizes and varieties. For use in inductor cores, ferrite is moulded into rods, tubes (as shown at right), toroids, E-I cores, threaded slugs etc.

is the magnetic bubble memory. The concept of using a magnetic bubble or domain as a memory storage element for computers was first proposed in 1967. The first types of ferrite investigated yielded bubbles that were large, slow moving and unstable, so attention was shifted to other ferrite types. Eventually, most of the problems were overcome and the first practical magnetic bubble memories are about to be released.

Another development has been the introduction of a non-toxic ferrite compound which is being used in research to determine whether it might be used as a replacement for currently-used barium sulphate in X-ray diagnosis.

Dr Takei's business card is impressive — it says he is "Professor Emeritus of Tokyo Institute of Technology" and "Professor Emeritus of Kejo University", which makes most business cards one sees pale into insignificance by comparison!

Undoubtedly, Dr Takei is one



We had the opportunity of meeting Dr Takei at the premises of TDK (Australia) during his visit here.

of the 'behind the scenes' personalities who has influenced greatly the electronics industry and our lives in many ways, and it seems, will continue to do so.

David Tilbrook



## TANDY ELECTRONICS

### FRANCHISE OPPORTUNITY

#### For established retailer COUNTRY AREAS

Now you can add extra profit, volume, traffic to your store by adding a range of the famous Tandy/Radio Shack Electronic products to your line.

If you have a successful store. (Hardware, Furniture, Appliance, Sporting Goods, Toys/Hobbies, Chemist, Radio, TV, etc.) contact us now!

A minimum investment covering inventory and start-up costs can begin a new and exciting association with Tandy — a leader in home entertainment and electronics!

Write or phone:  
Mr. E. Epps, Franchise Manager.  
Tandy Corporation.  
P.O. Box 229, Rydalmere, N.S.W. 2116.  
Phone: (02) 638 4333

# The Hafler DH101 preamp and DH200 power amplifier

“... it is unusual to find a high fidelity amplifier ... intentionally designed to be assembled by the purchaser.”

IN AN AGE of consumer items factory finished to high standards and pre-tested to overcome the many possible problems that can eventuate between design, fabrication or delivery, it is unusual to find a high fidelity amplifier with the hallmark of the Hafler units, that are intentionally designed to be assembled by the purchaser. Not that the concept itself is unusual but rather we thought that the market had succumbed to the insidious outlook that only a factory with properly trained people and proper quality control could produce a long lasting and worthwhile piece of equipment. Most of the readers of this magazine would not subscribe to this view and even the junior members of my own family have constructed many worthwhile pieces of equipment, the majority of which have worked when first switched on. Notwithstanding, as equipment becomes more complex and fragile (both mechanically and electronically) it is either a brave (or experienced) person who would opt to construct his own hi-fidelity equipment in the current era.

David-Hafler Co. obviously do not support this viewpoint and the pre-amplifier (but not the main amplifier) that we received was field constructed by some enterprising owner prior to our receiving it.

## The preamp

The appearance of the Hafler pre-amplifier is neat but not exciting. The front escutcheon is satin black aluminium with white stencilled lettering which stands out neatly and effectively. On the left hand side of the

panel are a concentric volume and outer balance control followed by a bass and treble control with neat black lines to indicate the position but without indents to facilitate the tone control setting to a neutral position. This function is, however, overcome by a tone defeat system elsewhere in the panel. On the centre of the panel is a light emitting diode to indicate that the unit is switched on. On the right hand side of that, are the two sets of push button switches in two rows with self-indicating background which artificially illuminate the front panel by white or yellow strips to indicate the selection of a function.

The top row of switches provide selections for Phono 1, Phono 2, Tuner, Auxiliary or Dub. The first two of which are interlocked with one another, whilst the Dub switch is capable of independent operation. The bottom row contains switches for Tape 1, Tape 2 — which are mutually exclusive; a Mono switch; a Tone Defeat Button and a Power on/off switch. The rear of the unit, although ostensibly designed for Australian conditions, contains the ubiquitous switched and unswitched parallel pin power outlet sockets of the type which are no longer approved by the Australian Electrical Design Authorities. The patching field uses RCA coaxial sockets for all of the inputs, together with left and right channel input/output patching links to allow the inter-connection of external equalisers, expanders or other special noise control facilities.

The inside of the unit features one medium sized printed circuit board at

the front of the cabinet and an enclosed regulated power supply system with integral transformer at the rear right hand corner. The preamplifier unit, which was hand-assembled, is neatly constructed and exhibited beautifully wired components and is generally a credit to whoever assembled it.

## The Main amp

The main amplifier is more attractive than the preamplifier and features a black cabinet with large heat sinks at either end. The name is engraved on the left hand side of the front of the cover and a power switch and overload light are located at the lower right hand section of the front cover. The rear of the amplifier features a left channel and right channel coaxial RCA input socket spaced well apart on opposite sides of the panel of the amplifier. These flank two 5 A fuses and the speaker output sockets for only one set of speakers at the centre.

Surprisingly, the design concept that is utilised is not normal as the two active terminals are placed closest together, whilst the two earths flank these on either side. In subsequently connecting up this unit we found how inconvenient the positioning of the coaxial sockets was in that most patching leads have a limited spread length between the plugs. When the two input sockets (which are spaced apart by 180 mm) are too widely spaced for the majority of commercial leads one can be temporarily embarrassed. The location of the two active output terminals so close to one another is another disadvantage which could



accidentally result in the shorting of the output circuits and the temporary demise of the amplifier.

The inside of the amplifier is well designed and well made with each heat sink incorporating the four output transistors, a thermal cut out, and its own power amplifier stage neatly supported vertically on the well designed heat sinks. The centre of the amplifier contains the transformer and two large 10 000 $\mu$ F electrolytic capacitors to provide the primary filter smoothing.

When we first switched the amplifier on for testing, we noted that the trans-

former provided was generating a significant level of hum and this level of 54 dB at 100 Hz was the highest we have experienced from any unit since the days of the valve amplifiers some 15 years ago.

The rest of the objective testing of this unit proved to be more rewarding than our passing interest in the transformer hum level. The frequency response of the unit proved to be remarkably smooth extending from 1.5 Hz to 117 kHz +1, -3 dB, with the tone control centred. With the tone control defeated this frequency response diminished to 2 Hz to 62 kHz which is an effective halving of the

bandwidth. This change is significantly great for us to recommend that users should generally avoid using the tone control defeat circuit as it is obvious that the transient performance of the unit will be slightly impaired by such a reduction.

The sensitivities of the unit are good, particularly the phono sensitivity which is 230  $\mu$ V for 1 Watt output, with an overload performance that is nearly 60 dB greater and thus more than adequate for the power output and range of the amplifier. The harmonic distortion characteristics of the unit, whilst good, are not nearly as good as claimed by the manufacturer. At the

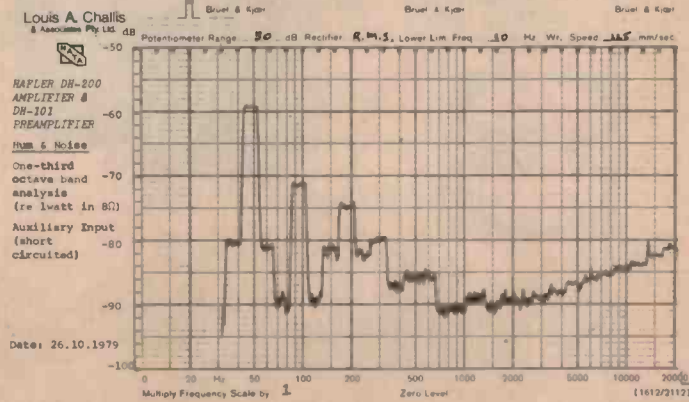
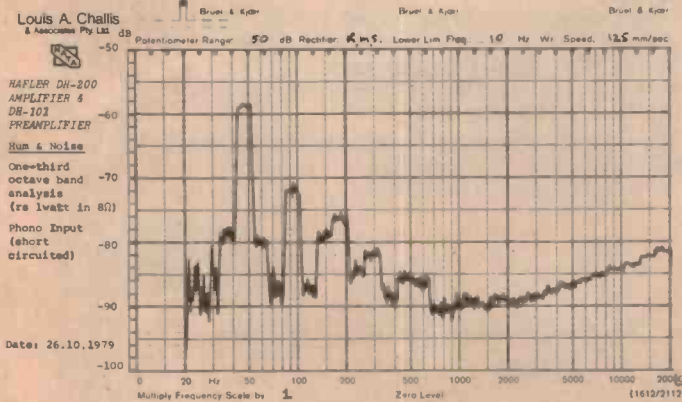

# How to improve on the perfect

Introducing the FR.12. The first Fidelity  
Research Tone Arm designed for Linn Sondek.

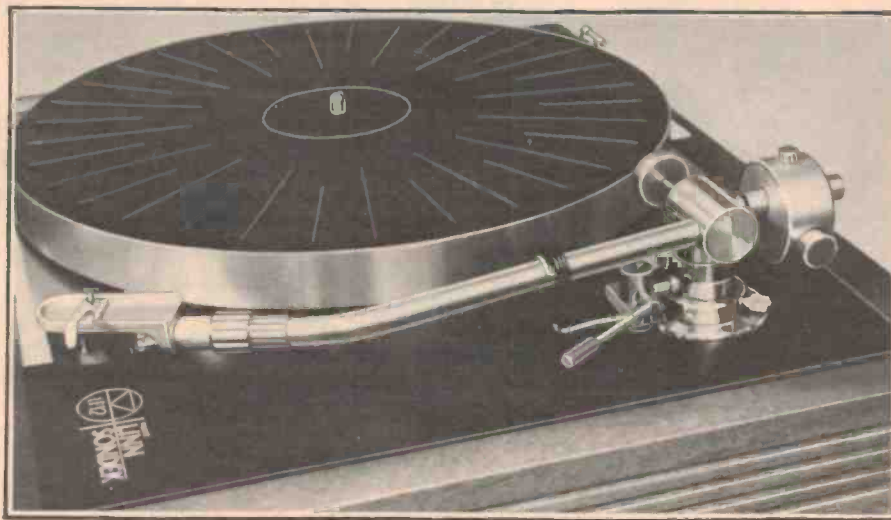

Now, after 12 months of careful development we can proudly announce a Fidelity Research moving coil cartridge tone arm especially designed for the Linn Sondek and other quality compact turntables.

The new FR.12 is designed for today's advanced moving coil cartridges. The headshell is machined from a solid block of aluminium with a unique collet chuck socket nut connection for improved rigidity.

The result is the performance of an integrated arm with the selectivity of an interchangeable head arm.

In fact the new FR.12 is so advanced that we believe it can actually improve the perfection of Linn Sondek . . . and that's something worth hearing at your nearest Fidelity Research dealer very soon.

The New Fidelity Research FR1 MK 3 Straight Line cartridge has been especially developed for today's State of the Art loudspeakers.

Like the previous FR.1 MK 3 there is no 7dB measured rise, true flat response has been achieved without loss of musicality.

This result is a smoothness and detail no other cartridge we have ever heard can equal.

We invite you to see your dealer for a demonstration – and be prepared for a new experience in ultimate high fidelity.



Also available from Fidelity Research

#### FR.1 MK 2

High performance moving coil cartridge that represents outstanding value.

#### FR 101

Moving magnet cartridge that delivers equal performance to other cartridges costing twice its price. Also available with 'Line Contact' stylus (Model FR 101SE).

#### FR 6SE

Moving magnet cartridge with Toroidal core and Line Contact stylus.

#### FRT3T Toroidal Transformer

The very popular single toroidal core single input transformer. It represents outstanding value.

#### FRT4 Stereo Step-up Toroidal Transformer

Highest quality boosting transformer with 4 impedance settings, 3 phono inputs and 2 toroidal cores.

Available through all reputable hi-fi stores.

Please contact Arena Distributors, 642 Albany Highway, East Victoria Park, Western Australia, for the name of your nearest dealer.

Sole Australian Agents  
**arena**  
DISTRIBUTORS  
Australasia Pty Limited

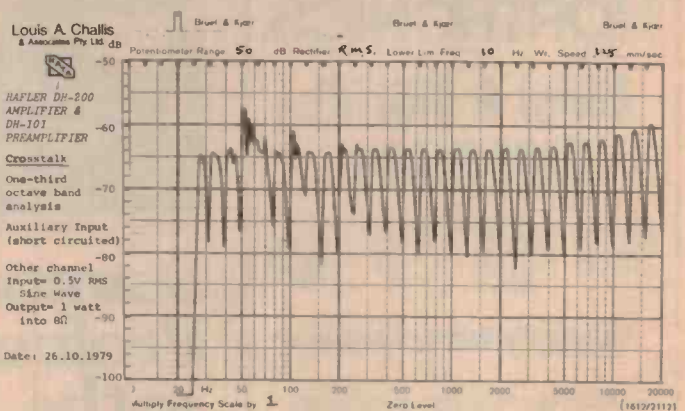
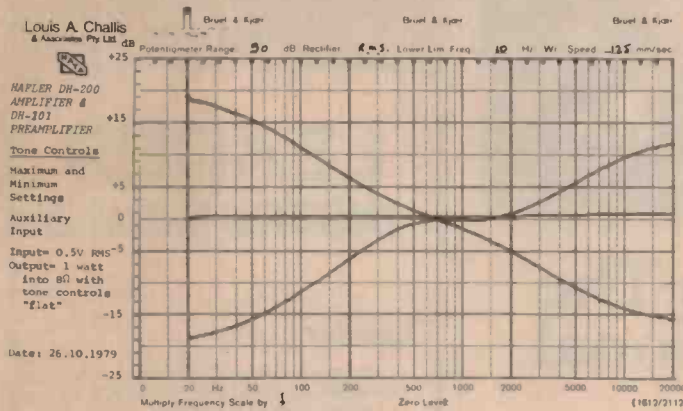

100 Watt level into 8 ohms they are 0.07% at 100 Hz, 0.014% at 1 kHz and 0.009% at 6.3 kHz. At the 1 Watt level these distortion figures are lower being 0.064% at 100 Hz, 0.004% at 1 kHz and 0.007% at 6.3 kHz. Notwithstanding, the transient intermodulation distortion performance is good, being less than 0.1%. This amplifier does exhibit an intermodulation performance that is better than most.

The hum and noise levels are not as good as the manufacturer claims being -79 dB(A) at the 1 Watt level and -58 dB unweighted under the same conditions. The dynamic headroom of the unit is 1.7 dB re 100 W condition, which is acceptable.

The subjective testing of this unit was a somewhat mixed bag. The extended frequency response, transient performance and lack of colouration of the amplifier was immediately apparent. Connected to a set of Quad speakers

and driven by a Shure V15 Mk III Cartridge, the amplifier provided some of the cleanest, uncoloured sound that we have heard. This performance was marred to a small degree by the hum level produced by the transformer. The performance of the unit on direct cut records was superlative but in the quiet passages in a room with a background noise level of 10 dB A-scale, we could still hear the residual hum from the overall system. We suspect that the hum problem experienced is an isolated case from a single faulty transformer and compounded slightly by the non-professional wiring carried out by an enterprising amateur.

## Summary

Our overall impression of the Hafler DH200 Amplifier and DH101 Preamplifier is that the unit is well designed, has the capability of providing superior performance, but is best constructed by a professional and not as a "do-it-yourself" home kit.

Whilst the performance of these units is good, it falls short of the performance claimed by the manufacturers. The problem of the transformer noise is not a major point of contention. The unit is one of the better amplifiers on the market but at a selling price of \$1230 assembled, or \$1030 as a kit, does not constitute one of the best buys in the market place.

## HAFLER DH-101 PREAMPLIFIER & DH-200 AMPLIFIER.

Price: Assembled Retail Price - \$475 (Pre-amplifier) \$755 (Amplifier)  
 Kit: Retail Price - \$375 (Pre-amplifier) \$655 (Amplifier)  
 Manufactured by David-Hafler Co., New Jersey, U.S.A.

Absolute copyright in this review and accompanying measurements is owned by Electronics Today International. Under no circumstances may any review or part thereof be reprinted or incorporated in any reprint or used in any advertising or promotion without the express written agreement of the Managing Editor.



Louis A. Challis and Associates Pty Ltd

### FREQUENCY RESPONSE:

(-3dB re 1 watt, 0.5V Input to Aux.)

Left: 1.5Hz to 117kHz  
 Right: 1.5Hz to 120kHz

### SENSITIVITY:

(for 1 watt in 8Ω)

**Tone Controls Centred**  
 Left: 13mV  
 Tuner: 13mV  
 Tape: 13mV  
 Phono: 220μV  
 Overload: 205mV

### INPUT IMPEDANCE:

**Tone Controls Defeated**  
 Left: 2Hz to 63kHz  
 Right: 2Hz to 62kHz

Output Impedance: 0.15Ω (at 1kHz)

### HARMONIC DISTORTION:

(at rated power of 100 watts into 8Ω = 28.3 volts)

	100Hz	1kHz	6.3kHz
2nd	-64.3	-79.2	-89.7 dB
3rd	-69.7	-	-82.0 dB
4th	-84.0	-82.8	-
5th	-74.0	-86.1	-
THD	0.073%	0.014%	0.009%

(at 1 watt into 8Ω)

	100Hz	1kHz	6.3kHz
2nd	-65.5	-88.0	-
3rd	-71.0	<-96.0	-82.2 dB
4th	-81.2	-	-
5th	-74.0	-	-
THD	0.064%	0.004%	0.007%

### TRANSIENT INTERMODULATION DISTORTION:

(3.15kHz square wave & 15kHz sine wave mixed 4:1)

Less than 0.1%

### NOISE & HUM LEVELS: (re 1 watt into 8Ω)

(with volume control set for 1 watt output with 0.5V input (Aux) 5mV output (Phono))

Aux:	-58dB(Lin)	-79dB(A)
Phono:	-58dB(Lin)	-79dB(A)

### MAXIMUM CLIPPING POWER AT CLIPPING POINT:

(IHF-A-202) (20mS burst repeated at 500mS intervals)

97V p-p = 147 watts

Dynamic Headroom = 1.67dB (re 100 watts)



# NORTRONICS

## AUDIO & DIGITAL TAPE HEADS



for long life extended response

- Replacement heads for cassette decks, reel to reel decks, cartridges and cassette recorders. Also professional recorders and duplicators.
- Will fit AMPEX, SCULLY, TEAC, ATC, GATES, PENTAGON, IFONICS and many more.
- Complete range of Alignment tapes for cassette, reel to reel and cartridge decks.
- REGULAR MAINTENANCE ENSURES CONTINUED OPTIMUM PERFORMANCE. Nortronics manufactures a full range of audio care products.



MAGNETIC TAPE DEVELOPER



ALIGNMENT TAPES



BULK ERASER



TAPE HEAD CLEANER



TAPE SPLICER

- NORTRONICS audio care products are designed to care for and maintain your valuable recording equipment.
- SEND TWO 20c STAMPS FOR OUR FREE BROCHURE ON THE COMPLETE NORTRONICS RANGE.

**E.I. EMAC INDUSTRIES Pty. Ltd.**

2 Bengal Crescent, Mount Waverley, Vic. 3149. Ph: (03) 277-9989.



Separating the mother from the master

## Stanton-The Professional in the Recording Industry

### Application — The Metal Mother — Stanton Plays it Back

Once the recording studio has delivered the lacquer disc to the plating plant it is sprayed with liquid silver making it electroconductive, and then electroplated with nickel which is separated from the lacquer. The nickel is now a negative image called a master and has, instead of a groove, a ridge that comes to a point. The master is treated and nickel plated again and upon separation forms a mother, a positive metal record. Engineers rely on the Stanton 881S cartridge in playback evaluation of the mother.

Stanton's 881S Professional Calibration Standard Cartridge is a sophisticated, low mass, phono pickup that features the patented Stereohedron® stylus tip for truest fidelity and gentlest possible treatment of the record groove.

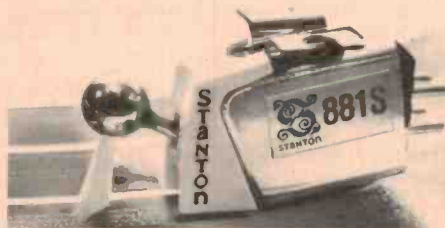

© 1979 STANTON MAGNETICS

Sole Australian Distributors:  
**LEROYA INDUSTRIES PTY LTD**

Head Office: 156 Railway Pde, Leederville, Western Australia, 6007. Phone 81-2930.

NSW Office: 7 Jordan Rd, Wahroonga, 2076. Phone 487-2543.



# STANTON

THE CHOICE OF THE PROFESSIONALS™

— PTY. LTD —  
**DELSOUND**  
BRISBANE

## LEADER INSTRUMENTS

### Leader

Provides one of the best known ranges of instruments available to the professional and hobbyist today.

### Leader

Instruments cover the whole range from audio through to U.H.F.

### Leader

Instruments include digital frequency counters and multimeters, oscilloscopes, RF and Audio signal generators, bench power supplies, audio system analysers, LCR bridges, TV/FM sweep generators, PAL pattern generators. There are many more in the catalogue.

### Leader

also provides a special range for the radio amateur — DIP meter, power and SWR meters to 500 MHz, 3 inch oscilloscope and antenna coupler.



For further information write or call:

**DELSOUND PTY. LTD.**  
1 Wickham Tce. (Cnr. Wharf St.)  
Brisbane. Phone 229-6155.  
Wholesale and Retail suppliers of  
Electronic Hardware and  
Components.

# MINI-MART

Where you can advertise FOR SALE/WANTED/SWAP/JOIN

**WE'LL PUBLISH up to 24 words (maximum) totally free of charge for you, or your club or association. Copy must be with us by the 1st of the month preceding the month of issue. Please, please write or preferably type your adverts clearly — otherwise it may not turn out as you intended! If we can't understand it, relatively few readers will (no insult intended). Every effort will be made to publish all adverts received — however, no responsibility for so doing is accepted or implied.**

## Conditions

Name and address plus phone number (if required) must be included within the 24 words allowed. Reasonable abbreviations, such as 25 Wrms or 240 Vac, count as one word. **Private adverts only** will be accepted. Please let us know if you find a commercial enterprise using this service. Adverts must relate to electronics, audio, communications, computing etc — general adverts cannot be accepted.

Send your ad to:-



ETI Mini-Mart,  
Modern Magazines  
15 Boundary St  
RUSHCUTTERS BAY NSW 2011

## AUDIO

**FOR SALE:** Stereo Amp — 60W/channel ETI 4000. Almost new. Call Brett Hays, (02) 599.4004 (message AH).

**WANTED** members, no experience needed to enjoy sound magazine monthly printed magazine bimonthly. Full details Boomerang Tape Recording Club, PO Box 118, Wellington NSW 2820.

**ULTIMATE** acoustic design MCP1 Mk II moving coil preamplifier, adjustable gain, suit most cartridges - \$45. Contact H Grant, 6 Seaforth Ave, Hazelwood Park, Adelaide 5066 phone (08) 79.1811.

**QUAD II/22** valve amplifiers, AM2 and FM tuners, original handbooks, excellent condition \$595. Quad AM tuner wanted (07) 33.5603 BH, (07) 371.5020 AH.

**NAKAMICHI 680** brand new unused, latest and finest but I can't afford the rest of the system. See Sept ETI review \$995. Gerry (02) 82.3620.

**WANTED** Quad 33 preamp only. Chapman, 22 Harwood Ave, Sandringham, Auckland, NZ.

**WANTED:** 8-3/4 inch tape spools containing tape or preferably empty, or advice on where to get them. Bernhard Asman, 2 Jolly Street, Dandenong, Vic 3175. Phone (03) 791.8160.

**SME** tonearm. 3009 Series 2 (improved) with Sure V15 Cartridge (Mk III) and spare stylus in perfect working order \$80. Phone Sydney 498.2952.

**FOR SALE:** one Quad Electrostatic Speaker \$300. Also available Quad AM/FM tuner and Garrard Model 301 turntable in mahogany cabinet. Ring Hinch (02) 439.2022 (Bus) or (02) 90.3333 (H).

**FOR SALE:** Ferrograph Series 7 1/4-track \$400. 1" EMI 825, 3600 ft, \$30. Synthesizer transient generator \$18, keyboard controller \$70, power supply \$50. Carl Vine (02) 33.5647.

**SOS:** All Thorens, Ortofon, Leak Owners, genuine need persuade you to sell TD 124 turntable, SL15 MK I, S 15T, S 15 MT cartridges. Any condition TL12, TL25, TL50 amplifier. Please reply L Nelson, 307 Bambra Road, South Caulfield 3162. Tel. (home) 578.1582, (work) 689.4411.

**SHAMROCK** Real-to-Reel tapes - 10 reels \$2.50 each. Refer to Ampex offer in December 79 ETI. Unboxed but as new. Phone Jan Collins (02) 33.4282.

## COMMUNICATIONS

**WANTED:** Urgently Model 15 Teleprinter. Will pay up to \$60 for good condition set to 45.45 Baud. T Robinson, L31105, Lot 92, Russell Avenue, Woodend, Vic 3442.

**SHORTWAVE** listeners: Southern Cross DX Club, GPO Box 336, Adelaide, SA 5001 produces monthly "DX POST". Sample bulletin and details for 20 cents stamp.

**VS6HK** repeater/beacon. Altitude 500 Mtrs. Input 145.0 MHz. Output 10W 145.6 MHz. Idents every 5 mins. Range 100 NM. M/Mobiles key 10 secs for initial access. QSL, POB 541, Hong Kong.

**NINE** Dragons Award celebrates Hong Kong's 50th year Amateur Radio. Claim nine countries including VS6 from Zones 18, 19 and 24-30 with \$3. HARTS, POB 541, Hong Kong.

## COMPUTING

**SELL** 8085 computer 1.25 KRAM, 1 K monitor 3 I/O ports programmable timer, keypad and 6 digit display. Power supply included. Powerful system. B Laird, 8 Kilkenny Road, Penrith (047) 21.5333.

**COMPETENT** assistance required in selection of microcomputer and peripherals (including printer, plotter) and programs relative to 80 CPL. Biological data processing. WNB Quick, Glen Waverley. Phone (Vic) 560.8145.

**FOR SALE:** MEK6800D2 fully assembled and buffered, in good condition. \$200 ONO. Phone (02) 53.6934 after 7 p.m.

**STATSLOTTO:** Statistical analysis of Tatts-lotto (Vic) for TRS 80 LII 16 K. Includes: Analysis of 1, 2 or 7 numbers, bar-graph, experimental projection (user). \$16.95 cassette. Maurice Copeland, 57 Alexander St, Hallam, Vic 3803 (03) 703.2407.

**TRS-80** Telephone Dialer with Redial, Index, Memory, etc. Does not use cassettes relay. Port Driven. Simple to follow circuit diagram and program listing. \$10. R Gareb, 17/37 O'Donnell St, Bondi 2026, ph (02) 30.8261.

**S-100 2650** microcomputer. Cabinet with regulated supplies and fan. SWTP full-ASCII keyboard. 2 x 8 K RAM and unloaded board. EA VDU, cassette recorder, documented, programs. \$600. D Bartel (08) 353.3370 Adelaide.

**TRS-80 L2** software available on swap basis, practical prog's and games include - Star Trek, Microchess, Address List, Sound Effects, C/R McCance, 72 MacFarlane Ave, Blairgowrie, Vic 3942.

**LIGHT** pen for TRS-80 allows you to communicate directly with the screen. Includes instructions and sample program. \$23 incl p&p. For more info write C/- PO Box 122, Bondi Beach 2026.

**CHESS** Computer, Chess Challenger 10 brand new unwanted gift. Ten levels of play. \$299. Phone AH (047) 21.4373.

**SALE:** Ithaca S-100 Z80 board, assembled, running with manual \$160. Old style ASCII encoded kbrd. \$30. INS8080AN \$5. R Gardner, 7 Weemala Ct, Mt Nelson, Tas 7007. Phone: 23.6941.

## MISCELLANEOUS

**SELL:** Quantity of 1/2W resistors, polyester caps and electo caps. Send SSAE for values and prices to A Matthews, 18 McDonald Way, Churchill, Vic 3842.

**WANTED:** Radio Service Manuals on old valve radios. Also books on same. Also on phonographs and old gramophones. State price. Goodwin, Bagdad, Tas 7407.

**WANTED** McMurdo 14-pin plugs and sockets (octal type with 2 centre pins). Also data books transistors circuits dimmers motor controls. Moggill Rd, Indooroopilly Qld 4068.

**WANTED** circuit for ex-army PSU/battery charger (General Dynamics type PP-6245) 0-32V, 0-60A. Please write Box 178, Ashgrove, Qld 4060.

**WANTED** valves-American 8 pin lock in base thin pins. ECH21. EF22. EBL21. G Bracey, PO Exeter, West Tamar, Tas.

**BOOK** collectors: Continuous and Alternating Current Machinery by J H Morecroft, First Edition printed 1914, excellent condition \$50 or offer. Tel Sydney 89.4645 (evenings).

# eti

Editor

**Roger Harrison VK2ZTB**

Project Manager

**Phil Wait VK2ZZQ**

Editorial Staff

**Roberta Kennedy**

**Jonathan Scott VK2YBN**

**David Tilbrook VK2YMI**

**Jan Vernon**

Art Direction and  
technical photography

**Ivy Hansen**

Layout/Assembly

**Bill Crump**

Reader Services

**Jan Collins**

Managing Editor

**Collyn Rivers**

Advertising (Sydney)

**Bob Taylor (Manager)**

**Geoff Petschler**

Advertising (Melb.)

**John Colquhoun**

Production Manager

**Bob Izzard**

Subscriptions & Circulation

**John Oxenford**

Acoustical Consultants

**Louis Challis & Associates**

Editorial-Advertising Offices

**Sydney**

3rd Floor,  
15 Boundary St 2011  
Rushcutters Bay  
Phone: 33-4282

**Melbourne**

150 Lonsdale St  
Melbourne, Vic 3000  
Phone: 662-1222  
Telex: AA 34340

Advertising

**Adelaide**

Admedia Group  
24 Kensington Rd  
Rose Park S.A. 5067  
Phone: 332-8144

**Hobart**

H.W. Lincone  
23 Lord St  
Sandy Bay Tas. 7005

**Brisbane**

Geoff Home  
57 O'Connell Tce  
Bowen Hills QLD 4006  
Phone: 52-8566

**Perth**

Aubrey Barker  
133 St George's Tce  
Perth W.A. 6000  
Phone: 322-3184

**Electronics Today International is published by Modern Magazines (Holdings) Ltd, 15 Boundary St, Rushcutters Bay, NSW 2011. It is printed (in 1980) by Wilke & Co, Browns Rd, Clayton, Victoria and distributed by Australian Consolidated Press. Recommended retail price only.**

**ETI subscriptions** cost \$19.00 per year (inc. postage) within Australia. Cost elsewhere is \$24.50 (inc. postage — surface mail). Airmail rates on application.

**Photostats** are available of any article ever published by ETI. We charge a flat \$2.00, regardless of page quantity, from any one issue of ETI. Thus, if the article is in three issues the cost is \$6.00. Send orders to the address below. The charge includes postage.

**Back issues:** cost \$1.40 each plus 45 cents post and packing. We can supply **only** the following issues:

**1976:** Nov Dec

**1977:** April May June July Aug Sept Oct Nov Dec

**1978:** Jan Feb Mar April May June July Aug Sept Oct Nov Dec

**1979:** all to date

**Binders** available for \$4.50 plus 90 cents post NSW, \$2. other states.

Orders to: **Subscriptions Department, ETI 3rd Floor,  
15 Boundary Street, RUSHCUTTERS BAY, 2011 NSW**

## READER ENQUIRIES

**By Mail:** There is no charge for replies but a foolscap-size stamped addressed envelope **must** be enclosed. Queries relating to projects can **only** be answered if related to the item as published. We cannot advise on modifications to projects, other than errata or addenda, nor if a project has been modified or if components are otherwise than specified. We try to answer letters as soon as possible. Difficult questions may take time to answer.

**By phone:** We can only answer readers technical enquiries by telephone after 4 pm. In enquiring by telephone about back issues or photostats, please ask for the "Subscriptions Department".

**33-4282**

## MICROFILM

Microfiche editions of this publication are available by annual subscription from Microsystems Pty Ltd, PO Box 188, North Sydney, NSW 2060.

## COPYRIGHT

The contents of Electronics Today International and associated publications is fully protected by the Commonwealth Copyright Act (1968).

Copyright extends to all written material, photographs, drawings, circuit diagrams and printed circuit boards. Although any form of reproduction is a breach of copyright, we are not concerned about individuals constructing projects for their own private use, nor by pop groups (for example) constructing one or more items for use in connection with their performances.

Commercial organisations should note that no project or part project described in Electronics Today International or associated publications may be offered for sale, or sold, in substantially or fully assembled form, unless a licence has been specifically obtained so to do from the publishers, Modern Magazines (Holdings) Ltd or from the copyright holders.

## Liability:

Comments and test results on equipment reviewed refer to the particular item submitted for review and may not necessarily pertain to other units of the same make or model number. Whilst every effort has been made to ensure that all constructional projects referred to in this edition will operate as indicated efficiently and properly and that all necessary components to manufacture the same will be available no responsibility whatsoever is accepted in respect of the failure for any reason at all of the project to operate effectively or at all whether due to any fault in design or otherwise and no responsibility is accepted for the failure to obtain any components parts in respect of any such project. Further, no responsibility is accepted in respect of any injury or damage caused by any fault in the design of any such project as aforesaid.



# KITS for projects

WE GET MANY enquiries from readers wanting to know where they can get kits for the projects we publish. This list is a guide to suppliers of kits and components for ETI projects.

We have only listed the projects published in the last few years, with their dates of publication, so this page can also be used as an index, even though kits are not available for some of them (as far as we know). Any companies who wish to be included in this list should phone Jan Collins on 334282.

## Printed circuit boards

Those suppliers listed against specific projects here are able to supply pc boards for those projects. Printed circuit boards for every project ever published in ETI are available through the following companies (to the best of our knowledge):

RCS Radio            Radio Despatch Service  
651 Forest Rd    869 George St  
Bexley NSW       Sydney NSW 2000

For current projects and a more comprehensive list of pc board suppliers refer to the Shoparound page in this and previous issues. This list will be updated roughly every four to six months.

Magnifying glasses may be bought at many general hobby shops, Newsagents and some stationary suppliers. Squint a little — it helps!

### Series 4000 stereo amplifier

Complete kits of this popular unit, featuring the 470 60 watt modules, the 471 preamp and power supply etc, are available from the following suppliers (see Key below): B,E,F,R.

## Key to Companies

- A Applied Technology Pty Ltd, 1A Paterson Avenue, Waitara, NSW 2077.
- B Bill Edge Electronic Agencies, 115 Parramatta Road, Concord IPO Box 1005, Burwood North 2134.
- C J. R. Components, PO Box 128, Eastwood, NSW 2122
- D Dick Smith Electronics P/L, Cnr Waterloo & Lane Cove Roads, North Ryde, 2113.
- E All Electronic Components, 118 Lonsdale Street, Melbourne, Vic 3000.
- F Tasman Electronics, 12 Victoria Street, Coburg, Vic 3058
- J Jaycar Pty Ltd, PO Box K39, Haymarket, NSW 2000.
- K S M Electronics, 10 Stafford Court, Doncaster East, Vic 3109.
- L Ellitronics, 289 Latrobe Street, Melbourne, Vic 3000.
- M Mode Electronics, PO Box 365, Mascot, NSW 2020.
- N Nebula Electronics Pty Ltd, 15 Boundary Street, Rushcutters Bay, NSW 2011
- O Orbit Electronics, PO Box 7176, Auckland, New Zealand.
- P Pre-Pak Electronics, 718 Parramatta Road, Croydon, NSW 2132.
- R Rod Irving, PO Box 135, Northcote, Vic 3070
- T Townsville Electronic Centre, 281E Charters Towers Road, Rising Sun Arcade, Townsville, Qld 4812.
- V Silicon Valley, 23 Chandos Street, St Leonards, NSW 2085.
- W Willis Electronics, 993 Hay Street, Perth WA 6000.
- Y Trilogy, 40 Princes Highway, Fairy Meadow, NSW 2519

## Project Electronics

- 041 Continuity Tester . . . . . T,D,B
- 042 Soil Moisture Indicator . . . . . T,D,B
- 043 Heads or Tails Circuit (Oct 76) . . . . . T,D,E,A,B,L
- 044 Two Tone Door Bell (Oct 76) . . . . . T,D,E,O,A,B,L
- 045 500 Second Timer . . . . . T,D,O,A,B
- 047 Morse Practice Set . . . . . T,D,O,A,B
- 048 Buzz Board . . . . . T,D,A,B
- 061 Simple Amplifier (Oct 76) . . . . . T,D,O,A,B
- 062 Simple AM Tuner (Mar 77) . . . . . D,E,B
- 063 Electronic Bongos . . . . . D,A,B
- 064 Simple Intercom (Nov 76) . . . . . T,O,A,B
- 065 Electronic Siren . . . . . D,O,A
- 066 Temperature Alarm (Dec 76) . . . . . T,D,E,A,B
- 067 Singing Moisture Meter . . . . . D,B
- 068 LED Dice Circuit (Oct 76) . . . . . T,D,E,A,B
- 070 Electronic Tie Breaker (Jan 77)
- 071 Tape Noise Limiter (Jan 78) . . . . . E,L
- 072 Two-Octave Organ (Jun 78) . . . . . D,B
- 081 Tachometer (Mar 77) . . . . . T,E,O
- 082/
- 528 Intruder Alarm . . . . . T,E,A
- 083 Train Controller
- 084 Car Alarm . . . . . D,A,B
- 085 Over-rev Alarm
- 086 FM Antenna
- 087 Over-LED
- 088 Hi-Fi Speaker

## Test Equipment

- 132 Experimenter's Power Supply (Feb 77) . . . . . E
- 133 Phase Meter (Apr 77) . . . . . E
- 134 True RMS Voltmeter (Aug 77) . . . . . E
- 135 Digital Panel Meter (Oct 77) . . . . . E
- 136 Linear Scale Capacitance Meter (Mar 78) . . . . . E
- 137 Audio Oscillator (May 78) . . . . . E
- 138 Audio Wattmeter (Nov 78)
- 139 SWR/Power Meter (May 78)
- 140 1 GHz Frequency Meter-timer (Mar 78) . . . . . C
- 141 Logic Trigger (Jan 79)
- 142 High Current Power Supply (Feb 79) . . . . . E
- 143 Curve Tracer (Jan 79)
- 144 Expanded-scale RMS Voltmeter (Jun 79)
- 148 Logic Test Probe (Jul 79)

## Simple Projects

- 243 Bp Beacon (Apr 77)
- 244 Alarm Alarm (Feb 77)
- 245 White Line Follower (Nov 77)
- 246 Rain Alarm (Apr 78) . . . . . L
- 248 Simple 12V to 22V Converter (Jul 78)
- 249 Combination Lock (Apr 79) . . . . . E
- 253 'Hot Potato' Game (May 79)
- 254 Egg Timer (Jun 79)

## Motorists' Projects

- 316 Transistor Assisted Ignition (May 77) . . . . . D,O,E
- 317 Rev Monitor Counter (Jul 77) . . . . . E
- 319 Varlwyper MK II (Sep 78) . . . . . E
- 320 Battery Condition Indicator (Apr 79) . . . . . D,E

## Audio Projects

- 448 Disco Mixer (Nov 76)
- 449 Balanced Microphone Amp (Nov 76) . . . . . J,E,L
- 450 Bucker Brigade Audio Delay Line (Dec 77)
- 451 Hum Filter (July 79) . . . . . D
- 470 60 W Amp Module (May 79) . . . . . A,B,E,P,R,S
- 471 Stereo Preamp (June 79) . . . . . A,B,E,P,R,S
- 473 Series 4000 Moving-coil Cartridge Pre-amplifier . . . . . J
- 480 50-100 Watt Amp Modules (Dec 76) . . . . . J,E,D,O,R,A,,B,L
- 481 12 V 100 Watt Audio Amp (May 77) . . . . . E
- 481 High Power PA/ Guitar Amp (Jun 77) . . . . . O
- 482 Stereo Amp (Jan 77) . . . . . O,E
- 482 Stereo Amp Part 2 (Feb 77) . . . . . O,E
- 483 Sound Level Meter (Feb 78) . . . . . E
- 484 Simple Compressor Expander (Jul 77) . . . . . E
- 485 Graphic Equalizer (Jun 77) . . . . . J,E
- 486 Gow-round Stabilizer (Nov 77) . . . . . J
- 487 Audio Spectrum Analyser (Feb 78) . . . . . E
- 489 Audio Spectrum Analyser 2 (Apr 78) . . . . . J,E
- 490 Audio Compressor (Dec 79)
- 491 Graphic Equaliser (Mar 79)
- 495 Transmission Line Speakers (Aug 77)

## Miscellaneous

- 546 GSR Monitor (Mar 77) . . . . . E
- 547 Telephone Bell Extender (Jun 77) . . . . . E
- 548 Photographic Strobe (May 77) . . . . . E
- 549 Induction Balance Metal Detector (May 77) . . . . . E
- 550 Digital Dial (Aug 78) . . . . . E
- 551 Light Chaser (Sep 78) . . . . . E
- 552 LED Pendant (Sep 78)
- 553 Tape/Slide Synchroniser (Oct 78) . . . . . E
- 556 Wind Speed/Direction Indicator (Dec 79)
- 557 Reaction Tester (Feb 79) . . . . . E
- 558 Mast-head Strobe (Feb 79)
- 559 Cable Tester (Mar 79)
- 577 General Purpose Power Supply . . . . . J
- 581 Dual Power Supply (Jan 77) . . . . . E
- 582 House Alarm (Jul 77) . . . . . T,O,E,A
- House Alarm —  
Installation Instructions (Aug 77)
- 583 Marine Gas Alarm (Aug 77) . . . . . E,E
- 585 Ultrasonic Switch (Sep 77) . . . . . R,O,E,T,L
- 586 Shutter Speed Timer (Oct 77) . . . . . E
- 587 UFO Detector (May 78)
- 588 Theatrical Lighting Controller (Nov & Dec 77 Jan & Mar 78) . . . . . N
- 589 Digital Temperature Meter (PCB135) (Dec 77) . . . . . E
- 590 LCD Stopwatch (Oct 78) . . . . . N
- 591 Up/Down Presettable Counter (Jul 78) . . . . . E
- 592 Light Show Controller (Aug 78) . . . . . E
- 593 Colour Sequencer (Dec 79)
- 594 Development Timer (Apr 79)
- 595 Aquarium Light Controller (May 79)

## Electronic Music

- 602 Mini Organ (Aug 76) . . . . . O,E,D,B
- 603 Sequencer (Aug 77)
- 604 Accentuated Beat Metronome (Sep 77) . . . . . E
- 605 Temp Stabilized Log-exponential Converter (Sep 78)

## Computer Projects

- 630 Hex Display (Dec 76) . . . . . E,A
- 631 ASCII Keyboard (Dec 78) . . . . . O,E,A
- 631 Keyboard Encoder (Apr 77) . . . . . O,E,A
- 632 Video Display Unit (Jan-Mar 77) . . . . . O,A
- 633 TV Sync Generator (Jan 77) . . . . . E,A
- 634 8080 Educational/Prototyping Interface (Jul, Aug 78)
- 635 Microcomputer Power Supply (Sep 77)
- 637 Cuts Cassette Interface (Jan 78) . . . . . V,O,E,A
- 638 Eprom Programmer (Jul 78) . . . . . E,A
- 639 Computerised Musical Doorbell (Mar 78) . . . . . A
- 640 S100 VDU (Apr, Jun 78) . . . . . V,O,A
- 641 S100 Printer (Sep 78)
- 642 16k S100 RAM Card (Feb 79) . . . . . K
- 650 STAC Timer (Nov 78)
- 651 Binary/hex Trainer (Jun 79)

## Radio Projects

- 712 CB Power Supply (Jun 77) . . . . . O,E
- 713 Add-on FM Tuner (Sep 77)
- 714 VHR-Log-Periodic Antenna (Feb, Mar 78)
- 715 VHF Power Amplifiers (Nov 77)
- 716 VHF Power Amplifiers (Jan, Feb 78)
- 717 Crosshatch Generator (May 78) . . . . . E
- 718 SW Radio (Oct 78) . . . . . E
- 719 RF Field Strength Indicator (Nov 78)
- 720 2 m VMOs Power Amp (Jan 79)
- 721 Aircraft Band Converter (Mar 79) . . . . . D,E
- 722 Antenna for ETI-721 (May 79)
- 724 Microwave Oven Leak Detector (Jul 79) . . . . . D

## Electronic Games

- 804 Selectagame (Nov 76) . . . . . O
- 804 Selectagame (Rifle Project) (Mar 77) . . . . . O
- 805 Puzzle of the Drunken Sailor (Oct 77)
- 806 Skeet (Jan 78)
- 810 Stunt Cycle TV Game (Jun 78) . . . . . O,D,B
- 811 TV Tank Game (Oct 78) . . . . . O,E,D,B
- 812 Wheel of Fortune (Dec 79)
- 813 Race Track Game (Jan 79)



THE CHORUS reaches a distinct low on Sundays . . . according to the Journal of Geophysical Research, but not the chorus you hear in church!

Messrs Lurette, Park and Helliwell, working on VLF-wave disturbances — variously named “whistler”, “hiss” and “Chorus” reported a connection between chorus emissions and ac mains power frequencies, in a paper in JGR vol 84, p 2657 published last year.

Using data obtained by the OGO-3 and OGO-4 satellites, the scientists logged the starting frequencies of the strong chorus emissions arising in the Earth’s magnetosphere. Chorus emissions are a frequency varying ‘noise’ that rises in frequency and amplitude, each component commencing at the background noise level and at a specific frequency the noise sweeps up in frequency and level at a rate of 200 to 2000 dB per second.

Messrs Lurette, Park and Helliwell found the starting frequencies over North America clearly correlated to



60 Hz harmonics, while over Europe and New Zealand they were correlated to 50 Hz harmonics.

To boot, chorus emissions were found to be more prevalent over industrialised areas, which consume the most power, whilst observations over Antarctica show that chorus emissions reach a pronounced low on Sundays — when power consumption is at a minimum!

### PUBLISHING AN INTERESTING ELECTRONICS MAGAZINE

That’s what we’re about and we’re looking for a person interested in doing the same thing — or at least curious about it, to join our staff. We’ll be asking you to write technical and general interest articles, maybe the odd news item, or perhaps construct and write up the occasional project. If you have a thorough understanding of the basics of electronics and can express yourself clearly with the written word — you pass ! Our ideas on what other attributes a suitable candidate might possess are entirely flexible. You don’t have to have formal qualifications and we won’t hold them against you if you do; gender is unimportant, along with age, but “enthusiast” and “self starter” come high on our list. Knowledge of magazine production is unimportant and typing ability doesn’t rate.

If you fit somewhere in there and would like to work with Australia’s most progressive electronics magazine, *right now contact:*

Collyn Rivers, Managing Editor  
Electronics Today International  
15 Boundary St, Rushcutters Bay NSW

# REAL HI-FI

## AND IT'S ALL IN OUR COLOUR CATALOGUE

The truth is, JVC have always produced real hi-fi components and we believe this current range represents JVC's finest range ever. Here are some real innovations and performance features to whet your appetite:— Quartz locked turntables with uncanny accuracy; Receivers/Amplifiers, some with built-in SEA Graphic Equaliser and DC, class A/B amplification; Cassette deck with JVC automatic computerised tape tuning; Computer designed

speaker systems; Separate but matching JVC components designed to compliment one another, perfectly. And all this real hi-fi know-how is yours ...merely for the asking.



**If you think they look different,  
wait till you've heard them!**

### FREE OFFER COLOUR HI-FI CATALOGUE

Just fill out this coupon and we'll fill you in on what's available and new in terms of JVC hi-fi entertainment...and it's all FREE!

Name \_\_\_\_\_

Address \_\_\_\_\_

\_\_\_\_\_ Postcode \_\_\_\_\_

WT1323/ETI/79

I am especially interested in...

- Cassette Decks
- Matching Systems  Amplifiers
- Speakers
- Turntables
- Receivers

Just address your envelope to...  
JVC Hi-Fi Advisory Service,  
Post Office Box 307,  
North Ryde,  
N.S.W. 2113

# JVC

**the right choice**

# What you see on the meters you'll hear on the tape.



Including the latest ideas in audio technology in modestly priced hi-fi components is a principle to which Technics is committed.

The inclusion of our most accurate metering system, the FL (fluorescent) bar graphs in the RS-M17 model cassette deck is another example.

To make an accurate recording you need accurate meters. The FL meters are

electronically controlled so response time is instantaneous. Each bar length is proportional to the sound level, and there's no overshoot - a characteristic of conventional needle-type meters. The meters give direct parallel readout for instant comparison between channels.

Other practical features on the RS-M17 cassette deck are rewind auto-play, so you spend more time listening to

your tapes and less time just pressing buttons; the highly reliable Super Permalloy head; 3-position tape selection for optimum results from the tape type you use; and Dolby\* noise reduction system.

You won't find a similarly priced cassette deck with more features than the RS-M17. See for yourself and your Technics dealer.

## Technics

\*Dolby is the trademark of  
Dolby Laboratories Inc.

Technics Advisory Service, P.O. Box. 319, North Ryde, N.S.W. 2113

T.79.32