

JUNE 1977 \$1.25*
NZ \$1.50

electonics

TODAY

Electronics Today International
is Australian owned & produced

PINE GAP - HOW SECRET?

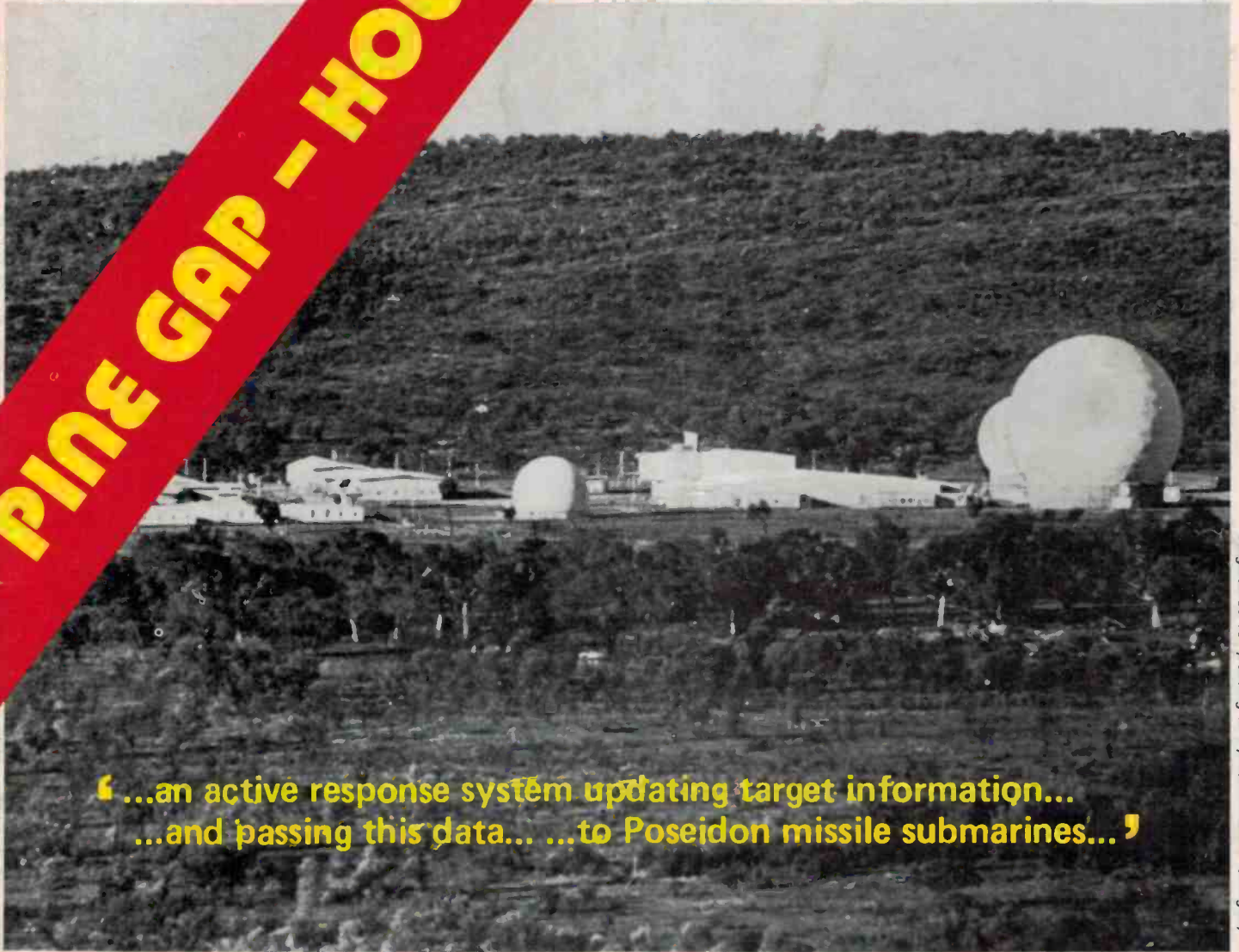

‘...an active response system updating target information...
...and passing this data... ..to Poseidon missile submarines...’

**12 VOLT 100 W AMPLIFIER
GRAPHIC EQUALISER
TELEPHONE BELL EXTENDER
CB POWER SUPPLY**

WHY YOUR NEXT CASSETTE SHOULD BE A MAXELL UD



3 THE SHELL — Even the best tape can get mangled in a poorly constructed shell. That's why Maxell protects its tape with a precisely constructed shell, made of lasting heavy-duty plastic.

No fixed guide posts are used. Instead Maxell uses nylon rollers on stainless steel pins thus eliminating the major cause of skipping, jumping and unwinding.

A tough teflon (not waxed paper) slip sheet keeps the tape pack tight and flat. No more bent or nicked tape to ruin your recording.

Maxell doesn't use a welded seal, but puts the cassette together with precision screws. Result — Maxell doesn't jam.



1 THE RESEARCH — More than twenty years ago, Maxell produced their first reel of magnetic tape. At that time, Maxell made a commitment to produce and sell only the finest magnetic products their technology could create.

That commitment still stands today.

2 THE TAPE — This continuous research has led to the development of the Maxell UD (ultra dynamic) cassette. A tape that has a coating of super-fine PX gamma ferric oxide particles with an extra smooth mirror-finish surface.

All of this adds up to high output, low noise, distortion free performance and a dynamic range equaling that of open reel tapes.

4 THE LEADER — A leader tape that has a four function purpose.

- Non-abrasive head cleaning leader (cleans recording head for 5 secs.).
- 5 second cueing line (recording function starts 5 seconds after the line appears).
- Arrows indicating direction of tape travel.
- A/B side mark (indicates which side is ready for play).

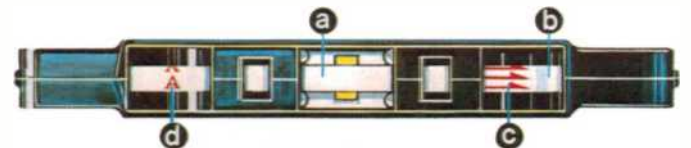

Now you know why your next cassette should be a Maxell UD (ultra dynamic).

maxell®

The sound expert's cassette. UD available in C60, C90 and C120. Distributed by Hagemeyer (Australasia) B.V. Branches in all States.

electronics TODAY

INTERNATIONAL



A MODERN MAGAZINES PUBLICATION

JUNE 1977, Vol. 7, No. 6

Editorial
Publisher

Les Bell
Collyn Rivers

NEXT MONTH'S
 READER OFFER
 SIDEBAND CB RIG
 SCIENTIFIC CALCULATORS

COVER: The Pine Gap satellite receiving station near Alice Springs, as photographed from an aircraft over 30 km away.

*Recommended retail price only

PROJECTS

GRAPHIC EQUALIZER.....	28
<i>Uses gyrators for simplified design</i>	
DUAL POWER SUPPLY.....	36
<i>Module for op-amp projects</i>	
TELEPHONE BELL EXTENDER.....	41
<i>Don't miss that vital call</i>	
CB POWER SUPPLY.....	56
<i>Use your mobile rig at home</i>	
100W/12V AMP.....	60
<i>How to put the 480 amp to work</i>	

FEATURES

PINE GAP.....	12
<i>What goes on at this installation?</i>	
SOUND.....	20
<i>Our new audio section</i>	
555 TIMER APPLICATIONS, PT3.....	45
<i>R. M. Marston continues this series</i>	
ELECTRONICS IN THE YEAR 2000, PT4.....	73
<i>Crystal-ball gazing</i>	
PRINT-OUT.....	83
<i>The 8080 under the microscope</i>	

NEWS & INFORMATION

News Digest.....	.5	Please Explain.....	.99
Calculator Contest.....	.9	Mini-Mart.....	.100
Kits for Projects.....	.90	Readers' Services.....	.102
Ideas for Experimenters.....	.91	Advertisers' Index.....	.102

Free Inside. . . CB Australia reviews SSB transceivers



The new 63cm and 53cm Luxor colour televisions feature interference free 'infra-red' remote control. Simulated picture.

Introducing Luxor interference free 'Infra-Red' Remote Control colour television to Australia. 26" (63cm) and 22" (53cm)

With self seeking Automatic Station Tuning - giving perfect channel selection at the touch of a button eliminating fine tuning.

Following the advances of Luxor 'modular circuitry' colour television, Luxor now introduce interference free 'infra-red' remote control to Australia with automatic self seeking station tuning, based on the most modern transmitting techniques available to the electronics industry.

Automatic self seeking station tuning

At the touch of a button, the set automatically seeks the strongest signal in your area from the television station and tunes in perfectly to that frequency. The result is extremely stabilized reception.



The remote control with the interference free 'infra-red' eyes

Interference free 'infra-red' remote control

From the remote control hand-set you can control all of the advanced Luxor features from a comfortable viewing distance. On, off, sound, pause control, channel selection, colour, brilliance, volume, tone (both bass and treble) and automatic colour contrast. Plus instant on at any selected channel.



Luxor's Magic Box

Advanced 'modular circuitry' design

The Luxor 'modular circuitry' system combines hundreds of individual components into 14 sophisticated modules. The serviceman simply connects The Luxor Magic Box to the circuit and within seconds locates the module in doubt. He then simply replaces it.

Luxor sets include the necessary modules for instant use of your video cassette recorder and incorporate VHF/UHF frequencies.

Swedish quality at its best

The more you know about Luxor colour televisions, the more impressive they become

- from the compact 43cm (18") up to the range of 63cm (26") models.



The remarkable Luxor warranty

Luxor offer 3 years' protection on the tube. 1 year on all parts. 10 year parts availability. See your nearest Luxor retailer or send the coupon below:



To: Luxor, P.O. Box 205,
Glen Iris, Victoria, 3146.

LUX195

I would like to know more about the Luxor range of colour televisions, especially the new 'infra-red' remote control models.

Name _____

Address _____

_____ P/Code _____

Luxor, c/- 1396 Malvern Rd., Tooronga 3146.

News Digest



SINCLAIR STRIKES AGAIN

Last month in News Digest we mentioned the Sinclair Cambridge Programmable. Details have now come in and we can tell you a bit more about it. For those readers who recall the original Sinclair Programmable, this model is totally different. It is packaged in the time-proven Cambridge case, and offers a quite comprehensive range of facilities. The basic scientific functions include the usual trig. functions (yes, all of them), $\ln x$, $\exp x$, $1/x$, square and square root, and algebraic logic, with parentheses. But the real power of the machine lies in its 36-step program memory, which can be written into through the keyboard to store programs, and edited to correct them. The program memory is line-number oriented, which makes possible a GO TO instruction, as well as a GO IF NEG conditional jump. The calculator comes complete with 12 sample programs, and a program library of 294 programs is also available. At a US price of only \$29.95, it looks like Sinclair are on to a winner here!

D/A APPLICATION NOTE

Precision Monolithics, Inc., has published a new 8-page application "Differential and Multiplying Digital to Analog Converter Applications." All of these applications make use of the DAC-08, an 8-bit low cost monolithic DAC available from several manufacturers. A tutorial section on multiplying DAC basics is given including 2-quadrant, 4-quadrant and AC-coupled types followed by detailed circuit examples.

Differential, true 4-quadrant ratio-metric, and tracking type A/D converters are illustrated plus examples for nulling bridge transducers and for monitoring AC power faults. The application note, AN-19, ends with a list of 36 more potential applications covering A/D conversion, test systems, arithmetic operations, data control applications, and audio systems applications.

The new series of application notes are available from Cema Distributors, 21 Chandos Street, St. Leonards 2065, who stock the full range of PMI products.

CE-15 SPECTRUM MONITOR

The CE-15 Spectrum Monitor will help improve the efficiency of any radio workshop or laboratory and is designed to quickly provide an indication of proper radio performance on TX and RX. Not only do you see it, but you can hear it from the built in AM-FM receiver ($.4\mu$ V sensitivity) and internal speaker which tunes from 0-1000 MHz.



Level accuracy is ± 3 dB display range on a 7 x 10 cm CRT with four scan widths from 10 KHz div to 10 MHz divisions down to 2 MHz. Other features include LED frequency display and simplified controls for easier operation. The Cushman range of equipment is distributed in Australia by N.I.C. Instrument Company; their Head Office phone number in Melbourne is 338-3111 and for further details ask for extension 243 - Electronic Instruments. Telex 31157.

HOUSEHOLD PET

Commodore Business Machines Inc is about to start marketing an assembled microcomputer designed for small office and home use. The PET (Personal Electronic Transactor) Computer 2001 contains a MOS Technology 6502 microprocessor, 9 inch CRT, 73-key keyboard, cassette player, and 4K bytes of RAM plus 12K bytes of BASIC and operating system ROM. The VDU can display 25 lines of 40 characters selected from a standard 64-character ASCII set, and a BASIC interpreter will be available. CBM's marketing forte lies in offering facilities originally developed by more advanced manufacturers but at a much lower price, and this unit is no exception — it is tied together by the Hewlett-Packard Interface Bus so that plotters, printers and floppy disks, etc. may be utilised. The crunch comes with the price: US\$495.

**DRAKE**

C-Line Amateur Equipment

\$775.00

Drake R-4C

Solid State Linear permeability-tuned VFO with 1 kHz dial divisions. Gear driven dual circular dials. High mechanical, electrical and temperature stability.

Covers ham bands with crystals furnished. Covers all of 80, 40, 20 and 15 meters, and 28.5-29.0 MHz of 10 meters.

Covers 160 meters with accessory crystal. In addition to the ham bands, tunes any fifteen 500 kHz ranges between 1.5 and 30 MHz, 5.0 to 6.0 MHz not recommended. Can be used for MARS, WWV, CB, Marine and Shortwave broadcasts.

Superior selectivity: 2.4 kHz 8-pole filter provided in ssb positions. 8.0 kHz, 6 pole selectivity for a-m. Optional 8-pole filters of .25, .5, 1.5 and 6.0 kHz bandwidths available.

Tunable notch filter attenuates carriers within passband.

Smooth and precise passband tuning.

Transceive capability, may be used to transceive with the T-4X, T-4XB or T-4XC Transmitters. Illuminated dial shows which PTO is in use.

Usb, lsb, a-m and cw on all bands.

Agc with fast attack and two release times for ssb and a-m or fast release for break-in cw. Agc also may be switched off.

New high efficiency accessory noise blanker that operates in all modes.

Crystal lattice filter in first i-f prevents cross-modulation and desensitization due to strong adjacent channel signals.

Excellent overload and intermodulation characteristics.

25 kHz Calibrator permits working closer to band edges and segments.

Scratch resistant epoxy paint finish.

\$685.00

Drake T-4XC

Solid State Linear permeability-tuned VFO with 1 kHz dial divisions. Gear driven dual circular dials. High mechanical, electrical and temperature stability.

Covers ham bands with crystals furnished. Covers all of 80, 40, 20 and 15 meters, and 28.5-29.0 MHz of 10 meters.

Covers 160 meters with accessory crystal. Four 500 kHz ranges in addition to the ham bands plus one fixed-frequency range can be switch-selected from the front panel.

Two 8-pole crystal lattice filters for sideband selection.

Transceives with the R-4, R-4A, R-4B, R-4C and SPR-4 Receivers. Switch on the T-4XC selects frequency control by receiver or transmitter PTO or Independently. Illuminated dial shows which PTO is in use.

Usb, lsb, a-m and cw on all bands.

Controlled-carrier modulation for a-m is compatible with ssb linear amplifiers.

Automatic transmit-receive switching. Separate VOX time-delay adjustments for phone and cw. VOX gain is independent of microphone gain.

Choice of VOX or PTT. VOX can be disabled by front panel switch.

Adjustable pi network output.

Transmitting agc prevents flat-topping.

Meter reads relative output or plate current with switch on load control.

Built-in cw sidetone.

Spotting function for easy zero-beating.

Easily adaptable to RTTY, either fsk or afsk.

Compact size; rugged construction. Scratch resistant epoxy paint finish.

\$265.00

Drake SSR-1

- Synthesized
- General Coverage
- Low Cost
- Selectable Sidebands
- All Solid State
- Built-in Ac Power Supply
- Excellent Performance

The SSR-1 Receiver provides precision tuning over the short wave spectrum of 0.5 to 30 MHz with capability of reception of a-m (amplitude modulated), cw (continuous wave) and ssb (upper and lower single side band) signals.

A synthesized/drift-cancelling 1st mixer injection system giving thirty tunable ranges from 0.5 to 30 MHz is derived from a single 10 MHz crystal oscillator providing frequency stability necessary for ssb operation.

A stable low frequency VFO tunes each of the 30 one-MHz ranges with a dial accuracy of better than 5 kHz which is sufficient to locate and identify a station whose frequency is known.

Separate detectors (product and diode) are used to provide for best performance whether listening to ssb or a-m signals. Narrow band selectivity for ssb and wide band selectivity for a-m reception is provided.

A manual tuned preselector provides for maximum sensitivity and maximum interference rejection.

Solid state circuitry throughout allows efficient operation from built-in ac power supply, internal batteries or external 12 V-dc source.



To receive a **FREE Drake Full Line Catalog**, please send name and date of this publication to:

Drake TVI Filters

provide more than 40 dB attenuation at 52 MHz and lower. Protect the TV set from amateur transmitters 6-160 meters.



Drake TV-300-HP

For 300 ohm twin lead **\$13.00**



Drake TV-75-HP

For 75 ohm TV coaxial cable; TV type connectors installed **\$16.50**

Drake TV-3300-LP **\$32.00**



1000 watts max. below 30 MHz. Attenuation better than 80 dB above 41 MHz. Helps TV i-f interference, as well as TV front-end problems.

Drake TV-5200-LP **\$32.00**



200 watts to 52 MHz. Ideal for six meters. For operation below six meters, use TV-3300-LP or TV-42-LP.

Drake TV-42-LP **\$19.00**



is a four section filter designed with 43.2 MHz cut-off and extremely high attenuation in all TV channels for transmitters operating at 30 MHz and lower. Rated 100 watts input.

ELMEASCO**Instruments Pty. Ltd.**

P.O. Box 30 Concord, N.S.W., 2137, 736-2888
Melbourne: 233-4044; Adelaide: 42-6666;
Brisbane: 36-5061; Perth: 25-3144.

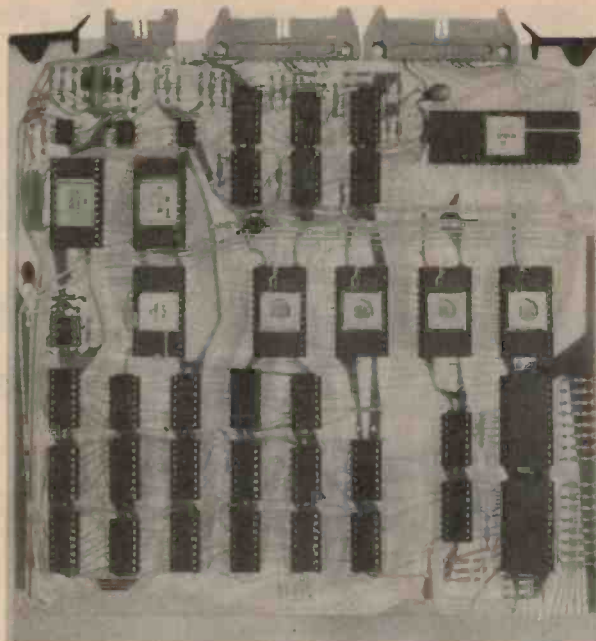

DUAL PROCESSOR MICRO

New from Fairlight Instruments Pty. Ltd. is the Quasar family of micro-processor products. The major feature of the system is the dual CPU board, which carries two 6800s both operating on the same bus, but using opposite phases of the clock so that both run

PHILIPS POST-GRAD OFFER

Each year Philips offer a number of scholarships to graduates of electrical engineering, physics or other related subjects, to study for a Master of Electronics Engineering at the Philips International Institute of Technological Studies in the Netherlands. The scholarships are for a period of one year beginning in January at a Philips manufacturing centre or research laboratory in Eindhoven. Course work involves lectures and experimental or design work in electronics and affiliated techniques. Financial assistance is offered and airfares to and from Europe will be paid by Philips. Applicants are drawn from all over the world but must be able to speak English and are normally under the age of 30. This is in line with Philips belief in assisting the younger talent to develop.

Applicants must possess a university degree or equivalent relevant to electronics engineering and illustrating a high level of achievement as only the very best will be chosen for this course. Applications close on September 1, 1977 and further information and application forms are available from Philips Research Manager in Australia, Dr. G. de V. Gippis at Philips Holdings Limited, P.O. Box 1138, North Sydney, N.S.W. 2060.

at full speed. This gives a major increase in throughput, and powerful debugging facilities. A wide range of software is available, as well as advanced hardware, including floppy disk controller and graphics devices. Fairlight Instruments Pty. Ltd., 15 Boundary St., Rushcutters Bay, NSW 2011.

MICRO COURSE

The Royal-Melbourne Institute of Technology, in conjunction with Technisearch Ltd., is holding a short course entitled "Using Microprocessors and Microcomputers", beginning on the 7th July. The lecturer is Dr. R.E. Hendtlass, of the RMIT Department of Applied Physics, and the course consists of seven two-hour lectures, an individual exercise and a workshop. The course material is slanted towards the professional engineer who will be engaged in developing systems and the fee of \$108.00 makes applications by interested amateurs unlikely. However, if you can get yourself sponsored by your employers, further information and enrolment forms may be obtained from: Mr. E.W. White, Manager, Continuing Education Unit, Technisearch Limited, RMIT, on (03)341-2532

DICK SMITH CLOSURES

Due to the annual stock-take, Dick Smith Stores will be closed for a day, but the days have been staggered so that there is always only one Sydney store closed and the other two are open. The days to miss are: Gore Hill store, Thursday 30 June; Bankstown, Friday 1st July; York St., Saturday 2nd; Melbourne and Brisbane branches, Thursday afternoon, 30th June.

QUADRAPHONIC CONFUSION

With the number of quadrasonic systems now available, and the amount of controversy over which is best, nobody is doing very well out of the situation. Of particular interest are the Nippon Columbia UD-4 system and the British NRDC's Ambisonic system. In view of the similarity between these systems, their principals have agreed to pool all patents and techniques into a system called 45J. Bear in mind though that UD4 and Ambisonics have not been heavily marketed so that when 45J is pushed into commercial production it will mean a fourth quad system to further the confusion.

Meanwhile, the BBC has put its considerable weight behind its own Matrix H system, and is already transmitting it, despite the fact that commercial decoders are not yet available. Where will it all end?

THE CASE FOR A DMM



Now available from Time Control Pty. Ltd. of 23 Warraba Road, North Narrabeen, NSW 2101, is this steel case which is ideal for containing that digital multimeter you've just finished building. It comes complete with a plain aluminium front panel and an aluminium handle is available as an extra. The cost is \$25 + p&p.

2-WAY TV

In Columbus, Ohio, Warner Cable Corp. are trying an experiment in viewer-response TV using a simple calculator-type keyboard which is polled by a computer located at the cable TV company's offices. The 30 channel service offers games, educational materials, and local programs that allow the subscribers to vote. Previous attempts at two-way TV have failed because of the economics of providing complex keyboards, but the simplified keyboard used in this scheme is much cheaper, and is made in Japan by Pioneer using a custom LSI chip.

How to crack a highly paid job as an electronics technician.



We'll give you excellent training - as good as you'll get anywhere in Australia.

We'll give you free medical, dental and hospital treatment.

We'll provide plenty of good tucker and a comfortable place to stay.

We'll give you substantial leave, and on top of all that, we'll pay you well while you're training.

On your side, you'll give us a period of hard, but interesting and rewarding work. And, when eventually you leave us, you'll find yourself a fully qualified Electronics Technician. Not a bad thing to be, these days.

So, if electronics is your idea of a great career and you are (at time of entry) approx. 15 to 17 for apprenticeship and over 17 for an Adult Trainee,

join the Navy, Army or Air Force.

Phone us at:

Adelaide 223 2891. Brisbane 226 2626.

Canberra (Navy) 65 3318.

Canberra (Army or Air Force) 47 6530.

Hobart 34 7077. Melbourne 61 3731.

Perth 22 4355. Sydney 212 1011.

Write to either the Navy, Army or Air Force Electronics Technician Counsellor, GPO Box XYZ in your nearest State Capital City

(please include your date of birth).

Learn Electronics with us.





IN-FLIGHT ENTERTAINMENT?

In order to show that their self-converging tube will stand up to the knocking and jarring that can occur in a household through cleaning or by children, EMI (Australia) Ltd took up a 48cm HMV set under the wing of a plane. This particular escapade is one of a series of TV adverts in which HMV sets are exposed to the rigours of various rough environments.

PULSE GENERATOR

A new, universal pulse generator, purpose-designed for use in most CMOS, TTL, other HNIL and in analog applications, has been added to the Philips Test & Measuring Instruments range. Fundamental design policy of the PM5716 has been concentrated on simplicity of operation and comprehensive circuit protection. All controls function independently and do not interact with others, allowing a "once-only" setting per operation.

Other features include a powerful 20V max. pulse amplitude and a wide range of transition times, continuously variable between 6ns and 100ms. This wide dynamic range is more than adequate for today's CMOS logic and with a 50MHz repetition rate, able to cope with any faster logic that may become available. It allows PM 5716 to be used not only with CMOS, TTL, RTL, DTL but also with analog devices such as operational amplifiers, etc.

The PM 5716 is available for immediate delivery from Philips Scientific & Industrial Equipment - Test & Measuring Instruments Department.

16K NOW IN VK

Mostek's TTL-compatible 16K dynamic RAM is now available on the Australian market from stock at Total Electronics. The new memory (MK4116P) is fabricated using Mostek's "poly 11" process, with a double level silicon gate process with ion implant, resulting says the company, in a 16K memory with performance equal to the fastest 4K device currently available.

Chip size of the MK4116P measures 122mm by 227mm, which is believed to be one of the smallest 16K memories in the industry, and putting it at less than twice the area of most 4K parts.

The memory uses the multiplexed address approach pioneered with Mostek's 16-pin MK4096 part. By replacing CS by A6, and using RAS or CAS to select the chip, the device can replace a 16-pin 4K part pin for pin, so allowing upgrades of systems using MK4096 and MK4027, with minimal artwork changes. Advanced circuit design techniques, used in the 4K MK4027 part, yield 16K parts with 150nS access times, while still having non-critical clock timing. The part can be operated with a 250nS cycle time if the system design calls for it. Considerable attention has been paid to noise-margin considerations, and the part has been designed to operate with plus or minus 10 per cent tolerance on all power supplies. Logic zero input level is specified at 0.8 volts, giving comfortable margins when using Schottky TTL.

For further information contact: Total Electronics, 239 Bay Street, 3186.

AILING OSCAR

Apparently, one of the NiCad cells in the Oscar 6 satellite is playing up and may fail completely. This means that it is imperative that all users comply strictly with the operating schedules, in order to keep that battery going.

FRENCH FOR ATA

The Australian Telecommunications Administration has signed a letter of intent with the Societe d'Applications Generale d'Electricite et Mecanique for the supply of 4,000 teleprinters over the next ten years. This ousts a previous agreement with Siemens.

CALCULATOR CONTEST

The winner of the April ETI/Unitrex Calculator Competition was Mr. M.G. Wagner of Para Hills, South Australia. His winning entry read as follows:

82526

19722

104

102352

For June the problem is:

While travelling in the outback a statistician's car ran out of petrol. After walking for some miles he came across a farmhouse.

When he asked for a gallon of petrol to get him to the nearest petrol station, the farmer refused him, but being a sporting type, offered the statistician the chance to win a couple of gallons. His rules for the bet were like this:

I've got two hats here, and I'm sure you've got ten one-dollar bills and ten two-dollar bills in your wallet. I'll let you split these, any way you want, between the two hats, I'll give them a shake, and then if you pick out a two-dollar bill, the petrol is yours. If not, then I keep the money. Go on, put the bills in the hats.'

Well, the statistician thought about it and figured out the best way to split the bills between the hats. Sure enough, he won the petrol, but he was in so much of a hurry to be gone that he forgot the money!

The question is, how did he arrange the money in the two hats, i.e. what is the arrangement that maximises the probability of drawing a \$2 from 10 x \$1 and 10 x \$2? And secondly, what is that probability?

Send your answer on the back of an envelope, (don't forget your name and address), to ETI/Unitrex Competition (June), ETI Magazine, 15 Boundary Street, Rushcutter's Bay, NSW 2011. Closing date is 15th July 1977.

10^W/CH STEREO AMP \$27

Features:— VOL. BASS, TREBLE, PRESENCE Controls, H'phone, tape skts & slumber, loudness, rumble, scratch switches, all assembled on expensive looking blk. anodised panel. Dual STC TA-108 hybrid power amplifiers give max. 15w/ch in 8-15 ohms, 32v. supply. Ceramic cart. input. Transformer extra \$6.50. Qty. 200.

SWR METER

June only special, SWR 300 normally \$19, while stocks last at \$14.00.



MAGNETIC MTG, WHIP ANTENNA

June only special, CA-70 normally \$15.75, while stocks last at \$12

NEW DIGITAL CLOCKS



MA-1002, 12 HR or 24HR, \$12. Transformer to suit \$6. MA-1010, 12HR \$17. Same as MA-1002 but large display.
MA-1003, 12HR CAR CLOCK
12V DC operation, includes xtal add only 3 switches, as in E.A. May issue, \$27.50.
Digital clocks post free

RELAY-MANIA

Over 12,000 to be cleared at bargain prices.

BIG DISCOUNTS FOR QUANTITY BUYERS.

QTY	1-9	10-24	25-99	100+
CBA 4% 10 AMP CONTACTS — Solder Terminals				
6,12,24,50V	AC	2-50	2-00	1-80
115,220,380V	AC	2-65	2-12	1-90
6,12,24V	DC	2-50	2-00	1-80
48,110V	DC	2-65	2-12	1-90
220V	DC	3-05	2-44	2-20
CBZ 4% 10 AMP CONTACTS — Plug-In				
220V	AC	2-65	2-12	1-90
Socket for above	2-70	2-16	1-94	1-80
CF 4% 10 AMP CONTACTS — P.C. Terminals				
220V	AC	2-65	2-12	1-90
12,24V	DC	2-50	2-00	1-80
K.G. OPEN TYPE RELAYS				
12V	DC5A	1-86	1-48	1-33
12V DC 10A		2-00	1-60	1-44
KP PLUG-IN 8 PIN (2%) AND 11 PIN (3%) 10 AMP CONTACTS				
24V	AC 8P	2-30	1-84	1-65
220V	AC 8P	2-45	1-96	1-76
380V	AC 8P	2-80	2-24	2-01
220V	AC 11P	2-80	2-24	2-01
380V	AC 11P	3-10	2-48	2-23
12,24,110V	DC 8P	2-30	1-84	1-65
12,24V	DC 11P	2-60	2-08	1-87
110V	DC 11P	2-76	2-20	1-98
TP 3 c/o 25A CONTACTS — SPAOE TERMINALS				
12,24,50V	AC	2-75	2-20	1-98
115,220V	AC	3-00	2-40	2-16
380V	AC	3-15	2-52	2-26
12,24,48V	DC	2-75	2-20	1-98
110,220V	DC	3-00	2-40	2-16

JUMBO BAGS \$3ea.

- 400 1/4W Asst. Resistors
- 500 1/4W " "
- 300 1W " "
- 100 Asst. Semiconductors
- 100 Asst. Poly Caps 160-630V
- 150 Asst. various caps
- 60 Asst. Electrolytics

BONANZA JACKPOTS
For experimenters and constructors, a large assortment of new, high quality parts — samples, specalts, end-of-line components incl. semiconductors.

JACKPOT No. 1
A 500gm (approx) Lucky-dip offer, all useable parts. Up to \$25 worth for only \$5.

JACKPOT No. 2
A 2Kgm (approx) assortment in a 315 x 270 x 160mm box includes relays, edge connectors, pots, switches, semis and many others too numerous to mention ONLY \$10.

3W AMP & TUNER-AMP



LAST FEW
Big sound with great features: vol, bass, treble controls, headphones & tape (5P din) sockets, slumber switch, LM 377 IC, complete incl. transformer, etc. The tuner incorporates an AM broadcast tuner. Both amps are Aust. made and ready-assembled. Suit extras as per 10W amp above. Matching speaker boxes with 2 way speakers PR \$48

3W stereo amp boards
Available with rotary or slider controls — dual LM380's, 12-18V supply, VOL, BASS, TREBLE, approx 200mV input. With rotary controls \$7.00 With slider controls \$8.00 240V Transformer, extra \$4.50



VORTEX VORTEX Stereo Cassette Deck mechanism with tape eject facility and resettable counter. Easily operated by 5 push-button (piano key) controls, & includes high quality "ALPS" recording/play back head & erase head. Tape speed 4.75cm/sec.
\$29
Record/Playback kit \$27. Transformer \$11.50

VORTEX SPARE PARTS
REC/PLAY HEAD \$9.50, DRIVE BELT COUNTER \$3.50, COUNTER BELT \$2.25, MOTOR 100V only \$7.50, \$1.90, ERASE HEAD \$2.20, MICRO-CAPSTAN \$2.50, TAKE-UP SPOOL SWITCH \$1.25, REWIND SPOOL \$1.75 \$1.50, PINCH ROLLER \$1.20, TAPE CLUTCH (White) \$1.40

CB RADIO POWERMATE

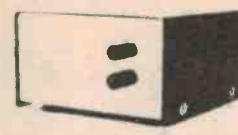

E.A. January Issue 240V input, 13.6V DC output at 1.5A. Complete kit to power your CB radio at home.
Kit \$16.50
New 2.5AMP model available
For those larger SSB sets, etc.
\$21.50

ROYCE 23 CH AM/FM/CB \$179



De-luxe model, AM/FM stereo radio combined with a CB transceiver for in-dash mtg. Includes squelch, ANL, S/R/FD meter, local/distant switch. "Gyro-Lock" circuit eliminates need for delta-tune, as receiver locks on centre channel of any signal.

SSB RIGS



GEMTRONICS 12W PEP.
AM or SSB, 23 Ch, freq. synthesized operation, dual conversion on AM, 25W PEP input, 12W PEP RF output on SSB, 4W RF output on AM. Controls — SQUELCH, FINE TUNE, LSB-AM-USB, NB, PA, RF ATT, large S/PWR meter, 3months guarantee.
\$229

CB ACCESSORIES

Trade prices available on application on official letterhead.
Plugs, Connectors and Cables.

Part No.	Description	Price
PL-259	HF Co-Axial Plug	\$1.20
PLA-1	Adaptor for PL-259 plug, for RG58/U cable	.28
PLA-2	Adaptor for PL-259 plug, for RG59/U cable	.28
PLA-3	Adaptor for PL-259 plug, for 75 ohm cable	.31
PLA-4	Adaptor for PL-259 plug, for 75 ohm cable	.31
SO-239	Panel Socket with flange, suit PL-259	\$1.25
SO-239/A	Panel Socket without flange, suit PL-259	.98
PL-258	Cable joiner, double female, suit PL-259	\$1.25
M-258	Cable joiner, double male, suit SO-239	\$1.65
M-358	Cable joiner, "T" Connector (Double female and male)	\$3.90
L-258	Lightning Filter and Arrestor (PL-259 plug to SO-239 socket)	\$4.75
D-258	Dummy Load with indicator lamp for transmitter power of 5 watts, 50 ohms impedance, PL-259 plug.	\$3.00
PC-258	1 metre Cable Assembly — RG 58/V cable with PL-259 plug each end — suit SWR and other test meters etc.	\$4.30
MP-4	CB 4 pin microphone plug	\$1.50
CC-2	Mic Cable-3 conductor, single shield curly-cord, colour black	\$1.75
RG-58/V	Cable, 52 ohm low loss, black-per metre or per 100 metres	.45 \$28.50
Accessories		
Part No	Description	Price
DM-95	Omn-Directional Hand-held Dynamic Microphone — with 2M curly-cord Imp: 500 ohms, Freq. Resp: 20Hz-10KHz. Sensitivity — 70dB	\$6.35
K-815	Extension Speaker, 8 ohms 5 watts, with mounting brackets and ON-OFF	\$13.50
MH-40	Microphone Holding Clip — magnetic mounting to car dash etc.	.75
MH-25	Microphone Holding Clip — with 2 self-tapping screws	.75
HL-1	"Hot-Line" Filter-reduces ignition interference — comprises choke and capacitor insert in 12V pos. lead	\$3.10
SWR-300	In-Line SWR and Field Strength Meter Measures forward & reflected power by bridge method, SWR 1:1 to 1:3 Imp: 52 ohms, Accuracy 5%, indicates transmitter power output strength A-101	\$19.00
Floor Mounting Kit	— clamps around centre hump on the floor, fully adjustable, suits most cars.	\$6.95
CB Antennae		
CA-60	AM/FM/CB Lock-Down-Centre-loaded with splitter cables and plugs, one for CB, one for AM/FM	\$32.00
CA-70	Magnetic Mount Whip — Centre-loaded coil with 3m. cable & PL-259 plug, heavy ceramic mounting, no installation required	\$15.75
CB-100	Roof or Boot Mount Whip — Centre-loaded coil, mount base for roof mount (hole) or boot mount (clamps to edge of boot lid) with cable & plug	\$19.95
CB-125	5ft Helical Whip Antennae-stagger wound, best performer, SWR down to 1:1:1 when tuned, with base	\$22.00
	12ft lead & PL-259 plug to suit, extra	\$3.00
CB-200	Base Station Ground Plane-ring-rod radiator, 19ft long, high efficiency vertically polarized, omni-directional, aluminium construction in 4 sections, accepts PL-259 plug	\$67.00

Electronic Agencies

Trading Hours — 12.00 — 6 pm Mon-Fri. 8.30 — 1 pm Sat.
Mail Orders — P.O. Box 1005 Burwood North 2134.
Post & Pack — Add 15 per cent up to \$25 order value. 10 per cent over.
Minimum Order Value — \$5.00 C.O.D.'s send \$3.00 pre-paid
Prices & Availability — as at 20/4/77

115-117 Parramatta Road, CONCORD, N.S.W. Telephone (02) 747 6472

Write your Name, Address, P/Code here and send your order to P.O. Box 1005, Burwood Nth. 2134.

Electronics Today International

4600 and 3600 SYNTHESIZERS



Complete plans for the Electronics Today International 4600 Synthesizer and the 3600 Synthesizer will soon be available in book form. Many hundreds of these remarkable synthesizers have been built since the series of construction articles started in the October 1973 issue of Electronics Today.

Now the articles have been re-printed in a completely corrected and up-dated form.

The International Synthesizers have gained a reputation as being among the most flexible and ver-

satile of electronic instruments available.

They have been built by recording studios, professional musicians, university music departments and as hobby projects.

This book will be on sale in mid-January as a limited edition of 2000 copies only.

Ensure your copy now!

Ensure your copy now. Send \$12.50 to Electronics Today, 15 Boundary Street, Rushcutters Bay, 2011.

AT LAST! A TRUE

RADIO DIRECTION FINDER

UNDER \$250 — DESIGNED FOR AUSTRALIA

An emergency navigation necessity for all boats, aircraft and 4WD's.



Covers the following AUSTRALIAN bands (not the useless overseas ones):

- * AM (Broadcast) Band
530 — 1600kHz
- * FM (Music) Band
88 — 108MHz
- * CB & Marine 27MHz Band
26.8 — 27.92MHz
- * LW (Beacons, etc) Band
150 — 400kHz
- * VHF (Aircraft etc) Band
108 — 174MHz

Note: This is a true R-D-F; NOT an 'adapted' portable receiver



FREE

With every Radio Direction Finder we give you FREE, a listing of all long wave beacons, etc, plus the standard AM broadcast stations - all you need to know for accurate, reliable direction finding.

RADIO SENSATION!

ONLY

\$125

Cat. D-2820

HANS THOLSTRUP USED THE R.D.F. TO CROSS BASS & TORRES STRAIGHTS.

He says:

"I found the DICK SMITH DIRECTION FINDER worked very well even when over 100 miles from the station. The good bearings on both Tasmanian and Victorian radio stations made navigation extremely simple."

You're miles from anywhere and your boat or plane battery supply fails. What would you do? With a Radio Direction Finder/Multiband Receiver from Dick Smith, you could get yourself out of trouble. It is able to obtain extremely sharp station nulls on any broadcast band station or any marine beacon (LW) that you can hear. You can use the station to home on or can use two stations for an extremely accurate position fix. What could be simpler?

But it's not only a Radio Direction Finder! You can listen to the FM stations for relaxing, good music — or to the CB channels, or the walkie talkie, marine or fishing/boating club frequencies, or to the aircraft bands, amateur operators, taxis, etc etc. What a fantastic, versatile little receiver.

For the technically minded, this unit has 19 transistors, 12 diodes and has 3 separate RF front ends! There are also 2 separate IFs (10.7MHz & 455kHz) and the CB band has dual conversion. It operates off internal batteries (4 x 'C' cells) or off external 6 volt power. It has controls for RF gain, tone and AFC as well as the usual volume and band switches. This unit is designed and built in Japan to Australian specifications (not some back-yard operation in Hong Kong as many 'rubbishy' units).

Don't be fooled by other units you may see around — this has been designed from the ground up as a radio direction finder. It is in no way an 'adapted' portable receiver. The extra bands were added to the DF as extra value.



DICK SMITH ELECTRONICS GROUP

MAIL ORDERS: P.O. Box 747, Crows Nest, N.S.W. 2065.

N.S.W. BRANCHES:

Gore Hill — 162 Pacific Hwy. Ph. 439 5311

Sydney — 125 York St, Ph. 29 1126

Bankstown — 361 Hume Hwy. Ph. 709 6600

INTERSTATE BRANCHES:

QLD. — 166 Logan Rd, Buranda. Ph. 391 6233

VIC — 656 Bridge Rd, Richmond. Ph. 42 1614

DEALERS ACROSS

AUST. PHONE

(02) 439-5311 FOR

THE DEALER

NEAREST YOU!

LOOK OUT FOR DICK'S GREAT NEW CATALOGUE IN ELECTRONICS AUSTRALIA MAY ISSUE

PINE GAP

-HOW SECRET?

What is the function of this isolated base in the centre of Australia?

'STORIES FED TO THE AUSTRALIAN PUBLIC over the last ten years — about the nature of these bases — has been deliberately misleading' — so reported the British publication 'Electronics Weekly'.

Another part of this report stated *'the function of one key base, Pine Gap, near Alice Springs, has changed from an inactive to an active role . . .'* and continued, *'Pine Gap's role has changed from that of a computing and relay centre to detect and interpret missile and rocket firings (within and from China), to that of an active response system updating target information from ICBM-monitoring satellites and passing this data, via the US Navy's VLF radio station at North West Cape, to Poseidon missile submarines operating in the Indian Ocean'*. The report also suggested that it was possible that the Pine Gap system *'provided course correction for Poseidon missiles during trajectory'*.

Once again these bases are in the news — this time because of allegations made during a trial, in the USA, of a

man charged with espionage. Amongst a number of allegations was one that the CIA had deliberately misled the Australian government about the bases' true functions.

Whether or not this allegation is true it is a fact that within Australia neither the previous Liberal government, the subsequent Labor government, nor the present government will make any official statement concerning the bases' purpose.

One of the main election pledges of the Whitlam government was to disclose information about the bases. That pledge was broken. In 1973 Mr Whitlam stated that he was unable to make good that pledge, *'they are not Australian secrets'*, he said, *'I know now why the Americans don't want those secrets revealed. But I accept that they (the bases) are not parts of weapons systems and cannot be used to make war on any country. You can believe us or not — I will tell you that and I will tell you no more.'*

PINE GAP -HOW SECRET?

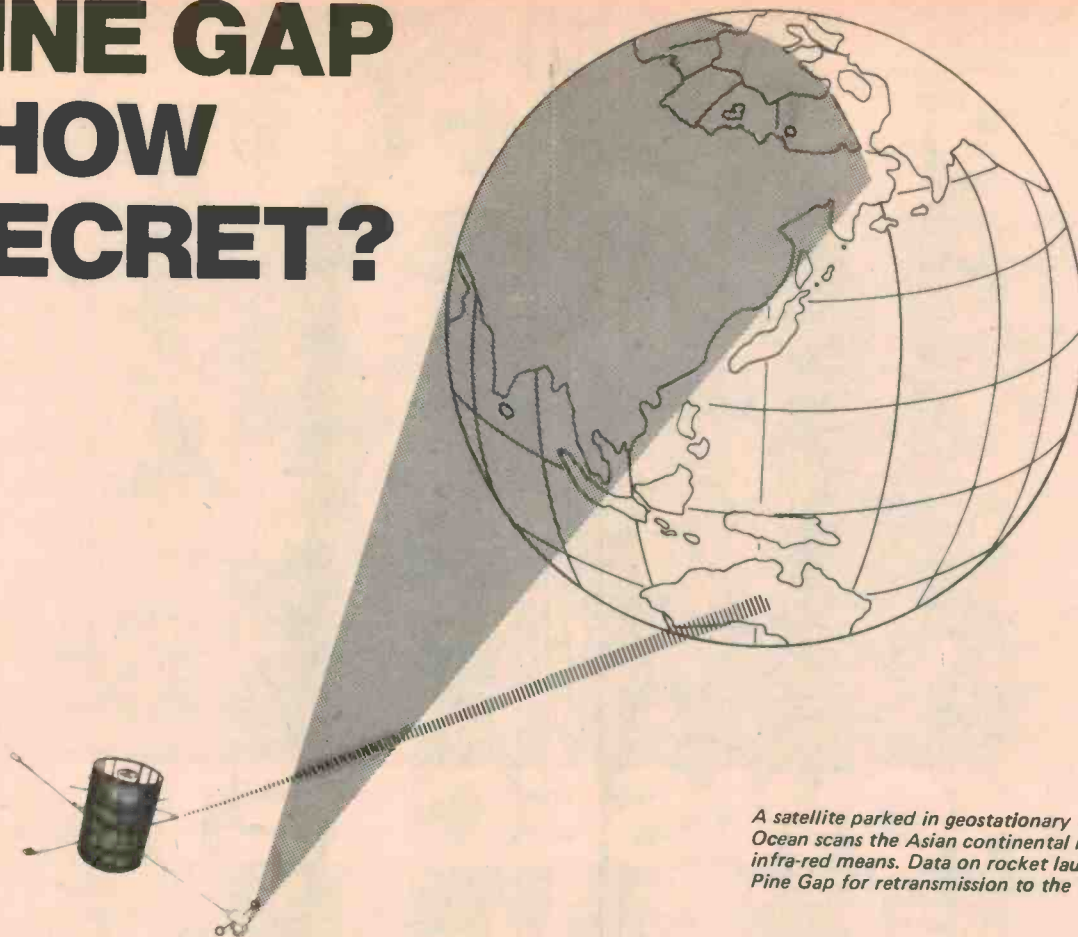

A satellite parked in geostationary orbit over the Indian Ocean scans the Asian continental mass by both visual and infra-red means. Data on rocket launchings is relayed to Pine Gap for retransmission to the USA.

Incredibly, on March 26th, 1973, Whitlam admitted that neither he nor his government knew of the purpose of the North West Cape facility. *'We don't know about this facility's operations but we are determined to find out'*.

WHY THE SECRECY?

Australian governments — both Labor and Liberal — have a penchant for not informing the population about matters such as these — or as in the early days of the OMEGA controversy — deliberately misrepresenting facts.

This is not the time nor place to resurrect the OMEGA controversy, but we would remind readers that we published a full report on that system and its uses in June 1971. This report was subsequently proven correct in all major details despite strong government denials at the time. Then, the McMahon government stated *'the OMEGA system is solely a civil navigation aid ... it has no military function whatever'*. Yet at that very time the promotional material which was freely available from the US Navy's OMEGA Project Office stated in part *'OMEGA is the only navigational method that is as well-suited for submarines as for aircraft or surface vessels. Its low frequencies penetrate seawater to appreciable depths. They also travel through sea ice. Thus a completely submerged submarine may be guided by OMEGA through any seas ... Only reception is required, so the submarine user does not reveal his position ...'* That quotation came from the Booklet *'OMEGA a Worldwide General Purpose Navigational System for Air, Surface and Sub-surface'*. It was an official document of the US Navy and was freely available outside Australia virtually

for the asking. (We obtained a copy simply by writing and asking for it via our London office). Yet for years successive Australian governments blatantly lied about OMEGA's military implications despite the USA's not only open admission of its uses for submarine guidance — but actual promotion of the system for that purpose!

Unlike OMEGA, information about Pine Gap, Nurrungar and North West Cape is not so freely available. Nevertheless a very great deal of material has been published — once again though, outside this country.

The main sources are the Swiss publications *'International Defense Review'* and *'Interavia'*, and the American publication *'Aviation Week and Space Technology'*. A further and very reliable, albeit rather surprising, source of information is India's *'Monthly Bulletin on Science and Technology'* which is published by the Indian Institute for Defence Studies.

No one publication claims to have definitive details of any specific Australian base — but by piecing together various data it is possible to build up a fairly accurate picture of what these bases are probably about. We must however stress that our report is based on a mixture of known facts from official sources, probable facts from authoritative but non-official sources and a small amount of conjecture.

PINE GAP

The main role of Pine Gap is to provide early warning of possible ICBM launchings against the USA (and other targets) from the USSR. It is virtually certain that this is so.

The concept of such a system began in 1957 when it became increasingly obvious to US defence planners that

conventional radar systems would not provide sufficient warning of an ICBM attack. It was therefore deemed essential to develop a method of detecting ICBMs immediately after launching.

Initially the proposed method was to use satellites equipped with infra-red sensors. These would hopefully detect the radiation from the ICBMs' rocket exhaust. This project was not totally successful for as with similar experiments elsewhere it was found that Murphy's Law being what it is infra-red sensors tend to lock onto anything warm except the target itself. ETI's publisher recalls working on an early de Havilland missile sensing head which had the engaging habit of locking onto the local Chinese laundry! The US project described above was code-named 'Midas' — perhaps more appropriately than had been intended considering the fate dealt out to Midas by Tmolus — a pair of asses' ears — in place of his own.

The Midas concept was subsequently expanded to take in visual as well as infra-red sensing and a successfully working (experimental) satellite was launched from the USA's Vandenberg Air Force Base late in 1968.

The first satellite was subsequently shifted in orbit to enable it to observe USSR ICBM sites (and experimental launchings) in the vicinity of Tyuratam. A second, similar, satellite was launched in 1970 and a third put into geosynchronous orbit on May 6th 1971. These are facts and readily checkable. In 1962 the USA and USSR mutually agreed to report all satellite launchings to the United Nations. Launch details include a brief description of purpose and initial orbital characteristics. These details are published at frequent intervals.

The ex-Midas early-warning satellite system is now code-named Project 647 and the purpose of the Pine Gap base is to receive coded digital data, related to possible USSR missile launchings, from the 647 satellite (now parked in geostationary orbit 35,400 km above the Indian ocean) and instantaneously to retransmit this data to the North American Air Force Command, the Strategic Air Command etc.

Reports back in 1973 indicated that Pine Gap's role had been extended to enable it to transmit data received from the 647 satellite directly to Poseidon-equipped submarines via the VLF facility at North West Cape.

It was further suggested that such facilities would be used on-line so as to update course directions for US Poseidon missiles. The latter part of this report is probably incorrect, because, unless the guidance philosophies have changed neither American nor Soviet ICBMs can be re-programmed once launched — thus preventing deflection by opposing guidance systems.

It has also been suggested that the Pine Gap installation controls laser-equipped satellites whose role is to 'knock-out' the guidance system of ICBMs — again this is improbable at present. As far as can be ascertained the laser technology to do this is not yet available although it is most certainly being developed.

NURRUNGAR

The Nurrungar 'joint defence space station' is situated about 25 km south of Woomera in South Australia. Unlike Pine Gap, Nurrungar is run directly by the US Air Force. It is believed to complement the role of Pine Gap in receiving and retransmitting data from the 647 satellite. The International Defense Review reports *'Digital data is flashed in real-time (from the 647) to a ground computer complex in Australia . . . from tracking information coupled with data in the computer memory pertaining to exactly which missiles are launched from where, the computer predicts the target and in turn flashes this warning*

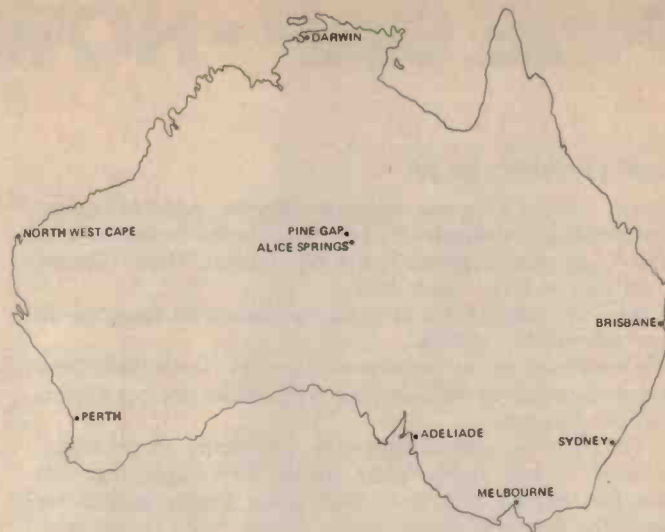

Vast spaces and Australia's position relative to Russia and China make it a natural for stations like Pine Gap and North West Cape.

to the US mainland via a synchronous orbiting satellite known as Program 313.'

A second probable function of the Nurrungar base is to monitor and receive coded data from the USA's many 'search-and-find' satellites. The USA have a number of these satellites constantly circling the globe from an altitude of about 160 km. These satellites carry cameras having resolution of sufficient adequacy to detect the general characteristics of major installations — particularly of new installations or installations undergoing major changes.

Exposed film is processed on board the satellite. The resultant pictures are initially scanned on board and then transmitted in 'rough' form to the receiving bases/s. The material is then physically sent down to Earth by an ejection/parachute technique and recovered by US Airforce C130 aircraft operating off the Hawaiian group of islands. These pictures are finally scanned and transmitted in digital form via communication satellite links to the National Photographic Interpretation Centre in Washington.

BIG BIRD

The 'crude' reconnaissance satellites are backed up by a more sophisticated satellite system code-named 'Big Bird'. Big Bird is a combined 'search-and-find' cum close-up satellite. It's big as satellites go. About 10 000 kg and 20 or so metres long. It is believed to be capable of resolving objects less than one metre across from its orbital altitude which varies from 160 km to approx 275 km.

Big Bird's role appears to be to act as a back-up to routine reconnaissance missions. As far as we can gather the photographic system processes films on-board, and these are then scanned, photo-electrically digitized, and transmitted by UHF radio link to a number of stations of which Nurrunga is one. The received data is then re-transmitted to the USA. Stations which appear to be similar to Nurrunga exist in the Seychelles, on Kodiak Island (Alaska), again at Guam, in New Boston, in Tanganyika and in Oahu in Hawaii, (the writer was recently in Oahu and as far as could be ascertained from a distant view the installation bears a remarkable resemblance to that at Nurrunga).

PINE GAP - HOW SECRET?

NORTH WEST CAPE

This is a fairly easy one. There's only two possible reasons for a military authority to use frequencies below 14 kHz (the 'Cape uses frequencies around 10 kHz). That's because

- (a) they're very hard to jam
- (b) Only frequencies this low can penetrate sea-water to any appreciable depth.

The existence of an installation such as North West Cape and knowledge of its operating frequencies are not secrets that can be kept.

To transmit such frequencies one needs an enormous antenna - and that's what North West Cape has. It's just too big to hide and thus being totally visible the operating frequencies can easily be calculated - and measured with equal ease.

North West Cape's function is to enable US agencies to communicate with submerged submarines. This is not a matter of conjecture - it's virtually one of physics. The attenuation of sea-water is approximately 3.0 dB/metre at 11 kHz compared with 45 dB/metre at 2.0 MHz. Verbum Sapienti.

THE IMPLICATIONS

We have in this article presented what we believe is a realistic assessment of what Australia's 'secret' bases are about. We are not for a moment suggesting that this account is definitive - but it is probably correct in outline if not in absolute detail. It is quite possible that some of the functions we have assigned to Nurrunga are true of Pine Gap and vice-versa. But as far as we can ascertain from careful study and subsequent assembly of data from sources of known authority - the totality of this report is substantially correct.

One must ask whether or not the presence of these bases makes localized parts of Australia a nuclear target.

Our opinion is that this would not necessarily be so, for a pre-emptive strike against these bases must necessarily give the USA advance notice of what is to follow. It is far more probable that any pre-emptive strike would be against the 647 satellite itself - for at present there does not appear to be a back-up system. One would have to decide whether there has been an attack - or just an equipment failure. Hopefully it would be the latter.

Those then are the probable facts as we see them. We think the overall picture is basically correct. No doubt one day we'll be told.

EDUCAL

THE KIT SPECIALISTS

No. 1 IN PRICE WHERE IT REALLY COUNTS

AM-FM STEREO TUNER KIT



\$89

FEATURES

- PRE-ALIGNED FM MODULES (3)
- MONO/STEREO
- LOCALLY PRODUCED - NOT IMPORTED
- 4 PRE-SET STATIONS ON FM
- FULL RANGE MANUAL TUNING AM-FM
- 75 or 300Ω INPUT
- A.F.C.
- STEREO BEACON
- PROFESSIONAL FINISH

SPECIFICATIONS

TUNING 88-108MHz
 BANDWIDTH 300kHz
 I.F. 10.7MHz
 I.F. REJECTION 65dB
 IMAGE SUPPRESSION 40dB
 A.M. REJECTION 40dB
 CHANNEL SEPARATION 38dB (min.)
 DIMENSIONS 13.75" x 10.5" x 4.25"

P.&P.
\$2.50

NOTE ALL KITS EX STOCK SENT RETURN MAIL.
 MAIL ORDERS BOX No.182, CARLTON SOUTH, VIC. 3053.

SPECIAL

CDI KIT

(12v Ne. earth)

CAPACITOR
 DISCHARGE
 IGNITION

FULL KIT FULL CDI

- Less points wear
- Less plug wear
- Better starting
- More m.p.g.

\$22.50

STEREO-AMP KIT

30 WATTS/CHANNEL RMS • FREQUENCY RESPONSE 8Hz-30kHz • (3dB down) 20Hz-20kHz (FLAT) • DISTORTION 0.1% INTO 8Ω • FULL BASS & TREBLE CONTROLS • LOUDNESS CONTROL • DIN SOCKET PHONES SOCKET • TEAK VENEER CASE • MAG. CARTRIDGE INPUT • AUX. INPUT TAPE INPUT

\$79

OR EDUCAL, 21 WELLS AVENUE,
 BORONIA, VIC. 3155 (Tel. 762 5713).

QUALITY COMMUNICATIONS GEAR

When you buy from VICOM you get only quality gear sold and serviced by the experts. All transceivers are given a thorough pre-delivery checkout supported by technical expertise and well equipped workshops. A wide range of spare parts is available and all new gear carries a 90 day warranty.

SWR & POWER METER

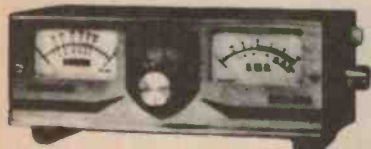

PROFESSIONAL SWR/PWR METER
The new Oskerblock SWR-200B Deluxe is a professional swr bridge using the thru-line principle, covers 3-200MHz, 52/75 ohms. Each unit is individually calibrated. Four power ranges, 2/20/200/2000 watts. \$79 + P&P

New standard model

\$59



\$36

Popular VC2 swr/pwr meter operates 3-150 MHz with power measurement 12/120 watts. Will handle up to 1000 watts. 50 ohms impedance, twin meters. A bargain!



\$269

**SYNTHESISED!
NO CRYSTALS
IC22S**



The new IC22S transceiver is a PLL synthesised rig with programmable ROM for any frequency multiple of 25 KHz from 144 to 148 MHz. Simplex, duplex or reverse achieved by a flick of a switch on the front panel. This fabulous new rig features ceramic discriminator, IDC, electronic Tx/Rx relay, full swr protection and VICOM 90 day warranty. Circuitry includes 34 transistors, 7 FETs, 13 ICs and up to 128 diodes. Receiver sensitivity better than 0.4 uV for 20 dB quieting. Your new IC22S comes complete with mic, mobile mounting bracket, plugs, cables, spare diodes for programmable matrix and English Instruction Manual.

IC215 HANDY FM PORTABLE

This is ICOM's first FM portable, and it puts good times on the go. Change vehicles, walk through the park, climb a hill, the ICOM quality FM communications go right along with you. Long lasting internal batteries make portable FM really portable, while accessible features make conversion to external power fast and easy!

- Fully collapsible antenna
- 15 channels (12 on dial + 3 priority)
- Dual power 3 watts/40 mW
- Lighted dial and meter
- Crystals same as IC22 series

\$199

Your new IC215 comes complete with 3 popular channels, mic, shoulder strap, connectors, batteries, English Manual and VICOM 90 day warranty.

QUALITY HANDY PORTABLES

IC202 \$219 IC502 \$219

The famous IC202 handy portable runs 3 watts pep with VXO control 144-146 MHz. Features noise blanker, RIT, lighted dial and meter, telescopic antenna and of course that ICOM quality! Comes complete with mic, carrystrap, dry cells, English manual and 90 day warranty.

Six metres SSB using the IC502 can be great fun! This handy portable runs 3 watts pep sb 52.53 MHz. Featuring VFO control, switchable noise blanker, RIT and provision for external power and speaker, 9 long-life C batteries, English manual and 90 day warranty.

A licence is required for all transmitting equipment.

27MHz



BUILT-IN SWR BRIDGE!

\$159 COUGAR

COUGAR 23 B AM DELUXE TRANSCIVER

Delux mobile 23 channel (synthesised) for the quality conscious Novice. The Cougar features built-in swr meter, noise blanker, delta tune, rf gain control, mc gain control, built-in modulation meter, separate PA switch. Circuitry consists of 1 IC, 20 transistors, 18 diodes. RECEIVER: dual conversion, sensitivity 0.5 uV for 10 dB S+N/N, selectivity 6 dB bandwidth 5 kHz, PA audio power 5 watts. TRANSMITTER: 5w input, spurious harmonic suppression better than 55 dB. Comes complete with mic, mobile bracket, dc cable and manual. *

HAM GEAR SPECIALS



TS520 ~~\$674~~ \$650 *



TS820 ~~\$940~~ \$850 *

E.A. LOG BOOK packed with handy reference data including Australian & New Zealand broadcast frequencies, how to get verification cards, 27MHz frequencies, Q code etc. All this for \$2.95 + P & P \$1

NEW



Model OB-330

ON-AIR MULTI-TESTER

Built-in Multi Tester & Field Strength Meter

- CB, AMATEUR RADIO
 - R/C GEAR
 - MARINE, AIRCRAFT
 - STEREO, HI-Fi
 - ELECTRONICS, OTHERS.
- \$39 *

SPECIFICATIONS

Model OB-330 DC 20000/V AC 8000/V
TAUT BAND METER, METER PROTECTED
• DC V: 0-0.25, 0-2.5, 0-25, 0-100, 0-250, 0-500, 0-1000V
• AC V: 0-10, 0-50, 0-250, 0-500V • DC mA: 0-50µA, 0-5mA, 0-50mA, 0-500mA. Ohm: 0-2KΩ, 0-20KΩ, 0-200KΩ, 0-2MΩ. Accuracy: ±3% at FS value on DC range/±4% at FS value on AC range/±10% at indicating value on Q range. • Battery: 1.5V(U.M.-3)X1 • Audio power: 0-12W, 0-300W at 8Ω Z line. 20Hz-100kHz ±1dB • Field Strength Meter: 1.9MHz-500MHz • Dimension: 125 X 95 X 45mm • Weight: 330gms.

ANTENNAS

BASE LOADED WHIP

Model M1 quality base loaded mobile whip, 40.5 inches long, 50 ohm impedance, vswr less than 1.5. Includes roof mount and optional boot lid mount, spring and coax with PL259 plug. \$27 + P&P
Model G2 as above with gutter clamp \$29.90 + P&P

HELICAL WHIP

Model HW-115-6 6ft helical whip, covered in tough plastic, this top loaded (helical) is designed to give a perfect 52 ohm match. \$22 + P&P
- spring base \$13
- roof base \$17.50

MARINE WHIP

Model HW-116M requires no ground plane and can be operated on fibreglass, wood surface or on mast. Comes complete with matcher, coax, PL259 plug. \$65

HUSTLER CENTRE LOADED WHIP

Ideal mobile whip, mounts on bumper bar.

Whip	\$19
Mast	\$26
Bumper Mount	\$19
Spring	\$11.50

HALF WAVE GROUND PLANE

Model V1 vertical ground plane (half wave) gain 3.75dB, overall length 5.5m, mounting on mast tubing up to 1 1/2" diameter. \$49 + P&P

TRUCK ANTENNA

Twin 50.4" 50 ohm mirror mounted truck antenna. Complete with coax and PL259 plug. \$42. + P&P

27MHz ground plane, superb quality, wound on strong fibreglass rod with teflon protection. \$79

1/2 wave high efficiency ground plane, solid 108 inch heat treated radials and radiator. Radials droop for 50 ohm match. Complete with SO239 socket. \$35 + P&P \$3

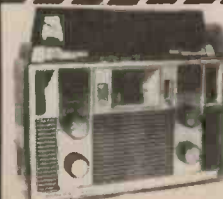

SWLs



BARLOW WADLEY

The famous portable Barlow Wadley Communications Receiver with crystal controlled reception of am/lsb/usb/cw

Standard model	\$319
With FM	\$339

ANTENNAS

Listener-1 "V" type covers 3 30MHz with special trap for DX reception \$22
Listener-3 long range wire dipole antenna 3:30MHz complete with balun, feed wax, VHF plug, insulators. Ideal for the serious SWL. \$49

SWL ANTENNA COUPLER

For matching receiver to the antenna line, this quality product handles signals from 2 30MHz with an output impedance from 50 to 800 ohms

Head Office & Mail orders—
139 AUBURN RD. AUBURN VIC. 3123. Ph. 82.5398

VICOM

VICOM gear also available at:
Sydney: Jack Gilham, 23 Whiting Street, Arfarmon. Ph. 439.1271
Canberra: Daicom Electronics, 29 Colbee Crt, Phillip. Ph. 82.3581
Adelaide: Graham Stallard, 27 White Ave, Lockleys. Ph. 43.7981
Perth: Netronics, 388 Huntriss Ave, Woodlands. Ph. 46.3232
Brisbane: Elite Electronics, 69 Wardell St, Dorrington. Ph. 38.4480
and a network of dealers throughout Australia. Dealer enquiries welcome.

DENON

Professional audio brand

DL-109R

MOVING MAGNET
CARTRIDGE



Output voltage: 3 mV (1 kHz
50 mm/sec)
Frequency response: 20 ~ 35,000
Hz

DL-103

MOVING COIL
CARTRIDGE



Output voltage: 0.3 mV (1 kHz
50 mm/sec)
Frequency response: 20 ~ 45,000
Hz

AU-310

TRANSFORMER FOR MOVING
COIL CARTRIDGE



Frequency response: 20 Hz ~ 40 kHz (± 1 dB)
Load impedance: 50 k Ω or more

DL-109D

MOVING
MAGNET CARTRIDGE

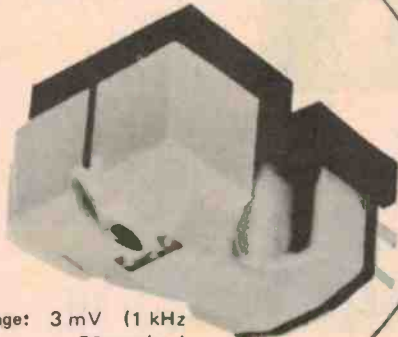

Output voltage: 3 mV (1 kHz
50 mm/sec)
Frequency response: 20 ~ 50,000
Hz

PCM RECORDS

(Pulse Code Modulation)

PIANO SONATAS

CONCERTOS

QUARTETS

and other classical music.
More works now
being released.



**Hi Fi Audio
Equipment**



AMALGAMATED WIRELESS (AUSTRALASIA) LIMITED

554 Parramatta Road, Ashfield. N.S.W. 2131. Phone 797-5757

MELBOURNE
580 4533

ADELAIDE
272 2366

HOBART
34 5266

CANBERRA
95 3431

TOWNSVILLE
79 6155

BRISBANE
44 1631

PERTH
71 0888

LAUNCESTON
44 5155

NEWCASTLE
2 5166

AD A2

A speaker unlike any other

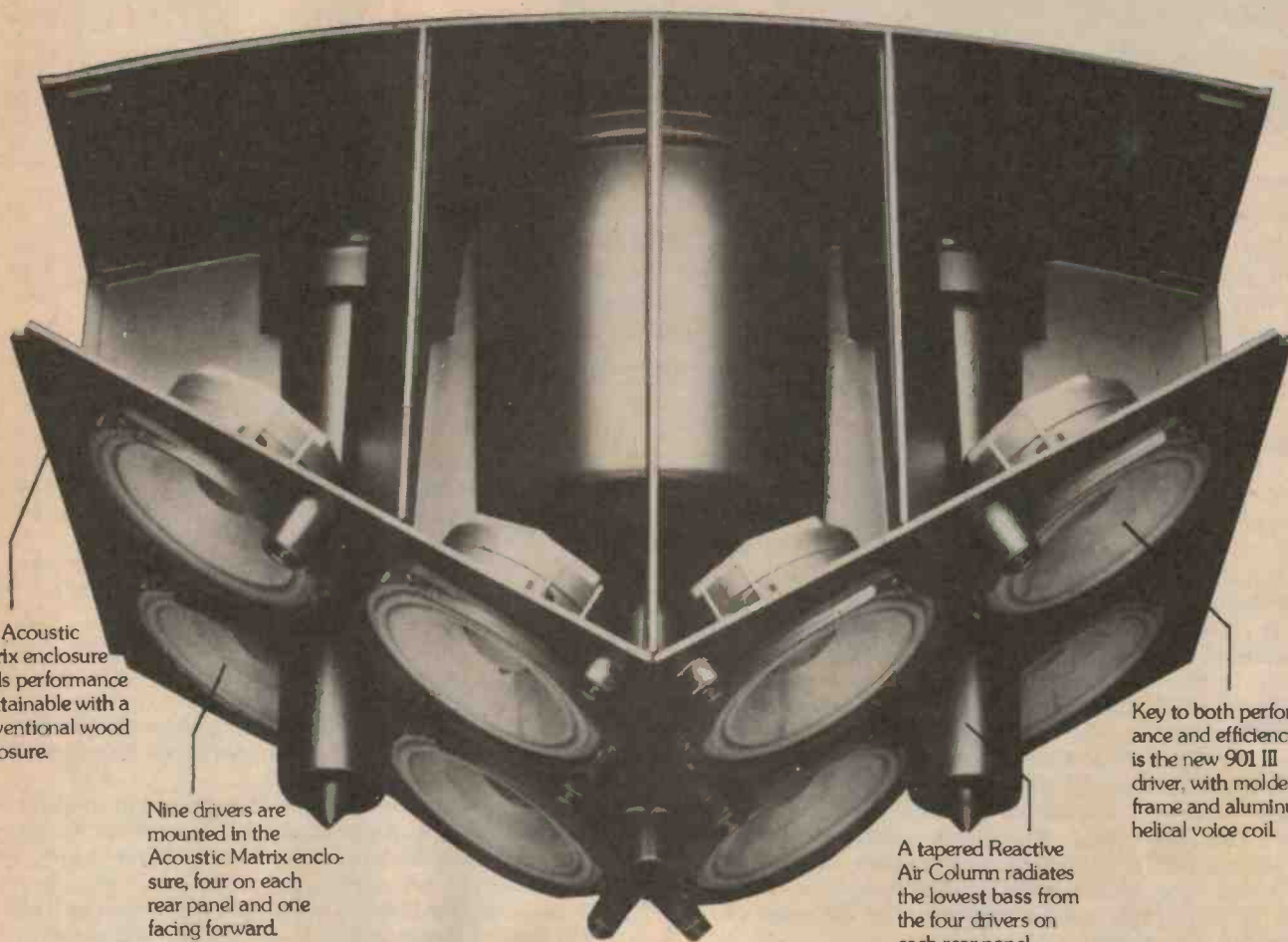

The Acoustic Matrix enclosure yields performance unattainable with a conventional wood enclosure.

Nine drivers are mounted in the Acoustic Matrix enclosure, four on each rear panel and one facing forward.

Key to both performance and efficiency is the new 901 III driver, with molded frame and aluminum helical voice coil.

A tapered Reactive Air Column radiates the lowest bass from the four drivers on each rear panel.

Introducing the Bose 901 Series III.

In 1968, Bose introduced an unconventional loudspeaker system: the legendary Bose 901. Now, we are introducing a new speaker of revolutionary concept, design materials, and performance: the Bose 901 Series III.

What you will hear.

You will be struck by a sense of immediacy and presence, spaciousness of sound, and accurate stereo image almost anywhere in the room. Equally startling are the realism and accuracy of the timbre of each instrument, the clarity and dynamic range of the deepest bass notes, and the precise definition of individual instruments.

Efficiency

Most dramatic, however, is the remarkable efficiency with which this level of performance is achieved: the new 901 Series III can produce the same volume of sound with a 15 watt amplifier as the original 901 with a 50 watt amplifier. This dramatic breakthrough in the basic economics of high-fidelity makes it possible to put together a high performance component system at a lower price than was previously possible, even though the 901 Series III is a more expensive speaker than its predecessor.

Technology

Spectacular performance and efficiency are the results of proven Bose

design concepts and technological innovations that include the unique, injection-molded Acoustic Matrix enclosure and a new, ultra-high efficiency driver.

At the same time, the 901 Series III is (as is the original 901), a Direct/Reflecting speaker with a separate electronic equalizer.

To appreciate the spectacular performance of the Bose 901 Series III, simply ask a Bose dealer to play the 901 III in comparison to any other speaker, regardless of size or price.

We submit that the 901 Series III provides more value in concepts, materials and performance than any other loudspeaker.



BOSE

PLEASE SEND ME THE 16 PAGE COLOUR BROCHURE ON THE BOSE 901 SERIES III

Name

Address

State Postcode

TO: W. C. WEDDERSPOON PTY. LTD.
3 FORD ST., GREENACRE, NSW 2190
PHONE: 642-3993 AUSTRALIAN DISTRIBUTORS

SOUND

Since we introduced our Audio Facts column some months ago, innumerable readers have asked us to expand the present coverage we give to the technical side of audio and hi-fi.

In response, here is the first issue of our new hi-fi/audio section. Its make-up will vary from month to month, depending on what's afoot, but the emphasis will be on news of developments with outstanding technical interest and/or performance.

Another Noise, Another Reduction

No noise reduction system so far available has tackled the problems of impulse noise — clicks and pops from records, crackles from radio, etc. So far, emphasis has been on removing hiss, and in this respect the obvious system for home use is Phase-Linear's auto-correlator, which we intend examining in detail before long.

Soon to be introduced into Australia, however, is an impulse noise reduction unit by SAE. This was still unavailable for investigation at time of going to press, and so we are unable to give any first-hand idea of how well it works.

But the sales material from SAE sounds most convincing. Impulse noise is characterised by high amplitude and very short attack and decay times, and can be recognised and thus filtered out. Should such an impulsive noise be present in a signal, the SAE electronics simply remove the entire signal, leaving a 'gap' whose duration is of the order of one-thousandth of a second.

And what happens next? Well, the gap has to be filled, and this function is carried out by a sampling circuit which extrapolates information either side of the gap, and having analysed what is likely to have been there, fills it. This is the only part of the operation which might seem to be hit-or-miss, although there would appear to be no more of a potential compromise than exists with the auto-correlator.

Probably the most flexible of noise-reduction systems would be both auto-correlator and impulse NR unit used together. Then, perhaps, one should also add a dynamic

filter for any hiss that slips through, and of course a Dolby unit for tape (and future FM?) processing. It should be stressed, of course, that both auto-correlator and the SAE device are one-part systems, and are therefore independent of prior processing.

With record quality so often marred by clicks, pops and sundry impulsive noises, it seems the SAE unit has much potential.

Damping and SME

Latest news from SME, the pickup arm people in England, is that model 3009/II improved can be further improved — with the help of viscous damping.

Viscous damping is normally only found in unipivot arms (e.g. JH Formula 4, Keith Monks M9 etc) where its use is essential to provide stability. The Inertia unipivot arm, which was undamped, behaved rather strangely and anyone acquainted with that arm will know why damping is needed!

But viscous damping also helps suppress the pickup fundamental resonance, and recently, with the introduction of some extremely sensitive cartridges (the new moving-coils and Decca's Mk 6E for example) the need for damping has become audibly obvious.

The SME 3009, a low-mass design, was only partially damped by virtue of its cleverly decoupled counterweight. This decoupling, incidentally, is not damping in itself — its effect is simply to reduce the effect of the counterweight mass as a contributor to pickup system resonance.

Now SME has come up with FD200, a new accessory.

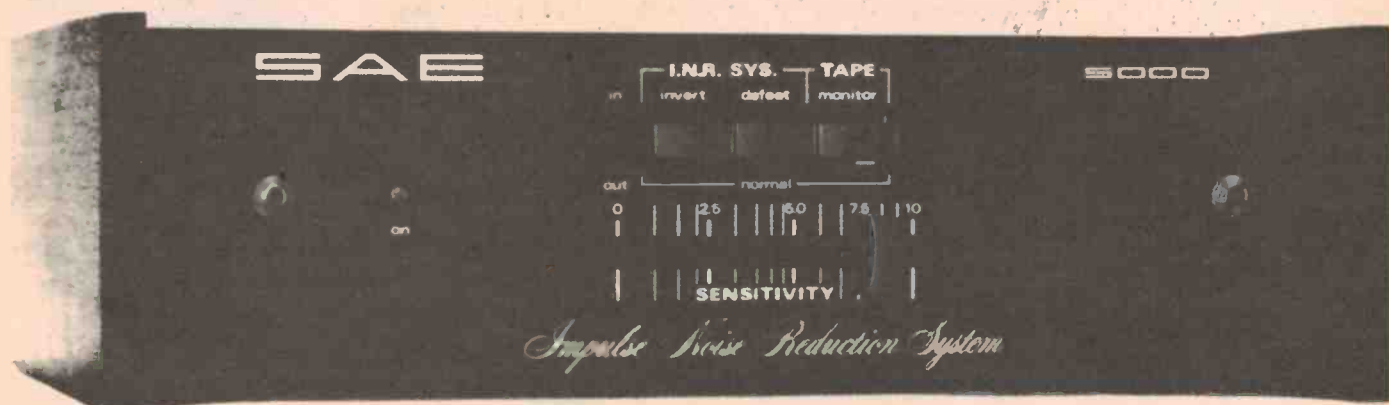

SAE has taken a new angle on the problem of impulse noise reduction with the smart 5000 Series unit.

It consists of a trough, containing the damping fluid which fits onto the body of the arm lifter, and a paddle, which clamps onto the arm tube just ahead of the pivot. SME claims that application of damping is more beneficial away from the bearing plane.

The new accessory should give audible improvement to bass performance of most cartridges, and would probably enable you to use a Decca 6E in your 3009, as well as giving greatly improved performance with many other cartridges. From the information so far to hand, it appears that the damping system reduces Q and at the same time, raises the resonance's frequency to around the optimum of 10 Hz.

This is, of course, big news for SME owners who want to use these more 'difficult' cartridges but who so far haven't been able to. At this stage, we are unable to say when the FD 200 will be available, but Audio Engineers, the distributors of SME products, should be able to advise before too long.

Nakamichi Spoken Here

Mr. Nakamichi recently paid a whirlwind visit to Australia, and took the opportunity to discuss recent and forthcoming developments from Nakamichi research.

He addressed a meeting of retailers at Convoy International's Woolloomooloo headquarters in Sydney. Convoy is the national distributor for Nakamichi.

Of interest to budget-conscious enthusiasts is the new 500 cassette unit, a top-loading machine with two heads and direct-acting mechanical controls. This model is based on, but, according to Mr. Nakamichi, superior to the machines seen under Thorn and Sonab guises. Both these models were made for the principals by Nakamichi.

Another fascinating product is the series 400 amplifier. This is available as a separate pre-amp and power amp, and in these days of excessive control facilities and gadgets, it is refreshing to see a minimum of knobs and switches on the pre-amp. Mr. Nakamichi describes the design as "black box — no gingerbread" and the units are indeed black boxes. The power amplifier isn't unlike the Quad 405 in size or appearance, although its front-mounted heatsink fins are less obvious than the Quad's.

The pre-amp has all normal facilities such as tone controls and tape monitoring but little else — as basic as the dedicated audiophile, intent on listening to music and not on playing with equipment, could wish for.

Also seen and heard was a new tuner pre-amp model which looked very smart indeed. Mr. Nakamichi stressed the design aim behind this product — "it should feel good . . . the control must work well . . .". He was referring to the tuning control, a large, circular dial centrally rotated via a reduction drive.

Here again is a similarity with a Quad product — the tuning indicator system uses lamps. The Quad FM3 uses only two lamps, however; Nakamichi's uses four plus, of course, a stereo beacon. The 630 tuner pre-amp is intended for use with other 600 series components, and can be incorporated into the System One rack mount.

We hope to be able to examine these new Nakamichi products before too long, and would like to investigate the MC-1000 moving coil pickup cartridge. This latter has enjoyed enormous success in Australia so far, despite its very high price. Performance is quite superb, putting the MC-1000 into our top five shortlist of cartridges.

Speakers . . . and Speakers

One often has the feeling that major Japanese manufacturers really aren't aware of how the audiophiles of the world regard their speakers. Mr. Nakamichi, however, seems to be an

(Continued Page 23)

NATIONWIDE ELECTRONICS

P.O.Box 1013,
BURWOOD NORTH. 2134
Phone: 749301

Owing to stringent Council requirements Nationwide Electronics will not be opening a store in Parramatta as promised. But for all your mail order requirements you can still write to us at the above address. We will be holding a comprehensive range of components but our main aim is to handle all you "SPECIAL" component requirements which you can't get anywhere else.

SPECIALS FOR JUNE.

NOVUS DIGITAL WATCHES

KL4WB Chrome 4 function hours/minutes/seconds/dates.
..... ONLY \$41.95 (Post \$2.00)
KL4WB. Gold ONLY \$46.00 (Post \$2.00)
KE5WB Chrome 5 function
Hours/minutes/seconds/dates/months ONLY \$50.50 (Post \$2.00)
KE5WB Gold ONLY \$55.90 (Post \$2.00)
PLESSEY 3 plus 3 Amplifier Kit 3 watts R.M.S. PER
channel (less transformer) ... ONLY \$17.50 (Post \$4.00)

NORTRONICS

AUDIO & DIGITAL TAPE HEADS
Long Life-Extended Response



Replacement heads for:

Domestic Cassette decks.
Recorders Cassette players.
Reel to reel.
Cartridge.

Professional Broadcast recorders in reel to reel & cartridge or
Recorders cassette.

Studio recorders 1/4" to 2" multi track.

Duplicators Reel to reel & cassette.

Aircraft Recorders, cockpit & background.

To fit: AMPEX, SCULLY, TEAC, ATC, GATES,
PENTAGON, INFONICS and many others.
ALIGNMENT TAPES — Reel to reel, Cartridge, Cassette.

EMAC INDUSTRIES PTY. LTD.
9 Meriton Place, Clayton South, Vic. 3169.
Ph: 544-5157

Wharfedale: Uncompromising dedication to true fidelity.

The discerning listener has long been aware of the absolute purity of 'uncoloured' English sound.

Wharfedale – Britain's largest manufacturers of hi-fi speakers – are dedicated to the design of speaker systems that exemplify this tradition.

Now Wharfedale speakers are fully imported into Australia.

Sold and serviced nationally by Rank Australia. Available at all leading Hi-Fi Specialists.



Glendale 3XP. Larger bass drive than Linton with increased cabinet volume. Power handling 40 watts DIN.

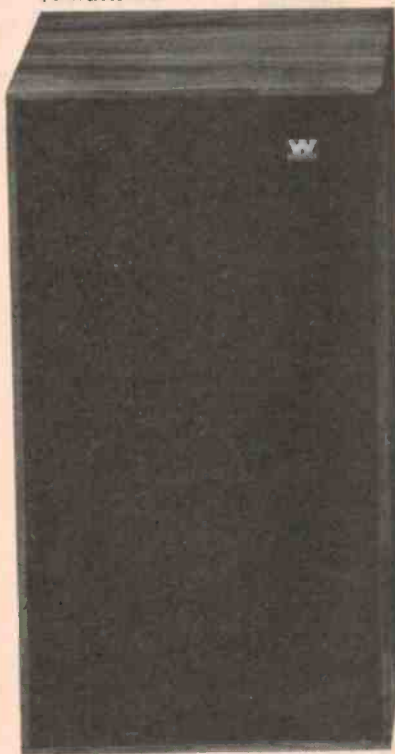

Dovedale SP. 4 drive units including 2 small bass drivers for excellent bass response. Handles power of 60 watts DIN.

Linton 2XP. Separate, specially designed drive unit for bass, midrange and treble. Handles power of 40 watts DIN.



(Not illustrated)

Airdale SP. Top-of-the-range model with 4 specialist drive units in reflex-loaded enclosure. Power handling 100 watts DIN.



We Keep Performing

**RANK
AUSTRALIA**

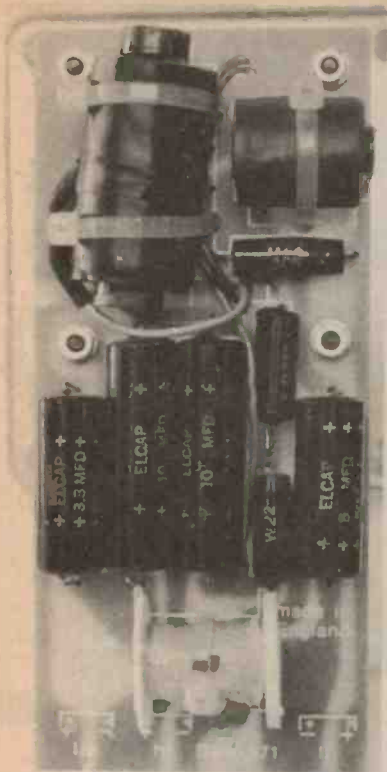

Latest KEF crossover improves the performance of that company's Model 104 speakers. It is available as a conversion kit from KEF dealers.

He added that the two types of American speaker — East Coast and West Coast — both displayed distinctive characteristics. "The British", said Mr. Nakamichi — "Very funny people. They listen to more music. They know what music sounds like."

More Speakers . . .

Another recent visitor to Australia was Raymond Cooke of KEF. His busy itinerary included a number of talks in Sydney and Melbourne, and he also spared time to meet representatives of ETI and Hi-Fi Review in pleasantly informal surroundings over dinner.

During our meeting, Mr. Cooke explained much about the recent design work at KEF which has resulted in new 'C' series loudspeakers. Positioning of midrange drive units, for example, has been altered to reduce colouration caused by proximity of the drive unit to the floor. Diffraction problems have also been studied, with the result that new flush front panels are used, together with surface-mounting grilles.

Mr. Cooke agreed that most speaker grilles caused audible problems, not so much by attenuation of high frequency information but by colouration as a result of the fabric being close and parallel to radiating surfaces. Such colouration was clearly audible and its influence tended to be greatest in the midrange region. He added that properly-designed grille frames had little adverse effect on sound quality, but that the fabric — acoustically transparent or otherwise — was the chief culprit. Reticulated foam was the best answer but there was one big problem — women disliked it because they believed it would be difficult to keep dust-free.

Further discussion revealed that the new 'deeper-than-wide' shape for the 'C' series was not simply a matter of jumping on a bandwagon but was fully intentional — again for

exception. Asked if his company would look seriously at the idea of high-quality speaker manufacture, Mr. Nakamichi stated somewhat discursively that he saw little point. He went on to imply that Japan's most popular speaker sounded decidedly 'commercial'.

(Continued Page 25)

A feature of the Nakamichi 630 tuner pre-amp is the super-sized tuning control dial.

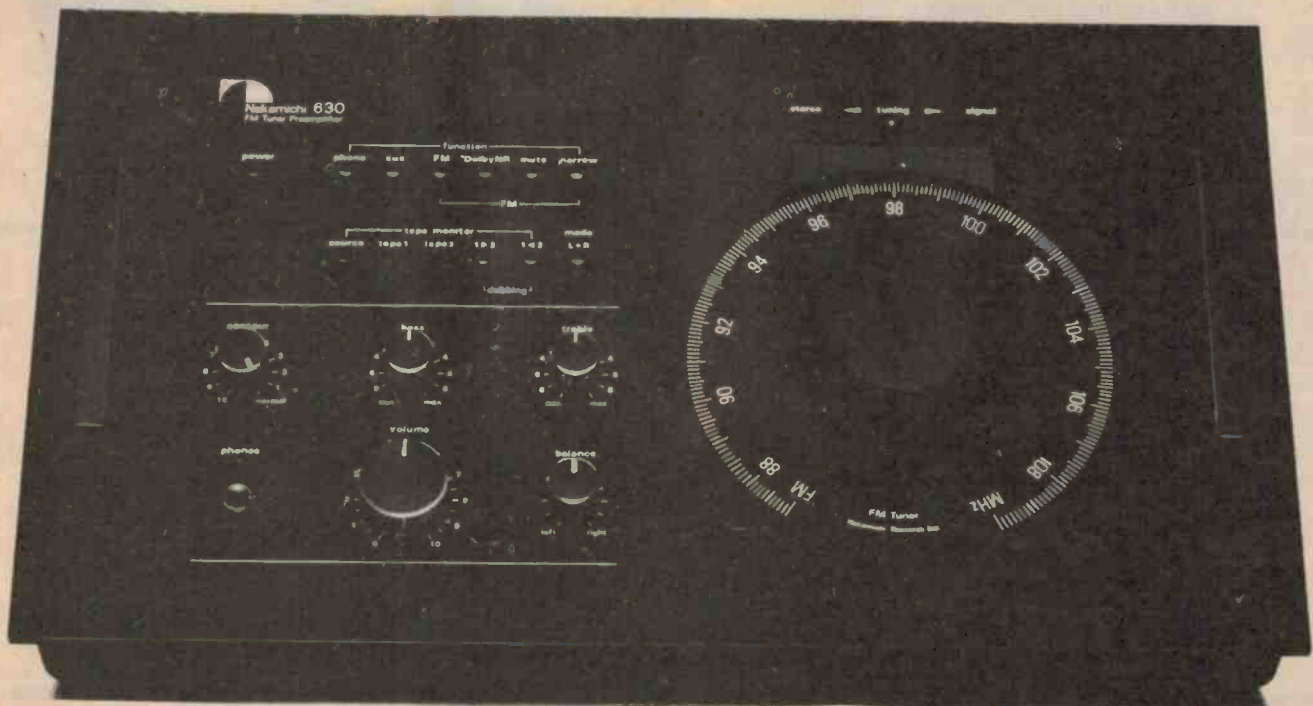

COUNT CORVUS
turns a blind eye
to devaluation!

Our
No.1 rated
scientific

CORVUS CALCULATOR

is only \$79.95



Believe it – despite devaluation this magnificent instrument is at a lower price than before. It will solve the most complex scientific and business calculations. You can just imagine what worlds we might have conquered if it had been invented 100 years ago!

THE MANY OUTSTANDING CORVUS FEATURES INCLUDE:

- 14 digit display
- 12 digit business mode plus sign
- 10 x 2 Scientific mode plus sign Mant + Exp
- 12 digit accuracy
- Reverse Polish Notation (4 stack)
- 10 addressable memories (incl. Last X) with memory to X exchange on all memories
- Radian mode
- To and from Radian Conversion
- Sigma plus standard deviation and mean
- Trig functions plus inverse and hyperbolic
- Range up to ± 200 exponential value
- Fixed, floating and scientific decimal point mode
- Percent – percentage difference
- π constant (11 digit accuracy)
- Natural and base 10 log and anti-log
- To polar – to rectangular conversion
- Vector additions
- All functions of X from and to
- 8 decimal conversions
- Ni-cad batteries
- AC/DC adapter charger
- Soft carrying case
- 1 year full warranty

Corvus Calculators are also available at all Sydney Wide Stores. For Victorian readers at The Calculator Supermarket, 274 Lonsdale Street.

Other Corvus Calculators available
804D for business, home and school \$14
615 Business Statistician \$19.95
610 Financial GENIUS \$74.95



Please send me by return mail the No. 1 Rated Scientific CORVUS CALCULATOR for only \$79.95 plus \$2.50 postage and handling. I am enclosing cheque money order postal note for calculator(s).

Bankcard Mail Order facility – please complete. Please charge my Bankcard.



bankcard

Bank _____

Bankcard No. _____

Expiry Date _____

Signature _____

NAME

ADDRESS

.....Postcode



ELECTRONIC CONCEPTS PTY LTD

Ground Floor, Cambridge House,
52-58 Clarence St., Sydney 2000.
Tel: (02) 29 3753

Money back guarantee if returned in original condition within 14 days.

reasons associated with diffraction. Not surprisingly, the subject of crossovers was discussed, and Mr. Cooke explained very clearly how resonances of drive units which fell into the stop-band of the associated crossover network could cause distortion and colouration, both within that stop-band and within the drive unit's pass-band. The latest KEF crossovers are the practical realisation of acoustic Butterworth filters, and are the result of exhaustive computer analysis of a large number of variables — in total the dynamic behaviour of a loudspeaker system.

... and More Yet

KEF isn't the only company to have looked carefully at crossover design. Closer to home, AMW in Sydney has stumbled across the same problem of unwanted resonances in stop bands. The audible effect of these resonances was, according to AMW, a reduction of clarity, most obvious in the upper midrange region. Colin Wait, AMW's technical director, has come up with a most elegant solution. He's added L/C/R tuned circuits to appropriate legs of the net-

works the effect being to suppress the offending resonances.

All AMW models have responded well to this treatment, and although the immediate impact is relatively small, prolonged listening shows how great the improvement is. AMW speakers have always sounded well balanced, tonally, and pleasantly non-fatiguing. They now sound even less fatiguing and more effortless. All AMW speakers of recent manufacture are fitted with the new crossover networks and AMW hopes to be able to provide a modification service through its national dealer network whereby older speakers may be updated at a nominal cost.

This virtually parallels the firm's arrangements for converting model 104's to superior-sounding 104ab's, although KEF supplies kits, the change being carried out by the owner. AMW insists that only authorised personnel should carry out the changes to its products — unauthorised attention nullifies the warranty. The company also plans introduction of at least one new model this year, hopefully in time for the Sydney CES in August. Rumours are rife about what this (these) new product(s) will be, although AMW is being very close-mouthed. We hope to receive more information soon.

SOUND BRIEFS

SONY MC CARTRIDGE

Sony have a moving-coil pickup cartridge, designated XL55, which looks as though it will become stiff competition for similar cartridges currently available. Also on its way, we understand, is a head amplifier which should also match other MC cartridges on the market.

DM6 MODIFICATIONS

Waggishly (and unofficially) designated 'The pregnant kangaroo', model DM6 by Bowers and Wilkins has undergone modifications designed to improve performance. The front panel is now made of a ribbed moulding to improve strength and reduce colouration, and the bass contour control has been omitted. Power handling capacity has been increased, and the new models should be arriving in Australia fairly soon.

KEF 105 DETAILS

Still to be introduced, the KEF 105 has been the subject of much rumour and anticipation. The reality is even stranger than we had imagined — a bass section with a novel form of loading, and separate enclosures for both midrange and treble units. The bass driver looks as though it will be the long-awaited B300 using a Bextrene diaphragm.

COMING SOON

Full details of how to build a truly magnificent pair of transmission line speakers — these are the one's we use ourselves for reference purposes. And for that purpose they have to be good!

DIGITAL TUNING

As 'digital tuning' now appears on professional and amateur communications equipment, the time is now long past due for comparable facilities to appear on hi-fi equipment. General Instruments have for some time been producing an LSI chip which provides both AM and FM digital frequency display and now they have released 'Stereomega', a new phase-locked loop-bored tuning system which features remote control, preprogramming of up to ten AM and FM stations, search and scan modes plus digital display of frequency. In addition, the Stereomega uses GI's EAROM which will remember stored programme information and a digital clock can be added if desired. Shouldn't be long before receivers start appearing which incorporate these facilities.

Leak 3000 Series: Computer designed for superior audio accuracy.

From the originators of high fidelity speaker design – the Leak 3000 Series.

A fully imported range of loudspeakers computer designed to reproduce your sound with authentic accuracy and the utmost clarity.

The 3000 Series is the result of an intensive research programme to evaluate and correct various

audible distortions in such key areas as intermodulation, doppler and delayed resonance.

Now the Leak 3000 Series can deliver:

- Design control to compensate for time delay.
- Bass/mid range driver

with no audible doppler distortion.

- Special compensating crossover network for improved treble performance.
- Treble unit with range up to 22kHz.
- Superb stereo imagery.

Hear the difference now at your leading Hi-Fi Specialist. Leak loudspeakers have never looked better, never sounded so accurate.



 **LEAK**

**NEW. FULLY
IMPORTED.**

We Keep Performing



**RANK
AUSTRALIA**

TDK SUPER AVILYN! THE EXPERT'S CHOICE



This is what the experts say:

**MR. E. NAKAMICHI, PRESIDENT,
NAKAMICHI RESEARCH INC.**

"TDK Super Avilyn cassettes are recommended for use with all Nakamichi tape decks. Before leaving our factory, all Nakamichi equipment has the bias set for TDK SA to achieve optimum performance."

ELECTRONICS TODAY APRIL 1976

"Listening tests proved that Super Avilyn tape sounds as good as its measured performance indicates. Background noise is substantially lower than other tapes and the dynamic range is unquestionably better. Frequency response is excellent."

HI-FI REVIEW JULY 1976

"TDK Super Avilyn lived up to its reputation in these tests. For the uncompromising tape enthusiast it is one of the best cassette tapes available. Its price is very competitive making this tape good value for money in the high performance range. For the perfectionist, TDK's hard to beat."

**LOUIS CHALLIS & ASSOCIATES, CONSULTING
ACOUSTICAL AND VIBRATION ENGINEERS.
NATA LABORATORY APPROVED.**

"TDK Super Avilyn looks like being one of the most important advances in tape formulation in the mid 70's."

 **TDK**

SOLE AUSTRALIAN AGENTS:
CONVOY INTERNATIONAL PTY. LTD.
4 DOWLING STREET WOOLLOOMOOLOO 2011. TEL 357 2444
MELBOURNE OFFICE 31 COVENTRY ROAD SOUTH MELBOURNE TEL. 699 4188

Wait till you hear what you've been missing.

Available at all good record bars and hi-fi stores.

GRAPHIC EQUALIZER

This revised version of our earlier equalizer now uses gyrators to replace the inductors making construction easier.

GRAPHIC EQUALIZERS are popular with both the professional and domestic user alike. However until the presentation of our earlier equalizer (ETI 427) the cost of such a device was very high and this limited its wide use. We have now redesigned the equalizer to simplify the construction and it now has no coils and one additional filter has also been added.

The advantages of an equalizer are not generally well known but are as follows.

Firstly an equalizer allows the listener to correct deficiencies in the linearity of either his speaker system alone, or the combination of his speaker system and his living room.

As we have pointed out many times in the past, even the best speakers available cannot give correct reproduction in an inadequate room. It is a sad fact that very few rooms are ideal, and most of us put up with resonances and dips, sadly convinced that this is something we have to live with.

Whilst the octave equalizer will not completely overcome such problems, it is possible to minimize some non-linearities of the combined speaker/room system.

In a concert hall it is also possible to use the unit to put a notch at the frequency where microphone feedback occurs, thus allowing higher power levels to be used.

Thirdly, for the serious audiophile, an equalizer is an exceedingly-valuable tool in evaluating the deficiencies in a

particular system. One adjusts the equalizer to provide a uniform response, the settings of the potentiometer knobs then graphically display the areas where the speaker etc is deficient.

There is a snag, however, one must have an educated ear in order to properly equalize a system to a flat response. It is not much use equalizing to your own preference of peaky bass etc in order to evaluate a speaker.

Ideally, a graphic equalizer should

have filters at 1/3 octave intervals, but except for sound studios and wealthy pop groups, the expense and size of such units are too much for most people.

The equalizer described here has 10 octave spaced filters but if desired it could be modified to give 1/2 or 1/3 octave spacing as large values of inductance are easily obtained with gyrators (active inductors).

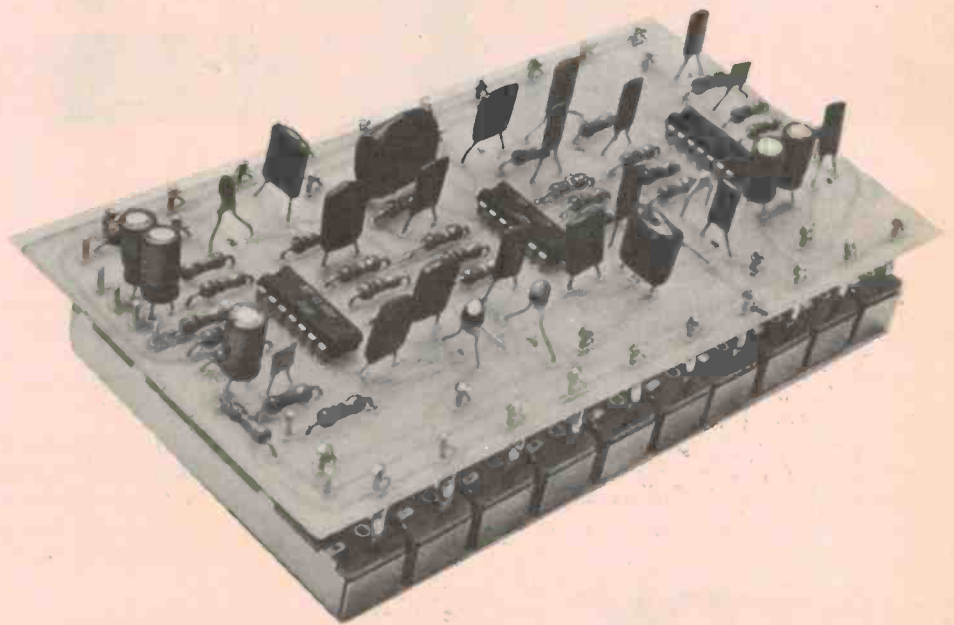
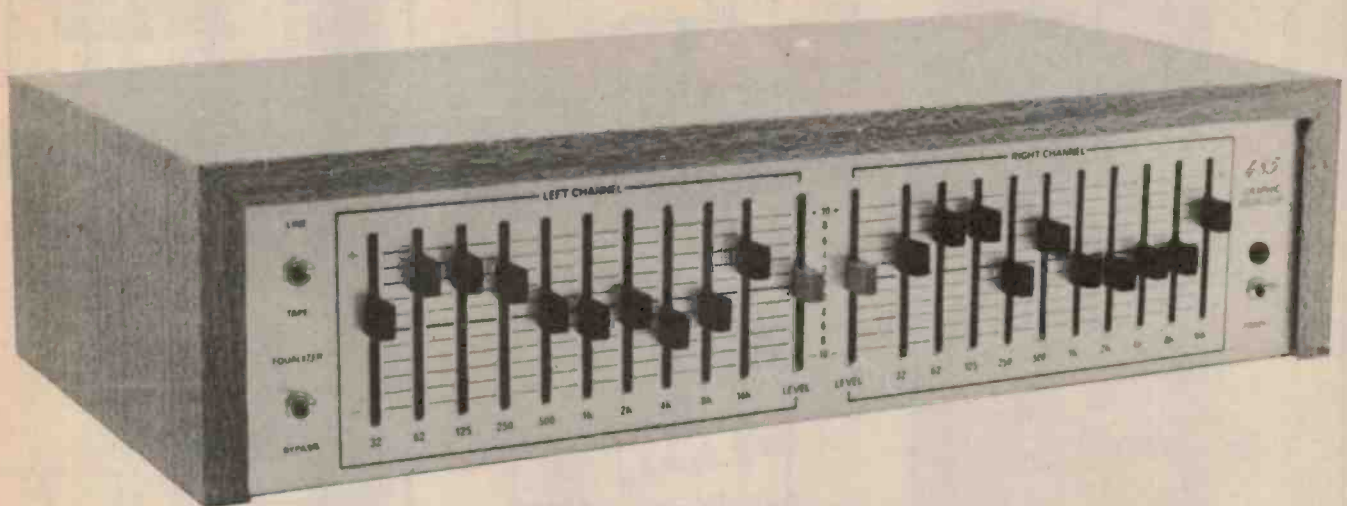

Photo showing one complete channel, less the volume control, removed from the chassis.



Construction

Assemble the PC board(s) with the aid of the overlay in fig 3 initially leaving off the potentiometers. Add pc pins for the external wires and the potentiometers connection points. Now double check the PC board soldering, the positioning and polarity of the components as once the potentiometers are in position changing components is difficult.

Now solder lengths, about 40mm, of tinned copper wire onto the end terminals of the potentiometers, and also onto one of the wiper contacts. Note that half the potentiometers use one wiper connection and the others use the other end. Now slide the wires through the holes provided such that the potentiometers are on the copper side of the board. Before soldering mount the potentiometers onto the support rails, space the board back about 10mm then twist the wire around the PC pins and solder the connections.

The volume controls can now be mounted and connected and the complete assembly mounted into the chassis using 12mm spacers. The power supply can be added along with the other components in the box and finally wire as shown in fig 6.

Third octave filters

While we have not built up a third octave unit we see no reason why it will not work. Additional stages can simply

be added except that the Q of the circuits must be changed to narrow the band. At the moment the impedance of the capacitor and inductor (gyrator) is about 3000 ohms at the centre frequency and this should be increased to about 8000 ohms for the third octave unit. The capacitors and inductors can be calculated by

$$C = \frac{1}{2\pi f X_C} \quad L = \frac{X_L}{2\pi f}$$

where $X_C = X_L = 8000\Omega$
and f = centre frequency

It is recommended to reduce loading IC1/2 that the potentiometers be increased to 10k.

SPECIFICATION ETI 485

Frequency response			
Equalizer out			Flat
Equalizer in	10Hz – 20kHz		$\pm \frac{1}{2}$ dB
and all controls at zero			
Range of controls			
Individual filters			± 13 dB
Level control			+ 14dB – 9dB
Maximum output signal			
at <0.1% distortion			6 volts
Maximum input voltage			10 volts
Distortion			
at 2 volts out, controls	100Hz	1kHz	6.3kHz
flat	0.02%	0.02%	0.04%
Signal to noise ratio			
re 2 volts out, controls flat			82 dB
Input impedance			47 k
Output impedance			100 ohms

GRAPHIC EQUALIZER

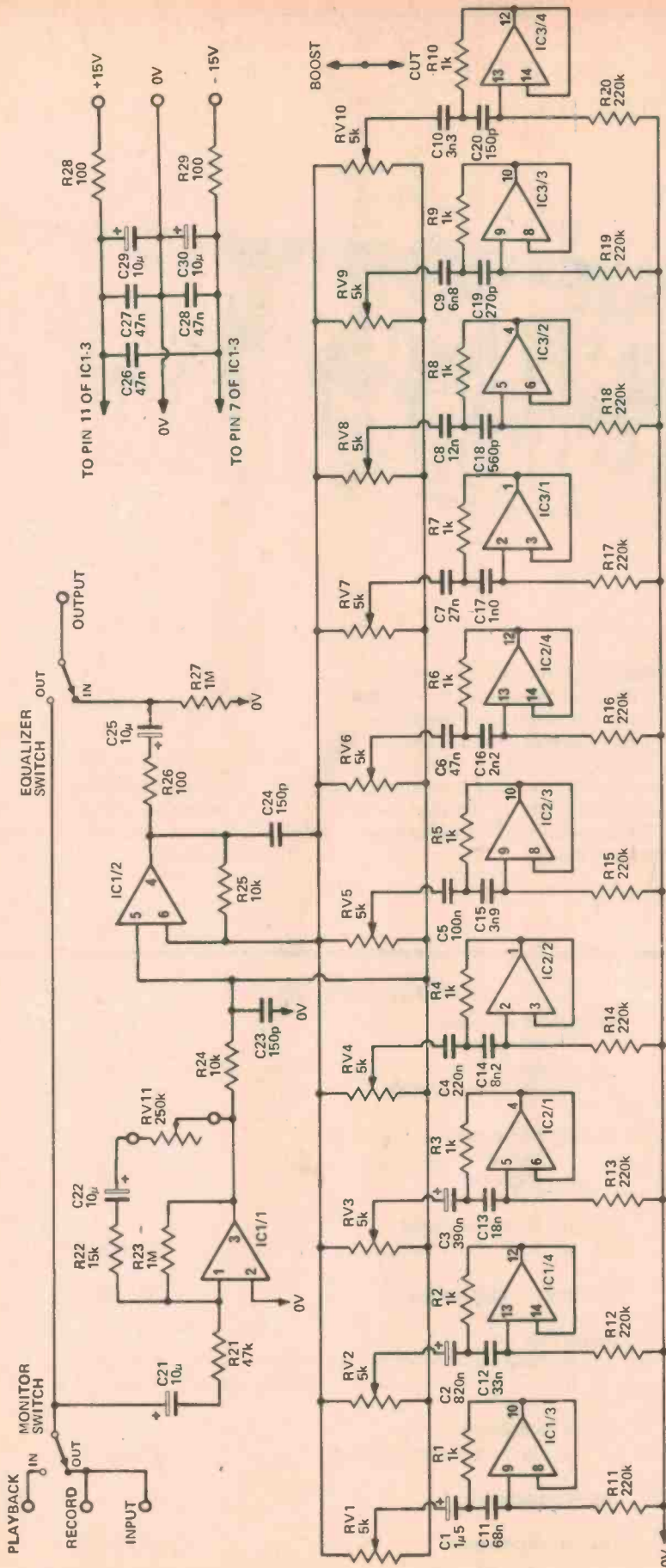

Fig. 1. Circuit diagram of one channel of the equalizer.

How It Works - ETI 485

This equalizer is basically similar to that used in the previous unit with the addition of an extra filter in each channel. The previous unit also used coils (inductors) - these have been replaced by gyrators to simplify construction. We will explain more about gyrators later but at the moment just assume that they are an inductor.

The equalizer stage is a little unusual in that the filter networks are arranged to vary the negative feedback path around the amplifier. If we consider one filter section impedance of the LCR network will be 1 k ohms at the resonant frequency

of the amplifier. The use of a second amplifier will increase the resistance to many megohms while the same formula holds for inductance.

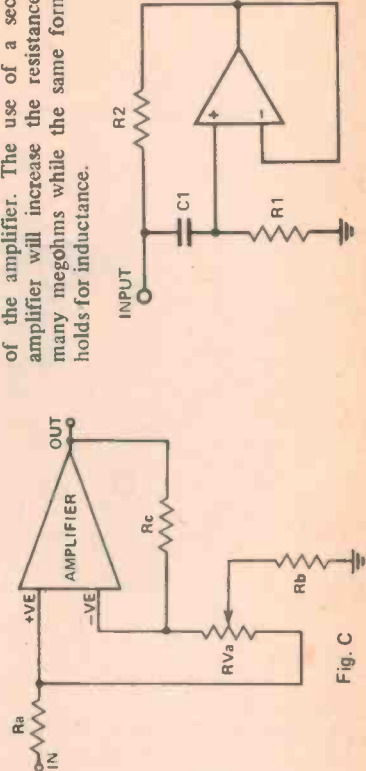

Fig. C

of the network. At either side of resonance the impedance will rise (with a slope dependant on the Q of the network which is 3) due to the uncanceled resonance. This will be inductive above resonance and capacitive below resonance. We can therefore represent the equalizer stage by the equivalent circuit below.

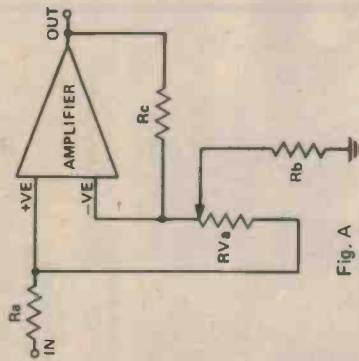

Fig. A

It must be emphasized that this equivalent circuit represents the condition with one filter only, at its resonant frequency. Additionally letters have been used to designate resistors to avoid confusion with components in the actual

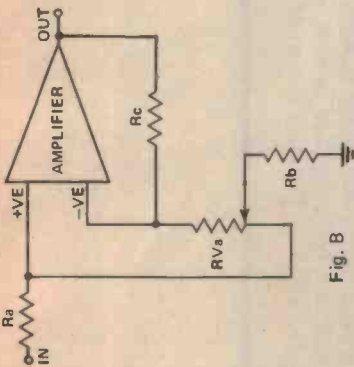

Fig. B

The output of the amplifier in this case is approximately the input signal times $(10\,000 + 10000)/100$ giving a gain of 20 dB. If the slider is at the other end of the potentiometer, (Fig. B), the signal appearing at the positive input, and thus also the negative input is about 0.1 (1000/(10 000 + 1000)) of the input. There will still be no current of the potentiometer and in RC, thus the output will be 0.1 of the input. That is, there will be a loss of 20 dB.

If the wiper is midway, both the input signal and the feedback signal are attenuated equally, and the stage will have unity gain.

With all filter sections in circuit the maximum cut and boost available is reduced, but ± 14 dB is still available.

In the actual circuit we have used the first op-amp (IC1/1) as a buffer for the input and also as the overall gain control stage. With the values shown the gain is adjustable over a range of -9 to +14 dB. By replacing R22 by a link RV11 will act like a normal volume control. Now to the gyrator.

The only difference between an inductor and a capacitor - electrically, that is, not mechanically - is the phase relationship between the current and voltage. In the gyrator we use an op-amp to reverse the phase relationship of a capacitor and make it appear like an inductor. In the circuit below the inductance is given by the formula

$$L = R1 \times R2 \times C1 \text{ H where C is in Farads}$$

Like a real inductor there is a series resistance (winding resistance) or R2 and a parallel resistance R1 (in a coil this is due to winding capacitance). The lowest value of R2 depends on the amplifier used but for standard op-amps it would be about 100 ohms. At the high end the value of R1 is limited by input current.

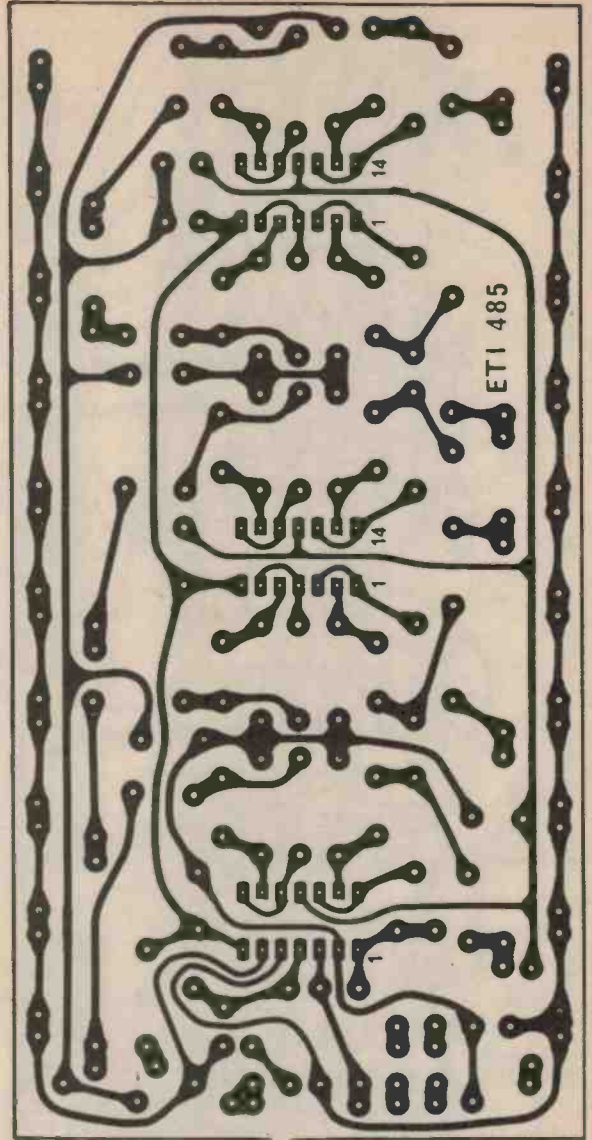
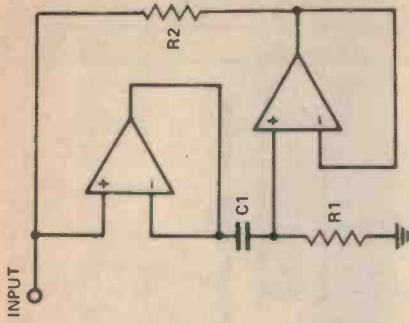

Fig. 2. Printed circuit layout. Full size 150 x 75 mm.

PARTS LIST - ETI 485

Resistors all 1/2W 5%

R1-R10 1k
 R11-R20 220k
 R21 47k
 R22 15k
 R23 1M
 R24,25 10k
 R26 100
 R27 1M
 R28,29 100

Potentiometers

RV1-RV10 5k lin 45mm slide
 RV11 250k log 45mm slide

Capacitors

C1 1/4.5 tantalum
 C2 820n "
 C3 390n "
 C4 220n polyester
 C5 100n "
 C6 47n "
 C7 27n "
 C8 12n "
 C9 6n8 "
 C10 3n3 "
 C11 68n "
 C12 33n "
 C13 18n "
 C14 8n2 "
 C15 3n9 "
 C16 2n2 "
 C17 1n0 "
 C18 560p ceramic
 C19 270p "
 C20 150p "

C21,22 10μ 25V electro
 C23,24 150p ceramic
 C25 10μ 25V electro
 C26-C28 47n polyester
 C29,30 10μ 25V electro

Semiconductors

IC1-IC3 4136 Quad op-amp

Miscellaneous

PC board ETI 485
 11 knobs McMurdo P/N 4093
 For stereo operation twice the above components are required
 Power supply ETI 581 (15V 40mA)
 Box to suit (see diagram)
 Three DPDT toggle switches
 Two 4 way RCA sockets
 Three core flex and plug
 Cable clamp, terminal block

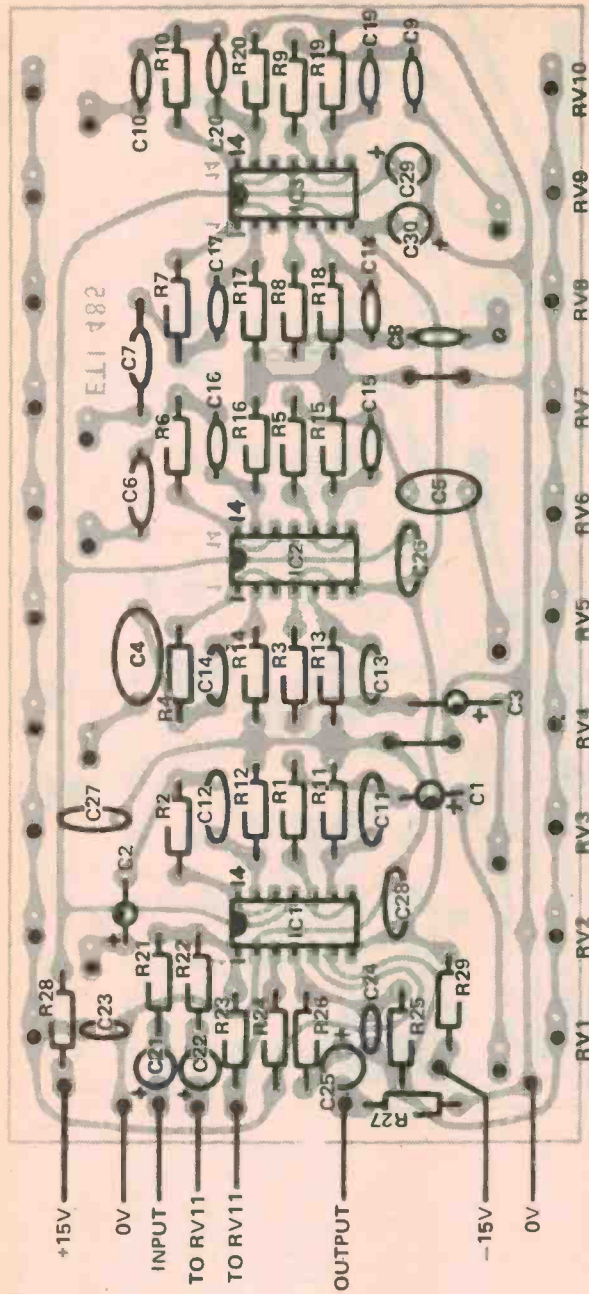

NOTE: RV1-RV10 ARE ON THE COPPER SIDE OF THE BOARD

Fig. 3. Component overlay of the equalizer board.

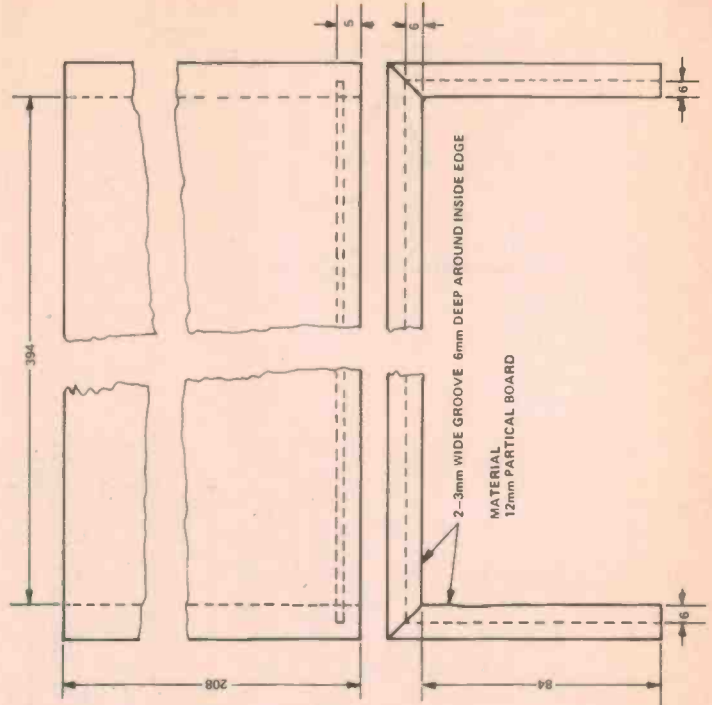

Fig. 4. Constructural details of the cover.

Note

The 4136 amplifier is manufactured by Raytheon and is distributed in Australia by Soanar Electronics (who supplied us with samples). It is also supplied by Technico Electronics.

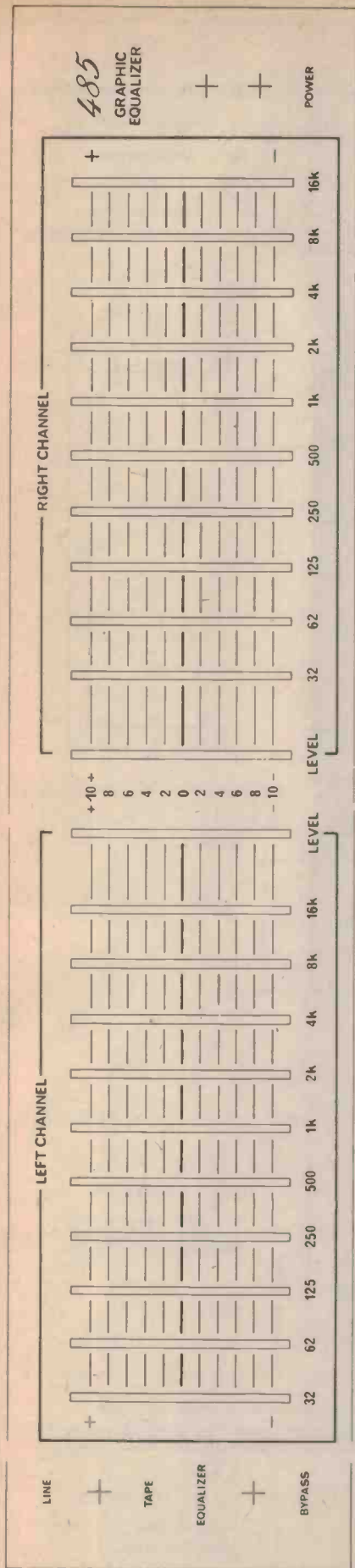

Fig. 5. Front panel artwork for the equalizer. See fig. 8 for dimensions.

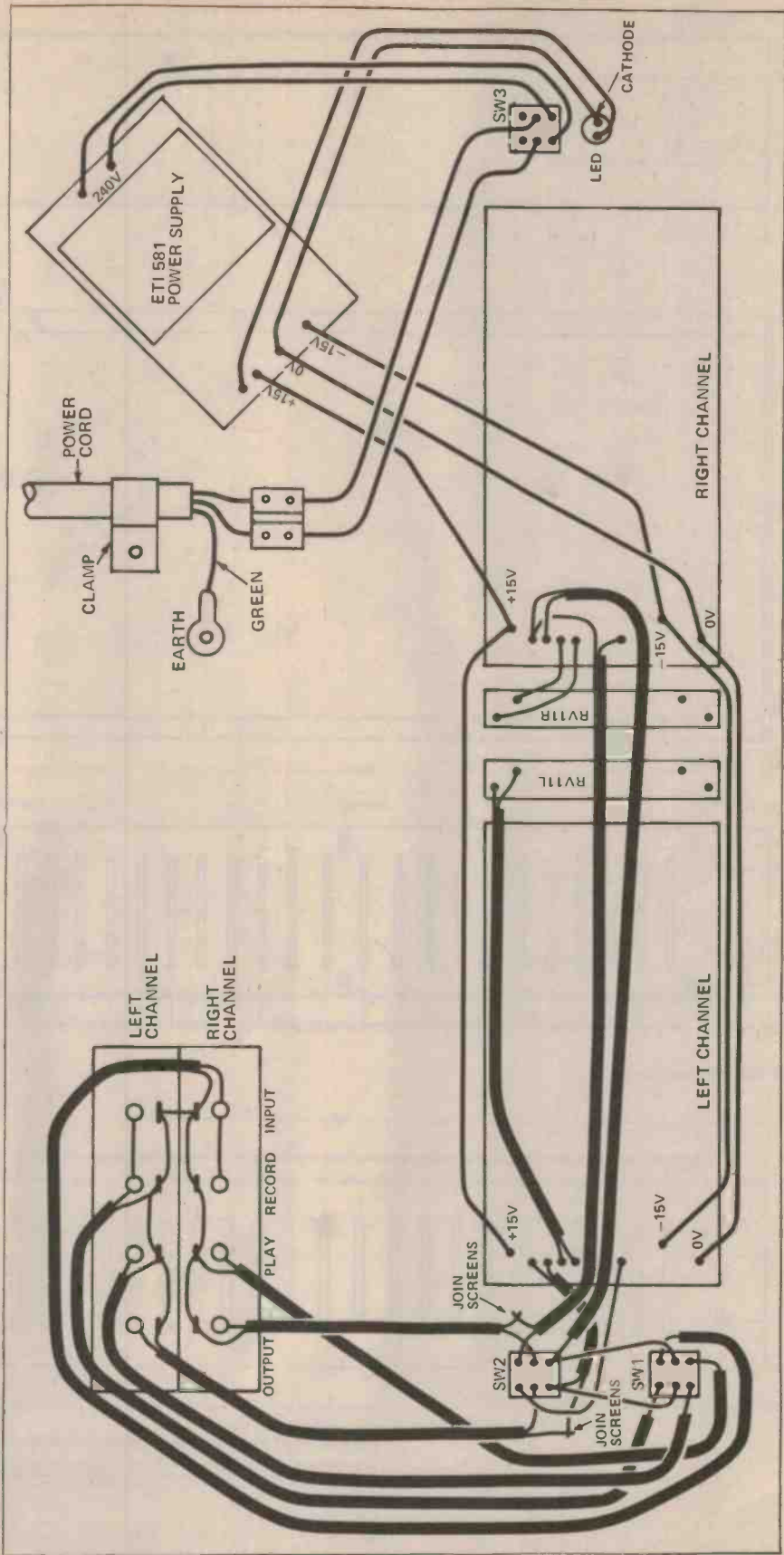
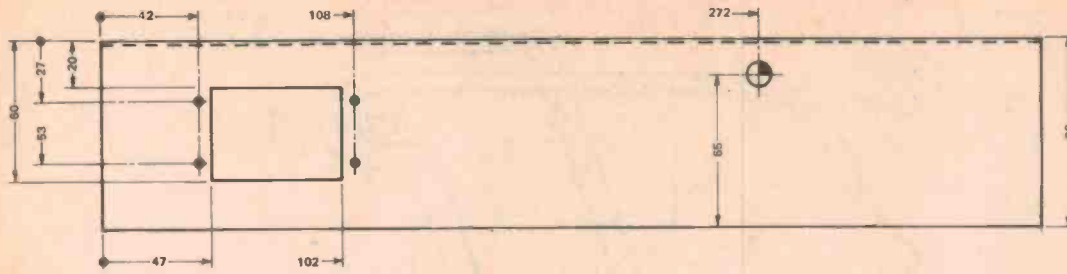

Fig. 6. Interconnection diagram for the unit.

Project 485



- ⊙ 6 HOLES 3.5mm COUNTERSUNK
- 8 HOLES 3.5mm DIA.
- ⦿ 4 HOLES 6.5mm DIA.
- ⦿ 1 HOLE 10mm DIA.
- ▭ 22 SLOTS 56mm 1.6mm
- MATERIAL: 1mm STEEL PLATED

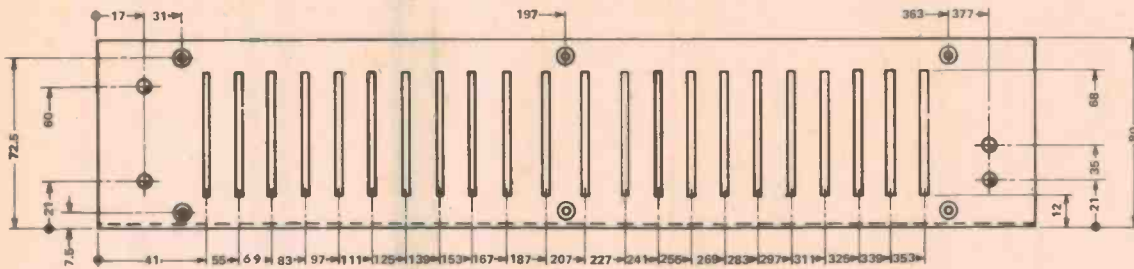
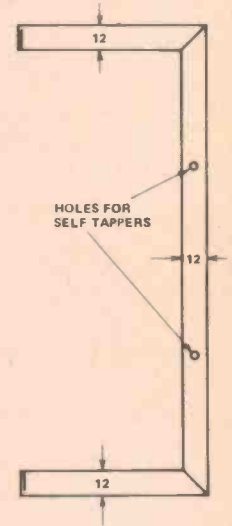
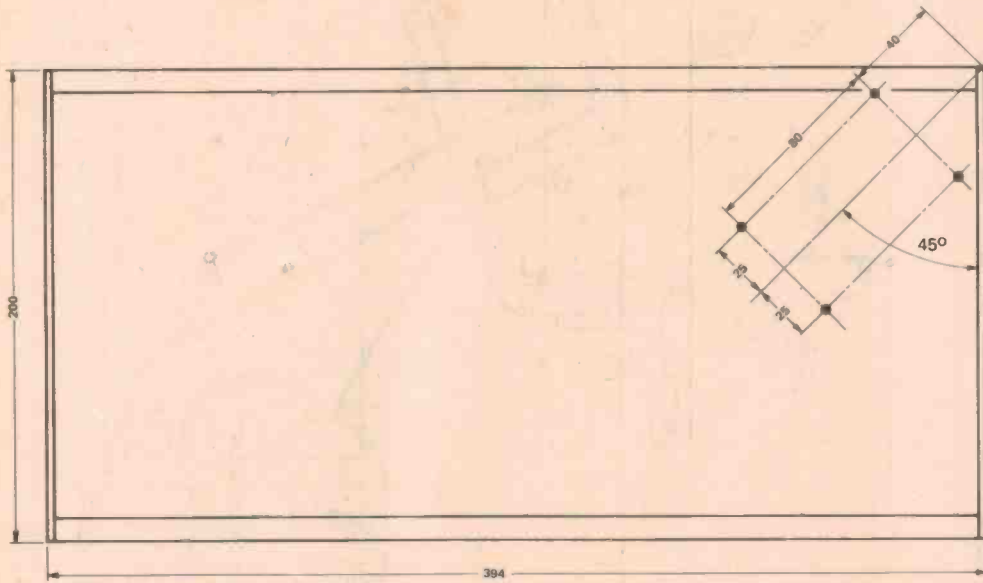
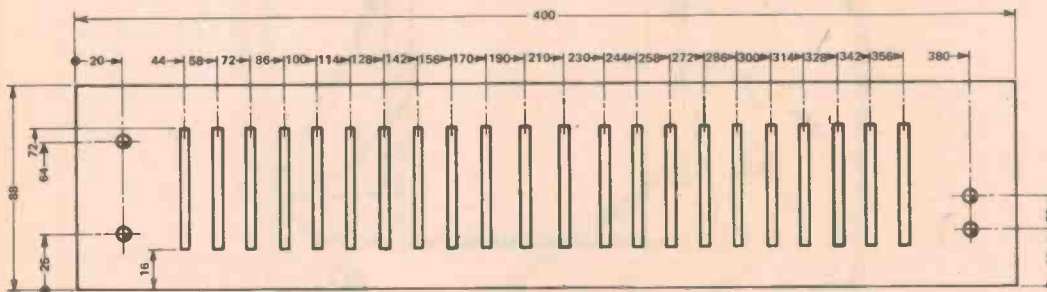
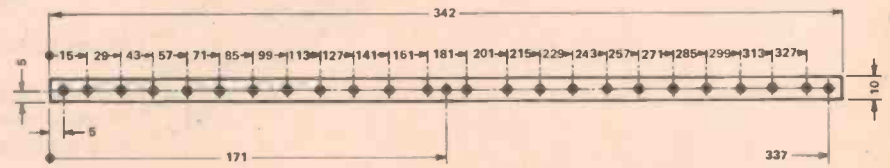

Fig. 7. Details of the chassis.



- ⊙ 4 HOLES 6.5mm DIA.
- ▭ 22 SLOTS 56mm x 1.6mm
- MATERIAL: ALUMINIUM SATIN ANODISED AND SILK SCREENED

Fig. 8. Metalwork details of the front panel.



- MATERIAL: 10mm x 3mm ALUMINIUM
- 25 HOLES 3.5mm DIA.

Fig. 9. Drilling details for the potentiometer support

Disco Scene '77



SOUNDOUT Series III
Inbuilt amplifiers in all models

To make your Disco alive, call the experts at

CASHMORE SOUND

- 3 professional discotheque portable units
- Series III mono (170 watts)
- Series VI mono (170 watts)
- Series III stereo (2 x 170 watts)
- Mirror balls
- Motors
- Light Units (coloured)
- Colourtron Amplifiers
- Rope Lights
- Strobes
- Smoke genies
- Bubble machines
- Projectors
- Jingle machines
- Speaker enclosures) manufactured
- JBL-Altec-Etone
- Portable disco stands
- Microphones - Shure AKG, etc.
- Amplifiers - Crown, H/H, Bose, etc.

Sales - Hire - Installation - Service

Top D.J.s Available - Demonstration if required.



cash-more sound
SYDNEY AUSTRALIA

CASHMORE SOUNDOUT DISCOS

149-151 Georges River Road, Croydon Park, NSW. 2133.
Ph. (02) 798-6782, 798-5647. Dealers required in all states.
FOR FREE CATALOGUE PHONE, WRITE, CALL.

COMPONENT MAIL ORDERS

P.O. BOX 60
TOONGABBIE, N.S.W. 2146

RESISTORS

All values to 1/2 watt. 2c each. 100 up 2.5c each. Power: 5 watt. 0.1 to 10 preferred values. 25c each. 10 up 20c each.

CAPACITORS

Ceramics: All preferred values from 1pf to 0.033 uF. 8c each 25 up 6c ea. 0.047 to 0.1 uF. 15c ea. 25 up 10ea. 0.47 uFd 29c ea. 25 up 23c ea

C/MOS

Value	Price	Value	Price
4000	33	4016	58
4001	33	4017	1.33
4002	33	4018	1.33
4006	1.33	4021	1.33
4007	33	4022A	1.33
4008	1.40	4023A	33
4009	64	4024	1.03
4011	33	4027A	63
4012	33	4028A	1.03
4013	55	4030A	58
4014	1.33		

TRANSISTORS

Value	Price	Value	Price
BC547	20	BC640	30
BC548	20	BD139	59
BC549	20	BD140	59
BC559	20	BF180	59
BC639	30		

SEMI-CONDUCTORS

T.T.L. Digital	10ff	10up	Value	Price
7400	40c	26	LM301	50
7402	40c	26	LM307	70
7404	40c	30	LM308	1.30
7408	40c	28	LM309K	1.95
7410	40c	26	LM324	2.24
7420	40c	26	LM339	1.55
7430	40c	26	LM377	1.95
7447	\$1.50	\$1.26	LM380	1.30
7451	40c	26	LM382	1.30
7454	40c	26	LM3900	1.10
7474	90c	26	LM555	57
7490	80c	65	LM566	2.29
7492	80c	65	LM709	45
74107	\$1.00	45	LM723	55
			LM741	45
			LM1458	72

LINEAR

ELECTROLYTICS

Value	Voltage	10ff	Value	Price
1 uFd	6.3 Axial	13	100 uFd	25 p.c.b. 15
2.2 uFd	25 p.c.b.	8	220 uFd	6.3 p.c.b. 17
3.3 uFd	25 p.c.b.	8	220 uFd	16 p.c.b. 17
4.7 uFd	10 p.c.b.	8	220 uFd	35 p.c.b. 22
4.7 uFd	25 p.c.b.	8	470 uFd	6.3 p.c.b. 22
22 uFd	10 p.c.b.	8	470 uFd	25 p.c.b. 22
22 uFd	50 p.c.b.	15	1000 uFd	10 Axial 35
25 uFd	16 p.c.b.	8	1000 uFd	16 p.c.b. 36
33 uFd	6.3 p.c.b.	9	1000 uFd	25 p.c.b. 47
33 uFd	16 p.c.b.	10	1000 uFd	35 p.c.b. 47
47 uFd	10 p.c.b.	12	1000 uFd	50 p.c.b. 80
47 uFd	25 p.c.b.	14	2200 uFd	50 upright \$1.60
47 uFd	50 p.c.b.	15	3300 uFd	50 upright \$1.75
100 uFd	10 p.c.b.	13	3300 uFd	75 upright \$2.40

DUAL POWER SUPPLY

This simple regulated supply is suitable for most projects requiring a dual voltage.

WITH THE PRICE of operational amplifiers being so low today, their use is becoming very popular among home constructors. These devices, however, normally need a dual power supply voltage, usually +15 and -15 volts.

A simple rectified and filtered supply suffers from the drawback that if it is designed to supply the correct voltage at a reasonable current, when a light load is connected the output may rise to an over-voltage condition. This problem is aggravated by variations in mains voltage. The regulated supply takes care of this problem, and also offers better hum rejection as the ripple voltage is also 'regulated'.

Most of the projects undertaken do not use more than 10 or so ICs and a high powered supply is not required. This simple supply has all the components mounted on the PC board including the transformer. Either of two regulators can be used giving either 40mA or 150mA outputs.

If a different output voltage is required regulators of the desired voltage can be used along with a different voltage transformer. If only a single output is required the unwanted components can be deleted.

To drive a power indicator LED we have provided a current limiting resistor R1. This comes from the unregulated supply so as not to load the regulator.

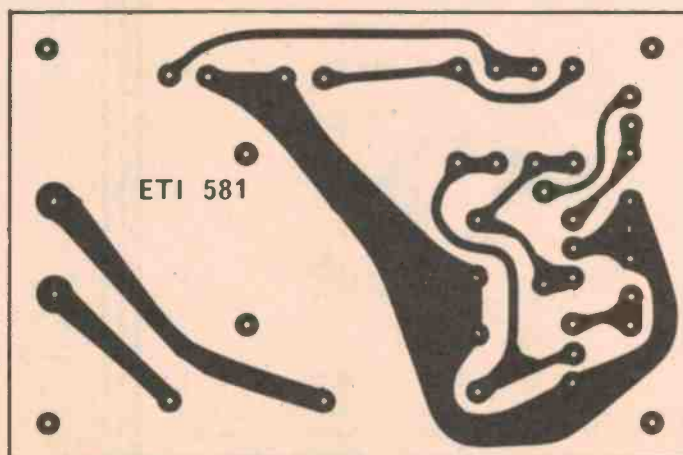
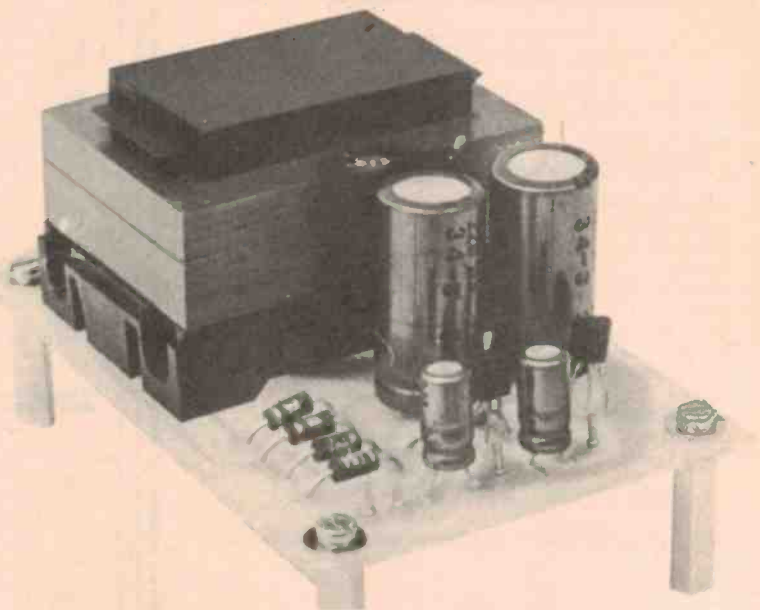

Fig. 1. Printed circuit layout. Full size 90 x 60 mm.

STAX: possibly the most significant improvement to be made to your system.

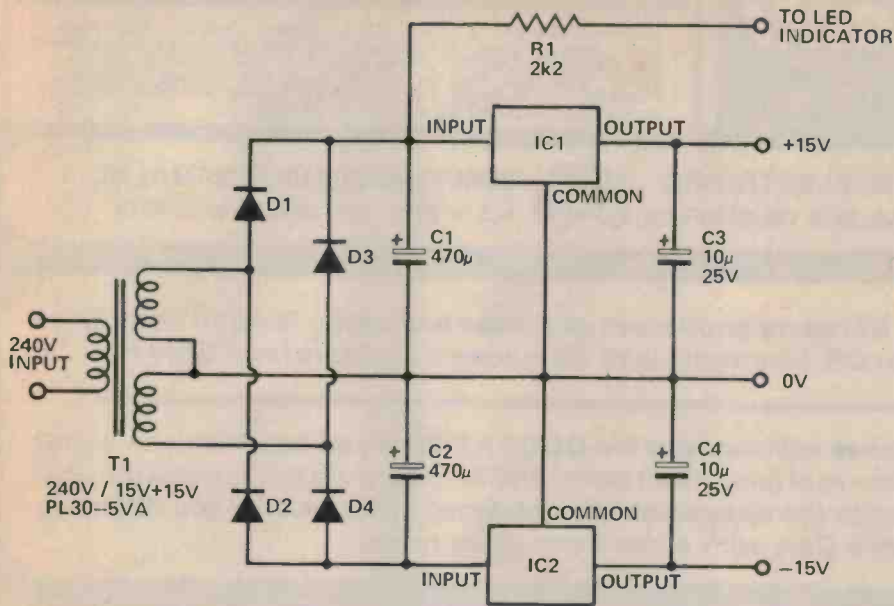

Fig. 2. Circuit diagram of the supply.

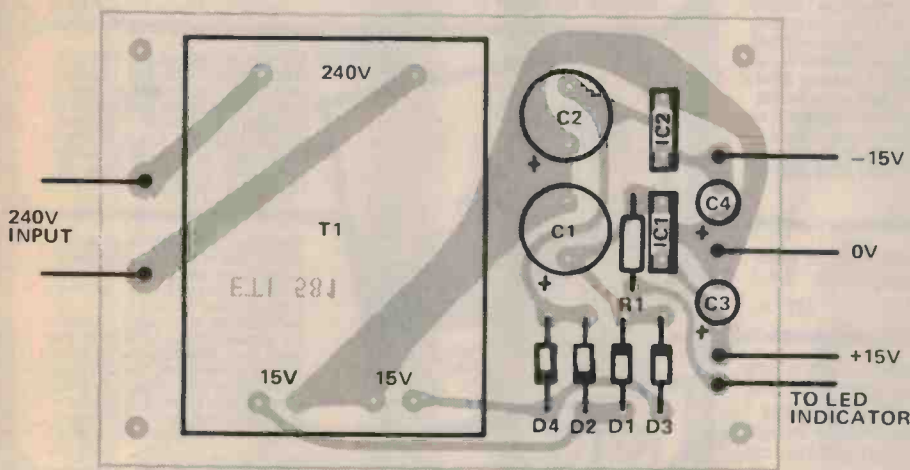
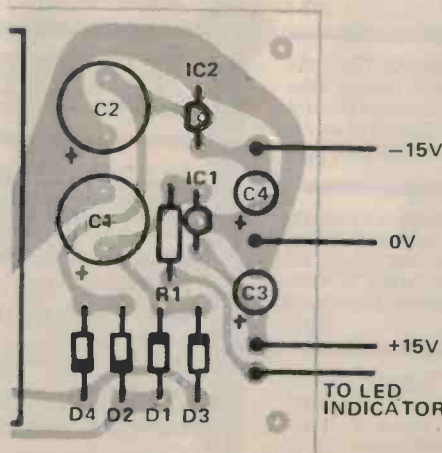

Fig. 3. Component overlay of the higher powered version.

Fig. 4. Changes in the overlay for the low power version.

PARTS LIST — ETI 581		
R1	Resistor	2k2 ½W 5%
C1,2	Capacitor	470µ 35V electro
C3,4	"	10µ 25 V "
D1—D4	Diodes	1N4001
LED1	Indicator	
IC1	Regulator	7815 *
IC2	"	7915 *
T1	Transformer	PL30—5VA

* 78L15 and 79L15 can be used if less than 40mA is required



The more sophisticated your equipment, the more accurately it will reproduce your tonearm's every false move. The more critical it becomes to avoid friction at the pivot point, resonance and mass. We believe the Stax UA-7 to be the best arm in the world. Only you can prove it in your system. Why not listen through a pair of SRX headphones. . . more accurate than any speaker system?

≡ **Stax** ≡

Distributed in Australia by:

INTERDYNE

International Dynamics (Agencies) P/L
P.O. Box 205, Cheltenham, 3192, Vic.
23 Erma Rd., Cheltenham 3192 (Melbourne).
Phone: 95 0366



I/STA/6001 Creative Load

MS Components

(Electronics) Pty. Ltd.

TRADING HOURS

MON-TUES-WED & FRI: 9am-5.30pm. THURS: 9am-7pm. SAT: 9am-12 noon. C.O.D.'s: Please add \$2.40 to posting fee. NO ORDERS UNDER \$4.00 accepted. For replies please send S.A.E. Post and Packing \$1.00 where not included in price. PLEASE . . . PLEASE PRINT YOUR NAME & ADDRESS ON ALL ORDERS AND CORRESPONDENCE.

THE GREAT NAME FOR ELECTRONIC

164-166 REDFERN ST., REDFERN, P.O. BOX 156 REDFERN,



COMPONENTS IN AUSTRALIA

N.S.W: 2016 TEL: 69-5922 or 69-6912

Hi Buffs, Experimenters, CB'ers. Got some good news and some bad news. The bad news first – 'fraid Dick has lost one of his best CB, Electronic, and Component advisers from Gore Hill.

Gary Temple is now at our address as advisor. Now the GOOD NEWS. If you need advice – about CB rigs, antennas, or components – real facts, then come and see Gary. He will tell you the true facts even if it means sending you to the opposition till such times as he can tell you different, AND THAT'S THE TRUTH . . . Here's Gary with some more good news.

First some good news for experimenters. For me there's always been something lacking in kits on the market, and I finally have an inkling of what it is. They are all planned to the last detail and deny us that niggling need to add, to take from and to change them, they deny us the fun of throwing in our own two cents' worth. Most of them we build without really understanding just how they work so we can't readily change them, or they don't work at all. Well, I'm trying to change that. I'm getting some ideas into kits made up of cheap and easy-to-get components mounted into Veroboard. None are overly ambitious or made to serve a specialized function but are basics like oscillators, timers, triggered alarms, counters, frequency dividers. Some transistor, some TTL, some C-MOS, but complete with clear instruction how to build the basic kit and hints and ideas of its possible uses. Most will be worth four or five dollars. If you have trouble with any of these you won't have to cop that blank look from the counter boy when you take it back for help. You can come and see me personally. COME IN, & SEE THESE KITS NEXT TIME YOU'RE PASSING OUR WAY . . . GAZZA

Two transistor oscillator. Suit Continuity Tester. Morse Practise Oscillator. Audio Signal Generator. Switchable Low Frequency Marker. Small Capacity Tester . . . Just \$1.50

KIT '1'

How about this two transistor (LDR) light triggered alarm kit. Suite simple games like, Rifle Shooting with light source, or Find The Bomb game. Just great for parties, try and find the kit in a dark room without activating it armed, only with a flashlight. Experiment with data transmission by light source. Hook it to relay and motor, open your garage doors with your car headlights. A thousand uses . . . Just \$2.50

KIT '2'

Try this two transistor (LDR) darkness triggered alarm kit. Suit Poor Light Photo warning, feed it to a relay and Turn On The House Lights. Great Tail Light Failure warning kit. Just \$2.50

KIT 3.

Here's a handy two transistor (LDR) darkness triggered FLASHING, FLASHING, FLASHING alarm kit. Has real possibilities. For late fishermen, an after dark buoy MARKER. Put this kit on your dash and Find Your Car in a big car park after the show. Give clear flashing warning of any light source failure. Industrial applications by the score . . . Just \$2.60

KIT 4.

Now, a CB EXPERIMENTER'S KIT, a two transistor miniature transmitter. Works at CB frequencies, puts out about 15mW of tone or voice modulated carrier. Can be picked up by any 27meg receiver sixty to a hundred feet away if the wind's right. Fits into a matchbox. Perfect for tuning receive sections of CB marine units or hand helds, but you'll have to find your own 27meg crystal . . . \$4.50

KIT 5

Another CB experimenter's kit, a Constant Volume Output Preamp kit. Add it to telephone amps, intercom systems, PA amps, Tapedecks, Cassette recorders, or work it into the audio stages of your short wave communications receiver to eliminate fading. How about; (if you're good, with the aid of our tiny metal film resistors) packing this into the mike of your CB or 144 portable to serve as a mike compressor. WHY PAY \$48 for a compressor almost as big as the ARRL hand book when you can experiment with this little bottler for a lousy . . . \$4.75

KIT 6.

IS YOUR LIFE WORTH THE PRICE OF A KIT??? Any buff at all that uses mains power, (don't we all) can really find uses for this kit. It sniffs out the fifty cycle mains hum radiating from cable, switches, transformers, appliances with absolutely no physical contact. Very handy too for determining if 50cycle AC is about. even if transformed down to low safe voltages. With red diode warning light the kit's worth Just \$3.00 KIT B P&P \$1. But for greater sensitivity use the meter kit at only \$6.00. KIT 8A. P&P \$1.

KIT 8



ALL KITS INCLUDE CLEAR AND COMPLETE INSTRUCTION AND POSSIBLE USES. THEY ARE PRIMARILY EDUCATIONAL KITS FOR THE EXPERIMENTER OR HOBBYIST. BACKUP REGARDING WIDER USES, OR CONSTRUCTION PROBLEMS WITHIN REASONABLE LIMITS MAY BE SOUGHT FROM OUR TOP ELECTRONICS ADVISOR.

Want to pay \$15 or \$18 for an antenna trimmer 'course you don't (who does?) but then if you don't know how to make a good one, then you haven't got much choice. But now you have a choice. Buy one simple kit. No it doesn't include a box or panel fittings for PL259s, who needs them! Most CB'ers would like to see their trimmer built into their rig or SWR meter, well you've got it, the kit and complete instruction on how to do it with less insertion loss than most commercial units . . . It'll cost you a lousy . . . \$2.50

KIT 9

Here's a couple of TTL kits for those of you breaking into ICs. A three IC counting unit, incorporating a 555, a 7490, and 7447. Simple enough for those already into TTL, but an IDEAL kit for the beginner and completely instructed to cater for the beginner. Not to mention a good run down of possible uses for the unit once working and understood by the constructor. This kit is complete with display, five volt regulation, veroboard, wire, solder, battery connections . . . Just \$8.30 plus P&P.

KIT 10

Another TTL kit. This one is very much like the one above but the final IC the 7447 is substituted for a 7441 making the kit an eleven led chaser with variable speed control and brightness. Once understood, this kit can be used to drive triacs at the mains for chasers at discos, dances, the local water hole. This kit is absolutely complete and worth just \$8.00 KIT 11 Plus P&P.

KIT 11

Ever wanted to build a frequency counter, but not sufficiently inclined or wealthy to come good for a minimum of \$100 for the commercially produced kits just yet. Well, try our mini frequency counter kit. Good to about 100k and a lot of fun to build. If you fancy your self as compact experimenter, there's no reason why you can't get this kit into a mini-box of the buck twenty variety. The kit includes board, wire, solder display . . . Just \$26.95 KIT 12 plus P&P \$1.

KIT 12

SUPER SPECIAL

MINI TRANSISTOR TESTER KIT.

So simple to use and to build yet will tell if a transistor is npn or pnp, which leg is which, leakage between collector and emitter. Even tests diodes. AND, FREE, EXTRA, BONUS. Fifty mixed transistors, marked and unmarked for you to test . . . FOR THIS KIT JUST \$10.00 p&p \$1.00

PNP Car Radio. Transistors 2SB367 — VCE25c 1c 400mA. A \$1 special elsewhere around town, but at MS.C. — 75c. A lousy \$6.50 for 10.

NOW SOME GOOD NEWS FOR THE CB'ERS. If you are passing our 10-20 and not on a 10-17 drop in and eyeball and let us give you a 10-9 on our latest. THE ROYCE 23CH CB UNIT. Not only a 23ch CB but an AM/FM STEREO RADIO too. But it's handsome. GOT TO BE EYEBALLED TO BE BELIEVED. Yours for \$195 even.



PRICE
\$195

SPECIAL . . . SPECIAL . . . SPECIAL!!! C.B. Power Supply Kit. Provision for independent 9V bench supply @ 2.5 amp. Kit Consists of metal case, 3 tap H.D. Transformer . . . (20V-6.3V-117V) ready assembled bridge rectifier, filter capacitor and 2 transistors, etc. Complete with instructions. Easy to build. **ONLY \$28.00. P & P \$3.00. Limited stock only.**

And now for the road Knight's gear jamming eighteen wheelers. If you want to get above the advertised propaganda splashed every where about CB RIGS, if you want to see CB, talk CB and do it with some one that knows CB, not a counter-jumper, it'll be my pleasure if you drop in. I've sweated my butt off in front of a 22tonne load or two in my time, and hauled wheat back of Moree on dust roads so potted you could lose your spare tyre in some of the holes if it fell in. You tell me what you want out of CB and your driving conditions I'll tell you your best buy. If we haven't got what I reckon you need, I'll send you to who has, that's no bull-bar. Something I don't need is a 16 stone Interstate gear jammer after my butt cause I pointed him the wrong way.



NOTE . . . KNOBS . . . Knobs for your hi-fi equipment — CB and projects. We've got some beautiful solid aluminium machine turned knobs, all sizes all styles at fifty to eighty cents each. **THESE ARE REALLY PRETTY.**



And now just to come back for the final, we've got a range of antennas from helicals to baby gutter mounts, \$29 to \$19.95 all covered, RF signalizers at \$42, extension horns and PA speakers around ten, eleven bucks, good quality PL259's at \$1.95 and the CALCOM CB BOOKS, at about four bucks. If you can't get in right now, at least give me a bell on the land line. Well for now I'll back up and stand on the side, perhaps catch you on the co-ax . . . I'm gone.

SNOOPER RADAR UNITS

Why settle for backyard brands. Sensitivity is not enough, nor looks, you need selectivity. What use is a RADAR DETECTOR, that detects everything from DC to DAYLIGHT. BUY AMERICA'S BEST SELLER, THE "SNOOPER". Complete with full instructions, and get a Radar Detector not a BROADBAND RECEIVER. STANDARD SNOOPER \$115.00 and SUPER SNOOPER at \$189.00 p&p \$2.50.

I found some solid state relays too. Anyone working with alarm systems will find use for these. They'll carry 5 amps and 250 V switch and need 3 to 32 V volts to work efficiently. They're about five by five centimetres by three deep, solid encapsulation. The weather won't hurt these . . . yours for \$3.50 each. Plus P&P \$1.

Bundles of hook up wire in all colours and lengths with pre-stripped ends. I figured if I mixed up the colours some and made up a fist size bundle of assorted lengths, with hook-up wire ten cents a meter off the roll now-a-days, a decent bundle would have to be worth a \$1.00.

RESISTORS. Metal film, half watt (bout the size of normal one-eighths) for a lousy three cents each. Almost every popular value covered up to the meg range. 3c Plus P&P.

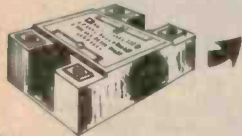

Get started in Electronics Kit. That's right, a kit with . . . 200 resistors, 100 capacitors, 50 transistors, 25 diodes, 10 potentiometers, 10 assorted, trimpots hookup wire, solder, board, tag strips and **FREE GIFT PACKAGE.** Compliments of MSC, the cheapest parts dealer in town, and finally, **INSTRUCTIONS,** in how to complete 25 experiments, and projects. **JUST A LOUSY \$20.00 p&p \$2.50.** Same kit with a soldering iron and multimeter \$42.00 p&p \$4.00.

I admit when it comes to speakers, turntables, crossovers and the like I'm done, out of my depth, just not my bag, but I couldn't help notice a new blank cassette in stock called G TAPE, C90. It's guaranteed to have a 20 to 20k response, screwed case, and written guarantee against faults in material and workmanship. Sounded good value to me at only 99c plus P&P. What do you audio buffs think?

SUPER SPECIAL, JUST IN. RF TRANSISTORS, Good to 470megs, at two watts output, Photo copy of specs available for 20cents. Would be perfect as drivers for that FM LINEAR. Only four hundred in stock, and they will not last long at only \$1.95 each.

2N5944

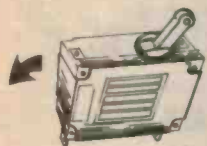
A SUPER EXTRA SPECIAL, 10 FOR ONLY \$15.



Found some Lag switches (circuit breakers) out back. Neat, small, one amp drop-out. Electricians, and you buffs working with power supplies will find good uses for these. **Just \$2.00 each plus P&P.**

MSC QUICK LIST

S.W.R. Meters, three types in stock. Single meter, \$16. ASAHI dual meters, \$29. TOYO, model VM-1E dual meter only \$31. Two PL259's, with 100cms co-ax inbetween, \$3.00.

CURLY CORD for that mike \$1.50. AMPHENOL PL259's, COMPLETE WITH REDUCING ADAPTOR, \$1.95. Got ELBOWS, 'T' PIECES, and JOINERS to sell with our CO-AX do COME IN, SEE. PLEASE DON'T FORGET P/P IS EXTRA.

WE HAVE A REAL SPECIAL FOR THIS MONTH ONLY

CB POWER SUPPLY But Good

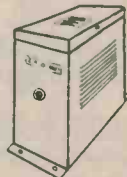

All Parts — including approved 3AMP Star Delta Transformer, 3AMP 200V Bridge Rectifiers complete with full building instructions. **\$42.50. P&P \$6.00.**

We've got good stocks of the 3AMP 200W full wave recs (filtered) if you've got your own trans. They are just \$2.00. Plus P&P 50c.

PAC No.	CONTENTS	PRICE
SC. 2	100 Assorted T018 & T05 NPN & PNP Silicon Transistors	\$2.50
SC. 3	5 T066 (2N3054 Series) Transistors & 5 MS3055-1 (Marked) Power Transistors	\$0.90
SC. 4	100 100V 3 amp Plastic Rectifiers	\$4.50
SC. 5	100 100V 5 amp T05 Metal Case Rectifiers	\$5.00
SC. 6	20 2N3055-1 (Unmarked) Power Transistors	\$3.00
SC. 9	50 EM402 Diodes, 200V 1 amp	\$3.00
SC. 10	50 EM404 Diodes, 400V 1 amp	\$3.75
SC. 11	50 EM406 Diodes, 600V 1 amp	\$4.00
SC. 12	50 EM408 Diodes, 800V 1 amp	\$4.25
SC. 13	50 EM410 Diodes, 1000V 1 amp	\$4.75

P&P 50c A PAC

THE RAMSGATE C.B. BARGAIN MART

CUTBACK ON PRICES

Resistors:

All values to 1/4 & 1/2 watt. 3c each 100 up 2.5c each.
1 watt Power: 5 watt 0.1 to 10 preferred values. 45c each. 10 up 40c each.

Capacitors:

Ceramics: All preferred values from 1 pf to 0.033 uF. 10c each. 25 up 8c ea. 0.047 to 0.1 uF. 17c ea. 25 up 15c ea. 0.47 uFd 30c ea. 25 up 25c ea.

ELECTROLYTICS:

Value	Voltage	1 off	25 up
1 uFd	6.3 Axial	15c	13c
2.2 uFd	25 p.c.b.	10c	8c
3.3 uFd	25 p.c.b.	10c	8c
4.7 uFd	10 p.c.b.	10c	8c
4.7 uFd	25 p.c.b.	10c	8c
22 uFd	10 p.c.b.	10c	8c
22 uFd	50 p.c.b.	17c	15c
25 uFd	16 p.c.b.	10c	8c
33 uFd	6.3 p.c.b.	11c	9c
33 uFd	16 p.c.b.	12c	10c
47 uFd	10 p.c.b.	14c	12c
47 uFd	25 p.c.b.	16c	14c
47 uFd	50 p.c.b.	17c	15c
100 uFd	10 p.c.b.	16c	13c
100 uFd	25 p.c.b.	18c	15c
220 uFd	6.3 Axial	20c	17c
220 uFd	16 p.c.b.	20c	17c
220 uFd	35 p.c.b.	26c	22c
470 uFd	6.3 Axial	25c	22c
470 uFd	25 p.c.b.	25c	22c
1000 uFd	10 Axial	38c	35c
1000 uFd	16 p.c.b.	40c	36c
1000 uFd	25 p.c.b.	52c	47c
1000 uFd	35 p.c.b.	52c	47c
1000 uFd	50 p.c.b.	89c	80c
2200 uFd	50 upright	\$1.80	\$1.60
3300 uFd	50 upright	\$2.05	\$1.75
3300 uFd	75 upright	\$2.70	\$2.40

SEMI-CONDUCTORS:

T.T.L. Digital	1 off	10 up
7400	40c	35c
7402	40c	35c
7404	40c	35c
7408	40c	35c
7410	40c	35c
7420	40c	35c
7430	40c	35c
7447	\$1.50	\$1.40
7451	40c	35c
7454	40c	35c
7474	90c	85c
7490	80c	75c
7492	80c	75c
74107	\$1.00	90c
ULM 3000S (Hall effect switch)	\$6.00	\$5.50

C/MOS

	1 off	10 up
4000	40	35
4001	40	35
4002	40	35
4006	2-50	2-25
4007	40	35
4008	2-75	2-50
4009	80	70
4011	45	40
4012	40	35
4013	1-00	90
4014	2-25	2-05
4016	85	75
4017	2-25	2-05
4018	2-50	2-25
4021	2-30	2-10
4022A	1-90	1-70
4023A	45	40
4024	1-35	1-20
4027A	1-00	90
4028A	1-90	1-70
4030A	80	70

LINEAR

	1 off	10 up
LM301	70	60
LM304	1-30	1-20
LM305	1-20	1-10
LM307	70	60
LM308	2-30	2-10
LM309K	2-80	2-60
LM319	2-80	2-60
LM324	3-20	3-00
LM339	3-20	3-00
LM377	2-80	2-50
LM380	1-50	1-35
LM382	2-45	2-30
LM3900	1-50	1-25
LM555	85	75
LM566	4-50	4-30
LM709	45	40
LM723	1-00	90
LM741	45	40
8038	6-95	6-50
LM1458	1-50	1-30

TECHNICAL
ADVICE FREELY
AVAILABLE

Project boxes, various sizes from \$1.20 to \$6.00. TV antennas and accessories, valves, dial parts, coils, semiconductors, sockets, brackets, heatsinks and most other popular parts for the enthusiast.

PLEASE INCLUDE STAMPED ADDRESSED ENVELOPE

OR RUSH REMITTANCE FOR OUR
RAPID MAIL ORDER SERVICE

(Min. mail order \$5.00, some items limited stock
(add \$1 P&P for items not otherwise marked)

WHOLESALE ENQUIRIES WELCOME

P.O. Box 38, Ramsgate, 2217

AERO ELECTRONICS

Shop 13, 191 Ramsgate Road, Ramsgate. Phone (02) 529-7438
(Cnr. Alfred St. Behind Commonwealth Bank)

CB RADIO

AT
AMAZING
PRICES



EXPO SSB
MADE BY PACE
INTERNATIONAL
ASTOUNDING VALUE
AT ONLY \$279.00
(\$2.50 P. & P.)

AIMOR 23CH AM
WITH BASE LOADED
ANTENNA
ONLY \$98.00
INCREDIBLE!
(\$2.50 P. & P.)

And the latest EXPO 23ch. AM. BOBCAT with delta tune. A.N.L. Squelch, P.A. 5W input. A beaut set for those who appreciate A.M. Great Value at only \$109.00. AND S.W.R. meters \$28.50. Helical antennas complete with cable, plug and base, \$28.50 and plugs, Coax, dummy loads, lightning arrestors, etc.

CALCULATORS CRASH

FAMOUS NOVUS Brand at
prices you can count on.
MODEL 750. Handy pocket
size ONLY \$8.30
MODEL 832. With per cent key
\$12.45



THE 4510

RPN Logic. For fast and accurate handling of sequence calculations. You work with only two numbers at a time; solve problems naturally. 3-Level Stack: Saves intermediate answers for further operations in chain calculations. All Arithmetic Functions. Trigonometric Functions: sine, cosine, tangent, and the inverse trig functions. Logarithmic Functions: Log, Ln, ex. Radian to Degree Conversions. Other Functions: Automatic square and square root, Pi entry key, yx, 1/x, change-sign key, register exchange key. LED: displays 8 significant digits: full-floating-decimal system.

Roll-Down Clear: clears one register at a time, last entry first. Separate: Addressable, Accumulating Memory: with M 1/2, M-, Mx1. Low Battery Indicator. Operates on standard 9-volt transistor battery. (Optional AC Adapter available). Operations Handbook.

ONLY \$26.80

MODEL 4520

Full scientific and mathematical functions, with NI-CAD rechargeable battery & charger included

ONLY \$56.20

MARINE BAND CRYSTALS
available shortly \$6.50 A PAIR.

STUDENTS:

On presentation of your registration card or your enrolment slip we will offer you a discount.

bankcard
welcome here

8.30 — 5.30 Mon-Fri.
8.30 — 8.00 Thurs.
8.30 — 12.30 Sat.

TELEPHONE BELL EXTENDER

This simple project allows you to leave the phone unattended as you move about the house.

MANY TIMES WHILE you're working in the garden the phone may ring and by the time it is heard, if it is at all, it is often too late to reach the phone. While the PMG will install a remote buzzer for you it has to be rented and for people who are hard of hearing it may not be loud enough.

This bell extender will allow you to add, without touching the phone, an external bell, buzzer or speaker anywhere it is desired. When using a horn loaded speaker the sound level is high enough to be heard over high ambient noise making it ideal for the industrial environment.

Adjustment

There are two controls to be set, these being sensitivity and volume. The volume can be set first by rotating RV1 until the tone starts then adjusting RV2 to give the desired volume. To adjust the sensitivity first tape the sensor coil to the underside of the phone and then adjust RV1 until the sound stops. Note however that it should be rotated slowly as C3 gives a delay on switch off. Check that picking up and replacing the phone does not operate the alarm then have someone ring you to check that the phone tone does. It may be necessary to experiment with the position of the pickup coil to get the best results.

Construction

While any construction method could be used we recommend that the PC board be used and the overlay in Fig.3 be followed. The pickup coil was made out of 0.125 mm enamelled wire, although the gauge is not important,

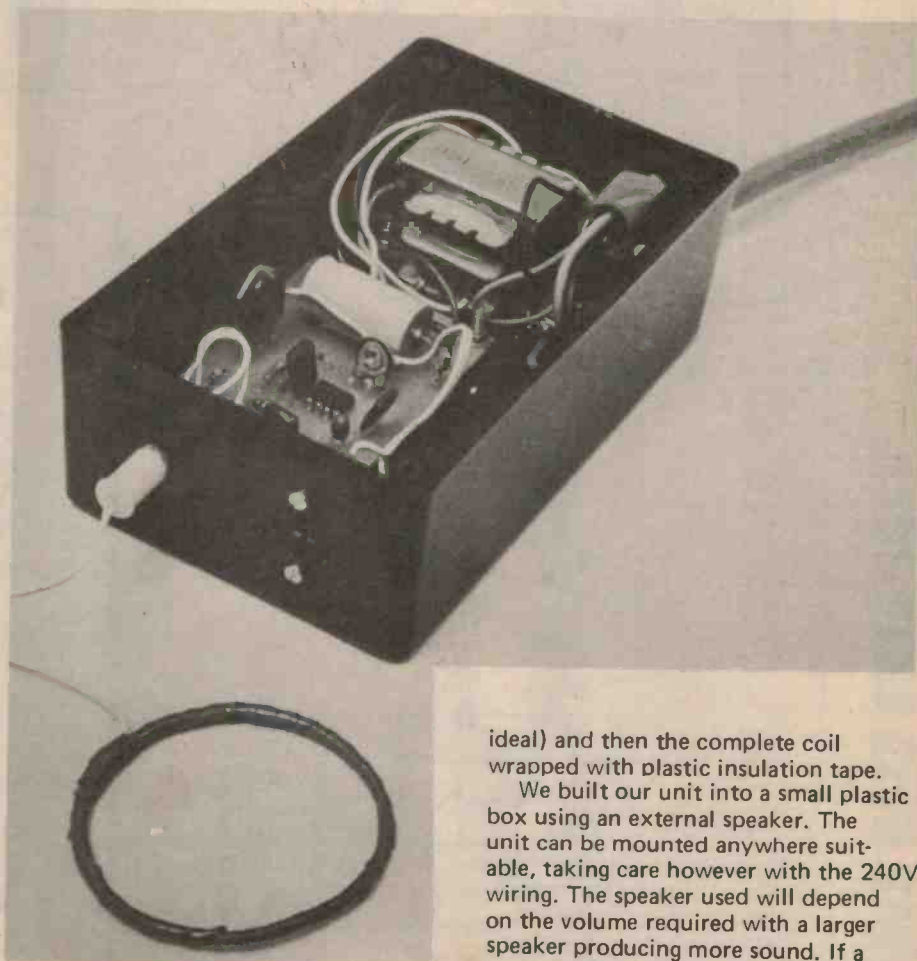

with about 200 turns wound around a mandrel about 50 mm diameter. The mandrel can then be removed, the wires terminated to some thin plastic insulated wires (twin "bell" wire is

ideal) and then the complete coil wrapped with plastic insulation tape.

We built our unit into a small plastic box using an external speaker. The unit can be mounted anywhere suitable, taking care however with the 240V wiring. The speaker used will depend on the volume required with a larger speaker producing more sound. If a horn speaker is used a very high sound level can be produced.

If it is required only to operate a buzzer the second IC can be altered to be an on-off device by deleting C5, R5, R6, D2 and RV2 and placing a link where C5 was.

TELEPHONE BELL EXTENDER

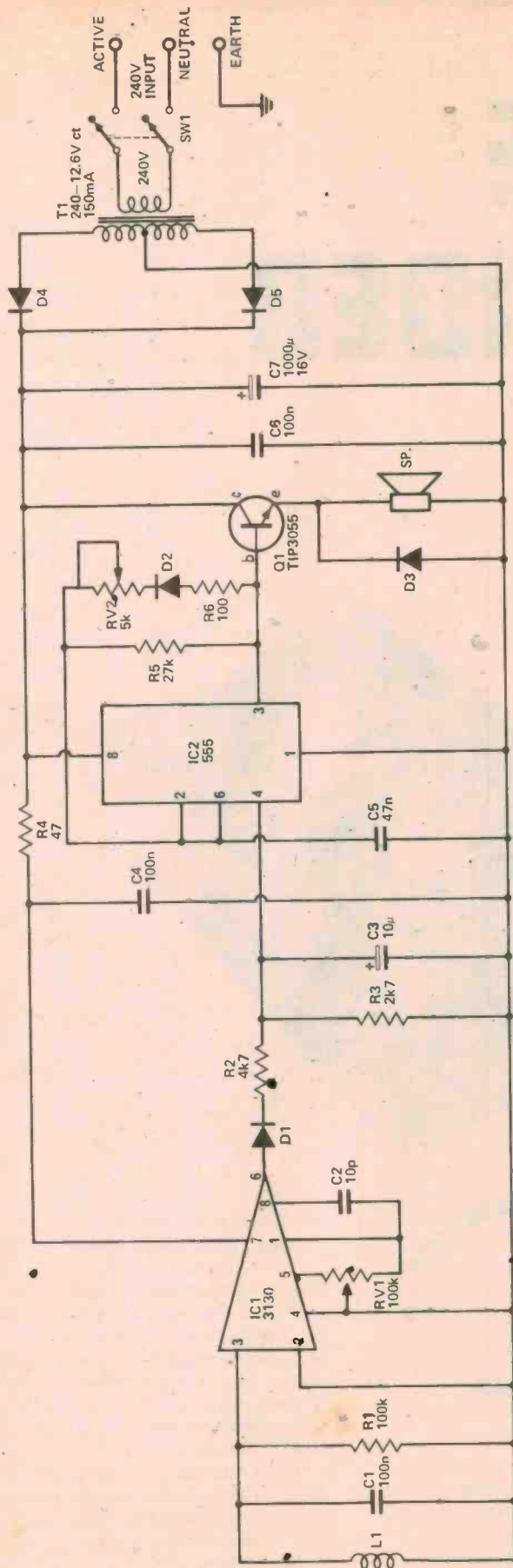

Fig. 1. Circuit diagram of the bell extender.

How It Works — ETI 547

Inside the telephone there is a solenoid which operates a striker which hits a pair of bells to give the ring tone. When it operates there is a high magnetic field generated and we detect this field to give the indication that the bell is ringing. To do this we use a coil wire under the telephone and use an IC to detect the presence of a signal. IC1 has its offset voltage adjusted by RV1 such that a slight positive voltage is needed to make the output go high. It is used in the open loop mode as a comparator only. The capacitor C1 is used to remove the unwanted higher frequency signals.

The oscillator used to operate the speaker is simply a 555 timer with a TIP3055 to buffer the output. The fre-

quency is determined by C5 and the volume by RV2. Changing the volume does change the frequency slightly. Oscillation can however only occur if the voltage at pin 4 is greater than 0.6V. If the output of IC1 is low, R3 ensures that pin 4 is less than this voltage. However when the bell rings the output of IC1 oscillates high and low in time with the ring tone of the bell. This lifts pin 4 high, allowing IC2 to oscillate and C3 holds pin 4 for a short time to prevent the oscillator turning on and off at the ring tone frequency.

The power supply is a simple full wave rectifier with no regulation with IC1 being decoupled further by R4 and C4. Batteries could be used but the drain is reasonably high.

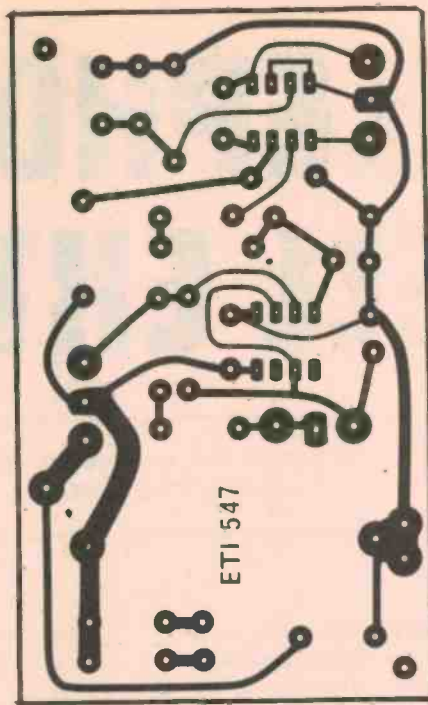

Fig. 2. Printed circuit layout. Full size 91 x 53 mm.

PARTS LIST — ETI 547

Resistors all 1/4W 5%

- R1 100k
- R2 4k7
- R3 2k7
- R4 47
- R5 27k
- R6 100

Potentiometers
RV1 100k trim
RV2 5k trim

Capacitors

- C1 100n polyester
- C2 10p ceramic
- C3 10µ 16V electro
- C4 100n ceramic
- C5 47n polyester
- C6 100n ceramic
- C7 1000 µ 16V electro

Semiconductors

- IC1 CA3130
- IC2 NE555
- Q1 TIP 3055
- D1-D5 1N4001

Miscellaneous

- PC board ETI 547
- Transformer 240V — 12.6 V ct
- Mains switch, 3 core flex
- Box, speaker, pickup coil

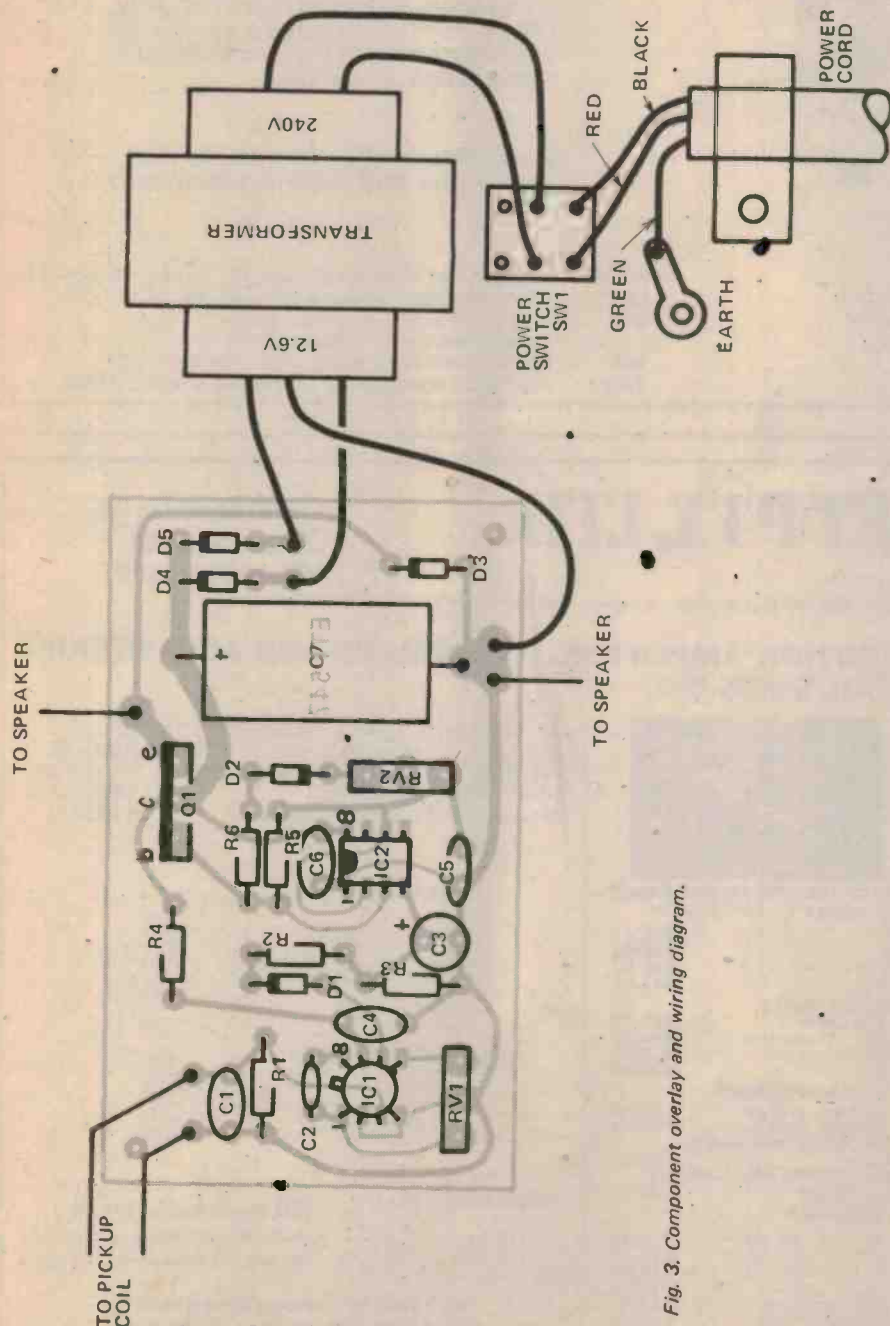

Fig. 3. Component overlay and wiring diagram.

ELECTRONIC DISPOSALS

297 Little Lonsdale St.,
Melbourne, 3000
Phone 663-1785

- Pioneer Tone Arms \$15.00 ea.
- AWA Solid State TV Tuners \$7.50 ea.
- AWA Thorn Valve TV Tuners \$5.00 ea.
- EHF Stick Rectifiers 13KV, 18KV, 20KV 75c ea.

Plessey 8" 10W 8Ω or 15Ω \$6.50 ea;
8" x 4" 8Ω 6W \$4.00 ea; 4" 8Ω \$1.50 ea;
M.S.P. 4" 15Ω Tweeters \$3.50 ea.
Many other types in stock.

- 12V DC 5 Ω Solenoids \$2.00 ea.
- 12V AC Min. Relays 5 Amp. \$1.50 ea.

Slide Pots. 20K to 3meg. Singles 35c ea.
Dual 60c ea.

Resistors. Most values 1/4 to 1 Watt. 3c ea.
Carbon Pots. Most values 30c ea. Duals 60c ea.

Skeleton Preset Pots 100Ω to 3 meg. 8c ea.
Green Caps .001 to .022µF 5c ea.
.033 to .22µF 10c ea. .47 to .68µF 15c ea.

Polystyrene Capacitors. Many Types 5c ea.

Disc Ceramics. Large Range. 5c ea.
Polyester Capacitors. Large Range. Up to 1.5µF 250V 10c to 25c ea.

New Desk Telephones — Grey. \$15.00 ea.

Polyester Capacitors 6.8µF and 3.3µF 60c ea. 2.2µF 40c ea. Tantalum Capacitors. Good range 15c ea.

BC.107 and 109 Transistors 10c ea.

OA636 1000V 2A Fast Recovery Silicon Diodes — TV Type 25c ea.

Dual 100 Ω 3W Wire Wound Pots. \$1.25 ea.

S.C.R. BT100A 300V 2AMP 60c ea.

Triacs. 2AMP 400V 60c ea.

2M3055, 90c ea. AD149, \$1.00 ea.

AY8110, 80c ea. OC912, \$1.00 ea.

AY8139 and 9139, 45c ea. IN914 diodes

10c ea. 5 amp AC panel meters \$3.50 ea.

2500 µF 35V P/T electrolytics, 60c ea.

2200 µF 25V P/T electrolytics, 40c ea.

Aluminium and plastic instrument boxes and ARLEC multimeters **NOW IN STOCK.**

Also in stock — large range of electrolytic capacitors — wire wound resistors — switches — panel meters — transistors — diodes — plugs — sockets — edge connectors — vero board — transformers — chokes. We could go on and on, so call in and browse around and check our low, low prices.

25 MHz Bandwidth

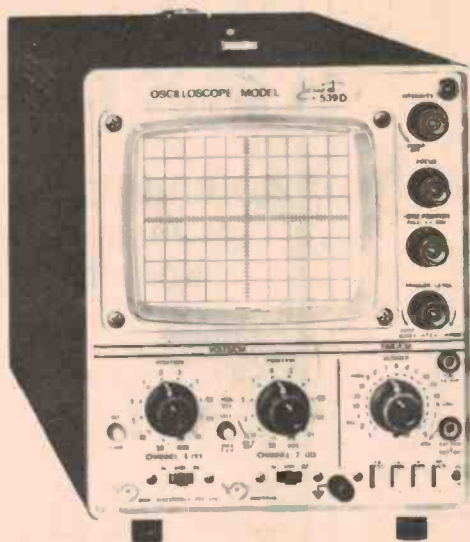

● 5mV Sensitivity

● 30MHz Triggering

Dual Trace Oscilloscope

at a price you expect to pay for half this performance.

The new BWD 539D is superb for CB Radio, μ Processors, Video recorders, Colour TV, Audio systems, Video games or any application where waveform fidelity and measurement accuracy is essential.

Break through the performance barrier.
Ask for your BWD 539D data sheet today.

BWD

ELECTRONICS PTY. LTD.
Miles Street, Mulgrave, Victoria. 3170.
P.O. Box 325 Springvale, 3171.
Telephone 561 2888 Telex 35115

N.S.W. Amalgamated Wireless (A'asia) Ltd., Sydney. Ph. 888 8111
QLD. Warburton Franki (Brisbane) Pty. Ltd., Phone 52 7255
S.A. Protronics Pty. Ltd., Adelaide. Phone 51 4713
Rogers Electronics, Adelaide. Phone 42 6666
W.A. Cairns Instrument Services, Perth. Phone 25 3144
TAS. Associated Agencies Pty. Ltd., Hobart. Phone 23 1843

W10

ELECTROCRAFT PTY. LTD.

106A Hampden Rd.
Artarmon, 2064
Phone 411-2989

Distributors of Belling Lee, Channel Master, Ecrafft, Hills, HI.Q, Lab Gear, Kingray, Matchmaster. Largest Television range of aerial equipment in Sydney.

**TELEVISION AERIALS, DISTRIBUTION AMPLIFIERS, EQUIPMENT AND ACCESSORIES
WHOLESALE, TRADE AND RETAIL SUPPLIED.**

ECRAFT

	Price
Neosid Balun 75/300 uncased	\$0.65
O S A B Outside aerial balun (water proof)	3.81
6 SB 6ft Balun Fly Lead	3.65
P S B Plug and Terminal Balun	2.53
2 75 T/S 2-way 75 ohm Transformer Splitter	6.74
3 75 T/S 3-way 75 ohm Transformer Splitter	8.41
4 75 T/S 4-way 75 ohm Transformer Splitter	8.94
5 75 T/S 5-way 75ohm Transformer Splitter	12.66
2 3T 2-way 300 ohm Splitter box	4.48
3 3T 2-way 300 ohm Splitter box	5.86
4 3T 2-way 300 ohm Splitter box	7.12
Adjustable Low Band Attenuator Ch 2	5.33
10" diameter degaussing coil	24.00
Coaxial Plugs	46c

All Types of Coaxial Cable In Stock from 30c Per Yard.

TELEVISION AERIALS FOR COLOUR

CHANNELMASTER

9el Colour Crossfire 3615A	\$43.64
13el Colour Crossfire 3614A	\$54.69
17el Colour Crossfire 3613A	\$68.17
21el Colour Crossfire 3612A	\$78.54
24el Colour Crossfire 3617A	\$99.84
28el Super Crossfire 3617A	125.73
Super Coloray the 3111 Ghost Killing Aerial	\$41.98
2el Small Coloray 3110	\$27.96

HILLS E.F.C. RANGE 75 ohm

E F C 1 75 ohm	\$31.43
E F C 2 75 ohm	\$41.70
E F C 3/24 75 ohm	\$60.64
E F C 4/24 75 ohm	\$76.30

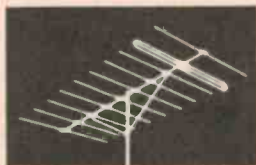

HILLS THE NEW TELRAY RANGE—

All Australia V.H.F. Channels & F.M.

6el	TL1	\$21.47
8el	TL2	\$29.52
9el	TL3	\$35.97
11el	TL4	\$43.67

HILLS AERIALS

2010	Airways	\$56.26
CA16	Phased Array	\$44.36
	Extra Gain Lift els for CA16	\$ 5.01
8el	215	\$24.42

HILLS AMPLIFIERS

05/26	Dist. 26dB gain	\$67.10
04/16	Dist. 16dB gain	\$59.37
MH2/75	Mast Head 20dB gain	\$72.44
75 ohm		
MH1/300	Mast Head 20dB gain 300 ohm	\$54.90

FM AERIALS

Hills	2EL FM1	\$ 9.39
HILLS	3EL 353	\$12.98
Hills	3EL FM3	\$18.27
HI-Q	4EL	\$18.75
HI-Q	Gutter clip	\$12.70
Matchmaster	G2FM	\$19.25
Austenna	FM3F	\$21.95

27 MHz high quality transceivers. Range up to 20 miles, 5 watts output. Switched PA suitable for dash mounting. Model G.M.E. 275 6 Ch's (Post Office Approved) \$156.00
Model G.M.E. C555 23 Ch's \$163.00

LAB GEAR AMPLIFIERS

VHF

	Price
Mast head 22 dB 75 ohm	\$72.43
CM 6014/OA 20 dB	60.25
CM 6034/OA 4 outlets 8 dB each	54.90
CM 6036/OA VHF 30dB UHF 28dB	84.63
Televerta (VHF to UHF frequency converter)	67.48

KINGRAY AMPLIFIERS

	Price
015/500 m/V	\$48.80
030/500 m/V	57.95
040/600 m/V	79.30
012/1500 m/V	67.10
MH 20 mast Head 300-75 ohm	64.63

TELESCOPIC MASTS

20ft	18g steel in	\$19.30
30ft	10h sections	\$30.81
40ft	must be guyed	42.00
50ft		54.42

CDE AR.22 Rotator \$79.00

Stolle Aerial Rotator with Thrust Bearing for heavier rigs \$115.56

ALL TYPES OF HARDWARE IN STOCK

Wall Brackets, Chimney Mounis, J Brackets, Guy Rings & Guy Wire. Masts from 8ft to 50ft.

555 TIMER APPLICATIONS

DESCRIBED BY R.M. MARSTON PART 3

In Part Three of this series we look at a variety of applications for the astable multivibrator.

MISCELLANEOUS ASTABLE APPLICATIONS

The 555 astable multivibrator has three outstanding advantages over other types of astable circuit. First, its frequency can be varied over a wide range via a single resistive control. Second, its output has a low impedance and can source or sink current up to 200 mA. Finally, its operating frequency can readily be modulated by applying a suitable signal to pin 5 of the IC. These features make the device exceptionally versatile, and it can be used in a vast range of practical applications of interest to both the amateur and professional user.

Morse Practice Oscillator

Figure 21 shows how the 555 timer IC can be used as a morse-code practice oscillator. The circuit acts as a normal astable, with frequency variable over the approximate range

300 Hz — 3 kHz via TONE control R3. The 'phone volume is variable via R5, and the 'phones can have any impedance from a few ohms up to megohms. The circuit draws zero quiescent current, since the normally-open morse key is used to connect the circuit to the positive supply rail, which can have any value in the range 5 volts to 15 volts.

Figure 22 shows how the 555 astable circuit can be used in LED flasher applications. This circuit operates at approximately 1 Hz, and has a single LED. The Fig 22 circuit has a single LED output, the dotted section shows how a second may be added, such that one LED is on while the other is off, and vice versa. Any types of LED's can be used in this circuit. Series resistors R1 or R4 determine the ON current of each LED.

Figure 23 shows how the Fig 22 circuit can be modified to

Fig.21. Code-practice oscillator with variable tone (300 - 3kHz) and variable volume.

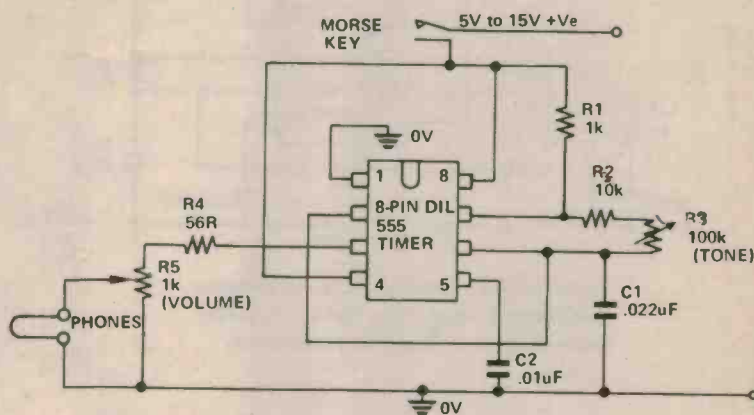
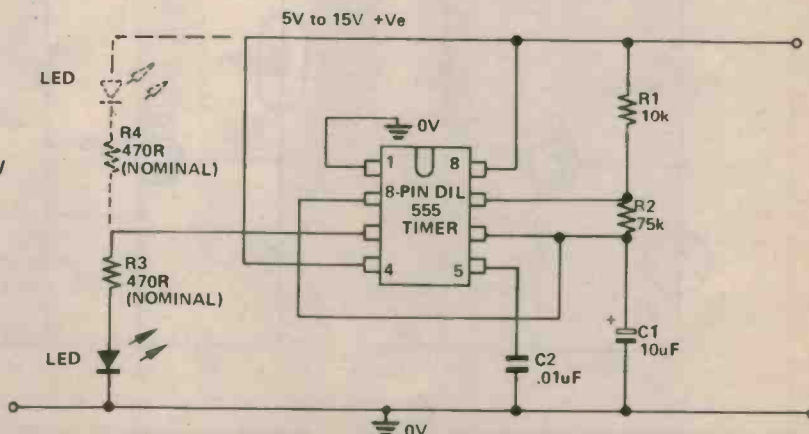

Fig.22. Single and dual output LED flashers give symmetrical 1 Hz outputs.



555 TIMER APPLICATIONS

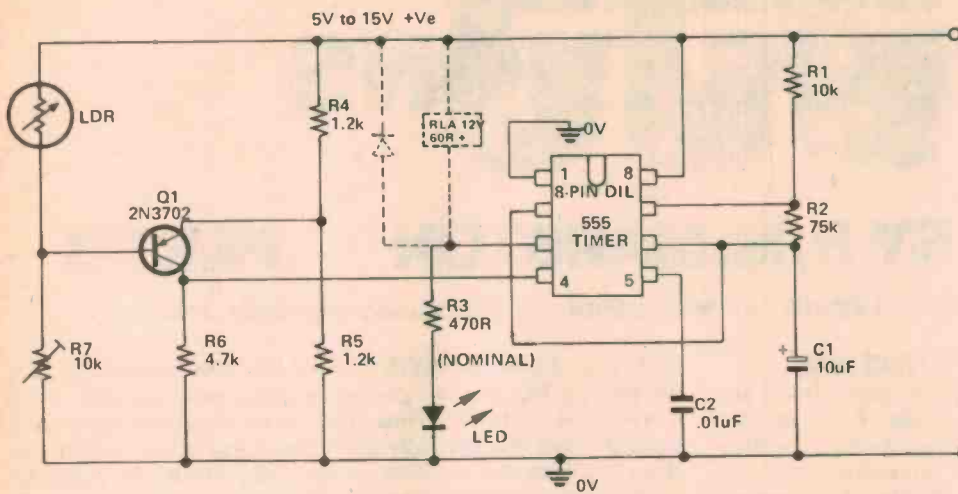

Fig. 23. Automatic (dark-activated) flasher.

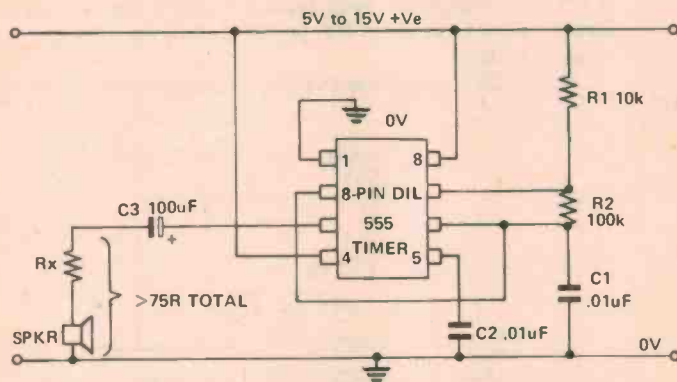
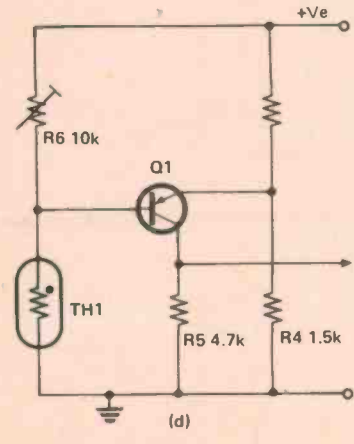
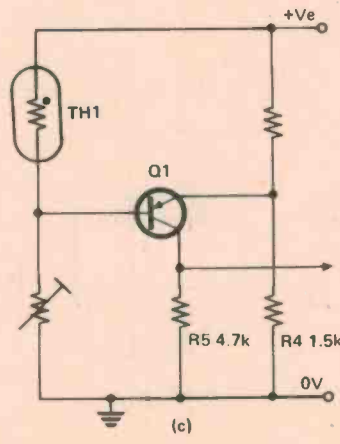
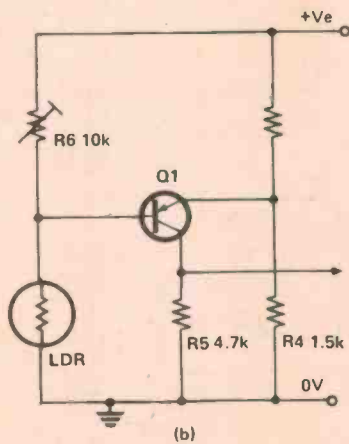
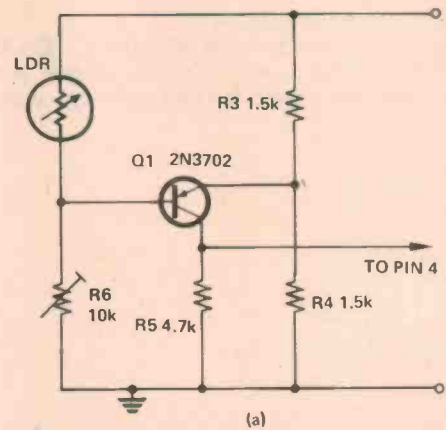

Fig. 24. 800Hz monotone alarm call generator
a) activated by dark, b) by light, c) by under-temperature, and d) by over-temperature.



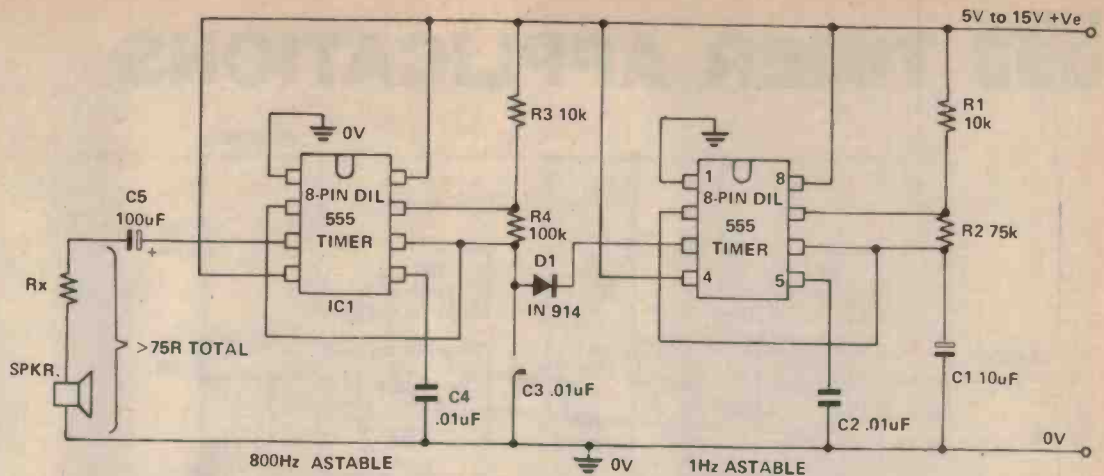

Fig. 25. Pulsed-tone (800Hz) alarm call generator.

give automatic dark-activated operation. Here, R4 and R5 are wired as a fixed potential divider that sets $1/2 V_{cc}$ on the emitter of Q1, LDR and R7 are wired as a light-sensitive potential divider that applies a variable voltage to the base of Q1, and the collector of Q1 is taken to RESET pin 4 of the IC, which is normally biased to ground via R6.

In use R7 is adjusted so that the voltage to the base of Q1 is greater than $1/2 V_{cc}$ under 'daylight' conditions, so Q1 is cut off, but under 'dark' conditions Q1 base is biased below $1/2 V_{cc}$, so it is driven on, thus, under daylight conditions Q1 is cut off, so the 555 astable is disabled, with its output driven low, by 4.7 kΩ resistor R6 which is wired between pin 4 and ground. Under 'dark' conditions, on the other hand, Q1 is biased on, so pin 4 is positively biased, and the astable operates normally and activates the LED.

The LDR used in the above circuit can be any cadmium-sulphide photocell that presents a resistance in the approximate range 470 Ω to 10 kΩ under the minimum 'dark' turn-on condition.

The dotted section shows how the 555 astable circuit can be used as a 12 volt relay pulser, which turns the relay on and off at a rate of one cycle per second. The relay can be any type with a coil resistance greater than 60 Ω.

Alarm Generator

Figure 24 shows the connections for making an 800 Hz monotone alarm-call generator. The circuit can be used with any supply in the range 5 to 15 volts, and with any speaker impedance. Note, however, that Rx must be wired in series with speakers of less than 75Ω impedance, and must be chosen to give a total series impedance of at least 75 Ω, to keep the peak speaker currents within the 200 mA driving constraints of the 555. The available alarm output power of the circuit depends on the speaker impedance and supply voltage used, but may be as great as 750 mW when a 75 Ω speaker is used with a 15 volt supply.

The above circuit can be modified so that it is activated by darkness (a), by brightness (b), by an under-temperature (c), or by an over-temperature (d). Pin 4 is disconnected from the +Ve supply, and connected to the triggering circuit, which is designed around Q1. This works in the same way as already described for the automatic (dark-activated) LED flasher. The LDR used in the light-activated versions of this circuit can be any cadmium-sulphide photocells that present resistances in the approximate range 470 Ω to 10 kΩ at the desired turn-on levels. The thermistors used in the temperature-activated versions of the circuit can be any negative-temperature-coefficient types that present resistances in the same range at the required turn-on temperatures.

Alarms and Sirens

The next four diagrams show a variety of useful alarm-call generator circuits. The Fig 25 circuit generates an 800 Hz pulsed tone alarm call. Here, IC1 is wired as an 800 Hz alarm generator, and IC2 is wired as a 1 Hz astable which gates IC1 on and off via D1 once every second, thus causing a pulsed-tone output signal to be generated.

The Fig 26 circuit generates a warble-tone alarm signal that simulates the sound of a police siren. Here, IC1 is again wired as an alarm generator and IC2 is wired as 1 Hz astable multivibrator, but in this case the output of IC2 is used to frequency modulate IC1 via R5. The action is such that the output frequency of IC1 alternates symmetrically between 500 Hz and 440 Hz, taking one second to complete each alternating cycle.

The circuit of Fig 27 generates a 'wailing' alarm that simulates the sound of an American police siren. Here, IC2 is wired as a low frequency astable that has a cycling period of about six seconds. The slowly varying ramp waveform on C1 of this chip is fed to pnp emitter follower Q1, and is then used to frequency modulate alarm generator IC1 via R6. IC1 has a natural centre frequency of about 800 Hz. The circuit action is such that the alarm output signal starts at a low frequency, rises for 3 seconds to a high frequency, then falls during 3 seconds to the low frequency, and so on ad infinitum.

Finally, to complete this quartet of alarm generator circuits, the Fig 28 circuit generates a siren alarm signal that is a simulation of the 'Red Alert' alarm used in the STAR TREK T.V. programme: This signal starts at a low frequency, rises for about 1.15 seconds to a high frequency, ceases for about 0.35 seconds, then starts rising again from a low frequency, and so on ad infinitum. The circuit action is as follows:

IC2 is wired as a non-symmetrical astable multivibrator, in which C1 alternately charges via R1 and D1, and discharges via R2, thus giving a rapidly rising and slowly falling 'sawtooth' waveform across C1. This waveform is fed to pnp emitter follower Q1, and is thence used to frequency modulate pin 5 of IC1 via R6. Now, the frequency modulation action of pin 5 of the IC1 astable circuit is such that a rising voltage on pin 5 causes the astable frequency to fall, and vice versa; consequently the sawtooth modulation signal on pin 5 causes the astable frequency to rise slowly during the falling part of the sawtooth and collapse rapidly during the rising part of the sawtooth. The rectangular pin 3 output of IC2 is used to gate IC1 off via npn common emitter amplifier Q2 during the collapsing part of the signal, so only the rising parts of the alarm signal are in fact heard, as in the case of the genuine STAR TREK 'Red Alert'.

555 TIMER APPLICATIONS

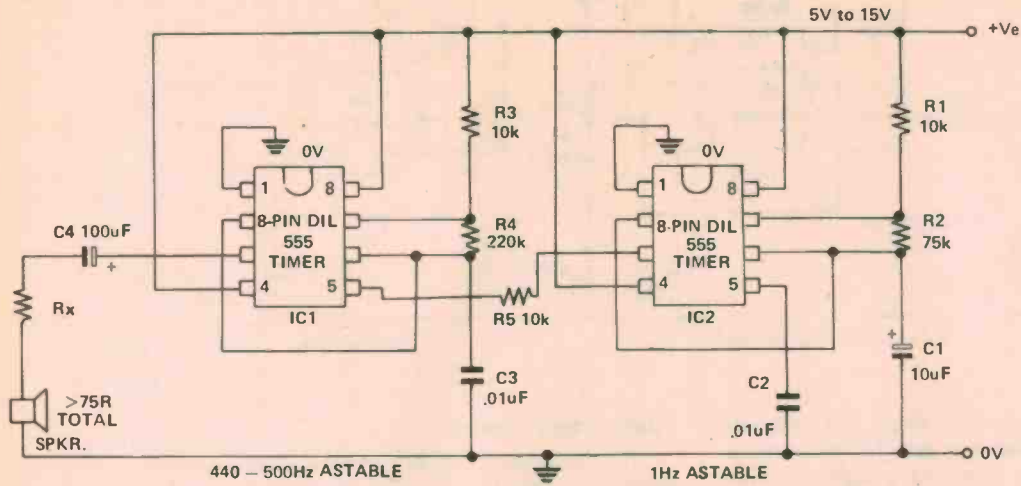

Fig.26. Warble-tone alarm call generator simulates British police siren.

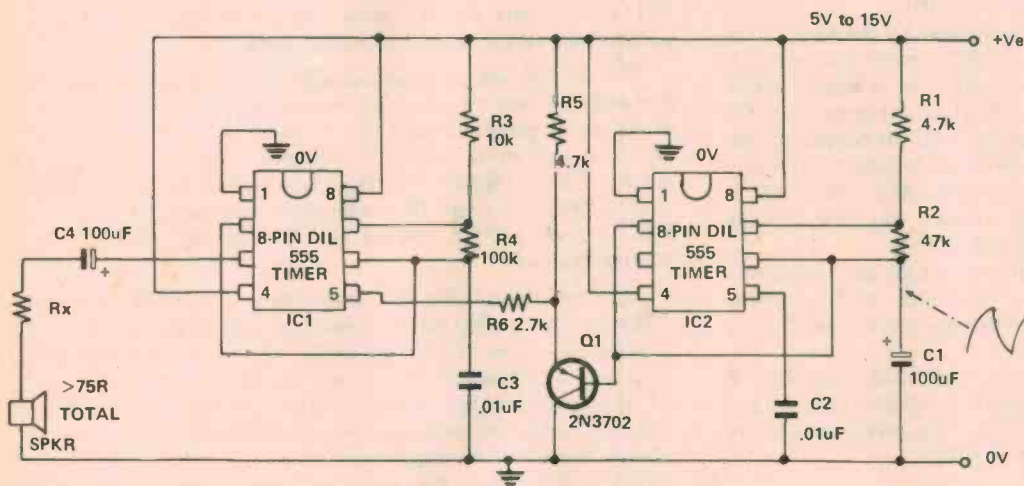
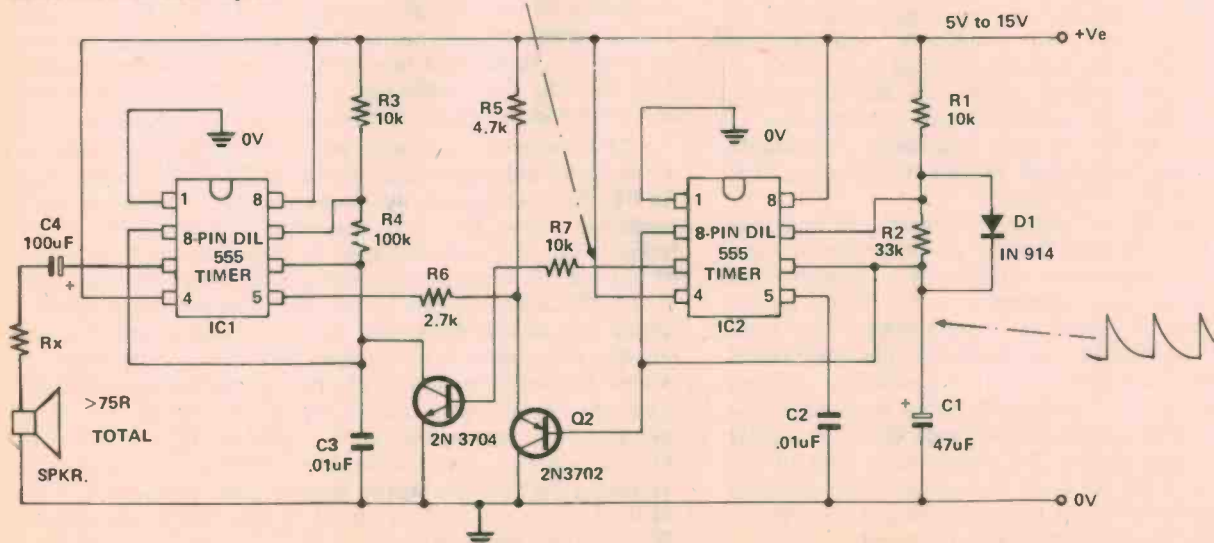

Fig.27. 'Wailing' alarm simulates American siren.

Fig.28. 'Red Alert' siren alarm simulates Star Trek alarm signal.



RESISTORS

PHILIPS FIXED RESISTORS AND THEIR USES

Two basic versions of film resistors are available from Philips: namely, Carbon film resistors and Metal film resistors. Nomograms are freely published for both types.

Carbon Film Resistors

The most general purpose resistors used if moderate demands are made for stability, temperature coefficient and tolerance. They generally surpass the performance characteristics of Carbon Composition types, whilst maintaining low unit cost.

They are ideal for use in a great variety of electronic circuits, from hearing aids to computers, telecommunications equipment to portable radios.

Metal Film Resistors

These resistors have been developed for applications in which precision, stability and low temperature coefficient are demanded.





They are ideal for use in computers, telecommunications equipment, industrial and scientific measuring apparatus and electronic devices for medical application.

In addition to the film resistors, Philips also make available Wire Wound Resistors. These are a high-power device which can be used in circuits where extremely high voltage spikes are likely to be encountered.



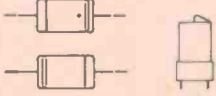

FIXED RESISTORS SURVEY

resistor type	resistance range	tolerance (%)	dissipation		type number or basic catalogue number
			at (°C)	(W)	
Carbon film	1Ω to 1 MΩ	5, 10	70	0, 2	CR16
				0, 33	CR25
				0, 5	CR37
				0, 67	CR52
				1, 15	CR68
				2	CR93
Metal film, t.c. 50 to 200 ppm/°C	4, 99 Ω to 1 MΩ	1, 2, 5	70	0, 4	MR25
				0, 5	MR30
				0, 75	MR52
Metal film, temp. coeff. 50 ppm/°C	49, 9 to 681 kΩ	1	70	0, 4	MR24
				0, 5	MR34
Metal film, according to MIL-R-10509F	10 Ω to 1 MΩ	0, 1, 0, 25	125	0, 1	MR24E, MR24C
				0, 125	MR34E, MR34C
				0, 25	MR54E, MR54C
				0, 5	MR74E, MR74C
				0, 125	MR24D
				0, 25	MR34D
				0, 5	MR54D
				0, 75	MR74D
Power metal film	10 Ω to 27 kΩ	5	70	1, 6	PR37
				2, 5	PR52
High voltage 2500 V (r.m.s.) 7000 V (r.m.s.)	1 MΩ to 68 MΩ	5	70	0, 5	VR37
				1	VR68
Cemented wirewound	5, 6 Ω to 16 kΩ	5	70	4	WR0617
				7	WR0825
				9, 5	WR0842
				15	WR0865
Enamelled wirewound	6, 8 Ω to 100 kΩ	5	70	7	WR0825E
				11	WR0842E
				17	WR0865E
Rectangular wirewound	0, 15 Ω to 12 kΩ	5, 10	40	5	2306 330
				8	2306 331
				10	2306 332
				15	2306 333
Low-ohmic wirewound	0, 1 to 10 Ω	10	70	2	2322 326
Pin-head carbon	33 Ω to 180 kΩ	10, 20	70	0, 05	2322 120

ELECTROLYTIC AND SOLID CAPACITORS

TYPE	CAPACITANCE RANGE	VOLTAGE RANGE	SERIES NO. 2222
Aluminium Electrolytic Types			
Miniature/Small 	0.33 to 2200 μF	4 to 400 V	015 016 017 040 108
Large 	680 to 150 000 μF	6.3 to 100 V	071 073 106 107
Solid Aluminium Types			
Small 	0.1 to 68 μF	6.3 to 40 V	122
Solid Tantalum Types			
Subminiature Resin Dipped 	0.01 to 68 μF	1.6 to 40 V	146

PAPER AND FILM CAPACITORS

TYPE	CAPACITANCE RANGE	VOLTAGE RANGE	SERIES NO. 2222
 paper a.c. capacitors	1-25 μF	250 - 600V R.M.S.	240 241
 metallised polyester and polycarbonate film capacitors ("inpelesco")	0.001-4.7 μF	100 - 1600 V	341
 metallised polyester and polycarbonate film capacitors ("nugget")	0.01 - 6.8 μF	100 - 400 V	344
 metallised polyester film capacitors (f.f.c.)	0.01-6.8 μF	100 - 630 V	342
 polyester film/foil capacitors ("p.p.c.")	0.0022-1 μF	100 - 630 V	347



Electronic Components and Materials

CEB

AUSTRALIA

*How to
get into
CB Radio*

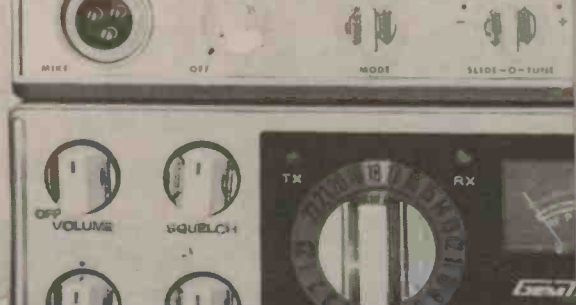

CB GEAR TO WIN!

CB

FANTASTIC BARGAIN!



PLUS FREE AERIAL!

UNIVERSE

FREE AERIAL OFFER
worth \$20 with the

**UNIVERSE 23 CHANNEL
AM TRANSCEIVER**

SPECIFICATIONS: (E. & O.E.)

\$88.50 p+p
\$3.50

• 23 Channels • 26.965 MHz to 27.255 MHz • Power to final 5W • Dual Conversion • 31 Semiconductors • Metal Case • P.A. Facility • Squelch • Illuminated Meter & Channels • Red T/m/t Light.

For a limited period only we will include a centre loaded tuneable whip, so rush in now don't miss out on this special deal. Mail Inquiries answered if S.A.E. enclosed. Selected dealers may purchase this special.

sensational! **CB BLACKBOX**

**USES EXISTING
CAR AERIAL!**



This is every novice's dream device. Thieves can no longer detect your C.B. because you have no tell tale C.B. aerial. No extra holes to drill either. With our "BLACK BOX" Aerial Matcher you can operate your C.B. using the existing car aerial S.W.R. of 1 to 1 possible with suitable car antenna. Scan your C.B. Channels while listening to your car radio. Go straight into transmit without a worry. Fitted in minutes. L.E.D. signal Indicator also acts as S.W.R. meter. (Owing to limited supplies this unit is not available through our wholesale division yet) \$35 p.p. \$2.



'CONTACT' MOBILE SSB-AM

New stocks have just arrived of our beefed up version. Now puts 6.5 watts AM into aerial. Fully synthesized. 23 Ch AM plus upper and lower sideband. Dual conversion AM power and S meter. P.A. facility, xtal lattice filter. For Novice or Ham use. 12 volt operation.

\$239 P&P \$4.00

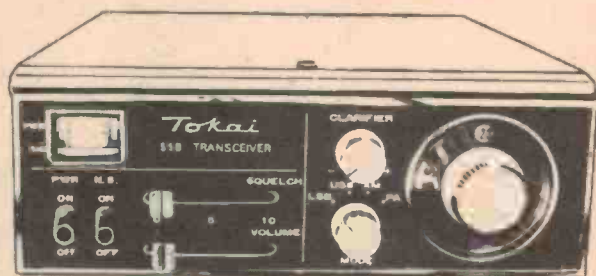

TOKAI SSB-AM 25 WATT P.E.P.

TOKAI'S NEW TC1001 has also gone for more power. The SSB section now delivers 25W P.E.P. The price is commensurate with the quality. Full metal case. 96 semiconductors including F.E.T's. Triple AM and dual SSB conversion. P.A. facility. Power and S meter. Delta tune on AM. Noise blander. This one is loaded with features. For the discriminating Novice or Ham. Porta pak available makes it into portable. PORTA PAK \$69 incl. aerial. MOBILE \$289. P&P \$4.00



KRACO 23 CHANNEL AM 5 WATT

SPECIAL BUY LIMITED QUANTITY

This exciting American style CB Transceiver is loaded with features. Apart from its smart black all metal cabinet it has a functional and attractive chrome control panel surround. Heavy duty control knobs with finger grips. Positive push button controls for automatic noise limiter. Public address. A most useful map lite is also incorporated. Illuminated channel indicator, variable squelch etc. 29 semiconductors plus I.C. dual conversion. FOR NOVICE OR HAM USE.

PRICE \$149.00 P&P \$3.00

**PETER SHALLEY
CB SPECIALIST**

**554 PACIFIC HWY KILLARA
NSW 2071 TEL. 4982611**

CB

**Vol.1 No 5.
How to
get into
CB Radio**

AUSTRALIA

CB *How to get into CB Radio* **AUSTRALIA**

Editorial:

Roger Harrison, VK2ZTB
Les Bell, ex-GM4CFM
Simon Bracken

Advertising:

Sydney Bob Taylor
 Geoff Petchler
 Tel 33-4282
Melbourne Tom Bray
 Poppe Davis
 Tel 51-9836

Publisher:

Collyn Rivers

This, the fifth issue of CB Australia, has been edited and produced by the staff of Electronics Today. It is presented free within the June 1977 issue of Electronics Today, and will also be available at the (recommended) price of 60 cents from all newsagents.

CB Australia is published by Modern Magazines (Holdings) Ltd, 15 Boundary Street, Rushcutters Bay, NSW 2011. It is printed by Wilke & Co, Browns Rd, Clayton, Victoria. Issues within Electronics Today are distributed by ACP, other issues by Gordon & Gotch.

A MODERN MAGAZINES PUBLICATION
15 Boundary Street, Rushcutters Bay,
NSW 2011

COVER:

*Some of the SSB rigs we
bench tested, see page 17.*

THE CONTINUING SAGA OF.....

AS THIS ISSUE goes to press, the Minister of Posts and Telecommunications, Mr. Robinson, has informed Parliament that he will lay a submission before them on the subject of CB sometime during the month of June. At the moment, it seems that he will propose an 18-channel set-up based on the US band, with a licence fee of \$20 per year, and possibly a short examination in operating procedures.

The 'ether' is a natural resource, and so we all own a small share in it; there is no objection to its users paying a nominal fee to a Government department to monitor and police abuses of that resource; but \$10 should be more than adequate to cover all administrative costs. Asking us to pay over the odds for the use of something we already own is a bit much.

And why an examination in operating procedures? We are not, I hope, talking about an amateur band where contacts will be made under difficult conditions, or where large nets of stations have to be controlled. The only group of CB'ers we can envisage having any need for rigorous operating procedures are CREST groups, who may have to handle emergency messages with both speed and accuracy. Allowing for the simplicity of operation of CB rigs, anyone who is not mike-shy and can speak distinctly can deal with any situation using plain English, whereas the use of 10-code, for example, could be misunderstood. The last thing we want on a band to be shared equally by everyone is groups of elitist small boys (of all ages) playing at being 'radio operators'.

Especially if we have to pay \$20 for the privilege of putting up with them.



CONTENTS

News.....	9
Come On.....	7
More on Submissions	10
SSB Transceiver Review	17
Advertisers Index	30
Suppliers Index	30
CB Marketplace	9
MS Components CB competition	4

MS COMPONENTS

guess the number contest

TO ENTER -

WE'VE filled this beautiful old jar chock full of diodes - you've got to guess how many diodes are in the jar.

Here's a few clues

All diodes are identical - we've shown one standing on a coin to give you some idea of size. The jar is totally full.

The jar's about 270mm. in diameter. It's spherical except for the base which is flat and a small concavity at the top where the lid fits on.

Simply fill in your name and address on the coupon printed at the bottom left of this page and place it in a sealed envelope addressed to 'CB Contest', 15 Boundary Street, Rushcutters Bay, NSW 2011.

Then write your estimate of the number of diodes on the outside back flap of that envelope - you're allowed three guesses only per envelope. If you want to send in more entries you may, but you'll have to send in another coupon and envelope for every three guesses.

Forms are also available at MS Components.

Remember the closing date - July 31st, 1977.



If you'd like to have a closer look, the jar will be displayed at MS Components during the contest period.

MS Components are at 164-166 Redfern Street, Redfern.

Yes, the jar is for sale - the owner's asking about \$75 (we seem to be in the wrong business!). If you're interested ring our publisher, Collyn Rivers, on 33 4282.

Entry Coupon - This coupon must be enclosed in the envelope on the back of which is written your entry.

Name

Address

Post Code

CONTEST RULES

This contest is open to all readers of ETI and CB Australia with the exception of members of the staff of Modern Magazines (Holdings) Ltd., MS Components, Wilke & Co., and Australian Consolidated Press.

Entrants may submit as many entries as they wish but each entry must be written on a separate envelope and accompanied by the entry voucher printed on the bottom left-hand corner of this page.

Entries should be addressed to CB Contest, Electronics Today International, 15 Boundary Street, Rushcutters Bay, NSW 2011. Closing date is July 31st 1977.

A count of the barrel's contents will be made as soon as possible after July 31st 1977. The count will be made in the presence of Mike Sheridan, Managing Director of MS Components, and Collyn Rivers, Publisher of Electronics Today International and CB Australia.

The winner will be that person whose entry comes closest to the actual determined amount. Runners-up will be those entries which came closest in order of correctness. In the event of a tie the winning order will be made by a draw.

The winner of the first prize will be notified by telegram, runners-up by letter. The names of the winners together with the actual diode count will be published in the News pages of Electronics Today International and CB Australia at the earliest possible opportunity.

Permit number TC9288

CB GEAR TO WIN!!!!

Here's a chance to win a superb Sidewinder III CB mobile transceiver. There's further prizes for the runners up. Second prize is an RF signaliser (that's a device for boosting those border-line signals) - third prize is a Kaiser 20,000 ohms/volt multimeter and there's a further couple of gift vouchers for fourth and fifth.

- * 1st prize Sidewinder III CB mobile transceiver
- * 2nd prize RF Signaliser
- * 3rd prize Kaiser multimeter
- * 4th prize \$15 gift voucher (MS Components)
- * 5th prize \$10 gift voucher (MS Components)

MS Components have agreed to exchange any prize for other goods of equivalent value if desired.



Sidewinder



SIDEWINDER III - the best of the range

C.B. RADIO ALL THE BIG NAME RIGS AT THE RIGHT PRICES XTAL XCB-12



\$139.50.

23 CHANNEL MOBILE WITH 2 CHANNEL SCANNER

Sensitivity: Less than 0.5uV for 10dB (S+N). Selectivity: 6dB at 5kHz, 60dB at 20kHz, 60dB at 40kHz, Squeich Sensitivity: Threshold less than 0.5uV Tight 500uV 1mA, Signal to Noise Ratio: 35dB min. Audio Output: More than 3W/10% distortion.

Other 23 Channel 5 Watt Units Available A.M.

• "Pace" CB143 23 Channel Mini Rig. P.A. Squeich \$89.95 • "Shigma" SR76 23 Channel A.M. PA/ANL Meter. Squeich \$79.95 • "TASC" AM 23 Channel ANL S/G Meter. CB/PA. \$109.00 • "Asahi" AS500 Delta-Tune AM/ANL/PA. Meter., etc. \$99.00 • "Beta" 2000. As above. Features 23 Channel. Mobile \$95.00 • "Cougar" 23B Top Quality AM version of Panther SSB. \$159.00

This month's special "XTAL" \$79

23-CHANNEL MOBILE CITIZENS BAND TRANSCEIVER



MODEL XCB-7

• "XTAL" XSSB10. 12W P.E.P. Clarifier Control, etc. \$239.50 • Gemronics 2325 AM/SSB 12W P.E.P. \$210 • 12 volt regulated power supply for above units \$39.50

SCOOP PURCHASE!

ROYCE ELECTRONICS AM/FM/CB Car Radio Combination Unit. Gyro Lock Channel AM. Mobil' C.B. Transceiver with AM/FM Multiplex Radio Combined In One In Dash Unit. \$179.00.



HAND HELD UNITS

• "Contact" CT10 2 Channel 1 Watt with Call System. Metal Case \$44.95 each.
• "Sideband" NC310 1 Watt 3 Channel. Ext. Power. Antenna Connections. \$44.95 each.
• "Sanyo" TA395 5 Watt. Hand Held Separate Speaker & Mike. \$79.50 each. • 12 Volt/Amp Regulated P/Supply for above units. \$18.50

MOBILE ANTENNAS

• Gutter Mount Aerial Centre loaded \$22.00
• Boot Trunk Mount. Base Loaded 12' Coax & PL259 \$20 • 5' Helical Fibreglass with Base, etc. \$25

LARGEST RANGE OF CB ACCESSORIES IN MELBOURNE SEND S.A.E. FOR DETAILS. POST PACK ON ALL CB UNITS \$2.00 PER UNIT ANYWHERE IN AUSTRALIA

BAY CITY pty.
ELECTRONICS hd.
Shop 11, Station St., Frankston 3199
Vic.
Phone 783-9212

Lafayette))

27MHz two-way



5 WATT 6 CHANNEL
'MICRO 66'

The latest Lafayette 27 MHz transceivers whose versatility, reliability and performance are famous world wide with 100,000's in constant use. Lafayettes two-ways offer ruggedness and compact size making them ideal for use in industry, farm, sports and marine applications.



All units Telecom Type Approved (Licence Required)

Lafayette are 2-way specialists. Full range 27MHz crystals, antennas, auxiliary equipment available!

Dealer enquiries invited

Lafayette))

the Communicators
LAFAYETTE ELECTRONICS
Div. of Electron Tube Distributors P/L
94 ST. KILDA RD., ST. KILDA
Victoria 3182. Tel. 94 6036

DISTRIBUTORS

for the Electronic Industry

ARE YOU AWARE??

THAT WE HAVE PROBABLY THE LARGEST RANGE IN AUSTRALIA OF TOP-BRAND, QUALITY PRODUCTS AT CURRENT MARKET PRICES WITH OFF-THE-SHELF AVAILABILITY.

Semi-Conductors

Delco
E.D.I.
General Electric
Intermetall
I.T.T.
National Semiconductor
N.E.C.
Philips
Sanyo
Signetics
Solitron
Texas Instruments

Passive Components

Bournes
Elna
Erie
I.T.T. Capacitors
I.T.T. Thermistors
Philips (Elcoma)
R.C.A.
Soanar
Sprague

Electro-Mechanical and Hardware

Alco
Cannon
Delco Heatsinks
I.T.T. Diecast Boxes
I.T.T. Fans & Blowers
Dica I.C. Accessories
I.E.E.
I.T.T. Relays
Jean Renaud
J.A.E.
National Relays
Pomona Accessories
Rotron Fans
Switchcraft Connectors
Thermalloy Heatsinks
T.I. I.C. Accessories



Trade enquiries to:

Instant Component Service

P.O. Box 2, Arncliffe. N.S.W. 2205. Ph (02) 597-1444
Adelaide 267-2393. Melbourne 95-9566. Sydney 597-1444

Instant Component Service

DISTRIBUTORS:—

NORTH. PARAMOUNT ELECTRONIC SERVICES.

47-49 Jersey Street,
(P.O. Box 301) Hornsby,
N.S.W. 2077
Phone: 476-5911

SOUTH. BRYAN CATT INDUSTRIES.

105 Miranda Road South,
(Near Motor Registry)
Miranda.
Phone: 524-4425
Telex AA27266

EAST. RADIO DESPATCH SERVICE.

869 George Street,
Sydney, N.S.W. 2000
Phone: 211-0191

WEST. ELECTRONIC ENTHUSIASTS EMPORIUM

Post Office Arcade,
Joyce Street,
Pendle Hill, N.S.W. 2145
Phone: 636-6222

COME-ON

We Hand The Mic To Our Readers...

Hon. E.L. Robinson M.P.,
Minister for Posts & Tele-
communications & Minister Assisting
the Treasurer,
House of Representatives,
CANBERRA, A.C.T. 2600.

Dear Sir,

Having read the national Citizens Radio Association submission to your Department dated April 1977, I believe that for the service to be of real value to the community and to satisfy the present need, CB radio should be low cost and without unnecessary restrictive government control. The licence to register a set should be relatively easy to obtain and without a prerequisite of belonging to clubs and associations.

The National Citizens Radio Association, in its Summary of Recommendations, recommends that the Federal Government:

"Phase out AM only sets and ban import of AM sets."

This is contrary to the concept of CB radio in making them unnecessarily expensive and would not satisfy the community need. Hand held AM 2-channel sets sell for \$47.50. The cheapest SSB set available sells for \$275. Hand held units are particularly important for distress and emergency use as statistics show that hand held units have been responsible for saving life and protecting property to a far greater extent than mobile or installed units.

The submission ignores that hand held and 4-channel units are only available in AM. Hand held units are not available for SSB and to manufacture these specifically would be enormously expensive.

SSB sets, as recommended by the N.C.R.A. submission, would cost a minimum of \$275. Well outside the means of many potential users who would most benefit from the introduction of a CB service.

AM sets, based on the US 23-channel service, are available for less than \$100, and would therefore satisfy the community need.

In paragraph 8.9A, the N.C.R.A. suggest that the units should be the same as the 23-channel US allocation and to the January 77 F.C.C. specification. It seems ludicrous that N.C.R.A. make this recommendation when no such sets exist at present, and would have to be specifically manufactured for the

Australian market at enormous cost.

"A licensing testing scheme to be adopted."

This would create unnecessary expense - people are not required to pass a licence test to operate marine 27 MHz sets or VHF sets, and therefore, it would be unwarranted for CB radio.

It would seem that the N.C.R.A. is trying to create a compromise solution and further its own interests as the "national self-regulating, self-disciplining body."

The N.C.R.A. further recommend that a licence issuing authority be set up similar to a Drivers' Licence issuing authority. This would be enormously expensive as the N.S.W. Department of Motor Transport spends \$31.6 million on administration costs alone through 70 offices and employs 3085 people.

I believe that the user should be able to obtain his licence at the point of sale to overcome the need for unrealistic government control. A yearly licence fee could then be paid at a post office and this would further obviate the need to create an administrative body as recommended by the N.C.R.A.

"The Department evaluates technical parameters with a view to drafting realistic standards"

These standards already exist in the U.S. The F.C.C. has many years of technical expertise in setting the necessary standards for CB radio.

"Introduce an automatic transmitter identity signal"

The introduction of an automatic transmitter identity signal is not necessary in the U.S.A. or any other country.

"The Government should hold a Royal Commission into spectrum management."

Unnecessary expense and completely unwarranted.

The submission does not make any mention of the hospital paging systems near channels 2 and 21, and the interference to the Marine (27.88 MHz) distress frequency. For a report to overlook this important point would appear irresponsible. It is estimated that it would cost well over \$100,000 to move these frequencies.

I suggest that the N.C.R.A. represents a minority of people who see CB radio as a way to further their own ends and create employment for their organisations.

Gerald Nolan

MATCH

Here is a low cost, compact, quality C.B. for \$79 available from FRANK MATCH P/L or any of the 500 Match — Bell Helmet dealers throughout the country.

Features

- Special level instructions
- Illuminated dials
- P.A.
- Delta switch
- A.N.L.
- Squelch
- Installation brackets
- 23 Channels

TRADE ENQUIRIES WELCOME



CLUB OR QUANTITY DISCOUNTS.
PRICE ON APPLICATION.

Frank Match Pty. Ltd

257 MILITARY ROAD, CREMORNE,
N.S.W. 2090 TELEPHONE: 909 1122

MATCH

BURGLAR ALARMS

WE STOCK:

Alarm Modules, Electronic Eyes, Photo Sensitive Cells, Microwaves, Ultra Sonics, Gas/Heat/Smoke Sensors, Sirens, Bells, Pressure Mats, Door Monitors, Car/Caravan/Home/Office Hold Up Factory Alarms, Key Switches, Reed Switches, Relays, Shock Recorders, Aluminium Tape. You Name It. We Have It.

**DO IT YOURSELF PRE-WIRED SYSTEMS
EASY INSTALLATION**

PORTABLE ALARMS

Microwave Systems concealed in Hi-Fi Speaker Enclosures or Desk Units, Mains Operated, Fully Automatic, Self-Resetting with battery standby.

Send 80c in Stamps for Illustrated Catalogue.

**N.S.W. AGENT FOR NIDAC SOLID STATE
SECURITY SYSTEMS**

WHOLESALE SECURITY FROM

PROTECTOR R.C. ALARMS

119-121 Pittwater Rd, MANLY N.S.W. 2095
PH: 977-6433

C.B. SETS

40 CHANNEL SETS

40 channels (1-40) takes in first normal 23 and then on 17 extra. LED readout. A.M. mobile 40 channel ant. \$9 extra. **\$150**

23 CHANNEL 'Mecoa'

Well known MECOA. Price includes antenna. Model BCB6. **\$95**

23 CHANNEL AM/SSB

'XTAL' brand. Model SSB 10. All the features. Price includes antenna. **\$212**

23 CHANNEL 'ROYCE'

23 channels CB, plus AM/FM/MPX. Set only \$150, antenna \$12 extra. Note speakers not included. **\$150**

OTHER C.B. ITEMS

"THE BEST BOOK ON C.B.:" covers the lot, 192 pages, \$6.25, plus \$2 post and pack. Power supplies 240W to 13.8V, while they last \$37.95. Antenna, base loaded mobile, boot or roof top mount \$12. Gutter clip, centre loaded \$12. Stereo lock mounts \$5. Note — All the above sets will be sent to your nearest rail station.

FOUR WHEEL DRIVES

304 Middleborough Road,
Blackburn South, Vic. 3130. Phone 89-0509

G.S.

STRATO GAINS FOUR NEW AGENCIES

Terry Brown from STRATO Communications scraped back into Sydney just before the recent air traffic controller's strike following a trip to Japan. While over there he secured agencies for the latest CB gear from four of the top-line manufacturers. Strato now stocks directly from the factory the TRAM Diamond 80, the complete COBRA range of transceivers, the Super PANTHER range from PEARCE-SIMPSON, the SBE range and the HY-GAIN range. All equipment is designed to meet 1977 FCC specifications. Strato offer after sales service on all their equipment and stock appropriate spares — even for equipment they stocked many years Ago!

JUNE CB-AMATEUR RADIO SEMINAR

A three day seminar for CB and amateur operators is to be held over the Queen's Birthday weekend (11th, 12th, 13th June) at Hill End. The theme for the seminar will be "An introduction to the hobby of Radio Transmitting".

The seminar is being jointly organised by the Bathurst and Orange CB clubs, the Orange Radio Club (amateur) and the Four-Wheel CB club from Sydney. The seminar construction for the beginner, radio operating procedure, how to organise Novice Amateur courses in CB clubs, radio theory for the beginner etc and encouraging CB-Amateur discussion. Those attending the seminar will be able to operate amateur equipment under the supervision of licensed amateurs to enable Cbers to get a 'taste' of what amateur radio is all about. Amateurs will be able to get an idea of what Cbers intersts are.

The idea of the seminar came from a previous meeting in April, held at Hill end. A 27MHz to 1.7MHz link operated that weekend provided some interesting contacts as a demonstration to Bathurst-Orange area Cbers. An on-air conversation over the Orange 2-metre repeater between the President of the Orange Amateur Radio Club and the president of the Orange CB club concluded with arrangements for a meeting between the two groups.

The seminar at Hill End will be a camping trip and more details may be obtained from Gus in Sydney on 80-3200 or by writing to Sam Voron VK2BVS at 2 Griffith St, East Roseville, 2069.

CB TECHNOLOGY JUMP



Regular readers of ETI will have noticed that there are two areas of interest in hobby/consumer electronics today: CB and microcomputers. Well, it was only a matter of time, and now it's happened. Texas Instruments (of watch and calculator fame) have introduced two new CB transceivers which incorporate advanced technology in the form of microprocessors and charge-coupled devices.

The SM-172 is an AM/SSB mobile rig and the SM-173 is an AM/SSB base station. Both radios incorporate two TMS1100 microcomputers; one in the handset and one in the transceiver body. The handset incorporates a five-digit LED display, 20 keys for channel and mode selection and two rocker switches for volume and squelch. The use of a microcomputer makes

possible a wide range of facilities: selective calling capabilities, including the ability to store the numbers of other units and 'dial' them at the push of a button; automatic channel scanning; automatic clarifier control on SSB (more later); automatic SWR measurement and shutdown; channel memory; and digital channel readout.

For simplified SSB reception, the transceivers use a CCD filter under control of a microcomputer which adjusts the filter's bandpass frequency and bandwidth automatically. This means that instead of manually adjusting the clarifier control to resolve SSB, the rig automatically locks onto the signal. The pricing is a contrast to TI's policy on watches: they've gone for the top of the market at top-of-the-market prices — US\$325 for the SM-172 and US\$375 for the SM-173.

ERRATA

We recently ran an item in CB AUST. regarding the Licensing and Regulating Department of the P.M.G. quoting a telephone number 654 4400. This is the number of Sanyo-Guthrie who are being inundated with telephone calls from people trying to contact the licensing and Regulating Department. The correct number should be 42 3721.

CB MARKETPLACE

SANYO 5W 6 channel Hand-held withxtals for 4 channels, power meter, sockets, antenna pwr, earphone, PA.\$90. Ring Michael 366659.

One TRC 101B Realistic handheld Ch 23 A1 condition, box etc. \$85.00 Ph 317128 075 Purchased April 1977.

For sale: 1 Electronics, 3 channel, 1 watt hand held CB transceiver, 3 months old. (All crystals included) \$40. 913 9634 (narrakeen, NSW)

Darwin: Midland 882C rig, good nick \$140 o.n.o. Box 40428, Casuarina N.T.

LEGAL CB?

This page was going to deal with Submissions but it looked a bit boring; so when Mr. Robinson announced that CB would be legalised and Tricky Dickey threw a commemorative champagne bash the next day, CBA was there to record the event for posterity. Although Mr. Robinson has said that he will place a proposal before Parliament this month, we are still not sure how many channels will be used or any other details. There are mutterings of a shift to UHF in 5 years — for further info on this and other CB happenings, see next month's CB Australia.

The crowd gathered, and there was wine, women, laughter and the day after....

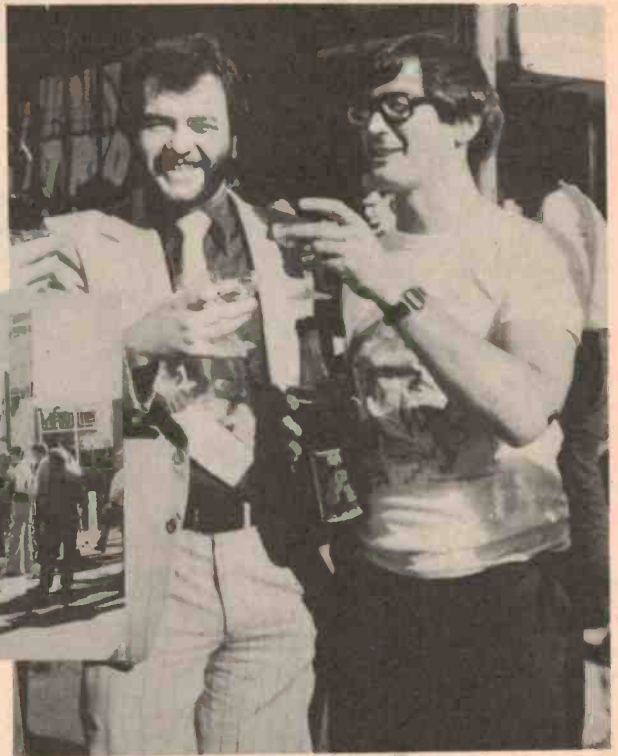

▲ Bill Payne, Dick Smith



◀ CBA's Simon Bracken (glass in hand as always) attempts to scrounge some more champagne.



▲ Enough said!

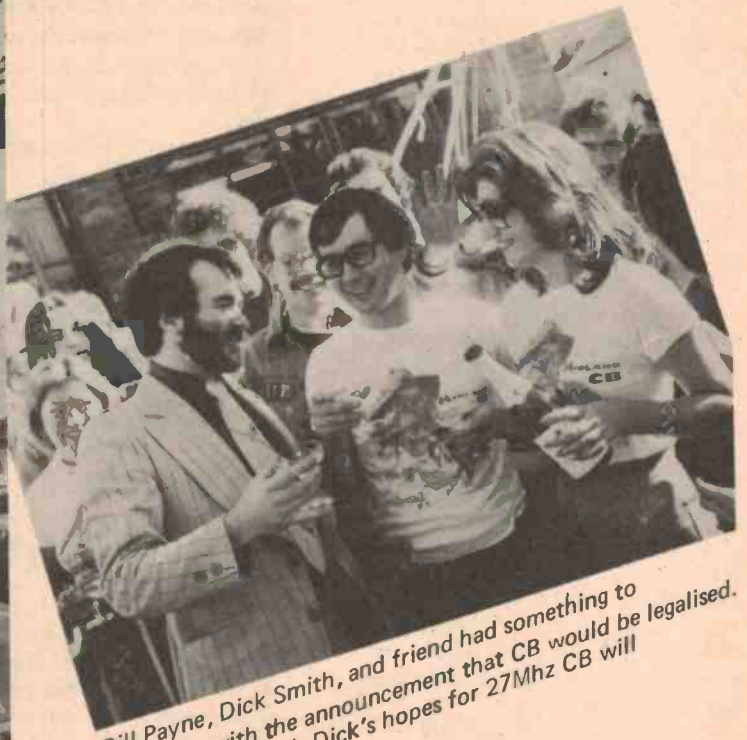

Bill Payne, Dick Smith, and friend had something to celebrate with the announcement that CB would be legalised. It looks as though Dick's hopes for 27Mhz CB will be realised.



XENON
WORLD IMPORTS

Import Agents Box 33 Warradale S.A. 5046. (08) 296-1033

WANER C.B. 777 SOLD OUT

100 per cent sell out
MAIL ORDERS TEMPORARILY CLOSED
FOR THIS MODEL

Some stocks available still at our dealers - see list

ANNOUNCING FROM PATCOM INC., CALIFORNIA

FULL F.C.C. APPROVAL

PACE 23 Channel, Delta Tuning, Automatic Noise Limiter



PACE 144
PRICE
\$149

SPECIFICATIONS

Transmitter Compliance FCC No 42248, part 95 4 Watt legal power average Modulations minimum 90 per cent T.V. Interference — 65D.B.

SIMULTANEOUS RELEASE WITH U.S. OF A.
300 Units Available Only.

IF YOU WANT THE BEST IN S.S.B., AND YOU ARE PREPARED TO PAY A LITTLE MORE TO GET IT, THEN YOU MUST INSIST ON

CHEROKEE SILTRONICS A23



25Watt-5Watt



PRICED AT \$295

SPECIFICATIONS

AM/5watt Double Conversion Superheterodyne. Hum & Noise below 40DB of Signal. SSB/524 watts Single Conversion superheterodyne. Modulation by filter method and 3rd order distortion below 20Db.

AMERICAN REVIEW: This new model Cherokee A23 from Siltronics is there BEST YET. It will OUTSELL all other models and continue to lead the field for some time yet. Like all fine quality products, it costs a little more but in this case, it is well justified.

ONE OF THE FEW TOP BRANDS THAT BY FAR EXCEEDS THE REQUIREMENTS OF THE NEW FCC RULES.

MAIL ORDER DEPARTMENT Guarantees discretion to all customers. Cash receipts available on request. Prompt despatch as always.

Purchase from:

Lou's T.V., Mt. Lawley W.A.
Coastwide Sound Service, Burnie Tas.
Cheshers Ltd., Port Lincoln S.A.
Dick Smith, Mitcham S.A.
Earnsmiths, City, S.A.
MAIL ORDER DIRECT.

DISTRIBUTORS WANTED IN VICTORIA, NEW SOUTH WALES AND QUEENSLAND.
AGENTS WANTED IN ALL STATES.

CB

SCOOP PURCHASE

PORTABLE
SSB FROM TOKAI



SSB UNIT

\$289 p & p \$3-50

- 23 CHANNEL SYNTHESIZED
- 5 WATT AM
- 25 WATT P.E.P. SSB

PORTA-PAK INCL. AERIAL **\$69**

GO ANYWHERE WITH THIS UNIT! P & P \$3

look at this 3 in 1 special!



- SWR METER
- FIELD STRENGTH
- ANTENNA MATCHER

only \$32

P & P \$2

DICK WOODS

77 Edgeworth David Avenue,
HORNSBY NSW 2077. ph.48 4238

Sideband Electronics Sales

HF TRANSCEIVERS

ASTRO - 200 digital solid state 200 W.P.E.P.	P.O.A.
TRIO KENWOOD model TS520-D-AC only 10 to 80 M.	\$590
TRIO KENWOOD model 520 AC-DC 10 to 80 M.	\$650
TRIO KENWOOD model TS-820S AC only 160 to 10 M with digital readout.	\$980
TRIO KENWOOD model TS-820 AC only 160 to 10 M.	\$850
TRIO KENWOOD model MC-50 Microphone.	\$ 49
TRIO KENWOOD model TS - 700 - A FM-AM- CW-SSB transceivers. Full 144-148 MHz coverage, 10-Watt output, VFO controlled, self-contained, AC-DC operation.	\$650
TRIO KENWOOD model TS-600-A FM-AM. SSB transceiver full 50-54 MHz coverage 10 Watt output variable from 1 Watt to full power. VFO controlled AC-DC operation. Styling as TS-700-A.	P.O.A.
TRIO KENWOOD model TR-7400 2 meter FM transceiver 10 to 25 watts output. Frequency range 144.00 to 147.995 MHz No. of channels 800, Double conversion super- heterodine sensitivity better than 0.4 UV for 20 DB.	\$385
KYOKUTO 2 M FM 15 W output trans- ceivers with digital read-out and crystal synthesized PLL circuitry now with 800 transmit and 1000 receive channels 5 KHz apart, covers all of 144-148 MHz, receive to 149 MHz. No more crystals to buy. Includes simplex, repeater and anti-repeater operation.	only \$310

NOVICE OPERATORS

All above HF transceivers will be modified for low cost to suit novice. Requirements 27 MHz conv. x-tals in stock now for Kenwood models. IT IS HERE AGAIN, the well known SE-501 in new style case 15 Watt pep 23 AM SSB for as low as	\$215
Same model with AC built in supply and DC built in SWR power meter and many goodies.	\$260
ICOM	
VHF TRANSCEIVERS SSB	
ICOM model IC-202 2 M SSB portable trans- ceiver 144-144.4 MHz	\$215
ICOM model IC-502 6 M SSB portable trans- ceivers 52-53 MHz.	\$215

KLM SOLID STATE POWER AMPLIFIERS

(MHz) 144-148 PA10-80BL 80 OUTPUT (watts)	
" PA10-140BL 140 "	
" PA10-160BL 160 "	
" PA2-70BL 70 "	
400-470 PA10-70CL 70 "	

FDK MULTY QUARTZ with 24 channels 10 sets of crystals supplied 10 Watts, new style.	\$265
YAESU MUSEN model FT-101-E AC-DC transceivers 10 to 160 M with speech processor	\$800

YAESU MUSEN model FT-301.	\$960
YAESU MUSEN model FT 301 - D	\$1140
YAESU MUSEN model FT - 301 - S	\$660
YAESU MUSEN model FL-2100-BLineal Ampl.	\$525
YAESU MUSEN model FP - 301	\$165
YAESU MUSEN FR 6-7. Uses Wadley loop princ.	\$300

FREQUENCY COUNTERS

YAESU MUSEN model YC-500-E-S-J	P.O.A.
--------------------------------	--------

HY - GAIN ANTENNAS

14AVQ 10-40M. verticals, 19' tall, no guys	\$ 65
18AVT-WB 10-80 M. verticals, 23' tall no guys	\$ 95
TH3JR 10-15-20 junior 3 el. Yagi 12' boom	\$160
TH3MK3 10-15-20 senior 3 el. Yagi 14' boom	\$220
TH6DXX 10-15-20 senior 6 el. Yagi 24' boom	\$250
HY-QUAD 10-15-20 cubical quad Yagi 8' boom	\$250
TIGER ARRAY 204BA 20M4 el. Yagi 26' boom	\$250
BN-86 balun for beam purchases only	\$ 25

MARK MOBILE ANTENNAS

HW-80, 6' long for 80 M.	\$ 28
HW-40, 6' long for 40 M.	\$ 25
HW-20, 6' long for 20 M.	\$ 23
Swivel mounts & chrome-plated springs for all	\$ 13

CUSH CRAFT ANTENNAS

A144-11 11 Element 2M-Yagi	\$ 45
A147-11 11 Element 2 M Yagi	\$ 45
A147-20 combination horizontal vertical 2 M	\$ 70
A144-20 combination Yagi with matching harness circular polarization	\$ 75

ANTENNA ROTATORS

Model CDR Ham-11 for all hf beams except 40 M	\$200
Model CDR AR-22 L junior rotator for small beams	\$ 65
KEN model KR-400 for all medium size hf beams with internal disc brake	\$110
KEN model KR-500 for vertical control of satellite tracking	\$110

All models rotators come complete with 230-
volt AC indicator-control units.

6-conductor cable for
KR-400-500 65 cents per metre

COAX CABLE CONNECTORS

PL-259	\$1.20
SO-239 Chassi Mount	\$1.20
Male to male joiner	\$1.20
Female to female joiner	\$1.20
Angle connector	\$1.70
T-connector	\$2.00

COAX CABLE

RG - 8 - U foam filled per metre	\$1.20
----------------------------------	--------

SWR METER

Twin meter model: Y.M. - I.E. 3.5 to 145 MHz prof quality	\$ 28
DRAKE TV - 3300 TV I lowpass filter	\$ 31
SSR-1 Receivers	\$270

CRYSTAL FILTER, 9 MHz, similar to
FT-200 ones. With carrier crystals.

Soon Available

All prices quoted are net SYDNEY, N.S.W., on cash-with-order basis, sales tax included in all cases, but subject to changes without prior notice. ALL-RISK INSURANCE from now on free with all orders over \$100; small orders add 50c for insurance. Allow for freight, postage or carriage; excess remitted will be refunded.

Sideband Electronics Sales

For personal attention: 24 KURRI STREET, LOFTUS
P.O. BOX 184, SUTHERLAND, 2232

OPEN ON SATURDAYS TILL 12 NOON
TELEPHONE: 521 7573

PETER SCHULZ, VK2ZXL

CATALOGUE

SIDEBAND ELECTRONIC SALES

DISTRIBUTORS OF COMMUNICATION TRANSCEIVERS

SUPPLIERS of: * TRIO KENWOOD * YAESU MUSEN * I.C.O.M. * V.H.F. TRANSCEIVERS
 * HY-GAIN ANTENNAS * MARK MOBILE ANTENNAS * CUSH CRAFT ANTENNAS
 * ANTENNA ROTATORS * COAX CABLE CONNECTORS * S.W.R. METERS.

TS-820 SERIES HF TRANSCEIVER

TRIO KENWOOD model TS-820 AC only
 160 to 10 M.



TS-820 PERFORMANCE SPECIFICATIONS

Frequency Range	160 meter band 1.8 to 2.0 MHz
	80 meter band 3.5 to 4.0 MHz
	40 meter band 7.0 to 7.3 MHz
	20 meter band 14.0 to 14.35 MHz
	15 meter band 21.0 to 21.45 MHz
	10 meter band 28.0 to 28.5 MHz
	28.5 to 29.0 MHz
	29.0 to 29.5 MHz
	29.5 to 29.7 MHz
	15.0 MHz (receive only)
Mode	A U X band
	CW, USB, LSB, FSK
RF Input Power	200 Watts PEP
	CW 160 Watts DC
	FSK 100 Watts DC
Antenna Impedance	50 to 75 ohms, unbalanced
Carrier Suppression	Better than 40 dB (Mod. freq. at 1.5 kHz)
Side-band Suppression	Better than 50 dB (Mod. freq. at 1.5 kHz)
Microphone	High impedance (50 kΩ)
AF Response	400 to 2,600 Hz
Spurious Radiation	Harmonics Less than -40 dB
	Others Less than -60 dB

Receiving Sensitivity	3/μV 10 dB or better at 0.25 μV
Image Ratio	160 to 15 meter band: Better than 40 dB
	10 meter band Better than 50 dB
IF Rejection	Better than 80 dB
Frequency Stability	Within ± 1 kHz during one hour after one minute of warm-up and within 100 Hz during 30 minute period thereafter
Receiving Selectivity	SSB 2.4 kHz (-6 dB)
	4.4 kHz (-60 dB)
	CW: 0.5 kHz (-60 dB), with optional CW filter
	1.5 kHz (-60 dB), with optional CW filter
AF Output Power	More than 1.5 watts (with less than 10% distortion) into an 8 ohms load
Audio Output Impedance	4 to 16 ohms (speaker or head phone)
Tube and Semiconductors	3 tubes (2 x 52001A, 12BY7A)
	5 ICs
	30 FETs
	74 Transistors
	165 Diodes
Power Requirements	120/220VAC, 50/60Hz
Power Consumption	Transmit: 280 watts
	Receive: 26 watts (with heater-off)
Dimensions	13-1/8 (333) wide x 6-0 (153) high x 13-3/16 (335) deep inch (mm)
Weight	35.2 lbs (16kg)

* Specification and design are subject to change without prior notice.



KENWOOD

DG - 1 Digital Display
 YG. 88C Crystal Filter
 SP. 520 - 820
 DS 1 DC Converter
 VFO - 820

TS-520 SERIES



TS-520... Specifications	
Frequency Range	80 meter band - 3.50 to 4.00 MHz
	40 meter band - 7.00 to 7.30 MHz
	20 meter band - 14.00 to 14.35 MHz
	15 meter band - 21.00 to 21.45 MHz
	10 meter band - 28.00 to 28.50 MHz
	28.50 to 29.10 MHz
	29.10 to 29.70 MHz
	29.70 MHz
	WWV - 10.00 MHz (Receive only)
Mode	USB, LSB, CW
Input Power	160 watts on 80 to 15 meter band, 140 watts on 10 meter band
Antenna Impedance	50 to 75 ohms, unbalanced
Carrier Suppression	40 dB
Unwanted Sideband Suppression	40 dB
Harmonic Radiation	-40 dB
AF Response	400 to 2,600 Hz (-6 dB)
Audio Input Sensitivity	High impedance (50 kΩ) 0.5 μV for 10 dB (S+N)/N on 80 to 15 meter band
Selectivity	1.0 μV for 10 dB (S+N)/N on 10 meter band
	SSB: 2.4 kHz (-6 dB)
	4.4 kHz (-60 dB)
	CW: 0.5 kHz (-60 dB)
	1.5 kHz (-60 dB) (with optional CW filter)
Frequency Stability	100 Hz per 30 minutes after warm-up
Image Ratio	50 dB
IF Rejection	50 dB
AF Output Power	1 watt (with 8 ohms load and 10% H.D.)
Antenna Impedance	4 to 16 ohms (Speaker or Headphone)
Tube and Semiconductor Complement	3 tubes (2 x 52001, 12BY7A), 1 IC, 18 FET's, 44 transistors, 84 Diodes
Power Requirements	120/220 VAC, 50/60 Hz
	Transmit: 280 watts
	Receive: 26 watts (with heater-off) or 13.8 VDC
	Transmit: 15 Amp.
	Receive: 0.6 Amp.
Dimensions	333 (13.11) wide x 150 (5.91) high x 335 (13.19) deep mm (inch)
Weight	16 kg (35.2 lbs.)

24 KURRI STREET, LOFTUS HEIGHTS, N.S.W. 2232 AUSTRALIA. PH.: 521-7573
 Postal Address P.O. Box 184, SUTHERLAND, 2232

KENWOOD

TR-7400A



TRIO KENWOOD model TS-700-A FM-AM-CW-SSB transceivers. Full 144-148 MHz coverage, 10-Watt output, VFO controlled, self-contained, AC-DC operation.

TRIO KENWOOD model TS-600-A FM-AM, SSB transceiver full 50-54 MHz coverage 10 Watt output variable form 1 Watt to full power. VFO controlled AC-DC operation. Styling as TS-700-A.

TR-7400A BLOCK DIAGRAM

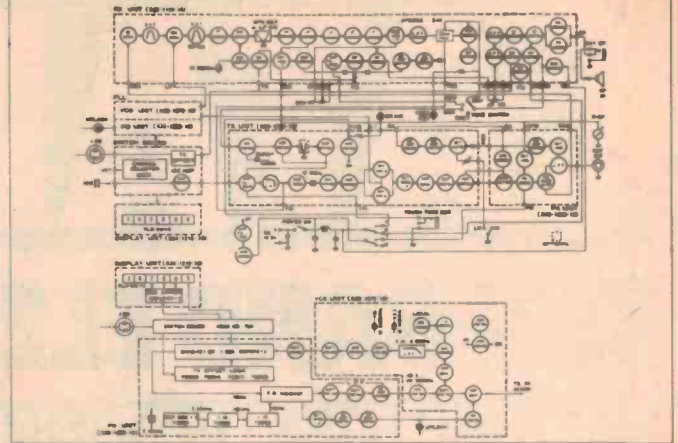

SPECIFICATIONS

GENERAL		Dimensions:	182 mm (7-1/8") wide 270 mm (11-5/8") deep 74 mm (3-7/8") high	RECEIVE SECTION
Semiconductors	Transistors: 50 FETs: 7 ICs: 18 Diodes: 63	Weight:	Approximately 2.8 kg (6.2 lbs.)	Receive System: Double conversion superheterodyne 1st IF: 10.7 MHz 2nd IF: 455 kHz Sensitivity: Better than 0.5 µV for 20 dB S/N Better than 1 µV for 30 dB S/N
Frequency Range	144,000 to 147,999 MHz	TRANSMIT SECTION	RF Output Power: High: 25 Watts Low: 5 Watts (approximate) Variable reactance frequency shift: 18 kHz	Squelch Sensitivity: Better than -70 dB down 40 kHz at -70 dB down
Mode	FM	Modulation:	Frequency Deviation: 18 kHz Spurious Radiation: Better than -60 dB Tone Burst Duration: 0.5 to 1.0 sec	Image Rejection: Better than -60 dB Spurious Interference: More than 1.5 watts across 8 Ohm load 10% distortion
No. of Channels	800	Microphone:	800 Ohm Dynamic microphone with PTT switch, 500 Ohm	Intermodulation: Better than 80 dB Outputs and ratings may be subject to change without notice due to development in technology.
Operating Temperature	-20 to +50 degrees C 11.8V DC nominal (13.8V DC nominal)			
Power Voltage	Negative ground 50 Ohms			
Grounding Polarity	Less than 1A in receive with no input signal Less than 8A in transmit (144)			
Antenna Impedance	Less than 4.5A in transmit (LOW) let 13.8V DC			
Current drain				



KYOKUTO DENSHI CO., LTD.

MODEL FM144-10SXR II



SPECIFICATIONS

KYOKUTO MODEL FM144-10SXR II

FREQUENCY COVERAGE:	Receive: 144,000 - 148,999 MHz Transmit: (a) 144,000 - 145,999 MHz, or (b) 146,000 - 147,999 MHz All above in 5kHz increments.
TYPE OF EMISSION:	F-3
ANTENNA IMPEDANCE:	50 ohms, unbalanced feed.
COMMUNICATION MODE:	Single and Duplex 1600MHz offset.
TEMPERATURE RANGE:	0°C to 45°C
POWER SOURCE:	DC 13.5 volts 10%, negative ground
CURRENT CONSUMPTION:	Max 4A transmit, receive .6A standby, max 1A
DIMENSIONS:	7 1/8" x 6 1/2" x 7 1/2" in. (186 x 165 x 195 mm)
NET WEIGHT:	4.1kg (9lbs, body only) (2.1kg)
SHIPPING WEIGHT:	Approximately 6.1kg (13.0kg)
TRANSMITTER	
OUTPUT:	10 watts or better (11.5V) high power 1 watt low power by switch on microphone IC (IC1648) voltage controlled oscillator
OSCILLATOR CIRCUIT:	0.002%
FREQUENCY STABILITY:	
MODULATION SYSTEM:	Direct frequency modulation of VCO
VCO FREQUENCY:	fcco = fchan + 16.9MHz (duplex 1600MHz)
DEVIATION:	15KHz (adjustable to max 15KHz)
SPURIOUS RADIATION:	Less than 60dB below carrier
RECEIVER	
RECEIVER CIRCUIT:	Double conversion superheterodyne
INTERMEDIATE FREQUENCY:	1st - 16.9MHz, 2nd - 455kHz
FREQUENCY STABILITY:	0.002%
SENSITIVITY:	$-100\text{ dB } (0.5\mu\text{V})\text{ for } 20\text{ dB quieting or better}$
SQUELCH SENSITIVITY:	$-100\text{ dB } (0.5\mu\text{V})\text{ or better}$
SELECTIVITY:	18dB at 40dB down, 42dB at 60dB down
IMAGE REJECTION:	Better than 60dB
AUDIO OUTPUT:	4 watts, 4 ohm load, less than 10% distortion
STANDARD ACCESSORIES	
DYNAMIC MICROPHONE:	600 ohm, push-to-talk, with "HI-LO" switch
POWER CABLE:	With 2 conductor connectors and fuse holder, 5A
SPARE FUSE:	5A
EXTERNAL SPEAKER PLUG:	Miniature phone plug type
AUTO MOUNTING BRACKET:	With mounting screws, nuts and wing-bolts, etc.
INSTRUCTION MANUAL:	With circuit diagram, etc.



YAESU

FRG-7 THE RADIO FOR WORLD WIDE LISTENING

The model FRG-7 is a precision built high performance communication receiver designed to cover the band from 0.5 MHz-29.9 MHz. Its state of the art technology offers an unprecedented level of versatility. The Watley Loop System (drift cancellation circuit) coupled with a triple conversion super heterodyne system guarantees an extremely high sensitivity and excellent stability. It provides complete satisfaction to amateurs as well as BCL's with superb performance and many features such as RF attenuator, selectable tone, and automatic noise suppression circuit.

• Type of Mode	A-M SSB (USB, LSB) C-W.	• Output Impedance	4 Ohms	• Semiconductors	1	
• Frequency range	0.5 MHz-29.9 MHz	• Audio Output	More than 2 watts	IC	AN214	
• Sensitivity	SSB: CW better than 0.2µV for 10 dB S/N at 30% modulation	• Power requirement	A.C. 117 V 50/60 Hz D.C. 13.5 V Negative ground	2SC1648	1	
• Selectivity	3 kHz-6 dB	• Dimensions	340(W) x 153(H) x 78.5(D) mm	2SC372V	2	
• Frequency stability	Within 500 Hz during any 30 minute period after warm-up	• Weight	7 kg without batteries	2SC1648	4	
• Input Impedance	0.5 MHz-1.6 MHz: High impedance 1.6 MHz-29.9 MHz: 50-75 Ohm unbalanced			2SD313	1	
				Ge diode	1N63AM	9
				Si diode	1S1595	2
				VDR	VDR	2
				Zener	WZ110	1
					82001	1

YAESU MUSEN Deluxe Mobile/Base Station Specifications FT-101E/EE



GENERAL

Frequency Range: 1.8-2.0 MHz, 3.5-4.0 MHz, 7.0-7.5 MHz, 14.0-14.5 MHz, 21.0-21.5 MHz, 27.0-27.5 MHz (receive only), 28.0-29.9 MHz, WWV 10.0-10.5 MHz (receive only)
 Mode: Selectable USB, LSB, CW or AM
 Frequency Stability: Within 100 Hz during any 30 minute period after warm-up. Not more than 100 Hz with 10% line voltage variation.
 Calibration Accuracy: 2 kHz maximum after 100 kHz calibration.
 Backlash: Not more than 50 Hz.
 Antenna Impedance: 50 to 75 Ohm unbalanced nominal.
 Circuitry: 40 Transistors, 3 Integrated Circuits, 38 Diodes and 3 Tubes
 Power Requirement: 100/110/117/200/220/234 V AC, 50/60 Hz, 350 Watts maximum or 13.5 V DC nominal, 5 A for standby, 0.5 A for receive

(Mixer OFF) and 20 A for transmit
 Size: 340(W) x 153(H) x 285(D) mm
 Weight: 15 kg

RECEIVER

Sensitivity: 0.3 μ V for 10 dB Noise plus Signal to Noise Ratio on 14 MHz.
 Selectivity: 2.4 kHz nominal bandwidth at 6 dB down, 4.0 kHz at 60 dB down on SSB, CW and AM, 600 Hz nominal bandwidth at 6 dB down, 1.2 kHz at 60 dB down with optional CW filter.
 Harmonic & Other Spurious Response: Image Rejection better than 50 dB. Internal Spurious Signal below 1 μ V equivalent to antenna input.
 Automatic Gain Control: AGC threshold nominal 3 μ V. Attack time 8 milliseconds and release time 1800 milliseconds.
 Audio Noise Level: Not less than 40 dB below 1 watt

Audio Output: 3 Watts to internal or external speaker at 4 Ohm impedance. Audio Distortion: Less than 10% at 3 Watts output.

TRANSMITTER

Input Power: 260 Watts PEP on SSB, 180 Watts on CW at 50% duty cycle and 80 Watts on AM except for 160 meter. (Slightly lower on 10 meter.)
 Microphone: 50 K Ohm dynamic type.
 Carrier Suppression: -60 dB.
 Sideband Suppression: -50 dB.
 Spurious Radiation: -40 dB.
 Distortion Products: -30 dB.
 Frequency Response: 350 to 2700 Hz \pm 3 dB.
 Final Tube: 6J56C x 2

YAESU MUSEN FT-301D



GENERAL

Frequency Range: 1.8-2.0 MHz, 3.5-4.0 MHz, 7.0-7.5 MHz, 14.0-14.5 MHz, 21.0-21.5 MHz, 27.0-27.5 MHz (receive only), 28.0-29.9 MHz, WWV 5 MHz (receive only).
 Mode: SSB (selectable USB or LSB), CW, AM or FSK.
 Frequency Stability: Within 100 Hz during any 30 minute period after warm-up. Not more than 100 Hz with 10% line voltage variation.
 Calibration Accuracy: 2 kHz maximum after 100 kHz calibration.
 Backlash: Not more than 50 Hz.
 Antenna Impedance: 50 ohm unbalanced nominal.
 Circuitry: 24 FETs, 47 Transistors, 27 Integrated Circuits and 94 Diodes.
 Power Requirement: 13.5 V DC nominal, 1.1 A (digital type) and 0.9 A (dial type) for receive and 2.1 A for transmit

Size: 280(W) x 125(H) x 370(D) mm
 Weight: Approx. 9 kg.

RECEIVER

Sensitivity: 0.25 μ V for 10 dB Noise plus Signal to Noise Ratio on 14 MHz.
 Selectivity: 2.4 kHz nominal bandwidth at 6 dB down, 4.0 kHz at 60 dB down on SSB, CW and AM, 600 Hz nominal bandwidth at 6 dB down, 1.2 kHz at 60 dB down with optional CW filter, 6 kHz nominal bandwidth at 6 dB down, 12 kHz at 60 dB down with optional AM filter.
 Harmonic & Other Spurious Response: Image Rejection better than 50 dB. Internal Spurious Signal below 1 μ V equivalent to antenna input.
 Automatic Gain Control: AGC threshold nominal 3 μ V. Attack time is 8 milliseconds and release time is selected from 3500, 1500 and 200 milliseconds.

second on front panel.
 Audio Noise Level: Not less than 40 dB below 1 Watt.
 Audio Output: 3 Watts to internal or external speaker at 4 ohm impedance. Audio Distortion: Less than 10% at 3 Watts output.

TRANSMITTER

Input Power: 200 Watts PEP on SSB, 200 Watts on CW at 50% duty cycle and 50 Watts on AM and FSK. (Slightly lower on 10 meter and 160 meter bands.)
 Microphone: 500 ohm dynamic type.
 Carrier Suppression: -40 dB.
 Sideband Suppression: -50 dB.
 Spurious Radiation: -40 dB.
 Distortion Products: -31 dB.
 Frequency Response: 300 to 2700 Hz \pm 3 dB.
 Final Transistor: S2535 x 2.

YAESU MUSEN model FT-301-S

YAESU MUSEN model FP-301

YAESU MUSEN FT-R 6-7. Uses Wadley loop principal

YAESU MUSEN model FT-301

YAESU MUSEN model YC-500



144MHz FM
HANDY
TRANSCIVER

IC-212

144MHz SSB CW 3W TRANSCIVER

IC-202



YAESU MUSEN

FT-221R 2 Meter Transceiver



● Solid State Ultimate 2 Meter Transceiver with Versatile SSB FM CW AM Operation

Here is a compact, versatile transceiver designed for the active 2 meter enthusiast. The FT-221R features all mode operation—SSB/FM/CW/AM—with repeater offset capability. Advanced phase lock loop circuitry offers unsurpassed stability and clean, spurious free signals. Modular, computer type construction offers reliability and ease of service. Pre-

set pass band tuning provides the optimum selectivity and performance needed on today's active 2 meter band. Join the fun on FM, DX, or OSCAR, with the FT-221R transceiver. Another winner from the world's leader in amateur communications equipment.

GENERAL

Frequency Range: 144.00 to 148.00 MHz in eight 500 kHz segments.
 Mode: SSB (selectable USB or LSB), AM, FM or CW.
 Frequency Stability: Within 100 Hz during any 30 minute period after warm-up. Not more than 20 Hz with 10% line voltage variation.
 Calibration Accuracy: 1 kHz maximum after 100 kHz calibration.
 Backlash: Not more than 50 Hz.
 Antenna Impedance: 50 ohm unbalanced nominal.
 Power Requirement: 100/110/117/200/220/234 V AC, 50/60 Hz, 100 VA maximum or 13.5 V DC, 3A

transmit maximum (11.5, 16.5 V DC).
 Size: 280(W) x 125(H) x 295(D) mm.
 Weight: 8.5 kg

RECEIVER

Sensitivity: 0.5 μ V for 10 dB Noise plus Signal to Noise Ratio on SSB/CW, 1.0 μ V for 10 dB Noise plus Signal to Noise Ratio with 400 Hz 30% modulation on AM. 0.75 μ V for 20 dB quieting on FM.
 Selectivity: 2.4 kHz nominal bandwidth at 6 dB down, 4.1 kHz at 60 dB down on SSB/CW/AM, 6 kHz nominal bandwidth at 6 dB down, 12 kHz at 60 dB down on FM. (8 kHz or 15 kHz filter is available on request.)

Harmonic & Spurious Response: Image Ratio better than 60 dB.
 Audio Output: 2 Watts to internal or external speaker at 4 ohm impedance. Squelch Threshold: Less than 0.3 μ V.
 I.F. Frequencies: SSB/AM/CW 10.7 MHz, FM 10.7 MHz and 455 kHz.

TRANSMITTER

Spurious Radiation: -60 dB.
 Frequency Response: Balanced SSB 300 to 2700 Hz \pm 3 dB. Low power AM better than 50%. Variable reactance FM 5 kHz maximum.
 Carrier Suppression: -50 dB.
 Sideband Suppression: -50 dB.



ALL NEW 6-Element SUPER THUNDERBIRD DX

Model TH6DXX

- New "Hy-Q" Traps
- Up to 9.5db Forward Gain
- 25db Front-to-Back Ratio
- SWR Less Than 1.5:1 on all Bands
- Takes Maximum Legal Power

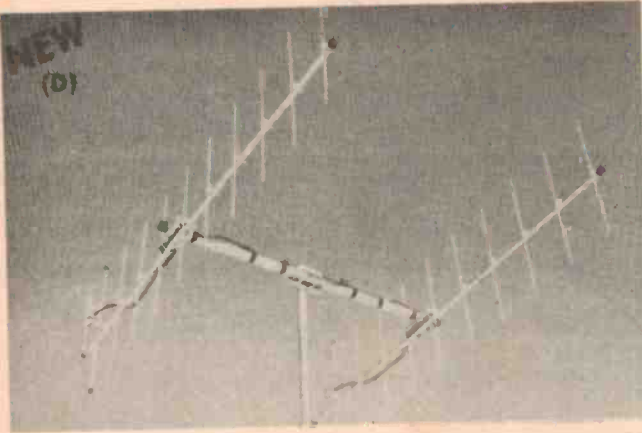

D-POWER PACK The big signal (22 element array) for 2 meter FM, uses two A147-11 yagis with a horizontal mounting boom, coaxial harness and all hardware. Forward gain 16 dB, F/B ratio 24 dB, 1/2 power beamwidth 42°, dimensions 144" x 80" x 40", turn radius 60", weight 15 lbs., 52 ohm feed takes PL-259 fitting.

A147-22 146 - 148 MHz, 1000 Watts, wind area 2.42 sq. ft.

CUSH CRAFT ANTENNAS

- A144-11 11 Element 2M-Yagi
- A147-11 11 Element 2 M Yagi
- A147-20 combination horizontal vertical 2 M
- A144-20 combination Yagi with matching harness circular polarization

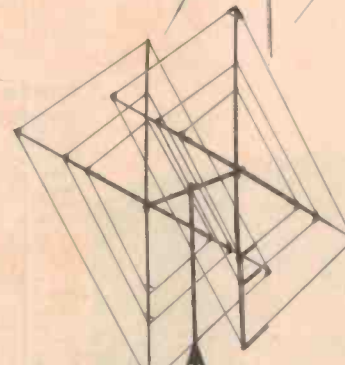

BLITZ BUG FEATURES

Model LAC-1 *

UHF connectors for direct to equipment installation, accepts one PL-259 and one SO-239



NOW...A GREAT NEW WIDE BAND VERTICAL for 80 through 10 Meters

Hy-Gain's 18AVT/WB

Take the wide band, omni-directional performance of Hy-Gain's famous 14AVQ/WB, add 80 meter capability plus extra-heavy duty construction—and you have the unrivalled new 18AVT/WB. In other words, you have quite an antenna.

- Automatic switching, five band capability is accomplished through the use of three beefed-up Hy-Q traps (featuring large diameter coils that develop an exceptionally favorable L/C ratio).
- Top loading coil.
- Across-the-band performance with just one furnished setting for each band (10 through 40).
- True 1/4 wave resonance on all bands.
- SWR of 2:1 or less at band edges.
- Radiation pattern has an outstandingly low angle whether roof top or ground mounted.



CONSTRUCTION ... of extra-heavy duty tapered swaged seamless aluminum tubing with full circumference, corrosion resistant compression clamps at slotted tubing joints... is so rugged and rigid that, although the antenna is 25' in height, it can be mounted without guy wires, using a 12" double grip mast bracket, with recessed coax connector.

Order No. 386

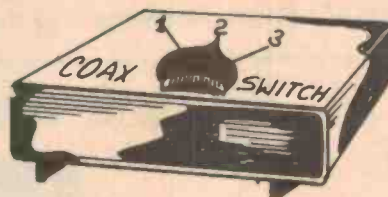

APOLLO

ANTENNA ROTATORS

Model CDR Ham-11 for all hf beams except 40 M

Model CDR AR-22 L junior rotator for small beams

KEN model KR-400 for all medium size hf beams with internal disc brake

KEN model KR-500 for vertical control of satellite tracking

All models rotators come complete with 230-volt AC indicator-control units.

6-conductor cable for KR-400-500

HY - GAIN ANTENNAS

14AVQ 10-40M. verticals, 19' tall, no guys

18AVT-WB 10-80 M. verticals, 23' tall no guys

TH3JR 10-15-20 junior 3 el. Yagi 12' boom

TH3MK3 10-15-20 senior 3 el. Yagi 14' boom

TH6DXX 10-15-20 senior 6 el. Yagi 24' boom

HY-QUAD 10-15-20 cubical quad Yagi 8' boom

TIGER ARRAY 204BA 20M4el. Yagi 26' boom

BN-86 balun for beam purchasers only

YAESU MUSEN Measuring Equipment YC-500E



SWR & POWER METER

MODEL YM-1E
For Professional Quality



COAX CABLE CONNECTORS

PL-259

SO-239 Chassi Mount

Male to male joiner

Female to female joiner

Angle connector

T-connector

COAX CABLE

RG - 8 - U foam filled

DRAKE TV - 3300 TVI lowpass filter
SSR-1 Receivers



EMONA
enterprises

**FOR PROMPT MAIL
ORDER SERVICE!**



EMONA
electronics

SALES: Room 208, 661 George St., Sydney. Phone: 212-4815 — C.B.C. Bank Bldg., Haymarket.
REG. OFFICE: 21 Judge St., Randwick. Phone: 399-9061.



**NEW — MINI CASSETTE
RECORDER-DICTATING MACHINE**
\$45.00 (p&p \$2.00).

Grip-size multi-functional Cassette Tape Recorder Featuring:
o Built-In Condenser Microphone o One-touch multi-functional bar for (1) Record, (2) Play, (3) Stop and (4) Phase Control (Push-Push type) o Instant Replay key for Review and/or Rewind use o Instant Pause mechanical control o Automatic Level Control Device.



**CR-102, ALL SOLID
STATE AM/FM 12/24
HOUR DIG. CLOCK RADIO.**
SLIDING BRIGHTNESS,
VOLUME & TONE
CONTROLS, ETC
EXCELLENT VALUE.

Warranty: 90 days
\$45.95 (p&p Int. \$4.00; NSW \$2.50)

ALSO AVAILABLE o EMONA E-4 stereo FM/AM 24 HOUR DIG. CLOCK RADIO. \$79.95 (P&P Int. \$4.50, NSW \$3.50). o EMONA E-2, All solid state AM/FM 24 HOUR DIG. CLOCK RADIO. \$49.95 (P&P Int. \$4.00, NSW \$2.50).

INTRODUCING!

**NEW 100W (AM) 250W PEP
(SSB)
10-80M
LINEAR
AMPLIFIER!**



HF-10-100L AMPLIFIER

Frequency Range: 3-30 MHz
Input Power: 10 W Nom., 5-20 W PEP range
Output Power: 100 W Nom., $\pm 1/2$ dB across band, 200-250W PEP output
Input Impedance: 50 Ω nom, adjustable to match exciter range under 2:1 across band
Output Impedance: 50 Ω nom, up to 3:1 VSWR acceptable with little degradation
Current Drain: 16 A nom, 20 A supply recommended at 13.6 VDC
Power Supply: 13.6 VDC recommended for best results, 11-14 VDC acceptable positive or negative ground
Pre-amp: 18 dB nom gain across entire HF band, 15 dB typ at 50 MHz, 3-4 dB NF
Size: 19.1 x 16.5 x 8.9 cm wt 1 1/2 Kg

OUR SCIENTIFIC CALCULATORS



The famous ELCON's:
o SCIENTIFIC — STATISTIC (10 memory, rechargeable battery & adaptor), SC6010 — \$39.00
o SCIENTIFIC SC44F (rechargeable battery & adaptor) — \$32.50
o PANASONIC — SCIENTIFIC JE8401U — \$25.00 adaptor optional \$6.00

Warranty: 12 months

CS-6010 To above prices add 15 percent S.T. if applicable (P&P inter. \$3.00, NSW \$2.00).

**EMONA DHM-95 SOLID
STATE — (9 transistors)**

AM/FM
POCKET
RADIO

\$12.50
(P&P \$1)



With large speaker — excellent sound. Earphone and battery included.
Warranty 90 days.

ALSO: 80w, 144 — 148 MHZ, FM, SSB
LINEAR AMPLIFIER 2M10 — 80L

ALSO AVAILABLE:



- o YAESU FRG-7 GENERAL COVERAGE RECEIVER-WADLEY LOOP SYSTEM
- o YAESU FT-101E TRANSCEIVER
- o KENWOOD TS-520 TRANSCEIVER

KENWOOD TS 820 H.F. TRANSCEIVER
KENWOOD TS-520 H.F. TRANSCEIVER
KENWOOD TR-7400A 2M DIG. TRANSCEIVER
o CHECK OUR STOCK ON OTHER YAESU AND KENWOOD AMATEUR RADIO EQUIPMENT

ALL AMATEUR RADIO EQUIPMENT IS AVAILABLE ON 10 PER CENT DEP. TO APPROVED BUYERS!

**AR-145 AM SHORT CHASSIS
PUSH BUTTON CAR RADIO**

\$38.00 (P. & P. Int. \$3.50, NSW \$2.30)



**HAM-WORLD TIME
CLOCK**

Battery operated.
New design from Japan.

\$28.00

(P. & P. Int. \$3.50, NSW \$2.50)



**EMONA, MODEL 12,
BATTERY ELIMINATOR**



9V,
150mA
\$5.00

(Incl. postage)

**CAR RADIO LOCK IN
AERIALS \$4.50 (P. & P. \$1.00)**

**C.B. THE DE-LUXE 23 CHANNEL
5 WATT SEIKI, HA-23C**

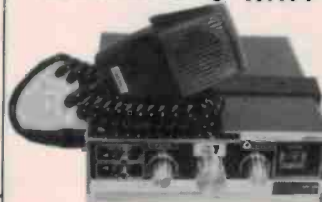

0.5uV for 10db S/N 6dB bandwidth selectivity, 50db minimum spurious rejection/Features local/Dist. switch, PA facility, Squelch etc.

As low as \$79.00!
(P. & P. Int. \$4.00 NSW \$3.50)

C.B. Aerials & accessories available.

C3-11 STEREO CAR CASSETTE



\$59.00 (P. & P. Int. \$4.50, NSW \$3.50)

Complete with round flush mount or convertible type speakers. Supply: 12V Neg ground. Excellent value!

WRITE, PHONE OR CALL IN!

MAIL ORDERS: Box 188, COOGEE, NSW, 2034

NOMOGRAMS TO FIND STYLE OR STABILITY

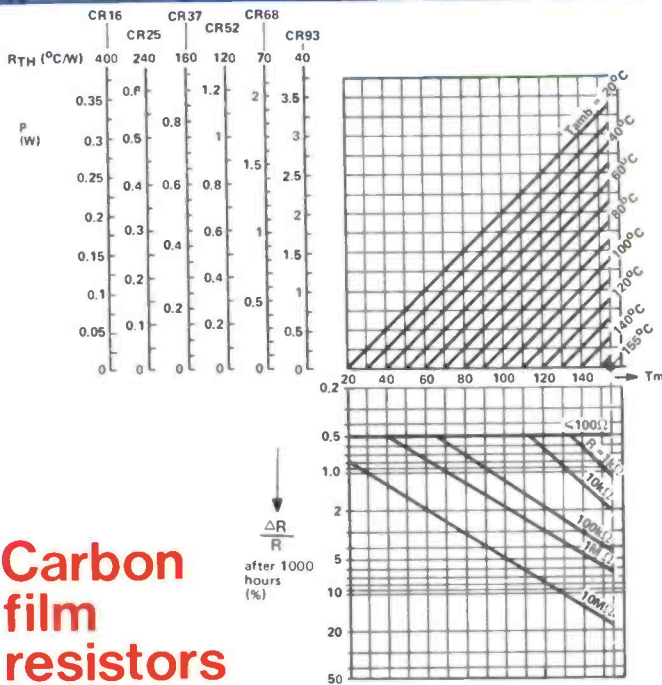

Carbon film resistors

Example

What is the stability of a 1 kΩ metal film resistor, style MR25, operating at 0.33 W in an ambient of 60°C? Take a horizontal line on the nomogram from 0.33 W to where it intersects the 60°C ambient line. Then vertically down to where it intersects the 1 kΩ line and horizontally to the stability calibration column, showing a stability of 0.28% change over 1000 working hours.

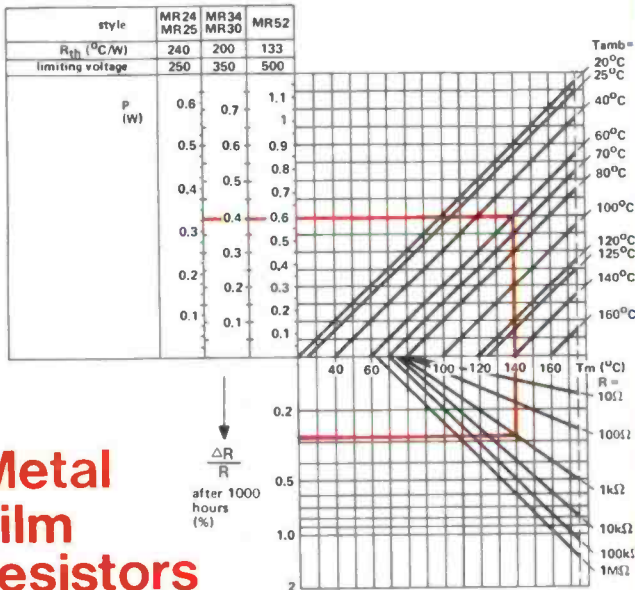

Metal film resistors



Electronic Components and Materials

RESISTORS

Carbon film

High volts metal film

Metal film

Metal film (close tolerance)

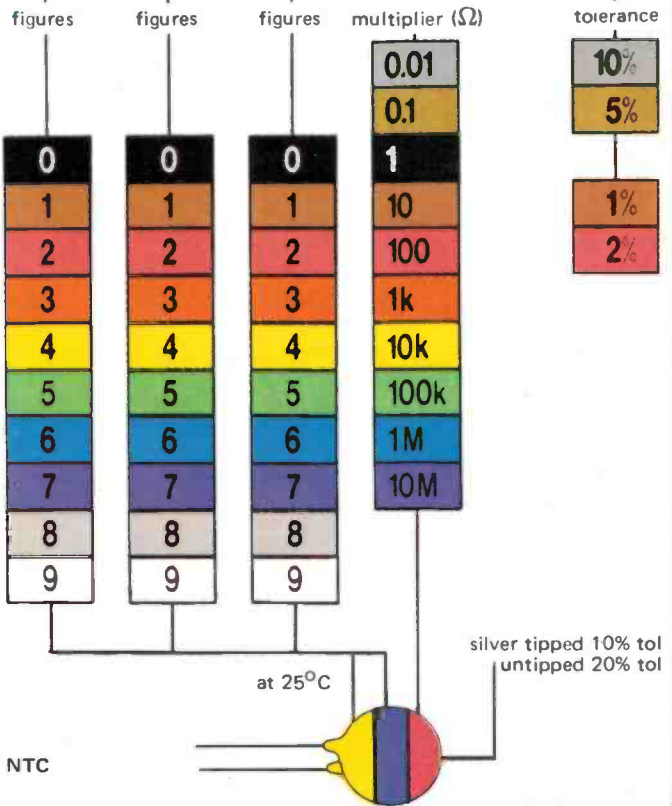

SYDNEY

67 Mars Road, Lane Cove, N.S.W. 2066
Box 50, Post Office, Lane Cove, Sydney, N.S.W. 2066
Telephone: 427-0888
Telex: 21611
Telegram: 'ELCOMA' Sydney

ADELAIDE

81-97 Flinders
G.P.O. Box 20
Telephone: 22
Telex: 82580
Telegram: 'ELC

MELBOURNE

153-173 Sturt Street, South Melbourne, Vic. 3205
Box 377, Post Office, South Melbourne, Vic. 3205
Telephone: 699-0300
Telex: 31497
Telegram: 'ELCOMA' Melbourne

BRISBANE

596 Tarragindi
Box 110, Post
Telephone: 277
Telex: 41466
Telegram: 'ELC

RESISTORS & CAPACITORS

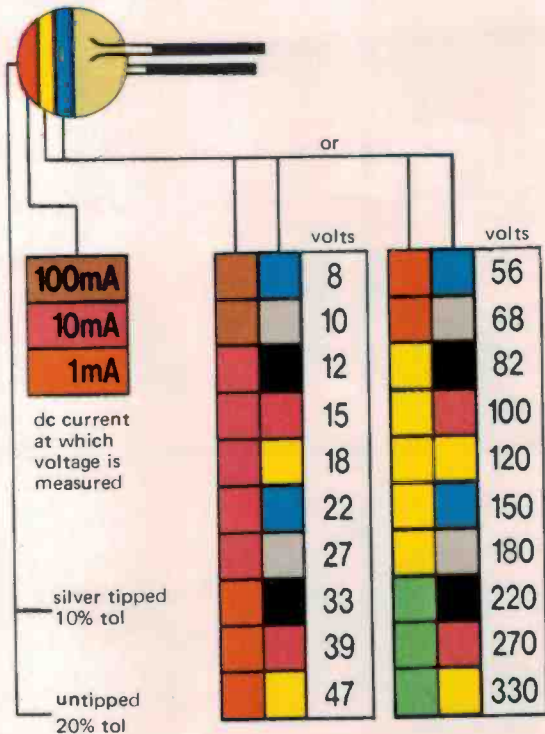

CAPACITORS

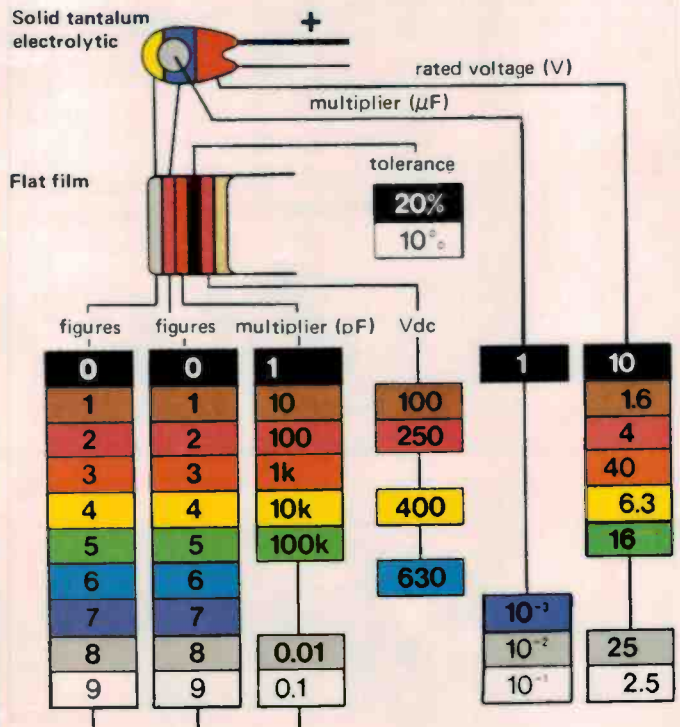

Miniature ceramic plate

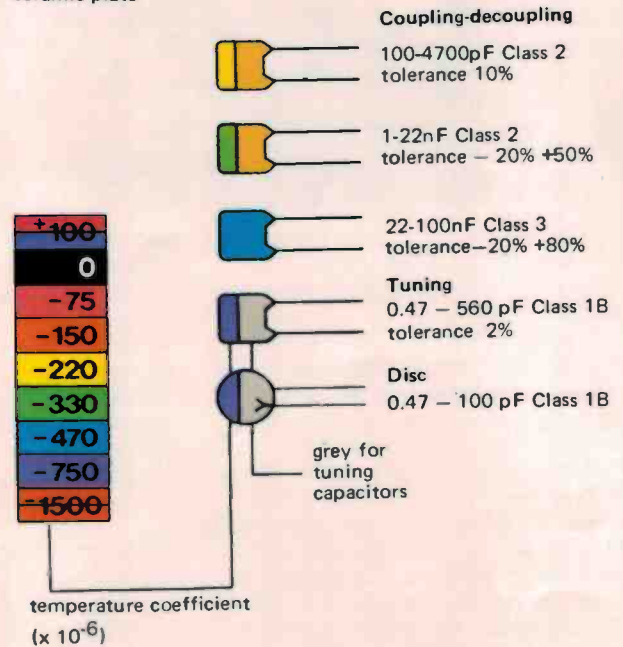

PERTH

Street, Adelaide, S.A. 5000
70, Adelaide, S.A. 5001
4022

OMA Adelaide

94 Belgravia Street, Belmont, W.A. 6104
Box 177, Post Office, Cloverdale, W.A. 6105
Telephone: 65-4199
Telex: 92327
Telegram: 'ELCOMA' Perth

PRODUCTION CENTRE

Road, Salisbury North, Qld. 4107
Office, Salisbury North, Qld. 4107
3332 (8 lines)

OMA Brisbane

Hendon Works
Tapley's Hill Road, Hendon, South Australia. 5014
Telephone: 45-0211
Telex: 82230

PHILIPS

Why would you put a highly sensitive tuner with a tough, powerful amplifier.



Strange as it may seem, those two concepts complement each other beautifully. And, of course, Pioneer planned it that way.

Normally, when choosing a tuner, *sensitivity* is of foremost importance because it determines the unit's ability to pull in weak or distant stations. You see, FM is subject to the same physical laws as TV. While distance is a major consideration, steel reinforced buildings, mountains or other terrain features may also reduce or partially block signals. In low-lying valleys, reception is usually difficult. These and other factors present considerable problems for clear, accurate reception. Which brings us to the Pioneer TX-9500II.

Usable sensitivity is 8.8dBf (1.5µV). What this means in your listening room is that the TX-9500II is capable of reaching out and capturing an

electronic signal of incredibly weak proportions. And then holding it while it's fed into the amplifier. Naturally, the resultant increase in tonal quality will be immediately discernible by your equally sensitive ears.

All speaker systems demand power (some more than others) to produce sound. So now that you've got your broadcast locked in, an amplifier tough enough to stand up to heavy speaker requirements is vitally necessary.

May we suggest our SA-9500II. Continuous power output is 80 watts per channel, min. RMS at 8 ohms from 20 to 20,000Hz with no more than 0.05% total harmonic distortion. Inputs hardly measurable are analyzed and processed into precise impulses of acoustical energy that will ultimately reproduce every musical nuance of the original performance. The delicate and the deafening.

But, sensitivity and sheer power are only two features that contribute to exceptional performance in a tuner/amp combination. Pioneer is offering a wide line of five amplifiers and four tuners. Something for everybody. Why not stop in for a demonstration and hear about such things as a SAW filter that scrubs out distortion or a tone control system that offers 5,929 different tonal characteristics. Strange as it may seem, you can be sure it won't sound that way.

Pioneer Electronics Australia Pty, Ltd.
178-184 Boundary Road, Braeside, Victoria
3195 Phone: 90-9011, Sydney 93-0246,
Brisbane 59-7457, Adelaide 433379,
Perth 24-9899.

PIONEER
leads the world in sound.

SSB TRANSCEIVERS REVIEW

by Roger Harrison

WE ASKED LOCAL AGENTS to submit a sample of their 'top-of-the-line' SSB transceivers for review, which would include technical checkouts on the bench as well as looking at them from an operator's point of view.

Well, we ended up with ten sets, covering nine different manufacturers. They were, in alphabetical order:—

- GEMTRONICS GTX3325 (from Bail Electronics Services)
- HY-GAIN HY-RANGE V (from Mobile One)
- JOHNSON VIKING 352 (from E.F. Johnson Aust)
- MIDLAND 13-895 (from Dick Smith)
- PACE EXPO 1000M (from Aero Electronics)
- PEARCE-SIMPSON PANTHER (one from Vicom and another from Strato)
- TOKAI TC1001 (from Peter Shalley)
- TRAM DIAMOND 60 (from Mobile One)
- UNIVERSE SSB-224M (from Stratos)

... which is a pretty fair sprinkling of what's on the market. They are all 23 channel SSB transceivers that were designed to meet FCC specifications prior to the introduction of the U.S. 40 channel system in January this year. The 1977 U.S. CB specifications for transceivers are somewhat more stringent now and it is fairly obvious from the tests that few of the units tested would meet the required specification. However, test results on a particular unit are not necessarily indicative of the 'line' of transceivers as a whole. The regulation authorities (FCC in the U.S., P & T in Australia) generally require a manufacturer or his agent to submit a number of units of particular type for type-approval testing. Nevertheless, having done the tests personally, one wonders ...

TECHNICAL TESTS

The complete specifications of each transceiver were not tested ... otherwise I'd still be at it! The tests that were performed were those generally considered to be most important from the technical performance point of view (RF power output, spurious emissions etc, receiver sensitivity, IF and image rejection etc), as well as a few from the operational point of view (squelch threshold, clarifier range, adjacent channel rejection).

Six tests were carried out on each transmitter:

RF POWER:	AM (carrier)
	Modulation
	SSB (PEP output)
SPURIOUS EMISSIONS:	Harmonic emission
	Other Spurious emissions
	SSB Carrier Suppression

In addition, the frequency tolerance on both transmission and reception was checked for each transceiver. In all cases it was found to be within the $\pm 0.005\%$ specified.

The opposite sideband suppression and transmitter modulation frequency response etc were not checked as

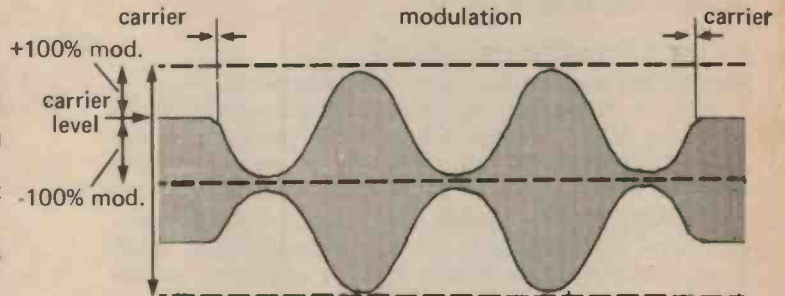

Fig 1: AM mode, 100% modulation

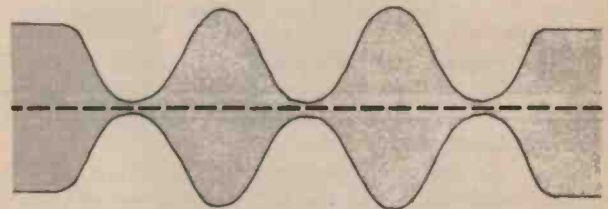

Fig 2: AM from the transceivers reviewed looked more like this. About 10-20% upward modulation, and 100% downward modulation.

these are time consuming and of only secondary importance.

Seven basic tests were carried out on the receiver sections of each unit:

SENSITIVITY:	AM sensitivity
	SSB sensitivity
	Squelch Threshold
REJECTION OF UNWANTED SIGNALS:	IF Rejection
	Image Rejection
	Adjacent Channel Rejection
	plus Clarifier Range.

Receiver sensitivity figures were obtained for a standard signal plus noise to noise ratio $(S + N)/N$ of 10 dB. The output level of the signal generator was adjusted until this ratio was achieved and the level noted. The AM signal was modulated 30% by a 400 Hz sine wave. Only carrier was used on SSB, offset 600 Hz to 1 kHz.

Crossmodulation measurements are time-consuming to set up and measure so I substituted adjacent channel rejection measurements as these give some indication of how the receiver performs when confronted with strong signals on an adjacent frequency.

For the record, the following equipment was used to perform the tests:

Spectrum Analyser, Hewlett Packard	85538
RF Power Meter, Bird 'Thru-Line'	with 5W/25-60 MHz and 25W/25-60 MHz plug-ins

SSB TRANSCEIVERS REVIEW

Oscilloscope, Tektronix 422
Signal Generator, Hewlett Packard digital readout,
phase-locked.

The transceivers were all powered from a variable, regulated supply set at 13.8 V.

EXPECTED PERFORMANCE

What sort of performance figures are acceptable?

Well, as far as the transmitter is concerned, a carrier power on AM of between 3 W and 4 W is perfectly acceptable. It makes little real difference to range or signal strength. In fact, none of the transceivers tested gave less than 3.0 W of carrier on AM and one set — the Universe — gave over 7 W! On SSB a 'Peak Envelope Power' (PEP) output of between 9 W and 12 W is acceptable for the same reasons.

On AM, the modulation percentage is of interest as it is a major factor in determining how 'loud' you sound to the station receiving you. Now, 100% modulation of a carrier should look like Figure 1, (like, if you whistle into the mike).

One hundred percent upward modulation (I've written it + 100% for simplicity) will raise the RF to twice the carrier level, 100% downward modulation (-100% mod.) will reduce it to zero.

Now, all the transceivers tested exhibited very little upward modulation, usually 10% to 20%, but all were capable of at least 80% downward modulation, and most could give 100% downward. It looks like Figure 2. I have been unable to find out why this is so.

If the carrier is *overmodulated*, the downward peaks of modulation will cut the carrier off for a short period. Now, this is not very good as the process produces some very nasty distortion causing the transmitter to radiate 'rubbish' on frequencies either side of the transmitter frequency. Not nice. Doesn't help you to be understood by the station receiving you either. Moral — don't shout into the mike.

All spurious emissions should meet the applicable specification or the manufacturer's specification (which is usually equivalent to the required FCC specification in any case — these transceivers being made for the US market). For these tests, that meant -50 dB (that's one/one hundred thousandth the power of the carrier!). It looks impressive when you put it that way but it's not such a tall order really. Only three sets made the grade though!

Receiver sensitivity presents a bit of a difficulty. Urban and city electrical noise levels (mostly man-made) are pretty high, and there is a natural peak for noise between 25 MHz and 30 MHz in any case. But, it ain't always necessarily so — as they say in the classics. A reasonable sensitivity figure on AM would be 1 μ V. This would more or less ensure that communications would be largely determined by the prevailing noise level. A lower figure would be better in low noise circumstances. For SSB, a figure of 0.5 μ V would apply. As for the squelch threshold, if it opens on a signal equivalent to the sensitivity figure then it's doing the job you want. The sensitivity figures represent a pretty weak signal which would be difficult to copy anyway.

To my way of thinking, the clarifier range should be roughly equivalent to the frequency specification. i.e.: \pm

0.005%. This is about ± 1.35 kHz. However, that's really covering extremes and something less, say ± 1 kHz, would be acceptable. Different manufacturers have different ideas on this it seems, from the test results.

As the IF frequencies employed in these transceivers are in the HF range (generally around 8 MHz or 11 MHz), where powerful shortwave transmitters operate, the IF rejection should be quite good. A figure of 70-80 dB would be a minimum acceptable.

The 'image' of the frequency channel selected is 2 x IF frequency above or below the channel frequency. I discussed these images in Vol.1., No.1. in describing double-conversion receivers. As the image frequency may fall on other occupied frequencies, these unwanted signals may be received along with the desired signal. Additionally, as all the 23 channel transceivers reviewed employed crystal synthesizers which select the desired channel by mixing the frequencies of three crystal oscillators, there arise a number of possible image frequencies — some within the 27 MHz band!

It seems that a reasonable image rejection would be about 60 dB, although many manufacturers only quote 50 dB. It depends whether you can live with it — obviously, many do, but probably out of ignorance.

A strong signal in a channel either side of the channel selected can be heard if it is sufficiently strong — even on top of a signal you may be copying. This problem is inherent in the circuitry, however, some receivers are better able to cope with this situation than others. A reasonable figure for adjacent channel rejection would appear to be about 60 dB.

Few manufacturers include a specification for this — only the TRAM Diamond 60 had it listed in the specs.

REVIEWING THE RESULTS

Leaving aside the technical results for the moment, let's look at how the transceivers shaped up operationally.

Most of the units reviewed suffered from a number of major disabilities. The control knobs on six units were round and very small in diameter making them difficult to operate for a start and poor indicators of the 'status' of the particular control. Concentric knobs of small diameter are the worst on a crowded panel. In addition, they were also poorly positioned on the front panel, adding to the inherent difficulties in operating a small knob. Thumb-and-finger knobs are by far the best where space is limited. Full marks to the GTX-3325, HY-Range and Panther.

Five rigs had meters that were too small to be of much use. A meter is potentially a very useful device; a meter too small to be reasonably visible from the operator's position, or at arm's length say, is really a waste. A lamp would give better indication. The Pearce-Simpson Panther makes good use of an 'edgewise'-mounted meter which gives a lengthy scale for the amount of panel space it occupies. Meter illumination is a must: some sets change colour of the meter illumination to indicate Tx or Tx condition.

Layout of the front panel was poor on some transceivers, making operating the controls a problem as one tended to knock adjacent controls when adjusting one. The two linear controls on the Tokai TC1001 are awkward to

operate at the best of time and could be bad news in a mobile situation. Some also suffered from markings which were difficult to see except in good light, looking directly at the front panel. The Gemtronics GTX-3325, the Hy-Gain Hy-Range V, the Johnson Viking 352 and the Pearce-Simpson Panther had the best panel layouts of the sets reviewed. The Midland 13-895 and the Tram Diamond 60 had a proliferation of knobs and switches — which is great I suppose if you're into that style of operating, but panel layout was not good, cramped in fact, and using the controls presented some problems.

Looking at the technical tests, there are some interesting results!

Only five met the specification for transmitter spurious emissions! The worst offender here was the Pace Expo 1000M — it grossly exceeded its specification. Others were quite close and would probably meet the spec. if operated on a lower voltage. There was a curious difference between the two Panther sets.

None of the transmitters gave less than 3.0W output on AM. Curiously, the Universe produced 7.3 W! All units except the Midland 13-895 gave 100% downward modulation.

Upward modulation ranged from 0% (13-895 again) to 30%, most sets giving 10-20%. The two Panther sets and the Tram Diamond 60 could overmodulate on negative peaks.

PEP output on SSB ranged from 5W (Viking 352) to 12W, seven delivering over 9W.

Receiver performance ranged from very good overall (Hy-Range, Panthers, Tram Diamond 60) to average (Midland 13-895, Pace Expo 1000M and Johnson Viking 352). All sets had noise limiters for AM and noise blankers for SSB. The effectiveness of these was subjectively tested — some appeared to work quite well, others had barely any effect.

The clarifier range on the Midland 13-895, the two Panther sets and the Tram Diamond 60 was somewhat restricted, as I explained previously. Some had a wide range that was a little 'skewed' — more shift on one side of the channel than the other. Several sets had a centre-detent clarifier control which is very useful.

Most handbooks supplied with units were satisfactory — some only barely so. The Viking 352 has a rather skimpy handbook, whereas the Hy-Range V had an excellent handbook complete with photographically illustrated installation instructions.

Of the transceivers reviewed, two types stand out for performance and operability. These are the Hy-Gain Hy-Range V and the Pearce-Simpson Panther. They are followed closely by the Gemtronics GTX-3325 and the Johnson Viking 352.

GEMTRONICS GTX-3325



TEST	MEASUREMENT	SPECIFICATION	COMMENTS
TX			
RF power output			
AM (carrier)	3.8W	4W	
Mod. %	-100%, +10%		
SSB (PEP output)	10W	12W	
Harmonic emission	-48 dB (2nd) -44 dB (3rd)	-50 dB or better	<i>Does not meet FCC spec.</i>
Other Spurious emissions	-47 dB	-50 dB or better	<i>Hum and noise quoted as better than -40 dB down on full output.</i>
SSB Carrier Suppression	-52 dB		
RX			
Sensitivity			
AM	1 μ V	-	
SSB	0.1 μ V	-	
Squelch Threshold	0.15 μ V	-	
Clarifier Range	+ 900 Hz, -2.4 kHz	-	
IF Rejection	80 dB	Spurious responses are quoted as better than 50 dB down.	
Image Rejection	50 dB		
Adjacent Channel Rejection	60 dB		

General Comments

A compact, easy to operate set with controls well-placed for mobile operation. The channel selector switch is smooth to operate but has a positive detent at each position. The panel had a large (by mobile transceiver standards), easy to see meter and Tx/Rx indicators. All controls operate smoothly. The receiver appears to have adequate sensitivity and the noise blanker on SSB

has adequate effect (some other sets are a little better). Noise limiting on AM reception appears to be effective to some extent and is all I would really expect for this type of equipment. The transmitter audio is quite 'clean' with a good balance between 'highs' and 'lows' on both SSB and AM. The handbook supplied with the equipment has concise, but clear, operating, connection and installation instructions. It does not include any basic theory of operation as some handbooks do but some very clear block diagrams are in-

cluded along with a complete circuit. Pre-sales and after sales service is provided by the agent, Bail Electronics Services.

SSB TRANSCEIVERS REVIEW

HIGH GAIN HY-RANGE V



TEST	MEASUREMENT	SPECIFICATION	COMMENTS
TX			
RF power output			
AM (carrier)	3.0 W	4W	
Mod. %	-100%, +30%		
SSB (PEP output)	10 W	15W (input)	
Harmonic emission	-50 dB	-50 dB	<i>Meets FCC specifications</i>
Other Spurious emissions	53 dB	-50 dB	
Carrier Suppression (SSB)	-40 dB	-40 dB	
RX			
Sensitivity			
AM	0.95 μ V	1 μ V	
SSB	0.08 μ V	0.25 μ V	
Squelch Threshold	2 μ V		
Clarifier Range	+1 kHz, -1.3 kHz	\pm 800 Hz	
IF Rejection	80 dB		
Image Rejection	60 dB		
Adjacent Channel Rejection	70 dB		

General Comments

I thought this transceiver outstanding in functional design and operation, and this is reflected in the engineering as it readily achieved the required specifications. Construction is robust and the controls had the best 'feel' of all the units reviewed. The panel layout was obviously designed for left-hand drive vehicles but, as the controls are all easily accessible and have 'thumb-

and-forefinger' grip this should present no problems. I found the *Hy-range* easy and convenient to operate with either hand. The channel selector switch operates smoothly with a positive detent. The meter is of adequate size for its purpose and the Tx/Rx indicators easy to see at a glance. Audio quality on transmit, SSB and AM is excellent.

On reception, audio quality appears particularly 'sharp' giving good, clear

sound and both the ANL (for AM) and the noise silencer (NS-for SSB) or noise blanker are effective. The handbook is particularly informative. It includes four pages of photographically illustrated installation instructions as well as clear, well written operating and connection instructions. Also included are basic details on suppressing noise interference in vehicle illustrated with diagrams. A circuit diagram is included with the book.

JOHNSON VIKING 352



TEST	MEASUREMENT	SPECIFICATION	COMMENTS
TX			
RF power output			
AM (carrier)	3.2W	4W	
Mod. %	-100%, +10%	80%	
SSB (PEP output)	5W	12W	
Harmonic emission	-52 dB	-50 dB	
Other Spurious emissions	-58 dB	-50 dB	
SSB Carrier Suppression	-44 dB	-40 dB	
RX			
Sensitivity			
AM	0.7 μ V	0.5 μ V	
SSB	0.16 μ V	0.35 μ V	
Clarifier Range	-1.0 kHz +1.1 kHz	\pm 1.35 kHz max.	
IF Rejection	60 dB		
Image Rejection	50 dB		
Adjacent Channel Rejection	70 dB		<i>Spurious rejection given as 50 dB by manufacturer.</i>

General Comments

The *Viking 352* has a muted, 'low key' appearance with good accessibility to all controls. However, the front panel styling and colour makes it difficult to see control markings under low light. The indicator lights and channel number are however, quite visible. The meter is a little small to be of much use. The channel selector was quite stiff and required quite a grip to operate it. The squelch was a little 'soft' in operation for my liking in that the actual thresh-

old was spread over a small portion of the control rotation rather than 'cutting off' at a well-defined spot. The receiver sensitivity on AM did not meet the manufacturer's specification but was nevertheless adequate as the urban RF noise level on 27MHz is quite high and is generally the limiting factor. SSB sensitivity was excellent. Audio quality on reception was quite clean and well balanced.

Transmit audio quality was good on both SSB and AM although close talking to the mike gave a somewhat muffled sound. Noise blanker on SSB reception was quite effective. The AM noise

limiter seemed to cope as well as could be expected, much the same as in the other sets reviewed. The clarifier control has a convenient centre-detent enabling the operator to return to the exact channel frequency when required. An unusual feature not seen on any other transceiver (by this writer anyway) is the location of the mike socket on the back panel of the unit. The operating mode lights (AM, USB, LSB) are colour coded — a useful feature. The handbook is a little brief but clear pictures of all the controls and connections are shown together with a brief explanation of their function.

MIDLAND 13-895
Serial No. 0034559



TEST	MEASUREMENT	SPECIFICATION	COMMENTS
TX			
RF power output			
AM (carrier)	3.5W	3 to 4W	
Mod. %	-90%		
SSB (PEP output)	8W	12W	
Harmonic emission	-47 dB	-50 dB	<i>Does not meet FCC spec.</i>
Other Spurious emissions	-46 dB	-50 dB	
SSB Carrier Suppression	-54 dB	-40 dB	
RX			
Sensitivity			
AM	0.75 μ V	1 μ V	
SSB	0.35 μ V	0.5 μ V	
Squelch Threshold	0.6 μ V	0.7 μ V	
Clarifier Range	-400 Hz +700 Hz	\pm 350 to \pm 800 Hz	
IF rejection	80 dB	80 dB	
Image rejection	50 dB	50 dB	
Adjacent Channel rejection	50 dB		

General Comments

All the knobs and switches makes the 13-895 a megalomaniac's delight! This transceiver may be operated from either 110V AC or 12V DC and is hence suitable for either a base or a home station or as a mobile rig. It is more suited as a base station as the operator really has to pay attention to the controls to make the most of the 13-895. The channel selector operates smoothly and the channel number is

easily seen. The meter is a little small to be of much use — like on most other transceivers, however, I guess it does give some indication. The TONE HI-LOW switch could be dispensed with; it is unnecessary really. The noise blanker, while reducing ignition and other impulse noise is not as effective on this unit as was noted with some others. Audio quality on both AM and SSB reception is quite good.

Audio quality on transmit is also good but on SSB the transmitter will distort ('flat-top') when the mic. gain is wound up approaching half-way. Modulation on AM seemed a little 'thin' or 'light-

on'. Accessibility of the controls is not good, unless you have slim, delicate fingers. Operation of the squelch control was quite awkward, knocking the mic. gain or the RF gain while trying to adjust the squelch was a constant hazard. The receiver was prone to overload and was noticeably troubled by strong signals in adjacent channels which would interfere with the signal being copied. While the transmitter did not meet FCC specs (for this type of TxQ) at its rated supply voltage, operation from a lower voltage improved the situation, although power output was reduced somewhat.

PACE EXPO 1000M
Serial No. 711108033



TEST	MEASUREMENT	SPECIFICATION	COMMENTS
TX			
RF power output			
AM (carrier)	3.3W	4W	
Mod. %	-100%, +20%		
SSB (PEP output)	9W	12W	
Harmonic emission	-42 dB (2nd & 3rd)	-50 dB	<i>Differs greatly from FCC spec.</i>
Other Spurious emissions	-46 dB	-50 dB	
SSB Carrier Suppression	-46 dB	-40 dB	
RX			
Sensitivity			
AM	0.52 μ V	1 μ V	
SSB	0.08 μ V	0.5 μ V	
Squelch Threshold	0.3 μ V	1 μ V	
Clarifier Range	\pm 1 kHz		
IF Rejection	50 dB		
Image Rejection	50 dB		
Adjacent Channel Rejection	60 dB		

General Comments

The Pace has rather flashy styling with chrome, silver and blue trimmed front panel and bright indicator lights. I

found the channel selector to be a little 'light' to the touch, giving the feeling that I wasn't sure I was actually on channel. The channel numbers however, are easily read. The controls are not very conveniently positioned, unless you have a left-hand drive vehicle or stay on one channel and one mode most of the time. All the controls operate

smoothly but the concentric squelch and volume controls are a little awkward to operate. The centre-stop clarifier is a very handy feature. The meter is not much use really, same as most other transceivers I'm afraid. Audio quality on both AM and SSB reception was good although lacking some bass. Transmit audio quality on

SSB TRANSCEIVERS REVIEW

both modes was quite OK. Modulation on AM was good. The noise blanker was not particularly effective.

The harmonic and other spurious emissions from this transmitter were the worst of the group of transceivers tested. The unit would certainly not meet FCC

specifications. Spurious products from the crystal synthesiser appeared on other, nearby channels and could cause problems to other band users. The high harmonic level could contribute to TVI and interference to other services. The handbook is quite reasonable and gives

clear directions on operating the controls and connections to the set but only minimal installation instructions are included. The handbook includes a circuit diagram.

PEARCE-SIMPSON PANTHER (No.1.)

Serial No. 605437



General Comments

The *Pearce-Simpson Panther* is a compact transceiver having a well laid-out front panel; the controls are well-sited and easy to use regardless of whether the manner of installation would require the operator to use his left or right hand. The channel selector is easy to use, having a large circular knob with a diameter almost equal to the height of the front panel. The channel number is back lighted and readily visible. The clarifier control (or 'slide-o-tune' as they call it) features a

thumb-and-forefinger grip knob as does the mode switch. The volume and squelch controls are concentric, which makes things a little awkward. The meter is an edge-mount type which has a reasonably sized scale, making the best of the space available on the front panel.

No RF gain control is provided, a 'DX-LOCAL' switch being substituted. Full receiver gain is available when switched to DX, the gain being reduced for strong local signals when in the LOCAL position. The noise blanker seems reasonably effective on ignition

noise. The receiver performs very well indeed, however, some extra range for the clarifier would be useful — note also that it is a little 'skewed', there being more range on the high frequency side than the low frequency side of the centre frequency. This may be caused by an out of tolerance crystal. Audio quality on reception is well balanced and sounds good. On transmit the audio quality on both AM and SSB is excellent. However, the transmitter will overmodulate on AM causing annoying distortion to spillover into adjacent channels.

TEST	MEASUREMENT	SPECIFICATION	COMMENTS
TX			
RF power output			
AM Carrier power	3.3 W	4W	
Mod. %	-100%, +20%	100%	<i>Will overmodulate on negative peaks on AM causing 'splatter'.</i>
SSB (PEP output)	12 W	12 W	
Harmonic emission	-64 dB (2nd)	-50 dB	<i>Compare these spurious emission results with Panther No.2. results.</i>
	-52 dB (3rd)		
Other spurious emissions	-52 dB	-50 dB	
SSB Carrier Suppression	-52 dB	-40 dB	
RX			
AM	0.34 μ V	0.8 μ V	
SSB	0.1 μ V	0.3 μ V	
Squelch Threshold	0.12 μ V	0.5 μ V	
Clarifier Range	-400 Hz, +800 Hz	\pm 600 Hz	
IF Rejection	110 dB		<i>Rejection measured at 7.8 MHz; 455 kHz rejection not measured.</i>
Image Rejection	60 dB		
Adjacent Channel Rejection	60 dB		

PEARCE-SIMPSON PANTHER (No. 2.)

Serial No: 6044150



TEST	MEASUREMENT	SPECIFICATION	COMMENTS
TX			
RF power output			
AM Carrier power	4.0 W	4W	
Mod. %	-100%, +10%	100%	<i>Overmodulates on negative peaks as previously noted.</i>
SSB (PEP output)	12W	12W	
Harmonic emission	-48 dB	-50 dB	<i>Harmonic suppression and spurious emissions do not meet 1976 FCC specifications, for this particular unit</i>
Other Spurious emissions	-42 dB	-50 dB	
SSB Carrier Suppression	-50 dB	-40 dB	
RX			
Sensitivity			
AM	0.37 μ V	0.8 μ V	
SSB	0.075 μ V	0.3 μ V	
Squelch Threshold	0.2 μ V	0.5 μ V	
Clarifier Range	-500 Hz, +600 Hz	\pm 600 Hz	
IF Rejection	60 dB		
Adjacent Channel Rejection	60 dB		

The major difference between this unit and the first one is in the harmonic suppression and other spurious emission levels. It appears that some adjustment of the output filter circuitry of this unit would improve the situation in regard to the harmonic suppression. Some realignment of the crystal synthesizer mixer circuitry would appear to be necessary to reduce the levels of

the spurious emissions generated here.

It is curious that two sets from the same manufacturer should produce such a large difference in these parameters. It would appear that pre-sales checking would be necessary if transceivers were to meet a given specification anything similar to the 1976 FCC specifications for 23 channel 27 MHz equipment. As far as the rest of the equipment per-

formance is concerned this unit behaved in a very similar fashion to Panther No. 1. and all other comments apply here.

The handbook supplied with the Panther is well written, clear and informative. Instructions on the function and use of all controls is clear and concise. A large (by CB equipment handbook standards!) circuit diagram is included on a fold-out page.

TOKAI TC-1001 Serial No. 114200



General Comments

The Tokai transceiver in most technical aspects is quite a good performer but the front panel design detracts from this. For a start the meter is impossibly small — better left off if a larger one could not be fitted. The clarifier and mode switch are cramped against the channel selector knob. The squelch and volume controls are linear slide types and are especially difficult to operate in mobile situations. They

are placed quite close together and I would often knock one while trying to adjust the other. The channel selector knob is a little small for my liking for a circular knob. However, the switch operates smoothly with a positive detent and the back-lighted channel numbers are clear and easily read.

The noise blanker appears to handle ignition noise quite satisfactorily. On reception, audio quality was good but the signal to noise ratio on AM was affected by an apparently noisy IF

stage. This may be peculiar to this particular unit. The adjacent channel rejection was not high, or not as high as some of the other sets reviewed, and some problems were evident in use. The transmit audio quality on both AM and SSB was clear and well-balanced. The handbook provided with the equipment is quite straightforward and contains a very good description of SSB for non-technical or semi-technical users. A circuit diagram is included in the handbook.

TEST	MEASUREMENT	SPECIFICATION	COMMENTS
TX			
RF power output			
AM Carrier power	3.5W	5W input	
Mod. %	-100%, +10%		
SSB (PEP output)	7.5W		
Harmonic emission	-70 dB (2nd) -62 dB (3rd)	more than 50 dB	
Other Spurious emissions	-60 dB		
SSB Carrier Suppression	-64 dB		
RX			
Sensitivity			
AM	0.9 μ V	Specification of 0.5 μ V does not indicate AM or SSB mode	<i>It appears that the AM IF-stage is a little noisy resulting in a slightly degraded signal to noise ratio.</i>
SSB	0.08 μ V		
Clarifier range	-800 Hz, +1.1 kHz	\pm 600 Hz	
IF rejection	-60 dB		
Image rejection	-70 dB	-50 dB	
Adjacent Channel Rejection	-50 dB		

TRAM DIAMOND 60 Serial No: 32445



TEST	MEASUREMENT	SPECIFICATIONS	COMMENTS
TX			
RF power output			
AM Carrier power	3.2W	3.75W	
Mod. %	-100%, +10%	95% to 100%	<i>Will overmodulate on negative peaks.</i>
SSB (PEP output)	11W	8W	
Harmonic emission	-54 dB	No spurious emission spec. given.	
Other Spurious emissions	-64 dB		
SSB Carrier Suppression	-52 dB		
RX			
Sensitivity			
AM	0.8 μ V	0.3 μ V gives more than 1W output	<i>This was measured on standard test. For the conditions listed in the spec. the figure of 0.35 μV was obtained.</i>
SSB	0.09 μ V	0.1 μ V	
Squelch Threshold	0.35 μ V		
Clarifier Range	-500 Hz, (SSB) +1 kHz	\pm 800 Hz ((SSB)	
	\pm 1.5 kHz (AM)	\pm 1.5 kHz (AM)	
IF Rejection	70 dB	60 dB	
Image Rejection	110 dB	50 dB	<i>See general remarks.</i>
Adjacent Channel Rejection	60 dB	60 dB	

SSB TRANSCEIVERS REVIEW

The *TRAM* has more front panel controls than the *Midland 13-8951*. Of necessity, six are combined in concentric controls on three shafts. These are; the volume and RF gain, SWR calibrate and Transmitter Tone Control (TTC), Clarifier and Squelch. Like most of these transceivers, intended for the US market, the front panel is laid out for use in left-hand drive vehicles. The control knobs, with the exception of the channel selector, are small and present some difficulty in operation. The

channel selector works smoothly, if a little stiff, but has a positive detent at each position. All indicators are easily seen. The meter is of reasonable size and functions as an SWR indicator apart from the usual S-meter and power output monitoring functions.

An unusual feature is the Transmitter Tone Control (TTC). This control allows the transmit audio to be 'tailored' to suit individual voice characteristics — a useful idea! Its effect is apparent on transmit and good

quality audio on both SSB and AM can be obtained. On receive, the noise blanker seems reasonably effective and audio quality is quite good on both AM and SSB reception. The image rejection was much greater than expected although possible images close to the 27 MHz band (a result of the crystal synthesizer mixing method) were not investigated due to lack of time. The handbook supplied with the *TRAM* is quite good, the explanation of the controls etc being quite clear. No circuit diagram is included.

UNIVERSE SSB-224M

Serial No. 09000008



TEST	MEASUREMENT	SPECIFICATIONS	COMMENTS
TX			
RF power output			
AM Carrier power	7.3W		<i>Exceeds 1976 FCC specifications</i>
Mod. %	-100%, +10%		
SSB (PEP output)	9.5W		
Harmonic emissions	-47 dB		<i>Does not meet 1977 FCC specification.</i>
Other Spurious emissions	-52 dB		<i>Meets above spec.</i>
SSB Carrier Suppression	-38 dB		<i>Does not meet above spec.</i>
RX			
Sensitivity			
AM	0.8 μ V		
SSB	0.12 μ V		
Squelch Threshold	1.1 μ V		<i>A little high.</i>
Clarifier Range	\pm 1.3 kHz		
IF Rejection	?		<i>IF frequency unknown.</i>
Image Rejection	?		
Adjacent Channel Rejection	70 dB		

General Comments

A handbook would have come in handy! None was included in the transceiver packaging but I presume one is available. Deduct ten marks if no handbook supplied. The *Universe*, although an attractively presented rig, suffers all the ills of compact rigs — small, awkward to operate knobs, a too small meter etc. I found the channel selector

on this unit stiff and somewhat difficult to operate but this may not be indicative of all units. Receiver performance is quite good, especially the adjacent channel rejection — it was as good as the *Hy-Range V* and the *Viking 352*. For a change, a reasonable clarifier range is provided. Audio quality on reception was good but on transmit it sounded a little thin — lacking in bass perhaps, especially on AM.

It is curious that the power output is more than double (WOW ... 3dB!) that of most of the other rigs, exceeding the FCC specification. The harmonic

emission does not meet spec. but this may be a result of the increased AM carrier power. However, it was the same on SSB which tends to suggest that there is some circuit maladjustment. It would be interesting to test another *Universe* or two. The squelch threshold was a little high at the most sensitive setting but 1 μ V at the antenna is quite a weak signal. Carrier suppression, although only 2dB above the required spec., was poor when most other transceivers can achieve around 50dB. The figure should improve with some circuit alignment. Noise limiting and blanking on reception seemed adequate.

Yes, Virginia - you can buy a \$79 CB Radio...



But would you take the risk?

Half the time the advertisers aren't even game to tell you the brand name!

Why does Dick Smith sell only two famous brands of CB radio when, as the largest importer of CB in Australia, he is continually being offered 'backyard' brands at far cheaper prices?

The simple reason is that Dick Smith believes that it will be almost impossible to obtain spare parts for these 'unknown' brands in the near future.

That's why Dick sells Midland - the world's largest selling Citizen's band radio equipment (and also Australia's: over 28,000 have been sold here alone) and Sanyo - one of the most respected names in electronic equipment. But the manufacture is just part of the story - there must be efficient service back-up on the local scene.

That's why Dick Smith Electronics maintains the largest service department of any similar organisation in Australia. A large spare parts inventory is also held to minimise delays to customers.

So if you are planning to purchase a CB radio, it makes a lot of sense to consider what would happen if something did go wrong.

With Dick Smith, you can be certain.

With the others: well you just don't know...

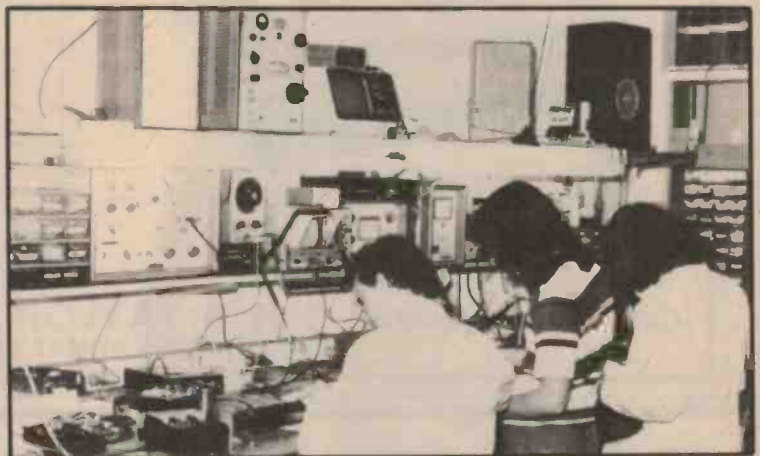

A section of the service department at our headquarters at Artarmon, NSW.

MIDLAND



SANYO

BRANDS THAT YOU CAN RELY ON; SERVICE THAT WON'T LET YOU DOWN

Would you like to be a Dick Smith CB Dealer?

And sell famous brands with the same service and spares back-up that we offer our own customers... Then write or phone, giving details of yourself, to:

Gary Johnston,
DS Distributors (a division of Dick Smith Electronics Pty Ltd).
24 Carlotta Street, Artarmon, NSW. 2064. Phone (02) 439-5311

DICK SMITH ELECTRONICS GROUP

VISIT YOUR NEAREST STORE:

SYDNEY: 125 York Street. Ph 29-1126

BANKSTOWN: 361 Hume Hwy. Ph 709 6600

GORE HILL: 162 Pacific Hwy. Ph 439-5311

MELBOURNE: 656 Bridge Rd, Richmond. Ph 42-1614

BRISBANE: 166 Logan Rd, Buranda. Ph 391-6233

MAIL ORDERS: PO Box 747, Crows Nest NSW 2065

DICK SMITH DEALERS: Perth 28 1599; Elizabeth South 255 2249;

Port Adelaide 473 688; Salisbury North 258 1267; Geelong 94 408;

Bendigo 43 1977; Hobart 34 8232; Devonport 24 4216; Wivenhoe

31 2560 Fyshwick 80 4307; Prospect 44 5835; Armidale 72 1895;

Tamworth 66 1363; Orange 62 6491; Broadmeadow 69 1222;

Goulburn 21 5440; Griffith 62 1577; Maryborough 21 4559; Alice

Springs 52 1713; Stuart Park 81 6751.



MIDLAND DEALERS: Bunbury 21 2777; Port Headland 73 2504; South Fremantle 35 5875; Claremont 86 2433; Geraldton 21 1194; Waroona 33 1595; Wickham 87 1089; Carnarvon 41 1362; Yorketown 29; Renmark 86 6127; Pt Lincoln 82 1981; Peterborough 307; Morsham 54 1035; Morwell 34 3626; Mildura 23 2439; Ferny Ck 755 1091; Sale 44 2677; Billabong 24 5814; Portland 23 2774; Nth Geelong 78 9660; Shepparton 21 3006; Avoca 84 2166; Trolburn 57 3135; Launceston 31 5688; Nowra 23 628; Bathurst 31 1200; Wyong 52 1702; Nelsons Bay 82 1274; Lavington 21 6058; Lithgow 31 3882; Dubbo 82 2377; Ballina 86 2669; Orange 62 6985; Laurieton 59 9044; Keiraville 29 5876; Milparinka 4; Gunnedah 42 0222; Gosford 24 4644; Glen Innes 1219; Georgetown 67 1472; Grenfell 43 1733; Cootamundra 42 1682; Mullumbimby; Bega 21 959; Gunnedah 43 7205; Rylstone 150; Leeton 53 2081; West Wyalong 721 2424; Nambucca Heads 68 6425; Walgett 243; Bourke 72 2129; Wazza 21 2125; Taree 52 1488; Junee 388; Madean; Tweed Heads 36 4649; Bateman's Bay 72 4555; Wollongong 29 2254; Forbes 52 2300; Wellington 1002; Dubbo 82 3793; Bundaberg 72 4263; Cairns 54 1085; Dalby 62 2389; Palm Bch 34 1248; Margate 84 2341; Myles 118; Mackay 51 1211; Victoria Pt 207 7308; Townsville 79 8844; Gympie 82 1327;

Dealer prices may be higher due to transport costs.

IN STOCK NOW!



IBETA 23-Channel AM Mobile Citizensband Transceiver

STILL AT THE PRE-DEVALUATION PRICE OF

\$89 + P&P \$5.00 (NORMALLY \$139.00)

SPECIFICATIONS

1. **Semiconductors:** 19 Transistors and 15 Diodes
2. **Frequency Range:** 26.965MHz-27.255MHz
3. **Mode of Operation:** AM
4. **Controls:** Volume Control with Power On-Off Switch
• Variable RF Gain Control • Variable Squelch Control
• Delta Tune Switch • Channel Selector Switch • CB-PA Switch • ANL Switch
5. **Connectors and Jacks:** Microphone Connector • Coaxial Type Antenna Connector • Public Address Speaker Jack 3.5mm • External Speaker Jack 3.5mm
6. **Speaker:** 3½ inches, 8 ohms
7. **Microphone:** Dynamic Microphone (500 ohms)
8. **Power Supply:** 13.8 VDC Positive or Negative Ground



Also in Stock

Mobile Antenna to suit Ibeta CB Transceiver \$15 plus p&p \$2.

Overall length: 47"

Cable: 17 feet RG-58U (52 ohms) coaxial cable w/PL-259 Connector

Mounting: a. Trunk Mounting b. Rooftop Mounting.

TRADE ENQUIRIES WELCOME

Call, write or phone to: **C. H. S. TAYLOR'S WAREHOUSE SALES**
169 JOHNSTON STREET, COLLINGWOOD. VIC. 3066 PHONE: 419 3862

((P)) PACE

WORLD-FAMOUS PACE TWO-WAY RADIO EQUIPMENT IS NOW AVAILABLE IN AUSTRALIA.

M-2000 6 Channel Marine Mobile	189-00.
M-2000/B 6 Channel Base Station	249-00.
CB-2300 23 Channel Mobile Unit	159-00.
P-5950 "Pace-Call" Sel-call unit	49-95.
M-1000 Marine Helical Aerial complete	29-95.
CB-1000 C.B. Helical Aerial complete	29-95.
MB-1500 Base Station Aerial Marine	59-95.
CB-1500 C.B. Base Station Aerial	59-95.
M-10-2 3 Channel Marine Mobile	89-95.
M-100ASA 6 Channel Marine Mobile	119-95.
M-125 3 Channel 2.5W Hand Held	69-95.
PS-2500 2.5A 13.6V Power Supply	49-95.
PS-4000 4.0A 13.6V Power Supply	59-95.
X-5252 Crystals for above (f-455)	6-00/pair.
X-5240 Crystals (Double Conversion)	9-00/pair.

PAGE COMMUNICATIONS

Box 95 Post Office,
MASCOT N.S.W. 2020.
PHONE: 02-667-1114. After Hours: 02-88-4140.

COMPUTER DISPOSALS

LARGE SELECTION OF USED COMPUTER PERIPHERALS AND OTHER EQUIPMENT SUITABLE FOR USE WITH MICROCOMPUTERS.

S.C.M. Hard Copy I/O Typewriter with S/S interface	375-00
8 Channel Stepping optical paper tape reader/loaders	95-00
8 Channel H/S Paper Tape Punches with co-axial feed	95-00
C.P.U. with 24V Power supply, components, etc. in cabinet	95-00
(All the above are 240V operated and form a complete word processor)	
Friden Flexowriters C/W 8 Channel Tape Punch & Reader	450-00
High Speed Tractor Feed Line Printers 240V c/w cabinet	550-00
1" Computer Paper Tapes (Boxes of 28)	30-00
11/16" Telex Paper tapes (boxes of 40)	28-00
11" x 14" fan fold forms (boxes of 250 sets 5 ply)	7-00
New ½" N.C.R. computer magnetic tapes 2400'	14-00
New ½" B.A.S.F. Audio magnetic tapes 2400'	8-00

Plus many other items too numerous to mention.

Send 20c in stamps for comprehensive catalogue.

COMPUTER DISPOSALS

Box 5043 G.P.O.,
SYDNEY N.S.W. 2001.
Phone: 02-669-3984. After Hours: 02-27-2982.

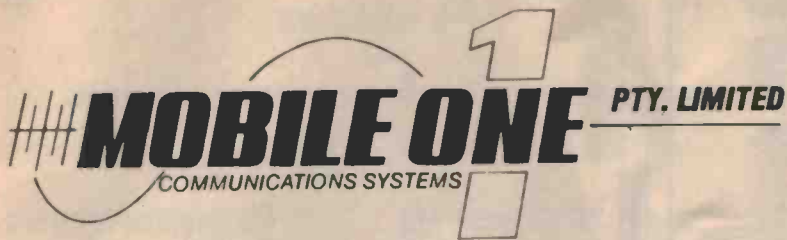

SPECIALISTS AND CONSULTANTS CITIZENS BAND TWO-WAY RADIO COMMUNICATIONS SYSTEMS.

hy-range V



TRANSCEIVERS

23 CHANNEL SSB
Hygain, Tram, Panther
23 CHANNEL AM
Raider, Pearce-Simpson

Manufacturers of "The Helical Antenna"
DISTRIBUTORS OF ALL CB PRODUCTS
TRADE ENQUIRIES WELCOME
EQUIPMENT AVAILABLE



ANTENNA

DX-1B - 5ft Helical Antenna
DX-3B - 40" Helical Antenna
DX1S - 6ft Helical Antenna
DX-9 - 8ft Marine Antenna
(with matching unit & cable).
Base station antenna

TEST EQUIPMENT

Model 140 Matcher
171 Twin Meter
175 Meter/Matcher
310 SWR/Power

Representatives in all States
Further information and list of distributors:

OFFICE & FACTORY
17 Sloane Street,
Marrickville 2204, N.S.W. Australia
Phone: (02) 516-4500

Telex: 21416 Mobileone
Cable: Mobilphone Sydney
P.O. Box 166, Randwick, N.S.W. 2031
Private: (02) 39-2395



**TRANSCEIVERS
AND
ACCESSORIES**

S.S.B.
COBRA
JOHNSON VIKING
HY-GAIN
X-TAL
COURIER
PANTHER

A.M.
COBRA 21
COBRA 26
SIDEWINDER 111
PANASONIC
A.M.-F.M.-C.B.

**ALSO AVAILABLE
FULL RANGE OF
ANTENNAS S.W.R.
METERS. PLUGS,
SOCKETS AND
CABLE.
FROM THE NORTHS
LARGEST SUPPLIER
OF C.B. EQUIPMENT**

Ron Chapman Hi-Fi Centre pty Ltd.,

880 Hunter Street, Newcastle West.2302, Phone 69-2733 - 69-2796

CITIZEN BAND ELECTRONICS

**"THE CB SPECIALISTS"
WE HAVE AVAILABLE**



- 5 WATT AM 23CH
- 5 WATT AM 6CH
- 5 WATT MARINE

15 WATT SSB 23CH, HELICAL
ANTENNA, MARINE ANTENNA, RINGO
BASE STATION ANTENNA

- ALSO:**
- COMPRESSOR MICROPHONES
 - SWR METER ● POWER METER
 - POWER SUPPLIES ● COAX
 - PL 259 PLUGS & SOCKETS
 - BATTERY CABLE ECT

WE SPECIALIZE IN REPAIRS AND
TUNE UPS OF ALL MAKES AND MODELS.

32 BILGA ST, KIRRAWEE,
N.S.W. 2232 TEL 5218389

CB ANDREWS COMMUNICATIONS SYSTEMS

23 Channel AM
Fairmate AC500
Raider by Claricon
XTAL XCB-7
Shigma
Seiki
Commander PR-76
Pace

23 Channel SSB/AM
Panther
Gemtronics 2325
Johnson Viking 352D
Tram XLS
Tram Diamond 60
SE-501
Hy-Gain Hy-Range 674B

Also 1W walkie-talkies Mobile One
Helicals, JD accessories, coax, plugs,
gutter grip antennas and more

LINEAR AMPLIFIERS NOW AVAILABLE!

13/17 CARLTON STREET
KENSINGTON, 2033. SYDNEY
MAIL ORDERS WELCOME.

For the best prices phone 662.4714
CB — Amateur — Marine



**SUPPLIERS OF TOP QUALITY AM & SSB RIGS, ANTENNAS AND ALL ASSOCIATED
EQUIPMENT FOR THE DISCERNING RADIO ENTHUSIAST.**

Our tech. consultants can best advise the unit for you, mail orders welcome.
Trading in communications equipment since 1960

STRATO COMMUNICATIONS PTY. LTD.



MAIN OFFICE & SHOWROOM
25 WENTWORTH STREET, PARRAMATTA. 2150
PHONE: 635-3370, 635-9856, 635-5569 TELEX: 24573.
Thursday night & Saturday morning trading. Shop Ph. 635-3370

GEMTRONICS

CB Transceivers from BAIL novice, CB and marine

also available from BAIL ELECTRONICS



GTX-3323

Delux AM 23 Channel transceiver featuring built-in range boost modulation, switchable Automatic Noise Limiter, Modulation indicator and front panel CB/PA switch. **\$99**

GTX-3325

Delux SSB/AM 23 channel transceiver featuring built-in Range Boost Modulation, FET RF amplifier for high receiver sensitivity, Noise Blanker, RF gain control and large S-meter. 15 watts PEP SSB, 5 watts AM. **\$279**



606CB

The Ultimate Communications/ Entertainment Centre.
In-Dash combination, AM 23 channel 27MHz 5 watt transceiver/AM BC receiver/FM MPx receiver/stereo cassette player. Switch on the 606CB's unique Stand-By control while you play your favourite cassettes or listen to regular AM or FM Stereo broadcasts. The 606CB will then monitor 27 MHz for you, Interrupt your programme for 27 MHz transmissions, and resume programme play afterwards. **\$368**



CBR9000

In-Dash mounted 6 channel 27MHz 5 watt transceiver/AM broadcast/FM broadcast plus scanning. Features Tx. Scan and Rx indicators. Scan control allowing the set to monitor 27MHz channel while you are listening to your favourite programme. **\$174**

Also available from BAILS — a large range of Antennas and Accessories. Above prices include S.T. Freight and Insurance is extra. 90 day warranty. Prices and specifications subject to change.

Note all transmitting Equipment Requires a Licence.

DEALER ENQUIRIES INVITED.

bail

ELECTRONIC SERVICES

60 Shannon St., Box Hill North, Vic.. 3129. Phone 89 2213
Distributors in all states and N.T.

JAS677—19

2 Exciting new Royce CB's help stop theft!

Maximum CB security plus AM/FM stereo entertainment

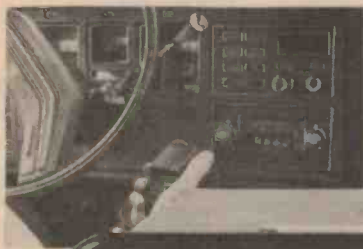

Royce Model 1-614 in-dash CB transceiver also has AM/FM stereo radio. So, you get security from theft, emergency protection, and entertainment—all in a set that measures only 7"W x 6"D x 2"H and installs in the dash.

TCL Approved — 12 Months Guarantee

\$179



Metropolitan police report far fewer thefts of in-dash units than conventional CB's. Reason: it takes far longer to disconnect an in-dash unit and thieves must work fast.

Mail Orders to: WIDMAN ELECTRO

16 Young St Parramatta 2150.
or Phone Sydney 633 1815 — 31 1988 — 357 2218.
Discount of \$4.00 Allowable on all prepaid orders.

1-614 Features

- Phase Lock Loop oscillator —23 channel operation from advanced integrated circuitry.
- AM/FM lighted slide rule tuning dial.
- Fully variable slide-type tone and balance controls.
- Local-distant FM switch is also RF gain switch on CB.
- Large (1 1/2" x 3/4") CB meter—measures output power, receiver input signal strength.
- Dual function L.E.D. (Light Emitting Diode) acts as stereo indicator light on FM, as transmit light on CB.
- Pushbutton noise eliminator.

Lunar Electronics

Presents the SCS Line of Amateur Radio Linearized Amplifiers

Photo HF3-100L

Photo 2M10-70L



Features:

- * Advanced Solid State Design
- * Low Harmonic Content -40 dB or better, means less wasted power and TVI
- * Remote Control Capability
- * Low Insertion Loss in Receive
- * Extra Stabilization Circuitry Ensures Spurious-free Operation at all Input Power Levels
- * One Year Warranty on Amplifier (90 Days on Transistors)
- * Full Coverage of Appropriate Amateur Band
- * RF Actuated Switching Relays
- * Microstrip-line Techniques in Design
- * All Mode Operation Capability
- * Rugged, Heavy Duty Construction
- * Increased T-R Delay for SSB/CW
- * Broadband no Tuning Required
- * Extra heavy Duty Heat Sink
- * Full VSWR and Reverse Voltage Protection

Model	Frequency	Input Power	Output Power	Nom. Current	Size H x W x L	Weight
2M3-30L	144-148 MHz	3	30	4 1/4 A	7.1x10.2x16.5cm	1.0 Kg
2M10-70L	144-148 MHz	10	70	9 A	7.1x10.2x16.5cm	1.0 Kg
2M10-80L	144-148 MHz	10	80	12 A	7.1x10.2x16.5cm	1.0 Kg
1.3M10-70L	220-225 MHz	10	70	9 A	7.1x10.2x16.5cm	1.0 Kg
HF3-100L	3-30 MHz	3	100	16 A	8.9x19.1x16.5cm	1.3 Kg
HF10-100L	3-30 MHz	10	100	16 A	8.9x19.1x16.5cm	1.3 Kg

Lunar Electronics

David McNicol
NARRUNG 5269

RADIO DESPATCH SERVICE

869 George Street,
Sydney

Cnr. George & Harris Sts.
Railway Square
Ph. 211-0816, 211-0191

1. C.R.C. 2-26 cleaner for Electronic Use, 6oz or 16oz can
2. C.R.C. Rapid freeze "for printed circuits, testing, etc 15oz can
3. Super servisol Electronic switch cleaner 8oz can
4. H.P.M. 790/white small power outlet with T.V. coaxial socket.
5. H.P.M. 799/white large power outlet with T.V. coaxial socket.
6. H.P.M. 787/white single power outlets.
7. H.P.M. 777/white double power outlets.
8. H.P.M. 366P B.C. battery lamp holders.
9. H.P.M. 333 B.C. Cord lamp holders
10. H.P.M. 310 B.C. Push-bar switch type lamp holders
11. H.P.M. 439 240V 3 pin P.V.C. electronic plugs.
12. H.P.M. 423 240V 3 pin P.V.C. Cord extension plugs
13. Clipsol 423 240V 3 pin mains suppressor plug
14. 20Watt Fluorescent tubes daylight or white
15. 40Watt Fluorescent tubes daylight or white
16. P2 20Watt Fluorescent Starters.
17. P10 40-80Watt Fluorescent starters
18. Electronic wire strippers with gauge
19. Servisol "Solder Mop" desolder unit T.V. aerials B & W Colour and accessories Project printed circuit boards

OPEN SATURDAY MORNINGS

ADVERTISERS INDEX

Andrews Communication	28
Bail.	29
Bay City	5
CB Electronics	28
Ron Chapman.	27
Computer Disposals	26
Four Wheel Drives	8
Instant Components	6
Lafayette	5
Lunar Electronics	30
Frank Match	8
Mobile One	27
Page Communications	26
Protector RC Alarms	8
Radio Despatch.	30
Peter Shalley	2
Sideband Sales	12 to 16
Mike Skovron	IBC
Dick Smith.	25, OBC
Strato	28
C.H.S. Taylor	26
Widman Electronics	29
Dick Woods	11
Xenon	11

CB SUPPLIERS

Below are the names and addresses of suppliers of CB equipment. If you know of any suppliers that are omitted please send us details.

- ACE RADIO**
136 Victoria Rd, MARRICKVILLE 2004
NSW
- AERO ELECTRONICS**
Shop 13, 191 Ramsgate Road, RAMSGATE
NSW
- ALAN HUGHES AGENCIES**
75 Longland St, NEWSTEAD, 4006
QLD
- ANDREW'S COMM.**
13/17 Carlton St., Kensington, 2033
NSW
- AURIEMA**
PO Box 604, BROOKVALE, 2100
NSW
- BAY CITY**
Shop 11, Station St., Frankston, 3199
VIC
- BAIL ELECTRONIC SERVICES**
40 Shannon St., BOX HILL NORTH 3129
VIC
- BRIGHT STAR CRYSTALS**
35 Eileen Rd., CLAYTON
VIC
- CITIZENS BAND ELECTRONICS**
32 Bilgus St., KIRRAWEE
NSW
- COMMAND AUTO ACCESSORIES**
11 Salsbury St., BOTANY 2019
NSW
- DEITCH BROS**
70 Oxford St., SYDNEY 2010
NSW
- DICK SMITH ELECTRONICS**
162 Pacific Highway, GORE HILL
NSW
- DICK WOODS ELECTRONIC**
166 Hume Highway, BANKSTOWN
NSW
- EDGE ELECTRIX**
656 Bridge Road, RICHMOND
QLD
- E. F. JOHNSON**
and many distributors throughout Australia
77 Edgeworth David Ave., HORNSBY
NSW
- ELECTRONIC AGENCIES**
31 Burwood Road, BURWOOD 2134
NSW
- EMONA**
Room 208, 661 George St., Sydney, 2000
NSW
- FOUR WHEEL DRIVES**
304 Middlebrough Rd., BLACKBURN SOUTH
VIC
- FRANK MATCH PTY LTD**
257-259 Military Rd. CREMORNE
NSW
- HACO**
PO Box 49, KENSINGTON, 2033
NSW
- HAM RADIO SUPPLIERS**
323 Elizabeth Street, MELBOURNE 3000
VIC
- HOSE & EQUIPMENT**
11 Salisbury St., BOTANY 2019
NSW
- L.F.T.A.**
21 Gilbert St., Dover Heights, 2030
VIC
- INTAG MARKETING**
42 Grantham St., WEST BRUNSWICK
VIC
- KEN-WAY ENTERPRISES PTY. LTD.**
34 SYDENHAM RD., MARRICKVILLE
NSW
- LAFAYETTE ELECTRONICS**
53 Rocky Point Rd. KOGARAH 2217
VIC
- MIKE SKOVRON AGENCIES PTY.
LTD.**
94 St Kilda Rd., ST. KILDA 3182
VIC
- M&K COMMUNICATIONS**
5 Curlewis St, BONDI, 2026
NSW
- M5 COMPONENTS**
561 Pittwater Rd., BROOKVALE 2100
NSW
- MOBILE ONE**
164-166 Redfern Street, REDFERN
NSW
- NATIONWIDE**
227 Victoria Rd., MARRICKVILLE
NSW
- NEW ELECTRONIC**
23 Renown St., Five Dock 2046
NSW
- NIC INSTRUMENTS**
57A The Centre, SEVEN HILLS 2147
VIC
- PARAMOUNT**
Parer Rd., Airport West, 3042
VIC
- PETER SHALLEY**
47-49 Jersey St., Hornsby, 2077
NSW
- RADIO DESPATCH SERVICE**
554 Pacific Highway, KILLARA 2071
NSW
- RADIO HOUSE PTY LTD**
869 George Street, SYDNEY 2000
NSW
- RADIO PARTS**
306-308 Pitt Street, SYDNEY 2000
NSW
- RON CHAPMAN H-FI**
760 George Street, SYDNEY 2000
NSW
- SIDEBAND ELECTRONICS SALES**
562 Spencer St., WEST MELBOURNE 3003
NSW
- STRATO COMMUNICATIONS**
880 Hunter St., NEWCASTLE
NSW
- TANDY**
23 Kurri St., LOFTUS 2232
NSW
- TELEVIEW**
169 Johnson St., PARRAMATTA 2150
NSW
- UNITREX**
throughout Australia (almost)
VIC
- VICOM**
218 Chapel Street, PRAHAN 3181
VIC
- WENTY CAR RADIO DSBR8**
139 Auburn Rd., AUBURN 3123
VIC
- WILLIS TRADING**
23 Whiting St., ARTARMON 2064
NSW
- XENON WORLD IMPORTS**
38 Station St., WENTWORTHVILLE
NSW
- 429 Murray St., PERTH 6000**
WA
- P.O. Box 33, WARRADALE 5046**
SA



JOHNSON CB



Viking 352D Digitally synthesized

Highly functional professional design provides improved SSB performance

The Viking 352D is a 23-channel AM/SSB mobile 2-way CB radio with automatic circuitry and individual professional controls to give the user a straight-forward approach to high level sideband performance. For ease of operation, Johnson provides precise individual controls for RF gain, fine tuning, volume and squelch. Channel selector is fully rotatable and has an illuminated indicator. A separate control with colour-keyed lights indicates AM, USB or LSB operating mode at all times. A noise blanker to slice out ignition noise is activated by a simple two-position switch. Another switch is provided for the built-in public address function. Inside the Viking 352D crystal lattice filtering rejects adjacent channel signals and a fully automatic noise limiter assures clean, clear reception. The voice-tailored audio system drops off signals above and below voice frequencies for additional clarity. Viking 352D also features Johnson's electronic speech compression and full allowable power for strong, crisp transmissions. The unit is assembled in Japan according to Johnson's exacting engineering and quality control standards. Viking 352D can be installed in positive or negative ground vehicles or with an AC power supply it becomes an attractive SSB base station.

For your nearest authorised Johnson retailer contact

MIKE SKOVRON AGENCIES PTY LTD

5 Curlewis St, Bondi
Phone (02) 30 4334 or 309 1957

Trade Enquiries to
Mike Skovron Agencies Pty Ltd
PO Box 36
Vaucluse NSW 2030

Mike Skovron Agencies Pty Ltd is the exclusive authorised importer and distributor of all CB products of the E. F. Johnson Company, USA. As such it is the **only** company authorised in Australia to represent the E. F. Johnson Company, USA, for marketing and servicing Johnson CB products.

MS115

WHY BUY A 'BACKYARD' CB



When you can have famous 'Sanyo' for no more!

FABULOUS
23ch TA-901C



We were selling
this for \$139.50.

NOW:
\$99⁵⁰
(or less*)

Cat D-1160



... and be SURE you will be CBing
years from now ...

THE FIRST FAMOUS
BRAND RIG TO SELL
FOR UNDER \$100.00!

NOTE:
THESE SETS
ARE NOT 'OBSOLETE'.
THEY CONFORM TO THE
USA FCC SPECIFICATIONS.
A LICENSE IS REQUIRED
TO LEGALLY OPERATE
THESE UNITS IN
AUSTRALIA

If you've been saving your money to buy a 'famous brand' CB instead of some of the rubbish around the place, wise you! But now, Dick Smith and dealers give you the chance to buy a famous brand and GUARANTEED rig for around the same price as you pay for the backyard cheapies! The Sanyo TA-901C was selling earlier this year for \$139.50. An incredible scoop purchase by Dick means the most you'll pay now is \$99.50 - less if you buy more. (see below). That's a whopping 30% cut. We're not just freezing prices - we make them so cold they drop off!

Big value Sanyo has big features, too: full power output, with modulation (transmit) indicator showing you you're 'alive'. 23 channels, with delta tune to help resolve 'off channel' signals (and there are a lot of those around from crook rigs!), built in PA facility, squelch control, full metering, and one feature not many of the r-e-a-l expensive ones have - a noise-cancelling microphone. Mounting hardware and full instructions are included.

* **SPECIAL OFFER:** Get together with four friends who want CB's and we will give each of you \$10.00 off. That's right: buyers of five or more of these units get them for the amazingly low price of just \$89.50!

AERIAL TO SUIT ABOVE RIG: Base loaded stainless steel whip, trunk lip or through-roof mounting.

Our most popular skyhook, comes complete with lead and PL-259 plug. Special base allows for mounting on lip of boot or bonnet, or can be mounted through roof for optimum performance. A real winner!

WAS \$27.50 ... NOW: **\$22-50**

Cat O-4450

DICK SMITH ELECTRONICS GROUP

VISIT YOUR NEAREST STORE:

SYDNEY: 125 York Street. Ph 29-1126
BANKSTOWN: 361 Hume Hwy. Ph 709 6600
GORE HILL: 162 Pacific Hwy. Ph 439-5311
MELBOURNE: 656 Bridge Rd, Richmond. Ph 42-1614
BRISBANE: 166 Logan Rd, Buranda. Ph 391-6233
MAIL ORDERS: PO Box 747, Crows Nest NSW 2065
DICK SMITH DEALERS: Perth 28 1599; Elizabeth South 255 2249; Port Adelaide 473 688; Salisbury North 258 1267; Geelong 94 408; Bendigo 43 1977; Hobart 34 8232; Devonport 24 4216; Wivenhoe 31 2560 Fyshwick 80 4307; Prospect 44 5835; Armidale 72 1895; Tamworth 66 1363; Orange 62 6491; Broadmeadow 69 1222; Goulburn 21 5440; Griffith 62 1577; Maryborough 21 4559; Alice Springs 52 1713; Stuart Park 81 6751.



MIDLAND DEALERS: Bunbury 21 2777; Port Headland 73 2504; South Fremantle 35 5875; Claremont 86 2433; Geraldton 21 1194; Waroona 33 1595; Wickham 87 1089; Carnarvon 41 1362; Yorketown 29; Renmark 86 6127; Pt Lincoln 82 1981; Peterborough 307; Morsham 54 1035; Morwell 34 3626; Mildura 23 2438; Ferny Ck 755 1091; Sale 44 2677; Billabong 24 5814; Portland 23 2774; Nth Geelong 78 9660; Shepparton 21 9006; Avoca 84 2166; Trillick 57 3135; Launceston 31 5688; Nowra 23 628; Bathurst 31 1200; Wyong 52 1702; Nelsons Bay 82 1274; Lavington 21 6058; Lithgow 31 3882; Dubbo 82 2377; Ballina 86 2669; Orange 62 6985; Laurieton 59 9044; Keiraville 29 5876; Milparinka 4; Gunnedah 42 0222; Gosford 24 4644; Glen Innes 1219; Georgetown 67 1472; Grenfell 43 1733; Cootamundra 42 1682; Mullumbimby; Bega 21 959; Gunnedah 43 7205; Rylstone 150; Leeton 53 2081; West Wyalong 721 2424; Nambucca Heads 68 6425; Walgett 243; Bourke 72 2129; Wagga 21 2125; Taree 52 1488; Junee 388; Madean; Tweed Heads 36 4849; Bateman's Bay 72 4555; Wollongong 29 2254; Forbes 52 2300; Wellington 1002; Dubbo 82 3793; Bundaberg 72 4263; Cairns 54 1085; Dalby 62 2389; Palm Bch 34 1248; Margate 84 2341; Myles 118; Mackay 51 1211; Victoria Pt 207 7308; Townsville 79 8844; Gympie 82 1327;

Dealer prices may be higher due to transport costs.

CAPACITORS

PHILIPS CAPACITORS AND THEIR USES

(1) Aluminium Electrolytic Capacitors

Ideal for use in filtering or smoothing rectified A.C.-energy storage as in Power Supplies. Also used for bypassing and coupling in audio applications and the timing element for non-critical circuits.

(2) Solid Aluminium Capacitors

These provide the highest reliability and longest life alternative to the Aluminium Electrolytic Capacitor. For professional application — as in Telecommunications.

(3) Solid Tantalum Capacitors

Similar application to that of the Solid Aluminium, but offers a size advantage. Also available are micro-miniature forms for such applications as in hearing aids and hybrid circuits.

(4) Ceramic Capacitors

Offer low cost and high capacitance in a small physical volume. There are generally two types:

Application 1 or tuning grade: For tight tolerance and high stability in radio frequency (RF) tuned circuits, including mobile UHF and VHF transmitters.

Application 2: Bypass capacitors in RF circuits — are now finding increased application in digital circuits for spike suppression and power supply filtering.

Other types of capacitors fall into two categories: Those with solid aluminium electrodes, or aluminium film electrodes.

Solid Aluminium electrode types are generally used where a fast charge and discharge rate are required. For example: Television deflection circuits and switch mode power supplies, (inverters and converters).

Film electrode types are generally used in all other areas of application because they offer a feature of "self-healing properties".

The electrodes are generally separated by a plastic-style material, the composition of which determines the temperature coefficient of the device. Such capacitors fall into the following headings:

Paper Capacitors

An original construction of capacitors for use in A.C. circuits. Still used for power factor correction in mains supply applications. For example in Lighting and electric motors.

(6) Polyester Capacitors

Lowest cost, most widely used for general purpose application.

(7) Polycarbonate Capacitors

Offer low temperature coefficient and lower dielectric losses at high frequency. Most often chosen for its temperature stability characteristics.

(8) Polystyrene Capacitors

Usually chosen for applications requiring tight tolerance coupled with high stability. Predictable temperature coefficient used in conjunction with particular ferrite coils makes highly stable tuned circuits or oscillators. Used, for example in telephone applications.



(9) Polypropylene Capacitors

Offer very low dielectric losses rivalling polystyrene. Suitable for high power inverters and converters and T.V. deflection.



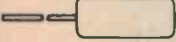

(10) Dual Dielectric Capacitors

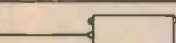
These offer the feature of double insulation using two materials of different characteristics for increased reliability. Ideal for interference suppression of domestic appliances.

Paper and Film Capacitors (continued)

TYPE	CAPACITANCE RANGE	VOLTAGE RANGE	SERIES NO. 2222
Polypropylene Capacitors			
 polypropylene film/foil capacitors (potted type)	0.039 — 0.82 μ F	250 V	357
Polystyrene Capacitors			
 polystyrene film/foil capacitors (micropoco)	51— 162000 pF	63V— 500V	424 to 431
 interference suppression capacitors, dual dielectric, single section type — paper — PETP film	4.7 — 330 nF	250 V (R.M.S.)	276
 dual dielectric capacitors for flyback purposes.	1.5 — 27 nF	750 — 2000 V(P)	278

CERAMIC CAPACITORS

VERSION	APPLI-CATION	CAPACITANCE	RATED DC VOLTAGE	CAPACITOR SERIES
 Plate	1	0.47 — 100 000pF	500 V 6 V	631—632
	2			638
 Disc	1	0.47 — 3900 pF	400 V 2000 V	641—643
	2			650
				629
				630
				640
 Feed-through	2	2.5 — 4700 pF	350 V	655
				660
 Chip	1	10— 470 000 pF	50 V	661
	2			700
				702
				851—856

PHILIPS

CB POWER SUPPLY

Here's the answer if you want to run the mobile rig off the mains as a base station.

WITH THE EXPLOSION in the popularity of CB radio and its imminent legalization there is a growing demand for a power supply designed to operate mobile transceivers as a base station. In the mobile situation these operate off a 12V battery but while a battery can be used for the base station the problem of keeping it charged is a nuisance. Some people have tried simply a transformer, rectifier and filter capacitor but have run into problems with hum.

This power supply has been designed to operate the base station and can supply up to 2.5A at 13.5V of well regulated and filtered power. While it has been designed for CB use it is a good general purpose fixed voltage regulator. By changing a few components voltages from 5 to 50 volts at up to 3 amps can be achieved. Current protection is of the foldback type which gives less current into a short circuit than at the nominal output voltage so giving more protection to the output transistor without affecting normal operation.

Design Features

While we could have designed this supply using a special voltage regulator IC such as the 723, we decided to use transistors as the availability is better, it allows a wider range of input — output voltages and from an educational point of view it is more worthwhile. By changing the value of R11 the output voltage can be altered provided the input voltage is suitable. We chose foldback current protection as it minimises the power dissipated if the output is shorted, reducing the need for a large heatsink.

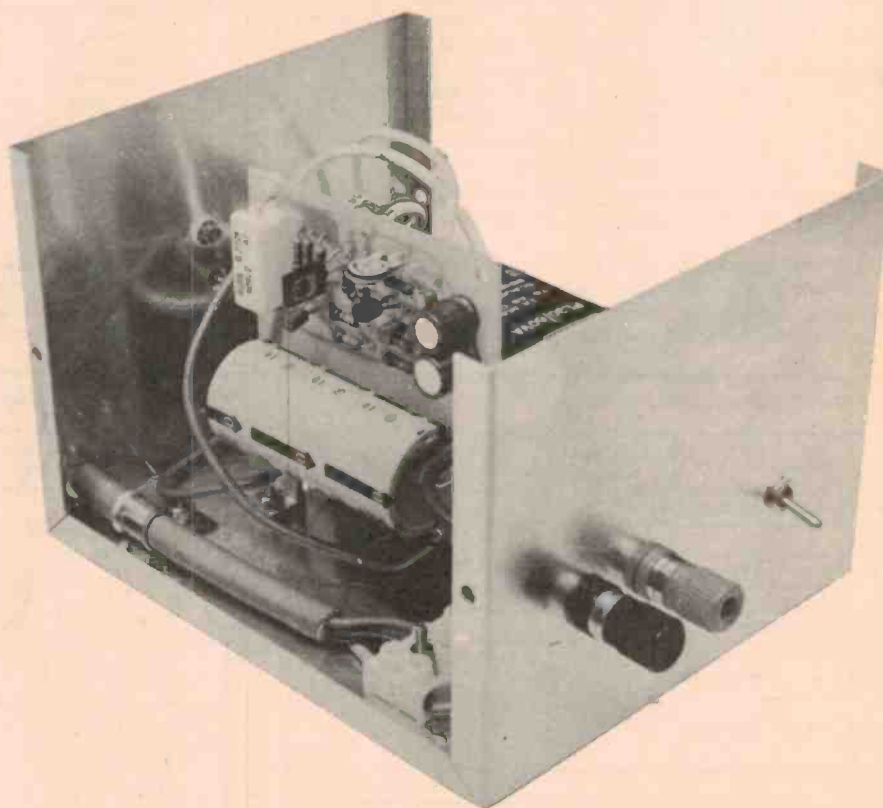

SPECIFICATION ETI 712

Nominal output voltage	13.5 volts
Adjustment range	12V — 14.5V
Nominal output current	0 — 2.5 amps
Load regulation 0 — 2.5 A	150mV
Ripple @ 2 A	0.8mV
Short circuit current	1A

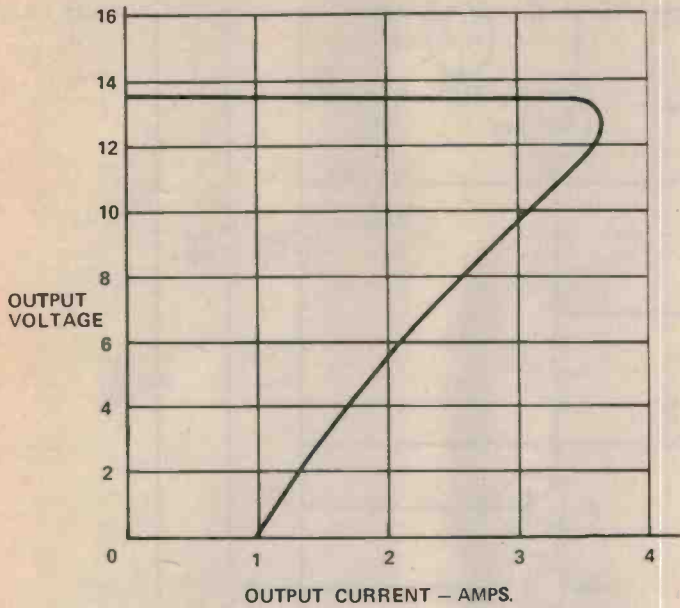

Graph showing relationship between output voltage and current. Note that the current into a short circuit is less than that available at 13 V.

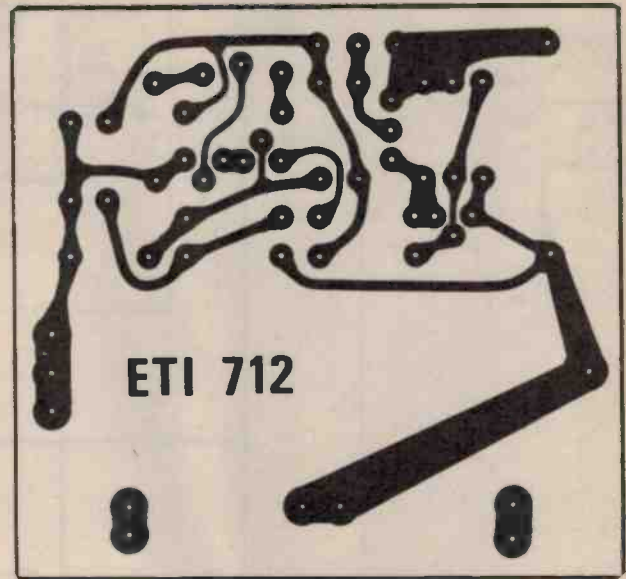

Fig. 2. Printed circuit layout. Full size 80 x 75 mm.

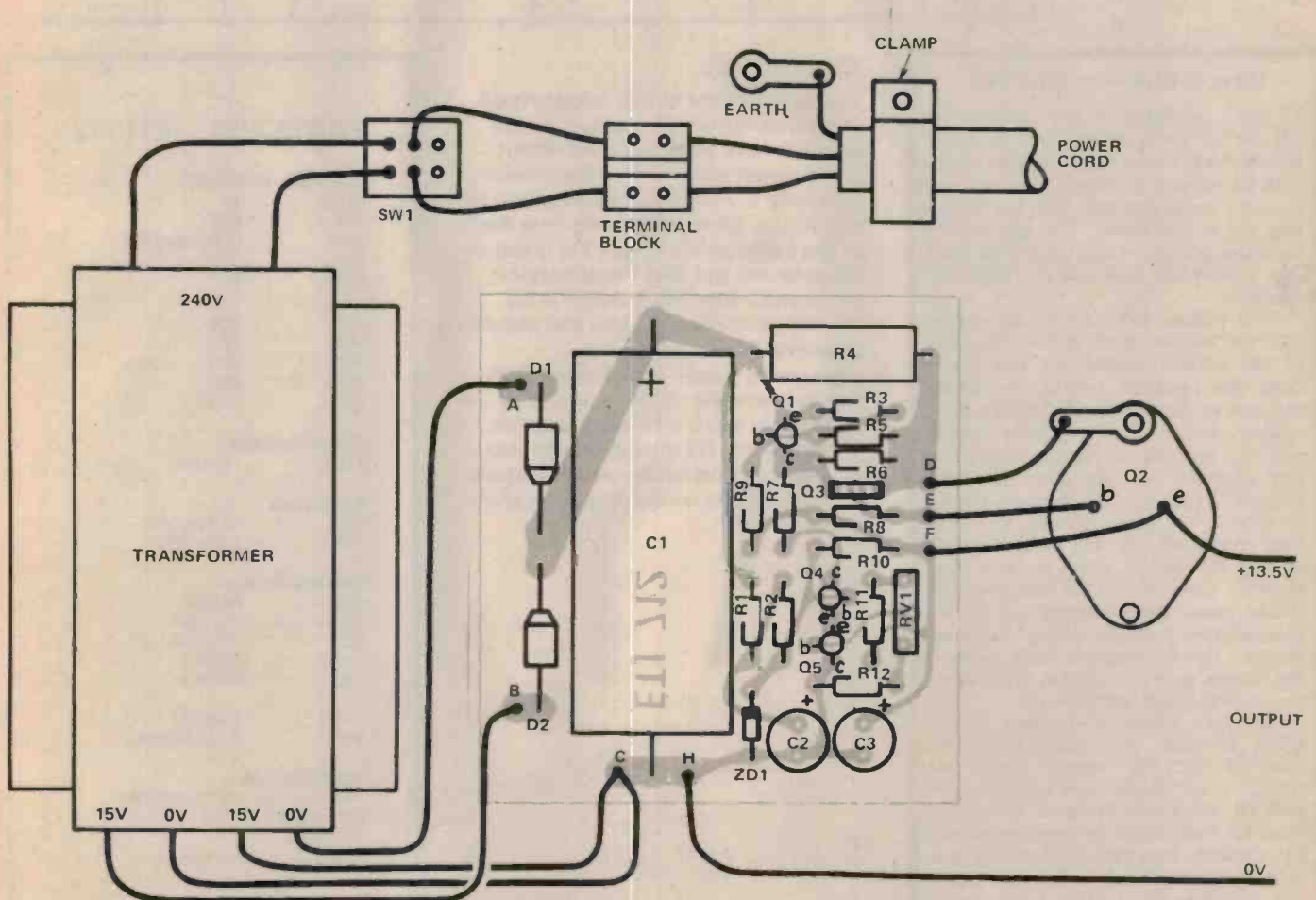

Fig. 3. Component overlay and wiring diagram.

Project 712

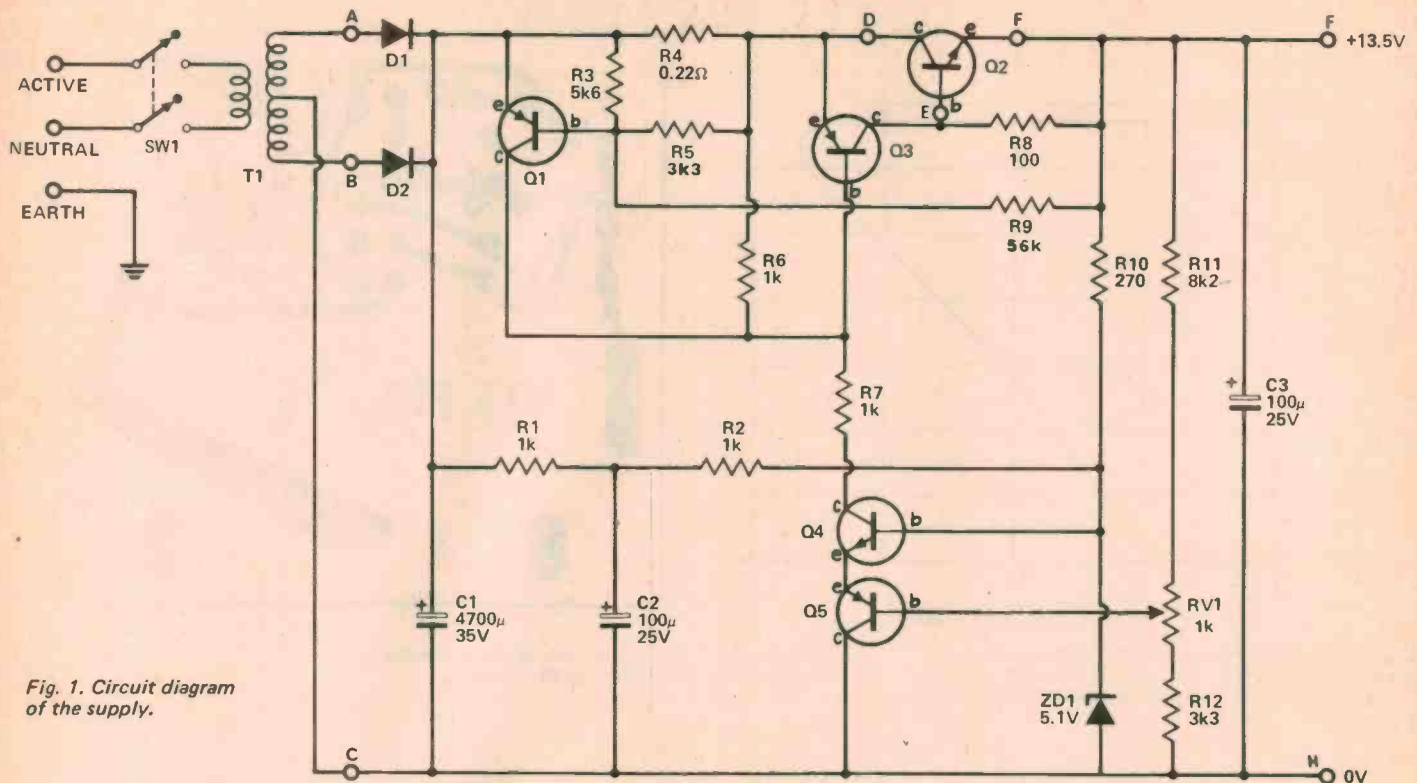

Fig. 1. Circuit diagram of the supply.

How It Works — ETI 712

As high regulation is not required for CB use or most applications, we deliberately chose not to use a high gain circuit with its stability problems. The regulator is of the series pass type with Q3 dissipating the excess power. The gain of this transistor is increased by Q2 and the Q2/3 pair appears as a high gain (> 1000) PNP transistor.

The voltage reference in the supply is a 5.1 V zener diode and the majority of the current needed for this comes from the regulated output. To enable the unit to start R1 and R2 supply some current from the unregulated supply and C2 provides additional filtering to help eliminate 100 Hz ripple from the reference voltage. The output voltage is divided by R11, 12 and RV1 and then compared to the reference voltage by Q4 and Q5 which act as a comparator. There is a 1.2V difference between these two voltages due to the base emitter junctions of the two transistors. The comparator then controls the output stage Q2 and Q3 maintaining the output voltage within limits.

Overload protection is given by Q1 which measures the voltage across R4 (current) and the voltage across the transistor and if the sum exceeds a set level Q1 will bypass some of the current from the base of Q2 so limiting the output current. This technique allows high output currents at normal output voltages but reduces the current, and power dissipation, if the unit is shorted.

Construction

The layout of the circuit is not critical and any construction method can be used. We have given a printed circuit board layout which will make it easier especially if you are not experienced in electronics. When assembling note that all the components except the resistors are polarised and that the orientation of the small transistors shown is for the Philips or Siemens type and should be reversed for other brands.

We used a simple folded aluminium box to house the supply as anything more fancy was a lot more expensive. The transistor Q3 should be mounted on a heatsink preferably on the outside of the box. The wiring diagram is given in Fig. 3.

PARTS LIST — ETI 712

Resistors all ½W 5%

R1,2	1k
R3	5k6
R4	0.22 ohm 5W
R5	3k3
R6,7	1k
R8	100
R9	56k
R10	270
R11	8k2
R12	3k3

Potentiometers

RV1	1k trim
-----	---------

Capacitors

C1	4700µ 35V
C2,3	100µ 25V

Semiconductors

Q1	BC558
Q2	BD140
Q3	2N3055
Q4	BC548
Q5	BC558

D1,2	1N5404
ZD1	5.1V 300mW

Miscellaneous

Transformer	PL30-60VA
PC board	ETI 712
Heatsink	
Case,	3 core flex and plug

NOW . . . FROM IMC

THE \$58.00 DPM
plus sales tax

IMC

- \$58 Single Unit Price
- 150 Hour Burn in
- Zero and Full Scale Front Panel Adjustments
- 3½ Digit, 4" LED Display Standard
- Accuracy to 0.05 %
- 5 vdc Power Input Standard . . . 12 vdc or 115-230 vac 50-60 hz Optional
- DIN Standard Case Dimensions

For complete information, call or write:

AMPEC ENGINEERING CO.

42 THE STRAND, CROYDON, N.S.W. 2132
PHONES: SYDNEY (02) 747-2731, (02) 74-8063



THE IMC SERIES 500. The only DPM designed to sell (in quantity) for less than \$58.00 is here. Built to the same high standards as the IMC Series 300 DPM, the new series 500 offers the user the advantages of a digital meter at a price competitive with analog meters. Also available as a kit.

MELBOURNE (03) 602-1885 • PERTH (092) 87-1026
BRISBANE (07) 391-5136 • ADELAIDE (08) 223-6261

A lot of Hi-Fi's are just heartless stereotypes.

Sure they can look like a million dollars. And could cost the manufacturers close to it — for design, facia dyes, knurled knobs, toggle switches and two tone timber.
But what's really missing is the timbre.

At Rambler, we know what counts, when it comes to sound performance. It's heart.

Not that our equipment is wanting for clean functional design either . . .

It's just that we have our priorities right, to give you good sound.

Without wasting money on gauche gadgetry. Which means you save money. Lend an ear to this Rambler Integrated Amplifier model AK635 with the Rambler AM/FM Stereo Tuner Model TK600.

TK600

This tuner is brushed silver finish, to match the AK635 Amp. features rack style handles, variable output control, 75 ohm coaxial cable terminal, PLL-MPX demodulator, FET front end, High blend switch.

AK635

This amplifier features 40w x 40w (8 ohms), Multi-Speaker switching. Bass and Treble dual control, separate volume and balance controls, stereo head-phone output, mike input and mike mixing, 2 tape system for dubbing, separate pre and main Amp operation, rack style handle, subsonic filter.

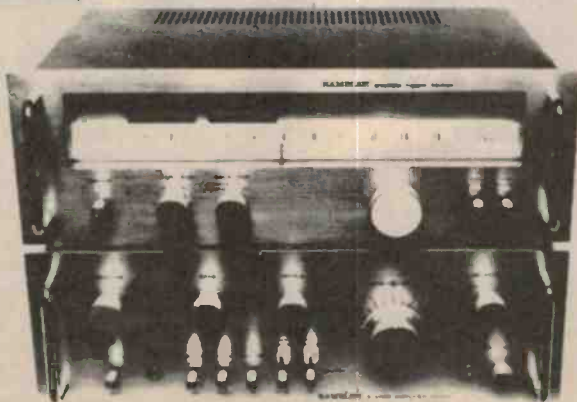

RAMBLER

Backed by the Sun Electric Company Pty. Ltd.

HIGH POWER PA / GUITAR AMPLIFIER

Revised version of the ETI 413 guitar amplifier uses our new ETI 480 power amplifier with a new tone control/mixer board and any of our existing peramplifier modules. It can be powered either by the mains or 12 volt dc.

AS THE ETI 480 amplifier module is so much easier to build than the 413 guitar amplifier and has the same power rating we have had many requests to describe it as a complete amplifier. Although this article does not specifically describe that unit, it shows how to interconnect modules which have been published in the past, along with a new mixer board described in this issue, to make an amplifier to suit your particular need. The new mixer board has two out of phase outputs to allow two 100 watt modules to be connected in a bridge configuration to give 200 watts into eight ohm loads. Note however that loads less than eight ohms cannot be used while in bridge and if the load can be broken into two separate four ohm loads this should be done and the amplifiers used separately.

Constructional Hints

Due to the various requirements of different groups we are not giving formal constructional details but will just give general procedures and things to watch for.

The first thing to decide is what arrangement of modules is needed. The various modules available are as follows;

Power modules

ETI 480/50W 50W into 8 ohms
ETI 480/100W 100W into 4 ohms
2xETI480/100W 200W into 8 ohms

Power supply

1xTransformer 240V in 100W out
2xTransformer 240V in 200W out

SPECIFICATION ETI 481

Unit built using two 100 watt modules connected in bridge with ETI 449 balanced microphone preamplifiers.

Output power into 8 ohms at < 1% distortion	200 watts
Frequency response controls flat, +0dB, -3dB	15Hz - 30kHz
Tone control range bass at 100Hz treble at 10kHz	+10dB -11dB +11dB -12dB
Sensitivity	3mV
Maximum input voltage *	500mV

* limit due to preamplifier clipping.

1x ETI 480PS 12Vdc in 100W out
1x ETI 480PS
+1 Transformer 12V/240V input
100W output

Mixer / tone controls
ETI 481M

Preamplifiers

ETI 445 two channel preamp. for
for magnetic pickups.
ETI 446 two channel limiter
suitable for high level
microphones.
ETI 449 balanced mic. amplifier
for low level microphones
up to 500mV max.output

Options

ETI 438 audio level meter

The box we used was supplied to us by Applied Technology and is suitable for rack mounting. If this box is used the heatsink bracket of the amplifier(s) should be the same as described for the 12V power supply to allow it to clamp directly onto the heatsink/ sides of the box. While this box looks large, when two power modules, power supplies and the preamps are fitted it becomes more crowded. Therefore layout all the boards before drilling any holes.

With the 12V supply we used a 15A

Text continued on page 62

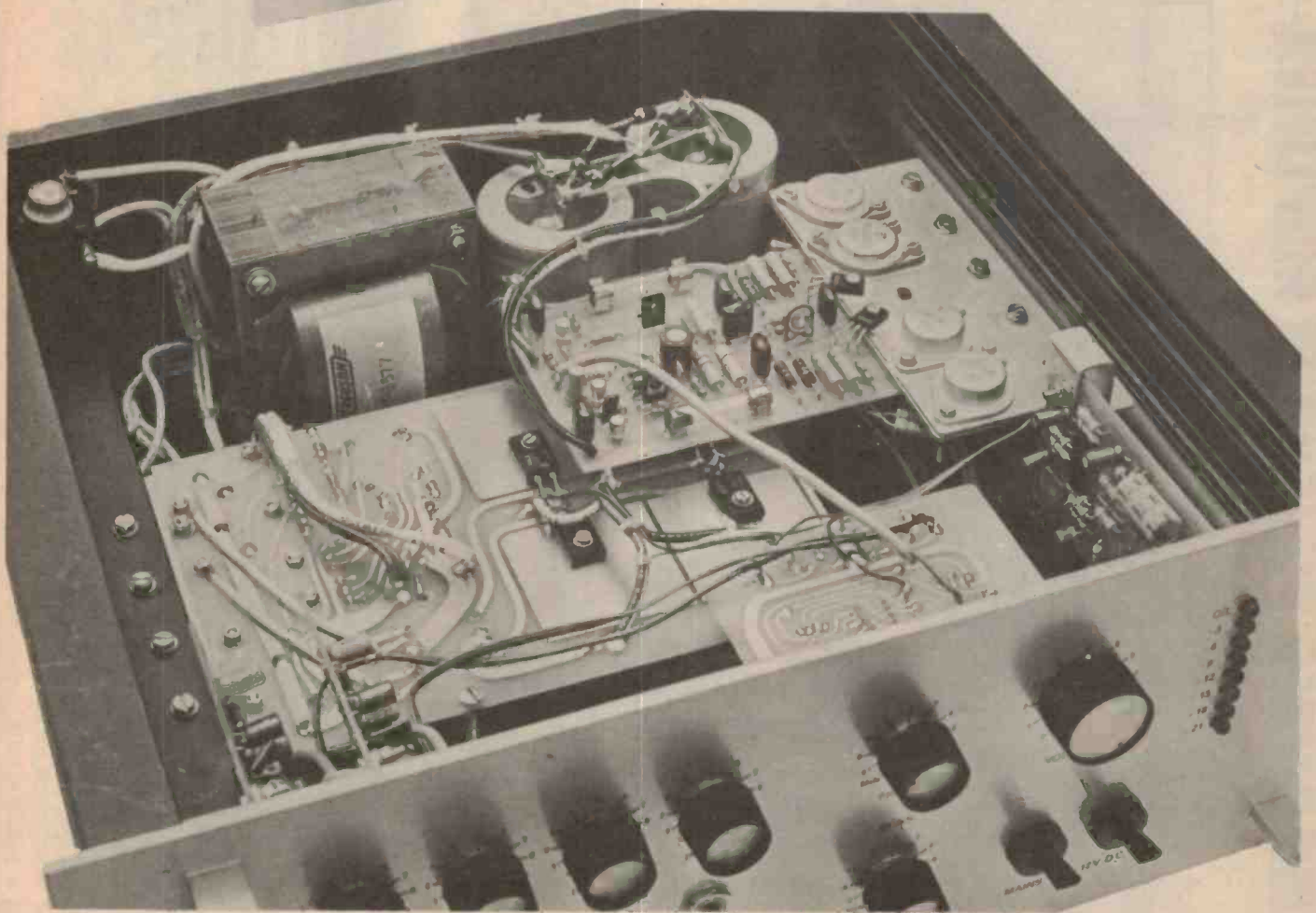
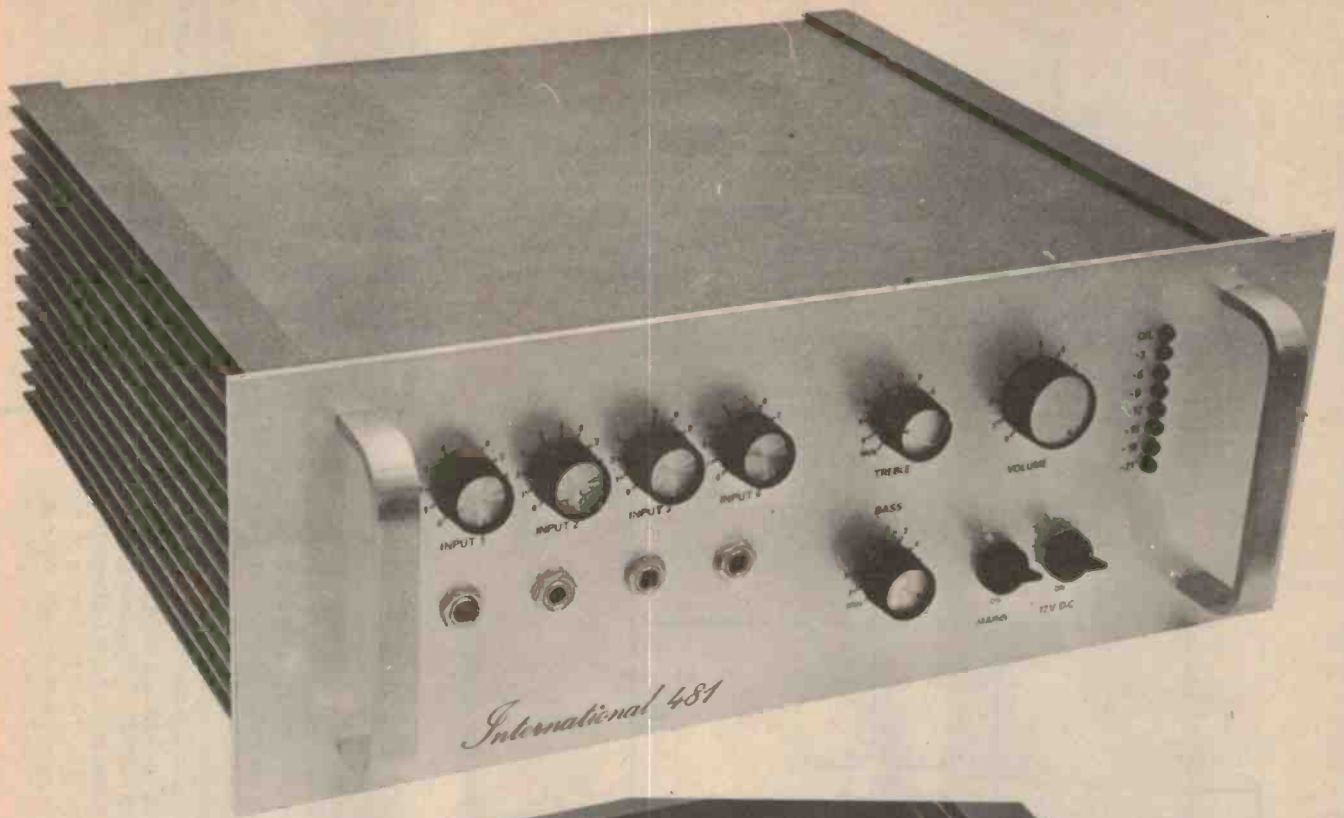

Internal view of the 12V / 240V 100W unit

HIGH POWER PA / GUITAR AMPLIFIER

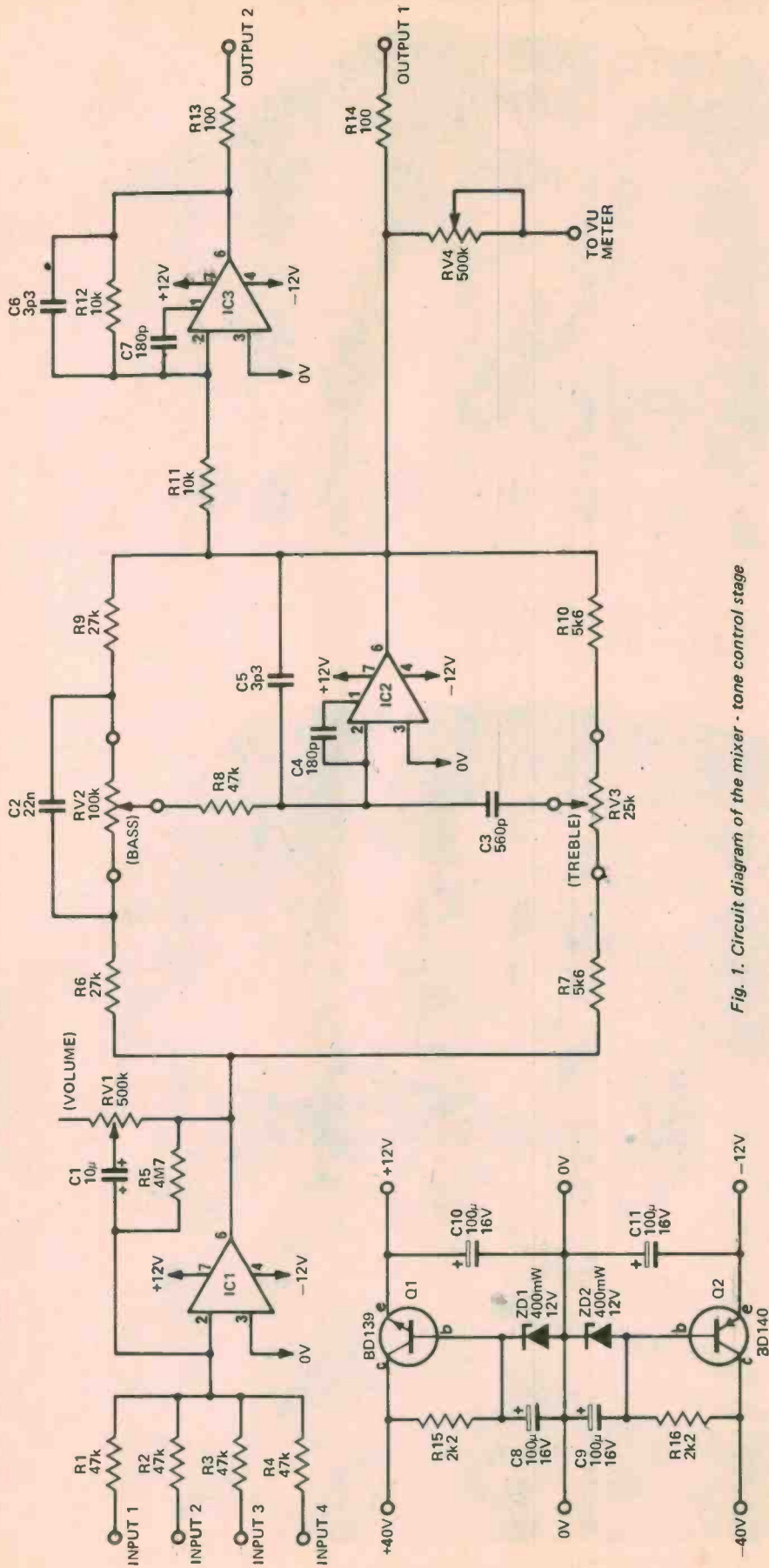

Fig. 1. Circuit diagram of the mixer - tone control stage

How It Works — ETI 481M

The mixing is done by IC1 where the gain is set by RV1 and is variable from zero to 10 (20dB) and for dc biasing R5 is used. Due to the high value of R5 we have used a FET op-amp (CA3140) for IC1. The tone controls are a standard network around IC2. The output of IC2 is inverted by IC3. The frequency compensation used on IC2 and IC3 is called 'feed forward' and extends the frequency response of the IC. The power supply reduces the +40V to +12V and has enough power to drive the preamplifiers as well.

We mounted the preamplifiers, mixer and VU meter on small brackets which were held on by the potentiometers. For the balanced microphone inputs we used stereo phone jacks as they are economical and also allow an unbalanced microphone to be used. The level control potentiometers on the microphone inputs were 10k log and are on the output of the preamplifier. We had some hum pickup into the mixer board from the wiring to the power switch and we have moved it more to the right since the photos were taken to help this problem.

used and larger filter capacitors or paralleled capacitors (we used 6800µ 50V) should be used. When connecting the power modules the +40V, 0V and -40V connections between the modules should be short. Most of the preamplifier modules need a dual 12V supply and this is available from the 481M board. In the audio level meter the diode D3 should be replaced by a 680 ohm resistor to lower the +40V to less than the 32V allowed. It should be connected as a VU meter with R5 as 220k. The unit can be calibrated on the mixer board.

Continued from page 60
fuse in series and a large automotive type diode (cathode to +Ve) across the 12V after the fuse so that the fuse will blow if the supply is the wrong polarity. The output of the 12V converter and simply be paralleled allowing the two supplies to be used separately or together without damage. The wiring on the 12V side carries 15 amps and should be a reasonable gauge. For connecting in bridge two separate transformers (or a larger one) are needed, separate rectifiers should be

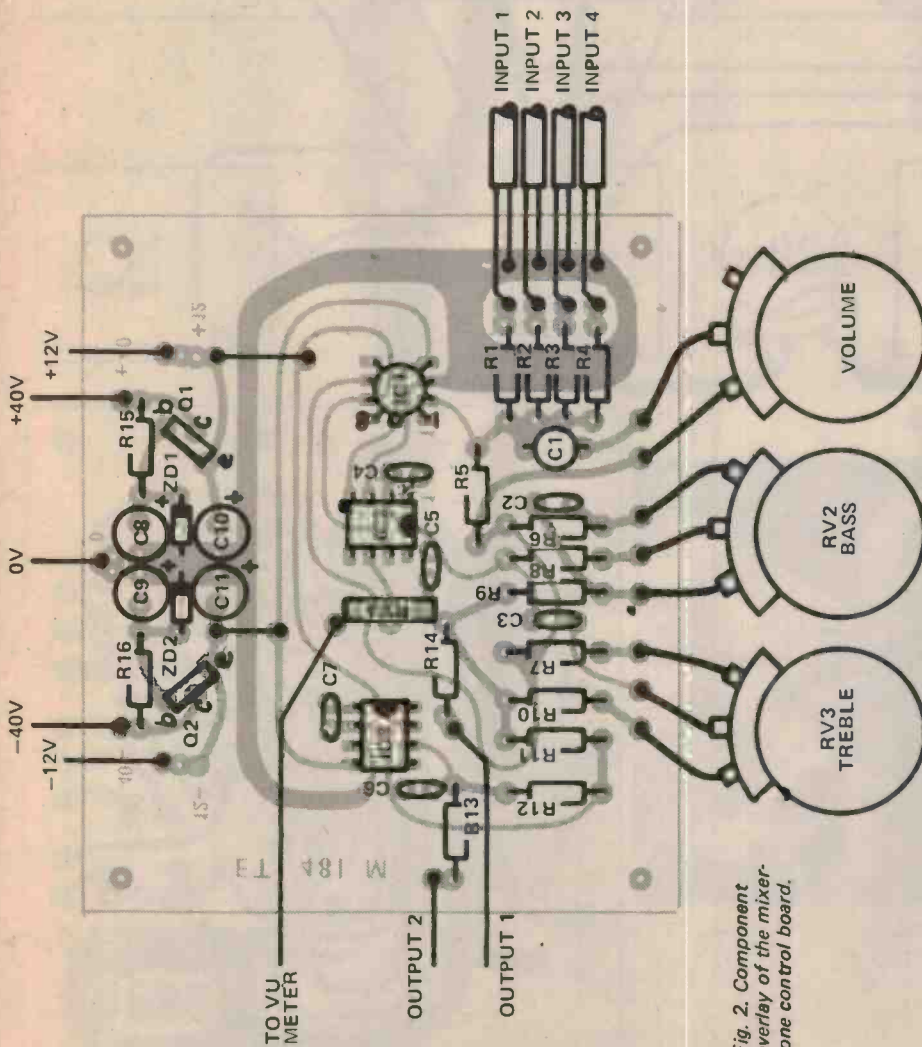
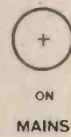
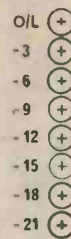
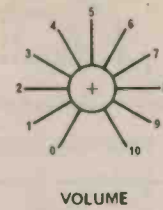
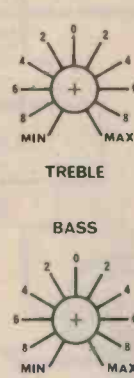
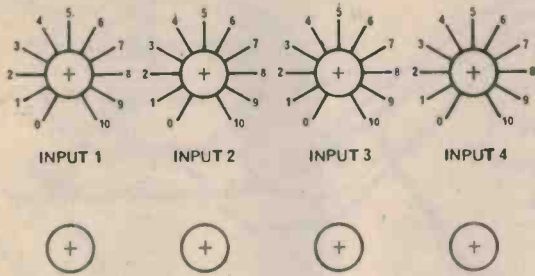

Fig. 2. Component overlay of the mixer tone control board.

PARTS LIST — ETI 481M

Resistors all 1/2W 5%	Potentiometers	Semiconductors
R1—R4 47k	RV1 500k log rotary	IC1 CA3140
R5 4M7	RV2 100k lin "	IC2,3 LM301A
R6 27k	RV3 25k lin "	Q1 BD139
R7 5k6	RV4 500k trim	Q2 BD140
R8 47k	Capacitors	ZD1,2 12V 400mW
R9 27k	C1 10 μ non polarised electro	Miscellaneous
R10 5k6	C2 22n polyester	PC board ETI 481M
R11,12 10k	C3 560p ceramic	
R13,14 100	C4 180p "	
R15,16 2k2	C5,6 3p3 "	
	C7 180p "	
	C8—C11 100 μ 16V electro	



International 481

Fig. 3. Front panel artwork. Full size 375 x 135 mm. Note that the full length is not shown here.

Project 481

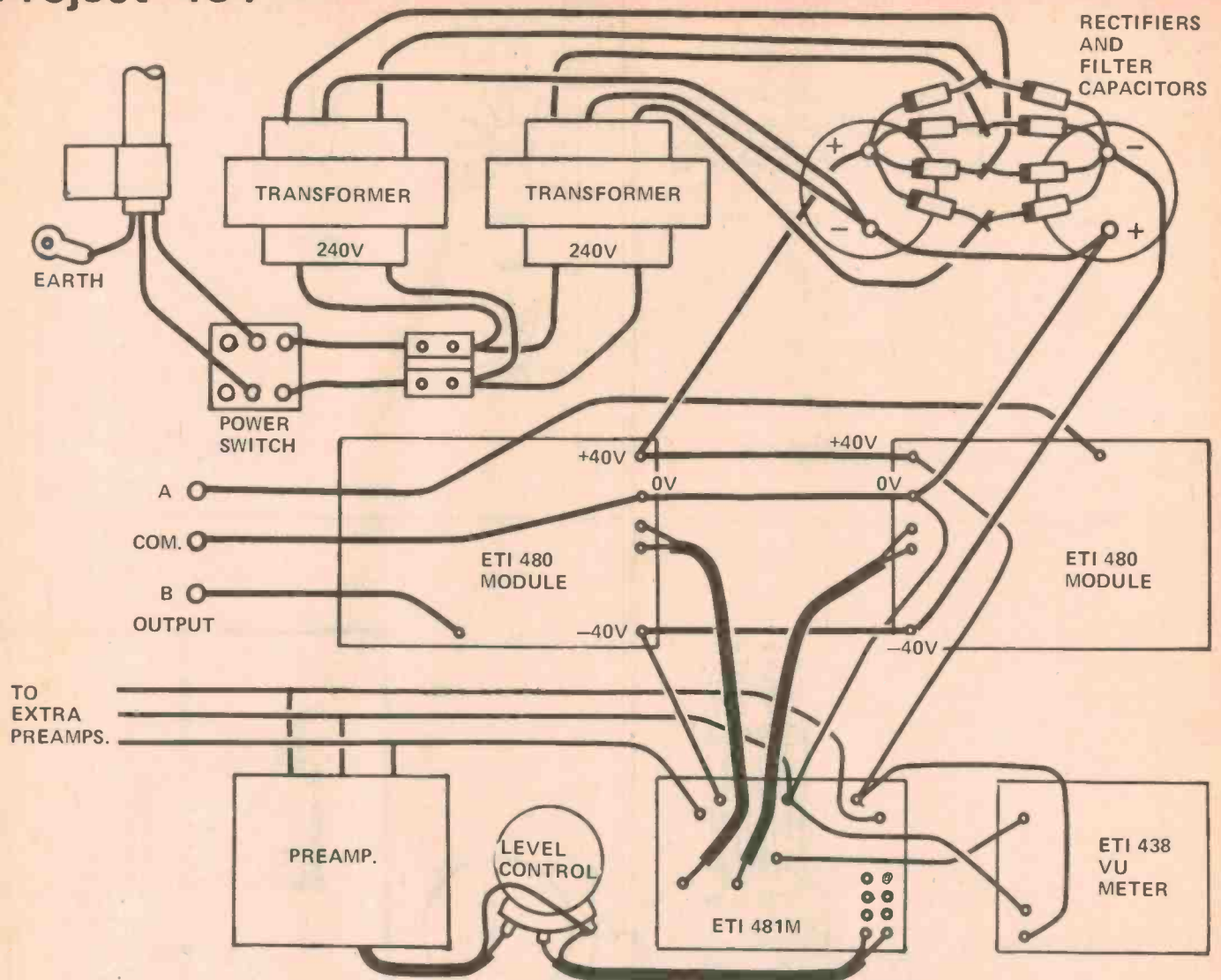

Fig. 4. Wiring diagram for the 200W bridge amplifier.

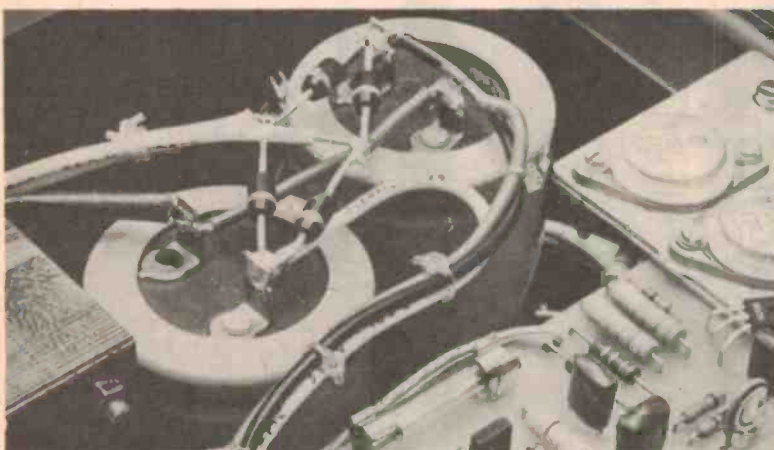

Photo showing how the rectifier diodes are connected. This is on the 12V / 240V version where a single transformer and rectifier are used.

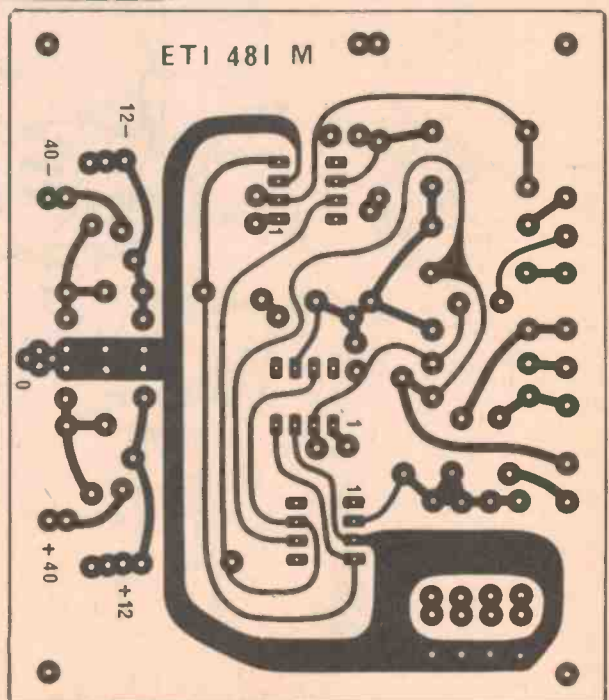

Fig. 5. Printed circuit layout. Full size 92 x 78 mm.

FANTASTIC OFFER!!!

THE LATEST TECHNOLOGY 100 STEP PROGRAMMABLE SCIENTIFIC CALCULATOR

Beautifully gift packed with strong adjustable desk stand, Carry Case, Pens, Note Book, Battery.

★
**PLUS
BONUS**

AT NO EXTRA CHARGE

6 FUNCTION DIGITAL WATCH

Hours, Mins, Secs,
Day, Month Date

**IN GOLD OR SILVER
METAL CASE AND BAND**

(Normal rec. retail is \$39.95)

★★ **PLUS
LATEST A.C. ADAPTOR**

for power to keep your programs intact without using your battery
(Normal Rec. Retail is \$7.99)

ONE YEAR WARRANTY



14 Freight Road, Tullamarine.
Melbourne. 3043. PH: 03-338-7223

**AUSTRALIA'S
HOTTEST
SELLING
DIGITAL
PRODUCTS**

WHILE STOCKS LAST

- Fully Computer Programmable
- Simple Keyboard Programming
- Full Scientific Keyboard Functions
 - Program Examination & Editing
 - Popular R.P.N. Logic for speed
 - Automatic Brackets Equations
- Multiple programs up to 100 steps
 - Separate Addressable Memory
 - 4 Level Operational Stack
 - Programmable Hats for Data entry of Readout
 - Load your own
 - Maths Physics
 - Chemistry or Finance
 - & Commercial
 - Programs with as many steps as you need for intermediate answers

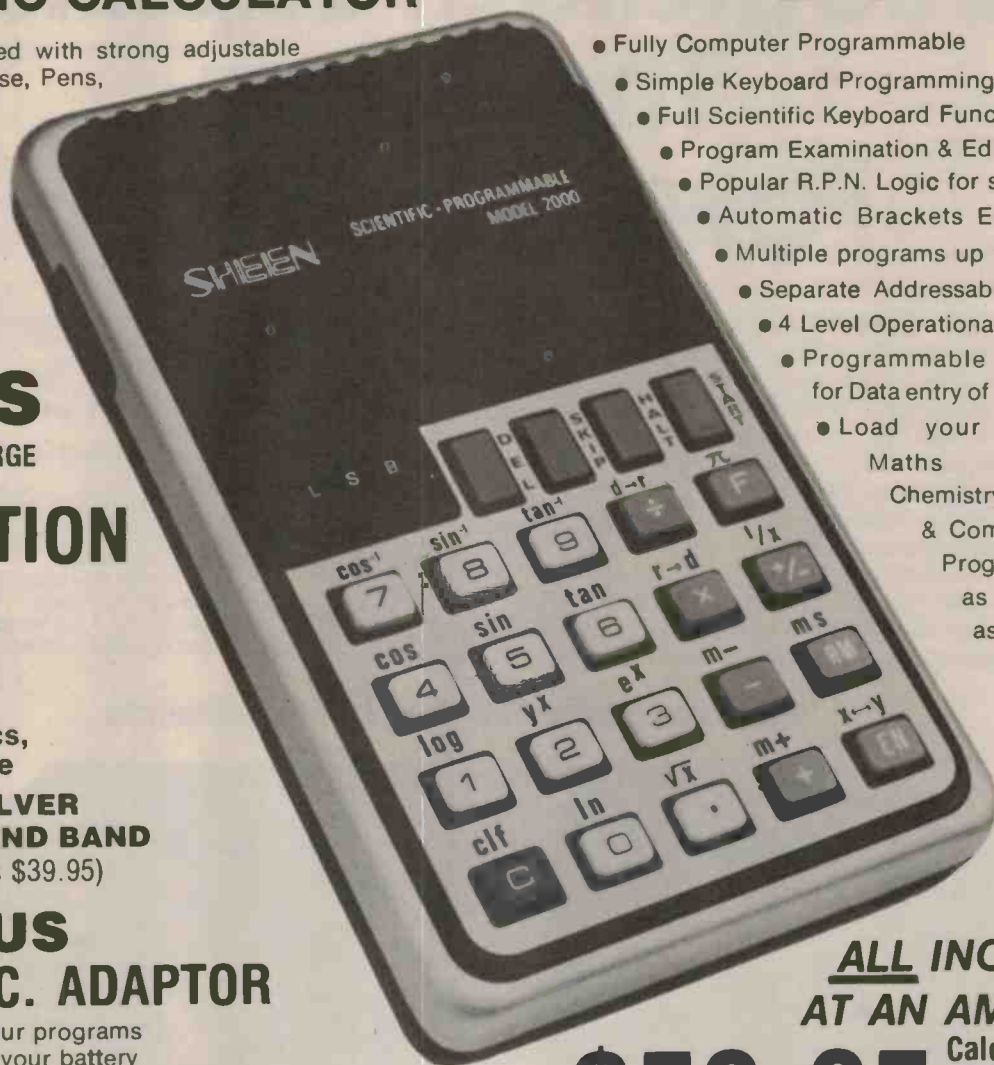

**ALL INCLUDED
AT AN AMAZING**

\$59.95 Calculator pack
Digital watch
A.C. Power adaptor

Please send me my model 200 Programmable CALCULATOR PLUS MY BONUS 6 FUNCTION DIGITAL WATCH IN GOLD.....
SILVER.....
PLUS BONUS A.C. ADAPTOR

NAME

ADDRESS

POST CODE

ENCLOSED \$59.95 PLUS \$2.00 Post & Handling

Sansui Stereo Integrated Amplifier: The Super Power Package.

From Sansui, the Stereo Integrated Amplifier AU20000, a super power package that pushes out 170 watts per channel. We call it integrated because it is a combination of the Definition BA-3000 power and CA-3000 preamplifier within the one unit.

That means the AU20000 is more compact to handle and is available at a price to please every true audiophile.

Specifications

Power Output: Min. RMS, both channels driven, from 20 to 20,000Hz, with no more than 0.05% total harmonic distortion 170 watts per channel into 4 and 8 ohms.

Power Bandwidth: 20 to 20,000Hz at or below rated min. RMS power output and total harmonic distortion.

Total Harmonic Distortion: Overall (from AUX) less than 0.05% at or below rated min. RMS power output.

Intermodulation Distortion: (70Hz:7,000Hz = 4:1 SMPTE method). Overall (from AUX) less than 0.05%.

Frequency Response (at 1 watt):

Overall (AUX to power output)
10 to 50,000Hz + 0dB, -1.0dB

Power Amplifier Only
10 to 70,000Hz + 0dB, -1.0dB

Damping Factor: approximately 80 to 8 ohm load

Channel Separation at rated output 1,000Hz:

Phono 1—better than 55dB
(at 3mV sensitivity)

Phono 2—better than 55dB
(at 3mV sensitivity)

Tuner—better than 60dB

Aux—better than 60dB

Tape Monitor—1,2,3 better than 60dB

Power Amplifier—better than 65dB

Available from all leading Hi-Fi specialists



Sansui

Sold and serviced nationally
by Rank Australia.
Sydney (02) 406 5666
Melbourne (03) 62 0031
Brisbane (07) 44 2851
Adelaide (08) 212 2555
Perth (092) 28 3933

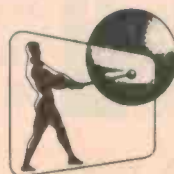

We Keep Performing.

**RANK
AUSTRALIA**

ETI data sheet

MC 14490 HEX BOUNCE ELIMINATOR

The MC14490 is constructed with complementary MOS enhancement mode devices, and is used for the elimination of extraneous level changes that result when interfacing with mechanical contacts. The digital contact bounce eliminator circuit takes an input signal from a bouncing contact and generates a clean digital signal four clock periods after the input has stabilized. The bounce eliminator circuit will remove bounce on both the "make" and the "break" of a contact closure. The clock for operation of the MC14490 is derived from an internal R-C oscillator which requires only an external capacitor to adjust for the desired operating frequency (bounce delay). The clock may also be driven from an external clock source or the oscillator of another MC14490.

CHARACTERISTICS

The single most important characteristic of the MC14490 is that it works with a single signal lead as an input, making it directly compatible with mechanical contacts.

The circuit has a built in pullup resistor on each input. The worst case value of the pullup resistor is used to calculate the contact wetting current. If more contact current is required, an external resistor may be connected between V_{DD} and the input.

Because of the built in pullup resistors, the inputs cannot be driven with a single standard CMOS gate when V_{DD} is below 5V. At this voltage, the input should be driven with paralleled standard gates or by the MC14049 or MC14050 buffers.

The clock input circuit (pin 7) has Schmitt trigger shaping such that proper clocking will occur even with very slow clock edges, eliminating any need for clock preshaping. In addition, other MC14490 oscillator inputs can be driven from a single oscillator output buffered by an MC14050.

The MC14490 is TTL compatible on both the inputs and the outputs. When V_{DD} is at 4.5V, the buffered outputs can sink 1.6 mA at 0.4V. The inputs can be driven with TTL as a result of the internal input pullup resistors.

OPERATION

To understand the operation, we assume all bits of the shift register are loaded with 1's and the output is at a 1 or high level.

At clock edge 1 the input has gone low and a 0 (low level) has been loaded into the first bit or storage location of the shift register. Just after the positive edge of clock 1 in input signal has bounced back to a logic 1. This causes the shift register to be reset to all 1's in all four bits — thus starting the timing sequence over again.

During clock edges 3 to 6 the input signal has stayed low. Thus a logic 0 has been shifted into all four shift register bits and, as shown, the output goes to a 0 during the positive edge of clock pulse 6.

It should be noted that there is a $3\frac{1}{2}$ to $4\frac{1}{2}$ clock period delay between the clean input signal and output signal. In this example there is a delay of 3.8 clock periods from the beginning of the clean input signal.

After some time period of N clock periods, the contact is opened and at N+7, a 1 is loaded into the first bit. Just after N+7, when the input bounces low, all bits are reset to 0. At N+8 nothing happens because the

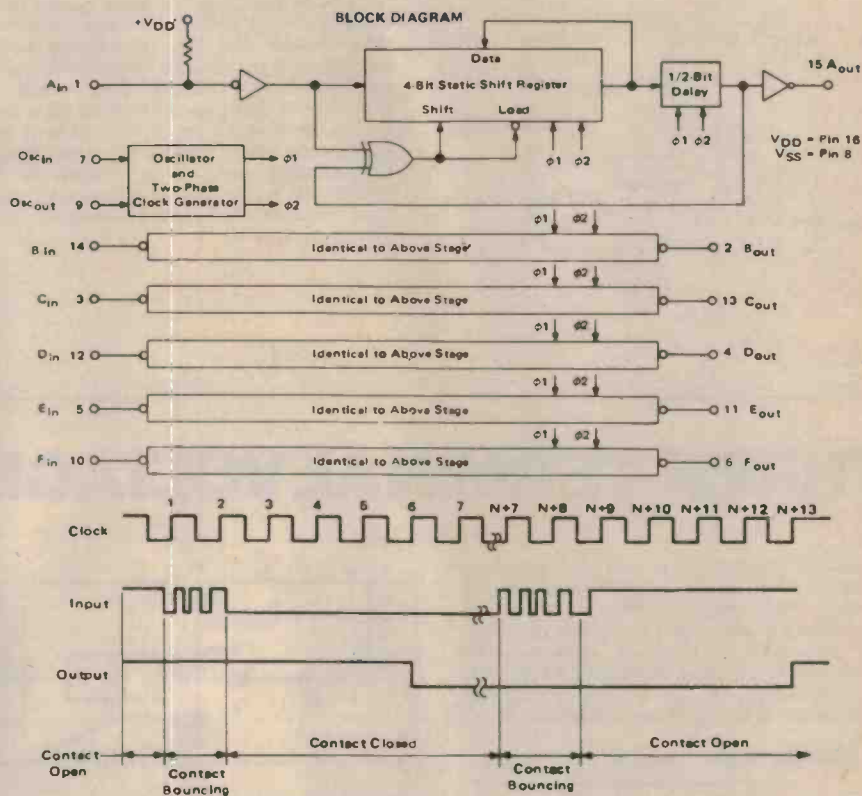

input and output are low and all bits of the shift register are 0. At time N+9 and thereafter the input signal is a high (1) clean signal. At N+13 the output goes high (1) as a result of four 1's being shifted into the shift register.

Assuming the input signal is long enough to be clocked through the Bounce Eliminator, the output signal will be no longer or shorter than the clean input signal plus or minus one clock period.

CLOCKING

The only requirement on the clock frequency in order to obtain a bounce free output signal is that four clock periods do not occur while the input signal is in a false state.

If the user has an available clock signal of the proper frequency, it may be used by connecting it to the oscillator input (pin 7). However, if an external clock is not available the user can place a small capacitor across the oscillator input and output pins in order to start up an internal clock source. The clock signal at the oscillator output pin may then be used to clock other MC14490 Bounce Eliminator packages. With the use of the MC14490, a large number of signals can be cleaned up, with the requirement of only one small capacitor external to the Hex Bounce Eliminator packages.

ASYMMETRICAL TIMING

In applications where different leading and trailing edge delays are required (such as a fast attack/slow release timer.) Clocks of different frequencies can be gated into the MC14490. In order to produce a slow attack/fast release circuit leads A and B should be interchanged. The clock out lead can then be used to feed clock signals to the other MC14490 packages where the asymmetrical input/output timing is required.

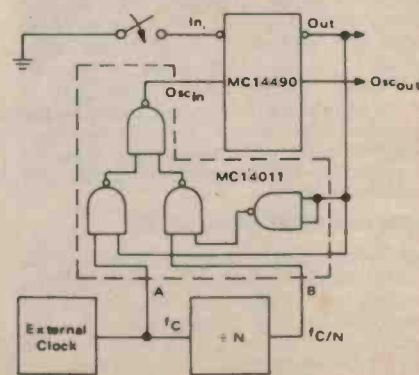

ETI data sheet

LATCHED OUTPUT

The contents of the Bounce Eliminator can be latched by using several extra gates. If the latch lead is high the clock will be stopped when the output goes low. This will hold the output low even though the input has returned to the high state. Any time the clock is stopped the outputs will be representative of the input signal four clock periods earlier.

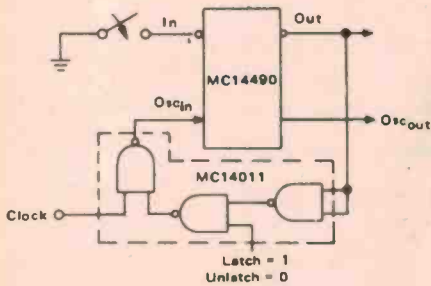

MULTIPLE TIMING SIGNALS

Bounce Eliminator circuits can be connected in series. In this configuration each output is delayed by four clock periods relative to its respective input. This configuration may be used to generate multiple timing signals such as a delay line, for programming other timing operations.

One application of the above is where it is required to have a single pulse output for a single operation (make) of the push button or relay contact. This only requires the series connection of two Bounce Eliminator circuits, one inverter, and one NOR gate in order to generate the signal AB. The signal AB is four clock periods in length. If the inputs to the NOR gate are interchanged the pulse AB will be generated upon release or break of the contact. With the use of a few additional parts many different pulses and waveshapes may be generated.

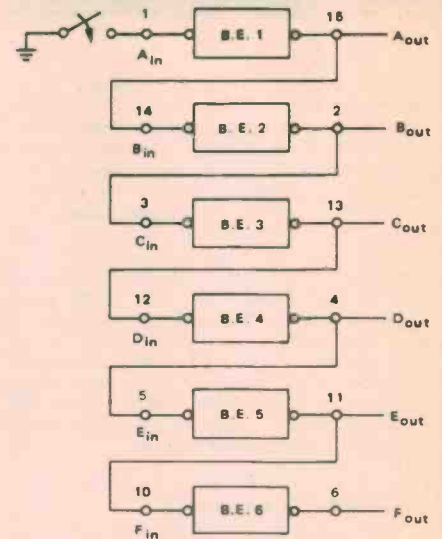

THREE TERMINAL VOLTAGE REGULATORS

Voltage regulator use can be expanded beyond that of the simple three-terminal fixed voltage regulator. Some of the circuits which are practical and useful are described in this section. Pertinent equations are included rather than providing fixed component values as the circuits are equally applicable to all regulators within a family.

POSITIVE REGULATORS

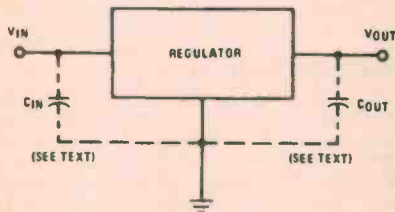

FIGURE 1 Basic Regulator Connection

If the regulator is located more than two inches from the supply filter capacitor, a supply bypass capacitor is required to maintain stability (much as is the case with op-amps). This should be a 0.22 μ F or larger disc ceramic, 2 μ F or larger solid tantalum, or 25 μ F or larger aluminium electrolytic capacitor. Transient response of all the regulators is improved when output capacitors are added. To minimize high frequency noise, an 0.1 μ F output capacitor is recommended on the LM78LXX and LM3910 series.

HIGH CURRENT REGULATOR

This current circuit takes advantage of the internal current limiting characteristics of the regulator to provide short-circuit current protection for the booster as well. The regulator and Q_1 share load current in the ratio set between R_2 and R_1 if $V_O = V_{REG(Q_1)}$

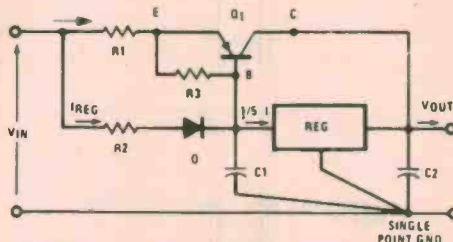

FIGURE 2 High Current Regulator with Short Circuit Limit During Output Shorts.

$$I_1 = \frac{R_2}{R_1} I_{REG}$$

During output shorts

$$I_{1(SC)} = \frac{R_2}{R_1} I_{REG(SC)}$$

If the regulator and Q_1 have the same thermal resistance θ_{JC} and the pass transistor heat sink has R_2/R_1 times the capacity of the regulator heat sink, the thermal protection (shutdown) of the regulator will also be extended to Q_1 . Some suggested transistors are listed below.

ADJUSTABLE OUTPUT VOLTAGE

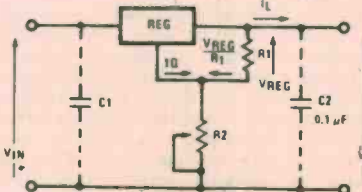

FIGURE 3 Adjustable V_{OUT}

A fraction of the regulator current V_{REG}/R_1 is used to raise the ground pin of the regulator and provide through voltage drop across R_2 , an adjustable output voltage.

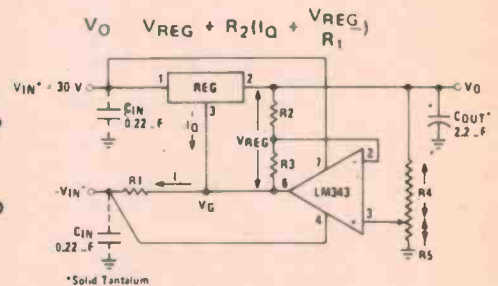

FIGURE 4 Variable Output Voltage of 0.5 - 28V

A wide range of output voltages can be obtained with the circuit of Figure 4. A 0.5- to 20-volt supply can be built using a 30-volt supply and a conventional op-amp, such as the LM143. If

$$R_2 + R_3 = R_4 + R_5 = R, \text{ and } R_2/R_3 = 1/10,$$

$$\text{then } V_O = V_{REG} \left(\frac{R_2}{R_4} \right) = V_{REG} \left(\frac{1}{11} \right) \left(\frac{R_4 + R_5}{R_4} \right)$$

Since V_O is inversely proportional to R_4 , low output voltages can be very accurately set. The required R_1 is

$$R_1 = \frac{V_{IN}}{I_O}$$

The $V_{O(MAX)}$ is dependent on V_{IN} and $V_{dropout}$, provided that the amplifier can source the current required to raise V_G to $V_O - V_{REG}$.

Example:

$V_{IN} = -15V$	$R_1 = 2K2$
$V_{IN}^+ = +30V$	$R_2 = 910R$
$V_O = 0.5-28V$	$R_3 = 9K1$
LM340K-05	$R_4 + R_5 = 10K$

ELECTRONIC SHUTDOWN

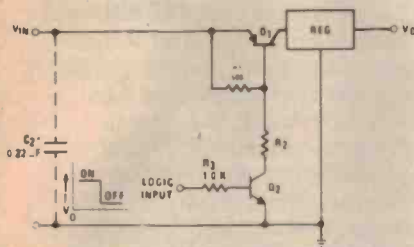

* Required if regulator far from power supply filter

FIGURE 5 Electronic Shutdown Circuit

Electronic shutdown in three-terminal regulators is done by simply opening the input circuit using a transistor switch. Q_1 operates as the switch which is driven by V_C . The control voltage V_C can be TTL compatible with the use of $R_3 = 1K$. R_1 is a biasing resistor, and R_2 can be calculated as

$$R_2 = \frac{V_{IN} - 1V}{I_O} - \beta_{SAT}(Q_1)$$

Figure 6 illustrates a short-circuit-dependent power shutdown circuit with reduced heat sink requirements under short-circuit conditions.

When the power is first applied, Q_2 turns ON and saturates Q_1 . The regulator output ramps up to turn Q_3 ON, which turns Q_2 OFF (V_C should be $> V_A$), thus maintaining Q_1 in the ON state.

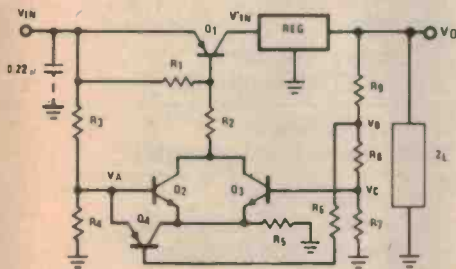

FIGURE 6 Output Electronic Shutdown on High Voltage Regulator

When the output is shorted, Q_3 turns OFF, Q_4 turns ON to clamp Q_2 OFF. Q_1 loses base drive and so opens to isolate the regulator from V_{IN} . When the short circuit is removed, Q_4 loses some base drive and enables Q_2 to re-start the regulator. Q_1 always operates as a switch and needs no heat sinking. Q_2 and Q_3 need not be matched. Q_4 may be any small signal PNP transistor. The entire circuit (less regulator) fits easily on a one-inch square PC board.

Example: LM340K-24

$V_{IN} = 36V$	$R_1 = 500R$
$V_O = 24V$	$R_2 = 250R, 2W$
$I_O = 1A$	$R_3 = 3K3$
$V_A = 2.5V$	$R_4 = 240R$
$V_B = 8V$	$R_5 = 62R$
$V_C = 4.8V$	$R_6 = 2K$
$Q_1 = NSD32$	$R_7 = 1K$
$Q_2 = 2N4141$	$R_8 = 680R$
$Q_3 = 2N4141$	$R_9 = 3K3$
$Q_4 = 2N2906$	

NEGATIVE REGULATORS

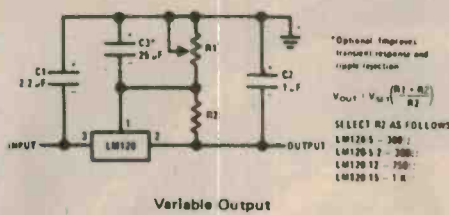

Variable Output

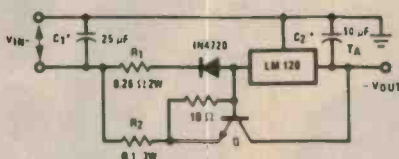

(d) High Current Regulator

$Q_1 = 2N3055$ (for 5 A)
or $NSD31$ (for less than 2-3 A)

FIGURE 7 Negative Regulator Circuits

All the applications circuits for positive regulators can be used with the polarities inverted for the negative regulator LM320/345 series (e.g., reverse the sense of the diodes, replace PNP's with NPN's etc., etc.).

BASIC DUAL POWER SUPPLY

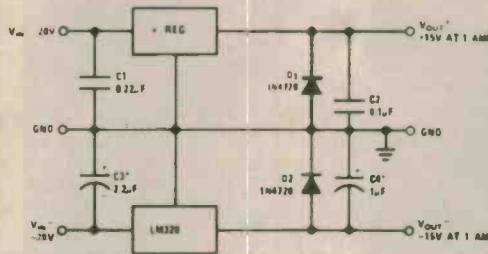

* Solid Tantalum

Note: C_1 and C_2 required if regulators are located far from power supply filter.

FIGURE 8 Dual Power Supply

A positive regulator can be connected with an LM320 to form a non-tracking dual power supply. Each regulator exhibits line and load regulation consistent with their specifications as individual devices. Protective diodes D_1 , D_2 allow the regulators to start under common load. They should be rated at the regulator short circuit current.

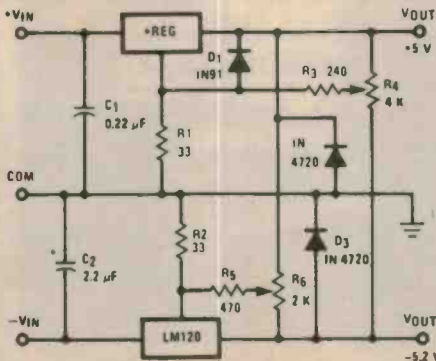
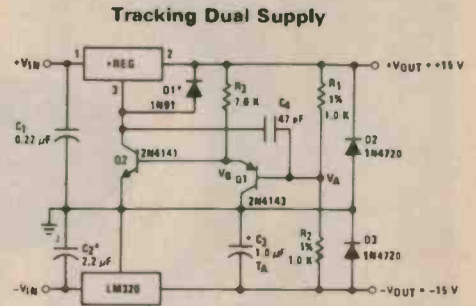

FIGURE 9 Trimmed Dual Supply

TRIMMED DUAL SUPPLY

Figure 8 may be modified to obtain a dual supply trimmed to a closer output tolerance. The trimming potentiometers are connected across the outputs so positive or negative trimming currents are available to set the voltage across the R_1 (R_2) resistors. R_3 , R_5 are included to linearize the adjustment and to prevent shorting the regulator ground pin to opposite polarity output voltages.



* Solid Tantalum

FIGURE 10 Tracking Dual Supply

A tracking supply can be built as in Figure 10 where the positive regulator tracks the negative regulator. V_A is a virtual ground under steady state conditions. Q_2 conducts the quiescent current of the positive regulator.

If $-V_{OUT}$ falls, V_A follows forward biasing collector-base junction of Q_1 . V_A falls, thus raising the collector voltage of Q_2 and $+V_{OUT}$ to restore V_A to desired voltage. Germanium diode D_1 may be needed to start the positive regulator with a high differential load.

Example: +15V, 1A tracking dual supply:
LM340T-05, LM320T-15.
The 340 will track the LM320 within 100 mV. D_2 , D_3 : IN4720.

VARIABLE TRACKING DUAL SUPPLY

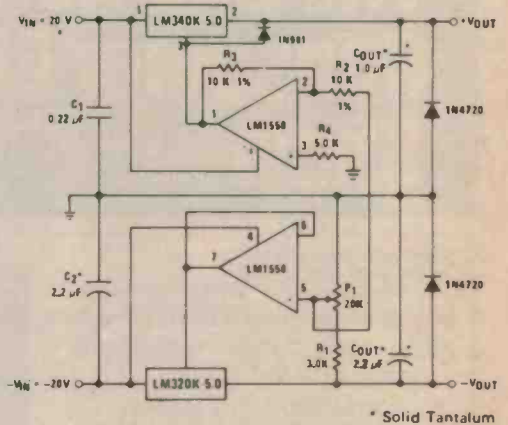

* Solid Tantalum

FIGURE 11 Variable Tracking Dual Supply $\pm 5.0V$ - $\pm @ 18V$

The ground pins of the negative regulator and the positive regulators are controlled by means of a voltage follower and an inverter, respectively. The positive regulator tracks the negative to within 50mV over the entire output range if R_2 is matched to R_3 within one per cent.



EXPERIENCE
THE ULTIMATE

The 2nd Australian Consumer Electronics Show

SYDNEY HILTON HOTEL
THURSDAY 4 TO TUESDAY 9 AUGUST, 1977.

PRIZES! You could win
one of these great PIONEER prizes:

- Avante 1, 6 piece component system valued at \$759
- Centrex 520 3-in-1 system valued at \$599
- Modular Car Stereo System II and TS-167 speakers valued at \$328.

Don't forget to fill in your entry form, available on 9th level.



An experience indeed! By far the most comprehensive show of its kind in Australia. All under one roof, at the one time (covers four levels of the hotel!)

See and hear over **100 different brands** of top hi-fi and stereo equipment and accessories from market leaders such as Akai, AWA-Thorn, E.M.I., Haco, Hagemeyer, Hitachi, Jacoby-Mitchell, Kriesler, Philips, Pioneer, Rank, Sharp, Sonab, Sony, Toshiba and many more. Experts will be on hand to answer all your questions.

Also you can view an enormous range of other consumer electronics equipment such as colour TV, radio, cassette decks, calculators, digital watches, etc. The 1st Australian Consumer Electronics Show held last year, was acclaimed Australia-wide. **This year it's twice as big.** Twice as exciting.

Although this is primarily a show for the Consumer Electronics Trade, special hours have been allotted for the general public. This is a unique opportunity to view the latest equipment from all over the world; a preview of the products which will soon be on the market.

HOURS

Thursday August 4
6.00 — 10.00 pm public

Friday August 5
10.00 am — 10.00 pm public

Saturday August 6
10.00 am — 6.00 pm public
7.30 pm — Gala Banquet —
trade only

Sunday August 7
10.00 am — 6.00 pm trade only

Monday August 8
10.00 am — 6.00 pm trade only
9.30 am — 4.30 pm —
Industry Conference

Tuesday August 9
10.00 am — 6.00 pm trade only

Enter via escalator from foyer of Hotel.



ADMITTANCE IS FREE



Riddell Exhibition Promotions Pty. Ltd.,
166 Albert Rd., South Melbourne 3205. Phone: (03) 699 1066

RP243

Six top careers in electronics

A top salary, job security and positive success. That's what a career in the exciting and rapidly expanding electronics industry can give you—if you have the right qualifications. An ICS course can give you the training you need for the rewarding career you deserve. With ICS, you learn at home, at your own pace. There's no time lost travelling to classes; ICS provide you with everything you need by mail. You're ready for success in electronics now, so select your course, then fill in and post the coupon today.



INDUSTRIAL ELECTRONICS SPECIALIST

If you're interested in specialising in industrial electronics, this course offers technical-level training. It is an ICS Diploma Course, with a full list of subjects ranging from Circuits, Electronic Diagrams and AM/FM Radio Receiving Systems to Ultrasonics and Computer Principles. The full range from the most basic to the most sophisticated technology.

ELECTRONICS TECHNICIAN

This Diploma Course will give you a particularly thorough knowledge of Electronic Technology. You will learn the principles, applications and maintenance of electronic equipment in industrial and other fields, including instruction on radio principles. Major sections cover electrical and electronic measuring instruments, telemetering, facsimile and radio-electronic telemetry.

COMMUNICATIONS BROADCASTING SPECIALIST

This course prepares students wishing to sit for the P.M.G. examinations for the various proficiency certificates—Commercial Operator's Certificate of Proficiency (Aust.), Radio-Telegraph Operator's Certificate of New Zealand, Broadcast Station Operator's Certificate of Proficiency and Certificate in Radio

Technology (New Zealand). Sections covered include: Electrical Theory, Radio Theory, Regulations, Telegraphy Tests, Practical and Oral Questions.

ELECTRONIC COMPUTER SERVICING SPECIALIST

A specialist course designed to provide a sound knowledge of the technical aspects of computers; how they function and their practical applications, including programming. The course covers Number Systems and Digital Components; Organisation and Maintenance of Computers; Servomechanisms and Fundamentals of Computer Programming.

COMPUTER TECHNICIAN

This compact Diploma course will be of special value to technical people who are likely to be concerned with the installation, maintenance and operation of digital computers. It provides a sound introduction to Electrotechnics, Electronic Theory, Electronic Computers and Digital Computer Programming. Practical applications are stressed throughout.

COLOUR TV

If you already have a knowledge of the principles and practice of TV, this course will prepare you for the introduction of colour TV. Subjects covered in detail include:

Colour in TV, the Colour TV system, Picture Tubes and Receiver Circuits for Colour TV, Troubleshooting Colour TV, Alignment of Monochrome and Colour Receivers and the PAL System.

International Correspondence Schools
400 Pacific Hwy. Crown's Nest NSW 2065. Tel: 43-2121
18-20 Collins St. Melbourne 3000. Tel: 63-7327
New Zealand: 182 Wakefield St. Wellington

Please provide me with Information

about the Career on _____

Mr/Mrs/Miss _____ Age _____

Address _____

Postcode _____

Occupation _____

27630 EAO

ICS

POST THIS COUPON TODAY TO

Hills TV Handyman Kits make it easy to install or change an antenna wiring system.



These kits enable the handyman to install new wiring or upgrade existing wiring for an antenna system by replacing ribbon leads with coaxial cable.

The kits also make it easy to add more antenna outlets so that two or more sets can operate from the same antenna in different parts of the home.

The range consists of three different kits.

No. 1 KIT. For new single point coaxial installation or to replace ribbon wiring.

No. 2 KIT. For new two point coaxial installation or to replace ribbon wiring.

No. 3 KIT. To add one coaxial point to existing coaxial installation.

ALL KITS SUIT EITHER

75 OHM or 300 OHM SETS.

Each kit contains all the coaxial cable, fittings, clips, outlet points, and coaxial 'wall to TV set' leads necessary for a complete installation. (All cable ends are prepared ready for use).

NOTE: These kits do not include an antenna.

Hills Antennas

Brisbane 44 0181. Sydney 534 3344. Melbourne 798 2555.
Adelaide 297 4188. Perth 79 5999. Hobart 34 3331.

A fully illustrated, easy to follow instruction leaflet is included with each kit. See your local electrical retailer for more information, or contact the Hills Industries branch in your state.

ELECTRONICS

IN THE YEAR
2000

EVOLUTION OR REVOLUTION

By Peter Sydenham

THE USE OF ELECTRICITY FOR medical purposes dates back to the Ancient Greeks who used the electric eel to treat various maladies. In 1759 Wesley collected case histories of the use of electricity. The first recorded use of electricity for treatment in a hospital in London was in 1767.

Not quite 200 years ago, in 1786 to be precise, Professor Luigi Galvani — an anatomist at the University of Bologna, Italy — discovered by chance that the muscles of a dead frog contracted under the influence of an electrical quantity.

He wrongly assumed that animal electricity stored within the muscle caused this to happen. It was, in fact, the result of dissimilar metals forming a primary electric cell which energised the nerves of the muscle. Volta of the Uni-



Fig. 1. Artist's idea of Galvani experimenting with frogs' legs in the 1780s. Note the friction electrostatic generator on the left and the Leyden jar on the right (Funk and Wagnells).

versity of Paris proved it and subsequently gave the world the voltaic battery, in 1800.

The contribution of these two men provided, in the simple primary cell, a workable basis for using electricity in

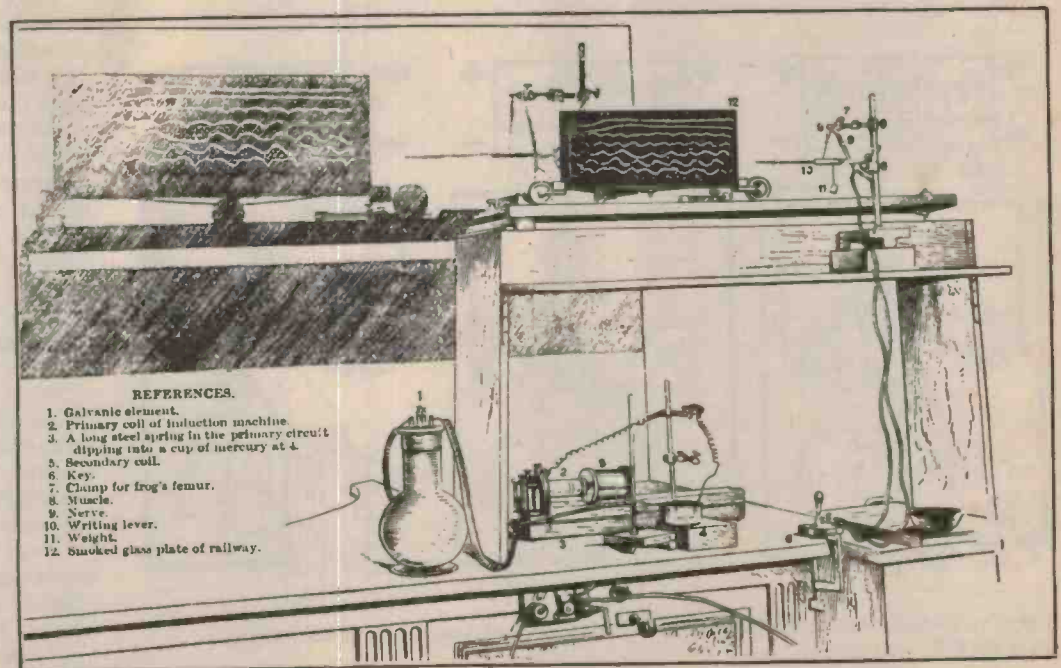

Fig. 2. Apparatus used by McKendrick to give lectures on life in motion to Royal Institution, London, audiences around 1890.

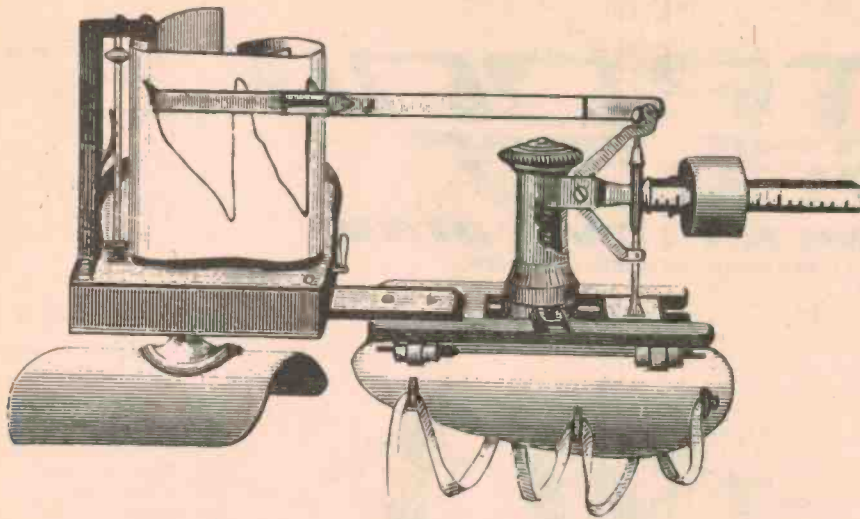

Fig. 3. Verdin's apparatus of the 1890s for recording action of the pulse.

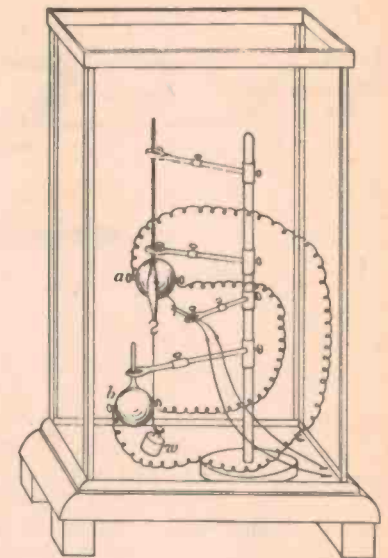

Fig. 4. Schematic of McKendrick's 1891 method for measuring heat generation in muscle.

practical ways not previously possible with the electro-static form of electricity. Galvani's work on "animal fluid" was amongst the earliest electro-medical studies. The apparatus he used was crude by today's standards — see Fig 1.

Research into physiological electric quantities gradually became more sophisticated as the 19th century passed. This development, however, had to wait for suitable experimental inventions such as the electro-magnetic

galvanometer which became available in its crudest form around 1830. A typical laboratory electro-medical instrumentation set-up of the 1890's is shown in Fig 2. A smoked glass plate moved steadily across the end of a mechanical pen secured to the end of a frog's leg muscle. The muscle was energised by high-voltage generated from a vibrating induction coil which was energised by a chromate primary single cell of the Grenet kind. Smoked screen recorders are still in use today

in some medical research measurements, blood flow parameters being one example.

The sphygmometrograph (as a pulse measuring instrument, was known in that time) was originated by Marey in 1860. A later design by Verdin is shown in Fig 3. Electronic method was little used in medicine in early times, as powerful electric signal amplification was not obtainable until the beginning of the 20th century — when the thermionic valve was invented by Fleming (in 1904).

Figure 4 shows experimental equipment for measuring heat production of muscular contraction around 1880. Thermocouples, forming a thermopile, drive the crude galvanometer.

Another aspect of medicine where electricity is used is for therapeutic treatment. Since the very early 1800s output of the various kinds of electric current generator, namely the Faraday induction coil, the galvanic chemical battery, the sine-wave rotating generator and the friction statical generator have been applied to appropriate parts of the body to provide a cure for all sorts of ailments. The bath shown in Fig 5 was in use around 1910 in conjunction with equipment such as, perhaps, the hand-cranked generator shown in Fig 6. Electronic forms of this equipment are still being designed and used today.

X-ray equipment was born in 1895 when Roentgen discovered X-rays in a chance situation using photographic plates. There is probably no case in instrument history where application

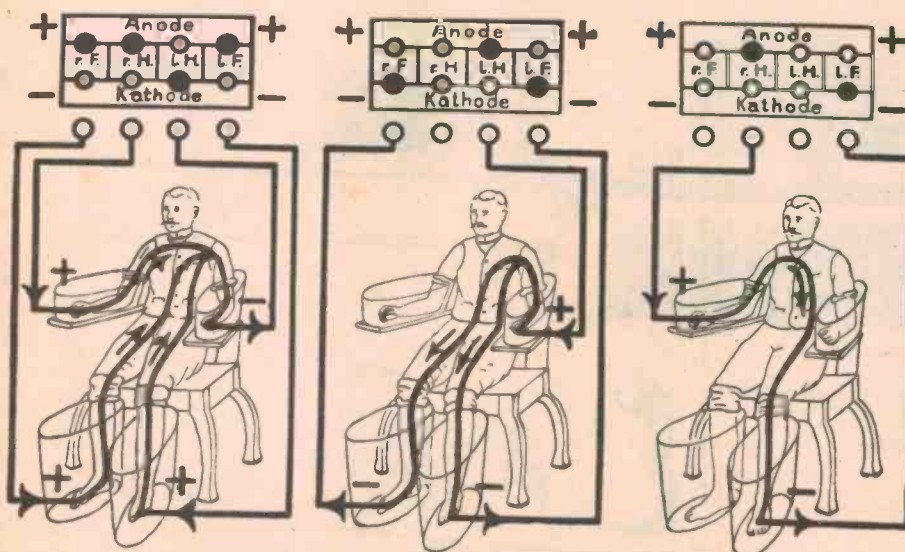

Fig. 5. Anyone for an electric bath? Contemporary sketch of routine therapeutic practice around 1910.

was more rapid. Edison, and others, had equipment in use in hospitals within months. Figure 7 shows contemporary American X-ray plant of 1899.

Measurement and recording of heart performance also began around 1900. Professor Einthoven of Holland devised a rapid response, high sensitivity detection instrument in 1903 — the string galvanometer. Soon after this was coupled to a photographic recording system, by the Cambridge Instrument Co., to produce an electrocardiograph. The first installation of this was made in 1909. By 1945 cardiographs were available in portable form. Figure 8 shows the interior of a 1930's Both Brothers portable electro-cardiograph invented and made in Adelaide, South Australia — possibly one of the first portable units devised anywhere. It used a loud speaker drive unit (right) to mark a rotating smoked disk. The record was viewed by the physician using an optical magnifier. Amplification to drive the stylus from skin electrode signals was obtained by thermionic valves.

As with all disciplines, electronic method opened the door to new accomplishments. In medical electronics it happened from the 1920s onward. Equipment for researching physiology at Oxford University, in 1949, is shown

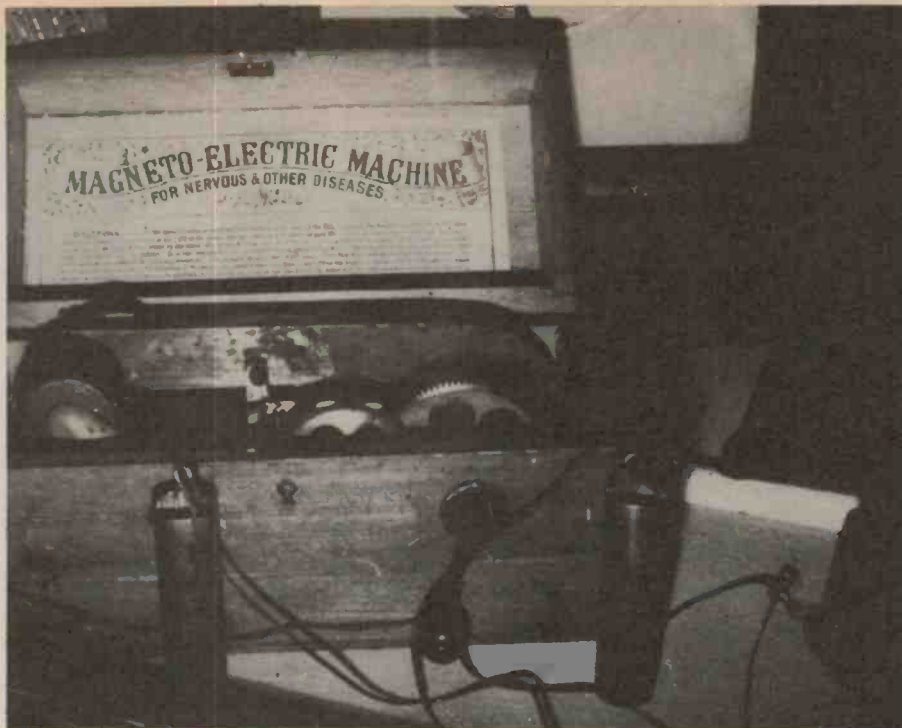

Fig. 6. In medical sine-wave generators a bobbin of wire is rotated in front of a permanent horse-shoe magnet. The design is almost identical with Clarke's 1830's original design and was still current around 1900.

in Fig 9. This unit, advanced for its time, incorporated amplifiers, a temperature control unit, stimulators to induce responses, a time base and a cathode ray tube display unit.

Electronic equipment used in medi-

cine has come a long way during the past 50 years. This can be seen by comparing the apparatus pictured above, which covers the 1800s to 1930's period, with modern equipment such as that used in pathological testing and nuclear medicine as was discussed in *Electronics Today International* issues of July and August, 1975.

Against this background let me now suggest developments we can expect to experience over the next quarter century.

Monitoring

The largest proportion of electro-medical equipment is concerned with measurement; for detection of abnormal states. At present comparatively few of the incredibly great range of medical measurements needed can be made in situ on the body and without disturbing its functions. Samples of tissue, blood, urine, etc. are removed for analysis in the pathological laboratory. This process, although performed faster today than ever before, can still take several hours before a diagnosis is available to the physician in order that he or she can decide corrective action. Analysers now exist that handle many measurements of a sample entirely automatically once the sample is loaded into the analyser.



Fig. 7. Complete X-ray apparatus in use in America around 1900. Note the lack of safety devices and precautions.

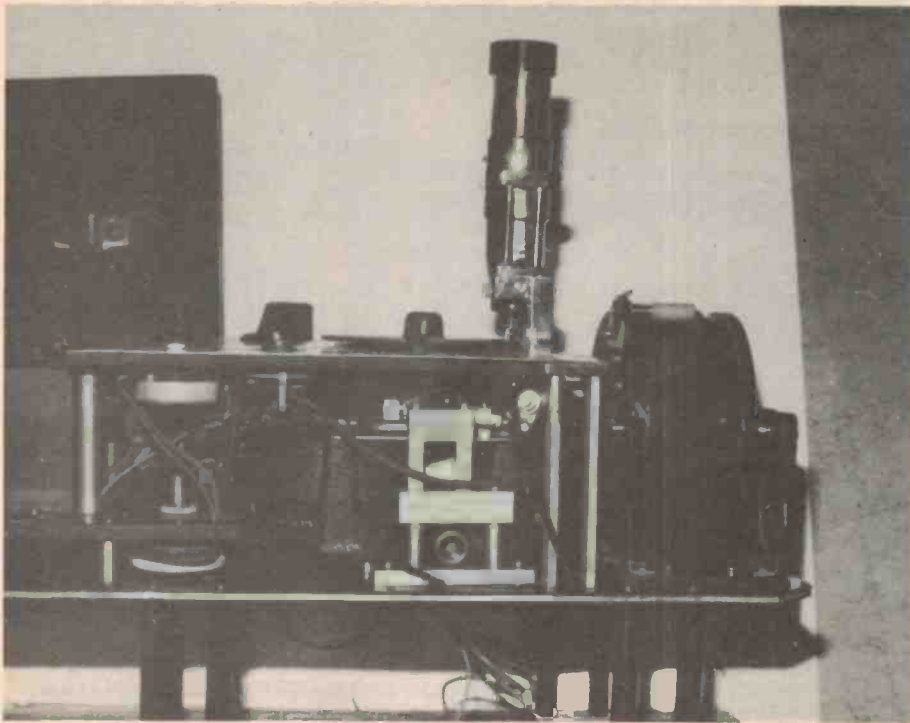

Fig. 8. Interior view of a Both portable electrocardiograph machine made in Adelaide around 1930.



Fig. 9. Electro-physiological research equipment used by Dickinson at Oxford University in 1949.

But the sample must first be extracted from the body and then be transported to the machine, processes which consume time and in some circumstances alter the sample from its original state.

It is realistic to expect the transport step to be eliminated in the future with most local clinics having their own units for analysis of samples. The next stage in progress will come about by the invention of units that measure parameters such as blood count, albumin, etc. by contact externally to a suitable vein or artery. Direct measurement like this would also provide more accurate measurement as the blood would be in its normal working state. Furthermore, it would then be possible rapidly to optimize drug dosage and to investigate changes in parameters as they happen. The concept of in-situ measurement will apply to numerous other tests.

In special cases some people have already been equipped with sensors of critical body parameters. The outputs are telemetered to a remote observer. Examples of this are in space-medicine, in fitness studies and in a few heart disease cases.

Considering the low-cost data processing power already available, and coupling this with inexpensive micro-miniature sensors we can expect to see developed in the future, it is possible that individuals will one day be able to obtain self-monitors that provide warning when body parameters exceed allowable limits.

Better measurement always leads to better control. As an example, respiratory tract problems, such as hay fever and asthma, are hard to combat effectively because of the lack of detailed data about each individual's characteristics in the various circumstances encountered. Not all people are allergic to the same pollens — we could benefit greatly if an easy way existed that determined the allergic pollens involved.

At present, a pollen count is usually taken by drawing the ambient air over a sticky surface for many minutes — hours sometimes. The surface is then observed with a microscope, the technician counting all pollen grains together to obtain the total pollen count. This process is now sometimes carried out using computer-controlled video tv camera systems, but the systems are still barely able to group the various kinds of pollen grain. (They are typically a micrometre in diameter or smaller — counts of a few grains per

cubic metre can cause unwanted symptoms).

A development that could help is a sensor that provides a virtually instant count of the individual kinds of pollen grain present — a real-time sampling analyser. With such a device the sufferer could test for the hostile situation *before* symptoms arise and take remedial action in time. Technologically such an instrument appears feasible. It is, however, cost and physical size that holds up its development and its practical everyday use at present.

A likely parallel already existing is the Coulter counter that analyses the size and number of cells in a blood sample. Blood-cell counting of several years ago required the blood to be smeared on a microscope slide and the cells counted by eye under a microscope. Today the machine makes the measurements in a few seconds by counting particles as they pass a small orifice — but it is neither portable nor inexpensive. Figure 10 shows a Coulter counter installation as used in the larger pathological laboratories.

Development of personal monitors will almost certainly pass first through a telemetry method in which a central computer processes the data, perhaps with the help of the trained physician to begin with. A direct self-contained method will then be developed in which the specific data processing requirements that have emerged from experience, are integrated into the unit.

Replacing the Sensors and Actuators of the Body

The human body is a vastly complicated chemical process plant. It has sensors feeding information to the brain for central processing. In turn, the brain sends signals to actuators — the muscles which cause the body to function and to do work. Nerves are the hardwired data channels for receiving and sending control information.

Slight deficiencies in the senses of sight and hearing have been aided using instruments — spectacles and hearing aids. The latter began as acoustic horns which provided sound pressure gain without active amplification. The advent of the telephone led to amplifierless hearing aids in the 1900's which used several mouthpieces coupled to the ear pieces (Fig 11). Then came electronic units which provided active signal gain from miniature thermionic valves. Today we have integrated semiconductor circuitry. We have still a

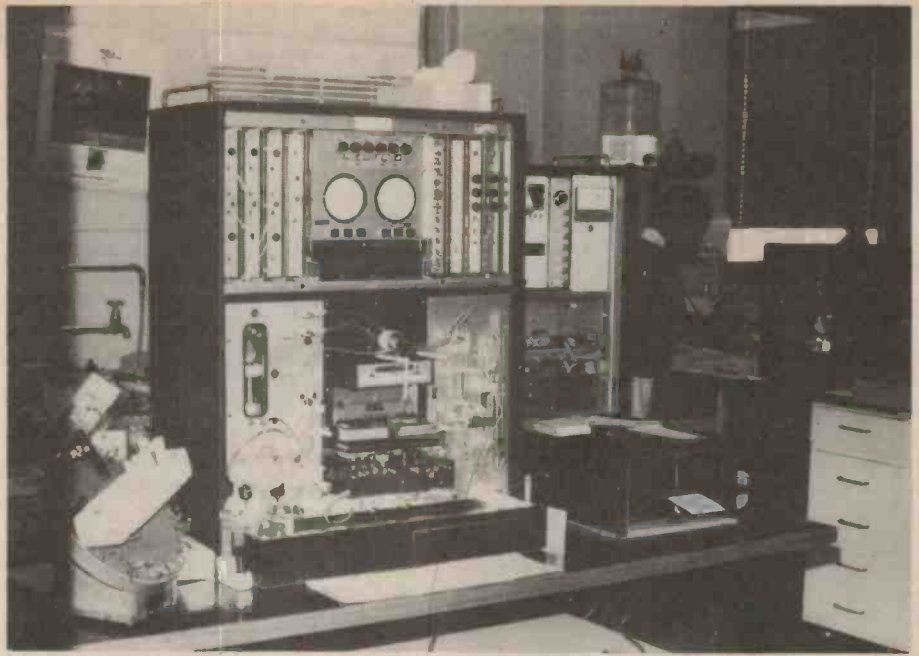

Fig. 10. Coulter counter unit of today that analyses blood sample particles providing a print-out (IMUS, Adelaide).

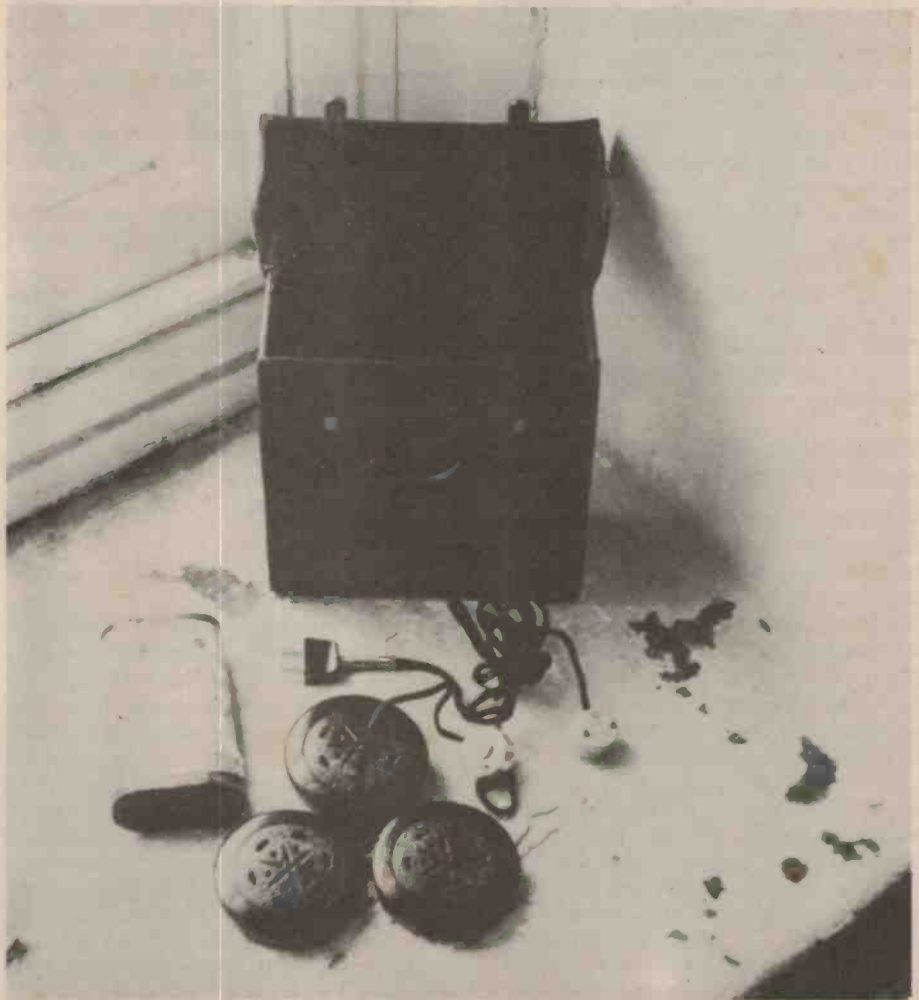

Fig. 11. 1900's hearing aid. The three receivers, which fit into the case, provide signal to the two earpieces. No active amplifier was involved. (Birdwood Mill Museum, S.A.)

way to go, however, before we are able to compensate for a failed action of the inner ear mechanisms.

Vision, until very recently, was aided only by optical lens compensation. But this applies only where the eye is still largely operative as an optical-to-electrical transducer. Quite recently experiments have been reported in which a miniature video camera provides electronic signals that drive cells in the brain to provide illusion of sight. The method is still crude compared with the performance of natural process. Given time for research it seems reasonable to assume that quite compact and useful artificial eyes will soon be available for blind people. Bionic man is not so fantastic! Interestingly, once the bionic eye is developed it is an easy matter to provide greater than natural visual acuity and to offer sensitivity to other than the visible light band — infra-red for instance.

Providing electronic replacements for the sense of smell will most likely be a much later development. We know too little about the olfactory senses and have no really compact and cheap smell sensors at this time to expect great progress to occur in the near future. Animals, such as dogs, possess a sense of smell vastly much more sensitive than humans. Ants track each other by a scent trail! Yet man has not yet produced small and inexpensive chemical analysers (smell is a largely chemical process) that can meet the complex sensing requirements of smell detection.

Mathematical Modelling of Body Functions

Medicine is basically a discipline of analysis in which the physiological functions are slowly analysed as their operation becomes better known. Once the parameters of the situation are discovered, control can be brought about by synthesis of man-made chemicals and structures. Much of medical knowledge is the result of experimental observation and trials.

A more recent approach, added to the methods used, makes use of mathematical models. These models are block-diagrams, generated by the operator, in which suitable mathematical equations define the input-output relationship of the black boxes thought to be a suitable realisation. As models are raised, they are tested overall by entering input data and equation constants and comparing the output to

the real-life situation. Interaction of equation forms and constants continue until close agreement with reality results.

Many complex processes, especially in medicine, are only measurable at various points in the process. For example, the effect of an administered drug is known in terms of certain output behaviours. But there are points within the physiological process that are not measurable due to the nature of the process. Mathematical modelling is valuable here because the data within the model, that is equivalent to the real process, may be available. It is not quite as easy as that for within the model the operation, although analogous, may not be quite the same in nature. Nevertheless, information learned about the interior structure of the model may provide useful insight and even suggest other parameters that can be measured on the living body.

At present, considerable research is being undertaken on such models as those of the respiratory system — oxygen input, oxygenated blood output; and on the sugar-urine process involving kidney action. In areas such as these we find multi-disciplinary teams at work — mathematicians, process engineers, measurement systems analysts, chemists and medical practitioners.

Far into the future we should possess computers with vast memory holding a mammoth mathematical model of the human body. Unusual complaints will be studied painlessly and safely by operating upon the model, not the patient, and at a speed in which the computation process speed is vastly faster than the real-time effects in the body.

Scanners

X-ray and nucleonic diagnostic methods have the valuable feature that certain internal structures of the body can be seen. But all such methods lack the spatial resolution we obtain by visual examination with the unaided eye or through a microscope. A nuclear radiation source set-up within the body provides a rather diffuse output picture. Resolution is improved by increasing the number of individual elements at the sensing stage. The gamma camera, for example, provides two-dimensional pictures using over thirty scintillometers connected in such a way as to provide many more picture elements. The latest development senses the body area by

scanning multiple sensors thereby collecting yet more data in a given time. Sophisticated processing is then used to provide video screen outputs which contain much more useful information than ever before. Similar techniques apply to X-ray, nucleonic and ultrasonic signal transmission. Now that vastly more powerful data processing capability exists the future development will be to incorporate many more sensors of the same kind and make more effective use of three-dimensional data. Other variables, such as, say, thermal emission will also be incorporated along with systematic experience gained into the processing, all this to providing data conversion for a more meaningful measurement process.

Surgery

Electrical methods in surgery traditionally include endoscopes with which to see into inaccessible places and cauterizing probes for sealing blood flow, cutting and destroying cells where need be. The recent introduction of the laser as a cutting tool has most valuable properties. Selection of the appropriate wavelength decides which kind of body tissue will be cut. For example, it is possible to weld the retina of the eye through the pupil without need for surgery. The radiation is only absorbed by retinal material, the pupil and fluid of the eye ball being transparent to the wavelength used.

The selective property of narrow-band radiation will enable some highly precise surgical operations in the future. An operation might go as follows: a rigid framework holds the patient fixed with respect to an x-y-z translating pulsed laser operating head. Wired to the control unit of the translator are electrodes fixed to the body. These sense when low-power sensing pulses are energising the specific part of the body required to be operated upon. The unit scans until sensing signals (operated by a non-cutting wavelength source) verify the location of the beam. Once at such a point the laser is switched to full cutting power continuing to cut as the time-multiplexed sensing signals indicate position is satisfactory.

Looking back, electro-medical apparatus has only been with us for a mere 50 years. In the last 10 years of that time we developed inexpensive and very powerful data processing methods. The next 25 years are likely to unfold undreamed of aids to medicine many of which we would regard as miraculous if we heard about them today.

KENT HI-FI PRESENTS THE MOBILE ONE DISCO

suitable for discos, parties, clubs and many other entertainment applications.

\$2200

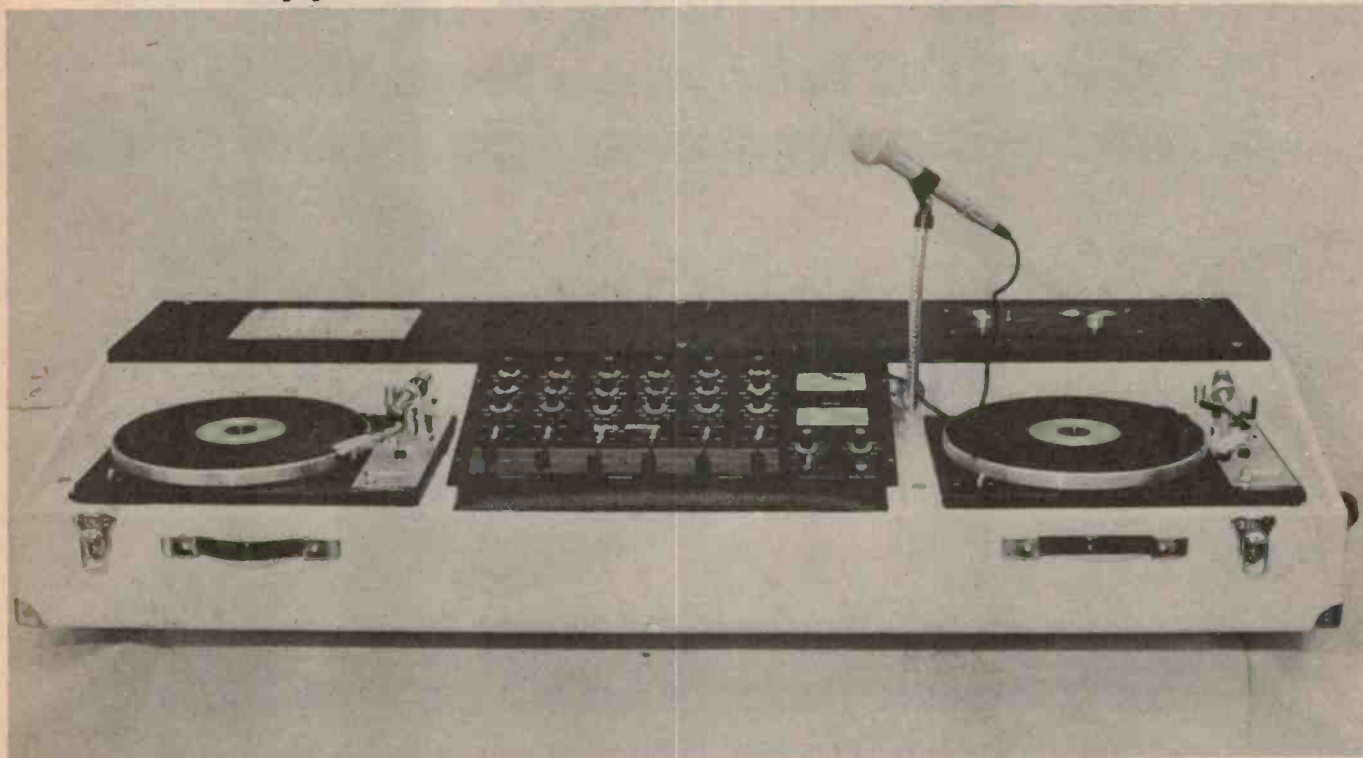

Features: —

- Lighting control unit included
- Separate equalisation and balance controls on each input
- Attenuator pads on microphone and auxiliary inputs
- Stereo cue for each input
- VU and peak overload indicators on masters out
- More than ample level from headphone amp

Has all the functions of a professional studio mixer at a fraction of the cost. Speakers available to suit your requirements. For more information, please contact Kent Hi-Fi.

KENT HI-FI

(WHERE THE BEST EQUIPMENT COSTS LESS)

410 KENT STREET
SYDNEY

ph: 29-2743



Now ADC frees you from the job of mounting the cartridge on the shell.



Introducing the pre-mounted ADC cartridges.

The "Uni-Head" is solidly engineered. It is a beautifully styled and tooled accessory. And it fits into practically all manual tonearms and many of the semi-automatic players.

Illustrated is the ADC XLM MKII which is the top of any line stereo cartridge with all the great ADC unique features:

- Nude elliptical stylus
- Low mass moving system
- Induced magnet principle
- One gram tracking - or less

Other cartridges available with the pre-mounted 'Uni-Head' (and the respective recommended retail values of each) are: the XLM Mark II-P, \$120.00; the VLM Mark II-P, \$100.00; the QLM-36P Mark II-P, \$65.00; the QLM-32P Mark II-P, \$55.00 and the QLM-30P Mark II-P, \$43.00. The 'Uni-Head' is available separately.



**Audio Dynamics Corporation
A BSR Company.**

Monarch Works Anne St. St. Marys
Postal Address: Box 272 St. Marys NSW 2760 Australia
Telephone 623 0375/6. Telegrams "BSR" St. Marys Telex 23159

INTERNATIONAL ELECTRONICS UNLIMITED

10% OFF WITH \$25 ORDER
15% OFF WITH \$100 ORDER
 THESE DISCOUNTS APPLY TO TOTAL OF ORDER — SPECIALS INCLUDED

TTL	.13	7451	.17	74153	.89
7401	.16	7453	.17	74154	1.20
7402	.15	7454	.17	74155	.97
7403	.15	7460	.35	74156	.97
7404	.16	7464	.35	74157	.99
7405	.19	7465	.35	74160	1.79
7406	.20	7470	.30	74161	.97
7407	.28	7472	.30	74162	1.39
7408	.18	7473	.35	74163	1.09
7409	.18	7474	.28	74164	.99
7410	.16	7475	.49	74164	.99
7411	.25	7476	.30	74165	.99
7413	.43	7483	.68	74166	1.25
7414	.65	7485	.88	74170	2.10
7416	.35	7486	.40	74173	1.49
7417	.35	7489	2.25	74174	1.23
7420	.16	7490	.43	74175	.97
7422	.30	7491	.75	74176	.89
7423	.30	7492	.48	74171	.84
7425	.27	7493	.68	74180	.90
7426	.26	7494	.78	74181	2.65
7427	.28	7495	.79	74182	.79
7430	.20	7496	.79	74184	1.90
7432	.23	74100	.98	74185	2.20
7437	.25	74105	.44	74187	5.75
7438	.25	74107	.37	74190	1.73
7440	.15	74121	.30	24191	1.25
7441	.89	74122	.30	74192	.95
7442	.59	74123	.65	74193	.85
7443	.73	74125	.54	74194	1.25
7444	.73	74126	.58	24195	.74
7445	.73	74132	.89	74196	1.25
7446	.81	74141	1.04	74197	.73
7447	.79	74145	1.04	74198	1.73
7448	.79	74150	.97	74199	1.69
7450	.17	74151	.79	74200	5.45

LOW POWER	.29	74L51	.29	74L90	1.40
74L00	.29	74L55	.29	74L91	1.20
74L03	.23	74L71	.29	74L93	1.50
74L04	.29	74L72	.45	74L95	1.50
74L06	.29	74L73	.56	74L98	2.25
74L10	.29	74L74	.56	74L164	2.25
74L20	.29	74L78	.75	74L165	2.30
74L30	.29	74L85	1.09		
74L42	1.39	74L86	.65		

LOW POWER SCHOTTKY	.36	74LS32	.38	74LS95	2.09
74LS02	.36	74LS60	.45	74LS107	.59
74LS04	.36	74LS42	1.40	74LS164	2.20
74LS08	.36	74LS74	.59	74LS193	2.20
74LS10	.36	74LS90	1.30	74LS197	2.20
74LS20	.36	74LS93	1.38		

HIGH SPEED	.25	74H22	.25	74H61	.25
74H01	.25	74H30	.25	74H62	.35
74H04	.25	74H40	.25	74H74	.58
74H08	.25	74H50	.25	74H101	.58
74H10	.25	74H52	.25	74H102	.60
74H11	.25	74H53	.25	74H103	.60
74H20	.25	74H55	.25	74H106	.72
74H21	.25	74H60	.25	74H108	.72

SCHOTTKY	.59	74S00	.68	74S22	.65
74S02	.59	74S10	.65	74S32	.68
74S03	.59	74S20	.65	74S74	.68
74S04	.72				

8000 (NATIONAL)	.61	8020	1.49	8811	.65
8092	.61	8020	2.19	8812	1.02
8095	1.25	8028	1.49	8822	2.19
8121	.80	8030	1.16	8830	2.19
8123	1.43	8052	2.19	8831	2.19
8200	2.33	8063	.62	8836	.75
8214	1.49	8810	.70	8880	1.19

8000 (SIGNETICS)	5.79	8267	2.59		
------------------	------	------	------	--	--

9000	.40	9309	.79	9601	.61
9381	1.03	9312	.79	9602	.79

Mark I Clock Kit
 A six digit clock kit with one double sided P.C. board accommodates MM5314 clock chip and 6 FND359 .375" displays. 12-24 hour, 50-60 Hz. Contains all necessary components, 3 switches and complete assembly instructions with schematics. Connections for remote displays.
Mark I \$13.95

TRANSFORMER & LINE CORD NOT INCLUDED



IC BREADBOARD
 Accommodates 16 pin IC's with additional interconnection holes. 1/16" phenolic with silver plated copper circuits. 2.5/16" x 6 9/16" \$1.80 ea.



CALC. KIT ONLY \$9.95
 +\$1.00 SHIPPING & HANDLING

OPTO ISOLATORS					
MC D1	Opto isolator diode	1.09			
MC 12	Opto isolator transistor	.70			
CMOS					
4000A	.26	4018A	1.39	4060A	.89
4001A	.25	4020A	1.72	4068A	.64
4002A	.25	4021A	1.18	4069A	.64
4006A	1.35	4022A	.94	4071A	.26
4007A	.26	4023A	.25	4072A	.35
4008A	1.52	4024A	.89	4071A	.39
4009A	.57	4025A	.25	4075A	.39
4010A	.54	4027A	.59	4078A	.39
4011A	.79	4028A	.98	4082A	.35
4012A	.25	4030A	.44	4518A	1.56
4013A	.45	4035A	1.27	4528A	1.56
4014A	1.27	4040A	1.14	4585A	2.10
4015A	1.27	4042A	1.47		
4016A	.48	4049A	.59		
4017A	1.01	4050A	.59		

74C00	.19	74C74	1.04	74C162	2.49
74C02	.26	74C76	1.34	74C161	2.66
74C04	.44	74C107	1.13	74C164	2.66
74C08	.68	74C151	2.62	74C171	2.22
74C10	.35	74C154	3.15	74C195	2.26
74C20	.35	74C157	1.76	80C45	1.15
74C42	1.61	74C160	2.48	80C47	.96
74C71	1.04	74C161	2.49		

MULTIPLE DISPLAYS					
NS511	1 digit 12" red LED	1.79			
HP5002	5 digit 11 red LED	1.49			
7405					
HP5002	4 digit 11 red LED	1.25			
7414					
SP-425-09	4 digit .25" gas disch.	1.79			

LED DISPLAYS					
MAN 5	2.25	DL33B	.48		
MAN 7	1.49	DL33-	.35		
MAN 8	2.25				
MAN 66	2.25	DISCRETE LED'S			
MAN 72	1.25	ME 4	.29		
MAN 3620	1.50	MV10B	.25		
FND 359	.95	MV50	.12		
FND 500	1.89	NSL100	.12		
FND 507	1.49				
DL10A	2.19	RED	.15		
		CLEAR	.15		

MEMORIES					
1101	256 bit RAM MOS 16 pin	1.39			
1103	1024 bit RAM MOS dynamic 18 pin	1.95			
1702A	2048 bit PROM static electrically programmable UV erasable 24 pin	10.95			
2102	1024 bit RAM static 16 pin	1.95			
5203	2048 bit PROM static electrically programmable UV erasable 24 pin	10.95			
5260	1024 bit RAM MOS dynamic 16 pin	1.95			
5261	1024 bit RAM MOS dynamic 16 pin	1.95			
7489	64 bit ROM TTL 16 pin	2.25			
82523	256 PROM-SCHOTTKY 16 pin	3.69			
F93410	256 bit RAM bi-polar 16 pin	1.95			
74187	1024 bit ROM TTL 16 pin	5.75			
74200	256 bit RAM tri-state 16 pin	5.45			

CLOCK CHIPS					
MM5311	6 digit multiplexed BCD, 7 seg. 12-24 Hr, 50-60 Hz — 28 pin	4.45			
MM5312	4 digit multiplexed BCD, 7 seg. lpps. 12-24 Hr, 50-60 Hz — 24 pin	3.95			
MM5314	6 digit multiplexed 12-24 Hr, 50-60 Hz 24 pin	4.45			
MM5316	4 digit, 12-24 Hr, 50-60 Hz, alarm 40 pin	4.95			
IS375AA	4-6 digit, 12 hour, 60 Hz snooze alarm brightness control capability, alarm tone output — 24 pin	6.95			
CT7001	6 digit, 12-24 Hr, 50-60 Hz, alarm, timer and date circuits — 28 pin	6.95			

CALCULATOR CHIPS					
CT5002	12 digit, 4 function fixed decimal battery operation — 40 pin	1.95			
CT5005	12 digit, 4 function plus memory, fixed decimal — 20 pin	2.49			
MM5275	8 digit, 4 function, floating decimal 18 pin	1.98			
MM5276	6 digit, 4 function, 9V battery operation — 18 pin	2.95			
MM5278	8 digit, 5 function plus memory and constant floating decimal, 9V battery operation — 24 pin	3.95			
MM5279	9 digit, 4 function, 9V battery operation — 22 pin	3.95			

8008 \$19.95
8080A \$19.95

CALCULATOR KIT
LITRONIX 1502 MEMORY
 FULL ACCUMULATING MEMORY — STORES AND RECALLS SUBTOTALS
 % KEY
 PERFORMS ALL PERCENT FUNCTIONS INCLUDING ADD-OHS, DISCOUNTS, MARRIAGES AND YIELDS.
 ARITHMETIC LOGIC — LITS YOU ENTER PROBLEMS BY ADDING MACHINE MODE, FLOATING DECIMAL SYSTEM — AUTOMATIC DECIMAL POINT POSITIONING FOR FULL 8-DIGIT ACCURACY.
 OVERFLOW SAVE — IN CASE OF OVERFLOW IN DISPLAY, THIS CLEARS THE CONDITION AND ALLOWS CALCULATOR TO CONTINUE USING THE OVERFLOWED RESULTS DIVIDED BY 10.
 AUTOMATIC TIMEOUT TO SAVE BATTERIES

4 Digit Clock Kit
 MM5312 and 4 NS71 .27" displays 12-24 hours, 50-60 Hz. One P.C. board accommodates clock, displays, and all necessary transistors, resistors, capacitors, diodes, 2 switches, complete instructions and schematics for assembly.
CK4-2 \$10.95

SHIFT REGISTERS					
MM5013	1024 bit accum. dyn. 8 pin	1.75			
MM5016	500/512 bit dyn. 8 pin	1.59			
515-4025	Quad 25 bit	.99			
2504	1024 bit multiplexed dyn 8 pin	3.95			

2518 \$2.95
HEX 32-bit STATIC SHIFT REGISTER

2519 \$2.95 ea.
HEX 40-bit STATIC SHIFT REGISTER

DVM CHIP 4 1/2 DIGIT —
MM5330
 P channel device provides all logic for 4 1/2 digit volt meter. 16 pin DIP with data.
\$6.95

MM5369 Divider mDIP \$2.35
Crystal 3.58 MHZ color TV \$1.50

UART \$6.95
AY51013A

1702A \$6.95
 2048 bit static PROM elect. prog. UV eam. 24 pin

2102 \$1.29
 1024X1 STATIC RAM 16 PIN

7489 \$1.75 ea.
 64 bit ROM TTL 16 pin

IC SOCKETS					
Solder Tall - low profile					
8 pin	.17	24 pin	.42		
14 pin	.20	28 pin	.59		
16 pin	.22	40 pin	.69		
18 pin	.29				

WIRE WRAP - gold plate					
14 pin	.49				
SPECIAL DEVICES					
372	AF-IF Strip Detector DIP	2.93			
546	AM Radio Receiver Subsystem DIP	.75			
1310	FM Stereo Demodulator DIP	2.90			
1496	Balanced Modulator-Demodulator	.99			
1800	Stereo multiplexer DIP	2.44			
ULN2308	FM Gain Block 34db (typ) mD				

\$194 for the whole kit & kaboodle.



the kit \$95

the kaboodle \$99

The kaboodle is our popular SC/MP Kit microcomputer package: SC/MP microprocessor, ROM, RAM, timing crystal, PC Board, and all necessary drive logic. All for just \$99.

The kit is our new, low-cost terminal kit: keyboard, display, and special ROM with debug keyboard/display scanning program. All for just \$95.

You don't need a \$500 development system.

You don't need a \$1,000 teletype.

You buy our kit and kaboodle, and you're in business. In microprocessors, video games, home control systems, whatever. For training, for learning, for development.

If you'd like complete information, we'll send it to you for nothing.

Or, if you'd prefer the actual micro-computer and terminal kit, that'll be just \$194 extra.

N.S. Electronics Pty Ltd,
P.O. Box 89 Bayswater, 3153.

Gentlemen:

- Please send me more information.
 - Please send me a real live SC/MP Kit (ISP-BK/200) \$99.
 - Please send me a real live Keyboard Kit (ISP-BK/400) \$95.
- Here's my cheque.

Also available at your local distributor.

Name Title

Company

Address

City State P.C.

 National Semiconductor

PRINT-OUT

ETI's COMPUTER SECTION

HEATHKIT

THROUGH THE GRAPEVINE

Rumour going about through the industry is that Heathkit who thus far haven't shown much interest in micros, are preparing to release a micro-computer based on Digital Equipment Corp's LSI-11 microprocessor. Now, DEC are the world's largest and probably most experienced manufacturer of minicomputers, and the LSI-11 (which uses the same instruction set as their PDP-11 range of minis) is a really powerful machine with lots of software support. So, if Heathkit introduce a computer based on the LSI-11 the waves will be felt around the world for quite a long time.

COURTLY DANCING AIRS

Out come another round of marriages in the high society of micros: Motorola have successfully courted Mostek and will reportedly give birth to a new version of the F8. AMD, on the other hand, have decided against the F8 in favour of the Intel 8048, another single-chip MPU. Incidentally, we notice that Imsai have released a single-board computer based on the 8048, and designed for controller applications. More details later.

HOBBY COMPUTING CONFERENCE

'Microprocessors - A Rethink in Computing' is the title of a two-day conference being sponsored jointly by the Australian Computer Society and Canberra College of Advanced Education. Aimed largely at the

personal computer hacker, whether hobby motivated or trying to do things in education, the conference will comprise a series of lectures, contributed papers and workshops with an attached exhibition and demonstrations. The fee for members of the ACS will be \$15, and further details can be obtained from the Secretary, Ms. Sandra Harding on Canberra 470-544.

IMSAI 8048

The IMSAI 8048 control computer features an eight-bit CPU (i.e. the Intel 8048) with BCD arithmetic capabilities 1 k of ROM, 64 words of internal RAM, interrupt, oscillator and clock driver circuits and an internal timer and event counter. Two versions are available: one has the system monitor on 8048 itself, while the other has the monitor on an EROM, so that it can be altered. Also on the board (8½" x 10"), are 12 quasi-bidirectional I/O lines, with handshaking, 14 regular I/O lines, 5 heavy-duty relays, and a 9-digit LED display with keyboard. To complete the system there are 1K of RAM and a cassette interface. US prices are \$249 with ROM and \$399 with EROM.

FORTRAN FOR 8080

Microsoft, of Albuquerque, New Mexico, who originally wrote the Altair 8800 BASIC, have now introduced a Fortran IV compiler. As this is a very important factor in the small business systems market, Microsoft are being inundated with inquiries from one or two well-known microcomputer manufacturers, i.e. MITS, IMSAI, and Cromemco. But don't get too excited just yet; Fortran compilers just don't come cheap.

SIGNETICS INTERFACES

Philips are now sampling two advanced peripheral interface chips which match

the 2650 MPU but will probably operate with most 8-bit micros. The 2651 is a universal synchronous/asynchronous data communications controller which contains a baud-rate generator, a modern controller, data transmit and receive buffers and support control logic. The baud-rate generator is software programmable and the 2651 will operate in full- or half-duplex modes.

The 2652 universal synchronous receiver/transmitter is an advanced data communications device which can handle three categories of protocols: *bit-oriented*, such as synchronous data link control (SDLC); *control character*, like IBM's Bi-Sync; and *byte count*, such as digital data communications message protocol (DDC MP). It offers a wide range of software controlled features, and is fully TTL compatible, operating from a single 5V supply.

Z-80 M.D.

A new arterial tonometer (a gadget for measuring and displaying arterial blood pressure) developed by Nicolet Instrument Corp. of Madison, Wisconsin, incorporates a microprocessor to give the device impressive control and display facilities. Previously, doctors have used a surgically-inserted catheter connected to a pressure transducer to display the pressure inside the artery, but this new machine uses a silicon transducer strapped to the wrist to measure the dilation of the artery wall, and displays the resultant waveform on the screen of a Tektronix scope. The inclusion of the Z-80 enables the tonometer to calculate blood pressures and heart rate. Definitely a machine for the faint of heart.

PRINT-OUT

ADVERTISERS - for details of rates phone Bob Taylor on 33-4282

Print -Out c/o ETI, Modern Magazines,
15 Boundary St,
Rushcutters Bay NSW 2011.

microbiology

The 8080 Instruction Set

IN MICROBIOLOGY THIS MONTH we finish our discussion of the 8080. In a previous issue we looked at the internal structure of the chip to try and gain an insight into how it works.

This month we look at the 8080 more from a programmer's point of view and examine the 8080's instruction set. By instruction set we mean the collection of instructions or commands that enable the 8080 to perform its many different tasks. As far as the 8080 is concerned these instructions are binary signals that flow into it via the data bus at different voltage levels. For convenience the manufacturer has given these instructions names such as MOV M,r or LDAX rp. Each instruction is different from all the other instructions and by grouping together an appropriate collection of instructions the programmer forces the 8080 to perform whatever task he wants it to do. Such a collection of instructions is called a program and the realm of the programmer is referred to as Software.

LOGICAL GROUPING

For convenience the basic instruction set of the 8080 can be broken into five groups. These are:—

Data Transfer Group — these instructions cause the contents of the 8080's internal registers to be moved around. For example the contents of one register (say the A register) are loaded into another (say the B register) or between a memory location and a register.

The Arithmetic Group of instructions cause arithmetical operations to be performed on data in the 8080's registers or in memory. For example such basic operations as ADD, SUBTRACT or INCREMENT are performed.

The Logical Group is like the arithmetic group except logical operations are performed instead of arithmetical operations. Such operations would be the AND, EXCLUSIVE OR and COMPLEMENT DATA operations.

The Branch Group are conditional and unconditional jump instructions,

sub-routine call and return instructions. These are the instructions that are used by the 8080 as part of its decision making ability.

Stack, I/O and Machine Control Group include I/O instructions, Stack maintenance instructions and internal control flags.

A list of these instructions is shown in Fig.1. To better understand this list refer back to the block diagram of the 8080 included in the first part of this article and note in particular the sections referred to as the Register Array and Accumulator.

DETAILS

Now let's look at the structure of an instruction in more detail. Each instruction can be broken into two parts. The first part is referred to as the operation code (opcode for short) and the other part as the operand. The opcode tells the hardware part of the 8080 what it has to do, and the operand part is what the 8080 does it to.

Instructions acted upon by the 8080 are stored sequentially in memory and vary in length from one to three bytes. The op code is in the first byte and the 8080 will always process it first to decide whether it needs to access memory again to complete the current instruction.

Generally the operand part of the instruction is an address, the address of the data to be acted upon. Note also that while an instruction has only one opcode it can have more than one operand. Consider the example MV1 M, data. Execution of this instruction causes the content of the 2nd byte, that's 'data', to be loaded into the memory location whose address is in registers H and L. The operand part of this instruction involves 'data', H and L registers and a location in memory.

ADDRESSING MODES

The 8080 has four different modes of addressing the data stored in memory or in its registers. They are:—

DIRECT MODE — bytes 2 and 3 of the instruction contain the exact memory address of the data that is to be acted upon. For example, 'LDA addr'. Here the contents of the memory location whose address is specified in 'addr' (bytes two and three) is loaded into register A.

REGISTER INDIRECT — here the instruction specifies a register pair which contains the memory address where the data to be acted upon is located. For example, 'MOV M, B' causes the contents of register 'B' to be moved to the memory location whose address is in registers H and L.

Note that this instruction needs only one byte of memory to hold it, yet it is capable of operating on any one of the 64K possible memory locations of the 8080. Programs using this class of instruction are both compact and fast. The 8080 has a number of these instructions and for this reason is quite powerful.

REGISTER — here the instruction specifies the register or register pair in which the data is located. The instruction 'INR C' is an example of this type of instruction. Its execution causes the contents of register 'C' to be increased by 1.

IMMEDIATE instructions contain the data itself. This is either an 8 bit or 16 bit quantity. These instructions also contain an implied operand, for example execution of 'CPI data' causes the contents of the second byte of the instruction (i.e. 'data') to be compared to the A register and if they are equal, a flag is set to 1. Here the operands are 'data' and register A.

An important ability of a micro-processor is its ability to make branches in its program. Of particular importance is the conditional jump or branch instruction. These specify an operation to be performed only if certain conditions have been met, for example jump to a different part of the program if the result of the last operation was zero. These conditional instructions provide a program with decision-making capability.

Fig. 1 THE 8080 INSTRUCTION SET

r stands for register eg A register
rp stands for register pair, eg B and C registers
'data' means the contents of the second or second and third bytes of the instruction
M stands for memory whose address is in the H and L registers

DATA TRANSFER GROUP

MOV r1, r2	Move register to register
MOV M, r	Move register to memory
MOV r, M	Move memory to register
MVI r, data	Move immediate (to register)
MVI M, data	Move immediate (to memory)
LXI rp, data 16	Load immediate (to register pair or to stack pointer)
STA addr	Store direct (accumulator to memory)
LDA addr	Load direct (memory to accumulator)
XCHG	Exchange H&L with D&E registers
STAX rp	Store accumulator indirect (with address in registers B&C or D&E)
LDAX rp	Load accumulator indirect (with address in registers B&C or D&E)
SHLD addr	Store H&L direct
LHLD addr	Load H&L direct

ARITHMETIC GROUP

INR r	Increment register
DCR r	Decrement register
INR M	Increment memory
DCR M	Decrement memory
ADD r	Add register to A
ADC r	Add register to A with carry
SUB r	Subtract register from A
SBB r	Subtract register from A with borrow
ADD M	Add memory to A
ADC M	Add memory to A with carry
SUB M	Subtract memory from A
SBB M	Subtract memory from A with borrow
ADI data	Add immediate to A
ACI data	Add immediate to A with carry
SUI data	Subtract immediate from A
SBI data	Subtract immediate from A with borrow
INX rp	Increment register pair (or stack pointer)
DCX rp	Decrement register pair (or stack pointer)
DAA	Decimal adjust A (gives two BCD digits)
DAD rp	Add B&C, D&E or H&L to H&L

LOGIC GROUP

ANA r	AND register with A
XRA r	EXCLUSIVE-OR register with A
ORA r	OR register with A
CMP r	Compare register with A
ANA M	AND memory with A
XRA M	EXCLUSIVE OR memory with A
ORA M	OR memory with A
CMP M	Compare memory with A
ANI data	AND immediate with A
XRI data	EXCLUSIVE-OR immediate with A
ORI data	OR immediate with A
CPI data	Compare immediate with A
RLC	Rotate A left
RRC	Rotate A right
RAL	Rotate A left through carry
RAR	Rotate A right through carry
CMA	Complement A
STC	Set carry
CMC	Complement carry

BRANCH GROUP

JMP addr	Jump unconditional
Jcond addr	Jump on condition specified (carry, no carry, zero, no zero, positive, minus, even or odd parity)
CALL addr	Call unconditional
Ccond addr	Call on condition specified (see above)
RET	Return
Rcond	Return on condition specified (see above)
RST	Restart
PCHL	H&L to program counter

STACK, I/O AND MACHINE CONTROL GROUP

HLT	Halt
IN port	Input (from port to A)
OUT port	Output (from A to port)
PUSH rp	Push register pair on stack (in memory)
PUSH PSW	Push A and flags on stack
POP rp	Pop register pair off stack
POP PSW	Pop A and flags off stack
XTHL	Exchange top of stack with H&L
SPHL	Move H&L to stack pointer
EI	Enable interrupts
DI	Disable interrupts
NOP	No op

To this end the 8080 has five conditional flags that are affected by the execution of instructions. They are the Zero, Sign, Parity, Carry and Auxiliary/Carry flags and are each represented by a 1 bit register in the 8080 chip. Execution of certain of the 8080's instructions causes one or more of the flags to be set (forced to a 1 state) or reset (forced to a 0 state).

To illustrate how the flags are used consider the immediate class of instruction ADI 20. This instruction causes 20 to be added to the A register and if the result of this turns out to be zero, then the zero flag is set to 1, otherwise the zero flag is reset to 0. Should the addition result in the most significant bit of the A register becoming a 1, then the sign flag would

be set to 1 (Modulo-2 representation of a negative number). This also demonstrates that one instruction can act on more than one flag.

All the instructions in the Arithmetic and Logic group shown in Fig. 1 affect the flags. There are some 39 different instructions (we count only once the instructions with the same operation code but different operand, i.e., INR A and INR C are counted only once).

Just toggling the flags is of little use on its own so the 8080 has a special group of instructions that can test a flag to see if it is set or reset. Then depending on the outcome of the test the 8080 goes one of two ways in program. Going one way the 8080 could, say, send a 1 to an output port

and operate a relay to turn on a lamp, going the other way it would output a zero to the port and turn off the lamp.

BRANCHES

The instructions that check then respond to a test belong to the Branch group. Figure 1 shows that there are 8 instructions in this group, and three of these are conditional branch instructions, that's to say they are the ones that test the flags to decide whether or not to branch. Since these three instructions need to test only one flag and there are five flags the actual number of different instructions expands to 24. Why 24 and not 15? Well the 8080 tests a flag for two conditions not one, that is branch if

microbiology

flag is set, or branch if flag is not set. Six instructions are lost, however, because the test Carry and no Carry looks at both the Carry flag and the Auxiliary Carry flag combined.

The fifth in the grouping of instructions is the Stack, I/O and machine control group. This last group is used by the programmer to control communications between the 8080 and the outside world. Also in this group are instructions to manipulate the Stack.

STACKING THINGS UP

The Stack on the 8080 is a reserved area of the main memory and so is external to the 8080 chip. The 8080 keeps track of where the stack is by maintaining a Pointer register (called a Stack Pointer) that contains the address of the most recent stack entry. Having an external stack allows the processor virtually unlimited subroutine nesting (or at least until the memory is used up).

The stack is in fact a last in — first out memory used for temporary storage of data. Both the 8080's internal control logic and the program can use the Stack. The 8080 uses it to save the return address when a call instruction is executed or an interrupt occurs.

The programmer can use the stack with the Push, Pop, XTHL and SPHL instructions. When you push data on to a stack it means you are storing data

in the stack and popping data off a stack means you are getting data back from the stack i.e., data pops out. At a particular point in a program it might be necessary to use the A register but it might already have data in it to be used later. Then to save that data the program executes a Push A and later when the data is needed again a Pop A is used to recover it.

Note also that the value of the stack pointer can be incremented, decremented or set to any value by instruction from the Data Transfer and Arithmetic group.

IN, OUT, IN, OUT . . .

Within the fifth group are the In and Out instructions. These two allow the transfer of data between the 8080 and the outside world. All data transfers using these instructions take place via the A register, with the 'data' being sent over the 8 bit data bus. These instructions are two bytes long with the second byte the operand. This allows the in/out instruction to specify any one of 256 different peripherals. So that the peripheral knows it has been selected, the value of the operand is sent out on the address bus where it can be interrogated by the peripheral.

Of course peripherals can also be set up to look like memory but this does not involve the use of the In and Out instruction and will not be looked at here.

STOP TALKING WHILE . . .

The remaining instructions in the fifth group control the interrupts. An interrupt occurs when an external device signals the 8080 that it requires attention. When the 8080 acknowledges the interrupt it suspends main program execution and automatically branches to a program that looks after the external device. This device could be a line printer or something much simpler, like a switch that operates when a window or door is opened.

To control the 8080 interrupt there are two instructions, EI and DI. The first enables or allows the 8080 to respond to an interrupt when it occurs while the other disables or prevents it from responding to the interrupt. A third instruction is the so-called software interrupt. This is a special one-byte Call instruction (the normal call or jump to subroutine instruction takes 3 bytes) and is called the Restart (RST) instruction. A variable three bit field contained in the one byte op code enables the interrupting device to direct a Call to one of eight fixed memory addresses. These addresses would have been loaded with the first instructions of a routine designed to service the requirements of the interrupting device.

This has been a very brief and limited description of the 8080. To those who would like to know and understand the 8080 better we recommend that you purchase a copy of the Intel 8080 Microcomputer Systems User's Manual.

Nerff

Brand new 1K Static Rams
at a fantastic new low price.

2102AL

- MAX access time less than 450 NS
- LOW power, single 5V power rail
- 3 state output

Quantity	Price per IC
1-7	\$1.99
8-31	\$1.92
32-63	\$1.85
64 AND OVER	\$1.80

SEND YOUR ORDERS TO

NERFF

PO Box 32, Drummoyne 2047, NSW.

SHIPPING AND HANDLING — \$1 PER ORDER
SORRY NO COD



Expand Your Micro Now!

The easy way with Fitkin unpopulated circuit boards. These boards are 4.45" by 6.75" and are solder plated, double sided boards with plated through holes. Each board uses a standard 56 pin edge connector. 76121-RAM CARD holds 32, 2102 rams configured as a 4K x 8 bit memory (see photo) on one end is an uncommitted section large enough to accommodate 12 sixteen pin IC'S. This area is provided for your Address decode and Data buffer chips. Price for bare board (no IC'S) . . . \$22.50
76021 — THE ORIGINAL ANYCARD with power and ground connections pre-made. Holds up to 36 standard IC'S and has a 44 pin edge connector and the standard 56 pin connector. This board ideal for I/O configuration. Price of board . . . \$13.50
76022 — SIX CARD MOTHER BOARD (sockets not included) — Card spacing is .75" and there is provision for further expansion at each end of the board. Board is single sided. Price . . . \$13.50.

SOANAR SOANAR SOANAR

The only name you need to know when buying electronic components.

● WE MAINTAIN HUGE STOCKS OF CAPACITORS, RESISTORS, RECTIFIERS, SUPPRESSORS, POTENTIOMETERS, SEMI-CONDUCTORS & ELECTRONIC HARDWARE.

● IMMEDIATE DELIVERY SERVICE.

● NO INVOICE SURCHARGE.

● FREE INTO STORE. AUSTRALIAN CAPITAL CITIES.

Catalogue available on request

SOANAR ELECTRONICS PTY. LTD.

SALES OFFICES

VICTORIA: 89 0661

N.S.W.: 78 0281

S. AUST.: 51 6981

QUEENSLAND: 52 5421

W. AUST.: 81 5500

30 Lexton Road, Box Hill, Vic., 3128
Australia. Telex 32286.



The Megabyte Memory

Until today, the largest memory you could fit and address in a single microcomputer CPU was 65K.

Now, IMSAI presents an incredible memory system for micros 16 times more powerful than yesterday's best.

Imagine, a full megabyte of power from sixteen 65K RAM boards.

And, to control all this, the IMSAI Intelligent Memory Manager (IMM), the super control board.

You can write protect blocks throughout the full megabyte. Or, map in 16K blocks.

Plus, preset 16 mapping configurations with protect for high speed transfer or rapid change.

All interrupts are fully vectored, and there's an interrupt if an attempt is made to write into protected memory.

There's even a real "time of day" clock.

65K, 32K and 16K RAM Boards

COMPUTER BITS

A DIVISION OF AUTOMATION STATHAM PTY. LTD.

47 Birch Street

Phone (02) 709 4144

BANKSTOWN N.S.W. 2200

Telex AA26770

Cordless Soldering..

for electronic circuitry

Complete freedom from cords, transformers, power points, plugs. The Wahl ISO-TIP soldering tool is light (170g), slim, powerful: suitable for tag soldering, printed circuits & miniature components.

- Heats in 5 seconds
- Up to 150 joints per charge
- Long life ni-cad batteries
- Choice of quick-change tips
- No leakage or induced current
- Exclusive 'lock-off' switch
- Spotlight illuminator
- Vehicle adaptor available

* Approval No. V174394/7578

From trade houses or

ROYSTON ELECTRONICS

22 Firth St., Doncaster, Vic., 3108.

VIC: 848 3777 QLD: 52 3166

N.S.W.: 709 5293 S.A.: 42 6655

W.A.: 81 5500

RE757

With the Wahl ISO-TIP Rechargeable battery electric soldering tools



* Automatically recharges when placed in stand.

CURRENT PRINTED CIRCUIT BOARDS

— top quality fibreglass,
precision etched and
drilled

JUNE 1977

ETI 485	\$3.00
581	\$2.50
712	\$2.50
547	\$2.50
481	\$2.75

EA 77 u P6	\$2.25
EA 77 E 05	\$3.00

MAY 1977

ETI 449 A	\$2.00
548	\$3.25
316	\$2.00
481 PS	\$6.75
444 M	\$1.00
444 S	\$3.25

EA 77 PRE 5	\$2.00
EA 77 TTY 6	\$2.50
77 UP 5	\$5.75

APRIL 1977

ETI 133	\$2.50
631-2	\$2.75
EA 77 TT 4	\$1.75
77 CC 4	\$5.00

MARCH 1977

ETI 546	\$2.00
062	\$2.00
081	\$1.50
EA 77 TTY 3	\$2.50
77 UP 2	\$5.50
77 FIA	\$2.50
77 FIB	\$5.00



ELECTRONIC COMPONENTS BY POST

SPECIALS OF THE MONTH

4013	.75	NSN61L	\$1.60	78L05	.70
4017	\$1.50	LM3795	\$7.00	78L12	.70
382	\$1.60	BD139	.65	78L15	.70
381	\$1.60	BD140	.65	79L05	.80
7401	.25	BD266	\$1.90	79L12	.80
7404	.25	BD267	\$1.90	79L15	.80
74192	\$1.50	309K	\$1.95	741	.55

VOLUME BUYS

2112	RAMS	2 for \$9.00
NE555	TIMERS	5 for \$3.00 With Applications/Data
IN4004	DIODES	20 for \$1.75
IN914	DIODES	20 for \$1.50
4001	GATES	5 for \$1.25
4011	GATES	5 for \$1.25
8, 14, 16 PIN SOCKETS		any 5 for \$1.50

MICROPROCESSOR COMPONENTS

PROCESSORS		INTERFACE	
SCM11 N Channel Processor with Data	\$16.75	8T26 Quad 3-state bus driver/receiver	3.75
RAMS		8T31 8 Bit Bidirectional I/O Port	12.75
2102 1K x 8	\$2.75	8T97 High Speed Hex Buffers	2.50
2112 256 x 4	4.75	8T98 High Speed Hex Buffers	2.50
2101 256 x 4	4.75	81LS95 Octal Buffer	2.00
6810 128 x 8	5.95	81LS96 Octal Buffer	2.00
PROMS		81LS97 Octal Buffer	2.00
82 S 23 32 x 8 Fusible Link	\$5.75	81LS98 Octal Buffer	2.00
82 S 123 32 x 4 Fusible Link	5.75	8544 Quad Switch Debouncer	1.75
1702A 256 x 8 E PROM	17.50	8551 Tristate Quad Flip Flop	4.00
5203A 256 x 8 E PROM	17.50	A-D : D-A	
5204 512 x 4 E PROM	39.50	5357 8 BIT A/D Converter	\$12.75
		1408 8 BIT D/A Converter	7.95

CLOCKS

MA 1002	MA 1003 CAR CLOCK
0.5" LED Display, 50 Hz, 12 hour Alarm facility, Clock Radio feature (EA Dec. 1976 refers)	Green Fluorescent Display. 12V DC operation. 2.097MHz Crystal Built in Protected against transients. Simple time setting low power on stand by Ideal portable instruments, cars, boats.
\$12.50 incl. data & Instruction	\$29.50 Complete with data & instructions
JT197 Transformer \$6.50	

Please add .75c towards Post and Packaging.

MAIL ORDERS:
ELECTRONIC MAILBOX
P.O. Box 355
HORNSBY 2077
Phone 476 4758

LOW POWER SCHOTTKY

74LS00 .45	74LS21 .45	74LS85 2.65	74LS164 2.30
74LS01 .45	74LS27 .51	74LS86 .70	74LS174 2.30
74LS02 .45	74LS28 .51	74LS90 1.65	74LS175 2.30
74LS03 .45	74LS30 .45	74LS92 1.65	74LS181 2.30
74LS04 .45	74LS32 .51	74LS93 1.65	74LS192 2.95
74LS05 .45	74LS37 .51	74LS109 .75	74LS193 2.95
74LS08 .45	74LS38 .51	74LS113 .70	74LS194 2.40
74LS09 .45	74LS40 .51	74LS114 .70	74LS195 2.40
74LS10 .45	74LS42 1.85	74LS138 2.20	74LS196 2.40
74LS11 .45	74LS73 .60	74LS151 2.00	74LS221 2.20
74LS12 .45	74LS74 .65	74LS154 2.65	74LS253 2.20
74LS14 2.35	74LS75 1.00	74LS157 2.20	74LS367 2.00
74LS20 .45	74LS78 .65	74LS163 2.70	74LS368 2.00

MICROPROCESSORS

2650: A VERY REAL HOME COMPUTER

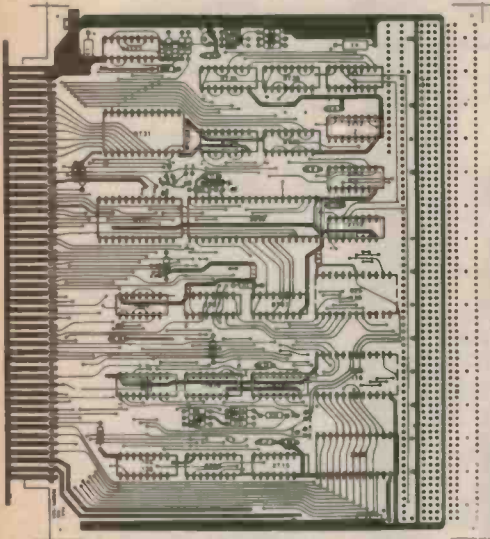

"BYTE" Magazine recently described the 2650 as the "unsung hero of the hobby market". Osborne refers to the 2650 as the "most minicomputer like" device of all the microprocessors described in his classic book "Introduction to Microcomputers".

Software is rapidly becoming available. A resident assembler has now been released and we understand 2650 BASIC will soon be available for the 2650. Extensive program development in both USA and Europe has already produced a substantial software base.

Why the sudden interest in the 2650? It is easy to use, easy to program, efficient to program, very powerful, and readily available and now backed by the immense resources of Philips worldwide.

BABY 2650

If you have access to a terminal (VDU, teletype etc.) you can't beat this kit as an ideal starting point. Supplied with the 1K PIPBUG ROM and 256 BYTES of RAM the BABY 2650 is very easy to get running after a couple of hours assembly time. As an exclusive we supply sample programs to run and full programming documentation.

BABY 2650 KIT \$75.00 post & pack \$2.50

2650 EXPANDER KIT

Want to convert your BABY 2650 to a fully buffered CPU?

This kit enables you to transfer your components to a top quality plated through hole PCB with adequate provision for system expansion.

The kit includes a complete documentation package with detailed notes on

MEMORY ORGANISATION OPTIONAL MEMORY CONFIGURATIONS

I/O PORT DECODING BUS & CONTROL LINE BUFFERS

CLOCK REQUIREMENTS MEMORY EXPANSION

STEP MODE OPERATION I/O PORT INTERFACE DESIGN EXAMPLES

When fully equipped the ATI 2650 card provides 1 serial interface, 2 parallel 8 bit ports, 1K ROM, 1.5K RAM, full system buffering on all lines, 100 pin edge connector, 24K direct addressing capability and becomes a very useable CPU module.

2650 EXPANDER KIT (PCB, edge connector \$45.00
complete documentation) plus \$2.50 p & p

MINISCAMP-8

Based on John Kennewell's design in EA the Applied Technology MINISCAMP 8 is an ideal starting point for those who don't have access to a terminal.

The MINISCAMP-8 uses the new N top quality printed circuit boards logically laid out so the student can readily understand the operation. The board has PROVISION for MEMORY EXPANSION and a TELETYPE INTERFACE OPTION to simplify expansion.

The front panel control board utilizes top quality PC mounting C & K switches which are in turn mounted on a really good looking screened aluminium control panel.

The MINISCAMP-8 uses the new IV Channel SC/MP and considerably simplifies the power supply requirements. Our EXCLUSIVE user manual and programming guide is supplied with each kit.

MINISCAMP-8 Complete kit \$79.50
with documentation package

POWER SUPPLY (5V) \$11.50
components Please add \$2.50 for certified p & p

CT750 CASSETTE INTERFACE

The CT750 is a complete cassette interface based on the KANSAS CITY standard adopted by the USA hobby market.

A major advantage of the design of the CT750 is that it can be readily used at other baud rates including 110 baud, 300 baud and even higher with careful adjustment.

The CT750 is supplied assembled and tested with full alignment instructions should you need to re check the performance at any time. Provision is made internally for

INTERNAL CLOCK
EXTERNAL CLOCK
RECOVERED CLOCK (preset for 4800Hz)
and LED status indicators considerably simplify the operation. The CT750 is ideally suited to the 2650 (with PIPBUG routines) and MINISCAMP with a suitable bootstrap loader program.

CT750 Cassette Interface \$39.50
assembled and tested P & p \$2.50

PROJECT 632 VDU

This is an ideal terminal for a home computer system. As described in ETI this popular kit can be assembled by anyone with reasonable experience in electronics. You can now build the kit on a modular basis as described in the article or if you prefer we have now produced a slimline economy version which consists of the same component layouts on 2 large fibreglass boards (14" x 6") and requires all the various inter connections be made with direct wire links.

MODULAR VDU

PACK 1	632 A,B control logic	\$ 29.50	PACK 5	632 UART interface	\$21.75
PACK 2	632 C character generator	\$ 49.50	PACK 6	632 MB mother board	\$20.00
PACK 3	632 M 1Kx8 memory	\$ 32.50	PACK 7	632 PS power supply	\$ 7.50
PACK 4	633 SYNC with modulator	\$ 17.75	PACK 8	TRANSFORMER	\$ 8.50

ECONOMY VDU

632 C complete kit with full instructions \$135.00

Please add \$2.50 to cover packaging and certified post for one or more packs ordered at the same time.

SM4000 ECONOMY 4K x 8 BASIC RAM KIT

Here is a simple to use, low cost universal RAM module. Does your microprocessor need some more memory? Designated as the SM4000 this RAM is ideal for use with 2650, SC/MP and many other popular processors.

The SM4000 uses a 10" x 5" card size and gold plated 100 pin edge connector compatible with the S100 buss currently proposed as the Australian Standard. The ingenious feature of the design of the SM4000 is that it can be operated on separate data I/O bus or bidirectional data lines.

Electrically the SM4000 requires only a single +5V supply. Provision has been made to add on-card regulators if required although these are not supplied with the basic kit. All address lines are fully tristate buffered as are the data input and output lines. Full address decoding is provided so you can locate this memory module at any 4K boundary in your microprocessor memory space. A very useful write protect facility is also provided so you can protect the contents of memory against unwanted erasure.

The SM4000 RAM uses a double sided epoxy glass circuit board with gold plated edge connectors. Top quality low profile sockets are provided for all IC's and all interconnections between the memory IC's are pre-etched ready for soldering. The actual allocation of address, data, control and memory select lines are to be wired according to the specific requirements of the constructor.

The SM4000 is supplied as a complete kit including PCB sockets, 32 prime quality 650ns 2102 RAMS, buffers and logic together with full application details and assembly notes.

SM4000 4K x 8 RAM \$99.95 (p & p \$2.50)

MAIL ORDERS: THE ELECTRONIC MAILBOX
P.O. BOX 355
HORNSBY N.S.W. 2077

SHOWROOM: 109 HUNTER ST. HORNSBY
HOURS: Monday - Friday 9 - 5 pm Saturday 8.30 - 3 pm

KITS FOR ETI PROJECTS

We get many enquiries from readers wanting to know where they can get kits for the projects we publish. The list below indicates the suppliers we know about and the kits they do.

Any companies who want to be included in this list should phone Steve Braidwood on 33-4282.

Key to companies:

A Applied Technology Pty. Ltd. of Hornsby, NSW.

C Amateur Communications Advancements, PO Box 57, Rozelle, NSW.

D Dick Smith Pty. Ltd. of Crows Nest, NSW.

E E.D. & E. Sales, Victoria.

J Jaycar Pty. Ltd. of Haymarket, NSW.

L Delsound Pty. Queensland.

N Nebula Electronics Pty. Ltd. of Rushcutters Bay, NSW.

O Apollo Video Games of Hornsby, NSW.

P Pre-Pak Electronics of Croydon, NSW.

PROJECT ELECTRONICS

ETI 043 Heads or Tails A
ETI 044 Two-Tone Doorbell A
ETI 061 Simple Amplifier A

ETI 064 Intercom A
ETI 066 Temperature Alarm A
ETI 068 LED Dice A

TEST EQUIPMENT

ETI 101 Logic Power Supply E
ETI 102 Audio Signal Generator E,D
ETI 103 Logic Probe E
ETI 107 Widespan Voltmeter E
ETI 108 Decade Resistance Box E
ETI 109 Digital Frequency Meter E
ETI 111 IC Power Supply E
ETI 112 Audio Attenuator E
ETI 113 7-Input Thermocouple Meter P,E
ETI 116 Impedance Meter E
ETI 117 Digital Voltmeter E,A
ETI 118 Simple Frequency Counter E,A
ETI 119 5 V Switching Regulator supply E
ETI 120 Logic Probe L
ETI 121 Logic Pulsar L
ETI 122 Logic Tester E
ETI 123 CMOS Tester E
ETI 124 Tone Burst Generator L
ETI 128 Audio Millivoltmeter L
ETI 129 RF Signal Generator L
ETI 131 General Purpose power supply E,N
ETI 132 Power Supply N

SIMPLE PROJECTS

ETI 206 Metronome E
ETI 218 Monophonic Organ E,D
ETI 219 Siren E
ETI 220 Siren E
ETI 222 Transistor Tester E
ETI 232 Courtesy Light Extender E
ETI 234 Simple Intercom E
ETI 236 Code Practice Oscillator E
ETI 239 Breakdown Beacon E

MOTORISTS' PROJECTS

ETI 301 Vari-Wiper E
ETI 302 Tacho Dwell E

ETI 303 Brake-light Warning E
ETI 309 Battery Charger P,E
ETI 312 CDI Electronic Ignition P,E
ETI 313 Car Alarm E,D

AUDIO PROJECTS

ETI 401 Audio Mixer FET Four Input E
ETI 402 Guitar Sound Unit E
ETI 406 One Transistor Receiver E
ETI 407 Bass Amp E
ETI 408 Spring Reverb. Unit. E
ETI 410 Super Stereo E
ETI 412 Music Callibrator E
ETI 413 100 Watt Guitar Amp P,L,E,J,D
ETI 413 x 200 Watt Bridge Amp E
ETI 414 Master Mixer E
ETI 414 Stage Mixer E
ETI 416 25 Watt Amplifier E
ETI 417 Amp Overload Indicator E
ETI 419 Guitar Amp Pre-Amp. P,E,D
ETI 420 Four-channel Amplifier L,E
ETI 420E SQ Decoder L,E
ETI 422 International Stereo Amp L,E,D
ETI 422B Booster Amp E
ETI 422 50 Watt Power Module E
ETI 423 Add-on Decoder Amp E
ETI 424 Spring Reverberation Unit L,E
ETI 425 Integrated Audio System E
ETI 426 Rumble Filter E
ETI 427 Graphic Equaliser L,E,J
ETI 430 Microphone Line Amp E
ETI 433 Active Crossover E
ETI 435 Crossover Amp E
ETI 438 Audio Level Meter L,E
ETI 440 Simple 25 Watt Amp L,E
ETI 441 Audio Noise Generator E
ETI 443 Compressor-Expander E
ETI 444 Five Watt Stereo E,N
ETI 445 Preamp J,E,D,A
ETI 446 Audio Limiter J,E,A
ETI 447 Phaser E,J,A
ETI 449 Balanced Mic Preamp. J,A
ETI 480 50W, 100W Power Amp A,J,D
ETI 480 P Power Supply A
ETI 482A Preamp Module A
ETI 482B Tone Controller A

MISCELLANEOUS

ETI 502 Emergency Flasher E
ETI 503 Burglar Alarm E
ETI 506 Strobe L,E,D
ETI 506 Infra-Red Alarm E
ETI 509 50-Day Timer E
ETI 512 Photographic Timer E
ETI 513 Tape Slide/Synchroniser E
ETI 514 Flash Unit E
ETI 515 Sound Operated Flash Unit E
ETI 515 Light operated E
ETI 518 Light Beam Alarm E
ETI 522 Photographic Timer E
ETI 523 Sweep Generator E
ETI 525 Drill Speed Controller E
ETI 526 Printer E
ETI 527 Touch Control Light Dimmer E
ETI 528 Home Burglar Alarm P,E
ETI 529 Electronic Poker Machine E
ETI 533 Digital Display L,E,A
ETI 534 Calculator Stopwatch A,D
ETI 539 Touch Switch E
ETI 540 Universal Timer E
ETI 541 Train Controller E
ETI 543 Double Dice A
ETI 544 Heartrate Monitor A

ELECTRONIC MUSIC

ETI 601 Synthesiser J
4600 Synthesiser J
3600 Synthesiser E,A,D
ETI 602 Mini Organ E,A,D

COMPUTER PROJECTS

ETI 630 Hex Display A
ETI 631 VDU Keyboard Encoder A
ETI 632 VDU 1 k x 8 Memory Card A
ETI 633 VDU Sync Generator A

RADIO PROJECTS

ETI 701 TV Masthead Amplifier E,D
ETI 702 Radar Intruder Alarm D
ETI 703 Antenna Matching Unit E
ETI 704 Crosshatch/Dot Generator L,A,D,E
ETI 706 Marker Generator L,E
ETI 707 Modern Solid State Converters C,E
ETI 708 Active Antenna C,E
ETI 710 2 metre Booster E
ETI 711B Single Relay Remote Control A
ETI 711C Double Relay Remote Control A
ETI 711R Receiver A
ETI 711AR Remote Control Transmitter A
ETI 711DR Remote Control Decoder A
ETI 740 FM Tuner A
ETI 780 Novice Transmitter A

ELECTRONIC GAMES

ETI 804 Selecta-Game O,A,D

DIGGERMAN ELECTRONICS

P.O. Box 33, Coramba, N.S.W. 2466

Keep electronics a hobby and not a luxury, compare our prices and buy from us. Same day turnaround service. Quality assured.

QUALITY ELECTROLYTIC CAPACITORS:

Cap.	upright		axial lead	
	16V	25V	16V	25V
1uF	6c	7c	8c	9c
4.7uF	6c	7c	8c	9c
10uF	6c	7c	9c	10c
22uF	7c	8c	9c	11c
33uF	8c	9c	10c	13c
47uF	9c	10c	11c	14c
100uF	11c	12c	13c	17c
220uF	13c	17c	15c	20c
470uF	18c	23c	21c	32c
1000uF	24c	37c	31c	40c

LEDs: 25c ea. big red with clip

ZENERS: 15c ea. 400mW 5% E24 values 3V to 33V

RESISTORS: 1/4W carb. film 5% E12 values 1 Ohm to 1M 2c ea.

SCRs:

0.8A 30V C103Y — 35c
4A 30V C106Y1 — 40c
4A 400V C106D1 — 75c
8A 400V C122D — \$1.05
25A 400V C37D — \$2.50

TRIACS:

2A 400V Esp240 — 65c
6A 400V SC141D — \$1.30
10A 400V SC146D — \$1.50
25A 400V SC260D — \$2.50
DIAC: ST2 — 35c

DIPDES:

1N4001 — 6c (1A 50V)
1N4002 — 7c (1A 100V)
1N4004 — 8c (1A 400V)
1N4007 — 10c (1A 1000V)
1N414B — 6c, \$4.50/100.

Chart to identify all leads plus triggering details — 15c

POTENTIOMETERS: 47c ea. .25 W rotary carb. sing. gang Log. or lin: 1K 5K 10K 25K 50K, 100K 250K, 500K, 1M, 2M.

TRIM POTS: 15c ea. — 10mm .1W horiz. or vert: 100Ω, 250Ω, 500Ω, 1K 2K, 5K, 10K, 25K, 50K, 100K, 250K, 500K, 1M, 2M.

All goods top quality & new — satisfaction guaranteed or money back against goods. No minimum order. One P&P charge of 40c regardless of quantity. Advert current for 3 months for benefit of late readers.

Mail Order - CB SELL-OUT - Mail Order

Seiki 23ch AM 5W, \$70.00. XTAL XCB7 23ch AM 5W Delta Tune, Remote volume, ANL switch, \$89.00.

SPECIAL THIS MONTH
Gemtronics SSB 23ch. USB.LSB. Noise blanker that really works! Nothing more to explain — \$215.00. And it's the best.

CB AERIALS

Base loaded universal mount, bonnet, etc. \$19.50. Twin Trucker aerial, \$48.00. 60" helical whip, \$29.00. Centre load whip, \$25.50. 1/2 wave Ringo Base Station aerial 3.7dB gain, \$65.00. 1/4 wave Base aerial, \$47.50

We also supply and install telescopic masts, brackets, and fittings. Complete base stations installed. Rigs, aerials, tele-masts supplied. T.V. antennae, masts, amplifiers, etc, supplied and installed all areas.

ALL EQUIPMENT is available on a fast mail order service. However, we do request that you include 5 percent of the value of your order to cover postage.

CLEARLITE TV ANTENNA SERVICE

214-216 Nicholson St, Fitzroy, Vic. 3065.
Phone (03) 41 2096, 435 7551

Ideas for experimenters

These pages are intended primarily as a source of ideas. As far as reasonably possible all material has been checked for feasibility, component availability etc, but the circuits have not necessarily been built and tested in our laboratory. Because of the nature of the information in this section we cannot enter into any correspondence about any of the circuits, nor can we produce constructional details.

Electronics Today is always seeking material for these pages. All published material is paid for — generally at a rate of \$5 to \$7 per item.

SIMPLE ACCURATE FREQUENCY METER

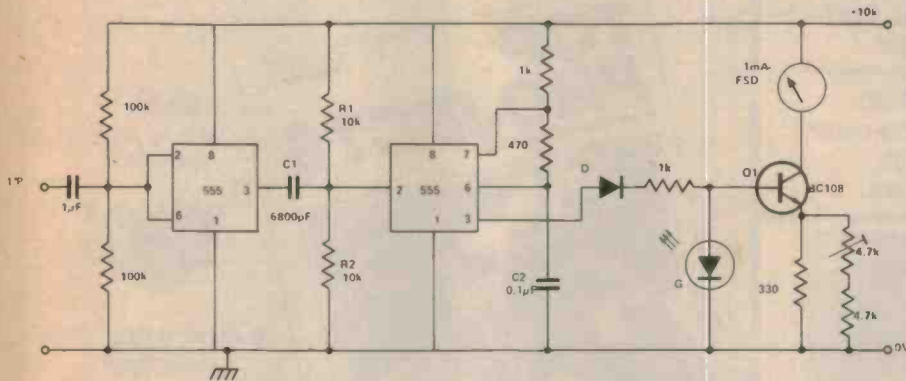

This circuit provides a meter deflection that is strictly proportional to the frequency of the input signal over the range 10Hz — 300Hz. The first 555 timer IC is used as a Schmitt trigger, to convert the I/P signal to a fast-edge square wave. This is differentiated by the network C1, R1 and R2, and the resulting spikes used to trigger the second 555, which operates as a monostable, generating constant width pulses. These are used to turn on the constant-

current source Q1, so that the average current in the meter movement is proportional to the number of pulses arriving per second. A green LED is used to bias the current source as this gives near-perfect temperature compensation; the 4k7 preset pot gives a fine adjustment for calibration purposes. When the 1 mA meter shown is used, fsd is given by 100 Hz. To extend the range, reducing C2 to $.01\mu\text{F}$ gives an fsd of 1 kHz.

LED RF INDICATOR

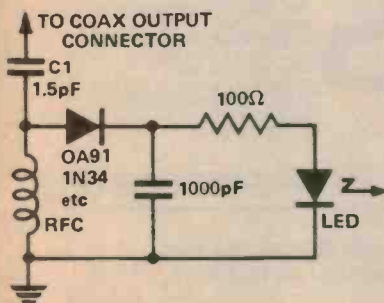

An RF output indicator using a LED is very useful for monitoring the output of a transmitter. This circuit will give indication from a 5 W transmitter. The capacitor C1 and the RFC are chosen for the appropriate frequency. The RFC could be replaced by a resistor for wideband use. The sensitivity depends on the value of C1 and the resistor used if the RFC is replaced. For high power transmitters, C1 could be a small 'gimmick' capacitor.

TELEX®

CUSTOM TAPE COMPONENTS

A wide variety of head and channel configurations with optional electronics to suit custom designers of broadcast, educational and entertainment systems.



MODEL 36 ENDLESS LOOP CARTRIDGE TRANSPORT

- NAB format, solenoid operation, remote control, three head facility, single or dual speed.



MODEL 230 OPEN REEL TRANSPORT

- Three motors, two speed, solenoid controls, high efficiency braking, four head facility, tape lifters, photo cell tape stop.



MODEL RP85 RECORD/PLAY PREAMPLIFIER

- Use with model 36 or 230 or most other transport systems. Direct head connections N.A.B. equalization for 3 speeds, -60DB bias rejection, optional rack mounting panel.

FOR FURTHER INFORMATION:

AUDIO TELEX COMMUNICATIONS PTY. LTD.

SYDNEY
54-56 Alfred Street,
Milsoms Point 2061
Telephone: 929-9848

ADELAIDE
Werner Industries,
28 Gray Street,
Kilkenny 5009
Telephone: 268-2801

BRISBANE
Bruce Window Elect.
10 Buchanan Street,
West End 4101
Telephone: 44-6844

MELBOURNE
828 Glenferrie Road,
Hawthorne 3122
Telephone: 819-2363

PERTH
Audio Equipment Ltd.
36 Gairloch Street,
Applecross 6153
Telephone: 64-4736

HOBART
Video & Sound Services,
141 Murray Street,
Hobart 7000
Telephone: 34-1180

SEMCON MICROCOMPUTERS

PTY. LTD. Would like to announce the availability of the following Australian designed and built products to help initiate or update your current micro-computer system.

1. POWER SUPPLY CARD

-- modular (suit rack mounting)

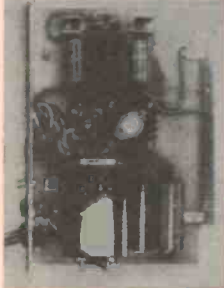

- + 5V at 3 Amps.
- ± 12V at 500 mA.
- real time clock interrupt, locked to 50Hz mains, optically isolated.
- thermal shutdown
- current limited
- power on indicator
- on/off switch

9¾ x 6¾ x (low profile)

\$56.00 plus tax.

2. ± 12V POWER SUPPLY

- + 12V @ 250mA
 - - 12V @ 250mA
 - 4" x 4"
- \$23.35



3. 8K STATIC RAM MEMORY CARD

- 8k bytes of fast access 450ns
- low power (Fairchild 2102LIPC Memory chips)

\$275*

- address decode selection to position. ram on any 8K boundary
- buffered address, data & control lines.
- 9¾" x 6"

4. CARD CAGE & BACKPLANE

- bus organised backplane 8 cards, expandable to 16
- 4 edge connector sockets supplied (2 x 43 x 0.156")
- anodised aluminium ideal for motorola range of boards.

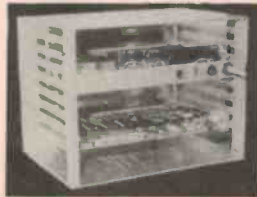

SHOWROOM: 1 CHILVERS RD. THORNLEIGH.
2120, N.S.W. Ph. 848-0007 or 848-0800
Mail Orders: P.O. Box 61 PENNANT HILLS
2120 (add \$2.00 P&P)

Send for free catalogue of all our available computer products.

Delivery: stock to 4 weeks.

Add 15% tax where applicable.

All prices subject to change without notice.

TOP PROJECTS

VOL. 3 from Electronics Today.

Latest volume in our series of project books — Reprints of some of the most popular projects from recent issues — FM tuner, 25 watt amplifier, ETI 400 speaker system, Colour organ, Frequency counter, Digital voltmeter, Radar intruder alarm and more.

Available at all newsagents or direct from our Subscriptions Department, Modern Magazines (Holdings) Ltd, 15 Boundary Street, Rushcutters Bay, NSW 2011.



\$2.50
(plus 40 cents postage)



A Modern Magazines
Publication.

MICROWAVE RADIATION SURVEY METERS

For monitoring microwave radiation levels from domestic, industrial, medical and communication microwave equipment. Ideal for servicing, research and development work. For \$295.00 complete. Expert advice available. Free booklet on servicing microwave ovens.



MODEL HI 1500

Specifications:

1. Calibrated at 2450 MHz for use in the I.S.M. Band.
2. Three ranges provided 0-2, 0-10 and 0-100 mw/cm², each calibrated at mid-point.
3. Accuracy ± 1db.
4. Time responses (0 to 90 per cent of final value for a step input). Fast — 1 second. Slow — 3 seconds.
5. Temperature compensated.
6. Cardinal point calibration chart provided with each meter.
7. Estimated battery life of 1 year.
8. Instrument package dimensions. 2½" x 3½" x 6".
9. Probe length 12".

Reg Geary & Associates

4/6 Garden Avenue Glenhuntly Vic.
Phone (03) 211-8183. All hours

AGENT FOR
Hitachi electric hoists — Electric chain blocks — Electric monorail trolley
Geared disc brake motors — Crane components — P.H.R. hand chain blocks
J.D.N. air operated chain blocks — Endo spring balances — Endo air hoists
Renlita remote controlled doors.

Ideas for experimenters

CARTRIDGE EQ AND RUMBLE FILTER

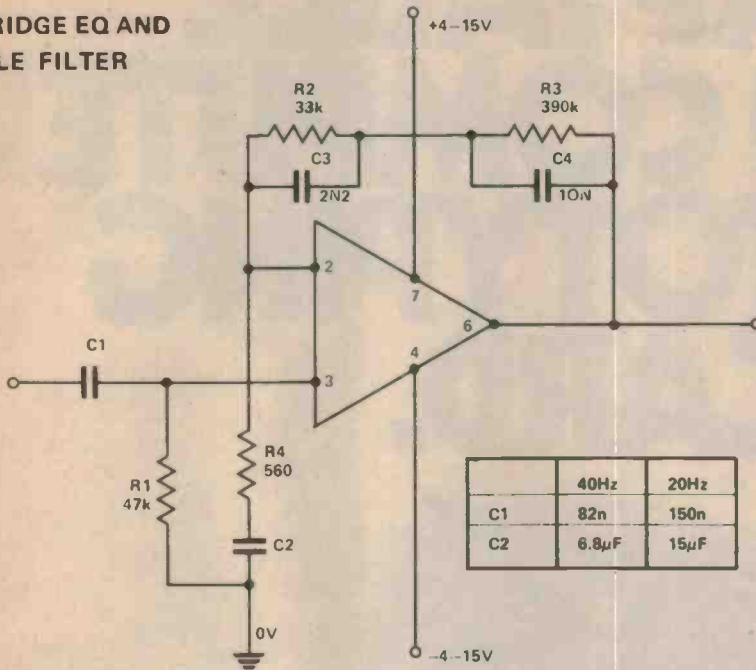

In this circuit a 741 op amp is used to provide standard RIAA equalisation for a magnetic pick-up cartridge. The input signal is coupled via C1 into the non-inverting input of the IC. R1 damps the inherently high impedance at this point and provides the correct load for the cartridge. Feedback from the output, pin 6, is taken through the equalisation network R2, C3, R3 and C4 to the inverting input.

The ratio of R2 to R4 sets the mid-band gain at 65, 35 dB. C1 and C2 together form a steep cut rumble filter whose cut off point can be set at 20 or 40 Hz by selecting the appropriate component values in the table.

C2 also reduces the dc gain of the circuit to unity so that the output offset voltage will be ± 5 mV with reference to 0V.

One of the major disadvantages of discrete equalisers is overload distortion. Although the output of a magnetic cartridge may be only about 5 mV normally a musical peak may well force the cartridge output to 100 mV. Clearly unless a large signal swing is possible the sound emanating from the speaker is not going to be Hi-Fi.

This circuit, operating from a ± 15 V supply, has an overload factor of +35 dB referred to a nominal input of 5 mV, equivalent to a maximum input of 325 mV!

DC LAMP FAILURE INDICATOR

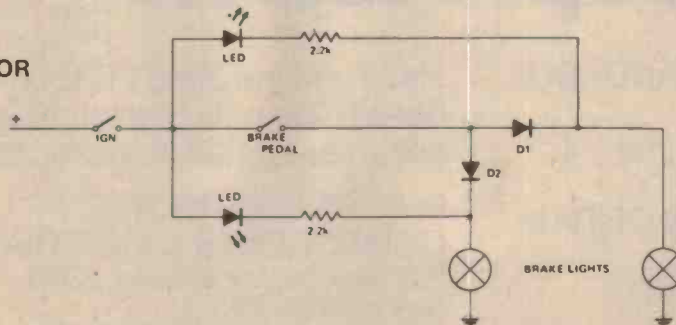

The very simple circuit here provides an on-if-good function for a lamp. D1 and D2 should be generously rated as they are outside the warning loop. On a car type D04 is recommended for

mechanical support. If all the lights on a car are to be monitored the diodes can be mounted in blocks behind the lamp housing that the wiring harness reaches first. A 'line of light' type LED makes a convenient display.

AUSTRALIA WIDE FAST DELIVERY monochrome — colour TV SPARE PARTS

A single source of supply for

AWA
GE
GENERAL
HEALING
HMV
KRIESLER

NATIONAL, PHILIPS
PYE
RANK
THORN
TYNE

and European brands
PC-BOARD SERVICE
TV-TUNER SERVICE

REPAIR OR EXCHANGE

Antenna equipment, (300 ohm and 75 ohm), electronic components, resistors, capacitors, speakers, transformers, I.C., transistors, diodes, lubricants, CRC-TF, replacement styli and cartridge supply.

FROM



SELECTRO PARTS Pty. Ltd.

482 Hume Highway
P.O. Box 118, Yagoona, NSW,
2199

Rail to Yagoona Station.

Phone (02) 708-3639

(24 hours)

WE HAVE NOW BEEN
APPOINTED DISTRIBUTORS
FOR PLESSEY-FOSTER
SPEAKERS. FULL RANGE IN
STOCK

ADAPTABLE BOARD COMPUTER PROTOTYPING CARD.

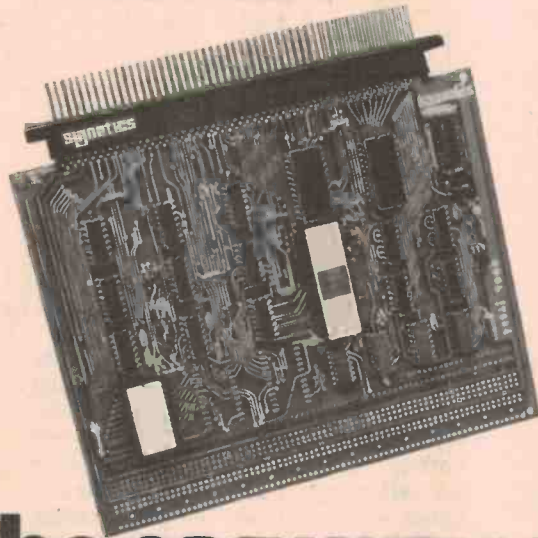

Two easy steps:
Plug in, Hook up
+ 5 volts, ground, and
a teletype,...and you're
in business!

Here is a short
list of features.

- 1 K BYTES ROM (PIPBUG EDITOR AND LOADER) BOARD EXPANDABLE TO 2 K BYTES ROM/PROM
- 512 BYTES RAM (2112B - 256 x 4 STATIC NMOS RAMS) BOARD EXPANDABLE TO 1 K BYTES OF RAM
- ON BOARD TTL CLOCK
- TWO - 8 BIT PARALLEL B1/D1 I/O PORTS
- RS232/TTY SERIAL I/O PORT

The easy way to start in Microprocessors

- CONNECTOR SUPPLIED
- AVAILABLE PRE-ASSEMBLED AND TESTED - 2650 PC1500 OR IN KIT FORM - 2650 KT9500

Ask your local
Philips stockist to

show you the 2650 PC1500 Adaptable Board Computer Prototyping Card, and get an easy start in Microprocessors.

PHILIPS ELECTRONIC
COMPONENTS & MATERIALS,
P.O. Box 50, Lane Cove, 2066.
Sydney 427 0888,
Melbourne 699 0300, Brisbane 277 3332
Adelaide 223 4022, Perth 65 4199



Electronic
Components
and Materials

PHILIPS



VIDEO TECHNICS

Now available

MONITOR ADAPTOR KIT FOR 26" RANK, 18" RANK, GENERAL, HEALING, DEAKON & HMV BRADDON.

- Converts receiver into video monitor.
- Allows off-air recording or recording with video camera.
- Easy to install.
- All instructions & circuit diagrams included.



MODEL HD6709

COLOUR TV TUNER

- Record one channel while watching another
- No modification required to existing television sets
- Will record while TV set is off
- Usable with any video recorder BW or Colour with an RF output which means this tuner allows video recording of TV programs and playback through aerial input of TV set.

Wanted: Franchise dealers

- Full range video equipment — colour and black and white
- Colour TV monitors for off-air recording
- Continuous demonstrations
- Special Prices
- Record your favourite movie or sporting event
- New, used and demonstration equipment always in stock
- Video gives you instant playback with 'sync' sound.

2nd Floor,
Telford Trust Building,
79-85 Oxford Street,
Bondi Junction. NSW
Phone 387-2555

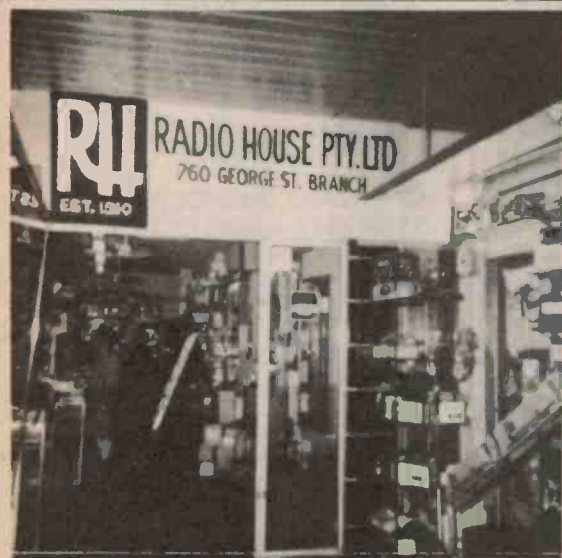

RADIO HOUSE PTY. LTD.

306-308 PITT ST. & 760 GEORGE ST.
P.O. BOX A108 SYDNEY SOUTH 2000.

- Audio Amps, Leads, Plugs, Cable etc.
- Burglar Alarm Components, Clock Radios.
- Cassette recorders & Record Players.
- Large range of hard to obtain globes.
- Multi Meters and other test equipment.
- Stylus-diamond and sapphire — 200 types.
- Transistors, Walkie Talkies, C. B. Radio.
- T.V. Antennas and all associated parts.

E.T.I. 485 GRAPHIC EQUALISER

- Flexible ● Professional
- Reliable ● Economical

The New 485 Equaliser is an extremely versatile & flexible unit.

Kits Are Available for

- Complete Stereo Unit to Match HI-FI Systems.
- Rack Mounted Two Channel Unit for the more professional user.
- Single Channel Units — Ideal for Mounting in Mixers, Guitar Amps electric Planos etc.
- All Individual Components Are Available Separately.

KIT A. — Fibreglass P.C. Board and all components necessary for one channel \$25.00 plus \$1.00 freight.

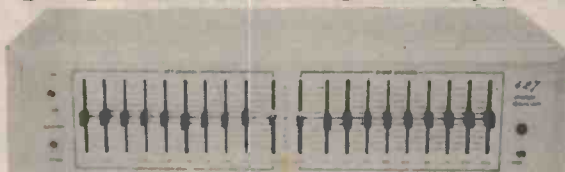

KIT B. — Power supply module — Also makes an ideal General purpose 15VDC supply. Kit includes PC board; Transformer; Fuse, Power Cord; Power Switch; led; etc., \$17.00 plus \$1.00 freight

KIT C. — Stereo Chassis & H'Ware: Includes printed front & Rear Panel; Input, output sockets; Bypass & Mon Switches and H'ware \$39.00 plus \$1.50 freight

Complete Stereo Kit
including WOODWORK
\$98.50
plus \$2.50 freight

ALSO AVAILABLE

- Rack Mount Adaptor Kit — Converts the Stereo Chassis to a Standard 3.5" x 19" Rack Mounted Unit.
- Mono Front Panel & Chassis — Ideal for 'on board' Mounting.

SEND STAMPED ADDRESSED ENVELOPE FOR PRICE LISTS OF COMPONENTS AND OPTIONS AVAILABLE.

jaycar PTY LTD.

Tel: 211-5077 P.O. BOX K39, HAYMARKET
N.S.W. AUST. 2000. 405 Sussex St., Sydney.
ENTRANCE OFF LITTLE HAY ST.

WE MISSED SOME OUT!

Even though we held our catalog up by one month this year, some products were so new they missed the bus! Here are just a few of them, and some others which are really great value. If you haven't seen our catalog yet, they are available at our stores or dealers for just 75c per copy.



2 MEG ROCKS

Universally used as a reference source, these crystals are one of the most sought-after frequencies. Use for counters, marker generators, time & frequency standards, etc. They're Australian made (by Hy-Q) so they're top quality. Fill up your junk box — you never know when you'll want one! Cat. K-6028 .. \$6.75

SAVE \$3
\$6.75

MIDLAND T-SHIRT OFFER

Not just for Midland owners — you can wear one even if you'd like to own the best! T-shirt comes in 3 sizes (med. large & ex large) and features 'Mr CB' — C.W. McCall. Let 'em know you're a CB'er. Cat D-9100 .. \$5

full color \$5.00

Sorry — Linda is definitely not for sale ...

CB RF Output Trans.

2SC1306

2SC1307

fr. \$4.50

We've got 'em ...

Probably the most popular RF power transistors in Australia at the moment — and also the scarcest! But we have some; a strictly limited supply. It won't last long, so get some spares now. You never know when you might pop your cork!

2SC1306 (12W M) Cat Z-2501 ... \$4.50
2SC1307 (25W M) Cat Z-2502 ... \$6.50

SAVE ON FORDS

Save over \$10 by buying now! Last year's catalog price was \$29.95. Now just \$19.50! For a full scientific calc with mem. Ideal for taxation returns (you can claim it as a deduction!) Don't miss out, stocks are limited. Never again at this price!

Cat. 3010 .. \$19.50 !!!!

Way below COST!! 1950

Special MULTI-7 deal:

SAVE \$47+

Buy this incredible 2m transceiver right now for the regular price of \$189, and we'll throw in a 2/6m mobile whip, a magnetic base to suit and, best of all, a 1977 Dick Smith Catalog! What fantastic value. Regular price of these items is over \$236 — you save over \$47! But only while they last ...

Multi 7 — Cat D-3007 .. \$189.00
Don't forget to ask for the goodies!

TV GAME KIT (UPDATED!)

\$49⁵⁰

Cat K-3432

IMPORTANT CHANGE TO OUR TV GAME KITS — NOW EVEN BETTER!

All of our TV game kits are now being supplied with the very latest G.I. AY-3-8550 integrated circuit, which allows 2-way movement of bats, at no extra charge!

In the standard game, this IC will work as normal — but with the addition of two 100k pots (or better still a pair of joystick controls) you can have horizontal movement of the bats as well as vertical — much more dynamic!

This new IC will also fit existing TV games so anyone who has previously bought our kits and wishes to convert, this is very easy. It simply plugs into the same socket.

Extra parts are as follows:
100k linear pots (2 req.) Cat R-1800 .. 70c
100k joystick pots (2 req) Cat R-1976 .. \$4.75
AY-3-8550 IC Cat. Z-6850 .. \$19.75

MIDLAND

\$219

THE POSE MACHINE

As well as being a high-performance CB to impress you, this beautiful wood-grain base/semi-mobile rig will be the envy of all your friends. You get the convenience of a dual supply rig, PLUS a digital clock, PLUS a built-in SWR meter — about \$250 worth if bought separately. And it's only \$30 more than the 882C! Fantastic value. (Licence required) Cat. D-1440 .. \$219.00

\$105 VALUE!

FANTASTIC MINISCAMP: New µcomputer

from EA. 256 bit, expandable to 1k at low cost. Learn programming, how computers work — start your career! Cat K-3446, \$105.00
Schools: Special offer for orders of 5 or more with tax ex. the price is only \$87.65 each.

MINISCAMP OUT OF YOUR DEPTH?

Try the digital logic trainer. Learn all about logic basics or use as a breadboard for trying out ideas. And for a short time save a massive \$26 on our cat. price — that's 27%!
Cat K-3010 .. 25 UNITS ONLY \$69.00

DIGITAL DC

\$85.00

Now \$45.00

Save \$40

Ideal for service, developmental work, etc — this little DC voltmeter has 3 digit readout in the end. Invaluable for working in close when you can't take your eyes off — one flash and you're ash!
3 ranges: 20V—200V—1000V. Battery operated. Cat. Q-1445 .. \$85.00

\$69 save 25%

We back the Freeze

DICK SMITH CUSTOMERS PLEASE NOTE:

Our stores will be closing for annual stocktake at the end of the financial year. Stores will close as follows:

Store	Thursday 30/6	Friday 1/7	Saturday 2/7
Gore Hill	Closed	Open	Open
B'town	Open	Closed	Open
York St	Open	Open	Closed
Melbn	Close 2PM	Open	Open
Brisbn	Close 2PM	Open	Open

We apologise for any inconvenience.

DICK SMITH ELECTRONICS GROUP

VISIT YOUR NEAREST STORE:
 SYDNEY — 125 York St, Ph. 29 1126
 BANKSTOWN — 361 Hume Hwy. Ph. 709 6600
 GORE HILL — 162 Pacific Hwy. Ph. 439 5311
 MELBOURNE — 656 Bridge Rd, Richmond. Ph. 42 1614
 BRISBANE — 166 Logan Rd, Buranda. Ph. 391 6233
 MAIL ORDERS: P.O. Box 747, Crows Nest, N.S.W. 2065.

WE HAVE DEALERS ACROSS AUSTRALIA. PHONE YOUR NEAREST STORE FOR THE DEALER CLOSEST TO YOU.



It's so easy with Playmaster: even you can do it!

See E.A. May 77 for project details.

It's true! Home construction has never been so easy — all you have to know is which hand is which, and how to read instructions. It's that simple! You will finish in next to no time, and save yourself a packet in doing so . . .

Take this speaker system for example:

A pair of beautifully made 75 litre boxes with simulated walnut veneer finish and expensive foam grille. 3 speaker system with crossover and balance controls, all supplied. Full instructions are supplied; all you need is a tube of glue and a few hand tools — and a couple of hours. Details are in Electronics Australia, May 77 issue (the issue containing the Dick Smith Catalog). System handles 80W (P), 8 ohms, size 717 x 475 x 239 (mm).

Order as follows:

- Kit of speakers, controls, etc (pair) Cat C-2042 \$130.00
- Enclosure kits, with instructions, Cat C-2622 \$124.00
- TOTAL SYSTEM PRICE (PAIR) \$254.00**

12" SPEAKER SYSTEM

\$254⁰⁰
PER PAIR

10" SPEAKER SYSTEM

Very similar to above system but more compact. Handles 60W (P), ext. dim. 620 x 393 x 293. Ideal system where space is at a premium.

- Spkr kit (pr) Cat C-2044 . . . \$99.75
- Enclos. kit (pr) Cat C-2624 . . \$89.50
- TOTAL SYSTEM PRICE (PR) \$189.25**

\$189²⁵



DESIGNED BY
NEVILLE WILLIAMS —
EDITOR-IN-CHIEF OF
ELECTRONICS AUST.
MAGAZINE,

DON'T FORGET — DICK SMITH ELECTRONICS HAS ALL THE AUDIO COMPONENTS AND ACCESSORIES YOU'LL EVER NEED. COMPARE OUR SPECIAL PRICES!

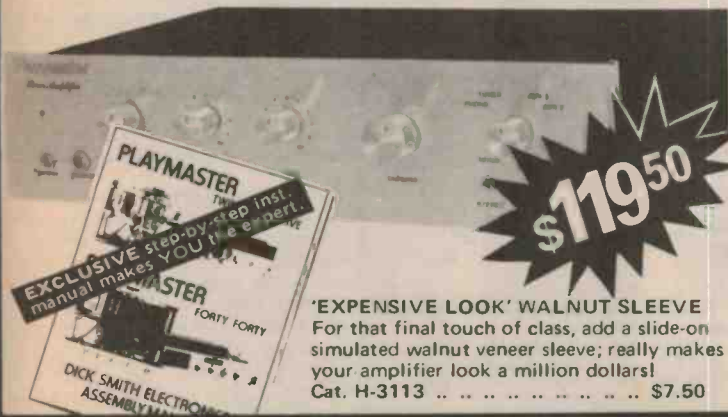

\$119⁵⁰

'EXPENSIVE LOOK' WALNUT SLEEVE
For that final touch of class, add a slide-on simulated walnut veneer sleeve; really makes your amplifier look a million dollars!
Cat. H-3113 \$7.50

PLAYMASTER STEREO 40 + 40 AMPLIFIER KIT

Incredible performance at an equally incredible price . . . Because you build it yourself, you save — and you can build it yourself! Thousands have been constructed; many by raw beginners who didn't even know what a resistor looked like!
40 + 40W (rms) output, 2mV sensitivity with 120mV o'load, S/N ratio 70dB, unconditional stability, THD less than 0.05% at normal listening levels. Real performance machine!
Cat. K-3411 \$119.50

WE BACK THE FREEZE

Don't spend too much this year!

Shop Address
179 Victoria St.,
Kings Cross.
(Just down from the Crest Hotel
on the newly opened Victoria St)

IC COUNTER PACKS... With board, instruction sheets and data.

Low power : FND500, 7490, 7448.
LP Counter... \$5.00.

High Brightness : FND507, 7446, 7490. HB Counter ... \$5.50.

Counter with latch : FND500, 7490, 9368. CL Counter...\$6.50.

FND500, FND507 .. .5" \$1.95.

7446, 7448 .. decoders \$1.00.

9368 ... latch decoder \$2.50.



POWER SUPPLIES ... With boards, diodes, zeners, and electros.

12/100... Capable of 16 volt at 100mA, or dual plus and minus 8 volt at 100mA unregulated, or a dual plus and minus 12volt 40mA zener regulated supply. \$6.50.

12/1.... Capable of 16 volt at 1 Amp unregulated, or dual plus and minus 12volt 40mA regulated supply together with 5 volt, 1A regulated by an IC. \$9.95.

12V CT 100mA Transformer \$3.25.

12V, 1 Amp Transformer \$6.00.

7805, 12, 15 regulators \$1.95.

LM309K regulator \$1.30.

3300uF 16V electro 49c.

2500uF 25V electro 49c.

1000uF 35V electro 49c.

2500uF 35V electro 79c.

1000uF 50V electro 79c.

400mW zeners.. 8.2,12,30V 12c.

22,24,27V 18c.

TRANSISTORS and DIODES

BC309 (BC179)	11c	\$1.00	\$8.00
BC350 (BC177)	11c	\$1.00	\$8.00
BFY50	60c	\$5.00	\$45.00
TIP31A	80c	\$7.00	\$65.00
TIP32A	80c	\$7.00	\$65.00
TIP33A	\$1.40	\$12.00	\$95.00
TIP34A	\$1.40	\$12.00	\$95.00
TIP3055	90c	\$7.00	\$60.00
2N2904	75c	\$6.00	\$50.00
2N3566	55c	\$4.50	\$40.00
PN3568	65c	\$5.50	\$50.00
PN4355	65c	\$5.50	\$50.00
2N3638	45c	\$4.00	\$35.00
40411	\$2.00	\$17.00	-

DIGITAL ICs

7400, 7413, 7440	28c	\$2.50	\$22.00
7442	55c	\$4.50	\$40.00
7445	75c	\$6.50	\$60.00
7446-7	\$1.20	\$10.00	\$90.00
7448	90c	\$8.00	\$70.00
7460, 7479	28c	\$2.50	\$22.00
7480, 7483, 7491	75c	\$6.50	\$60.00
7492, 7496,	85c	\$7.50	\$70.00
74121, 74151,	65c	\$5.00	\$45.00
74154.	\$1.20	\$10.00	\$90.00

1101 memory \$1.20 \$11.00 \$95.00

.25" readout common cathode 45c \$4.00

POLYSTYRENE CAPACITORS

120, 270, 470, 820, 4700 pF 15c \$1.00 \$8.00

POLYCARBONATE CAPACITORS

.047, .082, 100V 15c \$1.00 \$8.00
.1, .33, .47, .56, 250V 15c \$1.00 \$8.00

CROSS HATCH and GREY SCALE

Crosshatch, blank raster, and grey scale generator. Both video and VHF outputs. Suitable for connection to antenna. Runs on 9 volt battery. Complete kit with box battery and instructions.... \$23.50

Built unit, aligned and tested.. \$32.50

SQ DECODER

Full logic SQ Decoder kit. EA Feb 1977 Complete kit with pots. \$29.50

Similar module to above, smaller board \$32.50

EA75CDI KIT

\$17.50

LINEAR ICs

719	\$1.20	\$10.00	\$95.00
741D	45c	\$3.59	\$30.00
741T	55c	\$4.50	\$40.00
777T	90c	\$8.00	\$75.00
MC1312	\$3.95	\$35.00	-
MC1314	\$4.95	\$45.00	-
MC1315	\$8.95	\$85.00	-

DUAL ROTARY POTS

25K, 50K, 100K, 470K, linear 70c \$5.00 \$45.00
50K, log 70c \$5.00 \$45.00

SINGLE SLIDE POTS

1K, 45mm linear 50c \$4.00 \$30.00
1K, 10K, 20K, 30mm linear 50c \$4.00 \$30.00
1M, 30mm log 50c \$4.00 \$30.00

SWITCHES and SOCKETS

Modern PMG toggles
2PDT 80c \$6.50 \$50.00
2PDT momentary 40c \$3.50 \$30.00
4PDT momentary 50c \$4.50 \$40.00
4PDT centre off \$1.40 \$11.00 \$90.00
8PDT \$1.40 \$11.00 \$90.00
Microswitch 60c \$5.00 \$45.00
RCA sockets
5 way 50c \$4.00 \$35.00
6 way 60c \$5.00 \$45.00
9V battery clip 12c \$1.00 \$8.00
4 AA holder 30c \$2.50 \$22.00

WIRES and COILS

25 gm rolls wire. enamelled.
18 to 40 gauge \$1.20 \$11.00 \$95.00
S201, S203 \$1.80 \$15.00
S195, S196 \$1.80 \$15.00
ST45C \$1.80 \$15.00

Trimmers 12 - 120 pF 30c \$2.50 \$22.00

Reverb springs Plessey type \$5.95 \$52.00 \$450.00

CAPACITORS

Greencap... 100 volt
.001, .0012, .0015, .0018, .0022, 9c
.0027, .0033, .0039, .0047, .0056 9c
.0068, .0082, .01, .012, .015, 11c
.018, .022, .027, .033, .039, .04 11c
.056, .068, .082, .1, .12, .15, 16c
.18, .22 16c

Greencap... 250 volt
.27, .33, .39, .47, .56, 36c
.68, .82, 1.0, 55c
1.2, 1.5, 1.8, 2.2, \$1.00

Greencap... 630 volt
.001, .0015, .0022, .0033, .0039, 13c
.0047, .0056, .0068, .0082, .01, 17c
.015, .022, .033, .047, .1, 22c

Ceramics... 630 volt
10, 12, 15, 18, 22, 27, 33, 39, 7c
47, 56, 68, 82, 100, 120, 150, 7c
180, 220, 270, 330, 390, 470, 7c
560, 680, 820, .001, .0012, .0015, 7c
.0018, .0022, .0027, .0033, .0039, 7c
.0047, .0056, .0068, .0082, 7c

Electrolytics... PC board 25V 50V
2.2, 3.3, 4.7, 11c 11c
10, 22, 33, 13c 15c
47, 100, 18c 22c
220, 330, 470, 45c 57c
1000 uF 55c 95c

Electrolytics... Pigtail 25V 50V
2.2, 3.3, 4.7, 11c 11c
10, 22, 33, 13c 15c
47, 100, 18c 22c
220, 330, 470, 45c 57c
1000 uF 55c 95c

layout aids

PR12 50ml positive photo resist \$3.95
PD16 80gm positive developer \$1.75
DPB Dalo resist pen \$2.38
FCA 500gm ferric chloride \$1.95
LFL 100ml liquid flux \$1.54
T04 20 yd .04 black tape \$1.60
T08 20 yd .08 black tape \$1.60
T06 20 yd .06 black tape \$1.60
D100 88 1 x .031 donut \$1.45
D156 88 .156 x .031 donut \$1.45
T018 18 group of 3 leadouts \$1.45
T05 18 group of 8 leadouts \$1.45
D114 16 groups of 14 pinouts \$1.45
D116 16 groups of 16 pinouts \$1.45
AFG Sheet with .1 grid layout 65c
X0B pack of five exacto blades \$1.45
X0K Exacto knife \$1.95

formers - ferrites

Coils
S201 90pF oscillator coil \$2.95
S203 200pF aerial coil \$2.95
ST45C 455kHz IF coil \$2.95
S195 Rf bandpass \$2.95
S196 Rf bandpass \$2.95
S500 Miniature Osc, 3 x IF set \$2.50

Slugs and Cores

F16 4mm to 15MHz. 12c
F29 4mm to 300MHz. 12c
500 6mm to 10MHz. 10c
900 6mm to 20MHz. 10c
901 6mm to 200MHz. 10c
910 6mm to 300MHz. 10c

Coil formers

722/1 5mm x 14mm former 10c
722/4 5mm x 33mm former 12c
5000A 7mm x 34mm former 27c
5000B 7mm x 61mm former 27c
6PLB 722 base 13c
7100 722/1 can 16c
7101 722/4 can 16c
DTV2 5000A can 30c
DTV1 5000B can 35c

PLESSEY

We are now distributors of Plessey components. Look at the selection!

WOOFERS

C300L05 (300 mm, 12 inch)
Nominal Impedance: 8 ± 15% (Ω)
Resonant Frequency: 32 ± 5 (Hz)
Maximum Power: 50 (W)
Resonant Frequency: 25 ± 5 (Hz)
Effective Freq. Range: fo - 3500 (Hz)
Sound Pressure Level: 92 ± 2 (dB/W)
Flux Density: 6500 GAUSS

C250L07 (250 mm, 10 inch)
Nominal Impedance: 8 ± 15% (Ω)
Maximum Power: 40 (W)
Resonant Frequency: 32 ± 5 (Hz)
Effective Freq. Range: fo - 6000 (Hz)
Sound Pressure Level: 92 ± 2 (dB/W)
Flux Density: 8000 GAUSS

C200L04 (200 mm, 8 inch)
Nominal Impedance: 8 ± 15% (Ω)
Maximum Power: 30 (W)
Resonant Frequency: 46 ± 7 (Hz)
Effective Freq. Range: fo - 8000 (Hz)
Sound Pressure Level: 91.5 ± 2 dB
Flux Density: 9500 GAUSS

MID RANGE

C130M06 (130 mm, 5 1/4 inch)
Nominal Impedance: 8 ± 15% (Ω)
Maximum Power: 30 (W)
Resonant Frequency: 600 ± 90 (Hz)
Rated Freq. Range: 1200 - 15000 (Hz)
Sound Pressure Level: 94 ± 2 (dB/W)
Flux Density: 9000 GAUSS

D035M13 (35 mm, 1.4 inch)
Nominal Impedance: 8 ± 15% (Ω)
Maximum Power: 40 (W)
Resonant Frequency: 720 ± 110 (Hz)
Rated Freq. Range: 1500 - 18000 (Hz)
Sound Pressure Level: 89 ± 2 (dB/W)
Flux Density: 10000 GAUSS

C160M02 (160 mm, 6 1/2 inch)
Nominal Impedance: 8 ± 15% (Ω)
Maximum Power: 80 (W)
Resonant Frequency: 220 ± 35 (Hz)
Rated Freq. Range: 500 - 6000 (Hz)
Sound Pressure Level: 91 ± 2 (dB/W)
Flux Density: 9200 GAUSS

TWEETERS

D025N15 (25 mm, 1 inch)
Nominal Impedance: 8 ± 15% (Ω)
Maximum Power: 30 (W)
Resonant Frequency: 1300 ± 240 (Hz)
Rated Freq. Range: 2600 - 22000 (Hz)
Sound Pressure Level: 88 ± 2 (dB/W)
Flux Density: 13000 GAUSS

HORNS

H016N06
Nominal Impedance: 8 ± 15% (Ω)
Maximum Power: 30 (W)
Resonant Frequency: 4000 (Hz) Max.
Rated Freq. Range: 5000 - 20000
Sound Pressure Level: 96 ± 2 (dB/W)
Flux Density: 10000 GAUSS

FOSTER

C300L05 \$29.50 D035M13 \$16.00
C250L07 \$22.50 C160M02 \$25.00
C200L04 \$19.50 D025N15 \$11.50
C130M06 \$11.50 H016N06 \$ 9.50

CONDUCTIVE PLASTIC POTS

All single gang log and linear potentiometers from 1k0 to 1M0 supplied by us will be the new low noise high quality plastic plessey type. Available in log and linear taper in the values
1k0, 2k2, 4k7, 10k, 22k, 47k, 100k, 220k, 470k, 1M0.
50 cents each or \$5.00 for 10.

Postal address

BKX Electronics Supply Service,
PO Box 787, Potts Point,
Sydney, 2010.

ELECTRONICS Supply Service
179 VICTORIA ST., KINGS CROSS N.S.W. 2011

PHONE 358 2420

MAIL ORDERminimum....\$8.00.
Pack and post.....free in Australia.
Catalogue....90c....40c with order.
Telephone enquiries..(02) 358 2420.

Please Explain



Air-Powered Speakers

My grandfather says he remembers a loudspeaker enclosure driven by compressed air. Is he pulling my leg — or was there really such a device — and if so how did it work?

A.Y.P. Double Bay, N.S.W.

There were indeed such devices. We know of at least two! The basic principle was to modulate a stream of compressed air — generally at 20-25 psi via a gate valve upon which was impressed the audio information. The output was generally via a horn.

One system we know of was used mainly for public address systems and military installations — it was certainly in use in airfields as late as the 1940s.

Another device using this technique was an early gramophone called the Stentorphone. In this unit the tone arm mechanically modulated the gate valve. The air supply was via a rotary air compressor driven by a half-horsepower motor!

These air-powered speakers worked surprisingly well by the standards of their day. Output levels of well over 120 dB could be readily achieved and mid-range sound quality was very good. Harmonic distortion was pretty rough though unless the valve mechanism was very carefully adjusted.

Component Markings

I don't understand all the prefixes and suffixes used for marking electronic components — what's meant by 3k9 etc in a parts list. Does this mean the same thing as 3.9 k?

— J.M. Canberra, ACT

Suffixes 'k', 'm', 'M' etc after component values indicate a numerical multiplier or divider — thus

Multipliers

k = X 1000

M = X 1000 000

G = X 1000 000 000

Dividers

u = ÷ 1000 000

n = ÷ 1000 000 000

p = ÷ 1000 000 000 000

Where the numerical value includes a decimal point the traditional way of showing it was, for example, 4.7k. Experience showed that printing errors occurred due to accidental marks being mistaken for decimal points. The Standard now calls for the ex-suffix to be used in place of the decimal point. Thus a 4.7 k resistor is now shown as 4k7. A 2.2 μ F capacitor is now shown as 2 μ 2 etc.

TV Game

I'm having a great deal of trouble getting your TV game to work as it should. Apart from starting again from scratch with all new bits I don't know what to do. Have you any suggestions — several friends have built the thing and their's work perfectly.

K.G. Perth, WA

We have found that the TV game works more satisfactorily on nine volts rather than the five to eight volts suggested when the project was first published.

The local representatives (of the chip manufacturers) tell us that they have reason to believe that some of the chips sold for this project were factory rejects. They point out that no chips were obtained via their company. We have no evidence for this one way or the other but our experience is that in most cases 'faulty' games are usually cured by replacing the chip.

FERGUSON

"DEVELOPMENTS"

DIRECT CURRENT OUTPUT POWER POINT ADAPTORS TYPE "PPA"

- For connecting to 240V 50Hz mains supply.
- Manufactured to comply with Australian Standard C 126.
- Electricity Authority Approved.

PLUGS DIRECTLY INTO A POWER POINT

This range has been designed to provide filtered, unregulated D.C. suitable as battery replacements for small solid state equipment such as radio receivers, tape players, calculators, etc. with a power requirement not exceeding 3 V.A. (i.e. volts multiplied by amps). The type numbers designate the voltage output at 300 Ma. However, the characteristics illustrated by the graph should permit the optimum selection to be made up to 500 Ma and 14 Volts within the above power limits.



HEIGHT 40mm
WIDTH 45mm
LENGTH 65mm
WEIGHT 0.3kg

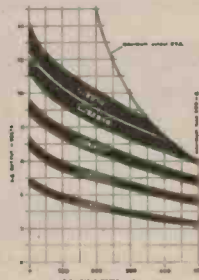

- No Mains Lead
- No Selector Switches
- Choose the correct "PPA" and forget batteries, alternatively choose a "PPA" and recharge your batteries.

AVAILABLE FROM
ELECTRICAL WHOLESALERS

Manufactured by:

FERGUSON TRANSFORMERS

P/L

Head Office: 331 High Street,
Chatswood, NSW 2067.

Phone (02) 407-0261 — Telex: AA25728.

MADE IN AUSTRALIA MADE IN AUSTRALIA MADE IN AUSTRALIA MADE IN AUSTRALIA MADE IN AUSTRALIA

MADE IN AUSTRALIA MADE IN AUSTRALIA MADE IN AUSTRALIA MADE IN AUSTRALIA MADE IN AUSTRALIA

DEL SOUND

PTY. LTD.

BRISBANE

32 Amelia St, Fort Valley 4006
35 Logan Rd. Woolloongabba 4102

Prices & Availability OK as at 15-3-77. Minimum order \$3.00

Mail Orders Welcome

Post & Pack 15 percent up to \$25.
10 percent over.

SPECIALS

Lge Red LED	40c
Lge Green LED	25c
Mtgs (with LED only)	2c
Metal BC107-8-9	15c
Metal BC197-8-9	15c
Diodes IN914 (4148)	6c
Diodes 2.5A 50 V Glass	11c
2N3055	90c
Diodes 1A 400	11c

1/3 1/2 resistors 5 percent	4c
1 W resistors 5 percent	8
1/2 W resistors 2 percent	8
5 W resistors	30c

Also stock range of
Polyester capacitors
Polystyrene capacitors
Polycarbonate capacitors
Electrolytic capacitors
Tantalum capacitors

BOOKS

World transistor cross reference guide	
Transistor specifications manual	\$5.60
Transistor data manual	\$2.80

SPEAKERS

All speakers freight on

Philips

AD 160/T81 dome tweeter 40W	\$13.80
AD 5060/SQ8 5" sealed back mid-range 40W	\$15.90
AD 8066/W8 8" woofer 40W	\$20.90
AD 12100/W8 12"	\$54.50
AS 1265/W8 12"	\$34.90
3 way crossover	\$16.75
2 way crossover	\$8.85

Philips Kits

AD8K40 \$144.00

2 x 8" woofers, 2 x 1" dome tweeters easy to assemble boxes and crossovers

AD12K12SK & TK \$265.00

2 x 12" woofers, 2 x 5" midrange, 2 x 1" dome tweeters, 2 x crossovers, easy to assemble boxes.

5 x 3/8 Magnavox	\$2.20
3" 5W tweeters	\$1.90
1" dome tweeters 20W	\$6.50
4 1/2 x 2" horn tweeters 30W	\$10.90
8" twin cone 20W	\$10.50

CLOCK KITS

1/ Model P109 \$29.50
P&P \$3.00

- AM/PM Indicator
 - Audio Alarm
 - Large Display
- 1/ Model 702 \$55.00 P&P \$3.00
- 120 Red LED Display
 - AM/PM Indicator
 - Hours, minutes, seconds
 - Month & Date (flashes 7 sec. intervals)
- Kits include A.C. Transformer, case & Instructions.



C.B. RADIO

'UNIVERSE' CB 747 INC MIC

Post & Pack \$4.00

- 23CH 5 WATT
- Automatic noise limiter
- Delta tuning switch (or-freq. variation)
- Dual facility meter for measuring signals, and relative power output.
- P.A. facility 3.5W by adding external speaker
- Loaded aerial to suit \$29.00.



CONDITIONS

Name and address plus phone number (if required) must be included within the 24 words allowed.

Reasonable abbreviations, such as 25 Wrms, count as one word. Private adverts only will be accepted. Please let us know if you find a commercial enterprise using this service.

Every effort will be made to publish all adverts received - however, no responsibility for so doing is accepted or implied.

Mini-Mart

We'll print your 24 words (maximum) totally free of charge. Copy must be with us by the 7th of the month preceding the month of issue. Please, please write or preferably type your adverts clearly, using BLOCK LETTERS.

send your ad to -
ETI MiniMart,
Modern Magazines,
15 Boundary Street,
Rushcutters Bay,
NSW 2011.

WANTED: Tape Equipment using discontinued RCA 4-track cartridge. Automotive player, preferably Pioneer TP60E. Recorder/player deck. Cartridges. I. Foran, Flat 1, 5/b Warburton St., Townsville 4810.

WANTED. Second-hand Arlunya colour pattern generator; 1A56057 AWA TV Callibrator. Condition and price G. E. Rand Electronics, 187 Tarlton Street, East Devonport Tas. 7310.

For Sale E.A.130 receiver 3.5 to 7.5 MHz with E.A. 10 watt novice transmitter 3.5 MHz AM \$200 Mr N. Mattick Hargraves 2850.

Farfisa Transicord. Electronic Organ Accordion with case and power supply unit. A1 condition \$500 or best offer. Geoff McLean, 4 Pevensey St., Wendouree, Vic. Ph (053) 391178.

Hewlett-Packard HP65 programmable pocket calculator with Standard and Maths 1 program pacs. \$400 or offer. R. Sanderson, 14/32 Flinders St. Mentone, Vic. 3194. Ph. 5501650

Sell, ETI 4600 synthesizer partially completed, worth \$350, will accept \$230. Must sell quickly. Contact Glenn Block, 19 Forfar Rd., H. Heights, Geelong 3215 Vic. 052-784884.

Wanted. Early American National communications Rx, NC100, NC240, or consider what you offer. Pse write Milton Woods, Unit One, 324 Mill Point Rd. South, Perth 6151.

Wanted to buy, two only 1mH audio frequency chokes. Contact L. Richardson, 2 Elberta St., Leeton, NSW. 53-3201.

Wanted to buy, two 2N277 transistors. Peter Wilkinson, 13 Wattle Terrace, Plympton Park 5038, SA.

SHARP EL1100 Full Scientific, trig, statistical functions, exponents, DMS conversion, memory. \$29. M. Thomas, 4 Simcock Street, West Beach, SA. 356-9509 after 3pm.

Mullard core storage unit 64 x64 x 4 x25 bits no drivers \$150 o.n.o. 38 Mount View St., Aspendale. Ph. (AH) 906187

For Sale - Rambler 5 band radio. Good condition. Urgent Sale \$40 o.n.o. with access. Contact G. Zeril, 65 Sherbrooke St., Ainslie 2602, Canberra. Ph. 477687

Wanted: copy of Top Projects Vol. One. Any reasonable price paid. Donald Withers, 83 Parklands Rd., Mount Colah, NSW 2079. Ph (02) 47-4622.

Sell SC/MPIO: assembled, working \$52. I will pay postage. Nigel Williams, 56 Rialannah Rd., Mt. Nelson, Tas. 7007 or Phone 236993.

Fexo-writer typewriter with full 8-hole dual readers and punches. Suitable, with conversion, for microprocessor. \$150.00. Brian, 30 Kanook Ave., Bayview, NSW. Ph. 997-3547

Akal X-2000 S.D. 3-in-1 cass./cart./R to R player/recorder comp. with access. speakers, leads, etc. \$800.00. S. Ethell, Bells Road, Grose Vale 2753. Ph (045) 721358

Wanted: Kitparts Ltd.(N.Z.) Homodyne HIFI tuner, as described E.A. July 1973. J. Thayer, 48 Alawa St., Waramanga, ACT 2611. Ph. (062) 881320 after hours.

Wanted: Directional Wattmeter, Bird or similar. State price and condition to Peter Birrell, VK5ZTT, Box 261, Mt. Gambler, SA 5290

Please urgently wanted two RCA No.3018 amp modules with data sheet if possible. L.Hollow, 844 Burke Road, Canterbury 3126 Vic.

WOW! GREAT FOR THE PRICE OF GOOD.

There are a lot of good loudspeakers around these days. Especially if you're going to pay \$300 or \$500. Some are pretty good. Some are really good.

But good isn't great.

Introducing Bolivar Speaker Works. We make two loudspeakers. Both are 3-way bookshelf systems. One is \$468, the other \$358. Both are really efficient. (Twice as efficient as the current leader in that price range.) You won't need a big receiver to get a big sound.

The enclosures are the same kind used for expensive loudspeakers, but we finished them in a warm-toned vinyl. No fancy wood veneers. We put the money in the sound. Come listen to Bolivar. Then listen to any other speaker that costs about the same. You'll buy Bolivar.



Bolivar Speaker Works

For name of Bolivar Dealer nearest you write to P.O. Box 6 Brookvale, NSW
or phone 939-2922

READERS' LETTERS

No charge for replies but a foolscap-size stamped addressed envelope must be enclosed. Project queries can only be answered if related to item as published. We cannot assist if project is modified nor if components are otherwise than specified. We regret we cannot answer readers' enquiries by telephone.

SUBSCRIPTIONS AND BACK ISSUES

ETI subscriptions cost \$17.00 per year (inc. postage) within Australia. Cost elsewhere is \$17.65 (inc. postage — surface mail). Airmail rates on application.

Back issues cost \$1.00 each plus post and packing.

We can supply only the following issues.

1975: April, Nov., Dec.

1976: May, Nov., Dec.

1977: Jan., Feb., March.

Photostats are available of any article ever published in ETI. We charge a flat \$1.00 regardless of page quantity from any one issue of ETI. Thus if the article is in three issues the cost is \$3.00. Send orders to address below.

COPYRIGHT

The contents of Electronics Today International and associated publications is fully protected by the Commonwealth Copyright Act (1968).

Copyright extends to all written material, photographs, drawings, circuit diagrams and printed circuit boards. Although any form of reproduction is a breach of copyright, we are not concerned about individuals constructing projects for their own private use, nor by pop groups (for example) constructing one or more items for use in connection with their performances.

Commercial organisations should note that no project or part project described in Electronics Today International or associated publications may be offered for sale, or sold, in substantially or fully assembled form, unless a licence has been specifically obtained so to do from the publishers, Modern Magazines (Holdings) Ltd or from the copyright holders.

LIABILITY

Whilst every effort has been made to ensure that all constructional projects referred to in this edition will operate as indicated efficiently and properly and that all necessary components to manufacture the same will be available, no responsibility whatsoever is accepted in respect of the failure for any reason at all of the project to operate effectively or at all whether due to any fault in design or otherwise and no responsibility is accepted for the failure to obtain any component parts in respect of any such project. Further no responsibility is accepted in respect of any injury or damage caused by any fault in the design of any such project as aforesaid.

A MODERN MAGAZINES PUBLICATION

Managing Director:

Secretary:

Publisher:

Arnold Quick

Charles O'Leary

Collyn Rivers

PRODUCTION

Art Director:

Artist:

Production Manager:

Subscriptions & Circulation:

Project Design:

Acoustical Consultants:

Jim Hattersley

Maree Stanley

Bob Izzard

John Oxenford

Nebula Electronics

Louis A Challis & Assoc.

ADVERTISING

Sydney:

Bob Taylor (Manager), Geoff Petschler (NSW Manager), 15 Boundary St, Rushcutters Bay 2011. Tel: 33-4282.

Melbourne:

Tom Bray (Manager), Poppe Davis, Suite 24, 553 St. Kilda Rd, Melbourne. Tel: 51-9836.

Brisbane:

David Wood, 11-14 Buchanan St, West End Brisbane. Tel: 44-3485.

Adelaide:

Ad Media Group of SA,

Perth:

37 Fullarton Rd, Kent Town 5067. Tel: 42-4858. Aubrey Barker, 38 Mounts Bay Rd, Perth. Tel: 22-3184.

Hobart:

H.W. Lincolne Advance Publicity, 281 Elizabeth St, Nth Hobart 7000.

Tokyo:

Genzo Uchida, Bancho Media Service, 15 Sanyocho, Shintoku-Ku, Tokyo 160.

London:

Electronics Today International, 25-27 Oxford St, London W1R2NT. Tel: 01 434-1781/2.

Electronics Today International is published by Modern Magazines (Holdings) Ltd, 15 Boundary St, Rushcutters Bay NSW 2011. It is printed (in 1977) by Wilkie & Co., Browns Rd, Clayton, Victoria and distributed by Australian Consolidated Press.

Aero Electronics.....	40
Amateur Communications	
Advancement.....	49
Ampec.....	59
Applied Technology.....	88-89
A&R Transformers.....	87
Audio Telex.....	91
Automation Statham.....	87
A.W.A.....	18
BKX Electronics.....	98
B.S.R.....	80
BWD.....	44
Cashmore.....	35
Clearlite T.V.....	90
Convoy.....	27
Delsound.....	100
Diggerman.....	90
Dick Smith.....	12,96-97
Educual.....	16
E.E.E.....	35,49
Electrocraft.....	44
Electronic Disposals.....	43
Electronic Concepts.....	24
Electronic Agencies.....	10
Elmeasco.....	6
Emona.....	51
Emac.....	21
Ferguson.....	99
Haco.....	OBC
Hagemeyer.....	IFC,IBC
Harman.....	101
Hills.....	72
Inter. Correspondence School.....	71
Interdyn.....	37
Intern. Electronics.....	81
Jaycar.....	85
Kent Hi-Fi.....	79
M.S. Components.....	38-39
Nationwide.....	21
Nerff.....	86
N.S. Electronics.....	82
OBC.....	4
Philips.....	50,52,53,55,94
Pioneer.....	54
Radio House.....	95
Rank.....	22,26,65
Recruiting.....	8
Reg Geary.....	92
Riddell.....	70
Royston.....	87
Selectroparts.....	93
Semicon Microcomponents.....	92
Sheen.....	65
Sun Electric.....	59
Vicom.....	17
Video Hi-Fi.....	95
Wedderspoon.....	19

Our power is your glory.



Our Tuners

Our new range of tuners is built with the same attention to detail to afford more listener satisfaction. We weren't satisfied with the general market standard, and it was only by doing a complete re-appraisal of the two main tuner functions that today we can offer you the best in AM/FM. Each tuner is built to deliver entire state-of-the-art high fidelity performance, and tuning accuracy, to afford you stable and errorless station selection.

JT-V71 tuner (to match JA-S71 amp.) Sensitivity — 1.8 microvolt (IHF); Signal to noise ratio — 75dB; Selectivity — 75dB. Also available: JT-V31 (to match JA-S11 and JA-S31).



the right choice

Our Amplifiers

Today's sound requirements demand high power at low distortion. And the new JVC lineup is no disappointment in this respect. Featuring extremely high quality transient response, very large plus-minus dual power supplies, large capacitors and large transformers, and the exclusive JVC tripple-power-protection. RMS output power — min. 80w. per channel; THD — less than 0.1%; Signal to noise ratio — 100dB; Power band width — 10Hz to 100kHz. Also available: JA-S11 (30 watts RMS per channel) and JA-S31 (40 watts RMS per channel).

For details on JVC Hi Fi Equipment, write to: JVC Advisory Service, P.O. Box 49, Kensington, N.S.W. 2033.

TECHNICS PRESENTS ITS CREDENTIALS.



SB-5000

SB-4500

SB-6000

The amazing waveform fidelity of Technics linear phase 2-way speaker systems is now almost legendary. To achieve sound that is virtually indistinguishable from the original, Technics research developed the linear phase system by adopting high performance, wide range units in a unique network configuration and ideal positional location.

With the Technics SB-4500 comes a similar system—priced to suit the economy minded. It retains the essential crisp transparency of sound all the way through the audio spectrum, easily handling peak power of up to 75 watts.

Technics also offer the SB-5000 and SB-6000 linear phase speaker systems for high fidelity components of compatible quality and performance.

SB-4500

- Extra wide-range 25 cm cone-type woofer.
- 6 cm wide-range edgeless cone tweeter eliminates edge resonance and so reduces distortion • 75 watts peak power input.
- 92.5 dB/W (1 m) sound pressure level.

SB-5000

- Wide range 25 cm woofer.
- 6 cm wide-range edgeless cone tweeter delivers a crisp transparency of high frequency sound • 75 watts peak power input.
- 93.5 dB/W (1 m) sound pressure level.

SB-6000

- 30 cm woofer gives low distortion from super-low frequencies through the midrange.
- 3.2 cm dome tweeter gives high efficiency and low distortion.
- 100 watts peak power input • 93 dB/W (1 m) sound pressure level.



For a National Technics catalogue please write to:
National Technics Advisory Service, P.O. Box 49, Kensington, N.S.W. 2033



Technics

hi-fi