

APRIL 1976 \$1.00*

electronics

TODAY

INTERNATIONAL

**THREE
COLOUR TV'S
TO WIN!**



Registered for posting as a periodical - Category C

**NEW SERIES:
DATA SHEETS**

INSIDE - 84 PAGE DICK SMITH CATALOGUE



A turntable with features you'd expect only on a more expensive unit

One feature you'll notice is the price; in fact we believe it to be 'the best buy' turntable available today.

With features only expected on more expensive units, such as wow and flutter of 0.5 WRMS thanks to the DC motor with FG (frequency generator) servo-controlled circuits.

How's this for a list of features. Practical, purposeful features like

- illuminated stroboscope
- elliptical stylus

- completely automatic tone arm return
 - viscous-damped cueing lever
 - anti-skating dial scale control
 - CD4 ready
 - audio insulated legs
- and the list just goes on.

Any way you want to look at it, you'll agree the Technics SL23 is a sound buy, with appearance and performance to match.

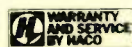

For a National Technics Catalogue please write to:
National Technics Advisory Service, P.O. Box 49, Kensington, N.S.W. 2033

 **Technics**
by National

WT GD 105 T

electronics TODAY INTERNATIONAL

PROJECTS

- AUDIO EXPANDER-COMPRESSOR49
Quieten noisy records and/or expand your music's dynamic range
- GENERAL PURPOSE POWER SUPPLY74
0-20 volts at 2.5 amps or 0-40 volts at 1.25 amps
- RF POWER AMPLIFIER88
Boost power output of your existing low power two metre transmitter

FEATURES

- THREE COLOUR TVs TO WIN18
Here's three separate chances to win a Toshiba colour TV
- SURVEY - 7624
Please tell us what you like and dislike about ETI.
- MEASUREMENTS28
Dr Sydenham discusses the philosophy of measurement - including the myths
- ELECTRONIC COMPONENTS - CAPACITORS38
New ETI series - a complete practical guide to all electronic components
- DATA SHEETS63
Another great new ETI feature series - transistor data sheets
- tone ARM DAMPING96
Low-cost way to improve tone-arm tracking performance
- ELECTRONICS IT'S EASY111
More about digital instrumentation
- IDEAS FOR EXPERIMENTERS125
A potpourri of circuits, ideas, hints and tips

EDITORIAL

Editorial Director: Collyn Rivers
 Engineering Manager: Barry Wilkinson
 Technical Editor: Brian Chapman



COVER: We have three Toshiba colour TV's to win! Turn to page 18 for full details.

REVIEWS

- SUPER AVILYN TAPE CASSETTE104
Exceptional performance from TDK's new formulation tape

NEWS & INFORMATION

NEWS 6; ADVERTISING INDEX 130; SERVICE NOTES 130.



A MODERN MAGAZINES PUBLICATION

*Recommended retail price only.

Why you need 220 watts of power to listen to soft music.



Stated simply, Pioneer's new SA-9900 stereo amplifier was created to faithfully reproduce music at any volume you desire. At 110 watts RMS per channel, it doesn't matter whether you're trying to liven up a party or just warm up your sweetheart.

Through a precision blending of Pioneer's advanced electronics, total harmonic distortion is never more than 0.1%. As a result, you hear all the sounds of all the music you play—clearly—even the soft ones.

And while the SA-9900 is easy to listen to, it's also easy to use. A newly designed chassis places all the output terminals on the left side and all

the input terminals on the right. Separated to eliminate any signal interference and convenient for access to cord connections.

The SA-9900 stereo amplifier. Another example of technical know-how and constant research applied to meet the listener's needs. After all, isn't that what you've come to expect from Pioneer audio equipment.

At Pioneer, we uphold that trust with almost 40 years of exclusive commitment to audio excellence. And from our vast resources as one of the world's leading audio specialists, we are privileged at this time to offer the SA-9900 as the best in an entire

line of outstanding stereo amplifiers. Stop by and see your local dealer for a demonstration. You'll get an earful of truly great music—any way you like it—loudly or softly.

Pioneer Electronics Australia Pty. Ltd.,
178-184 Boundary Road, Braeside,
Victoria 3195, Phone: 90-9011,
Sydney 93-0246, Brisbane 52-8213,
Adelaide 433379, Perth 76-7776

PIONEER
leads the world in sound.

harman australia Pty Ltd

271 harbord road
brookvale nsw 2100
939 2922 telex: aa 24873

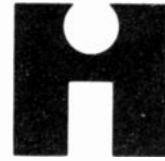

We extend hearty
congratulations to
**ELECTRONICS TODAY
INTERNATIONAL
MAGAZINE**

on their
**FIFTH
ANNIVERSARY**

 *Citation* *dynaco* **EMPIRE**

harman/kardon



Rabco ST-7
straight line tracking system



news digest

ELECTRONICS TODAY – FIVE YEARS OLD

The Australian edition of *Electronics Today* was started in April 1971 – just five years ago.

One year later the magazine made Australian publishing history by establishing a subsidiary edition in the UK – this was the first time that such a move had ever been attempted – and followed this up later that year with a French language edition published in Paris. Both overseas editions have proved remarkably successful and like our parent edition here in Australia have a record of ever-increasing circulation and reader acceptance.

Five years is not a long period in our type of journalism – so we're not turning this issue into a panegyric of self-congratulations. However we felt that we could not let the occasion go totally unmarked so this issue contains a grand contest in which there are three colour TVs as prizes, plus two new main features. And there's more to come in the near future.

So thank you – readers and advertisers alike for your kind support and encouragement. Especially thank you to those countless people who have written and telephoned us to wish us well for the future. It's really appreciated.

TEACH YOURSELF BRAILLE – NEW METHOD

A new do-it-yourself method of learning braille has been developed in Britain. Already it is being used by hundreds of blind people, aged between 11 and 78, who are now able to learn to read at their own pace in their own homes. The main advantage of the system is its simplicity, as it can be used by anyone with access to a portable tape recorder.

Developed by Dr Michael Tobin, of the Research Centre for the Education of the Visually Handicapped at the University of Birmingham, the system comprises two pre-recorded C120 cassette tapes and a braille booklet divided into 20 lessons. Dr Tobin who has studied the problems of teaching braille to blind children and newly blinded adults, set out to find a method

which would overcome the shortage of teachers, or the pupil's dislike of joining group classes.

He established that learners did best by starting with a large braille cell and then he created a programmed learning system using a braille booklet and tape-recorded instructions. The learner listens to the instructions on the tape, and then carries them out using the booklet. The advantage is that the lesson can be repeated as often as the pupil wishes.

There is no copyright on the system and the cassettes together with the booklet can be reproduced by blind organisations throughout the world. For further information contact:

Royal National Institute for the Blind,
224 Great Portland Street, London,
England,

SIGNIFICANT DEFENCE OFF-SET CONTRACT AWARDED TO STC

A significant electronics contract under the Australian Government off-set programme has been awarded to Standard Telephones and Cables Pty Limited.

The contract, valued at \$235,000 calls for the assembly and testing of power units for tactical computers for the Royal Australian Navy designed by



Univac Defence Systems in Minneapolis, USA. Univac is one of the largest suppliers of tactical computers to the US Navy.

The contract is significant as it is a direct result of efforts by the Australian Government and, in particular, the Department of Defence to obtain off-set orders for the Australian electronics industry in relation to the current services re-equipment programme.

The "off-set" contract programme means that when an Australian Government Department lets a prime contract to an American or other overseas company, the contract conditions usually require that the company allows a certain percentage of the value of the contract to be placed back with Australian industry subject to Australian tenders being competitive with overseas prices.

By this means, the Government hopes to achieve advancement of technology within local industry and improved local support for the equipment being purchased.

STC Executives are confident that success with this off-set contract will lead to the placement of even more significant off-set contracts within Australia, thus extending the Australian electronic industry's capability to better serve this country.

The power unit equipment will be manufactured at STC's Liverpool facility.

MINIATURE HALF-WATT RESISTOR



IRH Components has introduced a metal glaze type GLP resistor. The miniature 1/2 watt rated resistor has a maximum surface temperature rise of 50°C, the physical dimensions of many other 1/8 or 1/4 watt resistors but a full 1/2 watt rating at 70°C ambient.

The smaller size allows 10mm lead spacing as standard for horizontal printed circuit board mounting — reducing demand on expensive PC board real estate. Even greater packaging density can be achieved by vertical mounting.

HIGH POWER RF BEAMED OVER ONE MILE

More than 30 kW of RF energy frequency has been successfully beamed over 1.6 km by scientists at the USA's Jet Propulsion Laboratory.

The 2 388 MHz beam was generated by a 450 kW klystron and transmitted via a 26 metre parabolic antenna.

The transmitted beam was received by an array of 17 flat receiver panels containing over 4500 tuned dipoles and special rectifiers that converted the RF energy to dc at an overall efficiency of 82%

An earlier experiment — in 1964 — was performed by Raytheon's William C. Brown who kept a small helicopter aloft for ten or so hours by powering it with energy from an RF beam.

The only previously known successful experiment was that of Nikola Tesla (funny how that name keeps coming up) who in 1899 lit a bank of 200 lamps at a distance of 42 km via energy beamed from an RF transformer (Tesla coil).

The transformer operated at the almost incredible voltage for 1899 — of 12 million volts. Frequency is believed to have been about 100 kHz.

PRICE INCREASE

Despite considerable increases in our own expenses we have, for some time, managed to keep the price of ETI at 75 cents.

But now inflation has not only overtaken us — it's way out of sight! So with the greatest reluctance we have increased our cover price to a recommended retail price of \$1.00. We trust you'll understand

PUT YOUR HANDS TO WORK MAKING MONEY AS A COLOUR TV TECHNICIAN

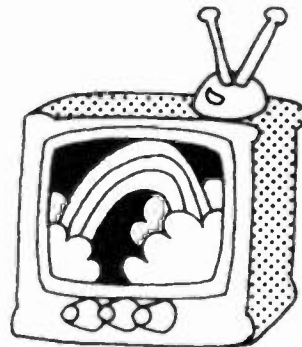

Do you like to find out why things work, or not work? And do you find electronics an interesting field? Because there is a demand for trained and skilled people to service the millions of pieces of electronic equipment used every day in Australia. Think how many colour TV sets have already been sold in Australia. These will need servicing. And there are millions of older Black and White sets that will also require the services of a good, trained Technician.

If you are interested in electronics, then you should find out more about the ICS training for Electronic and Colour TV Technicians. Send the coupon now, and ICS will return you a complete Career Program guide that tells you how the ICS method works and what the training program teaches you. You study at home, at your own pace. Almost from the first lesson, you can start putting your new knowledge to work. And the study program only asks for about an hour a day.

Would you spend an hour a day to earn more money?

Mail the coupon — today!

International Correspondence Schools,
400 Pacific Highway, Crows Nest,
N.S.W. 2065

ICS

International
Correspondence Schools
400 Pacific Highway
Crows Nest N.S.W. 2065

Yes I would like to put my hands to work to make money. Please send me without cost or obligation the Career Program guide I have ticked below.

Colour TV Technician

Electronics Technician

Mr / Mrs / Miss

Address

Postcode

Occupation

Age

160126VX

news digest

CHANGES AT ETI

Since our very first issue back in April 1971 all but ten or so of our published constructional projects have been designed by one man — Barry Wilkinson.

Now Barry has decided to extend his activities. Barry Wilkinson and ETI Technical Editor Brian Chapman have joined forces to form a new technical design and manufacturing company called Nebula Electronics Pty Ltd.

Part of Nebula's activities will be to design and develop ETI's projects — so Barry's design expertise will continue to be one of ETI's main attractions. Nebula will also be entering the kitset market — and will supply selected kits and specialised components associated with ETI projects.

Nebula will also undertake specialised on-off design and development for professional organisations. The company's address is Nebula Electronics Pty Ltd, 4th Floor, 15 Boundary St, Rushcutters Bay, NSW. Telephone 335850. That's just one floor above us.

EARLY WARNING FOR FIRES

A new fire-detection device is claimed to be 100 times more sensitive than existing warning systems has successfully completed a series of trials in Melbourne. The device is so sensitive

it can detect smoke from a burning match. An inbuilt analyser also prevents false alarms.

The detection system was designed from a device developed by the CSIRO to measure the density of bushfire smoke. It was adapted for use in office buildings by its inventor, Mr. David Packham of the CSIRO Division of Mineral Chemistry and Mr. Len Gibson, the Australian Post Office (Telecom) Fire Protection Officer for Victoria.

The device, known as a nephelometer, gains its effectiveness from its ability (unlike other detection systems) to work in the return air duct of air conditioning systems. Any smoke generated in the building is drawn into this duct. The slightest trace of smoke causes the disturbance of a light beam emitted from a special lamp. This scattered light is then picked up by a special detector which activates a signal. The size of the signal depends on the amount of scattered light and therefore the amount of smoke.

The early warning system is especially useful after hours when buildings are not manned but air conditioning systems remain operating.

Mr. Packham explained that if a small quantity of smoke is detected over a period of one minute, the monitor moves to a "yellow alert", signifying

an abnormal amount of smoke. If the yellow alert continues and thicker smoke is detected, an "orange alert" is declared and the premises are inspected. The inspection could find that an overheating power transformer or some other mechanical or electrical failure resulted in smoke emission.

If a large signal is transmitted to the monitor a "red alert" exists. An alarm sounds and the fire brigade is called automatically — red alert can be nothing other than a fire.

Following the successful use of the systems in the Melbourne telephone exchanges, Telecom is expected to install the CSIRO invention in most of its major city and suburban exchanges.

The CSIRO has applied for patents on the device both in Australia and overseas. It is expected that a commercial manufacturer will soon be licensed to mass-produce the systems.

DIGITAL QUARTZ LIQUID CRYSTAL CHRONOGRAPH

Seiko has introduced digital quartz chronograph with liquid crystal display. The new unit combines the Seiko quartz timekeeping mechanism with a highly sophisticated electronic stopwatch.

When reading standard time, the dis-

(Continued on page 13)

ETI
by **jaycar**
PTY LTD.

PROFESSIONAL SOUND
EQUIPMENT FOR THEATRE
AND ROCK BANDS

ETI 3600 and 4600
MUSIC SYNTHESISERS

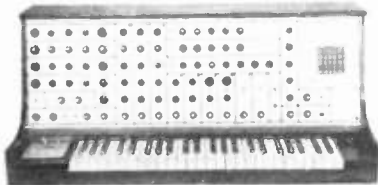

ETI GRAPHIC EQUALISER

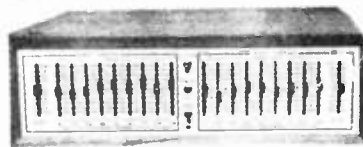

STAGE MIXER



414 MASTER MIXER

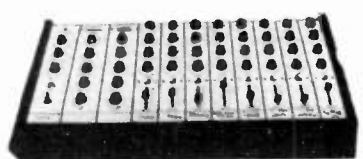

For audio engineers we have a wide range of electronic components at wholesale prices, cannon plugs and sockets, microphone cable etc.,

also available:— electronic cross-overs 100 watt power slaves

Send stamped addressed envelope for price lists.

jaycar
PTY. LTD

Telephone 211-5077
P.O. BOX K39, HAYMARKET
N.S.W. AUSTRALIA 2000
405 Sussex St, Sydney
ENTRANCE OFF LITTLE HAY ST.

Presenting a remarkable range of products... a remarkable philosophy.

The world's reviewers agree that each of the products presented here represents true state-of-the-art, design, engineering and performance.

None is cheap, but each item is realistically priced considering the standards achieved and maintained.

And that brings us to our Remarkable Philosophy.

We feel our equipment and your interests are worthy of the finest demonstration facilities, the most expert installation and the advice of interested, knowledgeable and honest consultants who will help you . . . not pressure you.

To this end we have appointed a small number of Hi-Fi Specialists to bring you Stanton, Fons, S.A.E., Monitor Audio and Neal state-of-the-art components.

We invite you to audition this remarkable equipment at the selected Hi-Fi specialists listed overleaf.





STANTON

STANTON pickups are the almost unanimous choice of recording studios, Radio Stations and TV stations.

They are unique in that they offer spectacular performance without fragility. They also lead the field in consistency—a quality lacking in most pick-ups.

From the illustrious Calibration Standard 681 EEE through the 681 EE and 500 EE to the Broadcast 500A (so popular with radio stations) there is a Stanton pick-up to meet the most exacting need.



Stanton 681 EEE, the New Calibration Standard Stanton's finest Cartridge.



Stanton 681 EE, for application where slightly greater tracking pressure than 681 EEE is required.

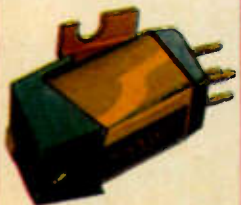

Stanton 500A, the Broadcast Standard Cartridge as used by the majority of radio stations throughout Australia.

the remarkable products...



Fons

FONS is a new name to the world of hi-fi. Built in Scotland, the Fons CO30 turntable has such exciting features as:—

- D.C. Servo controlled motor with gold plated commutator and silver plated brushes.
- Speeds, push button selected for 33, 45 and 78 RPM but continuously variable from 29 to 100 RPM.
- Hyper-concentric bearing typically better than ± 0.000076 mm.
- Rumble typically -79dB
- Wow and Flutter better than $\pm 0.03\%$.
- Anti-feed back phase cancellation suspension system.

Fons claim that the virtual absence of wow and flutter, rumble and vibration lead to a noticeably cleaner sound, and direct comparisons with other units certainly confirm this. In fact, direct comparison with another highly regarded unit using the same Stanton 681 EEE cartridge showed a dramatic improvement.

Neal 102



Neal 103



NEAL

Neal is a name new to Australia but it has established a formidable reputation in the U.K. for quality, ruggedness and performance stability.

The Neal Transcription Cassette Recorder is the product of people who have many years experience in the design and manufacture of tape recording equipment.

The one word that sums up their design and their product is "integrity". You will find no miracles, no way-out designs, no change for the sake of change, just an obsession with doing everything the right way.

Separate preamplifiers are used for each of the three stereo inputs to reduce noise. This also allows three stereo (or six mono) inputs to be mixed.

Bias is readily adjustable to optimize performance from any tape thanks to Neal's exclusive Varitape facility.

Neal are the only cassette recorder company in the world to offer the ultimate quality control check. A cassette actually recorded on the machine you buy. This is your guarantee of quality.

"Hi-Fi for Pleasure" (August 1975) consider the Neal 103 as being "the obvious choice of the serious enthusiast or semi-professional".

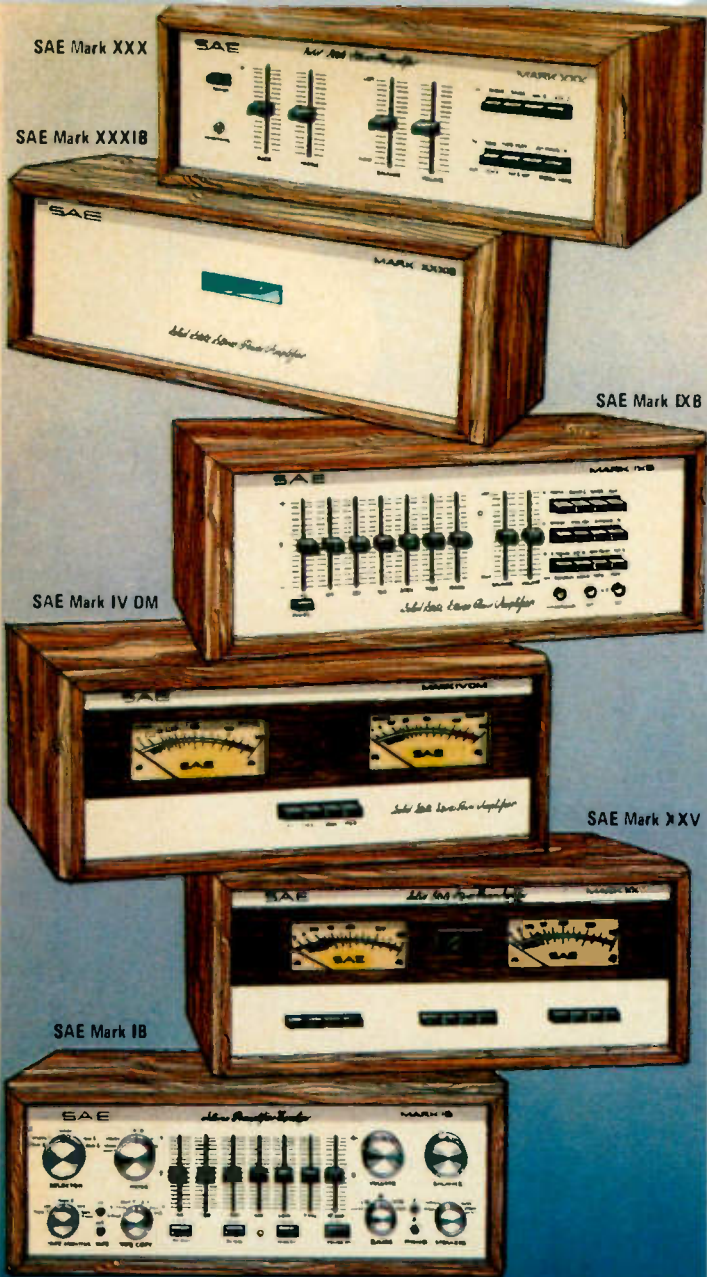

SAE Mark XXX

SAE Mark XXXIB

SAE Mark DXB

SAE Mark IV DM

SAE Mark XXV

SAE Mark IB

SAE

S.A.E. Preamplifiers, Power amplifiers and Equalizers have taken the professional field by storm. The acceptance of S.A.E. into their ranks has been almost unprecedented.

Mark XXX Preamplifier with Mark XXXIB Power Amplifier brings you Connoisseur Sound at budget prices. All unnecessary items have been omitted in the pursuit of the highest possible performance to price ratio.

The S.A.E. Mark XXXIB was tested by "High Fidelity" in May 1974, at 0.031% THD 20HZ to 20KHZ at 50 watts output per channel.

Mark IXB Preamplifier with Mark IVDM Power Amplifier. This combination brings you a versatile Equalizer Pre-amplifier with a power amplifier that was described in the "Popular Electronics" May, 1975 review as "True state-of-the-art performance with distortion levels that cannot be measured with any but the most advanced laboratory instruments." "For all purposes the Mark IVDM is a distortionless amplifier". Actual measurements were 0.005% at Rated 100 watts per channel and only 0.1% at 190 watts per channel!

Mark XXV Power Amplifiers. This is surely today's ultimate amplifier. It is rated at 300 watts per channel, both channels driven, into 8 ohms, and S.A.E. ratings are almost unreasonably conservative! Built-in forced air cooling ensures long life for all components.

Mark IB Preamplifier was designed for those who have, or intend to have, very complete audio installations. "Stereo Review" October, 1975, says "When it comes to operating and control flexibility, the S.A.E. Mark IB has few peers."

The harmonic distortion, excluding hum which "was far below audibility" was 0.0075% at all frequencies up to 20,000HZ.



MA1

MA3

MA5

MA7

Monitor Audio

MONITOR AUDIO is another new company. It has leapt to prominence in only two years. In the "Practical Hi Fi Audio" October 1975, comparison of ten loudspeakers including Spondor BCI, B & W DM4, Kef Cadenza, IMF Super Compact, the Monitor Audio MA5 Series 11 was chosen as best of all. Its very low colouration, sweet-sounding treble, openness, and tight extended bass endeared it to the reviewers.

Similarly the tiny MA7 was chosen as the best of five speakers in a test conducted by "Popular Hi Fi" (June 1975) although it was the smallest and cheapest of the units tested.

At the top of the range is the mighty MA3 which retains the qualities that have established Monitor Audio at the pinnacle of loudspeaker design and manufacture, but combining these—possibly for the first time—with a power output which is awesome and a level of bass distortion which must set new standards.

"Practical Hi Fi and Audio" May 1975, measured the third harmonic distortion of the MA3 at 100 HZ at "close to 1 per cent" at 96dB sound pressure level. At the critical midrange the distortion is between 0.3% and 0.6%.

They go on to say "The first impression one gets when listening to the MA3 is one of physical presence, and this quality seems to be independent of the closeness of recording. This may be attributable to the exceptional smoothness of its midrange unit together with the use of a very analytical tweeter."

All we ask is that you give them a hearing.

V.I.P

This is your special invitation to a full V.I.P. treatment at these selected Hi-Fi specialists throughout Australia. They guarantee you a personal hearing on our remarkable products.

N.S.W.: Kent Hi-Fi, 412 Kent St, Sydney.
Hi-Tel Hi-Fi, Skiptons Arcade, 541 High St,
West Penrith.
Hi-Fi House, Hurstville & Wollongong.
Newcastle Hi-Fi, 642 Hunter St, Newcastle.

VIC.: George Hawthorn Electronics, 966 High St.
Armadale.
Sound City, 360 Lonsdale St., Melbourne.

QLD.: Stereo Supplies, 95 Turbot St., Brisbane.

W.A.: The Audio Centre, 883 Wellington St., Perth

TAS.: United Electronics—Hobart, Launceston and
Burnie.

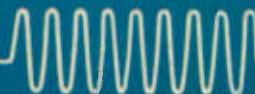

LEROYA INDUSTRIES LTD

Head Office: 156 Railway Pde., Leederville, Western Australia, 6007. Phone 81 2930.
N.S.W. Office: 100 Walker Street, North Sydney, N.S.W. 2060. Phone 9224037.
Victoria Office: 103 Pelham Street, Carlton, 3053. Phone 3477680.



(Continued from page 8)



play indicates the hour and the minute, the date, and AM or PM. The large, bright liquid crystal display can be seen in any light. In the dark, a built-in lamp can be activated to illuminate the face.

When split-second timing is required, the display can be switched to read in minutes, seconds, and tenths of seconds. Two buttons start, stop and reset the stopwatch. Unlike most conventional wrist chronographs, the built-in stopwatch on the Seiko unit is capable of performing multiple tasks. A lap timing feature allows the display to be frozen while internal timing continues. And a special 'one-two finish' feature allows the times of both the winner and runner-up of an event to be recorded, even if it's a very close contest.

The electronic stopwatch can also be used to measure elapsed time up to one hour.

Seiko Watch Sales
490 Kent St
Sydney 2000

FCC AMPLIFIER RULING REVISED

The recent ruling of the US Federal Trade Commission regarding amplifier testing has been revised.

The original ruling specified that amplifiers must be warmed up for one hour prior to testing at one third maximum load. This ruling was impractical

for most high-powered hi-fi amplifiers, which never operate under such conditions in real life, and caused major and unnecessary restrictions on claimed power ratings.

In the revised ruling amplifiers may be warmed up in a series of power bursts — going through as many on/off cycles as may be necessary to accumulate an hour of 'on' time.

CALCULATOR THAT TALKS



A calculator that speaks has been introduced by Telesensory Systems of Palo Alto, California, USA.

The unit called 'Speech Plus' enunciates each entry as it is made and then announces the answer. The unit has a

vocabulary of 24 words.

The advantage claimed for the speech facility is that it enables the user to perform a series of entries and calculations without continuously looking at the read-out.

FLUX-CORED SOLDER FOR ALUMINIUM JOINTS

Multicore Solders has applied for world patents for a flux-cored solder composition, called Alu-Sol 45D silver loaded solder, which is claimed to have excellent corrosion resistance and a melting range of only 178 to 270°C.

Joining aluminium and its alloys has previously been considered impossible except by welding or high temperature

brazing with very aggressive fluxes. It is difficult to heat aluminium to the high temperature required — for such treatment distorts the aluminium. Lower temperature brazing and soldering has not been effective, the filler metals used having been incompatible with aluminium and the joints having failed subsequently due to electrolytic corrosion.

The new solder easily solders wrought aluminium and its alloys containing up to 3 per cent magnesium or 1.5 per

the Elephant & the Ant



The old fable, of the ant bragging about how he was stronger than an elephant, is pretty well known. By simply taking residence in the trunk, he was able to make the elephant do precisely what he wanted. But, in spite of this, the tiny ant's antics still didn't diminish by one jot the power and capabilities of his mammoth protagonist. Think of the Klipsch as the elephant. The speaker wires as the trunk; and the comparatively insignificant Marantz 1070 amplifier as the ant. The fortune you spend on the 'La Scala' could be the savings you make in the system. Because Klipsch speakers are *efficient*. So huge power ratings are totally unnecessary to drive them to perfection. The Klipsch 'La Scala' comes King-size in a speaker jungle of pygmies. But it's

not just dimension that makes it so awesome. Consider its low distortion system over a wide range of frequencies, with bass range extending solidly to 45 Hz usable to 40. And, although the woofer unit occupies only 8 cubic feet, the response, range and efficiency equal or exceed systems of considerably larger size. So, when you're considering a music system—or upgrading your present gear, take a look at the TOTAL figure, and then see how economical one of the world's most expensive speakers can be! You'll never forget the experience of KLIPSCH! Available from highly selective Hi-Fi dealers or write for brochure to: Auriema (A'asia) Pty Ltd P.O. Box 604, BROOKVALE, N.S.W. 2100. Phone: 939 1900.

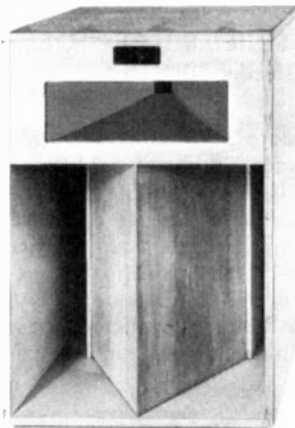

Klipsch

AUM10.25.19cm

cent each of magnesium and silicon, and aluminium-copper. Cast aluminium can be soldered if the rough case surface is machined off. Other solderable metals include tin-plate, copper, brass, nickel, stainless steel and zinc alloy diecastings.

Multicore Solders Aust Ltd, PO Box 150, Ermington NSW 2115.

SEMICONDUCTOR APPLICATIONS MANUAL

A revised and updated edition of the popular 92-page Applications Manual covering the Plessey SL600 series of semiconductors designed specifically for radio communications is available through the Components Division of Plessey Australia, PO Box 2, Villawood 2163 for \$2.85 a copy.

First published in the UK in 1972, the new edition will satisfy an extensive Australian demand for full information on the Plessey range.

NEW MINIATURE CASSETTE

An ultra-small tape cassette measuring only 33.5 by 50.2 by 8.1 millimetres has been developed by Olympus Optical Co of Japan for use with a new series of tiny pocket sized cassette voice recorders that that company are already producing. A similar machine using the same cassette is also being produced by Matsushita. Sony too are planning to enter this market.

The tiny recorders operate at a tape speed of 24 mm a second.

CALCULATOR TO WIN!

THIS MONTH our Unitrex contest features the model 901SN. This is a scientific calculator with scientific notation permitting the solution of problems ranging from 10⁹⁹ to 10⁻⁹⁹.

The unit has an nine digit display in arithmetic mode, five digit mantissa and two digit exponent in scientific notation.

Functions include — computing trigonometric, inverse trigonometric, logarithmic exponential and convenience functions (1/x, x², √x, π) etc. The keyboard consists of momentary keys and a static mode select switch for choosing angle values in degrees or radians.

That's a lot of computational power for its recommended retail price of \$39.95.

Here's a chance to win one of these units. It's not a new problem but it is one the answer to which often surprises those who've never thought about it before — or worked it out for themselves.

Twenty six people work in an office in Melbourne.

What do you think the chances are that two or more of these people will have their birthday on the same day?

Just ring the answer on the entry form that you think is the closest.

All answers, which must be received before May 15th, will be put into a barrel and drawn one at a time until a correct answer is received. That first correct entry will be the winning one.

Entries should preferably be sent on the official entry form printed on this page. If like many of our readers you'd sooner not cut up your ETI just copy the entry form

on to a sheet of paper. Do please remember to include your name and address. Entries close May 15th 1976.

The winner will be announced in ETI as soon as possible.

RESULT OF FEBRUARY CONTEST

Winner of our February contest was Mr B. Fergie of Brighton, Victoria.

Thirty five contestants sent in entries with absolutely correct answers to the main question — which concerned the monthly payments and interest payable each year on a loan of \$9387 over four years at 11.25%.

Most contestants failed to realise that the interest payable each year falls very considerably.

The correct answers to this part of the question are — monthly payments —

	\$243.75
interest 1st year	\$956.59
interest 2nd year	\$723.36
interest 3rd year	\$462.49
interest 4th year	\$170.71

The second part of the contest which we used as a tie breaker asked entrants to estimate how long it took our technical editor to obtain the correct answer (having first worked out the routine) on a basic four function machine. And secondly how long it took him using a Unitrex 901F.

Our winning entrant estimated the times as 207.5 secs and 38.5 secs respectively. The actual times were 181.5 secs and 32.4 seconds respectively.

So congratulations Mr. Fergie, you'll have your Unitrex 901F financial calculator very soon.

Send to Calculator Contest (April)

Electronics Today International, 15 Boundary St, Rushcutters Bay, NSW. 2011.

The chances are 5%, 10%, 14%, 21%, 25%, 33%, 39%, 45%, 50%, 63%

Name

Address

P/Code

Permit Number TC 7407.



COLOUR TV & COLOUR VIDEO ANNOUNCEMENT

OPEN 7 DAYS FOR SALES AND SERVICE. HAVE COLOUR TV TODAY

IMMEDIATE DELIVERY

- 63 cm. Phillips ● 63 cm. Blaupunkt, Siemens, Normende, Grundig, Luxor, with full remote control.
- 63 cm. Spectra 75, push-button tuning ● 63 cm. Finlux, beautiful Consul Rosewood, push-button tuning.

VIDEO EQUIPMENT

- National Cartridge recorder colour ● Nivico Umatic cassette recorder colour ● Loewe Opta VCR TV tuner recorder colour ● ITC 1/2 in J reel to reel recorder colour ● Sony 13 receiver monitor colour ● Rank video technics 43 cm receiver monitor colour ● Rank video technics 63 cm receiver monitor colour.

Authorised dealers Akai portables, colour or black and white, Akai colour camera sets. Used black and white video equipment always in stock at keen prices. Trade terms.

The Video & Hi-Fi Centre

Commercial Concepts

Phone 312-555 — 445 Oxford St., Paddington, N.S.W. A.H. 451-7876



It's very gratifying when you start at the bottom and work your way to the top.

At AKAI, we concentrate on being better. Not bigger. So you'll probably find bigger hi fi ranges than ours.

But you'll have your work cut out finding a better range. For quality. Performance. And reliability.

All our equipment is listed below. And each and every piece of hi fi equipment distributed by AKAI Australia is covered by the Complete Protection Plan[†]. Which simply means

12 months full parts and labour warranty on all Tape Equipment, 2 years full parts and labour warranty on all Amplifiers, Turntables and Speakers and a lifetime warranty on all GX Tape Heads.

So, whether you're new to hi fi, or an old hand at it, you'll find something exactly right. We'll stack our reputation on it.

PORTABLE	\$	OPEN REEL DECKS		RECEIVERS		SPEAKERS	(per pair)
CT-5	175.00	GX-230D	550.00	AA-810	250.00	SW-30	75.00
CASSETTE RECORDERS		GX-265D	710.00	AA-810DB	310.00	SW-35	119.00
CS-34	280.00	GX-270D	685.00	AA-1020	330.00	SW-42	150.00
GXC-39	380.00	GX-400D	1445.00	AA-1020DB	455.00	SW-126	245.00
CASSETTE DECKS		GX-400DP	1365.00	AA-1030	375.00	SW-136	310.00
CS-34D	220.00	GX-400DSS*	1593.00	AA-1040	430.00	SW-156	385.00
GXC-39D	360.00	GX-600DP	770.00	AA-1050	485.00	SW-176	580.00
GXC-75D	498.00	GX-630D	810.00	AA-1070	760.00		
GXC-325D	550.00	GX-630DB	910.00	AS-1080	845.00		
GXC-710D	439.00	GX-630DSS*	1090.00	AS-1080DB	990.00		
CARTRIDGE RECORDERS		GX-1820D	605.00	TUNER			
GXR-82	395.00	4000DB	379.00	AT-550	260.00		
CR-80SS*	528.00	AMPLIFIERS		TURNTABLES			
CARTRIDGE DECKS		AA-5210	215.00	AP-001C	155.00		
GXR-82D	345.00	AA-5210DB	299.00	AP-003	235.00		
CR-80DSS*	435.00	AA-5510	299.00	AP-005	290.00		
OPEN REEL RECORDERS		AA-5810	375.00	AP-006	330.00		
1730SS*	535.00						
GX-1820	660.00						

[†] The AKAI Complete Protection Plan warranty does not cover equipment purchased outside Australia

* 4 channel
DB in model name signifies Dolby System
Prices quoted are the recommended retail prices only

AKAI

The name you don't have to justify to your friends.

THE CELESTIONS ARE COMING

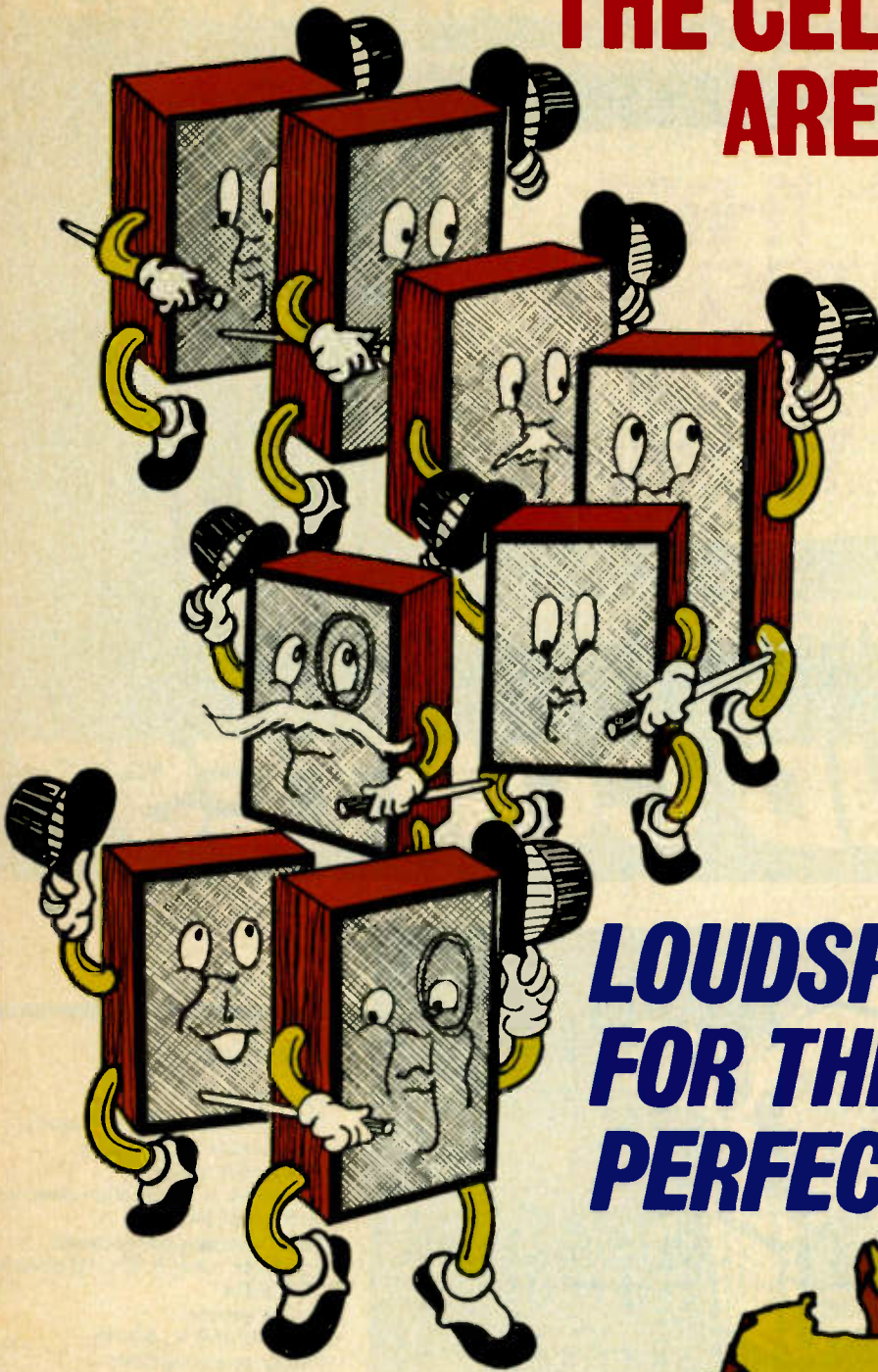

LOUDSPEAKERS FOR THE PERFECTIONIST



Celestion

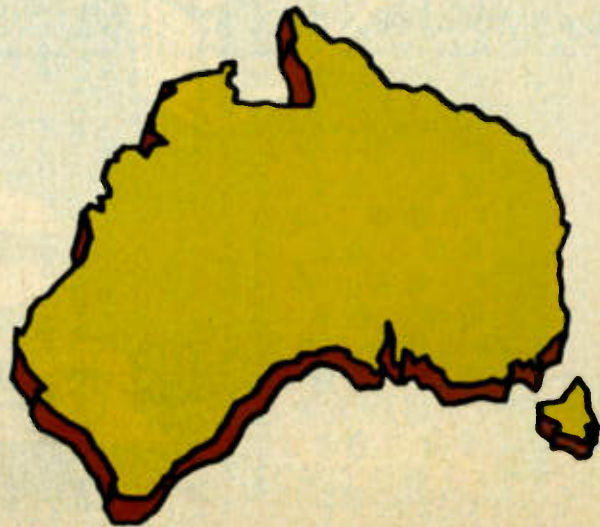

ELECTRONICS TODAY - TOSHIBA



GRAND CONTEST

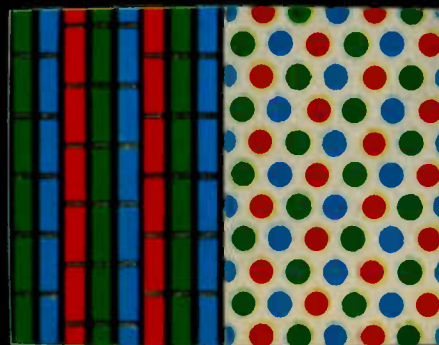
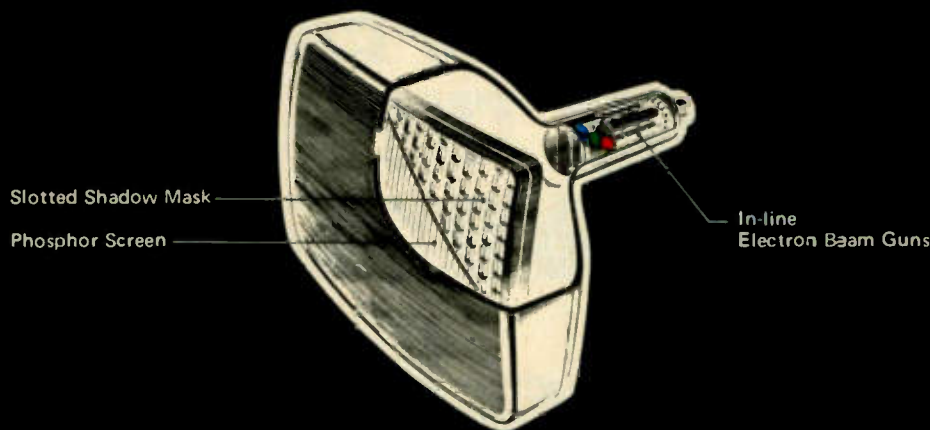

Toshiba "BLACKSTRIPED" Usual Colour
Picture Tube Colour Picture Tube

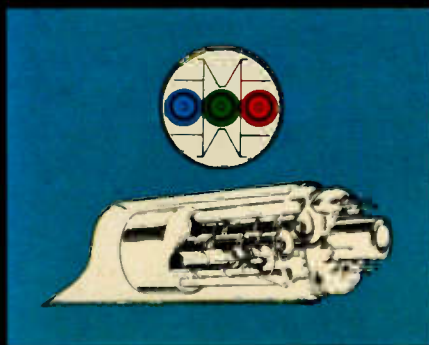

Toshiba's Special In-line Electron Beam Gun

Specifications

- Picture size:**
33.5cm measured on diagonal
of viewable picture area
- Frequency range:**
Receivers all Australian channels
VHF and UHF.
- Tube and semiconductors:**
1 picture tube, 8 ICs, 18 transistors,
37 diodes
- Power source:**
AC 240/250 V, 50 Hz
- Power consumption:**
78W
- Audio output:**
1.0W (max.)
- Speaker:**
7cm x 10cm (oval)
- AGC system:**
Keyed
- Dimensions:**
47.8cm (W) x 34.1cm (H) x
40.7cm (D)
- Weight:**
17.5 kg
- Design and specifications subject
to change without notice.

HERE ARE THREE SEPARATE CHANCES to win one of Toshiba's magnificent portable colour TV's. On the following pages are three competitions. Each is self-contained and quite different from the others. Entrants may enter any or all of the contents. Each contest will be judged independently but if one contestant wins more than one contest, only one prize will be awarded to that contestant — the runner-up will then receive the prize.

The contest is sponsored jointly by Electronics Today International and Toshiba — who have most generously donated the prizes.

PORTABLE colour television never looked better — both for cabinet design and performance. It never looked better, because the Toshiba C-412 Portable Colour Television comes to you in a beautiful white cabinet to tone in with any home's decor. For performance the Toshiba C-412 uses Toshiba's unique BLACKSTRIPE™ Picture Tube to assure you of crisp colours and long lasting brilliant images.

The BLACKSTRIPE™ picture tube is the perfect answer for achieving beautiful natural colour. With the BLACKSTRIPE™ tube, there is no loss of sharpness in images you see on the screen because only the necessary phosphors are illuminated. This lets you enjoy images with maximum natural brilliance — without glare.

Another outstanding feature of the Toshiba C-412 is the new 'in-line

electron beam gun'. There is nothing like it when it comes to beaming out natural colour.

On the rare occasions when your Toshiba C-412 receiver requires servicing, replacement and repair is fast and easy. This is because the module suspected of containing a fault is removed and a replacement module is slotted in its place. It is as simple as changing a stereo cassette or cartridge.

TOSHIBA

Japan's first electrical equipment factory was started almost exactly 100 years ago. Its founder, Hisashige Ghi-emon Tanaka was born 75 years previously - in 1799.

Ghi-emon's company was the beginning of the great Toshiba organisation which today is one of the largest in the world and has acquired a world-wide reputation of innovative and advanced technology.

Today Toshiba products are exported to more than 120 countries worldwide. Most popular among the great variety of products are television receivers, stereo sets, electronic ovens, air conditioners and electronic calculators. In addition to these, orders are increasing for large-scale and heavy electric equipment.

Three 820 000 HP water turbines, the world's largest, were recently supplied to the United States; a large-capacity, high-voltage power generating system for Canada included transformer and 282 000 kW water turbines; and two steam turbine generating equipment of 660 000 kW each plus six 283 000 kW water turbines were built for Australia.

Other important exports include broadcasting equipment supplied to Brasil and Malaysia, large quantities of X-ray equipment and linear accelerators for medical use; and other sophisticated, technologically advanced equipment to the United States and other countries.

CONTEST RULES

This contest is open to all persons normally resident in Australia with the exception of members of the staff (or relatives thereof) of Modern Magazines (Holdings) Ltd, Australian Consolidated Press, Wilkes Pty Ltd and/or associated companies.

Entries should be addressed to, ETI/Toshiba Contest, Electronics Today International, 15 Boundary St, Rushcutters Bay, NSW 2011.

Closing date for the contest is May 31st 1976. Entries received within seven days after May 31st will be accepted as long as they are postmarked May 31st or before.

The contests will be judged by the Editor and Assistant Editor of Electronics Today International. Their decisions will be final. No correspondence can be entered into concerning their decisions.

In the event of one or more tied results the finalists' entries will be thoroughly mixed and then drawn by the Editor.

It should be noted that each contest is a totally separate entity — the results achieved in one will in no way affect the score in another — nor will they in any way influence the final judging.

Winners will be advised by telegrams sent on the same day that the results are known. The names of the winners, together with the winning answers, will be published in the first possible issue of Electronics Today International.

Contestants must enter their names and addresses where indicated on each contest — they must *also* complete and return the official entry form and must answer the questions on that form (page 23 of this issue). Photostats or clearly written copies of the various contests will be accepted but we *must* have the *original* of page 23 with each set of entries.

Remember the entry form on page 23 covers one, two or all three of the contests. However if you wish to submit multiple entries (or sets of entries) for any particular contest you will of course need extra copies of the magazine so that you can send page 23 with each set.

A reader survey form is printed on the *back* of page 23. We would very much appreciate it if you would complete this when sending in your entry but we would however like to stress that completing the survey form is in no way a condition of entering the contest/s.

Who-What-Which-Why

Here are fifteen questions several of which have multiple parts.

All single-part questions have a maximum obtainable score of ten, multi-part questions have a maximum obtainable score of five per part.

Although we're probably about to be proven wrong by half the entrants we don't really expect that any entrant will have a perfect score, so if you can't find the answers to some of the questions just have a guess. You could well be right!

Needless to say the entry with the highest total score is the winner. In the event of a tie the conditions described in the contest rules will be applied.

Contest No.1

A1 Why is a transistor so-called? (i.e. from which two or more words is the name derived?)

.....
.....

A2 Who invented the Wheatstone Bridge?

.....
.....

A3 Born in 1768 he accompanied Napoleon on his expedition to Egypt (in 1798). He was a member of the French Academy of Sciences. The techniques he developed are today particularly relevant to electronics. Can you analyze who he was?



.....
.....
.....

A4 Who said 'Evil communications corrupt good manners'?

.....



A5 The moving coil principle as applied to microphones and loudspeakers is generally accredited to Rice and Kellog (1926). There were however at least two earlier patents in this field. Who were the people or companies who filed these patents — and in roughly which years.

.....
.....
.....
.....

A6 "The moment man cast off his age-long belief in magic, science bestowed on him the blessings of the Electric Current". Who wrote that?

- | | | | |
|--------|--------------------------|----------|--------------------------|
| Huxley | <input type="checkbox"/> | Emerson | <input type="checkbox"/> |
| Fromm | <input type="checkbox"/> | Carlyle | <input type="checkbox"/> |
| Shaw | <input type="checkbox"/> | Giradoux | <input type="checkbox"/> |

A7 Who opened the window to the study of what — and which unit appropriately bears his name?

.....
.....

A8 What is The Comma of Pythagoras?

.....

When

A9 Briefly, what is Barkhausen noise?

.....

A10 This man is better known for his religious activities — he also wrote this book — who was he?

.....

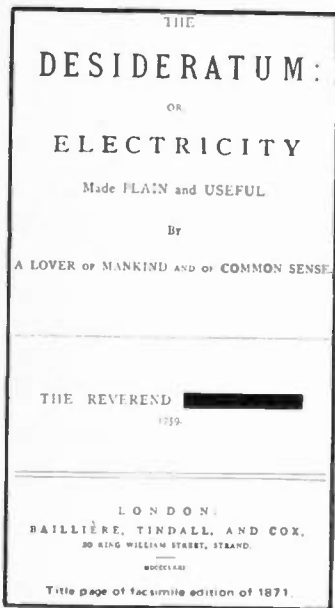

A11 By what title was John William Strutt better known — and in which field of endeavour did he primarily make his scientific reputation?

.....

A12 From a mathematical viewpoint, mechanical mass, electrical inductance and a volume of air contained in an enclosure each represent the same quantity. Without using mathematics explain what the quantity is.

.....

A13 Did the first galvanometer use electromagnetic — or electrostatic-detection?

.....

A14 The terms cation, anion and ion were coined to help explain the electrolysis process: they began the doctrine of electronics. In what year and by whom were the terms proposed?

.....

A15 Who was 'the Princess of Parallelograms'?

.....

Who was her tutor?

What was her husband's name and title?

.....

Who was her daughter's executor?

What do all the above questions have to do with the picture below?

.....

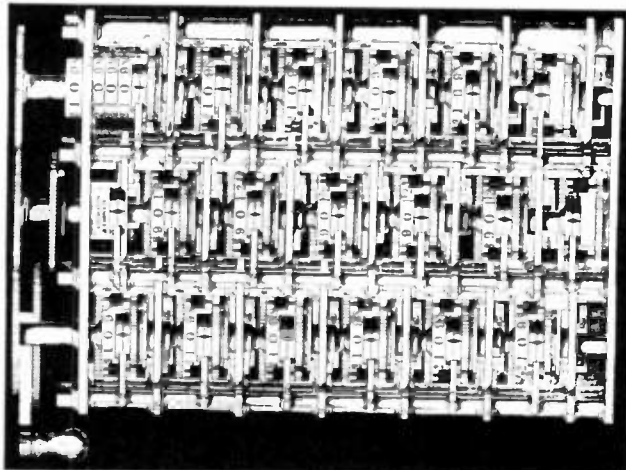

Name

Address

.....

.....Postcode

Permit Number: TC 7407

...a pair of long-nosed fliers

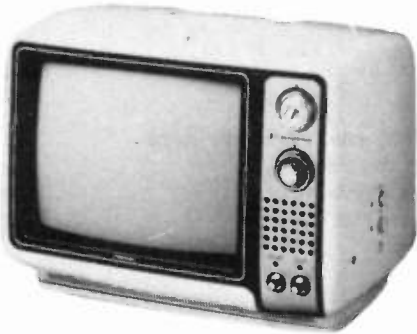

Contest No.2

... a pair of long-nosed fliers.

Duck Smith

The control element is in fact in a fridge.

Electronics emitted from the heated cathode piss across the anode.

Engineers at Motorola are urging their customers to consider using germanium devices.

Ultra-high selectivity is obtained by using a double super-heat system

... a pulse is provided so that an oscilloscope can be concreted to the instrument.

Mozart wrote a concerto for the first abo.

the amplifier is guaranteed for three tears.

In the explosion method, the shock wave generated by a charge is made to travel through an argon filled box ... the resultant compression of the argon gas causes it to emit intense radiation in the ultra-violet region.

slugged relazy coils

NEW DETERGENT FOR DRUNKEN DRIVERS

... such an arrangement is now known as a double-sided snadwich motor.

A WELL KNOWN AUSTRALIAN CAMERA MAGAZINE RECENTLY distinguished itself in the introduction to an article on photography for beginners by printing the lead picture back to front.

And no one in the publishing business even smiled — because it can happen to any of us and it can happen only too easily. It's extraordinary how errors can creep into the printed word. Even more extraordinary how they stay unnoticed until after the magazine is printed — when they glare from the page like a beacon.

Every single page of Electronics Today is very thoroughly checked on at least three separate occasions before printing. Our projects are checked by three different people at separate times.

Yet still errors occur!

It's an old old problem going back right to the early days of printing. "The Fates", said Santayana, "like an absent-minded printer, seldom allow a single line to stand perfect and unmarred".

Sometimes an attempt to correct a fault will introduce another. A picture might be improved by increasing its size — but, as happened to us back in 1972, the printer may now print the larger picture back to front. Shakespeare knew all about this. In King Lear he said "Striving to better, oft we mar what's well".

Even the most respected of publications contains the occasional error. That most authoritative of journals 'Sciences' (published by the New York Academy of Science) once confessed that 'the object captioned the great icosidododecahedron is actually the great icosicosidodecahedron'. If you don't believe it check their September/October issue of 1972.

Errors creep in primarily because magazines are handled by a large number of people — such as compositors, platemakers, printers etc — who whilst being conscientious and careful — have no specialised knowledge of the subject matter.

It is totally obvious to ourselves and to our readers when a pc board pattern is printed back to front. But to a printer it's not — and whilst it's never happened to us so far, one otherwise respected electronics journal once had every pc board layout printed back to front throughout an issue because a printer corrected what he assumed was an editorial mistake.

For every error which does creep in there's a dozen or so that we find in time. Some of these are quite funny and sometimes we're sorely tempted to leave them in.

Over the years we've made a note of some of the odder or funnier 'literals' (as they're called in the industry).

Some of these are reproduced on this page. Here's a chance to see what was *almost* printed. PLUS a chance to win a Toshiba Colour TV by telling us what you think each faulty item *should* have read. Using the same sequence as in our original just rewrite each separate item as you think it *should* have been — and in fact as each finally appeared.

The comical Walsh driver can be clearly seen at right

Having the loudspeaker sound originate near the original source provides a more natural effect for the audience — and avoids fusing the performer.

SINEWAVE POWER SAUCE

LEARNING THE NORSE CODE

The output of IC5 is negative however and must be invented by IC6.

Suspend the coil from a horse-show magnet

chassis earth bug

A plastic cover is fitted to provide damage to the output transistors.

Basic variable sin circuits.

Name:

Address:

..... Post Code

Permit number TC7404

Jumbo less six Contest No.3

All answers are numbers — not words. Decimal points and leading zeros are ignored.

ACROSS

1. TTL decade counter
4. Half of 29 down
6. How many symphonies did Mozart write?
7. Frequency ratio of two adjacent notes in musical scale
9. Speed of light — miles/second
12. Standard atmosphere (S1)
14. Proton-to-electron mass ratio
16. 1011111 in decimal.
17. 2N ——— a popular power transistor
19. TV line frequency (PAL system)
21. 63 in octal
22. CMOS dual JK master/slave flip flop
24. 1313.6° Fahrenheit in SI system
27. It should be induced how you would react to 2 _ FL
30. Carbon used for dating
31. Intel microprocessor IC
32. Last but not lucky

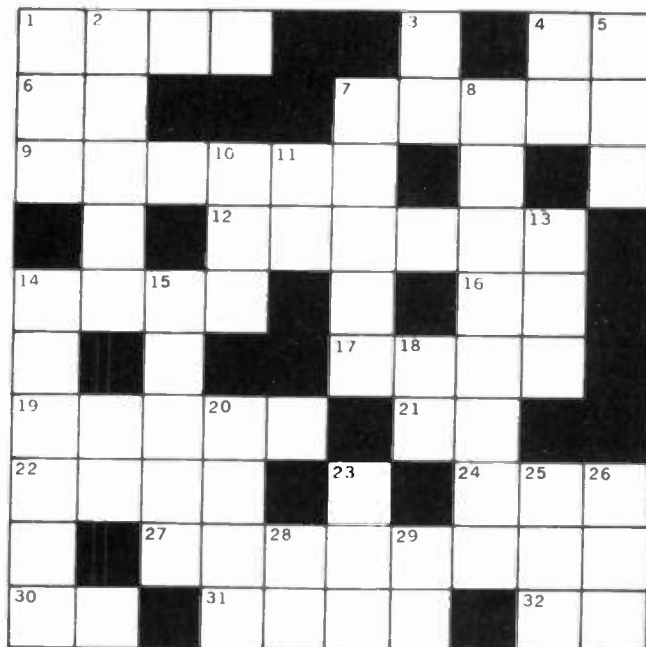

DOWN

1. Jumbo less six — an operational amplifier
2. How many joules in an international calorie?
3. It's violet and black
4. Atomic number of a policeman
5. Most sensitive wavelength to standard eye
7. Voltage of Weston standard saturated cell
8. One radian in decimal degrees
10. Twice the number of BC108s
11. Cross twice and add C.
13. Eight-pin timing IC
14. Ratio of peak to rms in a sine wave

15. 5 dB as a power ratio
18. James Bond has lost nothing
20. Base of Naperian logarithms
23. An operational amplifier — to be precise from National
25. A square cricket team
26. Absolute zero
28. The roaring — — s
29. L

Permit number TC 7404

Official Entry Form

Please answer these questions relating to the Toshiba colour TV's offered as prizes. The answers to these questions can be found by studying page 18 of this issue.

I have read and agree to abide by the contest rules published on page 19 of this issue.

NAME

ADDRESS

.....

.....

..... Post Code

PLEASE SEND IN THE WHOLE OF THIS PAGE

TOSHIBA COLOUR TV

What advantages are claimed for Toshiba's Black Stripe picture tube?

Will the C-412 receive *all* Australian TV channels — including UHF channels?

What particular feature ensures that the C-412 receiver can be speedily serviced. It has been described as 'simple as changing a

Fill in missing words.

The electron beam gun in the Toshiba C-412 is an '..... Add missing words.

Survey '76

Our survey in July 1974 provided us with a great deal of useful data as a result of which we made a number of changes.

We would now once again very much like to know what readers think about our present format — particularly regarding our constructional projects. We would like to hear from readers who like things just as they are (if we have any!) as well as those who would like to see some changes.

As a token of our appreciation we will draw 12 of the received forms at random and award one year's free subscription of ETI to the senders of each.

Please rank our constructional projects in your order of preference. If two or more categories are of equal interest use same ranking number in each.

- Test equipment
- Simple projects
- Car equipment
- Audio
- Amateur radio
- General

What other types of project would you like to see

Are our projects generally —
 too simple
 about right
 too complex

Do you buy parts for your projects
 In kit form
 As and when required

There are many possible projects such as garage door openers, yacht and aircraft radio control etc etc for which we can readily supply electronic, but not mechanical details (as the latter will vary a great deal from one application to another. Would you still nevertheless like to see such projects published — albeit in semi-complete form. Please grade your interest on a scale of 0-10. (0 = zero interest).

Please tell us any way in which you think our projects could be improved.

What is your occupation?

Comments — ETI generally

Please circle the applicable number or numbers in each question.
 1/ How did you get this copy of Electronics Today?

- Bought yourself at newsagent 1
- Comes on subscription 2
- Bought by someone else in household 3
- Someone (outside family) passes it on 4
- Other means 5

2/ Usually, how many issues of Electronics Today do you read?

- Less than 3 copies a year 1
- 3-6 copies a year 2
- 7-9 copies a year 3
- More than 9 copies a year 4

3/ How many people other than yourself read this copy of Electronics Today?

- | | | | | |
|---|---|----|----------|---|
| 1 | 4 | 7 | Nil | 0 |
| 2 | 5 | 8 | Not sure | X |
| 3 | 6 | 9+ | | |

4/ What happens to this copy of Electronics Today?

- Keep it for a while 1
- Pass it on 2
- Throw away 3

5. How many of the advts do you read in Electronics Today?

- Most 1
- About three-quarters 2
- About half 3

- About a quarter 4
- Very few 5

Generally, how often do you look at each of the following:
 Please circle the applicable number against each of the magazines listed.

	Do not read	Less than 3 copies a year	3-6 copies a year	7-9 copies a year	More than 9 copies
6/ REVS	1	2	3	4	5
7/ Two Wheels	1	2	3	4	5
8/ Motor Cycle News	1	2	3	4	5
9/ Modern Motor	1	2	3	4	5
10/ Wheels	1	2	3	4	5
11/ Motor Manual	1	2	3	4	5
12/ Modern Boating	1	2	3	4	5
13/ Seacraft	1	2	3	4	5
14/ Modern Fishing	1	2	3	4	5
15/ Australian Angler	1	2	3	4	5
16/ Fishing News	1	2	3	4	5
17/ Electronics Today	1	2	3	4	5
18/ Electronics Australia	1	2	3	4	5
19/ Hi Fi Review	1	2	3	4	5
20/ Australian Hi Fi	1	2	3	4	5
21/ Camera and Cine	1	2	3	4	5
22/ Australian Photography	1	2	3	4	5
23/ Wireless World	1	2	3	4	5
24/ Practical Electronics	1	2	3	4	5
25/ Practical Wireless	1	2	3	4	5
26/ Elementary Electronics	1	2	3	4	5

27/ Sex

- Male 1
- Female 2

28/ Salary (Gross)

- Less than \$8,000 p.a. 1
- \$8,000—\$9,999 2
- \$10,000—\$14,999 3
- \$15,000—\$19,999 5

29/ Educational Level

- School Leaving Certificate 1
- Matriculation 2
- Higher School Certificate 3
- Technical College 4
- University 5
- Post-graduate 6

30/ Age

- Under 16 1
- 16—20 2
- 21—25 3
- 26—30 4
- 31—35 5
- 36—40 6
- 41—45 7
- 46—50 8
- 51—55 9
- 56—60 0
- 61 and over X

If you would like to be included in our free subscriptions draw please add your name and address.

- Name
- Address

ms Components

electronics pty ltd

THE GREAT NAME FOR ELECTRONIC
95-97 REGENT ST., REDFERN. TEL. 69-5922.



COMPONENTS IN AUSTRALIA
P.O. BOX 156, REDFERN, NSW 2016

NEW

MINIATURE MODEL MOTORS

12 v dc permanent magnet 'Lenco' motor, Italian manufacture with inbuilt centrifugal speed regulation originally used in record players. Complete with electromagnet shield and series inductor. Dimensions:
Overall length 70 mm.
Diameter: 35 mm.
Spindle Length: 20 mm.
M.S.C.'S PRICE:
\$2.25 POST FREE.



SCOOP PURCHASE OF DIGITAL CLOCK MECHANISM'S

All new and unused... fully imported. Complete with Time-setting control, denoting HOURS, MINUTES & SECONDS. Clearly visible figures of 5/16" Ht. Also incorporated are two remote micro-switches for setting Alarms, Radio's or Television etc. With 240V 50Hz Motor.
AMAZING VALUE AT
\$10.25 each P & P \$1.25



THE NEW & GREATLY IMPROVED 3 WAY CROSS-OVER NETWORK BY PHILIPS.



Type ADF600/4000/8A.
Specs: 8 Ω 240 Watts. Frequency: 600 & 4000 Hz. Dimensions: 102 x 185 x 30 mm. Complete with Connecting Leads & Faston Connectors.
M.S.C.'s Price ONLY \$48.00 per pair. P & P \$2.

NEW

HEWLETT PACKARD NUMERIC INDICATOR DISPLAY

DESCRIPTION

The HP 5082-7300 series solid state numeric indicators with on-board decoder/driver and memory provide a reliable, low-cost method for displaying digital information. The 5082-7300 numeric indicator decodes positive 8421 BCD logic inputs into characters 0-9, a ".", sign, a test pattern, and four blanks in the invalid BCD states. The unit employs a right-hand decimal point. Typical applications include point-of-sale terminals, instrumentation, and computer systems. Supply Voltage 4.5 - 5.5V. Size: 4" x 2 9/16".
M.S.C. SPECIAL PRICE
\$12.00 ea.
Post Free.

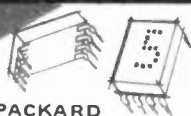

'INTERNATIONAL TIME' DIGITAL CLOCK KIT.

A new kit with extraordinary efficiency. Easy to build, and complete with all necessary components, including: 4 1/2" Digit fluorescent readout (blue), Texas TS3834 chip, speaker, ready etched P.C. board, switches, wire and screws etc. Also has snooze alarm and seconds readout. Supplied with handsome moulded ready-to-fit case.



M.S.C. PRICE ONLY
\$36.00 P & P \$2.00.

THE PHILIPS 14A SPEAKER SYSTEM KIT.

Finish up with a fantastic sound with Philips technology. The Kit comprises the following:— 2 x AD12100/W8 12" 40 Watt Woofers.
2 x AD0210/SQ8 2" Dome Squawkers at 50 Watts.
2 x AD0160/T8 1" Dome Tweeters.
2 x AD600/4000/8 New 3 Way-Cross-Over Networks.
SPECIAL M.S.C. Offer \$225.
Sent Freight Forward by COMET.

THE PHILIPS 2" HIGH POWER DOME SQUAWKER TYPE AD0210/SQ8



Power handling capacity: 50W rms (with cross-over filter type ADF600/4000/8)
Impedance: 8 ohms. Resonance freq: 270 Hz.
Freq. range: 300 Hz-7 kHz. Operating power: 5W rms. Power handling capacity: 15W rms.
Magnet material: Ferroxdure Wt. of loudspeaker: 1 Kg. **M.S.C.'s SPECIAL INTRODUCTORY OFFER \$38.00 ea. P & P \$2.00**

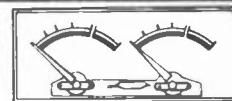

DUAL VU METER - in clear plastic case. Size 4 1/2" x 2" (type 48)
F.S.D.: 500 mA at 1.2 K Ω
\$8.95 EA. P & P 75c.



SIGNAL METER - in clear plastic case. Scale 0-5
F.S.D. 500 mA at 410 Ω 7/8" x 1 1/4".
\$3.50 EA. P & P 50c (TYPE 49)



SIGNAL METER - as above (type 54).
Dimensions: 1 1/2" x 1 1/2".
\$3.00 EA. P & P 50c.

LOOK!

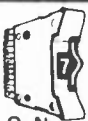

10 POSITION THUMBWHEEL SWITCH, BCD & COMPLIMENTARY BCD. Moulded grey body, White numerals on Black background. Size approx: 10mm x 33mm x 46mm. Normally \$4.50 each. **M.S.C.'s SPECIAL OFFER ONLY \$2.25 each or 10 for \$21.00. P & P Single Item 30c or 10 for 75c.**

SPECIAL



AN IDEAL GIFT. The EXPO DX-2020. TRANSISTOR STEREO AMPLIFIER. Specifications: 20 Watts RMS per channel. **FREQUENCY RANGE: 20-30 KHz.** Channel separation better than 45 dB.
NORMAL PRICE \$145.00 NOW FROM M.S.C. \$110.00 P & P \$5.00.

LOCK-DOWN AERIALS.

Suitable for all cars for wing mounting. Extends to 3' 4". Completely vandal proof & includes 4' lead & Connector.
Clearing offer ONLY \$2.99 each P & P \$1.



NEW

REFLEX HORN SPEAKERS.

Useful for Outdoor paging etc. Impedance 8 Ω Power rating approx. 6 watts. Complete with swivel bracket. **ONLY \$8.95 each. P & P \$1.25.**



MOTORIZED ELECTRIC AERIAL.
M.S.C.'s Price only \$17.60. P & P \$3.00.



bankcard
welcome here

Trading Hours

MON-TUES-WED & FRI: 9am-5.30pm. THURS: 9am-7pm. SAT: 9am-1pm.
C.O.D.'s: Please add \$2.40 to posting fee. NO ORDERS UNDER \$3.00 accepted. For replies please send S.A.E. Post and Packing 50c where not included in price. PLEASE... PLEASE PRINT YOUR NAME & ADDRESS ON ALL ORDERS AND CORRESPONDENCE.

MS Components

electronics pty ltd

Scoop Purchase

OF 1,000,000 (ONE MILLION) SEMI-CONDUCTORS. MUST BE CLEARED AT THE MOST STAGGERING PRICES EVER OFFERED — THESE DEVICES ARE MAINLY UNMARKED AND SLIGHTLY BELOW SPEC'S, BUT ARE GUARANTEED USABLE.

ALL EM SERIES DIODES ARE MARKED AND FULLY GUARANTEED. TAKE YOUR CHOICE WITH THESE SPECIAL PACS. POST & PACKING 50c per pack.

PAC No.	CONTENTS	PRICE	PAC No.	CONTENTS	PRICE
SC. 1	3 100 V 3 amp Rectifiers, 3 100V 5 amp TO5 Rectifiers & 3 2N3055-1 Power Transistors	\$1.00	SC. 8	10 each of the following:— 100V 3 amp Plastic Rectifiers, 100V 5 amp TO5 Metal Case Rectifiers, 2N3055-1 Power Transistors, TO66 Power Transistors, TO18 Silicon Transistors, TO5 Silicon Transistors (NPN & PNP) (Total 60)	\$5.00
SC. 2	100 Assorted TO18 & TO5 NPN & PNP Silicon Transistors	\$2.50	SC. 9	50 EM402 Diodes, 200V 1 amp	\$3.00
SC. 3	5 TO66 (2N3054 Series) Transistors & 5 MS3055-1 (Marked) Power Transistors	\$0.90	SC. 10	50 EM404 Diodes, 400V 1 amp	\$3.75
SC. 4	100 100V 3 amp Plastic Rectifiers	\$4.50	SC. 11	50 EM406 Diodes, 600V 1 amp	\$4.00
SC. 5	100 100V 5 amp TO5 Metal Case Rectifiers	\$5.00	SC. 12	50 EM408 Diodes, 800V 1 amp	\$4.25
SC. 6	20 2N3055-1 (Unmarked) Power Transistors	\$3.00	SC. 13	50 EM410 Diodes, 1000V 1 amp	\$4.75
SC. 7	20 MS3055-1 (Marked) Power Transistors	\$3.50			

SPECIAL PRICES CAN BE QUOTED FOR 1000 off ON ANY DEVICE SHOWN. A BONUS GIFT OF 50 EM401 DIODES WILL BE ADDED TO ALL ORDERS OF \$25 AND OVER. (Only applies to SC1-SC13 packs).

7 TRANSISTOR + 2 DIODE RADIO BY BENDIX

Completely ready wired with volume control and switch. Large tuning dial and complete with 3 1/2" 8 ohms .6 watt speaker. Battery container included. (Batteries not included) — READY TO GO!!

M.S.C.'s CRAZY PRICE!!

2 FOR \$6.50 P&P \$1.50



\$3.85 EA

PLUS P&P \$1.00

ANOTHER GREAT IDEA FROM THE STATES

The WAHL 'Iso-Tip' CORDLESS QUICK CHARGE INDUSTRIAL SOLDERING KIT, Model 7700. Consists of Cordless 'Quick Charge' Soldering Iron; Separate Recharging Stand; One No: 7545 Fine Tip; One No: 7546 Heavy Duty Tip; One Instruction booklet. Special features include: Complete Portability — Solders up to 125 Electronic Joints Per Charge; No AC leakage — No Grounding necessary; Soldering Heat in 5 Seconds; NEW SPECIAL PREMIUM QUALITY Long-Life Nickel Cadmium Batteries (Outlast Standard Batteries) GUARANTEED FOR ONE YEAR.

NOT TO BE CONFUSED WITH SIMILAR AND CHEAPER IMITATIONS ON THE MARKET.

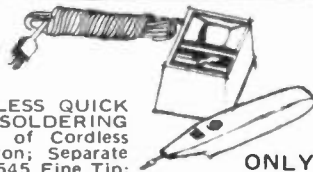

ONLY FROM US AT **\$39.95** ea P&P \$1.00

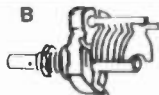
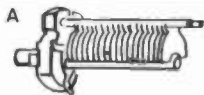

AIR SPACED VARIABLE CAPACITORS.

Top quality brand by JACKSON BROS. (UK) Superior made with silver plated vanes & ceramic end plates.
Type 'A' 150 pf (Screwdriver adjustment) \$1.25 each P & P 50c.
Type 'B' 50 pf with 1" x 1/4" spindle. \$1.75 each P & P 50c.

NEW

SWITCHES



ONLY \$2.50 ea. P&P 40c

"Shadow" miniature modular push-button switch assembly. 4 x DPDT, 3 momentary and 1 hold. Solder lugs and complete with 4 chrome faced buttons.

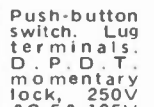

Push-button switch. Lug terminals. D.P.D.T. momentary lock, 250V AC 5A 125V AC Type SB-63A. \$1.10 P&P 20c ea

See-Saw switch. D.P.D.T. on/off/on momentary white button. 5A 125V AC or 3A 250V AC. 95c ea. P&P 20c ea.

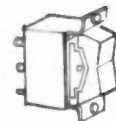

AT BARGAIN PRICES

Lamp lighted power push button switches. With 1 micro switch. Type NB-SL red lens. Only \$3.00 P&P 75c.

As above but with 2 micro switches and green lens. Type NB-DL. Only \$3.50 P&P 75c.



Push-button switch — dual buttons in double white or white and red lug terminals. D.P.D.T. reciprocal. 6A 250V AC Type SDB-122. Only \$1.95 ea. P&P 20c ea.

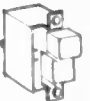

'Mulon' precision micro switch with pin plunger S.P.S.T. normally open/normally closed. Type MGA-100P. Only 65c ea. or 5 for \$3.00 P&P 20c ea. or 5 for 75c.



WOW!

LOOK AT THIS OAK MINIATURE ROTARY SWITCH

Precision engineered for precision work. ONCE IN A LIFE-TIME OFFER... compare M.S.C.'s Prices with our nearest cheapest competitor and save yourself a BOMB. ALL NEW... ALL PERFECT. Standard 1/4" shaft. 2 Section. 8 Pole 2 Position or 6 Pole 4 Position. \$1.75 each or 2 for \$3.00. P&P 60c



THE 'SIG-MITTER'

Powerful trouble shooting signal injector. Model SE-260. Complete with batteries. ONLY \$8.95 P & P 50c

ms Components

electronics pty ltd

THE GREAT NAME FOR ELECTRONIC
95-97 REGENT ST., REDFERN. TEL. 69-5922.



COMPONENTS IN AUSTRALIA
P.O. BOX 156, REDFERN, NSW 2016

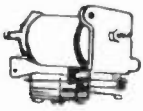

RELAYS

Magnetic Devices Series 596 (DC)
One of the smallest DC Relays
available. A very versatile relay for
general switching applications.
5A contacts 11.3 KΩ Max. Coil
Resistance. Max. operating voltage.
150 V. 2 pole C/O.

\$1.25 each or 10 for \$11.00.
P & P 50c or 10 for \$1.50.

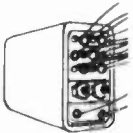

SEALED TYPE RELAY.

12 volt 4 pole C/O. With Flying
Leads.

\$2.75 each P & P 75c.



MINIATURE PLUG-IN RELAY.

Complete with clear plastic cover.
Coil Resistance 2.1 KΩ 48 V DC
4 pole C/O.

\$2.00 each. P & P 50c.

ELECTRET CONDENSER MICROPHONE WITH TIE-CLASP MODEL ECM-102.5

* Tiny 'as flower bud', yet performs like large
instrument.

- * Swivel and detachable tie-clasp.
- * Built-in, self-powered FET pre-amplifier, to
match popular 600 ohms input circuit.
- * Long battery life, more than 1,000 hours of
intermittent use.
- * Excellent for entertainers in all fields,
school teachers, public address and paging.

\$11.35 + P & P 75c.



FM WIRELESS MICROPHONE

Model 707 OMNI — directional
microphone

\$26.30 + P & P \$1.25.

Model 101 UNI — directional
microphone

\$29.80 + \$1.25.

NEW

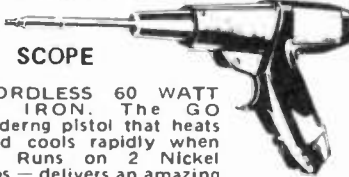

SCOPE

The SCOPE CORDLESS 60 WATT
SOLDERING IRON. The GO
ANYWHERE soldering pistol that heats
in 6 seconds and cools rapidly when
trigger released. Runs on 2 Nickel
Cadmium batteries — delivers an amazing
60 watts of soldering power — capacity is around 100
typical electrical connections — 200 to 400 joints have
been achieved with light gauge wire while heavier joints
mean proportionately less capacity — overnight
recharge from car or power point.

DESIGNED FOR TRADESMEN, HOBBYISTS and
HANDYMEN who can't always bring the job to the
workbench.

ONLY \$36.00 each P&P \$2.50.

Accessories to suit:

Auto cigarette lighter adaptor \$5.95 P&P 75c; 240 volt
Power adaptor \$9.75 P&P \$1; Stepdown transformer
\$13. P&P \$2.

MS 1	25 Assorted NPN & PNP SILICON TRANSISTORS. All marked and unused. Not rejects. Very useful assortment. \$2.00 P&P 25c.
MS 2	GOLDRING DC-DC Car converter. High current at 800mA. Output 6V — 7.5V — 9V. Complete with 4 way output plug. Only \$4.95 P&P 50c.
MS 4	4 DIGIT ELECTRO-MAGNETIC HIGH-SPEED COUNTERS. Will operate from 18-36V. Non resettable. 40c each or 10 for \$3 P&P 20c or 75c.
MS 5	PAPER BLOCK CAPACITORS in aluminium Can. 2 mfd 200V. Suitable for X-Over's 10 for \$1.50 P&P \$1.00.
MS 6	200 ASSORTED ¼ — ½ — 1 & 2 watt resistors. 10 & 20%. 200 for \$2.00 P&P 50c.
MS 7	PHILIPS POLYESTER CAPACITORS. 50 different values in 160-400 & 600V. \$3.00 P&P 50c.
MS 8	MINIATURE TRANSISTOR I.F.T. COILS. 455 MHz. A selection of 4 types including OSC coils. 10 for \$2 Astounding value. P&P 50c.

Specials

THE 'MARUNI' ELECTRET CONDENSER MICROPHONE



A versatile high quality mike. For
professional recording in studios and
perfect for use with tape recorders.
Freq. response: 50-13 kHz. Power
supply: AA type, UM-3 (1.5v).
Output level: (1000Hz) — 68 dB ± 3
dB. Comes complete with swivel
mount stand adaptor, wind screen and
a 15' cable. ONLY \$12.50 each
P&P \$1.25.

NEVER AGAIN AT THESE PRICES



2N3055 (STC) 10 for \$7.75 P&P 50c

NPN POWER
TRANSISTOR Complete
with Mounting Kit. ALL
NEW. ALL
MARKED. ALL
GUARANTEED.



2SB337 (ASZ16)
GERMANIUM PNP POWER
TRANSISTOR

Sim. to OC28. Complete with
mounting kit. Now only from
M.S.C. \$1.10 or 10 for \$10.
P&P 1 to 5 30c 10 up 48c.

THE FAMOUS "ETONE" HIGH PERFORMANCE SPEAKERS



NOW AVAILABLE

15" Model 451 100W rms 40-5 kHz	\$92.00
15" Model 467 160W rms 50-4 kHz	\$138.00
15" Model 474 160W rms 30-4 kHz	\$135.00
15" Model 475 200W rms 30-3.5 kHz	\$144.00
12" Model 225 Hi-Fi woofer 80W rms	20-4 kHz \$43.00
12" Model 231 60W rms 40-7 kHz	\$41.00
12" Model 511 40W rms 40-8 kHz	\$28.00
12" Model 518 Hi-Fi woofer 50W	20-4 kHz \$31.00
12" Model 246 twin cone 80W rms	40-12.5 kHz \$54.00
12" Model 365 130W rms 30-6 kHz	\$114.00
12" Model 366 twin cone 130W rms	30-12.5 kHz \$129.00
12" Model 367 130W rms 40-10 kHz	\$125.00

All the above speakers carry a 5 year warranty;
please add \$8.00 for P/P. Refund will be given
if P&P is less than this amount.

5% off for quantities of 10 and over.

**Trading
Hours**

MON-TUES-WED & FRI: 9am-5.30pm. THURS: 9am-7pm. SAT: 9am-1pm.
C.O.D.'s: Please add \$2.40 to posting fee. NO ORDERS UNDER \$3.00 accepted. For replies please send
S.A.E. Post and Packing 50c where not included in price. PLEASE ... PLEASE PRINT YOUR NAME &
ADDRESS ON ALL ORDERS AND CORRESPONDENCE.

Measurements

Misunderstandings, misuse, mistakes, mirth and misrepresentation — this article is written by Dr. Peter Sydenham, University of New England, Armidale, NSW.

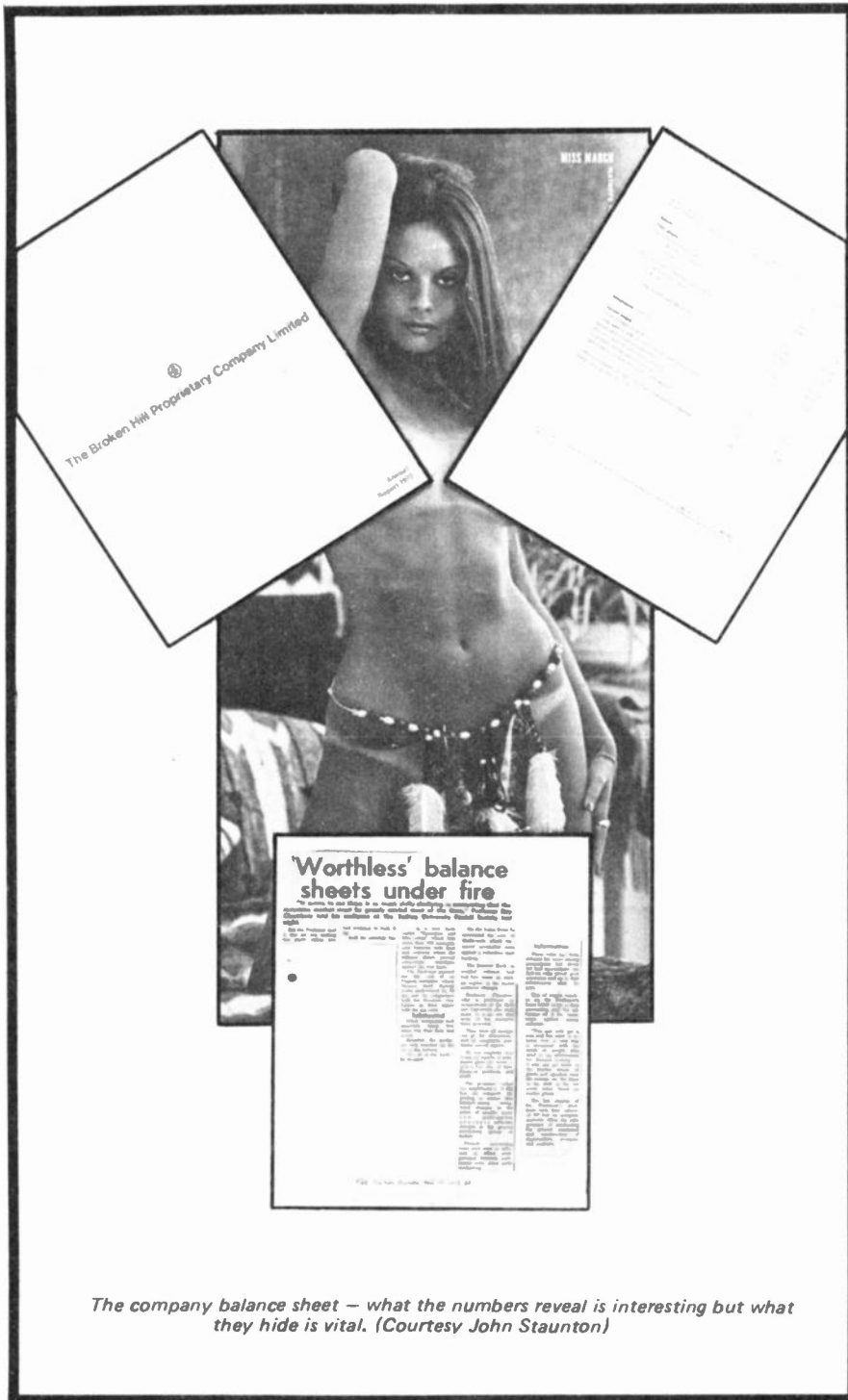

The company balance sheet — what the numbers reveal is interesting but what they hide is vital. (Courtesy John Staunton)

FROM the very beginning man has been a measurer. It is not hard to reason that he inherited the basic ability from the lower forms of life, for living creatures that cannot assess a situation and act for the better eventually die out or become subservient in some way.

Once a particular kind of measurement has been established as necessary, two things can happen. It either remains as is, being adequate for the daily need, or alternatively, constant effort is made to improve it in order to gain the benefits that might accrue from a better determination. Measurements are useful as tools of control of the routine, or as the basis for gaining new knowledge.

WHAT IS A MEASUREMENT?

To some people measuring implies attaching sophisticated black boxes to a system in order to obtain data about it. Others see the opposite — the use of simple tools such as a ruler to put data to an object. Both are right in a narrow sense. A first basic rule is that *measurement is the comparison of an unknown magnitude of a quantity with an agreed standard declared as the unit, the measure coming forth as the difference expressed in numerical form.*

The most basic number is a binary kind having just two states. The crudest measurement we can thus make is one that provides a yes or no, smaller or larger, up or down, go or no-go, true or false types of answer. Enormous effort can be expended to obtain (or try to obtain) such an answer in many cases. Indeed, it is this kind of measurement that is often the hardest to make. Politicians would give the earth to be able accurately to predict the outcome of an election, social-scientists would be enthralled at the prospects of certainty of success of implemented crime-control measures, geographers seek to know which factors affect what.

As the understanding of a subject is improved — by the use of simple tests

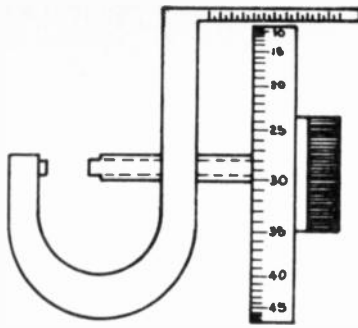

Fig. 2. Adding a huge drum to the dial of a screw micrometer increases its resolution but not necessarily the precision and accuracy of measurements made.

giving yes-no type answers — it becomes possible to deploy more and more advanced techniques of hardware and software. The difference between the standard and the unknown (called the measurand) becomes expressible in continuous rather than two-state number terms. For example, the battery in the car will not turn the starter motor because its voltage is *too low* (the two-state situation has been extended by a superlative). Measurement using a voltmeter enables us to say that the battery output is only 6.6 V instead of 12.0 V (the designer's standard requirement now expressed in numbers on a continuous scale).

It would seem that the ability to use sophisticated measurement processes is a large part of the criteria in deciding if a subject is scientific or not — that is of course, provided the numbers really *mean* something — see Fig. 1.

BASIC MEASUREMENT TERMS

Even though we have not yet talked in terms of sophisticated measurements or measuring equipment, the above explanation begins to reveal the need for some definitions of certain facets arising in the intercomparison process. (We need more standards to define standards!)

The misuse and abuse of basic terminology is rife. A first group of terms relates to the description of results provided by the process.

Resolution — at the finest scale available from a particular process of comparison — is the ability to resolve between successive increments in the chosen scale. A person using a mercury-thermometer might be able to resolve, say, 0.1°C intervals, subdividing these intervals into two divisions by eye gives a resolution of 0.05°C. By adding an optical magnifying system (or mechanical gain in, say, a micrometer — as depicted in Fig. 2) which has an inscribed scale at its focal plane, it is possible to raise the resolution 10 times or higher.

The unexperienced, unlightened measurer will often quote this fact as a

measure of how good a device is for measuring with but having resolution may not mean much in reality. It is very much the first basic requirement of comparison, but if it lacks accuracy the answers can be quite wrong. For example, if the optical magnifier on the thermometer has a badly ruled scale or optical distortion each increment will not be equal. Furthermore, the thermometer is supposed to measure temperature but, in fact, pressure of the air or liquid around it will also cause the mercury to rise or fall a little.

As another example, consider the balance-sheets issued as financial statements of the healthiness of commercial enterprises. Accountants are loath to round off, so statements involving millions of dollars may be listed down to the final dollar or even cent! The resolution is, therefore \$1 (or one cent) but no one seriously believes that this is always, if ever, the level of accuracy. For in such statements many costs (seemingly exactitudes) are pure guesstimates plucked from experience or designed to hide the real value of resources and returns. We come back to accuracy in a moment.

Precision — Two men argue as to which is the better rifle-shooter. It is to be settled by a contest on the range. The standard of excellence is to place the shots into the bulls-eye of the target but the game places the contestants sufficiently far back from the target that this is not easy to achieve. If it were, and each man placed all shots in the bulls-eye, the only assessment made would be that both were equally good. This situation lacks resolution to discriminate between them; the range is increased to increase the resolution. Thus emerges an important second rule of measurement — *there must be adequate resolution to a measuring process or little will be learned from the measurement.*

Each fires his group of shots and the two sets are intercompared. The first thing to be seen is that one group

EMONA enterprises

Distributors of ELCON Calculators NEW REDUCED PRICES

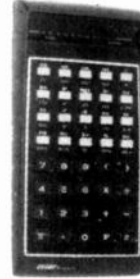

- Scientific-statistic, Elcon SC-6010 \$83.00*
- Scientific-statistic, Elcon SC-60 \$70.00*
- Scientific, Elcon SC-44 \$55.00*
- Financial Computer, Elcon FN-85 \$56.00*
- Mini desk, Elcon M-80HX \$31.00
- Slide rule, Elcon KP-460 \$23.00
- Super memory, Elcon KP-450 \$22.00
- Algebraic, Elcon 8413M \$15.00

*Indicates calculators including rechargeable batteries and charger.



NEW Full scientific panasonic JE-8410U \$35.00

- Multi-Scientific Functions — Trigonometric, Inverse trigonometric, Common and natural logarithmic, Anti-Common logarithmic, Anti-logarithmic functions, Square, Square root, Reciprocal, Pi and Power, Scientific Notation.
- Degree/Radian/Gradian Mode Selection
- Degrees-Minutes-Seconds/Decimal Degrees Conversions
- Versatile Memory and Automatic Constants in all four basic functions
- AC/Battery Operation, AC Adaptors for Models JE-8401U, M-80H, KP-460, KP-450 and 8413-M \$7.00.

To above prices add 15% sales tax if applicable. All models are guaranteed for a period of one year. Serviced locally.

MAIL ORDERS — Package, Insurance & Airfreight to all States (except N.S.W.) — \$4.00 within N.S.W. — \$3.00.

Emona E-2 all electronic AM/FM digital clock radio



\$45.95
(Incl. S.T.).

This 12 hour Digital Clock Radio is completely electronic — no moving parts — 100% solid state. You can listen to FM or AM wake up to music or alarm, or preset the radio program. It can be used as an accurate stopwatch. And there is even an indicator that blinks whenever there has been an AC power interruption.

WARRANTY — Fully guaranteed for a period of 90 days.

MAIL ORDERS — Package, Insurance & Airfreight to all States (except N.S.W.) — \$5.00. Within N.S.W. — \$3.00.

QUANTITY DISCOUNT — Available!
For further information: Write, phone or call at

EMONA ENTERPRISES,

21 Judge St., Randwick,
N.S.W. 2031. Phone: 399-9061.

Measurements

• The foregoing profits are stated after deducting all charges and expenses, providing for depreciation and making such other provisions as the directors considered necessary. The adjustments made by us to the profits are set out in the following statement

	1957	1958	1959	1960	1961	1962 (1/2 year)
	£	£	£	£	£	£
Net earnings of the group as shown by the consolidated accounts, arrived at after allowing for the interest of outside share holders in retained earnings, but before allowing for the undermentioned dividends	1,622,850	2,006,971	2,083,561	2,017,998	1,652,011	1,060,182
Less, Dividends paid by subsidiary companies to outside shareholders	7,278	7,278	7,270	7,260	7,200	3,600
	1,615,572	1,99,693	2,076,291	2,010,738	1,644,811	1,056,582
ADD						
Appropriations of profit charged in the Companies' profit and loss accounts by the directors, before arriving at net earnings	586,471	537,077	560,710	370,000	212,954	55,000
Amounts charged against profits by the directors to provide for the increased cost of replacing plant in the future, but regarded by us as appropriations of profit for the purposes of this report	350,000		100,000	100,000		
Net amounts set aside from profits by the directors as provisions (including income tax provisions) which have subsequently proved to be in excess of requirements	474,937	241,836	121,571	6,106	78,146	(17,471)
Adjusted net profits of the group	£3,026,980	£2,778,606	£2,858,572	£2,486,844	£1,935,911	£1,100,835

Fig. 3. This statement appeared in a prospectus of a company. It seems profits can be adjusted at will!

lies in a smaller total enclosed area on the target — as shown in Fig. 4a — but (in our chosen case) none is in the bulls-eye. The other shooter, on the other hand, has shots which are contained in a much larger circle, with one actually in the bulls-eye, as shown in Fig. 4b. The argument begins as to who is the better shot. The better

shooter is probably the first, not the second, for his precision, that is, his ability to keep on the same spot, is much better than the other person. Precision then, as the third rule, is the measure of scatter of values obtained in a test.

In this case the first shooter would be able to make a correction to his

sight or allow for cross wind in order to move his group over to put more on the bulls-eye than the other person. The less precise shooter could not improve his accuracy. This leads us to what is accuracy in measurement.

Accuracy — In the shooting exercise the aim of each shooter was to reduce the distance between his individual shots and the bulls-eye — which is defined as the standard in this determination. The measurement that gives the closest value to the agreed standard is the most accurate. But in the example above the less precise shooter is, in fact, the most accurate if they decide that the averaged central position of the group is the criteria chosen.

In electrical terms a voltmeter may provide precise values but be very inaccurate due to a bent pointer or an altered value series ballast resistor.

Thus a fourth rule can be seen: *Precision and accuracy are quite different descriptive terms.* These are too often confused. Excellent precision does not imply equally fine accuracy and vice versa. It is always necessary to provide adequate resolution in order to determine the desired fineness of precision and to state the accuracy precisely enough.

TYPES OF ERRORS

The numerical value between the standard value and the measurand is termed the measurement error. Error

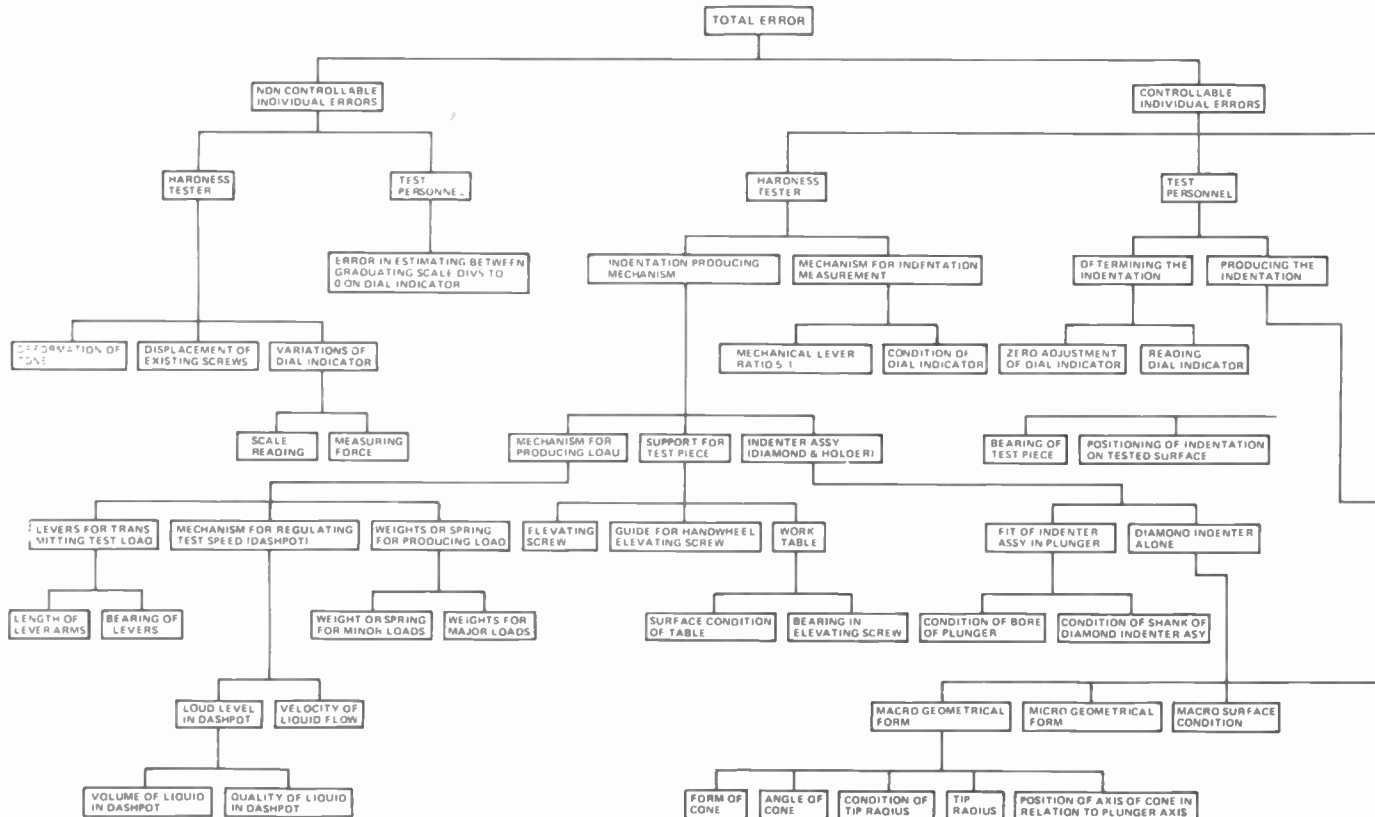

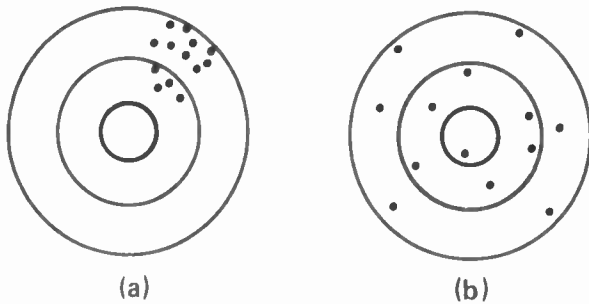

Fig. 4. Rifle-shooting is a good example illustrating the concepts of precision and accuracy. (a) A precise group of shots that is not as accurate as could be — the mean position is not on the bullseye. (b) An imprecise group which has an accurate mean centred on the bullseye.

magnitudes may affect the degree of precision and the accuracy obtained. They arise from many different sources, ranging from clearly identifiable processes, to never-identified mechanisms. Ideally, the measurer desires to eliminate all errors but the fact of life is that the closer we investigate a process in order to improve its resolution, precision and accuracy, the more errors loom up. Numerous sources of error can be identified with even the simplest of processes. Several years ago a study was made of the make-up of total error of a simple measurement (in principle at least) involving the pressing of a hardened point into a surface to measure its relative hardness by the degree of penetration — the Rockwell-C hardness test in this case. Something close to 40 sources of error were identified (as shown in Fig. 5).

There are three main classes of

error into which similar errors can be typified. Each has to be eliminated, reduced or lived with in different ways. A fifth rule of measurement is that *errors limit the usefulness of a measurement* and need to be reduced to tolerable levels.

Systematic errors — these are the derivations of values that always occur in the same way, and for which a corrective value can be applied to get the right value once the magnitude of the error is known. The rifle shooter resets his sights, the bent pointer is straightened. Or, the voltage reading can be corrected by adding the difference due to a bent pointer, or multiplied by a constant to make up for a wrong value series ballast resistor. It is, however, not necessary to know what *causes* the systematic error, only what its rules of occurrence are so that it can be allowed for. A calibration chart enables a meter reading to be corrected (Fig. 6). Knowing the rules, a correction can be applied to individual measurements to improve the accuracy of individual values.

Random errors — In strong contrast are errors that appear as the name implies, with random amplitude and sign. It is by definition impossible to predict what the random error will be on an individual value basis — the best that can be done is to place a level of probability of such and such a value arising at a certain time. In other words, seen as a group rather than a single occurrence of errors, it is

possible to be reasonably certain about the value of such parameters as the *mean value* of the group and the *spread* of the group, but never the facts about the individual until it has occurred.

Random values follow statistical laws for collections of events. The most common occurrence of random error is with the so-called Gaussian distribution (also called top-hat or normal distribution). This form of error has a symmetrical profile for the plot of probability of occurrence of a value versus value changing as shown in Fig. 7. The peakiness of the curve is a measure of the spread of values and from the mathematical laws of this type or error it is possible to define a term that expresses the peakiness — the standard deviation (or s.d. or δ). In practical terms a s.d. of 1 means the limits $\pm 1\delta$ contain 68 per cent of values, $\pm 2\delta$ limits contain 95 per cent and $\pm 3\delta$ limits contain 99.7 per cent. If the chance of a value occurring is 50 per cent within a given limit and 50 per cent outside this limit then the probable error — has a value of 0.67δ .

It is conventional practice to quote the random error of a process in terms of the standard deviation as this conveys the tightness of the random error in the measurement situation.

A trap that exists, however, is that not all random processes are Gaussian in distribution. Nuclear radiation particle occurrence, for instance, has a lop-sided distribution (Poisson) and another quite different set of mathematical formulae describes the chance of occurrence of values. In the majority of cases Gaussian statistics apply — white noise for example in electronic circuits.

Personal errors — To be correct these reduce to random or systematic causes of error, but by treating them as a specific group the deleterious effects of human observation are emphasised. There are numerous sources of personal error. The

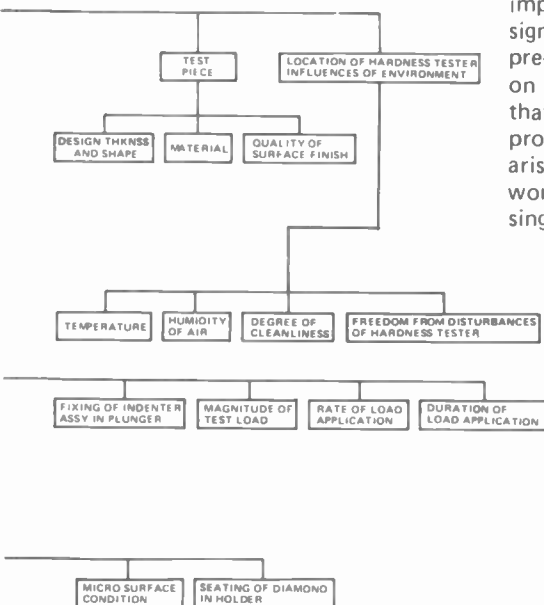

Fig. 5. Personal errors involved in using a simple technique of pressing a point into a surface to measure its hardness.

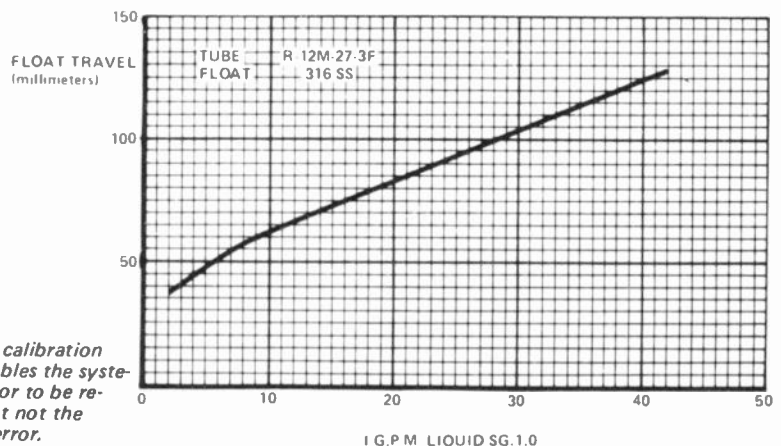

Fig. 6. A calibration chart enables the systematic error to be reduced but not the random error.

Measurements

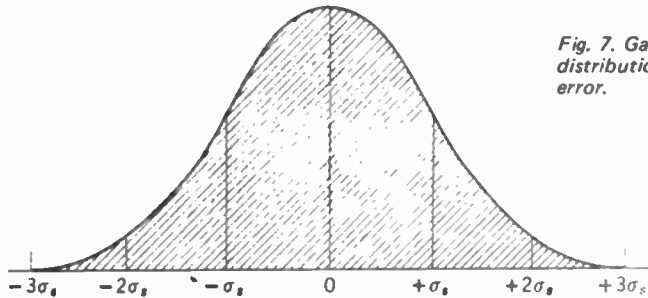

Fig. 7. Gaussian or top-hat distribution of random error.

individual making the measurement may view a scale line at a different angle to another person thus introducing parallax error, the way of driving an adjustment screw dial may be different to another – moving from the opposite direction to the mark or at a different speed could introduce slightly differing values from one observer from another. In surveying practice it is quite normal for the theodolite or level operator to repeat the observation from the opposite direction. This reduces systematic errors of calibration by differential cancellation, thus reducing the personal error. Measurement in studies not using hardware sensing are particularly rife, for personal judgment is usually involved.

TRACEABILITY

We saw above how a standard must be created as the sole legitimate value of the unit, and how a measurement was made by comparing the unknown against this.

If the standard varies, then so does the measurement value. In the case of physical standards such as length, mass and time it is possible to provide some defined physical apparatus that acts as the standard. In some disciplines this is not so easy. Biological experiments use a control group – a group of test subjects that do not undergo the test given to the test group – as the temporary standard. In economic studies even the concept of a control group is hard to create, for we cannot ask half the country's population to stay the same economically and isolated at the same time as the other half have their financial situation altered. We would probably learn more about economic procedures if we could!

Whatever the standard it must be adequately constant for a long enough duration and be usable. For physical standards the demand for use is so great that it is necessary to have a sole fundamental standard controlling many working standards in each country, these controlling, in turn, the field standards used by individual

laboratories. These control the value of the unit actually used in practice. Thus we can have as many as five or six steps between the fundamental standard and the working instrument. Each stage loses some accuracy so international standards must be maintained in the highest state possible by a national laboratory devoted to this task – the National Measurement Laboratory in Australia, the National Physical Laboratory in Britain, the National Bureau of Standards in the USA, etc.

Clearly if this tree of standards were not strictly controlled any individual unpoliced link could upset the sequence. The process of traceability is used to ensure that a measurement (at least with high-performance instrumentation) is traceable right through to the fundamental standard with the loss in

accuracy being designed at each level. This concept is vital to the maintenance of standards in practical use.

MIRTH

Looking back in time, man's measurement endeavours include some highly amusing methods of producing standards. One early standard of length for the inch was 'three barleycorns, round and dry'. Another standard of length was prescribed by taking the first 16 men as they came out of church, making them standard with their left feet end to end – this gave a standard 'rod'. Not quite as bad as it may seem for at least a vaguely reproducible average was obtained. But the last man out defined the foot! In 1800, in Germany, there were 112 different size standards used to define just one common unit of length.

A peculiarity still with us today, concerns the gallon – the US gallon being smaller than the British Imperial gallon. In fact the US gallon is the earlier British gallon – the Pilgrim Fathers used the then-smaller Imperial gallon when they emigrated to the Americas in the 15th century. The Americans retained the original standard (more or less) but the British one was subsequently re-defined.

A 14th century treatise related an English penny – called Sterling – as the same weight as 32 grains of wheat. Thus in a very round-about way 20 pence make an ounce, 12 ounces a pound, eight pounds make a gallon of

Continued on page 35

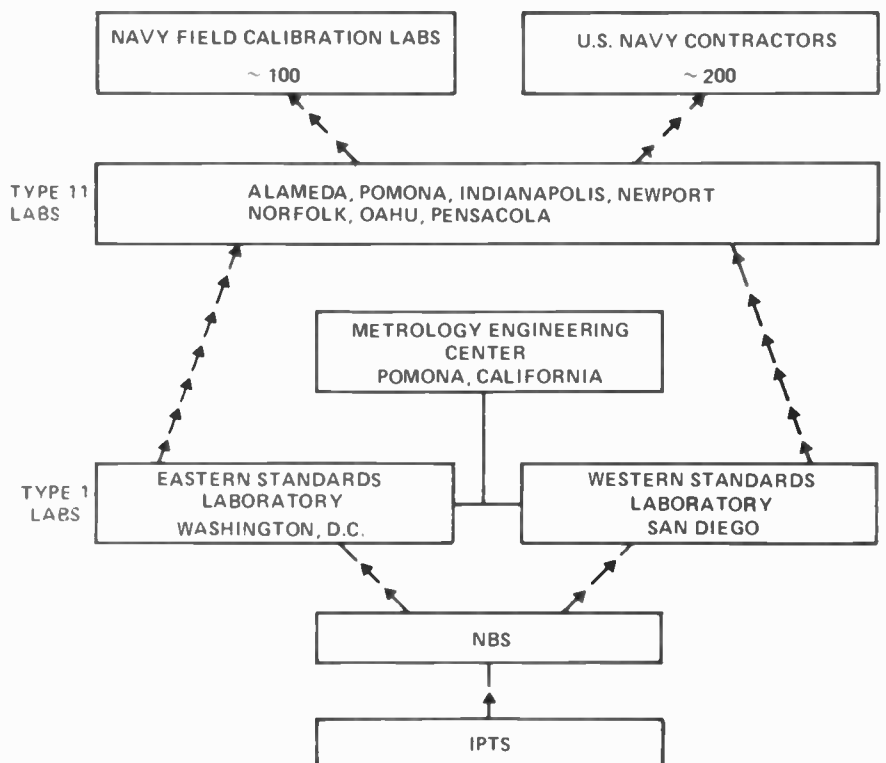

Fig. 8. Traceability relies on a hierarchy of standards reaching from the actually used measuring instruments to the fundamental sole standard. This is the calibration chain for U.S. Navy temperature standards.

The hungry leader.

At Altec, we're not taking our leadership position for granted. We're always trying harder — challenging ourselves to develop studio monitor speakers that stay a step ahead of constant improvements in the contemporary recording process. And we can prove it. Here's the latest data on monitors installed in U.S. studios, as published in Billboard's 1974 International Directory of Recording Studios.

MANUFACTURER | **NUMBER OF MONITORS USED IN U.S. STUDIOS**

Altec	522
JBL	339
EV	82
KLH	39
AR	34
Tannoy	24

But we're not really satisfied — even with this impressive track record. We're still trying to better ourselves. In fact, Altec has three all-new studio monitors available right now. They're a whole new generation of speakers designed to meet the whole new range of tomorrow's dynamic recording techniques. Your studio may need them. Why not call us for full details.

Altec gives you the best of both worlds proven leadership, plus an unrelenting commitment to doing a better job. That's because we've really grown to enjoy being #1 in studio monitor sales during the past three decades. And we intend to stay right there for at least the next three decades by always being our own biggest competitor — in research, in quality, in service and in satisfying the demanding needs of an ever-evolving industry. The domestic ALTEC recently introduced into Australia has already gained rapid response from the discerning Hi-Fi enthusiasts.



Domestic from

\$320

pair

ALTEC
the sound of experience.

Number one. And have been for nearly 3 decades.

Limited numbers of 604E professional monitors available at \$285 each.

KENT HI-FI

(WHERE THE BEST EQUIPMENT COSTS LESS)

410 KENT STREET
SYDNEY
ph: 29-2743

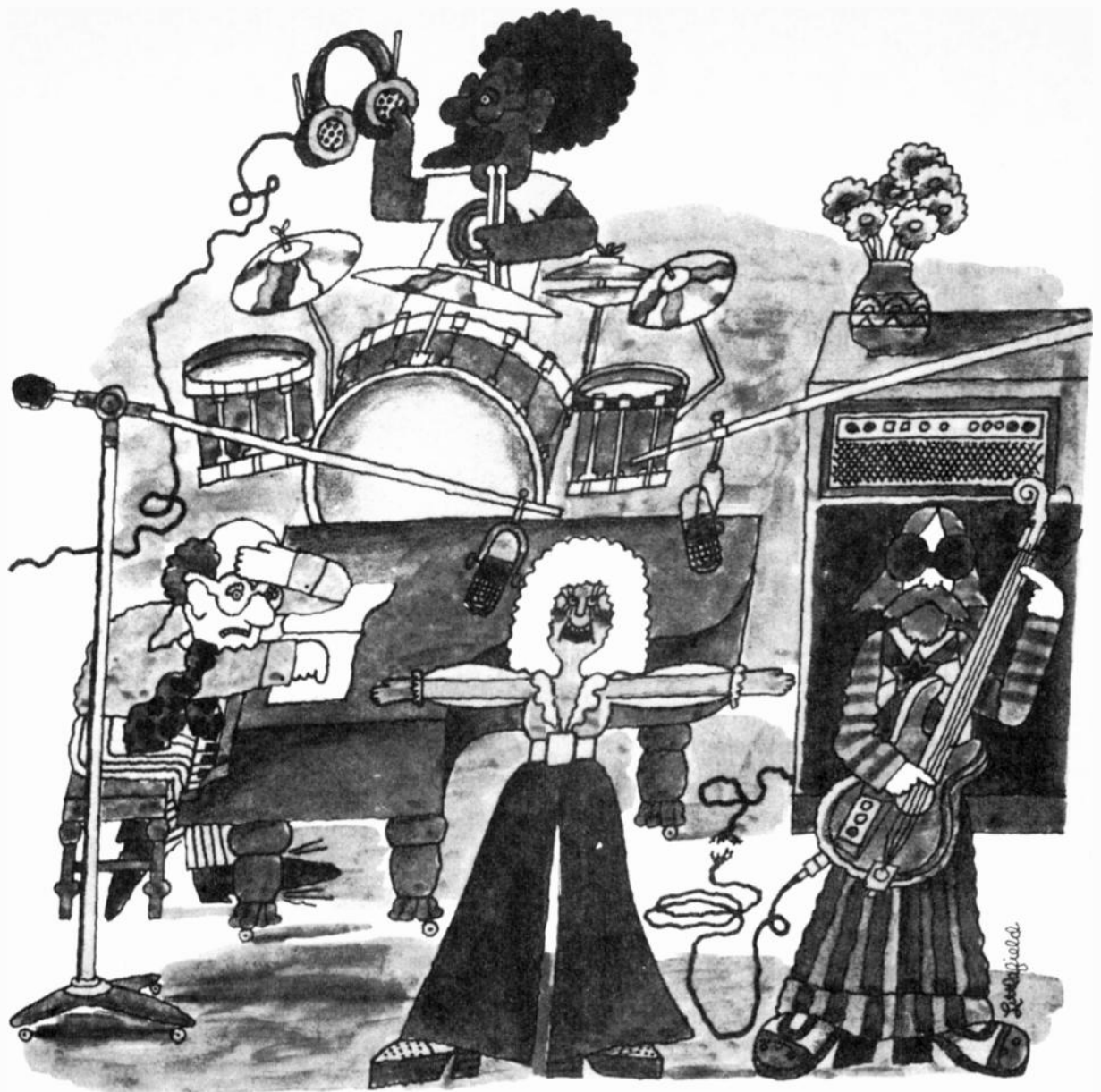

Hot talent and hot material need Hot Sound Tape by Ampex

An ordinary tape just won't do these days for most audio recording jobs. You need the hot Ampex 406/407 studio mastering tape or, the hottest, Ampex GRAND MASTER. With 406/407 you'll get 72 dB s/n ratio, high output, low noise and low distortion. If your requirements call for an even hotter tape, then you need Ampex GRAND MASTER. This spectacular mastering tape offers a full 76 dB s/n ratio and as much as 3 dB

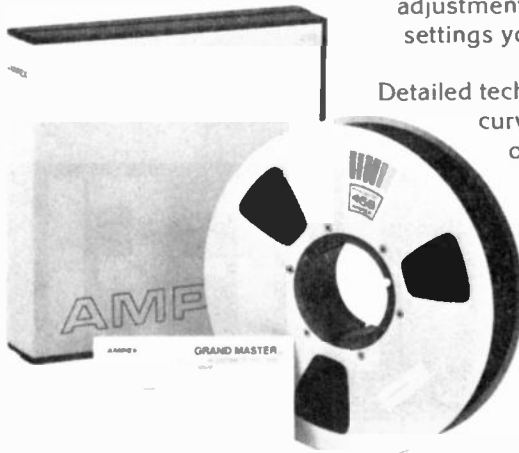

extra sensitivity on the high end. You can drive GRAND MASTER tape harder than you've ever driven a tape before. From a whisper to a scream, it responds with more undistorted output across the entire audible range than any other mastering tape available. It has high erasability so it is fully reuseable. And there's no need for bias adjustments: use GRAND MASTER at the same settings you've established for Ampex 406/407 or for 206/207.

Detailed technical specifications and performance curves are available in our free brochure, offered to all audio professionals. Just ask us for literature on the Ampex Hot Sound Tapes, GRAND MASTER and 406/407.

AMPEX

Ampex Australia Pty. Ltd.
4 Carlotta St., Artarmon, N.S.W. 2061
TLX 20608, Phone 439-40
and 292 Victoria St.
North Melbourne, Victoria, 30
Phone Melbourne 329-52.

wine and eight gallons make a bushel of London. No wonder Londoners still buy winkles (small sea snails) and shrimps by the pint measure!

Some units had, and still have, great names! A nitometer was once used to measure light-intensity in units of "nits". Even today we retain the cross-sectional area of capture of nuclear particles as a "barn".

And Kayzers are not nylon stockings but a measure of wavelength of radiation.

Early methods used to create a seemingly unchangeable standard were also often interesting. Like length, for instance. The metre was originally proposed as a small proportion of the distance of a quarter way round the earth's circumference. But this presented innumerable problems when tried in practice. Around the same time (the end of the 18th century) it was also thought that a pendulum swinging with 1s period would be adequate to define a metre length.

Today some of our basic standards are still based on physical apparatus that is subject to damage or change. The standard (prototype as it is called) kilogram is still a piece of metal held in Paris. Most standards, however, can now be reproduced from a stated description of an apparatus which can be used to replicate the standard to within extraordinarily fine limits. Length for instance is defined as so

many wavelengths of radiation from a Krypton discharge lamp.

Some extraordinary anomalies in measurement occur in every-day life — the most frequent being of a kind that imply an accuracy that does not exist.

- A recipe in a recent issue of an Australian magazine dutifully translated 'take 5 oz of flour' as 'take 141.75 grams' and half a pint of milk as '.354 litres'.
- Motoring magazines frequently quote standing quarter mile (or 400 metre) acceleration runs to three decimal places of one second. Yet one overseas magazine to my certain knowledge measures the required distance simply by a member of the staff pacing it out!
- A 'hundred thousand ton' ship was recently described in a daily paper as displacing '101,606.44 kilograms' — leaving aside that this contained an error of several orders of magnitude — the conversion implied that the original displacement was known almost exactly.
- After hearing that an aircraft was 'one minute late' I'm still trying to determine at precisely which point in its journey that an aircraft officially 'arrives'.
- Until very recently the altitude

record for aircraft (and balloons) was recorded to two decimal places of a metre. Yet the actual height recorder was an aneroid instrument with an accuracy at best of plus or minus 0.1 per cent — thus the actual recorded height would not have been known to within 50 to 100 metres!

- A British millionaire was recently described as being worth \$1.612 million dollars!

A recent advertisement for a certain make of car — one that would be expected to be more careful over advertisements, says: "The car responds as quick as adrenilin". This is an entirely meaningless expression. It states nothing of substance. The same advertisement states that the car is "20 per cent safer than the safest car on the road". How do we measure safety in quantitative number terms? It is also said to have "precise rack and pinion steering" — let's hope so! And later: "Every one of its over 5000 parts is the result of adaption and re-adaption of . . . s" pioneering safety programme. It is very doubtful if every single one has been such — if so the designers need sacking for never getting there first-time in their design. Finally, "you need greater reserves of power to outdistance danger" — what a meaningless jumble of measurement statements! ●

SPECIAL NOTICE

DICK SMITH CATALOGUE

DICK SMITH'S CATALOGUE PRESENTED WITH THIS ISSUE OF ELECTRONICS TODAY INTERNATIONAL, AND WITH THE APRIL ISSUE OF ELECTRONICS AUSTRALIA HAS AN ADVERTISEMENT ON CATALOGUE PAGE 20 IN WHICH THE PHRASE: "ALL CALCULATORS DUTY FREE" IS USED AS A HEADING. THE PHRASE "DUTY FREE" IS ALSO USED ON PAGE 21.

THE PHRASES USED ARE NOT INTENDED TO IMPLY THAT ELECTRONIC CALCULATORS SOLD BY DICK SMITH ARE SPECIFICALLY FREE OF DUTY — RATHER THAT ALL CALCULATORS IMPORTED INTO AUSTRALIA ARE DUTY FREE.

IN THE QUEST FOR TRULY NATURAL SOUND WE ADMIT TO RUNNING SECOND

If one really appreciates music, there's one way, and only one way, to hear it in its completely natural form; with perspective, with dimension, with depth, without 'artificial colouring'. That's to be there, at the time, at the concert.

The piccolo players are not wedged in between the violinists, and the man with the tympany drums is not standing up front with the conductor. At IMF, we design and build speakers with one goal uppermost in our minds; to reproduce music naturally, as it was played with each instrument in its proper place, and at its proper weight. Call it perspective; call it depth; call it dimension; call it lack of extraneous gimmickry; call it what you will. It's the goal we've set ourselves, and we believe (as many leading world authorities on music and its reproduction are beginning to agree) that our success in achieving that goal is, so far, unrivalled.

There are those, especially hard rock enthusiasts, who will find our sound (at least at first) a little

unexciting. But 'natural sound', like anything to which one is unaccustomed, is a taste one needs to acquire.

If you appreciate not only fine music, but also fine equipment, we invite you to take a look at; and a good listen to; our speakers.

Available from:

- N.S.W.:** M & G Hoskins Pty. Ltd, 400 Kent St., Sydney 2000, Telephone: 546 1464, 547 1093.
QLD.: Stereo Supplies, 95 Turbot St, Brisbane 4000, Telephone: 21-3623.
S.A.: Challenge Hi Fi Stereo, 96 Pirie St, Adelaide 5000, Telephone: 223-3599.
TAS.: Audio Wholesalers 9 Wilson St, Burnie 7320, Telephone: 31 4111.
VIC.: Encel Electronics Pty. Ltd, 431 Bridge Rd, Richmond 3121. Telephone: 42-3762.
W.A.: Arena Distributors, 282 Hay St, Perth 6000, Telephone: 25-2699.
A.C.T.: Duratone Hi Fi, Cnr. Botany St. & Atree Crt, Phillip 2606, Telephone: 82-1388.

Sole Australian Distributors
**INTERNATIONAL DYNAMICS (AGENCIES)
 PTY. LTD.,**
 23 Elma Rd., North Cheltenham, 3192, Melbourne 95-1280.

ALS 40

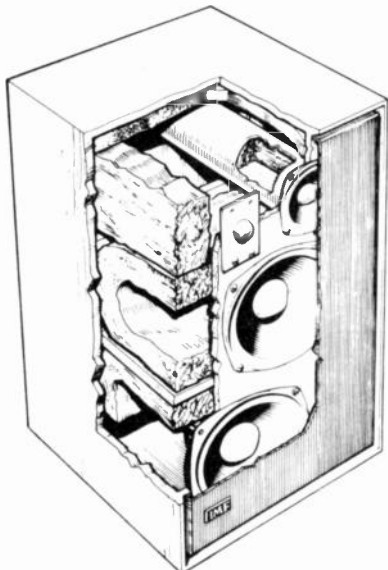

TLS 50



COMPACT II



IMF

WHAT GOES IN, COMES OUT. NATURALLY



PHILIPS



A screwdriver and about 1/2 an hour is all you need to build this 40 watt Philips speaker system.

Philips make it easy and inexpensive for you to own a professional speaker system. Assemble it yourself in about 30 minutes and you have 40 watt (RMS) capacity speakers to complement your hi-fi gear.

The AD8K40 Speaker Kit includes:

- 2 precut, pre-finished wood grain cabinet enclosures with pre-painted baffle boards.
 - 2 mounted grill cloths with pre-painted baffle boards. • 2 x 8" woofers. • 2 x 1" dome tweeters.
 - 2 x 2-way crossover networks with leads and fastons fitted.
 - Innerbond lining. • Wood screws.
 - Wood glue. • Caulking compound.
- Plus full assembly instructions.

For further information contact
ELCOMA
Electronic Components and Materials,
P.O. Box 50,
Lane Cove N.S.W. 2066.
Or phone 42 1261 or 42 0361
Branches in all States.

ELCOMA

Fixed capacitors

This essentially practical down-to-earth series will study each family of electronic components — and provide all the essential data that is otherwise so difficult to obtain.

MODERN FIXED CAPACITORS can be placed in three general classes according to the characteristics of their dielectric.

- (A) Low loss, high stability e.g. mica, low-K ceramic, polystyrene.
- (B) Medium loss, medium stability e.g. paper, plastic film, high-K ceramic.
- (C) Polarised capacitors e.g. electrolytic, tantalum.

MICA CAPACITORS

Mica capacitors have low RF losses right through to UHF and very good capacitance stability. They are suitable for use in RF circuits up to 500 MHz and are recommended for use in oscillators and filters where their stability characteristics are almost unrivalled. Mica capacitors of appropriate size can handle large RF

currents and high voltages and are often used in transmitting applications.

Mica capacitors are usually larger than ceramic capacitors of equivalent value but their temperature stability characteristics are usually better.

Moulded Mica or "Postage Stamp" — the most common form is the "Postage stamp" style, so named because of its size and shape. Often cheaper than real postage stamps and taste better when licked! General purpose mica capacitors have good stability and can be obtained with high voltage and high RF current ratings. They are constructed of layers of foil interleaved with mica (referred to as "stacked mica") or layers of metallized mica. Obtainable in values between 10 pF and 0.1 μ F. They may be marked 'M.S.' to indicate Stacked Mica.

Silvered Mica — usually labelled with an S.M. marking, not to be confused with Stacked Mica capacitors. These have very high stability and are recommended for use in oscillators, filters and other critical applications requiring highly stable capacitance. Tolerance is also very good, usually specified to $\pm 5\%$ but in practice often better. Generally obtainable in values from 4.7 pF to 3300 pF.

Metal-Clad Mica — a square or rectangular-shaped capacitor having a metal clamp holding the stack of interleaved plates of foil and mica. This form of construction has low lead inductance and can handle high RF currents. It is used for dc blocking and bypassing in RF circuits.

Button Mica — named after their shape.

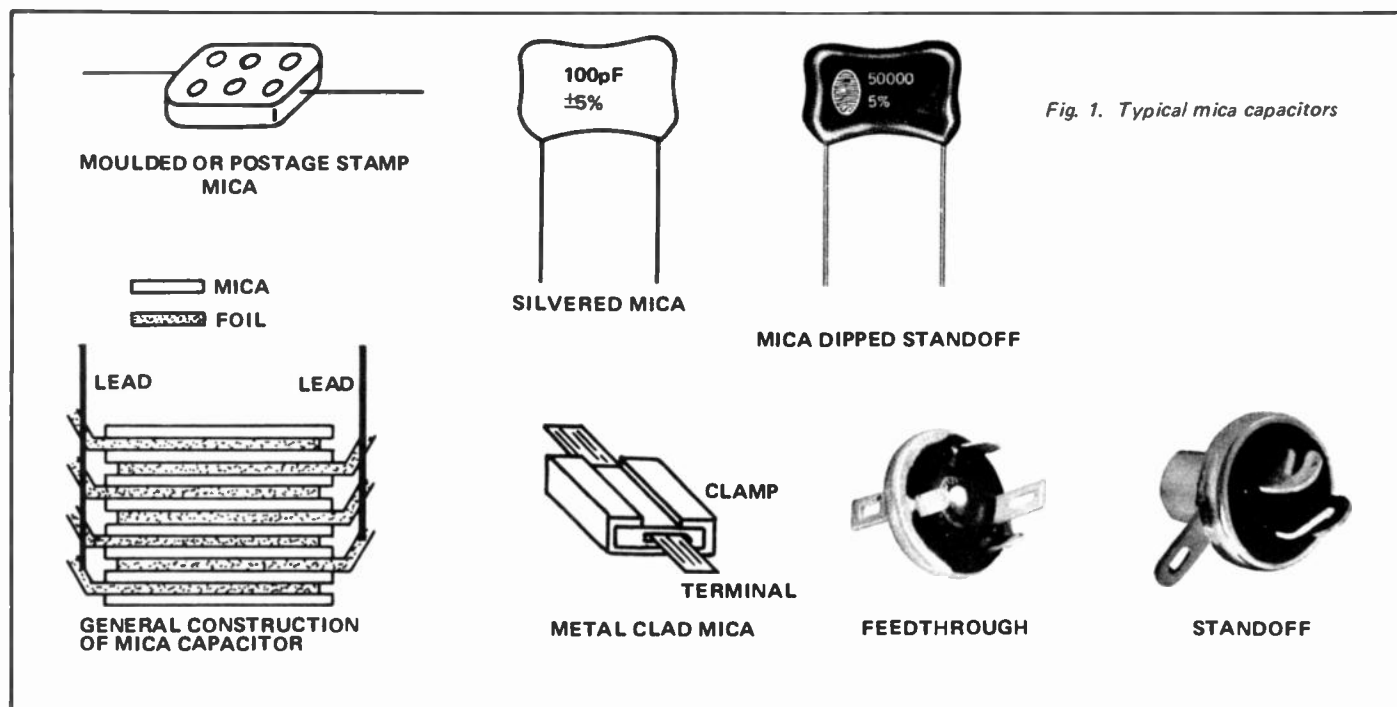

Characteristic	Capacitance range (pF)		
	0.4-2	2.2-3.9	4.7-10
NPO - N330	± 250 ppm	± 120 ppm	± 60 ppm
N470 - N750	± 250 ppm	± 120 ppm	± 120 ppm
N1500 - N5600	same as 10 pF and over		

TABLE 1

improved electrical characteristics and higher reliability than moulded types. Obtainable in values from 10 pF to 0.1 μF.

CERAMIC CAPACITORS

There are two basic types of ceramic capacitors - low permittivity ("Low-K") and high permittivity ("High-K"). They have widely different characteristics.

Low-K ceramics have low loss and exhibit small, linear changes of capacitance with temperature. They are useful up to 1000 MHz and are made for both low voltage and high voltage applications.

High-K ceramics provide large

Very good RF bypasses. Made in standoff and feedthrough styles. They have very low inductance connections and are used for RF bypass, filter, and tuned circuit applications up to UHF. The feedthrough style provides a bypassed connection through a chassis

while the standoff style provides a direct bypass or bypassed tie point. Obtainable in values between 5 pF and 10 000 pF.

Dipped Mica - this style is encapsulated by dipping in resinous material below atmospheric pressure. They have

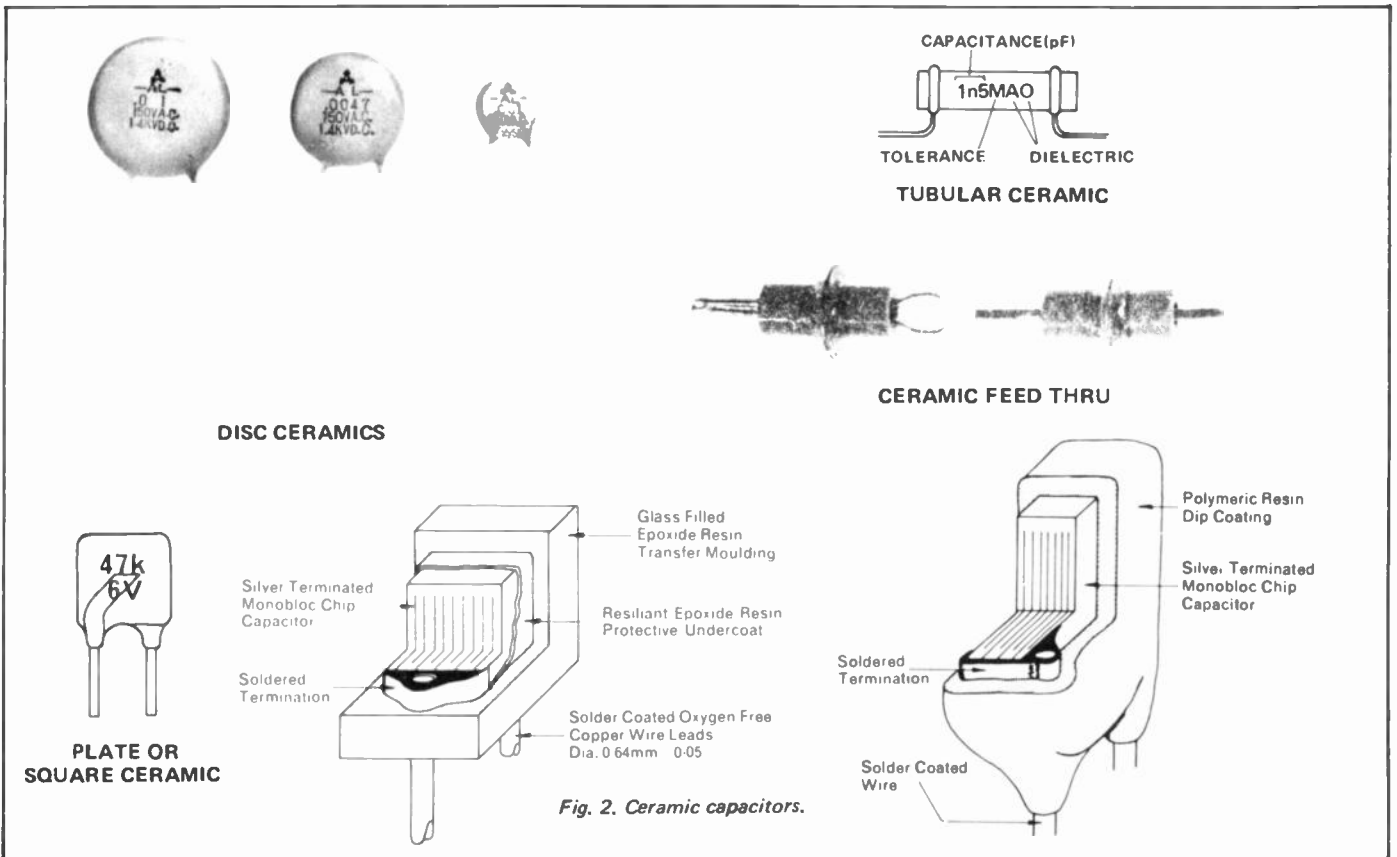

Fig. 2. Ceramic capacitors.

	Paper		Polyester		Polycarbonate		Polypropylene		Polystyrene		Ceramic		Mica	Electrolytic			
	metalized	film/foil	metalized	film/foil	metalized	film/foil	metalized	film/foil	disc/tube	monolithic	disc/tube	monolithic	aluminum foil	aluminum foil	tantalum solid & wet		
Insulation resistance (in megohms)	3x10 ¹²	2x10 ¹⁴	5x10 ¹⁴	10 ¹⁵	5x10 ¹⁴	10 ¹⁵	10 ¹⁵	5x10 ¹⁴	10 ¹⁶	10 ¹⁷	10 ¹⁴	10 ¹⁵	10 ¹⁵	← variable →			
Tolerance	10	5%	5%	5%	5%	2%	5%	2%	0.625%	10%	20%	0.5%	10%	10	5		
Temperature range (°C)	-30 to 100	-30 to 100	-55 to 125	55 to 125	55 to 125	-55 to 125	40 to 85	40 to 100	-40 to 70	55 to 125	-55 to 125	55 to 125	-20 to 80	40 to 125	-40 to 150		
Size per CV*	small	large	small	small	small	small	small	small	large	small	small	small	very small	small			
Stability	fair	fair	fair	fair	fair	fair	fair	excellent	excellent	fair	fair	excellent	fair	very good	excellent		
Capacitance range (μF unless indicated)	0.01 to 100	0.001 to 100	0.001 to 10	100 pF to 0.01 μF	0.001 to 100	5 pF to 0.01 μF	0.001 to 100	100 pF to 0.47 μF	100 pF to 0.6 μF	5 pF to 1 μF	0.001 to 10	5 pF to 0.01 μF	typically 1-22 000	1	1000	3500 max	
Voltage (ac) (dc)	250 630 500-5000	250 630	63 400 100 1500	90-160 160 400	40 250 63-1000	63-160 100 400	250 440 750 1000	63 500 100 1500	63-1000	63 250 63 10 000 63 450	63 250 63 10 000 63 450	63-630	6.3-500	6.3-300	1-50	1000 (non linear)	200-1000
Temperature coefficient PPM/°C	300	300	400	400 (non linear)	150	-50 to -100	-170	-120	150	non linear positive to 1000 neg	100	100	1500	1000 (non linear)			
Appr. resonance MHz	0.1	0.1	0.1	1	0.1	1	0.1	1	1	10	100	1.0	0.05	0.1	0.1		

Table 2. Capacitor Comparison Chart.

Fixed capacitors

capacitance values in small space. Their losses are dependent on applied ac and dc fields. They exhibit large, non-linear changes in capacitance against temperature. As a consequence they find application as decoupling and bypass capacitors (discussed later).

Low-K Ceramic Capacitors. Low-K ceramic capacitors are manufactured in a range of temperature characteristics. They are sometimes referred to as "temperature compensating" capacitors as they can be used to compensate for temperature changes in other circuit components. This property is particularly useful in RF oscillators and filters.

The temperature characteristic or coefficient, is quoted in parts per million per °C (ppm/°C), either positive or negative e.g. a capacitor marked 100 pF/P100 will *increase* its capacitance by 100 ppm for each degree centigrade increase in temperature. For a temperature rise of 10°C it will increase its capacitance by 0.1 pF. As a further example, a 1000 pF capacitor will *decrease* its capacitance by 1500 ppm for each degree centigrade rise in temperature. For a temperature rise of 10°C, its capacitance will drop by 15 pF.

Low-K capacitors are also produced having an extremely small temperature characteristic. These are known as NPO

ceramics ("Negative-Positive Zero"). Their stability rivals that of silvered mica capacitors.

The graphs in Fig. 3 indicate the range of standard characteristics manufactured. The nominal value of ceramic capacitors is specified at 25°C. It should be noted that the change in capacitance is not strictly linear, having a small curvature, at low temperatures k becomes more negative. The tolerance on the temperature characteristic ranges from ± 30 ppm for NPO capacitors, to ± 1000 ppm for N5600. Below values of 10 pF stray capacitances begin to have a marked effect on the temperature characteristic and the tolerances are widened as shown in Table 1 (page 39).

The temperature coefficient of silvered mica capacitors is usually about +20 ppm/°C but may be as low as +5 ppm/°C which is somewhat better than NPO ceramics.

Low-K ceramic capacitors are made in disc, square and tubular forms. They are obtainable in a range of working voltages from 50 V to 15 kV. They are useful in RF circuits up to three or four hundred megahertz. Above this frequency, leadless unencapsulated "chip" capacitors are used.

POLYSTYRENE CAPACITORS

Polystyrene capacitors are one type of plastic film capacitor. They are

constructed usually by interleaving strips of foil and polystyrene film, the alternate strips of foil being staggered to provide connections. The assembly is then rolled up to form a tubular shaped capacitor. See Fig. 4. They exhibit low loss and good stability and are manufactured in a range of working voltages from 100 volts to 630 volts. They exhibit a small negative temperature characteristic of about 150 ppm/°C and are sometimes used as temperature compensating capacitors. Their main application is in tuned circuits and as coupling capacitors up to about 100 MHz. The higher values (0.01 μ F and above) are sometimes used in bypass and decoupling applications.

Polystyrene capacitors are affected by heat, greases and solvents. Care must be taken when using them to keep them away from heat sources (e.g. power resistors). Exercise care when soldering. Flux solvents and other chemical solvents will dissolve the capacitor, with disastrous effects.

PAPER CAPACITORS

Paper capacitors are medium loss, medium stability capacitors that were once widely used. They have been largely replaced by plastic film types for most purposes but are unsurpassed in high voltage dc and low frequency ac power applications.

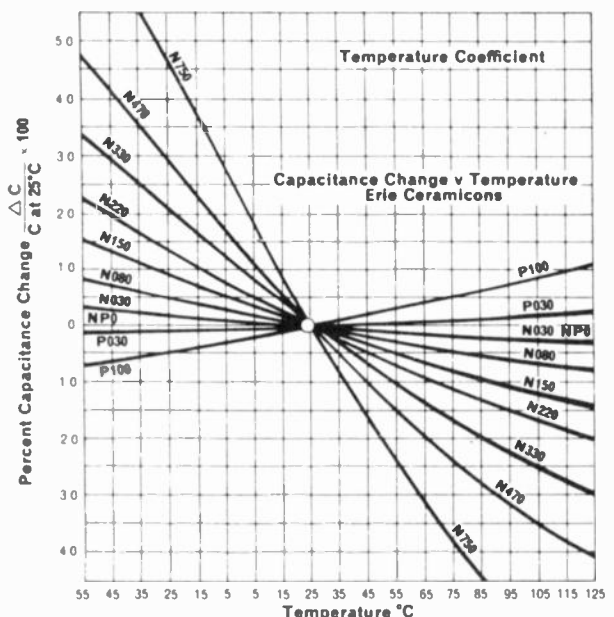
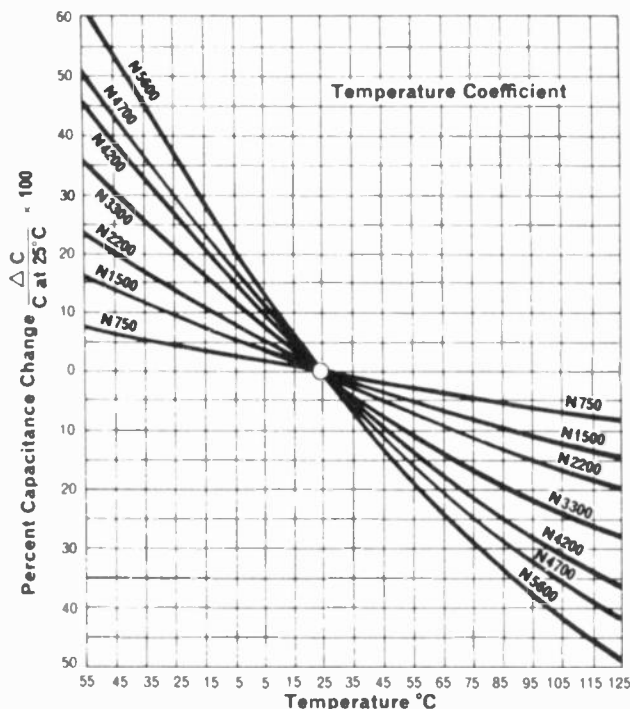

Fig 3 Characteristics of ceramic capacitors

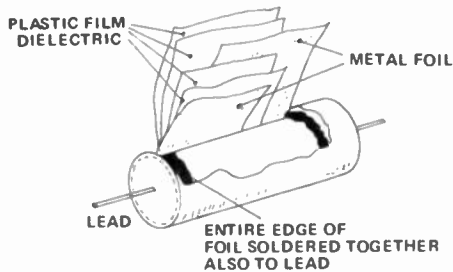

Fig 4 How polystyrene capacitors are made

There are two basic types of construction, the metal foil type and the metallized type. The metal foil type is constructed by winding together interleaved layers of foil and impregnated paper similar to plastic film capacitors, see Fig. 4. This type is best for high voltage and high current applications, a common form being the paper "block" capacitor. See Fig. 5. They are available in voltage ratings up to 4000 V and will withstand considerable charge-discharge currents. The metallized type has the impregnated paper dielectric coated with a thin layer of aluminium or zinc. This form of construction results in a capacitor of relatively smaller physical size.

The paper dielectric is impregnated with another dielectric substance to replace the water content inherent in paper and to prevent the absorption of moisture. A variety of natural oils or waxes, or synthetic chemicals, is used.

Encapsulation of the capacitor assembly is usually by moulding in resin or encasing in hermetically sealed metal cans as is done with block capacitors.

PLASTIC FILM CAPACITORS

Plastic films are widely used in capacitor manufacture due to their high

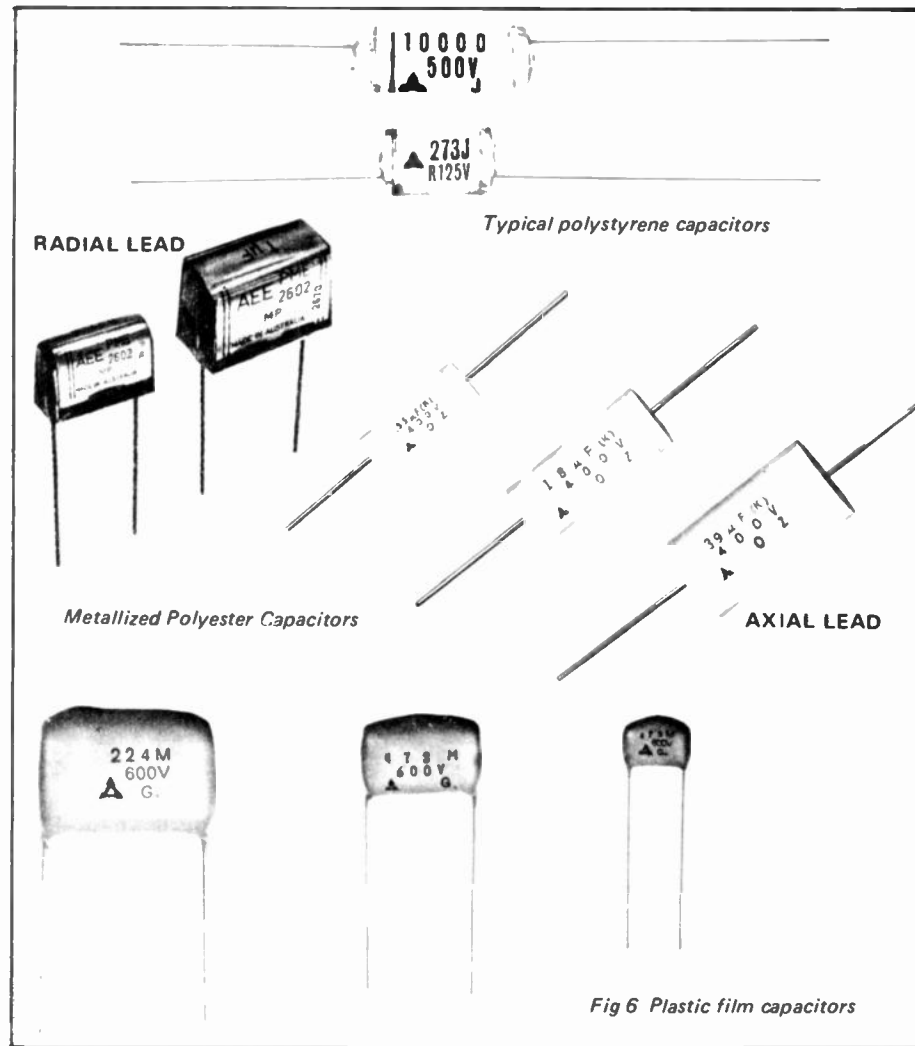

Fig 6 Plastic film capacitors

reliability and low cost. They have medium loss and medium stability characteristics except for polystyrene capacitors which have already been discussed. Many types of plastic film are used but these fall into three general groups:— polystyrene, polyester and polycarbonate.

The common form of construction uses strips of aluminium foil interleaved with the plastic film dielectric, alternate layers of foil being staggered to provide lead connections. The assembly is then rolled-up to form a tubular-shaped capacitor. Some types are wound flat to form a flat rectangular-shaped capacitor which enables it to be packed more densely on a printed circuit board. They are referred to as 'flat film' capacitors.

Metallized film construction is also extensively used with plastic film capacitors, resulting in physically small dimensions. These capacitors have largely replaced paper capacitors in most low voltage applications owing to their superior electrical characteristics and considerably smaller size.

Plastic film capacitors are generally encapsulated in a tough, impervious plastic or resin or in a metal case.

The polyester films used are generally of the polyethylene type (Mylar, Melinex etc) or polypropylene, and for most purposes they have similar properties to polycarbonate films. The latter though, has less loss and exhibits

Continued on page 44.

Fig 5a Paper block capacitors

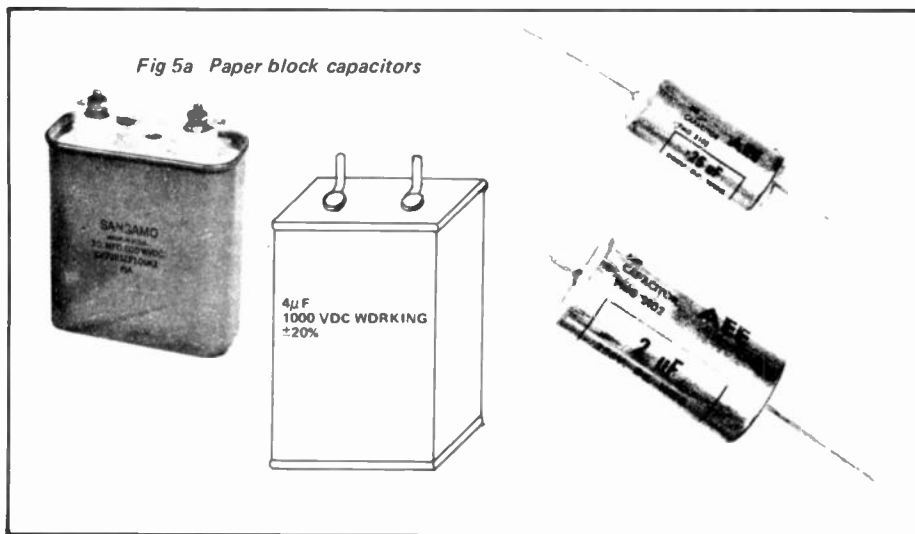

6 DIGIT LED CLOCK KIT

If you've been considering building a digital clock, but were discouraged by the high prices, we've solved your problem! **SATISFACTION GUARANTEED.**

KIT CONTAINS

- 1 - National MM5314 Clock Chip 12-24 hour, 50-60 Hz option
- 6 - Bright red common cathode displays 0.27" character height
- 7 - NPN Segment driver transistors
- 6 - PNP Cathode driver transistors
- 9 - Carbon resistors
- 5 - Diodes
- 2 - Disc caps
- 1 - Electrolytic filter cap
- 3 - Switches for time setting
- 2 - Etched drilled and plated PCB boards
- 1 - Illustrated assembly instructions manual



\$13.95

- SLOW SET
- FAST SET
- TIME HOLD
- 12/24 HOUR
- 50/60HZ
- BRIGHT LEDS

All you provide is a 9-12Vac transformer and a case of your choice.

Also available: Same kit as above, but with 0.5 inch jumbo displays **\$18.95**

INTRODUCING THE KING



Follow the King in future issues, and he will introduce a series of fantastic Maidens representing sophisticated circuits designed especially for the KING.



DIGITAL ALARM CLOCK

THE KING-FEATURES:

- 1) 6 digit 24 hour, 50 or 60 cycle alarm clock
- 2) Time-sharing capability for display of additional information
- 3) Built-in alarm generator and automatic output for intensity control of LED's
- 4) Single 12V supply and a minimum of interface components
- 5) AM PM and automatic power failure indications
- 6) 10 minute snooze
- 7) Complete data and construction manual included



\$23.50

Shipped Surface Mail
Add \$3.00 for Air Mail

- Kit No. 70250 1R (Red readouts) **\$23.50**
 Kit No. 70250 1G (Green readouts) **\$23.50**
 Kit No. 70250 2R (DL727 readouts) **\$28.50**

Upon conclusion of our introductions you will have the most advanced timepiece on the market. Watch next issue for the King's first addition to his harem.

DL747

Jumbo 6 pin high read only 20mA per segment Common Anode

2.75

DL707

Red, 30 in high 15mA per segment Common Anode

1.25

727

Common Anode One of our Best Read outs, 5 in high, 20mA per segment

3.75



NEW HP7730

1.20

33 in high read only bright readout, 25mA per segment Common Anode



DL33

If you like an array of displays, we have it. 10mA per segment Common Cathode

1.45



FND503

We like it, you will love it, our range 5 in common cathode type by Fairchild

1.60

5FOR-750



BURROUGHS 12 DIGIT DISPLAY

25 in high, Orange digits, low voltage operation, 100V DC. We will mount in free socket as a bonus

3.25

TEXAS INSTRUMENTS 6 DIGIT DISPLAY

A perfect choice for your mini 6 digit clock or why not a stop watch Fully multiplexed, common cathode 1 Class and goldplated

1.30



MAN 5 GREEN MAN 7 RED MAN 8 YELLOW

Why not make a clock or 3 digit watch, we have it and it looks nice - 27 in height

1.25



FND70

25 in high bright red readout, Common Cathode type by Fairchild

.95

5FOR-4.50

LEDs

Mini Red 12 points ea
 Jumbo Red 15 points ea
 Jumbo Green 20 points ea
 Jumbo Yellow 26 points ea

SABCHRON DIGITAL LED WATCH KIT

\$45.00

Join the large number of satisfied hobbyists, professionals and experimenters worldwide who have successfully assembled this unique, space-age kit.

THE SABCHRON FEATURES:

- Six Full Functions - displays hours/minutes, minutes/seconds, month/date and AM/PM.
 - Single Command Button - controls all time functions with just one button.
 - Quartz Crystal Accuracy - a 32,768 Hz crystal assures timekeeping to within 5 seconds per month.
 - Automatic Brightness Control - adjusts LED display brightness according to varying light levels.
 - Gold-plated Case - with a stainless steel back is elegantly styled and only slightly larger than a conventional watch.
 - Long-Life Power Cells - two silver-oxide batteries provide power for up to one full year with normal use.
 - Automatic Calendar - knows the difference between 28, 30 and 31 days and makes the change automatically.
 - Easy Time or Date Resetting - change the time or date without affecting the operation or accuracy.
 - Complete Kit - contains all components, batteries, case, comprehensive assembly manual (step-by-step instructions) and full technical assistance backup service. (Bracket not included).
- ALSO AVAILABLE READY-BUILT WITH A 12-MONTH GUARANTEE **\$55.00**



CAPS

Tantalum 1uF 10V 20% tol	0.20
Tantalum 4.7uF 10V 20% tol	0.25
Electrolytic 10uF 25V PC	0.15
Electrolytic 50uF 25V A+	0.20
Electrolytic 100uF 15V PC	0.20
Electrolytic 200uF 25V PC	0.25
Electrolytic 470uF 16V A+	0.30
Electrolytic 1000uF 16V PC	0.35
Electrolytic 2000uF 16V PC	0.45
Electrolytic 1500uF 2000uF	0.85
dual 30 Volt metal can, twist	
Electrolytic 300uF 250V PC	0.45
Ceramic Discs 0.1uF 25V	0.05
Ceramic Discs 68PF 50V	0.05
Ceramic Discs 220PF 50V	0.05
Distilled Mica 150PF 100V 5%	0.10

TRANSISTORS

2N3055 NPN 115W TO3 Power	0.85
RCA 200V 115W TO3 Power NPN	1.25
GE D40C NPN Darlington Cut leas	0.25
2N4443 SCR 400V a 8Amps TO220	0.65
2N2222 NPN Gen. Amplification	0.20
2N3904 NPN Driver	0.15
2N3906 PNP Complimentary 2N3904	0.15
2N4400 NPN Low level noise	0.20
2N5401 PNP Nixie driver 160V	0.25

CPU'S

8008 8 bit parallel CPU	19.50
2102 1K Static RAM for 8008	2.25
MM5203 2K UV erasable PROM	12.25

6 Function Calculator

Chip 7020 with 6000 Segment Drive 8 digit

Price to Sell **\$2.25**

LINEAR'S

555 Timer - Misc. dist. Low Price	0.45
8038 Function Generator	4.25
RCA 3043 FM IF Audio Preamp	1.20
565 Phase Locked Loop	0.95
567V Tone Dec Phase Locked Loop	1.50
LM 723 Pos. Voltage Regulator	0.55
LM 309 5 Volt 1 Amp Regulator	1.10
LM 741 Operational Amplifier	0.25

RCA 3062

Photodetector with power amplifier **\$2.25**

DIODES

1N4004 400PIV 15 for 1.00	
1N4007 1000PIV 10 for 1.00	

TRANSFORMER

220/240 Prim. 12V CT. 500mA Sec **2.75**

LOOK!

1N4148 Switching diodes Leads are cut for PCB insertion, but still very usable.....	40 for 1.00
Ceramic Disc Caps .01 uF 100V PCB leads.....	30 for 1.00
Miniature SPDT slide SW.....	4 for 1.00

LED DRIVER IC's

75491 Segment	35
75492 Digit	45

Duty may be payable on products imported.

All prices are listed in AUSTRALIAN DOLLARS. Remittance by BANK CHEQUE or INTERNATIONAL MONEY ORDER. (Receipt must be included with order if the latter is used). MINIMUM ORDER \$45.00. Unless otherwise indicated, all prices include Air Mail postage.

sabtronics
INTERNATIONAL

P.O. Box 64683, Dallas, Texas 75206, U.S.A.

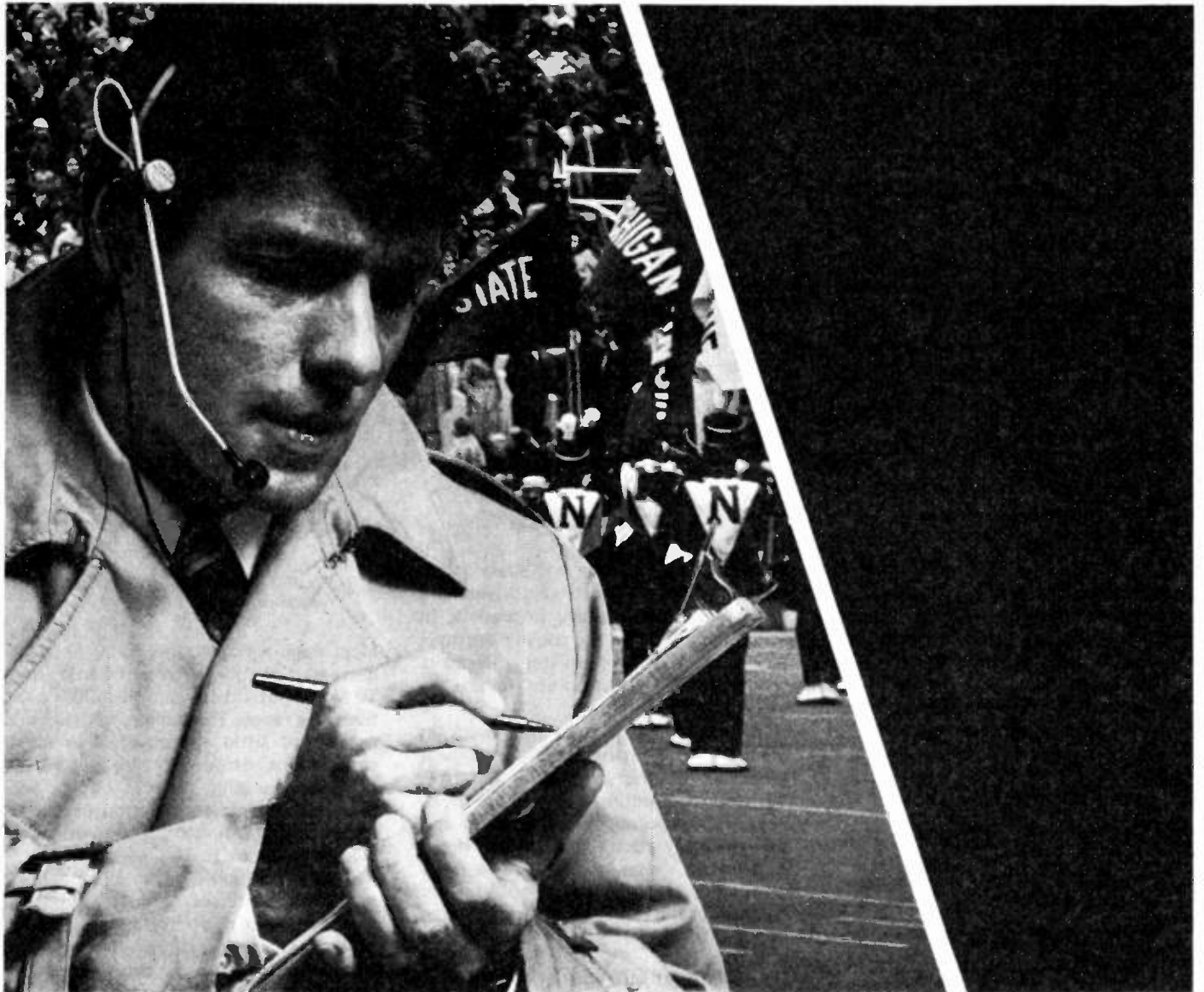

**Next best thing
to a sound proof booth.**

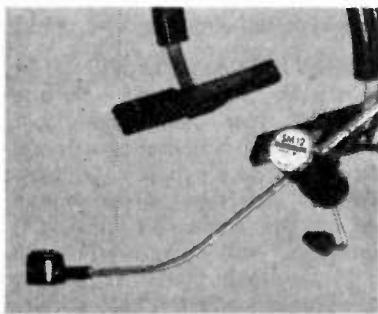

Shure's new headset microphones are coming through loud and clear. With their unique miniature dynamic element placed right at the end of the boom, Shure's broadcast team eliminates the harsh "telephone" sound and standing waves generated by hollow-tube microphones. The SM10 microphone and the SM12 microphone/receiver have a unidirectional pickup pattern that rejects unwanted background noise, too. In fact, this is the first practical headset microphone that offers a high quality frequency response, effective noise rejection, unobstructed vision design, and unobtrusive size.

Distributed in Australia by
AUDIO ENGINEERS PTY. LTD.
342 Kent Street, Sydney. Write for catalogue.



AUDIO ENGINEERS (Vic.)
2A Hill Street
THORNBURY. 3071. Vic.

RON JONES PTY. LTD.
57 Castlemaine Street,
MILTON. 4064. Qld.

ATHOL M. HILL PTY. LTD.
1000 Hay Street,
PERTH 6000 W.A.

Fixed capacitors

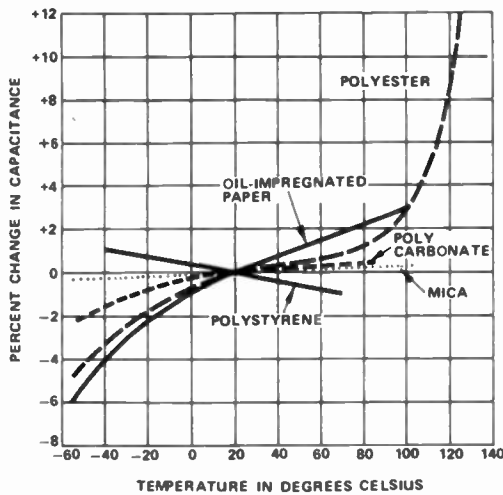

Fig. 7. Temperature versus change in capacitance.

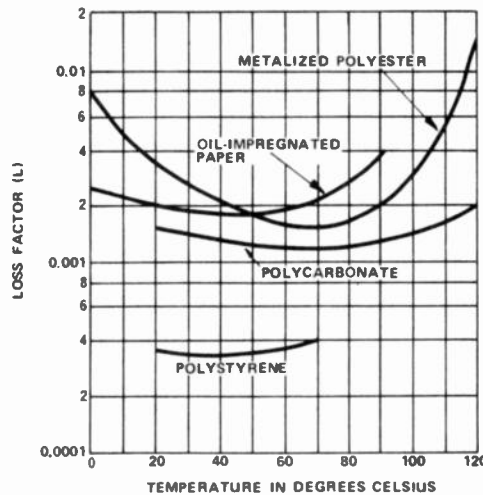

Fig. 8. Temperature versus loss factor.

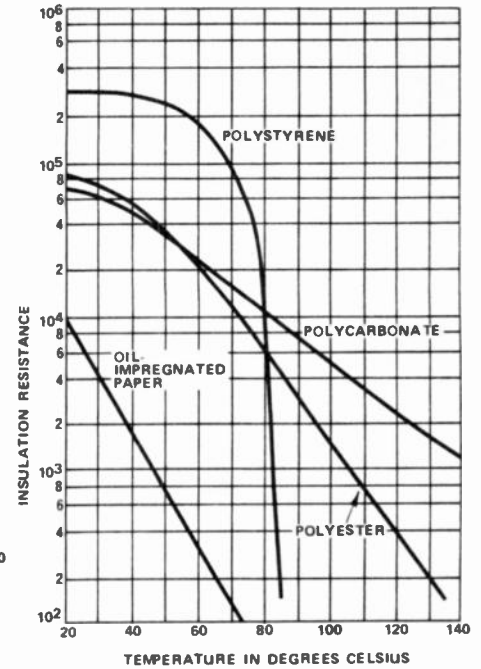

Fig. 9. Temperature versus insulation resistance.

less change in capacitance with temperature. Polyester capacitors are available in ratings up to 100 Vdc (or 250 V rms ac), Polycarbonate capacitors are usually only available in ratings up to 400 Vdc.

A comparison of the temperature, loss factor and insulation resistance of various capacitors is given in Figs. 7, 8, and 9.

A small defect, such as a hole, in the

dielectric of a capacitor will allow an arc between the electrodes when a sufficiently high voltage is present. In foil capacitors, the arc usually destroys more of the surrounding dielectric, resulting in catastrophic failure — usually a short circuit.

This disadvantage does not occur in metallized capacitors. The heat generated by the arc rapidly vaporizes the electrode section, clearing the short. A very short pulse of current occurs and the voltage across the capacitor drops and then rises again in a few microseconds. Usually, no further damage results. The process is illustrated in Fig. 10.

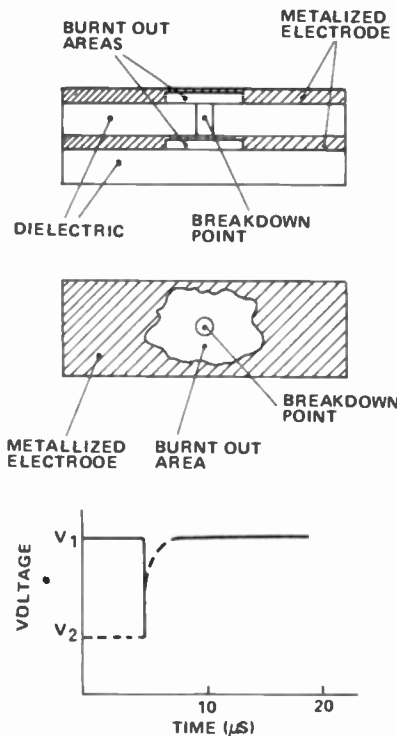

Fig. 10. Process of self healing of a metallized dielectric capacitor. The voltage trace is typical during the process.

HIGH-K CERAMIC CAPACITORS

High-K ceramic capacitors provide large values of capacitance in a very small space. Owing to their method of manufacture they have appreciable loss and show large non-linear changes in capacitance with temperature. Primarily for these reasons they largely find application in bypassing and dc blocking. They change capacitance with applied dc and ac voltage, showing a decrease in capacitance with increasing dc voltage which ranges from 14% for the relatively low permittivity high-K ceramics to 80% for the higher permittivity ceramics. Ac voltage effects are the reverse of dc, giving an increase in capacitance with increasing voltage. This may be only 2% for the lower permittivity ceramic or up to 80% with the higher permittivity types.

High-K ceramic capacitors also change capacitance with frequency. The change is primarily dependent on the particular ceramic used, rather than high or low permittivity. They decrease in capacitance with increasing frequency.

Most high-K capacitors only show a decrease of 5% between 1 kHz and 10 MHz, but others can drop 20% over the same range. These characteristics are usually of little consequence in most applications. However, care should be exercised in using them as bypass and decoupling capacitors around oscillator circuits. Plastic film capacitors or low-k disc ceramics are to be preferred.

In general, high-K ceramic capacitors have less internal inductance than plastic film or paper capacitors, as well as smaller size and are preferred in bypass applications. Disc or plate style ceramic capacitors are suitable for bypass applications from 10 MHz to 100 MHz. High-K ceramic capacitors are also made in button feedthrough and bypass styles for bypass applications to 1000 MHz. The tubular style is suitable in bypass applications to 50 MHz while the ceramic feedthrough is useful to 500 MHz. See Fig. 2 for illustrations. The large value (1000 pF — 0.47 μ F) 'chip' or 'block' style, which has very low lead inductance, is very useful for bypassing in digital circuitry.

ELECTROLYTIC CAPACITORS

Electrolytic capacitors consist basically of two aluminium foils interleaved with an absorbent paper and wound tightly into a cylinder. Contacts are provided by tabs of aluminium attached to the foils. The winding is impregnated with electrolyte and housed in a suitable container, usually an aluminium can, which is hermetically sealed (Fig. 11).

A dielectric layer of aluminium oxide is 'formed' electrolytically on the

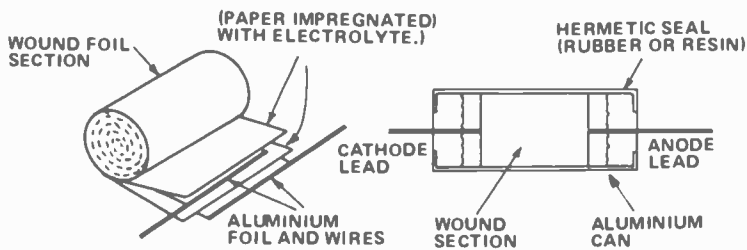

Fig. 11. Construction of typical electrolytic capacitor.

surface of one aluminium foil which acts as the positive plate, or anode, of the capacitor. The electrolyte serves as the second plate of the capacitor and also to repair any flaws in the oxide film when the electrolyte is polarised. The second foil, usually called the cathode foil, provides contact to the electrolyte. Since this film will have a thin oxide film, due to natural oxidation, it will also possess very high capacitance. The thinness of the oxide films, and their high breakdown potential, is responsible for the very high capacitance values per unit volume and high working voltages of electrolytic capacitors.

As a result of their construction, these capacitors are polarised and require the anode terminal to be at a positive potential to the cathode terminal. Most types will only withstand a reverse voltage of 1 V or 2 V for short periods and about 1.5 V peak-to-peak ac without a depolarising voltage.

There are two types of electrolytic capacitor, the plain foil type and the etched foil type. The plain foil construction is described above. The etched foil type is constructed similarly to the plain foil except that the

aluminium oxide on the anode and cathode foils has been chemically etched to increase its surface area and permittivity. It results in a capacitor which is physically smaller than a plain foil type of equivalent value but has the disadvantage of not being able to withstand high ac currents, compared with the plain foil type.

Etched foil electrolytics are best used in coupling, dc blocking and bypass applications. Plain foil types are better suited as reservoir capacitors in power supplies.

Electrolytic capacitors are usually manufactured to a tolerance of $-20 +100\%$ or $-50 +100\%$ (they really are!).

The capacitance value and leakage current both increase with temperature. The leakage current increases with applied dc voltage, this increase becoming more rapid at voltages in excess of the rated working value. This can lead to increased heat dissipation in the capacitor which will, in turn, increase the leakage current, leading ultimately to destruction.

Most electrolytics are rated to withstand a short voltage surge about 15–20% greater than the rated working voltage. e.g. a capacitor rated at 450 V may be marked 450 VWdc (volts, working, dc), 525 V surge.

Electrolytics can be used below their rated voltage. There may be a slight increase of capacitance with time. Leakage current is usually considerably reduced, resulting in an increased service life.

In manufacture, the internal negative connection may be taken directly to the case or to a tag on the insulated end disc. In this case the capacitor winding is inserted in the case without surrounding insulation so that, even though the negative tag is not directly connected to the case, it is not deliberately insulated from it and leakage current can flow between the case and negative terminal. These capacitors are usually covered in shrunk-on plastic sleeve to insulate the can.

Electrolytic capacitors are made in a range of voltage ratings from 10 V to 600 V.

NON-POLARISED ELECTROLYTICS

These capacitors are constructed using several foils in one winding and connected 'back-to-back'. They are usually larger than polarised capacitors of equivalent value. Since double the foil area than is normally required is used they have increased leakage current. Ac voltage without a dc polarising voltage is permissible, the value depending on ripple current ratings and the frequency.

These capacitors are used as speaker coupling and crossover network capacitors. They are obtainable in values from $1 \mu\text{F}$ to $100 \mu\text{F}$.

TANTALUM CAPACITORS

These capacitors use tantalum oxide as a dielectric. This has a much greater permittivity than aluminium oxide resulting in high value capacitance in relatively small space. Owing to their construction, they are also used as polarised capacitors.

There are three different types of tantalum capacitors, each having different construction. These are the tantalum foil type, the solid tantalum, and the wet-sintered tantalum. The tantalum foil type is similar in construction to electrolytic capacitors but the electrolyte and anode and cathode terminals use different materials.

Solid tantalum capacitors use solid manganese dioxide (which is a semiconductor) as the electrolyte, and a tantalum anode. The cathode connection is formed by coating the electrolyte with graphite and silver. These capacitors may be encapsulated in epoxy resin, polyester sleeve with epoxy seals, or a can with epoxy seals.

Tantalum capacitors are rated at much lower voltages than electrolytic capacitors. Their small size makes them very suitable for use in transistor circuits. Low leakage current and better capacitance stability than electrolytics are two features which make them suitable for timing applications.

Tantalum capacitors are generally available in values between $0.1 \mu\text{F}$ and $100 \mu\text{F}$. Tolerance is usually $+50\%$ -20% . Solid tantalum capacitors are available in voltage ratings from 3 V to 100 V. Wet sintered tantalums are available up to 125 V rating and foil tantalums up to 450 V.

Next month — all the various capacitor codes etc.

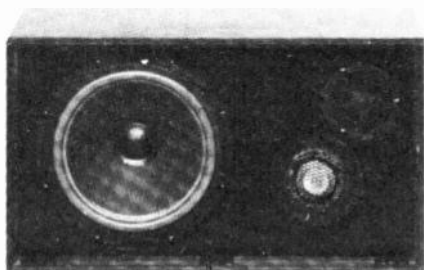
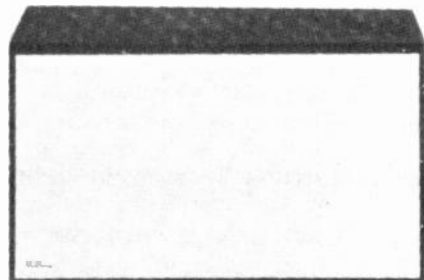

Fig. 12. Electrolytic capacitors.



A TELEDYNE COMPANY

THE AR 3a / IMPROVED an evolutionary new SPEAKER SYSTEM



The AR-3a/Improved is the best home speaker system we know how to make. It has been designed to reproduce music as accurately as present-day knowledge of acoustics and electronics permits.

In addition to incorporating the 305mm (12in) bass driver with which AR introduced acoustic suspension to home listeners, the AR-3a/Improved also uses the two miniature hemispherical dome speakers developed for the AR-3a to offer an unprecedented degree of accuracy at middle and high frequencies.

Concepts and techniques developed for the AR-LST and other AR speaker systems have now enabled AR engineers to improve the spectral energy characteristics of the AR-3a and further reduce its already small degree of coloration, while retaining all the virtues of the original design. These improvements have been accomplished by means of significant changes in the design of the crossover: all other components, including driver units and cabinet, are exactly the same as those of the AR-3a.

The AR-3a/Improved is capable of a more linear spectral energy output than was the AR-3a. A two-position switch makes it possible to tailor this characteristic for maximum realism under either reverberant or relatively damped listening conditions.

On-axis response

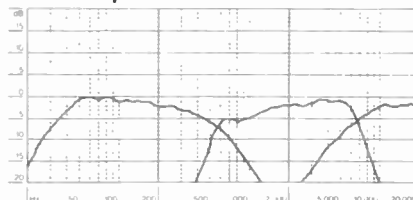

Acoustic power output

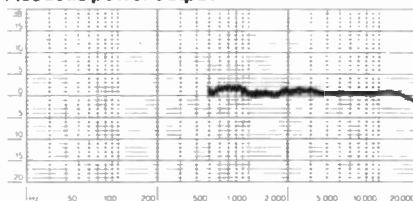

Woofer harmonic distortion

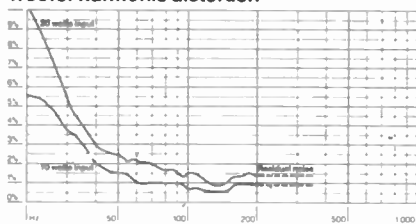

Drive units: 305 mm (12 in) acoustic suspension woofer, 38 mm (1½ in) midrange hemispherical dome, 19 mm (¾ in) high-frequency hemispherical dome

Crossover: 575 Hz, 5000 Hz
Impedance: 4 ohms nominal

Controls: Midrange and high-frequency driver level controls

Amplifier: Up to 100 watts per channel
Size: 356 x 636 x 289 mm deep (14 x 25 x 11½ in)
Weight: 24 kg (53 lb)
Woofer resonance: Free air 18 Hz, in enclosure 42 Hz
Volume of enclosure: 48.2 litres (1.7 cu ft)

'... the best speaker frequency response curve we have ever measured using our present test set-up... virtually perfect dispersion at all frequencies... AR speakers set new standards for low-distortion, low-frequency reproduction, and in our view have never been surpassed in this respect'. *Stereo Review*

'On any material we fed to them, our pair of AR-3a's responded neutrally, lending no coloration of their own to the sound... the speakers sounded magnificent, filling the place with a lot of clean, musical sound and an excellent stereo image... Our tests of the AR-3a simply confirm the manufacturer's design aims and claims for this system'. *High Fidelity*

'The harmonic distortion at bass frequencies was outstandingly low... The high-frequency dispersion is the widest of any speaker we have tested... a new high standard of performance at what must be considered a bargain price'. *Audio*

'Acoustic Research have achieved what they set out to do - a first class loudspeaker by any standard'. *Hi-Fi News*

'Finest bass performance I have heard or measured'. E J Jordan, *Wireless World*

The AR guarantee

The workmanship and performance in normal use of AR speakers are guaranteed for 5 years from the date of purchase. This guarantee covers parts, repair labour, and freight costs to and from the factory or nearest authorized service station. New packaging if needed is also free.

The acoustic research 3A improved is now on demonstration at these franchised dealers:

Sydney
Sydney Hi-Fi Centre
Instrol Hi-Fi
Electronic Enterprises
Mastertone Electronics
Hi-Fi House
Apollo Hi-Fi
Autel Systems
Kent Hi-Fi
Adelaide
Blackwood
Sound Centre

Melbourne
Brash's
Denman Hi-Fi
Douglas Trading
Instrol Hi-Fi
Pantiles Hi-Fi
Mordiallot Electrical

Geelong
Sound Spectrum
(E & B Wholesale)

Perth
Alberts Hi-Fi
Leslie Leonard
The Audio Centre

Canberra
Douglas Hi-Fi

Wollongong
Hi-Fi House

Newcastle
Ron Chapman & Assoc.,

Brisbane
Reg Mills Stereo
Stereo Supplies

Darwin
Pritznars Music House

Hobart
Quantum Hi-Fi

Launceston
Wills & Co.

Australian Distributors
W.C. Wedderspoon Pty Ltd.,
3 Ford St., Greenacre (P.O. Box 21)
Phone 642-2595, 642-3993

\$390 COMPUTER*!!

In January of 1975, MITS (Micro Instrumentation & Telemetry Systems, U.S.A.) stunned the Computer world with the announcement of the Altair 8800 Computer that sells for under \$500.00* in form. TODAY MITS IS ANNOUNCING THE ALTAIR 680 COMPUTER THAT SELLS FOR UNDER \$390.00 in kit form.

*in kit form — plus sales tax if applicable.

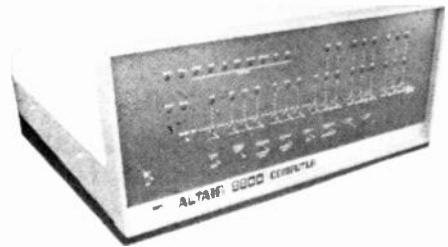
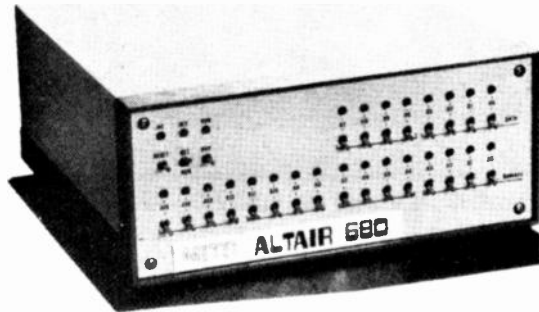

The Altair 8800 is a superbly engineered, variable word length computer. Its byte orientation structure was designed to give the Altair the most efficient utilization possible — an efficiency only found in the most advanced Computers. It has a cycle speed of 2 microseconds; it can directly address 65k bytes of memory and 256 input/output devices; and has 78 basic machine instructions with variations over 200 instructions. The Altair has been designed with buss orientation to be easily expanded and easily adapted to thousands of applications. It is ideal for teaching, commercial and industrial applications. Yet, it has the power and versatility for the most advanced data processing

requirements. Its basic memory of 256 words of static RAM memory can be extended to 65,000 words of directly addressable memory, static or dynamic memory, PROM or ROM memory, or a floppy disk system which can store over 200,000 bytes of information on a flexible disc with a data transfer rate of 250K bits/sec. Using standard MITS interface cards the Altair can be connected to MITS peripherals (computer terminals, line-printers, audio cassette interface, character alpha numeric display, teletype, Interface Card between Computer & TV set to generate action games, 8 channel Analog-to-digital converter Cards etc. etc.

Australian Sole Distributor: W. H. K. ELECTRONIC & SCIENTIFIC INSTRUMENTATION

Also listed in our catalogue:— 7-decade counter-latch-decoder-driver CMOS IC, will count up to 9,999,999 ideal for frequency meters, time interval counters, etc; 8-digit stopwatch IC needs only a crystal, switches and display, can also be used as 24 hour clock; 4-decade presettable up-down counter-decoder-driver IC, ideal for batch counters; crystal time bases for clocks and frequency meters; 12V battery operated chronometer kits ideal for boats and cars; digital clock kits with large Liquid Crystal Display or extra large LED displays; digital clock IC's with alarm, date & month display: TTL, CMOS, ECL & Linear IC's; Memories, Character Generator IC's; very low cost analog to digital converter IC's; Function Generator IC with sine, square and triangle wave outputs; low cost red, yellow, green and orange LED's; Alpha numeric displays; solid state linear temperature transducers; solid state pressure transducers; dual tracking voltage regulators; Hall Effect devices for magnetic field measurements; Magneto Resistors; Printed Circuit Boards; Anti-Reflective Filters for Displays; Drafting Templates with electronic symbols; Dual Stereo Preamplifier I.C.'s; CBS SQ DEcoder IC's; Four Channel SQ Decoder IC's; Electronic Attenuator IC 0-90 dB; Power

Amplifiers, new infra-red Transmitter/Receiver kits for Headphones use on your TV set; TV games; Construction plans for Laser Pistols, FM BUG Transmitter; Wind Generators and many others; Infra-red Viewers; Diffraction Gratings; Polarization Filters; Fresnel Lenses; Fiber Optics; Heatpipes; Scientific Calculators; low cost digital Meter kits, TV Typewriter Terminal, Computer Keyboard with encoder, Stereo Octave equalizer, CD-4 Demodulator kit, 250 Watt Amplifier kit with output meter etc.

WHK No 7 catalogue \$2.00 plus 0.50 p/p with the catalogue you receive two \$1.00 vouchers which can be used towards the purchase of goods. Catalogue free to INDUSTRY & EDUCATION DEPARTMENTS.

Please forward WHK No 7	Please Print:
Name
Street
Town	Postcode
E.T.4	



W.H.K. ELECTRONIC & SCIENTIFIC INSTRUMENTATION

MANUFACTURING, IMPORT, EXPORT, WHOLESALE & RETAIL

2 GUM ROAD, ST. ALBANS, 3021. VICTORIA, AUSTRALIA. PHONE: 396-3742 (STD area code 03)

POSTAL ADDRESS: P.O. BOX 147, ST. ALBANS, VICTORIA, AUSTRALIA 3021.

JUST RELEASED!

The Gold-Star GA-6000 FM Receiver

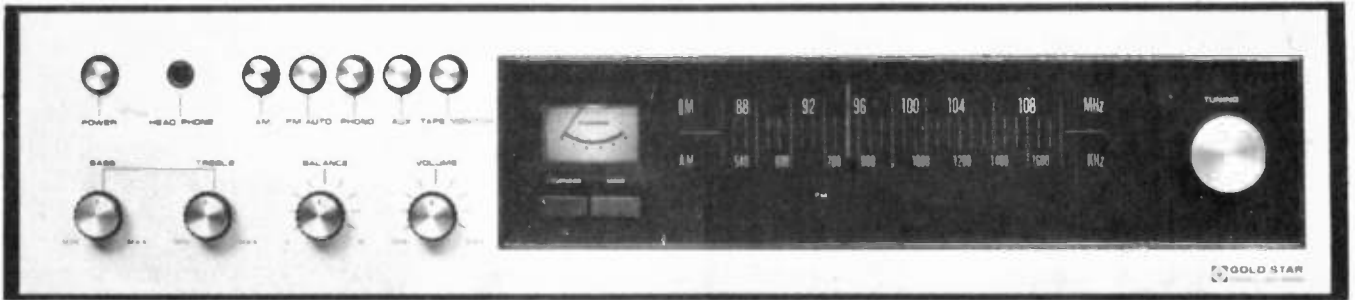

Challenge Hi-Fi have scooped the hi-fi scene with this first Australian release of the GA-6000 AM/FM stereo tuner/amplifier from Gold Star Electronics! The GA-6000, rated at 10 watts r.m.s. per channel and priced around \$140, provides hi-fidelity performance from disc, tape and FM broadcasts at a surprisingly low cost. Although in the "budget" price area the workmanship and circuit design is sound and reliable. Twelve months guarantee, parts and labour, are effective from the date of purchase. FM de-emphasis is set to the Australian 50 microsecond standard. Technical Details * 10 watts r.m.s. per channel from 50-20,000Hz at less than 1% total harmonic distortion with both channels driven into 8 ohm load * Total Harmonic Distortion: 0.2% at 1,000Hz, 10 watts r.m.s. per channel (both driven).

CHALLENGE CSP-2 TURNTABLE

Belt drive system with auto start/auto return tone arm * Separate oil-damped cueing lever * repeat play selector * wow & flutter 0.1% wrms, rumble - 50dB wrms * magnetic cartridge with diamond stylus * anti-skate mechanism * tension spring hinged cover.



CHALLENGE FLH SPEAKER SYSTEMS

Designed and assembled in Australia using top quality imported loudspeaker components.

FLH-1

10" acoustic suspension woofer (2" voice coil), 5" midrange, 1" dome tweeter * frequency response 30-20,000Hz: handles the output from a 30 watt r.m.s. per channel amplifier (1,000Hz 8 ohms) * cabinet size 645mm(H) x 370mm(W) x 315mm(D).

FLH-2

12" acoustic suspension woofer (2" voice coil) 5" midrange 1" dome tweeter * frequency response 25-20,000Hz: handles

the output from a 35 watt r.m.s. per channel amplifier (1,000Hz 8 ohms) * cabinet size 740mm(H) x 440mm(W) x 300mm(D).

FLH-3

15" acoustic suspension woofer (2" voice coil) 5" midrange 1" dome tweeter * frequency response 20-20,000Hz: handles the output from a 45 watt r.m.s. per channel amplifier (1,000Hz 8 ohms) * cabinet size 940mm(H) x 490mm(W) x 400mm(D).

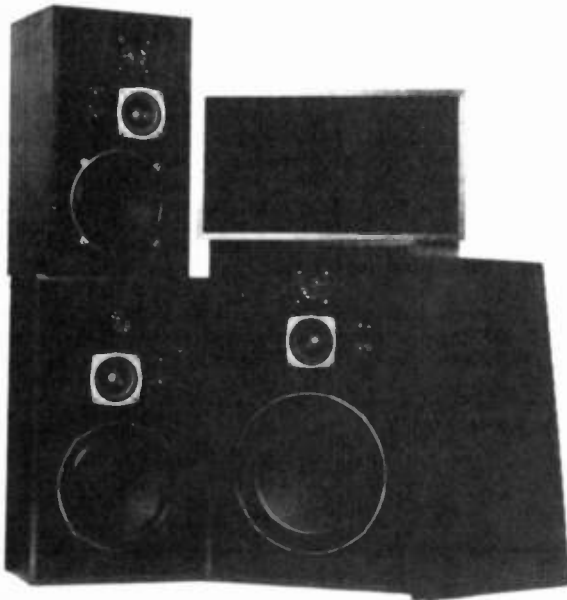

Challenge

HI-FI STEREO PTY LTD

96 PIRIE ST.
ADELAIDE

STH. AUST. 5000

PHONE: 223 3599

Audio expander compressor

Increase dynamic range of tape recordings and/or reduce record surface noise with this versatile unit. This project is based on an original design by Frank Gillespie of Findon, South Australia.

International 443
AUDIO COMPRESSOR-EXPANDER

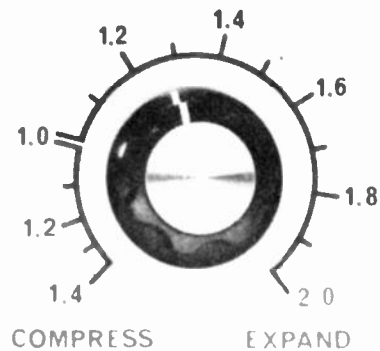

MANY OF US HAVE TAPES IN either the reel to reel format or on cassettes which have poor signal to noise ratio. It is not that we necessarily made a bad job of the recording in the first place, but rather the limitations of our equipment and tape were generally just a little bit too much compared with what is available today. And because the signal to noise ratio is so poor, many of these tapes (and quite a few records as well) tend to lie on the shelf because of their audible inadequacies. Apart from this it is by no means unknown for commercially pre-recorded tapes and records to be below an acceptable standard.

Many people arbitrarily think that this problem is what the Dolby system is intended to resolve. But this is not so. The Dolby system helps *maintain* the original signal to noise ratio when recording from one medium to another but it has very little to offer when faced by *existing* inadequacies.

Another problem that plagues many of us is the poor dynamic range of our tape recorders or of the pre-recorded material that we buy. For example, the majority of cassette recorders are hard pressed to offer even a 55 dB dynamic range. Many of them offer little more than 40 dB. As

if this were not bad enough, very few records have a dynamic range exceeding 50-55 dB and even this is considerably degraded after a dozen or so playings in a dusty environment.

One at least partial solution to these problems is the use of dynamic volume expansion, and units are available commercially that do just this.

The dbx 117 dynamic range enhancer reviewed in ETI in January 1975 performed remarkably well — to the extent that one of our readers decided to design a dynamic volume expander — starting from basic principles.

It was decided that the cost of incorporating root mean square detection was not justified — so absolute mean detection was used instead.

Our reader's unit was then passed over to our development laboratory who made minor changes to the circuitry and designed suitable metalwork etc.

The final unit described here is relatively inexpensive to build, yet its performance is quite adequate for all practical purposes. It is sufficiently versatile to interface with most existing audio equipment, at nominal signal levels from about 25 millivolts to 1 volt.

CONSTRUCTION

Due to the relative complexity of the circuit a double-sided printed-circuit board has been used to simplify the construction, and we strongly recommend that this board be used. A single-sided board could be used but it would be much larger and would require a great number of wire links.

Begin construction by assembling the components on to the board following the component overlay. Take particular care with the orientation of components as marked on the overlay. When soldering component leads to the top of the printed-circuit board use a soldering iron which has a small tip and use a small gauge of solder (1 mm recommended). Take care not to bridge solder between the IC pads. It is easy to miss soldering connections on the component side of the board and these should be double checked.

Take care to insert the electrolytics with the polarity as marked on the overlay and even more care with the orientation of the diodes. A reversed diode can result in the destruction of one of the dual transistors.

The resistors in the signal side of the circuit and those in the current-sink circuit should be 2% or better.

Audio expander compressor

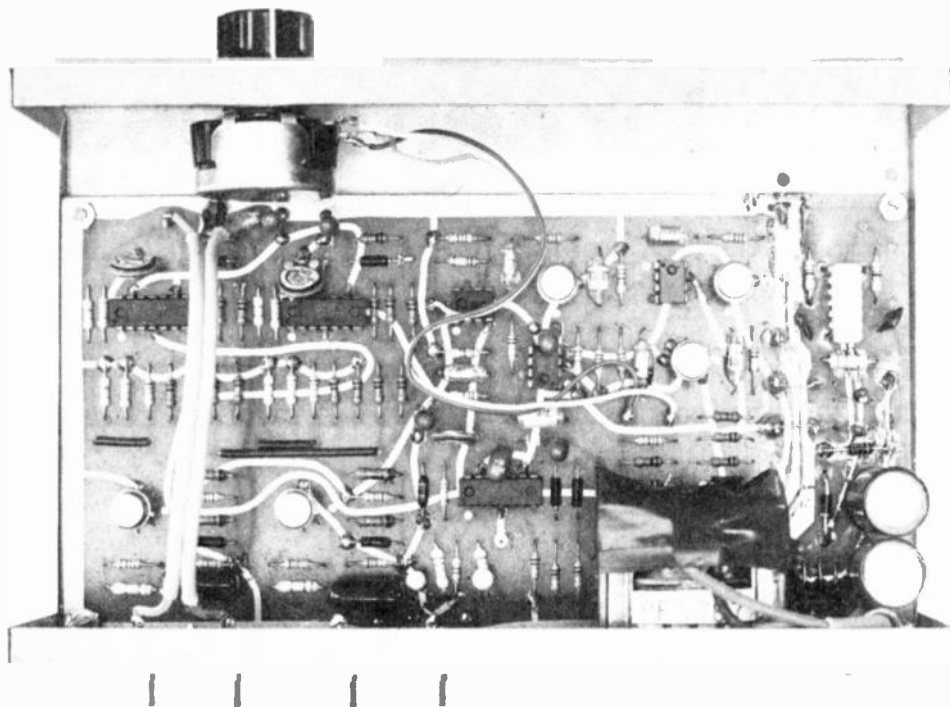

Alternatively they may be selected from 5% values. In selecting values an ordinary multimeter (operated at about the centre of the range suffices). The resistors in question are all those values between R37 and R65.

For best results the two 12 volt zeners should also be matched but in practice any slight discrepancy may readily be compensated by using the normal stereo-balance control.

As explained below, capacitor C5 should be chosen in accordance with the particular compromise that suits the user of the unit. Alternately a switch may be used to select different values. A value of 1 microfarad for C5 allows compression or expansion to follow the signal amplitude so rapidly that the ear is unlikely to detect the attack or release, which is virtually complete in about 20 milliseconds. However, with this value, low frequency signal components (50 Hz or lower) will not be averaged out in obtaining the gain-control voltage, and severe intermodulation and 3rd harmonic distortion will result. At the other extreme, a value of 4.7 microfarads for C5 will prevent such distortion right down to the lower audible limit, but the attack and release time (about 100 milliseconds) is long enough so that the control effects can be audible, although not necessarily unpleasant. Nevertheless for the small compression or expansion ratios which should be most used, a value of C5 equal

to 4.7 microfarads will be found quite acceptable by most people.

Potentiometer RV1 is a trimpot used to match the signal levels of the compressor-expander with those of the associated equipment.

The box used in our prototype measured 200 x 125 x 63 mm and, although a little cramped did adequately hold the unit. The next larger box available was thought to be too big. The printed-circuit board is mounted at the rear of the box to allow room for the front-panel potentiometer to be mounted. The board is mounted on 6 mm spacers and the transformer is then mounted directly onto the rear panel together with the RCA input and output sockets.

POWER SUPPLY

The output of the transformer is rectified by a full-wave bridge to provide ± 22 volts as set by the zener diodes. The voltages obtained from the MC1468 voltage regulator are near enough to the nominal ± 15 volts for correct operation of the compressor-expander.

SETTING UP

With the power supply connected (check for correct polarity), apply a strong (about 1 volt) audio signal to both stereo inputs, while the point marked 'X' is shorted to ground. Monitor the left channel output with a high sensitivity meter (or amplifier) and adjust

RV3 to the point where the output *just* disappears. Repeat with the right channel and RV4. This procedure balances out the input offset voltage of the current sinks, and ensures that the audio gain will be controlled correctly at the low end. Remove the input signal and the short circuit.

Potentiometer RV1 is a trimpot, this is set by the following procedure:

- (1) Connect the compressor-expander to its associated equipment, and supply an input of moderate level (e.g. music of average loudness). Potentiometer RV1 should be fully clockwise when viewed from the input edge of the board.
 - (2) Turn the compress-expand control to full compression, and adjust RV1 to bring the output up to its original level (loudness).
 - (3) Turn the compress-expand control towards the expansion end, and note any obvious change in output level.
 - (4) If a decrease in level occurs, turn RV1 slightly anticlockwise; if an increase occurs, turn RV1 slightly clockwise.
 - (5) Repeat steps (3) and (4) until the level remains reasonably constant over the whole range of compression and expansion. Note that this adjustment is subjective, and it does not need to be done with any great accuracy.
- If RV1 cannot be adjusted as described, it means that the signal level is outside the optimum range of the compressor-

expander. Somewhat higher signal levels can be accommodated by increasing the value of R1 and R2 whilst for lower signal levels, R4 should be decreased. If correct adjustment of RV1 is obtained well towards the anticlockwise end, then an improved signal-to-noise ratio results if R34 and R36 are increased to 18k, and the stereo outputs are each attenuated by a 470 ohm/3.9 k divider. However, this modification is not essential.

With no input signal applied adjust RV2 such that the voltage at its wiper is zero volts. Now fit the knob such

that the pointer lines up with the 1.0 calibration. Check that the potentiometer travel approximately matches the scale. If not reverse the two outside leads of RV2.

HOW TO USE

The use of a compressor-expander need not be confined to those situations where such a device is really needed. Practically all tapes and many records become more listenable with a small amount of expansion. On the other

hand, background music is far less obtrusive if the volume is compressed to some extent. The key to listening pleasure lies in the handling of the compressor-expand control. Don't move it far from the 1.0 position unless there is some definite reason.

One final word of warning — on full expansion this device is quite capable of outputting a signal of 10 volts. It would be wise to ensure that your amplifier is capable of accepting this voltage without damage if full expansion is ever used.

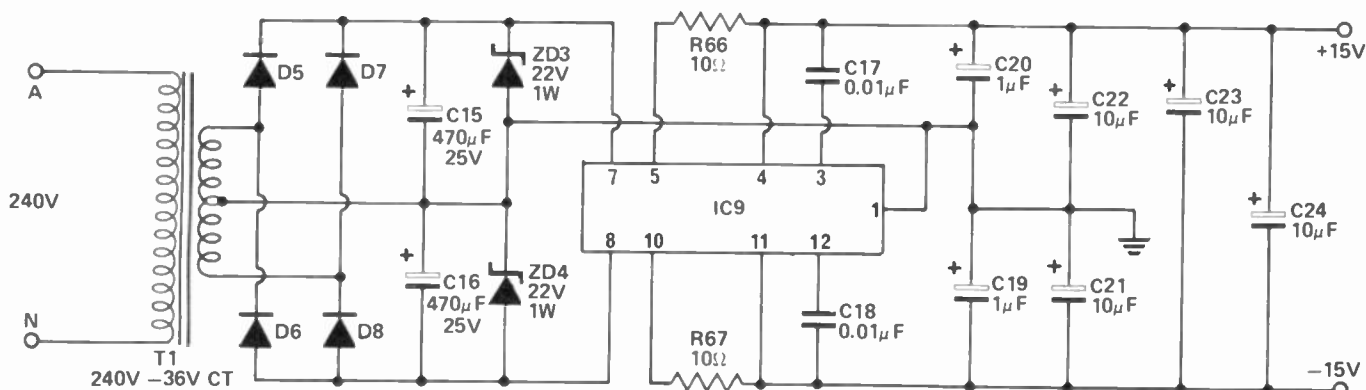

NOTES

D5-D8 ARE EM401 OR SIMILAR
ZD3,ZD4 ARE 22V 1W ZENERS
IC9 IS MC1468L,SG4501N, XR1568

Circuit diagram for the power supply section. (On the same board as the circuitry of Fig. 1).

Coilmaster

DELUXE ACCURATE COIL WINDER

\$23-95

Post & Pack \$1.50

This Easy-to-use machine winds honeycomb, spiderweb and solenoid coils of various widths and diameters — equal in appearance to a factory job. Also suitable for winding chokes, transformers and filter inductors. Indicator counts number of turns on coil. The COILMASTER is suitable for both experimental and practical work. Supplied with accessories including wood spools, metal pegholders and extension for making long solenoid coils. Instructions included.

SEND REMITTANCE WITH ORDER FOR IMMEDIATE DELIVERY ANYWHERE TO THE SOLE AUSTRALIAN AGENTS.

LAFAYETTE ELECTRONICS 94 HIGH ST., ST KILDA, VIC 3182. Phone 94-6036

HOBIPAK

P.O. Box 224,
South Carlton, Vic. 3053.

CARBON FILM RESISTORS

1/8 W 10% 4c ea.
Special — 100 for \$3.40 —
25¢ for 92c.

1/8 W E12 5% 5c ea.
1/2 W E24 5% 5c ea.
Special — 100 for \$4.50

1 W E12 5% 6c ea.
Special — 100 for \$5.40

METAL FILM RESISTORS

MR30 metal film E24 2%10c ea.
Special — 100 for \$9.00

SOLID STATE DEVICES

7489 . . . \$4.85 8223 . . . \$9.00
7490 . . . \$1.65 MEL12 . . \$1.90

TRANSISTORS

2N2926 \$1.00 ZTX108 . . .99
2N3693 . . .41 ZTX109 \$1.15
2N4121 . . .40 ZTX114 \$2.00
2N5133 . . .85 ZTX304 \$1.90
2N5134 . . .86 ZTX382 \$1.40
2N5137 . . .86 ZTX501 \$1.18
2N5138 . . .86 ZTX502 \$1.25
2N5139 . . .80 ZTX503 \$1.38
BF561 . \$1.69 ZTX531 \$1.95
BF598 . \$1.60 ZTX550 \$1.60
ZTX107 \$1.00 OA47 . . .94

SLIDE POTS AND CHROME KNOBS

Linear 5K to 100K 93c ea.
Logarithmic 5K to 50K . 93c ea.

CAPACITORS

Tantalum 0.1-2.2µF 35V 29c ea.
Ceramic .0001 — .05 . . .9c
Polyester (100VDCW) .0047 —
16c; .01 — 18c; .012 — 18c;
.015 — 18c; .022 — 18c; .033 —
18c; .056 — 23c; 1-24c.

Electrolytic P.C.B. Type

47/63V . . .26c 25/25V . . .18c
470/50V . .88c 100/25V . .26c
470/25V . .59c 220/25V . .54c

Electrolytic Pigtail Type

47µF/25V 25c 100µF/25V 32c
47µF/50V 34c 470µF/25V 60c
220µF/25V 48c 470µF/50V 88c
250µF/50V 62c 2000µF/25V 92c

DENCO COILS

Dual Purpose type —

Green Range 1-5 \$2.50
All other D.P. \$2.30

Transistor type —

All ranges and colours . . . \$2.30
Coil formers (T or D.P. type) 75c
BF02 1.6 or 465 \$2.99
IFF1/1.6 or 465 \$2.50
IFT15/1.6 or 465 \$3.15
IFT16 IF Trans \$2.45
RFC 11 (RF choke) 70c
Choke Cores CH1 30c

FM Coils

RDT2 \$3.80
IFT 15 \$2.80
Ferrite Coil Cores 8c
1/2" x 1/4" dia. (R900, R910, F29 grades)

Coil Cans

2 5/16" x 3/4" x 3/4" 40c
(2 for 75c 3 for \$1.00)
722/2 Coil Former and base 50c

POSTING AND PACKING 30c per order,
92B/113 Swanston St., Melb.

PARTS LIST – ETI 443

Resistors

R1-2	— 15k	½ watt	5%
R3	— 5k6	"	"
R4	— 47 ohm	"	"
R5-6	— 22 k	"	"
R7-8	— 10 k	"	"
R9	— 22 k	"	"
R10-11	— 10 k	"	"
R12	— 4k7	"	"
R13	— 22 k	"	"
R14	— 100 k	"	"
R15	— 150 k	"	"
R16-17	— 2 k2	"	"
R18-19	— 1 M5	"	"
R20-21	— 22 k	"	"
R22	— 10 k	"	"
R23	— 820	"	"
R24	— 2 k2	"	"
R25	— 150 k	"	"
R26-27	— 1 M5	"	"
R28-29	— 2 k2	"	"
R30	— 100 k	"	"
R31-32	— 270 k	"	"
R33-36	— 1 k5	"	"
R37	— 12 k	2%	"
R38	— 1 k5	"	"
R39	— 12 k	2%	"
R40	— 27 k	"	"
R41	— 470 k	"	"
R42	— 27 k	"	"
R43	— 470 k	"	"
R44	— 12 k	2%	"
R45	— 1 k5	"	"
R46	— 12 k	"	"
R47	— 27 k	"	"
R48	— 470 k	"	"
R49	— 27 k	2%	"
R50	— 470 k	"	"
R51-52	— 10 k	"	"
R53	— 22 k	"	"
R54	— 15 k	"	"
R55-56	— 10 k	2%	"
R57	— 22 k	"	"
R58	— 100	"	"
R59-60	— 10 k	"	"
R61	— 22 k	"	"
R62	— 15 k	"	"
R63-64	— 10 k	"	"
R65	— 22 k	"	"
R66-67	— 10 ohm	5%	"

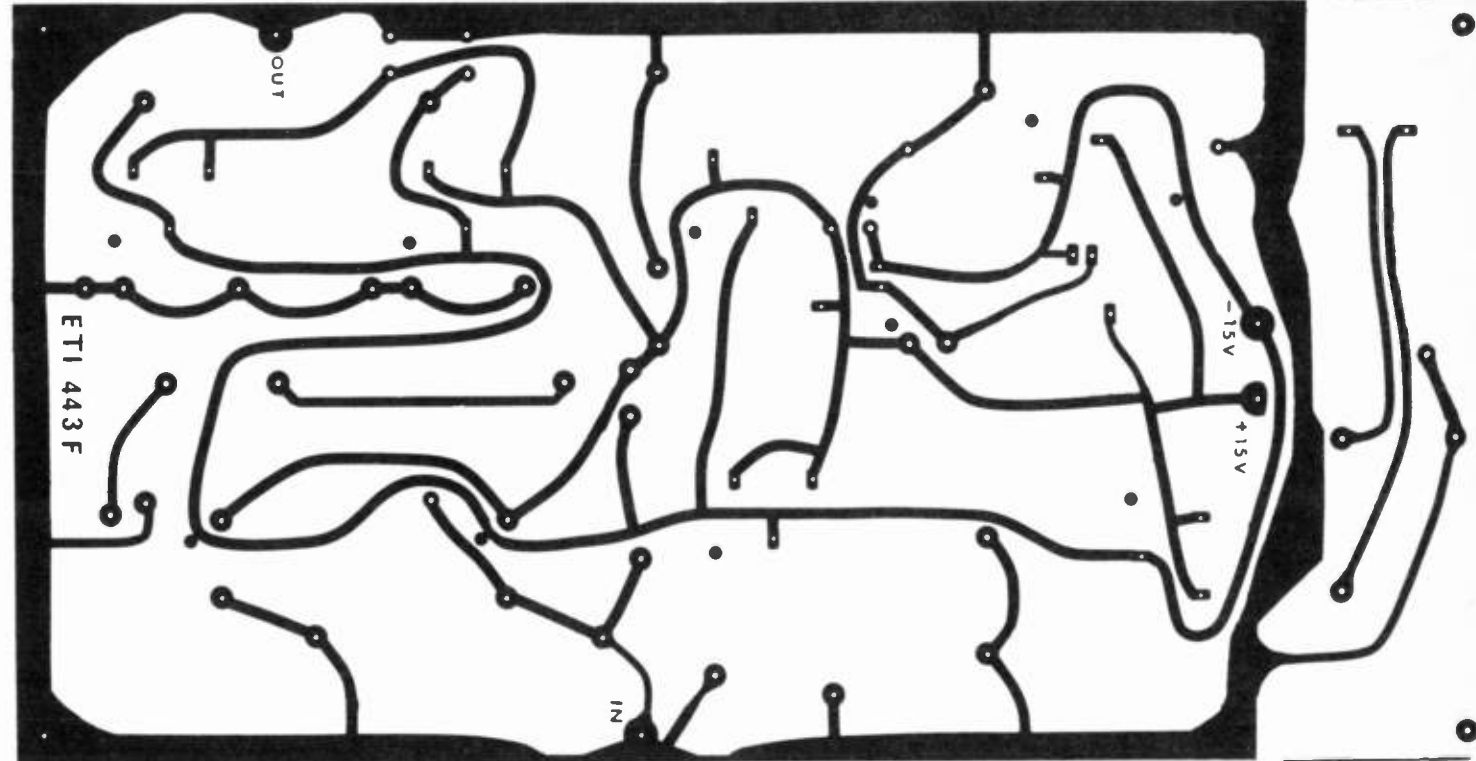

Fig. 4. Printed-Circuit layout of the component side of the board.

*The 2% resistors may be selected from 5% valves.

Resistor Summary

2 x 10Ω, 1 x 47Ω, 1 x 820, 6 x 1.5 k, 5 x 2.2 k, 1 x 4.7 k, 1 x 5.6 k, 13 x 10 k, 4 x 12 k, 4 x 15 k, 10 x 22 k, 4 x 27 k, 2 x 100 k, 2 x 150 k, 2 x 270 k, 4 x 470 k, 4 x 1.5 M

Variable Resistors

RV 1 — 2 k trim
RV 2 — 5 k wire wound rotary
RV 3-4 — 10 k trim

Capacitors

C1-2 — 4.7μF 25 V tantalum
C3-4 — 10μF 25 V tantalum
C5 — 4.7μF 25 V "
C6-7 — 330 pF

C8 — 22 pF
C9-10 — 150 pF
C11 — 22 pF
C12 — 33 pF
C13-14 — 0.47μF polyester
C15-16 — 470μF 25 V electro
C17-18 — 0.01μF polyester
C19-20 — 1μF 25 V tantalum
C21-24 — 10μF 35 V "

Dual Transistors

TP1-TP4 LM14, 2N2920A, 2N3424

Integrated Circuits

IC1-2-7-8 — LM 747
IC3 — LM 308
IC4-5-6 — LM 301
IC9 — MC 1468L, SG 4501N, XR 1568

Diodes

D1-D4 — IN 914 or similar
D5-D8 — EM 401 or similar

Zener Diodes

ZD1-ZD2 — 12 V 400 mW
ZD3 - ZD4 — 22 V 1 W

Miscellaneous

240V/36V CT PF 3787
PC Board ETI 443
4 RCA sockets
Power cord and plug
Four 6 mm spacers
Chassis and cover 200 x 63 x 125 mm
Front Panel
Knob

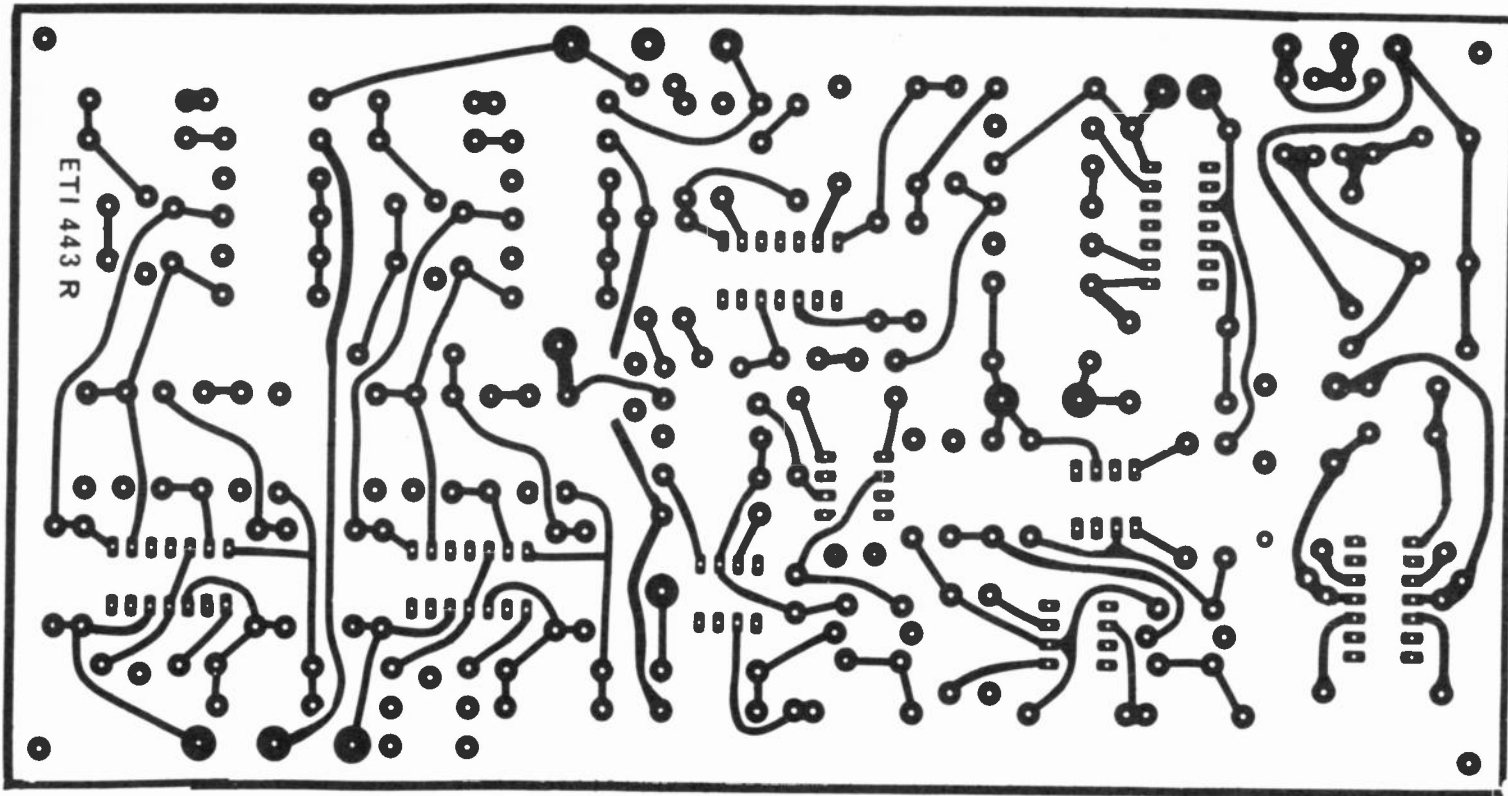
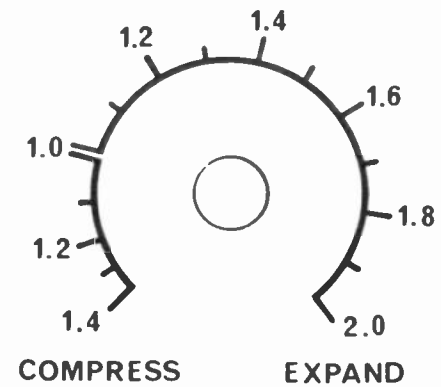

Fig. 5. Printed-Circuit layout of the non-component side.

International 443
 AUDIO COMPRESSOR-EXPANDER



Front panel layout shown full-size.

Audio expander compressor

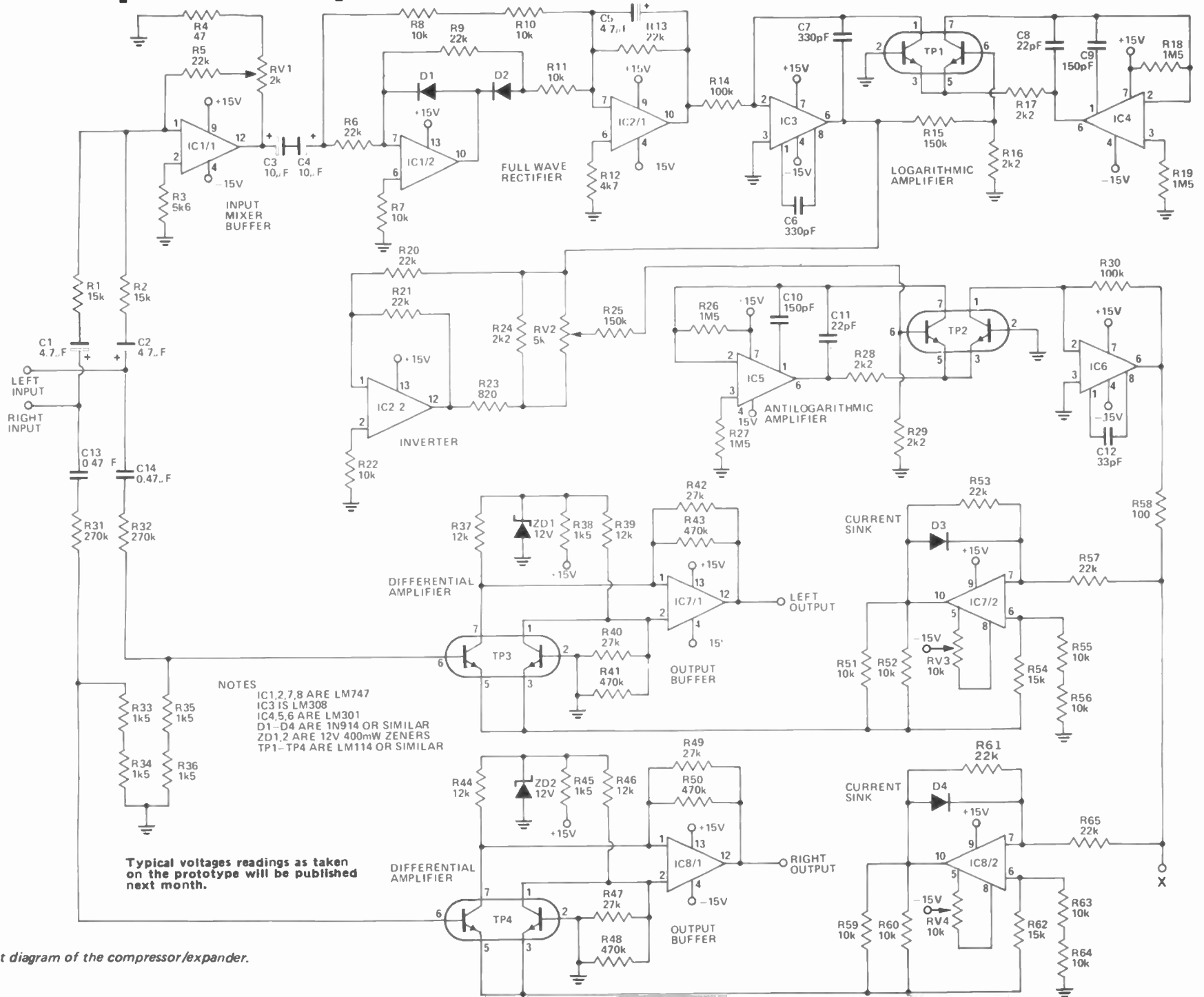

NOTES
 IC1,2,7,8 ARE LM747
 IC3 IS LM308
 IC4,5,6 ARE LM301
 D1-D4 ARE 1N914 OR SIMILAR
 ZD1,2 ARE 12V 400mW ZENERS
 TP1-TP4 ARE LM114 OR SIMILAR

Typical voltages readings as taken on the prototype will be published next month.

Circuit diagram of the compressor/expander.

HOW IT WORKS — ETI 443

The heart of an audio compressor-expander is invariably a voltage controlled amplifier; that is, an amplifier whose gain is set by means of an applied dc voltage. This dc voltage itself must be derived from the amplitude of the audio input signal, averaged over some preset period, and modified to give the required compression or expansion characteristics. In the circuit of Fig. 1, each portion of the circuit is identified according to its function. These portions, in turn, are grouped into three main sections; an ac to dc converter, a power function generator, and a stereo analogue multiplier.

The two channels of stereo input are mixed in buffer amplifier 1C1/1, and the gain of this stage is set so that an output of about 1 volt is given by a signal which corresponds to moderate loudness. Amplifiers 1C1/2 and 1C2/1 are used to obtain precision full-wave rectification of the mixed input, and the resulting positive dc voltage is stored in capacitor C5. The choice of value for C5 is important, and it will be discussed in detail later on.

Amplifiers IC3 and IC4 together with the transistor pair TP1 constitute a logarithmic amplifier. With the components shown, the behaviour of this amplifier is described by the equation:

$$E_{out} = -4.15 \log E_{in}$$

The inverse of E_{out} is obtained from amplifier 1C2/2 and by connecting the compression-expansion control potentiometer as shown between the input and output of this stage, any voltage between E_{out} and $-0.3E_{out}$ can be obtained. IC5, IC6 and TP2 are combined as an antilogarithmic amplifier (or exponential), which is the exact inverse of the logarithmic amplifier so that the effect of all these operations on the input signal is to give a positive dc output voltage, equal in magnitude to the input voltage raised to the power k , where k can have any value from -0.3 to 1 .

In the analogue multiplier sections, this voltage (E_{in}^k) is converted to current by amplifiers 1C7/2 and 1C8/2, thus setting the effective gain of the differential amplifiers TP3 and TP4. These are directly coupled into the output buffers 1C7/1 and 1C8/1, so that the stereo signals reaching the outputs have been amplified by a factor which depends on the average amplitude of the signals, and the compression-expansion control setting. The actual voltage gain can vary from 0.0004 to 14, which represents a power gain range of 97 dB.

Component overlay. Note the foil pattern of the non-component side of the board is shown in blue — the foil pattern of the component side is in grey.

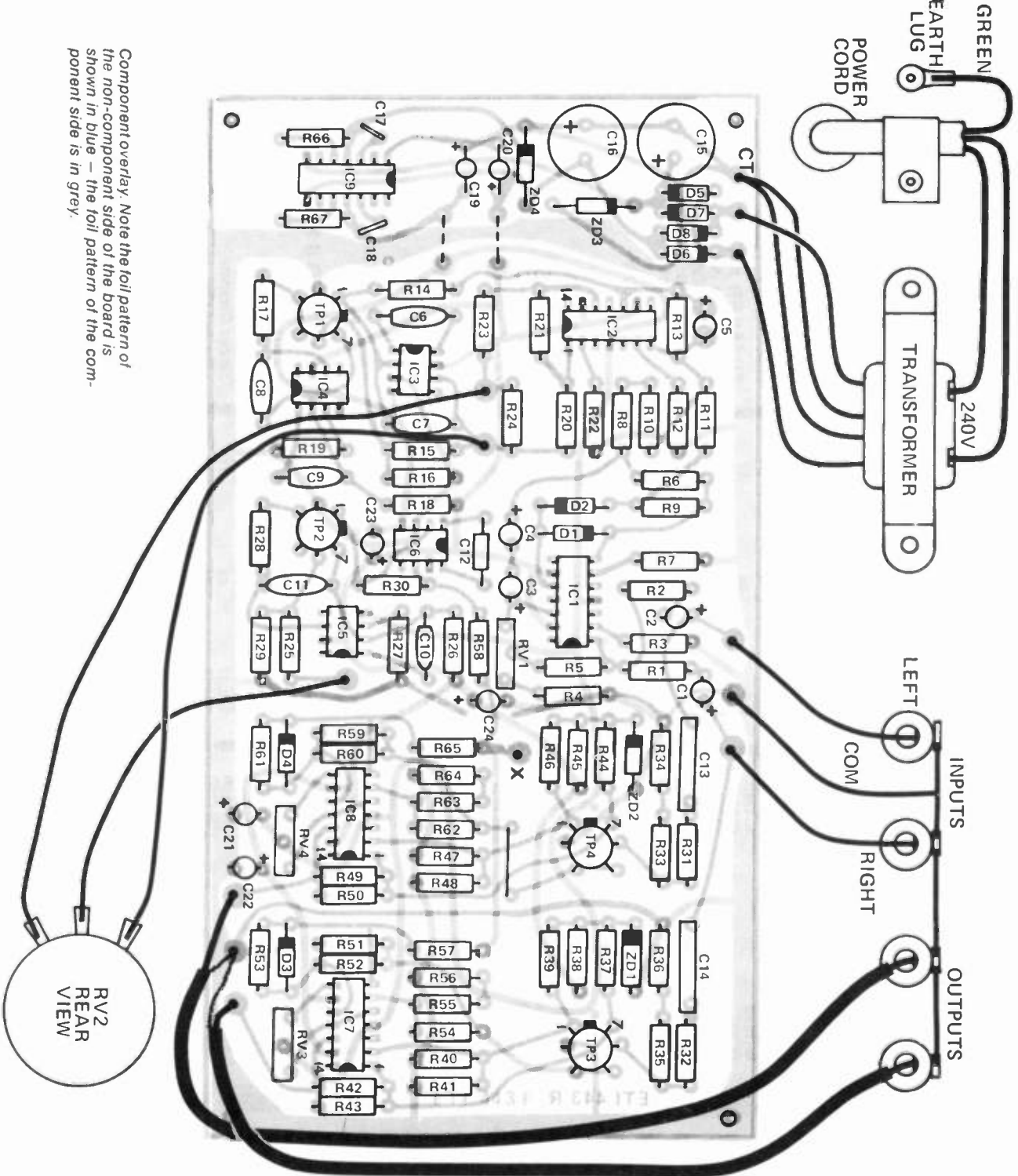

edge electric

31 BURWOOD ROAD, BURWOOD. TELEPHONE 747 2931

SEMI CONDUCTORS

	\$ c
AF126	.98 each
BA219	.39 each
BA102	.60 each
BB105G	.45 each
BC107	.40 each
BC108	.40 each
BC109	.40 each
BC177	.50 each
BC178	.50 each
BC179	.50 each
BC548	.40 each
BC549	.40 each
BC558	.40 each
BC559	.40 each
BC639	.60 each
BC640	.60 each
BD139	1.00 each
BD266A	2.73 each
BD266B	3.26 each
BD267A	2.73 each
BD267B	3.26 each
BF115	.64 each
BF180	.90 each
BF199	.50 each
BFR84	1.44 each
C103YY	2.20 each
C106B1	2.16 each
C106DI	1.64 each
C106Y1	1.20 each
C122D	2.30 each
EM404	.30 each
MJE2955	3.50 each
MJE3055	3.20 each
MPF102	1.25 each
MPF105	.98 each
MPF106	.98 each
SC141D	2.00 each
SC146D	3.00 each
TT800	1.00 each
TT801	1.00 each
BD140	1.00 each

VALVES

	1 to 9 Each	Mixed 10 Ea.
1B3	1.71	1.55
1S2	1.08	.97
6AL3	1.09	.98
6AN7	2.38	2.16
6AQ5	1.31	1.18
6AU4	1.61	1.45
5AU6	1.13	1.02
6AX4	1.61	1.45
6BA6	1.50	1.36
6BE6	1.75	1.59
6BL6	.99	.89
6BM8	1.17	1.06
6BQ5	1.52	1.38
6BQ7	2.04	1.85
6BX6	1.42	1.29
6CA7	3.47	3.17
6CM5	1.67	1.52
6DQ6A	2.69	1.44
6DX8	1.52	1.38
6EA8	1.53	1.39
6EB8	1.87	1.71
6EJ7	1.30	1.18
6EH7	1.30	1.18
6ES8	1.76	1.60
6GV8	1.65	1.51
6GW8	1.63	1.49
6M5	2.00	1.82
6N3	2.57	2.44
6N8	2.20	2.00
6U8	1.52	1.38
6U9	2.03	1.85
6V4	1.22	1.12
6V9	3.28	2.99
6X4	1.17	.97
6X9	2.03	1.85
6X9	2.24	2.04
12AU7	.85	.77
12AX7	1.90	1.73

PHILIPS SPEAKER KITS

With Latest 2" Squawker

SPEAKER KITS

2 x AD 12.00 W8
2 x AD 020 SQ8
2 x AD 160 T8
2 x 3-Way Cross-Over
ADF 500/4500/8

\$210

PHILIPS 7A

2 x AD 12-100W8
2 x AD 5060SQ8
2 x AD 160 T8
2 x ADF 500/4500/8

\$165

PHILIPS 4A

2 x AD 8066W8
2 x AD 5060 SQ8
2 x AD 160 T8
2 x ADF 500/4500/8

\$120

PHILIPS AD 8 K40

2 x AD 8066 W8
2 x AD 160 T8
2 x Cross-Over Networks
Timber Cabinets
Work included

\$129

MONTHLY SPECIALS

DIGITAL CLOCKS NATIONAL PORTABLES CASSETTE HOLDERS BIG DISCOUNTS

AKAI TURNTABLES

AP001C — \$135.00
AP003 — \$182.00

APAN TURNTABLES

BMU-121 — \$120.00
Fully manual. Separate cue device.

BRU-121 — \$135.00
Semi-automatic. Integrated hydraulic cue device.

BFU-121 — \$150.00
Fully automatic. Fully manual for the enthusiast. 4 channel ready. Separate cueing hydraulic device.

BRA-121 — \$185.00
Integrated hydraulic cue device. Semi-automatic. 4 channel ready. Servo assisted.

HITACHI CASSETTES

PRICED LOWER THAN EVER

	Qty.	1 to 11	12 to 23	24 plus
C60 Low Noise		1.50	1.35	1.25
C90 Low Noise		1.85	1.75	1.65
C120 Low Noise		2.45	2.30	2.20
C46 Ultra Dynamic		1.85	1.75	1.65
C60 Ultra Dynamic		2.05	1.95	1.85
C90 Ultra Dynamic		2.40	2.30	2.20
C120 Ultra Dynamic		3.20	3.10	2.90
C60 Ultra Dynamic Royal		2.40	2.30	2.20
C90 Ultra Dynamic Royal		3.00	2.85	2.70

CORAL KITS

12SA1 2 x 12" Drivers \$77.00
2 x 5" Midrange
4 x 2½" Tweeters
2 x Cross Over Networks

SPEAKER SPECIALS

MAGNAVOX 8-30
PLESSEY KITS
PHILIPS KITS
KEF KITS

Please rush me

Enclosed is my cheque
For \$..... (+P&P \$3.00) speaker
kits only.

Name.....

Address.....

.....P/Code.....

PRICES SUBJECT TO CHANGE
WITHOUT NOTICE

BISHOP

Printed circuit drafting aid materials.

PHOTO

Resists, developers, etchants, for printed circuits.

ADLAKE

Mercury wetted contact and Mercury displacement relays.

MINI LAMPS

Miniature low voltage panel mounting indicators.

XENON

Flash, strobe, tubes and trigger transformers.

BDC

Electronic, inductive proximity switches.

RDI

Barrier, terminal strips, octal sockets for printed circuits.

ALBA

Miniature long life filament lamps.

NEW RAPITYPE

Rub on dry transfer letters and numbers, various styles and sizes. \$4.48 per sheet including sales tax (postage extra).

CIRCUIT COMPONENTS (A/ASIA) PTY LTD

1st Floor, 383 Forest Road,
(P.O. Box 70) Bexley, N.S.W. 2207
Telephones 59-6550, 59-3720
Telegraphic Code CIRCOSYDNEY

SPECIAL PURCHASE TRANSISTORS CAPACITORS RESISTORS & MAGNETIC CARTRIDGES

We have purchased from a manufacturer who has ceased the production of radio equipment due to the tariff reductions, their current stock of capacitors transistors and resistors, which we can offer at a fraction of original cost.

60 TRANSISTORS FOR \$9.00 PLUS 12 DIODES

P&P \$1.00

TRANSISTORS: 12-2N3055-1 power transistors, 12 BC108 general purpose audio, 6 BC109C low noise audio, 6 TT770 NPN low level amp, 12 EM404 silicon rectifiers 400 volt 1 amp. PLUS 24 mixed silicon transistors.

Mounting kits for 2N3055 (mica washers & brushes 9c ea.).

56 TRANSISTORS FOR \$4.80 PLUS 12 DIODES

P&P \$1.00

TRANSISTORS: 24 BC108 general purpose audio, 6 BC109C low noise audio, 6 TT770 low level amp, NPN, 12EM404 silicon rectifiers 400 volt 1 amp. PLUS 20 mixed silicon transistors.

40 TRANSISTORS FOR \$3.30 PLUS 10 DIODES

P&P \$1.00

TRANSISTORS: 10 BC108 general purpose audio, 10-TT770 low level amp. NPN, 10-EM404 silicon rectifiers 440 volt 1 amp. PLUS 20 mixed silicon transistors.

NEW GOLDRING MAGNETIC CARTRIDGES AT LESS THAN HALF LIST PRICE ES 705 \$5.75

P&P \$1.00

SPECIFICATIONS:

MODEL: ES-705
Frequency Response: 15 Hz - 25,000 Hz
Output Voltage:5mv 1,000Hz/5cm/sec.
Channel Balance: Within 1.5db at 1,000Hz.
Channel Separation: (Minimum) 20db at 1,000Hz.
Tracking Force: 1 - 2.5 grams.
Stylus: Diamond, Conical, radius 16 microns.
Overall Dimensions: 21 x 17 x 17.6mm
Mounting: 12: 7mm or 1/2"

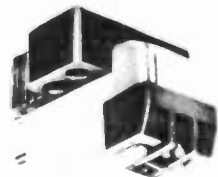

100 CAPACITORS FOR \$3.50

P&P \$1.00

CAPACITORS: 100 compromising approx. equal quantities of Phillips tubular polyester (315 series) Polyester film "greencaps" & Styroseal in standard values to .47 mfd with a list price of over \$18.00.

100 RESISTORS FOR \$1.00

P&P \$1.00

RESISTORS: 100 mixed 1/2 and 1 watt Morganite, Ducon, and IRH, 15 different standard values.

POSTAGE \$1.00 WILL COVER POSTAGE ON ANY 3 PACKS

METROPOLITAN RADIO SUPPLIES.

2 WATTLE STREET, HABERFIELD.
POSTAL ADDRESS: BOX 105 P.O. HABERFIELD 2045.

NEW BOOKS NEW EDITIONS

Radio, Valve and Semiconductor Data Tenth Edition 1975 *A.M. Ball*

Characteristics of 1,000 Valves, monochrome and colour Cathode Ray Tubes, 9,800 Transistors, Diodes, Rectifiers and Optical Semiconductors. The continuing development of semiconductor technology and rapid obsolescence of many valves have necessitated a new edition of *Radio Valve and Transistor Data*, a book which sold over 450,000 copies in its Nine Editions. The new title reflects the widening range of solid state devices, from simple diodes and transistors through to thyristors, triacs, light emitting diodes, etc. A comprehensive list of semiconductor comparables and valve equivalents has also been included.

Foundations of Wireless and Electronics Ninth Edition 1975 *M.G. Scroggie*

Since *Foundations of Wireless* was first published in 1936 it has helped thousands of students and amateur enthusiasts as they encountered the principle of radio and electronics for the first time. This book covers the whole basic theory, assuming no previous knowledge and using only a minimum of mathematics. The Ninth Edition has been up dated to emphasize printed and integrated circuits, ceramic filters, single sideband radio and the increasing range of photoelectric devices.

Audio on Wheels

Vivian Capel

1975

240 pages

Although there is a tremendous and growing enthusiasm for 'in car entertainment', surprisingly little information has been published to help in choosing and installing mobile audio equipment. The radio engineer, the motor mechanic and the amateur DIY man who needs comprehensive information on mobile audio will find this book an essential source.

Contents: Audio Amplification, Principles of Radio Reception; Sound Recordings; Power Supplies; Loudspeakers, Car Aerials, Car Radios; Stereo and Multi-speaker Systems; Cassette Players; Cartridge Players; Motor Control Circuits; Disc Systems; Installation; Interference Suppression; Mobile Public Address; Setting up a Workshop; Repairs and Maintenance; Index.

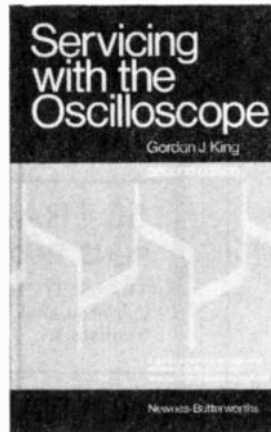

Coming
Soon

Servicing With The Oscilloscope Second Edition

Gordon J. King

1976

208 pages

This new edition has been expanded and updated with more information on the oscilloscope itself, recent design developments and more emphasis to test and measurement applications. The book is therefore important not only to the engineer, particularly those concerned with the complexity of colour television, but also valuable to the technician.

Hi-Fi Loudspeakers and Enclosures Second Edition

A. B. Cohen

1975

438 pages

Both the 'do-it-yourself' enthusiast and the owner of a packaged system will benefit from the many authoritative suggestions contained in this classic work. To ensure complete understanding, a step-by-step explanation of the complete acoustic chain is provided.

Newnes Technical Books

At these fine shops:

N.S.W.
Dick Smith (Wholesale) Pty Ltd
162 Pacific Highway
ST. LEONARDS 2065
Phone: 439 5311

Dick Smith (Wholesale) Pty Ltd
361 Hume Highway
BANKSTOWN 2099
Phone: 709 6600

Dick Smith (Wholesale) Pty Ltd
125 York Street
SYDNEY 2000
Phone: 29 1126

M S Components (Electronics) Pty Ltd
95-97 Regent Street
REDFERN 2016
Phone: 69-5922

Digitronics
186 Parry Street
NEWCASTLE WEST 2302
Phone: 69-2040

Victoria
McGill's Newsagency
183 Elizabeth Street
MELBOURNE 3000
Phone: 60 1475

Technical Book &
Magazine Co Pty Ltd
289-299 Swanston Street
MELBOURNE 3000
Phone: 663 3951

W.A.
Rellim Booksellers
834 Hay Street
PERTH 6000
Phone: 21 5684

Tasmania
Elison Hawker Pty Ltd
90-92 Liverpool Street
HOBART 7000
Phone: 34 2322

New Zealand
Technical Book Company Ltd
Auckland — Wellington
Whitcoulls
Auckland — Wellington —
Christchurch
Maurice Kennedy
Christchurch
and
Butterworths of New Zealand
Wellington

BUY
NOW

Refuse to compromise.



TEST CARD	
Diaphragm excursion	✓
Mechanical centring	✓
Impedance Metering	✓
Resonance frequency	✓
Tone sweep	✓
Polarity	✓
D C resistance	✓
Magnet flux	✓
Diaphragm mass	✓
Visual appearance	✓

Choose your drive units with the same single-mindedness KEF apply to building them. That check list is only one facet of a no-compromise approach at every stage... basic research to final test. An approach that begins by rejecting conventional diaphragm materials in favour of new concepts, combining optimum acoustic performance with reliability that's guaranteed for five years. Every KEF drive unit benefits from these advances. B139 for example, renowned 13 by 9 inch bass unit. A solid flat moulded diaphragm with laminated aluminium skin, acts as a rigid piston, giving B139 clean, low-distortion quality. Unique construction, built to meticulous KEF standards. Every component tested, every subassembly tested, and a final comparative listening test to be certain.

The same care goes into every KEF drive unit. Bass, mid-range and high-frequency units, designed to work together with their dividing networks, in related systems. Buy them individually, as Kefkits, or complete KEF speaker systems. You're refusing to compromise where it matters most... the drive units at the heart of your system.

Tell me more about the four advanced KEF drive units and their dividing networks.

Stamps for return postage appreciated.

Name

Address



the speaker engineers



Audioson International Pty. Ltd.,
P.O. Box 361,
BROOKVALE, N.S.W. 2100

Enjoy great Hi-Fi Sound While on the Move...

Fit a **DOMINION** Car Stereo

DOMINION Model 4100 *\$61.20



Mini under-dash cassette stereo player, 5 watts per channel, fast forward, rewind, auto stop, with slider volume and tone and balance controls.
Dimensions: 5¼" wide x 6½" deep x 2" high.

A large range of matching stereo speakers is available from \$10.20 per pair.

DOMINION Model 4511 *\$99.45
With stereo FM radio

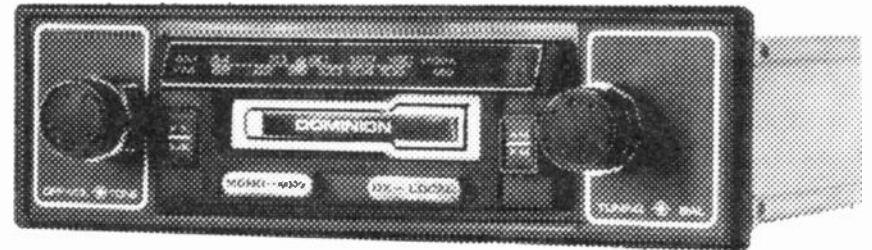

High quality, in-dash mounting stereo cassette player. With a sensitive AM/FM stereo radio. A DX local-long distance reception switch, fast forward control, 5 watts output per channel. Dimensions: 7" wide x 5" deep x 2" high.

Distributed
throughout
Australia by:

radioparts GROUP

562 Spencer Street, North Melbourne. Phone: 328 2224.
1097 Dandenong Rd., East Malvern. Vic. Phone: 211 8122.



CHAN MERCHANDISING CO. PTY. LTD.

Advanced Scientific Calculator

Hornet SR-40

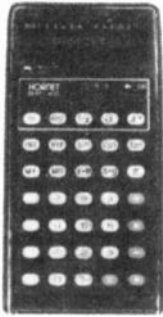

*Rugged LED red display.

*Power: 3 AA-sized dry or rechargeable batteries.
\$10.00 for Adaptor & rechargeable batteries.
Add sales tax if applicable \$4.80 for Calculator \$1.20 for Battery. Adaptor

12 months guarantee

\$39.00

TAX EXEMPTED

Features:

- *12 digit display. 10 for mantissa, 2 for exponent.
- *Wide data range. 10^{-99} to 10^{99}
- *One key per function. *One memory.
- *Automatic selection of correct notation for result display (scientific or floating point).
- *Algebraic mode operation.
- *Display and Y-register exchange.
- *Trig function: \sin , \cos , \tan , \sin^{-1} , \cos^{-1} , \tan^{-1} .
- *Radian, degree or grads selection. *Hyperbolic function: \sinh , \cosh , \tanh , \sinh^{-1} , \cosh^{-1} , \tanh^{-1} .
- *Log function: \log \ln , anti log , anti ln .
- *Square root, & reciprocal *x to y power.
- *automatic constant.
- *Auto clear when power on.
- *Adaptor available.
- *12 months guarantee.

Logitech LC-100



*Bright Green display.

*Power: Build-in rechargeable batteries.

[(Including adaptor & rechargeable batteries)
Add sales tax \$6.00
if applicable
12 months guarantee

\$49.00

TAX EXEMPTED

Logitech LC-1233s

Features.

- *Large green 10 digit display
- *8 for mantissa, 2 for exponent
- *Two levels of parentheses. { ()}.
- *Floating decimal point or scientific notation
- *Wide data range. 1×10^{99} to 1×10^{-99}
- *Auto clear when power on
- *full Trig function:
 \sin , \cos , \tan , \sin^{-1} , \cos^{-1} , \tan^{-1}
- *Degree or radian mode
- *Degree to radian or radian to degree exchange.
- *Full logarithmic function
 \log , \ln , anti log , anti ln
- *Power function e^x , 10^x , a^x
- *Factorial function $X!$, $x < 70$.
- *Square root & reciprocal
- *Algebraic mode operation.
- *Chain & repeat operation
- *Full capability of memory calculation
 $M+$, $M-$, Mx , M .
- *Power 4 AA-sized dry batteries or rechargeable batteries
- *AC adaptor available
- *Full 12 months guarantee



\$37.00

TAX EXEMPTED

\$12.00 for Adaptor & rechargeable batteries
Add sales tax if applicable
\$4.50 for Calculator
\$1.50 for Battery & Adaptor
12 months guarantee

Logitech LC-831s



- *8 digits green display
- *Common arithmetic calculation
 \sin , \cos , \tan , \sin^{-1} , \cos^{-1} , \tan^{-1}
- \log , \ln , e^x , x^y
- *Accumulating memory
- *Constant calculation
- *Full floating decimal point
- *Power dry or rechargeable batteries
- *AC adaptor available
- *12 months guarantee

\$25.00

TAX EXEMPTED

\$12.00 for adaptor & rechargeable batteries
Add 15% sales tax if applicable
\$3.75 for calculator
\$1.80 for battery of adaptor
12 months guarantee

ZENY 812

Features

- *Large 8 digits green display
- *Memory
- *Full floating decimal point
- *Chain operation
- *Constant operation
- *Percentage calculation
- *Power 4 AA-sized batteries or by Adaptor
- *Adaptor available
- *Size 207(L) x 120(W) x 76(H)mm
- *Weight GW 350gm NW 160gm
- *3 months guarantee



\$14.00

TAX EXEMPTED

\$6.00 for Adaptor
Add Sales Tax if applicable
\$1.65 for Calculator
\$0.75 for Adaptor
3 months guarantee

Fill in tear off and return to

CHAN MERCHANDISING CO. PTY. LTD.
906 CASSON AVENUE, MOUNT HUTTON, N.S.W., 2290
Phone (049) 48-9676

Please send by return (quantity)

..... Model Electronic Calculators

I have enclosed cheque/money order for \$.....

including \$2.00 for packaging and delivery

Name
(Block Letters)

Address

(Postcode)

SALES TAX (EXEMPTIONS AND CLASSIFICATIONS) ACT

TO : - THE COMMISSIONER OF TAXATION AND
THE COMMONWEALTH OF AUSTRALIA

I hereby certify that the (Goods Description)
purchased by me from (Supplier)
on (date) is for use in

(Name of University or School) in or directly and essentially in connection with the production of facts by means of observing measuring testing or otherwise experimenting with material phenomena for the purpose of proving or illustrating natural principles or laws or in the study of pure or mixed mathematics. Exemption is accordingly claimed under item 63 (1) in the First Schedule to the Sales Tax (Exemptions and Classifications) Act

Signature of official of University or School

Designation

Name of University or School

Date Signature of Student

Address of Student

A beautiful combination of components that were made for each other.

If you want a perfectly matched combination of stereo components without spending hundreds and hundreds of dollars and having your house look like a recording studio, it's hard to go past the Toshiba SX 150 C.

Each piece was designed with the other components in mind.

The receiver has all the features you would expect from separate units. A pre-amplifier, power amplifier and tuner all in the one space-saving unit. The performance is something that has to be experienced to be really appreciated.

The high-precision turntable is semi-automatic in operation with an MM phono cartridge and an S-type tone arm. The two-way speakers give superb reproduction with beautiful highs and lows divided between tweeter and woofer.

And if you buy two more speakers you can enjoy speaker matrix 4-channel effects at the flick of a switch.

All-in-all, the SX 150 C is a sensible combination of beautiful units put together by the company with its feet on the ground and its thoughts on tomorrow.



Specifications

2/4 channel speaker matrix. AM/FM/LW-FM stereo receiver with output of 6 watt x 2 (RMS at 8 ohms). Turntable is belt driven from 4-pole synchronous motor. Aluminium die-cast turntable. S-type tone arm. Two-way speakers comprising 2 x 16 cm

woofers and 2 x 5 cm tweeters. Dimensions of receiver 450 mm (W), 331 mm (D), 110 mm (H). player 450 mm (W), 350 mm (D), 180 mm (H). speaker 280 mm (W), 170 mm (D), 460 mm (H). Power Source is 110/120/220/240 V AC, 50/60 Hz.

Price and specifications subject to change without notice.

Toshiba SX 150 C
\$319 recommended retail price
AR201 Audio Rack—Optional extra

 **TOSHIBA**
In Touch with Tomorrow

TS7756

New ETI Service Feature

**electronic component
data sheets**

If desired these pages can be removed from the magazine and bound into a standard ETI magazine binder — obtainable from our Subscription Department for \$4.50 (plus \$1.10 postage in NSW or \$1.50 all other States);

ETI data sheet

Here is a new ETI feature — a regular data sheet service, so arranged that the section may be easily removed from the magazine if required.

We hope to provide details of several devices each month — although there may be some months when space limitations will prevent our including this feature.

Details will be limited to essential practical data together with brief specifications.

We will be including details of all types of semi-conductor devices — from the basic transistors covered this month — up to the more exotic forms of integrated circuits.

BC 107-109 Low power Amplifier

QUICK REFERENCE DATA

		BC107	BC108	BC109
Collector-emitter voltage ($V_{BE} = 0$)	V_{CES} max.	50	30	30 V
Collector-emitter voltage (open base)	V_{CEO} max.	45	20	20 V
Collector current (peak value)	I_{CM} max.	200	200	200 mA
Total power dissipation up to $T_{amb} = 25^{\circ}\text{C}$	P_{tot} max.	300	300	300 mW
Junction temperature	T_j max.	175	175	175 $^{\circ}\text{C}$
Small signal current gain at $T_j = 25^{\circ}\text{C}$ $I_C = 2 \text{ mA}; V_{CE} = 5 \text{ V}; f = 1 \text{ kHz}$	h_{fe}	≥ 125 < 500	125 900	240 900
Transition frequency at $f = 35 \text{ MHz}$ $I_C = 10 \text{ mA}; V_{CE} = 5 \text{ V}$	f_T typ.	300	300	300 MHz
Noise figure at $R_S = 2 \text{ k}\Omega$ $I_C = 200 \mu\text{A}; V_{CE} = 5 \text{ V}$ $f = 30 \text{ Hz to } 15 \text{ kHz}$	F typ.			1.4 dB 4 dB
$f = 1 \text{ kHz}; B_w = 200 \text{ Hz}$	F typ.	2	2	1.2 dB
Collector current (dc)	I_C max.			100 mA
Thermal Resistance				
From junction to ambient in free air	$R_{th j-a}$			0.5 $^{\circ}\text{C}/\text{mW}$
From junction to case	$R_{th j-c}$			0.2 $^{\circ}\text{C}/\text{mW}$
Saturation voltages 1)				
$I_C = 10 \text{ mA}; I_B = 0.5 \text{ mA}$	V_{CEsat} typ.		90 mV	
	V_{BEsat} typ.		250 mV	
			700 mV	
$I_C = 100 \text{ mA}; I_B = 5 \text{ mA}$	V_{CEsat} typ.		200 mV	
	V_{BEsat} typ.		600 mV	
			900 mV	
Collector capacitance at $f = 1 \text{ MHz}$ $I_E = I_c = 0; V_{CB} = 10 \text{ V}$	C_c		2.5 pF	
			4.5 pF	
Emitter capacitance at $f = 1 \text{ MHz}$ $I_C = I_c = 0; V_{EB} = 0.5 \text{ V}$	C_e typ.		9 pF	

V_{BEsat} decreases by about 1.7 mV/ $^{\circ}\text{C}$ with increasing temperature

		BC107A BC108A	BC107B BC108B BC109B	BC108C BC109C
DC current gain $I_C = 10 \mu\text{A}; V_{CE} = 5 \text{ V}$	h_{FE}	$>$ typ. 90	40 150	100 270
$I_C = 2 \text{ mA}; V_{CE} = 5 \text{ V}$	h_{FE}	$>$ typ. 110 $<$ 220	200 290 450	420 520 800

The BC 107-109 series are npn low power transistors commonly used in audio frequency applications. They are housed in TO-18 metal cases with the collector connected to the case. Their pnp complement is the BC 177-179.

The BC107 is primarily intended for use in driver stages of audio amplifiers and in signal processing circuits of television receivers.

The BC108 is suitable for a multitude of low voltage applications e.g. driver stages of audio pre-amplifiers, and in signal processing circuits of television receivers. The BC109 is primarily intended for low noise input stages in tape recorders, hi-fi amplifiers and other audio frequency equipment.

Each type is made in forms A, B and C — the main difference being in gain (h_{FE}). The A version has the lowest gain — the C version has the highest. Details are included in the Quick Reference Data panel.

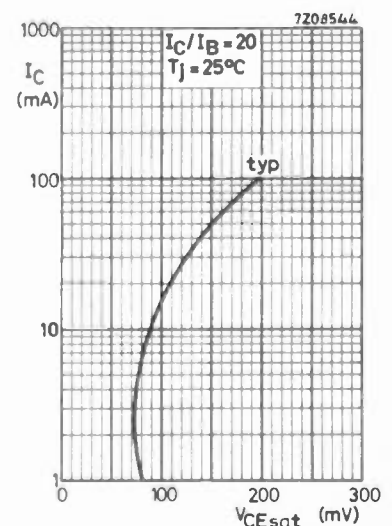



STAR DELTA CO.

PTY. LTD.

TRANSFORMER
MANUFACTURERS

We can supply transformers, chokes, etc. for most of the projects featured in Electronics Today at competitive prices.

We also manufacture a range of transformers in single and three phase up to 20 KVA, all manufactured to comply with the relevant Australian Standards.

8 East St.,

Granville, N.S.W. 2142

P.O. Box 31, Phone 637-7870

"COWPER"

Cabinets and chassis for all projects featured in this magazine are available from

COWPER SHEETMETAL

& ENGINEERING

11 Cowper Street,

Granville, N.S.W. 2142

Phone 637-8737

(P.O. Box 31)

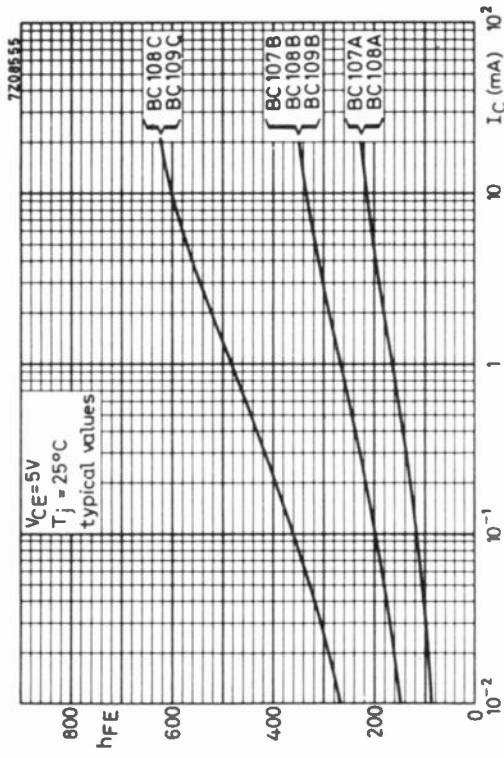
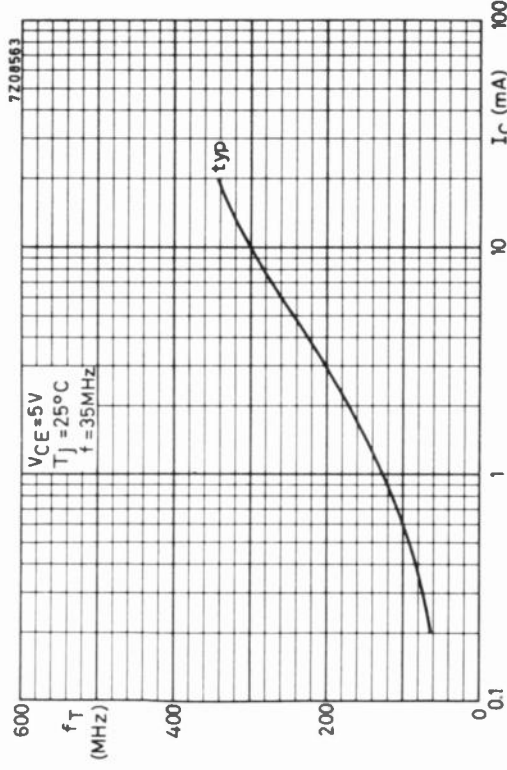

Transistor types	Connections
BC107 BC108 BC109	1
BC147 BC148 BC149	2
BC237 BC238 BC239	3
BC547 BC548 BC549	4* 5†

Electrically similar types

NOTE: * Philips types only † all others

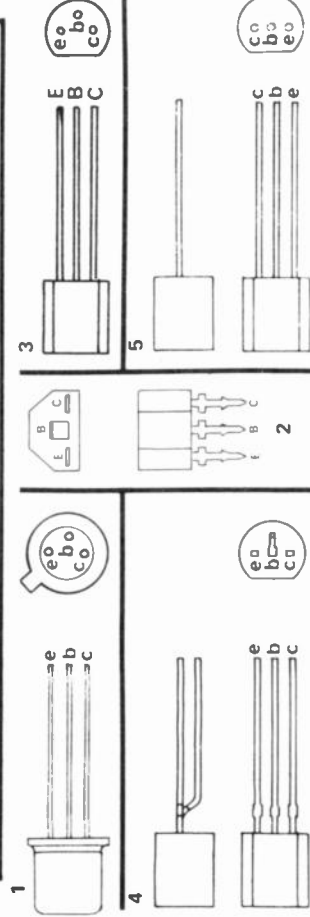

BC 177-179 Low power AF amplifier

The BC 177-179 series are pnp low power transistors commonly used in audio frequency applications. They are housed in TO-18 metal cases with the collector connected to the case. Their npn complement is the BC 107-109.

The BC177 is a high voltage type primarily intended for use in driver stages of audio amplifiers, and in signal processing circuits of television receivers. The BC178 is suitable for a multitude of low voltage applications e.g. driver stages or audio pre-amplifiers

and in signal processing circuits of television receivers. The BC179 is primarily intended for low noise input stages in tape recorders, hi-fi amplifiers and other audio frequency equipment.

As with the BC 107-109 series each BC 177-179 type is manufactured in forms A, B or C — the main difference being in gain (h_{FE}). The A version has the lowest gain — the C version has the highest. Details are included in the Reference Data panel.

QUICK REFERENCE DATA

	BC177	BC178	BC179
Collector-emitter voltage (+ $V_{BE} = 1$ V)	$-V_{CEX}$ max. 50	30	25 V
Collector-emitter voltage (open base)	$-V_{CEO}$ max. 45	25	20 V
Collector current (peak value)	$-I_{CM}$ max. 200	200	200 mA
Total power dissipation up to $T_{amb} = 25^\circ\text{C}$	P_{tot} max. 300	300	300 mW
Junction temperature	T_j max. 175	175	175°C
Small signal current gain at $T_j = 25^\circ\text{C}$	h_{fe}		
$-I_C = 2$ mA; $-V_{CE} = 5$ V; $f = 1$ kHz	$>$ 75	75	125
	$<$ 260	500	500
Transition frequency at $f = 35$ MHz	f_T typ. 150	150	150 MHz
A: $-I_C = 10$ mA; $-V_{CE} = 5$ V			
Noise figure at $R_S = 2$ k Ω	F		1.2 dB
$-I_C = 200$ μ A; $-V_{CE} = 5$ V	$<$		4 dB
$f = 30$ Hz to 15 kHz	$<$		4 dB
$f = 1$ kHz; $B_w = 200$ Hz	F	10	10
Collector current (dc)	$-I_C$ max.		100 mA
Thermal Resistance	$R_{th\ j-a}$		0.5 °C/mW
From junction to ambient in free air	$R_{th\ j-c}$		0.2 °C/mW
From junction to case			
Saturation voltages	$-V_{CE\ sat}$	typ. 75	mV
$-I_C = 10$ mA; $-I_B = 0.5$ mA	$-V_{BE\ sat}$	typ. 300	mV
$-I_C = 100$ mA; $-I_B = 5$ mA	$-V_{CE\ sat}$	typ. 700	mV
	$-V_{BE\ sat}$	typ. 250	mV
	$-V_{BE\ sat}$	typ. 850	mV
Collector capacitance at $f = 1$ MHz	C_c typ.		4.0 pF
$I_E = I_e = 0$; $-V_{CB} = 10$ V			
DC current gain	h_{FE} typ.	140	180
$-I_C = 2$ mA; $-V_{CE} = 5$ V			290

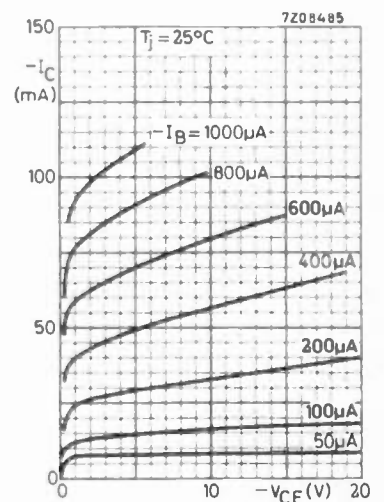
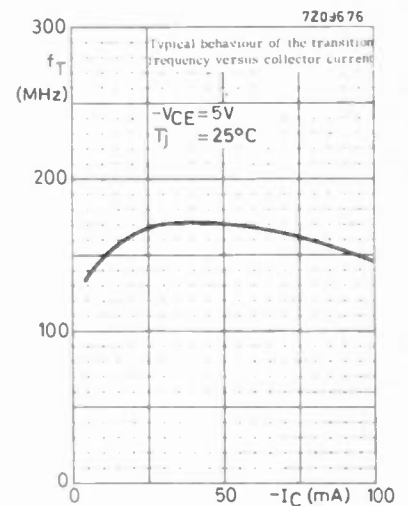
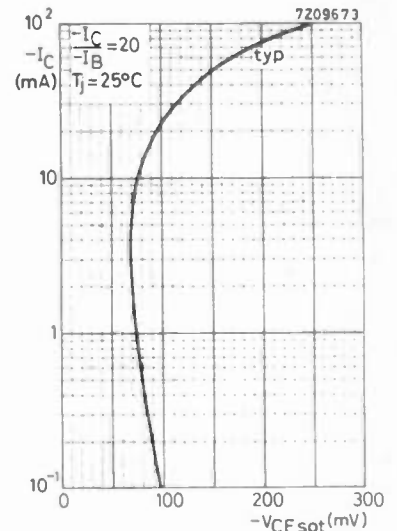

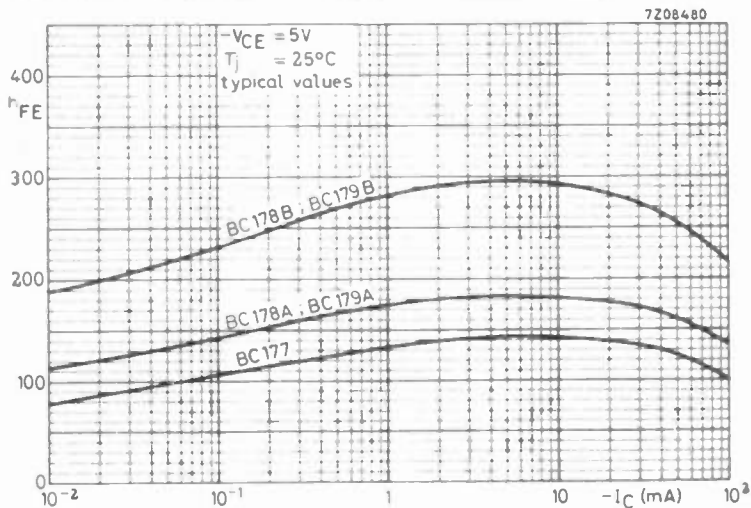

Transistor types		Connections
BC 177 BC 178 BC 179		1
Electrically similar types	BC 157 BC 158 BC 159	2
	BC 307 BC 308 BC 309	3
	BC 557 BC 558 BC 559	4* 5*
	Note: * Philips types only † all others	

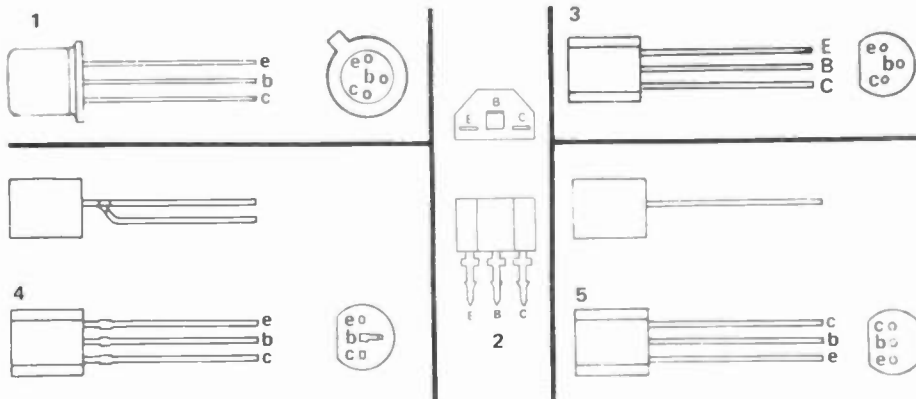

HAM RADIO ELECTRONICS BARGAIN CENTRE

390 Bridge Road, Richmond, Vic. 42-5174

Please allow for postage & packing when ordering by mail

Plenty of BARGAINS for the Radio Amateur or the Hobbyist.

NEW 4 TRACK STEREO CARTRIDGE PLAYERS. 5 watts output 12V D.C. operation. In sealed carton. \$15. P&P \$2.50.

6ft 240V AC POWER CORDS with moulded 3 pin plug 75c each or 10 for \$6.50

STEREO TONE ARMS complete with ceramic cartridge \$5.90 each P&P 30c.

EDGEWISE 0-1 mA METERS 2 1/2" x 1 1/2" face 3" deep calibrated 0-5 \$3 P&P 75c

PANEL METERS 5 7/8" x 4 1/4" face with 0-1 mA movement. Various scales on meters (gas analyser, etc) \$5 P&P 75c

NEW QEO 6/40 CERAMIC VALVE SOCKETS \$2 P&P 40c.

MORSE CODE PRACTICE KEYS \$1.50 P&P 30c

BATTERY ELIMINATORS to suit transistor radios and cassette recorders AC-DC 6 volt 300 mA. PS6300 \$7.50 P&P 75c

SPEAKER CABLE, colour codes twin flex 20c yd.

SONAR SLIDER POTENTIOMETERS, 2 7/8" x 3/8" x 3/8". Available in 500 OHM, 20K, 25K, 100K, 500K and 1 MEC. 65c each or 10 for \$5.00 P&P \$1.00.

CAR EXTENSION SPEAKER CONTROLS. Use both speakers together or separately. \$1.50 P&P 30c.

JACKSON SLOW MOTION DRIVES 6:1 ratio \$2.30 P&P 30c.

THIS MONTH'S SPECIAL

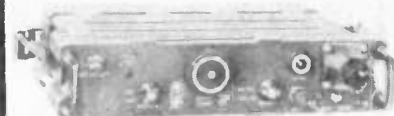

RF AMPLIFIER AM-4306/GRC

Originally used in conjunction with PRC25 which covers 30-75 MHz FM. Requires 1-4 watts drive and gives a nominal 25 watts out. Brand new in sealed box. \$19 each \$3.50 p&p

15 kHz CRYSTAL FILTERS 10.7 MHz M.E.W. \$5 each P&P 75c

2N3055 TRANSISTORS \$1 each

58 ohm COAX CABLE 100 yd Rolls, 1/8" diam. \$12 roll P&P \$1.75

52 ohm COAX CABLE 1/4" diam. 45c yd, 50c metre.

DOW KEY COAXIAL RELAYS 48 volt D.C. operation \$15 P&P 75c.

3 "N" TYPE CONNECTORS to suit above \$5

SPLIT STATOR CAPACITORS with screwdriver slot drive, 9 pF, 17 pF or 25 pF. Brand new Eddystone type \$3 each P&P 75c

2" SQUARE FACE 0-1 mA METERS calibrated 0-60 \$3 P&P 75c.

MAIL ORDERS WELCOMED.

Please allow pack and post items listed on this page, if further information required send a stamped S.A.E. for immediate reply from the above address.

BD 135-139 General purpose npn transistors

QUICK REFERENCE DATA

		BD135	BD137	BD139
Collector-base voltage (open emitter)	V_{CBO} max.	45	60	100 V
Collector-emitter voltage (open base)	V_{CEO} max.	45	60	80 V
Collector-emitter voltage ($R_{BE} = 1 \text{ k}\Omega$)	V_{CER} max.	45	60	100 V
Collector-current (peak value)	I_{CM} max.	1,5	1,5	1,5 A
Total power dissipation up to $T_{mb} = 70^\circ\text{C}$	P_{tot} max.	8	8	8 W
Junction temperature	T_j max.	150	150	150 $^\circ\text{C}$
D.C. current gain	h_{FE}	$>$	$>$	$>$
$I_C = 150 \text{ mA}; V_{CE} = 2 \text{ V}$		40	40	40
		$<$	$<$	$<$
		250	160	160
Transition frequency at $f = 35 \text{ MHz}$	f_T typ.		250 MHz	
$I_C = 50 \text{ mA}; V_{CE} = 5 \text{ V}$				
Collector current (d.c.)	I_C max.		1,0	
Total power dissipation to $t_{mb} = 70^\circ\text{C}$	P_{tot} max.		8 W	
Thermal Resistance				
From junction to ambient in free air	$R_{th j-a}$	100 $^\circ\text{C/W}$		
From junction to mounting base	$R_{th j-mb}$	10 $^\circ\text{C/W}$		
Saturation voltage				
$I_C = 500 \text{ mA}; I_B = 50 \text{ mA}$	$V_{CE sat}$		0,5 V	
D.C. current gain ratio of matched pairs				
BD135/BD136; BD137/BD138 BD139/BD140	h_{FE1}/h_{FE2}	typ.	1,3 1,6	
$I_C = 150 \text{ mA}; V_{CE} = 2 \text{ V}$				
D.C. current gain				
$I_C = 5 \text{ mA}; V_{CE} = 2 \text{ V}$	h_{FE}	$>$	25	25
$I_C = 150 \text{ mA}; V_{CE} = 2 \text{ V}$		$>$	40	40
$I_C = 500 \text{ mA}; V_{CE} = 2 \text{ V}$		$>$	250	160
		$>$	25	25

THE BD 135-139 SERIES ARE general purpose npn transistors recommended for driver stages in hi-fi amplifiers and TV receivers. They are housed in SOT-32 plastic cases. Their pnp complement is the BD 136-140.

Transistors BC635, 637 and 639 use the same chip as the BD135-139 series.

The devices are however mounted in a T092 plastic case. Power is limited to 1 watt - thermal resistance $R_{th j-a}$ increases to 156 $^\circ\text{C/W}$.

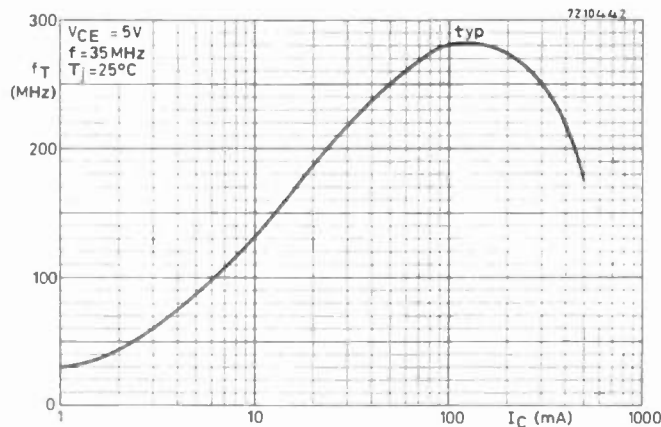
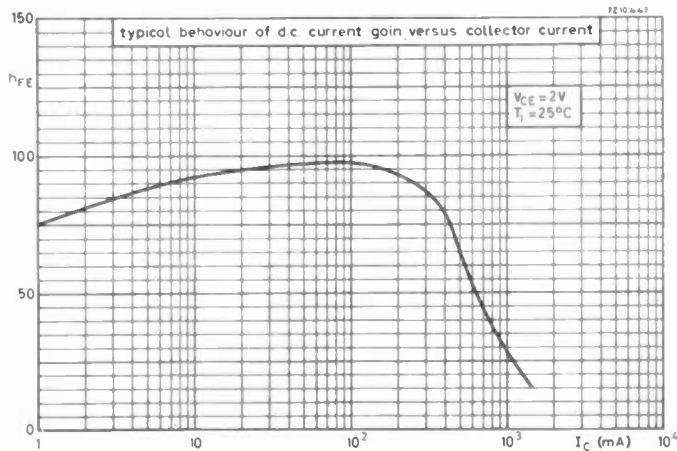
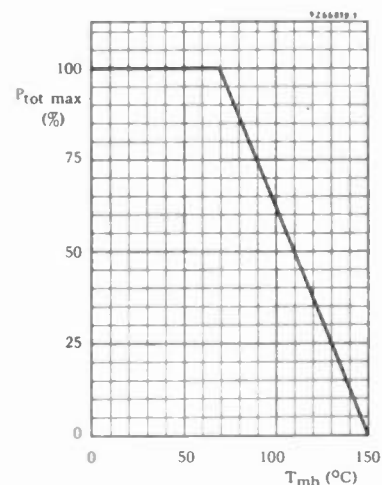

Maximum power dissipation related to case temperature.



HYBRID AMPLIFIERS
for electronic cross-overs,
stereo, public address and
other audio applications.



- Models – S1 – 1010G
- S1 – 1020G
- S1 – 1030G
- S1 – 1050G

ELECTRICAL CHARACTERISTICS

Symbol	SI-1010G	SI-1020G	SI-1030G	SI-1050G
Supply Voltage	10	10	10	10
Operating Current	10	10	10	10
Power Output	10	10	10	10
Frequency Response	10	10	10	10
Distortion	10	10	10	10
Temperature Range	10	10	10	10
Storage Temperature	10	10	10	10
Mounting	10	10	10	10
Lead Length	10	10	10	10
Weight	10	10	10	10
Dimensions	10	10	10	10
Notes	1. All values are typical values at 25°C unless otherwise specified.			

**AUTOTRONICS
PTY.LTD.**

47 Anzac Ave., Engadine, 2233
(02) 520-9442.

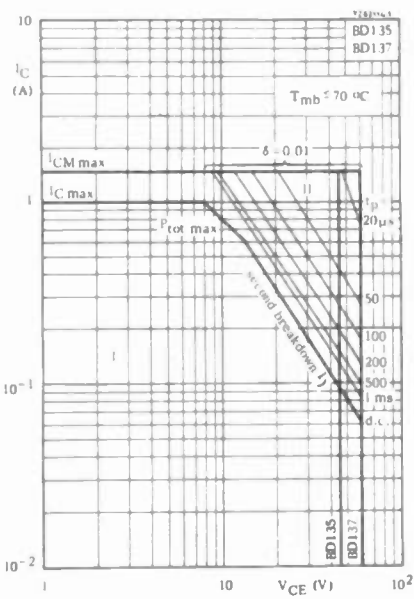

Safe operating area for BD 135 & 137.

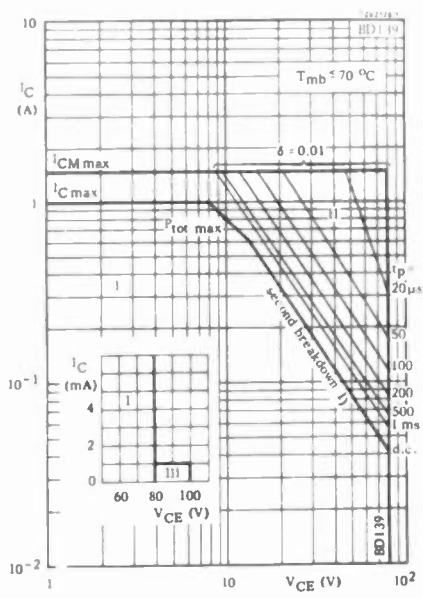

Safe operating area for BD 139.

WARNING – operation outside the areas shown for longer than the time specified can lead to transistor failure.

Transistor Types			Connections	
BD135	BD137	BD139	1	
Electrically similar (but see main text)	BD635	BD637	BD639	2

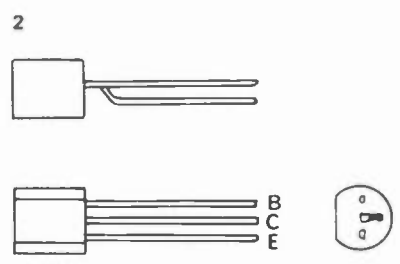
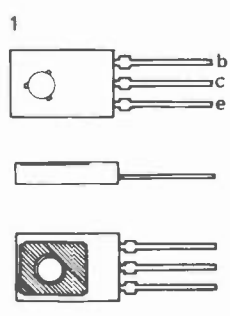

How to cut costs on your valuable P.C. board real estate...

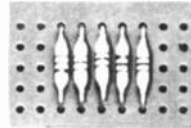
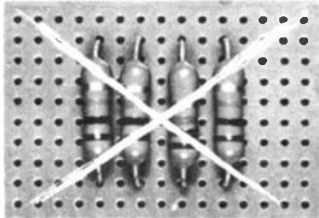

use type GLP miniature resistor.

IRH Components introduces the Metal Glaze type GLP resistor, a miniature 1/2 watt, with a maximum surface temperature rise of 50°C, the physical dimensions of many other 1/8 or 1/4 watt resistors but a full 1/2 watt rating at 70°C ambient.

The smaller size allows .4" (10 mm) lead spacing as standard for horizontal printed circuit board mounting — reduces demand on expensive PC board real estate. Even greater packaging density can be achieved by vertical mounting.

Another IRH "FIRST," the Australian made GLP is a result of extensive research, development & testing for Australian conditions.

STOCK THE GLP resistor and you automatically stock 1/8 watt, 1/4 watt and 1/2 watt and significantly reduce your resistor inventory. USE IT with confidence.

GLP FEATURES INCLUDE:

- Low cost.
- Small size. Length 5.5 mm
Diameter 2.0 mm.
- 1/8, 1/4, 1/2 watt rating.
- Thick film reliability.
- 60/40 plated leads for excellent solderability.
- Solvent resistant coating and colour bands.

irh

COMPONENTS

DIVISION OF NATRONICS PTY. LIMITED

The Crescent, Kingsgrove, N.S.W. 2208. Tel. 50 0111
74 Raglan Street, Preston, Vic. 3072. Tel. 44 5021



To: IRH components, The Crescent, Kingsgrove, N.S.W. 2208

Please forward your engineering bulletin featuring the GLP resistor.

NAME

ADDRESS

..... POSTCODE

GLP/76

Psst!

Everybody's talking about Australia's new Switch Specialists... C & K. This time-proven range is now available with an all new and improved factory oriented service.

World leaders, these professional subminiature and microminiature switches come in a multitude of configurations with basic toggle, pushbutton, slider, lever and rocker handle actions... long, short, rounded or flatted actuators... printed circuit, wire-wrap, quick connect or standard terminals... locking lever and illuminated rocker styles. Yes, oodles of options including snap-in bezels, L.E.D. adaptable styles, colour caps, panel dress nuts, etc. In fact there's something to suit your every requirement... and then there's a new thumbwheel switch that will really turn you on.

Examine the extended range of these American masterpieces now.

An obligation-free and comprehensive set of catalogues is yours for the asking.

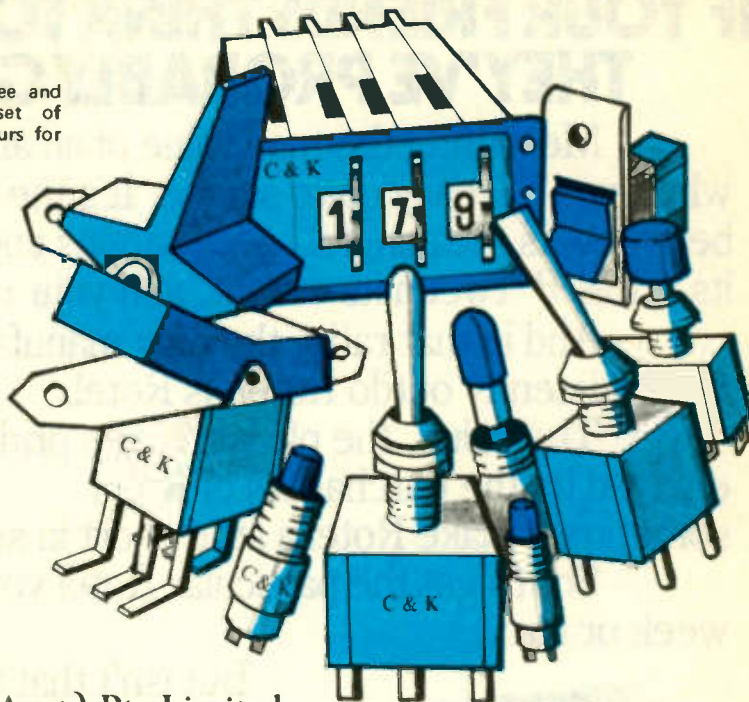

C&K Electronics (Aust.) Pty Limited

Office 2/6 McFarlane Street Merrylands NSW 2160
PO Box 101 Merrylands 2160 Telephone 682 3144

Agents: Melb. 88 5282/Adel. 223 6294/Brisbane 70 8097/Perth 68 7111.

nebula

ELECTRONICS PTY. LTD.

ETI 131 Power Supply

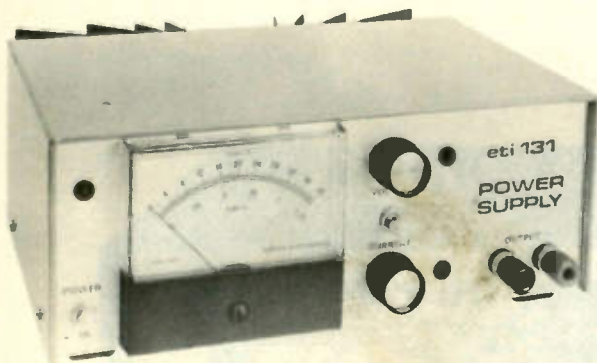

Build this superb 0-20 volt (or 40V) 0-2.5A (0-1.25A) general purpose power supply.

The ETI 131 power supply is the first kit to be made available from Nebula Electronics Pty Ltd.

The complete kit for the power supply includes all metalwork, rescaled meter, silk screened front panel and fibre-glass board screened with the component overlay.

Complete kit for ETI 131 power supply including all metalwork and rescaled meter.

\$70.00 plus \$5.00 P&P

*Built and fully tested**

\$90.00 plus \$5.00 P&P.

*when ordering specify whether 20V or 40V unit is required. Send money with order to:-

nebula
ELECTRONICS PTY LTD

15 Boundary Street, Rushcutters Bay, 2011.

ROTEL

IF YOUR FRIENDS THINK YOU PAID A LOT MORE, THEY'VE PROBABLY GOT GOOD EARS.

Measuring the true value of an amp., a receiver, a turntable, or whatever, is really quite simple. It's the ratio between its meaningful specifications and its price. Between its output, and your outlay.

And in that ratio, the only manufacturer to consistently outdo Rotel, is Rotel.

The value, the pleasure, the pride enjoyed by the purchasers of Rotel sometimes make Rotel a little short in supply.



Rotel RP 3000 Direct Drive Turntable

So, to get the particular Rotel you want, you may have to wait a week or two.

But isn't that the price of anything that represents genuine value?

The specifications, and the price.

Take a close look at both.

And then you be the judge, of the value, of Rotel.



Rotel RA 812 Integrated Amp.

Sole Australian distributors: International Dynamics (Agencies) Pty. Ltd., 23 Elma Road, North Cheltenham, 3192. Melbourne.

Available from: N.S.W.: M & G Hoskins Pty. Ltd., 400 Kent St, Sydney 2000, Telephone: 547 1093 & 546 1464. QLD.: Stereo Supplies, 95 Turbot St., Brisbane 4000, Telephone: 21 3623. S.A.: Challenge Hi Fi Stereo, 96 Pirie St., Adelaide 5000, Telephone: 223 3599. TAS.: Audio Wholesalers 9 Wilson St., Burnie 7320, Telephone: 31 4111. VIC.: Encel Electronics Pty. Ltd., 431 Bridge Rd., Richmond 3121, Telephone: 42 3762. W.A.: Arena Distributors, 282 Hay St., Perth 6000, Telephone: 25 2699. A.C.T.: Duratone Hi Fi, Cnr. Botany St. & Altree Crt., Phillip 2606, Telephone: 82 1388.

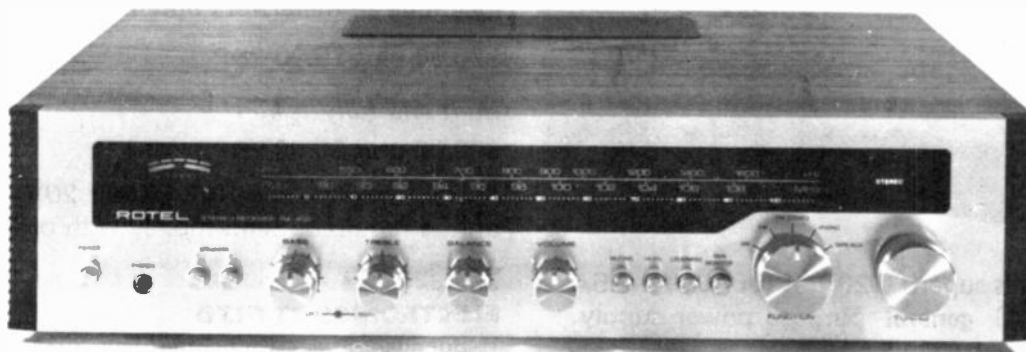

Rotel RX 402 FM/AM Receiver

L.E. CHAPMAN

EST. 1940

103 ENMORE ROAD, ENMORE, N.S.W. 2042. PHONE 51-1011
NEW Postage Rates Please Add Extra.

TAPE RECORDER DECK



7 inch reel to reel, complete except head and face plate. \$10

SUPER SPECIAL B.S.R. RECORD CHANGER

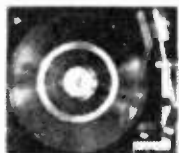

12 inch turntable balanced arm cueing device etc. \$35, pack and post \$1.50. Interstate \$2.50.

LEVEL AND BALANCE METERS

1200 Ohm
100 microamps

\$2

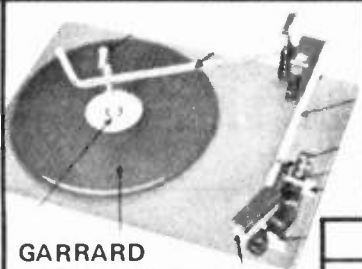

GARRARD MINI-CHANGER
Stereo \$19.00
Pack and post \$1.00
Interstate \$2.50

SPEAKER SPECIAL



6 1/2 inch Dual Cone
4 ohm

\$5

WAFER SWITCHES

2 position: 50 cents
4 position: 75 cents

DELUXE SPEAKERS FOR CARS

5 inch 8 ohm in plastic cabinets. \$5.50 each

BSR 4 SPEED 240V GRAM



Motor and Pickup \$7.95

PUSHBUTTON SWITCHES 5 POSITION

1/240 volts, toggle 50 cents



BSR CERAMIC CARTRIDGE STEREO

\$4



TRANSISTOR 7 RADIO

Complete with 3 1/2 inch speaker
No cabinet \$3.95



TRANSISTOR EAR PLUGS 3 for \$1.00

MINIATURE TUNING CONDENSORS



75 cents



VU METER
\$3.00 pair

SPECIAL SOLID STATE STEREO AMPLIFIER AND TUNER

5 Watts RMS per channel, famous make \$30. Pack and post \$3 interstate, \$1.50 NSW.

SPEAKER CABINETS
10 x 7 1/4 x 4 \$3.50

BARGAINS

Hook up wire 30 mixed colours \$1.
250 mixed screws with self tappers, bolts, nuts, etc. \$1.25 + postage 50c.
100 mixed radio TV knobs including fine tune & channel change \$5.00.
1/2 meg. double pole switch pots 50c.
100 mixed condensers, mic as polyester ceramic 50c.
Mixed pots 30 including ganged & concentric \$5.
Morganite & IRC 33 useful valves fresh stock \$2.00 + postage 50c.
Slide switch 3 position 50 cents.
50 ohm Pots ideal for ext. Speakers 50 cents. Transistor and Driver Speaker Transformers \$1.00 pair.
Ferrite Rods 6 1/2 x 1/2 inch 50 cents.
Pots 30 mixed values including ganged and concentric \$5.
In Line Fuse Holders 20 cents
Stereo Speaker Wire 12 cents yard.
100 Mixed TV and Radio Knobs including Fine Tune and Channel Change \$5.
Car radio suppressor condenser 30 cents.

BARGAINS

100 mixed condensers micas polyester ceramic \$2 per pack and post 45c.
Electros 3 in one 100-25-40, 24-250-300. 50-250-300 75 cents.
Screw in 6 Volt Pilot Lights \$1.50 for 10. Plug-in type 10 for \$1.00.
100 mixed condensers micas polyester ceramic \$2 per pack and post 45c.
Indoor TV Aerials Vertical Spiral \$1.
3.5 to 3.5 Jack Plugs 7ft Shielded Cable 75 cents; 6.5 to 3.5 Jack Plugs 7ft. Shielded Cable 75 cents.
Mixed Tag Strips 50 cents for Dozen.
Tape Recorder Heads Transistor - Top quality suit most recorders \$5.00.
Jack Plug Sockets 6.5 mm 35 cents.
Morganite and IRC resistors 33 values \$2 per 100 pack and post 45c.
Philips Gramo Motor and Pickup 4 Speed 6 Volt \$7.75.
Crossover Condensers 2 mfd 60 cents.
Crystal Microphone Inserts \$1.00. Microphone Transformers 50 cents.

BARGAINS

Switch Wafers: 11 position 20 cents.
Philips Pick-up Cartridges: mono female \$2.50.
Pots: 50k 50 cents; 1M 50 cents.
Tape Spools: 7 inch 75 cents.
1/2 Meg Double Pole Switch Pots 50 cents.
Coaxial TV Feeder Cable 75 ohm 30 cents yard.
Jack Plugs 6.5 mm 50 cents; 3.5 mm 25 cents. R.C.A. Plugs 25 cents.
Battery Saver 240 to 6-7, 5-9 Volt, 6 Volt/300mA, 9V 200mA, \$10.
Hook Up Wire 30 mixed colours lengths \$1 bag.
Speaker 4 pin plugs 15 cents.
25 mixed 5 and 10 Watt resistors \$2.00
250 mixed screws, BSA, Whit self-tapper bolts, nuts, etc. \$1.25 bag plus 40c post.
BSR Stereo Player Model P-128 \$52 pack and post \$1.50. Interstate \$2.00.
TV Aerials Complete Range Hills Colour \$12 to \$60.
Car radio aerials, lockdown, top quality extended 1600 mm \$4.50.
Electros 3-in-one: 20, 400, 450; 10, 400, 450, 75, 50, 65 \$1.00.

BARGAINS

AWA 11 inch P.I. TV EHT transformers \$5.00.
Car Converters: 12 volt to 6-7, 5-9 volt 500 MA \$6.00.
Microphones - Dynamic 10k \$3.50.
Valve Sockets: 7 or 9 pin 10 cents. Octal 10 cents.
Speaker Transformers: 6 Watt 7000 to 8 ohm \$2.50; 3 1/2 Watt 7000 to 15 ohm \$1.75; 6 Watt 7000 to 1k \$2.50; 500 to 27 ohm 50 cents.
Ferrite Rods 6 inch 50, 9 x 1/2 75 cents.
Pots: 10K ganged log 50 cents; 1 Meg ganged log \$1.25; 1/2 Meg ganged log \$1.25; 2 Meg ganged log \$1.25;
2 Meg double pole switch \$1.50.
Sharp TV Flyback Transformers 8FT 604 \$7.00.
Miniature Speaker Transformers, drive and output \$1.00 pair.
Heat Sinks: 4 x 2 1/4 \$1.50.
Universal Mono Pick-up Cartridges; fit most type record players \$3.50.
Shure M 75/6 Magnetic Pick-up Cartridge \$11.
Picture Tubes - New 110 Deg 17 inch \$15.

SPEAKERS SPEAKERS SPEAKERS

6 1/2 inch Dual Cone 4/OHM \$5.00
4 x 2 8 OHM \$1.50
12 TACX in 8 or 15 ohm 10 Watts \$11.00
8 TACX 8 ohm \$8.00
6 x 9 in 8 or 15 ohm \$6.00
5 x 7 in 8 or 15 ohm \$5.00
6 1/2 inch 8 or 15 ohm \$4.50
8 x 4 8 or 15 ohm \$4.50
6 x 4 8 or 15 ohm \$3.50
5 x 4 15 ohm \$2.50
4 inch 8 ohm \$2.75
3 inch 3.5 ohm \$2.50
5 inch Tweeters 8 ohm \$3.50
6 inch Dual Cone Tweeters \$6.00
5 x 3 80 ohm \$3.00
5 inch Magnavox dual cone \$6.00
8" 27 ohm \$6.00

8 inch National built in \$14.00
Tweeter
Rola custom kit 63G x Tweeter C60 \$19.00
woofer cross over and pot
MSP 2 3/4 inch 8 ohm \$2.00
3 inch 8 ohm \$1.50
Magnavox 5 inch 4 ohm 8 Watts \$5.00
Magnavox 5 inch 15 ohm \$4.00
Pioneer 3 1/2 inch 8 ohm \$4.00
Magnavox 5 inch dual cone \$1.50
Tweeter \$6.00
Magnavox 10 inch 8 ohm \$8.00
Pioneer horn type Tweeter 3 inch \$9.50
Pioneer horn-type Tweeter \$12.00

Pioneer midrange 5 inch \$9.50
MSP 6 x 2 \$3.50
MSP 4 x 2 5 ohm \$2.50
MSP 6 x 4 47 ohm \$3.50
ROLA 5 x 7 47 ohm \$6.00
ROLA 6 x 9 47 ohm \$6.00
Magnavox 5 inch 8 ohm \$4.00
Magnavox 10 Watt \$12.00
Pioneer 3 1/2 inch 45 ohm \$3.50
MSP 3 inch 8 W 15 ohm \$3.50
MSP 8 inch Woofers 8 ohm, 30 Watt \$12.00
MSP 12 inch 12 VAX 8 ohm, 20 Watt RMS \$17.50
MSP 4 inch 120 ohm \$3.50
4 inch 120 ohm \$4.50

General purpose power supply

This versatile general purpose supply produces up to 2.5 amps from zero to 20 volts – or up to 1.25 amps from zero to 40 volts. Current limiting is adjustable over the entire range for either output option.

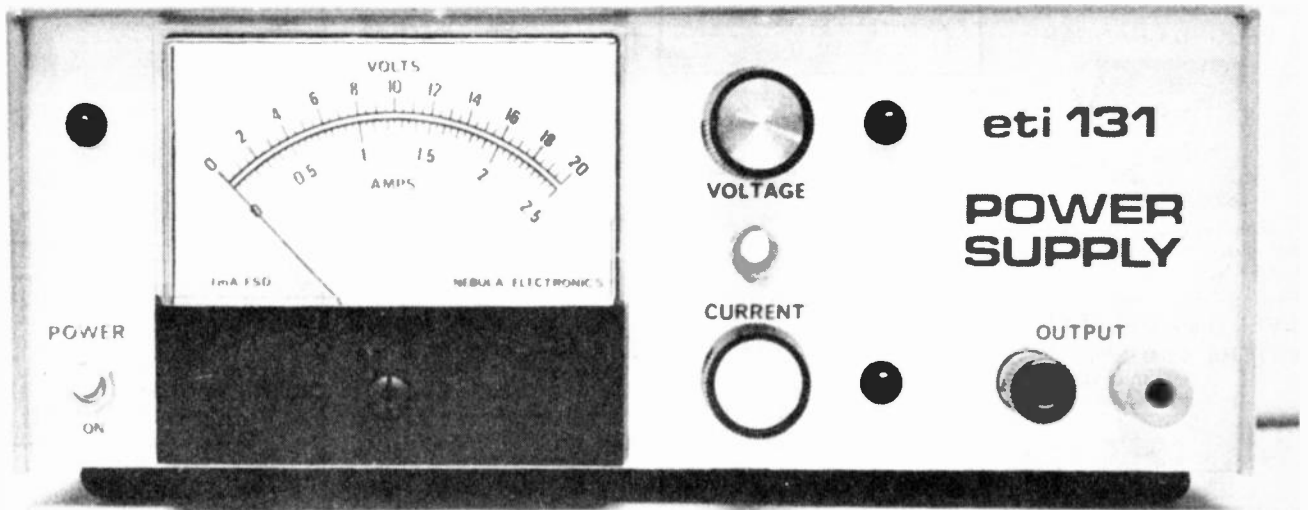

SPECIFICATION – ETI 131

20 VOLT VERSION

VOLTAGE

Output	0–20 volts
Regulation	< 20 mV (0–2.5A)
Ripple and noise	< 1 mV at 2.5A

CURRENT

Output	0–2.5A (up to 18 V) 0–2.0A (up to 20 V)
Limit	0–2.5A
Regulation	< 10 mA (0–20 V)

40 VOLT VERSION

VOLTAGE

Output	0–40 V
Regulation	< 20 mV (0–1.25A)
Ripple and noise	< 1.5 mV at 1.25A

CURRENT

Output	0–1.25A
Limit	0–1.25A
Regulation	< 10 mA (0–40 V)

In both versions LEDs indicate voltage or current modes and the meter is switchable to read voltage or current.

AN IDEAL POWER SOURCE

should supply a voltage which is adjustable over a wide range, and which remains at the set voltage regardless of line voltage or load variations. The supply should also be undamaged by a short circuit across its output and be capable of limiting the load current so that devices are not destroyed by fault conditions.

Two such supplies have previously been described in ETI. The first was a simple supply providing 0 to 15 volts at up to 750 mA. The second was a dual tracking supply providing ± 20 volts at up to one ampere. Both these supplies have been extremely popular, especially the simple one, and are still being built by many people. However there have been many requests for a supply having a greater output current capability than either of these previous designs could provide.

This project describes a supply that will provide 2.5 amperes at up to 18 volts (up to 20 volts at lower currents).

Alternately a few simple changes can make the supply provide up to 40 volts at 1.25 amperes. The supply voltage is settable between zero and the maximum available, and current limiting is also adjustable over the full range. The mode of operation of the supply is indicated by two LEDs. The one beside the voltage control knob indicates when the unit is in normal voltage-regulation mode and the one beside the current limit control indicates when the unit is in current-limit mode. In addition a large meter indicates the current or voltage output as selected by a switch.

DESIGN FEATURES.

During our initial design stages we looked at various types of regulator and the advantages and disadvantages of each in order to choose the one which would give the best cost-effective performance. The respective methods and their characteristics may be summarized as follows.

The shunt regulator. This design is suitable mainly for low-power supplies — up to 10 to 15 watts. It has good regulation and is inherently short-circuit proof but dissipates the full amount of power it is capable of handling under no-load conditions.

The series regulator. This regulator is suitable for medium-power supplies up to about 50 watts. It can and is used for higher power supplies, but heat dissipation can be a problem especially at very high current with low output voltages. Regulation is good, there is little output noise and the cost is relatively low.

SCR regulator. Suitable for medium to high power applications, this regulator has low power dissipation, but the output ripple and response time are not as good as those of a series regulator.

SCR preregulator and series regulator. The best characteristics of the SCR and series regulators are combined with this type of supply which is used for medium to high-power applications. An SCR pre-regulator is used to obtain a roughly regulated supply about five volts higher than required, followed by a suitable series regulator. This minimizes power loss in the series regulator. It is however more expensive to build.

Switching regulator. Also used for medium to high-power applications, this method gives reasonable regulation and low power dissipation in the regulator but is expensive to build and has a high frequency ripple on the output.

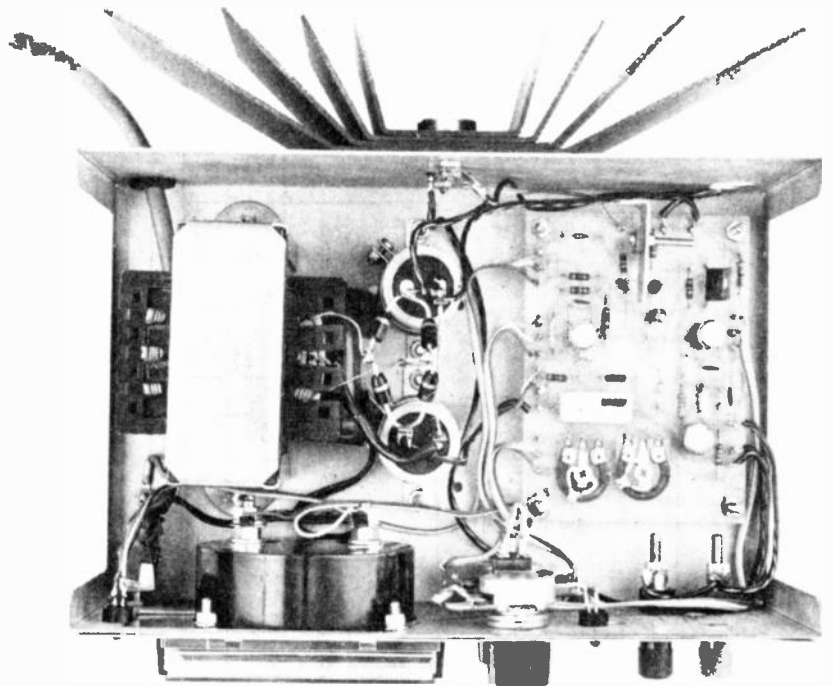

Inside view of the completed 40 volt power supply. Note how the heatsink is mounted to the rear of the unit.

Switched-mode power supply.

The most efficient method of all, this regulator rectifies the mains to run an inverter at 20 kHz or more. To reduce or increase the voltage an inexpensive ferrite transformer is used, the output of which is rectified and filtered to obtain the desired supply. Line regulation is good but it has the disadvantage that it cannot easily be used as a variable supply as it is only adjustable over a very small range.

OUR OWN DESIGN

Our original design concept was for

a supply of up to 20 volts at 5 to 10 amps output. However, in the light of the types of regulator available, and the costs, it was decided to limit the current to about 2.5 amps. This allowed us to use a series regulator — the most cost-effective design. Good regulation was required, together with variable-current limit, and it was also specified that the supply would be useable down to virtually zero volts. To obtain the last requirement a negative supply rail or a comparator that will operate with its inputs at zero volts is required.

Rather than use a negative supply

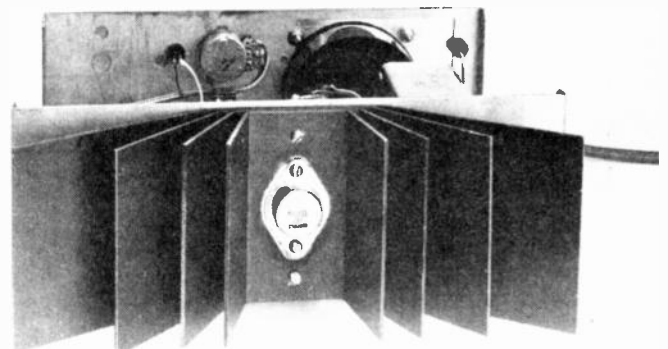

Rear view of the heatsink showing how it and the transistor are mounted.

HOW IT WORKS — ETI 131.

The 240 volt mains is reduced to 40 Vac by the transformer and, depending on which supply is being built, rectified to either 25 or 50 Vdc. This voltage is only nominal as the actual voltage will vary between 29 volts (58 volts) on no-load to 21 volts (42 volts) at full load. The same filter capacitors are used in either case. They are connected in parallel for the 25 volt version (5000 μ F) and in series for the 50 volt version (1250 μ F). In the 50 volt version the centre tap of the transformer is connected to the centre tap of the capacitors thus ensuring correct voltage sharing between the capacitors. This arrangement also provides a 25 volt supply for the regulator IC.

The voltage regulator is basically a series type where the impedance of the series transistor is controlled in such a way that the voltage across the load is maintained constant at the preset value. The transistor Q4 dissipates a lot of power especially at low output voltages and high current and is therefore mounted on the heatsink on the rear of the unit. Transistor Q3 adds current gain to Q4, the combination acting as a high-power, high-gain, PNP transistor.

The 25 volts is reduced to 12 volts by the integrated-circuit regulator IC1. This voltage is used as the supply voltage for the CA3130 ICs and is further reduced to 5.1 volts by zener diode ZD1 for use as the reference voltage. The voltage regulation is performed by IC3 which compares the voltage as selected by RV3 (0 to 5.1 volts) with the output voltage as divided by R14 and R15. The divider gives a division of 4.2 (0 to 21 volts) or eight (0 to 40 volts). However at the high end the available voltage is limited by the fact that the regulator loses control at high current as the voltage across the filter capacitor approaches the output voltage and some 100 Hz ripple will also be present. The

output of IC3 controls transistor Q2 which in turn controls the output transistor such that the output voltage remains constant regardless of line and load variations. The 5.1 volt reference is supplied to the emitter of Q2 via Q1. This transistor is in effect a buffer stage to prevent the 5.1 volt line from being loaded.

Current control is performed by IC2 which compares the voltage selected by RV1 (0 to 0.55 volts) with the voltage generated across R7 by the load current. If say 0.25 volts is set on RV1 and the current drawn from the supply is low, the output of IC2 will be near 12 volts.

This causes LED 2 to be illuminated as the emitter of Q1 is at 5.7 volts. This LED therefore indicates that the supply is operating in the voltage-regulator mode. If however the current drawn is increased such that the voltage across R7 is just above 0.25 volts (in our example) the output of IC2 will fall. When the output of IC2 falls below about 4 volts Q2 starts to turn off via LED 3 and D5.

The effect of this is to reduce the output voltage so that the voltage across R7 cannot rise further. When this happens the voltage comparator IC3 tries to correct for the condition and its output rises to 12 volts. IC2 then takes more current to compensate and this current causes LED 3 to light, indicating that the supply is operating in the current-limit mode.

To ensure accurate regulation the voltage sensing leads are taken to the output terminals separately from those carrying the load current.

The meter has a one milliamp movement and measures the output voltage (directly across the output terminals) or current (by measuring the voltage across R7) as selected by the front panel switch SW2.

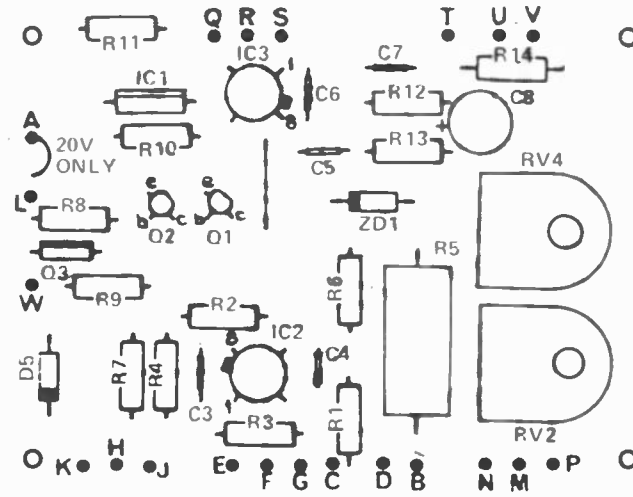
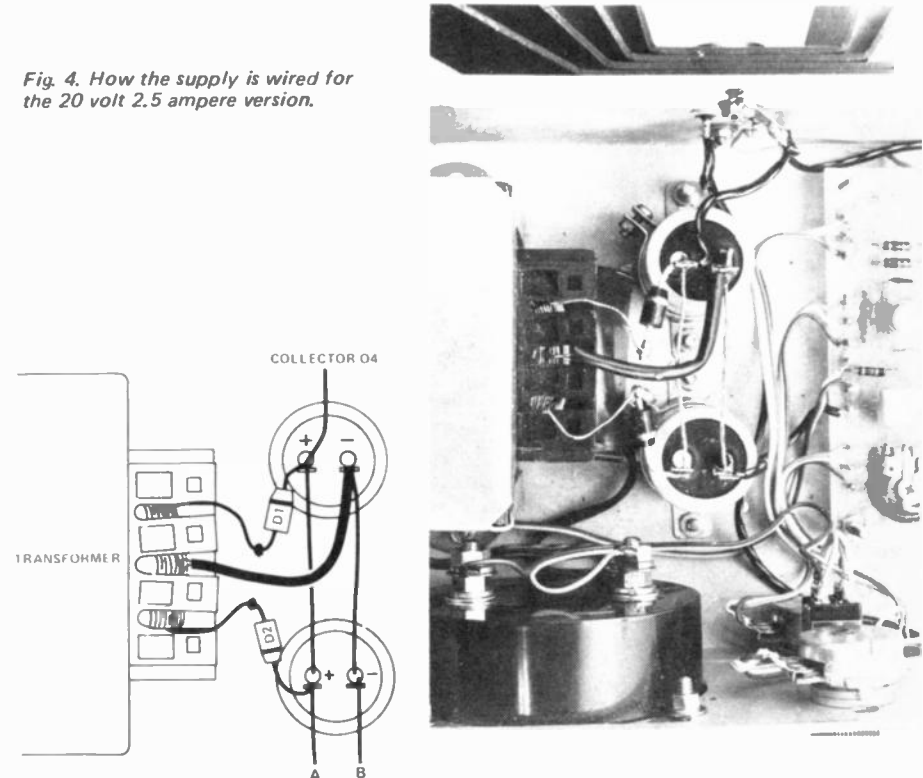

Fig. 3. Component overlay for the printed-circuit board assembly.

Fig. 4. How the supply is wired for the 20 volt 2.5 ampere version.



General purpose power supply

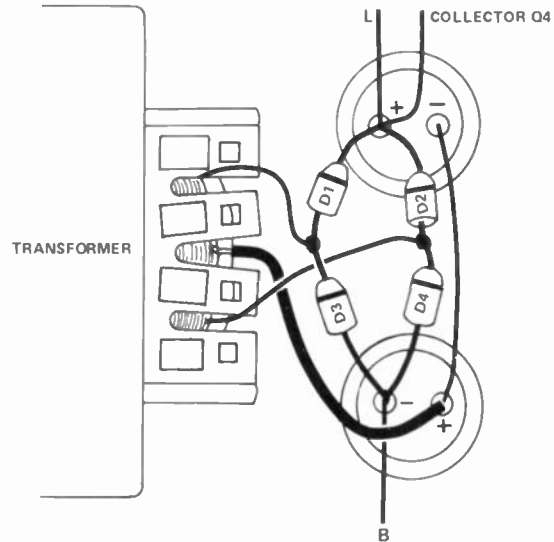
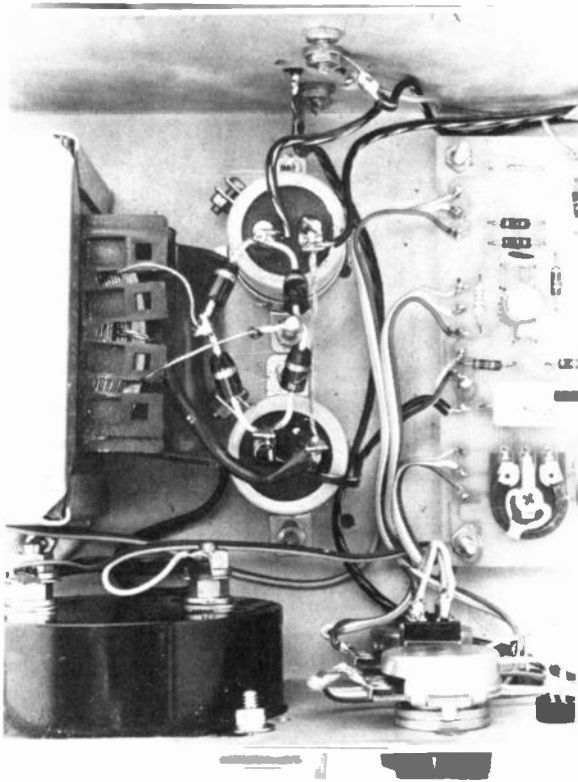

Fig. 5. How the supply is wired for the 40 volt 1.25 ampere version.

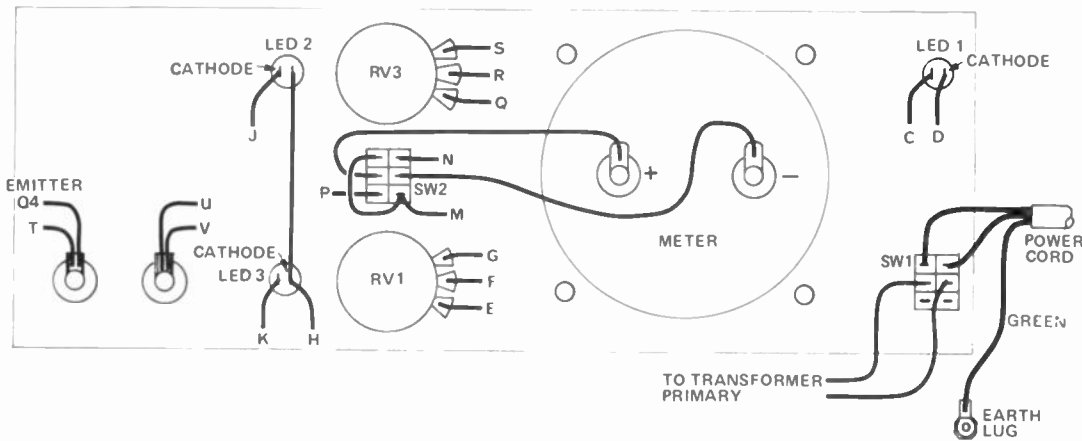

Fig. 6. Front panel wiring diagram.

rail we chose to use a CA3130 IC operational amplifier as the comparator. The CA3130 requires a single supply (maximum of 15 volts) and, initially, we used a resistor and 12 volt zener to derive a 12 volt supply. The reference voltage was then derived from this zener supply by another resistor and a 5 volt zener. It was felt that this would have given sufficient regulation for the reference voltage but in practice the output from the rectifier was found to vary from 21 to 29 volts and some of the ripple and voltage change that occurred across the 12 volt zener, as a consequence, was reflected into the 5 volt zener reference. For this reason

the 12 volt zener was replaced by an IC regulator which cured the problem.

With all series regulators the series-output transistor by the nature of the design, must dissipate a lot of power especially at low output voltage and high current. For this reason an adequate heatsink is an essential part of the design. Commercial heatsinks are very expensive and sometimes difficult to mount. We therefore designed our own heatsink which was not only cheaper but worked better than the commercial version we had been considering — being easier to mount. However at full load the heatsink still runs hot as does the transformer, and under high-current

low-voltage conditions the transistor may even be too hot to touch. This is quite normal as the transistor under these conditions is still operating within its specified temperature range.

With any highly regulated supply, stability can be a problem. For this reason in the voltage-regulation mode of operation, capacitors C5 and C7 are incorporated to reduce the loop gain at high frequencies and thus prevent the supply from oscillating. The value of C5 has been chosen for best compromise between stability and response time. If the value of C5 is too low the speed of response is greater — but there is a higher chance of instability. If too high

the response time is unduly increased.

In the current-limit mode the same function is performed by C4 and the same remarks apply as for the voltage case.

As the supply is capable of fairly high current output there is inevitably some voltage drop across the wiring to the output terminals. This is overcome by sensing the voltage at the output terminals via a separate pair of leads.

Whilst the supply was primarily designed for 20 volts at 2.5 amps it was suggested that the same supply could be used to supply 40 volts at 1.25 amps and that this would be of more value to some users. This may be done by changing the configuration of the rectifier and by changing a few components. Some thought was given to making the supply switchable but the extra complication and expense were such that it was not considered to be worthwhile. Thus you should simply decide which configuration suits your need and build the supply accordingly.

The maximum regulated voltage available is limited either by the input voltage to the regulator being too low (at over 18 volts and 2.5 amps) or by the ratio of R14/R15 and by the value of the reference voltage.

$$\text{(Output)} = \frac{R14 + R15}{R15} V_{\text{ref}}$$

Due to the tolerance of ZD1 the full 20 volts (or 40 volts) may not be obtainable. If this is found to be the case R14 should be increased to the next preferred value.

Single turn potentiometers have been specified for the voltage and current controls because they are inexpensive. However if precise setability of voltage or current limit is required ten-turn potentiometers should be used instead.

CONSTRUCTION

The recommended printed-circuit board layout should be used as construction is thereby greatly simplified. Printed-circuit board pins should also be used for the 20 wire connections to the board. These should be installed first. The rest of the components may now be assembled onto the board making sure that the polarities of diodes, transistors, ICs and electrolytics are correct. The BD140 (Q3) should be mounted such that the side with the metal surface faces towards IC1. A small heatsink should be bolted onto the transistor as shown in the photograph.

If the metalwork as described is used the following assembly order should be used.

- a) Mate the front panel to the front of the chassis and secure them together by installing the meter.

- b) Fit the output terminals, potentiometers and meter switch on to the front panel.

- c) The cathodes of the LEDs (that we used) were marked by a notch in the body which could not be seen when the LEDs were mounted onto the front panel. If this is the case with yours, cut the cathode leads a little shorter to identify them and then mount the LEDs into position.

- d) Solder lengths of wire (about 180 mm long) to the 240 volt terminals of the transformer, insulate the terminals with tape and then mount the transformer into position in the chassis.

- f) Install the power cord and the cord retaining clip, wire the power switch, insulate the terminals and then mount the switch onto the front panel.

- g) Assemble the heatsink and screw it onto the rear of the chassis via two bolts – then mount the power transistor using insulation washers and silicon grease.

- h) Mount the assembled printed-circuit board to the chassis using 10 mm spacers.

- i) Wire the transformer secondary, rectifier diodes and filter capacitors. The diode leads are stiff enough not to need any additional support.

- j) The wiring between the board and the switches may now be made by connecting points with corresponding letters on the front panel diagram and component overlay diagrams.

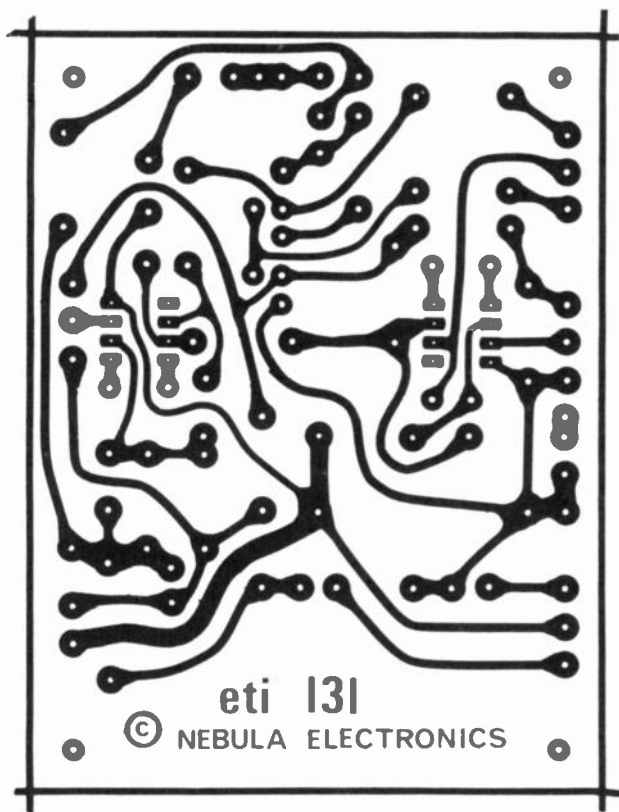

Fig. 7. Printed-circuit board layout for the power supply. Full size 100 x 75 mm.

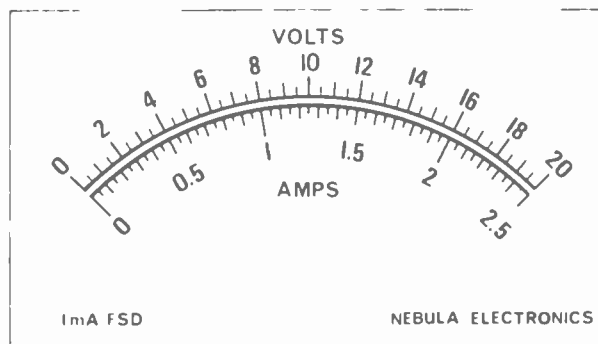
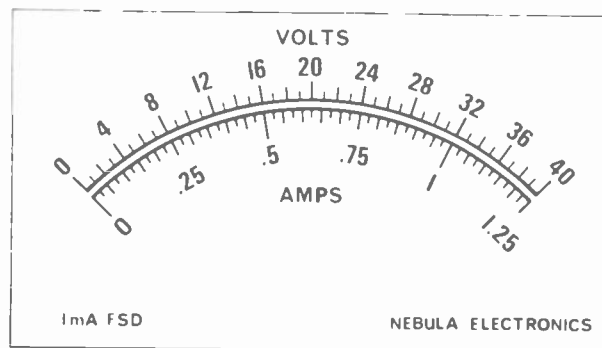

Fig. 8. Scales for the alternative meters for the unit shown full size.

General purpose power supply

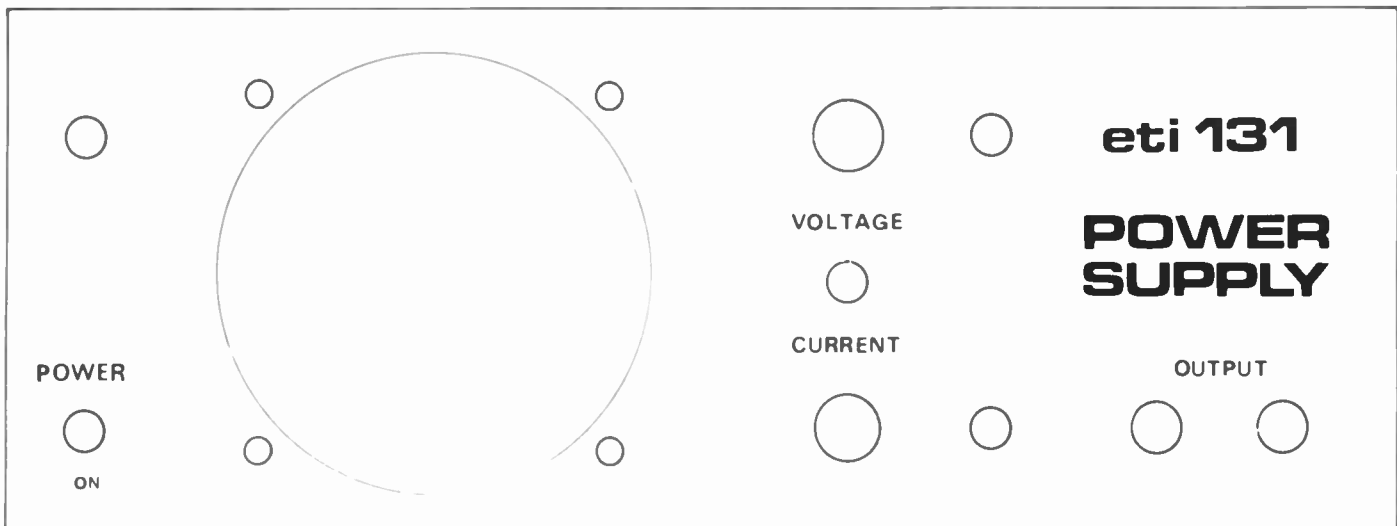

Fig. 9. Artwork for the front panel. Full size 224 x 82 mm.

The only setting up required is to calibrate the meter. Connect an accurate voltmeter to the output terminals and wind up the voltage control of the power supply until the external meter reads 15 volts (or 30 volts on

the alternate arrangement). Switch the internal meter to read volts and adjust RV4 to obtain the same reading.

To set up the current reading first wind the supply voltage down to zero and connect an accurate ammeter across the output. Wind up the voltage

control and observe that the current limit LED is on. Now adjust the current limit control so that the external meter indicates two amps (or one amp on the alternative unit). Now adjust RV2 so that the same reading is obtained on the internal meter when it is switched to the current position.

Complete kits of components for this project can be obtained from Nebula Electronics Pty Ltd, 4th Floor, 15 Boundary St, Rushcutters Bay — telephone 335850 — see advertisement on page 71 of this issue.

PARTS LIST — ETI 131A

Resistors

R1	—	1 k	½ W	5%
R2	—	1 k	"	"
R3	—	1 k5	"	"
R4	—	10 k	"	"
R5	—	0.22 ohm	5 W	
R6	—	10 k	½ W	5%
R7	—	1 k	"	"
R8	—	1 k	"	"
R9	—	1 k	"	"
R10	—	1 k	"	"
R11	—	47	"	"
R12	—	18 k	"	"
R13	—	5 k6	"	"
R14	—	15 k	"	"

Potentiometers

RV1	—	10 k lin rotary
RV2	—	1 k trim
RV3	—	10 k lin rotary
RV4	—	10 k trim

Capacitors

C1	—	2500 µF 35V electro
C2	—	2500 µF 35V electro
C3	—	68 pF ceramic
C4	—	150 pF "
C5	—	820 pF "
C6	—	68 pF "
C7	—	68 pF "
C8	—	47 µF 50V electro

Transistors

Q1	—	BC559
Q2	—	BC547
Q3	—	BD140
Q4	—	2N3055 (with insulation kit)

Diodes

D1,2	—	IN5404
D5	—	IN914

Other Semiconductors

ZD1	Zener Diode	5.1V 400 mW
LED 1,2	LED	5023 or similar
IC1	Integrated Circuit	LM341P-12
IC2,3	"	CA3130

Miscellaneous

PC board ETI 131
Transformer 40V CT 2A A&R 5755
SW1,2 switch DPDT toggle
Meter 1 mA FSD scaled 0-20V, 0-2.5A
Chassis to Fig. 11
Cover to Fig. 13
Heatsink to Fig. 10
Front panel to Fig. 9
Two terminals
Power cord & clamp
Two knobs
Four 10 mm long spacers
20 PC board pins
Four rubber feet
nuts, bolts, washers etc.

PARTS LIST — ETI 131B

All parts for ETI 131A except

Change	R3	to	1 k8
	R5	to	0.47 ohm
	R12	to	39 k
	R14	to	33 k
	RV4	to	25 k

FERGUSON

Manufacturers of: Electrical/ electronic equipment, wound components and lighting control equipment.

BRANCHES IN ALL STATES

FERGUSON TRANSFORMERS PTY. LTD.

HEAD OFFICE:

331 High St., Chatswood. 2067
P.O. Box 301,

Chatswood, NSW, Australia 2067

Phone: 02-407-0261

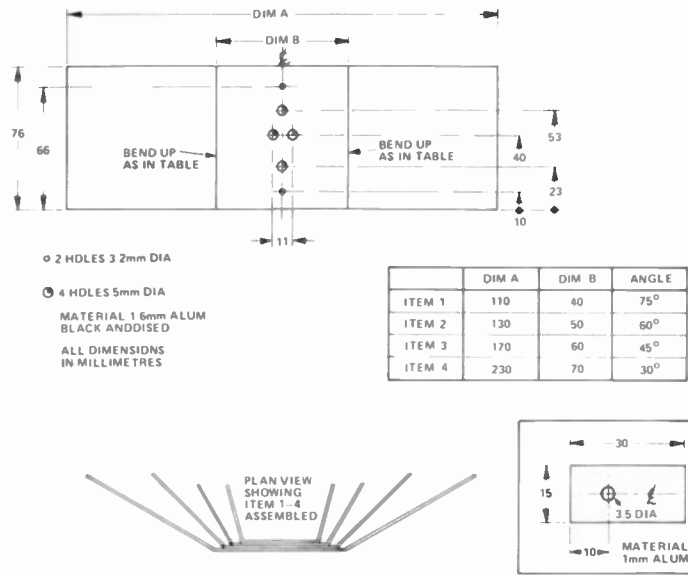

Fig. 10. Heatsink detail.

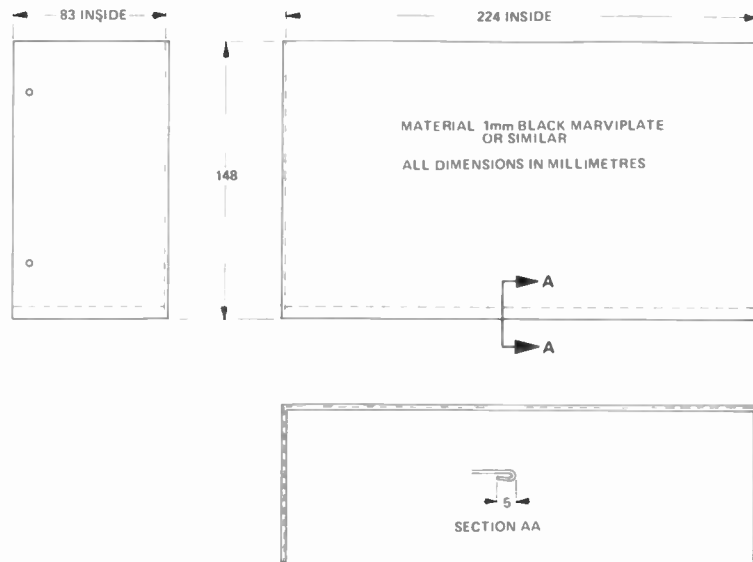

Fig. 13. Detail of metal cover.

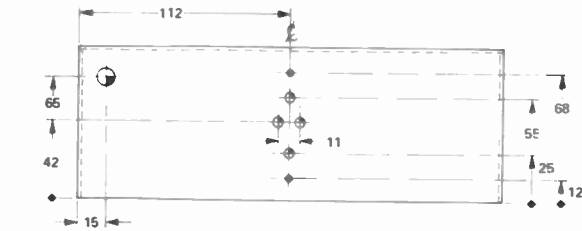

Fig. 11. Chassis metalwork.

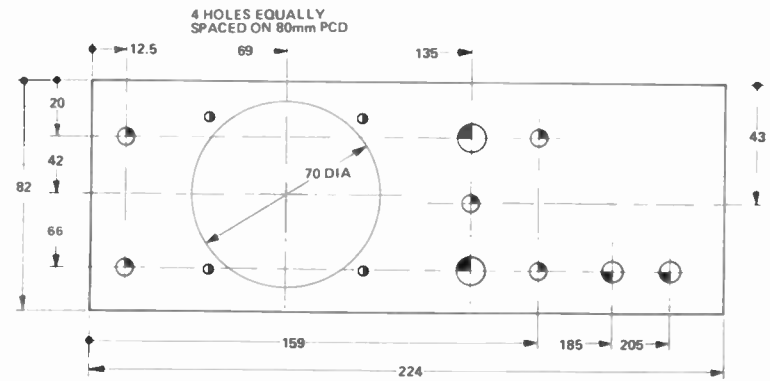
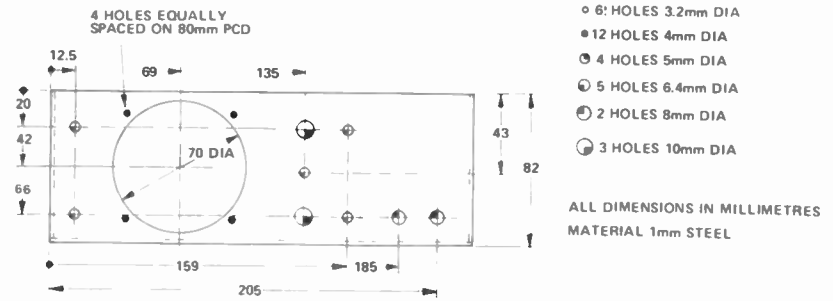
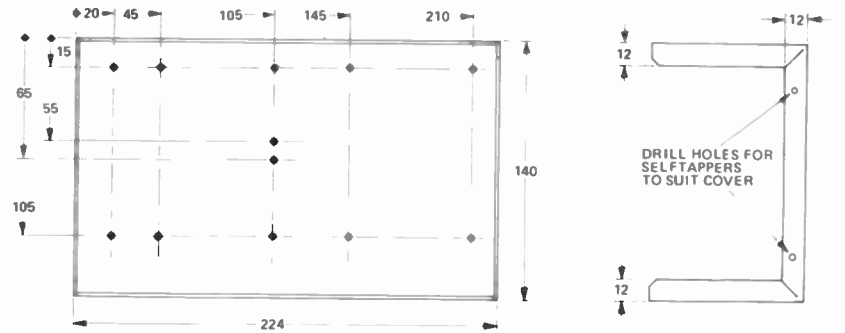
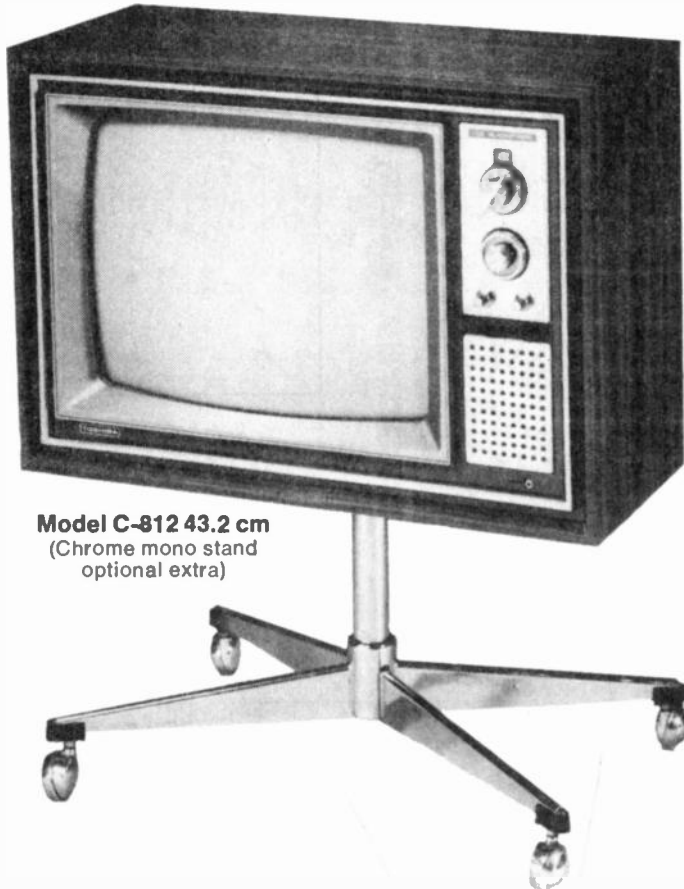

Fig. 12. Front panel drilling.

What has a **BLACKSTRIPE™** got to do with colour TV?



Model C-812 43.2 cm
(Chrome mono stand
optional extra)

Model C-412 33.5 cm
(Swivel base
optional extra)



Model 12-KL 29.2 cm
(Black and white
portable)



The BLACKSTRIPE™ picture tube is a revolutionary development from the resources of Toshiba, one of Japan's largest electrical manufacturers. Instead of making pictures with dots of colour on a whitish tube, Toshiba produces crisp areas of colour separated by minute black stripes. This means there is no bleed of one colour into another. The result is sharp, natural, brilliant colour without glare.

Toshiba C-812 and C-412 colour sets are fitted with both VHF and UHF tuners which will allow you to receive all current and future TV channels.

Whether it be a Colour or Black and White, when you take everything into consideration Toshiba has a lot going for it. So even if you don't win one of the three sets being given away in Electronics Today, remember the name Toshiba.

Toshiba **TOSHIBA**
In Touch with Tomorrow

TS7755

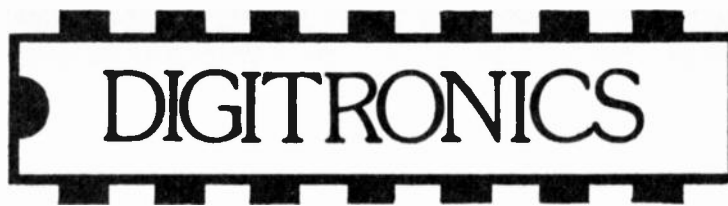

FROM NEWCASTLE TO MOREE,
FROM THE SIMPSON TO THE SEA.
WE ARE "THE" DISTRIBUTORS OF E.E.C.

Electronic Equipment & Components

Here are a few examples:

Oscilloscopes • Power Supplies • Multimeters
• Signal Generators • Amateur Radio
Equipment • Stroboscopes • Recorders



Military Connectors • Edge Connectors • RF.
BNC. UHF Connectors • Printed Circuit
Board Materials • Chemicals

T.T.L. Transistors • Triacs SCR'S
• Optoelectronics • Capacitors • Resistors
• Transformers • Transducers



*We can offer all kinds of credit purchase to approved customers.
BANK CARD • HIRE PURCHASE • RENTAL PURCHASE
• LEASE PURCHASE • CONTINUOUS CREDIT*

Phone numbers 049-69-2040; 049-61-4991
Ask for Digitronics Sales, 186 Parry Street, Newcastle West, 2302

HAM RADIO SUPPLIES

MAIL ORDER SPECIALISTS

323 Elizabeth Street, Melbourne (2 doors from Little Lonsdale Street) 674286 67 7329
new Richmond branch now at 390 Bridge Rd., Richmond Phone 42-5174

MODEL NC-310 DE LUXE 1 WATT 3 CHANNEL C.B. TRANSCEIVER

- WITH CALL SYSTEM
- EXTERNAL AERIAL CONNECTION

SPECIFICATIONS, NC-310

Transistors: 13
Channel Number: 3, 27.24 OMHz
Clz. Band
Transmitter Frequency Tolerance: $\pm 0.005\%$
RF Input Power: 1 Watt
Tone Call Frequency: 2000 Hz
Receiver type: Superheterodyne
Receiver Sensitivity: $0.7\mu\text{V}$ at 10 dB S/N
Selectivity: 45 dB at ± 10 kHz
IF Frequency: 455 kHz
Audio Output: 500 mW to External Speaker Jack
Power Supply: 8 UM-3 (penlite battery)
Current Drain: Transmitter: 120-220mA
Receiver: 20-130mA.

\$49.00 each or \$95 a pair.
Post & pack \$1.50 per unit.

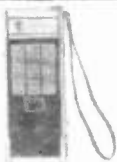

1 watt 2 channel transceiver with call system, 27.240 MHz. 12 transistor. PMG approved type.

SPECIFICATIONS:
Transmitter — Crystal Controlled: 1 Watt input power to RF stage. Operating frequency — Any 2 channels in the 11-meter Citizens Band. Receiver — Crystal-controlled superheterodyne circuit with 455 Kc IF. Antenna — Built-in 60" telescopic whip antenna. Audio Output — 0.8 Watt maximum. Power supply required — 12 volts DC (Eight 1.5 volt DC battery cells). Loudspeaker — $2\frac{1}{4}$ " PM type (built-in) function as microphone on transmit.

\$45.50 each or \$89 a pair.
Post & pack \$1.50 each unit.



BARLOW-WADLEY XCR-30

a truly portable communications receiver, based on the WADLEY LOOP principle, the same principle as applied in the

DELTAHET and RACAL receivers. A truly crystal-controlled highly sensitive multiple-heterodyne portable receiver of exceptional stability with continuous, uninterrupted coverage from 500 kHz to 31MHz.

BARLOW-WADLEY XCR-30 features Include: Selectable USB/LSB, CW & AM reception, frequency read-out 10kHz throughout the entire range, calibration accuracy within 5kHz, antenna resonator, tuning signal-strength meter, zero-set control, clarifier-vernier tuning, MHz & kHz tuning controls, telescopic antenna. Power source: 6 type D dry cells; provision for external DC power supply. Weight 9 lbs; size $11\frac{1}{2}$ x $7\frac{1}{2}$ x 4in.

\$239

P&P \$4.50

When not in use or for carrying, the top meter/megahertz scale flips down flush with the case and clear of the handle.

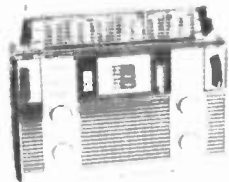

\$6.95
Post Free.

**MODEL C1000M
MULTIMETER**
Compact, handy and versatile, the C1000M is the ideal low cost pocket meter, Mirror Scale. Specifications: 1,000 Ohm/Volt DC; 1,000 Ohm/Volt AC; DC volts — 10; 50; 250; 1,000; AC volts — 10; 50; 250; 1,000; DC amps — 1 mA; 100 mA; Ohms — 150 K Ω ; Centre scale — 3 K Ω ; Decibel — 10 dB to 22 dB; Dimensions — $3\frac{1}{2}$ " x $2\frac{3}{8}$ " x $1\frac{1}{8}$ " 90 x 60 x 30 mm.

**MODEL C-7077/P
MULTIMETER.**
Specifications: 100,000 ohms/volt DC; 10,000 ohms/volt AC; DC volts — 5; 25; 50; 250; 500; 1,000. AC volts — 10; 50; 250; 500; 1,000. DC amps — 10 μA ; 2.5 mA; 25 mA; 500 mA. Ohms — 10 K Ω ; 1 M Ω ; 10 M Ω ; 100 M Ω . Centre scale — 150 Ω ; 15 K Ω ; 150 K Ω ; 1.5 M Ω . Decibel — -20 to +22 dB. Dimensions — 151 x 102 x 48 mm Diode protected movement. Carrying case available Model C.



\$27.95
P&P \$1.50.

**MODEL OL64 D/P
MULTIMETER.** Very ruggedly constructed this model is particularly suitable for workshops. It features special scales for measurement of capacitance and inductance. Diode protected movement. Specifications: 20,000 Ohm/Volt DC. 8,000 Ohm/Volt AC. DC volts — 0.25; 1; 2.5V; 10; 50; 250; 1,000; 5,000. AC volts — 10; 50; 250; 1,000. DC amps: 50 μA ; 1 mA; 50 mA; 500 mA; 10 A. Ohms — 4 K Ω ; 400 K Ω ; 4 M Ω ; 40 M Ω . Centre scale — 40 Ω ; 4,000 Ω ; 40,000 Ω ; 400,000 Ω . Decibel: -20 to +62 dB. Dimensions: 6" x $4\frac{1}{5}$ " x 2"; 152 x 107 x 51 mm. Capacitance: 250 pF to 0.02 μF . Inductance — 0/5000H Carrying case available Model C.



\$24.90 P&P \$1.50.

**MODEL AS100 D/P
MULTIMETER.** This meter features double zero diode meter protection and $3\frac{1}{2}$ " full view easy to read 2 colour scale. It is fitted with polarity reversing switch and housed in a strong moulded case with carrying handle. Specifications: 100,000 ohm/volt DC. 10,000 ohm/volt AC. DC volts — 0.3; 12; 60; 120; 300; 600; 1,200. AC volts — 6; 30; 120; 300; 600; 1,200V. DC amps — 2 K μA ; 200 K μA ; 20 M μA ; 200 M μA . Centre scale — 20 Ω ; 2,000 Ω ; 20,000 Ω ; 200,000 Ω ; 20 M Ω . Decibel — -20 to +57 dB. Dimensions — $7\frac{3}{5}$ " x $5\frac{2}{5}$ " x $2\frac{3}{5}$ " 193 x 137 x 66 mm. Carrying case available model I.



\$37.50
P&P \$1.50.

SIGNAL INJECTOR

battery operated

\$8-90 P&P \$1.00

THIS MONTHS SPECIAL

SOLID STATE
19 TRANSISTOR MULTI-
BAND RADIO — 9 RANGES



AM, SW, FM, VHF, AIR, PB BATTERY/OPERATED COLOUR CODED 9 BAND DIAL 1. AM 535 to 1600 kHz, 2. Marine 1-5 to 4 MHz, 3 & 4. combined SW 4 to 12 MHz, 5. 30 to 50 MHz, 6. 88 to 108 MHz, 7, 8 & 9 combined VHF Aircraft 145 MHz-174 MHz Incorporating weather band. Slider controls, Dial light, Fine tuning control, Flip-up Time Zone map, Telescope antennas complete with batteries

SPECIAL PRICE \$59 Post Pack \$3.50

8 transistor, push-button car radio. 12 volt neg or pos earth switching. With large 7 x 5 inch speaker and lock down aerial.

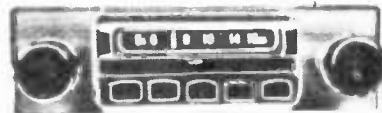

\$39.95 P&P \$2.50

AM / FM / VHF / TV .
MULTIBAND RADIO. NEW
MODEL AC/DC.

Latest military design multi-band radio, 30 transistors and diodes. With exclusive (LED) light emitting diode tuning indicator for positive station selection. Battery and electric covers all popular AM and FM bands.



NEW PRICE \$39.00
P&P \$2.50

APPROVED BY ELECTRIC SUPPLY DEPT. BEWARE OF MORE EXPENSIVE IMITATIONS.

STEREO TODAY. QUADRAPHONY TOMORROW.



BANG & OLUFSEN BEOSYSTEM 3400

Bang & Olufsen's Beosystem 3400

Bang & Olufsen have designed the new Beosystem 3400 so that you can enjoy stereophonic sound today, and quadrasonic sound whenever you're ready for it. Connect two speakers and you have a remarkable stereo system—add two more and you have an outstanding quadrasonic music system.

So, when you're ready to change from stereo to quadrasonic sound, no complicated or costly conversions are necessary. **Why a quadrasonic system when all your records are stereo?**

Some of your records are possibly mono, because you couldn't get them in stereo. But you wanted them purely because of the music or artist. In the future, finding stereo records may be as difficult as finding

mono today, because more and more recordings are being produced in the quadrasonic mode.

The Beosystem 3400 allows you to take advantage of the multi-dimensional reality of quadrasonic sound now and at the same time continue to enjoy your mono and stereo records.

What makes the Beosystem 3400 outstanding?

First, a combined high-fidelity FM tuner with four output amplifiers, so that you can have two sets of stereo speakers in separate rooms, or full quadrasonic in one room.

The amplifier power output is 2 x 30 watts R.M.S. for stereo and 4 x 20 watts R.M.S. for four channel. And thanks to advanced electronic design with the use of "split supply" coupled Darlington transistors at the output

stages, distortion is minimal. There are terminals for four loudspeakers, a two or four channel record player, a two or four channel tape recorder and a set of two or four channel headphones.

The stereo/4 channel record player is an example of totally new construction. You can select all operations by lightly touching a rectangular control panel—the rest is done automatically.

The pick-up cartridge has a titanium framed Shibata-cut diamond. This special cartridge can provide every kind of sound reproduction—mono, stereo and 4 channel—both SQ matrix and CD-4 discrete. The new Uni-Phase loudspeakers

From Bang & Olufsen's most recently announced range of Uni-Phase loudspeakers, a pair of S45s with a power handling capacity

of 45 watts R.M.S. All the units in the cabinet operate in the same phase, even in the crossover range, so that the sound from all units reaches the ear simultaneously.

Thus the new B & O Uni-Phase loudspeakers produce sound more accurately and with more reality than most commercial speakers on the market to date. The Uni-Phase S45s also take up much less space than conventional pressure chamber speakers.

With the exception of two extra speakers (which you need not buy right away), Beosystem 3400 costs no more than a comparable stereo system.

BANG & OLUFSEN



with respect
for the true
sound

Danish HI FI, Southern Cross Plaza. 638930 and Burke Road. Camberwell. 824839 Melbourne. Convoy Technocentre, Woolloomooloo. 3582088 Sydney. Danish HI FI, Mount Lawley. 710100 Perth. Brisbane Agencies Audio Centre, Fortitude Valley. 219944 Brisbane.

BO729

Booster amplifier for 2 metre band

Most mobile two metre transceivers are limited to about ten watts output. This RF power amplifier designed by Roger Harrison VK2ZTB and Phil Wait VK2ZZQ, boosts output to 45 watts.

ONE OF THE MOST POPULAR amateur activities these days is mobile operation using the FM nets between 146 MHz and 148 MHz on the two-metre band. The use of FM, particularly for mobile operation, has a number of advantages. It reduces the effects of impulse noise interference, mostly generated by the ignition system of cars and provides clear, largely noise-free communications. Fixed, commonly-agreed channels are used, making tuning of receivers and transmitters unnecessary. However, the effectiveness of a mobile transceiver is affected by terrain, large buildings and other structures. These both reflect and absorb signals causing the commonly experienced 'mobile flutter' which is noticeable on all but the strongest of signals. The terrain and the necessity of having a relatively small antenna system with little or no gain limits the range one can achieve.

Most of these problems have been largely overcome by the installation of open-access repeaters which receive a

transmission on one channel and re-transmit (hence, repeat) it on another channel. These repeaters are located in a high well-sited area so as to obtain wide coverage of a desired area.

The range of any mobile installation, and likewise the coverage of repeaters, is largely limited by the mobile's transmitter output power. Most mobile transceivers in use, such as those made by Icom, Yaesu, Trio etc, and many base station transceivers, produce about 10 watts power output. The sensitivity of the receivers in most of these commercially produced transceivers leaves little to be desired, and, as a consequence, output power and receiver sensitivity are not 'matched'. That is to say, one can often hear a higher power station, or a repeater, for a much greater distance than they can copy your transmitter. Not what you'd call an ideal situation.

The way to remedy this state of affairs is to add an RF power amplifier after the transmitter to boost the power output to a more suitable level. One

thus gains more range and more 'solid' communications with less mobile flutter. More power for base station or home-station use is also an advantage. The normal ground-wave coverage is increased.

The next question is: 'What is a suitable power level'? This is largely determined by two things: the power supply and the pocket. Obviously, for a mobile installation, the power supply is a twelve volt battery. It is possible to run powers of 100 watts or more (witness the number of FT101's in mobile installations) but that sort of power really requires alteration of the alternator-regulator system in the car to cope with the increased battery drain. Running 150 watts DC input mobile on two metres is certainly possible, but that will have to be the subject of another article.

When considering the pocket, or how much a suitable power amplifier would cost, a good rule of thumb is 'less than a dollar per watt'. Thus, one needs to consider a single transistor. This must

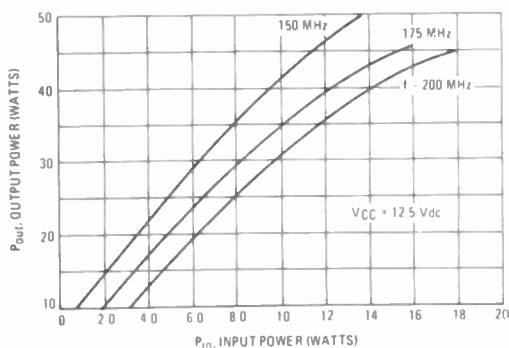

Fig. 1. Power output Vs power input for 2N6084.

fo = 175 MHz, Vcc = 12.5 VOLTS			
P _{IN} WATTS	P _{OUT} WATTS	INPUT OHMS	OUTPUT OHMS
4	21.7	0.8 - j 1.1	2.2 - j 0.3
8	37.1	0.8 - j 1.3	1.7 - j 0.5
10	40	0.8 - j 1.45	1.65 - j 0.4
12	46.5	0.8 - j 1.6	1.6 - j 0.3

Fig. 1(b). Input and output impedances vs power for 2N6084.

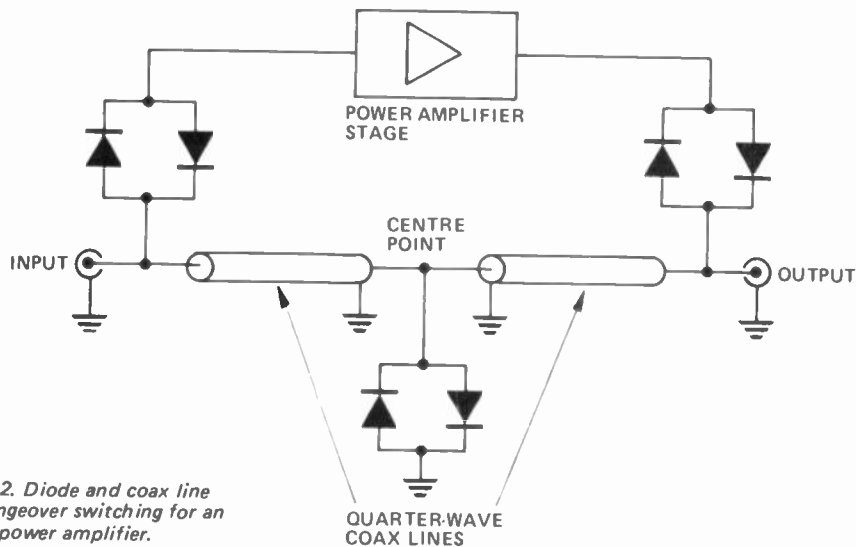

Fig.2. Diode and coax line changeover switching for an RF power amplifier.

have adequate gain and be able to accept an input power in the range of 8 to 12 watts. There are a number of suitable transistors that commence at this level and will produce output powers in the range of 25 to 50 watts or more from a power supply rail of 12 V. Those transistors producing output powers over 50 watts from the 10 to 12 watt level become more expensive on a dollar-per-watt basis than those transistors producing output powers below 50 watts. The higher power transistors require a substantially larger heatsink also – increasing size and cost considerations. As most of the popularly used commercial transceivers – and many homebrew ones, are quite small physically, the size of the power amplifier is also a consideration.

Apart from cost, availability of suitable transistors and other components is a necessary consideration. The 2N6084 transistor fits all our requirements very well. The data sheet on this transistor indicates a power output of between 37 watts and 46.5 watts at 175 MHz for a power input of between 8 watts and 12 watts at a supply voltage of 12.6 volts. The manufacturers claim that the transistor will withstand severe mismatch under operating conditions. A graph of power output versus power input (i.e: drive power) is given in Fig 1 – along with a table of typical performance and base input – collector output impedances.

Having chosen the device, an appropriate circuit, suitable for a kit or simple home construction was necessary. The current ARRL VHF Handbook describes a circuit that works very well, but has a number of drawbacks. Local availability of some of the components in particular. It was also felt that the design could be simplified with a consequent reduction in components and

cost. Another drawback was the problem of an antenna changeover relay. To cope with this level of power and have adequate isolation between the transmitter output and receiver input contacts a coaxial changeover relay is necessary. These items are not on everybody's shelf and generally cost in excess of \$20 over the counter. Very off-putting.

DIODE AND COAXIAL LINE SWITCHING

Quarter wave coaxial lines and diodes are now being successfully used for this

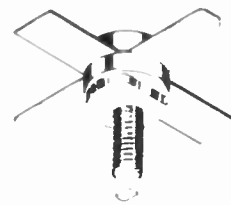

Physical construction of 2N6084

purpose however – and several articles describing the technique have recently been published in amateur radio publications. The method is simple, cheap and very effective. The circuit is shown in Fig 2 and works as follows:

During the receive condition, all the diodes are non-conducting and thus present a high resistance to the signal coming from the antenna. Thus, no signal is dissipated in the amplifier input or output circuits. The two diodes from the centre point present a high impedance across the coax line and thus have no effect on incoming signals from the antenna. Thus the signals travel through the two quarter-wave coax lines to the antenna input of the receiver without loss. When the transmitter is operated, all diodes conduct. The diodes at the centre point of the two quarter-wave lines will conduct and since a quarter-wave line shorted at one end presents an open circuit at the other end, each quarter wave line will present a high

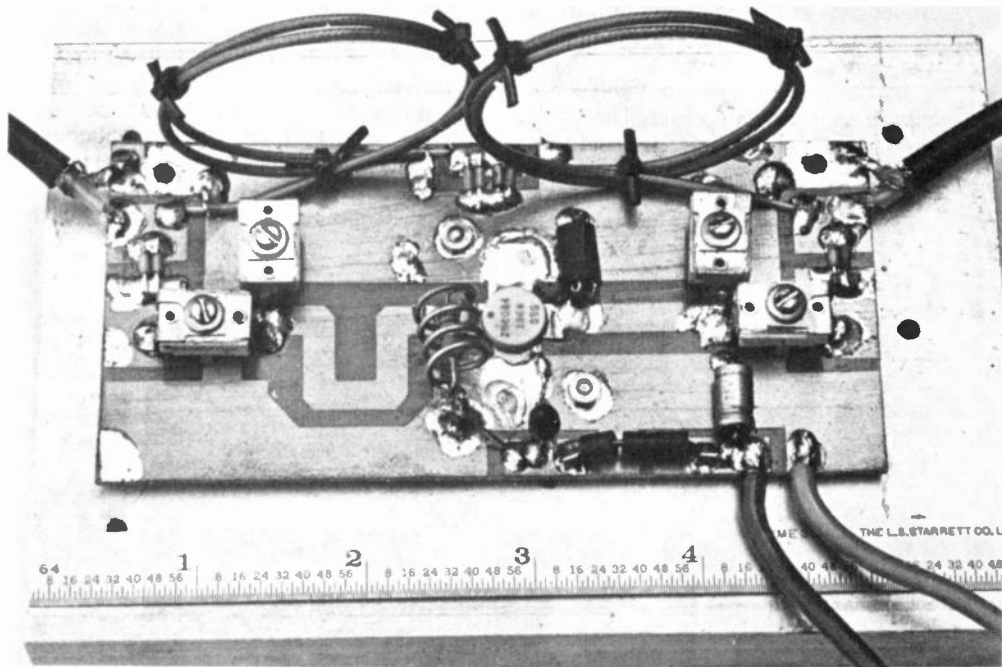

Fig.4. The 45/W, two metre RF power amplifier. The 2N6084 transistor is visible in the centre of the p.c. board. The mica compression trimmers located on the right hand side are for tuning the input, those on the left for tuning the output. The printed inductances are readily visible. The two quarter wave coax lines are visible at the top. They may be coiled up as shown or conveniently arranged in some other way. Note that the components are soldered on the copper side of the printed circuit board.

Booster amplifier for 2 metre band

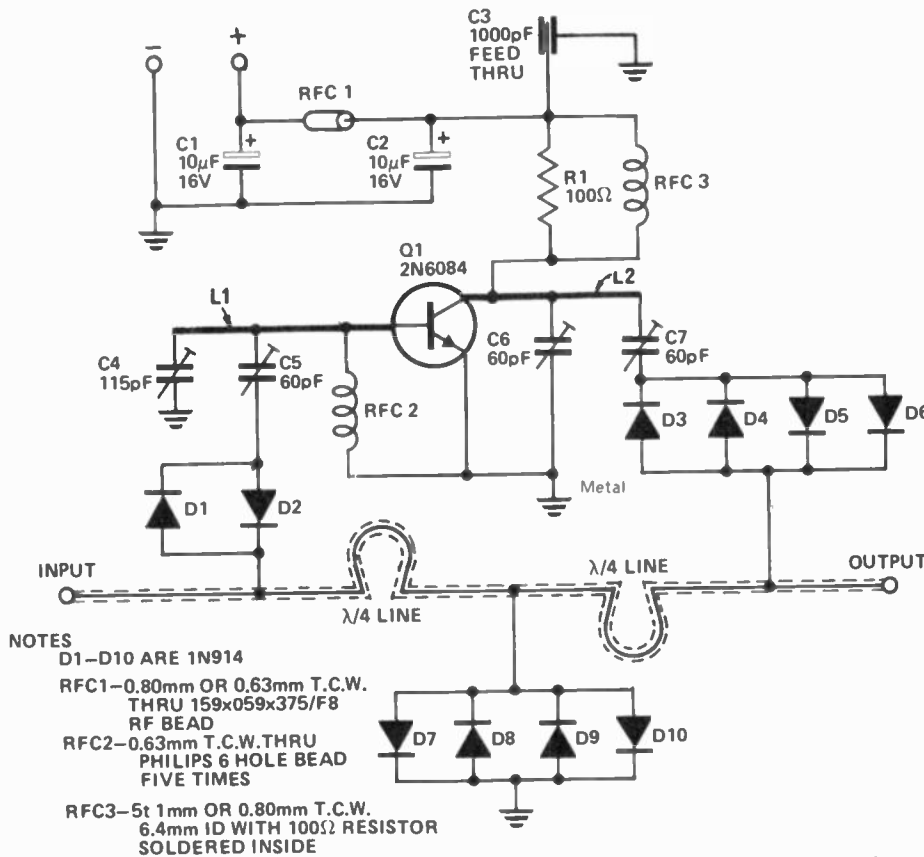

Fig. 3. 45 W 2 metre RF power amp circuit.

impedance at the input and output terminals respectively. The diodes between the input terminal and the power amplifier stage input will conduct and pass the driving power. The diodes between the power amplifier and the output terminal will likewise conduct, passing the output of the amplifier to the output terminal. The output power

cannot return to the input as the two diodes from the centre point of the coax lines will conduct, shorting the quarter-wave line and presenting a high impedance at the output terminal. Happily, the impedance of the quarter-wave coax lines is immaterial and anything suitable may be used. However, their lengths must be an accurate quarter

wavelength electrically taking into account the velocity factor of the cable. In developing this project, some trouble was experienced in this respect — so make sure you have the right length. It appears that the velocity factor of ordinary, run-of-the-mill, garden variety RG58/U coax, obtainable from most suppliers varies considerably in its velocity factor, even over relatively short lengths. You can use this type of coax but a lot of pruning and tuning will be required. If a cable manufactured to tighter tolerances in velocity factor is used, this problem disappears. It is suggested that cables such as RG59B/U (or C/U) or RG223/U, which are nominally 5 mm diameter be used. Alternatively, a 2.5 mm diameter cable such as RG174/U may be used. All these cables have a velocity factor of 0.665 and have been found to be consistent in practice. They must, however, be accurately cut to the lengths specified, as detailed later.

Some trouble was also experienced with a commonly available 2.5 mm diameter cable of unknown type number, so be wary.

THE POWER AMPLIFIER CIRCUIT

The circuit is illustrated in Fig 3. Inductances L1 and L2 are actually rectangular, 5.5 mm wide strips, on the printed circuit board. They are not microstripline sections which would, require a double-sided printed circuit board, single-sided p.c. board is used in this project.

Tuning capacitors, C4, C5, C6, C7 are all mica compression trimmers mounted on a ceramic base and are readily seen in Fig 4 (page 87).

The dc return for the transistor base circuit is via an RF choke, RFC2, visible just to the right of the transistor in Fig 4. This consists of a number of turns of tinned or enamelled copper wire passed through the holes of a six-hole ferrite bead. This makes a low resistance, high inductance RF choke. Some published circuits specify the use of a low value resistor, or two resistors in parallel, in place of an RF choke in this part of the circuit. However, this is not recommended as the available power output is considerably reduced.

The transistor collector is shunt fed from the supply via RFC3. This is simply five turns of tinned or enamelled copper wire of a suitable heavy gauge, anything between 16 B & S and 22 B & S is adequate, with a low value resistor mounted inside to dampen it and lower the Q. A resistor value between 47 ohms

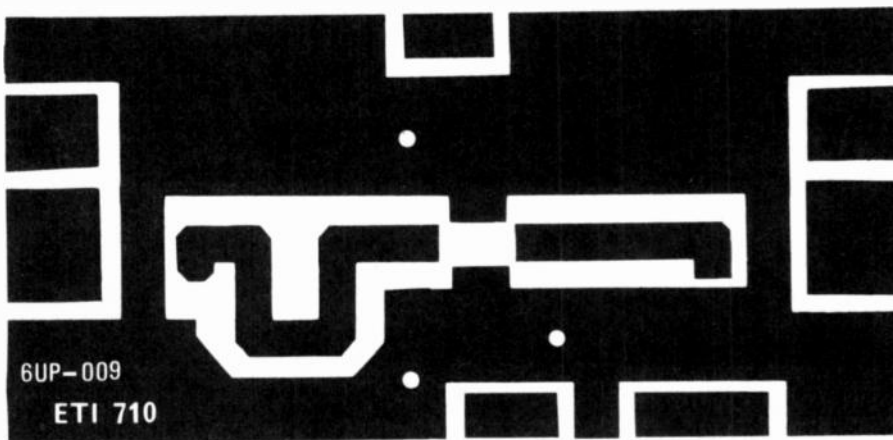

Fig. 5. Printed circuit board layout, copper side.

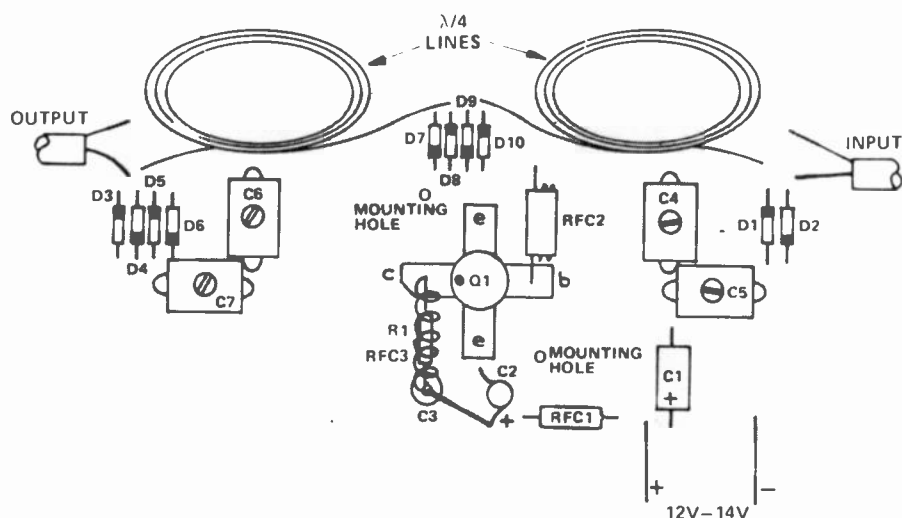

Fig. 6. Component layout.

and 180 ohms is quite satisfactory. The supply end of RFC3 is decoupled for RF by a 1000 pF feedthrough capacitor used as a standoff and tie point.

As the low frequency gain of the 2N6084 is quite high, the supply is also decoupled by several large value electrolytic capacitors, C1 and C2. The latter is a 10uF/35 V tantalum. The supply input is decoupled by C1 and RFC1. C1 is a 10 uF electrolytic. RFC1 is a 9.5 mm long F8 material ferrite bead, 4 mm in diameter, slipped over a 22 mm length of tinned copper wire. The gauge of wire is largely immaterial. Anything between 18 B & S and 22 B & S is quite satisfactory.

The diode switching requires a total of ten diodes. These may be 1N914 (1N4148) or 1N916 types, although these were found to be only barely adequate for the job. They do get quite hot to the touch after only a few minutes operation. More suitable types would be the Philips type BAX13, or even better still — BAV10. These latter ones are recommended. Despite the heating problem, no failures have been experienced with 1N914 diodes. However, if you have a predilection for holding long 'overs', then use the recommended types for added safety. Absolute minimum lead length possible must be used when soldering them into position.

The input and output tuned circuits, consisting of L1-C4-C5 and L2-C6-C7 respectively, are designed to match the transistor base input and collector output impedances, at the required input and output power levels, to about 50 ohms. C5-C4 and C7-C6 form capacitive dividers. From the table included with Fig 1, it is obvious that

the transistor impedances vary with power level. Thus the amplifier should be tuned up at the power level at which it is intended to be used. There is sufficient range in the tuning capacitors to accommodate a range of input power levels.

The 2N6084 is encased in an MT-72 stripline package, having two emitter leads. The collector lead has one corner removed — see the illustration of the package in Fig 3. The collector lead is also marked by a dot on the header as can be seen in Fig 4 & 6. The threaded stud is electrically isolated from the transistor leads. This sort of package construction reduces lead inductance and allows the stud to be bolted directly in contact with a heatsink for maximum heat transfer. The 2N6084 is manufactured by both Motorola and Solid State Scientific (SSS).

HEATSINK REQUIREMENTS

A heatsink is required to dissipate at least 45 watts of heat with a low temperature rise. As operation is of an intermittent nature, with relatively long intervals between on periods, heatsinks requirements can be relaxed somewhat. A 150 mm length of 100 mm wide heatsink having fins on one side only (fins about 25 mm deep) as can be seen in Fig 4, was found to be quite adequate. A diecast box having dimensions somewhat larger than the pc board could be used but its heat-sinking properties would be barely adequate and amplifier on times would have to be kept short. A proper heatsink is recommended. The heatsink illustrated was obtained un-anodised. A black anodised heatsink would certainly do a better job. However, it is

good practice to sand off the anodising in the immediate vicinity of the transistor stud, where it contacts the heatsinks.

POWER OUTPUT INDICATION

It is handy to be able to monitor power output, or at least have some indication of RF output. Some published RF power amplifier designs have included a stripline directional coupler (SWR indicator) on the pc board. This idea was rejected for a number of reasons. If you want to measure SWR it is best done at the antenna, not at the transmitter. All the best texts will tell you this. As an output indicating device it needs to be properly calibrated if you wish to read output power — a measurement normally carried out at rare intervals. It is also wasteful of space, and increases the cost of the project. A simple half-wave diode detector, capacitively coupled to the output connection with a very low value capacitor and a suitable meter is quite adequate. The meter may be remotely mounted.

CONSTRUCTION

The amplifier is constructed on a single-sided printed circuit board, 120 mm long by 58 mm wide, the board layout being given in Fig 5. The component layout is illustrated in Fig. 6, and one can get a good idea of the component layout also from Fig. 4. Note that all the components are mounted on the *copper side* of the board, contrary to common practice adopted with most other circuits constructed on pc board.

If you have facilities for making your own pc board, construction should commence by first making the board. Although the board is of very simple design, it should preferably be made by one of the etching processes. Do not attempt to make the pc board by cutting away the unrequired copper. This usually results in: (a) board that looks grotty and, (b) a project that either does not work at all or does not work satisfactorily.

Boards should soon be available from suppliers if you wish to purchase one.

Commence by drilling the transistor mounting hole in the pc board using a 9.5 mm (3/8") drill. File it out slightly with a small round file so that the transistor header is a loose fit through the board. Next drill the two mounting holes, which are positioned diagonally opposite each other either side of the transistor, and the 1000 pF feedthrough capacitor mounting hole. Use a 3.2 mm (1/8") diameter drill. A clearance hole of about 4.5 mm to 5 mm diameter (3/16") will need to be drilled in the heatsink beneath the position of this capacitor.

Booster amplifier for 2 metre band

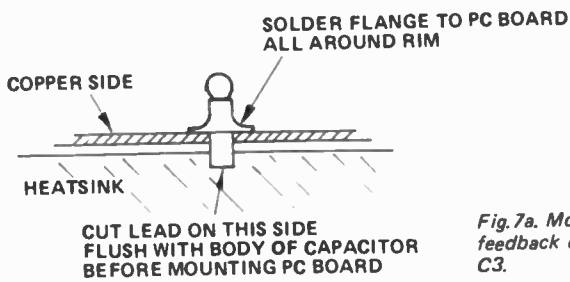

Fig. 7a. Mounting feedback capacitor C3.

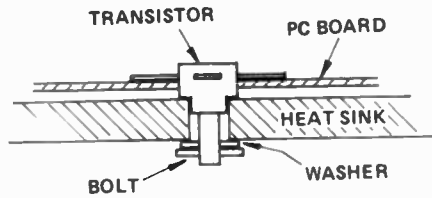

Fig. 7b. How the 2N6084 is mounted.

Now place the pc board centrally over the heatsink to be used and mark the positions of the transistor mounting hole, the feedthrough capacitor clearance hole, and the two mounting holes. Drill the heatsink using a 4.5 mm drill (3/16") as this is a good clearance size for the American 4-40 threaded stud on the 2N6084. Then drill clearance holes in the heatsink for the mounting bolts and the feedthrough capacitor.

Once the pc board and heatsink have been drilled and the hole positions checked to see that everything fits correctly without strain, the pc board may be wired.

Commence by mounting the mica compression trimmers, C4, C5, C6, C7. Refer to the layout in Fig. 6. The trimmer capacitors are constructed with large lugs, formed of the capacitor plates, that project more or less straight down from the ceramic body of the component. Carefully bend the end of each lug out at right angles before soldering the capacitor in place. Use a hot soldering iron with a large tip and solder rapidly, making sure that the solder is adequately melted to ensure proper wetting of the joint. It is advantageous to lightly tin the lugs before soldering. A temperature-controlled iron, such as the Weller, with an appropriate tip, is recommended.

Next slip a 22 mm or 25 mm length of 20 or 22 gauge B & S tinned copper wire through the Neosid type 159 x 059 x 375/F8 RF bead, making RFC1, and solder it into place as shown in Fig. 6. Now mount C1, C2 and C3. Cut the lead of the feedthrough capacitor (C3) flush with the body of the component on the back (heatsink) side of the board, as shown in Fig. 7.

When mounting C1 and C2 ensure that the proper polarity is observed. If C2 is connected in reverse it goes up in flames when the power is applied. It may damage C1 as well.

Mount all the switching diodes using an absolute minimum of lead length. Check that they are correctly oriented.

Before mounting the 2N6084, cut the base and collector leads to about 6 mm (1/4") length. This should be done with care so as not to damage the rather soft leads. A pair of sharp, ordinary household scissors is a good tool for the job. On the premise that what people don't know won't hurt them, turn your back when you do this little job or else do it at some suitable hour in the dead of night so that the prime user/owner of the scissors doesn't see what you are doing. It avoids complications such as black eyes and minor stab wounds. Reasoned arguments such as the softness of the metal tend to go unheeded.

Straighten the leads carefully if necessary, so that they run straight out from the transistor header without any kinks. Place the transistor on the board and see that the leads sit flush on the board right up to the transistor header. Orient the transistor as shown in Fig 6. Carefully solder it into position, flowing the solder near to the 2N6084 case. Use a hot iron and ensure that proper wetting of the joints occurs.

Next wind RFC2 and RFC3. RFC2 requires a length of 22 gauge B & S tinned copper wire about 100 mm long. Thread it through the six-hole Philips ferrite bead five times. Solder it into position from the base of the transistor to the ground plane as shown in Fig 6. Keep the leads short. RFC3 requires a 100 mm length of 18 or 20 gauge B & S tinned copper (enamelled copper wire is also suitable). Wind five turns around the shank of a 6 mm (1/4") diameter drill or other suitable former and then slip it off. Cut the leads to a suitable length, 5 mm to 7 mm is adequate, and then stretch the coil to a length of about 12 mm. Solder one end to the collector of the 2N6084 and the other end to the top terminal of the feedthrough capacitor, C3. Solder a short link of hookup wire from this terminal to the rectangular pad nearest C3, see Fig 7.

The pc. board may now be mounted in position on the heatsink. Apply a little silicone grease or heatconducting compound such as Bevaloid GS-13 to the transistor stud where it contacts the heatsink. Bolt the transistor down first. Carefully orient the mounting holes beforehand. Now slip a suitable-sized nut or fibre washer under the pc board mounting holes. Either should be a close fit between the pc board and the heatsink so that no upward or downward strain is placed on the transistor leads. Any upward strain may cause the cap to pop off — an inconvenience rather than a disaster, as it can be glued back on with a quick-setting glue such as 'Bondza' or 'Super 5000' without any apparent ill effect. Extreme care must be exercised

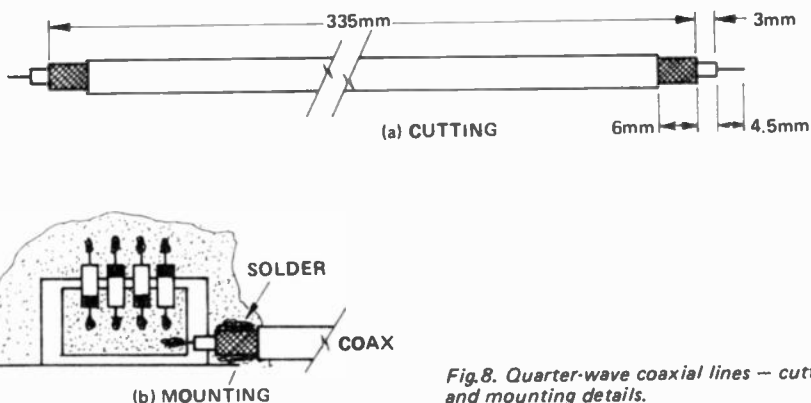

Fig. 8. Quarter-wave coaxial lines — cutting and mounting details.

in doing this though. Not a recommended procedure, but possible. Any downward strain can cause the transistor leads to 'tear' at the header. This sort of damage is very difficult to repair.

The quarter-wave coax lines may now be installed. Cut two lengths to the dimensions shown in Fig 8. Solder the lines into position as illustrated, being careful not to damage the centre conductor or insulation. Use a hot iron and solder quickly. The braid at each end is best tinned beforehand. Alternatively, wrap it with a length of light gauge (say 22 B & S) tinned copper wire and tin the lot before attaching the line to the p.c. board.

The coax lines may be coiled and tied up as shown in Fig 4 or they may be wrapped conveniently in any position around the inside of any cabinet or case the amplifier may be mounted inside.

Finally, the input and output connections can be made via short lengths of coax to convenient coax sockets. As individual constructors will have different requirements in this regard, it is best left as an individual decision. Sockets that are compatible with the existing installation are best used.

The power supply leads will need to be rated to carry currents up to six amps. Any connectors will need to be adequately rated to carry these currents. As the amplifier is completely stable with no drive, and does not draw any current, it is not necessary to switch the 12 volt supply rail, except perhaps as a precaution, and this may be routed via a complete installation supply switch.

TUNE UP

Tune up is quite simple. You will need a dummy load of adequate rating and either an in-line power meter of reasonable accuracy or some power output indicating device. A power supply that can deliver up to six amps at 14 volts (maximum) is necessary. An ammeter that can read up to at least six amps would be handy also.

After carefully checking the construction, apply a supply voltage of between 12 and 14 volts. Check that no current is drawn by the amplifier.

With the dummy load connected and the driving transceiver or transmitter, apply a drive of between 5 W and 12 W, preferably the lower power. Tune the input trimmers for a peak in the output power indication. Do not hold the drive on too long with the amplifier in this condition. Next, apply drive again and tune the two output trimmers for a maximum in output indication.

Now, with the maximum drive power to be used, touch up all the trimmers for maximum power output.

Maximum collector dissipation should be kept under 80 watts. Also see that the maximum continuous collector current of six amps is not exceeded.

PERFORMANCE

At a supply voltage of close to 13 volts and a drive level of between 7 to 8 watts, a power output of 42 watts was obtained from the prototype. This is a gain of around 7 dB. The manufacturers of the 2N6084 specify a minimum gain of 4.5

dB at 175 MHz. However, one could expect a somewhat higher minimum gain at 146 MHz. An efficiency in excess of 55% is readily obtainable. ●

PROTECT YOUR MAGAZINES ETI BINDERS hold 12 copies

electronics
TODAY
INTERNATIONAL

Send \$4.50 plus 80c postage
NSW & A.C.T., \$1.50 postage
elsewhere with order to

Subscription Department,
Modern Magazines (Holdings) Ltd.,
15 Boundary Street,
Rushcutters Bay, 2011.

ORGAN

ELECTRONIC EXPERT

Invited if interested to form
new company with overseas
backing. Ring Melbourne
288-7899 B.H. or 277-5696
A.H. before 5th April.

COLOUR TV GUIDE

BUYING

*Why Pal
What size
Buy or Rent*

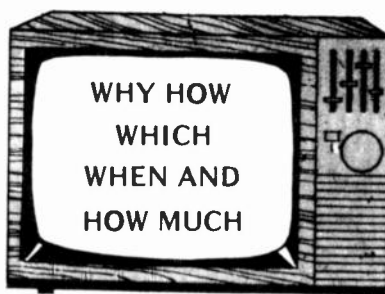

RENTING

*Local or Import
Installing your set
Problems Problems*

PLUS — chance to win a magnificent HMV colour T.V.



ALL IN COLOR TV GUIDE — ON SALE NOW.

Obtainable from most newsagents \$1.00 or send \$1.40 (to cover pack. & post.) to Subscriptions Department MODERN MAGAZINES (HOLDINGS) LIMITED, Third Floor, Ryrie House, 15 Boundary Street, Rushcutters Bay, N.S.W. 2011.

Extracts from an address by
Mr. E. Nakamichi, President
Nakamichi Research Inc. at a recent
Seminar in Sydney for Nakamichi
dealers.

"Chromium Dioxide tape is not
recommended for use with any
Nakamichi tape decks."

"The wear on recording heads is
significantly reduced by using TDK
Super Avilyn as compared with any
Chromium Dioxide tape."

"TDK Super Avilyn Cassettes are
recommended for use with all
Nakamichi tape decks. Before leaving
our factory, all Nakamichi equipment
has bias voltages set for TDK SA to
achieve optimum performance".

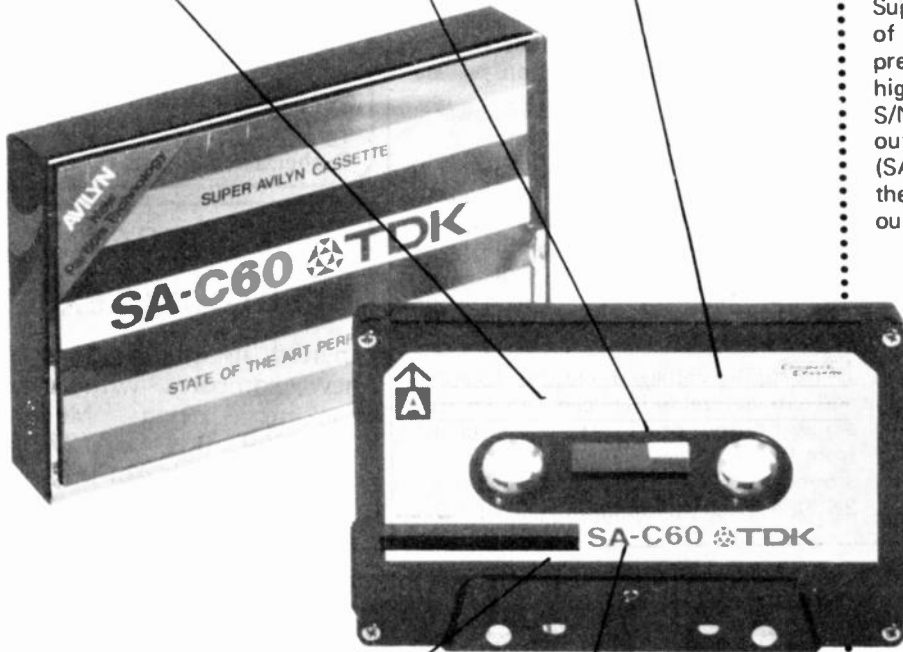

From the report by Louis A. Challis
& Associates Pty Ltd. Consulting
Acoustical & Vibration Engineers,
NATA laboratory.

"TDK Super Avilyn Tape looks like
being one of the most important
advances in tape formulations in the
mid-seventies"

TDK SA breakthrough in tape technology

Super Avilyn's performance exceeds that of Chromium Dioxide formulation which previously was the best choice for linear high frequency response and high-end S/N, but CrO₂ suffered from reduced output in the middle and low frequencies (SA provides 1.5-2db more output than the best CrO₂ in those ranges, equal output at high frequency).

SA also outperforms the ferric oxide tapes (regular or cobalt energized) which are unable to take full advantage of the noise reduction benefits of the CrO₂ equalization because their high end saturation characteristics are not compatible with this standard (they require 1EC 120ms, normal or high EQ).

The net result of SA's characteristics and this EQ difference is a tape with an impressive 4.5db S/N gain over the latest top-ranked high output ferric oxide tapes and more than 10-12 db S/N gain over many so-called low noise ferric oxide tapes.



TDK

Australian Distributor
Convoy International Pty. Ltd.
4 Dowling Street,
Woolloomooloo 2011 358 2088

NATIONAL RADIO SUPPLIES

332 Parramatta Road Stanmore 2048 Ph. 567398.

STEREO RADIOGRAM
FM-AM - 3 piece

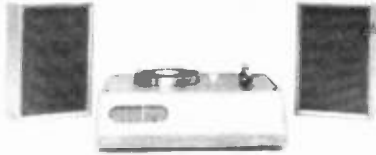

**SPECIAL
AT
\$49.00**

ELECTRONIC CLOCK RADIO

AM-FM with alarm-seconds-snooze-sleep control.



**SPECIAL
\$40.00**

AUTO EJECT CASSETTE CAR STEREO

- 4-IC Circuit
- Fast Forward & Fast Rewind
- Auto Eject
- Indicator Light
- Separate Tone, Volume & Balance Controls
- 9 Watts Output

Four Star - 12 mths Warranty



\$69.00 with Speakers

BASF TAPES

C 60 LHSM	\$1.80
C 90 LHSM	\$2.00
C 120 LHSM	\$2.80

SPECIAL

Yokes 110° Philips
few at \$8.50
3101 EHT \$9.00

VALVES GALORE

- Cheaper than ever.

6X9 - \$1.20	6SN7 - \$1.00
6U9 - \$1.20	6IN8 - \$1.30
IS2 - \$1.00	6AL3 - \$1.15
6BL8 - \$1.00	6DX8 - \$1.20
6BM8 - \$1.00	6U7 - 30c
6Y9 - \$1.50	6GW8 - \$1.10
	807 - 80c
	6BM8 - \$1.10
	6K8 - \$1.00

POWER PACKS

240V - 6-9V
300ma - \$6.90
Suitable for radio,
calculator, etc.
Eliminates battery
costs.

PACK SPECIALS AT LAST YEARS PRICES

SPECIAL
C60 LHSM \$1.80
C90 LHSM \$2.00
C120 LHSM \$2.80

POLYESTER PACK
Mixed 50 at \$2.00

CERAMIC CONDENSOR PACK
100 for \$2.50

RESISTOR WIRE-WOUND PACK
50 for \$5.00 - 3 & 5 & 10 watt

MICA PACKS
50 for \$3.00 - 20 for \$1.80

POTENTIOMETER PACK
20 for \$2.50

**DOUBLE POTENTIOMETER
PACK**
10 for \$4.00

RESISTOR PACK
100 for \$1.50

7 Transistor RADIO SPECIAL
with speaker and printed board.
Ready to go.
Only \$4.50

STEREO FM-AM TUNER
FM 88 - 105 MC
Complete in wood case
\$62.00

ELECTRIC CAR AERIAL
Complete, ready for installation.
\$18.00

T.V. BALUN
300 ohms to 75 ohms 80c ea.

TRANSISTOR SPECIALS
MJ3055 eqv. 2N3055
60c ea. or 10 for \$5.00

TRANSISTOR SPECIALS
BC147, BC148, BC149
10 mixed for \$1.20

BRIDGE RECTIFIER
3.8 AMP 100v \$1.80
25 AMP 200v \$3.50

BATTERY ALLIGATOR CLIPS
Heavy Duty 50 AMP
10 for \$5.00

SPEAKER TRANSFORMERS
10k - 3.5 ohms - 7k - 15 ohms
\$1.20 ea. or 10 for \$10.00

VIBRATORS
6v 5211 A.W.A.
still only \$1.00 each.

PLEASE INCLUDE 20% OF ORDER TO COVER POSTAGE & PACKING. C.O.D. IF NEEDED. ALL EXCESS POSTAGE REFUNDED.



**At 'Eveready' we put our energy
into making batteries better.**



'Eveready' and 'Union Carbide' are registered Trade Marks.

C.E.C. has a turntable to turn YOU on...



BD1000

the ideal system starter BD1000 complete with EMPIRE 2000E cartridge

- Wow and flutter less than 0.12%.
- Rumble better than 40DB.
- Complete in fully imported base and cover.

Frequency response 10HZ to 30KHZ tracking 1 to 3GM.



BD7000

for the audiophile BD 7000

- DC Hall motor—Servo controlled.
- Built-in strobe light.
- Fine speed adjustment.
- Auto or manual operation.
- Wow and flutter less than .04% (WRMS).
- Signal to noise ratio 65DB (DINB).
- Tracking weight 0.25 to 3GM.
- J-shaped tone arm with hydraulic cueing.
- Magnificent, fully imported base and cover.
The BD7000 is supplied without cartridge.

The  turntable range includes the semi-automatic BA300 and fully automatic BA600. One of the four models is right for you. All have the famous C.E.C. 5-YEAR WARRANTY.



 harman australia pty ltd
271 Harbord Road, Brookvale, Tel 939 29 22
PO Box 6, Brookvale NSW 2100

Tone arm damping

Dramatically improve your stereo sound for less than \$5.00! by James Brinton

A PROPERLY DAMPED tone arm and cartridge, compared with an otherwise identical combination, has many advantages. These include better tracking of warped records, cleaner reproduction of low-frequency information, greater immunity to shock and vibration, reduced high-frequency playback distortion, and — particularly with some of today's very-high-compliance phono cartridges — a dramatically solidified stereo image. In addition, because damping reduces or nearly eliminates the subsonic resonances characteristic of most arm-cartridge combinations, the once irksome task of matching an arm to a cartridge becomes simpler.

Damping appears under several labels. Pivot damping and viscous damping generally mean the same thing. There also is a related approach called "counterweight decoupling," which is far more common than viscous damping.

Early examples of damped arms are the 1960-vintage Weathers and ESL models; the Weathers unit (now reincarnated by Win Laboratories) was viscously damped while the ESL used a decoupled counterweight.

Today, a list of damped tone arms includes British designs like the Decca, the KMAL, and the Audio and Design arms — all with viscous damping in one form or another. Arms with decoupled counterweights are widely available today on record changers and single-play units (Dual and Lenco, for example, have applied the idea with considerable success), and separate

arms with this form of damping include the SME, the Audio-Technica, and the Connoisseur.

This is far from a complete list, since damping isn't one of those characteristics raved about in advertisements. Even if the engineering department realizes its value, the fact that damping is part of a design often gets lost somewhere in sales and advertising. Thus, a feature that might help sell a tone arm can become a well-kept secret!

There is, to the sales-oriented executive or retailer, a rationale for ignoring viscous damping. It can be difficult to manage in shipment; perhaps worse, the inexpert audiophile might mistake the "feel" of an arm with viscous damping for that of one with high mass or friction, with the possible result being a lost sale.

HOW ARM DAMPING WORKS

Because counterweight decoupling is easier to manage in the factory, during shipment, and in the store, it is employed more often than viscous damping. It usually consists of a flexible coupling between the counterweight and the body of a tone arm — perhaps a sleeve or rod or doughnut of rubber or plastic. This allows the arm and the counterweight to vibrate independently to some extent. In practice, with a simple decoupled counterweight, an arm-cartridge combination will have two lower-amplitude resonant peaks instead of the single higher-amplitude peak that would have appeared

without decoupling. So decoupling ameliorates, but does not fully eliminate, the problem of subsonic resonances.

Harder to implement, and less convenient for maker and retailer, viscous damping can do a much more thorough job of solving the resonance problem. In its simplest form, viscous damping, or pivot damping, consists of a drop or two of very thick fluid — heavy petroleum or one of the ubiquitous silicones perhaps — placed in the tone arm's bearings. The fluid serves two purposes: First, it reduces whatever friction there is in the pivot; and second, it drastically reduces the effect of sudden or large movements on the motion of the arm. But the smaller, slower movements necessary for accurate tracking even of warped records are not interfered with. This selectivity is pivot damping's most desirable feature. Shock, vibration, and resonances are damped out quickly; the desirable arm movements actually become smoother and less encumbered by friction.

Thus, viscous damping has the same relationship to the vibrations and movements of your tone arm that shock absorbers do to those of your automobile.

Anything mechanical vibrates. Obviously, if the tone arm vibrates while you are playing a record, the vibration is going to be coupled to the stylus cantilever of the phono cartridge. Think of the stylus tip as analogous to a wheel on an automobile and the semi-elastic cantilever suspension as an automobile spring. Shock can be transmitted both from the road to the auto body and from the body to the wheel via the spring.

Any stylus cantilever motion not due to groove modulations is — or becomes — distortion in the cartridge's output. The cartridge, after all, can't be expected to tell the difference between motion caused by the groove and that caused by the movements of the arm alone. Now while it is just about impossible to keep a mechanical system like an arm and cartridge assembly from vibrating, viscous damping can be used not only to keep the level of the vibration low, but also to make the arm-cartridge system stop vibrating sooner than it ordinarily

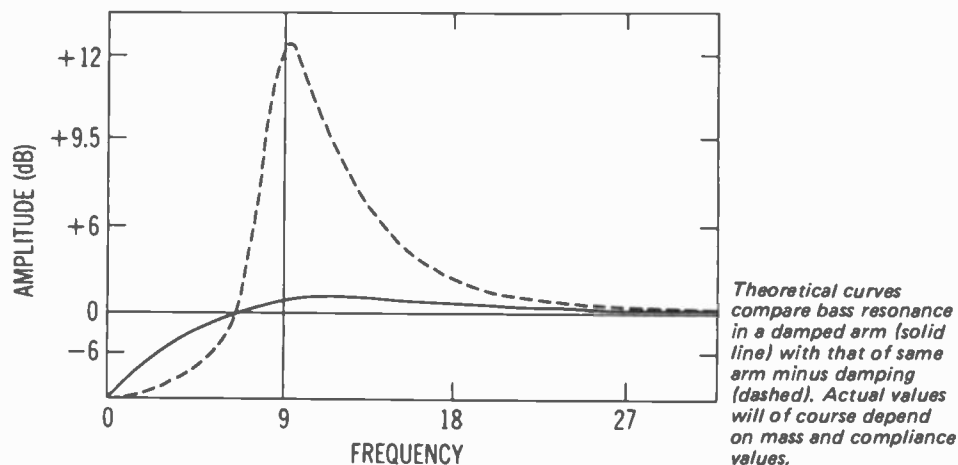

would have. With today's very-low-friction arms, this is important.

When an arm-cartridge combination is "excited" into vibration by acoustical feedback, a warp, or a shock, it continues to move up and down for from side to side about its pivots at its resonant frequency — say, anywhere from about 15 Hz down, depending on the cartridge used, the mass of the arm, and other factors. The length of time it will continue bouncing will be inversely related to pivot friction. With current low-friction designs, a single shock can engender movements that might take minutes to die away naturally. Something else is needed, like a shock absorber, to stop the bounce quickly. Viscous damping does the job. Because it does, the cartridge will convert far less of the arm's movement into unwanted electrical output. And that means less distortion.

SOME PRACTICAL TESTS

How important is this? After all, you can't hear "sounds" below 20 Hz. True, but you can hear their effects — and enjoy their absence.

Recently the USA's Boston Audio Society, with the guidance and encouragement of Dr. S. L. Phoenix of Cornell University's Department of Mechanical Engineering, has been experimenting with viscous damping. The results have been exciting. Usually damping was added to existing tone arms, since it is a rare audiophile who has enough know-how to build his own arm. This was a sometimes sticky job (see the box for do-it-yourselfers), but the payoffs often were dramatic.

Some members of the group had experienced difficulties using the ADC XLM cartridge, for example. The cartridge got rave reviews and turned into something of an audio cult symbol. But its users had found that in some arms it could bottom out on warps, mistrack, or otherwise disappoint. With the tone arm damped, however, the XLM sailed unperturbed over warps and traced grooves with less distortion than ever.

Similarly, some members had complained that the Shure V-15 Type III (which also has plenty of admirers so appreciative as to represent something of a cult) produced "a somewhat vague stereo image." Directionality and placement of instruments weren't as sharp as with some other cartridges, they had felt. But when it was mounted in a damped tone arm, the Shure gave what its users now felt was near-pinpoint localization.

DO-IT-YOURSELF TONE-ARM DAMPING

If you are the adventurous sort — and handy — you can duplicate the experiments mentioned in the body of this article. They involve little investment in either time or money and can pay large dividends in improved phono reproduction.

Although several approaches were tried, the easiest to manage is the one described here. Not only is it simple to apply, but it also allows the user to vary the amount of damping and thus approach the optimum amount for his arm and cartridge. It was developed by Robert Graham of the MIT-Lincoln Laboratory.

The parts required are a nylon clamp, a nylon nut and bolt some stiff brass wire, and a small amount of brass sheet stock. Lighter metal could be used and would, in fact, be preferable. Also necessary is a small trough — say, 25 mm in both depth and width and about 60 mm long — capable of holding about half a cup of STP motor-oil additive. (Obtainable from most garages.)

The figure shows how these elements go together to form a tone-arm "damper". Note that the amount of damping can be varied by pushing the clamp closer to, or farther away from, the arm's pivots. In practice, the distance of the damping paddle from the pivots will be decided by the space between the turntable and the arm's vertical shaft; the paddle must move freely with the arm so it tracks to the inner grooves of a record — it shouldn't touch anything but the STP damping fluid.

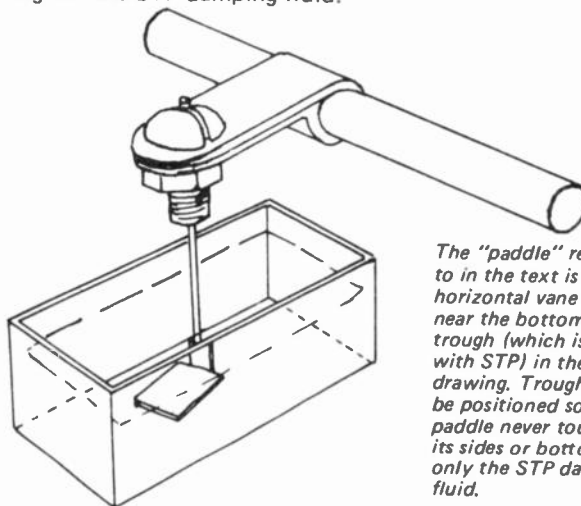

The "paddle" referred to in the text is the horizontal vane visible near the bottom of the trough (which is filled with STP) in the drawing. Trough must be positioned so that paddle never touches its sides or bottom — only the STP damping fluid.

Horizontal damping appears to be a bit less critical than vertical damping, so begin your experiments by epoxying a paddle at right angles to the wire and making it about ½ inch square. Attach the damping assembly to your arm and — carefully — pour the STP in the trough, covering the paddle. Leave room below the lip of the trough so that the fluid won't lap over when you move the arm. (This is the messy part of homemade damping; but if you don't spill, you won't have to clean up. STP, is astonishingly 'sticky'. Try to avoid touching it — it's safe enough but very hard to wash off).

Now check for improved tracking of warped discs; with near optimum damping, no movement of the stylus cantilever should be visible. The stylus cantilever and the cartridge body should appear to move as a unit. Increase or decrease the paddle area until you achieve this condition. If you have a set of test records, you might go further and optimize the paddle area for best low-frequency tracking or square-wave response.

Chances are that you will slightly over- or under-damp your arm, but your approximation will be close enough. After obtaining the correct amount of horizontal damping, add a vertical paddle and experiment with it until there is as little side-to-side cantilever movement as possible when playing warped or off-centre records.

If all this seems a little bit *ad hoc*, bear in mind that it will give good results cheaply. But be warned: The experiment may convert you to an avid arm-damping enthusiast (as, obviously, it did me). — J.B.

Isn't it nice to know that someone still makes Hi-Fi like this?

You'll find that Lux units usually perform rather better than their printed specifications. For instance if we claimed our amplifiers could do 100 mph it wouldn't be downhill with the wind behind us. Our specifications are minimum standards and the goal is always ultimate performance. With Lux you're liable to get a little more than you bargained for.



LUX 309, 308

To Lux, sound is not only a science, but an art. That's why the company conducts tests not only with engineers, but with musicians in different fields to ensure that Lux amplifiers sound best, apart from what looks good in brochures.

Consider: the precise tonal balance with LUX's exclusive, and the world's first, linear equalizer. A dual rail power supply system that ensures a clear,

tight bass response down to 5Hz with absolute control of speakers. A differential input, fully complementary direct coupled power amplifier that offers you a genuine 75W x 2 RMS into 8 ohms. Main amp and preamp distortion below 0.03%, frequency response 10-50,000Hz.

And above all, the Lux 'ultimate fidelity' — the quality of sound that must be heard to be believed!



**Hear L 308, L 309, and AM/FM STEREO RECEIVER R800
(40 + 40 watts, 8 ohms) at the addresses below—an experience
in living sound that will thrill you!**

Distributed in Australia by:

INTERDOWN

INTERNATIONAL DYNAMICS
(AGENCIES) PTY. LTD.
23 Elma Rd., North Cheltenham,
Melbourne, Victoria 3192

Available from:
A.C.T. Duratone Hi Fi, Cnr. Botany St & Aitree Crt, Phillip 2606. Telephone: 82-1388.
N.S.W. M & G. Hoskins Pty. Ltd, 400 Kent St., Sydney 2000. Telephone: 546-1464, 547-1093.
O.L.D. Stereo Supplies, 95 Turbot St, Brisbane 4000, Telephone 21-3623. S.A. Challenge Hi Fi Stereo, 96 Pirie St, Adelaide 5000, Telephone: 223-3599 T.A.S. Audio Wholesalers 9 Wilson St, Burnie 7320, Telephone 31-4111. VIC. Encel Electronics Pty Ltd, 431 Bridge Rd, Richmond 3121, Telephone 42-3782. W.A. Arena Distributors, 282 Hay St, Perth 6000 Telephone: 25-2699.

tone arm damping

There were other experiences with other cartridges. Some experimenters reported cleaner, tighter bass reproduction. Some appeared to suffer less preamplifier overload in critical pickup-input combinations. A few reported no striking difference in performance, but almost all of these either had outdated tone arms with high mass or friction, or were using low-compliance phono cartridges.

The most demanding audiophiles — those with the most advanced arms and most compliant cartridges — noticed the most improvement. Could it be that the better the record-playing equipment, the greater the need for damping?

There was another side to these admittedly informal tests. Some of the group used good cartridges in marginal arms, added damping, and noticed improved performance. Does this make damping a cure for so-so tone-arm design? No, but it might indicate that the movement of the past few years toward ever lower masses and friction may have reached a point of diminishing returns: Some resistance to arm motion may be desirable.

But why did things sound different? The group still is trying to answer this to its satisfaction, but there are some pretty fair guesses.

There are no absolutely flat records; arms and cartridges are continually being forced into resonance by nearly invisible warps. Higher-quality arms and cartridges, especially, respond readily to them. And there is no such thing as perfect acoustic isolation for any record player. Again the result is resonant vibration, this time triggered by shock, room vibration, and acoustic feedback.

Just getting these resonance products out of the cartridge's output should have cleaned up the sound, and seemingly did. After all, there was now less subsonic material and consequently less audible intermodulation between the resonances, their harmonics, and the music.

This freedom from subsonics may be especially important to owners of some super-preamps with response reaching almost to dc. Unless they are removed by damping, or filtered out electronically, signals due to arm-cartridge resonances not only could enter the preamp at levels several times as high as midrange musical signals, but also could be boosted by as much as 60 dB by RIAA equalization that (incorrectly) continues its rising bass characteristic

into the subsonic region. Some of the better preamps offer a switchable subsonic filter as a preventive for the severe overloading that resonance-rumble interaction can cause in phono preamp stages — even those that have plenty of headroom at higher frequencies. (A subsonic filter project was published in *Electronics Today*, October 1974.)

There are other, less obvious payoffs, some still being explored, such as damping's effect on tracking-force variations. Among the advantages that may emerge is reduced record wear due to the suppression of instantaneous tracking-force extremes.

Like other electromagnetic transducers, a magnetic phono cartridge has a region of best performance — its so-called linear region — within which it accurately transforms the movements of its stylus cantilever into an electronic equivalent of the groove modulations. Tracking forces are specified not only to assure decent groove tracing, but also to place the stylus cantilever in about the centre of its linear range of motion (that is, of vertical flexing) with respect to the cartridge body. But tracking force is a static specification, and record playing is a dynamic situation; when a rising warp is encountered the effective tracking force will be increased as the arm is forced upward and/or the cantilever spring flexed toward the cartridge body. As the record surface descends, the effect is reversed. Thus begins the so-called pogo-stick effect that, particularly in an undamped arm, can cause continuing variations in instantaneous tracking force and even make the stylus hop out of the groove altogether.

Incorrect tracking force, whether it is too low or too high, momentarily moves the cantilever out of its optimum location. Either way, tracing suffers. There may be repeated, even if momentary, losses of contact with either or both groove walls and repeated instants at which tracking force exceeds the bearing strength of the groove walls. And the angular flexing of the cantilever will produce what is aptly known as "warp wow" — a change in relative stylus-groove velocity and hence a waver in the music's pitch. With damping, this sort of abuse seems to be greatly reduced because the stylus more consistently is in good contact with the groove walls and its cantilever less often is deflected outside its optimum range of movement.

One listener felt that, simply because

the stylus no longer was being subjected to as much unwanted movement at resonant frequencies, the effect was as if someone had stopped fiddling with his system's volume and balance controls. It was, to him, similar to switching from a turntable with flutter to one without — only the difference was not in pitch, but in space. The feeling of "uncertainty" was gone.

Another reason for apparently cleaner sound may be that, because of improved tracing, there is less of the high-frequency "chatter" usually caused by the stylus rattling about in the groove. Although mostly above 20 kHz, this chatter could be indirectly responsible for some audible distortion.

On the basis of these experiments then, the desirable properties of arm damping seem amply confirmed. But, like most techniques, it can be abused. Too much damping, for example, can make a tone arm respond arthritically to warps and shocks and (though it might make for a nearly nonresonant arm-cartridge combination) reintroduces excessive cantilever flexing and hence some tracking problems. It's a question of finding optimum values.

In practice, the buyer of a damped tone arm needn't worry about overdamping. The arm designers have taken the problem into account and generally will have picked an amount of damping that will fill the needs of a wide variety of cartridges. The arm may overdamp or underdamp slightly without causing problems, while still obtaining nearly all of damping's advantages.

If there's no viscous-damped arm available for your particular needs, you can compromise by selecting one of the many good designs using counterweight decoupling. But bear in mind that, while decoupling lessens resonance difficulties, it may not be as complete a solution as viscous damping.

This article has been adapted from material originally published in the July 1975 issue of the US magazine 'High Fidelity'. It is reproduced here by permission of the publishers — ABC Leisure Magazines.

FANE 100w LOUDSPEAKERS

PUBLIC ADDRESS & MUSICAL INSTRUMENT RANGE



20% OFF!

Fane P.A. and Musical Instrument loudspeakers from England are great value at their normal advertised prices, but now we are offering a special stock clearance at prices never to be repeated again. This offer will last until stocks are cleared — but hurry, we have only a couple of hundred in stock. Models subject to this special offer are as follows:

● POP 100 18" bass ● 100 watt r.m.s. power handling ● fundamental resonance 55 Hz ● 3" voice coil diameter, 14,000 gauss magnet.

Normal price \$79

WITH 20% DISCOUNT **\$63.20!**

● CRESCENDO 12" 12A ● full-range 100 watt r.m.s. power handling ● fundamental resonance 70 Hz ● 2" voice coil diameter, 20,000 Gauss magnet ● Very high efficiency.

Normal price \$79

WITH 20% DISCOUNT **\$63.20!**

● CRESCENDO 15" 15/100 Bass ● 100 watt r.m.s. power handling ● fundamental resonance 40 Hz ● 3" voice coil diameter, 15,000 Gauss magnet ● Very high efficiency.

Normal price \$99

WITH 20% DISCOUNT **\$79.20!**

Challenge

HI-FI STEREO PTY LTD

96 PIRIE ST.
ADELAIDE
STH. AUST. 5000
PHONE: 223 3599



**JACOBY
MITCHELL**

**one source for all
your electronic needs**

SNAP-ON METERS

**KEW SNAP 3c
COMPACT, POCKET AC VOLT-AMMETERS**

Volts: 250; Amps: 30
Size: 115 x 70 x 30 mm



\$19.50



\$39

**KEW SNAP 5, 6 SNAP-ON
AC VOLT-OHM SWIVEL CASE
AMMETERS**

5A, Amps: 5/25
5B, Amps: 10/50
5C, Amps: 30/150
5D, Amps: 60/300
Volts: 150/300/600
Size: 115 x 60
x 40 mm



\$54



\$77

**KEW SNAP 8, 9
ROTARY SCALE
SNAP-ON AC VOLT-OHM
AMMETERS**

8-Amps: 6/15/40/
100/300
Volts: 150/300/
600
OHMS: 0/2000
Size: 215 x 70 x
40 mm

9-Amps: 10/30/
100/300/900
Volts: 150/300
/750
OHMS: 0/2000
Size: 230 x 75
x 45 mm

**KEW SNAP 7
ROTARY
SCALE
DC VOLT-
OHM
AMMETERS**

Amps: 30/75/150/
300/600
Volts: 3/30/300
OHMS: 0/2000
Size: 255 x 87
x 40 mm



\$186

**KEW SNAP 10
ROTARY
SCALE
AC VOLT-OHM
AMMETERS**

Amps: 10/30/
100/300/1000
Volts: 150/300/
750
OHMS: 0/2000
Size: 290 x 109
x 47 mm

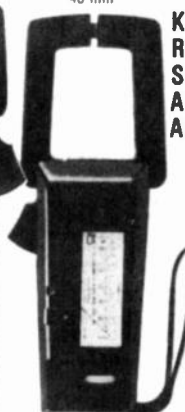

\$92

The full range of KEW Instruments is available from selected radio and electrical wholesalers.

For full information contact Australian Representatives:

Specifications and prices quoted are for general guidance only, are subject to verification and change without notice.



\$87



**KEW MEG
INSULATION TESTER
VOLT & OHM METERS**

Model 510: 500 V/100 M Ω
Model 1000: 1000 V/2000 M Ω
Volts: 0/300
OHMS: 0-2/200 K

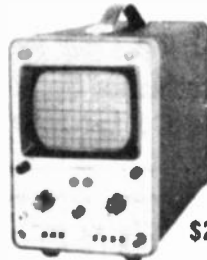

\$260

**558, 5 INCH, 7-5 MHz
OSCILLOSCOPE**

Band width: DC-7.5 MHz
Sensitivity: > 10 mVcm
Single Beam

\$112

**418
SINE AND
SQUARE
WAVES
OSCILLATOR**

Frequency: 10 Hz to 1 MHz, 600 OHMS
Distortion: 0/3% (1 kHz-100 kHz)



**KEW K200
VOM FIELD
EFFECT
TESTER**

Volts: AC/DC, 8 ranges
0-0.3/1000 V
Amps: DC 8 ranges
0-30uA/300uA
OHMS: 7 ranges 1 ohm
500 megohms

\$75

**KEW EARTH
MEG 600 RESISTANCE METER**

Resistance: 0-10/100/1000 Ω
Volts: 0/30



\$114

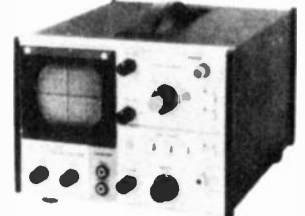

**537, 3 INCH, 5 MHz \$190
OSCILLOSCOPE**

Band width: DC-5 MHz
Sensitivity: > 10 mV/DIV
Single Beam



\$328

**5510, 5 INCH, 10 MHz
OSCILLOSCOPE**

Band width: DC-10 MHz
Sensitivity: 10 mV/cm; Single Beam



**KEW K1200P
ELECTRONIC-
ALLY
OVERLOAD
PROTECTED
MULTIMETER**

DC ACCURACY 2%
Volts: DC, 0-0.25/1/2.5/10/50/250/500/
1000, 20 KOPV
Volts: AC, 0-2.5/10/50/250/500/1000,
5 KOPV
Amps: DC, 0-50uA/1/10/100 mA/10A

**KEW K1400
LARGE SCALE
OVERLOAD
PROTECTED
MULTIMETER**

Volts: DC, 8 ranges,
0 25/5000, 20
KOPV
Volts: AC, 6 ranges
2.5/5000, 50
KOPV
Amps: DC, 6 ranges
50 uA/10A
OHMS: 3 ranges
0.2K/20 megohms



\$72

The Crescent, Kingsgrove, N.S.W. 2208, Phone 50 0111
OFFICES: Melbourne 44 5021 • Adelaide 293 6117
• Brisbane 52 8266 • Perth 72 2696

* ALL PRICES QUOTED INCLUDE SALES TAX,
PACKAGING AND POSTAGE.

Racal makes Sound Sense



Amplivox Headsets.

We'd like to give you some sound advice. For headsets of any kind, look to the specialists . . . Amplivox. World technological leaders in communications headsets. Amplivox offer equipment that meets any environmental situation.



Handheld 3½ Digit Digital Multimeter

This fine meter from Data Technology has all the refinement of elaborate bench models. Check the features, small size lightweight portability, ease of operation full 2000 count, automatic digital readout, battery operated, impact resistant four D.C. voltage ranges, four A.C. voltage ranges, four resistance ranges, four capacitance ranges, solid state construction and simplified calibration.

RACAL
The Electronics Group

Racal Electronics Pty. Ltd.
47 Talavera Rd. North Ryde, 2113.
Tel: 888 6444; Melbourne: 51 9994;
Canberra: 86 1267; Wellington, NZ:
41 608.

AMATEUR KITS

45 W TWO METRE RF AMP!

A simple 2 metre RF amp. kit that really works. Features simple design and diode switching (no relays!), and good power gain — eight to twelve watts gives 35 W to 45 W output from 13.6 V supply. Uses the tried and proven 2N6084 transistor, printed inductors and a fibreglass, tin-plated p.c. board. Straightforward instructions included. Just the thing to boost your 10 watt mobile or base rig to reasonable power output — repeaters notwithstanding! (Heatsink supplied at extra cost of \$2.50) p.c. board only \$2.50. Only . . . \$27.

The LEGAL LIMIT Two metre RF amp!

The ultimate sock-it-to 'em in RF power amplifiers. Uses two CTC BM70-12 transistors. Only 20 W or so will drive this amp to 150 W dc input from a 12.6 V supply. So who needs repeaters? Work the DX direct! Features broadband microstripline design (136 MHz to 174 MHz) — no tuning!, fibreglass tin-plated p.c. board, small size (80 mm x 135 mm, less heatsink), all spurious outputs down 60 dB or better, capable of withstanding infinite VSWR at all phase angles at full power output on 16 V supply. Instructions supplied, but this kit is for experienced constructors only. Available on order only. (Heatsink supplied at extra cost). Superb value at . . . \$130

3-Stage BROADBAND Two Metre RF amp — 40 W

Smaller, simpler and better performance than any other 3-stage kit around. Features 35 W to 45 W output from 200 mW to 500 mW input, broadband microstripline design (136 MHz to 174 MHz) — no tuning this one either!, commercial specifications — all spurious outputs down 60 dB or better, overall efficiency better than 50%, capable of withstanding infinite VSWR at all phase angles on 15.5 V supply. Small size — 122 mm x 67 mm (heatsink a little larger). Coming soon — WATCH FOR ANNOUNCEMENT!

VHF CONVERTERS —

These converter kits are simple, easy to construct and align.
● 28/52 MHz (ETI 707B)

This is a tried and proven design and was featured in the January issue of ELECTRONICS TODAY INTERNATIONAL. Noise figure on 10 m or 6 m is a little meaningless but this converter produces a noise figure of around 2 dB. Gain is 20 dB or greater, bandwidth is 3 MHz on 6m, 2 MHz on 10m, spurious responses — 50 dB or better. Choice of IF frequencies to suit yourself. Please specify 28 MHz or 52 MHz operation. Crystal not supplied. Fibreglass p.c. board. Value at . . . \$11 or just the p.c. board . . . \$3.10

WHEN ORDERING BY MAIL

Don't pay ripoffs on post and packing. The p&p charge for all kits is 60 cents, not including such items as heatsinks for the RF power amps which are optional and will cost more as well as increasing the postal. Please specify if you want a heatsink with the RF power amp kits — we will advise charges. Small orders of components will cost 30 cents p&p, large orders will cost 60 cents. If you wish your order to be registered, please add sufficient to cover the cost.

FROM AMATEUR COMMUNICATIONS ADVANCEMENTS 14 ROSEBERY ST, BALMAIN 2041

● 144 MHz (ETI 707A)

Naturally another simple converter. An original 6UP design, this was also featured in the January 1976 issue of ELECTRONICS TODAY INTERNATIONAL. This converter was designed for low noise (3 dB or better) and low crossmod. performance. Gain is adjustable, with a maximum of about 20 dB. Bandwidth is also adjustable between about 0.5 MHz and more than 1 MHz. Spurious responses are down 50 dB or better. Choice of IF frequencies to suit yourself. No neutralization. Crystal not supplied. Fibreglass p.c. board. What more could you want for . . . \$14 or p.c. board only . . . \$3.50

● 432 MHz (6UP-004)

The famous design by VK5QZ — now a standard of sorts! Improved p.c. board. This is probably the simplest way to begin on the UHF bands. A simple and straightforward design that produces good performance. . . noise figure approx. 4 dB, JFET front end, gain of 10-15 dB, IF of 28 MHz or 52 MHz although some constructors have used 146 MHz successfully for FM net operation. Bandwidth approx. 4 MHz. Fibreglass p.c. board. Crystal not supplied. Complete with straightforward instructions. Head for the frontiers for . . . \$14 or p.c. board only . . . \$3.35

● MARKER (6UP-006)

This provides harmonics to 1296 MHz from a 1 MHz crystal or to 432 MHz from a 100 kHz crystal. Can accept crystals to 15 MHz. Uses 5 transistors. Crystal not supplied. Find the band edge for . . . \$7 or p.c. board only . . . \$2.55

SOLID STATE DEVICES

2N6084 silicon RF power transistor	\$16.00
2N5770 silicon NPN, Hfe = 50, Ft = 900 MHz G.P. RF transistor	25c
2N5485 JFET, 1.5 dB NF @ 200 MHz, 450 MHz top frequency	90c
40841 dual-gate FET, hi gain, low NF top frequency 450 MHz	90c

NEOSID COIL COMPONENTS AND FERRITES

7100 cans, 1/2" x 1/2" x 3/4"	10c
6-pin bases to suit 7100 cans	10c
7300 cans, 1/2" x 3/4" x 1"	12c
8-pin bases to suit 7300 cans takes two formers	11c
722/1 formers, 3/16" dia., (suit above) 9/16" winding length	08c

LAFAYETTE

27MHz TWO-WAY RADIO

FOR INDUSTRY, FARM,
BOATS, SPORTS, ETC.

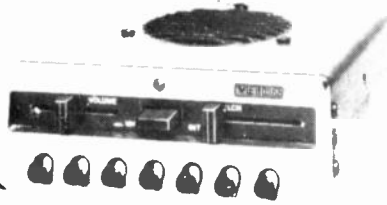

MICRO 66 Only 1-15 16H x 5-3/16W x 6-13/16"D.
5 WATTS
6 CHANNELS **\$139.50** Crystals Extra)

The latest in the famous LAFAYETTE Micro series the MICRO 66 embodies the versatility, reliability and performance which have made LAFAYETTE famous throughout the world in 27MHz communications. With an extra sensitive receiver of better than 1uV for 10dB S-to-N ratio, "Range Boost" modulation circuitry, a built-in speaker plus push button selected external speaker-microphone (supplied), the MICRO 66 is ideal for Boats or Base Station operation. Operates from 12V DC or 240V AC with optional Base Station Power Supply.

5 WATTS 12 CHANNELS
DYNA-COM 12A
\$139.50 (Crystals Extra)

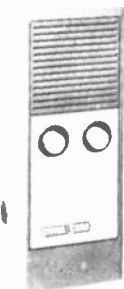

A powerful 5-Watts input power in a hand held Transceiver! Excellent sensitivity and selectivity. Ruggedly designed for extra reliable performance. This high-power walkie-talkie operates from internal batteries (rechargeable Ni-cad batteries available) or an external 12V source.

1 WATT 3 CHANNELS
Model HA-310
\$73.50 (Incl. 27.240MHz)

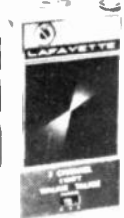

1,000's of LAFAYETTE HA 310 walkie-talkies in use in Australia. 100,000's throughout the world attest to their superior qualities. A professionally designed, sturdily constructed, commercial quality unit for top performance and long term reliability. Rechargeable Ni-cad batteries are available to suit.

All above transceivers are P.M.C. Type Approved (Licence Required)

A LARGE RANGE OF ACCESSORIES IS AVAILABLE. ANTENNAS, CRYSTALS, CONNECTORS, ETC PLEASE ENQUIRE FOR DETAILS.

LAFAYETTE

ELECTRONICS

div. of Electron Tube Distributors P/L
94 ST. KILDA RD., ST. KILDA,
VIC. 3182. Phone 94-6036.

Make Your Own ONE-OFF PRINTED CIRCUIT BOARDS

New, revolutionary, British invention enables the electronics engineer or the hobbyist to produce one-off or prototype p.c.b. layouts to professional standards in an hour or so (depending on complexity).

No special drafting skills or equipment needed.

Accurately shaped etchant-resistant circuit symbol transfers are pressed directly on to copper-clad p.c.b. which can be etched immediately.

Use your own or any published p.c.b. layouts.

Full step-by-step instructions enclosed. These transfers are also suitable for the production of artwork for the quantity production of printed circuit boards.

Each pack contains 10 sheets of transfers which cover all normally required shapes such as, round pads, 0.1" & 0.15" edge connectors, straight lines & bends, tees, 3 & 4 lead transistor, 8, 10, 12 pin T05 I.C. & d.i.l. I.C. pad sets etc. etc.

Separate replacement sheets will be available to purchasers of packs in a few months, so you need only purchase the sheets you use most — not the whole pack.

A pack of 10 sheets @ \$6.98 + 50c P.&P. will enable you to prepare quite a number of small p.c. boards, and remember, you can purchase individual sheets if you run out of a particular symbol.

Act now! Send your cheque or postal order to the sole Australian agent:

ENRITE ELECTRONICS
67 Clarke St., Peakhurst, 2210. N.S.W.

Logan Brae Audio Sales

BLANK TAPES BY MAIL ORDER
New lower prices

HITACHI	less than 12	12 off	36 off
C90	\$1.80 ea.	\$1.70 ea.	\$1.60 ea.
C120	\$2.35	\$2.20	\$2.10
UDC90	\$2.30	\$2.20	\$2.10
UDC120	\$3.10	\$2.90	\$2.70
UDR C60	\$2.30	\$2.20	\$2.10
UDR C90	\$2.90	\$2.75	\$2.60

• Features of the UDR Cassette
Low Distortion, High M.O.L., Low Noise

New "Epitaxial" magnetic material, Gamma-hematite possesses characteristics that display high sensitivity and reliable output in the low and medium-frequency bands, while cobalt-ferrite displays excellent performance in the high-frequency band. By combining both materials into a crystal, Hitachi has created an EPITAXIAL substance.

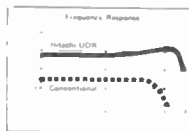

BASF Cr02
C90SM \$2.90 \$2.80 \$2.65
Genac Ultra High Fidelity
UHF 60 \$1.70 ea. \$1.60 ea. \$1.50 ea.

POSTAGE: Up to 6, 60c or \$1.20 airmail or N.S.W. \$1.20 plus 10c per doz. Vic., S.A., Qld., \$1.75 plus 25c per doz. W.A., Tas., N.T., \$1.90 plus 40c per doz.

P.O. Box 24, Carlton, NSW 2218
Please send SAE with enquiries
Telephone (02) 587-3475

ELECTRONIC DISPOSALS

297 Lt. Lonsdale St.,
Melbourne. 3000

Phone: 663-1785

PHILLIPS G.C.065.S Automatic Stereo Turntable complete with cartridge and stylus. Push button operation, lift and 10" platter. Brand new. ONLY \$29.50 each. P/P \$4.

S.C.R. BT100A — 300R. 300V. 4-5 amp. R.M.S. 2 amp average. 60c each. P/P 25c.

PHILIPS Tuning Capacitors for AM, SW and FM. \$2. each. P/P 60c.

PHILIPS Beehive Trimmers. 4 to 25PF. 10 for \$2. P/P 50c.

6.5mm Chassis Mount Switched Stereo Sockets. 40c each. P/P 25c.

Stereo Amplifier and R.F. Board 4 watts RMS per channel including circuit diagram. Boards are complete with all transistors, capacitors — resistors, etc. and are brand new — famous make. Only \$6 set P/P 60c.

Healing 1280 — 1290 T.V. circuit assembly. Sound output IF. AFC video amp Sync. Separator. Brand new with all components inc. I.C. and 17 transistors — normally approx. \$30 as Spare Part. Our price only \$4 each P/P 60c.

Transistors — AY 9150 PNP 60v 150w — AY 8110 NPN 60v 115 80c ea. AY 8139 NPN — AY 9139 PNP 40v 10w 45c ea. AY 6120 NPN — AY 6121 PNP 50v 1A 40c ea. 2N5088 NPN PN 3694 NPN 10c ea. BF 198 — BF 199 NPN 20c ea. P&P 30c.

A.3065 TV/FM Sound System. I.C. Silicone Dual In Line suitable for a wide variety of applications including T.V. sound channels — line operated and car F.M. radios and mobile communication equipment — brand new. Only \$1 ea. P/P 40c.

Balance Meters 1 1/2" x 7/8" x 1 1/4" Deep 200 UA \$2.25 ea. P/P 40c.

M.S.P. 250V A.C. 3 AMP D.P. Toggle switches 50c ea. P/P 25c.
10 1/2" 3 Watt. Wire wound pots 75c ea. P/P 25c.

7" Dia. Alum. Fans 240V A.C. \$6 ea. P/P \$1.

Multiple Electrolytics. 200 uF — 50 uF — 25 uF at 300V Plus 100 uF at 325V. VW. \$1 ea. P/P 30c.

LEVEL METERS 200 micro amp sensitivity size 1" x 1" x 3/4" \$1.50 P/P 40c.

SOLENOIDS — tape recorder type. 12V D.C. 55 coils. 1 1/2" x 1 1/2" x 3/4" \$2 ea. P/P 30c.

TRANSISTOR RADIO. 5k miniature switched pots. 30c ea. P/P 15c. Miniature 2 gang variable capacitors 30c ea. P/P 15c.

Slide Pots. Single gang. 500Ω, 20KA, 25KA, 100KC, 200KA, 200KB, 500KA, 500KB, 1 meg. D. 35c ea. P&P 35c. Dual gang — 50KA, 250KB 1 meg.C, 2 meg.C, 60c ea. P&P 35c.

Skeleton Preset Pots. 100Ω — 220Ω 470Ω, 2.2K, 10K, 22K, 47K 10c ea. P&P 20c.

Philips 8Ω dual cone 6" x 4" speakers \$2 ea. P&P 60c.

LARGE RANGE OF COMPONENTS — GOVERNMENT AND MANUFACTURERS DISPOSAL EQUIPMENT, ALSO STEREO AND HAM GEAR ALWAYS IN STOCK.

Super Avilyn tape cassette

Exceptional performance from TDK's new formulation tape.

OVER THE PAST FIVE YEARS, WE have seen the cassette recorder advance from its former lowly position in the high fidelity field to become truly comparable with reel-to-reel equipment whose position it now threatens and which it could ultimately usurp.

One cassette recorder has basically outshone the rest and may currently be regarded as the uncrowned champion. This is the Nakamichi 1000 Tri-Tracer 3-Head Cassette Recorder. Choosing the best cassette recording tape is more difficult — the contenders are many and their relative merits far more difficult to assess.

Over the past two years, we have evaluated literally dozens of different types of cassette tapes. Of these many have offered real improvements but have had limitations of one form or

another. These tapes have included special formulations of chromium, cobalt, gamma-ferric oxide, multi-layered formulations, magnetically polarised (during the coating process), magnetically oriented formulations, and, last but not least, more finely ground particles with various forms of controlled particle dispersion.

Whilst it is true to say that most of these tapes had some particular merits none has been perfect. The Nakamichi Research Company, during the first two years of sales of their Model 1000 machine, recommended a chromium formulation which offered unquestionably good frequency response together with the possible option of a specially formulated gamma-ferric oxide tape, which, whilst not quite as good as the chromium

dioxide tape, nonetheless offered a particularly good response.

Now however, for what are apparently good technical reasons, Nakamichi have standardised their latest machine on a new formulation tape from TDK. This formulation, called Super Avilyn, is a combination of cobalt and ferric oxide together with binders, but is not a cobalt-doped or cobalt-energised tape of the type currently being manufactured and marketed in the U.S.A. The end result is a basic particle with an extremely high coercivity, typically four times as high as that provided by regular gamma-ferric oxide particles, and 50% higher than that provided by cobalt-doped ferric oxide formulations.

TDK claim that this is a far more stable formulation offering a number of further advantages including higher stability, higher sensitivity and better uniformity, together with a better tolerance to varying bias settings than previous products that they have produced. It would appear that this tape formulation also causes less head wear than ferrichrome tapes or standard chromium dioxide tapes and, as such, is a preferable tape for use on the Nakamichi 1000.

Nakamichi have recently introduced a number of improvements to their machines which make them even better and more flexible than before. These improvements have resulted in Nakamichi standardising on a bias setting based on the Super Avilyn tape with the tape selection switch set for CrO₂ tapes. Our task was to find out why Nakamichi made this change and what has been achieved by it.

We had previously conducted an exhaustive evaluation on twelve other tapes, using the same procedures and instrumentation (Hi-Fi Review June 1975) and decided to use these tests as a yardstick for evaluating the Super Avilyn tape. Our procedure was simple and straightforward: firstly, to measure the frequency linearity as a record-to-replay response at levels of 0 dB, -10 dB and -20 dB, the 0 dB level being that indicated by the inbuilt recording level/meter whilst the -10 dB and -20 dB levels were accurately determined by an external

MEASURED PERFORMANCE OF SUPER AVILYN C-60 CASSETTE.

FOR COMPARISON THE FIGURES ON THE RIGHT ARE OF THE BEST CASSETTE PREVIOUSLY MEASURED BY OUR LABORATORY.

	TDK SUPER AVILYN	BEST OTHER
Frequency Response:		
0 dB	24 Hz to 11 kHz	24 Hz to 9 kHz
-10 dB	24 Hz to 19 kHz	24 Hz to 15 kHz
-20 dB	24 Hz to >20 kHz	24 Hz to 20 kHz
Total Harmonic Distortion	100 Hz 1 kHz	6.3 kHz Not Tested
0 dB	.95% 1.69%	2.84% —
-6 dB	.34% .35%	1.52% —
Bulk Erased Noise:	Dolby "In"	Dolby "In"
100 Hz	-70 dB	-70 dB
1 kHz	-80 dB	-77 dB
6.3 kHz	-78 dB	-76 dB
Saturation Level (for 0.1 dB compression):		
100 Hz	+5 dB	Not tested
1 kHz	+4 dB	+2 dB
6.3 kHz	-5 dB	Not tested.
Dynamic Range:		
100 Hz	75 dB	—
1 kHz	84 dB	79 dB
6.3 kHz	73 dB	—

attenuator. The level recordings were automatically produced for each level without any special adjustment of the machine, apart from the normal azimuth alignment using the tri-tracer system.

The frequency response at 0 dB, measured performance extending to beyond 11 kHz, was better than any other we have seen, indicating the tape's capacity to accept high levels without saturation. This capacity was further exemplified by the response at -10 dB extending to about 19 kHz, a response which would normally be expected only at a level of -20 dB. The response at -20 dB to beyond 20 kHz is most certainly equal to or slightly better than any other tape we have evaluated.

Our next series of tests involved the determination of the noise spectrum existing on the tape after bulk erasure. A one-third octave band frequency analyser was used to measure the noise threshold of the erased tape across the audible frequency spectrum when replayed in the normal mode, then with Dolby noise reduction, and finally with Dolby noise reduction and dynamic noise limiting together. The results achieved here were not in themselves astounding, but the measured level of noise compared with our previous measurements showed that the Super Avilyn tape has a threshold at least two decibels lower in the 1 kHz region than any tape previously measured. The figure here was -80 dB (compared with the normal 0 dB recording level), a particularly good performance.

To determine the upper limit of the tape's dynamic range, we recorded three signals at frequencies of 100 Hz, 1000 Hz and 6.3 kHz, at levels which were raised in one decibel steps from -5 dB to +5 dB. The playback response was then recorded graphically on our level recorder and was used to determine the upper level of the dynamic range. Obviously, as the recording level approaches the tape saturation point, the 1 dB steps become compressed and depart from what is true record-to-replay linearity. We set as our criteria limit the point at which an increase in input level of 1 dB resulted in an output step of 0.9 dB - that is, 0.1 dB compression. This was a far more rigorous test than we had previously applied in tests on other tapes. Even so, it showed that the Super Avilyn tape has a dynamic range of 75 dB at 100 Hz, of 84 dB at 1 kHz, and 76 dB at 6.3 kHz - really excellent figures.

Our next investigation was aimed at determining longterm variation in stability and dropout performance respectively, at 100 Hz, 1 kHz and 10 kHz. At 100 Hz, both in terms of

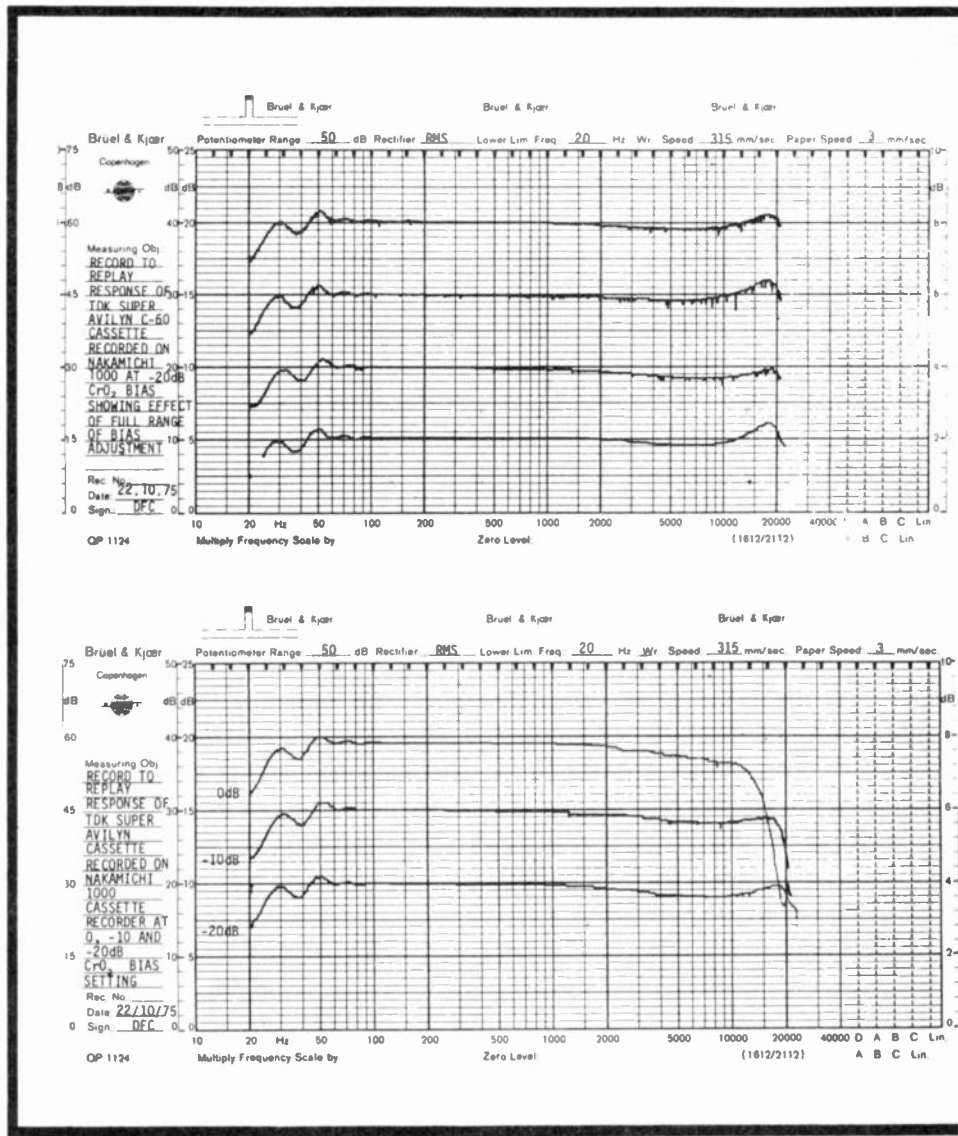

longterm and short-term variation, the results were as linear as one could hope for, and certainly better than anything we had previously seen. At 1 kHz, the dropout performance was very slightly higher than the best we had previously seen, but still exemplary. At 10 kHz the performance was still extremely good with the maximum excursions (typically) being 1 dB and the statistical mean being 0.3 dB - i.e. inaudible. The longterm variation for a full tape was also recorded (at 400 Hz) and this was remarkably flat, showing no significant variation in the mean recording level; most certainly the stablest longterm linearity response that we had seen from any cassette tape to date.

Our next test was an unusual one. We decided to take the Nakamichi 1000 and alter the bias to four different settings to see to what extent we could improve the frequency response at the -20 dB level by small variations in the bias adjustment. By altering the standard bias to alternative settings,

we found that we would vary the frequency linearity at the top end of the frequency scale to produce responses ranging from level through to a peak of approximately 2 dB at 18 kHz. The level response was that set by the factory. We found however that the Nakamichi factory setting was already optimal for the Super Avilyn tape.

Listening tests proved that Super Avilyn tape sounds as good as its measured performance indicates. Background noise is substantially lower than other tapes and the dynamic range is unquestionably better. Frequency response is excellent, and the relatively non-critical bias requirements are a step in the right direction.

Providing you have a cassette recorder capable of exploiting the very high performance of which this tape is capable then it is really worth using - Super Avilyn tape looks in fact as being one of the most important advances in tape formulations in the mid-seventies.



ANNOUNCEMENT!



NEW GENERAL COVERAGE RECEIVER FROM YAESU MUSEN CO OF JAPAN



TYPE FRG-7

FEATURES:

- Electronic band changing
- Uses similar principle to Wadley Loop
- 0.5 to 30 MHz continuous coverage. Frequency readout 10 kHz (readable to better than 5 KHz)
- SSB (LSB, USB selectable) CW and AM
- 0.5µV 10dB S+N/N SS band CW, 2µV for 10dB S+N/N AM
- 230V AC 12V DC (External DC or Internal, 8 dry cells)
- 340mm x 153mm x 285mm

Ideal for Short Wave listening and amateur band monitoring (inc. 11 metres). Delivery expected June-July.

Also, NEW: FR-160 fixed channel receiver for monitoring marine, amateur, SSB and AM & (1.5-4.5 MHz) 12ch.

BAIL ELECTRONIC SERVICES

60 Shannon St., Box Hill Nth., Vic. 3129 Ph: 89-2213

microlith SCIENTIFIC CALCULATORS



FEATURES:

- 12 character display capacity. • 8 digit mantissa plus sign indication. • 2 digit exponent plus sign indication. • Four standard arithmetic functions, mixed and chain calculations, automatic and repeat calculations in all four functions. • Algebraic memory calculation. • Trigonometric functions: sin X, cos X, tan X. • Inverse trigonometric functions: Sin -1 X, cos -1 X, tan -1 X. • Logarithms and exponential function: Log X In X, e^x 10^x.
- Exchange function: X - Y
- Degree to Radian, Radian to Degree

Degree • Factorial function: 1/X, √ X, a^x. • Parenthesis: two levels • Guaranteed 6 months • Adaptor 9 volt.

Also available at RADIO DESPATCH SERVICE, 869 George Street, Sydney

AMPEC ENGINEERING CO.

42 THE STRAND, CROYDON, N.S.W. 2132
POSTAL ADDRESS: P.O. BOX 18, STRATHFIELD, 2135, AUSTRALIA
CABLE ADDRESS: AMPEC SYDNEY
PHONE: (02) 747 2731 (02) 74 8063

\$29.95

Adaptor . . . \$8.00

+15% Sales Tax (\$4.49). Postage 60 cents or \$2.60 if registered. Additional \$1.00 postage for adaptor if required.

Please affix imprint of official rubber stamp of university or school.

SALES TAX (EXEMPTIONS AND CLASSIFICATIONS) ACT

TO — THE COMMISSIONER OF TAXATION AND THE COMMONWEALTH OF AUSTRALIA

I hereby certify that the purchased by me from

(Goods Description)

on (date) is for use in

(Supplier)

(Name of University or School) in or directly and essentially in connection with, the production of facts by means of observing measuring, testing or otherwise experimenting with material phenomena for the purpose of proving or illustrating natural principles or laws or in the study of pure or mixed mathematics. Exemption is accordingly claimed under item 63 (1) in the First Schedule to the Sales Tax (Exemptions and Classifications) Act

Signature of official of University or School

Designation

Name of University or School

Date

Signature of Student

Address of Student

SAVE with an A+R plug-pack BATTERY ELIMINATOR



**MAKES
DRY
BATTERIES
OBSOLETE**

**For your 6 volt
Electronic Calculator
Portable Radio
Electronic Flashgun etc.**

- ELIMINATES THE NEED FOR COSTLY DRY BATTERIES IN PORTABLE EQUIPMENT.
- PLUGS DIRECTLY INTO MAINS POWER SOCKET.
- FITTED WITH COAXIAL CONNECTING PLUG. (ALTERNATIVES CAN BE FITTED BY YOUR DEALER)
- DOUBLE INSULATED FOR ABSOLUTE SAFETY.
- APPROVED BY ELECTRICITY SUPPLY AUTHORITIES.
- 12 MONTHS' GUARANTEE.
- 2 MODELS AVAILABLE:
100mA and 300mA (MAX. OUTPUT)

A+R-Soanar Electronics Group
30-32 Lexton Rd.,
Box Hill, Vic. 3128
Australia
Telex: 32286

Sales Offices Phones:
VIC: 89 0238, NSW: 78 0281,
SA: 51 6981, QLO: 52 5421,
WA: 81 5500.



TANNOY

professional

STUDIO MONITOR speakers

TANNOY 85 wtt.
15" 'MONITOR
H.P.D. MODEL
Integrated full
range system

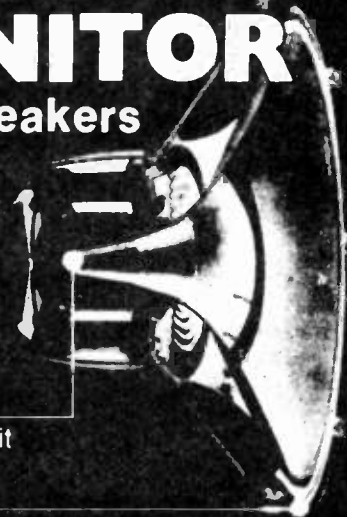

- HORN LOADED
High Frequency Unit
- DIRECT RADIATOR
Low Frequency Unit

20-20,000 Hz. RESPONSE

RESPONSE
CURVE, FITTED
IN 'AMESBURY'
BASS REFLEX
ENCLOSURE

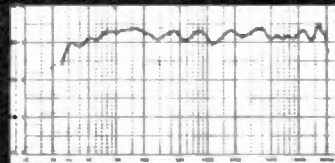

Treble roll-off, energy control

HIGH POWER
CROSSOVER NETWORK
(1000 Hz.) WITH FULL
TREBLE CONTROLS



3 BIG TANNOY H.P.D. MODELS

- Mod. 385 15" 8 Ω 20-20,000 Hz. 85 wtt.
- Mod. 315 12" 8 Ω 20-20,000 Hz. 60 wtt.
- Mod. 295 10" 8 Ω 22-20,000 Hz. 50 wtt.

George Hawthorn Electronics

966-968 HIGH ST, ARMADALE,
MELBOURNE, VIC, 3143.
TEL 509 0374, 509 9725



"you will be at first surprised, and in the long-term, delighted by the increased listening pleasure the Parabolic can provide"

parabolic

RECORD STYLUS

carefully and expertly fitted to any type of cartridge

Recommended Price

\$37-50

plus \$1 postage

FOR GREATER LISTENING PLEASURE PHONE (03) 93 1201

ASK FOR THE LOCATION OF YOUR NEAREST AGENT



BAY ROAD ELECTRONICS

36 Luxmoore Street Cheltenham Vic. 3192

CAMERA AND GINE *KEEPS YOU IN FOCUS*

EXCLUSIVE

EXCLUSIVE

PLUS



**LORD SNOWDON
ON ASSIGNMENT**

FREEZE ACTION



**BUILD YOUR OWN
LIGHT AND SOUND
FLASH TRIGGER**

- * TURNING KIDS ON TO PHOTOGRAPHY
- * HOW TO ROLL YOUR OWN AND SAVE
- * COPING WITH THE AUDIO VISUAL BUG
- * TWO BIG CONTESTS
- * TESTS * NEWS
- * REVIEWS

***ITS ALL IN
THE MARCH* CAMERA AND GINE**

5% OFF ON ORDERS OVER \$50.00
10% OFF ON ORDERS OVER \$100.00
15% OFF ON ORDERS OVER \$250.00

APRIL SPECIALS

POCKET CALCULATOR

5 function plus constant — addressable memory with individual recall — 8 digit display plus overflow — battery saver — uses standard or rechargeable batteries — all necessary parts in ready to assemble form — instructions included.



Calc. Kit. Kit only \$10.95
Batteries (alkaline, disp.) 2.00

MARKED — NO FACTORY LOGO GUARANTEED FUNCTIONAL

7400	\$.10	7420	\$.11	7460	\$.11
7402	\$.10	7437	\$.20	7474	\$.25
7403	\$.11	7440	\$.11	7493	\$.39
7404	\$.12	7445	\$.09	7496	\$.09
7406	\$.20	7450	\$.11	74195	\$.59
7408	\$.12	7453	\$.11		
7410	\$.11	7454	\$.11		

UV ERASABLE PROM

1702A — 2048 bit static PROM 256x8 elect programmable & erasable TTL/DTL comp. \$14.95

DVM CHIP 4 1/2 DIGIT

MMS330 — P channel device provides all logic for 4 1/2 digit volt meter. 16 pin DIP with data \$14.95

8038 FUNCTION GENERATOR

Voltage controlled oscillator — sine, square, triangular output. 16 pin DIP with data \$3.95

7001 CLOCK CHIP

4-6 digit, 12-24 hr. alarm, timer and date circuits — with data \$6.95

6 DIGIT LED CLOCK KIT

INCLUDES: MM3314 clock circuit 6 FND70 LED displays (250" red 7 segment)

All necessary transistors, resistors & capacitors 1 double sided PC board accommodates LED's & clock circuitry Schematic & Instructions Does not include 12V-300 ma transformer, switches & case \$11.95

CLOCK CHIPS WITH LED's

CT7001 4-6 digit, 12-24 hour clock with alarm, timer & date circuits plus 4 MAN 66.6" LED display \$14.95
above items plus 2 MAN 1 for date \$17.95

MMS314 clock chip 12-24 hour 4-6 digits Plus choice of 6 MAN 5 green 7 SEG LED .27" 6 MAN 7 red 7 SEG LED .27" 6 MAN 8 yellow 7 SEG LED .27" \$ 9.95

UNIVERSAL BREADBOARD

Silver plated copper circuit board 3-1/2" x 5-1/2" 2 rows of 27 holes for DIP IC's — space for transistors, resistors & capacitors. Versatile and simple for bread-boarding IC circuits \$1.50 ea. 50 pcs. 1.00 ea.

TANALUM CAPACITORS SOLID-DIPPED -20%

.1 mld	35V	.25 ea.	6.8 mld	6V	.30 ea.
.33 mld	35V	.25 ea.	6.8 mld	50V	.40 ea.
1 mld	35V	.25 ea.	10 mld	25V	.40 ea.
2.2 mld	20V	.25 ea.	15 mld	10V	.40 ea.
2.2 mld	35V	.30 ea.	33 mld	10V	.40 ea.
4.7 mld	16V	.30 ea.	47 mld	6V	.40 ea.

TTL

7400	\$.14	7451	.17	74154	1.25
7401	.16	7454	.17	74155	1.07
7402	.35	7473	.35	74157	.99
7403	.16	7464	.35	74158	1.79
7404	.19	7465	.35	74160	1.39
7405	.19	7470	.30	74161	1.25
7406	.35	7472	.30	74162	1.49
7407	.35	7473	.35	74163	1.39
7408	.18	7474	.35	74164	1.59
7409	.19	7475	.57	74165	1.59
7410	.16	7476	.39	74166	1.49
7411	.25	7483	.79	74170	2.30
7413	.55	7485	1.10	74173	1.39
7416	.35	7486	.40	74174	1.62
7417	.35	7489	2.48	74175	1.39
7420	.16	7490	.59	74176	.89
7422	.26	7491	.97	74177	.84
7423	.29	7492	.71	74180	.90
7425	.27	7493	.60	74181	2.98
7426	.26	7494	.94	74182	.79
7427	.29	7495	.79	74184	2.29
7430	.20	7496	.79	74185	2.29
7432	.23	74100	1.30	74187	5.95
7437	.35	74105	.44	74190	1.35
7438	.35	74107	.40	74191	1.35
7440	.17	74121	.42	74192	1.25
7441	.98	74122	.45	74193	1.19
7442	.77	74123	.85	74194	1.25
7443	.87	74125	.54	74195	.89
7444	.87	74126	.63	74196	1.25
7445	.89	74141	1.04	74197	.89
7446	.93	74145	1.04	74198	1.79
7447	.89	74150	.97	74199	1.79
7448	1.04	74151	.79	74200	5.90
7449	.17	74153	.99		

LOW POWER TTL

7400	\$.25	74151	\$.29	75L90	\$1.49
7402	.25	74155	.33	74191	1.45
7403	.25	74171	.25	74193	1.69
7404	.25	74172	.39	74195	1.69
7406	.25	74171	.49	74198	2.79
7410	.25	74174	.49	74164	2.79
74120	.33	74178	.79	74165	2.79
74130	.33	74185	1.25		
74142	1.49	74186	.69		

HIGH SPEED TTL

74H00	\$.25	74H121	\$.25	74H55	\$.25
74H01	.25	74H22	.25	74H60	.25
74H04	.25	74H30	.25	74H61	.25
74H08	.25	74H40	.25	74H62	.25
74H10	.25	74H50	.25	74H72	.39
74H11	.25	74H52	.25	74H74	.39
74H20	.25	74H53	.25	74H76	.49

8000 SERIES

8091	\$.53	8214	\$1.49	8811	\$.59
8092	.53	8220	1.49	8812	.89
8095	1.25	8230	2.19	8822	2.19
8121	.80	8520	1.16	8830	2.19
8123	1.43	8551	1.39	8831	2.19
8130	1.97	8552	2.19	8836	.25
8200	2.33	8554	2.19	8880	1.19
8210	2.79	8810	.69	8263	5.79
				8267	2.59

9000 SERIES

9002	\$.15	9109	\$.79	9601	\$.89
9301	1.03	9312	.79	9602	.79

CMOS

4000A	\$.26	4017A	1.19	4060A	.89
4001A	.25	4020A	1.49	4068A	.44
4002A	.25	4021A	1.19	4069A	.44
4006A	1.35	4022A	1.10	4071A	.26
4007A	.26	4023A	.25	4072A	.35
4008A	1.79	4024A	.89	4073A	.39
4009A	.57	4025A	.25	4075A	.39
4010A	.54	4027A	.59	4078A	.39
4011A	.29	4028A	.98	4081A	.26
4012A	.25	4030A	.44	4082A	.35
4013A	.45	4035A	1.27	4528A	1.60
4014A	1.49	4042A	1.47	4585A	2.10
4015A	1.49	4049A	.59		

74C00	\$.22	74C74	\$1.04	74C162	\$2.93
74C02	.26	74C76	1.34	74C163	2.66
74C04	.44	74C107	1.13	74C164	2.66
74C08	.68	74C151	2.61	74C171	2.61
74C10	.35	74C154	3.15	74C195	2.35
74C20	.35	74C157	1.76	80C95	1.35
74C42	1.61	74C160	2.48	80C97	1.13
74C73	6.04	74C161	2.91		

NEW ITEMS

TTL		LOW POWER SCOTTKEY	
74132	\$.89	74LS00	\$.36
74H101	.58	74LS02	.36
74H102	.58	74LS04	.36
74H103	.63	74LS08	.38
74H106	.63	74LS10	.36
74H108	.63	74LS12	.36
		74LS15	.36
		74LS20	.36
		74LS32	.38
		74LS40	.45
		74LS47	.59
		74LS49	1.30
		74LS50	1.30
		74LS53	2.09
		74LS107	.59
		74LS164	2.20
		74LS193	2.50
74574	.38		

LINEARS

733	Diff. video AMPL TO-5	.89
5556/ MC1456	Int. compensated Op Amp mDIP	1.59
7525	Dual core mem. sense AMPL DIP	.98
CA3046	Transistor array 14 pin DIP	.89

LED's

MV10R	Red TO 18	\$.22
MV50	Asial leads	.18
MV5020	Jumbo Vis. Red (Red Dome)	.22
	Jumbo Vis. Red (Clear Dome)	.22
ME4	Infra red diff. dome	.54
MAN1	Red 7 seg. .270"	2.19
MAN2	Red alpha num. .32"	4.39
MAN4	Red 7 seg. .190"	1.95
MAN5	Green 7 seg. .270"	3.45
MAN6	.6" high solid seg.	4.25
MAN7	Red 7 seg. .270"	1.19
MAN3	Red 7 seg. .127"	.29
	straight pins	.29
MAN8	Yellow 7 seg. .270"	3.45
MAN66	.6" high spaced seg.	3.75
MCT2	Opto-iso transistor	.61

MULTIPLE DISPLAYS

NSN33	3 digit .12" red led 12 pin fits IC skt.	\$1.79
HP45082	5 digit .11 led magn. lens com. cath.	3.49
HP5082	4 digit .11 LED magn. lens com. cath.	3.25
FNA37	9 digit 7 seg led RH dec. chr. magn. lens	4.95
SP-425-09	9 digit .25" neon direct interface with MOS/LSI, 180 VDC, 7 seg.	1.79

SHIFT REGISTERS

MMS5013	1024 bit accum. dynamic mDIP	\$1.75
MMS5016	500/512 bit dynamic mDIP	1.59
SLS-4025	QUAD 25 bit	1.29

DTL

930	\$.15	937	.15	949	.15
932	.15	944	.15	962	.15
936	.15	946	.15	963	.15

METAL FILM RESISTORS

QTY	PRICE EACH	PRICE MINIMUM 10 PER VALUE	PRICE MINIMUM 100 PER VALUE
0 - 10	\$.20		
10 - 100	.20	\$.15	
100 - 1000		.10	\$.09
1000 -		.10	.08

RESISTANCE (OHMS)

22.6	71.5	182	887	11.8K	40.2K
23.7	78.7	187	1.15K	13.0K	45.3K
25.5	84.5	191	1.5 K	15.0K	48.7K
30.9	105	205	2.49K	18.2K	54.9K
34.8	110	232	3.57K	19.1K	60.4K
40.2	115	243	4.75K	19.6K	64.9K
45.3	137	499	5.49K	22.6K	69.8K
51.1	147	604	6.04K	24.9K	84.5K
61.9	158	715	7.15K	28.0K	
64.9	178	806	8.25K	37.4K	

MISC. DEVICES

2602	1024-bit static RAM, N-channel DTL/TTL compatible	3.95
F93410	256 bit RAM	2.19
MV5020	Jumbo green	.22
IC209-R	.125" red LED	.15
L100	Red LED	.15
L101	Red LED	.15

MEMORIES

1101	256 bit RAM MOS	\$ 1.50
1103	1024 bit RAM MOS	3.95
1702A	2048 bit static PROM UV eras.	17.95
2102-2	1024 bit static RAM	4.25
5203	2048 bit UV eras PROM	17.95
5260	1024 bit RAM	2.49
5261	1024 bit RAM	2.69
5262	2048 bit RAM	5.95
7489	64 bit RDM TTL	2.48
82523	Programmable ROM	3.69
74200	256 bit RAM tri-state	5.90

CALCULATOR & CLOCK CHIPS

5001	12 DIG 4 func fit dec	\$2.49
5002	Same as 5001 exc. bit power	2.79
5005	12 DIG 4 func w/mem	2.99
MMS5725	8 DIG 4 func chain & dec	1.98
MMS5736	18 pin 6 DIG 4 func	4.45
MMS5738	8 DIG 5 func k & mem	5.35
MMS5739	9 DIG 4 func (btry sur)	5.35
MMS5311	28 pin BCD 6 dig mux	4.45
MMS1312	24 pin 1 pps BCD 4 dig mux	3.95
MMS5313	28 pin 1 pps BCD 6 dig mux	4.45
MMS5314	24 pin 6 dig mux	4.45
MMS5316	40 pin alarm 4 dig	5.99

Data sheets on request. With order add \$.30 for items less than \$1.00 ea.

LINEAR CIRCUITS

300	Pos V Reg (super 723) TO-5	\$.71
301	Hi Perf Op Amp mDIP TO-5	.29
302	Volt follower TO-5	.53
304	Neg V Reg TO-5	.80

Lots of people tell you what their speakers will do.

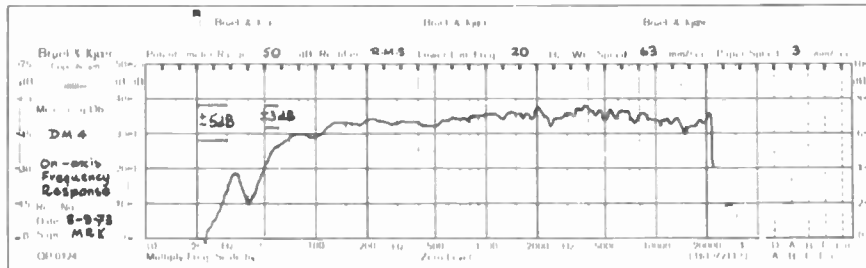

When you buy a B&W, you get it in writing.

B&W's reputation is based on producing clean natural sound without distortion, even at low volume. Each B&W speaker is tested in an Anechoic Chamber and issued with its own individual pen graph. You know exactly the performance of the speaker you are buying.

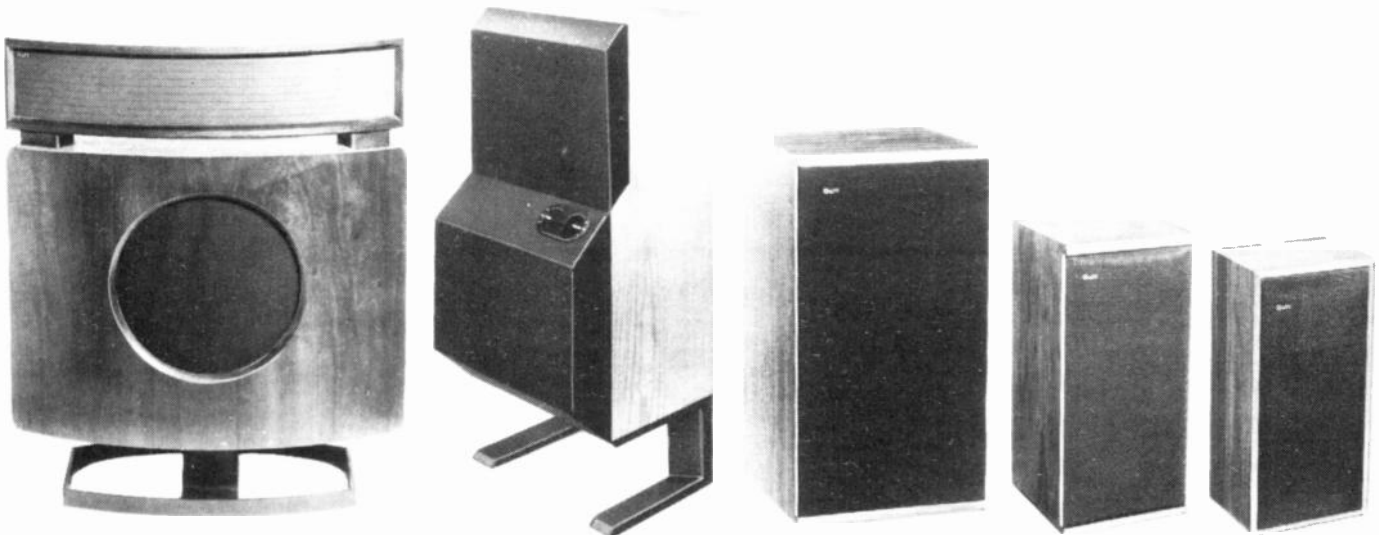

B&W DM70 Monitor Electrostatic.

A combination of dynamic bass unit and electrostatic mid and high frequency module. One of the best speakers you can buy.

B&W DM6 Monitor.

A brand new design. A high powered dynamic loudspeaker with low colouration and very high transient performance.

B&W DM2A Monitor.

A more conventional design utilising B&W research into acoustic line rear loading. Brilliant clarity and lack of distortion.

B&W DM4 Monitor.

A speaker with large B&W Monitor characteristics, its performance surpasses speakers of much greater size.

B&W D5.

A speaker for small living areas. It has above average performance at moderate cost.

HEAR B & W HERE:

VICTORIA: Allans Music (Aust.) Ltd, Melbourne 63-0451 • Encel Electronics Pty. Ltd., Richmond 42-3761 • Instrol Hi-Fi, Melbourne 67-5831 • Southern Sound, Melbourne 677-7869 • Southern Sound, Moorabin 97-7245 • Tivoli Hi-Fi, Kew 80-4956. N.S.W.: Arrow Electronics, Sydney 29-8580 • Convoy Sound, Sydney 358-2088 • The Gramophone Shop, Westfield Shopping Town, Parramatta 633-2846 • Instrol Hi-Fi Pty. Ltd, Sydney 29-4258 :290-1399 • Jock Leate Pty. Ltd, Hurstville 579-6399 • Milversons Pty. Ltd., Brookvale 938-2205 • Milverson Pty. Ltd. Chatswood 412-2122 • Milverson Pty. Ltd. Parramatta 635-3588 • Riverina Hi-Fi, Brookvale 938-2662 • United Radio Distributors Pty. Ltd. Sydney 232-3718 • Wests Pty. Ltd. Burwood 747-4444. QUEENSLAND: Audio Laboratories, Milton 36-0080. TASMANIA: Bel Canto, Hobart 34-2008. W.A.: Technical Services (W.A.) Pty. Ltd., Mosman Park 31-5455. A.C.T. Pacific Stereo, Manuka 95-0695 • Duratone, Aitree Court, Phillip 82-1388.

B&W



Sole Australian Agents
Convoy International Pty. Ltd.
4 Dowling Street, Woolloomooloo 2011
Sydney. 358 2088

PF693

ELECTRONICS —it's easy!

More about digital instrumentation.

VERY FEW VARIABLES to be measured by electronic means provide a digital signal directly: this is because the real-world is predominantly analogue by nature. Consequently, most so-called digital measurement systems involve a number of stages to make the signal compatible with the digital circuits of a system.

The most straight-forward 'digital' measurement method (at least at present), is to employ a suitable analogue sensor that provides a voltage (or current) output, related to the variable being measured. This signal then feeds an A/D converter to obtain a digital equivalent.

The low cost of digital calculation circuitry now enables linearization of sensor processes at moderate cost. Figure 1 gives an example of the digital linearization used in a thermocouple thermometer unit.

By referring to Fig. 2 we see that the linearization process, in the dual-slope digital voltmeter section of the system, is achieved by changing the ramp slope at a number of points. To do this a rate multiplier is used to multiply the clock frequency by a variable number, $N/256$, where N may be any number between 1 and 256. By this means 256 different ramp slopes may be generated. The slope in use is tracked by a segment counter which, in turn, causes a read-only-memory (ROM) to set up the correct digital-readout code.

Some sensing principles lend themselves to a more direct digital signal approach. For example, in the Moire-fringe displacement sensor, a grid of fine lines (called a grating) formed on glass is attached to the moving (or fixed) member of the machine whose movement is to be monitored. This is shown in Fig. 3. The other member carries a small index grating set to produce Moire-fringes which move as the two grids pass relative to each other. Movement of these fringes is monitored by photocells which provide a number of electronic pulses proportional to the magnitude of the displacement. These pulses can be counted directly with a reversible direction counter, thus allowing both directions of movement to be followed. Such a unit is known in the

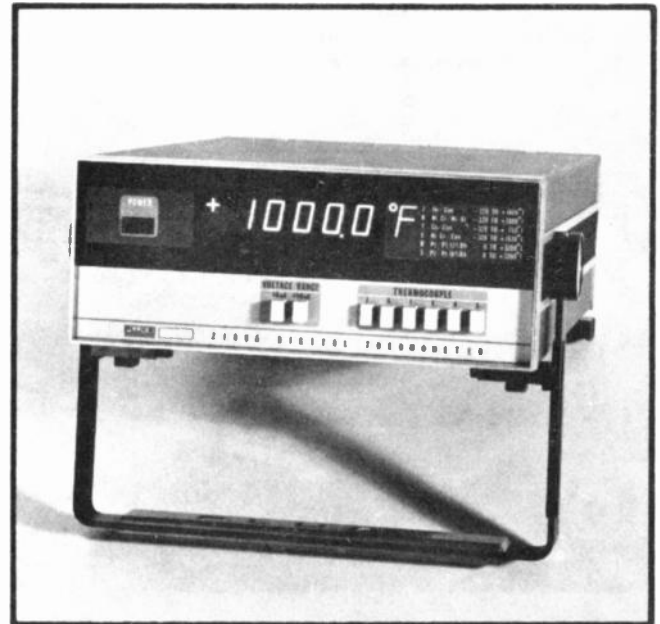

Fig. 1. This Fluke 2100 series digital thermometer incorporates digital linearization. It is suitable for use with any one of six common thermocouples.

Fig. 2. Block diagram of the digital linearization technique used in a digital thermometer.

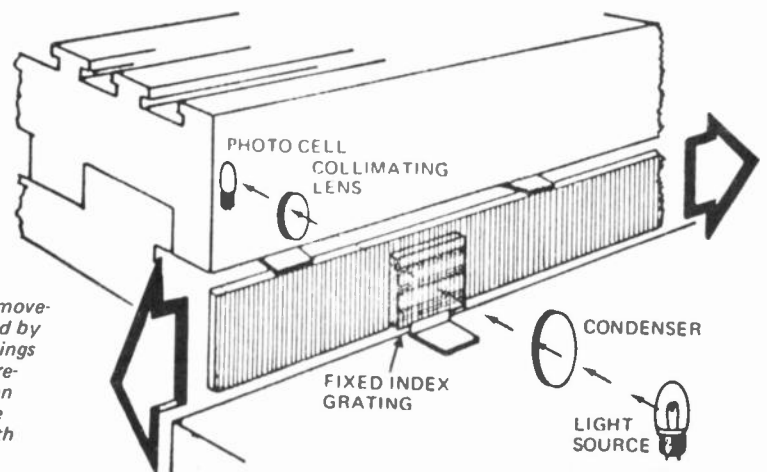
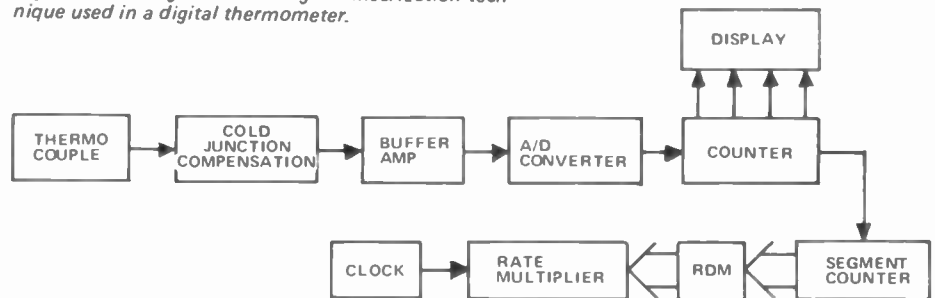

Fig. 3. Accurate measurement of movement is performed by using optical gratings to produce "moire-fringes" which can be counted as the gratings move with respect to each other.

ELECTRONICS—it's easy!

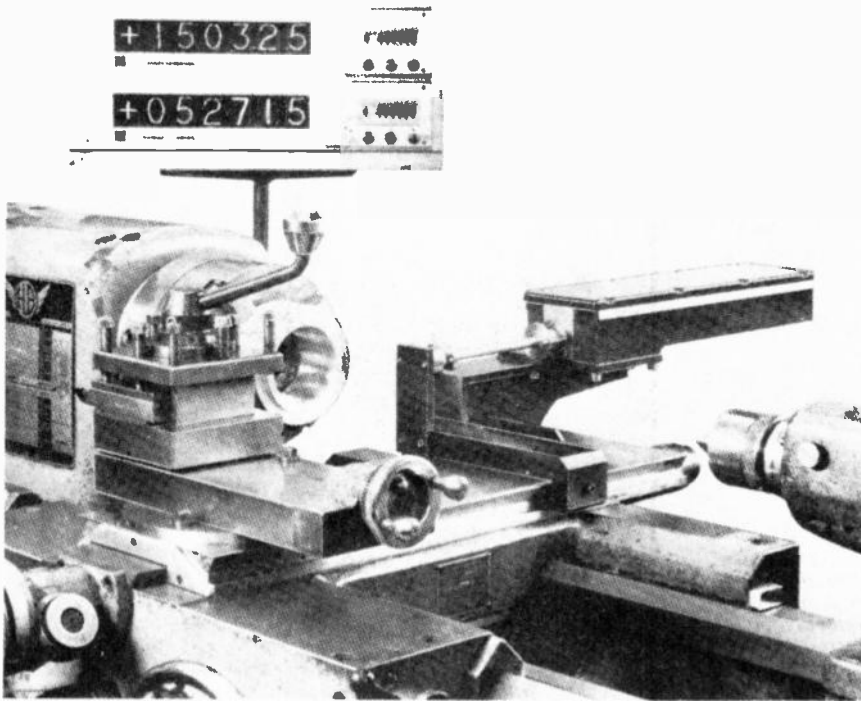

Fig. 4. This lathe is fitted with a digital readout of displacement. The self-contained Heidenhain linear sensor is to be seen high at the back of the cross slide.

metal working industry as digital readout (DRO) — a typical system is shown in Fig. 4. A somewhat similar length measuring system is the laser interferometer — this also provides fringes that can be counted to provide a measure of absolute displacement. Clearly in such cases the digital

instrument must not lose or gain stray counts or else the wrong value is indicated. Such systems are called incrementals.

There is an alternative method which uses digitally encoded discs similar to those shown in Fig. 5. This is an absolute method which is not subject



Fig. 5. The absolute digital code disc acts as a store of the angular value of displacement. It is interrogated as though it were a register whose value is read optically across a radial line.

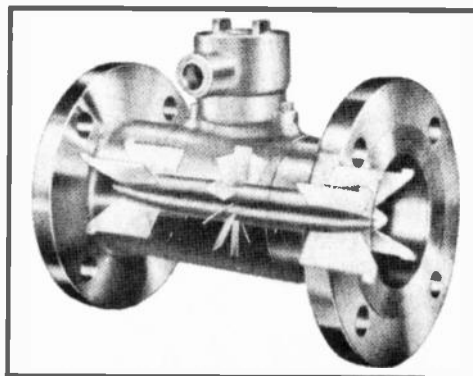

Fig. 6. Turbine flow meters like this one provide an output in the form of a pulse train with a pulse repetition rate proportional to flow rate.

to pulse loss or gain, or to power failure errors which occur in the previous system if not fitted with a special non-volatile memory. The discs of such a system are read optically as though they were registers or other forms of digital store, each position having a different digital code as read across a radial line.

In some forms of digital pulse transducer it is the rate of pulse production that represents the variable, not the absolute number of pulses. An example of this sensor is the turbine flow meter used to measure liquid or gas flow. Figure 6 shows such a flowmeter where a small turbine rotates inside a pipe at a speed related to the flow rate. Rotation may be converted into pulses using optical, magnetic, capacitive or, in earlier designs, mechanical sensing. This form of sensor provides a variable frequency output which can be converted by a counter/timer system into a direct readout of flow rate.

Digital transducers are somewhat similar. They provide a signal which varies in frequency as the variable being measured changes. The sensor of such a transducer is made such that it alters a parameter of a frequency generating circuit. For example the quartz-crystal thermometer shown in Fig. 7 operates in this manner. In this unit temperature causes the resonant frequency of a crystal, mounted in the end of the probe, to change in a predictable fashion.

It is interesting to note that many natural physiological sensors operate on the pulse-rate system — neurons (the digital nerve sensors on the end of the nervous system) trigger with pulse repetition rates that rise in accordance with the intensity of the actuating signal (heat, cold etc).

Considerable effort has been expended — especially in the Eastern European countries in the late 60's — to produce reliable low-cost industrial sensors that provide a digital form of output. These have not, however, been accepted to the extent hoped. The current low-cost of extremely powerful digital circuits, however, is likely soon to produce a trend toward sensing devices having digital output.

ANALYSERS

Analysis is the general process used to break down an unknown by methods which separate and distinguish basic elements of seemingly complex arrangements, the elements so derived being satisfactorily understood basic quantities.

Synthesis is the alternative approach wherein a system is built up from known elements to produce the complex case.

Analysis may be regarded as being

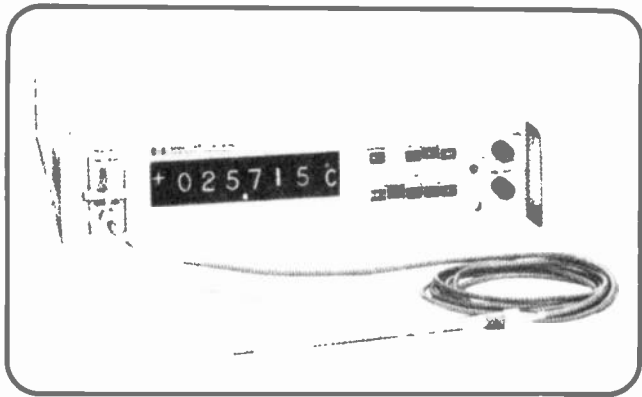

Fig. 7. Quartz-crystal thermometer from Hewlett Packard.

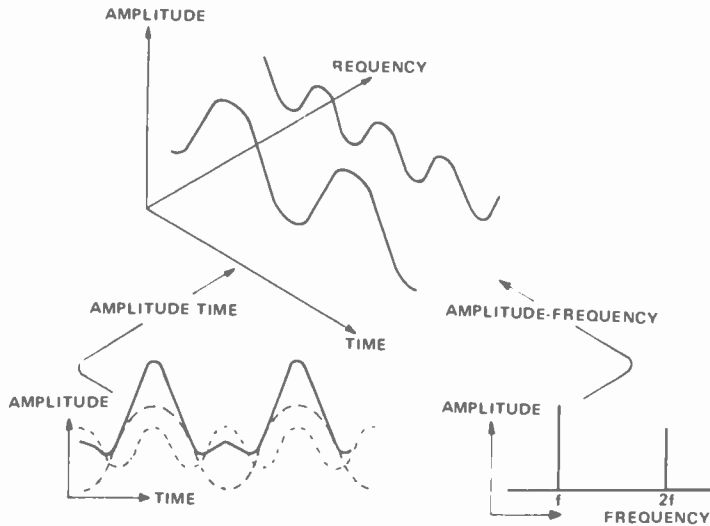

Fig. 8. Second harmonic distortion is not always easily seen on an amplitude versus time display. In the amplitude versus frequency display the second harmonic distortion and its amplitude are clearly seen.

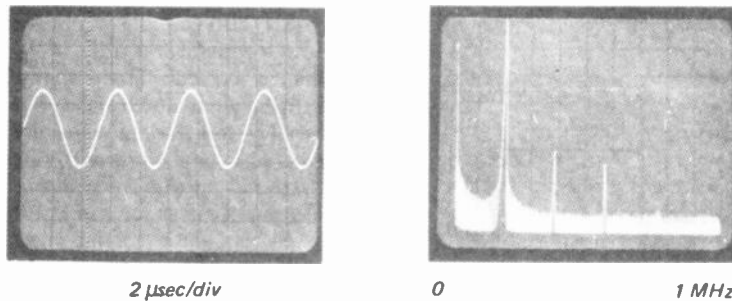

Fig. 9. Frequency domain displays are often better than the time-domain method as these HP displays illustrate: (a) In the time domain (left) the signal looks pure but the spectrum analyser shows that it has significant distortion.

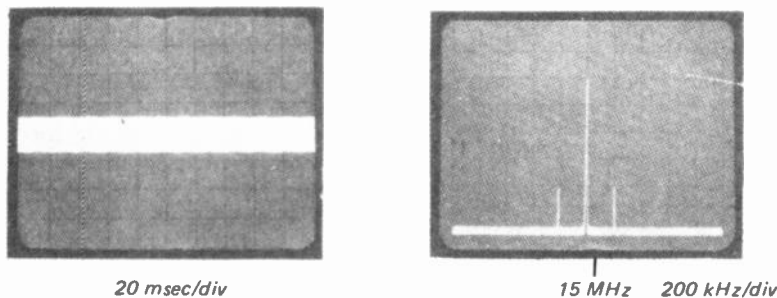

Fig. 9b. A 2% amplitude modulation is barely discernible on time domain plot (left). The frequency domain plot clearly shows the frequencies present and their amplitude.

required when the behaviour of an existing system needs to be *studied*. Synthesis is used when a system is to be *devised*. There are of course many instances when both approaches are used to yield a solution.

Various types of electronic analysers are used in electronics. We will look here at spectrum analysers, logic state analysers and pulse-height analysers as these types are commonly met in modern circuit work. Each of these operates on an existing electrical signal breaking it down into frequency content, logic-state content and height of pulses, respectively.

SPECTRUM ANALYSERS

Signals in the time-domain, that is those displayed as amplitude versus time graphs, can also be displayed in terms of their amplitude-versus-frequency and phase-versus-frequency characteristics. (This was discussed in Part 4 where an example wave-form — a square wave — was broken up into its harmonics). The relationship between time, amplitude and frequency are seen by studying the three forms (shown in Fig. 8) of a fundamental sine wave having a large degree of second harmonic added in. Signals displayed as amplitude (or phase) versus frequency are said to be in the frequency domain. This kind of plot shows the frequency spectra of the signal, hence the name spectrum analysers.

The role of spectrum analysers is to display the signal content in its frequency domain form. There exists many instances where this form of display is better than a time-domain representation. Typical examples are where a fundamental has distortion (Fig. 9a) or where low levels of modulation or noise exist (Fig. 9b). Neither of these conditions could be satisfactorily detected, let alone measured, by a time-domain test.

Basic spectrum analysers use analogue circuitry and therefore do not qualify properly for inclusion in a discussion on digital instruments. However, as we will see later, the current trend is to include digital techniques in such instruments. Advanced analysis equipments, for example, often use a built-in digital computer.

There are two alternative forms of spectrum display. First, the repetitive signal can be studied over an extended time period by scanning across the expected frequency-range with narrow band-pass filters. A speedier, but more expensive method, works in a real-time mode thus preserving the time-dependency between signals. These are known as swept-tuned and real-time spectrum analysers respectively.

ELECTRONICS—it's easy!

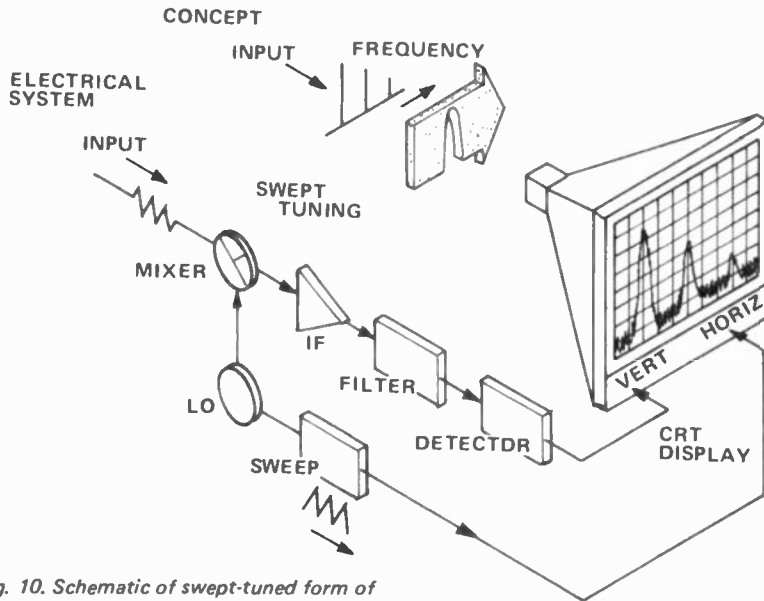

Fig. 10. Schematic of swept-tuned form of spectrum analyser.

Swept-tuned systems — Basically the task is to establish the amplitude (and sometimes phase) of the signal at each frequency in turn. Many practical difficulties exist because the absolutely narrow band filter does not exist and even if it did, it would take an enormous time to sweep it across the full bandwidth of the signal. Practical filters also have finite

bandwidth and roll-offs. The bandwidth of the filter may also need to change if the requirement is for a filter bandwidth that is always a given proportion of the signal frequency as it sweeps the range.

Most difficulties are overcome by mixing the signal with a swept local oscillator and then detecting the output and using it to drive the Y

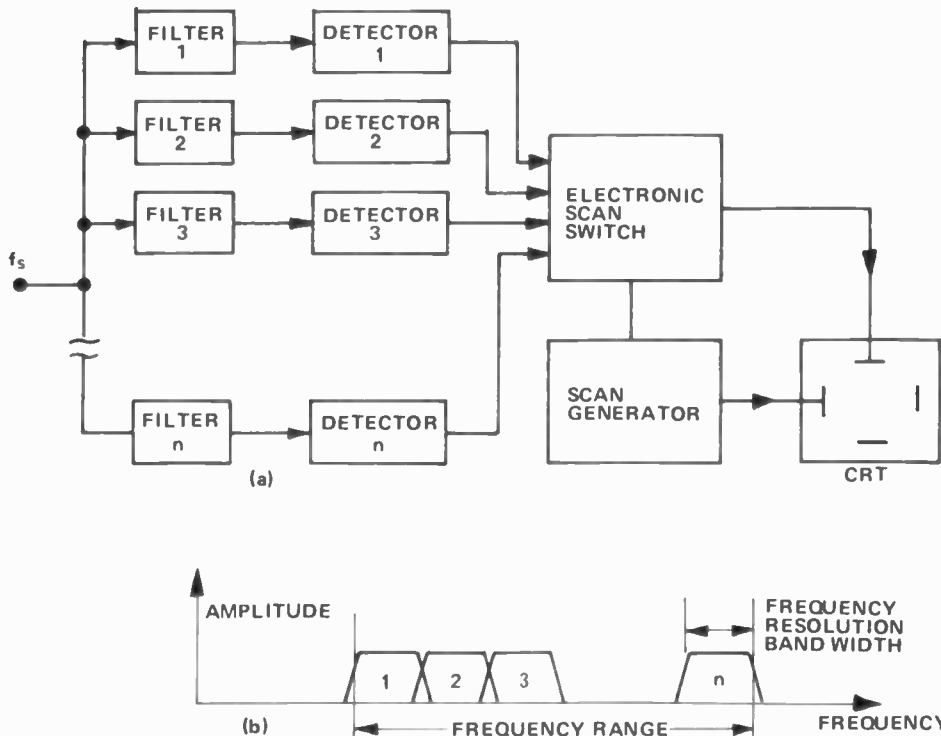

Fig. 11. Block diagram of real-time spectrum analyser based on stacked filters: (a) schematic (b) frequency response showing individual filter windows.

plates of an oscilloscope. The sweep signal drives the X plates. Figure 10 depicts this arrangement.

Real-time systems — These use a stack of band-pass filters and detectors each connected to the signal simultaneously and with each having staggered centre frequencies. This is shown schematically in Fig. 11. The scan generator multiplexes the individual channels in order to produce a continuous spectrum on the oscilloscope screen.

It is clear that this method is much more expensive because many filters are needed. It does, however, enable a detailed analysis of once-only transient signals which could not be analysed with the swept-tuned arrangement of a spectrum analyser.

A range of spectrum analysers is available for the study of signals from 5 Hz to 50 GHz. Different instruments (or the use of different plug-ins with the same display unit) are needed because units typically cover only 4 to 5 decades, that is, say 5 Hz-50 kHz, 10 kHz-300 MHz and so on. The range is, however, ever widening. Wide range, however, is not always the virtue needed for spectral resolution is related to width of display screen.

Fourier Analysers — A third method of providing a frequency analysis is based on direct mathematical calculation using the Fourier transform technique to convert a time-domain signal into its frequency-domain equivalent. Such systems are extremely expensive compared with the above analysers, but provide a vastly greater capability.

They can also handle signals at the very-low-frequency end — dc to 100 kHz is typical. Their operation is quite different from the above in that the signal is fed as data values into the analyser unit via keyboard or paper tape from another computer or mass-storage system. It can also be fed in as an analogue signal from, for example, magnetic tape. The heart of the Fourier analyser is a micro-programmable computer system which can be set to compute using various programmes such as the so-called Fast-Fourier method of analysis. The same unit may also be able to carry out correlations between signals, plus many other processing techniques.

Digital circuitry in spectrum analysers

— Digital circuits are being added by manufacturers to enhance the performance of analysers. Advantages claimed include operating ease and better placement of controls. Digital storage of the display signals can be used to enhance the display brightness and to allow a spectrum to be 'held' for comparison against a second spectrum obtained later. Digital

Professional Trio Test Gear at Amateur Prices

Trio 'E' Series instruments are outstanding value. Take your pick of R.F. and audio signal generators, scope and FET Volt-ohm-meter. These instruments are popular with advanced hobbyists, education establishments and many professional laboratories. Check the specs below and you'll see what we mean.

You can see Trio 'E' Series at leading electronics stores or at the sole Australian agents - Parameters Pty. Ltd.

Call in for a demonstration:-

SYDNEY: 68 Alexander St., Crows Nest, 2085
Tel: 439 3288

MELBOURNE: 53 Governor Rd., Mordialloc, 3195
Tel: 90 7444.

Take advantage of your Bankcard.

bankcard
welcome here

PARAMETERS PTY LTD

NEW MODEL D SCOPE
WITH EXTENDED
BANDWIDTH TO 5MHz.
CHECK FULL SPEC. BELOW.

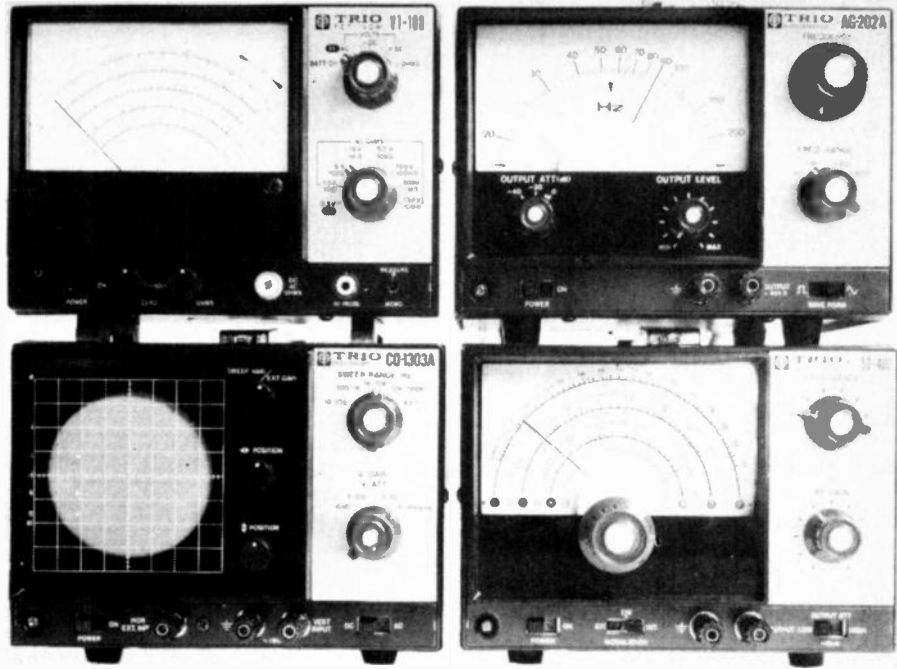

CO1303D 5MHz Scope

CRT:
Vertical Sensitivity: 20 mV/cm
Attenuator: 1/1, 1/10, 1/100 plus fine control
Bandwidth: DC to 5 MHz (-3 dB)
AC: 2 Hz to 5 MHz (-3 dB)
1 M Ω 30 pF
Input R and C: 300 V (DC + AC peak) or 800 V p-p
Horizontal Sensitivity: 500 mV/cm
Attenuator: Continuously variable
DC to 250 kHz
Freq. response: 1 M Ω , 40 pF
Input R and C: 10 Hz to 100 kHz in 4 ranges
Sweep Freq: Internal (-)
Synchronisation: 100/117/230 V AC 50/60 Hz.
Power requirements:

SG402 R.F. Generator

Freq. range: 100 kHz to 30 MHz in 8 ranges
Freq. accuracy: $\pm 1\%$
Output Voltage: 0.1 V r.m.s.
Attenuator: HIGH/LOW (10:1) and variable control
Modulation:
Internal: 400 Hz, 40% mod degree
External: Requires 1.5 V r.m.s. for 40% mod degree
Power requirements: 100/117/230 V AC 50/60 Hz 8 W
Dimensions: W 186 mm x H 131 mm x D 220 mm
(W 190 mm x H 154 mm x D 245 mm
Max dimensions)
Weight: 2.5 kg

VT108FET Volt-Ohm-Meter

DC volt meter: 0.5 to 1,500 V in 8 ranges
11 M Ω on each range
Accuracy: $\pm 3\%$ at full scale
AC volt meter: 1.5 to 1,500 V r.m.s. full scale in 7 ranges
dB: -15 to $+66$ dBm
[Any other voltage]: 4.2 to 4,200 V p-p full scale in 7 ranges
1 M Ω
80 pF at 500 to 1,500 V range
Input impedance: 18 Hz to 5 MHz $\pm 10\%$
30 Hz to 2 MHz $\pm 3\%$
0.1 Ω to 1,000 M Ω in 7 ranges
Ohm meter: $\pm 5\%$ of setting range at scale 0.3 to 3
 $\pm 10\%$ of setting range at scale 0.1 to 10
Memory: 1% scale variation: Approx 30 sec

AG202A Audio Generator

Frequency range: 20 Hz to 200 kHz in 4 ranges
Freq. accuracy: $\pm 1.3\%$ ± 2 Hz
Sine wave characteristics:
Output voltage: 10 V r.m.s. $\pm 10\%$
Distortion: 0.5% at 50 Hz to 100 kHz
Square wave characteristics:
Output voltage: 10 V p-p
Overshoot: 3%
Sag: 10% at 20 Hz
Output impedance: 800 Ω
Output attenuation: HIGH/LOW (40 dB) and variable
Drift with line voltage: $\pm 10\%$ variation
Freq: $\pm 0.5\%$
Level: ± 0.5 dB
External synchronisation:
Synchronisation voltage: 1V approx
Max. input voltage: 3 V r.m.s.
Input impedance: 10 k Ω 9PM38

audio

NEWS....is back in action!

Bigger, brighter, bolder!

The completely revised Audio News will be appearing every second month - starting in March.

Subscriptions are only \$10 a year and Audio News is available on subscription only. Don't miss out - subscribe now!

To ensure you will receive your copies of Audio News, simply fill out this form and send it to Audio News together with \$10 for each subscription you require.

Name of Subscriber

Address

.....

..... Post Code

I enclose \$..... for..... subscriptions to Audio News, to commence with the March 1976 issue.

This form and the subscription fees should be posted to Audio News, Modern Magazines (Holdings) Ltd., 15 Boundary St., Rushcutters Bay, 2011.

MOD AMP

AUDIO KITS

PM 140	Quad, 15W, discrete decoder	\$139.00
PM 141	Basic stereo, 5W, no trans.	\$ 19.50
PM 142	Complete 5W stereo,	\$ 39.50
PM 143	Stereo, 15W.	\$ 69.00
ETI 413	100W Guitar Amplifier	\$ 79.50
ETI 419	Preamp for ETI413	\$ 12.50
ETI 420	10W Quad, discrete decoder	\$139.00
ETI 420	20W Quad, discrete decoder	\$169.00
ETI 422	50W Stereo	\$115.00
ETI 424	Stereo, spring reverberation	\$ 65.00
ETI 427	Stereo, graphic equaliser	\$139.00
ETI 440	25W Stereo Amplifier	\$ 89.00

P&P on above is \$5.00 or 10%, whichever is the lower.

SPECIAL OF THE MONTH

60W AMP MODULE
Absolute maximum supply voltage 90 Volt centre tap. Continuous power output, sine wave 60 Watt R.M.S. at 84V centre tap; 50 Watt R.M.S. at 78V centre tap; 40 Watt R.M.S. at 72V centre tap. Frequency response 10 Hz to 50 kHz at -3 dB. Load Impedance 4 ohm minimum, 8 ohm. Distortion - typically less than 0.2%. Input Impedance 10k ohms. Input level 500 mV for full output. **\$39.50 P&P \$2.00 each.**

	Kit	P&P	KIT	P&P
ETI 533	\$24.00	\$1.50	EA Drill speed control	\$14.00 \$2.00
ETI 117	\$16.00	\$1.00	EA 75 CDI	\$29.50 \$2.00
ETI 704	\$25.00	\$2.50	ETI Strobe kit	\$22.50 \$2.00
ETI 120	\$13.95	\$1.00	EA Transistor tester	\$17.50 \$2.00
ETI 121	\$12.95	\$1.00	Glide tone generator	\$ 9.75 \$1.50
ETI 118	\$49.50	\$1.50	Five state probe	\$15.00 \$1.50
ETI 441	\$5.95	\$1.50	Warble Dauble	\$25.00 \$2.00
ETI 129	\$25.50	\$2.50	ETI 238	\$ 5.95 \$1.50
ETI 128	\$45.00	\$2.50	ETI 438	\$11.95 \$1.50

"ECSTASY" COLOUR ORGANS



Just plug into mains, connect to speakers and watch your music with a 4 colour multiple light display with control of each channel.

SMALL \$49.50 LARGE \$69.50, P&P \$5.00.

RESISTORS

	Bulk Discount price	Quantity in pack
1/2 Watt E12 values, 10 ohm-10 megohm (Code RFH)	\$2.00	100
1 Watt E12 values, 10 ohm-10 megohm (Code RFI)	\$4.75	100
5 Watt wire-wound, .33, .47, .51, E6 values from 1 ohm-4.7 kohm. (Code RFF)	\$2.00	10

FOUR INPUT MIXER

Two 2 mV inputs, two 100 mV inputs with active mixing, built and tested unit. **\$35.00 plus P&P \$2.50.**

FOUR CHANNEL AUDIO TO LIGHT DRIVER

Just plug into mains, connect to speaker and plug in 4 external coloured lights (not supplied) - Gives you your own Disco show! Built and tested \$49.50 plus P&P \$2.50.

SEMICONDUCTORS

	Bulk Dis. Price	Qty in pack
IN914 Small signal diode	\$2.00	25
EM404 400V., 1A	\$3.25	25
EM410 1000V., 1A	\$5.00	25
A15A 100V., 3A	\$6.00	10
NL 5023 Red LED with mounting	\$5.00	25
MB4 400V., 1A bridge	\$4.60	4
MB10 1000V., 1A bridge	\$5.80	4
PA40 400V., 10A, bridge	\$5.60	1
PB40 400V., 25A, bridge	\$6.30	1
DL727 .3" 7 segment read-out	\$2.30	1
DL747 .6", 7 segment read-out	\$2.90	1
2N2646 Unijunction	\$5.60	4
2N6027 Programmable Unijunction	\$4.40	4
C106D1 400V., 4A. Thyristor	\$5.60	4
C122D 400V., 8A. Thyristor	\$7.80	4
C122E 500V., 8A. Thyristor	\$4.80	2
SC141D 400V., 6A. Triac	\$5.20	4
SC146D 400V., 10A. Triac	\$4.40	2
ST2 Diac	\$3.60	5
ST4 Assymetrical Diac	\$4.00	5

Equivalent may be supplied, but in all cases they will have the same specifications and similar style cases. Prices may be slightly higher interstate.

NOTE: Mixed value packs of 1/2W, 1W, resistors, ceramics and greencaps are not available. Packs contain one value only. Other components available in any quantity subject to 20% surcharge on quantity not in standard pack. EXAMPLE: 7 double-gang slide pots: Pack of 5 = \$6.00 plus 2 = \$2.40. 20% surcharge on 2 = 48c. Sub-total = \$8.88 plus 10% P&P (88c) TOTAL \$9.76.

DIGITAL I.C.'s

	Bulk Disc. price	Qty. in pack
SD7400	\$3.40	10
SD7401	\$3.40	10
SD7402	\$3.40	10
SD7403	\$3.40	10
SD7404	\$3.40	10
SD7405	\$3.40	10
SD7408	\$3.40	10
SD7409	\$3.40	10
SD7410	\$3.40	10
SD7413	\$4.90	10
SD7416	\$4.90	10
SD7420	\$3.40	10
SD7430	\$3.40	10
SD7438	\$3.40	10
SD7440	\$3.40	10
SD7441	\$3.70	5
SD7442	\$3.40	5
SD7446	\$2.75	2
SD7451	\$3.40	10
SD7473	\$5.90	10
SD7474	\$5.90	10
SD7475	\$4.00	5
SD7476	\$3.00	5
SD7483	\$2.50	2
SD7489	\$2.40	1
SD7490	\$6.00	10
SD7491	\$2.25	2
SD7492	\$3.40	2
SD7493	\$6.00	10
SD7495	\$2.50	2
SD7496	\$3.00	2
SD74107	\$3.00	2
SD74121	\$3.40	2
SD74123	\$4.00	2
SD74141	\$4.30	2
SD74151	\$4.30	2
SD74153	\$4.30	2
SD74160	\$5.70	2
SD74161	\$5.70	2
SD74162	\$5.70	2
SD74613	\$5.70	2
SD74164	\$5.70	2
SD74165	\$2.50	2
SD74175	\$5.00	2
SD74192	\$5.00	2
SD74193	\$5.00	2

Prices may be slightly higher interstate.

Built and tested, simply plug in and use. **\$25.50 plus P&P \$2.00**



HI-POWER STROBE

THE ELECTRONICS SHOPS:
9 Young St., Southport, Qld. 32-3632
23 Russell St., Toowoomba, Qld. 32-6944
36 Station St., Booval. 82-2322

EDA DELSOUND
35 Logan Road, Wooloongabba, Qld. 391 7048
30 Amelia St., Valley, Qld, 52-8694

HI-TEL RECORD BAR:
Shop 4 Skipton's Arcade, Penrith, NSW
Shop C Nepean Arcade, Penrith, NSW
Phone 21-0850

THE ELECTRONIC AND HOBBY CENTRE:
1168 Gold Coast Highway, Palm Beach, 34 2835

K & A STEVENS
P.O. PARKES, NSW

KTRONICS:
12 Peel St., Adelaide. 87 5505.

A. E. COOLING RADIO & T.V. SERVICE
6 Trimmer Rd., Elizabeth South, S.A. 255 2249

CALA ELECTRONICS:
Shop 5A, Village shopping centre,
High St, Coffs Harbour. 52 4035.

MAIL ORDER

Add 10% for post and packing, unless otherwise stated.

MOD-AMP

P.O. Box 180, AVALON 2107
Phone (02) 913-3334

included; this reduces the noise thereby enhancing the signal/noise ratio on the display — as is illustrated in Fig. 12. Character generation (using digital methods) has been incorporated to display the relevant graph-axes factors — as shown in Fig. 12. The same unit also uses a photo-optical absolute-digital code disk to replace the mechanical switch usually used in a range control-knob.

Spectrum analysers are invaluable and are finding increasing use. Successful use is, however, a matter of experience and frequency-domain techniques are not dealt with as extensively as time-domain ones in training programmes. More details are available in the reading list — we can only provide the most elementary introduction here.

Logic-State Analysers — We check the operation of analogue circuits by measuring signal levels and frequency spectra at various points in the circuit. Digital circuits are different in that they contain the signal information in the form of multi-digit 'words' made up of two-state bits. To check operation, therefore, we must ascertain simultaneous logic-states at various points in the circuitry. The simplest analyser for this work is a probe which indicates logic hi or lo state at a selected point; coloured lights are used as indicators. A store function can be built-in to the probe to catch a short transition that would

Fig. 12. The Tektronix spectrum analyser incorporates various digital techniques that provide character generation on the display and reduce the noise level of a signal. The adjacent photo shows the original unfiltered signal containing the two small signals and noise (recovered in the CRO display).

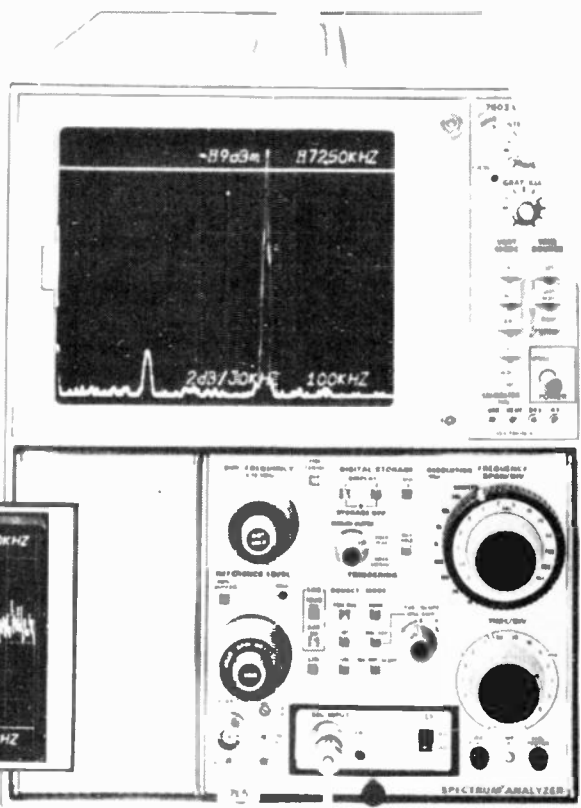
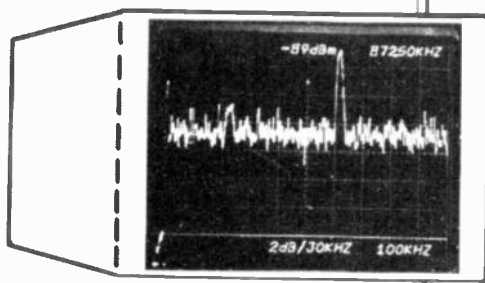

not otherwise be seen in the lamp display. It must also have connections suitable for PC board digital circuitry — see Fig. 13.

The single probe can be used to analyse the state of a circuit by

moving from point to point in turn. To speed-up the analysing process a more extensive facility to use would be one that simultaneously shows the logic states of multiple points in the so-called Data-domain. The

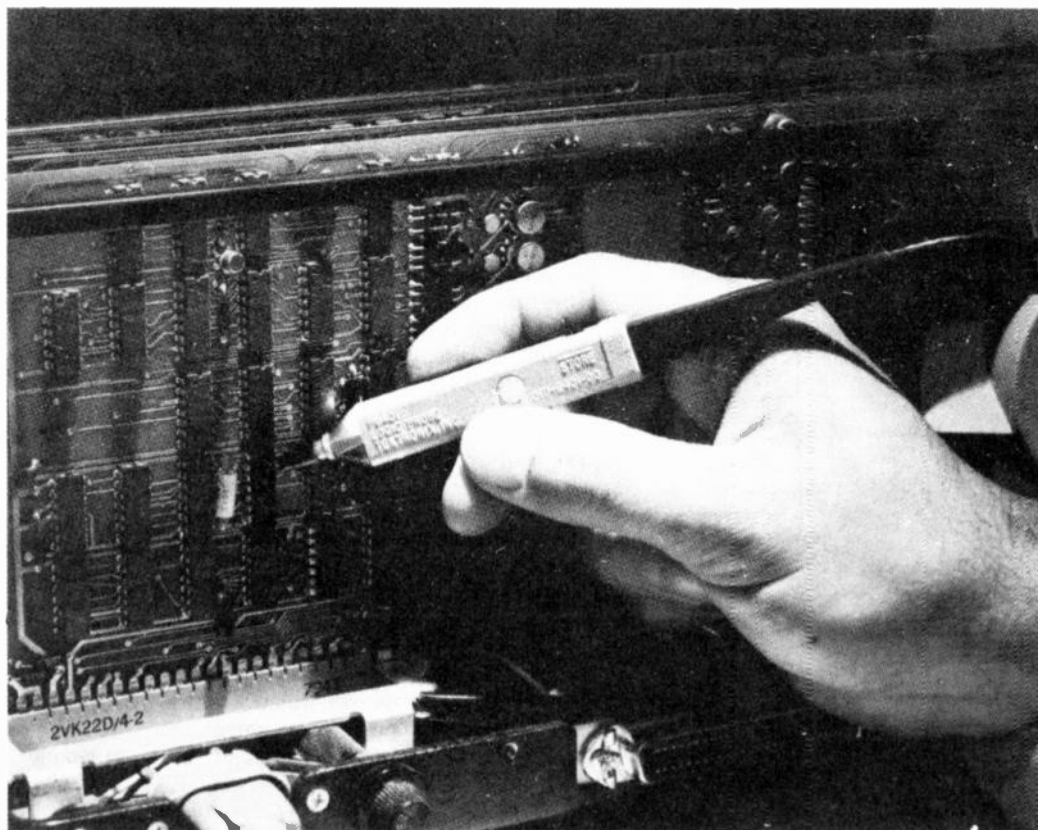

Fig. 13. Simple logic probe in action.

ELECTRONICS—it's easy!

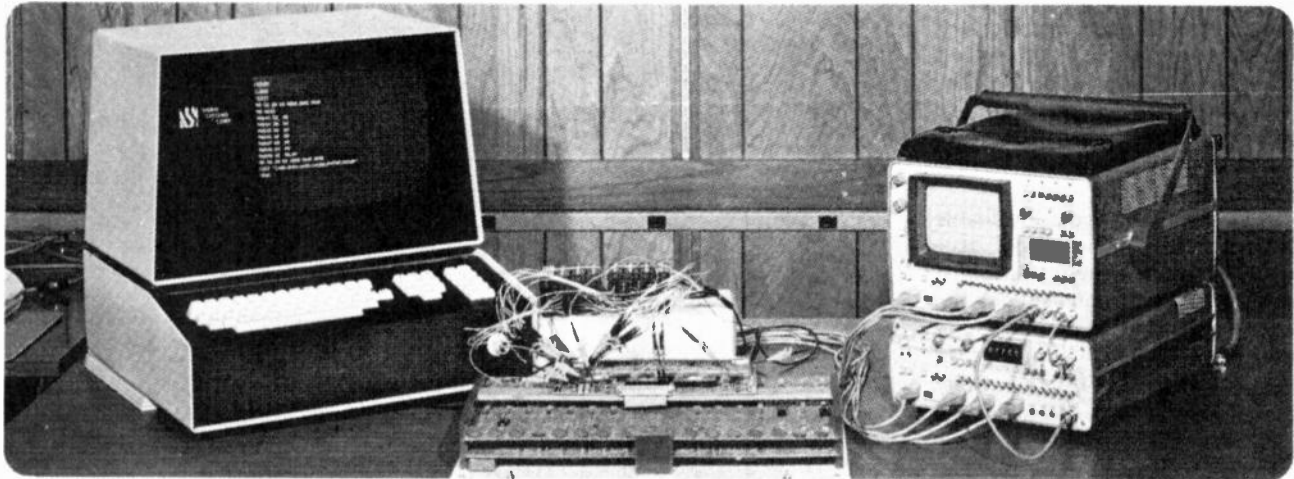

Fig. 14. Hewlett Packard logic-state analyser as set up to test a printed-circuit board card.

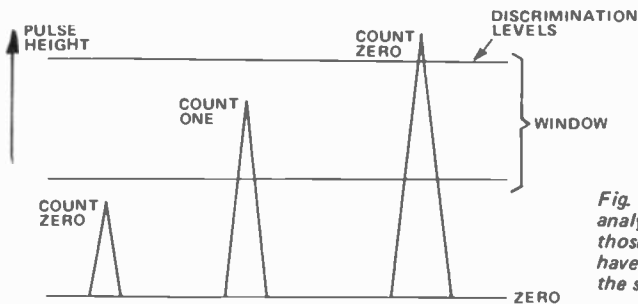

Fig. 15. Pulse-height analysers count only those pulses which have amplitudes within the specified window.

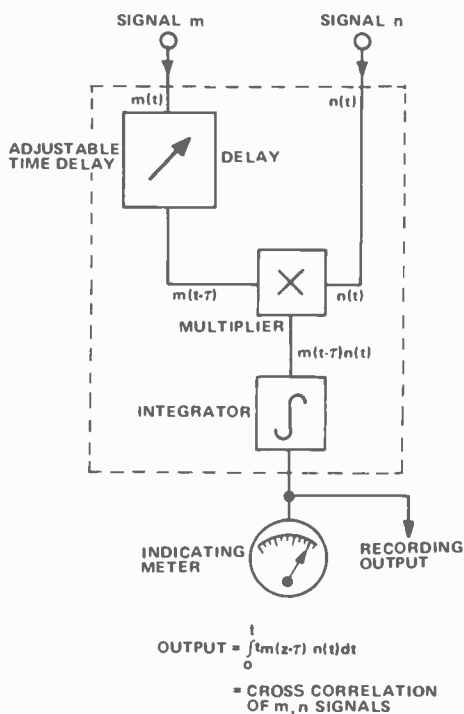

Fig. 16. Block diagram of the mathematical function performed by a correlator unit.

Hewlett-Packard system, for example (shown in Fig.14), displays over 500 points as a matrix of 0's or 1's on a CRO screen. These instruments are used to debug, test or trouble-shoot complex digital circuits. Only large laboratories, however, would be able to justify the cost of such advanced logic analysers.

Pulse-height analysers (Discriminators) — Measurement processes involving ionising radiation and sometimes light-intensity levels rely on pulse counting, the pulses appear as rapid electrical currents produced from a photo-multiplier or ionisation detector. The relative amplitude of a pulse often distinguishes it from pulses from other sources. For example, different radio-active isotopes produce pulses of different energy, enabling an assay of radio-active mineral to be made by a study of occurrence of pulses of different height. Photons arising from the various noise sources in photo-multipliers have different energy from those generated at the photo-cathode. This is a true detection process: noise can be reduced by discrimination of pulse heights.

Pulse height analysers use carefully selected trigger levels to accept only

those pulses (for counting) that arise from the particular source of interest. Pulses above the trigger window, or below are rejected (not counted) as demonstrated in Fig. 15.

CORRELATORS

Correlation as a physical process can be visualized by considering two identical optical patterns formed on film transparencies. When the two are exactly overlaid, the maximum transmission of light occurs. At any other position the light transmission falls off to a minimum at greatest misalignment. The mathematical process modelling this is that whereby the two patterns (represented as formulae) are multiplied together and the multiplicand signal is averaged as depicted in Fig. 16. This process is repeated using a slightly different spatial (or timewise) phase-shift between signals each time the sums are performed. The same idea of correlation applies for time-domain as well as space-domain signals. When two identical 'patterns' are compared in this way it is called auto-correlation. When two patterns that are not identical are compared it is cross-correlation. Correlation brings out any similarity as a peak in the correlator output when the greatest degree of correlation is achieved.

Early correlators used entirely analogue methods to carry out the signal processing. Today, correlators mainly use digital techniques in the manner shown schematically in Fig. 17. The two inputs are converted from analogue to digital form in the quantizers. One channel is progressively delayed by storage in a shift register. Multiplication and

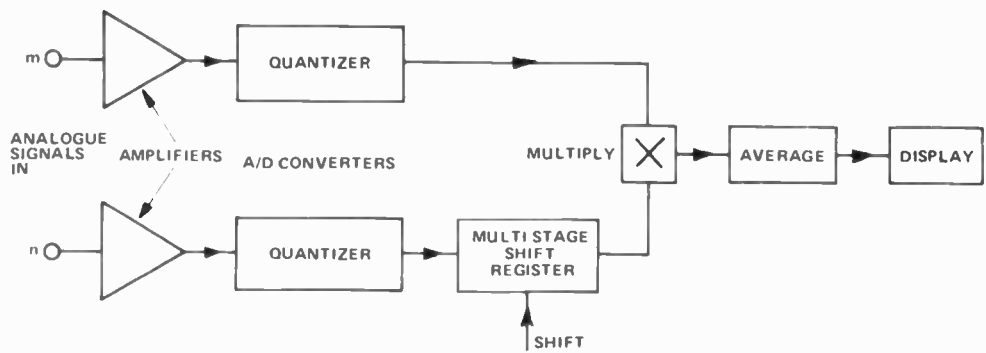

Fig. 17. The simplified block diagram of an auto correlator.

averaging are also achieved by digital methods.

Correlation finds use in the detection of periodic signals buried in noise; in establishing the degree of coherence between random signals; in establishing transmission time and source of transmission of a signal; in identifying the characteristics of a complex system (the input is perturbed with a noise-like signal which is cross-correlated with the output to give the transfer functions of the system). It is a particularly powerful tool and we should see more of its use if the cost of digital correlators continues to fall.

SYNTHESIZERS

These are a special kind of signal generator in that the signal output is

formed by addition of a number of sources or by manipulation of a single, stable-reference frequency. A music synthesizer provides a whole range of musical sounds by combining many different tones into a single output. Although synthesizers work upon basic analogue signals the trend is to combine or modify the signals using digital control.

The advantages offered are (in the variable frequency generator kind of synthesizer) that a very stable reference oscillator has its frequency translated to (literally) billions of other values (the HP 8660 gives 10 kHz-2600 MHz) whilst retaining high stability. By pressing digital-key inputs, any chosen frequency value is generated. It is also possible to control

the output via a programmable BCD digital input. Programming enables an enormous range of signals to be synthesized, a typical requirement being as part of an automatic test procedure. Figure 18 shows the philosophy of the HP 3330 series of automatic synthesizers with a typical programme card marked up for a frequency sweep routine.

Digitally-controlled power sources may be used to synthesize varying voltage (or current) levels over a test period at the commands of a mini computer in the same way as the above unit synthesizes frequencies.

Frequency and voltage synthesizers are often combined in the hybrid-computer (digital and analogue combined) in order to generate synthesized signals which are needed

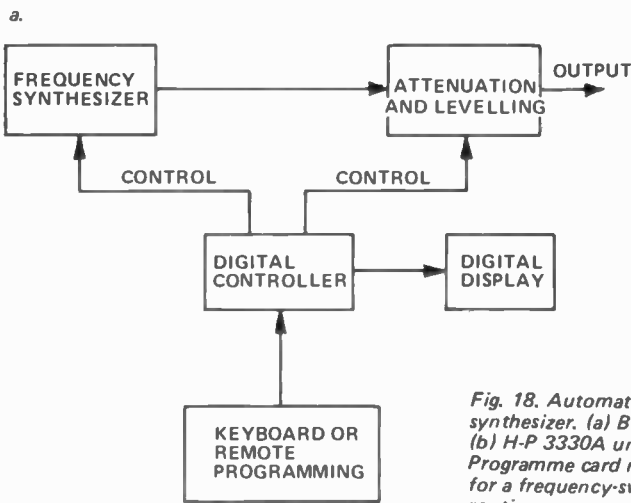
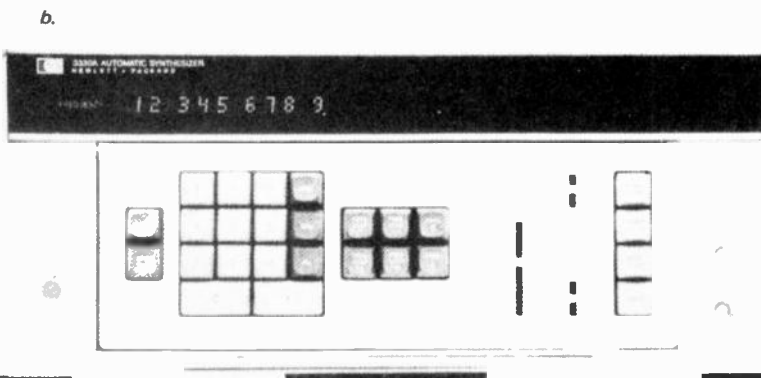

Fig. 18. Automatic frequency synthesizer. (a) Block diagram. (b) H-P 3330A unit. (c) Programme card marked up for a frequency-sweep routine.



PROGRAM CARD
CARD NO. 1 OF 1
TITLE: 3330B WIDE RANGE FREQUENCY SWEEP

NO.	STEP	CODE	200	100	40	20	10	4	2	1
1		.44								
2										
3	STOP	13								
4	FREQ	114								
5	CTR	765								
6	FREQ	077								
7	FREQ	115								
8	FREQ	45								
9	FREQ	76								
10	AMPL	116								
11		761								
12		61								
13	LEVEL	073								
14	FAST	136								
15	NO OF STEPS	107								
16	TIME STEP	127								
17	FREQ SWP	102								
18	START SINGLE	111								
19	START SINGLE	133								
20										
21										
22										
23										
24										
25										
26										
27										
28										
29										
30										
31										
32		277								

UNADDRESS

1. USE SOFT PENCIL
2. DO NOT MARK IN SHADED AREA (TOP)
3. ERASE COMPLETELY
4. INSERT THIS SIDE UP

HP PART NO. 9120-2886

ELECTRONICS—it's easy!

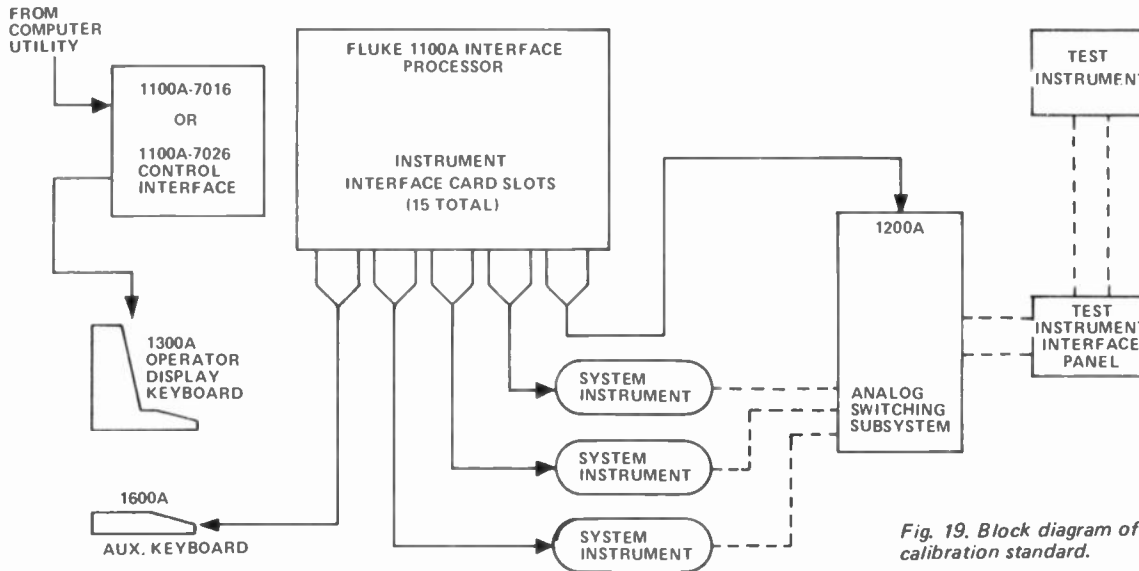

Fig. 19. Block diagram of Fluke calibration standard.

to derive a simulation of a complex system, such as a missile in flight.

COMPUTER CONTROLLED TEST SYSTEMS

With the enormous increase in complexity of routine complex processes (such as aircraft instrumentation and controls, refineries, automatic and large-volume manufacture of electronic systems) came the need to improve and speed-up the testing procedures needed to check out the thousands of different parameters involved. Computer controlled testing is far more reliable than human operator testing and is extremely fast. It can be economic even for the testing of small volume electronic equipment, especially where a large range of tests is involved.

The instrument or process to be tested is interfaced to the main test

console which usually incorporates a wide range of facilities that are chosen with flexibility of operation in mind. Figure 19 shows an automatic system used to calibrate a test instrument. The test programme must be devised by a highly-trained professional designer, but once developed and programmed the testing can be performed by a less trained person.

It is not possible here to deal in depth with automatic testing as the range of requirements and equipment available are both great. The overall concept and scope of an automatic test system is shown in Fig. 20. Suffice to say very complicated automatic testing systems are in routine use in a wide variety of manufacturing and maintenance situation.

Further reading:

Digital Sensors — these are variously described in the many general books

on sensors but rarely as digital concepts, specifically. Recent releases are:

"Transducers in measurement and control" — P.H. Sydenham, UNE Publishing Unit, Armidale, 1975 (Available ETI).

"Transducers in Industrial Measurement" — P.H. Mansfield, Butterworths, London, 1973.

"Analysers — detail is available in the data sheets and journals of companies such as Marconi Instruments, Hewlett-Packard, Tektronix, Honeywell, Spectral-Dynamics, Bruel and Kjaer and others.

"Counting Photons", ETI, November, 1974 and "Electronics in Medicine — Pt. 2" ETI, August, 1975, dealt with pulse-height analysis.

Hewlett-Packard offer a series of varied booklets on Spectrum Analysers, as well as video tapes. Application Note 150 provides basic understanding.

Synthesizers of the music kind are discussed in "Electronics in Music", F. C. Judd, Neville Spearman, London, 1972. A complete project of a music synthesizer was covered in articles in ETI beginning October, 1973. Part 1 contains reference to digital control of the synthesis process.

Manufacturers' data sheets are a source of reference to both laboratory synthesizers and programmable dc power supplies (which are also referred to as programmable power — DACs).

Auto Testing Systems have been described in a number of ETI articles.

"Computer-interfaced instrumentation in the Development Laboratory", April 1972 discussed the potential.

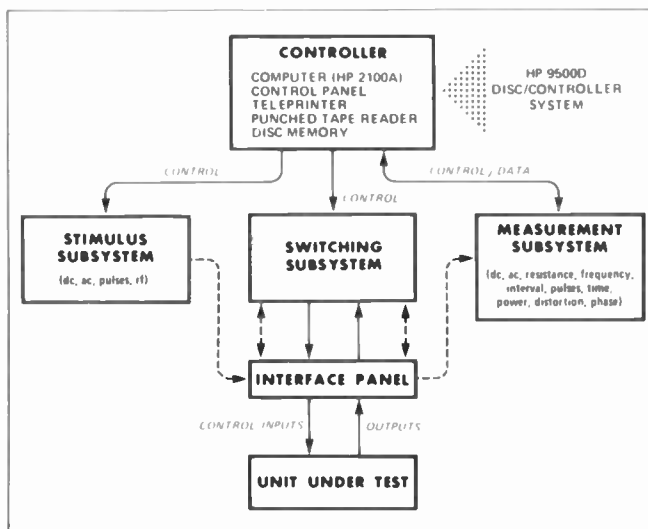

Fig. 20. Overall concept of HP9500 series of automatic test systems.

THE WORLD'S TOP NAME IN SUBMINIATURE LAMPS AND INDICATORS.

Plessey brings you the world's leading range of subminiature lamps and indicators in incandescent, neon and LED styles.

RODAN lamps and indicators are designed for compatibility with and to enhance the presentation of a wide range of electronic, electrical and industrial equipment. These lamps and indicators provide high reliability, long life operation, simplified one-hole mounting, front-of-panel lamp replacement, space-saving physical size, choice of capped or wire-ended styles, insertable indicator lens of various colours and indicator housings of chrome-plated bronze or moulded plastic.

A standardised range is available ex-stock including lamps which comply to International Industrial Specifications. Literature is available on request to the Professional Components Division.

PLESSEY 

Plessey Australia Pty Limited
Components Division

Box 2 PO Villawood NSW 2163
Telephone 72 0133 Telex 20384
Melb Zephyr Products Pty Ltd
56 7231 Adel K. D. Fisher & Co
223 6294 Bris L. E. Boughen & Co
70 8097 Perth H. J. McQuillan Pty
Ltd 68 7111 NZ Henderson (NZ)
6 4189

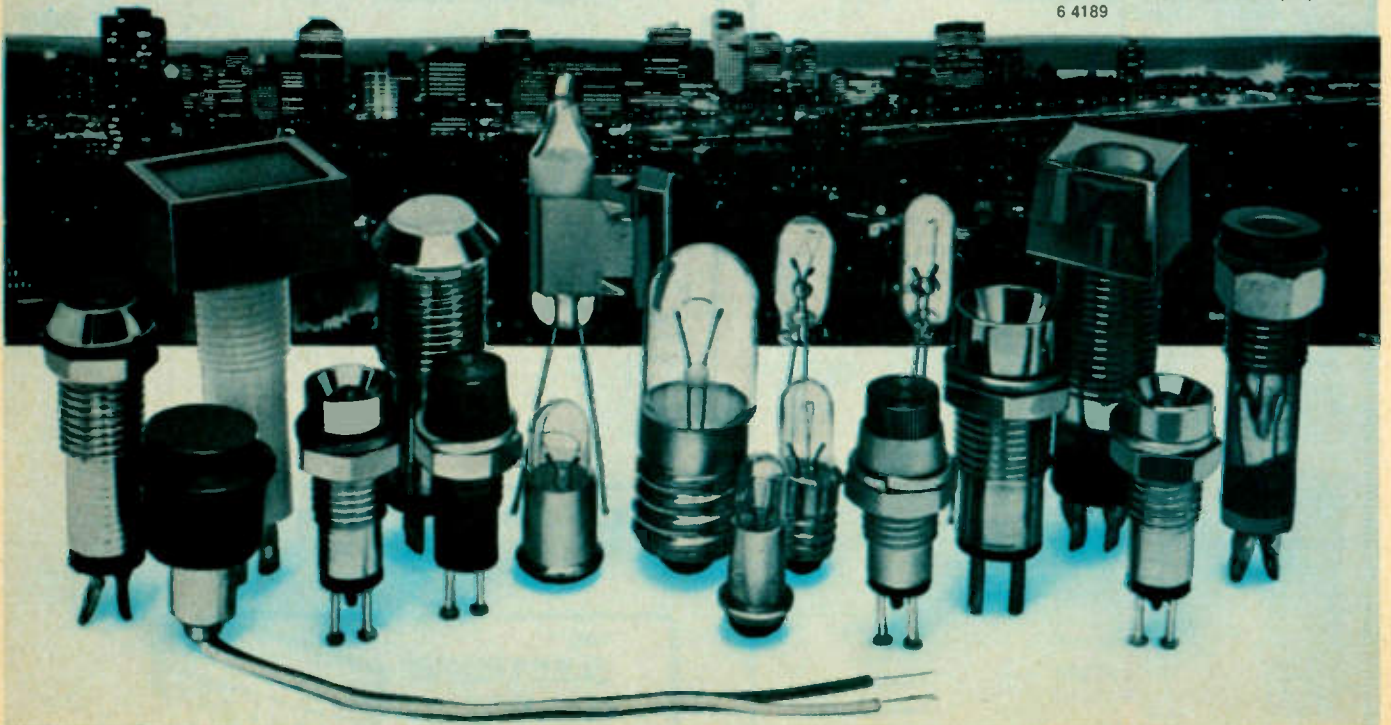

- FAST SERVICE — ALL ITEMS DESPATCHED AT TOP SPEED
- ALL NEW ITEMS — UNUSED AND CARRY MANUFACTURER'S GUARANTEE
- SATISFACTION OR MONEY BACK — (IF GOODS RETURNED WITHIN 7 DAYS)
- PRICES INCLUDE SALES TAX, POSTAGE AND PACKING
- DATA SHEETS/APPLICATION NOTES AVAILABLE — 20c EXTRA PER DEVICE
- FIRST QUALITY BRANDED COMPONENTS FROM THE WORLDS LEADING SEMI CONDUCTOR HOUSES
- 10% DISCOUNT ON ORDERS OVER \$25.00 (COMPONENTS ONLY - NOT HOBBY KITS)

EXPERIMENTERS BONANZA! Special Purpose IC Collection

- "BAR-O-LIGHT"**
UAA180 LED DRIVER - Drives up to 12 LEDs to give bar chart type indication - add 7 resistors to make up VU meters, thermometers, tachometers etc. etc. (Suitable LEDs readily available - 20c each) supplied complete with socket, data and applications notes. **\$3.30**
- "SPOT-O-LIGHT"**
UAA170 LED DRIVER - Drives up to 16 LEDs with a moving pointer type Indicator. Add 8 resistors to make voltmeters, frequency indicators, dial drives etc. etc. (Suitable LEDs readily available - 20c each). Supplied complete with socket, data and application notes. **\$3.50**
- "TACHOMETER" SAK140**
Automotive Tachometer IC. Add resistors and capacitors to build a very simple tachometer to suit virtually any car. Combined with UAA180 will produce a very economical tachometer with LED readout. Supplied complete with socket, data and applications notes. **\$2.00**

- LM3909 LED FLASHER**
A proven winner. This incredibly popular device can be built into low drain flashers, radio, electronic sirens. Supplied complete with socket, data and application notes. **\$1.60**
- DUAL 6W HI FI**
LM379 is a single IC which can drive 8 ohm speaker at 7 watts! It is internally stabilized and the output is thermally protected. This can be easily used to produce a very low cost HI FI system with the minimum of components. Supplied complete with data and applications notes. **\$6.25**
- MC1310 FM STEREO DECODER**
The MC1310 is a phase locked loop intended for decoding FM stereo transmissions. The IC is very simple to use and it requires no external coils whatsoever. Convert your mono FM receiver to stereo. Supplied complete with socket, data and applications notes. **\$4.25**
- 1024 BIT MEMORY**
MM2102N - 1024 bit static RAM
Experiment with computer memories using this remarkable device. Arranged in a 1 x 1024 bit array this IC only requires a single +5V supply and because operation is STATIC no complex refreshing circuits are used. Quantity prices for 6 or 8 2102's are also available. Supplied complete with socket and applications data. **\$6.50**

- ### SPECIALS OF THE MONTH
- | | |
|-------------------------|--------|
| 4011 CMOS NAND GATE | .30 |
| 4001 CMOS NOR GATE | .30 |
| 7490 TTL DECADE COUNTER | .75 |
| 556 DUAL 555 TIMER | \$1.50 |
| LM3900 QUAD AMPLIFIER | \$1.20 |
| NE555 TIMER | .70 |

- ### VOLUME BUYS
- | | |
|-----------------------------------|---------------|
| 5023 LEDs | 10 for \$2.00 |
| 1N914 DIODES | 20 for \$1.50 |
| 1N4004 DIODES | 10 for \$1.00 |
| 741CN OP AMP | 5 for \$3.00 |
| 2N3055 NPN 115W Power Transistors | 4 for \$3.20 |
- (Complete with hardware)

- ### TRANSISTORS
- | | | |
|-------------|-----------------------------------|--------|
| BC107/BC547 | NPN Audio Driver Amplifier | .25 |
| BC108/BC548 | NPN Low Voltage Audio | .25 |
| BC109/BC549 | NPN Low Noise HI FI Amp | .25 |
| BC177/BC557 | PNP Audio Driver Amplifier | .25 |
| BC178/BC558 | PNP Low Voltage Audio Amplifier | .25 |
| BC179/BC559 | PNP Low Noise Input Stages | .25 |
| BC639 | NPN 80V 1W Driver | .60 |
| BC640 | PNP 80V 1W Driver | .60 |
| BD137 | NPN 60V 8W Driver | .85 |
| BD138 | PNP 60V 8W Driver | .85 |
| BD139 | NPN 80V 8W Driver | .90 |
| BD140 | PNP 80V 8W Driver | .90 |
| BF180 | NPN High Frequency Pre Amp | \$1.20 |
| MU10 | UJT General Purpose | .60 |
| 2N2955 | PNP 114W Power Driver (T03) Metal | \$1.70 |
| 2N3053 | NPN 5W Medium Power Driving | .80 |
| 2N3054 | NPN 25W 4A Power Switching | \$1.50 |
| 2N3055 | NPN 115W Power Driver (T03) Metal | \$1.20 |
| 2N3638 | NPN 500mA High Current Amp | .45 |
| 2N3643 | NPN 500mA High Current Amp | .50 |
| 2N3644 | PNP 500mA High Current Amp | .45 |
| 2N4220 | FET | \$1.20 |
| MPF102 | FET | .60 |
| 2N5459 | FET MPF105 | .65 |
| 2N5461 | FET | .75 |
| 2N5485 | FET MPF106 | .80 |
| 2N6027 | PUT D13T1 | \$1.20 |
| 2N2646 | UJT | \$1.40 |

- ### OPTO ELECTRONICS
- | | | |
|--------|--|--------|
| BPX25 | Photo Transistor | \$3.00 |
| ORP12 | Photo Resistor | .85 |
| 5023 | General Purpose Red LED with Clip | .25 |
| LD261 | Miniature PCB Mounting LED - Infra Red | \$1.50 |
| LD461 | Miniature PCB Mounting LED - Visible Red | .60 |
| NCT200 | Photo/Transistor Opto Coupler | \$1.50 |
| NSN61 | .6" Common Anode Display (747) | \$3.50 |
| NSN64 | .6" Common Cathode Display | \$3.50 |
| NSN71 | .3" C Anode 7 Display (707) | \$2.40 |
| NSN73 | .3" \bar{C} Format C Cathode | \$2.40 |
| RED 1 | Red LED 6mm JUMBO size with Clip | .30 |

CATALOGUE OF COMPLETE STOCK LISTING AVAILABLE ON APPLICATION

THE
ELECTRONIC MAILBOX
P. O. BOX 355,
HORNSBY N.S.W. 2077



ELECTRONIC HOBBY KITS

To-days Technology for Your Enjoyment

ETI 740 - SUPERB FM!

high quality push button varicap FM stereo tuner sets new standards of performance

THE FM TUNER KIT YOU HAVE WAITED FOR
 The ETI 740 is a novel design for an FM tuner which achieves high performance and eliminates the critical setting up required with many other tuners. The front end is a ready built pre aligned module which then feed CA3089 IF and demodulator integrated circuit via ceramic filters. The CA3089 provide AGC, AFC muting as well as signal strength and tuning varicap drive voltages. Temperature compensated varicap tuning allows stations to be selected either by a ten turn tuning potentiometer or by a choice of three preset push button controls. The actual frequency selected is displayed on the unique "electronic dial" display mounted behind the front panel. The stereo decoder is based on a well proven integrated circuit phase locked loop which is followed with active filters to remove subcarrier harmonics and "birdies". A LED stereo beacon indicates when stereo transmissions are being received. The specially designed transformer has a built in electrostatic shield to eliminate annoying mains "clicks". The ETI 740 is available as a complete pack or assembled and tested. Please write for further details.



Now available: your choice of black anodized or brushed finish front panels, please specify when ordering.

KIT PRICE
\$120.00

(plus \$5.00 freight and packaging)

Assembled and tested
 ETI740 complete \$155.00 (plus \$5.00 freight and packaging)
 AT3089 demodulator module \$22.00 (delivered free in Australia).
 AT1310 stereodecoder or module \$17.50 (delivered free in Australia).

ETI 440 SIMPLE 25 WATT AMPLIFIER

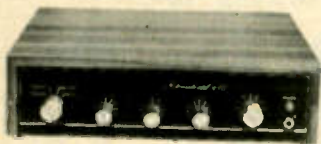

Designed by the ETI Team the International 440 is a remarkable combination of high performance, easy construction and low cost. We offer our own exclusive step by step assembly manual, the choice of buying individual packs or the full kit and a really good looking Walnut Veneered Cabinet that guarantees you a professional finished product anyone would be proud to own. For pack prices, see December ETI.

With our full Technical support and Warranty Service (see below) you just can't fail to build this kit!

\$85.00 nett. Assembled and Tested \$115 nett, Plus \$5 freight and packaging.

For other kits please refer to our ad in ETI Merch, 1976 pp 44-45.

FULL TECHNICAL SUPPORT AND WARRANTY SERVICE

All Applied Technology HOBBY KITS are covered by our exclusive 90 days warranty against faulty components and packaging (full details with each kit).

Yet another exclusive is the full technical support service. If you are unable to make your HOBBY KIT operational help is just a phone call or letter away. If you do have to return any KIT for factory attention, it will be repaired for a nominal service fee.

All kits are on display at our Factory Showroom. Personal callers welcome - weekdays by appointment, or anytime Saturday Mornings. Phone 476 4758.



108-111 Hunter Street,
 HORNSBY, N.S.W. 2077
 Phone (02) 476-4758
 Open Saturday morning

Please supply

.....

Enclosed is my Cheque/Postal Note/Money Order for \$.....
 made out to APPLIED TECHNOLOGY PTY. LTD.
 (PLEASE PRINT CLEARLY)

NAME

ADDRESS

..... P/C

ETI 4/76

HI-FI BONANZA



SURE BEATS
DIGGING
FOR GOLD

Rush into the hi-fi Bonanza and stake your claim on a mountain of pure hi-fi equipment. With savings what they are, it sure beats digging for gold.



'AKAI' 46D DOLBY
CASSETTE DECK
\$249

The works, at the craziest discount price. Auto Dolby noise reduction system to assure distortion free sound reproduction. Life time guarantee on GX head, auto stop hi-fi frequency response, tape selector switch, hi volume recording level, O.L.S. switch. 30-18,000 Hz.

SCOOP BUY



Save \$290 on
MARANTZ HI-FI AMP

WAS \$789
NOW **\$499**

Delivers a fantastic 140 WATTS R.M.S. Both channels operating 4 x 25 watts R.M.S. Quad radial operation. Full 3 years parts & labour warranty. Be quick.



LATEST 'AKAI' AM/FM
TUNER AMP
Save \$100
on model AA 1040
40 x 40 watts R.M.S. **\$329**



'AKAI' 4,000 D.S. Mk II
PROFESSIONAL 3 HEAD
DECK

4 track stereo & mono operation. Sound mixing system with sound on sound facility. Stacks of features. Hurry!

Previously discounted down to \$259
now **\$219**
Spools not Incl.

TAPE SPECIALS

BASF C60 Chrome \$1.30
Agfa C90 Super Chrome \$2.50
Memorex C90 \$2.50
Memorex C90 Chrome \$3.30



FAMOUS JENSEN Model 2
was \$179
With 5 year warranty. Better hurry.
NOW **\$149** PR.



SONY TC 121
Superb stereo cassette deck with auto stop & pause control. Bargain. **\$109**

SONY ST 70
AM/FM stereo Tuner. Only a limited number at this soundational discount price. **\$107**



SANSUI 771 FM/AM
TUNER AMP
45 x 45 Watts R.M.S.
Great unit. Great value. **\$369**
Hurry.

HI-FI STRIKE OF THE YEAR!
ATRON 3000 SYSTEM
From the makers of acoustic research.

\$375

You can't beat the system. Not this one at a sensational \$375! With superbly designed FM/AM hi-fi tuner amp. Built in quad 4 channel synthesizer. 15 x 15W R.M.S. Full range Speakers, auto return belt drive table. At just \$375 it's RED HOT.



bankcard



The SET everyone's talking about!
GENERAL COLOUR TV

\$449 UHF & VHF TUNER
FULL PAL 'D' SYSTEM
445 mm screen. (approx 18") Black matrix tube. \$449 incl. delivery & manufacturer's warranty, plus \$15 installation, plus \$35 service contract if required.

Douglas-hifi

SELLS SOUND FOR LESS

191 BOURKE ST., MELBOURNE — 63 9321
338 GEORGE ST., SYDNEY — 25 3701
(Previously Palings buildings opp. Wynyard Station)

Ideas for experimenters

As the name of this section implies, these pages are intended primarily as a source of ideas. As far as reasonably possible all material has been checked for feasibility, component availability etc, but the circuits have not necessarily been built and tested in our laboratory.

Because of the nature of the information in this section we cannot enter into any correspondence about any of the circuits, nor can we produce constructional details.

Electronics Today is always seeking material for these pages. All published material is paid for — generally at a rate of \$5 to \$7 per item.

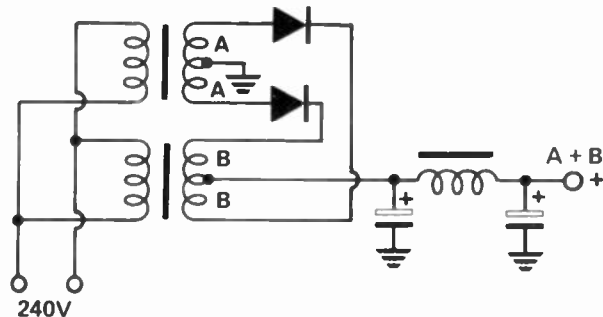

circuit should be of interest.

The transformer on the positive side must have sufficient insulation breakdown voltage to handle the combined voltages. Current capacity of each should be sufficient for requirements. The rectifiers should

have a peak inverse rating greater than the combined voltages. Transient protection is best placed across the primary side. The transformers must of course be correctly phased or the output will be reduced. Phasing is best accomplished in the primary circuits.

STORING CMOS IC'S

CMOS IC's can easily be damaged by constant handling. One method to overcome this problem is to wrap the I.C. in foil thereby ensuring that all the pins are shorted together. One disadvantage of this method however is that with several devices in the same drawer each one must be unwrapped to find out what it is. The method I have been using with complete success is to cut up a piece of polystyrene sheet, (a ceiling tile is quite satisfactory) to fit my component drawer, then wrapping it in aluminium foil.

The I.C.'s can then be pushed through the foil into the polystyrene. Not only are all the pins shorted but the I.C.'s can be easily identified.

COMBINING TRANSFORMERS

We all need power supplies from time to time . . . unless you work for Union Carbide!

Two unlike power transformers cannot usually be connected together, in series that is, to obtain a higher dc output voltage from a power supply as no centre tap is then available. And as bridge rectifiers are not always convenient in such cases the following

BROADCAST BAND PRESELECTOR

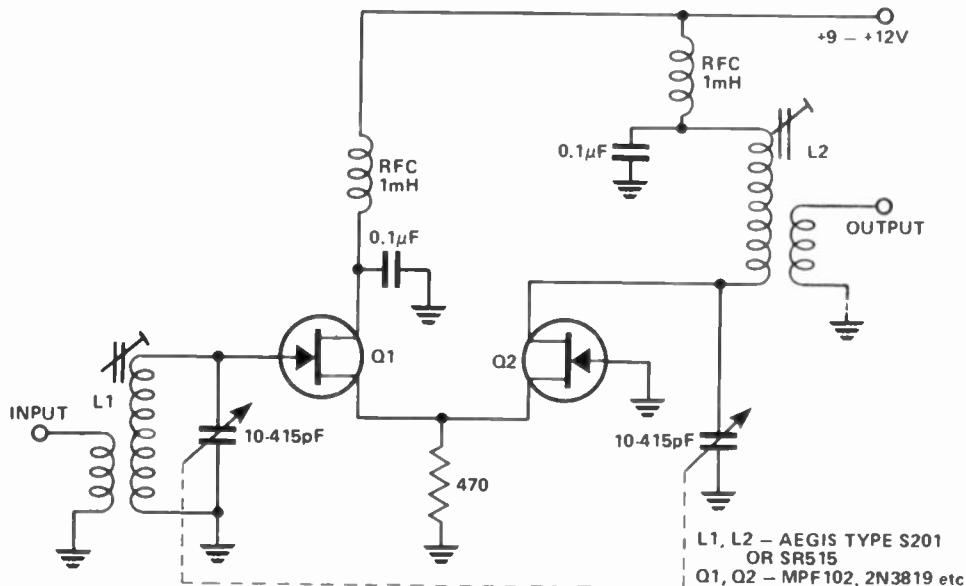

A preselector is very useful for broadcast band DX listening or for improving reception in country areas. It provides extra front-end selectivity as well as improving sensitivity. The circuit given here is simple to construct and performs very well. The coils L1 and L2 are locally available

but other types made for broadcast band RF or antenna applications are suitable. L1 and L2 should be mounted no closer than 150 mm to each other to avoid RF feedback and possible instability although they are shielded.

Special Readers' Offer

CORVUS

Advanced Scientific Calculator

Because of exceptionally high reader interest this offer originally made in our March issue is now extended to May 10th 1976.

\$99.50*

THE CORVUS 500 is an advanced scientific calculator similar in many ways to Hewlett-Packard's HP-45 and Texas Instruments' SR 51. This is understandable as Corvus was the calculator division of Mostek — the people who made the microprocessor chips for the HP 45 and HP 35 calculators.

A comparison of the three calculators is contained in Table 1 below. As can be seen the Corvus has quite remarkable capabilities for its (special offer) price. In addition the Corvus 500 is one of the most attractive and well styled units we have yet seen.

The Corvus 500 uses Reverse Polish notation and a four level stack to perform its calculations in either fixed point (number of decimal places displayed is selectable) or scientific display mode (10 digits plus two digit exponent).

In addition 12 digit floating operation is possible — which automatically changes to scientific notation if 12 digits overflow. Thus $\sin 20^\circ$ is calculated as 0.342020143328!

The valid exponent range in scientific notation can extend from +199 to -200 whilst still obtaining a correct answer in the mantissa (leading figures of exponent not displayed). When exponent overflows the display flashes cyclically. The flashing warning may be deleted by pressing the clear flag once — whence calculations can be continued with the calculated number, or the x register may be completely

cleared by pressing the clear key for a second time.

The Corvus 500 has flexible statistical functions. It is possible to sum two sets of data simultaneously (x and y registers). The sum and standard deviation of the x sum are called up by keyboard command, as well the number of x entries can be found in memory 7, the sum of x^2 in memory 8 and the sum of x in memory 9.

The percentage calculations offered are very useful. The two keys % and $\Delta\%$ may be used to calculate percentage difference, percentage mark-up or discount and gross profit margin. The Reverse Polish mode of operation makes these calculations particularly straightforward.

CRITICISMS

The handbook supplied doesn't really do justice to the machine's capabilities. Like most of its kind it's almost adequate but has a few surprising omissions.

The machine's 62 functions are controlled by 30 keys. Because of this it is necessary to use the calculator fairly frequently to remember the various sequences. This criticism is of course applicable to other machines of this type.

Because the display reads out to 12 digits, transcendental and log functions take about three seconds to complete — it's a trade off between time and accuracy.

SUMMARY

The above criticisms relate to only minor drawbacks in a calculator which is flexible, extremely accurate and much less expensive than others with similar capability.

We thoroughly recommend this powerful advanced scientific calculator. It is excellent value for money.

COMPARISON OF ADVANCED SCIENTIFIC CALCULATORS

FEATURES	CORVUS 500	T.I.SR 51	HP 45	FEATURES	CORVUS 500	T.I.SR 51	HP 45
Type of Display	LED	LED	LED	Vector Addition/	Yes	No	Yes
Digits in Display	14	14	14	Subtraction	Yes	Yes	No
Fixed Decimal	to 9 places	to 8 places	to 9 places	No. Memories	9	3	9
Rechargeable	Yes	Yes	Yes	Memory Exchange	Yes	Yes	No
Type of Logic	RPN	Algebraic	RPN	Permutations	No	No	Yes
No. Keys	30	40	35	Scientific Notation	Yes	Yes	Yes
+, -, x, =	Yes	Yes	Yes	"	Yes	Yes	Yes
Trig	Yes	Yes	Yes	Change Sign	Yes	Yes	Yes
Inverse Trig	Yes	Yes	Yes	Stack Operation	Yes	No	Yes
Range of Trig	Full Circle	Full Circle	Full Circle	Rotate Stack	Yes	No	Yes
log x, LN x	Yes	Yes	Yes	Recall Last x	Yes	No	Yes
e^x	Yes	Yes	Yes	CONVERSIONS			
10^x	Yes	Yes	Yes	Degrees — Radians	Yes	Yes	No
Hyperbolic Functions	Yes	Yes	Yes	Degrees — Grads	No	Yes	No
Degrees/Radians	Yes	Yes	Yes	Polar — Rectangular	Yes	Yes	Yes
Grads	No	No	Yes	Deg/Min/Sec — Decimal	No	Yes	Yes
$Y \times$	Yes	Yes	Yes	Litres — Gallons	Yes	Yes	Yes
$x^n \sqrt{y}$	Yes	Yes	No	Centigrade — Fahrenheit	Yes	Yes	No
$x^2 \times \frac{1}{x}$	Yes	Yes	Yes	Centimetre — Inches	Yes	Yes	Yes
$x!$	Yes	Yes	Yes	Kilograms — Pounds	Yes	Yes	Yes
$x \text{ ex } y$	Yes	Yes	Yes	Mils — Microns	No	Yes	No
%, $\Delta\%$	Yes	Yes	Yes	Feet — Metres	No	Yes	No
Gross profit margin	Yes	No	No	Yards — Metres	No	Yes	No
$\Sigma + \Sigma -$	Yes	Yes	Yes	Miles — Kilometres	No	Yes	No
Mean/standard deviations	Yes	Yes	Yes	Miles — Nautical Miles	No	Yes	No
Variance	No	Yes	No	Acres — Ft. 2	No	Yes	No
Random No. Gen	No	Yes	No	Fluid Oz. — Litre	No	Yes	No
Linear Regression	No	Yes	No	Fluid Oz. — CC	No	Yes	No
Slope/Intercept	No	Yes	No	Ounces — Grams	No	Yes	No
				Short Ton — Metric Ton	No	Yes	No
				BTU — Calories	No	Yes	No
				Voltage Ratio — dB	No	Yes	No

Data supplied by manufacturers of Corvus unit.



CORVUS 500

"THE SCIENTIST/ENGINEER'S PROBLEM SOLVER"

WITH REVERSE POLISH NOTATION

... this new entry to the scientific field offers the ultimate package—the efficiency and simplicity of Reverse Polish Notation, a powerful 4-register stack with nine memory registers, a 12-digit display for exacting accuracy, (scientific format of 10-digit mantissa, 2-digit exponent), total capability in scientific functions plus additional capabilities in statistics, conversions, and business

- | | | |
|------------------------------------|--|---|
| Clear | Memory recall, 9 registers | Summation plus (adds X and Y to memory for vector addition recalls sum of X and sum of Y) |
| Clear display | Memory exchange, 9 registers | Percentage |
| Add subtract, multiply divide | X ↔ Y exchange | Percentage difference (%) |
| Scientific display format | Common log | Mean |
| 10-digit mantissa | Natural log | Standard deviation |
| 2-digit exponent | 4-stack register | Centigrade to fahrenheit |
| floating decimal | Rotate stack | Liters to gallons |
| Mode set to radians | Recall last X | Centimeters to inches |
| Fix decimal point (0-9) in display | Y to the X power | Kilograms to pounds |
| Sine | Reciprocal for all values, exponent range from .199 through .200 | Degrees to radians |
| Cosine | Pi | Set radian mode for trigonometric functions |
| Tangent | Change sign | Trigonometric rectangular to polar |
| Hyperbolic sine | Square root | Hyperbolic rectangular to polar |
| Hyperbolic cosine | Factorials | |
| Hyperbolic tangent | | |
| Memory store, 9 registers | | |

THESE FUNCTIONS ARE OBTAINABLE THROUGH THE INVERSE CALCULATION SEQUENCE:

- | | | |
|------------------------------------|--|---|
| Business display format, 12-digits | Gross profit margin percentage | Trigonometric polar to rectangular |
| floating decimal point | Summation minus for vector subtraction | Hyperbolic polar to rectangular |
| Arc sine | | Set degree mode for trigonometric functions |
| Arc cosine | Anti log, natural (e ^x), for all values from .230 through .230 | X ^Y |
| Arc tangent | Anti log, common (10 ^x), for all values from .999 through .999 | Fahrenheit to centigrade |
| Arc hyperbolic sine | | Gallons to liters |
| Arc hyperbolic cosine | | Inches to centimeters |
| Arc hyperbolic tangent | | Pounds to kilograms |
| Xth root of Y | | |

OTHER FEATURES:

- | | |
|---|--|
| Display number (X) times 10 to 100 power as 0.X.99 | Anti-logarithm and logarithm accuracy near 0 and 1 respectively |
| Display indicator for radian mode (decimal in right most LED) | Nickel-cadmium rechargeable batteries, AC adapter/charger carrying case included. Six hours operation on full 12-hour charge |
| Trig/Hyperbolic accuracy near angle 0 (and 90 degrees) | |

Corvus calculators are marketed in Australia by Unitrex Pty Ltd, 414 Collins St., Melbourne.

NOTES

The Corvus 500 is warranted for a period of 12 months from original purchase date — under normal use and service — against defective materials or workmanship. Defective parts will be repaired or replaced at Unitrex's option when the calculator is returned prepaid to Unitrex of Australia Pty Ltd., 414 Collins St, Melbourne, Vic 3000. The warranty is void if the calculator has been damaged by accident or misuse. Removal or alteration of serial number or repair by unauthorised personnel also voids warranty. The warranty contains the entire obligation of Unitrex of Australia Pty Ltd and no other warranties, expressed, implied or statutory are given — this warranty does not exclude limit restrict or modify any condition or warranty implied by the Trade Practices Act 1974, or other State laws or Acts...

Price includes sales tax. Authorized purchasers may obtain units tax free (\$86.32 + \$2.50 post and packing) if a valid tax certificate is supplied.

The units can only be obtained as below. Electronics Today International cannot supply directly nor can undertake to demonstrate or discuss details of the units offered.

All units will be thoroughly inspected before despatch. The package should be carefully inspected before accepting delivery. Acceptance should be refused if the package is damaged.

Orders must be addressed exactly as per the coupon. Due to postal delays, readers should expect a delay of between three to four weeks between posting an order and obtaining delivery.

Finally — in the event of the unit not working — please return it directly to Unitrex, 414 Collins St, Melbourne, Vic 3000. NOT to ETI. This offer now closes on May 10th, 1976.

Corvus Offer

Name
Address

Please forward Corvus 500 Calculator/s. My cheque/postal note for is attached. Make cheque/postal note payable to Corvus Offer. Please forward \$102 (i.e. \$99.50 plus \$2.50 postage and packing) per unit.

Send to Corvus Calculator Offer
c/- Electronics Today International
15, Boundary St., Rushcutters Bay, NSW 2011.

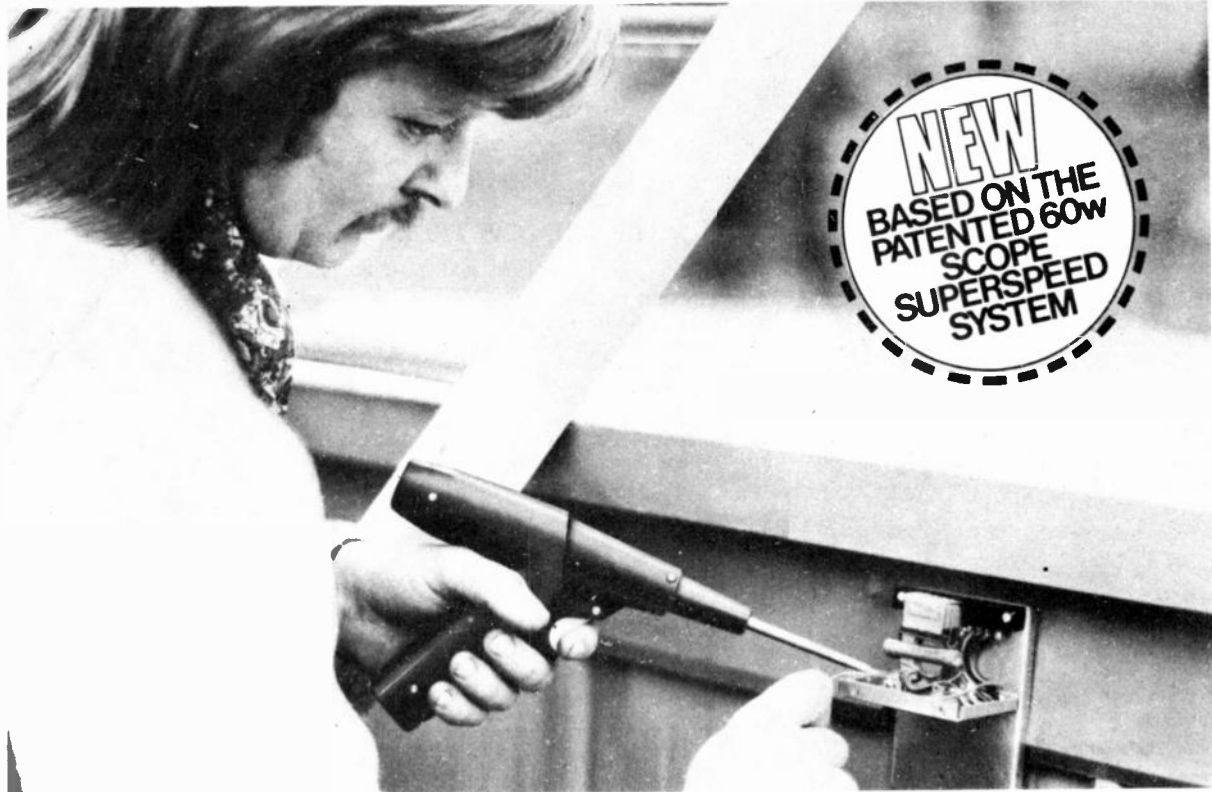

Scope Cordless 60w Soldering Tool

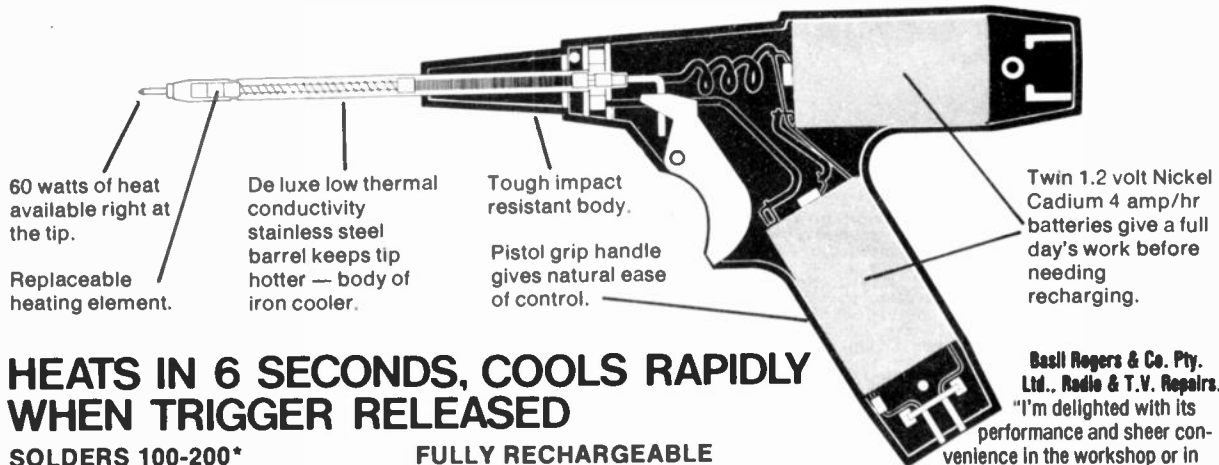

60 watts of heat available right at the tip.

Replaceable heating element.

De luxe low thermal conductivity stainless steel barrel keeps tip hotter — body of iron cooler.

Tough impact resistant body.

Pistol grip handle gives natural ease of control.

Twin 1.2 volt Nickel Cadmium 4 amp/hr batteries give a full day's work before needing recharging.

HEATS IN 6 SECONDS, COOLS RAPIDLY WHEN TRIGGER RELEASED

SOLDERS 100-200* TYPICAL JOINTS BEFORE RECHARGING

* Light electrical connections. Capacity will vary for lighter or heavier joints.

PISTOL GRIP DESIGN balances weight of cells for comfort and tip control.

FULLY RECHARGEABLE OVERNIGHT, from car, power-point or Scope Transformer.

ABSOLUTE SAFETY
No earth leakage currents. Solder anywhere with total personal and component protection.

Basl Rogers & Co. Pty. Ltd., Radio & T.V. Repairs.
"I'm delighted with its performance and sheer convenience in the workshop or in the field. It's light, fits easily in your hand and you can solder even with the set on."

Kevin Ball, T.V. Technician.
"In my job I work mainly on circuit boards and I'm rapt with Scope Cordless. I've never reached a point where the gun can't handle a day's soldering. I like the feel of it; tremendous balance."

SCOPE

Distributors to the Electrical Trade:

NATRONICS PTY. LTD. The Crescent, Kingsgrove, N.S.W. 2208

Manufactured by: **SCOPE LABORATORIES, MELBOURNE.**

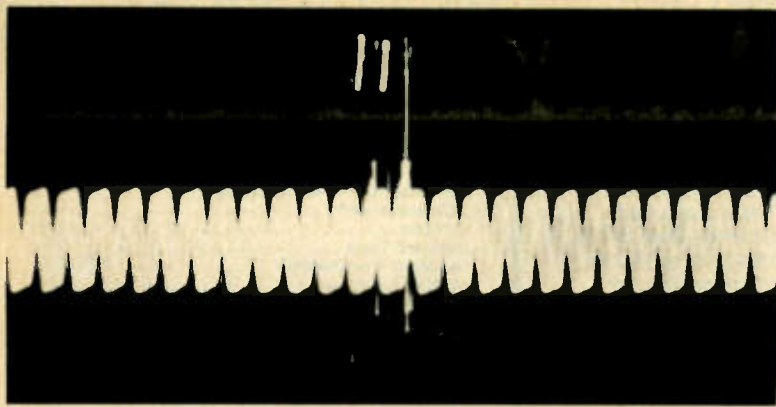

Actual, unretouched photo of an oscillograph test.

the sound of a fingerprint

The oscillograph you see is an actual photo of a high-quality audio system "playing" a fingerprint.

You're hearing some now through your speaker system. Instead of the sound your precious discs are capable of. And no vacuum record cleaner, brush-arm or treated cloth will remove them. None.



But Discwasher™ —with new  fluid— removes fingerprints completely. Along with dust. And manufacturing lubricants (added to make pressing faster) that can act like groove-blocking fingerprints. All this cleaning without pulling polymer stabilizers from your vinyl discs.

Discwasher™. The safe, effective way to silence the printed finger. For further information contact



Auriema (A'asia) Pty Ltd

for quality in audio.

Postal Address: PO Box 604, Brookvale, NSW 2100

Phone 939 1900



electronics TODAY SERVICES/ADVERTISERS INDEX

READERS' LETTERS

We make no charge for replying to readers' letters, however readers must enclose a foolscap-size stamped addressed envelope if a reply is required. Queries concerning projects can only be answered if the queries relate to the project as published. We cannot assist readers who have modified or wish to modify a project in any way, nor those who have used components other than those specified.

TELEPHONE QUERIES

We regret that we cannot answer readers' queries by telephone.

SUBSCRIPTIONS

Electronics Today International can be obtained directly from the publishers for \$10.80 per year (including postage) within Australia.

The cost for countries outside Australia is \$10.90 including postage (surface mail). Airmail rates will be quoted on application. Subscription orders and enquiries should be sent to the address below.

BACK ISSUES

Our subscriptions dept can supply most back issues of ETI for the twelve months preceding the date of this current issue. Some earlier issues are also available.

The price of back copies is currently 75 cents, plus 40 cents postage and packing. Please address orders to Subscriptions Dept, Electronics Today, 15 Boundary St, Rushcutters Bay, NSW 2011.

PHOTOSTATS

Photostats of any article ever published in ETI can be obtained from our subscription dept (address above). The price is currently 45 cents per page including postage.

CONTRIBUTORS

Material is accepted from time to time from outside contributors. Payment is based on quality and is paid 30 days after the date of publication.

Constructional projects will be considered for publication but the standard of design must be to fully professional level. All material must be typed using double spacing and wide margins. Drawings, circuit diagrams etc need not be to professional standards as they will be redrawn by our staff. It is advisable to contact the Editor before submitting copy.

A large stamped addressed envelope must be included if unsolicited material is required to be returned.

ADVERTISING QUERIES

Queries concerning goods advertised in ETI should be addressed directly to the advertiser — not to ourselves.

NEWS DIGEST

News Digest items are published free of charge. Manufacturers and importers should send material at least four weeks before the date of publication.

Photographs should be of high contrast and preferably at least 100 by 150 mm. Press releases must be of a factual nature — these pages are not free advertising. The Editor reserves the right to accept or reject material at his discretion. Preference will be given to components and equipment of an essentially practical nature.

BINDERS

Binders to hold 12 issues of ETI are available from our subscription dept (address above). Price is \$4.50 (plus 80 cents postage NSW & ACT — or \$1.50 all other States)

COPYRIGHT

The contents of Electronics Today International and associated publications is fully protected by international copyright under the terms of the Commonwealth Copyright Act (1968).

Copyright extends to all written material, photographs, drawings, circuit diagrams and printed circuit boards reproduced in our various publications. Although any form of reproduction is technically a breach of copyright, in practice we are not concerned about private individuals constructing one or more projects for their own private use, nor by pop groups (for example) constructing one or more items for use in connection with their performances.

Commercial organisations should note however that no project or part project described in Electronics Today International or associated publications may be offered for sale, or sold, in substantially or fully assembled form, unless a licence has been specifically obtained so to do from the publishers, Modern Magazines (Holdings) Ltd or from the copyright holders.

A&R Sonar	107
Akai	16
Amateur Communications	
Advancement	102
Ampec	106
Ampex Tape	34
Applied Technology	122, 123
Audio Engineers	43
Audioson	59
Aurlema	14, 129
Autotronics	69
Ball Electronics	106
Bayroad Electronics	108
Butterworths	58
C&K Electronics	71
Challenge Hi-Fi	48, 100
Chan Merchandising	61
Circuit Components	57
Classic Radio	57
Convoy	92, 110
Danish Hi-Fi	85
Digitronics	83
Douglas Hi-Fi	124
Edge Electrix	56
Electronic Disposals	103
Emona	29
Enrite Electronics	103
Ferguson Transformers	80
George Hawthorn	107
Haco	I.F.C.
Ham Radio	67, 84
Harmon Aust.	5, 95
Hobipak	51
ICS	7
IRH	70
International Dynamics	36, 72, 98, 131
International Electronics	
Unlimited	109
Jacob Mitchell	101
John Carr	8
Kent Hi-Fi	33
Lafayette	103, 51
Leroy	9, 12
Logan Brae	103
MS Components	25-27
Mod Amp	116
National Radio Supplies	93
Nebula Electronics	71
Parameters	115
Philips Elcoma	37
Pioneer	4
Plessey Aust.	121
Racal	102
Radio Parts	60
Rank Industries	132
Sabtronics	42
Scope Laboratories	128
Star Delta Co	65
Toshiba	62, 82
Tudor Radio	73
Union Carbide	94
Video Hi-Fi	15
W.C. Wedderspoon	46
WHK Electronics	47

ADVERTISING

Sydney: Terry Marsden (Manager),
15 Boundary St., Rushcutters Bay, 2011.
Tel 33-4282.

Melbourne: Clarrie Levy, Suite 24,
553 St. Kilda Rd, Melbourne. Tel 51-9836.

Brisbane: David Wood, 11-14 Buchanan
St, West End, Brisbane. Tel 44-3485

Adelaide: Ad Media Group, 12-20
O'Connell St., N. Adelaide.

Tel 267-1129.
Perth: Aubrey Barker,
38 Mounts Bay Rd. Tel 22-3184.

London: Electronics Today International, 36
Ebury St, SW1 WOLW Tel 01-730 8282. New
York: A.C.P. 444 Madison Ave, New York,
10022.

Electronics Today International is published
by Modern Magazines (Holdings) Ltd, 15
Boundary St, Rushcutters Bay, NSW 2011. It
is printed (in 1976) by Wilke & Co Browns
Road, Clayton, Vic and distributed by
Australian Consolidated Press.
*Recommended price only. Copyright.

MAGNEPLANAR®

They don't look like speakers.
They don't sound like speakers.



They sound like you're there ...

Distributed in Australia by

INTERDOYN

INTERNATIONAL DYNAMICS
(AGENCIES) PTY LTD
23 Elma Rd. North Cheltenham,
Melbourne. Victoria 3192

Available from:

A.C.T. Duratone Hi Fi, Cnr. Botany St & Aitree Crt, Phillip 2606. Telephone: 82-1388.
N.S.W. M & G, Hoskins Pty. Ltd, 400 Kent St., Sydney 2000. Telephone: 546-1464, 547-1093.
QLD. Stereo Supplies, 95 Turbot St, Brisbane 4000, Telephone: 21-3623. S.A. Challenge Hi Fi
Stereo, 96 Pirie St, Adelaide 5000, Telephone: 223-3599. TAS. Audio Wholesalers
9 Wilson St, Burnie 7320, Telephone: 31-4111. VIC. Encel Electronics Pty Ltd, 431 Bridge Rd,
Richmond 3121. Telephone: 42-3762. W.A. Arena Distributors, 282 Hay St, Perth 6000.
Telephone: 25-2699.



NOW COMES THE POWER LINE. FROM SANSUI.

Good, solid Sansui quality in a line of receivers with more stereo power and performance for less than you'd expect.

Top-of-the-line is Sansui 881: 63 watts per channel minimum RMS into 8 ohms from 20 to 20,000Hz with no more than 0.3% total harmonic distortion.

Inside, eleven computer-grade ICs and special Circuit Board Module construction eliminate a lot of the internal wiring to assure long-term stability.

Outside, rugged controls tailor the sound and direct 'signal traffic' throughout the 881 for 3 pairs of stereo loudspeakers, tuner section, turntables, decks, tape dubbing, microphone mixing, and much more.

But if the 881 is too much of a good thing, the Power Line offers other big-value receivers with similar cost/performance advantages.

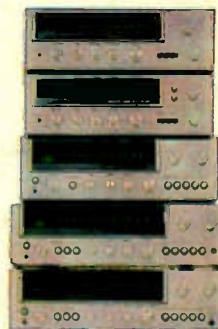

Sansui is Hi-Fi Stereo.



RANK AUSTRALIA

12 Barcoo Street, East Roseville, N.S.W. 2069. Phone: 406 5666
 58 Queensbridge Street, South Melbourne, Victoria 3205. Phone: 61 3281
 14 Proe Street, Fortitude Valley, Queensland 4006. Phone: 52 7333
 2 Bowen Street, Kensington, South Australia 5068. Phone: 332 4288