

MARCH 1976
75c*

electronics

TODAY

INTERNATIONAL

**FM TUNER
TO BUILD**

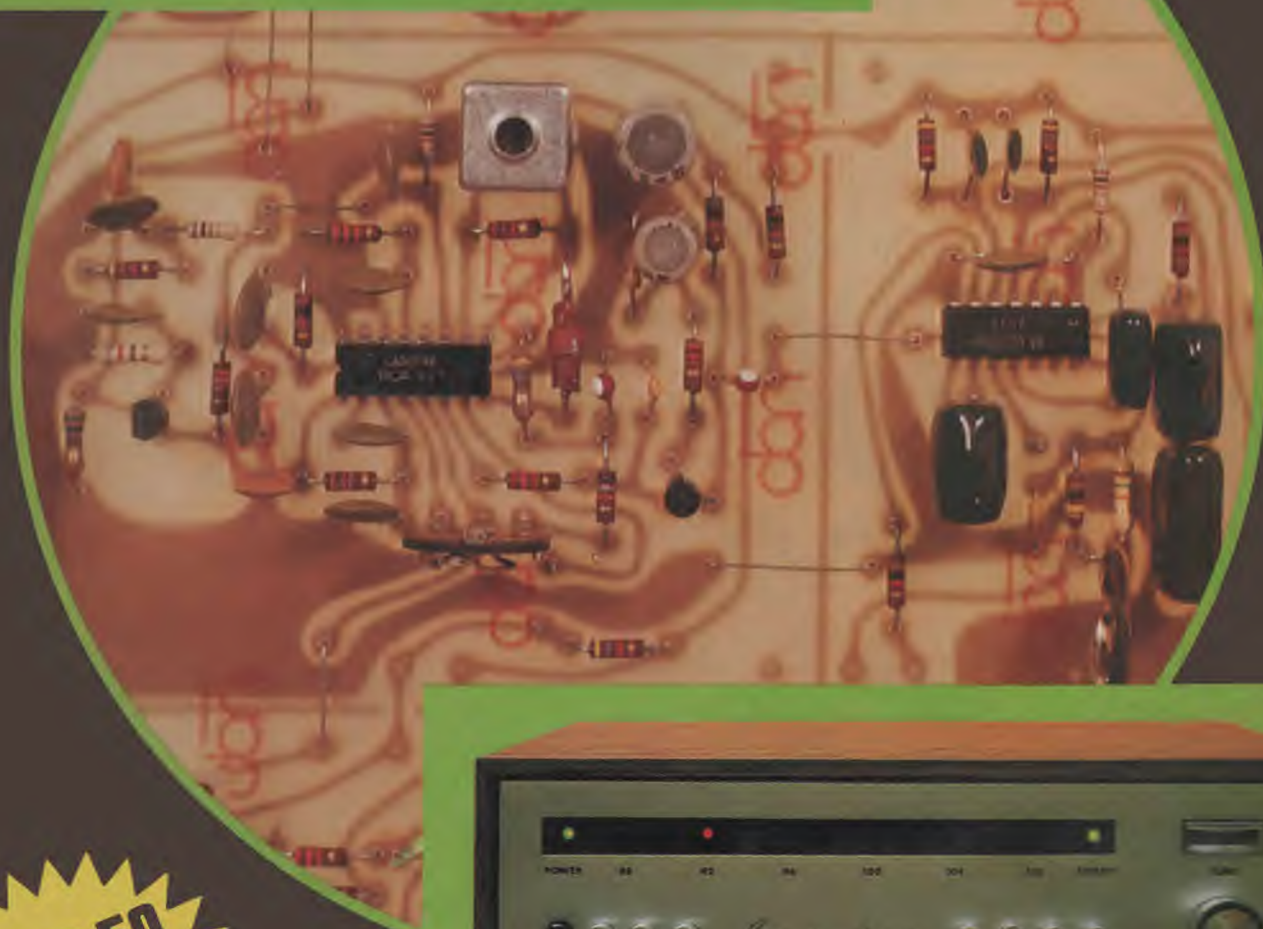

**\$99.50
OFFER!**

ADVANCED SCIENTIFIC CALCULATOR

Registered for posting as a periodical-Category C

electronics

TODAY

INTERNATIONAL

MARCH 1976, VOL 7, NO3.

EDITORIAL

Editorial Director: Collyn Rivers
Engineering Manager: Barry Wilkinson
Technical Editor: Brian Chapman

ADVERTISING

Sydney: Terry Marsden (Manager),
 15 Boundary St., Rushcutters
 Bay, 2011. Tel 33-4282.
Melbourne: Clarrie Levy, Suite 24,
 553 St. Kilda Rd,
 Melbourne. Tel 51-9836.
Brisbane: David Wood, 11-14 Buchanan
 St, West End. Brisbane.
 Tel: 44-3485
Adelaide: Ad Media Group, 12-20
 O'Connell St.,
 N. Adelaide. Tel 267-1129.
Perth: Aubrey Barker,
 38 Mounts Bay Rd.
 Tel 22-3184.

PUBLISHER: Collyn Rivers

OVERSEAS

London: Electronics Today
 International, 36 Ebury St, SW1 WOLW
 Tel 01-730 8282. **New York:** A.C.P. 444
 Madison Ave, New York, 10022.

GENERAL:

Electronics Today International is
 published by Modern Magazines
 (Holdings) Ltd, 15 Boundary St,
 Rushcutters Bay, NSW 2011. It is
 printed (in 1975) by Wilke & Co,
 Browns Road, Clayton, Vic and
 distributed by Australian Consolidated
 Press. *Recommended price only.
 Copyright.

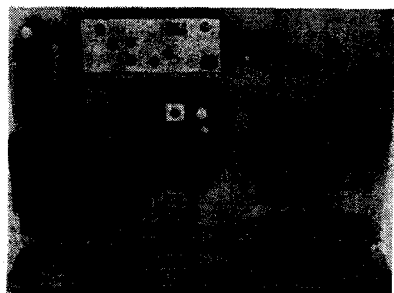

COVER: ETI'S state of the art FM
 tuner. Full constructional details of this
 fine new unit complete in this issue -
 page 27 onwards.

PROJECTS

- FM TUNER**27
Full constructional details of ETI's brilliant new design.
- TOUCH SWITCH**39
Total safety touch switch for 240 Vac operation.
- ACTIVE ANTENNA**47
Improve short and medium wave listening with simple active antenna.
- RF ATTENUATOR**59
0-31 dB attenuation in 1 dB steps to plus 200 MHz.

FEATURES

- LASERS LIGHT & TELEPHONES**20
Laser technology may revolutionize telecommunications - Prof. Gambling reports.
- THE PARABOLIC STYLUS**52
Significant advantages in the search for fine quality sound.
- ELECTRONICS IT'S EASY!**76
Digital instruments and testing equipment
- STATE OF THE ART**87
Eighty four contacts via moonbounce - full report.
- IDEAS FOR EXPERIMENTERS**92
Pot pourri of circuits, ideas, hints and tips
- ADVANCED SCIENTIFIC CALCULATOR**100
Special reader offer - don't miss this under \$100 unit.

PRODUCT TEST

- TOSHIBA DIGITAL SYNTHESIZER FM TUNER**
Full in-depth review of Toshiba's state of the art FM tuner. 66

NEWS & INFORMATION

NEWS 5, ERRATA AND ADDENDA 13, AUDIO FACTS 17, NEXT
 MONTH'S ISSUE 37, ADVERTISING INDEX 102, SERVICE NOTES 102.



A MODERN MAGAZINES
 PUBLICATION

**NEXT MONTH SPECIAL
 FIFTH BIRTHDAY
 ISSUE SEE
 PAGE 37**

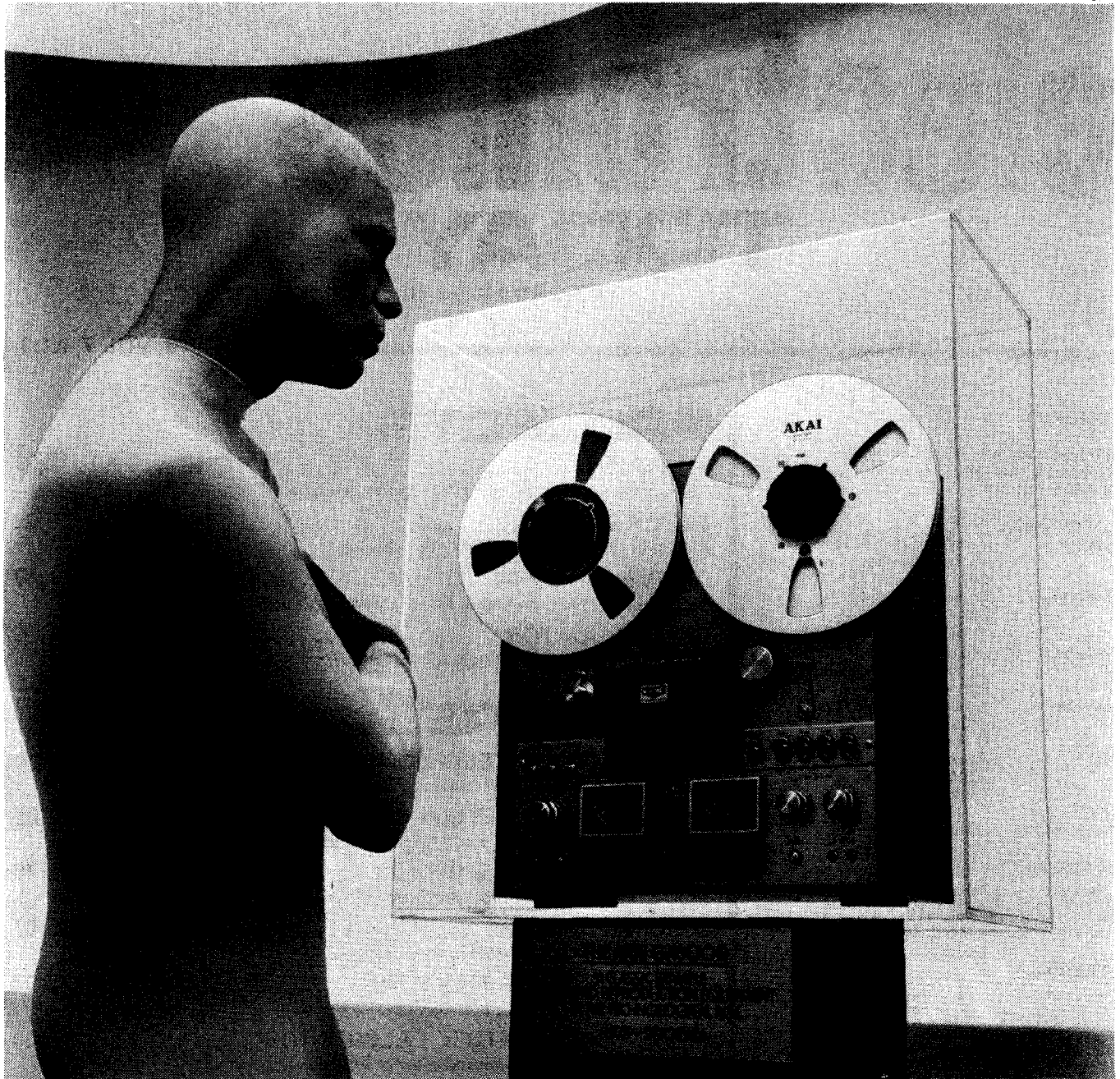

Its rewards might be in another place and time, but yours are here and now.

The GX600D tape deck illustrated above is one of our top models. It retails around \$770. That's a lot. But the GX600D is a lot of tape deck. It's totally professional in every function. Recording, dubbing, mixing, playback.

Yet the controls are beautifully simple. After all, we want to give you good times. Not hard times.

It comes, like all AKAI hi-fi equipment distributed by AKAI Australia, with our Complete Protection Plan*. Which simply

means 12 months full parts and labour warranty on all Tape Equipment, 2 years full parts and labour warranty on all Amplifiers, Turntables and Speakers and a lifetime warranty on all GX Tape Heads.

If you're still thinking about the price, think about this: sure, we could have compromised and saved a hundred. But we can't see any future in that.

The AKAI Hi-Fi Professionals are: **NEW SOUTH WALES — SYDNEY CITY AND METROPOLITAN.** Sydney: Douglas Hi-Fi, 338 George Street; Duty Free Travellers Supplies, 400 Kent Street; European Electronics, 187 Clarence Street; Instrol Hi-Fi, Cnr. Pitt & King Streets; Magnetic Sound Industries, 32 York Street; Jack Stein Audio, 275 Clarence Street. **Bankstown:** Selsound Hi-Fi, Cnr. North Terrace & Apian Way. **Burwood:** Electronic Enterprises, 11 Burwood Road; Edge Electrix, 31 Burwood Road. **Concord:** Sonarta Music Services, 24 Cabarita Road. **Cremorne:** Photo Art & Sound, 287 Military Road. **Crows Nest:** Allied Hi-Fi, 330 Pacific Highway. **Hurstville:** Hi-Fi House, 127 Forest Road. **Liverpool:** Miranda Stereo & Hi-Fi Centre, 166 Macquarie Street. **Miranda Fair:** Miranda Hi-Fi & Stereo Centre, Shop 67, Top Level. **Mona Vale:** Warringah Hi-Fi, Shop 5, Mona Vale Court. **Parramatta:** Gramophone Shop, Shop 151, Westfield Shoppingtown; Selsound Hi-Fi, 27 Darcy Street. **Roselands:** Roselands Hi-Fi, Gallery Level. **South Hurstville:** Selsound Hi-Fi, 803 King George's Road. **Summer Hill:** Fidela Sound Centre, 93B Liverpool Street. **Sutherland:** Sutherland Hi-Fi, 5 Boyle Street. **Waitara:** Hornsby Hi-Fi, 71 Pacific Highway. **Westleigh:** Sound Incorporated, 16 Westleigh Shopping Centre. **NEW SOUTH WALES COUNTRY.** **Albury:** Haberecht's Radio & TV, 610 Dean Street. **Bega:** Easdowns, 187-191 Carp Street. **Bowral:** Fred Hayes, 293 Bong Bong Street. **Broken Hill:** Pee Jay Sound Centre, 364 Argent Street. **Gosford:** Gosford Hi-Fi, 163 Mann Street; Miranda Stereo & Hi-Fi Centre, Cnr. Donnison & Baker Streets. **Moss Vale:** Bourne's Merchandising, 1 White Street. **Newcastle:** Ron Chapman Hi-Fi, 880 Hunter Street; Eastern Hi-Fi, 519 Hunter Street. **Nowra:** Nowra Hi-Fi, Shoalhaven Arcade. **Taree:** Taree Photographics, Graphic House, 105 Victoria Street. **Wagga Wagga:** Haberecht's Radio & TV, 128 Baylis Street. **Wollongong:** Hi-Fi House, 268 Keira Street; Selsound Hi-Fi, 2-6 Crown Lane. **A.C.T. Civic:** Allied Hi-Fi, 122 Bunda Street. **Fyshwick:** Allied Hi-Fi, 3 Paragon Mall, Gladstone Street. **QUEENSLAND.** **Brisbane:** Chandler's, 120 Edward Street; Chandler's, 399 Montague Road, West End; Stereo Supplies, 95 Turbot Street; Tel Air Electronics, 187 George Street. **Nambour:** Custom Sound, Currie Street. **Mt. Isa:** The Sound Centre, West Street. **Rockhampton:** Chandler's, 144 Alma Street. **Southport:** Stokes Electronics, Scarborough Street. **SOUTH AUSTRALIA.** **Adelaide:** Ernsmiths, 48-50 King William Street; Flinders Trading Co., 55 Flinders Street; Sound Centre 2001, 115 Gouger Street. **Blackwood:** Blackwood Sound Centre, 4 Coromandel Parade. **Glenside:** Steiner Electronics, Conygham Street. **Moana:** Bob Carmen, 185 Commercial Road. **VICTORIA.** **Melbourne:** Douglas Hi-Fi, 191 Bourke Street; Pantiles Hi-Fi, Cnr. Flinders Lane & Elizabeth Street. **Warrnambool:** A. G. Smith, 159 Liebig Street. **WESTERN AUSTRALIA.** **Perth:** The Audio Centre, 883 Wellington Street. **Calista:** Hub Hi-Fi, Kwinana Hub, Gilmore Avenue. **East Victoria Park:** Japan Hi-Fi, 889 Albany Highway. **Nedlands:** Audio Distributors, Broadway Shopping Centre, Broadway. **Midland:** Midland Audio, 16B Great Northern Highway. **Mossman Park:** Audio Distributors, 14 Glyde Street. **W.A. COUNTRY.** **Bunbury:** Aabel Music, 130 Victoria Street. **Kalgoorlie:** Hambley's Hi-Fi, Shop 13, Central Arcade, Hannan Street. **TASMANIA.** **Burnie:** James Loughran & Sons, 29-31 Wilmot Street. **Hobart:** Quantum Electronics, 181 Collins Street. **Launceston:** Wills & Co., 7 Quadrant. **NORTHERN TERRITORY.** **Darwin:** Pitzners Music House, Smith Street.

*The Complete Protection Plan does not cover equipment purchased outside Australia.

AKAI
The name you don't have to justify to your friends.

news digest

CORDLESS DRILL

One of the hardest jobs for the handyman or the professional tradesman is to shift a locked in or rusted nut, drive a screw into hardwood or metal, drill through steel or masonry when a conventional ac power source for electrical tools is a long way away. For a roadside running repair to car, caravan, or a hundred jobs around the home such as fixing or dismantling a TV antenna, the lack of a power tool usually requires the grip of a professional wrestler and the patience of Job.

Skil power tools have just released one answer to the problem. Their new Skil model 2002 cordless screwdriver drill is powered by rechargeable high-energy nickel cadmium storage cells. The batteries can be recharged overnight from any 220-240 volt ac power point.

The Skil Model 2002 operates at a fixed low-speed 300 rpm which makes it ideal for the heaviest work. Other accessories available at small, additional cost include a full selection of Philips and slotted bits for all practical applications and a seven piece socket set.



LASER ACUPUNCTURE

Chinese acupuncturists have for some time been using electronic skin-resistance sensors to help pinpoint the exact location of the various acupuncture points.

West Germany's Messerschmitt-Bolkow-Blohm have now developed a laser sensor which they claim is even more effective than the electronics devices (which really do work!).

MBB's new laser equipment consists of a helium-neon gas laser which emits a very narrow beam at a wavelength of 0.632 micrometres. Power output is approximately one milliwatt and can be pulsed at a rate rivable between 0.2 Hz and 200 Hz. It is not yet clear whether or not the device can be used for treatment as well as acupuncture point detection - the electronic devices are used in this way.

EFFECTS OF ELECTRICITY ON THE HUMAN BODY - REPORT

A publication entitled 'Report on Effects of Current Passing Through the Human Body' (MP 30) has been published by the Standards Association of Australia.

The report represents the findings of various authorities throughout the world in respect of the pathophysiological effects of sinusoidal ac. and sustained dc. currents on adult persons.

Its purpose is to give guidance to those persons and organizations who are concerned with electrical safety. The report is not to be regarded as absolute or mandatory.

The data given in the report represent a purely medical aspect of the effects of electrical current passing through the human body and are intended to serve as a basis for establishing safety requirements from an engineering point of view, which is only one of the many aspects that have to be taken into account when fixing such safety requirements.

It is expected that alterations will be made to the report as results from the continuing investigations come to hand.

Copies of MP 30 (\$1.60) may be obtained from the offices of the Association in all state capitals and Newcastle. (Postage and handling 50c extra).

ROTEL®

IF YOUR FRIENDS THINK YOU PAID A LOT MORE, THEY'VE PROBABLY GOT GOOD EARS.

Measuring the true value of an amp., a receiver, a turntable, or whatever, is really quite simple. It's the ratio between its meaningful specifications and its price. Between its output, and your outlay.

And in that ratio, the only manufacturer to consistently outdo Rotel, is Rotel.

The value, the pleasure, the pride enjoyed by the purchasers of Rotel sometimes make Rotel a little short in supply. *Rotel RP 3000 Direct Drive Turntable*



So, to get the particular Rotel you want, you may have to wait a week or two.



Rotel RA 812 Integrated Amp.
Melbourne. 95 1820.

But isn't that the price of anything that represents genuine value?

The specifications, and the price. Take a close look at both. And then you be the judge, of the value, of Rotel.

Sole Australian distributors: International Dynamics (Agencies) Pty. Ltd., 23 Elma Road, North Cheltenham, 3192,

Available from: N.S.W.: M & G Hoskins Pty. Ltd., 37 Castle St., Blakehurst 2221, Telephone: 546 1464. QLD.: Stereo Supplies, 95 Turbot St., Brisbane 4000, Telephone: 21 3623. S.A.: Challenge Hi Fi Stereo, 96 Pirie St., Adelaide 5000, Telephone: 223 3599. TAS.: Audio Services, 44 Wilson St., Burnie 7320, Telephone: 31 2390. VIC.: Encel Electronics Pty. Ltd., 431 Bridge Rd., Richmond 3121, Telephone: 42 3762.

W.A.: Albert TV & Hi Fi, 282 Hay St., Perth 6000, Telephone: 25 2699. A.C.T.: Duratone Hi Fi, Cnr. Botany St. & Atree Crt., Phillip 2606, Telephone: 82 1388.

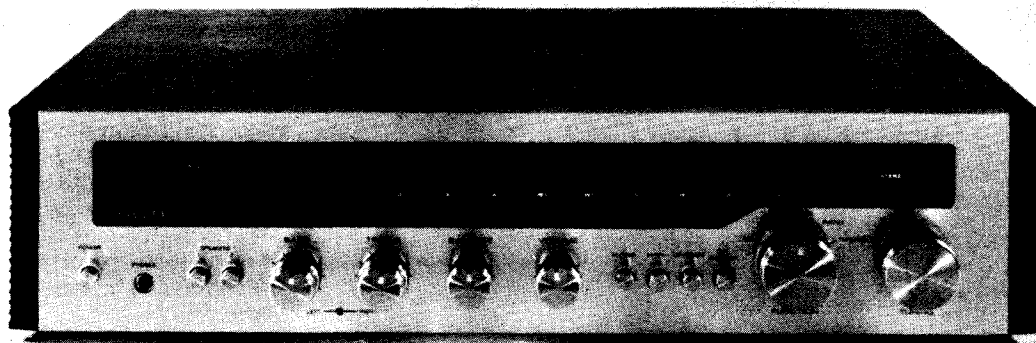

Rotel RX 402 FM/AM Receiver

COMPUTER TEACHING SYSTEM

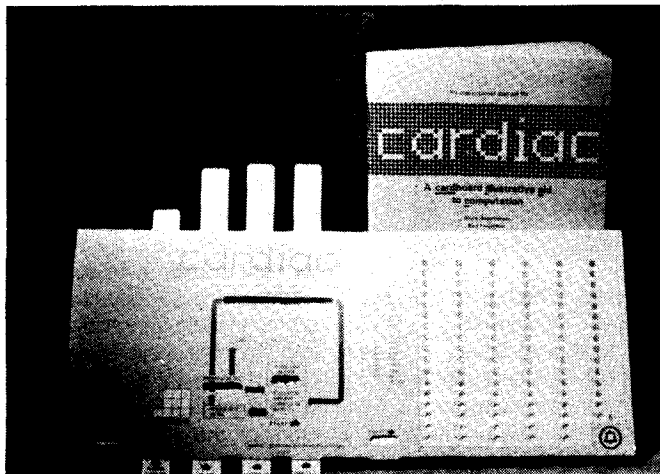

Cardiac is an illustrated instruction manual developed for and copyrighted by Bell Telephone Laboratories U.S.A., which is supplied with a most effective teaching aid.

The device illustrates the working

concepts of a basic computer. It is manipulated by six cardboard slides which display the contents of registers through windows. Control procedures are shown by a marked path that automatically switches with the sign

of the accumulator. For simplicity, Cardiac is a decimal device with a "three byte" word consisting of a two digit address plus OP code. The ten OP codes are Read, Clear and Add, Test Accumulator, Shift, Print, Store, Subtract, Jump, and Halt-Reset. The contents of the 100 memory cells are entered and erased manually as indicated by an instruction decoder.

Loops, indexing, bootstrapping, double precision techniques and sub-routine are all demonstrated by program exercises contained in the manual. The manual also contains sections on the distinctions between language levels and between macro and micro flowcharts.

Besides being a valuable training aid, scientists and business personnel who use computers only at the compiler level for occasional problem solving or information retrieval, will find Cardiac a painless and entertaining approach to understanding computer programming. Price of the system is \$5.95.

Electro-Technics Pty. Ltd., 36 Park Street, South Melbourne 3205.

METRASCOPE

THE WHOLE PICTURE - in one display! A new design Metrascope (typically) displays pressure, vibration and temperature on a single CRT in bargraph form. Calibrations, for example, may be 0-100 PSIA pressure, 0-5 in/sec vibration velocity, 0-10 mils vibration amplitude and 0-500°F temperature. Individual high and low alarms are provided. A switch dials any channel for digital readout of the selected channel or of high or low alarm levels on that channel. The manufacturer, Metra Instruments Inc of the United States can provide alternate calibrations and various groupings of channels.

Available as optional equipment is a printer for the purpose of maintaining a permanent record of data displayed on the bargraph. Printing occurs in one of three modes according to a preset switch: (a) periodic all-channel printout on preset time cycle; (b) push button activation of printout, or (c) continuous printing of all channels in alarm. The printer will print 16 columns which may include day, hour, minute, channel number and signal level.

Other options such as high-high alarms for shutdown, more than four calibrations, computed alarm levels, alarm memory, etc are also available.

Typical applications are found in process control industries such as petrochemical plants or power plants. Other uses are in test installations

such as windtunnels, nuclear test facilities or test stands. Monitoring engine operations such as with jet engines in a gas transmission station is also a constructive use.

John Morris Pty. Ltd.
PO Box 80, Chatswood, NSW 2067

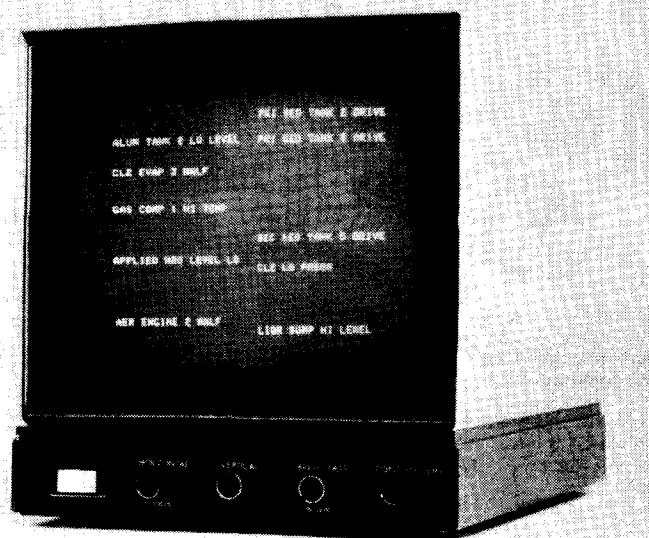

news digest

TANDY LOSSES

Tandy Electronics' accumulated losses in Australia have risen from the previously reported \$428,986 to \$1,115,662 in the year to June 30.

A major part of the loss is due to payment of \$230,541 interest to the US parent company.

Tandy's Australian operation has of course increased very considerably in size during this period as is shown by the value of stock which has risen from \$1.38 million to over \$10 million.

The US parent company has now made further loans to Tandy here - short term loans (previously \$58,045) have been increased to \$6,020,748 and there is a new long term loan of \$497,714.

MINIATURE DIGITAL COMPASS

A miniature digital compass, developed for Australia's defence forces, has attracted wide interest in Britain and the United States. The compass, measuring only 65 mm by 50 mm and weighing 130 gm, uses the integrated optoelectronics to achieve outstanding accuracy with rugged construction and low cost.

Developed by the Microelectronics Division of Amalgamated Wireless (Australasia) Limited with support from the Australian Government, the

compass has been supplied for use in Australian defence and scientific applications. It is also highly suitable for marine and land vehicle navigation, surveying, remote monitoring and surveillance, oceanographic work, and aircraft back-up operations.

Engineers at AWA, in developing the compass, had to choose between the three principles commonly used in direction finding - the north-seeking needle or card compass, the gyroscope compass, and the fluxgate compass.

The gyro compass, which uses a gyroscope instead of a magnetic needle to point to the north, is accurate and stable, but complex and expensive. The flux gate compass, which operates by the measurement of magnetic flux, has good dynamic characteristics and moderate cost but only fair accuracy.

Faced with the need to develop a low-cost, accurate compass which would be rugged enough for military use, the AWA engineers chose the north-seeking principle, because of its accuracy and simplicity. The miniature digital compass operates through a photo-electric cell reading the movements of a transparent, coded compass card or disc. This information is converted into a digital data stream which gives a four-digit numeric readout on an associated display unit. The

readout is expressed in degrees relative to magnetic north.

A dual-magnet assembly is mounted on a shock-proof, single-pivot bearing. To this assembly is attached a photo-engraved code disc bearing a 10-bit cyclic Gray code on concentric tracks. The magnet, disc and pivot are enclosed in a sealed, fluid-filled cavity fitted with a compliant diaphragm.

An infra-red, light-emitting diode illuminates the disc through a collimating lens and a shadow of the code pattern falls on a 10-element, monolithic photo-diode array. This integrated circuit incorporates scanning and signal-processing circuitry which outputs a serial digital data stream corresponding to the code on the segment of the disc immediately below it. Thus, the position of the magnets relative to the case is encoded with a 10-bit (1 in 204) accuracy.

When the compass is coupled to a display unit, a four digit numerical readout of angular position is obtained. The display unit can be placed remotely from the compass, with repeater units if required.

The digital compass has a design life in excess of 10 years and, in conjunction with the display unit, can be powered from either inbuilt batteries or an external a.c. source.

!##! 9!+!♦?* †|| ‡\$*|

London's Science Museum has recently opened a new gallery devoted to the history of computing science. Part of the display consists of a computer terminal and video display for visitors to experiment with.

The Science Museum staff, realising that the odd visitor might fill the display with various graffiti, loaded the computer's memory with a vocabulary of unsuitable words and phrases.

If any such words are entered via the terminal the computer discretely prevents them being displayed.

At least that was the intention.

Apparently the system worked quite well for a time until one day a teacher with a large class of genteel girls was faced with a display totally filled with obscenities - the computer had somehow contrived to display it's vocabulary of bad words!

DESOLDERING



**FAST
SAFE
EASY**

with **Soder-Wick**



1. Hold Soder-Wick on termination with hot soldering tip. Wicking action soaks up solder.

2. Remove tip and braid. Termination is left clean and free of solder.

Soder-Wick is a specially treated copper braid which soaks up molten solder like a sponge. Desolders a P.C. pad in a second or so: acts as a heat sink to protect circuits and components.

In a range of sizes from your wholesaler or

02-709 5293
03-848 3777

**ROYSTON
ELECTRONICS**

RE475

VARIABLE SPEED SPEECH

Variable speed speech facilities are now being incorporated in a number of cassette recorders - notably from Hitachi.

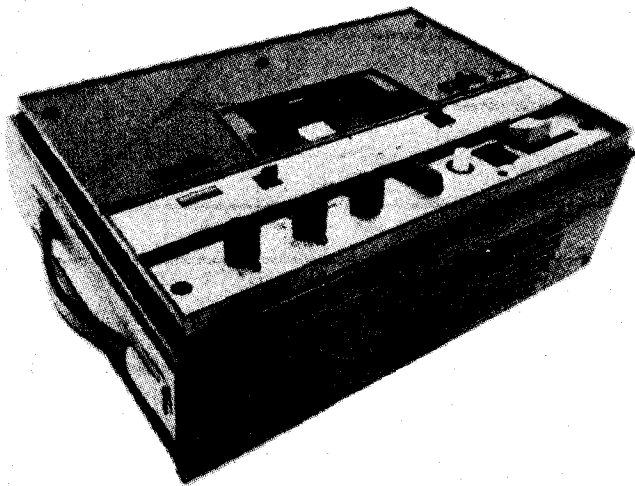

The unit shown here is made specifically for speech speed change: it covers a range of plus or minus 300%. The new unit known as the Vari-speech II is made by Lexicon (60 Turner St Waltham, Mass. USA).

ARLUNYA DATA ACQUISITION RANGE

The Arlunya Data Acquisition range of equipment has been extended with the addition of a new Data Logger designed and manufactured in Australia. The unit is claimed to fill the gap between highly expensive test systems and chart or manual recording.

The system essentially comprises input scanner, measurement device, digital clock, controller and output device. Signals from transducers, having analogue, digital and event status outputs, may be scanned, measured, linearised etc., and the data outputted on to a wide range of peripherals.

The scanner mainframe may accept either relay or FET switching modules, each having ten channels allowing a 100 channel mainframe capacity with further expansion to 1000 channels using slave chassis.

The Data Logger is designed to accept a wide range of measuring devices such as digital voltmeters, digital multimeters, digital panel meters etc. having TTL BCD output with manual, automatic or programmable functions capabilities. These devices may be either an integral part of the data acquisition system or a free standing unit connected by a single multicore cable.

PEN CALCULATOR

Four function plus percentage calculator from Unitrex is also very effective ball-point pen. The calculator section has an eight digit floating decimal display. Price is about \$80. Unitrex Pty Ltd 414 Collins Street Melbourne

HEWLETT-PACKARD ENTERS DIGITAL WATCH MARKET

Hewlett-Packard's Optoelectronics division has just started to market a range of LED display for digital watches. The company is also believed to be about to produce complete watches.

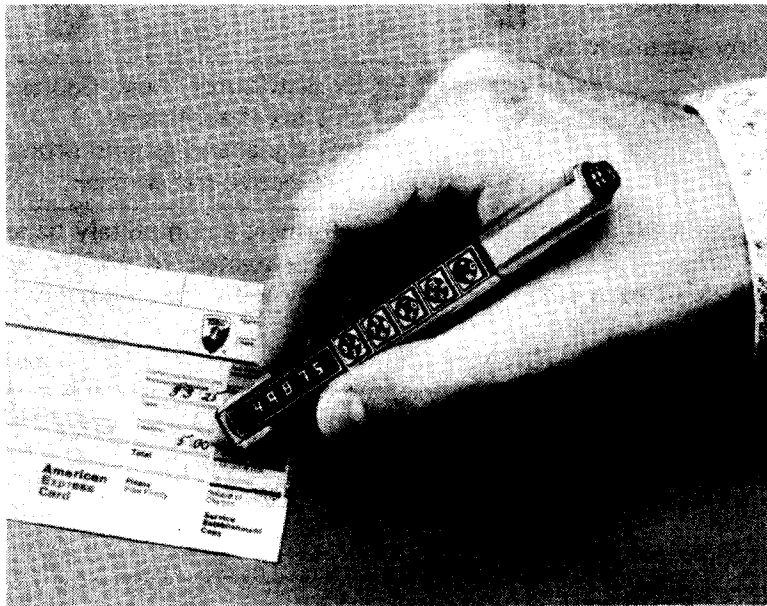

IMPROVING RADIO PERFORMANCE

A technique claimed to improve the performance of portable-radio antennae has recently been patented by the Australian Post Office (British Patent 1 411 704).

Most portable and table radios have inbuilt antennae made of coils wound around ferrite rods. The rods work quite well but are very directional - so the radio must often be positioned to optimize reception.

Attempts are sometimes made to use a pair of such antennae mounted at right angles - but this is often not effective due to phase cancellation.

The APO's technique is to retain the two antennae but to add simple sensing circuitry which continually evaluates the respective signal strengths and switches the radio circuitry exclusively to that antenna which is producing the strongest signal.

A DC to 6MHz, CALIBRATED, TRIGGERED, OSCILLOSCOPE

FOR UNDER \$200!

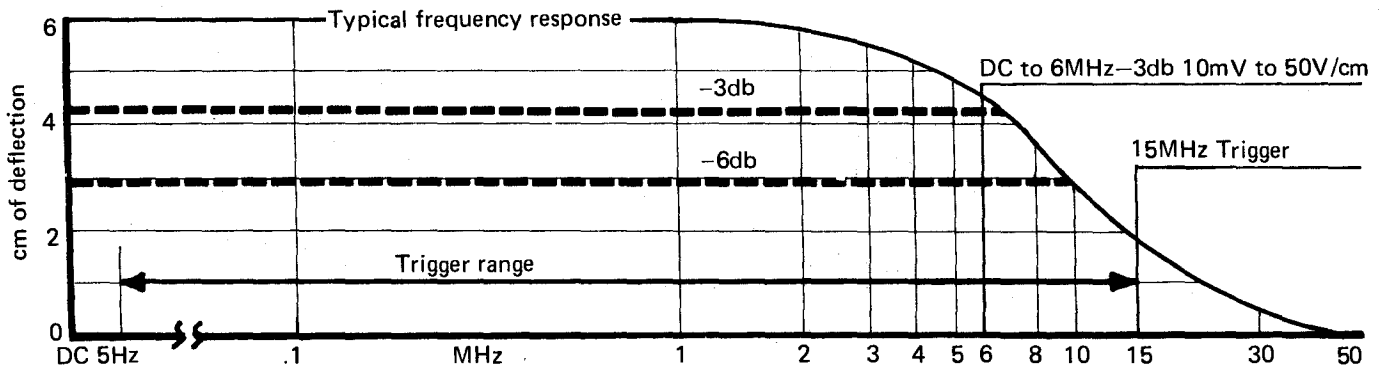

bwd 504

5.5kg of high performance with 12 months warranty.

JUST LOOK AT THIS SPEC

- | | |
|--------------------|---------------|
| DC to 6MHz-3db | bandwidth |
| 10mV to 50V/cm | sensitivity |
| 5Hz to 15MHz | triggering |
| 0.5µSec to 1sec/cm | time base |
| DC to 1MHz-3db | X-Y operation |
| 8 x 10cm | CRT screen |
| 1.6KV | EHT |
| ±400V DC isolation | input ground |

PLUS

5% calibration including effects of a 10% line change.

Completely automatic triggering of almost any waveform to 15MHz

Phase corrected X-Y operation to 3° from DC to 50kHz.

Usable frequency response to beyond 25MHz.

AND LOOK INSIDE...

there's an all silicon solid state circuit, an astatically wound 'C' core transformer, a completely balanced vertical amplifier with excellent pulse response, a FET input stage fully protected to ±400V and a compensated 12 step attenuator accurate to 2% at each step. Built in reliability with conservatively rated high stability components throughout.

bwd 504 an AUSTRALIAN instrument for the INTERNATIONAL market.

MB7601A

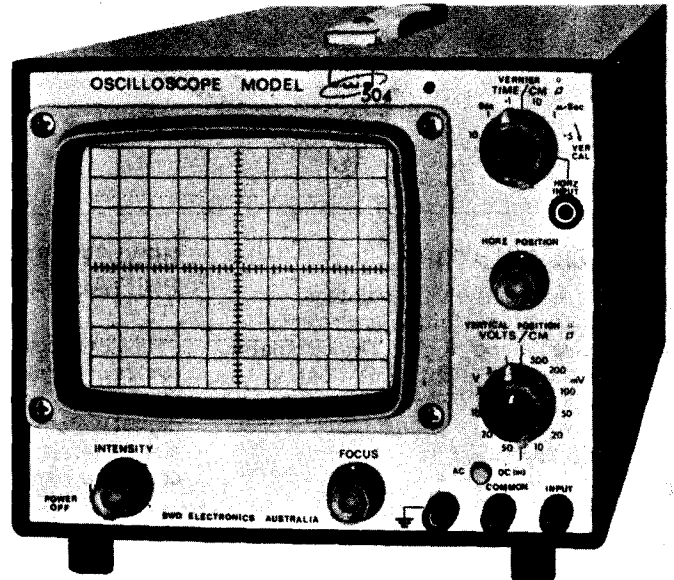

\$195 Ex distributor, Aust. Capital City plus tax if applicable.
Price includes x1 signal and ground probes plus moulded protective transit pack.

B.W.D. ELECTRONICS PTY. LTD.



MILES STREET, MULGRAVE, VIC., 3170
PHONE: (03) 561 2888
CABLES: 'OSCILLOSCOPE, MELB.'
N.S.W. PHONE: (02) 929 7452
DISTRIBUTORS: S.A.: (08) 269 1244
W.A.: (092) 25 3144
QLD.: (072) 52 7255
TAS.: (002) 23 1843

1955/1976 21 YEARS OF AUSTRALIAN DESIGN INNOVATION

B.W.D. Electronics Pty. Ltd.,
P.O. Box 325, Springvale, Vic., 3171

Please let me have full details on the bwd504 oscilloscope.

Name

Company

Address

WORLD TECHNOLOGY EXCHANGE SERVICE

The Australian section of a revolutionary computer-based technology exchange service known as Technotec has been set up in Melbourne by Control Data Australia Pty. Ltd. on its Cybernet time-sharing service.

Technotec, first introduced in the U.S. in September, is an interactive technology marketing service provided through Control Data Corporation's world-wide computer time-sharing networks.

Its operation is comparable with a newspaper classified advertising system with three sections. One section is technology wanted; another is technology for sale; and the third is technologist expertise available.

Subscribers to Technotec who want to market such information as ideas, processes, and patents can write descriptions of these into the data base. Other subscribers who seek information can explore the data base from terminals for solutions to their technological needs.

The data base also contains a list of individuals or organisations with particular expertise or know-how that may be needed in transferring technology. This file contains sources of financial, consulting, marketing and training assistance.

Control Data Corporation also has set up another service organisation, Worldtech, a world-wide organisation

of individuals and organisations interested in offering their financial resources, training expertise or consulting and marketing services to promote technology exchange on a global basis.

Technotec customers search the data base by entering their own choice of keywords or phrases related to the information they are seeking. Computer retrieval techniques, pre-programmed into the system, perform the task of matching the customers' keywords with the subscribers' keywords existing in the selector file. When appropriate "hits" or "matches" are displayed by the system, the user may request the retrieval and printing of the pertinent Descriptors.

NEW WEATHER STUDY DEVICE FOR CSIRO

CSIRO has acquired a new device for studying the role played by clouds and atmospheric dust in determining the world's climate. The device, called lidar (Light Detection And Ranging) is similar to radar in concept, but uses light instead of radio waves. It is able to probe the heart of Australia's thickest clouds or to detect the thinnest haze layers which are invisible to the eye.

Head of the lidar project, Dr. Martin Platt of CSIRO's Division of Atmospheric Physics located at Melbourne, said the device would increase understanding of the factors affecting the world's climate, leading

to further refinement of weather forecasting. This was imperative in view of the disastrous droughts and floods which occurred periodically, and because of recent apparent climatic changes around the world.

The lidar device sends pulses of ruby laser light into clouds or dust hazes, detecting light reflected back with an optical telescope. A device at the focus of the telescope then interprets the returning light as an electrical signal, which when displayed on a screen presents a "profile" of the cloud which could be related to the size and concentration of particles of which it was made.

Dr. Platt said the Earth's climate was controlled by the direct balance between incoming solar radiation and the amount of solar and heat radiation reflected or emitted back into space.

Low clouds cooled the climate by reflecting back into space up to 80 per cent of incoming solar radiation. High clouds could actually warm the climate, because as cold objects they lost less heat into space.

An infra-red radiometer to be used in conjunction with the lidar device would measure the cloud's heat radiation. Dr. Platt said the lidar device would also be used to measure cloud and haze heights, their internal behaviour, and at which heights the most solar and heat radiation was absorbed, reflected or emitted.



COLOUR TV & COLOUR VIDEO ANNOUNCEMENT

OPEN 7 DAYS FOR SALES AND SERVICE. HAVE COLOUR TV TODAY
IMMEDIATE DELIVERY

● 63 cm. Phillips ● 63 cm. Blaupunkt, Siemens, Normende, Grundig, Luxor, with full remote control. ● 63 cm. Spectra 75, push-button tuning ● 63 cm. Finlux, beautiful Consul Rosewood, push-button tuning.

VIDEO EQUIPMENT

● National Cartridge recorder colour ● Nivico Umatic cassette recorder colour ● Loewe Opta VCR TV tuner recorder colour ● ITC ½in J reel to reel recorder colour ● Sony 13 receiver monitor colour ● Rank video technics 43 cm receiver monitor colour ● Rank video technics 63 cm receiver monitor colour.

Authorised dealers Akai portables, colour or black and white, Akai colour camera sets. Used black and white video equipment always in stock at keen prices. Trade terms.

The Video & Hi-Fi Centre

Commercial Concepts

Phone 312-555 - 445 Oxford St., Paddington, N.S.W. A.H. 451-7876

Powerful alternative.

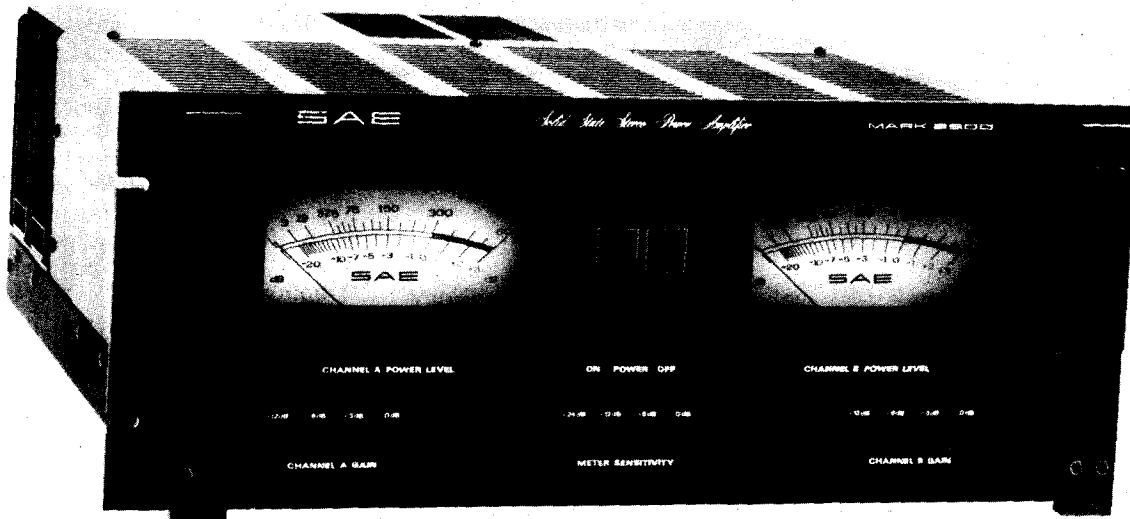

SAE 2500 Professional Dual-Channel Power Amplifier

When you compare power amplifiers, you have to look at the hard facts. The SAE 2500 Professional Dual-Channel Power Amplifier has them—top power, specifications, reliability and features that make it the most "powerful alternative."

Power. 450 Watts RMS per channel, both channels driven into 4 Ohms from 20Hz to 20kHz at no more than 0.1% total harmonic distortion. Or, 300 Watts RMS per channel, both channels driven into 8 Ohms from 20Hz to 20kHz at no more than 0.05% total harmonic distortion.* Plus, a new, smaller wide-channel power transformer coupled to 4 computer-grade capacitors for a power supply that varies no more than 10% from no load to full load. (For extra protection, there are relay and thermal cut-out devices.)

Other Specifications:

IM Distortion from 250mW to rated power at 4 or 8 Ohms with any 2 mixed frequencies between 20Hz and 20kHz at 4/1 voltage ratio..... 0.05 Max.
 Frequency Response at rated power..... ± 0.25 dB, 20Hz to 20kHz
 Noise..... Greater than -100dB below rated power
 Transient Response of any Square Wave..... 2.5 μ sec. rise and fall time
 Slew Rate..... 40V/ μ sec.
 Dimensions..... Front panel: 19"Wx7"H, Chassis: 15 $\frac{1}{4}$ "D
 (excluding handles, controls and connections)

*These specifications comply with FTC requirements for power amplifiers.

2500 INTERMODULATION DISTORTION @ 8 OHMS, FULL POWER 49V RMS BOTH CHANNELS DRIVEN

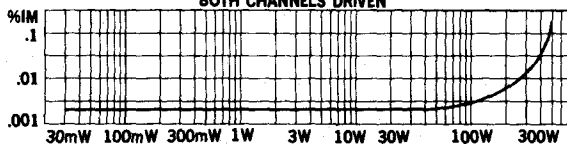

2500 TOTAL HARMONIC DISTORTION @ 8 OHMS, FULL POWER 49V RMS BOTH CHANNELS DRIVEN

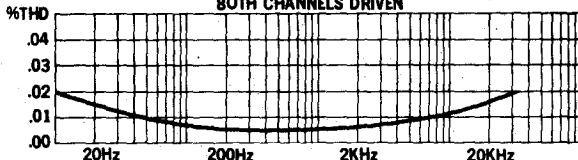

Reliability. The SAE 2500 gives you high current capability with Parallel-Series-Output Circuitry (PSO)—without loss of wide power bandwidth, low leakage current or super-high slew rate. Sixteen triple-diffused output transistors have an electrical and thermal SOA 50% higher than maximum design requirements for reliable high demand capability. This configuration can handle anything from continuous full signals to highly reactive surge loads—all day long without failure or overheating. Dual relay disconnect circuits and plug-in board design further assure reliable performance.

Features. Feedback level controls assure a constant input impedance of 50k Ohms and reduce the noise figure to more than 100dB below rated output in all positions. Loudspeaker protection relay-activated circuit automatically disconnects speakers in case of \pm DC outputs. Plus, direct power reading VU meters and forced air cooling.

The SAE 2500 Professional Power Amplifier weighs only 58 lbs. making it practical for portable sound reinforcement, public address, communications and recording applications.

The professional alternative.



For full details contact your nearest 'Leroya' office.

Sole Australian Distributors.

LEROYA INDUSTRIES LTD

Head Office, W.A.: 156 Railway Pde., Leederville 6007. Phone 81 2930.

N.S.W. Office: 100 Walker St., North Sydney. 2060. Phone 922 4037

VICTORIA Office: 103 Pelham St., Carlton. 3053. Phone 3477620.

CSIRO ASSISTS HEARING STUDY

Despite the noise of industry, heavy traffic and low-flying aircraft, primary school children in Sydney's inner south-eastern suburbs have hearing just as sharp as that of pupils in the quieter outer suburbs.

This was the finding of a joint research project by the National Acoustic Laboratories, the Laboratories' special adviser, Dr. Volney Bulteau, and CSIRO's Division of Mathematics and Statistics, conducted during the past two years.

NAL psychologist Mr. Norman Carter, who was in charge of the project, said that no difference existed in the hearing acuity of children in low-noise and high-noise environments. It indicated that environmental noise alone was insufficient to damage hearing, at least in children up to the age of 12. Mr. Carter said studies elsewhere had shown if

noise levels were sufficient to damage hearing, the effects would show within 10 years or not at all.

Mr. Cliff Gray, a scientist with CSIRO's Division of Mathematics and Statistics in Sydney, helped prepare a special questionnaire seeking details of each pupil's health record, family hearing history and factors at and since conception which might have impaired hearing.

A total of 460 pupils aged between 10 and 12 were tested by NAL clinical audiologists on their ability to hear (with either ear) six pure tones of different pitch. The test was preceded by an ear examination to detect any infection which might have affected hearing.

Mr. Carter and Mr. Gray believe the study has brought research closer to defining the point where noise levels begin to damage hearing. They plan further studies in different environments, for adults in industry, for example, where hearing damage is known to occur.

ERRATA AND ADDENDA MAGNAVOX MV-50 SYSTEM

February 1976 - page 38

The top, bottom and three sides may be cut from a 2400 x 300 mm sheet (old 8 x 1 feet size), not a 7 x 1 feet as specified in the article.

FM TUNER

January 1976

The LED spacing is 1.25 MHz not 800 kHz. Display is an UAA 170 not UA 170. Varicap stabilizer is a TAA 550 not a TA 550.

BWD WAVEMAKER

BWD advise us that the specifications of their new 'Wavemaker' — published in ETI page 13 December 1975 — contained an error. It was stated that "it can operate as a self-contained function-sweep generator over a 20 Hz to 50 Hz range . . .". The 50 Hz figure which appears throughout the text should have read 50 kHz.

BWD apologize for the error and inconvenience.

CALCULATOR TO WIN!

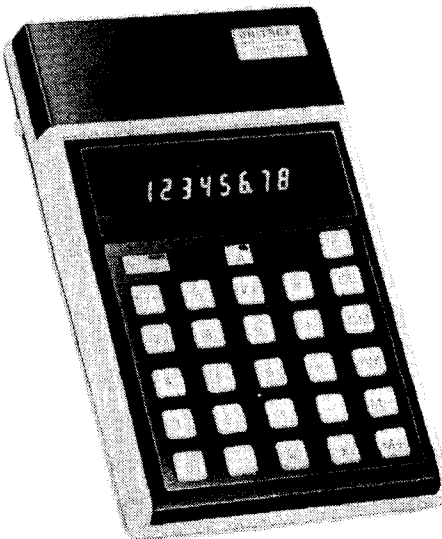

THIS MONTH'S Unitrex contest features the model 901 PM calculator. This calculator handles virtually all commercial and arithmetic operations with speed and simplicity. For its size and recommended retail price of just under \$25 it has tremendous calculating capability and convenience.

The 901 PM has the usual four functions of addition, subtraction, multiplication and division — plus square root and percentage calculations. It has a full accumulating memory, floating decimal point, constant and sequential mode operation etc etc.

Here's your chance to win one of these great little units. All answers received before March 21st will be put into a large barrel. These will be thoroughly mixed and entries drawn one at a time until a correct answer is found. That first correct entry will be the winning one. Right? Then here's the problem —

What is the (simple) interest due after 150 days on a principal of 765 talents 1095 drachmas 5 obols at a rate of 1 drachma a day for 5 talents?

Entries should preferably be sent on the official entry form printed on this page. If like many of our readers you'd sooner not cut up your ETI just copy the entry form on to a sheet of paper. Do please remember to include your name and address. Entries close March 21st 1976.

The winner will be announced in ETI as soon as possible.

Send to
Calculator Contest (March)
Electronics Today International,
15 Boundary St,
Rushcutters Bay,
NSW 2011.

Interest payable is

Name

Address

.

. Post code

Permit No. TC7296

**Announcing a breakthrough
in speaker design that took Bang & Olufsen's
best brains four years to develop—
the new B & O Uni-Phase speakers.**

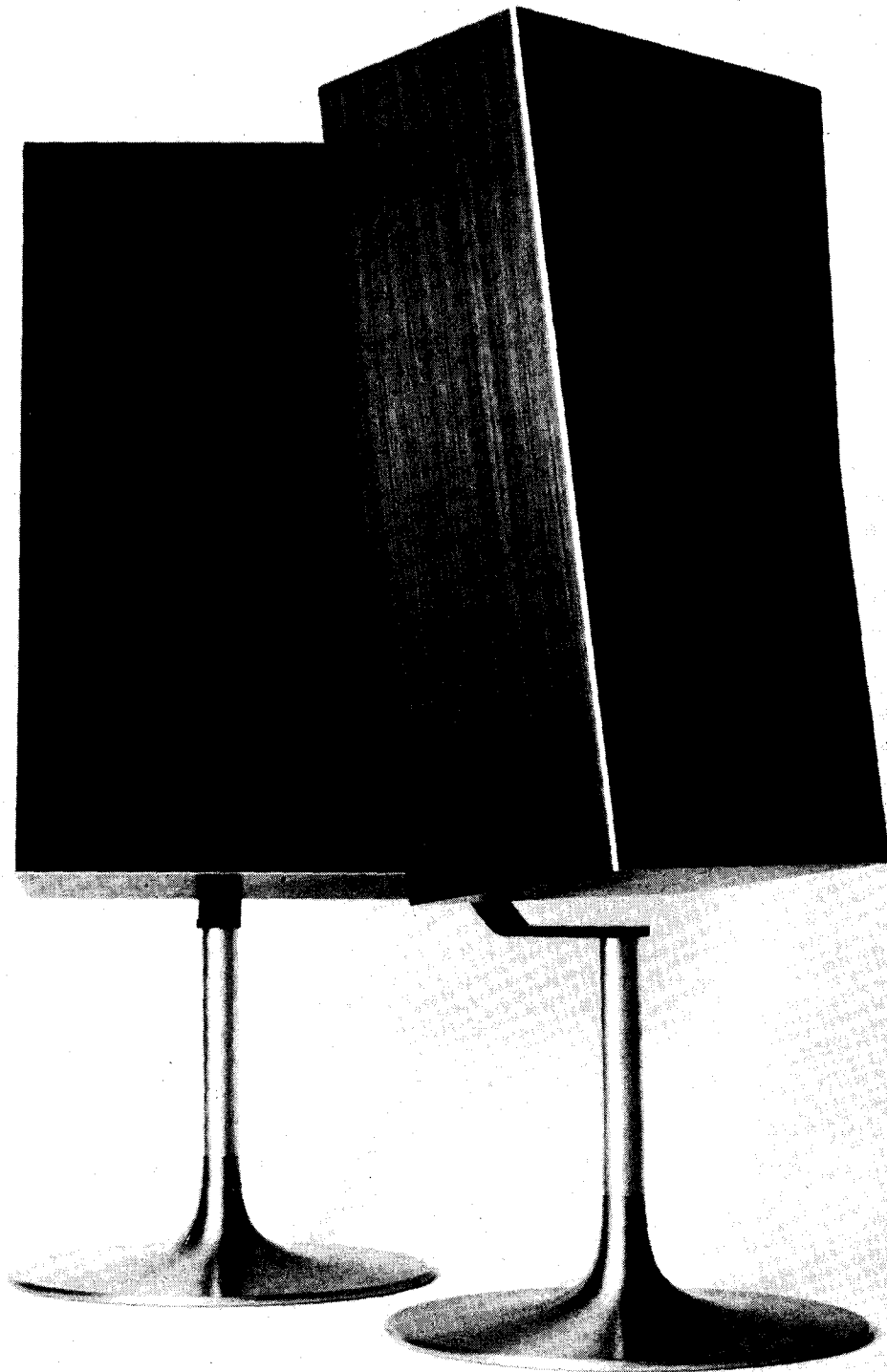

Pictured: the M70, top-of-the-range of new B & O Uni-Phase speakers, featuring optional stand. Ask about the full range of Beovox Uni-Phase Speakers at any of the B & O dealers listed on the opposite page.

Bang & Olufsen is far from being among the largest manufacturers of high fidelity equipment in the world. Yet, in recent years they have astounded the world with their products.

Within the past two years, B & O have put the only quadraphonic music set with ultrasonic remote control on the market: The Beosystem 6000. And the only gramophone with an electronically controlled tangential tone arm, which reproduces your records exactly the same way as they were cut.

These products have met with the unreserved acclaim of critics and music lovers throughout the world.

Now Bang & Olufsen is introducing a speaker series that will undoubtedly be received the same way: **The Beovox Uni-Phase speakers.**

It took Bang & Olufsen's best brains four years to create these speakers, plus some assistance from the largest computer in the world, at Cleveland, Ohio, which is also used by NASA in the American space programme.

Although at first sight the new **Beovox Uni-Phase speakers** resemble other pressure chamber speakers, they have little in common with them. In order to create these new

speakers, B & O scientists have had to reject old established design theories and start from basic principles.

The results are just as revolutionary as their techniques: The new **Beovox Uni-Phase speakers** are the only pressure chamber speakers whose transient response lies in the same class as that of amplifiers. And the only ones in which all the units in the cabinet operate in the same phase even in the crossover range—the only speakers in which the sound from all the units reaches the ear simultaneously.

One of the secret developments which made all this possible is the "patent pending" Baekgaard Phase-Link crossover network combined with the dynamic impulse corrector.

As well, there are other developments—like the fact that here is a loudspeaker that can reproduce the sound of a whole orchestra yet takes up little space in your living room.

The main development, of course, is the entirely unique sense of reality the new Phase-Link crossover network brings to your music.

The purpose of this advertisement has been to let you know that speakers no longer need be the weakest link in the high fidelity chain.



BANG & OLUFSEN **BEVOX UNI-PHASE SPEAKERS**

With respect for true sound.

Victoria: Danish Hi Fi. Telephone 824839, 63 8930. N.S.W.: Convoy. 357 2444.
Queensland: Brisbane Agencies. 219944. W.A.: Danish Hi Fi. 710100.

U691/95

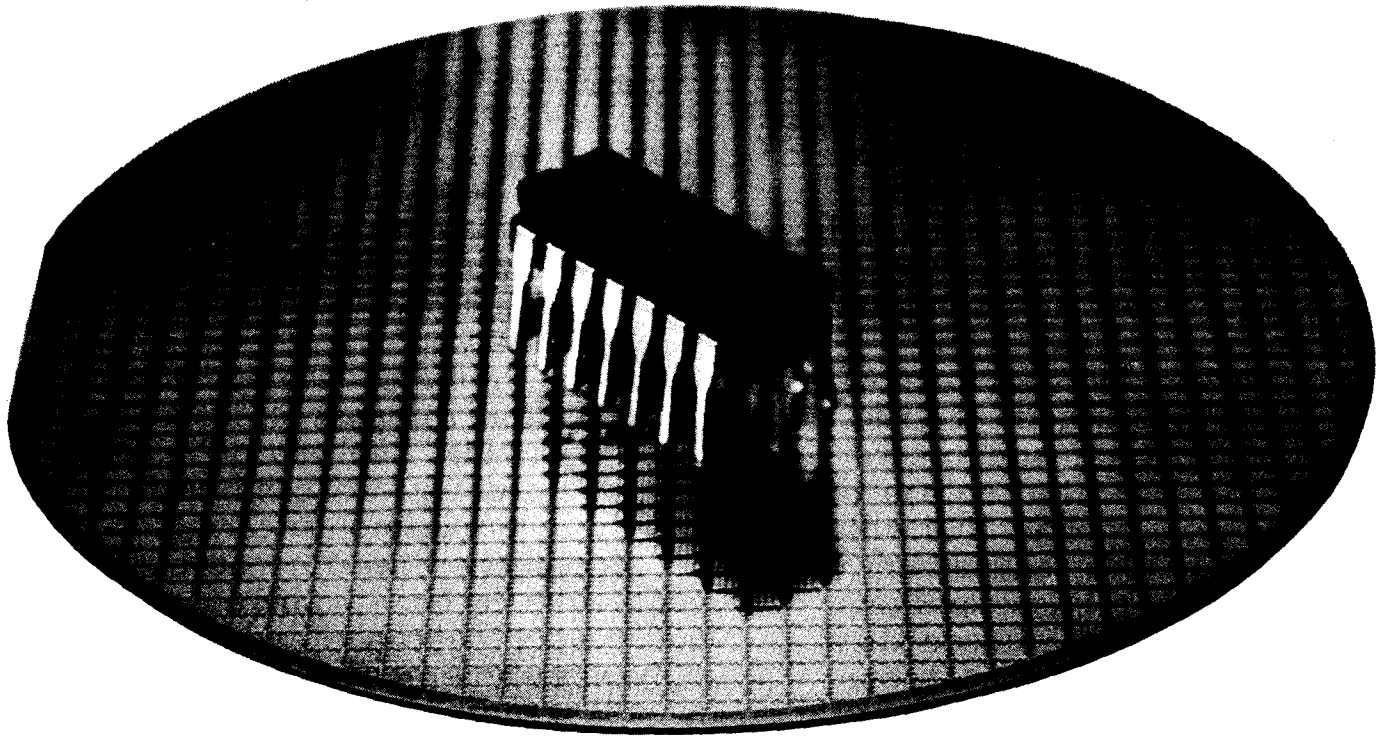

For quality-plus buyers— Solid-Plus CMOS.

100% pre-screened and burned in.

If you're one of those people who knows it pays to get tough about quality, we have what you're looking for in CMOS. Our new Solid-Plus grade. Here's what you get.

On all devices:

100% electrical testing and full military grade specification measurements, like we've been doing on all our products.

PLUS: 100% screening to 15-volt operation.

PLUS: independent test laboratory certification to 0.15 AQL

PLUS for Epoxy B packaged devices—

150°C bake to insure against hot opens

48-hour burn-in at 125°C at 10 V bias

PLUS for Cerdip packaged devices—

inspection to MIL standard 883 Class B, Method 2010.1

168-hour burn-in at 125° at 10 V bias.

We can't tell you how much Solid-Plus can save you, by reducing or eliminating your costs of incoming inspection and replacing infant mortality failures. But we can tell you that the cost-plus for Solid-Plus ranges from 9 cents for epoxy gates to 15 cents for Cerdip. On top of our already-low prices. Just specify Solid-Plus on your order. It's available on all of the nearly 100 standard devices we make in the 4000, 4400 and 4500 series.

CEMA (DISTRIBUTORS) PTY. LTD.

21 CHANDOS STREET,
CROWS NEST, N.S.W., 2065.
PHONE: 439 4655

543 KING STREET,
MELBOURNE, VIC., 3000.
PHONE: 329 7144

2 WATSON AVENUE,
ROSE PARK, S.A., 5067.
PHONE: 32 4311



SOLID STATE SCIENTIFIC INC.

The alternate source that's better than equal.

CATACOUSTIC?

Anyone who has ever lived with a Siamese cat will tell of their extraordinary characteristics.

To such people it will be of no great surprise that there is in Britain a Siamese that can tell when a Yamaha CA 1000 amplifier is switched to class A from class B operation.

This admittedly neurotic Siamese apparently dislikes classical piano recordings — leaving the room whenever such a recording is played. But for some extraordinary reason the creature will remain in the room if the same recording is played with the amp switched to class A operation! We don't have any theories either. (The Editor who has two Siamese says he's not even remotely surprised).

(This event was originally reported in the UK magazine Hi-Fi for Pleasure).

TRANSIENT INTERMODULATION DISTORTION

Our article on transient intermodulation distortion in amplifiers published in our December issue raised a good deal of interest.

The article was particularly timely as there is now world wide interest in this phenomenon — together with phase and time distortion.

Until recently these effects have been very difficult to measure. Now such measurements will be easier to perform — Bruel & Kjaer Instruments Inc have just announced new systems specifically to measure these parameters.

The availability of the new measuring systems may well result in quite major improvements in amplifier performance. There is an ever-growing belief that transient intermodulation distortion, phase distortion and time distortion have a major part to play in the way amplifiers sound.

NEW PRODUCTS FROM NAKAMICHI

NAKAMICHI are about to release a number of new products — a preview of some of these was held in Sydney earlier this month.

Two cassette recorders have been produced which are truly portable. The two machines are intended to be used in under-dash mounting — in cars — or handheld as truly portable units.

Model 300 is the more elaborate of the two — it has both record and playback facilities. The model 200 has playback facilities only.

Maintaining their reputation for state-of-the-art products, Nakamichi have produced a three-head, console cassette recorder — the Model 600. Acknowledging that cassettes suffer from distortion more than open reel tapes, Nakamichi has developed a unique intermodulation distortion suppressor for this machine. Used on playback only, it will replace the DNL system that is found on the model 1000. Nakamichi claim that the IM suppressor reduces distortion from a typical value of 2% to less than 0.5% and also expands the useable dynamic range. In addition an improvement of 5 dB is gained in S/N ratio.

A matching console preamp — the Model 610 — is claimed to be the best in the world. Noise and distortion are claimed to be virtually unmeasurable. The 610 has mixing facilities and inputs for:— Five microphones, three tapes (input and output), two phono, two tuners, and outputs for three amplifiers with adjustable output levels for each.

The 610 will be ideal for professional and comparative uses. It has a built-in pink noise oscillator and three signal tone oscillators. Facilities are available for A-B-C comparisons of all inputs and all outputs so that speakers, amplifiers, tuners, cartridges, tape decks and so on may be

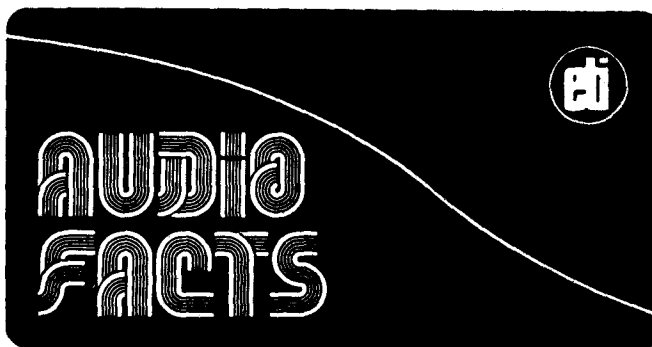

compared at the same levels. Signal to noise ratio is claimed to be 93 dB.

Nakamichi have also developed a spectacular moving-coil cartridge — but unfortunately one that we are unlikely to see on the domestic scene. Design aims useable frequency response to 60 kHz and wide channel separation to more than 20 kHz. The cantilever is made of a single crystal which has to be specially made in Zurich, and it takes one month to adjust the cartridge correctly before it leaves the factory — one week in each of four separate chambers. Because of the care that is taken in adjusting the cartridge, it will not be provided with a removeable cartridge and must be returned to the factory if stylus replacement is desired.

The cartridge is aimed at high quality laboratory work where low distortion and a high degree of accuracy to levels above 50 kHz are required.

CORDLESS HEADPHONES

Those long trailing headphone cords may soon be a relic of the past. Sennheiser, Seimens and Beyer all have cordless systems either in production or under development.

Beyer's system is now available in the USA and that from Sennheiser should be on the market very soon.

In all these systems an infra-red transmitter is connected to the audio amplifier output and floods the listening area with harmless and invisible infra-red radiation.

The infra-red carrier is modulated by a frequency modulated carrier of about 90 kHz. The frequency modulated signal is of course multiplexed to accommodate the two separate channels of a stereo system. The infra-red signal is received by small sensors mounted on the individual head sets.

Range is said to be excellent — the system being usable in a large concert hall or film studio for example. Frequency response etc is fully to hi-fi standards.



Psst!

Everybody's talking about Australia's new Switch Specialists... C & K. This time-proven range is now available with an all new and improved factory oriented service.

World leaders, these professional subminiature and microminiature switches come in a multitude of configurations with basic toggle, pushbutton, slider, lever and rocker handle actions... long, short, rounded or flatted actuators... printed circuit, wire-wrap, quick connect or standard terminals... locking lever and illuminated rocker styles. Yes, oodles of options including snap-in bezels, L.E.D. adaptable styles, colour caps, panel dress nuts, etc. In fact there's something to suit your every requirement... and then there's a new thumbwheel switch that will really turn you on.

Examine the extended range of these American masterpieces now.

An obligation-free and comprehensive set of catalogues is yours for the asking.

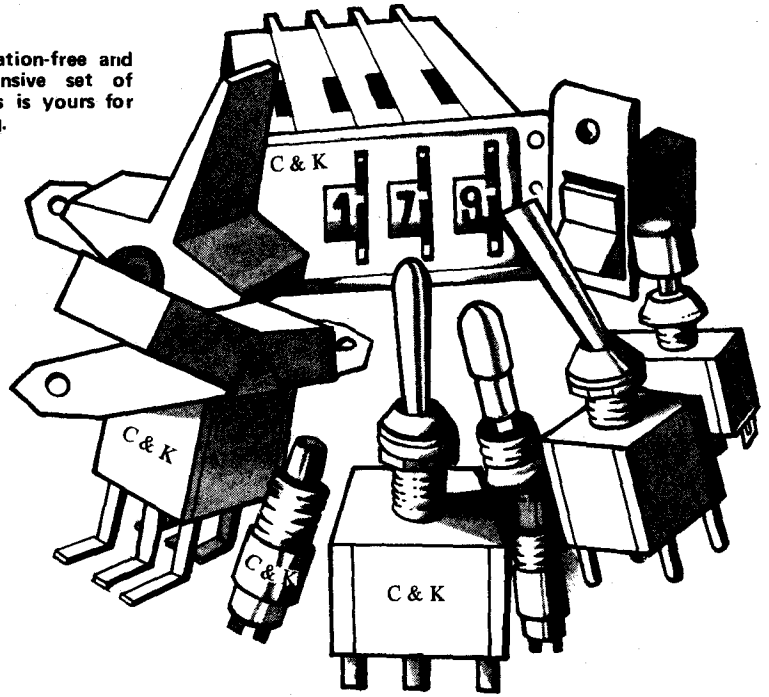

C&K Electronics (Aust.) Pty Limited

Office 2/6 McFarlane Street Merrylands NSW 2160
PO Box 101 Merrylands 2160 Telephone 682 3144

Agents: Melb. 88 5282/Adel. 223 6294/Brisbane 70 8097/Perth 68 7111.

COLOR BUYING TV RENTING GUIDE

- Why Pal?
- Local or import?
- What size?
- Installing your set
- Buy or rent?
- Problems — problems

PLUS — chance to win magnificent HMV colour TV.

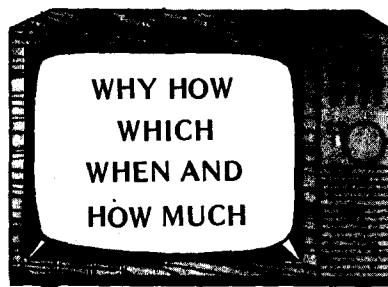

All in COLOR TV GUIDE — ON SALE NOW — ALL MAIN NEWSAGENTS \$1.00 (recommended retail price).

AT LAST!

THIRTY FIVE SIMPLE PROJECTS IN ONE GREAT VOLUME! PLUS A COMPLETE BEGINNER'S GUIDE TO PROJECT CONSTRUCTION.

SIMPLE PROJECTS

VOLUME 1
from electronics today INTERNATIONAL

CONSTRUCTING ELECTRONIC PROJECTS	5	DRILL SPEED CONTROLLER	58
CONSTRUCTIONAL METHODS	6	ELECTRONIC WINDICATOR	61
CRYSTAL RADIO	7	HI-POWER STROBE	62
THREE SIMPLE RECEIVERS	11	LIGHT OPERATED SWITCH	62
DNE TRANSISTOR RADIO	12	CAR ALARM	66
KILL THAT 'GHOST'	13	ELECTRONIC FLASH TRIGGER	68
TV MASTHEAD AMPLIFIER	16	CODE PRACTICE OSCILLATOR	70
FM ANTENNA	18	ETI UTILIBOARD	70
SIMPLE SPEAKER	20	TRANSISTOR TESTER	72
SIMPLE AMPLIFIER	25	CANNIBALS AND MISSIONARIES	75
SIMPLE STEREO AMPLIFIER	26	WHY DOESN'T IT WORK?	78
BETTER SOUND FOR SS	28	POOL ALARM	81
AUTO AMP	30	COURTESY LIGHT EXTENDER	82
SURROUND SOUND	32	RESISTOR COLOUR CODE	85
SIMPLE INTERCOMS	34	STANDARD VALUES	86
MONOPHONIC ORGAN	37	POTENTIOMETERS	86
TWO SIREN CIRCUITS	38	TAG TANTALUM CAPACITORS	87
SPRING REGENERATION UNIT	40	CERAMIC CAPACITORS	87
SIMPLE LUDIHAILER	45	POLY-CARBONATE CAPACITORS	88
BASIC POWER SUPPLY	46	HOW TO SOLDER	88
RESISTORS IN PARALLEL	51	BUYING COMPONENTS	89
FET CC VOLTMETER	52	TRANSISTOR CONNECTIONS	89
THINGS WORTH KEEPING	54		90
	57		



ON SALE NOW AT ALL NEWSAGENTS OR DIRECT FROM ELECTRONICS TODAY INTERNATIONAL, 15 BOUNDARY STREET, RUSHCUTTERS BAY, NSW 2011. \$2.00 (plus 40c POSTAGE)

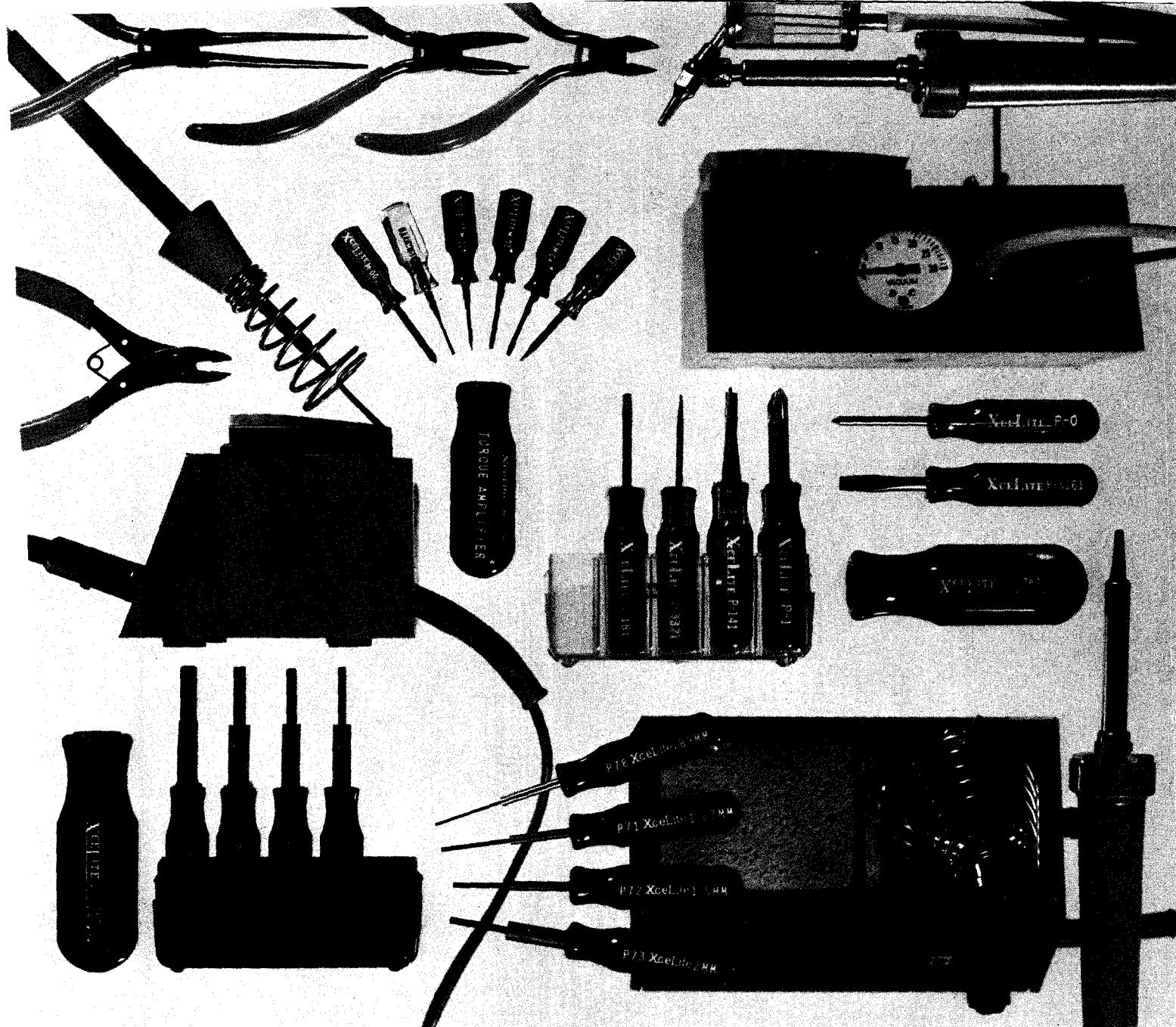

Cooper puts precision instruments into professional hands

The Cooper Group make the instruments that make productivity. We make them quality precision instruments for you to get the finest professional work out of them. Weller leads in the electronics field with a full range of soldering equipment, including advanced power vacuum soldering and desoldering stations. Crescent precision pliers are available for every type of cutting and holding angle

requirement. Xcelite offers the ultimate in hex socket, Phillips Form and conventional screwdriver assortments, plus complete cases of equipment for virtually every requirement. For maximum productivity, choose professional instruments from The Cooper Group, keyed to greater output and profitability.

The Cooper Group make more of productivity

The Cooper Group

CRESCENT · LUFKIN · NICHOLSON · WELLER · XCELITE

The Cooper Tool Group Limited,
Nurigong Street, P.O. Box 366, Albury, NSW 2640. Tel: 215511, Telex: 56995



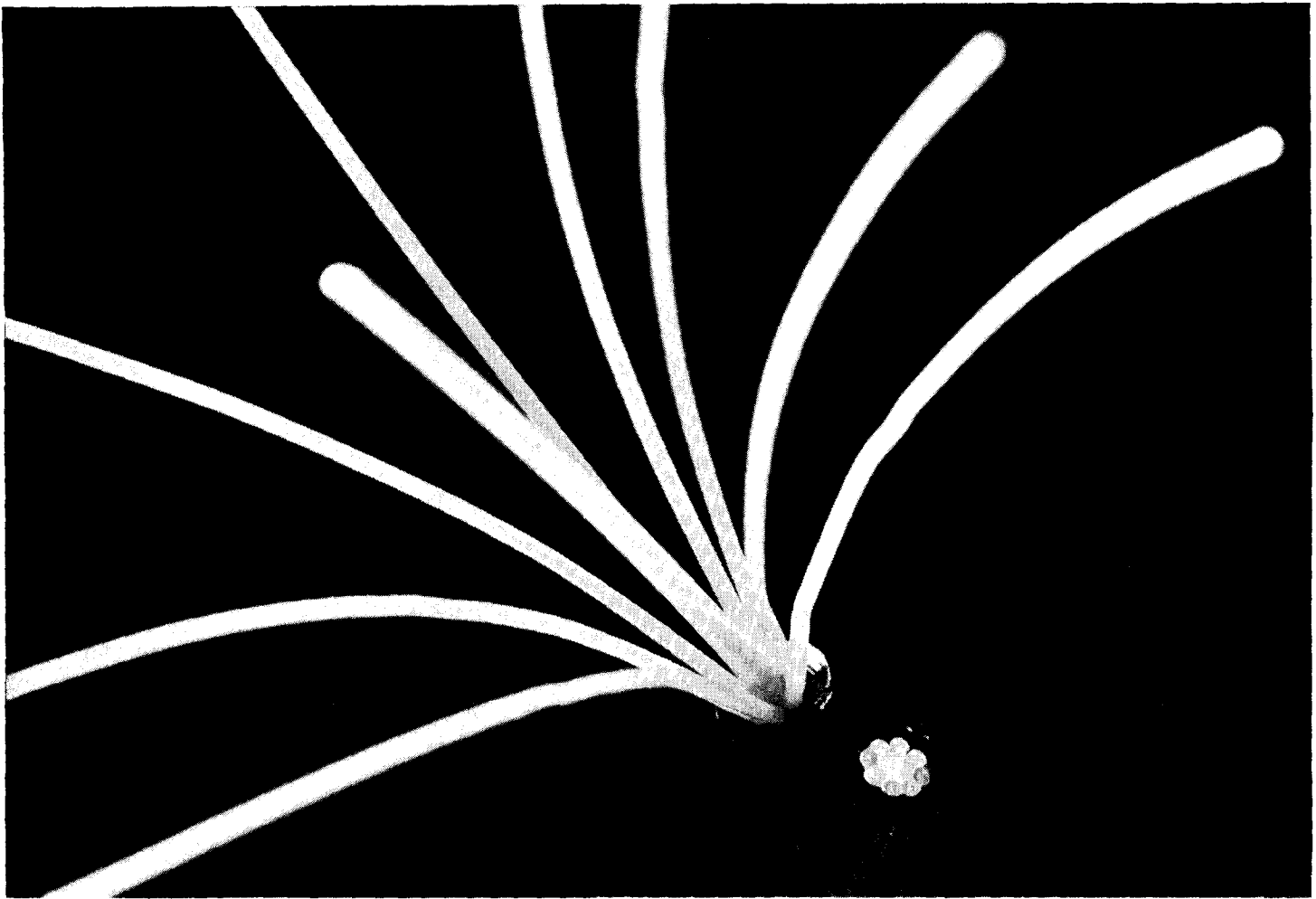

Optical fibre cable with eight cores. When made of the purest materials available, such a line is theoretically capable of carrying more than one million telephone channels simultaneously. The prototype seen here was developed by Standard Telecommunication Laboratories at Harlow (UK).

LASERS LIGHT AND TELEPHONES

Spectacular advances in the way that telecommunications can serve us are promised by the transmission of light along optical fibres instead of electricity along wires.

by Professor W.A. Gambling
University of Southampton.

IN 1588, when the Armada was sighted sailing up the English Channel for the invasion of England, a warning signal was sent to the Queen by the lighting of bonfires on a chain of hilltops from Devon to London. This was a common method of sending important messages for many centuries, and the hills on which the fires or beacons were made came to be known as 'Beacon Hill' — a name which many of them still retain.

Although nowadays it seems a crude and clumsy technique, it represents

one of the earliest forms of optical communication system. Only the simplest possible message could be sent, either a 'yes' or a 'no': absence of the fire meant 'No, the Armada has not been sighted' changing when the bonfire was lit to 'Yes, the Armada is coming'.

Only one 'binary digit' or 'bit' of information could be sent at a time and could not be repeated until the beacon had burnt out and was rebuilt. When one reflects that it takes nearly four million bits of information to

make one frame of a colour television picture and the frames are flashed onto the screen fifty times every second, it is possible to appreciate just how sophisticated present-day communications systems have become.

An improvement on beacons is the heliograph, which consists of a mirror so adjusted as to reflect sunlight to an observer. By tilting the mirror a series of flashes can be sent in the form of Morse code, and the rate of transmission is increased from something like one bit of information

per day in the case of the beacon to perhaps several bits or flashes per second.

The heliograph can only be used if the sun is visible but in the modern version an artificial light source is provided and, by means of a shutter or a dipping reflector, coded flashes of light can be sent, as with a naval signalling lamp. However, the rate at which messages can be sent is limited by two factors: firstly by the mechanical shutter and secondly by the fact that the human eye has a response time of about a tenth of a second. If the eye did not retain images for this length of time, then we would see on our television screen pictures flickering on and off at the rate of fifty times per second, instead of the steady image that there appears to be.

Thus the signalling lamp can send relatively slow and simple messages, such as those required between ships at sea when radios cannot be used, but it would take a long time, no less than 11½ days at 24 hours/day to send as much information with a lamp as there is in even a single static colour television picture.

SIMPLE OPTICAL SIGNALLING

One way of speeding up the transmission of information is to replace the mechanical shutter by an electrical one which can be switched on and off much more rapidly. These came about with the development of transistors. Now certain semiconductor diodes emit light when an electric current is passed through them, and the intensity of the light varies with the strength of the current. These devices are called light-emitting diodes and some versions can be switched on and off by electrical pulses more than a hundred million times per second. The most common use of such devices is in electronic pocket calculators. The readout is produced by arrays of light-emitting diodes, seven to each figure.

Thus light-emitting diodes can replace the flashing light. The eye, in turn, can be replaced by a semiconductor diode detector which also can have a very fast response.

A light detector acts more or less in the opposite way to a light-emitting diode in that it can be so operated that, when light of varying intensity falls on it, an electric current of varying strength is produced. The combination of light-emitting diode and diode detector can be used to transmit more than a hundred million bits of information per second, which is enough to send many television pictures simultaneously.

Although a lot of information can be sent along such a light link it cannot

Fig. 1. Total internal reflection of a ray of light at an interface between two media of refractive indices $n_1 > n_2$.

- A ray at a small angle to the normal to the interface is partially reflected and partially transmitted.
- At the critical angle to the normal most of the light travels along the interface but the remainder is reflected back into the denser medium.
- At a larger angle to the normal (a small angle to the interface) all the incident light is totally reflected within the denser medium.

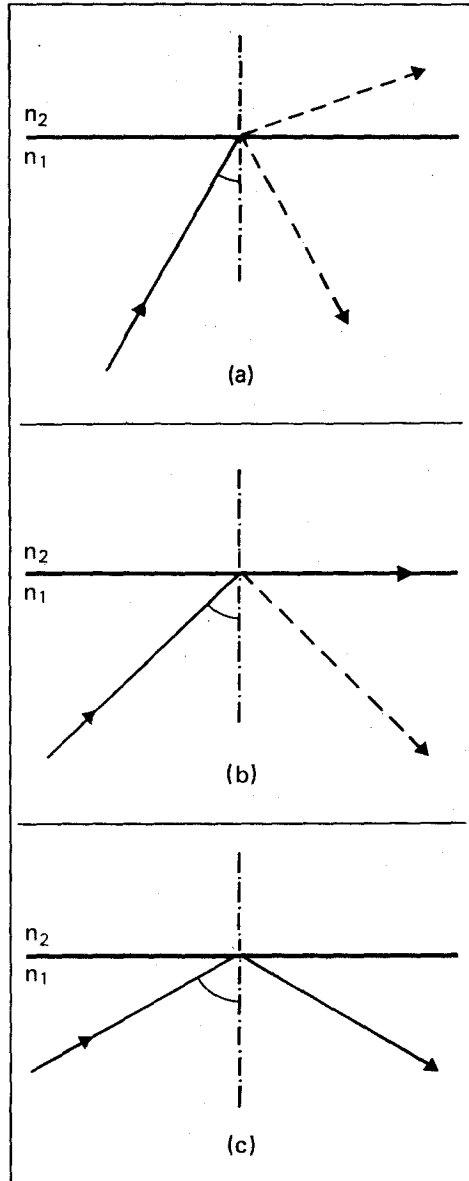

be sent very far because the light from ordinary lamps and diodes, however carefully they are collimated, always spreads out. As a result, when the detector is far away the light is spread over a large area and not enough gets into the detector to give a usable signal.

THE LASER

What is needed therefore for long-distance transmission is a new type of light source producing very pure light that can be accurately controlled, so that it can be made into

a narrow beam that does not spread much. Such a light source is the laser.

The laser is completely different from any other light source. The light it produces is very pure and bright (since brightness is defined in terms of power per unit area per unit solid angle). The laser behaves almost like an electronic oscillator which operates at a very high frequency, about 5×10^{14} Hz in fact. This has several consequences which are of great importance.

Firstly it is possible to collimate the output radiation very accurately. Even the smallest and cheapest laser produces a narrow pencil-like beam that can be sent over long distances without spreading too much. This directional property has been used in an experiment where a laser beam was directed at the Moon from a 60-inch (1.52 m) telescope, with the result that in travelling 400 000 km it only spread to a spot 0.8 km across. In other words the beam spreads by only 25 mm in every 16 km of travel. Incidentally the distance to the Moon was measured to an accuracy of plus or minus 25 mm!

Laser light can also be modulated, or switched on and off, very much faster than other light sources and can, in principle at least, be used to send more information per second, than any other method including radio, microwaves, etc. Thus if we can learn to use laser light, and to transmit it efficiently from one place to another, then we will have a greatly improved method of sending messages in the form of telephony, television and so on.

COMMUNICATIONS DEMAND

However, before looking into optical communication more closely let us ask the question 'Is such a new system needed and will it be of any practical value?' The answer is strongly in the affirmative and telecommunications authorities the world over are spending a lot of money on developing new systems. Many more connections are being made to computers over the telephone system, and computers are becoming bigger and more numerous, so that more and better telephone lines are required. Television programmes are increasingly sent over landlines, and there are other new and interesting possibilities. So let us consider how we might be able to use laser beams and light signals instead of electric currents in a wire.

LASER SIGNALLING

A simple way of sending a signal along a laser beam is to pass it through an electro-optic crystal which can act as an amplitude modulator to control the intensity of the beam passing through. Thus an ordinary electrical

LASERS LIGHT AND TELEPHONES

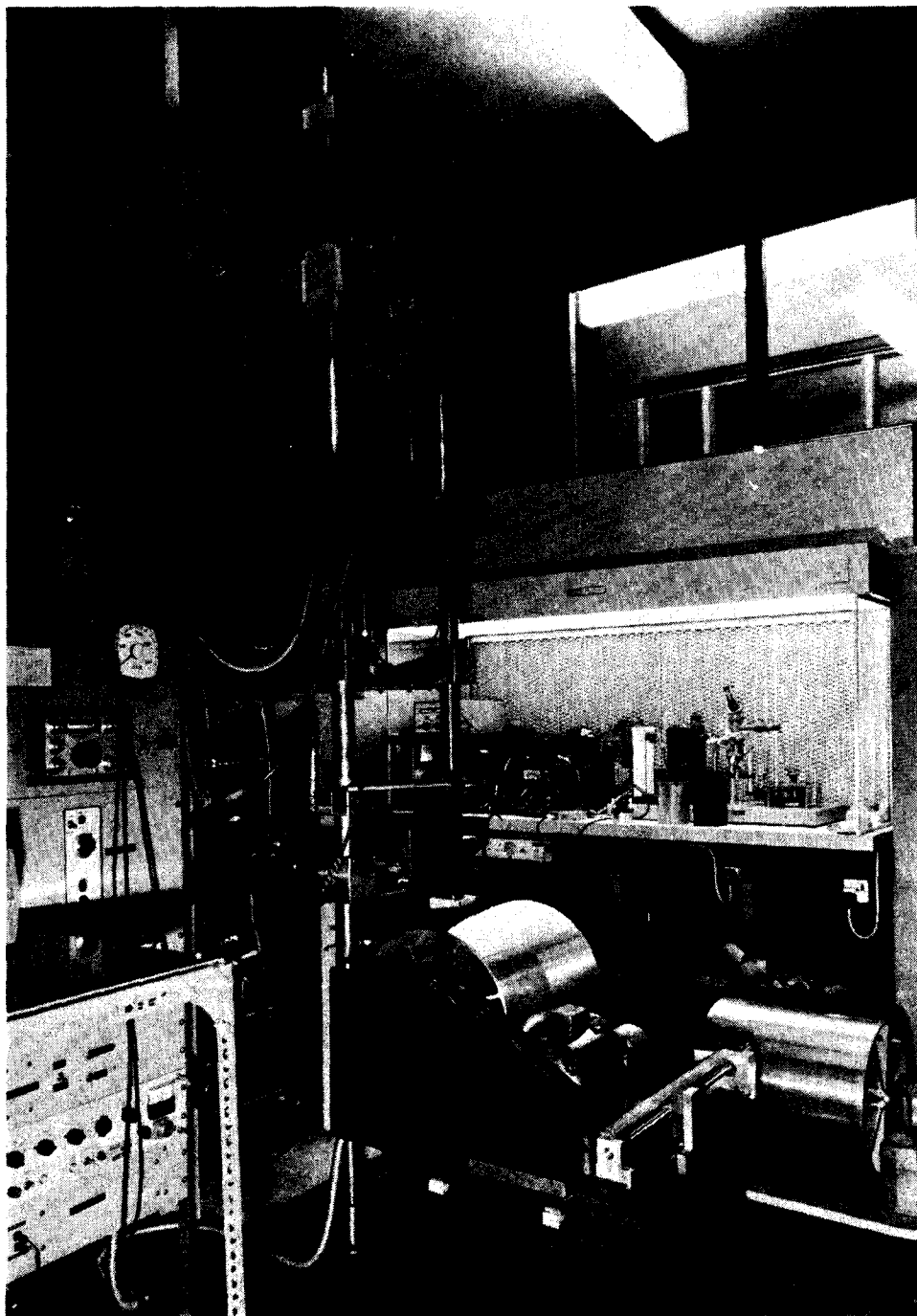

Fibre-drawing machine built at Southampton University. A glass preform can be seen entering a small vertical furnace; the resulting fibre is drawn onto the winding drum at the bottom. The precision is such that a fibre of diameter 100 μm varies by less than 1 μm over a length of several hundred metres. Several kilometres of fibre can be drawn in one continuous operation.

signal, such as that from a telephone or a television signal, when applied to the modulator causes the strength of the beam to vary in synchronism with the signal. If a light detector is placed at the other end of the beam it will pick out the variations in beam intensity and turn them back into electrical signals. These are amplified and used in the normal way.

With a technique such as that just described, signals can be sent on a laser beam over quite long distances and when the beam is protected there are no great problems. Out of doors, on the other hand, there are two big disadvantages. Firstly the beam can be blocked by rain, clouds and snow, but even in clear weather it will be bent and broken up by temperature gradients or turbulence in the atmosphere and therefore transmission is unreliable. Secondly, light beams travel in straight lines, making it difficult to turn corners and get in and out of buildings since it would be necessary to have a highly-reflecting and accurately-positioned mirror at every slightest bend.

GUIDING THE LIGHT

In 1966 two British engineers suggested a novel method of sending light over long distances. They said that if pure glass could be produced, glass fibres would be capable of guiding light over several kilometres at a time. Glass fibres have been known for many years but at the time they could send light over only a few metres because of the high transmission loss of nearly 1000 decibels/km; that is to say, half of the energy was lost in travelling only three metres.

To understand how glass fibres 'conduct' light it is necessary to recall some simple physics. If a ray of light is travelling in a dense medium and strikes the surface of a less dense medium at an angle near the perpendicular, as in Fig 1, then some of the light is reflected and some is transmitted through the surface. On the other hand, if the ray strikes the surface at a shallow angle, then it is all reflected; that is, there is no energy lost due to reflection. A perfect reflection of this kind is known as 'total internal reflection'. The angle to the perpendicular at which total internal reflection just occurs is known as the critical angle.

A light-guiding optical fibre consists of dense core material of pure glass surrounded by cladding material, also of glass but having a smaller refractive index. Thus if rays enter the fibre and strike the surface of the core at a large angle to the axis (a small angle to the perpendicular), they are partially reflected and go on to make another

reflection at the same angle at the other side of the core, and then another and so on. However, some energy goes into the cladding each time, and after many reflections there is no light left in the core and the ray does not reach the far end of the fibre. On the other hand an input ray at a shallow angle to the axis is totally reflected with no loss of energy and, if it is not absorbed in the body of the core, it can keep on reflecting right to the end of the fibre. The beauty of this technique is that the fibre does not need to be straight.

As Fig 2 shows, the rays continue to reflect around curves and, within broad limits, the fibre can be bent as much and as often as required. In addition it can be very thin, as fine as a human hair, 50 micrometres (μm) in fact, thus becoming quite flexible; it behaves much as a piece of copper wire and can be wound around the finger without harm.

An unprotected fibre is rather weak, since surface flaws form very rapidly on exposure to air, but if suitably protected immediately after drawing, a glass fibre even as small as 100 μm in diameter becomes surprisingly difficult to break by hand.

A single fibre is so small that it is difficult to see easily and to handle, but bundles consisting of a large number of fibres contained in plastic tubing have been used for light transmission over distances of a metre or two for some years. Typical examples are fibre endoscopes for viewing internal cavities of the human body by surgeons. Several fibre bundles can be used to display patches of light in a particular configuration to produce display signs, the advantage being that only one simple light bulb is used, instead of many bulbs or expensive fluorescent tubing. In addition they are less easily damaged by vandals. Traffic signs on motorways are of this type.

COMMUNICATING BY FIBRES

While bundles of fibres can guide light, to send a signal we need only one fibre and a small amount of light which can be modulated in some suitable way. One fibre could guide laser light over distances of several kilometres. By using one of the techniques described earlier, the laser beam itself could be made to carry as many as 100 000 telephone different colour television programmes. Thus a thin fibre could transmit more information than a telephone cable made of the rather expensive metal copper, and presently about 50-100 mm in diameter.

Since glass fibres have been used for conducting light for some years one

might well ask why they have not been used for communications purposes before. The answer is that glass of sufficient purity has not been available. Ordinary window glass looks quite transparent, but if you look at a pane of glass edge on, it appears dark because very little light can come through a thickness of even half a metre or so. Even the best available optical commercial glass is not nearly good enough because, after going along a kilometre of it, the light would be ten thousand million times weaker!

This is because some of the light propagating along a fibre is lost by absorption due to impurities and some is scattered by even very small inhomogeneities. Some of the impurities are difficult to remove and they can have a serious effect even if present only as one part in every hundred million parts of glass. To ensure that the signal is not lost completely it has to be amplified when the power has fallen to a low value; each amplification being carried out in repeaters spaced at suitable intervals along the fibre. To keep the number of repeaters, and therefore the total cost, down to an economic level the transmission loss has to be as low as possible and certainly less than 20 dB/km (corresponding to a fall in signal power to 1 per cent of its original value after travelling 1 km).

FIBRE FABRICATION

At first it seemed that this low-loss transmission requirement would be very difficult to achieve but in the past

four years tremendous advances have been made in several laboratories, including my own at Southampton University. Two years ago we held the world record for the best fibre, with a loss of only 5.8 dB/km, in a configuration consisting of a fine glass capillary tube as the cladding filled with a special liquid (hexachlorobutadiene) as the core. Other laboratories in the USA improved on this result using solid fibres consisting of silica doped with titania, germania or boric oxide as one component and pure silica as the other. Then a year ago we produced another new type of fibre using a rather unexpected material (because it is extremely difficult to make in bulk form), namely a phosphosilicate glass.

The fibre is made by passing vapours of phosphorous oxychloride (POCl_3) and silicon tetrachloride (SiCl_4), together with oxygen (O_2), down a silica tube (which need not be very pure), and heating to a temperature of about 1500°C in a furnace. Layers of phosphosilicate glass can then be deposited on the inside of the tube. The initial layers, which become the cladding, can be made to have a low refractive index by using a small concentration of phosphorous oxychloride (or by using boron trichloride instead) while the later layers of higher refractive index form the core. After deposition of the layers the tube is collapsed to a solid preform which is then drawn into fibre by the precision fibre-drawing machine shown in the photograph; the overall process is depicted in Fig 3.

The great advantages of the foregoing process are that the raw materials are cheap and, because they come in liquid form, they are easily purified. The resulting fibre is dimensionally very accurate and has the low attenuation of only 2 dB/km over the interesting wavelength range of 0.8 to 0.9 μm where gallium arsenide lasers and light-emitting diodes operate. Figure 4 shows that the transmission loss is low over a wide range; only one other fibre has been produced having a lower attenuation and that not, apparently, repeatedly.

BANDWIDTH

Another major factor of prime importance in the design of optical fibres for signal transmission, and indeed of any communications medium, is the bandwidth or maximum rate at which information can be transmitted.

The components of a modulated carrier wave cover a spread of frequencies and normally all travel at different velocities (an effect called dispersion) so that over a long length of fibre the components become separated in time, and distortion

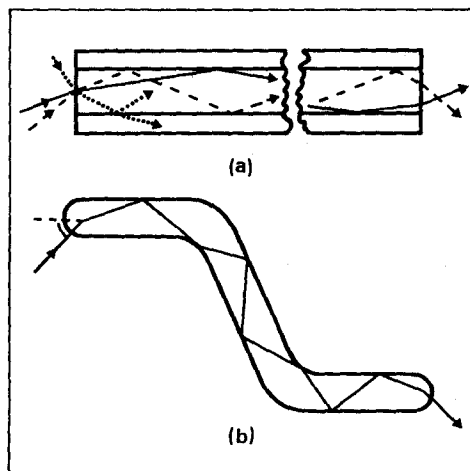

Fig.2. Ray propagation along a cladded multimode fibre.

a). Rays incident on the core/cladding interface at an angle greater than the critical angle are completely reflected (if core and cladding are lossless) and are guided by the core. The ray represented by the dotted line falls outside the numerical aperture of the fibre and loses energy at each reflection.

b). Providing a ray strikes the interface at an angle to the normal greater than the critical angle it will continue to be reflected along the fibre, even around bends.

LASERS, LIGHT AND TELEPHONES

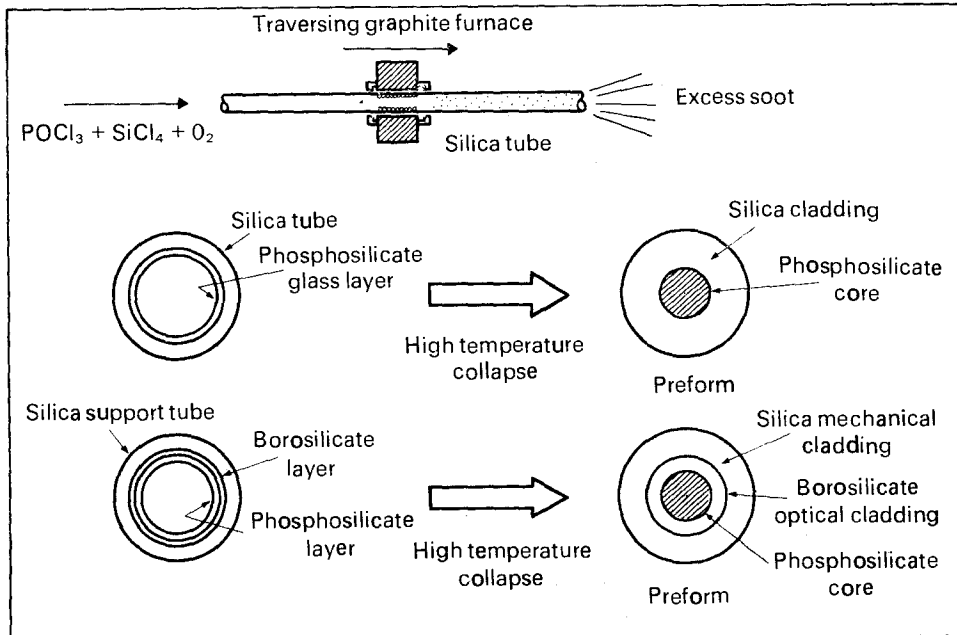

Fig.3. The manufacture of phosphosilicate fibres. In the two-layer process the silica tube acts only as a supporting structure.

occurs. In a single-mode fibre, that is, one with a very fine core, the limiting dispersion is that caused by the bulk glass and the particular surface wave mode and corresponds to pulse rates, or bandwidths, of several gigahertz over several kilometres. However, if a semiconductor laser source is used, the spread in its output would limit the overall bandwidth to about 1 GHz over 1 km or perhaps even less. There are problems with single-mode fibres because of the very small core diameter (about $1 \mu\text{m}$), namely those of launching efficiently from semi-conductor lasers and jointing (especially at night in a trench in the rain!) between adjacent sections of fibre. To get fibre ends flat and accurately aligned to an accuracy of better than $0.1 \mu\text{m}$ is no mean problem.

MULTIMODE FIBRES

An alternative approach, begun in 1967 as a joint project between Britain's Signals Research and Development Establishment and the Department of Electronics at the University of Southampton, is to consider multimode fibres.

These have core diameters in the region 20 to $100 \mu\text{m}$ and are easier to manufacture than single-mode fibres. However, because of the large core

diameter they are capable of supporting many modes and it was expected that the bandwidth would be quite small. For a thick-core fibre, instead of thinking of modes, it is more convenient to visualise energy propagation in terms of rays, as discussed earlier, which travel along the fibre by total internal reflection from the core/cladding interface. As long as the angle to the interface is not greater than that corresponding to the critical angle, given by $\cos^{-1}(n_2/n_1)$ where n_1, n_2 are the refractive indices of core and cladding respectively, no energy is coupled into the cladding, at least when the latter is lossless.

If an input beam is launched so as to fill the aperture of the fibre, or if scattering occurs, then the spreading of a transmitted pulse can become comparable with the difference in transmission times of the axial and extreme rays which, for a length of 1 km and a typical fibre, is $0.5 \mu\text{s}$. This is equivalent roughly to a bandwidth of 1 megahertz. However, careful measurements showed that if a narrow beam is properly launched into a well-made fibre, a pulse spread of as little as 0.3 nano-seconds (ns) occurs over 50 m with core diameters in the range $50\text{--}100 \mu\text{m}$. It followed that if such a low dispersion could be maintained for greater lengths, a

bandwidth exceeding 100 MHz over 1 km might be attained. This is greater than that currently available from coaxial cables, and the spatial multiplexing which is possible increases the advantage still further.

Later work has confirmed this result, and, by the introduction of a refractive index which falls gradually from the axis of the core, instead of having a step change at the core/cladding interface, the phosphosilicate and other fibres can be made to have a bandwidth of 1 GHz over a 1 km length.

TELEVISION TRANSMISSION

As a result of these and other developments there is now a great interest in the use of optical fibres for communications. The major difficulties of attenuation and bandwidth have been solved but before fibres find widespread applications there are many other problems to be faced, such as jointing and cabling, but these are not likely to be difficult. The first use of fibres is likely to be for special links such as data or television transmission, with trial installations in the telephone network following by the end of this decade.

Equipment developed and built at Southampton University for the BBC was used in the first commercial application of optical fibre communications by any national network in January 1973, when an entire colour television programme from the Royal Institution was sent through 1.25 km of fibre before being broadcast. The electrical signals from the colour camera were taken to drive circuits feeding into a light-emitting diode, which turned the fluctuations of electric current into fluctuations in light intensity passing along the fibre. Light emerging from the fibre was directed onto a fast-acting light detector so as to reproduce faithfully the original electrical signal, and the output from the detector was amplified and fed to the television transmitter. Thus the pictures on all the domestic receivers had been transmitted through a long length of fibre. Needless to say there was no deterioration in the normal picture quality.

POTENTIAL

The simple but realistic demonstration described above showed that glass fibres can be used for long-distance communication. Various forms exist and while the ideal fibre has perhaps not yet been made, suitable ones are already available. Light detectors are no problem. Although present-day diode lasers are not yet reliable enough, they are

getting better all the time and light-emitting diodes can also be used.

If optical-fibre transmission lines are put into use what effect will they have on our everyday lives? Initially the result would not be spectacular but it would mean that telephone system costs would not rise as fast as they would do otherwise, and telephoning might become easier. Videophones which require 300 times the frequency space of conventional telephones, might become feasible. Branches of banks are connected to a central computer to enable a rapid and up-to-date check to be kept of all accounts, a service so valuable that perhaps in the future offices and factories of most firms may be inter-connected in the same way, thus increasing the amount of data transmission throughout the country. Already attempts are being made to provide computerised references for research workers, and the logical extension of this would be to commit all journals and books to some form of computer store. It would then be possible to do away with most school, college, industrial and public libraries in favour of video links to a relatively few regional centres. The advantages would be many.

There are many other fascinating possibilities. If a glass fibre cable can be made as cheaply as the telephone wires that come into the home from the local exchange, then the meagre bandwidth we presently have could be greatly increased.

The private citizen could have a communication capability, or

bandwidth, exceeding that of any commercial or private enterprise today. He could have direct access to a national or regional computing centre and could dial the computerised library of the future from his armchair, to have pages from books displayed on his own TV screen.

If we miss our favourite TV programme perhaps we could dial it from a video store at a time convenient to us rather than to the television authorities.

Viewed objectively the present method of disseminating news by means of newspapers is crazy. We cut down acres of forest, ship thousands of tons of wood pulp all over the world. When the papers are printed, trains and trucks and vans in every country carry hundreds of tons of newspapers in all directions and thousands of paper boys and girls deliver them to homes. After that there is the problem of disposing of them. Great damage is done to the environment and there is a great waste of natural resources. Sending news by electrical or optical means is easier and much more efficient. It would be more sensible to dial our newspapers from home and read them on the television screen.

There are lots of other exciting ideas — it has even been suggested that instead of *commuting* to work we will *communicate* to work. These developments will depend on our ability to understand, design and produce new and better materials, and to make communicating with light a practical reality. ●

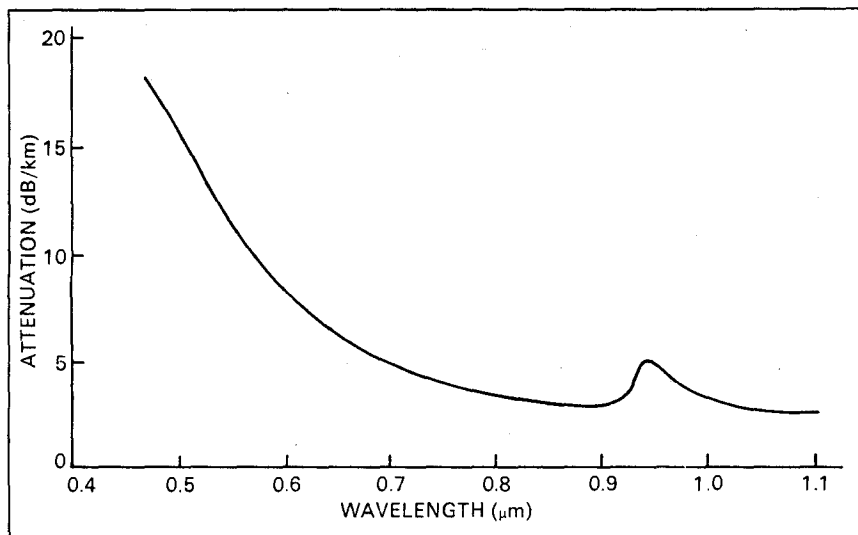

Fig. 4. Spectral attenuation curve of a 1.2 km length of silica-clad fibre with phosphosilicate core.



**the speaker
engineers**



**speaker
systems**

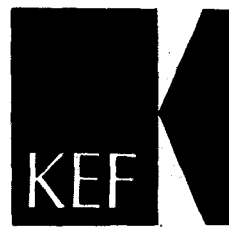

**speaker
units**

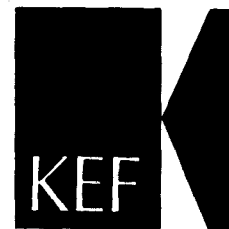

**speaker
kits**

Distributed by Audioson International Pty. Ltd.
 Sydney Melbourne Adelaide Perth
 938 1186 329 6066 337 7000 25 9993

Lots of people tell you what their speakers will do.

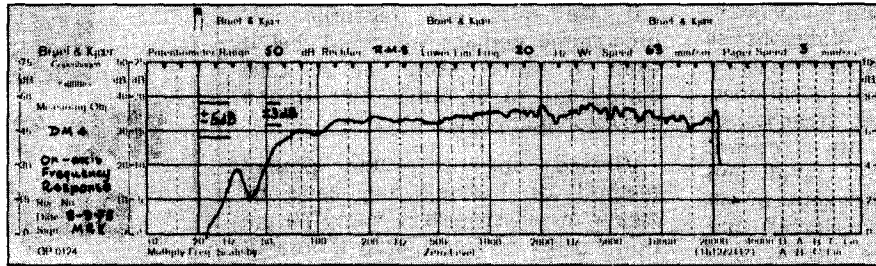

When you buy a B&W, you get it in writing.

B&W's reputation is based on producing clean natural sound without distortion, even at low volume. Each B&W speaker is tested in an Anechoic Chamber and issued with its own individual pen graph. You know exactly the performance of the speaker you are buying.

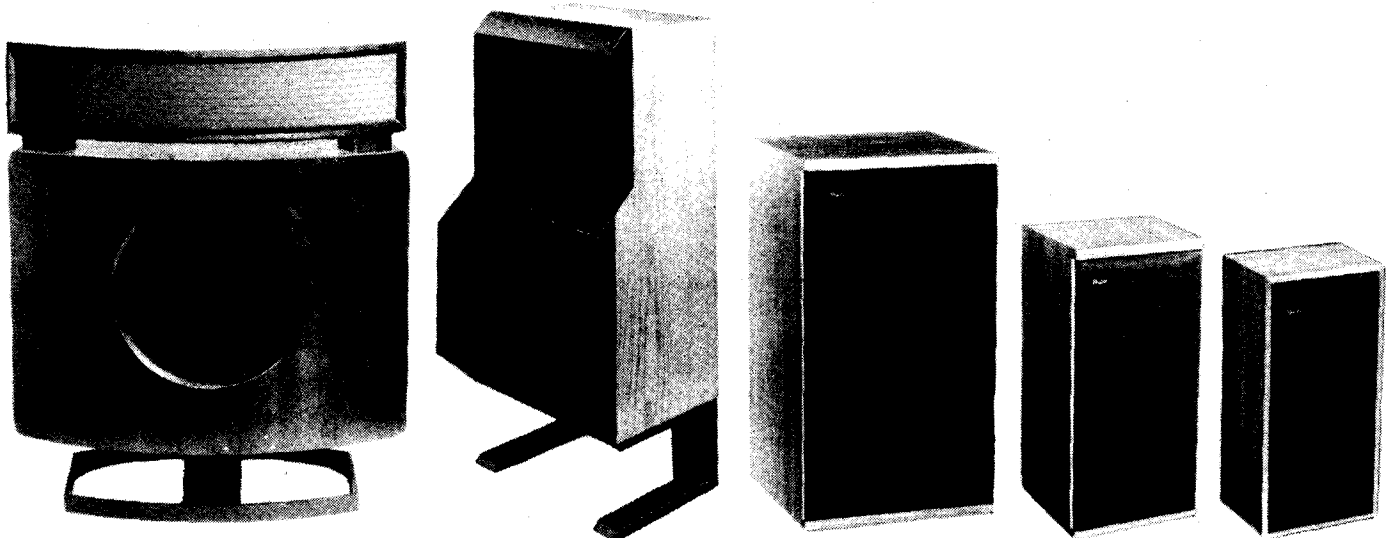

B&W DM70 Monitor Electrostatic.

A combination of dynamic bass unit and electrostatic mid and high frequency module. One of the best speakers you can buy.

B&W DM6 Monitor.

A brand new design. A high powered dynamic loudspeaker with low colouration and very high transient performance.

B&W DM2A Monitor.

A more conventional design, utilising B&W research into acoustic line rear loading. Brilliant clarity and lack of distortion.

B&W DM4 Monitor.

A speaker with large B&W Monitor characteristics: its performance surpasses speakers of much greater size.

B&W D5.

A speaker for small living areas. It has above average performance at moderate cost.

HEAR B & W HERE:

NSW Arrow Electronics, 342 Kent Street, Sydney 29-8580. • Convoy Technocentre, Cnr. Plunkett & Maclean Sts., Woolloomooloo 357-2444. • Insound, Cnr. Hayberry & Wests Sts., Crows Nest 929-2714. • Instrol, 89 York Street, Sydney 29-4258. • Jock Leate Hi-Fi, 191 Forest Road, Hurstville 579-6399. • Milversons, 793 Pacific Highway, Chatswood 412-2122. • Milversons, 327 Church Street, Parramatta 635-3588. • U.R.D., Shop 32, Angel Arcade, Ash Street, Sydney 232-3718. • West's (Burwood) Pty Lt., 170 Burwood Road, Burwood 747-4444. WA Audio Distributors, 10 Glyde Street, Mosman Park 31-5455. TAS Wills Hi-Fi, 8 The Quadrant, Launceston 31-7737. VIC Allans Music, 276 Collins Street, Melbourne 63-0451. • Brystand Geelong Electrical Centre, 192 Ryrie Street, Geelong 9-1524. • Buy-Rite Electrix, 459 Bridge Road, Richmond 42-6200. • Southern Sound, 337 La Trobe Street, Melbourne 67-7869. • Southern Sound, 963 Nepean Highway, Moorabin 97-7245. • Tivoli Hi-Fi, Cotham Road, Kew 80-4956. SA Sound Spectrum, 33 Regent Arcade, Adelaide 223-2181. ACT Duratone Hi-Fi, Cnr. Botany St. & Ahree Court, Philip 82-1388. QLD Audio Labs, 12 Douglas Street, Milton 36-0080.

B&W



Sole Australian Agents
Convoy International Pty. Ltd.
4 Dowling Street, Woolloomooloo 2011
Sydney. 358 2088

PF693

FM TUNER

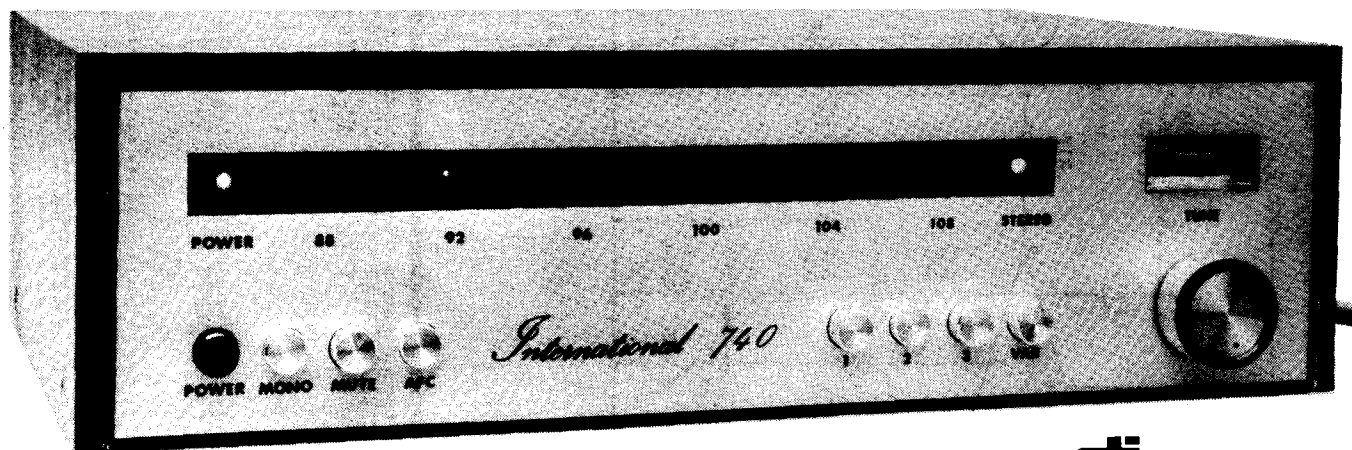

Full constructional details.

eti PROJECT 740

THE ETI 740 tuner has been designed with the aim of making it as simple as possible for the inexperienced hobbyist to build. The only components not mounted on the printed circuit boards are the fuse, input and output sockets, tuning meter and the tuning potentiometer. Interconnecting wires have been reduced to an absolute minimum. Whilst only two boards have been used, the main printed-circuit board has been laid out in such a way that it may, if so desired, be cut up if it is required to build the modules separately.

CONSTRUCTION

Components may be assembled on to the main circuit board in any sequence, but we recommend that the lowest height components, eg resistors and diodes, be fitted first followed by the larger components. Ensure that the diodes are inserted with the polarity as marked on the overlay and that integrated circuits are orientated correctly. The cbe connections shown on the overlay for the BC548 and BC558 transistors are correct for Philips devices. If other makes are used the connections may be different and should be carefully checked.

The tuner is installed by first securing it into position with a piece of double-sided tape. The terminals are then connected to the board by means of tinned-copper wire links. Pin 2 of the tuner module should only be connected to the main printed-circuit board if the main amplifier used in association with the tuner is not earthed. The transformer and the function switches are mounted directly onto the printed-circuit board.

Commence the assembling of the display board by installing the nine links shown on the overlay. To install the LEDs it is first necessary to cut a piece of fibre-glass board 230 mm long by 4 mm wide. By examining the photographs it is possible to see how this strip of fibreglass is used to align the LEDs and to correctly space them from the printed-circuit board. It will be noticed that some links pass beneath this strip and it is therefore advisable to file small notches for the links so that the strip sits down flat on the printed-circuit board. Do not force the LEDs over the strip, if they are tight, file the strip until they slip on easily. Note that all the LEDs are mounted so that the cathode lead, marked by the notch, flat or longer lead, is on to the top of the display board.

The rest of the components may now be mounted taking particular care to locate the trim potentiometer flush with the board. If desired, although not essential, a hole may be drilled through the display board so that the trim potentiometer may be adjusted from the rear after the unit is mounted in the chassis. If the hole is not so drilled the potentiometer must be adjusted before the unit is mounted into the case.

The two boards are joined together by tinned-copper links. This should be carried out by first soldering 20 mm long tinned-copper leads to the display board (nine leads required). Bend these leads so that they lie flush with the board and then thread them through the mating holes in the main printed-circuit board. The display board should be positioned behind the mounting surface of the function switches and secured to the switches

KITS
All components, part kits and full kits for this project are available now from Applied Technology Pty Ltd, 109-111 Hunter St, Hornsby, NSW 2077. Tel: 476-4758.
NOTE — The front panel supplied with project is now silver lettering on black — to match ET1440 amplifier — not as shown in our lead picture.

by self-tapping screws or nuts and bolts.

The power switch and the mains transformer are both mounted directly onto the printed-circuit board and for safety sake we feel that it is necessary to insulate these areas of the board with a layer of epoxy cement as shown in the photograph. It is also necessary to insulate the terminals on the top of the power switch (both used and unused).

We advise that the completed module now be carefully checked for any errors in component installation. Also check that all joints have been correctly soldered. The unit may now be temporarily connected up to the tuning meter, potentiometer and power cord and then connected to an amplifier for testing before final assembly (see section below).

After testing is satisfactorily completed the module may be installed in the case and all the controls and power lead etc properly connected. The front panel is secured to the front of the chassis with a little contact cement and is also secured by the potentiometer nuts. The polarized plastic window in the front panel is

(Main text continues page 32)

FM TUNER

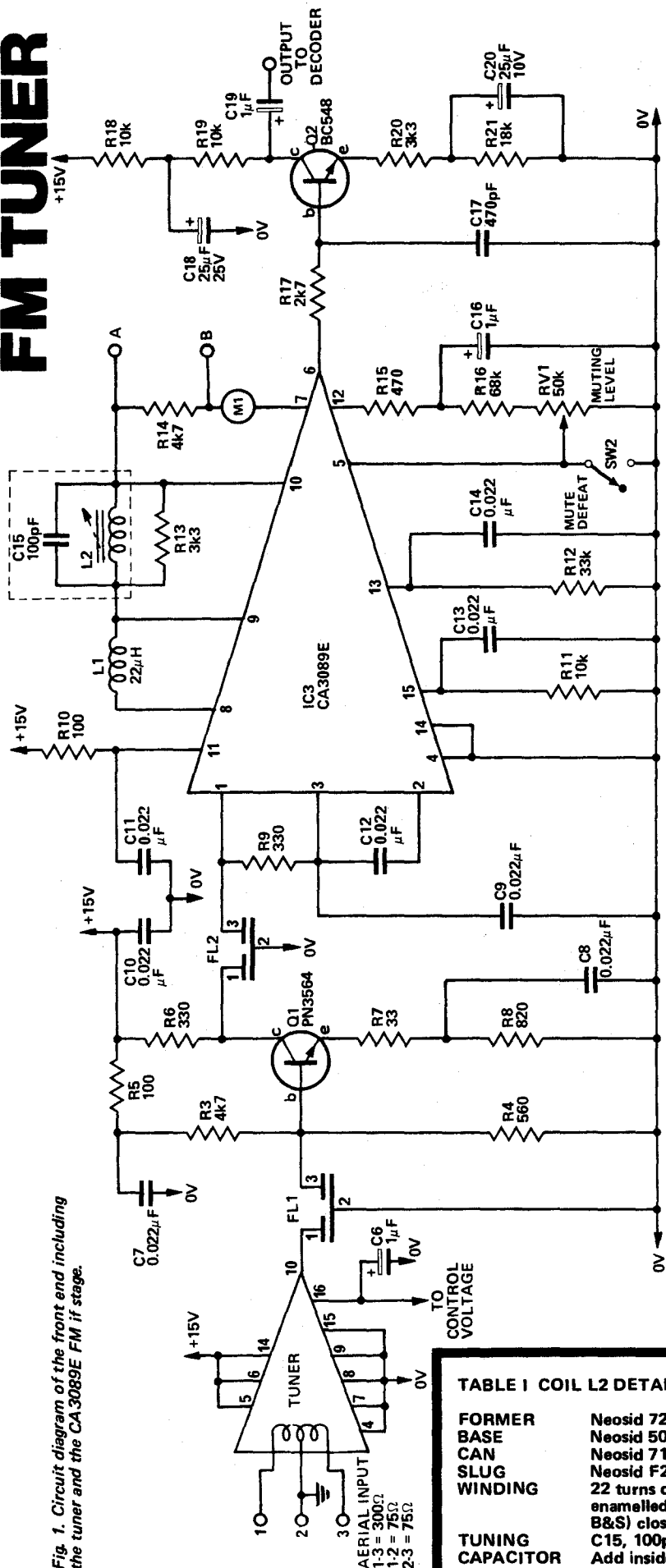

Fig. 1. Circuit diagram of the front end including the tuner and the CA3089E FM IF stage.

TABLE I COIL L2 DETAILS	
FORMER	Neosid 722-1
BASE	Neosid 5027/6PLB
CAN	Neosid 7100
SLUG	Neosid F29
WINDING	22 turns of 0.63 mm enamelled wire (22 B&S) close wound.
TUNING CAPACITOR	C15, 100pF ceramic. Add inside can across coil leads.

PARTS LIST ETI 740

R7	Resistor	33ohm	5%	1/4 or 1/2W
R5,10,24	"	100 "	"	"
R6,9	"	330 "	"	"
R15	"	470 "	"	"
R4	"	560 "	"	"
R8	"	820ohm	"	"
R2,25,26	"	1k	"	"
R47,56	"	1k5	"	"
R17,50	"	2k7	"	"
R13,20	"	3k3	"	"
R1,3,14	"	4k7	"	"
R27,28,49	"	4k7	"	"
R53,55	"	4k7	"	"
R41	"	8k2	"	"
R11,18,19	"	10k	"	"
R33,34	"	10k	"	"
R29,38	"	15k	"	"
R21	"	18k	"	"
R29,30,31,32	"	22k	"	"
R12,51	"	33k	"	"
R40	"	39k	"	"
R47	"	47k	"	"
R16	"	68k	"	"
R22,39,52	"	100k	"	"
R43,45	"	120k	"	"
R46	"	150k	"	"
R42	"	220k	"	"
R44	"	820k	"	"
R35,36	"	1M	"	"
RV1	Potentiometer	50k TRIM TYPE		
RV2,3	"	5k TRIM TYPE		
RV4,5,6	"	50k MULTI TURN TRIM		
RV7	"	100k 10 TURN ROTARY		
C15*	Capacitor	100pF ceramic		
C3,32	"	250pF		
C17,21	"	470pF		
C29,30	"	0.001µF polyester		
C27,28	"	0.01µF polyester		
C7,8,9	"	0.022µF Disc ceramic		
C10,11,12	"	0.022µF Disc ceramic		
C13,14	"	0.022µF Disc ceramic		
C1	"	0.033µF 250V ac		
C23	"	0.047µF polyester		
C24,25	"	0.22µF polyester		
C26	"	0.47µF polyester		
C6,16,19	"	1µF TAG Tantalum		
C33,34	"	1µF TAG Tantalum		
C35	"	4.7µF 10V electro		
C22	"	22µF 16V TAG Tantalum		
C20	"	25µF 10V electro		
C18,36	"	25µF 25V electro		
C2	"	47µF 63V electro		
C3	"	1000µF 25V electro		
C4	"	100µF 63V electro		
C5	"	100µF 35V electro		
L1	Inductor	22µH		
L2	"	see table 1		
D1-D4	Diodes	EM401 or similar		
D5,6	"	1N914 or similar		
LED1,18	Light emitting diode	GREEN		
LED2	Light emitting diode	RED		
LED17	Light emitting diode	RED		
Q1	Transistor	PN3564 or similar		
Q2,3,4,5	"	BC548 or similar		
Q6	"	BC558 or similar		
IC1	Integrated Circuit	7815		
IC2	"	TAA 550		
IC3	"	CA 3089		
IC4	"	LM 1310		
IC5	"	(14 pin) UAA 170		
TUNER	PHILIPS	AP 2157		
SW1-4	Switch Module	IRH P/N TS0361		
SW5-8	"	IRH P/N TS0362		
M1	Tuning meter	50µA-0-50µA		
T1	Transformer	PL 30/5 V/A (Ferguson) or similar		
PCB		ETI 740 A ETI 740 B		

- Fuse holder and 500 mA fuse
- 3 core flex and plug
- Rubber grommet
- Cable clamp
- 2 Earth lugs
- 75 ohm socket
- 2 pin plug and socket McMurdo P/N 12-01-01, P/N 18
- 2 WAY RCA socket McMurdo P/N 1291-03-02
- 4 12.7 mm tapped spacers (1/8 whit)
- 16 Screws 1/8 whit 6 mm long R.H.
- 8 Nuts 1/8 whit
- 150 mm Twin coax cable
- 50 mm 300 ohm ribbon
- Knobs for tuning pot
- Chassis to fig 11
- Front panel to I/O
- Cover to fig 9
- Rubber feet (4)
- 75 mm x 25 mm double sided tape.
- 10 pc board pins
- 250 mm x 35 mm circular polarized plastic

HOW IT WORKS — ETI 740

The AP2157 is a varicap tuner module which tunes frequencies within the range 88 to 108 MHz by means of a control voltage adjustable between 3.3 and 22 volts. The frequency tuned is not linearly related to the control voltage and a much higher increment of voltage per frequency increment is required at the high end of the band. The tuner operates on the heterodyne principle and hence the incoming signal is mixed with a local-oscillator frequency which is also varicap controlled so that a 10.7 MHz IF frequency (difference) is produced by the mixing process, the sum product of the mixing process being rejected by the following IF stages in the tuner.

The tuner is followed by an IF filter, FL1, and then by a transistor to compensate for the 10 dB loss in the filter. The transistor is followed by a further IF filter. The filters are followed by IC2, a CA3089 which is a complete IF amplifier, limiter and detector system. Thus from this chip we obtain an audio output, an output which can be used for muting, and an output voltage proportional to signal strength which can be used to control the gain of the RF stage (ie AGC).

The distortion introduced by this IC is dependant on the phase linearity of the quadrature coil L2. With a single tuned circuit the

distortion is typically 0.5% whilst with a doubled-tuned circuit it is typically only 0.1%. However test equipment is needed to align the double-tuned coil and for this reason we have used the single-tuned circuit.

The output of IC2 is amplified by Q2 before being passed to the stereo-decoder IC3. The purpose of Q2 is to provide the gain necessary to obtain an adequate drive for the particular power amplifier used with the tuner. The gain is determined by the ratio of R19/R20 and may be altered by changing the value of R20.

The stereo-decoder IC, an LM1310, works on the phase-locked loop principle. The loop is locked to the 19 kHz subcarrier (if present) and decodes the stereo signal accordingly. The stereo outputs have the required 50 microsecond de-emphasis applied by R27/C27 and R28/C28. Each output is then taken through a low-pass filter (Q3 and Q4) which gives an added 4 dB rejection of the 19 kHz pilot tone (which is already 34 dB down) and an extra 20 dB rejection of the 38 kHz which is already 45 dB down. Additional filtering was not considered necessary. The stereo-defeat facility is carried out by raising the phase-lock loop frequency out of the lock range of the loop.

The +15 volt supply is derived from a full-wave rectifier followed by an IC regulator. The voltage required for

the varicaps is derived by a voltage doubler which provides about 55 volts on C4. This is reduced to 32 volts by R1 and IC2. IC2 is an active zener specially designed for varicap supplies. The varicap supply is again filtered by R2 and C5 further to reduce the amplitude of any supply ripple which may still be present. This supply is then fed to the tuning potentiometers RV4,5,6 and 7, the end limits of these potentiometers being set by R48 and R49. In the AFC mode the AFC voltage derived by the CA3089 IF stage is used to control, via Q4 and Q5, the voltage at the top of the tuning potentiometers and hence provides automatic tuning within a small capture range.

The output of the station selector network is fed to IC5 as well as to the tuner. This IC is an analogue-to-one-of-sixteen decoder and LED driver. One of the 16 display LEDs will be alight — which one is on depends on the input voltage. The LEDs come on at sixteen equally spaced voltages between the limits of the two voltages as set on pins 12 and 13 of the UAA 170 IC. The input voltage to the IC is modified by a diode-resistor network (D5, D6 etc) to compensate for the non-linear relationship of frequency versus tuning voltage of the tuner. Thus this network provides a reasonably linear dial scale.

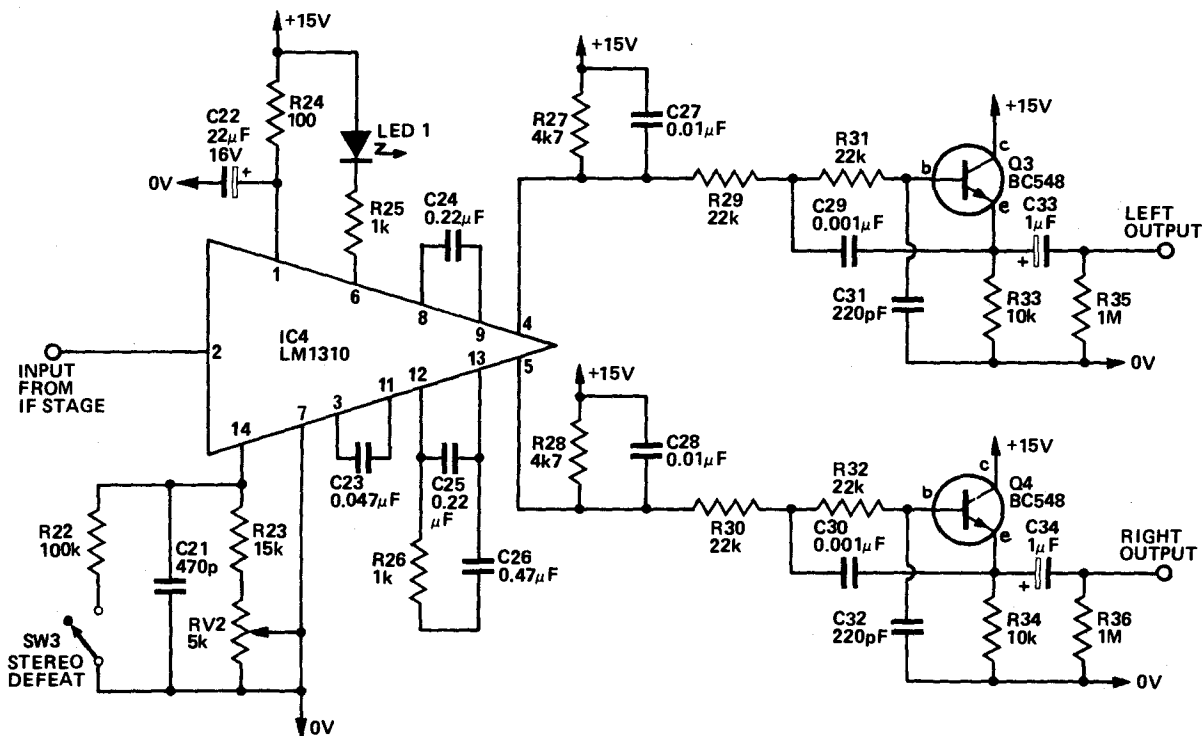

Fig. 2. Circuit diagram of the stereo-decoder stage.

FM TUNER

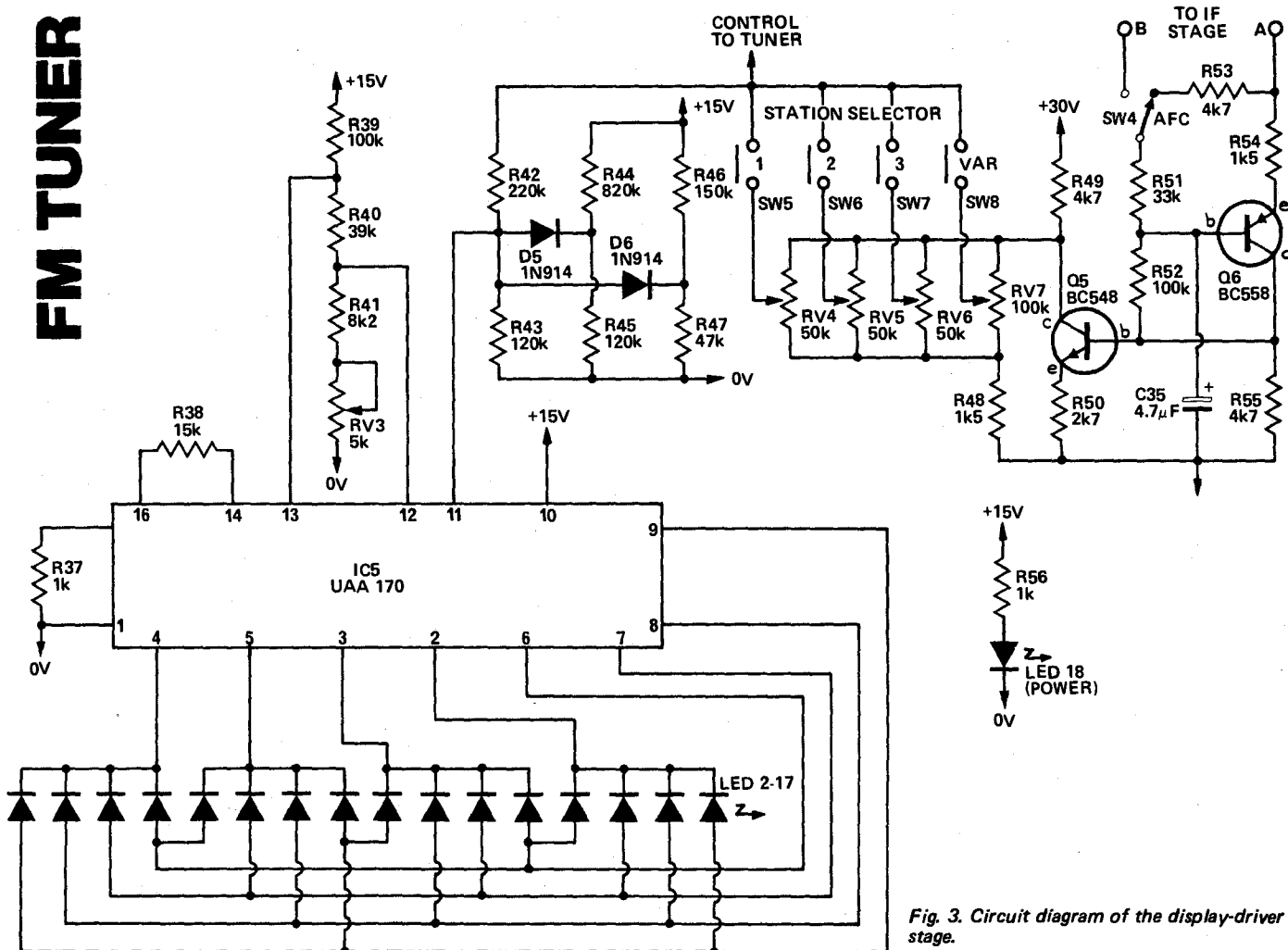
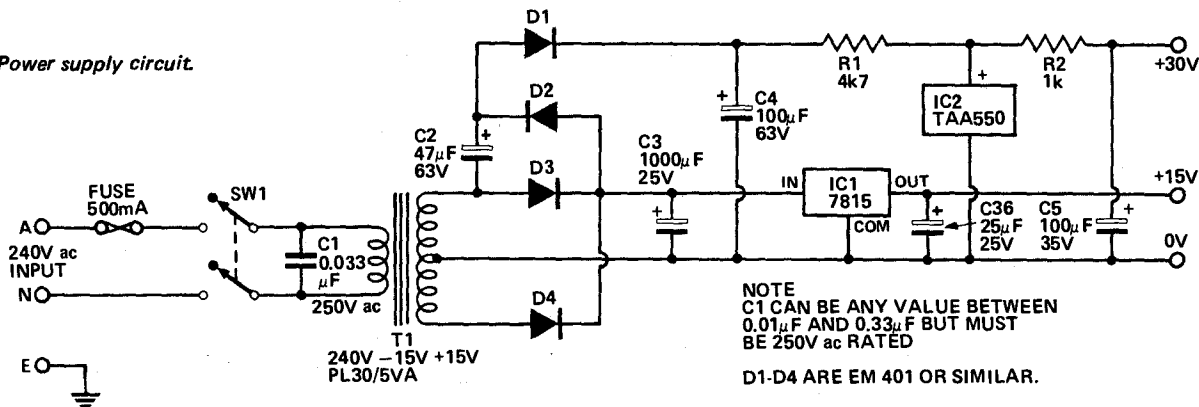

Fig. 3. Circuit diagram of the display-driver stage.

Fig. 5. Power supply circuit.



NOTE
C1 CAN BE ANY VALUE BETWEEN
0.01 μ F AND 0.33 μ F BUT MUST
BE 250V ac RATED
D1-D4 ARE EM 401 OR SIMILAR.

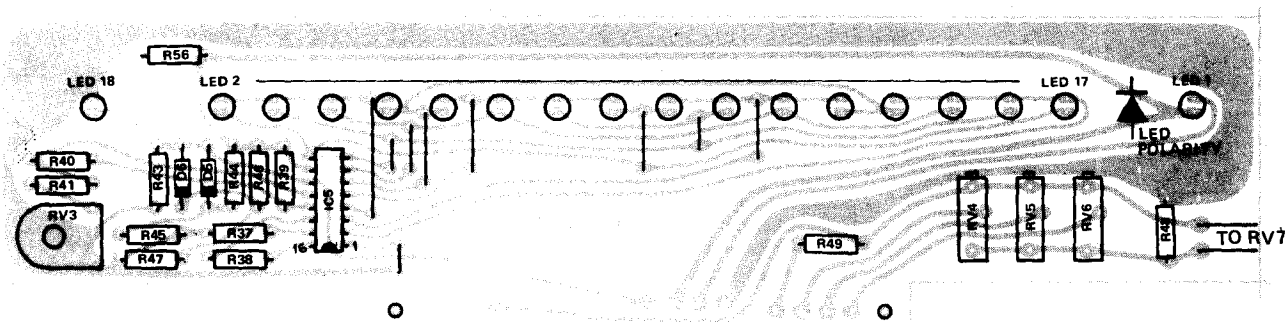
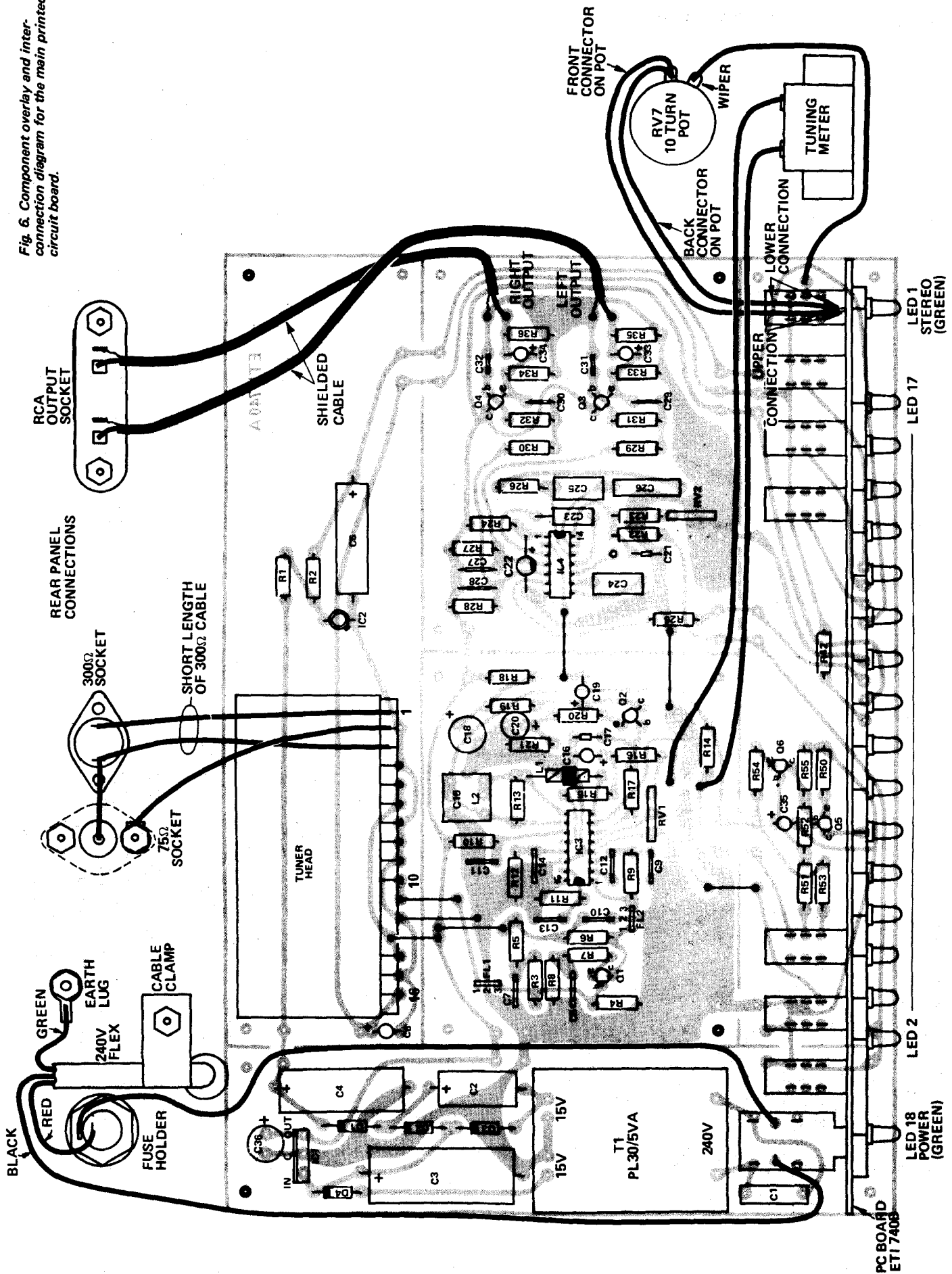

Fig. 4. Component overlay for the display board.

Fig. 6. Component overlay and inter-connection diagram for the main printed-circuit board.



FM TUNER

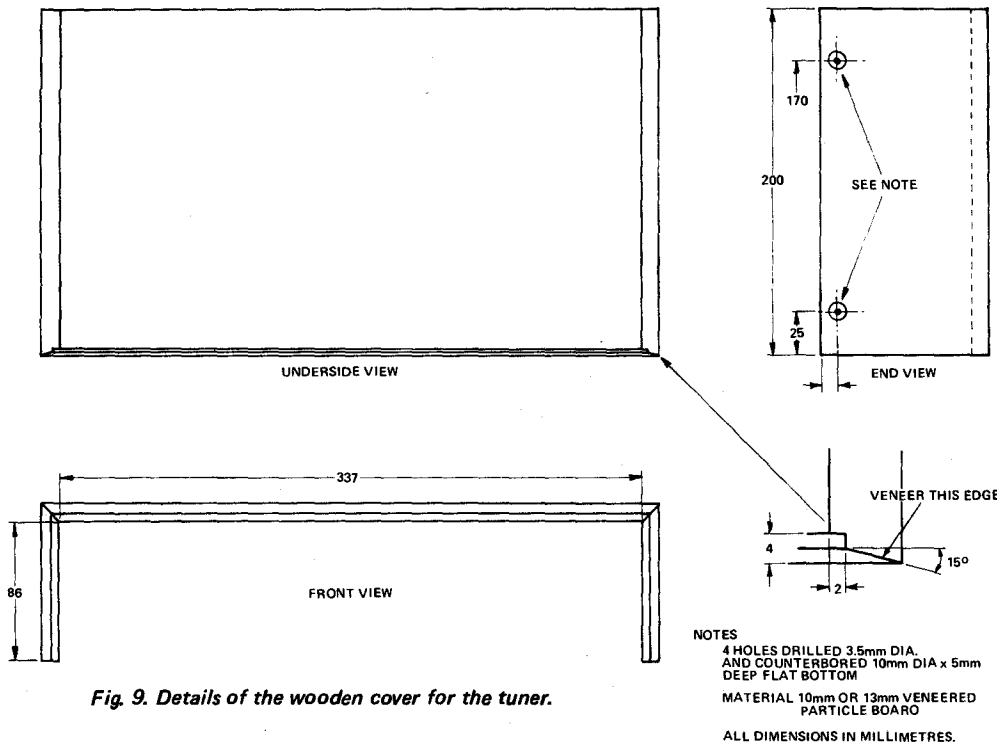

Fig. 9. Details of the wooden cover for the tuner.

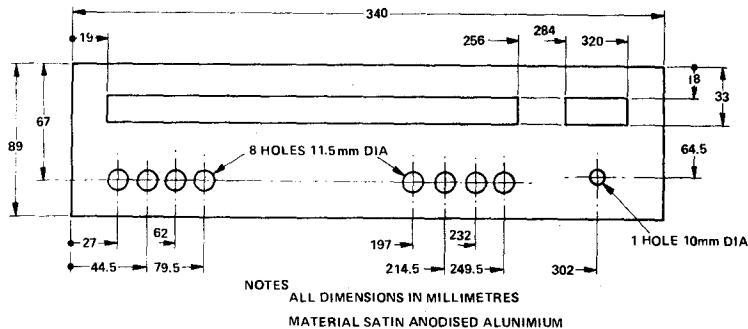
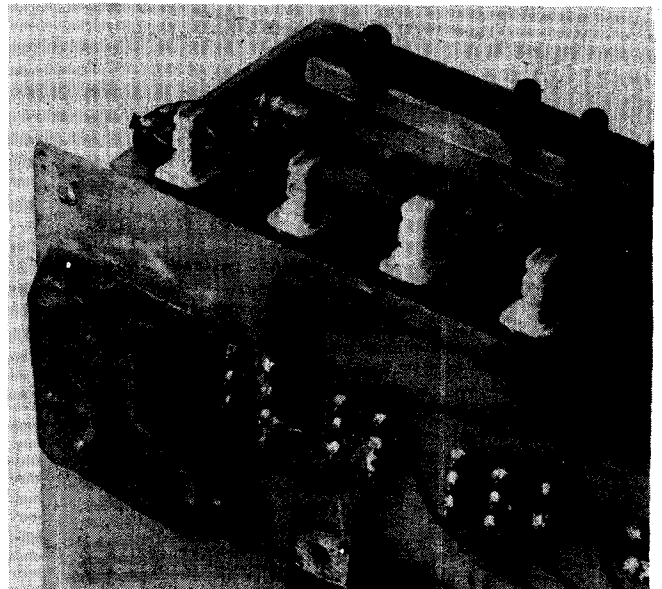
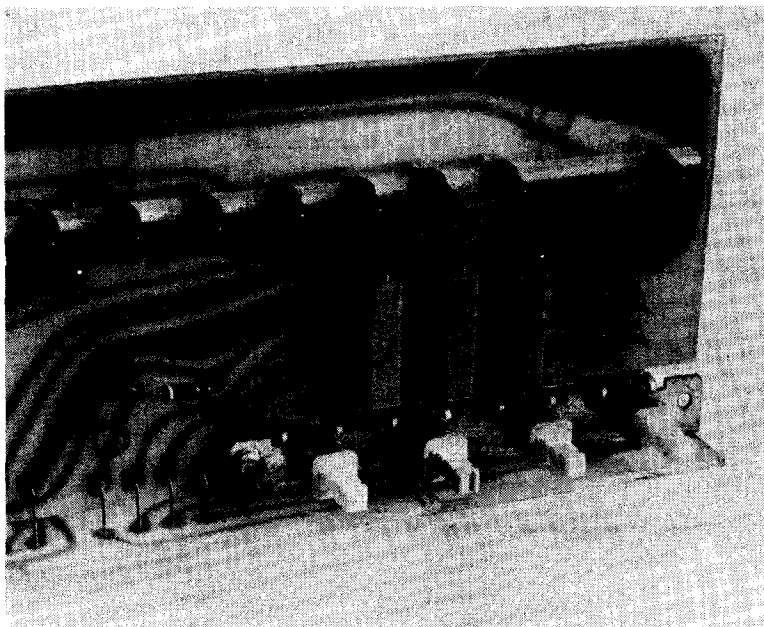

Fig. 10. Front panel metalwork.



▲ This view shows how the solder joints at mains potential are insulated with a layer of five minute epoxy. Note also RV3 on the display board.

◀ This picture shows details of the mating of the main and display boards. Note the alignment strip for LEDs, the mounting of the switches and how the display board is secured to the switch bracket.

secured to the inside of the front panel — again by contact cement. The tuning meter is held in position by epoxy cement to avoid having screws protruding through the front panel.

TESTING

Switch on the power and check that the +15 V and +30 V supplies are both operating correctly. The power indicator LED and one of the display LEDs should be alight.

Select STEREO MODE, MUTING OFF, AFC OFF and VAR. By rotating the tuning potentiometer it should be possible to sequentially vary the LED's illuminated.

Adjust the tuning potentiometer (RV7) so that its output is 3.5 volts from the slider with respect to 0 volts, and then adjust RV3 so that the first and second LEDs are both equally illuminated, (see below).

Connect an antenna and tune in a strong audible signal. Measure the voltage across R12 and adjust the tuning for maximum reading (voltage across R12 is proportional to signal strength). Now adjust L2 so that the tuning meter indication is exactly at centre. Next adjust the tuning so that the tuning meter indicates about half scale away from centre and press the AFC switch. The tuning meter should move back to centre indicating that the AFC circuit is working correctly.

Now move completely off the station. The noise level will increase suddenly. Press in the muting switch and adjust RV1 to reduce the noise level so that it is almost inaudible. Do not try to eliminate *all* the noise as this may prevent weak signals from being heard.

Finally tune to a station which is known to be transmitting in stereo. A zone will be found in the adjustment of RV2 where the stereo indicator is on. Position RV2 to the mid position of this zone. The light should go off if the MONO switch is pressed. Note that the noise behind a stereo signal is higher than when in mono.

In some parts of Australia, FM stations may be spaced only 800 kHz apart – and the same LED may be illuminated when either station is tuned. Separate LED indication may be obtained by slightly readjusting RV3.

TUNER MODULE

The tuner module as supplied to us had provision for either 75 or 300 ohm inputs as shown on the circuit diagram. Philips have advised that all the AP 2157 tuner modules in stock at the moment are fitted with both inputs. They cannot guarantee that future stocks will have the 300 ohm input. To check if your tuner has a 300 ohm input measure the resistance between pins 1 and 3 of the tuner module with an ohmmeter, a low resistance indicates that the tuner has a 300 ohm input. If the tuner does not have a 300 ohm input it will be necessary to use a balun when using it with a 300 ohm antenna. Of course if

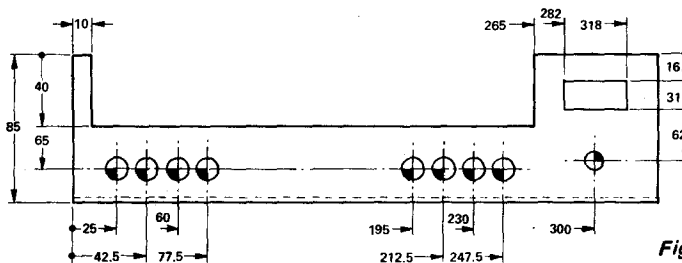
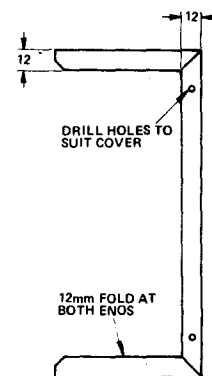
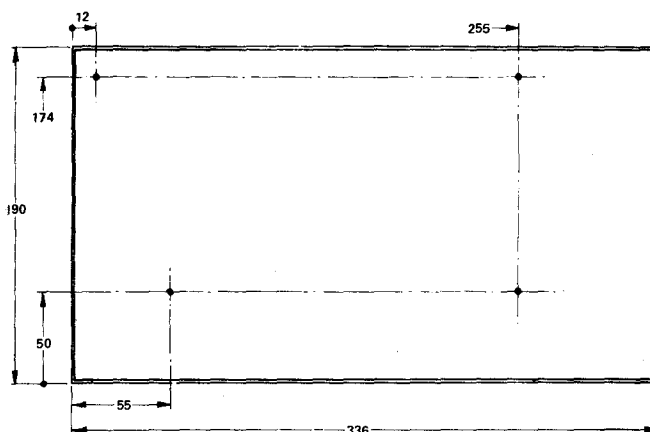
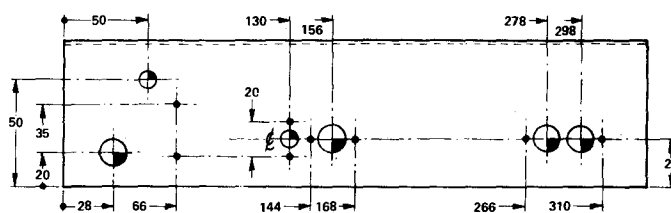

- 12 HOLES AT 3.5mm DIA
 - 3 HOLES 10mm DIA
 - 8 HOLES 13mm DIA
 - 4 HOLES 15mm DIA
- NOTES:
MATERIAL 1mm STEEL
ALL DIMENSIONS IN MILLIMETRES

Fig. 11. Chassis metalwork.

the feed from the antenna is 75 ohms it may go straight into the tuner 75 ohm input.

Note that the following errors occurred in the introductory article last month.

The LED spacing in the dial is 1.25 MHz not 800 kHz.

The display is an UAA 170 not an UA 170.

The varicap stabilizer is a TAA 550 not a TA 550.

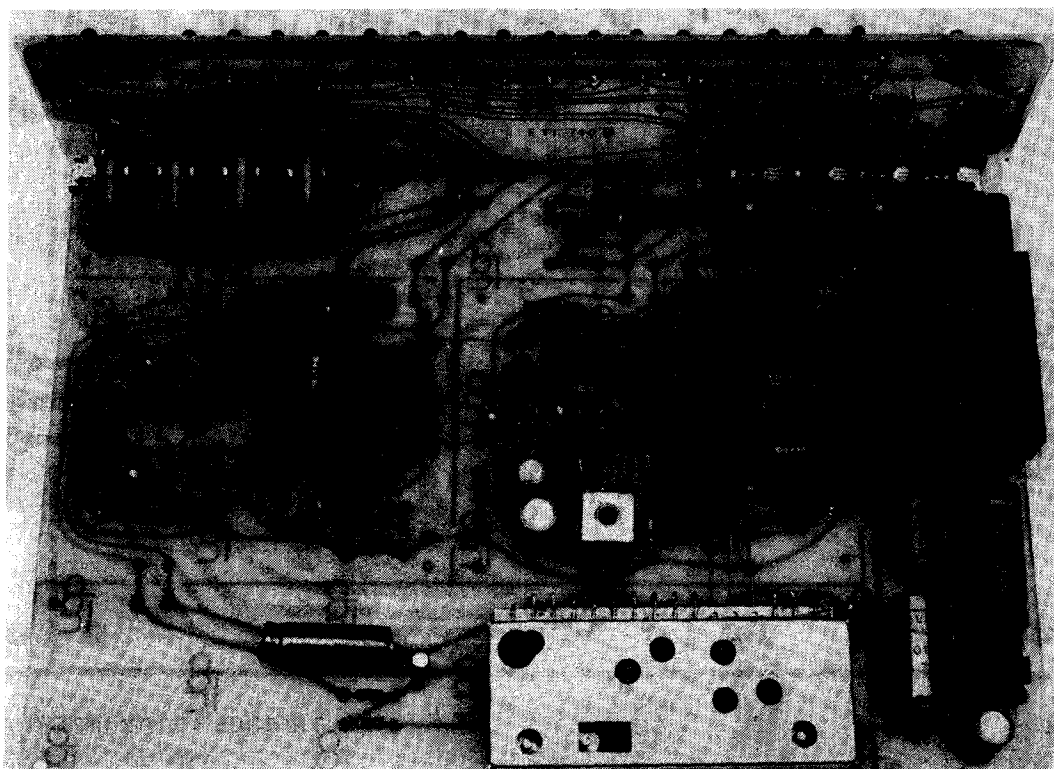

Internal view of completed unit.

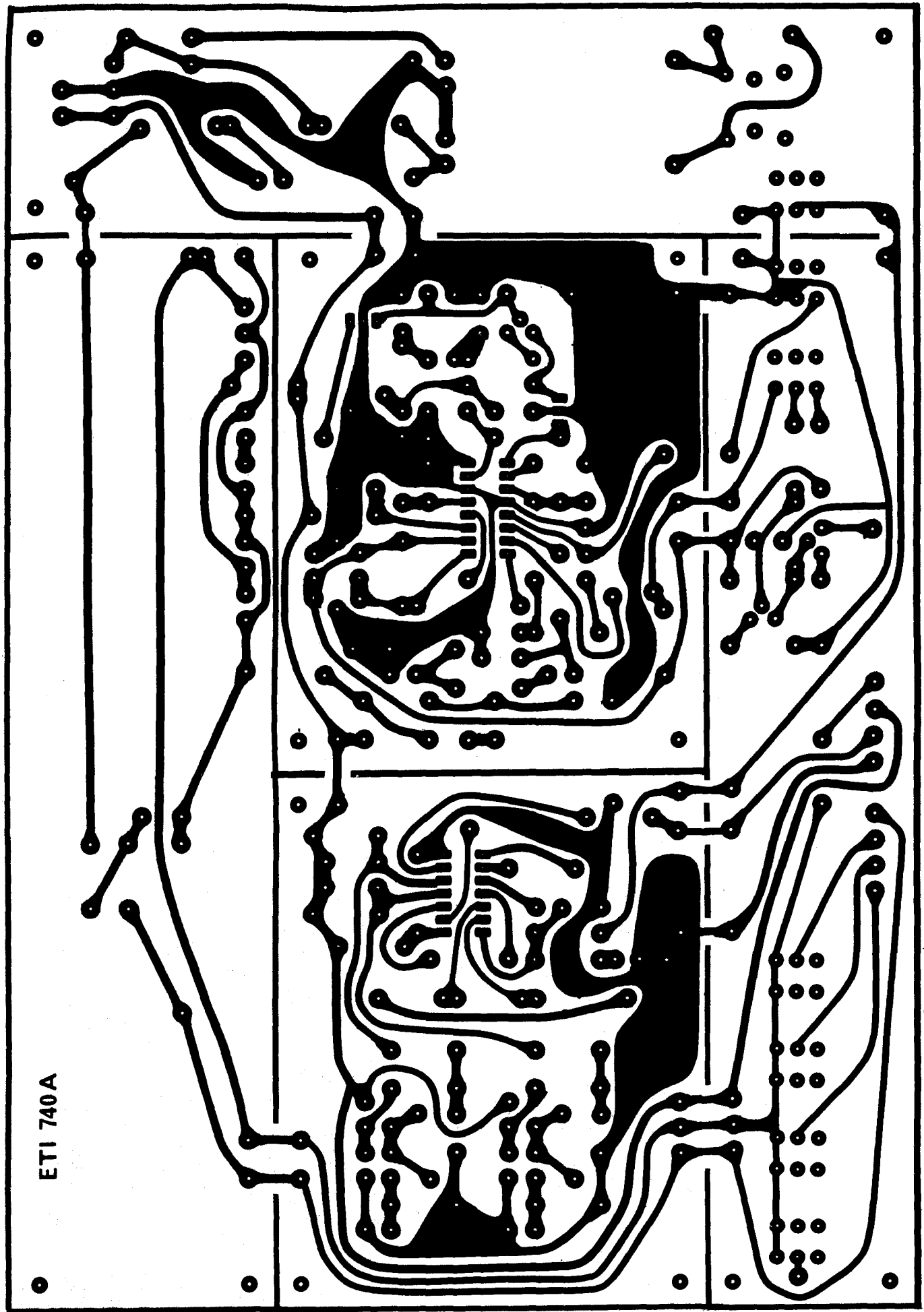

ET1 740A

Fig. 7a. Main printed-circuit board artwork. 253 mm x 177 mm.

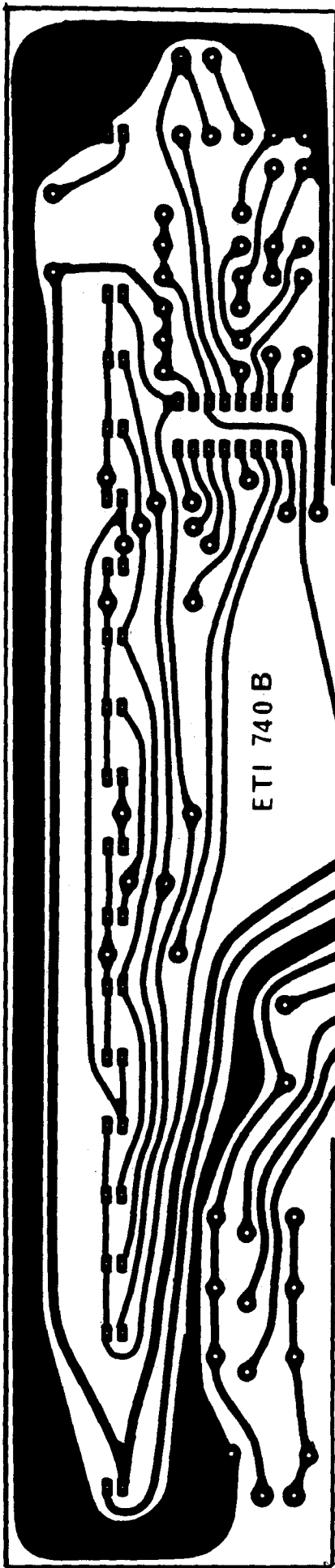

FM TUNER

Fig. 7. Printed circuit layout for the display board. 253 mm long.

Fig. 8. Front panel artwork. Full size 340 x 89 mm.

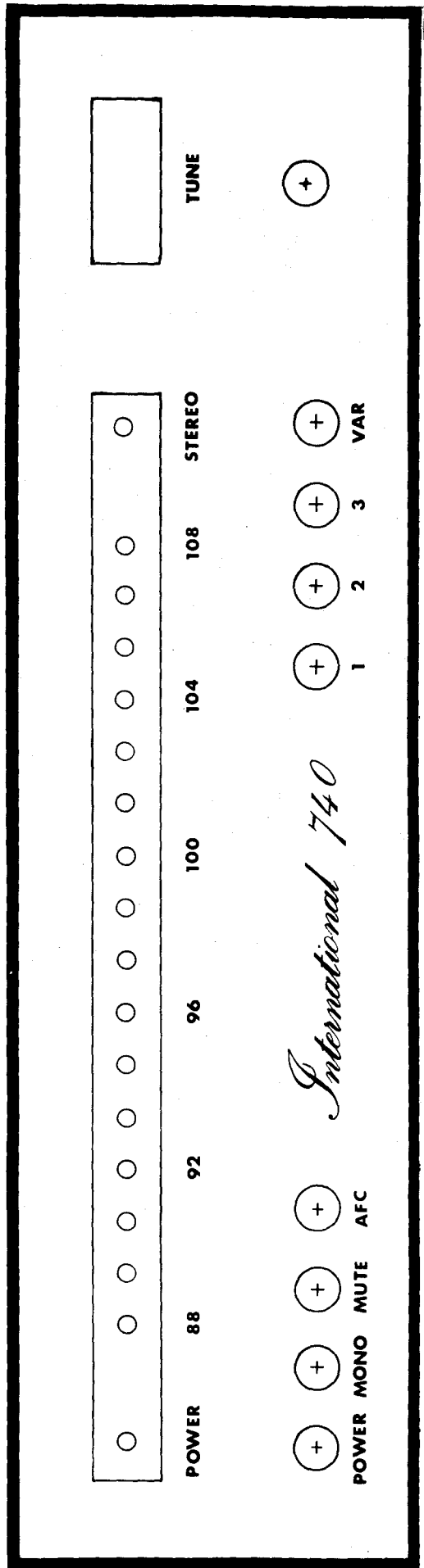



PHILIPS



A screwdriver and about 1/2 an hour is all you need to build this 40 watt Philips speaker system.

Philips make it easy and inexpensive for you to own a professional speaker system. Assemble it yourself in about 30 minutes and you have 40 watt (RMS) capacity speakers to complement your hi-fi gear.

The AD8K40 Speaker Kit includes:

- 2 precut, pre-finished wood grain cabinet enclosures with pre-painted baffle boards.
 - 2 mounted grill cloths with pre-painted baffle boards. • 2 x 8" woofers. • 2 x 1" dome tweeters.
 - 2 x 2-way crossover networks with leads and fastons fitted.
 - Innerbond lining. • Wood screws.
 - Wood glue. • Caulking compound.
- Plus full assembly instructions.

For further information contact ELCOMA Electronic Components and Materials, P.O. Box 50, Lane Cove N.S.W. 2066. Or phone 42 1261 or 42 0361 Branches in all States.

ELCOMA

153-111

electronics TODAY INTERNATIONAL

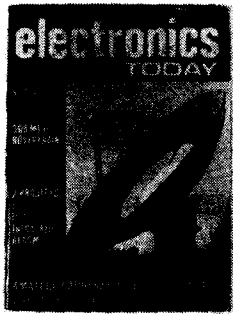

5

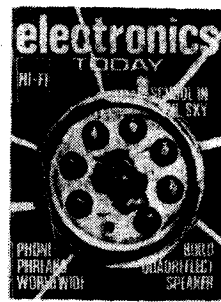
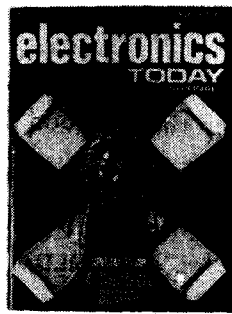

We're **years old next Month**

To mark the occasion we're making our April issue into a 'birthday special'.

FEATURES INCLUDE:

- Major contest – prizes three colour TVs.
- Special electronics data supplement.
- New feature series – 'Project Builder's Guide to Components'.
- High constructional project content.
- Plus – further special features with exceptional reader appeal.

The special content of this issue will ensure that it will be kept and referred to for years to come – and advertisers please remember that in ETI the advertisements are read as avidly as the editorial!



Thank you for your support and encouragement during our first five years – we look forward to publishing a page like this in 1981 – when we're ten!

IN THE QUEST FOR TRULY NATURAL SOUND WE ADMIT TO RUNNING SECOND

If one really appreciates music, there's one way, and only one way, to hear it in its completely natural form; with perspective, with dimension, with depth, without 'artificial colouring'. That's to be there, at the time, at the concert.

The piccolo players are not wedged in between the violinists, and the man with the tympany drums is not standing up front with the conductor. At IMF, we design and build speakers with one goal uppermost in our minds; to reproduce music naturally, as it was played with each instrument in its proper place, and at its proper weight. Call it perspective; call it depth; call it dimension; call it lack of extraneous gimmickry; call it what you will. It's the goal we've set ourselves, and we believe (as many leading world authorities on music and its reproduction are beginning to agree) that our success in achieving that goal is, so far, unrivalled.

There are those, especially hard rock enthusiasts, who will find our sound (at least at first) a little

unexciting. But 'natural sound', like anything to which one is unaccustomed, is a taste one needs to acquire.

If you appreciate not only fine music, but also fine equipment, we invite you to take a look at; and a good listen to; our speakers.

Available from:

- N.S.W.: M & G Hoskins Pty. Ltd, 37 Castle St, Blakehurst 2221, Telephone: 540-1464.
- QLD.: Stereo Supplies, 95 Turbot St, Brisbane 4000, Telephone: 21-3623.
- S.A.: Challenge Hi Fi Stereo, 96 Pirie St, Adelaide 5000, Telephone: 223-3599.
- TAS.: Audio Services, 44 Wilson St, Burnie 7320, Telephone: 31-2390.
- VIC.: Encel Electronics Pty. Ltd, 431 Bridge Rd, Richmond 3121. Telephone: 42-3762.
- W.A.: Albert TV & Hi Fi, 282 Hay St, Perth 6000, Telephone: 25-2699.
- A.C.T.: Duratone Hi Fi, Cnr. Botany St. & Atree Crt, Phillip 2606, Telephone: 82-1388.

Sole Australian Distributors

**INTERNATIONAL DYNAMICS (AGENCIES)
PTY. LTD.,**
23 Elma Rd., North Cheltenham, 3192, Melbourne 95-1280.

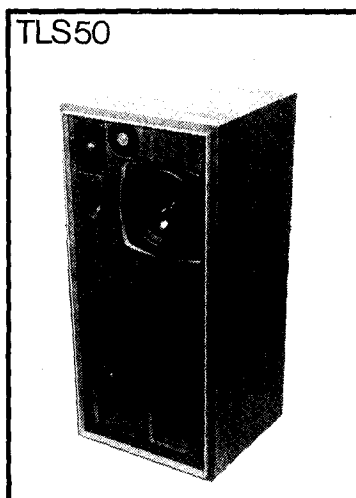
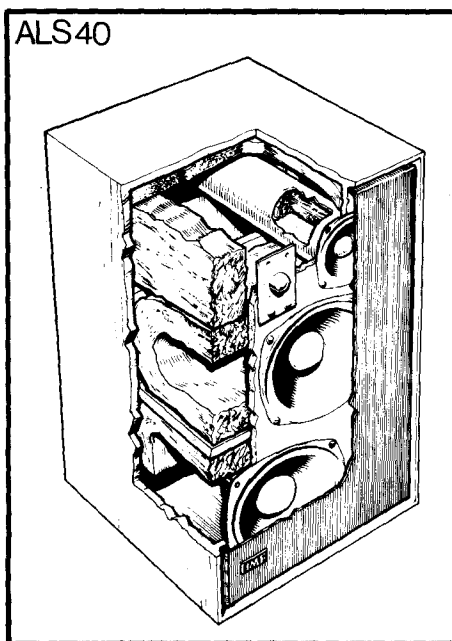

IMF

WHAT GOES IN, COMES OUT. NATURALLY

New 240V design offers toggle action and complete safety.

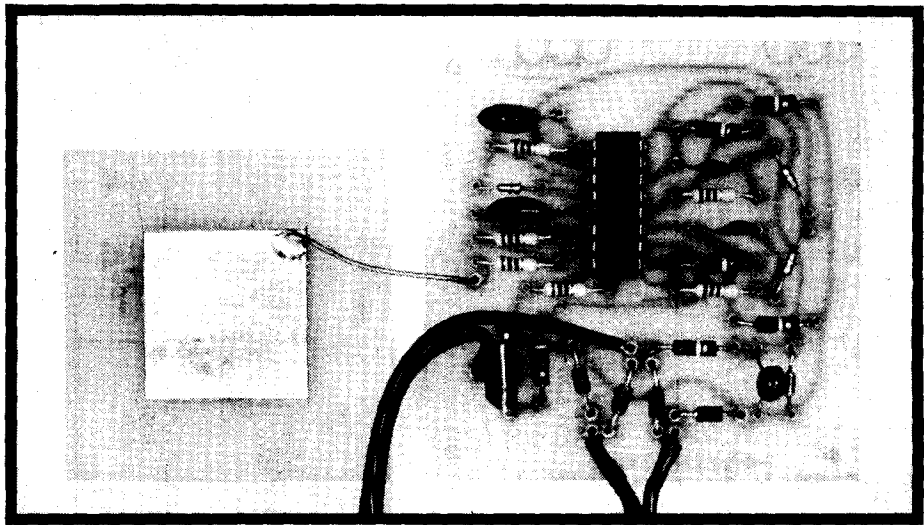

TOUCH SWITCH

TOUCH switches are fascinating devices and have been in use for many years in lift controls. The circuit used in lifts usually consists of a high-frequency oscillator which has a touch plate connected to the tuned circuit. When the plate is touched the additional capacitance introduced either detunes the oscillator thus changing the frequency, or couples the oscillation into the detector and switching circuitry. This approach, whilst effective, is very expensive and thus touch switches of this type are not widely used.

Most of the touch switches published in electronics magazines to date have required the sensing element actually to be touched — usually via a series resistor of about one megohm or higher. Such circuits rely on body resistance to activate the switch, and are therefore not safe for use in controlling devices operated on 240 Vac.

In the touch switch described in this project, it was specified that the action of the switch should be touch-on touch-off and that no actual contact with the circuit be made (for safety reasons). These constraints led us to use a capacitive circuit. The touch plate is in effect a capacitor. When this plate is touched, the input of the first stage is capacitively referenced to earth, however as the supply rails to the control circuit are floating at rectified 240 Vac the 50 Hz waveform effectively appears at the input of the control circuit and initiates the switch action. The actual contact plate is a piece of single-sided printed-circuit board arranged so that the *non-copper side* is touched — the copper on the other side is connected to the control circuit. Thus a full 1.6 mm of

insulation is always between the user and the circuitry at mains potential.

CONSTRUCTION

A touch switch may be constructed (and used) in many different ways. It may be mounted within the base of a lamp; fitted onto a conventional switch-plate to control overhead lights; or mounted in a piece of electronic equipment. It is however unlikely that the switch would be used as a separate unit and for that reason housing details have not been provided.

As stated above the touch plate is constructed from a piece of printed-circuit board as detailed in the drawing. The touch-plate need not be exactly as shown but can be any convenient shape or size. However make sure that the copper surface of the plate cannot touch any of the external metal surfaces and that it cannot be touched by the fingers. If the unit is to be built into a lamp that has a plastic base a piece of aluminium foil may be glued to the *inner* surface of the base to act as the pickup plate.

If the plate is too large or the lead

connecting it to the circuit too long, stray capacitance to ground may be sufficient to prevent the switch operating. If the lead is more than about 50 mm long shielded cable should be used (shield connected to '0' volts not to ground). If a large plate is used the gain of the first stage should be reduced by changing the value of R2. (Try 3.3 M first and if this is not effective try 1 M).

The circuit given in the main circuit diagram supplies the load with pulsating dc and is therefore suitable to drive resistive loads (such as light globes) only. If an inductive load must be supplied the slightly more complex alternative circuit (shown in the insert) must be used. In this circuit the load must be inserted in the neutral lead if the switch is to operate correctly. Thus it is essential to ensure that the active and neutral are connected correctly. To make the changes required for inductive loads it is necessary to install a link between D4/D6 and the anode of the SCR. The resistor R11 is removed from the board and D8 and the new R11 are glued to the board with epoxy cement.

SPECIFICATION

Mode of Operation	touch-on, touch-off
Triggering Mode	capacitance
Power	450 VA resistive 450 VA inductive*

*alternative circuit for load.

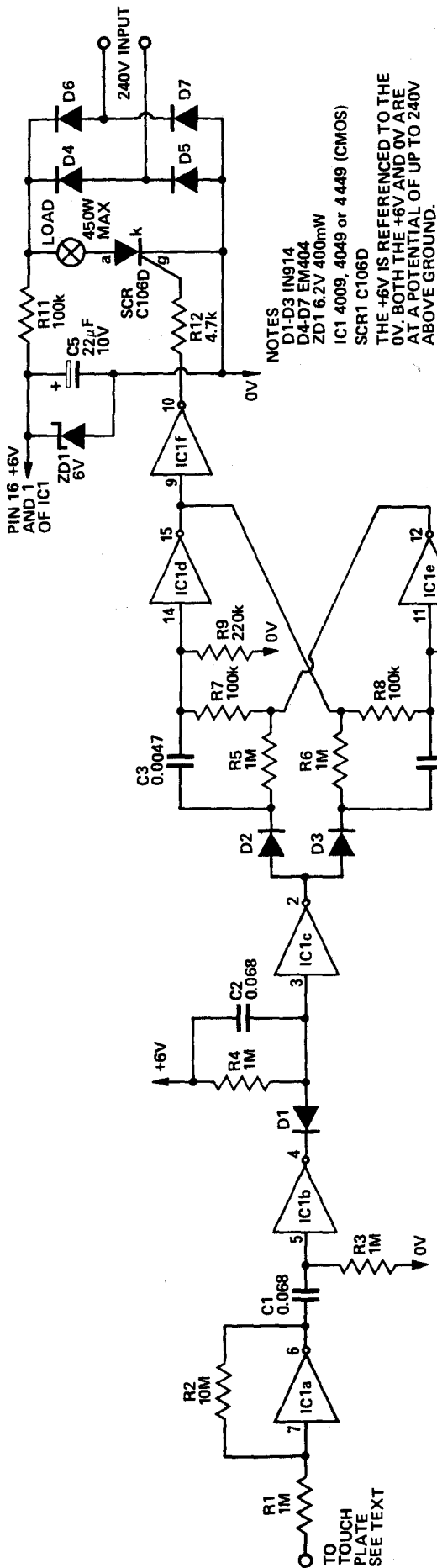

NOTES
 D1-D3 1N914
 D4-D7 EM404
 ZD1 6.2V 400mW
 IC1 4009, 4049 or 4449 (CMOS)
 SCR1 C106D
 THE +6V IS REFERENCED TO THE 0V. BOTH THE +6V AND 0V ARE AT A POTENTIAL OF UP TO 240V ABOVE GROUND.

ALL PARTS OF THIS CIRCUIT ARE CONNECTED TO THE MAINS AND MUST BE CONSIDERED DANGEROUS. ANY TEST EQUIPMENT USED MUST BE ISOLATED FROM THE MAINS TO PREVENT DAMAGE AND PERSONAL INJURY.

Circuit diagram of the touch switch.

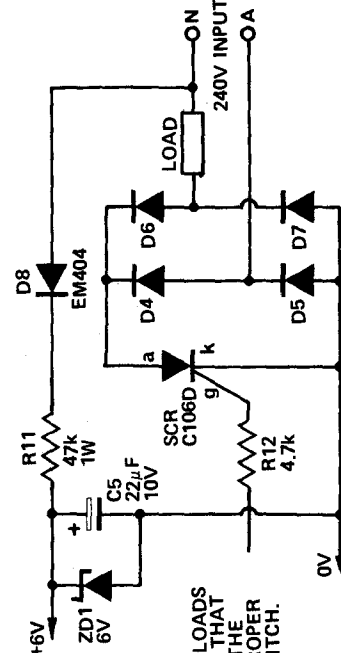

CIRCUIT IF INDUCTIVE LOADS ARE TO BE USED. NOTE THAT THE LOAD MUST BE IN THE NEUTRAL LEAD FOR PROPER OPERATION OF THE SWITCH.

PARTS LIST - ETI 539

R1,3,4,5,6	Resistor	1M	5%	1/2W
R7,8,11	"	10M	"	"
R9,10	"	100k	"	"
R12	"	220k	"	"
	"	4.7k	"	"
C1,2	Capacitor	0.068μF		
C3,4	"	Polyester		
	"	0.0047μF		
C5	"	Polyester		
	"	22μF 10V electro		
D1-D3	Diode	1N914 or similar		
D4-D7	"	EM404 or similar		
ZD1	Zener Diode	6.2V 400mW		
SCR		C106D		
PCB		ETI 539		

Case to suit

For inductive loads change R11 to 47k 1W add D8 - EM404

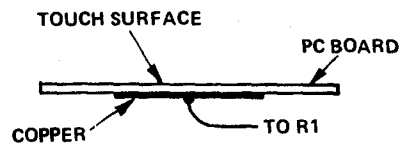
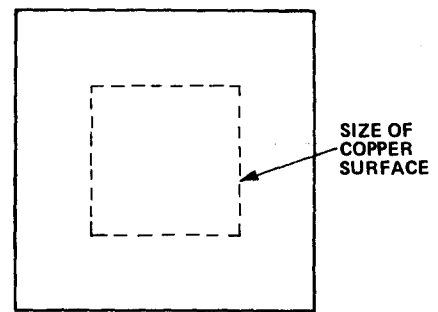

We constructed our touch plate from a 50 mm square piece of printed-circuit board. The board was etched to leave a 25 mm square section of copper in the centre. See text if different sized plate or long connecting lead is to be used.

HOW IT WORKS

POWER SUPPLY

The 240 Vac is rectified by diodes D4 to D7. The output of the diode bridge is then reduced, smoothed and regulated to 6 volts dc by R11, ZD1 and C5. The load is connected after the rectifier and has power switched to it via the silicon-controlled rectifier, SCR. Note particularly that the load is supplied with pulsating dc and therefore the type of load used with this circuit must be resistive, for example, an incandescent lamp. For inductive loads such as transformers etc, the load circuit must be modified as shown in the small diagram.

DETECTOR

The detector is formed by one section of a CMOS hex inverter, IC1a, in which the gain is set by the ratio of R2/R1. The touch plate is connected to the input of the detector and touching it effectively adds a capacitor to ground. However the '0' volt line (due to the diodes D4 to D7) when referenced to ground is effectively 50 Hz 240 volt rectified. The touch plate capacitance introduced therefore couples this waveform into the input of the

detector and over-drives the amplifier so that the output is a 50 Hz squarewave. If the plate is not touched the capacitance is very much lower and hence the output of the amplifier is very much lower in level. The sensitivity may be altered by changing the value of R2 (lower value gives less sensitivity).

LEVEL SHIFTER

The output of IC1a is centred about 3 volts, and C1, R3 and IC1b are used to provide level shift such that the output of IC1b is normally high at +6 volts until the plate is touched. When the plate is touched the output of IC1b oscillates between +6V and 0 V at a 50 Hz rate. The hex-inverter IC has diodes internally which connect each input to ground. Thus these diodes prevent the inputs from being driven below -0.6 volts.

PULSE STRETCHER

The 50 Hz output from IC1b is not in a convenient form and must be converted into a signal which is only high and stays high whilst the plate is touched. This is performed by a pulse stretcher and inverter consisting of IC1c together with R4 and C2. The

output of IC1c is normally low and goes high and stays high whilst ever the plate is touched.

FLIP FLOP

To meet our mode of operation requirement the circuit needs to be held on after the finger is removed from the plate and only switched off when the plate is touched a second time. Thus a toggle action is required and this is obtained by incorporating a flip flop formed by IC1d and IC1e. Cross coupling of gates normally provides an RS flip flop which may take up any state if both inputs are taken high together. For this reason the capacitors, resistors and diodes at the inputs to the flip flop are used to provide steering logic to ensure that correct toggle action is obtained.

BUFFER

To prevent loading the flip flop, and because a spare section of the hex inverter is available, a buffer amplifier is inserted between the flip flop and the SCR. The SCR used is a C106D which is a sensitive gate type. This particular SCR will operate reliably with the 1 mA gate current provided. The SCR specified will be used - don't try substitutes.

TOUCH SWITCH

Printed-circuit board layout for the touch switch. Full size 68 mm by 68 mm.

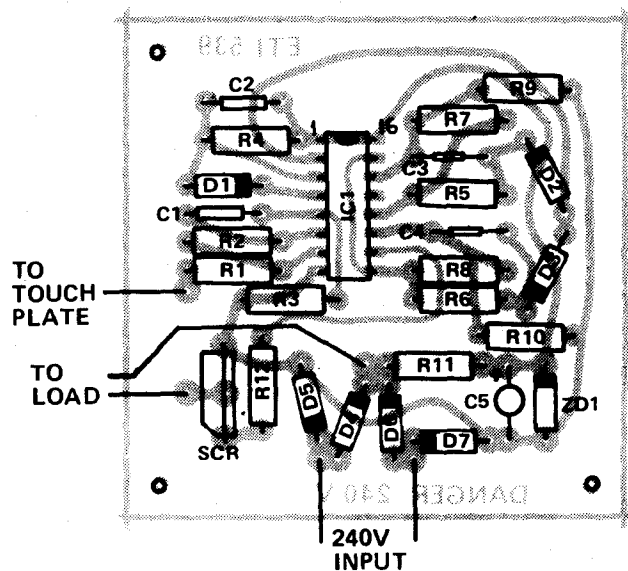
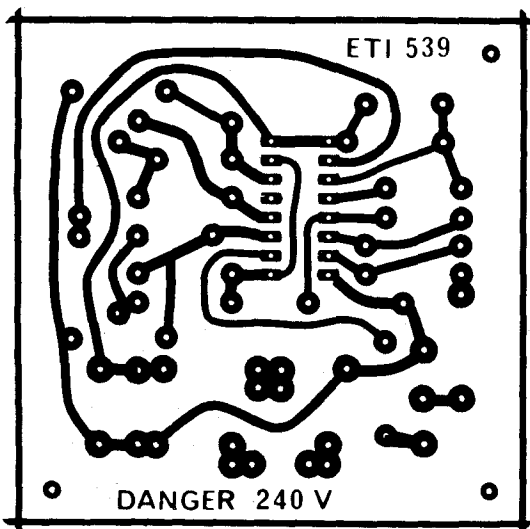

How the components are positioned on the board.

WIGO ACUSTIC HI-FI LOUDSPEAKERS FROM GERMANY

A top-quality range of respected loudspeakers from Germany, Wigo (pronounced "Vee-go") are now available in Australia as separate component speakers or as complete speaker systems in walnut finish cabinets.

If you're a handyman, choose from this large range of loudspeaker units and build your own loudspeaker system.

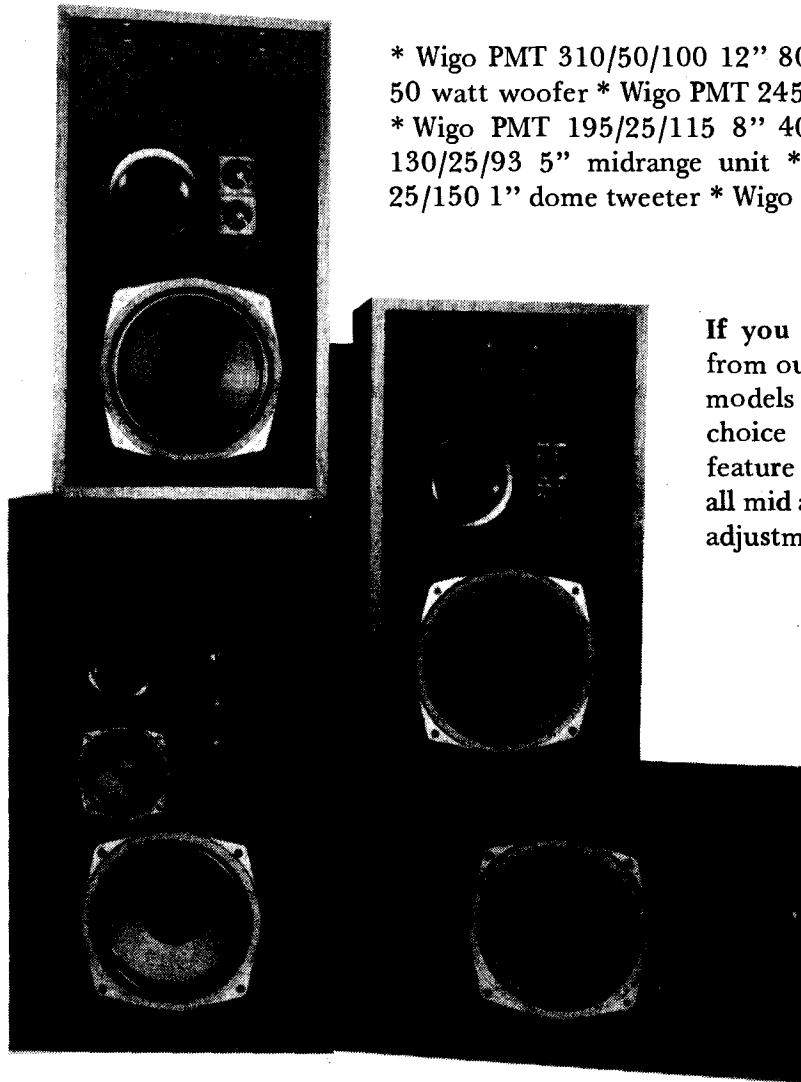

* Wigo PMT 310/50/100 12" 80 watt woofer * Wigo PMT 245/37/100 10" 50 watt woofer * Wigo PMT 245/25/115 10" 40 watt bass/midrange speaker * Wigo PMT 195/25/115 8" 40 watt bass/midrange speaker * Wigo PMM 130/25/93 5" midrange unit * Wigo 37/110 1½" dome midrange * Wigo 25/150 1" dome tweeter * Wigo 19/135 ¾" super tweeter.

If you prefer to buy ready made systems Choose from our new range with walnut finish cabinets. All models have removable front grille cloths with a choice of patterns. Three and four-way systems feature constant impedance volume controls on all mid and high range loudspeakers to allow suitable adjustment to suit listening area acoustics.

Wigo M102 2-way 40 watt. 8" Bass/mid-2" tweeter. 19" (H) x 10¼" (W) x 9¼" (D)

Wigo M132 2-way 40 watt 10" Bass/mid - 1" dome 25" (H) x 14½" (W) x 9¼" (D); Wigo M133 3-way 40 watt 10" Bass - 1½" dome - ¾" dome 25" (H) x 14½" (W) x 9¼" (D); Wigo M203 3-way 50 watt 10" Bass - 1½" dome - ¾" dome 25" (H) x 14½" (W) x 12½" (D); Wigo M254 4-way 50 watt 10" Bass - 5" mid - 1½" dome - ¾" dome 29" (H) x 17" (W) x 12" (D).

Wigo M504 4-way 80 watt. 12" Bass - 8" mid - 1½" dome - ¾" dome. 37" (H) x 19¼" (W) x 15¾" (D).

Challenge

HI-FI STEREO PTY LTD

96 PIRIE ST.
ADELAIDE

STH. AUST. 5000

PHONE: 223 3599

- FAST SERVICE — ALL ITEMS DESPATCHED AT TOP SPEED
- ALL NEW ITEMS — UNUSED AND CARRY MANUFACTURER'S GUARANTEE
- SATISFACTION OR MONEY BACK — (IF GOODS RETURNED WITHIN 7 DAYS)
- PRICES INCLUDE SALES TAX, POSTAGE AND PACKING
- DATA SHEETS/APPLICATION NOTES AVAILABLE — 20c EXTRA PER DEVICE
- FIRST QUALITY BRANDED COMPONENTS FROM THE WORLDS LEADING SEMI CONDUCTOR HOUSES
- 10% DISCOUNT ON ORDERS OVER \$25.00 (COMPONENTS ONLY - NOT HOBBY KITS)

EXPERIMENTERS BONANZA! Special Purpose IC Collection

"BAR-O-LIGHT"

UAA180 LED DRIVER - Drives up to 12 LEDs to give bar chart type indication - add 7 resistors to make up VU meters, thermometers, tachometers etc. etc. (Suitable LEDs readily available - 20c each) Supplied complete with socket, data and applications notes. **\$3.30**

"SPOT-O-LIGHT"

UAA170 LED DRIVER - Drives up to 16 LEDs with a moving pointer type indicator. Add 8 resistors to make voltmeters, frequency indicators, dial drives etc. etc. (Suitable LEDs readily available - 20c each). Supplied complete with socket, data and application notes. **\$3.50**

"TACHOMETER" SAK140

Automotive Tachometer IC. Add resistors and capacitors to build a very simple tachometer to suit virtually any car. Combined with UAA180 will produce a very economical tachometer with LED readout. Supplied complete with socket, data and applications notes. **\$2.00**

LM3909 LED FLASHER

A proven winner. This incredibly popular device can be built into low drain flashers, radio, electronic sirens. Supplied complete with socket, data and application notes. **\$1.60**

DUAL 6W HI FI

LM379 is a single IC which can drive 8 ohm speaker at 7 watts! It is internally stabilized and the output is thermally protected. This can be easily used to produce a very low cost HI FI system with the minimum of components. Supplied complete with data and applications notes. **\$6.25**

MC1310 FM STEREO DECODER

The MC1310 is a phase locked loop intended for decoding FM stereo transmissions. The IC is very simple to use and it requires no external coils whatsoever. Convert your mono FM receiver to stereo. Supplied complete with socket, data and applications notes. **\$4.25**

1024 BIT MEMORY

MM2102N - 1024 bit static RAM Experiment with computer memories using this remarkable device. Arranged in a 1 x 1024 bit array this IC only requires a single +5V supply and because operation is STATIC no complex refreshing circuits are used. Quantity prices for 6 or 8 2102's are also available. Supplied complete with socket and applications data. **\$6.50**

SPECIALS OF THE MONTH

4011 CMOS NAND GATE	.30
4001 CMOS NOR GATE	.30
7490 TTL DECADE COUNTER	.75
555 DUAL 555 TIMER	\$1.50
LM3900 QUAD AMPLIFIER	\$1.20
NE555 TIMER	.70

VOLUME BUYS

5023 LEDs	10 for \$2.00
1N914 DIODES	20 for \$1.50
1N4004 DIODES	10 for \$1.00
741CN OP AMP	5 for \$3.00
2N3055 NPN 115W Power Transistors	4 for \$3.20

(Complete with hardware)

TRANSISTORS

BC107/BC547	NPN Audio Driver Amplifier	.25
BC108/BC548	NPN Low Voltage Audio	.25
BC109/BC549	NPN Low Noise HI FI Amp	.25
BC177/BC557	PNP Audio Driver Amplifier	.25
BC178/BC558	NPN Low Voltage Audio Amplifier	.25
BC179/BC559	PNP Low Noise Input Stages	.25
BC639	NPN 80V 1W Driver	.60
BC640	PNP 80V 1W Driver	.60
BD137	NPN 60V 8W Driver	.85
BD138	PNP 60V 8W Driver	.85
BD139	NPN 80V 8W Driver	.90
BD140	PNP 80V 8W Driver	.90
BF180	NPN High Frequency Pre Amp	\$1.20
MU10	UJT General Purpose	.60
2N2955	PNP 114W Power Driver (T03) Metal	\$1.70
2N3053	NPN 5W Medium Power Driving	.80
2N3054	NPN 25W 4A Power Switching	\$1.50
2N3055	NPN 115W Power Driver (T03) Metal	\$1.20
2N3638	NPN 500mA High Current Amp	.45
2N3643	NPN 500mA High Current Amp	.50
2N3644	PNP 500mA High Current Amp	.45
2N4220	FET	\$1.20
MPF102	FET	.60
2N5459	FET MPF105	.65
2N5461	FET	.75
2N5485	FET MPF106	.80
2N6027	PUT D13T1	\$1.20
2N2646	UJT	\$1.40

OPTO ELECTRONICS

BPX25	Photo Transistor	\$3.00
ORP12	Photo Resistor	.85
5023	General Purpose Red LED with Clip	.25
LD261	Miniature PCB Mounting LED - Infra Red	\$1.50
LD461	Miniature PCB Mounting LED - Visible Red	.60
NCT200	Photo/Transistor Opto Coupler	\$1.50
NSN61	.6" Common Anode Display (747)	\$3.50
NSN64	.6" Common Cathode Display	\$3.50
NSN71	.3" C Anode 7 Display (707)	\$2.40
NSN73	.3" I Format C Cathode	\$2.40
RED 1	Red LED 6mm JUMBO size w/th Clip	.30

CATALOGUE OF COMPLETE STOCK LISTING AVAILABLE ON APPLICATION

THE
ELECTRONIC MAILBOX

P. O. BOX 355,
HORNSBY N.S.W. 2077

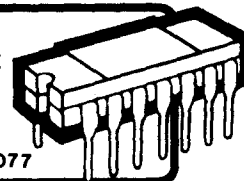

ELECTRONIC HOBBY KITS

To-day's Technology for Your Enjoyment

ETI 740 - SUPERB FM!

— high quality push button varicap FM stereo tuner sets new standards of performance.

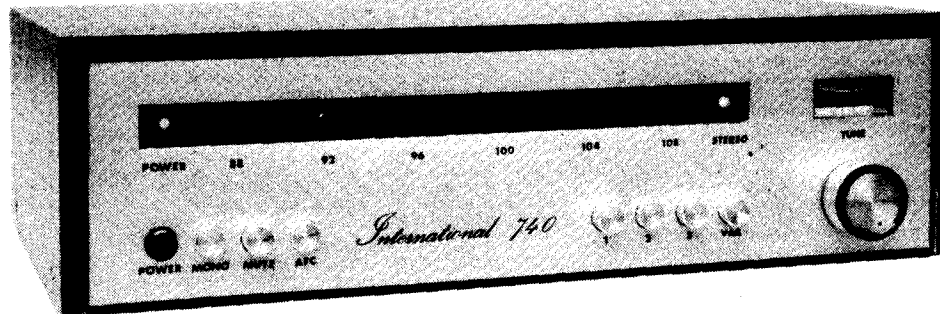

THE FM TUNER KIT YOU HAVE WAITED FOR

The ETI 740 is a novel design for an FM tuner which achieves high performance and eliminates the critical setting up required with many other tuners. The front end is a ready built pre aligned module which then feeds CA3089 IF and demodulator integrated circuit via ceramic filters. The CA3089 provides AGC, AFC muting as well as signal strength and tuning meter drive voltages. Temperature compensated varicap tuning allows stations to be selected either by a ten turn tuning potentiometer or by a choice of three preset push button controls. The actual frequency selected is displayed on the unique "electronic dial" display mounted behind the front panel. The stereo decoder is based on a well proven integrated circuit phase locked loop which is followed with active filters to remove subcarrier harmonics and "birdies". A LED stereo beacon indicates when stereo transmissions are being received. The specially designed transformer has a built in electrostatic shield to eliminate annoying mains "clicks". The ETI 740 is available as a complete pack or assembled and tested. Please write for further details.

KIT PRICE

\$120.00

Plus \$5 freight & packaging

Assembled and tested

ETI740 complete \$155.00

(plus \$5 freight and packaging).

AT3089 demodulator module \$22.00

(delivered free in Australia).

AT1310 stereodecoder or module \$17.50

(delivered free in Australia).

All technical support and warranty service available
— see next page.



109-111 Hunter Street,
HORNSBY, N.S.W. 2077
Phone (02) 476-4758
Open Saturday morning

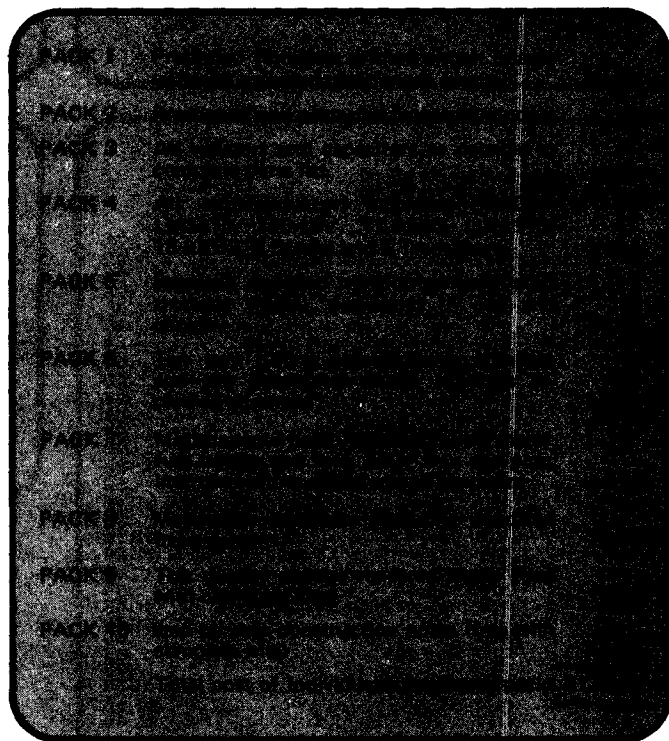

ELECTRONIC HOBBY KITS

To-days Technology for Your Enjoyment

Designed by the ETI Team the International 440 is a remarkable combination of high performance, easy construction and low cost.

We offer our own exclusive step-by-step assembly manual, the choice of buying individual packs or the full kit and a really good looking Walnut Veneered Cabinet that guarantees you a professional finished product anyone would be proud to own. For pack prices, see December ETI.

With our full Technical support and Warranty Service (see below) you just can't fail to build this kit!

\$85-00 nett

Assembled and Tested \$115 nett
Plus \$5 freight and packaging

ETI 440 SIMPLE 25 WATT AMPLIFIER

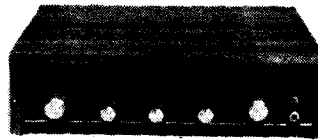

\$16-75

Nett, delivered free anywhere in Australia \$21.75 nett, assembled and tested.



SPECIAL OFFER!

ETI 534 STOPWATCH/CALCULATOR — A MUST FOR ALL SPORTSMEN

By special arrangement with N.S. Electronics we are pleased to offer this NOVUS 650 calculator together with the complete set of components to build the ETI 534 Stopwatch/Calculator. The kit includes a specially designed fibreglass printed circuit board with a silk screened component overlay. With our unique STEP-BY-STEP ASSEMBLY MANUAL and TECHNICAL SUPPORT virtually anyone can build this exciting and useful project. We thoroughly recommend it for beginner or professional.

ETI 704 CROSS HATCH/DOT GENERATOR

\$27-50 nett

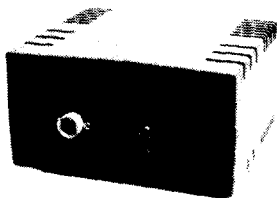

This incredibly popular project now given the HOBBY KIT treatment.

- Pre drilled/screened front panel.
- Fibreglass PC Component Overlay.
- Pre-wound coils.
- Sockets for all IC's.

Complete to last detail including solder and hook up wire. Full warranty support applies. (Doesn't include battery.)

Delivered free in Australia

MR 25 SCORPIO CD1



Based on one of the most popular CDI projects in the world, this proven design has been updated and re-engineered to ensure that the kit can be readily assembled by anyone from a novice to an expert design engineer. The kit comes complete in every detail including all components and hardware; screened, etched and drilled PC Board, machined and finished metal work, pre-wound and tested transformer and a unique, easy to follow assembly manual that converts the assembly task to sheer pleasure.

If you have any problems before, during or after assembly — just call on our exclusive Technical support and Warranty Service.

\$28-50 nett

Assembled and tested \$36.00 nett
Delivery free in Australia

FULL TECHNICAL SUPPORT AND WARRANTY SERVICE

All Applied Technology HOBBY KITS are covered by our exclusive 90 days warranty against faulty components and packaging (full details with each kit).

Yet another exclusive is the full technical support service. If you are unable to make your HOBBY KIT operational, help is just a phone call or a letter away. If you do have to return any KIT for factory attention, it will be repaired for a nominal service fee.

All kits are on display at our Factory Showroom. Personal callers welcome — weekdays by appointment, or anytime Saturday Mornings. Phone 476 4758.



109-111 Hunter Street,
HORNSBY, N.S.W. 2077
Phone (02) 476-4758
Open Saturday morning

Please supply

Enclosed is my Cheque/Postal Note/Money Order for \$.....
made out to APPLIED TECHNOLOGY PTY. LTD.
(PLEASE PRINT CLEARLY)

NAME

ADDRESS

P/C

ETI 3/76

KITSETS

UNDER NEW MANAGEMENT

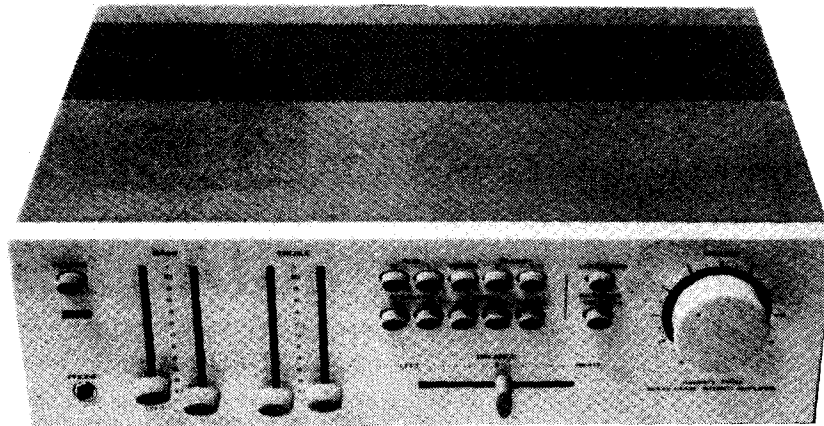

THE BEAUTY

Mustard yellow control knobs punctuating a fresh white front panel. Large (1 5/8" dia) volume control knob backlit with a discreet azure light. Set in a smoke blue rack mounting chassis.

THE BEAST

32 watts R.M.S. into 8 ohm (both channels driven.) Total harmonic distortion at full rated output below 0.2%. Frequency response of 10 Hz to 50 kHz. Plus a host of features including separate bass and treble controls for each channel, loudness control, 2 auxiliary inputs, 2 phono inputs, 4 ch monitor switch and low and high filters.

The combination of all these features may only be found in the L & G L2600 Integrated Stereo amplifier.

Look at your present amplifier... read its specifications...

CATALOGUE PRICE \$179

CURRENT PRICE \$155

AVAILABLE AT ALL STORES

SYDNEY: 400 Kent St., Sydney, 29-1005. 657 Pittwater Rd., Dee Why, 982-7500.

BRISBANE: 293 St. Paul's Tce., Fortitude Valley, 52-8391.

MELBOURNE: 985 Whitehorse Rd., Box Hill, 89-8371.

**NEW STOCKS ARRIVING
DAILY
SEE US FOR ALL YOUR
COMPONENT NEEDS**

ACTIVE ANTENNA

Simple broadband antenna covers 0.5 to 30 MHz – or can be used to boost single stations in the broadcast band.

 PROJECT 708

the receiver. The antenna and transmission line must be matched to each other if the maximum amount of signal incident on the antenna is to be transmitted to the receiver. However since the size of an antenna is related to frequency, one particular sized antenna will only be suitable for a limited bandwidth. Fortunately very efficient antennas are not always needed on the HF band due to the excellent sensitivity of modern day receivers.

A rod antenna has an impedance of less than 50 ohms at its tuned frequency and can therefore easily be matched into a 75 ohm coaxial cable. However if a quarter-wave rod antenna is used at frequencies lower than its natural resonance its impedance increases so that it cannot easily be directly matched into a 75 ohm cable.

Our solution to the problem of obtaining wide band operation with a simple rod antenna is to feed it into an active impedance converter before the transmission line.

An active impedance converter must have a very high input impedance and low input capacitance. At low frequencies the effective input impedance is the value of the biasing resistor, whilst at high frequencies (above 1 MHz) the effective impedance is that of the input capacitance. The converter must have high linearity but no voltage gain. If voltage gain were incorporated the converter would have to provide a high power output to avoid the possibility of inter-modulation occurring.

The number of transistors used have been kept to an absolute minimum as each transistor adds its own noise contribution to the signal coming from the antenna. Two transistors are used and these are both low-noise RF types.

One particular application for the antenna was to boost the level of the Sydney station 2JJ which is very low in level and cannot be received by an average car radio when driving around the city. When using the converter in a straight broad-band mode the reception from 2JJ was greatly improved but other strong stations overloaded the receiver producing some rather unpleasant distortion. For this reason the alternative circuit was developed to allow one particular station to be handled at maximum

efficiency whilst with other stations away from resonance the converter impedance is lowered, thus reducing the output from stronger stations.

It must be remembered that if the signal level from a station is below the ambient-noise level it is impossible to improve the signal-to-noise ratio with any type of active antenna. For the short wave listener an occasional burst of noise is not so objectionable and the active antenna will give good results over the entire 0.5 to 30 MHz band. It must be remembered that when operating in a car the signal level from shortwave signals will be improved but the apparent noise level may also increase if it is raised above the masking of the ambient noise level in the car.

CONSTRUCTION

The use of a printed-circuit will greatly simplify construction and the pattern provided will suit the car or broad-band version by simply adding some components or deleting others as required for the particular version.

Broad-band SWL version

After the printed-circuit board is assembled in accordance with the respective overlay it is fitted into a small metal box (a diecast box is best as it may be more easily sealed against moisture) upon which a commercial car whip antenna is mounted as shown in the photo. Lead was placed in the bottom of the box so that the unit will not tip over easily and rubber feet were fitted to raise it above surface water when used outside. The coax is fed in through a hole in the bottom of one side and a water seal is maintained by fitting the cable through a rubber grommet. Once the unit is checked out it is a good idea to spray the inside of the unit with clear lacquer to seal against moisture.

For those who do not wish to purchase a commercial antenna a length of ordinary hook-up wire taped to a light wooden support or even taped to the wall is adequate. Make sure however that the wall is non-metallic and that the antenna is not close to any electrical wiring or other metallic structures.

Car or broadcast version

From Table 1 determine the number

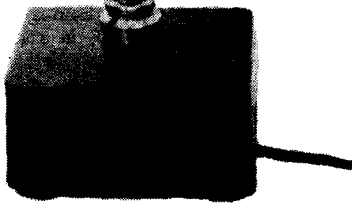

SHORT wave listeners often have difficulty in installing a suitably adequate antenna – especially if living in a flat or home unit. Parents and neighbours may quite justifiably complain about large and unsightly structures. In addition there are difficulties in building an antenna which adequately covers the whole range of 0.5 to 30 MHz and there is also the problem of antenna portability if required.

DESIGN FEATURES

An efficient system consists of the antenna itself together with a transmission line to carry the signal to

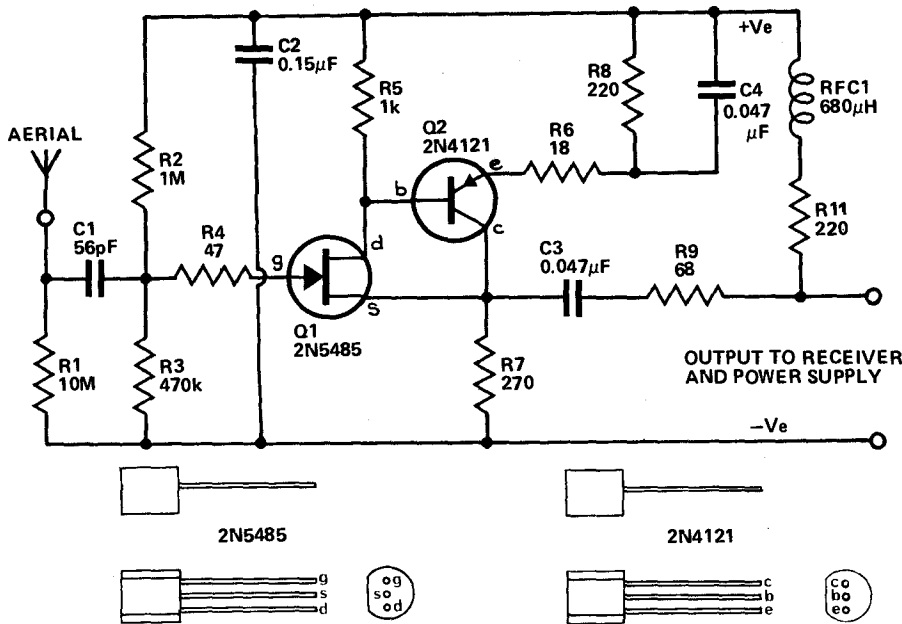

Fig. 1. Circuit diagram of the SWL version (0.5 to 30 MHz).

HOW IT WORKS - ETI 708

In effect the active antenna consists of a rod antenna followed by a buffer amplifier which has a very high input impedance (to match the antenna) and an output impedance of 75 ohms to match the lead-in cable.

Signals picked up by the antenna are coupled to the amplifier via C1 the value of which has been kept small to attenuate any 50 Hz pickup on the antenna. Resistors R2 and R3 set the bias point for Q1 such that a four-volt drop is obtained across R7. The voltage gain is maintained at unity and the linearity improved by applying feedback from the collector of Q2 to the source of Q1. The function of Q2 is to provide a very low output impedance. Resistor R4 is used to suppress any parasitic oscillation which may occur to the high gain which both Q1 and Q2 have up to UHF frequencies. Resistor R9 increases the output impedance of the amplifier to match the 75 ohms of the coaxial cable.

In the broad-band version the supply current is fed to the unit via the coaxial cable - the shield being at earth. RFC1 and R11 appear as a very high impedance to the RF but as a low impedance of 250 ohm, to the dc. In effect it forms a low-pass filter in conjunction with C2. Capacitor C3 prevents the supply voltage from upsetting the bias conditions of the transistors. The signal is passed down the coax to the antenna circuit where C6 couples the signal to the receiver whilst blocking the dc, and RFC2 connects the dc supply to the coax whilst preventing the RF signals from entering the power supply.

In the broadcast version L1 and C5 form a parallel-resonant circuit that appears to one particular station in the broadcast band as a high impedance, and to the other stations as a much lower impedance. Thus the voltage developed at the input of the amplifier is a maximum at the frequency to which L1 and C5 are tuned, whilst the other stations are attenuated. Resistor R10, in series with the tuned circuit, sets a minimum value into which the short antenna works and so assures some response to the stations other than that tuned by L1 and C5. The value of R10 is best found by experiment as detailed in the text.

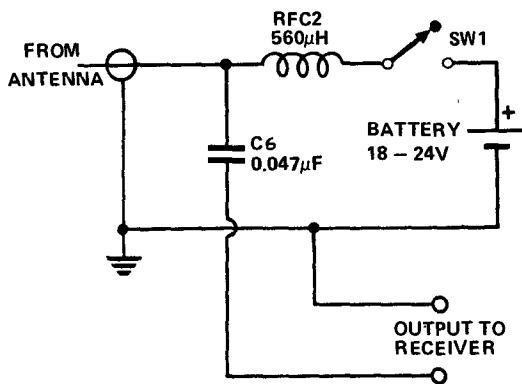

Fig. 2. Circuit for combining supply volts and antenna signal onto the coaxial feeder cable. Used with SWL version where long feeder cable is required.

PARTS LIST - ETI 708

R6	Resistor	18 Ω	¼ W	5%
R4	"	47 Ω	"	"
R9	"	58 Ω	"	"
R8,11	"	220 Ω	"	"
R7	"	270 Ω	"	"
R5	"	1 k	"	"
R3	"	470 k	"	"
R2	"	1 M	"	"
R1	"	10 M	"	"
R10	"	See text	"	"
C1	Capacitor	56 pF	"	"
C5	"	5-70 pF	Ceramic Philips 2222 808 01001	"
C3,4,6	"	0.047 µF	"	"
C2	"	0.15 µF	Ceramic	"
Q1	Transistor	2N5485 (FET) or similar	"	"
Q2	"	2N4121 or similar	"	"
RFC1	Radio frequency choke	680 µH	"	"
RFC2	"	560 µH	"	"
L1	See table 1	"	"	"
SW1	Single pole single throw toggle switch.	"	"	"
PC Board ETI 708 coax cable				

of turns necessary for L1 and wind it as detailed in Table 1. The coil L1 must be mounted close to the base of the antenna so that it can be connected to the antenna by no more than 75 mm of wire. The earth connection to the chassis must also be kept short and C5 should be mounted so that it is accessible for tuning.

A good place to mount the antenna is on the rear mudguard with the base protruding into the boot. The converter may then be mounted to an aluminium bracket which is secured to the car with the antenna base retaining bolt.

The converter should be fed with a 12 volts supply obtained from the accessory fuse in the fuse box.

On cars with generators that produce hash (interference) on the 12 volt supply an 820 microhenry choke, in

series with the supply lead, and an 0.15 microfarad ceramic capacitor to ground (from where the two RFC chokes meet) should help.

SETTING UP

The transistor Q1 has quite a spread in parameters from one device to another and some circuit adjustment may be required for optimum performance. The voltage drop across R7 should be approximately one third of the supply voltage to the converter. That is, four volts for a supply of 12 volts. If necessary adjust this voltage by adjusting the value of R3. No other setting up is required on the SWL version.

In the car version temporarily place a link across R10, tune the receiver to the station which needs to be boosted and adjust C5 for maximum volume. This is best done when the car is

parked in an area where poor reception is encountered. Resistor R10 is best selected by experimentation. A good starting value is 1000 ohms. Adjust R10 so that the stations to which L1 and C5 are *not* tuned are received free of noise. Too large a value of R10 will reduce the effectiveness of the tuned circuit. (see text)

We found that an antenna length of two metres was suitable for the HF version and a one metre length was suitable for the broadcast band version.

TABLE 1

L1	Frequency	No of turns
	below 700 kHz	45
	700 to 950 kHz	34
	950 to 1200 kHz	26
	above 1200	20

CORE Philips potcore P18 series material 3B7 or 3H1, $\mu_e = 220$
 Part No 4322-022-24280 or 4322-022-24080
 FORMER 4322-021-30270
 CLIP 4307-021-20000
 one each of core, former and clip required to assemble one complete coil

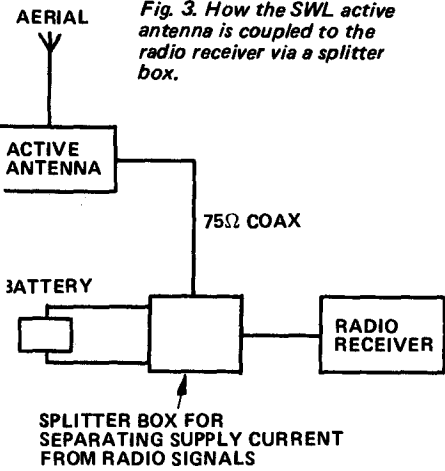

Fig. 3. How the SWL active antenna is coupled to the radio receiver via a splitter box.

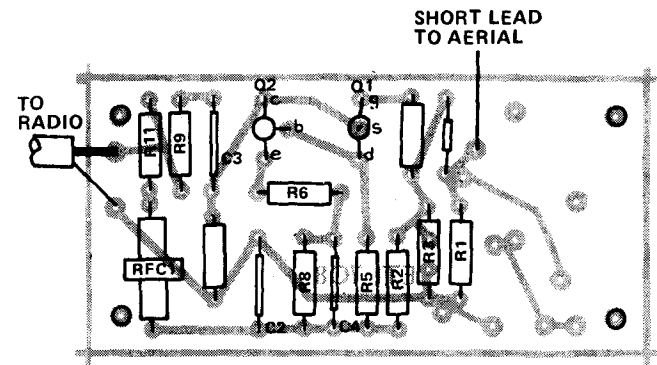

Fig. 5. Component overlay for the SWL version.

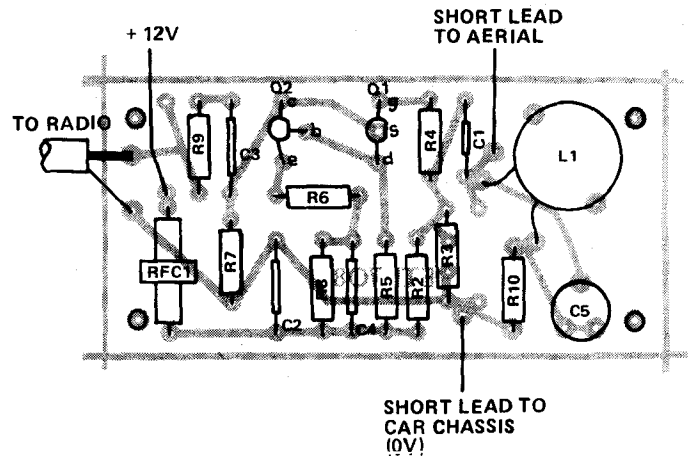

Fig. 6. The component overlay for the broadcast or car version. Note that the same printed-circuit board is used for both versions.

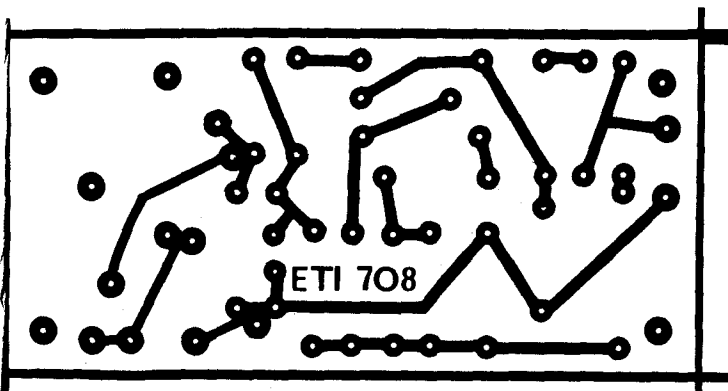

Fig. 7. Printed-circuit layout for both versions. Full size 92 x 46 mm.

How the finished board for the broadcast version appears. ▶

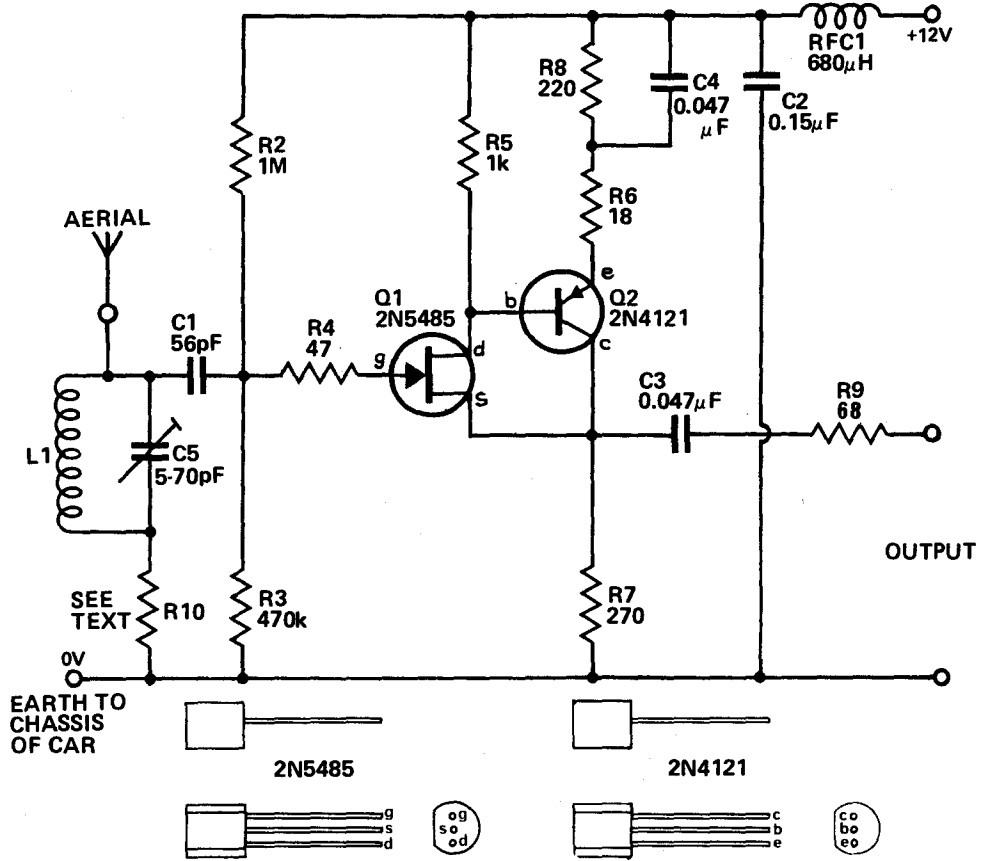
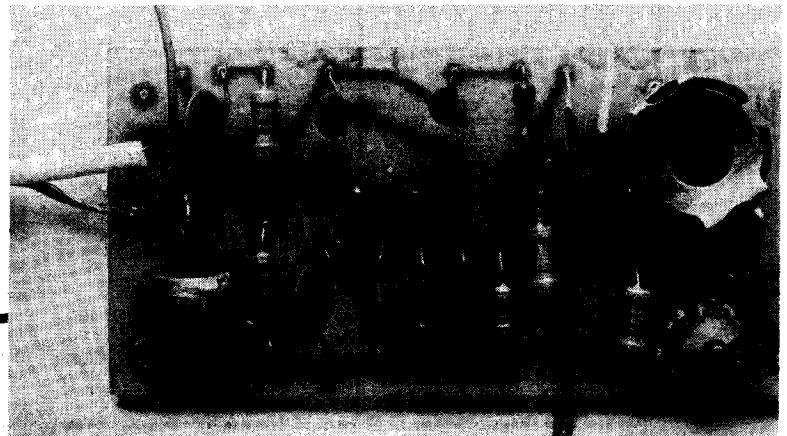

Fig. 4. Broadcast version has a tuned circuit, L1, C5 to attenuate stations other than the one tuned.

Our Prices?
Our Service?
Our Name?
the best there is!

MS COMPONENTS

(ELECTRONICS) PTY. LTD.

95-97 Regent St., Redfern, N.S.W., 2016. Phone: 69-5922
P.O. Box 156, Redfern, N.S.W., 2016.

HOURS OF TRADING:
MON-TUES-WED & FRI:
9am-5:30pm. THURS: 9am-7pm.
SAT: 9am-1pm.
C.O.D's: Please add \$2.40 to posting
fee. NO ORDERS UNDER \$3.00
accepted. For replies please send
S.A.E. Post and Packing 50c where not
included in price. PLEASE
PLEASE PRINT YOUR NAME &
ADDRESS ON ALL ORDERS AND
CORRESPONDENCE.

THE GREAT NAME FOR ELECTRONIC **HSD** COMPONENTS IN AUSTRALIA

SCOOP PURCHASE

OF 1,000,000 (ONE MILLION)

SEMI-CONDUCTORS. MUST BE
CLEARED AT THE MOST STAGGERING
PRICES EVER OFFERED - THESE
DEVICES ARE MAINLY UNMARKED AND
SLIGHTLY BELOW SPEC'S, BUT ARE GUARANTEED USABLE.

ALL EM SERIES DIODES ARE MARKED AND FULLY GUARANTEED. TAKE YOUR CHOICE
WITH THESE SPECIAL PACS. POST & PACKING 50c per pack.

PAC No.	CONTENTS	PRICE	PAC No.	CONTENTS	PRICE
SC. 1	3 100 V 3 amp Rectifiers, 3 100V 5 amp TO5 Rectifiers & 3 2N3055-1 Power Transistors	\$1.00	SC. 8	10 each of the following:- 100V 3 amp Plastic Rectifiers, 100V 5 amp TO5 Metal Case Rectifiers, 2N3055-1 Power Transistors, TO66 Power Transistors, TO18 Silicon Transistors, TO5 Silicon Transistors (NPN & PNP) (Total 60)	\$5.00
SC. 2	100 Assorted TO18 & TO5 NPN & PNP Silicon Transistors	\$2.50	SC. 9	50 EM402 Diodes, 200V 1 amp	\$3.00
SC. 3	5 TO66 (2N3054 Series) Transistors & 5 MS3055-1 (Marked) Power Transistors	\$0.90	SC. 10	50 EM404 Diodes, 400V 1 amp	\$3.75
SC. 4	100 100V 3 amp Plastic Rectifiers	\$4.50	SC. 11	50 EM406 Diodes, 600V 1 amp	\$4.00
SC. 5	100 100V 5 amp TO5 Metal Case Rectifiers	\$5.00	SC. 12	50 EM408 Diodes, 800V 1 amp	\$4.25
SC. 6	20 2N3055-1 (Unmarked) Power Transistors	\$3.00	SC. 13	50 EM410 Diodes, 1000V 1 amp	\$4.75
SC. 7	20 MS3055-1 (Marked) Power Transistors	\$3.50			

SPECIAL PRICES CAN BE QUOTED FOR 1000 off ON ANY DEVICE SHOWN. A BONUS GIFT OF 50 EM401 DIODES WILL BE ADDED TO ALL ORDERS OF \$25 AND OVER. (Only applies to SC1-SC13 packs).

NEW



10 POSITION THUMBWHEEL SWITCH, BCD & COMPLEMENTARY BCD. Moulded grey body, White numerals on Black background. Size approx: 10mm x 33mm x 46mm. Normally \$4.50 each. M.S.C.'s SPECIAL OFFER ONLY \$2.25 each or 10 for \$21.00. P&P Single item 30c or 10 for 75c.

THE PHILIPS 2" HIGH POWER DOME SQUAWKER
TYPE AD0210/SQ8



Power handling capacity: 50W rms (with cross-over filter type ADF600/4000/8) Impedance: 8 ohms. Resonance freq: 270 Hz. Freq. range: 300 Hz-7 kHz. Operating power: 5W rms. Power handling capacity: 15W rms. Magnet material: Ferroxdure Wt. of loudspeaker: 1 Kg. M.S.C.'s SPECIAL INTRODUCTORY OFFER \$38.00 ea. P&P \$2.00

SWITCHES



ONLY \$2.50 ea. P&P 40c

"Schadow" miniature modular push-button switch assembly, 4 x DPDT, 3 momentary and 1 hold. Solder lugs and complete with 4 chrome faced buttons.

AT BARGAIN PRICES

Lamp lighted power push button switches. With 1 micro switch. Type NB-SL red lens. Only \$3.00 P&P 75c.

As above but with 2 micro switches and green lens. Type NB-DL. Only \$3.50 P&P 75c.



NEW



HEWLETT PACKARD NUMERIC INDICATOR DISPLAY

DESCRIPTION
The HP 5082-7300 series solid state numeric indicators with on-board decoder/driver and memory provide a reliable, low-cost method for displaying digital information. The 5082-7300 numeric indicator decodes positive 8421 BCD logic inputs into characters 0-9, a "-" sign, a test pattern, and four blanks in the invalid BCD states. The unit employs a right-hand decimal point. Typical applications include point-of-sale terminals, instrumentation, and computer systems. Supply Voltage 4.5 - 5.5V. Size 4" x 29". M.S.C. SPECIAL PRICE \$12.00 ea. Post Free.

NEVER AGAIN AT THESE PRICES





NPN POWER TRANSISTOR Complete with Mounting Kit. ALL NEW. ALL MARKED. ALL GUARANTEED. ALL

2N3055 (STC) 10 for \$7.75 P&P 50c

Push-button switch. Lug terminals. D.P.D.T. momentary lock, 250V AC 5A 125V AC Type SB-63A. \$1.10 P&P 20c ea.

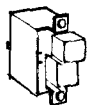

Push-button switch - dual buttons in double white or white and red lug terminals. D.P.D.T. reciprocal. 6A 250V AC Type SDB-122. Only \$1.95 ea. P&P 20c ea.

2SB337 (ASZ16) GERMANIUM PNP POWER TRANSISTOR

Sim. to OC28. Complete with mounting kit. Now only from M.S.C. \$1.10 or 10 for \$10. P&P 1 to 5 30c 10 up 48c.

See-Saw switch. D.P.D.T. on/off/on momentary white button. 5A 125V AC or 3A 250V AC 95c ea. P&P 20c ea.

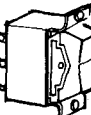

"Mulon" precision micro switch with pin plunger S.P.S.T. normally open/normally closed. Type MGA-100B. Only 65c ea. or 5 for \$3.00 P&P 20c ea. or 5 for 75c.



TECHNICAL BOOKS FOR EVERYONE

Beginners Guides - 'Questions & Answers' on Electronics, On Hi-Fi, On I.C.'s, On Transistors. All \$2.25 each plus P&P 50c.

Integrated Circuit Pocket Book	\$6.00 P&P \$1.00	Rapid Servicing of Transistor Equipment	\$4.50 P&P \$1.25
Beginners Guide to Electronics	\$4.00 P&P \$1.00	Transistor Manual - includes Drawings & Case Sizes	\$3.00 P&P 75c
Beginners Guide to Transistors	\$4.00 P&P \$1.00	The World Transistor Cross Reference Guide	\$9.50 P&P \$2.00
Beginners Guide to Radio	\$3.50 P&P \$1.00	The G.E. S.C.R. Manual (Including Triacs & other Thyristors)	\$4.50 P&P \$1.00
Semi-Conductors - Basic Theory & Devices	\$8.00 P&P \$1.50	The G.E. Electronics Experimenters Circuit Manual	\$3.75 P&P 75c
Thyristor Projects Using SCR's & Triacs.	\$4.00 P&P \$1.00	The G.E. Transistor Manual	\$4.50 P&P \$1.00
Semi-Conductor Projects for the Home Constructor	\$4.00 P&P \$1.00	The G.E. Semiconductor Data Book (1482 Pages)	\$7.50 P&P \$2.00
I.C. Projects for the Home Constructor	\$4.00 P&P \$1.00	The N.S. Linear I.C. Manual	\$4.75 P&P \$1.50
20 Solid State Projects for the Home Constructor	\$4.00 P&P \$1.00	The N.S. Digital I.C. Manual	\$3.00 P&P \$1.25
Transistor Pocket Book (312 Pages)	\$6.00 P&P \$1.25	The N.S. M.O.S. I.C. Manual	\$3.00 P&P \$1.25
Newnes Radio Engineers Pocket Book, 14TH ED.	\$4.00 P&P \$1.00	The N.S. C.M.O.S. I.C. Manual	\$3.00 P&P \$1.25
Radio Servicing Pocket Book (256 Pages)	\$4.50 P&P \$1.25		

bankcard
welcome here



Scope Cordless 60w Soldering Tool

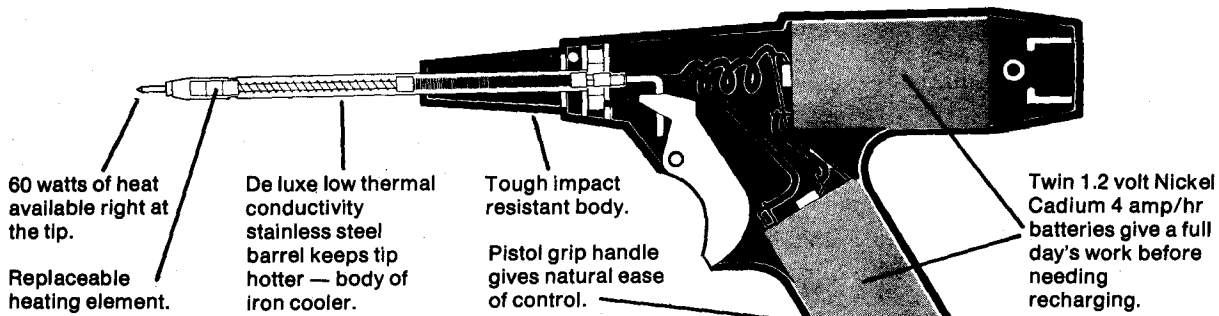

60 watts of heat available right at the tip.
Replaceable heating element.

De luxe low thermal conductivity stainless steel barrel keeps tip hotter — body of iron cooler.

Tough impact resistant body.
Pistol grip handle gives natural ease of control.

Twin 1.2 volt Nickel Cadmium 4 amp/hr batteries give a full day's work before needing recharging.

HEATS IN 6 SECONDS, COOLS RAPIDLY WHEN TRIGGER RELEASED

SOLDERS 100-200* TYPICAL JOINTS BEFORE RECHARGING

* Light electrical connections. Capacity will vary for lighter or heavier joints.

PISTOL GRIP DESIGN balances weight of cells for comfort and tip control.

FULLY RECHARGEABLE OVERNIGHT, from car, power-point or Scope Transformer.

ABSOLUTE SAFETY
No earth leakage currents. Solder anywhere with total personal and component protection.

Basil Rogers & Co. Pty. Ltd., Radio & T.V. Repairs.
"I'm delighted with its performance and sheer convenience in the workshop or in the field. It's light, fits easily in your hand and you can solder even with the set on."

Kevin Bail, T.V. Technician.
"In my job I work mainly on circuit boards and I'm rapt with Scope Cordless. I've never reached a point where the gun can't handle a day's soldering. I like the feel of it; tremendous balance."



Distributors to the Electrical Trade:
NATRONICS PTY. LTD. The Crescent, Kingsgrove, N.S.W. 2208

Manufactured by: **SCOPE LABORATORIES, MELBOURNE.**

THE PARADOXIC



Gift supplied by
Bay Road Electronics
24 Linniers Street,
Chesham, Bucks HP82
Telephone 07-7231

Advertisement price code
S720, price 31.00
 postage

Significant advantages in the quest for fine quality sound

THE MOST neglected, hard-working and taken-for-granted item in a modern sound system is still to be hardly be seen by the listener's unaided eye. This is a guide sheet, a pamphlet issued by Bay Road Electronics of Melbourne and the text goes on to describe the tips of the stylus with particular reference to problems of high frequency, high-velocity tracking.

Bay Road Electronics has, for some time, been active in the development of a new stylus profile, designed to provide all the advantages of elliptical, but without the disadvantages. It would be easy to dismiss the significance of this new product in view of the large number of new stylus profiles introduced during the past couple of years or so. Most of these have been designed for use on CD-4 records, whose response to CD-4 and beyond is needed to extract encoded information, for detection, of four discrete channels from the normal recorded audio-frequency information.

In essence, the problems of CD-4 are simply an extension of those encountered with conventional two-channel stereo and matrix four-channel records. It's worth looking into these problems, since solutions may well lead to improved fidelity from all records.

The groove of a record is V-shaped and mechanically modulated with the audio information. Stereo records

carry two sets of information, one on each groove wall. Matrix-coded records, for four-channel, provide equal information from both sets of information by use of deliberate differences in phase relationship between the two sets; and CD-4, each groove wall includes additional high frequency information which is in the form of an FM carrier. This can be extracted electronically using a straightforward process, essentially similar to the method used in an FM tuner.

The overall problem lies in extracting this high-frequency information from the groove. As frequency increases, the physical length of each modulation decreases. A stylus must be sufficiently small to follow the finest modulation — an oval tip will simply ride over small modulation. A spherical stylus can have its high-frequency response improved by reducing the radius of its tip — making it more pointed. But there's a limit to the reduction we can make, for if the tip is too small it will travel along the bottom of the groove instead of resting correctly between the groove walls.

Yet some of the modulations encountered on modern records (particularly those on the inner grooves close to the label, which are shorter than outer-groove modulations of similar frequency), are smaller than the stylus-tip radius. Result: the stylus

rides over them, producing no response (or fast or distortion). There's also a tendency for such modulations to be completely worn away by the tremendous pressure of the stylus.

One solution to this problem is the elliptical stylus, the long axis of which lies across the groove. The radius of the side is small enough to penetrate the void between modulation peaks, the stylus thus retaining more intimate contact with each groove wall at higher frequencies. However, an elliptical stylus with the same large radius as a given spherical stylus, both with tracking with the same downward force, exerts greater pressure on the groove walls. This is why cartridges equipped with elliptical styli must be able to track at very low forces: some elliptical exert two or three times the pressure on each groove wall compared with an equivalent spherical stylus (even at the same force). The latter Shure V15/III exerts nearly as much pressure when tracking with a force of one gram as did the original spherical-tipped Decca FFSS tracking at three grams.

In many, elliptical styli are unsuitable for the very high frequencies encountered on CD-4 records, even using tracking forces below two grams, because they wear these tiny modulations extremely rapidly. And of course, an elliptical stylus tracking high audio frequencies at too high a force on conventional two-channel stereo and matrix four-channel records will likewise just ride over the modulations!

So if elliptical styli are to be used for the high-frequency reproduction demanded for CD-4, tracking force must be drastically reduced. And this at present is almost completely impracticable, for reduced tracking force must be accompanied by a decrease in overall mass of the arm/cartridge system, together with a reduction of effective tip mass — the mass of the moving parts of the stylus and suspension as measured at the stylus itself. Compliance or yielding ability of the stylus suspension must be increased as effective tip mass is reduced, otherwise the intimacy of contact between stylus and groove walls will be degraded.

Overall arm/cartridge mass will continue to be an obstacle to low tracking force and mass can be effectively servo-operated (as with the

THE PARABOLIC STYLUS

is) but that the Elac would be vastly improved. Thus we expected that there would be less difference between the two after the Parabolics had been fitted.

Onward to the turntable!

The arm used was an SME 3009/II improved with detachable headshell — theoretically inferior to the fixed headshell 3009 but in practice having no serious differences, subjectively at least.

ELAC

The Elac cartridge had first wack of the whip and was duly fitted to the SME. Our first test involved the original Shure 'Audio Obstacle Course' recording — now superseded but still a daunting experience for an inexpensive, medium performance cartridge. Results are tabulated below. Tests were carried out using the Parabolic first, on the confident assumption that this stylus would be less likely to cause groove damage than the standard spherical stylus. This, we hoped, would make the results more meaningful; no stylus, however good, can remedy damage already done!

It was apparent from the outset that the Parabolic provided far sweeter treble than the spherical. Overall balance of sound using either stylus was little different. Eventually we resorted to a Revox A77 for checking out tonal balance: we simply recorded the signal from one channel of the cartridge, using one track of the tape. Halfway through, we switched from upper to lower track of the recorder. Next we replaced the spherical stylus with the parabolic, recording the same material from the same channel on the

unrecorded tracks. The procedure was repeated for the other cartridge channel. By switching from track to track after the recordings were made, and using single-speaker mono (stereo tends to confuse one's assessment of tonal quality under circumstances of this sort), we were able to gain a fair idea of the parabolic's performance. Such differences as were noticed in bass performance could be attributed to very slight changes in level settings of the tape recorder — they were barely noticeable. Midrange performance using the Parabolic was more detailed and smooth, without the slight stridency produced by the spherical stylus. Careful listening indicated that with increasing frequency, the difference between spherical and parabolic stylii became greater, the latter being preferable at all times.

SHURE

And now for the V-15/III. This cartridge, introduced a couple of years ago, received world-wide acclaim by experts and laymen alike. It is without doubt a very fine performer, having better response linearity than its predecessor. Shure engineers dramatically reduced the effective tip mass of the new cartridge, whilst retaining a reasonably high output level primarily by redesigning the magnet structure.

Few cartridges can match the V-15/III's all-round clarity of fine recorded detail — so initially we doubted that the Parabolic stylus would make any real improvement in subjective performance — our cautious

nature often makes us think it's better to leave a good product well alone.

Nevertheless we settled down to some very intense comparative listening (cicadas permitting) on a large selection of records — old and new — even a few early mono albums, these being rather 'dim' by modern standards.

We were genuinely surprised by the increase in definition provided by the Parabolic. Nor did this apply only to high frequencies; bass was even smoother than from the standard V-15/III. Good sound reproduction is characterised by a 'transparency' in which dozens of tiny details can be perceived — the difference, between good and poor reproduction is rather akin to that between moulded glass and crystal glass. Nothing is emphasised yet all is clearly defined. Transients become far more dramatic, providing to give a big, open sound. (In the writer's experience, newcomers to hi-fi have difficulty in adjusting to this kind of sound, having become used to the 'warmth' and apparent solidity provided by the average stereogram).

Returning to the bass performance of the Parabolic-equipped V-15; there was a complete absence of muddiness, and the differentiation between foot-drums and electric bass was the clearest we've ever heard. Bass from a standard V-15 is smooth and well-balanced; with a Parabolic, to judge from our sample, it is even cleaner and uncluttered.

Midrange was quite exemplary. On occasions, we've blamed the midrange drive-units in our reference speakers for slight edginess at times, especially with choral and operatic material. We're now thinking again, for an almost complete lack of stridency or harshness was evident using the Parabolic. Again, the wealth of detail the sample provided was surprising, and had our V-15 not had a new stylus a very short time ago, we'd have suspected this needed replacement. Brass sounded particularly delightful; beautifully subdued at times, dominant when it should have been, yet without obscuring quieter sounds from other instruments. Strings, massed strings particularly, sounded sweetly resonant and 'woody' but not overpoweringly so; simply natural-sounding — and the depressed sighing bloom of violin was there in what sounded like just the right proportion.

At this stage, we decided to abandon our test procedure using the tape-recorder. The differences wrought by the Parabolic sample were so obvious that we had no need to refer back directly, in A-B fashion, to the sound of a standard V-15.

TEST RESULTS: ELAC CARTRIDGE WITH SHURE TTR-101 TRACKABILITY TESTS RECORD.

STANDARD STYLUS.

Level	Side One (Mono)			Side Two (Stereo)									
	OB	D&C	BD	LEFT				RIGHT					
				O	P	A	H	O	P	A	H		
1	1(1)	1(1)	1(1)	1(1)	1(1)	1(1)	1(1)	1(1)	1(1)	1(1)	1(1)	1(1)	1(1)
2	2(1)	2(1)	2(1)	1(1)	1(1)	1(1)	1(1)	1(1)	1(1)	1(1)	1(1)	1(1)	1(1)
3	2(1)	3(1)	2(2)	1(1)	2(1)	1(1)	1(1)	1(1)	1(1)	1(1)	2(1)	2(2)	2(2)
4	3(2)	3(2)	4(2)	1(1)	3(1)	1(1)	2(2)	1(1)	2(1)	2(1)	2(2)	2(2)	2(2)

KEY:	OB	orchestral bells	SCORING SYMBOLS:
	D&C	drum and cymbal	1 — tracking correction
	BD	bass drum	2 — slight mistracking
	O	electric organ	3 — mistracking
	P	piano	4 — crackles considerably
	A	accordion	
	H	harpsichord	

HIGH FREQUENCY PERFORMANCE

Orchestral bells, violins and so on, recorded at alarming levels on Shure's 'Obstacle Course' albums, didn't ruffle the Parabolic at all. Cymbals and other percussion sounds were delightful, but equally impressive to us was the integration of sounds from instruments producing large amounts of harmonics. There was no fragmentation of these sounds, and a happy by-product of such superb tonal performance was a deeper, more stable stereo image — as if the proverbial window into the studio had been opened wider. It's often said that the wider you open the 'window', the greater the amount of 'dust' that can blow in. Agreed, but surface noise using the Parabolic diminished considerably, those annoying 'clicks' sounding muted and far less obvious than before. Nor could this be the result of high-frequency roll-off using the Parabolic; as far as we could judge from the subjective standpoint overall response linearity was as good as with a standard V-15. We also feel that separation was improved — though we've already attributed the improvement of stereo image to the sample's better HF definition. Possibly a combination of these two was

responsible for the excellence of the stereo images we obtained.

It was clear to us that the Parabolic can give a very appreciable improvement in performance over spherical and elliptical styli. Comparison of the Elac and Shure cartridges in standard form revealed vastly superior performance from the Shure. Yet when both cartridges were fitted with Parabolics, the differences were less apparent, more confined to response variations than anything else.

It would therefore seem that use of a Parabolic stylus in almost any cartridge, no matter what the price of that cartridge, can provide significant and sometimes dramatic improvements in fidelity. Some of our old mono records (with shame, we point out that some of these aren't in best condition!) seemed to take on a new lease of life, largely because of the reduction of surface noise when using the Parabolics.

On the face of it, there is something absurd about fitting a \$20-\$30 cartridge (such as the Elac sample) with a replacement stylus costing \$37.50. Yet the improvement in performance brought about by using a Parabolic speaks for itself. We are not suggesting that the Elac sample supplied, fitted with a Parabolic,

sounded better than the standard elliptical-equipped V-15/III. It didn't. Yet we feel any person intending to upgrade any reasonably good cartridge in the lower price-ranges by replacing it with a more expensive model would be advised to consider fitting a Parabolic instead — and this makes a good deal of sense if a lower-priced cartridge is used in a similarly low-priced arm. The results using a high-compliance, low-tracking-force cartridge in an arm not designed for the purpose are often disappointing, and because the Parabolic-equipped cartridge requires the same tracking force as in standard form, the problems otherwise caused by an unsuitable arm are nullified.

The Parabolic stylus offers significant advantages to the person wanting ultimate sound quality from stereo records. In theory, the Parabolic will also last longer than a standard spherical or elliptical — and this also implies reduced record wear.

The improvement of sound from the Parabolic is in itself good enough reason to invest in this remarkable new product. We're certain many listeners will be at first surprised, and in the long-term, delighted by the increased listening pleasure a Parabolic can provide. ●

NATIONAL RADIO SUPPLIES

132 Parramatta Road Stanmore 2048 567398.

AUTO EJECT CASSETTE CAR STEREO

- 4-IC Circuit
- Fast Forward & Fast Rewind
- Auto Eject
- Indicator Light
- Separate Tone, Volume & Balance Controls
- 9 Watts Output



SERVICE PACK SPECIALS. STOCK UP FOR THE NEW YEAR.

CERAMIC CONDENSOR PACK
100 for \$2.50

MICA PACK.
A 50 for \$3.00
B 20 for \$1.80

RESISTOR WIRE WOUND PACK.
50 for \$5.00
3 & 5 & 10watt

MIXED RESISTORS
1 watt & ½ watt
100 for \$1.50

POTENTIOMETER PACK.
20 for \$2.50

DOUBLE POTENTIOMETER PACK.
10 for \$4.00

POLYESTER PACK.
50 for \$2.00

5BP1 OSCILLOSCOPE TUBE.
\$1.50 Each.

T.V. BALUN
300ohms to 75ohms 80c

TRANSISTOR SPECIALS.
BC147, BC148, BC149
10 mixed for \$1.20

TRANSISTOR.
2SC463a Equivalent
BU105 \$2.60

BRIDGE RECTIFIER
3.8amp 100V \$1.80
25amp 200V \$3.50

WALKIE TALKIE

SANYO. The Best.
1/3w \$36.00
1 watt \$46.00

SPECIAL IN VALVES.

6CM5 \$1.50
6BL8 \$1.00
6BM8 \$1.00
6Y9 \$1.50
6X9 \$1.20
6U9 \$1.20
1S2 \$1.00

\$1.50
\$1.00
\$1.00
\$1.50
\$1.20
\$1.20
\$1.00

6DX8 \$1.20
6BU8 \$1.10
6GV8 \$1.10
6GW8 \$1.10
6SN7 \$1.00
6JW8 \$1.30
6AL3 \$1.15

VIBRATORS
6 Volt. 5211 A.W.A. only \$1.00 each.

SPEAKERS — DUAL IMPEDANCE.
8ohms & 4ohms.
5" \$3.00
6" \$3.20
7by5" \$4.20
6by9" \$5.20

Dick's New Kits for '76

L.E.D LADDER KIT

\$16.75

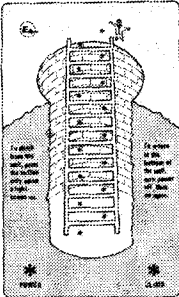

E.A. L.E.D. LADDER
As in E.A. March 1976

Push the button - make the light climb up the ladder - but it gets harder near the top.

Easy to build uses one small P.C.B. uses sixteen red light emitting diodes. Special decorative front panel.

All parts supplied.
Cat. K3390 Complete Kit for only \$16.75

NOVICE TRANSVERTER KIT

DICK SMITH "NOVICE TRANSVERTER"

10 metres to 80 metres at up to 30W p.e.p.
* Designed by Australia's top R.F. Engineer, exclusively for us.

- * The cheapest and best way for a novice to get going on 80 metres.
- * Put in any signal (AM/FM/SSB) on the 27MHz novice band and it is instantly "Transformed" down to 80 metres.
- * Inbuilt receiver converter "Transverts" 80 meter signals up to 10 meter novice bands.
- * Max power 10 watts and 30 watts p.e.p. SSB from as little as 100mw input (and suitable 100mw-3 Watts)
- * Easy to build (takes about 3 hours) fiberglass boards, fully reverse voltage protection
- * Input and output 50ohm
- * Free "Contest" forms with each unit - you may win a brand new Kenwood TSS20
- * 13.8 volt DC (max) operation - ideal for Mobile rigs
- * Supplied with special 27 MHz Xtal which allows follow frequency to 81 transverters to 80 metre section of novice band.

Dick's
LOW
Price
\$99.50

SALE SPECIAL

see E.A. nov. 75

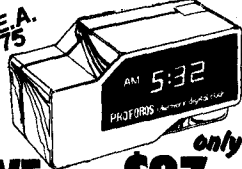

only **\$27.50**

Save \$7.00 on regular price of \$34.50

PROFORDS FANTANTASTIC ALARM CLOCK KIT

- AN INCREDIBLE CLOCK, THE DC8 HAS EVERYTHING
- * HUGE 10mm FLURO READOUT
- * BRIGHT DISPLAY HOURS, MINUTES, AM, PM
- * ELECTRONIC ALARM TO THE MINUTE
- * 7 MINUTE SNOOZE CYCLE * 240 Volt OPERATION
- * MODERN CASE AND FILTER PANEL \$3.00 EXTRA IF REQUIRED.
- Cat. K3340 KIT VERSION \$27.50
- FULLY BUILT AND TESTED UNIT \$37.50

SOLID STATE INSULATION TESTER

- MODEL SK-3000
- * Compact, lightweight versatile insulation tester measures up to 1,000 Meg ohms.
- * Low ohm measurements are convenient on two a ranges, X1 and X1K
- * Zero ohm adjustment can be made easily by Ohm ADJ. knob.
- * With 250V AC range.

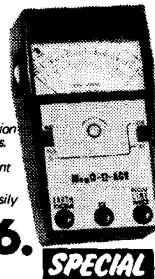

SPECIFICATIONS	
Meg Ohm Rated voltage:	500 volts
Rated resistance:	0 - 1,000MΩ (center 20MΩ)
Low Ohm X1 range:	0 - 1,000Ω
X1K range:	0 - 1MΩ
AC Voltage:	0-250 volts
Accuracy Meg Ohm:	±4% (of scale length)
Low Ohm:	±4% (of scale length)
AC Voltage:	UM3 X 4
Batteries:	148 x 8 78 x 50mm, 540g
Size and weight:	1 pair Test leads and Vinyl leather case.
Accessories:	

Cat. Q1430 ONLY \$66.00

MOSQUITO REPELLER KIT \$5.50

Ideal for picnics, barbecues or around the house. Even good when fishing. WHY BUY ONLY ONE!!

At this price they're a super special complete with instructions in our Deluxe UB3 Zippy Case.
Cat. K3380 ONLY \$5.50

AMP KIT \$27.50

NEW 45 WATT 2 METRE R.F. AMP KIT

Fantastic new 2 metre R.F. Amp kit, simple design (you'll make it in less than an hour). Uses the new 2N6084 45 watt transistor 8-12 watts in - gives 35-45 watts out - at 13.8 ohms. Fully solid state switching, double sided fiberglass board, everything supplied including expert instruction. There's even provision on the board for a VSWR meter! Edystone Box to suit (if required)

Cat. K3132 Really Good Price \$27.50

ELECTRONIC ORGAN KIT

Kit including all electronic parts, high quality Matsushita Keyboard (as used in article) - everything other than the cabinet (you can easily build that yourself). See price in next issue of this magazine.

KEY BOARD ONLY \$97.50
FOR COMPLETE KIT PRICE SEE NEXT MONTHS ISSUE OF THIS MAGAZINE.

IDEAL BEGINNERS KIT! START YOUR SON THE DENSHI WAY.



ST100 DENSHI KIT

Features a build it yourself radio. Comes with Morse key, earpiece, & components for building alarm circuits and electronic gun.
Cat. K 2120 \$19.95

AUDIOPHILES DELIGHT !!

AC-320 \$36
Millivoltmeter:
- 10 mV to 30V in 8 ranges!
- 52 dB to +32dB
- Frequency response 20Hz to 100 KHz ± 1 dB
- input impedance 1 Megohm
- Accuracy ±3% F.S.D.
The unit runs for ages off a 9V transistor radio battery and weighs only 300 grams.
Yes, now you can check the level of PMG lines, signal sources etc, easily.
You must have one of these for only—\$36.00
DIMS: 92mm x 145mm x 42mm
EXCELLENT PRICE \$36.00

CRT HIGH VOLTAGE TEST PROBE

SK-9000
Built-in meter assures safe and easy measurements up to 30,000 volts DC.
600mA DC range enables to monitor the cathode current of the horizontal output tube of TV set.
Barriers are installed to protect the probe handle from high voltage.
The test probe is compact, light and easy to handle.
SPECIFICATIONS \$30.50
DC Voltage: 30,000 volts (internal resistance 500MΩ)
DC Current: 600MA (450mV drop)
Accuracy: ±3% (of full scale at 20° C)
Temperature coefficient: ±0.15% per 1°C
Size and weight: 374 X 48 X 45mm, 240g
Accessory: 1 pair Test leads

Cat. Q1440 ONLY \$30.50

BOOKS



COLOUR TELEVISION THEORY

By G. Hutson
326 pages of text, diagrams and illustrations (some in colour) in this hardback edition. A must for students, engineers and technicians who wish to have a thorough understanding of the PAL system. Describes the difference between PAL, NTSC and SECAM. Standard work on subject.
Cat. B3210 \$12.50

AUDIO CYCLOPEDIA

By Howard M. Tremaine
The most comprehensive and authoritative reference volume on audio ever published. Its 25 sections cover every aspect of the audio art from the basic principles of sound to the latest in solid-state equipment. 1760 pages.
Cat. B1096 Normally \$39. NOW \$26.00

TTL COOKBOOK

By Don Lancaster
TTL (transistor-transistor logic). The purpose of this book is to show you what TTL is, how it works and how to use it. The author suggests several TTL projects that the reader may wish to try, relying on his own resources. WAS \$10.75
Cat. B1246 SAVE \$2.00. NOW \$8.75

NOVICE RADIO GUIDE

This book is the perfect book for any beginner. Several chapters of theory help the reader to both prepare for his licence and also to better understand his station as he puts it together.
Cat. B2280 Very reasonable price \$4.75

Super Sensitive Metal Detector \$9.75



Just tell a builder or handyman about this fantastic gadget - locates any metal object - wires, pipes, reinforcing steel, even nails, inside wells and plaster etc.

- * Light comes on in presence of metals
 - * Penetration/sensitivity control locates metal 6" away
 - * Supersensitive electronic circuit pinpoints even small nails
 - * Easy to operate from 9V transistor battery
- Range depends on size of metal object. Ideal for electricians who once had to pay \$30-\$40 for such a unit. (9 Volt battery 40¢ extra)
Cat. X 1060 \$9.75

SIGNAL INJECTOR \$4.75

This Signal Injector (TE-101) uses a circuit designed to make blocking modulation for high frequency at low frequency of 1 KHz. Transistorised. Complete with battery.
Cat. Q 1270 \$4.75

FANTASTIC 8 DIGIT PANAPLEX READOUT

(Shown approx 30% actual size)
8 LARGE Digits for less than 90¢ each.
INCLUDING GOLD PLATED SOCKET. 180 Volt OPERATED IDEAL FOR CLOCK AND CALCULATOR PROJECTS.
AVAILABLE SOON: Driver Transistors and Power Transformer to suit.
Cat. S 3890 \$6.75

MJ001 IC TEST CLIP

DON'T PAY \$1.40 EACH
PAY ONLY \$1.00 for 2
A MUST FOR ALL MULTIMETERS
Cat. W4580 BARGAIN AT ONLY \$1.00 For Two

JUMPER LEAD KIT \$1.50

J5119 Jumper Lead Kit
Here's ten 15" leads with croc. clips. Two each in five colours. Worth over \$2.00.
Cat. W 4570 NOV ONLY \$1.50

NEW ELECTRONIC STOP WATCH KIT

NOVUS TIMER KIT (ET JAN 1976)
Special kit includes silk screened printed circuit and all components to build this handy timer. INCLUDING THE NOVUS 850 CALCULATOR!
Cat. \$18.50



PACK OF 300 RESISTORS \$5.90

DICK SMITH ELECTRONICS KIT
WHAT A SENSATION!!
Now we have improved our already famous computer resistor pack.
For example, in this pack you get 20 x 1 K ohm and only 2 x 560 K resistors - 300 useful values in all, as selected by a computer.
All resistors are 1/4 watt 5% tolerance carbon film high stability - not cheap composition types. They come in a compact neatly printed box. 60 different values 10 ohms to 1 meg.
Box measures 2 7/8" x 1 3/4" x 1 3/4"
There honestly isn't a hobbyist or serviceman who should not have a box
Cat. R7010 FANTASTIC PRICE OF \$5.90

BELLSONIC CAR CONVERTOR \$22.

Converts 6V D.C. to 12V D.C. ideal for running 12V Car radios, car stereos etc. In any 6V vehicle. Used to be \$29.50
Cat. M95922 Only \$22.00



DICK SMITH ELECTRONICS CENTRE
Head Office & Mail Orders
Shop hours: Mon-Fri 9-5:30 Sat 9-12
162 Pacific Highway Gore Hill N.S.W 2065 tel:439 5311
telex: AA20036
cables: DIKSMIT Sydney

Also at CITY 125 York St tel:291126 (Nr Town Hall) and BANKSTOWN 361 Hume Hwy tel:709 6600 (Nr Chapel Rd)

BAKELITE T03 TRANSISTOR SOCKETS. High Quality. SPECIAL PRICE! Cat. P4023 30¢ ea. Buy 5 for only \$1.



DICK SMITH AMP Model 6000

**30+30 WATTS RMS
100 WATTS MUSK POWER**

DICK SMITH MODEL 6000 STEREO AMPLIFIER
As reviewed in E.A. February 76.

Hum and Noise (IHF) Phone.....Better than 70 dB
Aux.....Better than 75 dB

Frequency Response : 20-30000 Hz ± 1dB
(at normal listening level)
Load Impedance : 8 ohm;



Harmonic Distortion :
Less than 0.8%
at rated output.

A professional high fidelity amplifier that is value packed. Similar powered units sell for around \$189.00. Inputs for microphone, turntable, tuner etc. Smart brushed satin finish, weighs in at 12 lbs and measures 36 x 9.5 x 25.5 cms. 240 volts AC. Cat. A 1262. . . . \$ 129.

Dicks Price \$129

EXPO CPR 145A AC/DC CASSETTE with AM/FM RADIO

DICK'S \$ PRICE
\$69.95

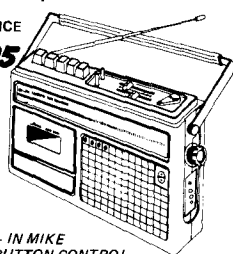

BUILT-IN MIKE
PUSH BUTTON CONTROL
VOLUME & TONE SLIDE CONTROLS
Cat. A 4056 \$ 69.95

CRAZY!



SHURE
Made in U.S.A.

A GENUINE SHURE M91ED STEREO CARTRIDGE WITH ELLIPTICAL DIAMOND STYLUS (THAT'S NEEDLE LADIES) THIS UNIT IS SO GOOD IT CAN EVEN BE USED WITH FOUR CHANNEL (MATRIX) RECORDS.

NORMAL 1/2inch SPACE FITTING WILL FIT MOST TURNTABLES.

FOR THE TECHNICIANS - OUTPUT IS :
5.0mv per CH @ 1,000Hz @ 5cm/sec PV.

NORMALLY RETAILING FOR \$44.00

DICK'S CRAZY PRICE
WHY NOT CHANGE YOUR CARTRIDGE NOW?
Cat. C 5515 \$ 25

SAVE

LAST YEAR WE WERE SELLING THIS REMARKABLE CALCULATOR FOR \$ 59.00

FORDS SCIENTIFIC CALCULATOR

8 Digit FLURO Readout (more expensive than LED's)
Memory + 4 Functions + Trig. Log and most scientific functions.
Floating decimal.
Comes complete with case and batteries.
Cat. Q 3010 . . . \$29.95
Tax Free



SAVE BY BUYING ONE OF THE FEW LEFT AT ONLY
\$29.95

TAX FREE
\$32.20 Inc. Tax

FANTASTIC

AM/FM STEREO ~ MONO TUNER

"VERY GOOD VALUE INDEED." NEVILLE WILLIAMS
IN FEB. 75 EDITION ELECTRONICS AUSTRALIA.

OVER 1800 HAPPY CUSTOMERS CAN'T BE WRONG.

GUARANTEED FOR 12 MONTHS

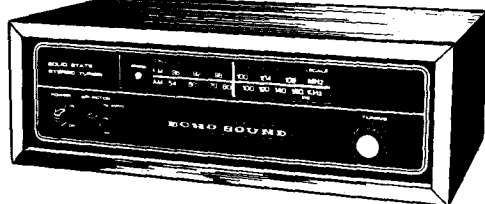

The ECHOSOUND TUNER is incredible value for money with separate AM and FM front ends, 10 transistors and 14 diodes. Covers FM 88 to 108MHz AFC, 60db S/N, 35 db separation, 600mV output AM 535 to 1605kHz ferrit rod antenna. Features multiplex adaptor complete with built in stereo indicator. 240V AC operation. Complete in walnut case. Cat. A1410. Now \$ 65.

P&R FREE
was \$75
now

\$65

DICK'S PRICES ARE LOWER

ELEGA DR-196C

COMPLETELY NEW DESIGN SUPER THIN VELOCITY TYPE HEADPHONES.

SPECIFICATIONS
*sensitivity 100dB SPL/mW
*frequency Range 18-22,000Hz
*matching impedance 4-150
*maximum input 0.1W
*weight 130gr without cord.

*Newly Designed
*Compact & Light Weight
*Velocity Type
*Super Compact
*Drive Unit
*Young look jeans type Headband



Cat. C4122. \$29.50

Dicks Price \$29.50

TAPE RECORDER SWITCH

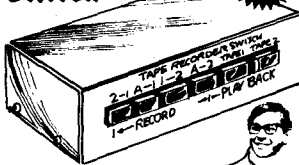

AUDIOPHILES & TAPE ENTHUSIASTS GRAB ONE OF THESE!! YES, THIS LITTLE UNIT IS THE ANSWER TO YOUR PRAYERS.

DIG THIS CUTE ITEM !

Dub from one tape unit to another tape unit using this beaut tape switch. Yes - if your Amp does not have dub features then just add this switch unit and have a feature more expensive Amps boast of ! No need for messy patch cords here. Now you can simply switch between your audio gear.
Cat. C7220 \$ 12.50

BARGAIN \$12.50

CASSETTE SPECIALS! sale

BASF C90 \$2.99

1500 ONLY - GENUINE BASF C90 CHROMIUM DIOXIDE IN SNAP PACK. DON'T BE MISLED THIS IS THE GENUINE PRODUCT. SAVE \$2 ON OUR SHOP LISTED PRICES FOR SINGLES. BUY ANY QUANTITY ONLY \$2.99 EACH

BASF C60 \$1.50

FROM NOW HAVE 5,000 ONLY BASF C60 C-60SM in "SNAP PACKS" STILL AT THE FANTASTIC PRICE OF \$ 1.75 each OR \$ 1.50 each ON LOTS OF 10 OR MORE HURRY WHILE STOCKS LAST !!!



WSV8 EXTENSION SPEAKER \$10.75

HUGE 8" Speaker in WALNUT Cabinet with black grill cloth. Has built in volume control so that sound can be adjusted independently.
Normal Price \$18.50
Cat. A2450 Now \$10.75
ROAD FREIGHT ON

EXPO 1212 STEREO AMP

EXPO DX 1212 12 + 12 WRMS STEREO AMPLIFIER
Full control amplifier - smart design with switches for loudness - tape monitoring - stereo/mono and high filter. Will take your Goldring ES 70S through its magnetic phono input. Frequency response from 20Hz to 25kHz - S/N ratio better than 60dB on phono Also accepts stereo Headphones 8-16 ohms.

SAVE \$20 or DICKS price of \$99

Cat. A1004. \$ 99.

SALE VINYL COVERED CUBE SPEAKER



IDEAL extension speaker. Handsome complete unit with 4" speaker. Buy now and SAVE well over \$ 2.00
Cat. A2457 \$4.50



INCREDIBLE EXPO CR50 NEAR COST! \$79.

A Tuner - Amplifier offering fantastic features : Full 8 watts RMS per channel. Two speaker system switch plus all usual controls. And greatest of all - Full MPX Stereo FM Radio incorporated plus AM Radio. Feature this unit in your rumour room audio system for this ridiculous price. Cat. A1660 Near Cost Give Away Price \$ 79.



Provides a drift-free ultra sharp performance with strong automatic frequency control coupled with dual varicap electronic tuning, followed by a 4-pole ceramic filter IF section for extra selectivity. Greater adaptability results from the tuner & stereo decoder section being made available separately. Tuning Range 88 to 108 MHz. AFC switchable, with thermistor control to prevent drift. One 28 transistor IC. Distortion 0.3% at 1kHz for 75kHz deviation. 23-32 volt Power requirement.
Cat. F4315 \$34.50



PROJECT 80 STEREO DECODER

SAVE OVER \$7 BUY BOTH FOR **\$48.50**

This unit gives a 30dB channel separation with an output of 150mV per channel. Gallium arsenide light emitting diode automatic lights up to show when a stereo transmission is tuned in. One 19 transistor IC. Power requirements 23-30 volts. Size 47x50x20mm. Cat. F4320 \$ 21.

DICK SMITH ELECTRONICS CENTRE

Head Office & Mail Orders

Shop hours:
Mon-Fri 9-5.30 Sat 9-12

162 Pacific Highway Gore Hill
N.S.W 2065 tel:439 5311
telex: AA 20036
cables:DKSMIT Sydney



Also at **CITY 125 York St**
tel: 291126
(Nr Town Hall)
and **BANKSTOWN**
361 Hume Hwy
tel: 709 6600
(Nr Chapel Rd)

NEW POSTAL CHARGING SYSTEM
Our new system can save you money! The larger your order the cheaper the packing and postage! Minimum charge is now \$1.00. Remember it doesn't just cost us stamps to send out mail orders. If you want your order sent by Air mail, C.O.D. or Comet, it will cost extra.
POSTAGE AND PACKING CHARGES
Order Value Charge
\$5 \$9.99 \$1.00
\$10 \$24.99 \$1.50
\$25 \$49.99 \$2.50
\$50 \$99.99 \$3.50
\$100 or more \$5.00
By Comet Freight Minimum packing and handling charge \$1.00. We dispatch freight on and you pay when you receive the goods. To avoid damage, all bulky or fragile articles will be sent by Comet freight on a freight paid by you on delivery.

'The AR-6 is just about the finest inexpensive speaker one could hope to encounter.

At Acoustic Research our first aim is to produce the most accurate speakers we can make, regardless of size or cost. The only limiting factors are the state of the art and our own engineering skill.

Low-cost loudspeakers

We have also designed speakers in which price was a consideration. But the performance standard has remained the same — the natural reproduction of music without exaggeration or artificiality of sound. And in designing the lower-cost AR speakers, it has been our aim to choose those compromises with cost that would have the least effect on the accuracy of sound reproduction.

This approach has resulted in a number of speakers in various price ranges whose performance often comes surprisingly close to that of the most expensive AR speakers.

The AR-6

One such speaker is the AR-6, which *Stereo Review* described this way: 'It is noteworthy that the bass response measured for the AR-6 was almost identical to that we measured for the AR-5 . . . This is exceptional performance for a speaker of this size and price . . . As we have mentioned, the AR-6's polar response was very good . . . quite similar to that of the more expensive AR speaker system



'All in all, the AR-6 acquitted itself very well in our tests. It was not quite the equal of the much more expensive AR models, whose sound it nevertheless resembles to an amazing degree, but on the other hand it out-performed a number of considerably larger and far more expensive systems we have tested in the same way. We don't know of many speakers with as good a balance in overall response, and nothing in its size or price class has as good a bass end.'

Musical realism

High Fidelity magazine characterized the AR-6 as 'another great bookshelf speaker from AR . . . a really terrific performer. The AR-6 has a clean, uncolored, well-balanced response that delivers some of the most natural musical sound yet heard from anything in its size/price class, and which indeed rivals that heard from some speakers costing significantly more.'

Our headline, quoted from Robert C. Marsh, writing in the *Chicago Sun-Times*, summarizes these observations. A low-cost speaker system that embodies so many of the performance characteristics of more expensive speakers would obviously provide exceptional value.

And, as with all AR speakers, the performance characteristics of the AR-6 are guaranteed for five years.



The AR-6: 'The finest inexpensive speaker one could hope to encounter'.



Australian Distributors W.C. Wedderspoon Pty. Ltd.
3 Ford St. Greenacre. Box 21, P.O. Greenacre 2190.
Telephone 642-3993 642-2595.

Available only through these franchise dealers:

Sydney

Kent Hi-Fi
Mastertone Electronics
Miranda Hi-Fi
Apollo Hi-Fi
Electronic Enterprises
Hi-Fi House
Instrol Hi-Fi
Autel Systems
Sydney Hi-Fi.

Melbourne

Instrol Hi-Fi
Tom's Hi-Fi
Denman Audio
Brash's
Mordialloc Electrical
Pantiles

Adelaide

Blackwood Sound Centre

Darwin

Pfitzners Music House

Brisbane

Reg Mills Stereo
Stereo Supplies

Newcastle

Ron Chapman & Assoc.

Wollongong

Hi-Fi House

Canberra

Douglas Hi-Fi

Hobart

Quantum Hi-Fi

Launceston

Wills & Co

Perth

Alberts T.V. & Hi-Fi.
Douglas Hi-Fi
Leslie Leonard.

Geelong

Sound Spectrum.

et PROJECT 709

EVERYONE experimenting with RF circuitry will sooner or later need an RF attenuator. Some of the typical uses of such attenuators are listed below.

- Checking intermodulation on HF, FM, and TV receivers.
- Checking if incoming signals are high enough to allow splitting - to feed more than one receiver.
- Changing signal levels when checking the performance of receivers.
- Evaluation of filters, RF amplifiers, and other electronic devices.
- To find the loss in coaxial cable by the substitution method (as well as the gain of amplifiers). This method is convenient as a calibrated detector is not required: merely one that will give the same reading for two successive inputs of the same level.

DESIGN FEATURES

An RF attenuator should have a useable frequency range of dc to 200 MHz. It is also necessary for the attenuator to be adequately shielded so that signals may only enter or leave via the coaxial connectors. For this latter reason a diecast box has been used to house the attenuator.

To obtain the wide frequency response required it is necessary to use resistors that have low inductance and capacitance - $\frac{1}{4}$ to $\frac{1}{2}$ watt carbon types are the most suitable. If higher power handling is required one or two watt carbon types may be used but with these accuracy will start to fall off at around 100 MHz.

The switches should also have low inductance and capacitance but specially designed switches are prohibitively expensive. Many Japanese slide switches were evaluated and initially gave good results. However the ingress of dust and dirt was found to cause faulty operation after a time. The types specified were found to give good and reliable operation over a long period.

Many commercial attenuators have switched values of attenuation - such as 3, 6, 10 and 20 dB. Although such values are commonly used this arrangement does not make maximum use of the switch capacity. In our attenuator we have used binary weighted values of 1, 2, 4, 8 and 16 dB. We can combine two or more of these switches to obtain values of attenuation from 0 to 31 dB in 1 dB steps. With the addition of one more switch and a 32 dB pad it would be

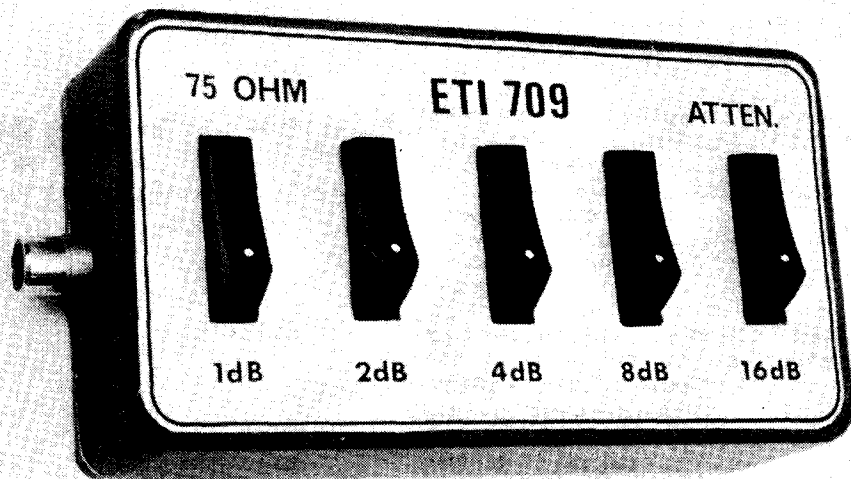

RF ATTENUATOR

0 to 31 dB attenuation in 32 steps of 1 dB - useable to more than 200 MHz.

possible to extend the attenuator to sixty four 1 dB steps. However at high frequencies the leakage of signal around switches becomes excessive and the accuracy at high frequency and large attenuation is thereby drastically reduced.

The sockets used for input and output are RCA types which are normally used with audio equipment. These are inexpensive and easy to obtain. These sockets are quite suitable for use in the low VHF region and are very rugged. Of course if proper 75 (or 50) ohm connectors are available they may advantageously be used instead.

Most RF systems are designed to work into 75 or 50 ohm with 300 ohms coming a poor last. Since TV and FM have standardized on 75 ohms we chose to design our attenuator for this impedance. Since other people may wish to work with 50 ohms we have included a chart showing exact and nearest preferred values for this impedance. It would pay to search with a multimeter to find the resistors having the value nearest to the exact value as specified.

CONSTRUCTION

Construction is simple and straight forward but to obtain optimum results we suggest that you follow our method as closely as possible.

Examine the photographs carefully, the method of construction may readily be seen from them. The unit is housed in an Eddystone diecast box having dimensions of 110 by 62 by 31 mm. The switches are mounted

flush onto the bottom of the box. Those at either end of the box are mounted so that the centre pin of the switch is in contact with the centre pin of the socket. This allows the connection to be made without the use of hookup wire. Evenly space the remaining three switches between the two outer ones. Note that a thin strip of tin plate is run the full length of the box and is held in place by the lugs and screws at one end of each switch. To this strip are soldered the ends of the resistors which go to ground. The resistors are held in such a position by their leads that the metal body of the switch acts as a shield between the resistors mounted on either side of it.

The centre poles of the switches are interconnected by first bending the centre lugs of the switch outward towards the next switch and then by soldering lengths of 3 mm wide tinplate between them as shown in the photos.

For general purpose use we recommend the RCA type connectors but if the unit is to be used solely for FM and TV the Belling and Lee type would be more suitable.

If difficulty is experienced in obtaining the exact type of switch specified select one that has a minimum amount of metal internally so that capacitance between switch contacts is not excessive. Also ensure that the switch is of sealed construction so that dust and dirt cannot enter and interfere with the operation of the switch.

Continued on page 62.

These are speakers you can really play with. Models are available with high or low resonance cones for use with electric guitars or as bass or wide-range speakers in hi-fi stereo systems.

CFL* cones developed by Plessey and ferrite magnets provide improved frequency response, efficiency and reliability under the highest loadings.

In any application where you have high power inputs and you want high power and quality output, The Plessey C12P is supreme.

Full construction details for suitable enclosures for the C12P range are available on request.

Look for the Plessey CFL sticker — your guarantee of a speaker with exceptional performance characteristics.

Models and Frequency Response
Plessey C12P — Guitar, 55Hz-10kHz,
C12P — Woofer, 35Hz-10kHz,
C12PX — Wide range, 35Hz-13kHz,
C12PX — Guitar, 55Hz-13kHz

*CFL with Plessey controlled fibre length cone.

PLESSEY 

Power to play with.

New high performance 12" speakers with CFL cones and 30 watts RMS.

Plessey Australia Pty. Limited
Components Division
The Boulevard, Richmond,
Victoria. 3121

Melbourne 423921 Brisbane 708097
Sydney 720133 Perth 687111
Adelaide 2236294

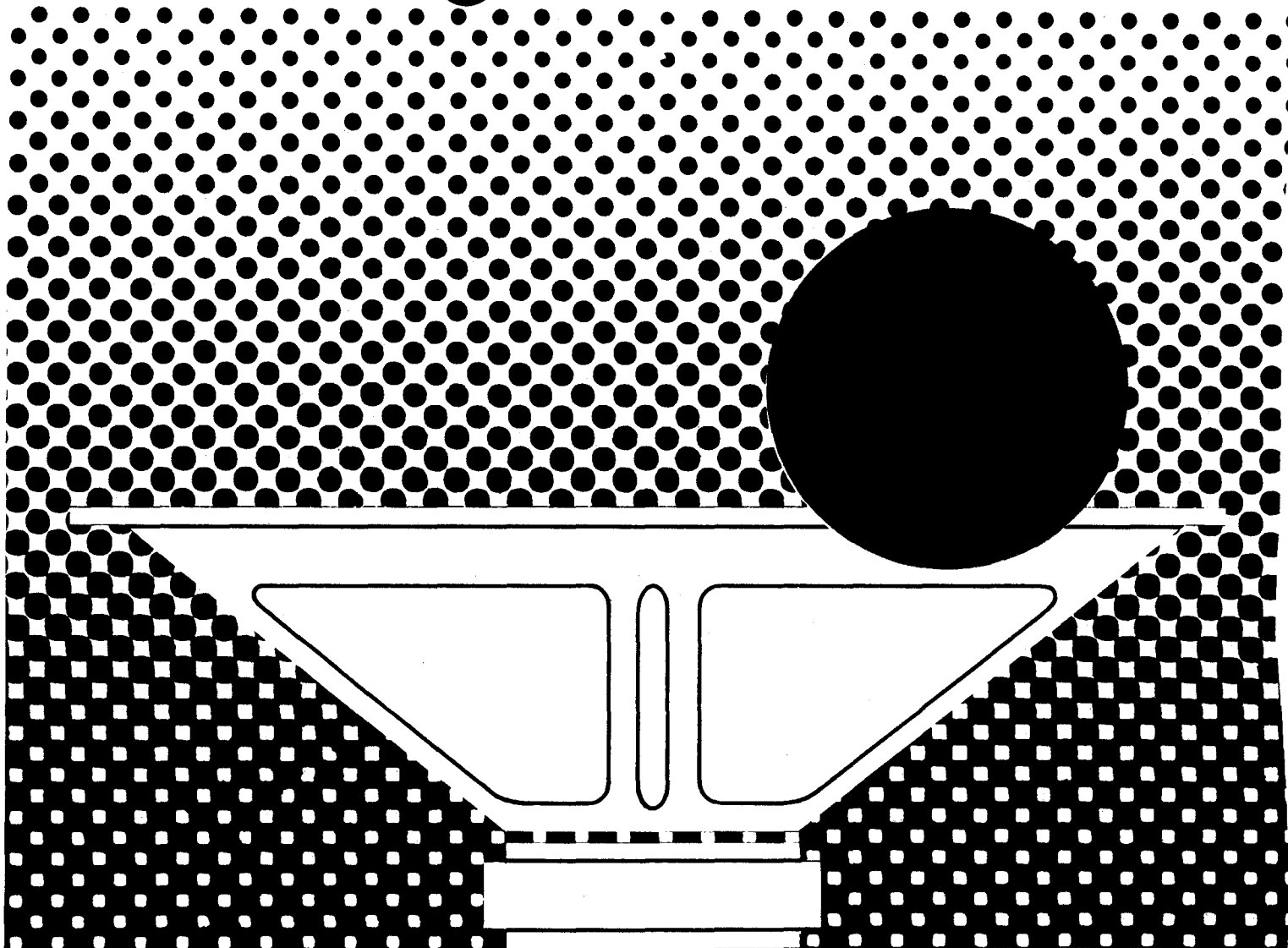

Distributors & Stockists: N.S.W. Lawrence & Hanson Pty. Ltd., Martin De Launay Pty. Ltd., Dick Smith Wholesale Pty. Ltd. VIC. Lawrence & Hanson Pty. Ltd., Radio Parts Pty. Ltd. W.A. Atkins Carlyle Ltd. QLD. The Lawrence & Hanson Electrical Co. (Qld.) Ltd. S.A. Gerard & Goodman Pty. Ltd. TAS. W. & G. Genders Pty. Ltd. N.Z. Plessey (N.Z.) Limited, Rata Street, Henderson, Auckland. In all states, Kits-Sets (Aust.) Pty. Ltd.

AR 71/R

Watt
 4
 2%. Input
 ut.

		P&P
Control	\$14.00	\$2.00
	\$29.50	\$2.00
kit	\$22.50	\$2.00
resistor tester	\$17.50	\$2.00
tone generator	\$ 9.75	\$1.50
state probe	\$15.00	\$1.50
Warble Double	\$25.00	\$2.00
ETI 238	\$ 5.95	\$1.50
ETI 438	\$11.95	\$1.50

	Bulk Dis. Price	Qty. in pack	DIGITAL I.C.'s	Bulk Disc. price	Qty. in pack
	\$2.00	25	SD7400	\$3.40	10
	\$3.25	25	SD7401	\$3.40	10
	\$5.00	25	SD7402	\$3.40	10
	\$6.00	10	SD7403	\$3.40	10
			SD7404	\$3.40	10
	\$5.00	25	SD7405	\$3.40	10
	\$4.60	4	SD7408	\$3.40	10
	\$5.80	4	SD7409	\$3.40	10
	\$5.60	1	SD7410	\$3.40	10
	\$6.30	1	SD7413	\$4.90	10
			SD7416	\$3.40	10
	\$2.30	1	SD7420	\$3.40	10
			SD7430	\$3.40	10
	\$2.90	1	SD7438	\$3.40	10
	\$5.60	4	SD7440	\$3.40	10
			SD7441	\$3.70	10
	\$4.40	4	SD7442	\$3.40	10
			SD7446	\$2.75	10
	\$5.60	4	SD7451	\$3.40	10
			SD7473	\$5.90	10
	\$7.80	4	SD7474	\$5.90	10
			SD7475	\$4.00	10
	\$4.80	2	SD7476	\$3.00	10
			SD7483	\$2.50	2
	\$5.20	4	SD7489	\$2.40	10
			SD7490	\$2.00	10
	\$4.40	2	SD7491	\$2.25	10
	\$3.60	5	SD7492	\$3.40	10
	\$4.00	5	SD7493	\$2.60	10
			SD7495	\$2.50	10
			SD7496	\$3.00	10
			SD74107	\$3.00	10
			SD74121	\$3.40	10
			SD74123	\$4.00	10
			SD74141	\$4.30	10
			SD74151	\$4.30	10
			SD74153	\$4.30	10
			SD74160	\$5.70	10
			SD74161	\$5.70	10
			SD74162	\$5.70	10
			SD74613	\$5.70	10
			SD74164	\$5.70	10
			SD74165	\$2.50	10
			SD74175	\$5.00	10
			SD74192	\$5.00	10
			SD74193	\$5.00	10

DIGITAL DICE
 - LIMITED STOCK ONLY
 Built and tested, 9v battery \$7.95 P&P

Equivalent may be supplied, but in all cases they will have the same specifications and similar style cases. Prices may be slightly higher interstate.

NOTE: Mixed value packs of 1/2W, 1W, resistors, ceramics and greencaps are not available. Packs contain one value only. Other components available in any quantity subject to 20% surcharge on quantity not in standard pack. EXAMPLE: 7 double-gang slide pots: Pack of 5 = \$6.00 plus 2 = \$2.40. 20% surcharge on 2 = 48c. Sub-total = \$8.88 plus 10% P&P (88c) TOTAL \$9.76.

Prices may be slightly higher interstate.

\$25.50
 Built and tested, simply plug in and use.



HI-POWER STROBE

INPUT MIXER
 two 100 mV mixing, built and \$2.50.
 CHANNEL
 TO LIGHT DRIVER
 plug into mains, connect to 4 external (not supplied) — gives you your own Disco show! Built and tested \$49.50 plus P&P \$2.50.

THE ELECTRONICS SHOPS:
 9 Young St., Southport, Qld. 32-3632
 23 Russell St., Toowoomba, Qld. 32-6944
 36 Station St., Booval. 82-2322
 EDA DELSOUND
 35 Logan Road, Wooloongabba, Qld. 391 7048
 30 Amelia St., Valley, Qld, 52-8694
 HI-TEL RECORD BAR:
 Shop 4 Skipton's Arcade, Penrith, NSW
 Shop C Nepean Arcade, Penrith, NSW
 Phone 21-0850

THE ELECTRONIC AND HOBBY CENTRE:
 1168 Gold Coast Highway, Palm Beach, 34 2835
 K & A STEVENS
 P.O. PARKES, NSW
 KTRONICS:
 12 Peel St., Adelaide. 87 5505.
 A. E. COOLING RADIO & T.V. SERVICE
 6 Trimmer Rd., Elizabeth South, S.A. 255 2249
 CALA ELECTRONICS:
 Shop 5A, Village shopping centre,
 High St, Coff's Harbour. 52 4035.

RF ATTENUATOR

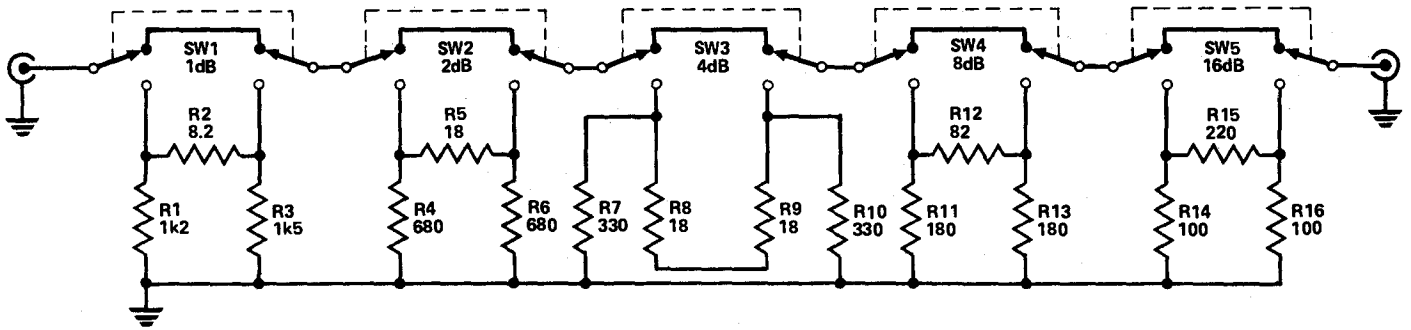

Fig. 1. Circuit diagram of the 75 ohm attenuator.

HOW IT WORKS - ETI 709

The ETI 709 attenuator works by switching into the signal path a selected network or group of networks that reduces the signal strength by known amounts. The networks are specially designed so that they do not disturb the characteristic impedance of the line. That is, they appear to both the source and the load as a single parallel resistor equal in value to the respective source or load impedance. In our case the networks have been calculated to provide matching to 75 ohm impedance.

As can be seen from the circuit diagram each section of the attenuator has a characteristic shape that has led to the use of the name 'pi network' for this attenuator section.

The steps of attenuation are expressed in decibels. The voltage attenuation in decibels is equal to

$$20 \log \frac{V_1}{V_2}$$

Where V_1 equals the

input voltage and V_2 equals the output voltage. Thus if the output is

half the input voltage then $\frac{V_2}{V_1}$ equals

0.5 and $20 \log 0.5$ equals -6.02 dB. (the minus sign indicating attenuation).

The use of decibels is very convenient as it allows the combined value of two or more attenuators to be found by simply adding their separate values rather than by multiplying the separate attenuation ratios.

Each succeeding attenuator is chosen to be twice that of the one previous. This binary form allows us to obtain a range of 0 to 31 dB in 32 steps with only five switches. Thus for example if we require 5 dB we depress SW1 and SW3 to give us $1+4=5$ dB.

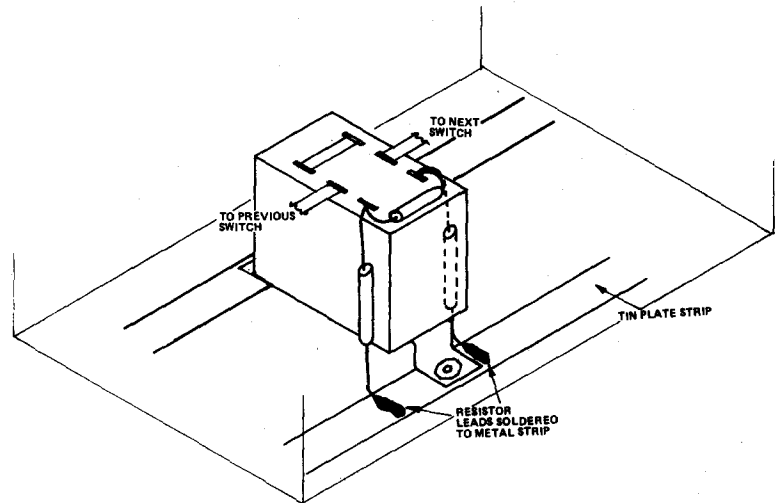

Fig. 2. How the switches are wired up.

TABLE 1

ATTENUATION	R*	ACCURATE VALUES 75 OHM	ACCURATE VALUES 50 OHM	CLOSEST PREFERRED VALUE 50 OHM
1 dB	R1 R2 R3	1304 8.6 1304	869.5 5.8 869.5	820 5.6 820
2 dB	R4 R5 R6	654 17.4 654	436 11.6 436	470 12 470
4 dB	R7 R8 R9 R10	331.5 35.8 0 331.5	221 23.9 0 221	220 12 + 12 0 220
8 dB	R11 R12 R13	174.2 79.3 174.2	116 52.8 116	120 27 + 27 120
16 dB	R14 R15 R16	103.2 230.7 103.2	68.8 154 68.8	68 150 68

* All values in ohms

PARTS LIST ETI 709

R2	Resistor	8.2Ω	¼W	5%
R5,8,9	"	18	"	"
R12	"	82	"	"
R14,16	"	100	"	"
R11,13	"	180	"	"
R15	"	220	"	"
R7,10	"	330	"	"
R4,6	"	680	"	"
R1	"	1k2	"	"
R3	"	1k5	"	"

SW1-5 Slide Switch min DTDP

2 RCA Phono Sockets (see text)
Die cast box Eddy stone 7134P
110mm x 60mm x 30mm

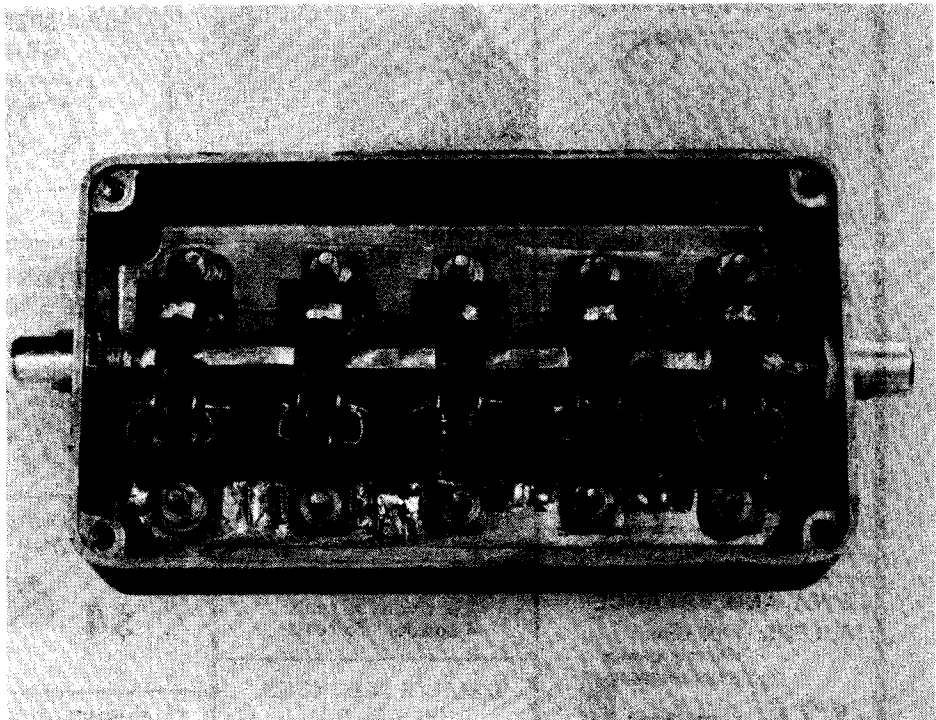

Internal view of the attenuator illustrates the method of construction.

SEMICONDUCTORS SALE

Fantastic semiconductor sale at Micronics for this month only!!! Never to be repeated. Stock up now and take advantage of these incredibly low prices!!!

BC 108 — metal can, gold plated, marked, guaranteed, new, no substitute — **10 for \$1** (Limit of 10 to each customer). Limited quantity at this price so get yours now!!

2N3055-1 — made by S.T.C. silicon N.P.N. power transistors TO3 metal package (marked, new) — **10 for \$6.50** (Limit of 10 to each customer). Get these now before they go!!

EM404 — silicon rectifier 400V, 1A, marked, guaranteed, new — **10 for 90c** (Limit of 10 to each customer). Hurry, these won't last!! 10% discount for orders over \$20. Money back if not satisfied.

Discounts for volume buyers. Ideal for all radio clubs, servicemen and group buyers etc., etc., etc.

25uf/300V	10 for \$2.50
16uf/300V	10 for \$2.00
2uf/300V	10 for \$1.50
40uf/200V	6 for \$2.00
6.4uf/25V	10 for \$1.00

STYROSEAL CAPACITORS

680pf/1000V	200 for \$14.00
100pf/125V	200 for \$6.00
680pf/630V	100 for \$4.00
680pf/125V	100 for \$3.00
270pf/125V	200 for \$6.00
220pf/125V	100 for \$3.00

POLYESTER PACK
Super pack of polyester caps all 10% incl. 160V, 270V, 400V types — **100 for \$3.50**.

TANTALUMS (Miniature type)

4uf/6V	100 for \$4.00
5uf/3V	100 for \$3.50
5uf/10V	100 for \$4.50
7uf/3V	100 for \$3.50
4uf/10V	100 for \$4.50

RESISTOR PACK
Super pack of resistors. Mostly ½ watt, 1 watt, 5% and 10% resistors. No short lead rubbish — **100 for \$1.25**.

ELECTROLYTICS
Top quality pigtails at bargain prices —

2500uf/25V (Elna)	5 for \$3.50
1000uf/25V	6 for \$2.50
1000uf/25V	10 for \$3.50
32uf/300V	6 for \$2.50

CERAMIC CAP. PACK
Super pack of ceramic caps incl. low and high volt types. Top quality — **50 for \$1**.

ELECTROLYTIC PACK
Super pack of electrolytics. Top quality pigtails. Low and high volt. — **25 for \$2.50**.

DISCOUNTS ON ALL ORDERS
10% OVER \$20.00
12% OVER \$100.00
15% OVER \$200.00

2N301
2N301 (new, guaranteed), audio output germanium transistors actually marked 2N301/2836 but superior in quality. Super bargain at \$1.50 ea. or 10 for \$12.

DIGITAL T.T.L. I.C.'s.
New, guaranteed. low, low, prices.

7400 — 35c	7430 — 35c
7401 — 35c	7440 — 35c
7402 — 35c	7441 — \$1.20
7404 — 35c	7442 — \$1.00
7408 — 35c	7447 — \$1.50
7410 — 35c	7473 — 90c
7413 — 80c	7474 — 90c
7420 — 35c	7475 — \$1.00

HA1322
Audio power amp. I.C. HA1322 (new, guaranteed) 5.5 watts peak. Supply volt 13V, input imp. 36 KOHM incl. circuit diagram. Fantastic value at: **\$2.25 ea. or 4 for \$8.**

TRANSISTORS AND DIODES

Look at these prices!!!

BC548	10 for \$1.80
BC328	10 for \$1.80
BC338	10 for \$1.80
AS148	10 for \$1.80
AS149	10 for \$1.80
AS320	10 for \$1.80
AS322	10 for \$1.80
BC557	
(BC177,BC157)	10 for \$1.70
BC558	
(BC178,BC158)	10 for \$1.70
BC559	
(BC179,BC159)	10 for \$1.70
EM402	10 for \$1.00
1N5059 glass rectifier	
	10 for \$1.00
1S188 (OA900)	10 for 80c
2N1637	10 for \$2.00
2N1110 (OC45)	10 for \$2.00
XA101 (OC45)	10 for \$2.00

COPPER CLAD BOARD
Real value — 6" x 3" — 4 for \$1.00. 9" x 12" — \$1.75 ea.

PA234 1W R.M.S. audio amp. I.C. Incl. CCT diagram — 95c ea.

MICRONICS P.O. BOX 175A, RANDWICK, N.S.W. 2031.

Basic post and pack 60c. Please assist by including extra postage for heavier parcels. Take advantage of these rockbottom prices as supplies are already limited. Stock up now!! Don't delay!! Post your order today!!

TAPE RECORDER DECK

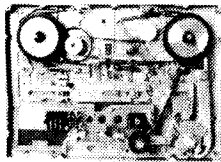

7 inch reel to reel, complete except head and face plate. **\$10**

SUPER SPECIAL B.S.R. RECORD CHANGER



12 inch turntable balanced arm cueing device etc. **\$35**, pack and post \$1.50. Interstate \$2.50.

LEVEL AND BALANCE METERS

1200 Ohm
100 microamps

\$2

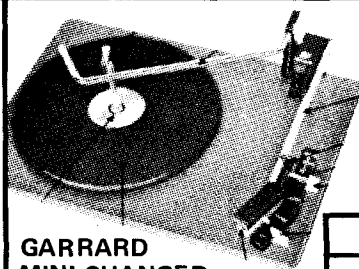

GARRARD MINI-CHANGER
Stereo **\$19.00**
Pack and post \$1.00
Interstate \$2.50

SPEAKER SPECIAL

6 1/2 inch Dual Cone
4 ohm

\$5



WAFER SWITCHES

2 position: **50 cents**
4 position: **75 cents**

DELUXE SPEAKERS FOR CARS

5 inch 8 ohm in plastic cabinets. **\$5.50 each**

BSR 4 SPEED 240V GRAM



Motor and Pickup **\$7.95**

PUSHBUTTON SWITCHES 5 POSITION

1/240 volts, toggle **50 cents**



BSR CERAMIC CARTRIDGE STEREO

\$4



TRANSISTOR 7 RADIO

Complete with 3/4 inch speaker
No cabinet **\$3.95**



TRANSISTOR EAR PLUGS 3 for **\$1.00**

MINIATURE TUNING CONDENSORS



75 cents



VU METER
\$3.00 pair

SPECIAL SOLID STATE STEREO AMPLIFIER AND TUNER

5 Watts RMS per channel, famous make **\$30**. Pack and post \$3 interstate, \$1.50 NSW.

SPEAKER CABINETS
10 x 7 1/4 x 4 **\$3.50**

BARGAINS

Hook up wire 30 mixed colours \$1.
250 mixed screws with self tappers, bolts, nuts, etc. \$1.25 + postage 50c.
100 mixed radio TV knobs including fine tune & channel change \$5.00.
1/2 meg. double pole switch pots 50c.
100 mixed condensers, mic as polyester ceramic 50c.
Mixed pots 30 including ganged & concentric \$5.
Morganite & IRC 33 useful valves fresh stock \$2.00 + postage 50c.
Slide switch 3 position 50 cents.
50 ohm Pots ideal for ext. Speakers 50 cents. Transistor and Driver Speaker Transformers \$1.00 pair.
Ferrite Rods 6 1/2 x 1/2 inch 50 cents.
Pots 30 mixed values including ganged and concentric \$5.
In Line Fuse Holders 20 cents
Stereo Speaker Wire 12 cents yard.
100 Mixed TV and Radio Knobs including Fine Tune and Channel Change \$5.
Car radio suppressor condenser 30 cents.

BARGAINS

100 mixed condensers micas polyester ceramic \$2 per pack and post 45c.
Electros 3 in one 100-25-40, 24-250-300. 50-250-300 75 cents.
Screw in 6 Volt Pilot Lights \$1.50 for 10. Plug-in type 10 for \$1.00.
100 mixed condensers micas polyester ceramic \$2 per pack and post 45c.
Indoor TV Aerials Vertical Spiral \$1.
3.5 to 3.5 Jack Plugs 7ft Shielded Cable 75 cents; 6.5 to 3.5 Jack Plugs 7ft. Shielded Cable 75 cents.
Mixed Tag Strips 50 cents for Dozen.
Tape Recorder Heads Transistor - Top quality suit most recorders \$5.00.
Jack Plug Sockets 6.5 mm 35 cents.
Morganite and IRC resistors 33 values \$2 per 100 pack and post 45c.
Philips Gramo Motor and Pickup 4 Speed 6 Volt \$7.75.
Crossover Condensers 2 mfd 60 cents.
Crystal Microphone Inserts \$1.00. Microphone Transformers 50 cents.

BARGAINS

Switch Wafers: 11 position 20 cents.
Philips Pick-up Cartridges: mono female \$2.50.
Pots: 50k 50 cents; 1M 50 cents.
Tape Spools: 7 inch 75 cents.
1/2 Meg Double Pole Switch Pots 50 cents.
Coaxial TV Feeder Cable 75 ohm 30 cents yard.
Jack Plugs 6.5 mm 50 cents; 3.5 mm 25 cents. R.C.A. Plugs 25 cents.
Battery Saver 240 to 6-7, 5-9 Volt, 6 Volt/300mA, 9V 200mA, \$10.
Hook Up Wire 30 mixed colours lengths \$1 bag.
Speaker 4 pin plugs 15 cents. 25 mixed 5 and 10 Watt resistors \$2.00
250 mixed screws, BSA, Whit self-tapper bolts, nuts, etc. \$1.25 bag plus 40c post.
BSR Stereo Player Model P-128 \$52 pack and post \$1.50. Interstate \$2.00.
TV Aerials Complete Range Hills Colour \$12 to \$60.
Car radio aerials, lockdown, top quality extended 1600 mm \$4.50.
Electros 3-in-one: 20, 400, 450; 10, 400, 450, 75, 50, 65 \$1.00.

BARGAINS

AWA 11 inch P.I. TV EHT transformers \$5.00.
Car Converters: 12 volt to 6-7, 5-9 volt 500 MA \$6.00.
Microphones - Dynamic 10k \$3.50.
Valve Sockets: 7 or 9 pin 10 cents. Octal 10 cents.
Speaker Transformers: 6 Watt 7000 to 8 ohm \$2.50; 3 1/2 Watt 7000 to 15 ohm \$1.75; 6 Watt 7000 to 1k \$2.50; 500 to 27 ohm 50 cents.
Ferrite Rods 6 inch 50, 9 x 1/2 75 cents.
Pots: 10K ganged log 50 cents; 1 Meg ganged log \$1.25; 1/2 Meg ganged log \$1.25; 2 Meg ganged log \$1.25;
2 Meg double pole switch \$1.50.
Sharp TV Flyback Transformers 8FT 604 \$7.00.
Miniature Speaker Transformers, drive and output \$1.00 pair.
Heat Sinks: 4 x 2 1/4 \$1.50.
Universal Mono Pick-up Cartridges; fit most type record players \$3.50.
Shure M 75/6 Magnetic Pick-up Cartridge \$11.
Picture Tubes - New 110 Deg 17 inch \$15.

SPEAKERS SPEAKERS SPEAKERS

6 1/2 inch Dual Cone 4/OHM	\$5.00	8 inch National built in Tweeter	\$14.00	Pioneer midrange 5 inch	\$9.50
4 x 2 8 OHM	\$1.50	Rola custom kit 63G x Tweeter C60	\$19.00	MSP 6 x 2	\$3.50
12 TACX in 8 or 15 ohm 10 Watts	\$11.00	MSP 2 1/4 inch 8 ohm	\$2.00	MSP 4 x 2 5 ohm	\$2.50
8 TACX 8 ohm	\$8.00	3 inch 8 ohm	\$1.50	MSP 6 x 4 47 ohm	\$3.50
6 x 9 in 8 or 15 ohm	\$6.00	Magnavox 5 inch 4 ohm 8 Watts	\$5.00	ROLA 5 x 7 47 ohm	\$6.00
5 x 7 in 8 or 15 ohm	\$5.00	Magnavox 5 inch 15 ohm	\$4.00	ROLA 6 x 9 47 ohm	\$6.00
6 1/2 inch 8 or 15 ohm	\$4.50	Pioneer 3 1/2 inch 8 ohm	\$1.50	Magnavox 5 inch 8 ohm	\$4.00
8 x 4 8 or 15 ohm	\$4.50	Magnavox 5 inch dual cone Tweeter	\$6.00	Magnavox 10 Watt	\$12.00
6 x 4 8 or 15 ohm	\$3.50	Magnavox 10 inch 8 ohm	\$8.00	Pioneer 3 1/2 inch 45 ohm	\$3.50
5 x 4 15 ohm	\$2.50	Pioneer horn type Tweeter 3 inch	\$9.50	MSP 3 inch 8 W 15 ohm	\$3.50
4 inch 8 ohm	\$2.75	Pioneer horn-type Tweeter	\$12.00	MSP 8 inch Woofers 8 ohm, 30 Watt	\$12.00
3 inch 3.5 ohm	\$2.50			MSP 12 inch 12 VAX 8 ohm, 20 Watt RMS	\$17.50
5 inch Tweeters 8 ohm	\$3.50			MSP 4 inch 120 ohm	\$3.50
6 inch Dual Cone Tweeters	\$6.00			4 inch 120 ohm	\$4.50
5 x 3 80 ohm	\$3.00				
5 inch Magnavox dual cone 8" 27 ohm	\$6.00				

How to cut costs on your valuable P.C. board real estate...

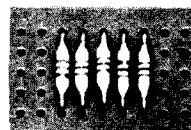
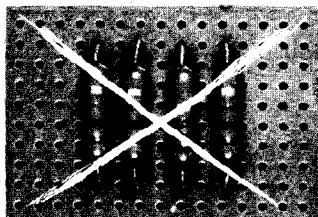

use type GLP miniature resistor.

IRH Components introduces the Metal Glaze type GLP resistor, a miniature 1/2 watt, with a maximum surface temperature rise of 50°C, the physical dimensions of many other 1/8 or 1/4 watt resistors but a full 1/2 watt rating at 70°C ambient.

The smaller size allows .4" (10 mm) lead spacing as standard for horizontal printed circuit board mounting — reduces demand on expensive PC board real estate. Even greater packaging density can be achieved by vertical mounting.

Another IRH "FIRST," the Australian made GLP is a result of extensive research, development & testing for Australian conditions.

STOCK THE GLP resistor and you automatically stock 1/8 watt, 1/4 watt and 1/2 watt and significantly reduce your resistor inventory. USE IT with confidence.

GLP FEATURES INCLUDE:

- Low cost.
- Small size. Length 5.5 mm
Diameter 2.0 mm.
- 1/8, 1/4, 1/2 watt rating.
- Thick film reliability.
- 60/40 plated leads for excellent solderability.
- Solvent resistant coating and colour bands.

irh

COMPONENTS

DIVISION OF NATRONICS PTY. LIMITED
The Crescent, Kingsgrove, N.S.W. 2208. Tel. 50 0111
74 Raglan Street, Preston, Vic. 3072. Tel. 44 5021



To: IRH components, The Crescent, Kingsgrove, N.S.W. 2208

Please forward your engineering bulletin featuring the GLP resistor.

NAME.....

ADDRESS.....

..... POSTCODE.....

GLP/76

TOSHIBA DIGITAL SYNTHESIZER

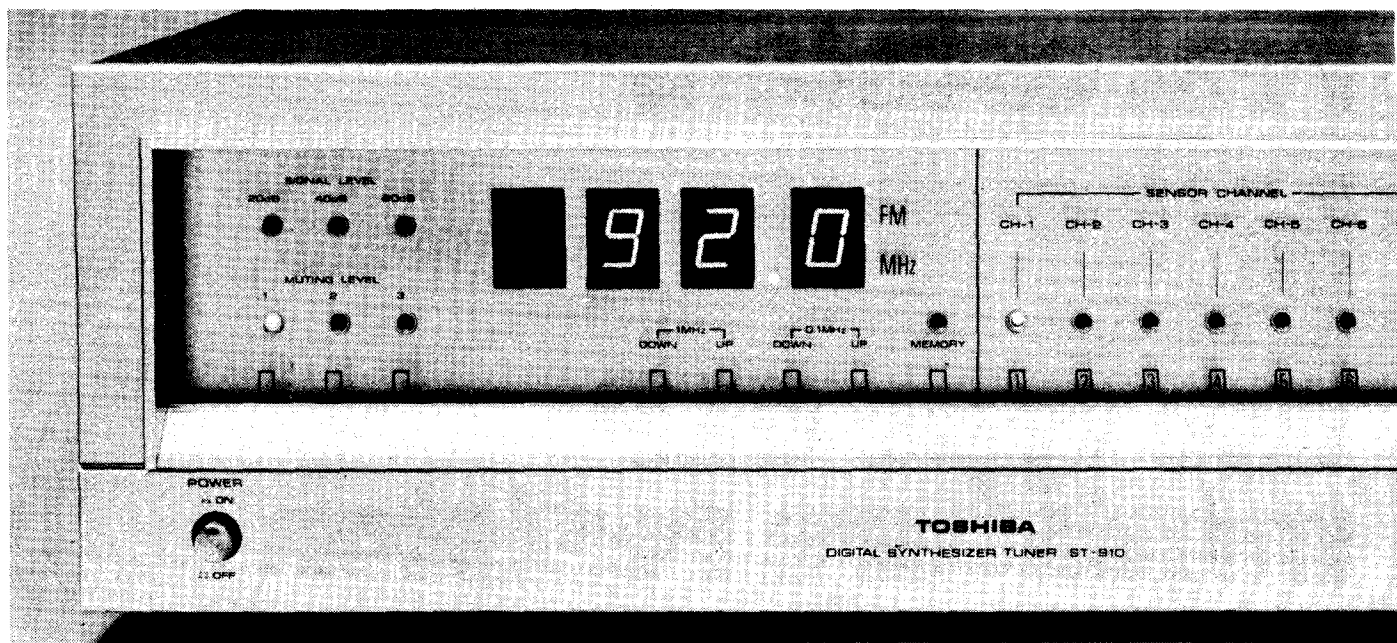

Recommended retail price \$1000+.

ALTHOUGH the invention of FM is rightly accredited to the USA's Major Armstrong, most post World-War II research has been done in West Germany. Apparently the victorious allies restricted Germany's broadcasting companies to using medium and high frequencies for internal communications — only VHF and UHF could be used for broadcasting.

The rationale behind this was strange and devious. It is commonly accepted that the purpose was to complicate and inhibit Germany's ability to produce and transmit her own broadcasting programmes. But if this really was the reason it largely failed, for German engineers soon developed VHF and UHF broadcasting to previously unparalleled heights of quality and technical excellence.

Americans and others were not slow to grasp the significance of the German research and it was not long before high quality FM broadcasting stations were set up, not only all over Europe, but also in America.

With the advent of stereo records in the mid 50's new pressure on our broadcast medium was created, in order to provide stereo broadcasts of comparable quality to the then fledgling stereo recording industry. Many of us will remember the early AM experiments using two broadcast stations at different frequencies.

Stereo FM broadcasting has been in general use for many years in overseas countries but it was not until just over a year ago that *stereo* FM broadcasting began in Australia.

Despite the still limited choice of FM stations a surprisingly large number of FM tuners and receivers are currently on sale in Australia — our recent survey of FM tuners published in our associated magazine *Hi-Fi Review* covered some 125 of them!

Several manufacturers have now produced very high quality units — one American-made device costs well over US\$3000. The unit tested here costs less than that — but it's still a hefty \$1000 plus and that's at least twice the price of many other FM tuners — three times the price of most.

The Toshiba ST910 is quite unlike any other piece of hi-fi equipment that we have previously seen. To start with there's not a single visible control apart from an ON/OFF switch. All other control functions are effected via capacitive touch switches, the positions for which are marked on the rear of the front glass panel forming most of the unit's front face.

The glass panel itself is divided into six sections which are from left to right; a signal level-indicating section consisting of six LED's, the top three being red LED's indicating signal level at +20 dB, +40 dB and +60 dB re $1 \mu V$; whilst the lower three LED's (which are green in colour) indicate the muting level that has been selected as the threshold level for the receiver to respond to. These are activated by touching the capacitive switches indicated below them. To the right of this section is a four digit display of FM frequency. This uses 7-segment LED displays for showing the frequency to which the receiver is tuned. The first three digits indicate the frequency in MHz, whilst the last digit indicates the frequency in

88 · 90 · 92 · 94 · 96 · 98

TUNER ST-910

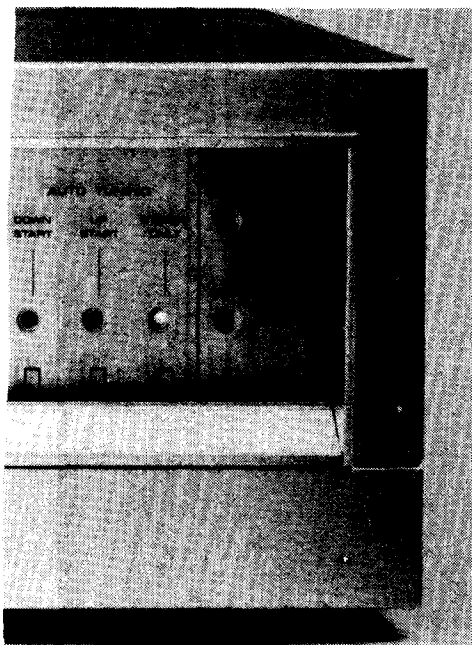

MEASURED PERFORMANCE OF TOSHIBA ST-910 FM TUNER S/N 52530001

Sensitivity (IHF Method)	1.5 μ V
Distortion Factor (500 Hz & 100% Modulation)	< 0.3%
Signal Noise Ratio	> 60 dB
Frequency Response	20 Hz – 15 kHz \pm 0.5 dB
Selectivity	> 80 dB
Image Rejection Ratio	> 80 dB
IF Rejection Ratio	> 80 dB
Capture Ratio	> 1.5 dB
FM Stereo Separation	\geq 30 dB
Dimensions	450 mm x 135 mm x 340 mm
Weight	8 kg

100 kHz increments.

Immediately below the digital display are two capacitive touch switches which enable the frequency to be increased up or down by 1 MHz steps. Two further capacitive touch switches allow the frequency to be increased up or down by 0.1 MHz steps. Immediately to the right of these is a memory switch which allows subsequently required stations to be preset by a series of IC devices. When this switch is touched the green indicator lamp is turned on. It is also necessary to touch one of the adjacent sensor panel capacitive switches, whose indicating LED is turned on by the process. Thereafter, all that is necessary to recall the memorised frequency is to touch one of the seven selected sensor channels switches. We found however that the memory would only 'hold' preselected stations for about two days.

To the right of the sensor channel switch positions is the auto-tuning section. This has a down-start capacitive selector switch, an up-start capacitive selector switch, and stereo-only capacitive selector switch.

The down-start starts the receiver searching down in frequency till it finds a signal the level of which is above the muting level (or sensitivity level) which has been pre-set. The up-start button does the same, but in the reverse direction. The stereo-only selector accepts only those stations having a 38 kHz or 19 kHz sub-carrier signal in their format.

At the extreme right hand end of the escutcheon is the stereo/monophonic indicator. When the capacitive touch switch is activated the green monophonic light comes on, the red stereo light is extinguished and the tuner looks for monophonic stations only.

The back panel is a little different from other FM receivers in that as well as input terminals for either 300 Ω feeder cable or 75 Ω co-axial cable, it provides output terminals for left and right channels; a multiplex output terminal to facilitate four channel reception in the unlikely event that somebody proposes introducing it; a remote control DIN plug to facilitate the use of special remote control offered as an optional extra; an output

level control which allows the setting of the audio line output levels; and a scanning speed control knob which allows the automatic tuning operation to vary between approximately 0.05 MHz/sec. to approximately 3 MHz/sec. scanning rate.

Another most interesting facility are two terminals which can be respectively connected to the horizontal and vertical axes of an oscilloscope to measure and minimise multi-path reception and thereby optimise signal quality. The handbook describes very simply yet practically, how this should be carried out.

DIGITAL FREQUENCY SYNTHESIZER

The heart of the ST910 is a digital frequency synthesizer based on a quartz crystal oscillator. This provides accurate and stable frequencies, replacing the normal variable frequency oscillator, to provide extremely accurate signal tuning. When used in conjunction with the phase locked loop, this provides an extremely precise and stable frequency

100 · 102 · 104 · 106 · 108

THE BIG HI-FI SALE

PREVIOUSLY
DISCOUNTED
NOW DOWN TO
\$279

SCOOP
BUY

Douglas-hifi

SELLS SOUND FOR LESS

191 BOURKE ST., MELBOURNE — 63 9321

338 GEORGE ST., SYDNEY — 25 3701

(Previously Palings buildings opp. Wynyard Station)

TOSHIBA DIGITAL SYNTHESIZER TUNER ST-910

tuning section. The great advantage of such a combined system is that the tuner receive frequency is extremely accurate (without the need for automatic frequency control) and nearly equal to the precision provided by the quartz crystal oscillator used in the original transmitting station.

Frequency stability claimed for the synthesizer section is better than 50 parts per 1 000 000 — subject to the period of operation and thermal conditions in which the receiver is used.

The inside of the receiver is more reminiscent of communication receiver construction and design than a piece of consumer electronics. Firstly, it makes use of a 300 mm x 240 mm mother card which is connected by plug-in sockets to the front circuit board on which are located the digital frequency display, the LED's and the capacitive touch switches. On the main section of the mother board are additional vertically mounted plug-in cards comprising the power supply, the digital memory sections, the frequency synthesizer and its crystal ovens and three cards on which are mounted the very high quality FM receiver.

An input pre-filter reduces the effect of unwanted high level AM signals on the following electronic circuitry.

The complete unit contains 32 transistors, 9 FET's, 100 diodes, 11

linear integrated circuits, 85 digital integrated circuits and 24 LED's. With a line up like that one would expect superlative performance — and that is exactly what we found.

Toshiba claim a frequency response of 20 Hz to 15 kHz \pm 0.5 dB. And that is exactly what we found in our testing.

Image rejection ratios and IF rejection ratios of 100 dB are also claimed, we couldn't confirm that these *were* 100 dB but they were certainly better than 80 dB. Toshiba claim a capture ratio of 1.5 dB, we found it to be slightly better than this. They also claim a FM stereo separation of 40 dB in the range of 100 Hz to 8 kHz — we certainly measured better than 30 dB, and if allowance is made for the performance of our signal generator the claim of 40 dB separation would be very near the mark.

The calibrated sensitivity signal level LED's which are supposedly 20 dB, 40 dB and 60 dB re 1 μ V are spot on at the 20 dB and 40 dB levels, and 57 dB for the 50 dB indicator. The major sensitivity on monophonic signals was 1.5 μ V which is better than the manufacturers' claim. Total harmonic distortion was (delightfully) less than 0.3% which is as good as one could ask for.

After all this one might well ask how does the unit perform. We found it

child's play to use and each time my children came into the laboratory that is exactly what they did, for this type of receiver is more resistant to abuse than any other we have ever seen and quite apart from its many features, attracts attention! Its listening performance is Grade A. We could in no way fault it, except for the minor possible criticisms that with digital frequencies set at 0.1 MHz intervals, one could possibly find oneself in a situation where the receiver was not tuned *exactly* to the station one was looking for and that on our review unit at least the preset tuning was effective for only a day or so before it needed to be reset.

We listened to all the available programme content we could find, the performance was in all respects almost perfect.

Is it really worth \$1000 plus? This is for you to decide — but you'll buy nothing approaching it for less. ●

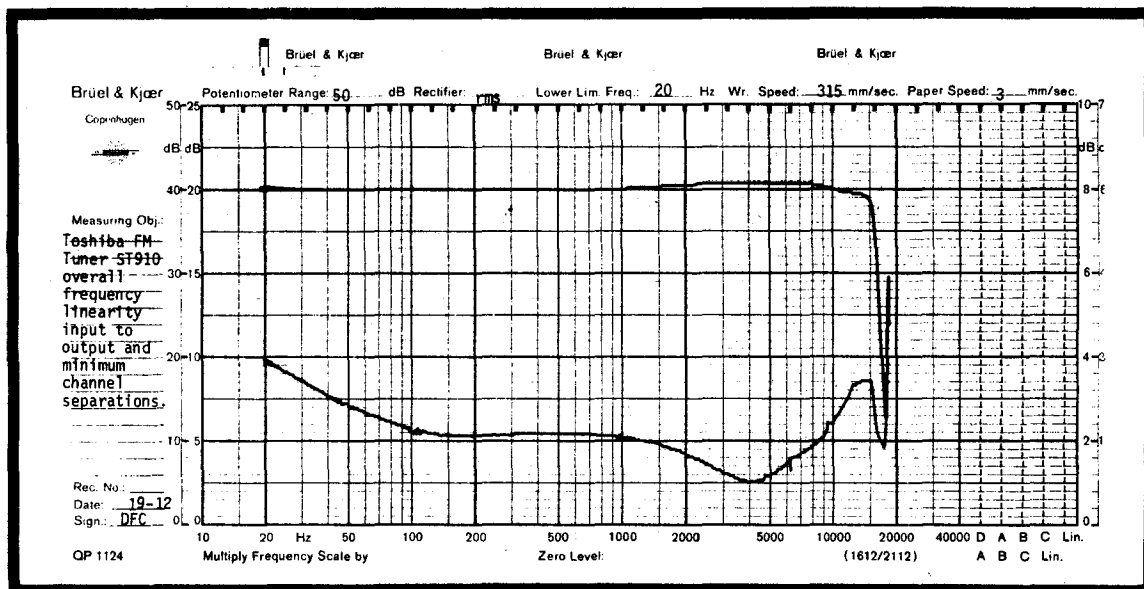



DRAKE

R.L. DRAKE

COMMUNICATIONS GEAR

DSR2 Digital readout communications RECEIVER 10 kHz-30 MHz continuous coverage, fully synthesized, for AM-USB-LSB-CW reception. **\$3495.**

SPR4 communications RECEIVER for AM-USB-LSB-CW reception. Direct frequency dialling 150-500 kHz plus any 23 x 500 kHz ranges between 0.5 and 30 MHz. **\$697**

R4C Amateur RECEIVER covers H.F. ham bands plus any 15 x 500 kHz ranges between 1.5 and 30 MHz except 5.0 to 6.0 MHz. **\$640.** (transceives with T4XC)

SSR1 Synthesized communications RECEIVER. Provides continuous coverage 500 kHz to 30.0 MHz for AM-USB-LSB reception. Operates from A.C. Mains or internal batteries. **\$375**

TR4C sideband TRANSCEIVER full amateur band coverage 10 through 80 meters. **\$630**

T4XC sideband TRANSMITTER full amateur band coverage 10 through 80 meters plus 160 meters accessory crystal plus 4 fixed frequency positions. **\$609** (Transceives with R4C).

MN4 and **MN2000** MATCHING NETWORKS – enable Feedline SWR's of up to 5:1 to be matched to the Transmitter. Built in Wattmeter. MN4 Handles 200 Watts. MN2000 Handles 1000 Watts continuous and 2000 Watts PEP MN4 **\$115** MN2000 **\$230.**

TV - 42 - L.P. FILTER for Transmitters below 30 MHz – 100 Watts continuous. **\$11.50**

TV - 300 - HP FILTER – TV Set protection from transmitters 6 – 160 meters. **\$9.00**

TV - 3300 - LP FILTER 1000 Watts continuous to 30 MHz with sharp cut off above 30 MHz. **\$24.00.**

RP500 – Receiver PROTECTOR for Receiver front end protection from close proximity high power transmitters. Less than 0.5 dB Insertion Loss to 30 MHz. **\$77.00**

W4 WATTMETER/SWR METER 2 – 30 MHz with 200 Watt and 2000 Watt ranges. **\$65.00.**

WV4 WATTMETER/SWR METER 20 – 200 MHz with 100 Watt and 1000 Watt ranges. **\$78.00.**

AC4 POWER SUPPLY for mains operation of TR4C or T4XC. **\$175.00**

DC4 POWER SUPPLY for battery operation of TR4C or T4XC. **\$187.00**

NIPPAN FC FREQUENCY COUNTER 15 Hz-250 MHz. Operates from mains or battery. **\$258.00**

MINIPET LARGE DISPLAY 10 DIGIT MAINS OPERATED 4 FUNCTION CALCULATORS with floating decimal and constant. **\$30.00**

PRICES shown include Sales Tax

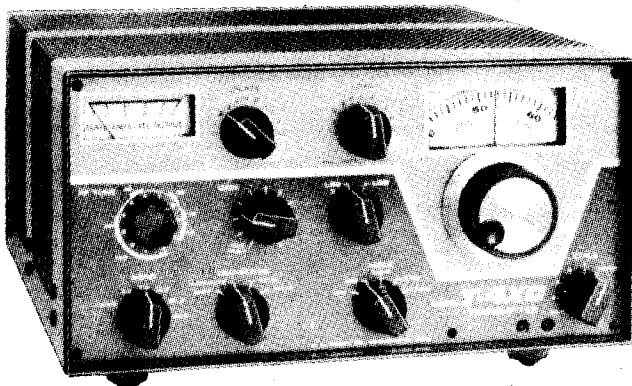

T-4XC TRANSMITTER

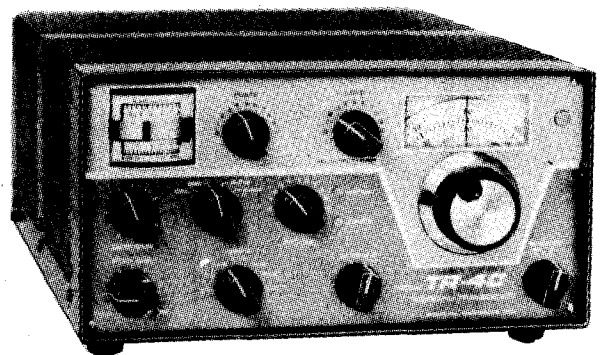

TR4C TRANSCEIVER

ELMEASCO

Instruments Pty. Ltd.

P.O. Box 334, Brookvale, N.S.W. 2100
939-7944.
Melbourne: 233-4044; Adelaide 42-666
Brisbane: 36-5061;
Perth: 25-3144;
Wellington, N.Z.: 69-7566

Announcing Bang & Olufsen's 50th Anniversary present-to you!

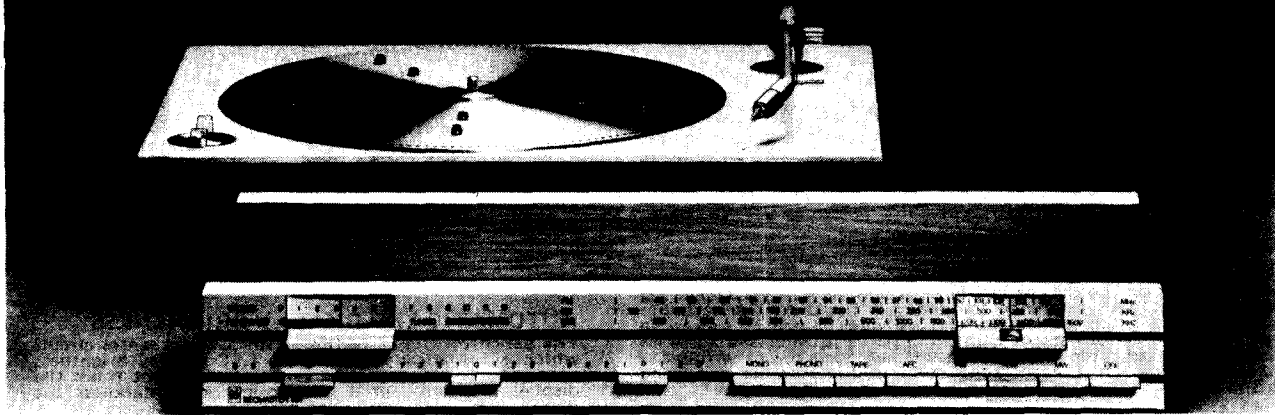

More than \$1000 worth of the world's most advanced stereo sound equipment-for \$695.

When a company of Bang & Olufsen's high international repute celebrates an anniversary, you can be sure the offer they make is not a cloaked attempt to clear stocks of a superseded model or a disguised effort to accelerate sales of a slow moving line.

Just the reverse—for instance, the B & O 50th Anniversary System offered here includes the world's most recent development in loud-speaker technology—two new B & O Uni-Phase speakers. This loud-speaker system was released in Australia in October 1975!

HERE'S WHAT YOU GET IN THE BANG & OLUFSEN 50TH ANNIVERSARY SYSTEM.

1. The Beomaster 901 Stereo Tuner/Amplifier A stereo amplifier combined with a stereo FM and Medium Wave radio tuner. The Beomaster 901 includes AFC

(Automatic Frequency Control) which keeps the radio tuned in to the desired FM station.

The stereo amplifier has a 2 x 20 watts RMS output, which is more than sufficient in most homes.

The exclusive Darlington output stage provides for less than 0.5% distortion at full power.

There are, of course, inputs for turntable and tape recorder, and outputs for headphones and two pairs of stereo loudspeakers.

2. The Beogram 1203 Record-Player

A fully automatic stereo record-player with high fidelity specifications. With its single press-button control, nothing could be easier to operate. The turntable and pick-up arm are mounted on a separate floating sub-assembly preventing vibrations effecting the tracking of the pick-up cartridge.

The special pick-up cartridge—the SP14A—has a spherical diamond

stylus and a tracking pressure of under two grams, protecting your records from wear. The unit comes complete with hinged cover.

3. The Beovox Uni-Phase S.30 Loudspeakers From Bang & Olufsen's new range of Uni-Phase loudspeakers, a pair of S.30's with a power handling capacity of 30 watts RMS each. The most outstanding features of the Uni-Phase S30's is that they take up much less room than conventional pressure chamber loudspeakers of a comparable power handling capacity. As well, they produce sound more accurately than most commercial loudspeakers on the market to date.

4. The Bang & Olufsen Guarantee Your B & O 50th Anniversary System is covered by the normal one year guarantee for both parts and labour.

The Bang & Olufsen 50th Anniversary Offer is a genuine price reduction made possible by Bang & Olufsen of Denmark celebrating 50 years of designing and producing the world's most advanced sound equipment. As a result, this complete system which normally retails for \$1,015.00 is offered at \$695.00 for a period limited to three calendar months from December 1st, 1975.

**BANG & OLUFSEN
OF DENMARK**



with respect for the true sound

Danish HI FI, Southern Cross Plaza, 638930 and Burke Road, Camberwell, 824839 Melbourne. Convoy Technocentre, Woolloomooloo, 3582088 Sydney.
Danish HI FI, Mount Lawley, 710100 Perth. Brisbane Agencies Audio Centre, Fortitude Valley, 219944 Brisbane.

BO/720MM

SABCHRON DIGITAL ^{T.M.} LED Watch kit

**SPECIAL OFFER
EXCLUSIVE TO ETI READERS**

\$49.00



The Sabchron Digital is probably the only six-function LED watch kit available today. It offers more features than many other LED watches — At the touch of a single Command Button you get the exact hour, minute, second, month and day-of-month . . . PLUS an automatic date change memory which knows whether the month contains 28, 30 or 31 days. And, AM/PM indication during hours setting.

1500 TRANSISTOR CMOS INTEGRATED CIRCUIT

A single silicon slice measuring only 1/50th square inch contains the equivalent of 1500 transistors and over 10,000 interconnections. The IC chip contains all the logic, decoding, multiplexing, counting and display drive circuits, and has static-protected terminals for handling safety.

QUARTZ CRYSTAL ACCURACY

The accuracy on the Sabchron Digital is controlled by a 32,768 Hz quartz crystal. This reference frequency is tuned to ± 2 parts per million via the trimmer capacitor and is divided in half 15 successive times through various stages within the IC to provide one accurate pulse per second. This means a timekeeping accuracy of within ± 5 seconds per month. Careful adjustment of the trimmer can bring this to within ± 1 second per month or ± 12 seconds per year!

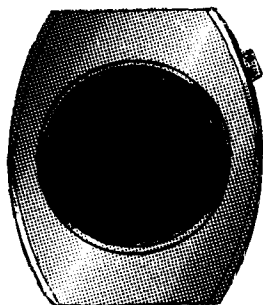

GOLD-PLATED CASE

Unlike many other watches which offer "goldtone" or "gold colour" watch cases, the Sabchron Digital offers a genuine gold-plated case. Made in Switzerland, it is water resistant and has a specially hardened ruby-red acrylic face. (Bracelet is not included). Elegantly styled and only slightly larger than a conventional watch, it is shown here actual size.

SIX FUNCTIONS

1236

Hours/Minutes

3658

Minutes/seconds

74

Date

10 P

AM/PM indicator

AUTOMATIC LED DISPLAY BRIGHTNESS

The Sabchron Digital features a special light sensor circuit which automatically adjusts the LED display brightness according to varying light levels. In a bright room the display brightens; in a dim room or in darkness the display dims, thus conserving battery power.

. . . PLUS THESE OTHER FEATURES:

- Shock-protected, anti-magnetic.
- Long-life power cells provide power for up to one full year with normal use.
- Easy time and date resetting — change the time or date without affecting the operation or accuracy. A very useful feature when crossing time-or-date-lines.
- ALSO AVAILABLE READY-BUILT WITH A 12-MONTH GUARANTEE.

COMPLETE KIT . . .

Contains all the components needed to construct this space-age watch, including batteries, solder, and easy to follow step-by-step assembly instructions manual. If you have problems in building, you can write to our service department for help. Clip the coupon and mail with your remittance, today!

ORDERING INFORMATION: The prices as listed are in Australian dollars. To order send a Bank Cashiers Cheque or International Money Order (include receipt with order). Insurance, if desired, add \$1.00.

sabtronics

INTERNATIONAL

P.O. Box 64683, Dallas, Texas 75206, U.S.A.

To: SABTRONICS INTERNATIONAL, P.O. Box 64683, Dallas, Texas 75206, U.S.A.

Please send via Airmail

..... (qty) Sabchron Digital kit(s)
at \$49.00 incl. postage \$.....
..... (qty) Sabchron Digital ready-
built watches at \$59.00 incl
postage \$.....

I enclose Bank Cheque International
Money Order valued \$..... total.

Insurance, if desired, add \$1.00.

Check here.

NAME

ADDRESS

eti/A376

"Bring it back alive."

When you relax to the purest sound of your favourite music, few things bring it back alive like the incredible sound of KOSS.

From the deepest toe-curling bass notes of a pipe organ, to the crisp, brilliant highs of the brass section, you would

find it hard to match the excitement of a live performance as well as KOSS Stereophones. In particular PRO-4AA. Because the KOSS PRO-4AA features the only driver element designed specifically for stereophones. So when it comes to mixing

the sound in your head instead of on the walls of your living room, you'll hear two more octaves than you've ever heard before in a dynamic stereophone.

Hear it like you've never heard it before on KOSS Stereophones . . . prices

from around \$30 upwards. Ask your Audio Specialist for a live demonstration.



KOSS stereophones
from the people who invented stereophones.

Choose from any of the following KOSS Stereophones:

K/6: Dynamic Stereophone
PRO/4AA: Dynamic Stereophone
PHASE/2: Panoramic Source Control
K/7: Dynamic Stereophone
TECHNICIAN/VFR: Variable Frequency Response

HV/1: High Velocity Stereophone
PRO/5LC: Professional Volume Control
PHASE 2+2: Quadrafone and Programmer
ESP/9B: Electrostatic Stereophone
ESP/6A: Electrostatic Stereophone

Distributed throughout Australia by:

AUDIO ENGINEERS P/L

342 Kent Street, Sydney, 2000. Phone 29 6731
Also MELBOURNE, BRISBANE and PERTH.

AE100/FP

The hungry leader.

At Altec, we're not taking our leadership position for granted. We're always trying harder — challenging ourselves to develop studio monitor speakers that stay a step ahead of constant improvements in the contemporary recording process. And we can prove it. Here's the latest data on monitors installed in U.S. studios, as published in Billboard's 1973 International Directory of Recording Studios.

MANUFACTURER	NUMBER OF MONITORS USED IN U.S. STUDIOS
Altec	514
JBL	256
EV	77
KLH	35
AR	29
Tannoy	28

But we're not really satisfied — even with this impressive track record. We're still trying to better ourselves. In fact, Altec has three all-new studio monitors available right now. They're a whole new generation of speakers designed to meet the whole new range of tomorrow's dynamic recording techniques. Your studio may need them. Why not call us for full details.

Altec gives you the best of both worlds proven leadership, plus an unrelenting commitment to doing a better job. That's because we've really grown to enjoy being # 1 in studio monitor sales during the past three decades. And we intend to stay right there for at least the next three decades by always being our own biggest competitor — in research, in quality, in service and in satisfying the demanding needs of an ever-evolving industry. The domestic ALTEC recently introduced into Australia has already gained rapid response from the discerning Hi-Fi enthusiasts.



**Number one.
And have been for
nearly 3 decades.**

Limited numbers of 604E professional monitors available at \$285 each.
Available in A.C.T. from DURATONE IMPORTS.

Domestic from

\$320 pair

ALTEC
the sound of experience.

KENT HI-FI

410 KENT STREET
SYDNEY
ph: 29-2743

(WHERE THE BEST EQUIPMENT COSTS LESS)

What kind of multimeter do you need?

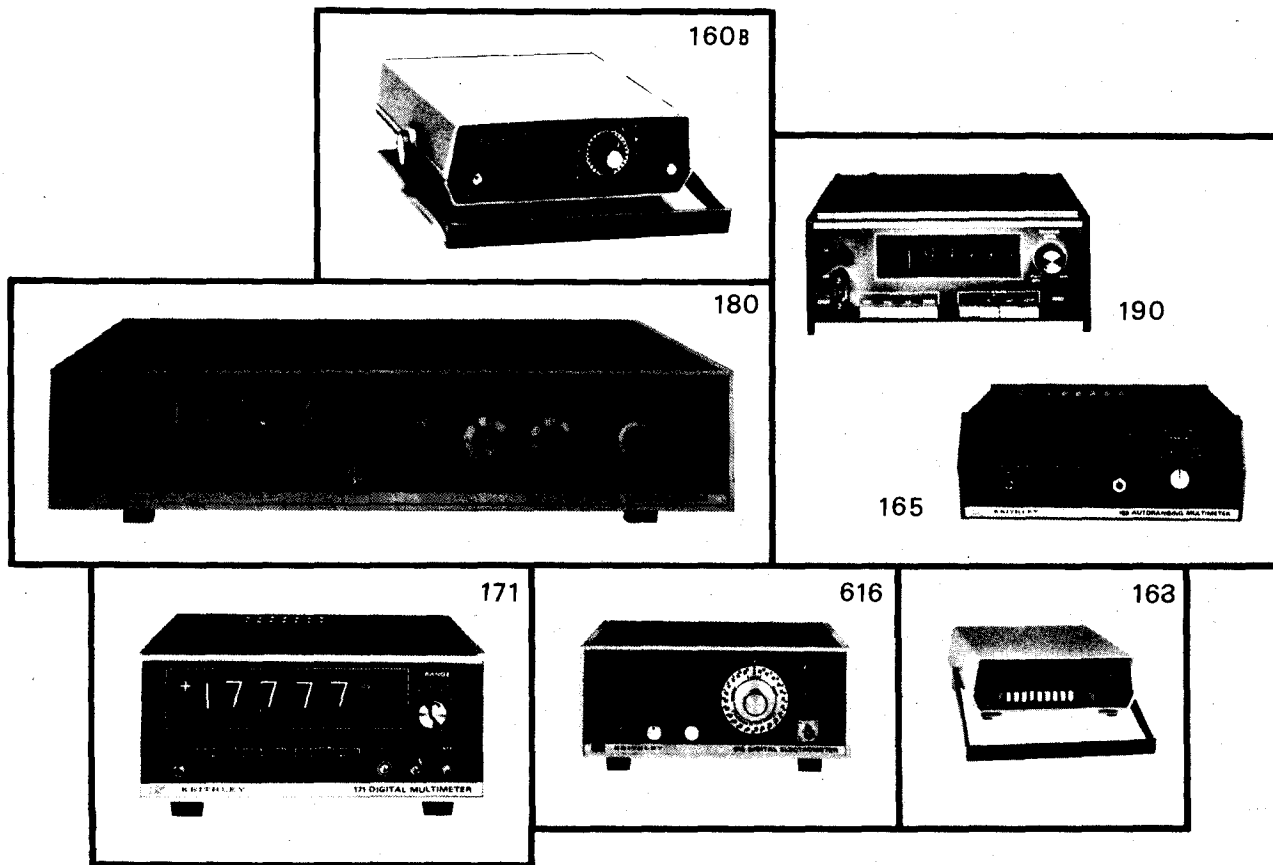

Keithley has a multimeter for every purpose!

model 160 B

Keithley's Model 160 Digital Multimeter features resolution as low as 1 microvolt dc on a 3½ digit display. The 160 also measures dc current and resistance. Excellent normal-mode and common-mode rejection make the 160 ideally suited to general-purpose laboratory or production measurements.

model 168

The low-cost Model 168 Autoranging DMM measures ac/dc voltage, resistance, and ac/dc current over wide ranges. The 168 automatically selects the proper range and moves the decimal point into position on its large 3½ digit LED display. It operates from any power line or an optional battery pack. The Model 168 is an ideal tool for design, troubleshooting, service, or production.

model 171

The Model 171 Digital Multimeter provides more measuring ranges than any other multimeter in its class. Its total measuring capability—which includes dc volts, ac volts, dc amps, ac amps, and ohms—makes it the ideal instrument for bench, systems, or servicing use. The 171 has a 4½ digit display, 1-microvolt dc resolution and an optional digital output is available.

model 616

The Keithley Model 616 Digital Electrometer also serves as an ideal dc multimeter. The 616 has an input resistance of over 10^{14} ohms and therefore can be used with virtually any source. The Electrometer measures V, I, R, and Q on a multitude of ranges. It has automatic ranging and an isolated digital output/control is optionally available.

model 180

The Model 180 Digital Nanovoltmeter extends digital convenience to low-level measurements. It is a 4½ digit autoranging nanovoltmeter with 0.01% resolution and sensitivity to 30 nanovolts. A floating input/floating output (FIFO) eliminates ground loops and simplifies sensitive measurements. The Model 180 is programmable and an optional BCD output provides full systems compatibility.

models 165 & 190

The Keithley Model 165 Autoranging Digital Multimeter measures ac and dc voltages down to 10 microvolts as well as ac and dc current and resistance.

The Model 190 is a highly accurate, 5½ digit AC/DC Multimeter with a built-in digital output. The 190 resolves ac and dc voltages as low as 10 microvolts and also measures amps and ohms.



- ADELAIDE 356-7333 • BRISBANE 52-7255 • HOBART 23-1841
- MELBOURNE 69-0151 • PERTH 65-7000 • SYDNEY 648-1711
- WELLINGTON N.Z. 698-272

ELECTRONICS —it's easy!

PART 28

Digital instruments and test equipment.



IN THE previous two sections we discussed the basic building blocks of digital systems. We are now in a position to study how these blocks are assembled into specific types of general-purpose instruments and test equipment.

Digital instruments may be defined as those in which the major proportion of the circuitry is digital rather than analogue. The circuitry of such instruments is seldom all digital, as few of the natural processes we require to measure are in digital form (a notable

exception is counting — a digital procedure). Hence the digital instruments that are used to measure real-world variables usually have an analogue-to-digital converter at the input. However there are many modern instruments designed to 'see' into logic circuitry — such instruments (having direct digital inputs) are truly digital.

Many test procedures could be implemented using solely analogue circuit techniques. However, there now exists a definite trend to replace analogue techniques with much more complex, but cheaper, digital equivalents.

Digital measuring equipments range in size and complexity from the simple panel meter for measuring voltage, current or resistance, Fig. 1, through medium complexity, portable and highly-flexible digital instrument systems, Fig. 2, to large automatic testing plants, Fig. 3, which operate on the commands of in-built computers.

Today, many testing instruments (even quite small units) possess self-testing facilities, in-built diagnostic ability and other advanced capabilities such as the automatic readjustment of the circuit under test to bring it within quoted specifications.

SOME HISTORY OF DIGITAL INSTRUMENT DEVELOPMENT

We have seen in Part 21 that most analogue signals can be converted to a digital equivalent. This concept first found serious economic application in computational systems, as was briefly explained in Part 22.

In the early days of digital systems even simple equipment had to be built using large numbers of thermionic valves and electro-mechanical relays. In the early 1940's the power requirements and the sheer bulk of such systems severely restricted the application of digital techniques to computers. Hence the early uses of digital systems in testing and evaluation first appeared in applications where portability was not required.

The need for an adequately-fast training simulator for aircraft pilots led to the development of the 'Whirlwind 1' computer by MIT in 1946. This evolved from work

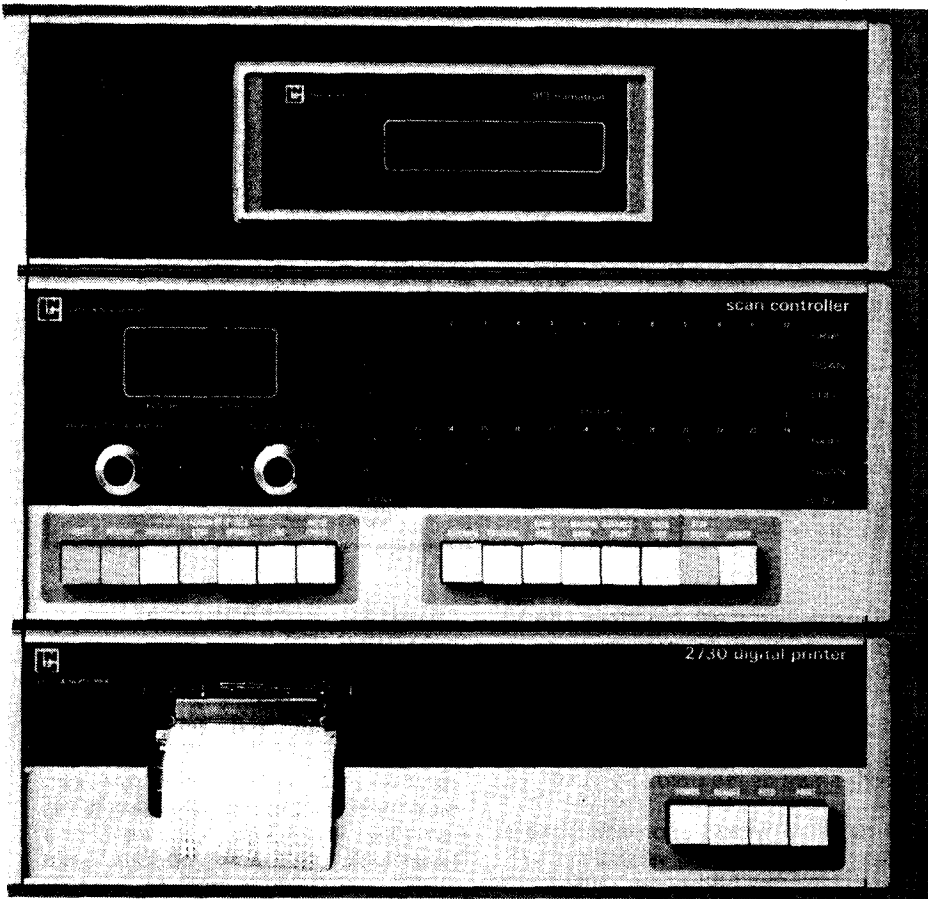

Fig. 1. Digital panel meters are extensively used in equipment, often replacing the moving needle indicator meter.

Fig. 2. The H.P. 3470 series measuring system consists of modules that clip together to form the digital multimeter instrument system required.

previously done on the use of digital techniques in the fire control of guns.

Digital voltmeters first appeared in the mid fifties and at least two companies, Non Linear Systems and Schumberger, lay claim to being first in the field. In the period 1955 to 1960 new skills, developed in the manufacture of computers, were used to build smaller cheaper and more effective instruments thus commencing the swing from analogue to digital instrumentation. The introduction of transistors enabled large-scale digital process control to be realised — Texaco Refinery at Port Arthur, 1959, was the first. They also allowed portable digital instrumentation to be made.

In the early 1960's integrated-circuits were conceived. The cost and space savings gained with their use removed any doubt that digital techniques were not competitive with traditional analogue methods.

THE DIGITAL MULTI-FUNCTION METER

We have already dealt with the basic sub-systems used to form most digital instruments. They usually comprise various assemblages of digital displays, A/D and D/A converters, counters, registers, gates and sources of precise frequency signals.

A digital multi-meter, for instance,

consists of analogue input, function and range selection stages which feed an A/D converter; this drives the digital readout form of display. They are marketed in a wide range of forms — from the neat compact fixed purpose units like that of Fig. 4 to systems such as shown in Fig. 2, in which modules are interchangeable to suit the very wide range of possibilities that the common power supply and digital readout allow. Functions offered (by choice of appropriate modules) may include more than the

traditional multi-meter measurements. Frequency measurement, timing, counting, totalizing, and ratio measurement may all be offered. Readout of any physical variable is possible provided a sensor exists that may be correctly interfaced with the digital end of the measurement system.

The simplified block diagram of the very compact H.P. 970A a hand-held digital multimeter, is given in Fig. 5. The circuits are of analogue form until the comparator stage after which

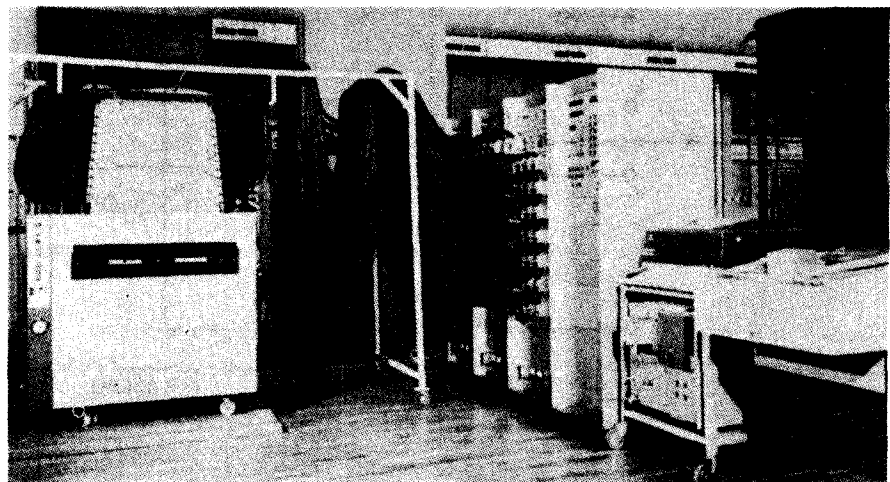

Fig. 3. Automatic Wiring Tester VD30, by Siemens — it handles 12,000 connections.

ELECTRONICS—it's easy!

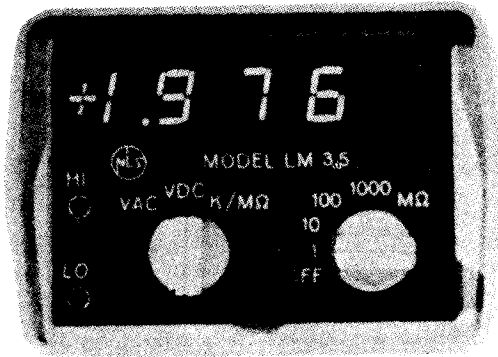

Fig. 4. This digital multimeter, by Non-Linear Systems, fits in the palm of the hand.

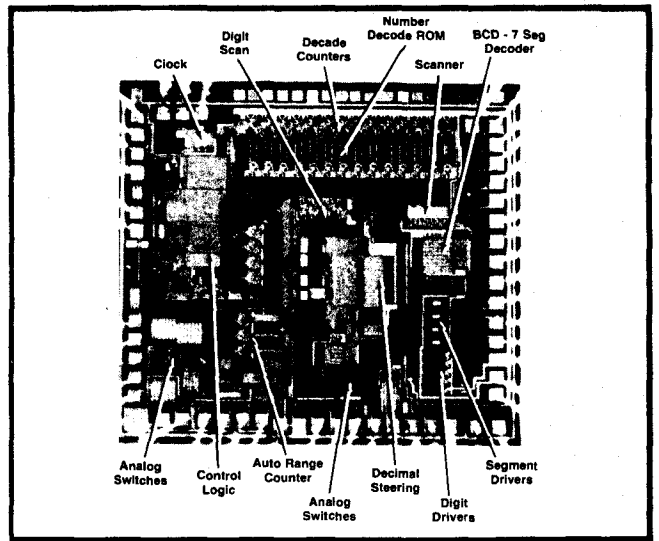

Fig. 6. Digital instrument circuits are often manufactured as custom-built chips. (a) Digital chip of HP 970A is just 3.9 by 4.3 mm in size.

digital signals are used. This unit uses the dual-slope integration method to convert from analogue to digital. Most of the circuitry is manufactured on just two custom-made monolithic IC chips — Fig. 6a shows an assembly with 40 flip-flops, 19 MOSFET switches and some 3500 bits of ROM (read only memory); Fig 6b shows the chip which carries the bulk of the linear circuits used.

Multimeter measurements of alternating current or voltage are only meaningful if the waveform is sinusoidal. If the waveform is complex, it is necessary to use an oscilloscope to gain knowledge of the ratio of peak to average or rms as measured by the multimeter. There are instruments available which incorporate the

multimeter and CRO functions within the one case. Such an instrument is the Tektronix type 213 unit as illustrated in Fig. 7. This instrument displays either the waveform or the scan-generated multimeter measurement as required.

A modular system approach is more expensive but gives versatility and continued flexibility to adapt to changing needs by not-so-expensive additions. Figure 8 shows one maker's modular approach — it retains the aesthetic shape of a complete portable set regardless of the number of modules needed at one time. The wasted space and extra weight penalty of the slide-in modular package is thereby avoided.

COUNTER-BASED DIGITAL INSTRUMENTS

Combining a display with a suitably gated counter and timing system provides the ability to count events; totalize and indicate elapsed time; determine frequency and period of periodic waveforms or provide a time-clock. In these options little analogue circuitry is involved, the unit either generating its own digital signals (a clock) or operating on input signals that are already in digital form.

We have dealt with the internal operation of counters in Parts 24 and 25: here we expand their use by studying the various modes of operation possible with a basic counter.

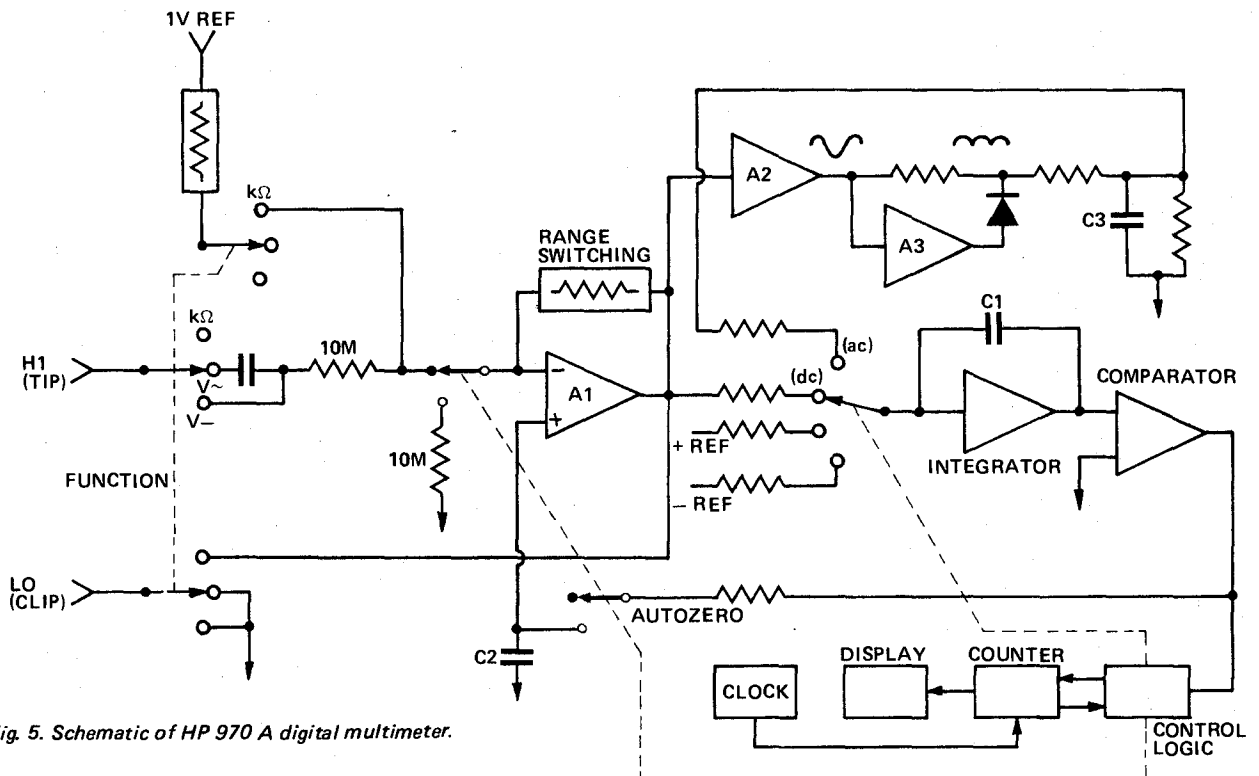

Fig. 5. Schematic of HP 970 A digital multimeter.

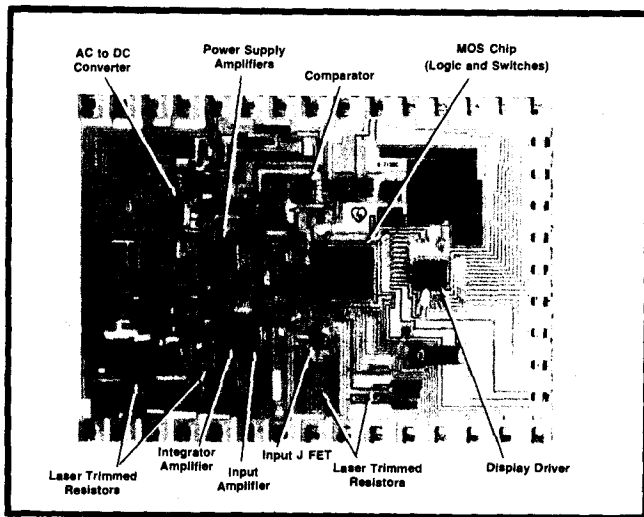

Fig. 6(b). Thin-film hybrid of HP 970A carries much of the analogue circuit on its 28 x 38 mm substrate.

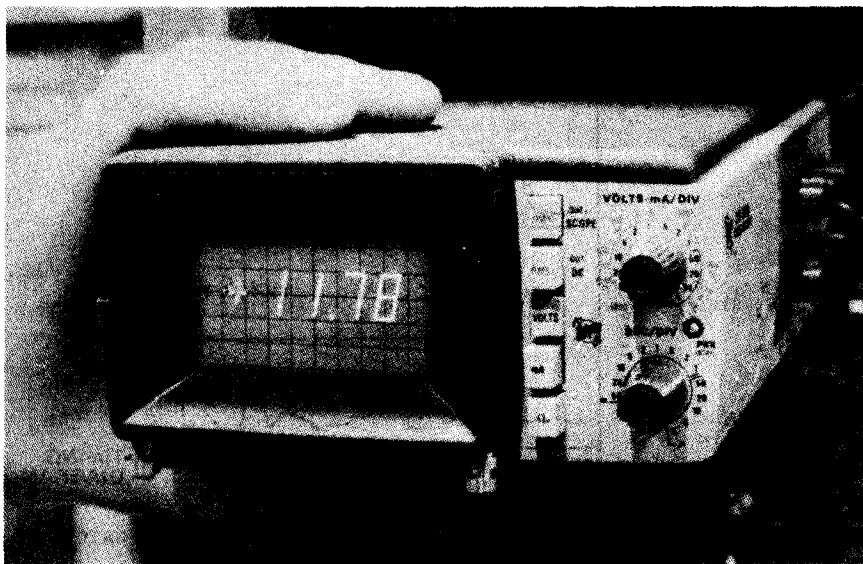
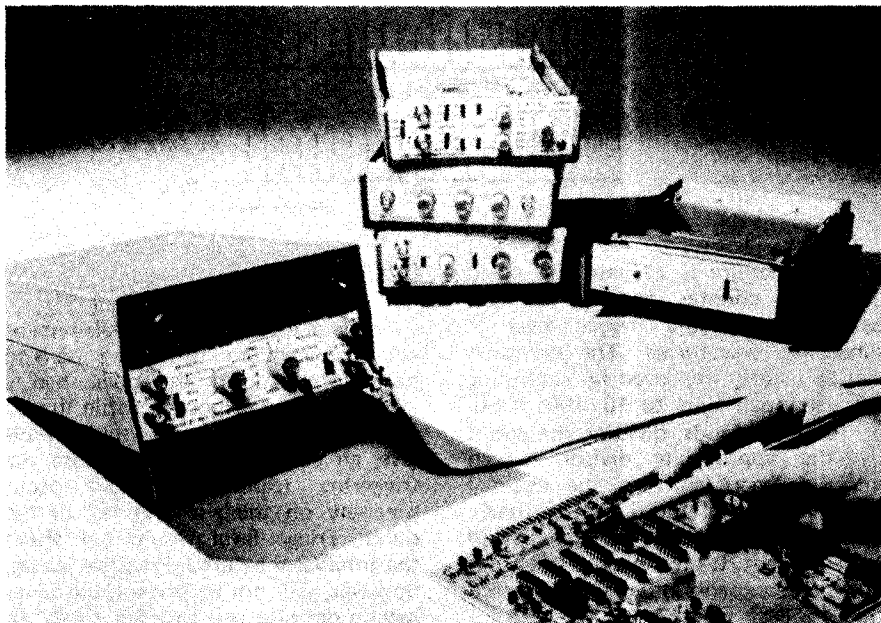

Fig. 7. The digital multimeter function is combined with a C.R.O. facility in the Tektronix 213 unit.

Fig. 8. Compact HP5300 series of modules allows many counting/timing measurements to be made.



TOTALIZING AND BATCHING

This is the simplest use of a counter. Events to be counted (for example packages on a conveyor belt may intercept an optical link, thus causing an electrical pulse to be generated each time the beam is broken). These pulses enter the counter, (Fig. 9) and are shaped into clearly recognisable counting pulses. Whether or not an event is counted is decided by the condition of the input gate which can be opened or closed on electronic command. In many applications the gate is quite simple, but its design can be a major problem when very fast signals are to be totalized to high-accuracy.

A batching counter goes a little further in that it counts to a predetermined value. When this is reached it provides an output command to the process being batched (for example, tins being counted into cartons) which causes some change in the process. At the same time, if the process is repetitive, the counter is reset to the starting value ready to count the next batch. It is sometimes more convenient to count downward from the number required, operating the batch command at the zero value. More complicated batching systems may have a stored program that sets each batch sequence to varying count values.

TIME INTERVAL MEASUREMENT

It is possible to measure the time-interval between two events by feeding pulses of known time separation into the input of the counter, as shown in Fig. 10, where a clock drives the counter. An example is the timing of a race. The gate is opened at the starting signal and stopped at the end. Counts accumulated represent the time interval. Obviously there is an advantage in choosing a pulse repetition rate that suits the units of time being used. The choice of clock frequency therefore depends on the resolution needed. For example, to measure one second with a resolution of 1 in 10^6 a pulse frequency of 1 MHz is needed to gain 1 μ s discrimination.

In some applications a common gate — control input is suitable — where the on and off event reproduces the same situation such as in period measurement of a sine-wave signal. Often, however, two separate input channels are needed so that each can have the specific pulse conditioning needed by different signal sources. Race timing, for example, might initiate the count on the sound of the starter gun and stop it on the signal from a pressure-pad sensor.

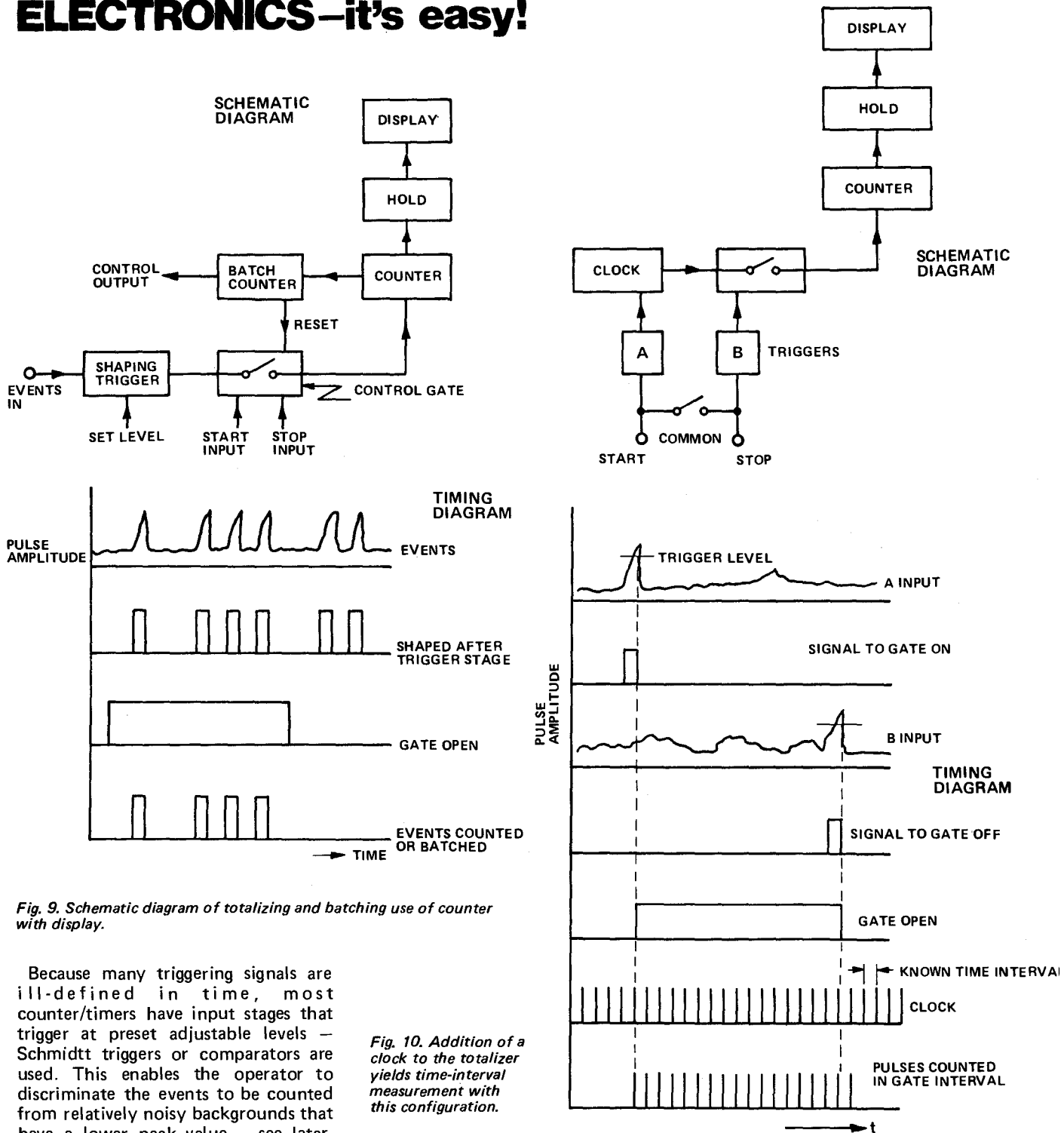

Fig. 9. Schematic diagram of totalizing and batching use of counter with display.

Because many triggering signals are ill-defined in time, most counter/timers have input stages that trigger at preset adjustable levels — Schmitt triggers or comparators are used. This enables the operator to discriminate the events to be counted from relatively noisy backgrounds that have a lower peak value — see later. Another reason for selective-level triggering is to allow the counter to operate at different points on a waveform — a sinewave input can be used to produce pulses of varying widths in this way. The counter output may also be used to trigger an event so as to provide automatic timing sequences, this being similar in principle to batch counting.

PERIOD OF REPETITIVE SIGNAL

The time interval measurement arrangement also enables the period of a wave-form to be measured. The most

Fig. 10. Addition of a clock to the totalizer yields time-interval measurement with this configuration.

basic procedure is to gate the clock into the counter for the interval between the same trigger level of successive waveforms. The precision can be greatly improved by extending the gate-open time to 10, 100, 1000, or 10 000 periods, dividing the count by the appropriate divisor (which means a mere shift of the decimal point if decimal multiples are used). This is referred to as multiple-period measurement, it gives greater precision but at the expense of greatly increased time for each measurement.

PULSE WIDTH

A special case of period measurement occurs when the width of a pulse is to be determined. If the pulse had a perfect square response profile the on and off gating points would always give an accurate answer because the triggering transitions would occur precisely on the rise and fall of the pulse. Trigger-level would not affect the interval measured. Practical pulses, however, will not be perfect, the edges having definite rise and fall times. In

this case the trigger-level becomes critical in width determination, as is depicted in Fig. 11. Counters usually provide a slope selection control. This decides whether the trigger operates on the positive or negative slope, that is, a or b slopes respectively (Fig. 11).

PHASE DIFFERENCE

Two identical waveforms can be regarded as two separate inputs for the start-stop inputs. If both trigger at the same point on each waveform (preferably at the zero-crossing to gain maximum precision) the ratio of the time-interval between the two crossings to the period of the waveform is the phase shift in terms of a fraction of one cycle.

FREQUENCY MEASUREMENT

The frequency of a repetitive signal is defined as the number of cycles (events) per unit time. A digital frequency meter, therefore, can be made with controlled gate-on period of precisely known time interval. In other words, it is the same combination as the interval timer (i.e. oscillator counter with display, gate control and precision) but with the difference that the clock now controls the gate (not the counter) through a precision divider that scales the basic clock frequency down to obtain the gate duration needed. Gate periods range from 1 μ s to 1 s. A simplified schematic is given in Fig. 12. The input signal is often sinusoidal; the input stage shapes this into a square wave to enhance individual cycle detection by the counter.

NOISE ERROR REDUCTION

The above descriptions give the basic operating modes of the various counter/time/frequency-meter combinations. In practice a number of refinements may be incorporated to obtain better practical performance.

Noise can be reduced by incorporating a fixed amount of backlash in the trigger circuit; this produces what is called the trigger window. On the way up the trigger level is at a higher level than on the way down, as shown in Fig. 13. Provided the noise added to the signal has an amplitude smaller than the window width, the counter will only trigger once on the way up and once on the way down. This method works well for high-frequency measurements where the noise is usually a small percent of the signal-plus-noise signal amplitude.

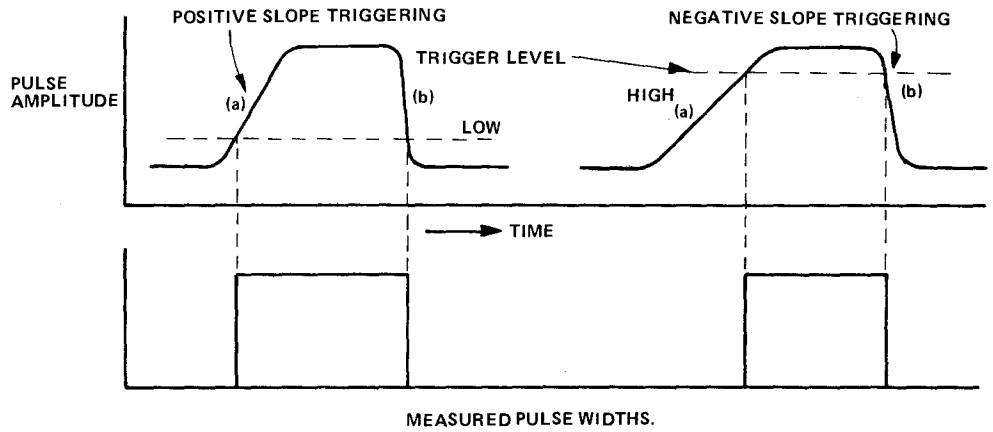
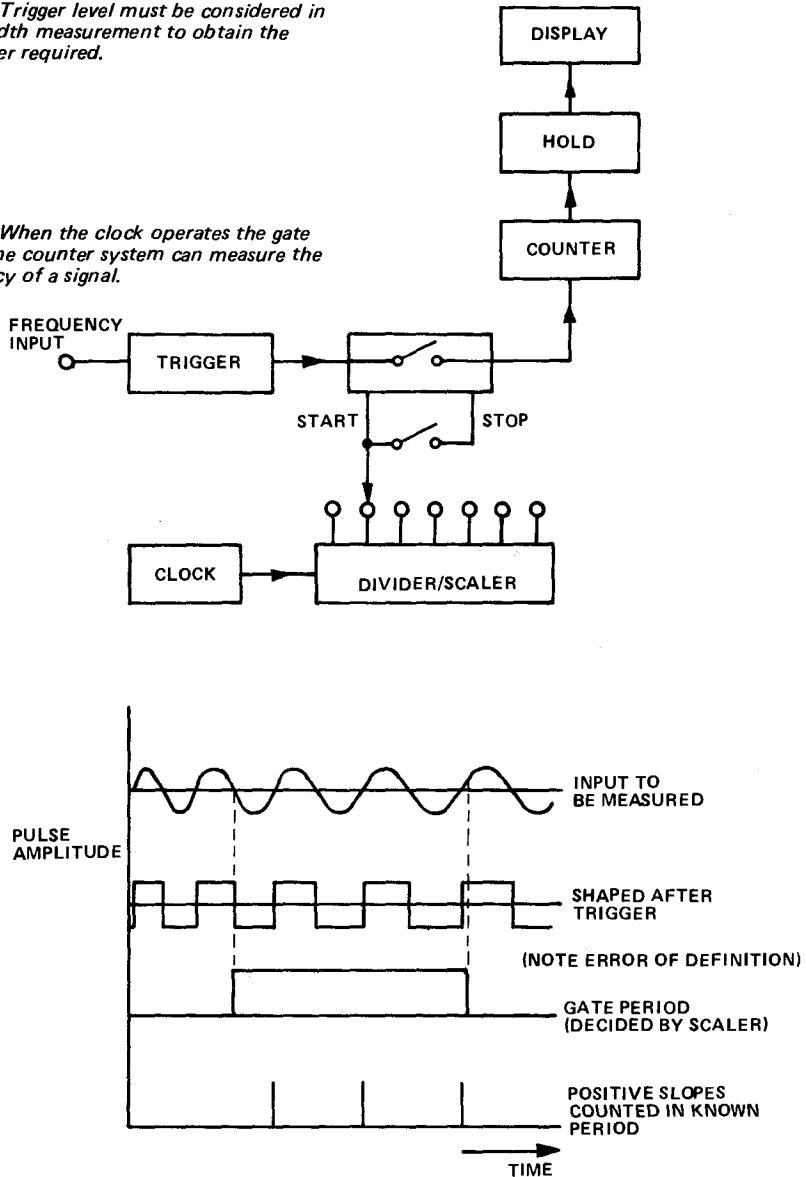

Fig. 11. Trigger level must be considered in pulse width measurement to obtain the parameter required.

Fig. 12. When the clock operates the gate length the counter system can measure the frequency of a signal.



Low frequency measurements can often involve interference sources that produce rapid spike transients. One simple method of reducing this is to use filters. Advanced designs contain filter systems that reject all frequencies higher than that being tested, the appropriate filter being automatically selected by the counter

itself after it has made a determination of the frequency of the signal.

A recent approach to the noise problem is to set up a time-window (as opposed to the trigger height window) that, once the counter gate is on, inhibits the off-state chance until after

(continued on page 84)

Portable Digital Multimeter at an Analog Price



Enjoy the benefits of auto-polarity digital readout plus full overload protection and high-low power ohms for accurate tests in solid-state circuits.

Accuracy better than analog VOM's!

22 RANGES

Reads in decades: AC and DC volts and mA, 1-1000; ohms, 100-10 meg.

Resolution: 1mV, 1mA, 0.1 ohm.

Accuracy: DC typically $\pm 1\%$ F.S.; AC and ohms typically $\pm 2\%$ F.S. except $\pm 2.5\%$ on highest range. Uses "C" cells.

SEND FOR FREE LITERATURE

TECNICO ELECTRONICS



PREMIER STREET, MARRICKVILLE, N.S.W. 2204. TEL. 55 7996
2 HIGH STREET, NORTHCOTE, VIC. 3070. TELEPHONE 489 9322
AVAILABLE FROM LEADING ELECTRONIC WHOLESALERS

MO9721/1075

ONE-OFF PRINTED CIRCUIT BOARD

New, revolutionary, British invention enables the electronics engineer or the hobbyist to produce one-off or prototype p.c.b. layouts to professional standards in an hour or so (depending on complexity).

No special drafting skills or equipment needed.

Accurately shaped etchant-resistant circuit symbol transfers are pressed directly on to copper-clad p.c.b. which can be etched immediately.

Use your own or any published p.c.b. layouts.

Full step-by-step instructions enclosed.

These transfers are also suitable for the production of artwork for the quantity production of printed circuit boards.

Each pack contains 10 sheets of transfers which cover all normally required shapes such as, round pads, 0.1" & 0.15" edge connectors, straight lines & bends, tees, 3 & 4 lead transistors, 8, 10, 12 pin TO5 I.C. & d.i.l. I.C. pad sets etc. etc.

Separate replacement sheets will be available to purchasers of packs in a few months, so you need only purchase the sheets you use most — not the whole pack.

Introductory Offer

Place your order within one month of the appearance of this ad., and we pay P&P (normally 50c). Pay only \$6.98 per pack, which will be posted free to anywhere in Australia.

Send in your cheque for postal order to the sole Australian agent:

ENRITE ELECTRONICS
67 Clarke Street, Peakhurst, 2210 N.S.W.

this outstanding new stylus
ensures much better reproduction
from all your recordings

parabolic

STYLUS

FOR GREATER LISTENING PLEASURE PHONE 931201



BAY ROAD ELECTRONICS
36 Luxmoore Street Cheltenham Vic. 3192

HAM RADIO ELECTRONICS BARGAIN CENTRE

390 Bridge Road, Richmond, Vic.
42-5174

Please allow for postage & packing when ordering by mail

Plenty of BARGAINS for the Radio Amateur or the Hobbyist.

NEW 4 TRACK STEREO CARTRIDGE PLAYERS. 5 watts output 12V D.C. operation. In sealed carton. \$15. P&P \$2.50.

6ft 240V AC POWER CORDS with moulded 3 pin plug 75c each or 10 for \$6.50

STEREO TONE ARMS complete with ceramic cartridge \$5.90 each P&P 30c.

EDGEWISE 0-1 mA METERS 2 1/2" x 1/2" face 3" deep calibrated 0-5 \$3 P&P 75c

PANEL METERS 5 7/8" x 4 1/4" face with 0-1 mA movement. Various scales on meters (gas analyser, etc) \$5 P&P 75c

NEW QEO 6/40 CERAMIC VALVE SOCKETS \$2 P&P 40c.

MORSE CODE PRACTICE KEYS \$1.50 P&P 30c

BATTERY ELIMINATORS to suit transistor radios and cassette recorders AC-DC 6 volt 300 mA. PS6300 \$7.50 P&P 75c

SPEAKER CABLE, colour codes twin flex 20c yd.

SONAR SLIDER POTENTIOMETERS, 2 7/8" x 3/8" x 3/8". Available in 500 OHM, 20K, 25K, 100K, 500K and 1 MEC. 65c each or 10 for \$5.00 P&P \$1.00.

CAR EXTENSION SPEAKER CONTROLS. Use both speakers together or separately. \$1.50 P&P 30c.

JACKSON SLOW MOTION DRIVES 6:1 ratio \$2.30 P&P 30c.

THIS MONTH'S SPECIAL



RF AMPLIFIER AM-4306/GRC

Originally used in conjunction with PRC25 which covers 30-75 MHz FM. Requires 1-4 watts drive and gives a nominal 25 watts out. Brand new in sealed box with complete service and user manuals. \$19 each \$3.50 p&p

15 kHz CRYSTAL FILTERS 10.7 MHz M.E.W. \$5 each P&P 75c

2N3055 TRANSISTORS \$1 each

58 ohm COAX CABLE 100 yd Rolls, 1/8" diam. \$12 roll P&P \$1.75

52 ohm COAX CABLE 1/4" diam. 45c yd, 50c metre.

DOW KEY COAXIAL RELAYS 48 volt D.C. operation \$15 P&P 75c.

3 "N" TYPE CONNECTORS to suit above \$5

SPLIT STATOR CAPACITORS with screwdriver slot drive, 9 pF, 17 pF or 25 pF. Brand new Eddystone type \$3 each P&P 75c

2" SQUARE FACE 0-1 mA METERS calibrated 0-60 \$3 P&P 75c.

MAIL ORDERS WELCOMED.

Please allow pack and post items listed on this page, if further information required send a stamped S.A.E. for immediate reply from the above address.



-that's where the money is!

Stott's course is totally comprehensive — and includes both sophisticated electronic equipment and project materials you need to gain a thorough understanding of servicing techniques.

Divided into three self-contained sections, the course covers:

Part 1 — Introduction to Electronics (theory and practice)

Part 2 — Monochrome Television Receivers

Part 3 — Colour Television, including processing circuitry, service techniques, fault tracing and trouble shooting techniques.

Like all Stott's courses, you work with your own instructor who is an expert in this exciting and rewarding field, at your own pace, in your own home.

If you are a beginner, Stott's will teach you everything you need to know concerning television principles and receiver circuitry.

If you are already working in the field, or have completed some studies in electronics, you may be eligible to enter the course at an advanced stage. Whether your aim is to enter the TV service industry or whether you wish to gain a thorough understanding of television theory and servicing as an aid to sales experience, this is the course which will help you make it!

Other electronics courses offered by Stott's include:

Radio for Amateurs — Amateur Operator's Certificate

For full information mail this coupon today:

<h1>Stotts</h1> 	
TECHNICAL CORRESPONDENCE COLLEGE The name to trust in correspondence education Please send me, without obligation, full details of the following courses:	
Stott's undertake that no sales counsellor will call.	
Mr., Mrs., Miss	Age
Address	
Postcode	
159 Flinders Lane, Melbourne.	66 King William St. Kent Town, S.A.
383 George Street, Sydney	89 St. George's Terrace, Perth.
290 Adelaide Street, Brisbane.	P.O. Box 3396, Singapore 1.
SIC815	ET376

ELECTRONICS—it's easy!

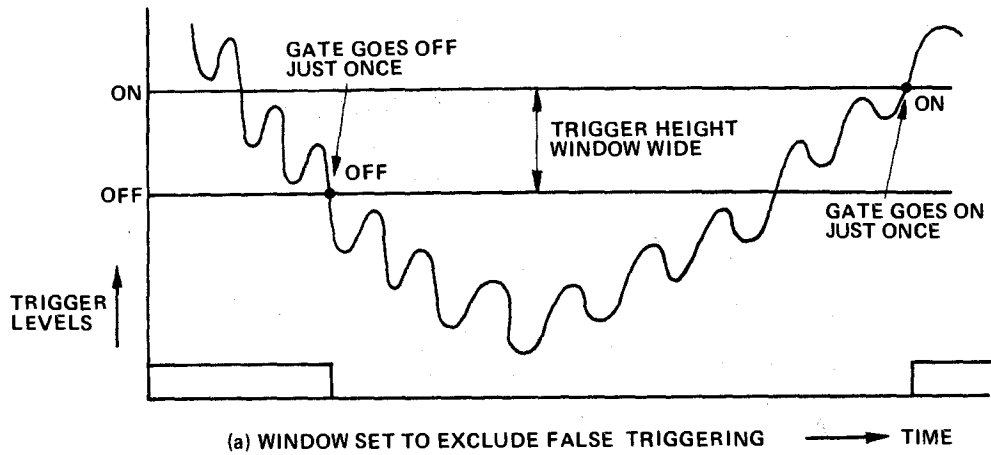
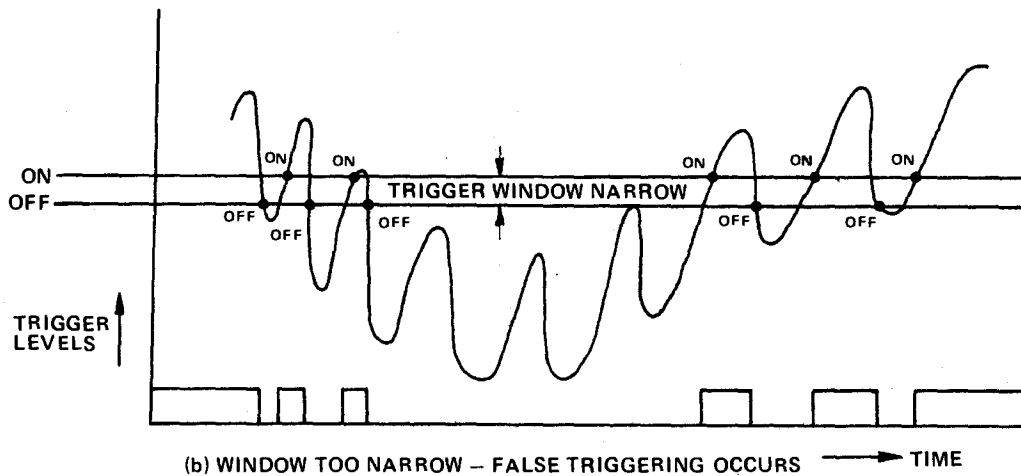

Fig. 13. Noise reduction in counting by use of a trigger height window.



a time just shorter than the expected interval. This is known as trigger masking. It is very useful in eliminating contact-bounce retriggers.

Before using a counter/timer on an unknown waveform it is, where feasible, good practice to study the waveshape on an oscilloscope in order

to decide the best strategy for trigger-level and height-window width settings. Figure 14 illustrates the differences between window level settings on various waveshapes.

As the readout is in digital form it is necessary to hold the display at the determined value for a period long enough to allow the value to be read. Some units incorporate a control that gives the operator a choice of hold time.

The following part of this series will continue with this general discussion of digital instruments, covering physical variable transducer systems, the various kinds of analysers and correlators, waveform generators and computer-controlled testing systems.

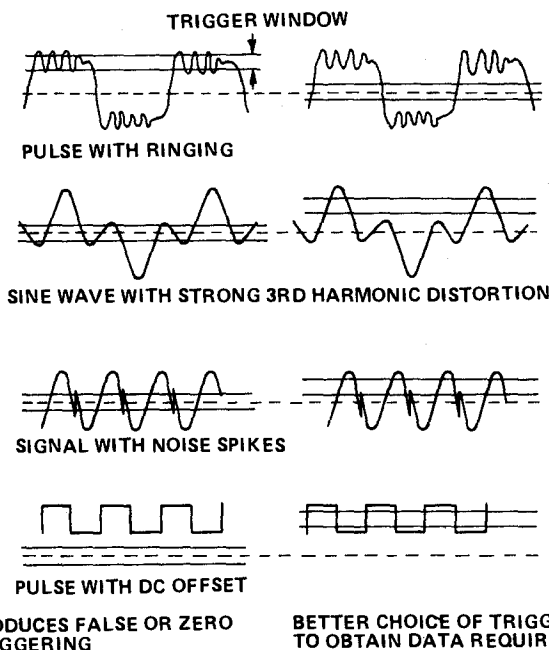

Fig. 14. Trigger height for the window must be chosen to suit the wave shape.

Further Reading:

Varies issues of Hewlett Packard Journal contain many detailed articles on a wide range of digital instruments. "Digital Instrument Course — Pt. 2", A. J. Bouwens, Philips Industries Holdings, Sydney, is useful to have. This booklet describes the practical use of counter/timer instruments in many varied applications.

ADVERTISERS INDEX

Akai	4
Amateur Communications	
Advancements	96
Applied Technology	43,44,45
Audio Engineers	73
Audioson	25
Autotronics	98
Bay Road Electronics	82
Bright Star	98
Butterworths	97
BWD	10
C&K Electronics	18
Cema	16
Challenge Hi-Fi	42
Chan Merchandising	95
Convoy	26,94
Cooper Tool Group	19
Danish Hi-Fi	14,15,71
Dick Smith	56,57
Douglas Hi-Fi	68
Adege Electrix	90
Electronic Disposals	93
Elmeasco	70
Emona	91
Enrite	82
Ferguson Transformers	91
Haco	IFC
Ham Radio	83,88
International Dynamics	IBC,6,38,89
International Elect. Unlimited	99
IRH	65
John Carr P/L	96
Kent Hi-Fi	74
Kitsets	46
Lafayette	96
Leroya	12
Logan Brae	96
M.S. Components	50
Micronics	63
Mod Amp	61
National Radio Supplies	55
Philips Elcoma	36
Pioneer	85
Plessey Aust.	60
Rank Ind.	OBC
Roystan	8
Sabtronics	72,98
Scope Laboratories	51
Stotts	83
Tecnico	82
Tudor Radio	64
Video Hi-Fi	11
W.C. Wedderspoon	58
Warburton Franki	75

electronics TODAY

SERVICES

READERS' LETTERS

We make no charge for replying to readers' letters, however readers must enclose a foolscap-size stamped addressed envelope if a reply is required. Queries concerning projects can only be answered if the queries relate to the project as published. We cannot assist readers who have modified or wish to modify a project in any way, nor those who have used components other than those specified.

TELEPHONE QUERIES

We regret that we cannot answer readers' queries by telephone.

SUBSCRIPTIONS

Electronics Today International can be obtained directly from the publishers for \$10.80 per year (including postage) within Australia.

The cost for countries outside Australia is \$10.90 including postage (surface mail). Airmail rates will be quoted on application. Subscription orders and enquiries should be sent to the address below.

BACK ISSUES

Our subscriptions dept can supply most back issues of ETI for the twelve months preceding the date of this current issue. Some earlier issues are also available.

The price of back copies is currently 75 cents, plus 40 cents postage and packing. Please address orders to Subscriptions Dept, Electronics Today, 15 Boundary St, Rushcutters Bay, NSW 2011.

PHOTOSTATS

Photostats of any article ever published in ETI can be obtained from our subscription dept (address above). The price is currently 45 cents per page including postage.

CONTRIBUTORS

Material is accepted from time to time from outside contributors. Payment is based on quality and is paid 30 days after the date of publication. Constructional projects will be considered for publication but the standard of design must be to fully professional level. All material must be typed using double spacing and wide margins. Drawings, circuit diagrams etc need not be to professional standards as they will be redrawn by our staff. It is advisable to contact the Editor before submitting copy.

A large stamped addressed envelope must be included if unsolicited material is required to be returned.

ADVERTISING QUERIES

Queries concerning goods advertised in ETI should be addressed directly to the advertiser — not to ourselves.

NEWS DIGEST

News Digest items are published free of charge. Manufacturers and importers should send material at least four weeks before the date of publication. Photographs should be of high contrast and preferably at least 100 by 150 mm. Press releases must be of a factual nature — these pages are not free advertising. The Editor reserves the right to accept or reject material at his discretion. Preference will be given to components and equipment of an essentially practical nature.

BINDERS

Binders to hold 12 issues of ETI are available from our subscription dept (address above). Price is \$4.50 (plus 80 cents postage NSW & ACT — or \$1.50 all other States)

COPYRIGHT

The contents of Electronics Today International and associated publications is fully protected by international copyright under the terms of the Commonwealth Copyright Act (1968).

Copyright extends to all written material, photographs, drawings, circuit diagrams and printed circuit boards reproduced in our various publications. Although any form of reproduction is technically a breach of copyright, in practice we are not concerned about private individuals constructing one or more projects for their own private use, nor by pop groups (for example) constructing one or more items for use in connection with their performances.

Commercial organisations should note however that no project or part project described in Electronics Today International or associated publications may be offered for sale, or sold, in substantially or fully assembled form, unless a licence has been specifically obtained so to do from the publishers, Modern Magazines (Holdings) Ltd or from the copyright holders.

CORVUS 500

"THE SCIENTIST/ENGINEER'S PROBLEM SOLVER"

WITH REVERSE POLISH NOTATION

... this new entry to the scientific field offers the ultimate package—the efficiency and simplicity of Reverse Polish Notation, a powerful 4-register stack with nine memory registers, a 12-digit display for exacting accuracy, (scientific format of 10-digit mantissa, 2-digit exponent), total capability in scientific functions plus additional capabilities in statistics, conversions, and business.

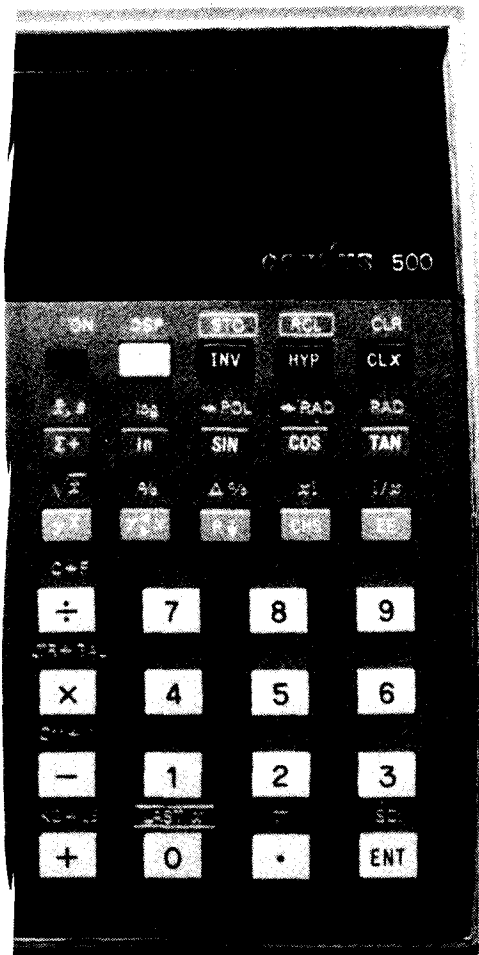

Clear	Memory recall, 9 registers	Summation plus (adds X and Y to memory for vector addition; recalls sum of X and sum of Y)
Clear display	Memory exchange, 9 registers	
Add, subtract, multiply, divide	X ↔ Y exchange	Percentage
Scientific display format: 10-digit mantissa, 2-digit exponent, floating decimal	Common log	Percentage difference (..%)
Mode set to radians	Natural log	Mean
Fix decimal point (0-9) in display	4-stack register	Standard deviation
Sine	Rotate stack	Centigrade to fahrenheit
Cosine	Recall last X	Liters to gallons
Tangent	Y to the X power	Centimeters to inches
Hyperbolic sine	Reciprocal for all values, exponent range from -199 through -200	Kilograms to pounds
Hyperbolic cosine	Pi	Degrees to radians
Hyperbolic tangent	Change sign	Set radian mode for trigonometric functions
Memory store, 9 registers	Square root	Trigonometric rectangular to polar
	Factorials	Hyperbolic rectangular to polar

THESE FUNCTIONS ARE OBTAINABLE THROUGH THE INVERSE CALCULATION SEQUENCE:

Business display format, 12-digits, floating decimal point	Gross profit margin percentage	Trigonometric polar to rectangular
Arc sine	Summation minus for vector subtraction	Hyperbolic polar to rectangular
Arc cosine		Set degree mode for trigonometric functions
Arc tangent	Anti log, natural (e ^x), for all values from -230 through -230	X ²
Arc hyperbolic sine	Anti log, common (10 ^x), for all values from -99.9 through 99.9	Fahrenheit to centigrade
Arc hyperbolic cosine		Gallons to liters
Arc hyperbolic tangent		Inches to centimeters
Xth root of Y		Pounds to kilograms

OTHER FEATURES:

Display number (X) times 10 to -100 power, as 0 X-99	Anti-logarithm and logarithm accuracy near 0 and 1 respectively
Display indicator for radian mode (decimal in right most LED)	Nickel-cadmium rechargeable batteries; AC adapter/charger carrying case included. Six hours operation on full 12-hour charge.
Trig/Hyperbolic accuracy near angle 0 (and 90 degrees)	

Corvus calculators are marketed in Australia by Unitrex Pty Ltd, 414 Collins St., Melbourne.

NOTES

The Corvus 500 is warranted for a period of 12 months from original purchase date — under normal use and service — against defective materials or workmanship. Defective parts will be repaired or replaced at Unitrex's option when the calculator is returned prepaid to Unitrex of Australia Pty Ltd., 414 Collins St, Melbourne, Vic 3000. The warranty is void if the calculator has been damaged by accident or misuse. Removal or alteration of serial number or repair by unauthorised personnel also voids warranty. The warranty contains the entire obligation of Unitrex of Australia Pty Ltd and no other warranties, expressed, implied or statutory are given — this warranty does not exclude limit restrict or modify any condition or warranty implied by the Trade Practices Act 1974, or other State laws or Acts...

We regret that we cannot arrange to supply these special-offer units against a sales-tax exemption.

The units can only be obtained as below. Electronics Today International cannot supply directly nor can undertake to demonstrate or discuss details of the units offered.

All units will be thoroughly inspected before despatch. The package should be carefully inspected before accepting delivery. Acceptance should be refused if the package is damaged.

Orders must be addressed exactly as per the coupon. Due to postal delays, readers should expect a delay of between three to four weeks between posting an order and obtaining delivery.

Finally — in the event of the unit not working — please return it directly to Unitrex, 414 Collins St, Melbourne, Vic 3000. NOT to ETI. This offer closes on March 31st 1976.

Corvus Offer

Name
Address

Please forward Corvus 500 Calculator/s. My cheque/postal note for is attached. Make cheque/postal note payable to Corvus Offer. Please forward \$102 (i.e. \$99.50 plus \$2.50 postage and packing) per unit.

Send to Corvus Calculator Offer
c/- Electronics Today International
15, Boundary St., Rushcutters Bay, NSW 2011.

Special Readers' Offer

CORVUS

Advanced Scientific Calculator

\$99.50*

THE CORVUS 500 is an advanced scientific calculator similar in many ways to Hewlett-Packard's HP-45 and Texas Instruments' SR 51. This is understandable as Corvus was the calculator division of Mostek — the people who made the microprocessor chips for the HP 45 and HP 35 calculators.

A comparison of the three calculators is contained in Table 1 below. As can be seen the Corvus has quite remarkable capabilities for its (special offer) price. In addition the Corvus 500 is one of the most attractive and well styled units we have yet seen.

The Corvus 500 uses Reverse Polish notation and a four level stack to perform its calculations in either fixed point (number of decimal places displayed is selectable) or scientific display mode (10 digits plus two digit exponent).

In addition 12 digit floating operation is possible — which automatically changes to scientific notation if 12 digits overflow. Thus $\sin 20^\circ$ is calculated as 0.342020143328!

The valid exponent range in scientific notation can extend from +199 to -200 whilst still obtaining a correct answer in the mantissa (leading figures of exponent not displayed). When exponent overflows the display flashes cyclically. The flashing warning may be deleted by pressing the clear flag once — whence calculations can be continued with the calculated number, or the x register may be completely

cleared by pressing the clear key for a second time.

The Corvus 500 has flexible statistical functions. It is possible to sum two sets of data simultaneously (x and y registers). The sum and standard deviation of the x sum are called up by keyboard command, as well the number of x entries can be found in memory 7, the sum of x^2 in memory 8 and the sum of x in memory 9.

The percentage calculations offered are very useful. The two keys % and $\Delta\%$ may be used to calculate percentage difference, percentage mark-up or discount and gross profit margin. The Reverse Polish mode of operation makes these calculations particularly straightforward.

CRITICISMS

The handbook supplied doesn't really do justice to the machine's capabilities. Like most of its kind it's almost adequate but has a few surprising omissions.

The machine's 62 functions are controlled by 30 keys. Because of this it is necessary to use the calculator fairly frequently to remember the various sequences. This criticism is of course applicable to other machines of this type.

Because the display reads out to 12 digits, transcendental and log functions take about three seconds to complete — it's a trade off between time and accuracy.

SUMMARY

The above criticisms relate to only minor drawbacks in a calculator which is flexible, extremely accurate and much less expensive than others with similar capability.

We thoroughly recommend this powerful advanced scientific calculator. It is excellent value for money.

COMPARISON OF ADVANCED SCIENTIFIC CALCULATORS

FEATURES	CORVUS 500	T.I.SR 51	HP 45	FEATURES	CORVUS 500	T.I.SR 51	HP 45
Type of Display	LED	LED	LED	Vector Addition/	Yes	No	Yes
Digits in Display	14	14	14	Subtraction	9	3	9
Fixed Decimal	to 9 places	to 8 places	to 9 places	No. Memories	Yes	Yes	No
Rechargeable	Yes	Yes	Yes	Memory Exchange	No	No	No
Type of Logic	RPN	Algebraic	RPN	Permutations	Yes	Yes	Yes
No. Keys	30	40	35	Scientific Notation	Yes	Yes	Yes
+, -, \times , \div	Yes	Yes	Yes	π	Yes	Yes	Yes
Trig	Yes	Yes	Yes	Change Sign	Yes	Yes	Yes
Inverse Trig	Yes	Yes	Yes	Stack Operation	Yes	No	Yes
Range of Trig	Full Circle	Full Circle	Full Circle	Rotate Stack	Yes	No	Yes
log x, LN x	Yes	Yes	Yes	Recall Last x	Yes	No	Yes
e^x	Yes	Yes	Yes	CONVERSIONS			
10^x	Yes	Yes	Yes	Degrees — Radians	Yes	Yes	No
Hyperbolic Functions	Yes	Yes	Yes	Degrees — Grads	No	Yes	No
Degrees/Radians	Yes	Yes	Yes	Polar — Rectangular	Yes	Yes	Yes
Grads	No	No	Yes	Deg/Min/Sec — Decimal	No	Yes	Yes
YK	Yes	Yes	Yes	Litres — Gallons	Yes	Yes	Yes
$x^n \sqrt{y}$	Yes	Yes	No	Centigrade — Fahrenheit	Yes	Yes	No
$x^2 \times \frac{1}{x}$	Yes	Yes	Yes	Centimetre — Inches	Yes	Yes	Yes
$x!$	Yes	Yes	Yes	Kilograms — Pounds	Yes	Yes	Yes
$x \text{ ex } y$	Yes	Yes	Yes	Mils — Microns	No	Yes	No
% Δ %	Yes	Yes	Yes	Feet — Metres	No	Yes	No
Gross profit margin	Yes	No	No	Yards — Metres	No	Yes	No
$\Sigma + \Sigma -$	Yes	Yes	Yes	Miles — Kilometres	No	Yes	No
Mean/standard deviations	Yes	Yes	Yes	Miles — Nautical Miles	No	Yes	No
Variance	No	Yes	No	Acres — Ft ²	No	Yes	No
Random No. Gen	No	Yes	No	Fluid Oz. — Litre	No	Yes	No
Linear Regression	No	Yes	No	Fluid Oz. — CC	No	Yes	No
Slope/Intercept	No	Yes	No	Ounces — Grams	No	Yes	No
				Short Ton — Metric Ton	No	Yes	No
				BTU — Calories	No	Yes	No
				Voltage Ratio — dB	No	Yes	No

Data supplied by manufacturers of Corvus unit.

BRIGHT STAR CRYSTALS

ESTABLISHED FOR THE PAST 35
YEARS FOR ALL YOUR
REQUIREMENTS
★ STILL ON TOP ★

CRYSTAL FILTERS

- 9 MHz side band with carrier crystals 4 & 8 pole type
- Specialised monolithic filters, 10-100 MHz
- Front end filters to 190 MHz

ELECTRONIC UNITS

- Decade Counting units to .1 Hz
- Wide band amplifier for your counter, 1 MV sensitivity, band width 1-250 MHz

DEVOTED EXCLUSIVELY TO
THE MANUFACTURE OF
PIEZO ELECTRIC
CRYSTALS

Contractors to Federal & State
Government Departments.

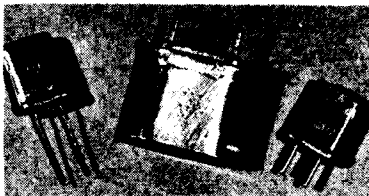

"All Types of Mountings"

REPRESENTATIVES -

- S.A.** Rogers Electronics
P.O. Box 3,
Modbury North, S.A.
Phone: 264-3296
- N.S.W.** Paris Radio Electronics,
7A Burton Street,
Darlinghurst, N.S.W.
Phone: 31-3273
- QLD** Fred Hoe & Sons Pty Ltd,
246 Evans Road,
Salisbury North, Brisbane,
Phone: 47-4311
- W.A.** W.J. Moncrieff Pty Ltd.,
176 Wittenoom Street,
East Perth, 6000
Phone: 25-5722
- TAS.** Dilmond Instruments,
P.O. Box 219,
Bellerive, Hobart, Tas.
Phone: 479-077.

Send stamped addressed
envelope for new catalogue or
quote for your requirements.

BRIGHT STAR CRYSTALS P/L.
35 EILEEN ROAD, CLAYTON,
VICTORIA, 546-5076

Japan's Leading
Manufacturer

SanKen[®]

- Hybrid Circuits
- Power Transistors
- Rectifier Diodes
- H.V. Diodes
- Fast Recovery Diodes
- G.P. Diodes

AUTOTRONICS PTY LTD

P.O. Box 71, Engadine, 2233

**PROTECT YOUR
MAGAZINES
ETI BINDERS
hold 12 copies**

**electronics
TODAY**
INTERNATIONAL

Send \$4.50 plus 80c postage
NSW & A.C.T., \$1.50 postage
elsewhere with order to

Subscription Department,
Modern Magazines (Holdings) Ltd.,
15 Boundary Street,
Rushcutters Bay. 2011.

hi-fi

REVIEW

ON SALE NOW
at all newsagents

6 DIGIT L.E.D. CLOCK KITS

12/24 HOUR

50/60 HZ.

BRIGHT
LED's



SLOW SET

FAST SET

TIME HOLD

\$13.95

Postpaid via airmail

COMPONENTS INCLUDE:

- National MM14 Clock Chip, 12/24 hour, 50/60 Hz. option.
- 6 Bright red L.E.D. readouts (0.27" digit height).
- 7 Segment driver transistors.
- 6 Cathode driver transistors.
- 4 1N4001 Rectifier diodes.
- 1 1N914 Diode.
- 9 Carbon resistors.
- 1 1000 μ F/25 V electro. capacitor.
- 2 0.01 μ F Disc capacitors.
- 2 Push button switches for slow and fast time settings.
- 1 Slide switch for time hold function.
- 2 Etched and drilled fibreglass p.c. boards.
- 1 Illustrated assembly instructions manual.

All you need add is a 9-12 Vac/200 mA transformer and a suitable case of your choice. No electronics knowledge required to construct this kit.

ORDERING INFORMATION: The price as listed is in Australian dollars. Remittance by Bank (cashiers) Cheque or International Money Order (send receipt with order).

sabtronics
INTERNATIONAL

P.O. Box 64683, Dallas, Texas 75206, U.S.A.

NEW BOOKS NEW REVISIONS

Radio, Valve and Semiconductor Data Tenth Edition 1975 A.M. Ball

Characteristics of 1,000 Valves, monochrome and colour Cathode Ray Tubes, 9,800 Transistors, Diodes, Rectifiers and Optical Semiconductors. The continuing development of semiconductor technology and rapid obsolescence of many valves have necessitated a new edition of *Radio Valve and Transistor Data*, a book which sold over 450,000 copies in its Nine Editions. The new title reflects the widening range of solid-state devices, from simple diodes and transistors through to thyristors, triacs, light emitting diodes, etc. A comprehensive list of semiconductor comparables and valve equivalents has also been included.

Foundations of Wireless and Electronics Ninth Edition 1975 M.G. Scroggie

Since *Foundations of Wireless* was first published in 1936 it has helped thousands of students and amateur enthusiasts as they encountered the principle of radio and electronics for the first time. This book covers the whole basic theory, assuming no previous knowledge and using only a minimum of mathematics. The Ninth Edition has been updated to emphasize printed and integrated circuits, ceramic filters, single-sideband radio and the increasing range of photoelectric devices.

Audio on Wheels

Vivian Capel

1975 240 pages

Although there is a tremendous and growing enthusiasm for 'in-car entertainment', surprisingly little information has been published to help in choosing and installing mobile audio equipment. The radio engineer, the motor mechanic and the amateur DIY man who needs comprehensive information on mobile audio will find this book an essential source.

Contents: Audio Amplification; Principles of Radio Reception; Sound Recordings; Power Supplies; Loudspeakers; Car Aerials; Car Radios; Stereo and Multi-speaker Systems; Cassette Players; Cartridge Players; Motor Control Circuits; Disc Systems; Installation; Interference Suppression; Mobile Public Address; Setting up a Workshop; Repairs and Maintenance; Index.

Also Available

- 110 Operational Amplifier Projects for the Home Constructor** - R.M. Marston
128 pages 1974
This book should have considerable appeal to the enthusiast who has not yet given serious attention to the operational amplifier. In fact, to anyone not yet familiar with this device, this book would seem to be a good place to start to make its acquaintance. Whether you need to solve a particular problem, or just want to learn about operational amplifiers, this book will give you a good start - and a lot of fun into the bargain!
- *Electronics Australia*
- 110 Thyristor Projects Using CSRs and TRIACS** - R.M. Marston
148 pages 1973
A chapter on basic principles and simple projects opens this useful book, with other sections on power switching, alarms, time delays, lamp heater and motor control, and miscellaneous projects. In all, a book to be recommended to anyone interested in electronic means of power control, whether on a hobby basis or as a professional.
- *Electronics Australia*
- 110 Semiconductor Projects for the Home Constructor** - R.M. Marston
136 pages 1969
The purpose behind this book is that of presenting information on established and new semiconductor devices by way of circuit design rather than by long-winded theory. The techniques to be recommended, and the considerable amount of information provided by the 110 working circuits in this book make it excellent value at its price. All circuits have full component values and are accompanied by brief but very explicit descriptions of their operation.
- *The Radio Constructor*
- 110 Integrated Circuit Projects for the Home Constructor** - R.M. Marston
136 pages 1971
- 80 Photoelectric Circuits and Systems** - P.S. Smith
92 pages 1972
Most of the circuits use cadmium sulphide cells, with a few circuits for photo-transistors and photo-diodes. Circuits for flame-detection use the 155UG a non-polarised photo-emissive cell sensitive only to ultraviolet. Summing up, I feel that the book would have wide appeal, not only to students and experimenters but to those engaged in the professional field.
- *Electronics Australia*
- 20 Solid State Projects for the Car & Garage** - R.M. Marston
124 pages 1970
- 20 Solid State Projects for the Home** - R.M. Marston
114 pages 1969
- Transistor Pocket Book** - Hibbard
312 pages 1965
The Transistor Pocket Book is a comprehensive guide to the characteristics and uses of the various types of transistor that have been developed in recent years. It is based on the junction type but deals with planar transistors, FETs, MOSTs, and thin film types.

- Radio and Electronic Laboratory Handbook 8th Edition** - Scroggie
628 pages 1971
This practical handbook has been completely revised, and covers techniques used in both radio and electronics. The opportunity has been taken in this edition to cover the ever growing use of transistors in instrumentation, and there is a useful chapter on the choice and care of equipment.
- Principles of Transistor Circuits 5th Edition** - Amos
92 pages 1975
Provides a clear and comprehensive account of the circuit applications of transistor devices and has been revised to include important trends in the use of FETs and ICs in sound, television and digital equipment.
- Guide to Broadcasting Stations - 17th Edition** - B.B.C.
206 pages 1973
This edition contains useful fundamental information on radio receivers, aerials and earths, propagation, signal identification and reception reports in addition to listings of stations broadcast in the long, medium, and u.h.f. bands, by both frequency and geographical location.
- Newnes Radio Engineer's Pocket Book - 14th Edition** - H.W. Moorehead
188 pages 1972
An invaluable compendium of radio facts, figures and formulas. This edition contains new tables on radio and television frequencies and channels, and information on metric wire sizes.
- Radio Servicing Pocket Book - 3rd Edition** - Vivian Capel
206 pages 1976
This is essentially a practical book for the radio servicemen, so most space has been devoted to workshop planning and practice, test equipment, repair techniques and hints, as well as fault finding and quick, economical repair and alignment practices.
- Rapid Servicing of Transistor Equipment - 2nd Edition** - Gordon King
184 pages 1973
Though biased towards fault finding this book provides a simple introduction to electronics and some useful practical advice.
- *S.R.L. Practical Electronics*
- Wideband Voltage Amplifiers** - C.W. Davidson
112 pages 1974
Published by International Textbook Co.
The emphasis of this concise text is on practical circuits, which illustrate typical circuit characteristics, and which can form the basis for more complex design.
- Beginner's Guide to Colour Television 2nd Edition** - King
180 pages 1973
- Beginner's Guide to Electronics - Squires & Deason**
248 pages 1972
- Beginner's Guide to Radio 7th Edition** - King
204 pages 1970
- Beginner's Guide to Television 5th Edition** - King
212 pages 1972

- Beginner's Guide to Transistors** - Sinclair
162 pages 1975
- Questions and Answers on Colour Television 2nd Edition** - Radcliff & Knight
128 pages 1975
- Questions and Answers on Computers** - Brown
86 pages 1969
- Questions and Answers on Electronics** - Brown
92 pages 1967
- Questions and Answers on Integrated Circuits** - Hibbard
98 pages 1973
- Questions and Answers on Radio and Television 3rd Edition** - Hellyer
128 pages 1971
- Questions and Answers on Transistors 3rd Edition** - Brown
96 pages 1969
- Audio Handbook** - King
304 pages 1975
- Colour Television Servicing - 2nd Edition** - King
352 pages 1976
- Electronics Pocket Book - 2nd Edition** - Hawker & Radcliff
314 pages 1967
- Elements of Linear Microcircuits - Towers**
116 pages 1973
- Elements of Transistor Pulse Circuits 2nd Edition** - Towers
182 pages 1974
- F.M. Radio Servicing Handbook - 2nd Edition** - King
1970
- Integrated Circuit Pocket Book** - Hibbard
262 pages 1972
- Newnes Colour Television Servicing Manual Vol 1** - King
238 pages 1973
- Newnes Colour Television Servicing Manual Vol 2** - King
224 pages 1974
- Operational Amplifiers** - Clayton
244 pages 1971
- Principles of PAL Colour Television** - Sims
162 pages 1969
- Radio, Television and Audio Test Instruments 2nd Edition** - King
208 pages 1972
- Solid-State Devices and Applications** - Lewis
268 pages 1971
- Telecommunications Pocket Book** - Squires
152 pages 1970
- Television Engineer's Pocket Book 5th Edition** - McCulloch
380 pages 1973
- Television Servicing Handbook 3rd Edition** - King
268 pages 1970

Newnes Technical Books

At these fine shops:

N.S.W.
Dick Smith (Wholesale) Pty Ltd
162 Pacific Highway
ST. LEONARDS 2065
Phone: 439 5311

Dick Smith (Wholesale) Pty Ltd
361 Hume Highway
BANKSTOWN 2099
Phone: 709 6600

Dick Smith (Wholesale) Pty Ltd
125 York Street
SYDNEY 2000
Phone: 29 1126

M S Components (Electronics) Pty Ltd
95-97 Regent Street
REDFERN 2016
Phone: 69-5922

Digitronics
185 Parry Street
NEWCASTLE WEST 2302
Phone: 69-2040

Victoria
McGill's Newsagency
183 Elizabeth Street
MELBOURNE 3000
Phone: 60 1475

Technical Book &
Magazine Co Pty Ltd
289-299 Swanston Street
MELBOURNE 3000
Phone: 663 3951

W.A.
Relim Booksellers
834 Hay Street
PERTH 6000
Phone: 21 5684

Tasmania
Ellison Hawker Pty Ltd
90-92 Liverpool Street
HOBART 7000
Phone: 34 2322

New Zealand
Technical Book Company Ltd
Auckland - Wellington
Whitcoulls
Auckland - Wellington -
Christchurch
Maurice Kennedy
Christchurch
and
Butterworths of New Zealand
Wellington

BUY
NOW

ETI
by **jaycar**
PTY. LTD.

**PROFESSIONAL SOUND
EQUIPMENT FOR THEATRE
AND ROCK BANDS**

- 427-R Two channel graphic equaliser. Features Cannon inputs and outputs and standard 19" rack mounting. R.R.P. \$195.00. Standard kit still available at \$110.00.
- 433-R ETI's new 3 way electronic crossover. Features selectable crossover points, buffered outputs, Cannon in and out and 19" rack mounting. R.R.P. \$155.00.
- 414 8 Channel master mixer; Now features Cannon inputs and outputs, robust vinyl cabinet facilities for use with stage mixer, new look front panel. R.R.P. \$547. Standard kit still available for \$254.00.
- 413 100W Power Slave. 1/2 rack mounting. Cannon inputs and outputs. R.R.P. \$135.00. Standard kit still available for \$75.00.
- 413-2R 2 x 413 mounted on rack panel. R.R.P. \$281.00.
- 413-BR 2 x 413 bridged to give 200W RMS into 8Ω. R.R.P. \$281.00.
- 414-16 16 channel sub mixer. Designed for use with 414 mixer. R.R.P. \$487.00. Standard kit still available at \$206.00.

Please send stamped self-addressed envelope for specification sheets and ordering information.

jaycar
PTY. LTD.

Telephone 211-5077
P.O. BOX K39, HAYMARKET
N.S.W. AUSTRALIA 2000
405 Sussex St. Sydney
ENTRANCE OFF LITTLE HAY ST.

VHF CONVERTER KITS

High performance, crystal locked converters as described in the February issue. Kits feature FET RF stages and solder-plated p.c. boards. All instructions included, crystal not supplied.

28/52 MHz kit \$11, 144 MHz kit \$14. Add 60c post and packing. Send SAE for free flyer on these and other kits.

**AMATEUR COMMUNICATIONS
ADVANCEMENTS**
14 Rosebery St, Balmain 2041.

Logan Brae Audio Sales

BLANK TAPES BY MAIL ORDER New lower prices

HITACHI	less than 12	12 off	36 off
C90	\$1.80 ea.	\$1.70 ea.	\$1.60 ea.
C120	\$2.35	\$2.20	\$2.10
UDC90	\$2.30	\$2.20	\$2.10
UDC120	\$3.10	\$2.90	\$2.70
UDR C60	\$2.30	\$2.20	\$2.10
UDR90	\$2.99	\$2.75	\$2.60

• Features of the UDR Cassette Low Distortion, High M.O.L., Low Noise

New New "Epitaxial" magnetic material, Gamma-hematite possesses characteristics that display high sensitivity and reliable output in the low- and medium- frequency bands, while cobalt-ferrite displays excellent performance in the high-frequency band. By combining both materials into a crystal, Hitachi has created an EPITAXIAL substance.

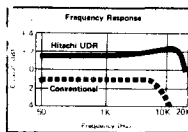

BASF Cr02

C90SM	\$2.90	\$2.80	\$2.65
-------	--------	--------	--------

Genac Ultra High Fidelity

UHF 60	\$1.70 ea.	\$1.60 ea.	\$1.50 ea.
--------	------------	------------	------------

POSTAGE: Up to 6, 60c or \$1.20 airmail or N.S.W. \$1.20 plus 10c per doz. Vic., S.A., Qld., \$1.75 plus 25c per doz. W.A., Tas., N.T., \$1.90 plus 40c per doz.

P.O. Box 24, Carlton, NSW 2218
Please send SAE with enquiries
Telephone (02) 587-3475

LAFAYETTE

27MHz TWO-WAY RADIO
FOR INDUSTRY, FARM,
BOATS, SPORTS, ETC.

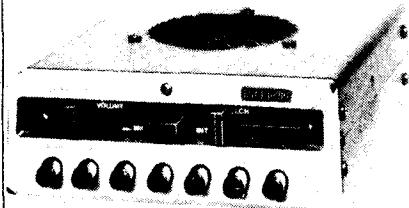

MICRO 66 Only 1-15/16H x 5-3/16W x 6-13/16"D.
5 WATTS
6 CHANNELS **\$139.50** Crystals Extra)

The latest in the famous LAFAYETTE Micro series the MICRO 66 embodies the versatility, reliability and performance which have made LAFAYETTE famous throughout the world in 27MHz communications. With an extra sensitive receiver of better than 1uV for 10dB S-to-N ratio, "Range Boost" modulation circuitry, a built-in speaker plus push-button selected external speaker-microphone (supplied), the MICRO 66 is ideal for Boats or Base Station operation. Operates from 12V DC or 240V AC with optional Base Station Power Supply.

5 WATTS 12 CHANNELS
DYNA-COM 12A
\$139.50 (Crystals Extra)

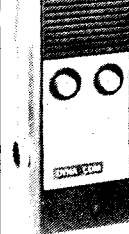

A powerful 5-Watts input power in a hand-held transceiver! Excellent sensitivity and selectivity. Ruggedly designed for extra reliable performance. This high-power walkie-talkie operates from internal batteries (rechargeable Ni-cad batteries available) or an external 12V source.

1 WATT 3 CHANNELS
Model HA-310
\$73.50 (Incl. 27.240MHz)

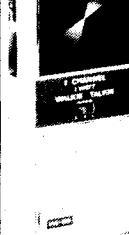

1,000's of LAFAYETTE HA-310 walkie-talkies in use in Australia, 100,000's throughout the world attest to their superior qualities. A professionally designed, sturdily constructed, commercial quality unit for top performance and long term reliability. Rechargeable Ni-cad batteries are available to suit.

All above transceivers are P.M.G. Type Approved (Licence Required).

A LARGE RANGE OF ACCESSORIES IS AVAILABLE, ANTENNAS, CRYSTALS, CONNECTORS, ETC. PLEASE ENQUIRE FOR DETAILS.

LAFAYETTE
ELECTRONICS

div. of Electron Tube Distributors P/L
94 ST. KILDA RD., ST. KILDA,
VIC. 3182. Phone 94-6036.

CHAN MERCHANDISING CO. PTY. LTD.

Advanced Scientific Calculator

Hornet SR-40



*Rugged LED red display.

*Power: 3 AA-sized dry or rechargeable batteries.
\$10.00 for Adaptor & rechargeable batteries
Add sales tax if applicable
\$4.80 for Calculator
\$1.20 for Battery, Adaptor

12 months guarantee

\$39.00

TAX EXEMPTED

Features:

- *12 digit display, 10 for mantissa, 2 for exponent.
- *Wide data range, 10^{-99} to 10^{+99}
- *One key per function. *One memory.
- *Automatic selection of correct notation for result display (scientific or floating point).
- *Algebraic mode operation.
- *Display and Y-register exchange.
- *Trig function: \sin , \cos , \tan , \sin^{-1} , \cos^{-1} , \tan^{-1} .
- *Radian, degree or grads selection. *Hyperbolic function: \sinh , \cosh , \tanh , \sinh^{-1} , \cosh^{-1} , \tanh^{-1} .
- *Log function: \log \ln , anti, \log , anti \ln .
- *Square root, & reciprocal *x to y power.
- *automatic constant.
- *Auto clear when power on.
- *Adaptor available.
- *12 months guarantee.

Logitech LC-100

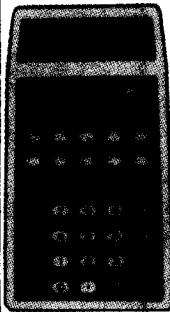

* Bright Green display.

*Power: Build-in rechargeable batteries.

(Including adaptor & rechargeable batteries)
Add sales tax \$6.00 if applicable
12 months guarantee

\$49.00

TAX EXEMPTED

Logitech LC-1233s

Features:

- *Large green 10 digit display
8 for mantissa, 2 for exponent.
- *Two levels of parentheses. [()].
- *Floating decimal point or scientific notation.
- *Wide data range, 1×10^{-99} to $1 \times 10^{+99}$
- *Auto clear when power on.
- *full Trig function:
 \sin , \cos , \tan , \sin^{-1} , \cos^{-1} , \tan^{-1} .
- *Degree or radian mode.
- *Degree to radian or radian to degree exchange.
- *Full logarithmic function:
 \log , \ln , anti \log , anti \ln .
- *Power function: e^x , 10^x , a^x .
- *Factorial function: $X!$, $x < 70$.
- *Square root & reciprocal.
- *Algebraic mode operation.
- *Chain & repeat operation.
- *Full capability of memory calculation
 $M+$, $M-$, Mx , $M\div$.
- *Power: 4 AA-sized dry batteries or rechargeable batteries.
- *AC adaptor available.
- *Full 12 months guarantee.

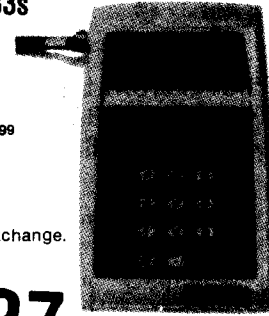

\$37.00

TAX EXEMPTED

\$12.00 for Adaptor & rechargeable batteries
Add sales tax if applicable
\$4.50 for Calculator
\$1.50 for Battery & Adaptor
12 months guarantee

Logitech LC-831s



- *8 digits green display
- *Common arithmetic calculation
 \sin , \cos , \tan , \sin^{-1} , \cos^{-1} , \tan^{-1} , \log , \ln , e^x , x^y
- *Accumulating memory
- *Constant calculation
- *Full floating decimal point
- *Power: dry or rechargeable batteries
- *AC adaptor available
- *12 months guarantee

\$25.00

TAX EXEMPTED

\$12.00 for adaptor & rechargeable batteries
Add 15% sales tax if applicable
\$3.75 for calculator
\$1.80 for battery of adaptor
12 months guarantee

ZENY 812



Features:

- *Large 8 digits green display
- *Memory
- *Full floating decimal point
- *Chain operation
- *Constant operation
- *Percentage calculation
- *Power: 4 AA-sized batteries or by Adaptor
- *Adaptor available
- *Size: 207(L) x 120(W) x 78(H) mm
- *Weight: GW 350gm NW 160gm
- *3 months guarantee

\$14.00

TAX EXEMPTED

\$6.00 for Adaptor
Add Sales Tax if applicable
\$1.65 for Calculator
\$0.75 for Adaptor
3 months guarantee

Fill in tear off and return to

CHAN MERCHANDISING CO. PTY. LTD.
906 CASSON AVENUE, MOUNT HUTTON, N.S.W., 2290
Phone (049) 48-9676

Please send by return (quantity)

..... Model Electronic Calculators

I have enclosed cheque/money order for \$.....

including \$2.00 for packaging and delivery.

Name
(Block Letters)

Address

(Postcode)

SALES TAX (EXEMPTIONS AND CLASSIFICATIONS) ACT

TO: — THE COMMISSIONER OF TAXATION AND
THE COMMONWEALTH OF AUSTRALIA

I hereby certify that the
purchased by me from
on (date) is for use in

(Goods Description)

(Supplier)

(Name of University or School) in or directly and essentially in connection with, the production of facts, by means of observing, measuring, testing or otherwise experimenting with material phenomena, for the purpose of proving or illustrating natural principles or laws or in the study of pure or mixed mathematics. Exemption is accordingly claimed under item 63 (1) in the First Schedule to the Sales Tax (Exemptions and Classifications) Act.

Signature of official of University or School

Designation

Name of University or School

Date..... Signature of Student

Address of Student

the AM/FM tuner that was designed-up to a guaranteed level of excellence

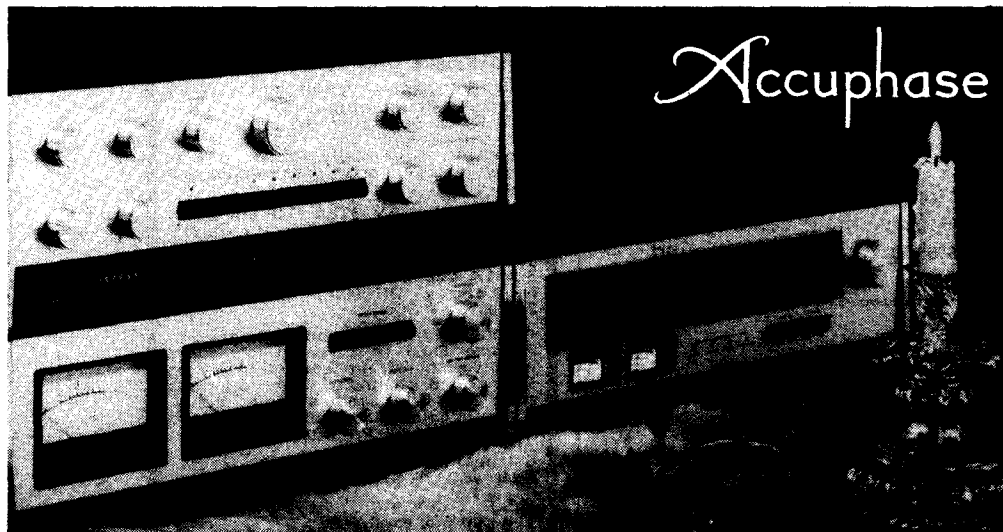

Illustrated the Accuphase Power amplifier, control amplifier and tuner

ACCUPHASE

T-100 AM/FM TUNER

The T-100 uses a 15-stage linear phase filter integrated circuit. This provides distortion of less than 0.1% and selectivity of 70 dB which surpasses transformer or mechanical filter tuners. The Stereo demodulator uses a Phase Locked Loop, giving separation of better than 45 dB (1 kHz) and distortion of less than 0.2%. Multipath Meter for FM. Two-stage FM muting and multiflex filter.

Accuphase offers a selection of very high quality power amplifiers, control amplifiers, an integrated stereo amplifier, and tuner. Accuphase lists eight factors on which they base their claim to top quality: originality, guaranteed performance statistics, mechanism, design, long life dependability, safety, service, and complete user satisfaction.

ACCUPHASE T-100 TUNER PERFORMANCE

FM Section (tests at 95 MHz and signals PD 75 ohms)

IHF: least usable sensitivity	1.4 μ V
30 dB quieting	0.8 μ V
50 dB quieting	2.2 μ V mono; 20 μ V stereo
Full limiting	1.5 μ V
Ultimate S/N ratio	78 dB mono; 75 dB stereo
Ultimate hum and noise	-62 dB
Output 30% modulation	540 mV fixed; 0-540 mV var.
Muting threshold	(1) 5 μ V; (2) 20 μ V
Tuning accuracy	within 1%
Rated IHF capture ratio	less than 1.5 dB
Rated IHF alternate ch. selectivity	80/100 dB
Front-end selectivity (figure of merit)	> 100 dB
Image rejection ratio	100 dB
Repeat spot suppression	100 dB
AM rejection ratio	60 dB
Distortion factor	0.05% mono; 0.2% stereo
Stereo separation	46 dB approx.

COMMENT

Towards the ultimate attainable.
Towards the ultimate attainable.
Excellent.
Excellent.
Excellent.
Mostly ripple content (See S/N ratio).
Two pairs of outputs.
Two positions and off.
Excellent.
Excellent.
Outside range of test equip.
Test equipment limits.
Outside range of test equip.
Test equipment limits.
At 1 mV input. Excellent.
30% modulation and 1 kHz.
At 1 kHz and 1 mV input.

You can hear Accuphase at the following dealers:

Audio Labs 12 Douglas Street Milton
Brisbane. Tel: 36.0080 • Encel
Electronics 431 Bridge Road, Rich-
mond Melbourne Tel: 42.3761 •
Southern Sound 337 La Trobe Street,
Melbourne. Tel: 67.7869 • Convoy
Technocentre 1 Maclean Street
Woolloomooloo Sydney Tel: 357. 2444

Australian Distributors (excluding W.A.)

Convoy Pty Ltd

SIMPLE EFFECTIVE SHORT-WAVE LISTENING ANTENNA

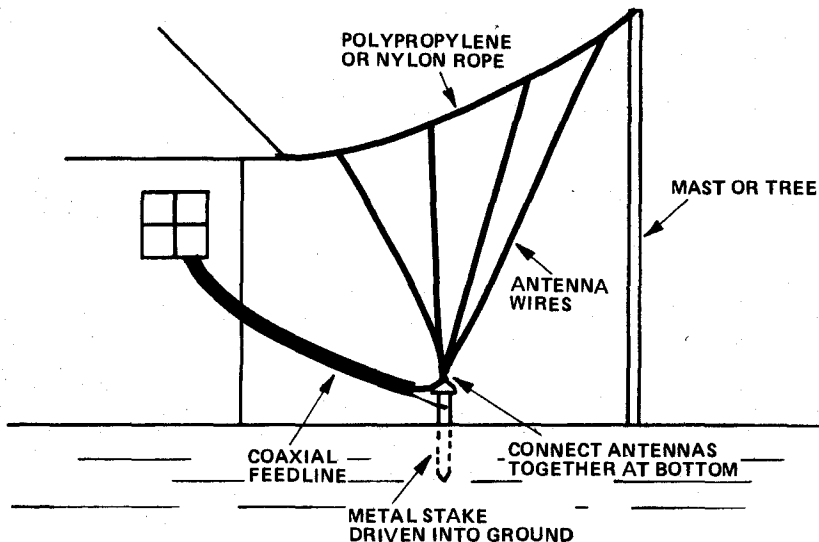

The simple shortwave listening antenna illustrated here is inexpensive and very effective. A poly-propylene or nylon rope is strung between a high support such as a suitable erected mast or perhaps a tree, and a low point such as the edge of a house roof or a fence. Keep the low end above head height or away from where people can walk. Four odd lengths of hookup wire are attached to the rope at different points prior to putting the rope up. Lengths are not too important. At a

convenient point below the rope a metal stake is driven into the ground for several feet. On the above-ground end is mounted an insulator to which are tied the ends of the antenna wires, the ends being connected together. A ceramic cone insulator or something similar is good. A piece of bakelite or fiberglass is also suitable. A coaxial feedline is connected with the centre conductor to the ends of the antennas and the outer braid connected to the metal stake which acts as a ground.

ADDING PULSES TO A COUNT

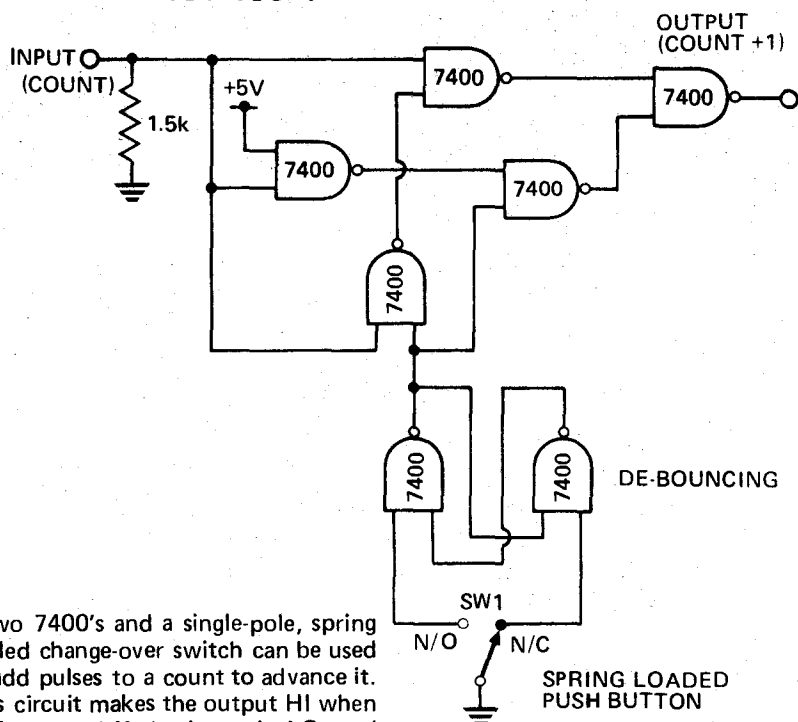

Two 7400's and a single-pole, spring loaded change-over switch can be used to add pulses to a count to advance it. This circuit makes the output HI when S1 is pressed if the input is LO, and the output LO if the input is HI when S1 is pressed momentarily. It is only useful for slow speeds of about 2 pps or less.

ELECTRONIC DISPOSALS

297 Lt. Lonsdale St.,
Melbourne. 3000
Phone: 663-1785

PHILLIPS G.C.065.S Automatic Stereo Turntable complete with cartridge and stylus. Push button operation, lift and 10" platter. Brand new. **ONLY \$29.50 each.** P/P \$4.

S.C.R. BT100A - 300R. 300V. 4.5 amp. R.M.S. 2 amp average. **60c each.** P/P 25c.

PHILIPS Tuning Capacitors for AM. SW and FM. **\$2. each.** P/P 60c.

PHILIPS Beehive Trimmers. 4 to 25PF. 10 for **\$2.** P/P 50c.

6.5mm Chassis Mount Switched Stereo Sockets. **40c each.** P/P 25c.

Stereo Amplifier and R.F. Board 4 watts RMS per channel including circuit diagram. Boards are complete with all transistors, capacitors - resistors, etc. and are brand new - famous make. **Only \$6 set P/P 60c.**

Healing 1280 - 1290 T.V. circuit assembly. Sound output I.F. AFC video amp Sync. Separator. Brand new with all components inc. I.C. and 17 transistors - normally approx. **\$30 as Spare Part.** Our price only **\$4 each P/P 60c.**

Transistors - AY 9150 PNP 60v 150w - AY 8110 NPN 60v 115 80c ea. AY 8139 NPN - AY 9139 PNP 40v 10w 45c ea. AY 6120 NPN - AY 6121 PNP 50v 1A 40c ea. 2N5088 NPN PN 3694 NPN 10c ea. BF 198 - BF 199 NPN 20c ea. P&P 30c.

A.3065 TV/FM Sound System. I.C. Silicone Dual In Line suitable for a wide variety of applications including T.V. sound channels - line operated and car F.M. radios and mobile communication equipment - brand new. **Only \$1 ea. P/P 40c.**

Balance Meters 1 1/2" x 7/8" x 1/4" Deep 200 UA **\$2.25 ea. P/P 40c.**

M.S.P. 250V A.C. 3 AMP D.P. Toggle switches **50c ea. P/P 25c.**

100/3 Watt. Wire wound pots **75c ea. P/P 25c.**

7" Dia. Alum. Fans 240V A.C. **\$6 ea. P/P \$1.**

Multiple Electrolytics. 200 μ F - 50 μ F - 25 μ F at 300V Plus 100 μ F at 325V. V/W/I. **\$1 ea. P/P 30c.**

LEVEL METERS 200 micro amp sensitivity size 1" x 1" x 3/4" **\$1.50 P/P 40c.**

SOLENOIDS - tape recorder type. 12V D.C. 5.5z coils. 1 1/2" x 1 1/2" x 3/4" **\$2 ea. P/P 30c.**

TRANSISTOR RADIO. 5k miniature switched pots. **30c ea. P/P 15c.** Miniature 2 gang variable capacitors **30c ea. P/P 15c.**

Slide Pots. Single gang. 500 Ω A, 20KA, 25KA, 100KC, 200KA, 200KB, 500KA, 500KB, 1 meg.D, **35c ea. P&P 35c.** Dual gang - 50KA, 250KB 1 meg.C, 2 meg.C, **60c ea. P&P 35c.**

Skeleton Preset Pots. 100 Ω - 220 Ω 470 Ω 2.2K, 10K, 22K, 47K **10c ea. P&P 20c.**

Philips 8 Ω dual cone 6" x 4" speakers **\$2 ea. P&P 60c.**

LARGE RANGE OF COMPONENTS - GOVERNMENT AND MANUFACTURERS DISPOSAL EQUIPMENT, ALSO STEREO AND HAM GEAR ALWAYS IN STOCK.

IDEAS FOR EXPERIMENTERS

UNTUNED HF CRYSTAL OSCILLATOR WITH LOW HARMONIC OUTPUT

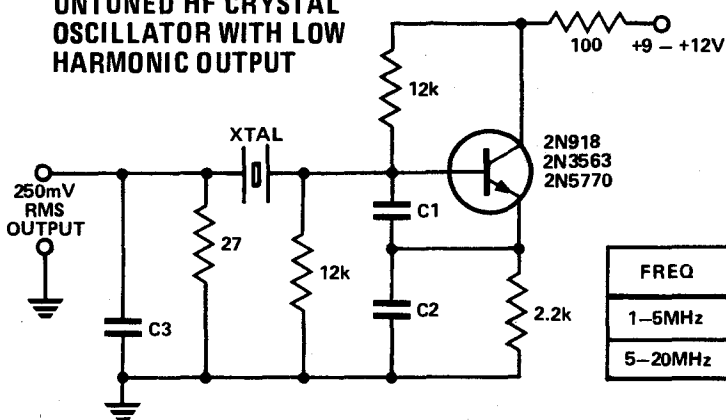

FREQ	C1, C3	C2
1-5MHz	0.0022 μ F	560pF
5-20MHz	390pF	10pF

This untuned version of the familiar Colpitts crystal oscillator will accept crystals in the range 1 to 20 MHz and provide an output with the second harmonic content (usually the highest amplitude) attenuated by 60 dB, or sometimes more. The crystal oscillates in the series resonant mode on the fundamental frequency. (Note that this frequency will differ from its parallel mode frequency). Parallel mode operation is achieved by placing a 5-6 pF trimmer in series with the crystal and trimming to frequency.

WIDEBAND AMPLIFIER

The wideband amplifier illustrated above provides a gain of 20 dB from below 10 kHz to above 100 MHz, flat within 1 dB. Gain at 200 MHz is about 3 dB. Several amplifiers can be cascaded but remove the 51 ohm input resistor on following stages if this is done. Shielding may be necessary to prevent instability. Maximum output level is about 1 V peak-to-peak before overload, greater gain can be realised by increasing R. Maximum gain is about 40 dB, however, bandwidth is reduced and the top cutoff frequency drops to about 30 MHz. The output load impedance should not be less than 1 k. A source follower using a MOSFET can be used to transform to lower impedances without significantly affecting the frequency response.

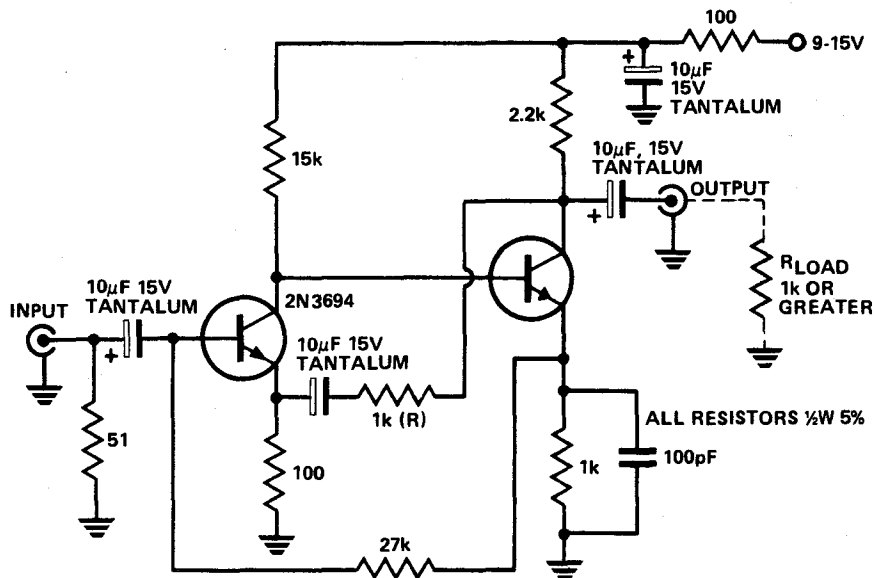

GATED TTL CRYSTAL OSCILLATOR

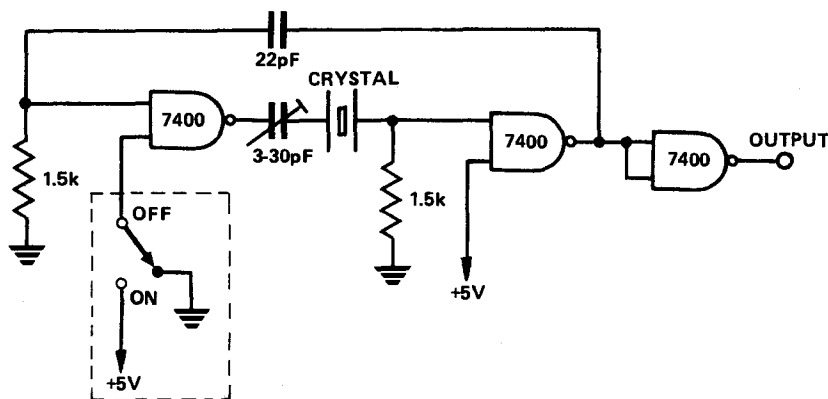

Gating a TTL crystal oscillator on and off with a digital signal is easily accomplished with the above circuit. The bracketed portion shows a switch that connects the spare input of one gate to LO to turn the oscillator off and H1 to turn it ON.



Manufacturers of: Electrical/
electronic equipment, wound
components and lighting
control equipment.

BRANCHES IN ALL STATES

FERGUSON TRANSFORMERS
PTY. LTD.
HEAD OFFICE
331 High St., Chatswood, 2067
P.O. Box 301,
Chatswood, NSW, Australia 2067
Phone: 02 407 0261



EMONA enterprises

Distributors of ELCON Calculators

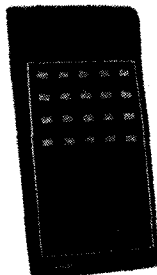

SCIENTIFIC
STATISTIC SC-6010
\$116.00 (Incl. rech.
battery & charger)

SCIENTIFIC
STATISTIC SC-60
\$95.00 (Incl. rech.
battery & charger)

SCIENTIFIC SC-44
\$64.50 (Incl. rech.
battery & charger)

SCIENTIFIC SC-33
\$42.00 (Incl. rech.
battery & charger)

FINANCIAL

COMPUTER FN-85 \$56.00 (Incl. rech.
battery & charger)

MINI DESK M-80HX \$33.00 (AC
adaptor optional)

SLIDE RULE KP-460 \$26.00 (AC
adaptor optional)

SUPER MEMORY KP-450 \$25.00 (AC
adaptor optional)

ALGEBRAIC 8413M \$15.00 (AC
adaptor optional)

AC ADAPTOR \$7.00

To above prices add 15% sales tax if
applicable

All models are guaranteed for a period of
one year. Serviced locally.

MAIL ORDERS: P&P by reg. air mail to
all states - \$4.50 except NSW - \$3.50

EMONA E-2, ALL ELECTRONIC
AM/FM DIGITAL CLOCK RADIO

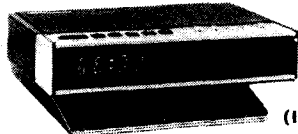

\$52.60
(Incl. S.T.)

This 24-hour Digital Clock Radio is
completely electronic - no moving parts
- 100% solid state. You can listen to FM
or AM, wake up to music or alarm, or
preset the radio program. It can be used
as an accurate stopwatch. And there is
even an indicator that blinks whenever
there has been an AC power
interruption.

MAIL ORDERS: P&P to all states by reg
air mail \$6.00 except NSW - \$3.50

For further information: Write, phone or
call at

EMONA ENTERPRISES,

21 Judge St., Randwick,
NSW 2031. Phone: 399-9061

PROJECTS FOR YOU

IN EVERY ISSUE OF



PLACE YOUR ORDER TODAY

USE THIS
COUPON

GIVE THIS
COUPON AND \$9,
TO YOUR LOCAL
NEWSAGENT

(If he already delivers your papers - as he probably does - there will be nothing
more to pay; if not, he may make a small charge for the service).

NEWSAGENT

Please deliver ELECTRONICS TODAY INTERNATIONAL for the next 12
months, starting with the issue to:

NAME

ADDRESS

..... POST CODE

EDGE ELECTRIX

31 BURWOOD ROAD, BURWOOD, TEL: 747 2931

MAIL ORDER SPECIALS

SEMI CONDUCTORS

	\$	c
AF126	.98	each
BA219	.39	each
BA102	.60	each
BB105G	.45	each
BC107	.40	each
BC108	.40	each
BC109	.40	each
BC177	.50	each
BC178	.50	each
BC179	.50	each
BC548	.40	each
BC549	.40	each
BC558	.40	each
BC559	.40	each
BC639	.60	each
BC640	.60	each
BD139	1.00	each
BD266A	2.73	each
BD266B	3.26	each
BD267A	2.73	each
BD267B	3.26	each
BF115	.64	each
BF180	.90	each
BF199	.50	each
BFR84	1.44	each
C103YY	2.20	each
C106B1	2.16	each
C106D1	1.64	each
C106Y1	1.20	each
C122D	2.30	each
EM404	.30	each
MJE2955	3.50	each
MJE3055	3.20	each
MPF102	1.25	each
MPF105	.98	each
MPF106	.98	each
SC141D	2.00	each
SC146D	3.00	each
TT800	1.00	each
TT801	1.00	each
BD140	1.00	each

Prices subject to change without notice.

MAGNAVOX 8-30

Speaker Special \$13.95

2N3055 TRANSISTOR

1 to 9	1.10	each
10 to 99	.95	each
100 plus	.80	each
NE555	.70	each
FUL 741 DIL	.72	each
LM3909	1.20	each

3 WATT WIRE WOUND POTS

1 to 9	\$1.96	ea
10 plus	\$1.50	ea
In values	100Ω, 1k, 2k, 3k, 10k	

HITACHI CASSETTES

PRICED LOWER THAN EVER

Qty.	1 to 11	12 to 23	24 plus
C60 Low Noise	1.50	1.35	1.25
C90 Low Noise	1.85	1.75	1.65
C120 Low Noise	2.45	2.30	2.20
C46 Ultra Dynamic	1.85	1.75	1.65
C60 Ultra Dynamic	2.05	1.95	1.85
C90 Ultra Dynamic	2.40	2.30	2.20
C120 Ultra Dynamic	3.20	3.10	2.90
C60 Ultra Dynamic Royal	2.40	2.30	2.20
C90 Ultra Dynamic Royal	3.00	2.85	2.70

PLESSEY SPEAKERS

	\$	c
C6M	7.40	each
C60	12.20	each
C6MR	8.80	each
C8M	8.38	each
C80	13.67	each
C100	14.86	each
C12P	21.75	each
12U50	39.00	each
C60X	13.77	each
C80X	14.95	each
C100X	16.15	each
C12PX	23.30	each
12UX50	43.00	each

VALVES

	1 to 9 EACH	MIXED 10 EA.
1B3	1.63	1.48
1S2	1.03	.93
6AL3	1.04	.94
6AN7	2.27	2.06
6AQ5	1.25	1.13
6AU4	1.53	1.39
6AU6	1.08	.98
6AX4	1.53	1.39
6BA6	1.43	1.30
6BE6	1.67	1.52
6BL8	.94	.85
6BM8	1.11	1.01
6BQ5	1.45	1.32
6BQ7	1.94	1.77
6BX6	1.35	1.23
6CA7	3.32	3.02
6CM5	1.59	1.45
6DQ6A	2.56	2.33
6DX8	1.45	1.32
6EA8	1.46	1.33
6EB8	1.79	1.63
6EJ7	1.24	1.13
6EH7	1.24	1.13
6ES8	1.68	1.53
6GV8	1.58	1.44
6GW8	1.56	1.42
6M5	1.91	1.74
6N3	2.45	2.33
6N8	2.10	1.91
6U8	1.45	1.32
6U9	1.94	1.77
6V4	1.17	1.07
6V9	3.13	2.85
6X4	1.12	.93
6X9	1.94	1.77
6Y9	2.14	1.95
12AU7	.81	.74
12AX7	1.81	1.65

HURST /AIRHEAT ELECTRONIC IGNITION

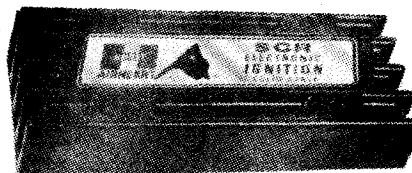

PROVIDES:

- Simple fitting to the coil/distributor
- Easier and quicker starts
- Increased point and plug life
- Increased time between tune-ups
- Improved ignition efficiency
- Better gas mileage (due to maintaining "tuned" condition longer and increasing point and plug life)
- Increased power to plugs
- Waterproof design (completely sealed unit)
- Failsafe design

SPECIAL OFFER ONLY \$29.95

PHILIPS SPEAKER KITS

WITH LATEST 2" SQUAWKER SPEAKER KITS

2 x AD 12.100 W8
2 x AD020 SQ8
2 x AD 160 T8
2 x 3 WAY CROSS OVER
ADF 500/4500/8

\$210

PHILIPS 7A

2 x AD 12-100W8
2 x AD 5060SQ8
2 x AD 160 T8
2 x ADF 500/4500/8

\$165

PHILIPS 4A

2 x AD 8066W8
2 x AD 5060 SQ8
2 x AD 160 T8
2 x ADF 500/4500/8

\$120

PHILIPS AD 8 K40

2 x AD 8066 W8
2 x AD 160 T8
2 x CROSS OVER

\$129

NETWORKS
TIMBER CABINETS
WORK INCLUDED

CORAL I2SAI \$77

2 x 12" DRIVERS
2 x 5" MIDRANGE
4 x 2 1/2" TWEETERS
2 x CROSS OVER NETWORKS

CORAL 10SA1 \$55.00

CORAL 8SA1 \$33.00

E.A. AND ETI KITS

F/M 146 FM AND AM TUNER WITH FRONT PANEL LESS CABINET **\$135**

ETI 440 INCLUDING METAL WORK **\$ 99**

PLEASE RUSH ME

ENCLOSED IS MY CHEQUE FOR \$..... (+P&P \$3.00) SPEAKER KITS ONLY OTHERS PREPAID

NAME

ADDRESS

..... P/Code

WE TOOK THE TROUBLE TO FIND OUT WHAT YOU REALLY WANTED THEN WE BUILT IT FROM THE GROUND UP.

We built a simpler machine to eliminate noise, vibration, and service problems.

In a multiple play turntable, every gear, cam, lever, pivot, spring and moving part that can be eliminated, eliminates a point of stress, wear, and possible malfunction.

Every part that isn't there, eliminates a source of noise, vibration, resonance, and service problems. Take a look underneath a B.I.C., and when you do, remember it's fair to say... "the simpler the better".

We combined belt-drive with multiple play.

Traditionally, automatics and changers have used the 'idlers' system, and the distortion which results is simply not acceptable with today's sophisticated records and playback systems.

We offer the benefits of multiple play, with a belt drive, and with a unique 300 r.p.m. 24 pole motor which is inherently freer from noise and vibration than those in even the best of conventional automatics.

We built in a control panel to do what no turntable has ever done before.

The exclusive B.I.C. programme panel give you 22 possible ways to play your records in automatic or manual modes; a single side up to 6 times in a row, or up to 6 records in a series. If you want the second record twice, fine. Three times, still fine. And so it goes on.

Available from:

- N.S.W.: M & G Hoskins Pty. Ltd., 37 Castle St, Blakehurst 2221. Telephone: 546-1464.
- QLD.: Stereo Supplies, 95 Turbot St, Brisbane 4000, Telephone: 21-3623.
- S.A.: Challenge Hi Fi Stereo, 96 Pirie St, Adelaide 5000, Telephone: 223-3599.
- TAS.: Audio Services, 44 Wilson St, Burnie 7320, Telephone: 31-2390.
- VIC.: Encel Electronics Pty. Ltd., 431 Bridge Rd, Richmond 3121, Telephone: 42-3762.
- W.A.: Albert TV & Hi Fi, 282 Hay St, Perth 6000, Telephone: 25-2699.
- A.C.T.: Duratone Hi Fi, Cnr. Botany St. & Altree Crt, Phillip 2606. Telephone: 82-1388.

Sole Australian Distributors

**INTERNATIONAL DYNAMICS (AGENCIES PTY. LTD.,
23 Elma Rd., North Cheltenham, 3192, Melbourne 95-1280.**



HAM RADIO SUPPLIES

MAIL ORDER SPECIALISTS

323 Elizabeth Street, Melbourne (2 doors from Little Lonsdale Street) 03/4281 67/7329
 new Richmond branch now at 390 Bridge Rd., Richmond Phone 42 5174

MODEL NC-310 DE LUXE 1 WATT 3 CHANNEL C.B. TRANSCEIVER

- WITH CALL SYSTEM
- EXTERNAL AERIAL CONNECTION

SPECIFICATIONS, NC-310

Transistors: 13
 Channel Number: 3, 27.24 OMHZ
 Citiz. Band
 Transmitter Frequency Tolerance: $\pm 0.005\%$
 RF Input Power: 1 Watt
 Tone Call Frequency: 2000 Hz
 Receiver type: Superheterodyne
 Receiver Sensitivity: $0.7\mu V$ at 10 dB S/N
 Selectivity: 45 dB at ± 10 kHz
 IF Frequency: 455 kHz
 Audio Output: 500 mW to External Speaker Jack
 Power Supply: 8 UM-3 (penlite battery)
 Current Drain: Transmitter: 120-220mA
 Receiver: 20-130mA.

\$49.00 each or \$95 a pair.
 Post & pack \$1.50 per unit.

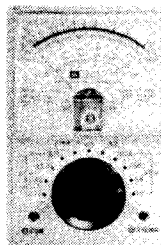

MODEL C1000M MULTIMETER

Compact, handy and versatile, the C1000M is the ideal low cost pocket meter. Mirror Scale. Specifications: 1,000 Ohm/Volt DC; 1,000 Ohm/Volt AC; DC volts — 10; 50; 250; 1,000; AC volts — 10; 50; 250; 1,000; DC amps — 1 mA; 100 mA; Ohms — 150 K Ω ; Centre scale — 3 K Ω ; Decibel — 10 dB to 22 dB; Dimensions — 3-1/2" x 2-3/8" x 1-1/8" 90 x 60 x 30 mm.

\$6.95
 Post Free.

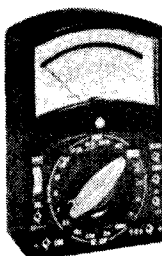

MODEL C-7077/P MULTIMETER.

Specifications: 100,000 ohms/volt DC; 10,000 ohms/volt AC; DC volts — 5.5; 25; 50; 250; 500; 1,000. AC volts — 10; 50; 250; 500; 1,000. DC amps — 10 μA ; 2.5 mA; 25 mA; 500 mA. Ohms — 10 K Ω ; 1 M Ω ; 10 M Ω ; 100 M Ω . Centre scale — 150 Ω ; 15 K Ω ; 150 K Ω ; 1.5 M Ω . Decibel — -20 to +22 dB. Dimensions — 151 x 102 x 48 mm. Diode protected movement. Carrying case available Model C.

\$27.95
 P&P \$1.50.

MODEL OL64 D/P MULTIMETER.

Very ruggedly constructed this model is particularly suitable for workshops. It features special scales for measurement of capacitance and inductance. Diode protected movement. Specifications: 20,000 Ohm/Volt DC. 8,000 Ohm/Volt AC. DC volts — 0.25; 1; 2.5V; 10; 50; 250; 1,000; 5,000. AC volts — 10; 50; 250; 1,000. DC amps: 50 μA ; 1 mA; 50 mA; 500 mA; 10 A. Ohms — 4 K Ω ; 400 K Ω ; 4 M Ω ; 40 M Ω . Centre scale — 40 Ω ; 4,000 Ω ; 40,000 Ω ; 400,000 Ω . Decibel: -20 to +62 dB. Dimensions: 6" x 4-1/5" x 2"; 152 x 107 x 51 mm. Capacitance: 250 pF to 0.02 μF . Inductance — 0/5000H Carrying case available Model C.

\$22.50 P&P \$1.50.

MODEL AS100 D/P MULTIMETER.

This meter features double zener diode meter protection and 3-1/2" full view easy to read 2 colour scale. It is fitted with polarity reversing switch and housed in a strong moulded case with carrying handle. Specifications: 100,000 ohm/volt DC. 10,000 ohm/volt AC. DC volts — 0.3; 12; 60; 120; 300; 600; 1,200. AC volts — 6; 30; 120; 300; 600; 1,200V. DC amps — 2 K μA ; 200 K μA ; 20 M μA ; 200 M μA . Centre scale — 20 Ω ; 2,000 Ω ; 20,000 Ω ; 200,000 Ω ; 20 M Ω . Decibel — -20 to +57 dB. Dimensions — 7-3/5" x 5-2/5" x 2-3/5" 193 x 137 x 66 mm. Carrying case available model I.

\$37.50
 P&P \$1.50.

200-H. p.p. 75c. 90 quadrant meter. Pocket size. AC V: 10V, 50V, 100V, 500V, 1000V (10,000 ohm/V). DC/V: 5V, 25V, 50V, 250V, 500V, 2500V (20,000 ohms/V). DCA/A: 50 μA , 2.5 mA, 250 mA. OHM: 60k ohm, 6M ohm. Capacitance: 100pF to 0.1 μF , .001 μF to .1 μF . dB: -20 dB to +22 dB. Audio Output: 10V, 50V, 120V, 1000V AC. Approx. size: 4-1/2" x 3-3/4" x 1-1/8"

\$15.90 \$1.50 Postage.

THIS MONTHS SPECIAL SOLID STATE 19 TRANSISTOR MULTI- BAND RADIO — 9 RANGES



AM, SW, FM, VHF, AIR, PB
 BATTERY/OPERATED
 COLOUR CODED 9 BAND DIAL
 1. AM 535 to 1600 kHz, 2. Marine 1-5 to 4 MHz, 3 & 4. combined SW 4 to 12 MHz, 5. 30 to 50 MHz, 6. 88 to 108 MHz, 7, 8 & 9 combined VHF Aircraft 145 MHz-174 MHz incorporating weather band. Slider controls, Dial light, Fine tuning control, Flip-up Time Zone map, Telescope antennas complete with batteries

SPECIAL PRICE \$59 Post Pack \$3.00

8 transistor, push-button car radio, 12 volt neg or pos earth switching. With large 7 x 5 inch speaker and lock down aerial.



\$35.00 P&P \$2.00

A M / F M / V H F / T V. MULTIBAND RADIO. NEW MODEL AC/DC.

Latest military design multi-band radio, 30 transistors and diodes. With exclusive (LED) light emitting diode tuning indicator for positive station selection. Battery and electric covers all popular AM and FM bands.



NEW PRICE \$41.90
 P&P \$2.50

APPROVED BY ELECTRIC SUPPLY DEPT. BEWARE OF MORE EXPENSIVE IMITATIONS.

1 watt 2 channel transceiver with call system. 27.240 MHz. 12 transistor. PMG approved type.

SPECIFICATIONS:

Transmitter — Crystal Controlled: 1 Watt input power to RF stage. Operating frequency — Any 2 channels in the 11-meter Citizens Band. Receiver — Crystal-controlled superheterodyne circuit with 455 Kc IF. Antenna — Built-in 60" telescopic whip antenna. Audio Output — 0.8 Watt maximum. Power supply required — 12 volts DC (Eight 1.5 volt DC battery cells). Loudspeaker — 2-1/2" PM type (built-in) function as microphone on transmit.

\$45.50 each or \$89 a pair.
 Post & pack \$1.50 each unit.

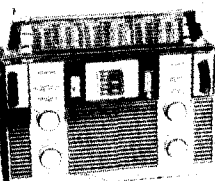
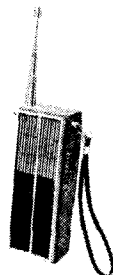

BARLOW-WADLEY XCR-30

a truly portable communications receiver, based on the WADLEY LOOP principle, the same principle as applied in the DELTAHET and RACAL receivers. A truly crystal-controlled highly sensitive multiple-heterodyne portable receiver of exceptional stability with continuous, uninterrupted coverage from 500 kHz to 31MHz.

BARLOW-WADLEY XCR-30 features include: Selectable USB/LSB, CW & AM reception, frequency read-out 10kHz throughout the entire range, calibration accuracy within 5kHz, antenna resonator, tuning signal-strength meter, zero-set control, clarifier-vernier tuning, MHz & kHz tuning controls, telescopic antenna. Power source: 6 type D dry cells; provision for external DC power supply. Weight 9 lbs; size 11-1/2 x 7-1/2 x 4in.

PRICE ON APPLICATION

When not in use or for carrying, the top meter/megahertz scale flips down flush with the case and clear of the handle.

AMATEUR RADIO

Roger Harrison VK2ZTB



THE STATE OF THE ART

New moon-bounce record.

A TEAM of nine radio amateurs has succeeded in breaking their old record of contacts via the moon. A 45 metre dish antenna located in Northern California, U.S.A., was used to beam 432 MHz signals to the moon, where they were reflected back to earth with a time delay of 2½ seconds. On November 23, 1975, during an 11 hour operating period, the team made 84 two-way contacts with radio amateurs in 20 states, 11 countries, and five continents. Fifteen of these contacts were on voice (ssb).

The communications test was made by a group of SRI amateur radio society (WA6LET) and UHF radio society (W6GD) members to encourage world-wide interest in moonbounce communications.

Use of the dish and various transmitting and receiving equipment was furnished by SRI (Stanford Research Institute), an independent non-profit research institute based in Menlo Park, California. Participants furnished UHF receiving converters, a backup transmitter, and "put it all together". The event was recorded by them on audio tape (four receivers), video tape, and 16 mm film, with the intention of producing a record of the test that may be shown at radio amateur conventions.

In addition to the two-way contacts, the group conducted two one-way variable-power tests to determine the lowest power level that each station could receive. Some stations with antennas having only 7 dB gain could detect the full power transmissions; while stations having better antennas could copy code groups sent at power levels as low as 25 watts.

The operators for this test were (in alphabetical order) Bruce Clark, K6JYO; Victor Frank, WB6KAP; Arne Gjerner, K7CAD/6; Bob Sutherland, W6PO; Bob Sutherland, Jr., WA6QCD; Edward Teyssier, WA6LCZ; Brian Westfal, K6OJm; Douglas Westover, K6TZX; and dish operator Bob Foss, WN6DIA. Assisting with photography and video camera were Jim Taylor (unlicensed) and Loren Hodapp, WA6BMR.

The 45 metre parabolic dish is a San Francisco mid-peninsula landmark. It is owned by the United States

Government, and was built by and is operated by SRI. The dish rides on top of a circular railroad truck. The 432 MHz feed was a built-in horn with left-hand circular polarization for transmit.

The most successful receiver polarization was right-hand circular. The preamplifier mounted at the feedhorn showed a noticeable improvement over one connected to the other polarization at the transmitting end of a run of 75 metres of 150 mm rigid coax and nine metres of 22 mm coax. Together, the transmit cable loss was about 1 dB. Although the transmitted polarization was nominally circular, a number of observers noted that the moon-reflected signals had a large linear polarization component.

Transmitting equipment belonging to SRI was used for most of the test. It consisted of a Collins KWM2, Carmichael transmitting converter, 4X150A driver amplifier, and 7213

final amplifier. A backup transmitter was used briefly, consisting of an Eldico SSB100F and transistorized converter/driver furnished by WA6QCD and a K2RIW-type 4X250B amplifier lent by W2GN of ARCOS. Receiving preamplifiers and converters were provided by K6OJM and K6JYO.

A shakedown test on October 31 netted seven contacts with six stations in just over one hour of operating time. During the November 23 test most of the amateurs contacted were in Europe and North America. One each was contacted in Asia (Japan), Australia, and Africa (Rhodesia).

The team is gratified by the response of the VHF amateur fraternity to these tests. A number of stations, having heard or contacted them, have found that it does not take an impossible improvement beyond what it takes to hear the group, to that necessary to hear and work others. The team would like to continue this stimulation of amateur EME activity. The SRI 45 metre dish is useable for moonbounce communication from 50 MHz to 1296 MHz. It has been used for amateur EME communications only on 144 and 432 MHz.

The team would like to use it on 222 and 1296 MHz, and are presently looking at the possibilities of getting suitable equipment going for 1296 MHz, possibly by late spring 1976. ●

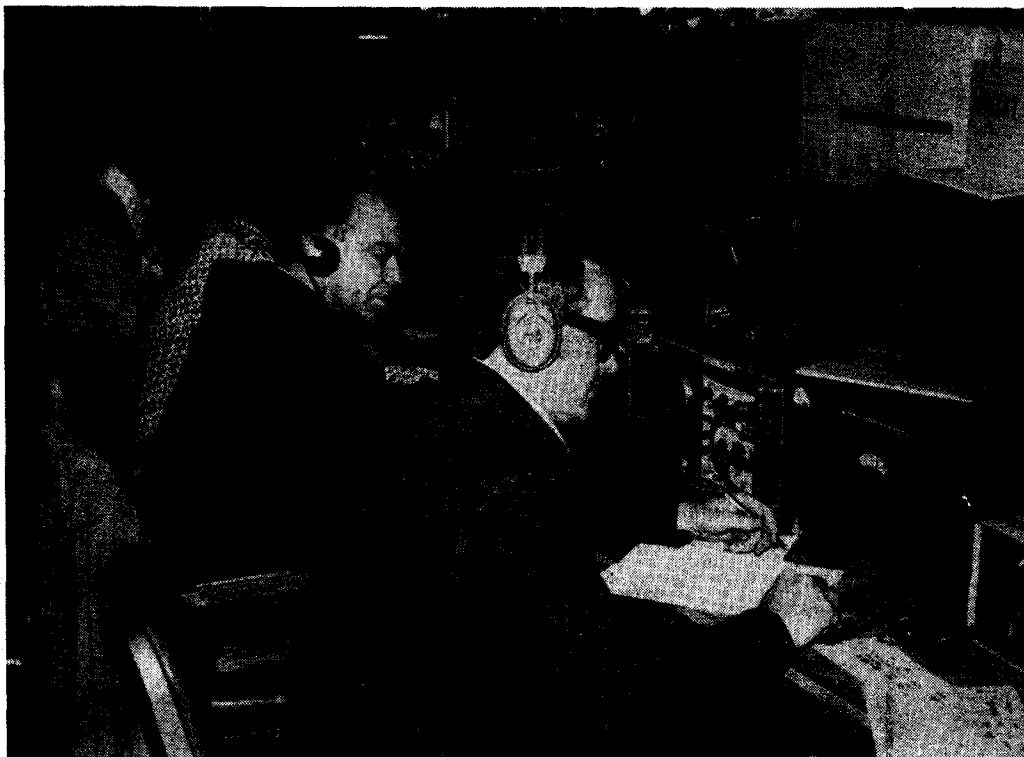

Station WA6LET

THE CELESTIONS ARE COMING

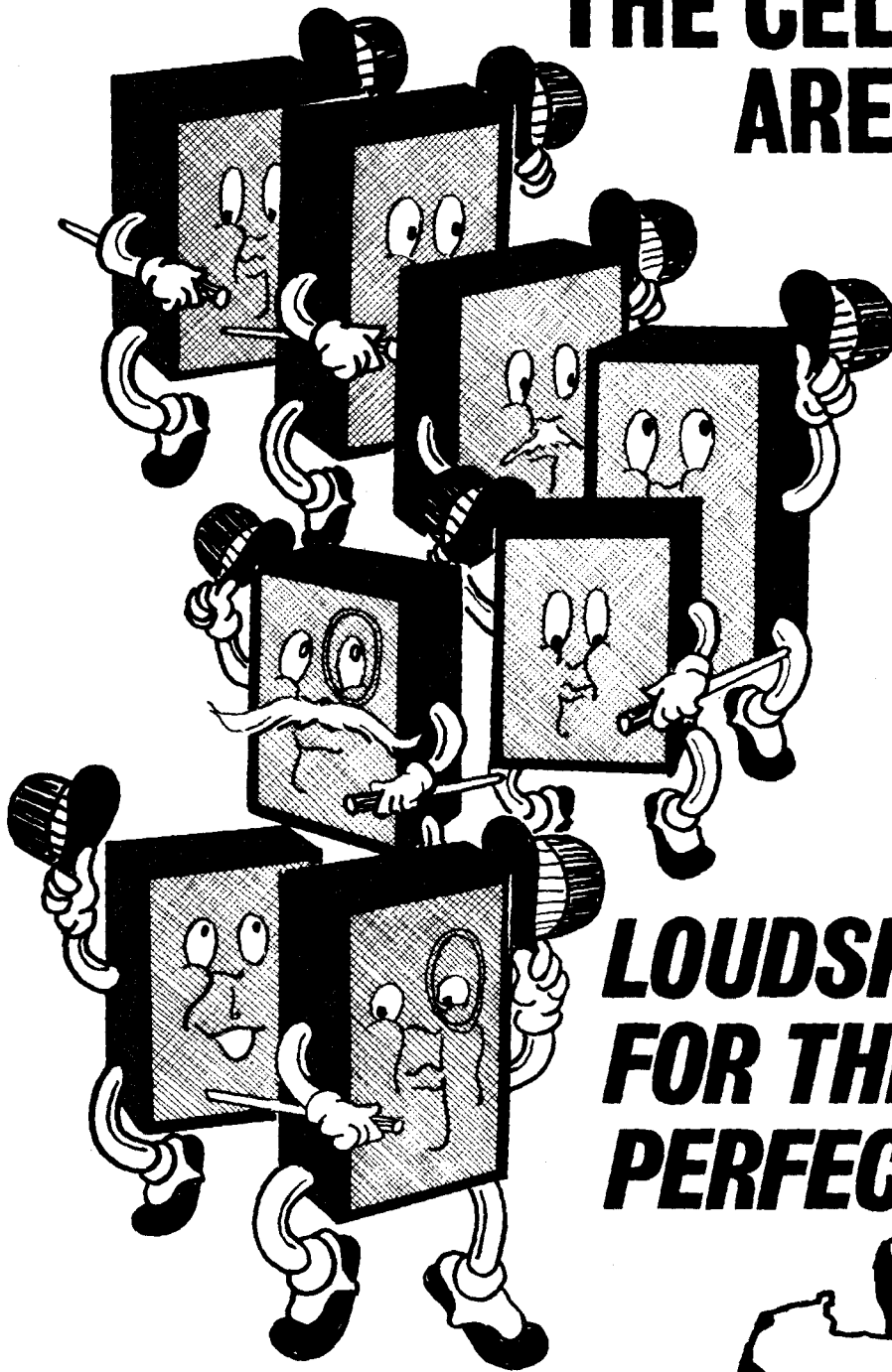

LOUDSPEAKERS FOR THE PERFECTIONIST



Celestion



FM. How to find a needle in an electronic haystack.

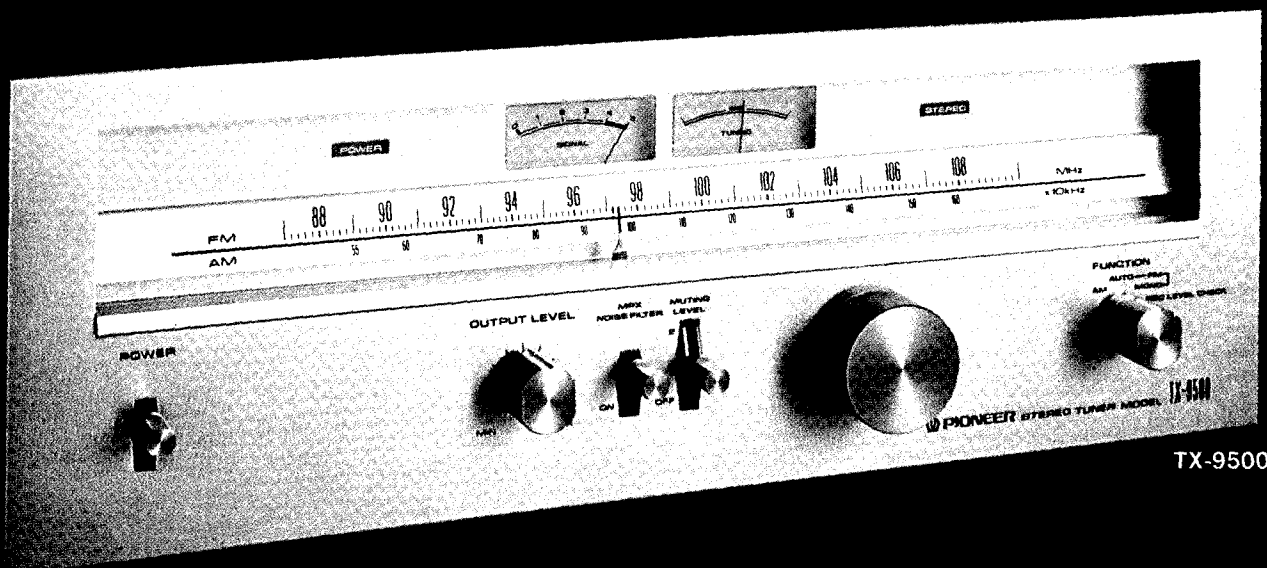

TX-9500

The recent advent of FM stereo broadcasting opens up an entire world of musical opportunity. FM is the only broadcasting method capable of meeting the standards of high fidelity. Frequency range, quietness of background and dynamic range. At the same time, FM presents certain problems for clear, accurate reception. FM is subject to the same physical laws as TV. Distance from the station, steel buildings, mountains or other terrain features may reduce or partially block signals. In low-lying valleys, reception is usually difficult. Sometimes, tuning in your desired FM station can be best described by comparing it to the metaphoric "needle in the haystack". You have the approximate location all right, but just being close isn't enough. The atmosphere is clogged with a jumble of transmissions and finding the right one requires an outstanding tuner. Which brings us to the Pioneer TX-9500.

Generally, *sensitivity* is of foremost importance because it describes a

tuner's ability to pull in weak or distant stations. The TX-9500 offers a usable *sensitivity* of $1.5\mu\text{V}$ (IHF). More than enough for even those in hard to reach fringe areas.

For those who may be in the center of congested signal areas, *selectivity* is a vital consideration because this determines the ability of the tuner to choose between two stations directly adjacent to each other on the dial. Here again, the TX-9500 excels. A rating of 85dB guarantees you receive the station you want without a lot of annoying noise and interference.

Making matters even more complicated is the occurrence of being in the middle of two FM stations in different cities broadcasting on exactly the same frequency. In this case, the *capture ratio* of a tuner comes into play. Good *capture ratio* enables a tuner to concentrate on the stronger of the two signals and reject the weaker one. The TX-9500 provides a highly discriminating 1.0dB.

Certainly another very important

characteristic of a tuner is the *signal to noise* (S/N) *ratio*. This indicates the strength of the signal compared to the amount of noise accompanying it. The TX-9500 delivers a hushed 75dB (stereo) with total harmonic distortion of no more than 0.2% (stereo) at 1KHz.

But, numbers only tell part of the story. The TX-9500 is from Pioneer and Pioneer is people. People who create some of the world's finest audio components—like the TX-9500—for people like you. All these talents combined—just to make your FM reception easier than finding a needle in a haystack.

Pioneer Electronics Australia Pty. Ltd.,
178-184 Boundary Road, Braeside,
Victoria 3195. Phone: 90-9011,
Sydney 93-0246. Brisbane 52-8213.
Adelaide 433379, Perth 76-7776

 **PIONEER**
leads the world in sound.