

JULY 1975
75c*

electronics

HI-FI

TODAY
INTERNATIONAL

Registered for posting as a periodical — Category C.

**ELECTRONICS
IN MEDICINE**

TAPE BIAS

**SIMPLE
25 WATT
AMP TO BUILD**

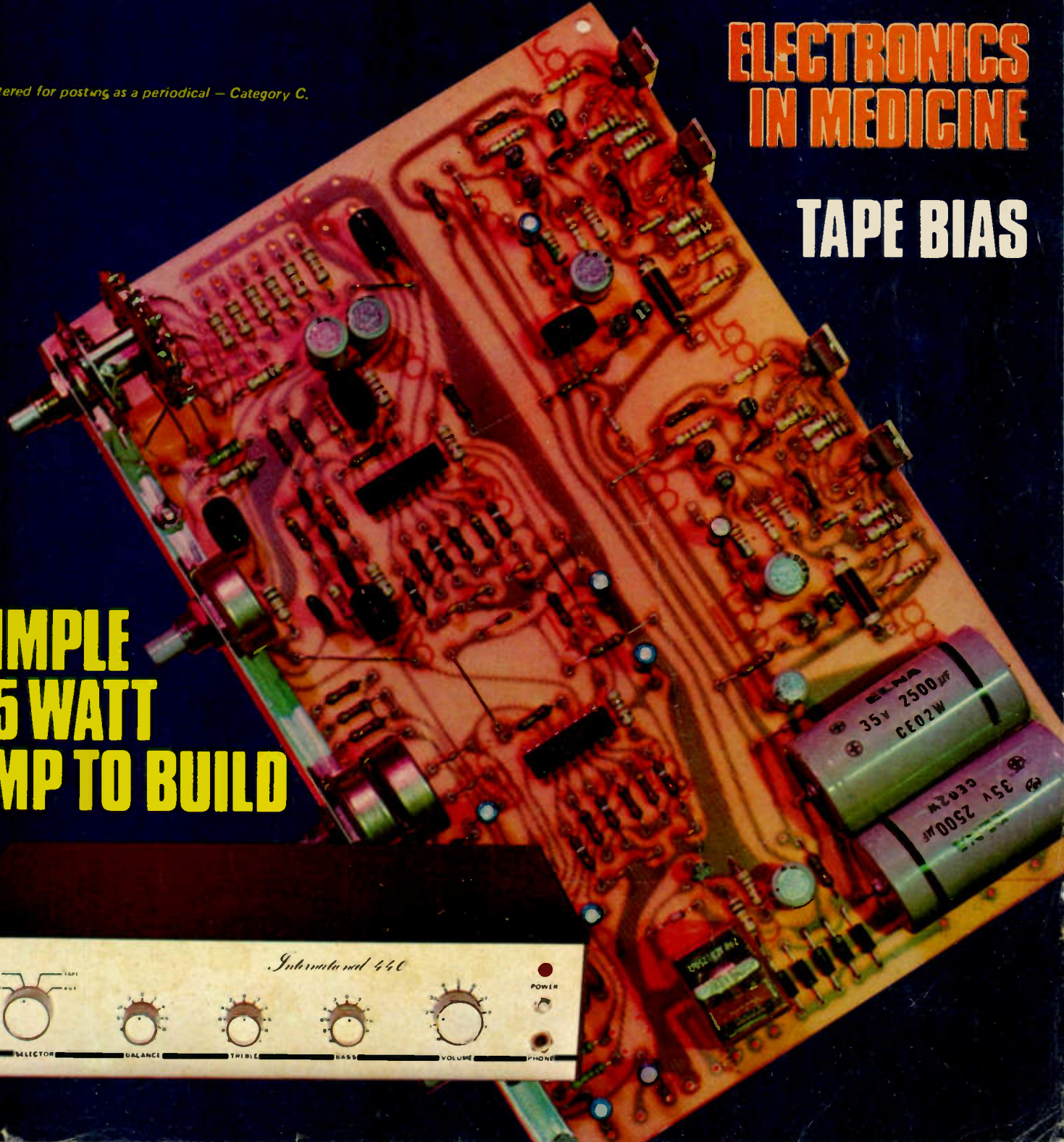
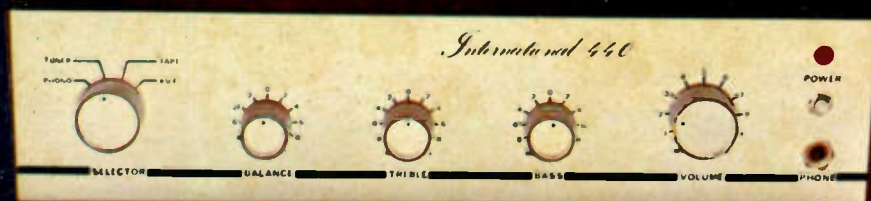

4VR 5446

4VR 5426



4VR 5436

4VR 5456

THE BEST BRED TUNERS & RECEIVERS

WT. 0064J

Designed and constructed with the latest design techniques and circuit components, these tuners and receivers offer exceptional value in terms of quality FM/AM reception.

Highly sensitive FM tuner allows exceptional station pulling power and clarity. Filters guarantee increased sensitivity, allowing the tuner to pin point stations with accuracy.

Long dial with a frequency-linear FM scale, tuning meters and FM multiplex demodulator for greater stability and stereo separation are just some of the advanced features.

Here is the line up of JVC best bred tuners and receivers, give them the ultimate test, your ears.

FM/AM Tuners

JT.V.310 JT.V.6

Stereo FM/AM Tuner Amplifiers

VR 5505 VR 5515
VR 5525 VR 5535

2/4 CH. FM/AM Tuner Amplifiers with CD4

4VR 5426 4VR 5436
4VR 5446 4VR 5456

JVC

Guaranteed and serviced throughout Australia and Pacific Islands by Hagemeyer (Australasia) B.V. Branches in all states.

electronics TODAY INTERNATIONAL

JULY 1975

Vol. 5, No. 7

main features

- ELECTRONICS IN MEDICINE** 16,
Instrumentation used in pathology
- EARLY RADIO PATENTS**26
Early ideas and patents in wireless and communications
- TAPE BIAS**34
What does it mean?
- MULTIMETER SURVEY**42
How to choose a meter to suit your needs
- CONTROLLED TEMPERATURE SOLDERING**76
What does it have to offer?
- UNDERSTANDING COLOUR TV**82
More about electronic filters
- ELECTRONICS ITS EASY – PART 20** 87
More about electronic filters
- IDEAS FOR EXPERIMENTERS**115
Circuits, ideas, hints and tips

product tests

- PIONEER SA9900 AMPLIFIER**38
120 watts per channel and many new features

projects

- DIGITAL DISPLAY – ETI 533**54
Three-digit module for experimenters
- SIMPLE 25 WATT AMPLIFIER –ETI 440**66
Big performance at low cost

news & information

NEWS DIGEST 5; EQUIPMENT NEWS 98; COMPONENT NEWS 107;
ADVERTISERS INDEX 118.

NEXT MONTH

CHEAP DIGITAL VOLTMETER

This simple voltmeter is based upon the digital display described in this issue.

SIMPLE CROSS HATCH AND DOT GENERATOR FOR COLOUR TV

Adjust convergence and linearity of your colour set.

CODE PRACTICE SET FOR NOVICE LICENCE

Get ready for the Novice Licence examination with this simple set-up.

PLUS LOTS MORE!

The feature articles listed above are included amongst those currently scheduled for our August issue. However, unforeseeable circumstances, such as highly topical news or developments may affect the final issue content.

Published by Modern Magazines (Holdings) Ltd., 15 Boundary St., Rushcutters Bay, 2011. Telephone 33-4282. Cables Modmags Sydney. Managing Director: Arnold Quick; General Manager: Max Press; Editorial Director: Collyn Rivers; Technical Editor: Brian Chapman; Engineering Manager: Barry Wilkinson; Advertising Manager: Terry Marsden; Advertising Rep (Sydney): Grant Evans; Advertising Manager (Melbourne): Clarrie Levy.

INTERSTATE advertising — Melbourne: Clarrie Levy, Suite 23, 553 St. Kilda Rd., (51-9936). Adelaide: Ad Media Group of South Australia, 12-20 O'Connell Street, North Adelaide, S.A., 5006. (67-1129). Brisbane: David Wood, Anday Agency, 11-14 Buchanan St., West End (44-3485). OVERSEAS — United Kingdom: Modern Magazines (Holdings) Ltd., Ludgate House, 107 Fleet Street, London EC4, U.S.A.: A.C.P. Room 2102, 444 Madison Avenue, New York 10022. Printed in 1975 by Compress Printing Ltd., 65 O'Riordan St., Alexandria N.S.W. Distributors: Australian Consolidated Press. (*Recommended and maximum price only). COPYRIGHT.



THE AR 3a / IMPROVED an evolutionary new SPEAKER SYSTEM

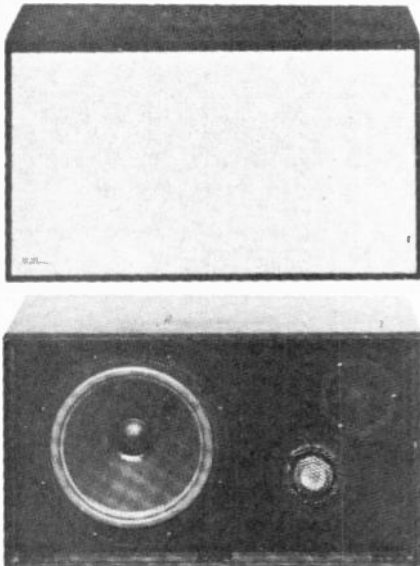

The AR-3a/Improved is the best home speaker system we know how to make. It has been designed to reproduce music as accurately as present-day knowledge of acoustics and electronics permits.

In addition to incorporating the 305mm (12in) bass driver with which AR introduced acoustic suspension to home listeners, the AR-3a/Improved also uses the two miniature hemispherical dome speakers developed for the AR-3a to offer an unprecedented degree of accuracy at middle and high frequencies.

Concepts and techniques developed for the AR-LST and other AR speaker systems have now enabled AR engineers to improve the spectral energy characteristics of the AR-3a and further reduce its already small degree of coloration, while retaining all the virtues of the original design. These improvements have been accomplished by means of significant changes in the design of the crossover: all other components, including driver units and cabinet, are exactly the same as those of the AR-3a.

The AR-3a/Improved is capable of a more linear spectral energy output than was the AR-3a. A two-position switch makes it possible to tailor this characteristic for maximum realism under either reverberant or relatively damped listening conditions.

On-axis response

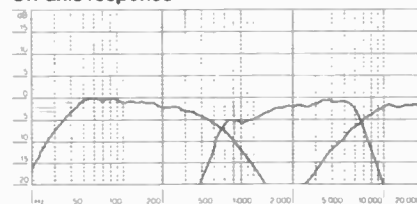

Acoustic power output

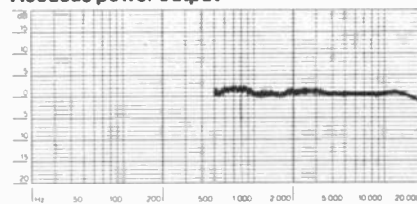

Woofer harmonic distortion

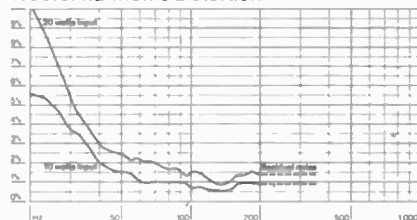

Drive units: 305 mm (12 in) acoustic suspension woofer, 38 mm (1½ in) midrange hemispherical dome, 19 mm (¾ in) high-frequency hemispherical dome

Crossover: 575 Hz, 5000 Hz
Impedance: 4 ohms nominal

Controls: Midrange and high-frequency driver level controls

Amplifier: Up to 100 watts per channel
Size: 356 x 636 x 289 mm deep (14 x 25 x 11½ in)
Weight: 24 kg (53 lb)
Woofer resonance: Free air 18 Hz, in enclosure 42 Hz
Volume of enclosure: 48.2 litres (1.7 cu ft)

'... the best speaker frequency response curve we have ever measured using our present test set-up ... virtually perfect dispersion at all frequencies ... AR speakers set new standards for low-distortion, low-frequency reproduction, and in our view have never been surpassed in this respect'. *Stereo Review*

'On any material we fed to them, our pair of AR-3a's responded neutrally, lending no coloration of their own to the sound ... the speakers sounded magnificent, filling the place with a lot of clean, musical sound and an excellent stereo image ... Our tests of the AR-3a simply confirm the manufacturer's design aims and claims for this system'. *High Fidelity*

'The harmonic distortion at bass frequencies was outstandingly low ... The high-frequency dispersion is the widest of any speaker we have tested ... a new high standard of performance at what must be considered a bargain price'. *Audio*

'Acoustic Research have achieved what they set out to do - a first class loudspeaker by any standard'. *Hi-Fi News*

'Finest bass performance I have heard or measured'. E J Jordan, *Wireless World*

The AR guarantee

The workmanship and performance in normal use of AR speakers are guaranteed for 5 years from the date of purchase. This guarantee covers parts, repair labour, and freight costs to and from the factory or nearest authorized service station. New packaging if needed is also free.

The acoustic research 3A improved is now on demonstration at these franchised dealers:

Sydney
Kent Hi Fi
Mastertone
Miranda Hi Fi
Apollo Hi Fi
Electronic Enterprises
Hi Fi House
Instrol
Autel Systems
Sydney Hi Fi
Perth
Alberts TV & Hi Fi Centre

Victoria Park W.A.
Alberts TV & Hi Fi Centre
Newcastle
Ron Chapman & Assoc
Wollongong
Hi Fi House
Canberra
Duratone
Douglas Hi Fi
Adelaide
Blackwood Sound Centre

Brisbane
Stereo Supplies
Reg Mills Stereo
Melbourne
Denman Audio
Brash's
Instrol Hi Fi
Tom's Hi Fi
Mordallic Sound
Darwin
Pfltzner's Music House

Geelong
Sound Spectrum

Hobart
Quantum
Launceston
Wills & Co.

Australian Distributors
W.C. Wedderspoon Pty Ltd.,
3 Ford St, Greenacre (P.O. Box 21)
Phone 642-2595, 642-3993

FACSIMILE TRANSMISSION NOW TOTALLY PORTABLE

Recent approval by the PMG's department for the use of acoustic coupling to facsimile transceivers has opened the way for the marketing of truly portable units.

Plessey Communications Systems have been quick off the mark with the release of the model KD211N facsimile transmitter/receiver. The compact (20 ins x 14 ins x 5 ins approx) unit weighing only 8.16 kg can be taken anywhere by the senior executive or staff for ready transmission of vital information using a standard telephone instrument.

The portable remote copier can be used with mains electricity, or be completely independent using power from a 12 volt battery.

Detailed information in printed, typed, handwritten or drawn form can be sent over any distance. The same phone call can be used to personally discuss other topics of concern.

Acoustic coupling eliminates the need for any wiring between the equipment and the communication line. The handset of a standard telephone is simply inserted into the acoustic coupler on the unit. It can be used in a public telephone if necessary.

The KD211N, a development by Plessey of their larger desk mounted KD111 unit, produces dry electro-sensitive copies for permanent reference.

The new portable transceiver can

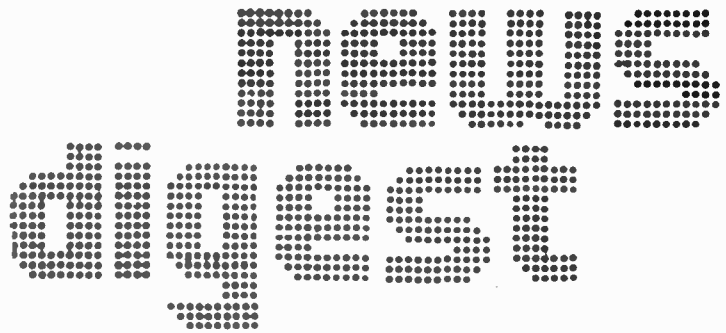

transmit a full A4 size with 64 lines/inch in only three minutes or a maximum of six minutes with 96 lines/inch.

The transmission system is an inbuilt line coupler. There is an optional phasing and line verification module to ensure correct reception.

The Plessey model KD211N acoustically coupled portable facsimile transmitter/receiver has already created interest among newspaper publishers with Interstate offices and organisations with branch offices where salesmen can send and receive information considered vital in finalising a sale

SILICON-LASER SUPER SWITCH

Bell Laboratories have developed a semiconductor switch that operates in 10 picoseconds, that is, 10 to 100 times faster than any conventional

junction semiconductor.

The new switch uses laser beams to start and stop an electrical signal and may be the first time optical pulses have been used to switch electrical signals.

The switch is capable of switching up to 100 volts with the application of only a few microjoules and potentially may be capable of working as fast as one picosecond.

1978 CALCULATOR SALES

MBA candidates at New York University recently performed a study of the sales of calculators on the domestic market in the U.S.

Their conclusion is that sales will reach 22 million units by 1978, almost double the 1974 figure of 12 million.

They predict that 85 percent of the total market will be shared by Hewlett Packard Co, Rockwell International and National Semiconductor Corporation. That is many smaller companies will either cease to exist or find it very difficult to maintain their share of the market.

Even though unit sales will almost double, lower unit prices will mean that sales volume in 1978 will amount to \$900 million US compared to last year's \$658 million U.S.

HISTORIC PICTURES FROM EMI'S NEW MEDICAL DIAGNOSIS SYSTEM

Details of the human body which it has previously been impossible or extremely difficult to detect using conventional X-ray techniques are revealed in an historic series of pictures just released. They were produced by a revolutionary medical diagnosis system for examining the whole body, originated in EMI's Central Research Laboratories, Hayes, Middlesex, England.

Specifically designed to apply a fundamentally new X-ray technique invented in the Laboratories to the examination of the body, the system produces highly accurate and detailed pictures of complete cross-sections through the patient. Each section is



approximately 1 cm thick and is scanned in only 20 seconds.

Commenting on these pictures, EMI's research director, Mr. W. E. Ingham, said, "This new method of examination is destined to bring about a complete transformation in the use of X-rays in medical diagnosis. It is as though a doctor can hinge open the patient's body at any point he chooses and study bones, organs and tissue formations in that cross-section of the body. Without any exploratory surgery he can examine the kidneys, spleen or lungs, for example, in relation to the surrounding tissue."

The pictures released by EMI were taken during recently-completed research trials on the new system, which is shortly to be installed at hospitals in

the UK and USA for full-scale clinical trials.

The 'whole-body' examination system uses the computerised axial tomography X-ray technique pioneered in EMI's research laboratories and first introduced in 1972 in the EMI-Scanner, a system for diagnosing brain conditions. In three years, the EMI-Scanner has achieved a remarkable success, radically changing the approach to brain disease diagnosis and winning to date over £27 million of orders from hospitals around the world.

As well as giving doctors 100 times more diagnostic information on tissue than can a conventional X-ray, the technique has made other major contributions to health care. It has eliminated factors which previously made many brain examinations painful and even hazardous to the patient and extremely costly in terms of hospital facilities and skilled medical staff.

FIRST FREE ICOM IC22A GIVEN AWAY

The first of ten Icom transceivers was handed over recently to the New South Wales Division of the Wireless Institute of Australia.

As part of a programme to increase interest in the 2 Metre band, Dick Smith Electronics is giving one free set away for every ten sold. Purchasers of the new Icom IC22A can nominate the club or division of the WIA they would like the sets to go to. Once ten nominations have been given, a free set is donated to the particular club or division.

The IC22A is a very compact transceiver covering the 146-148 MHz band in 22 channels. Output is switchable from 10W to 1W. Receiver sensitivity

is 0.4 μ V and the front end is equipped with 5 helical resonators. Units are ideal for repeater or WICEN emergency use.

Tim Mills (VK22TM on right) President of the NSW Division of the WIA is seen in the picture receiving the first Icom IC22A from Harry Tyreman (VK2BHT/G3SLL) Manager of the Amateur Radio section at Dick Smith Electronics.

Amateurs wishing to take advantage of this special offer will find full details in 'Amateur Radio' or should contact Mr Tyreman at the Gore Hill Electronic Centre.

Further details from Dick Smith Electronics Centre, 160-162 Pacific Highway, Gore Hill 2065.

SATELLITE X-RAY MYSTERIES

Ariel V, the British satellite carrying sensitive equipment to look at the X-ray sources in the universe, was launched last October and has already revealed new mysteries.

At a conference in London, Professor Ken Pounds of Leicester University, said the outstanding feature of X-ray stars shown by the satellite was their incredible energy.

They are radiating 1000 times as much energy in the X-ray band alone than the sun does across the whole of its radiation spectrum.

Ariel V's payload comes from several British universities and the experiments are designed to give a closer and more detailed scrutiny of X-ray stars than possible up to now and to map their location accurately.

The first results began to come in last year and just before Christmas 1974, a new X-ray source was detected near the centre of the galaxy. This caused excitement because it had not shown up there in other satellite X-ray surveys even as late as November. Since then it has increased in brightness and in February was the second brightest X-ray source yet discovered.

"This is a remarkable object," said Professor Peter Willmore, the leader of the Birmingham University X-ray astronomy team. "It is totally different from other stars."

One of the remarkable things about the X-ray sources is that they appear to come and go. Ariel V, for instance, has discovered 19 new sources in the milky way alone, that had not previously been detected.

Another newly discovered astronomically exciting object is a pulsating X-ray star. This flared up in brightness on Christmas Day and has been named Cen-Xmas to fit the date. The star is unique.

Radio pulsars have been known for some years but no X-ray pulsars had been found. Explanation of its pulsating may be that it is a rotating neutron star, an object unbelievably dense and possessing enormous gravitational fields.

But it is more likely to be a binary system, consisting of a burnt-out star, called a White Dwarf, and a neutron star, or even a black hole, circling round each other.

The X-ray emission would come from material being torn from the White Dwarf. Cen-Xmas pulsates once every 6.7 minutes.



(Continued on page 11)

for the love of music



dynamic range enhancer

dbx 117

The dbx 117 is an incredible piece of equipment that will give you greater listening pleasure than you ever thought possible to achieve.

It does this in two extremely efficient ways; by literally expanding the material deliberately compressed in the recording studio, so that full dynamic range is restored, and by effectively limiting the background noise inherent in most recorded product to the extent that it becomes, in most cases, totally inaudible.

This is what Electronics Today said. "We first used the dbx unit by playing ordinary records with average background noise . . . and the background noise all but vanished. The music sounded far cleaner with a presence that was unquestionably better than the original unexpanded record."

"Our next evaluation involved a piece of newly recorded orchestral music . . . when played in the normal manner, tape hiss was quite prominent . . . when played through the dbx 117 . . . the problem all but completely disappeared . . . the music had a quality which could genuinely be described as sounding comparable with the original."

Australian Hi-Fi discusses the remarkable dbx 117 in detail. Here are a few direct quotes. "And it does work well, giving back a 'sparkle' to some recordings which have always sounded

over-compressed. Its action is particularly impressive during pauses—the disc's surface noise and any tape hiss disappear completely."

"The dbx 117 uses true RMS level sensors which respond to the overall level in both stereo channels even though the signal paths themselves are separate. This technique is necessary for dynamic range enhancement or there would be a wandering of the stereo image."

Hi-Fi Review expressed their findings of the dbx 117 this way: "Yet another way of 'quieting' noisy records is to use a clever little device called the dbx 117, dynamic range enhancer."

This device 'expands' the program material so it sounds more like the real thing, and reduces background noise so effectively, that it all but disappears. It's particularly effective with old or antique records."

dbx 117 restores up to 20 dB of the dynamic range missing from records, tapes and FM broadcasts.

Rediscover the beauty and excitement of an actual performance. Write for full details and list of stockists to

Auriema (A'asia) Pty Ltd, 15 Orchard Rd Brookvale, NSW 2100. Telephone: 939 1900



2000 AXT



INFINITY
THE WAVE OF THE FUTURE

SO TECHNICALLY ADVANCED IT SHOULD HAVE BEEN INVENTED TOMORROW

SPECIFICATIONS

Frequency Response:
30 to 21 KHz ±3.5 db

Crossover Frequency:
500 Hz, 5000 Hz

Nominal Impedance:
8 ohms

Maximum Amplifier Power:
200 watts/channel program

Minimum Amplifier Power:
20 watts. RMS/channel

Dimensions:
27½" high, 20" wide, 14" deep

The reviewers of Hi Fi Newsletter had this to say about the Infinity 2000A:

"... The Infinity people have demonstrated with the 2000A that they know their way in the problematic and highly controversial speaker world. Their representative, then, deserves our highest rating, and until something better comes along it remains our standard in its price category."

Infinity is proud to announce that something better has come along — the 2000AXT. It is better because it is smoother in frequency response, has much better dispersion and has about 5 db added efficiency.

It is smoother in frequency response because we use three new drivers, each developed for its smoothness of frequency response and low distortion. It has better dispersion principally due to our patented wave transmission line tweeter. Finally, it has higher efficiency due to the application of our original research into the physics of transducers as applied to speaker systems.

The Infinity 2000AXT has the advantage of being used with various medium priced receivers as well as the super-power amplifiers of today.

THE TWEETER SECTION

The wave transmission line tweeter is probably Infinity's most stunning achievement. It's neither a cone nor a piston drive, not an electrostatic, not a ribbon and not an ionic device. In fact, it really doesn't appear in any textbooks on acoustics.

This Walsh tweeter, acting as a vertical, pulsating cylinder, is a purely coherent source of sound radiation — directly analogous to the light emitted by a laser beam. Therefore, it is transient perfect — a feat which no other speaker has achieved.



The drive mechanism of the tweeter is a voice coil in a very intense magnetic field. This drive mechanism was selected for its simplicity and inherent reliability, although any drive system could be used inasmuch as the cone is only plucked at the base.

Sound velocities much higher than the speed of sound in air are propagated up the metallic cone. Sound is emitted on various parts of the cone corresponding to the temporal and spatial scheme of Figure 1. Thus, each bit of audio information fed into the device is emitted intact at the same instant of time. This is true around the entire device so that 360° coherent radiation is a reality.

THE MIDRANGE SECTION

The midrange speaker is a very high efficiency 4.5" cone utilizing a large Alnico V magnet, the cone of which is treated for five times the stiffness to mass ratio of conventional speakers. The sound quality of this device is big and open with excellent transient response due to its low time delay distortion.

THE BASS SECTION

The bass driver is a 12" woofer with a full *one inch* movement capability. Its cone is treated twice — once to increase the stiffness to mass ratio by a factor of three, while the second treatment ensures proper cone damping to complement the added stiffness. The woofer is loaded into the "Infinity transmission line" enclosure for superb bass transients. It accurately reproduces the very lowest fundamental bass frequencies with excellent transient response and very low harmonic distortion.



The infinity fine family of speakers available from

INSTROL — CNR PITT & KING STREETS, SYDNEY; 91a YORK STREET, SYDNEY; 375 LONSDALE STREET, MELBOURNE • **MIRANDA HI-FI** — SHOP 67 MIRANDA FAIR, 525-7800 • **QUANTUM ELECTRONICS** — HOBART • **TRUSCOTTS** — ADELAIDE

ANNOUNCING
THE GRAND OPENING
 OF THE NEW WALK THRU PREMISES
EDGE'S
ELECTRONIC
WORLD

31 Burwood Rd, BURWOOD, N.S.W. Telephone 747-2931

HI-FI SPEAKER KITS

CORAL

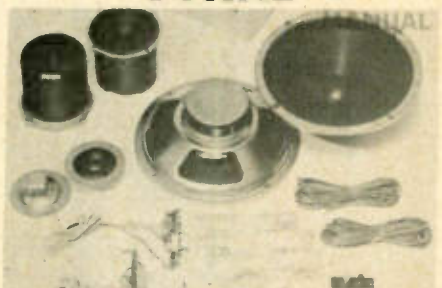

12" Speaker System Kit 12SA-1 \$77.00 Pair
 10" Speaker System Kit 10SA-1 \$55.00 Pair
 8" Speaker System, Kit 85A-1 \$33.00 Pair

PHILIPS

Philips Kit No.1	Philips Kit N6.2
2-AD 8065/W8	2-AD 10100/W8
2-AD 5060/Sq8	2-AD 5060/Sq8
2-AD 0160/T8	2-AD 0160/T8
2-3 way Crossover	2-3 way Crossover
TOTAL PRICE \$115.00	TOTAL PRICE \$150.00

Philips Kit No.3	Philips Kit No.4
2-AD 1265/W8	2-AD 12100/W8
2-AD 5060/Sq	2-AD 5060/Sq8
2-AD 0160/T8	2-AD 0160/T8
2-3 way Crossovers	2-3 Crossovers
TOTAL PRICE \$140.00	TOTAL PRICE \$160.00

* * * PLUS **MAGNAVOX** 8-30's only \$12.95 * * *

TRANSPARK CC007A

CAR CASSETTE PLAYER



only
\$29.95

TRANSPARK TR250

AM/FM CAR RADIO

(11 Transistor 1 ic. & 7 Diodes)

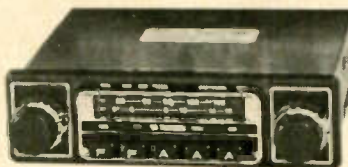

only
\$64.95

ALSO AM-FM STEREO CAR RADIOS
 (17 Transistor 2 ic. and 6 Diodes) PLUS
 FM CONVERTER FOR AM RADIO

CASSETTES

HITACHI

	1 of	12 of	23 of
C60	\$1.60	\$1.47	\$1.33
C90	2.20	2.00	1.80
C120	2.85	2.50	2.25
UDC46	2.05	1.95	1.85
UDC60	2.35	2.14	1.93
UDC90	3.15	2.84	2.56
UDC120	4.35	3.92	3.53

One of the largest ranges of blank cassette tapes in Sydney's Western District — We have low noise, Ultra Dynamic — We stock BASF AND SONY TOO.

ALSO AVAILABLE A GREAT RANGE OF PRE-RECORDED TOP ARTIST RECORDS & CASSETTES

CAR SOUND ACCESSORIES

ALSO AVAILABLE — Suppressors, Antenna Extensions, Leads, Aerials, Fibreglass Lockdown, Sidemount, Gutter Grip Types, 2 & 4 Speaker Fader Controls, Car Stereo Lockmounts, Stereo to Quad Converters, Stereo "L" Brackets, Speaker Switches and more.

PLUS A SHOWROOM FULL OF ELECTRONIC COMPONENTS

PLUGS SOCKETS SWITCHES TRANSISTORS RESISTORS CAPACITORS ETC. ETC. ETC...

CONVERTING SEA WAVES INTO ELECTRICITY

Future sources of energy are a major preoccupation of most industrialised countries. Now a British research engineer has discovered ways of tapping a supply of power which is not only free for the taking but also non-polluting and seemingly infinite.

Mr. Stephen Salter, of Edinburgh University's department of mechanical engineering, has received a \$100,000 grant from the British Government to enable investigations to continue into a system he has devised for converting the motion of sea waves into electricity or some other form of energy.

He admits that commercial development of the idea may well be a long-term proposition taking 15 years or more to reach fruition. But he believes the work could help provide an alternative supply of power to compensate for the eventual decline in another source of offshore energy — the oilfields beneath the British sector of the North Sea.

Like all potentially revolutionary technical ideas, Mr. Salter's method of converting waves into energy is basically simple in concept. It involves the stationing at suitable offshore locations of large concrete breakwaters fitted with movable vanes which would convert wave motion into electricity.

Calculations have shown that such a structure the size of a supertanker, submerged to a depth of 10 to 20 metres and with the vanes protruding a metre above the surface, could gen-

erate 5 megawatts of electricity throughout the year — about a tenth of the needs of a large town.

There is no theoretical reason, Salter says, why a large part of Britain's electricity demands could not be met by a batch of these offshore generators stretched out across the Atlantic at suitable intervals. The breakwater effect of the structures, he claims, would create a sheltered area of calm water behind them which would be attractive to fishing and sailing craft.

In addition, energy from the waves would have the advantage of producing a peak output during the winter storms when demand for power would also be greatest. This is the reverse of the often-mooted solar power schemes which are not considered feasible in northern latitudes.

Much of the early work on the project has centred on finding the most suitable shape for the movable vanes to ensure that the maximum possible amount of wave motion can be utilised by the generating equipment.

After computer studies and the tank testing of models Salter has produced a design which he says can capture up to 90 per cent of the wave motion compared with about 10 to 15 per cent achieved by free floating mechanisms of earlier wave-utilisation experiments.

The wave power picked up by the moving vanes would be transferred to internal pumping mechanisms which would create a continuous flow of fluid to drive the electricity generators.

The Government grant will enable Salter to study other aspects of the project over the next few years, including the ability of the offshore structures containing the plant to withstand the giant peak waves encountered periodically in the North Atlantic.

Mr. Salter plans at least one trip to sea to study wave movements on location. But from the comprehensive data available from Britain's National Institute of Oceanography, he has already reached the conclusion that a suitable position for wave generators lies 16 km from the Hebrides off the west coast of Scotland.

Should all the problems of being able to generate electricity from wave power be overcome the next problem to be faced is getting the power ashore to a point where it can be fed into the national grid.

Salter has already discussed this point with electricity authority experts. They have told him it should be possible to transmit alternating current by undersea cables without suffering transmission loss of an order to render the scheme uneconomic.

A further, if more futuristic, means of utilising electricity generated offshore would be to use it to convert seawater into hydrogen by electrolytic action. Research is being carried out at various centres into the possibility of using hydrogen as an alternative energy form and development work could reach the stage of being commercially viable in 15 to 20 years — about the same timescale envisaged for a prototype wave-powered generating scheme.

Hydrogen produced at sea would have to be brought ashore for distribution at points where it could be burned to produce heat or mechanical power.

Investigations into both wave power and hydrogen energy possibilities are just part of a more comprehensive research programme being carried out in Britain. Its aim is to ensure security of supply and economic utilisation of resources in a changing energy situation.



18" & 26"

COLOUR MONITORS

Based on the technically advanced Rank Arena colour receiver. To view the many excellent features of these monitors, give us a call.

The Video & Hi-Fi Centre

Phone 312-555 445 Oxford Street, London, N. 1. A. R. V. 1876

The Challenge...

TO CREATE ACCURATE SPEAKER SYSTEMS FOR ALL FORMS OF MUSIC

INTERDYN

using world famous **SEAS** drive units, have achieved this aim. You can now obtain a speaker system that is a servant, not a master of the input signal. These systems deliver clean high sound pressure levels with minimal distortion and colouration. Delicate reproduction of quiet music is also possible without losing tonal quality.

Seas Speaker Systems use this advanced design hemispherically shaped soft dome tweeter to obtain very wide even dispersion, high loading with extraordinarily low distortion and no diaphragm breakup. The large voice coil with aluminium windings extends the smooth natural treble.



The woofers are designed with long throw acoustic suspension and soft neoprene surround. This ensures linear cone motion with clear tight deep bass without the resonance effects of some reflex designs.

Select From:	10-2	30	35	Type 60
	2 way	2 way	2 way	3 way
Frequency Response:	45-20,000 Hz	30-20,000 Hz	30-20,000 Hz	25-20,000 Hz
Sensitivity 1watt/1metre:	88 dB	88 dB	89 dB	91 dB
Crossover:	1500 Hz	1500 Hz	1500 Hz	600 and 3000 Hz
Power Handling:	40 watts	60 watts	120 watts	120 watts
Cabinet:	14 1/4" x 9" x 9 1/4"	22" x 12 1/2" x 9 1/4"	23 1/2" x 14" x 12"	26 1/2" x 18" x 11.1/8"

Interdyn do not have Model Z rock speaker or Model X for classical. Because with their excellent reproduction of transients and higher power handling over the whole frequency range they will play rock music. Their smooth treble allows realistic reproduction of classical music while having such low distortion, voice reproduction is superb.

Interdyn speakers play all music. As well as their sonically superb performance the Interdyn speaker systems have tasteful and subdued styling that won't be out of date next year. The prices are also most attractive.

Hear them — compare them.

Sole Australian distributors

**INTERNATIONAL DYNAMICS
(AGENCIES) PTY. LTD.,**
PO Box 205 Cheltenham Vic 3192

INTERDYN

Available from:

N.S.W.: M & G Hoskins Pty Ltd, 37 Castle St, Blakehurst 2221. Telephone: 546-1464.
QLD.: Stereo Supplies, 95 Turbot St, Brisbane 4000. Telephone: 21-3623
S.A.: Challenge Hi Fi Stereo, 96 Pine St, Adelaide 5000. Telephone: 223-3599
TAS.: Audio Services, 44 Wilson St, Burnie 7320. Telephone: 31-2390
VIC.: Encel Electronics Pty Ltd, 431 Bridge Rd, Richmond 3121. Telephone: 42-3762
W.A.: Albert TV & Hi Fi, 282 Hay St, Perth 6000. Telephone: 25-2699
A.C.T.: Duratone Hi Fi, Cnr Botany St & Aitree Crt, Phillip 2606. Telephone: 82-1388

IDS1

ROTEL

AM-FM STEREO TUNERS



Acclaimed in so many countries as audio components with an excellent cost-performance ratio, Rotel AM-FM tuners are the ideal units for those wanting fine performance at realistic prices.

RT 222 (top)

Designed for those whose prime requirement is quality at low cost. All the basic facilities you'll need for clear, low-distortion FM listening.

RT 322 (centre)

Has an FM sensitivity of 2.0 micro-volts, along with capture ratio of 1.5 dB, assuring performances of a standard not normally found in its price category.

Note: RT222, RT322 and RT622 are made in the same style and finish as the popular RA311 and RA611 Rotel amplifiers.

Also available: Receivers - RX202, RX402, RX602, RX802 and a complete range of pre-main amplifiers.

RT 622 (bottom)

Utilizes advanced solid state design with a super sensitive FET front end for clear and precise reception. Sensitivity is 1.7 micro-volts, signal to noise ratio 70 dB. Its performance and handsome good looks will satisfy the most fastidious purchaser.

RT 1220 (not shown)

Offers highly transparent performance with exceptional characteristics. Dual-gate front end tuner for FM sensitivity as high as 1.5 micro-volts. Highly sophisticated controls, signal to noise ratio 70 dB, variable muting, multipath sockets, capture ratio 1 dB.

Available from:

N.S.W.: M & G Hoskins Pty Ltd, 37 Castle St, Blakehurst 2221, Telephone: 546-1464.
 QLD.: Stereo Supplies, 95 Turbot St, Brisbane 4000. Telephone: 21-3623
 S.A.: Challenge Hi Fi Stereo, 96 Pine St, Adelaide 5000. Telephone: 223-3599
 TAS.: Audio Services, 44 Wilson St, Burnie 7320. Telephone: 31-2390
 VIC.: Encef Electronics Pty Ltd, 431 Bridge Rd, Richmond 3121. Telephone: 42-3762
 W.A.: Albert TV & Hi Fi, 282 Hay St, Perth 6000. Telephone: 25-2699
 A.C.T.: Duratone Hi Fi, Cnr Botany St & Aitree Crt, Phillip 2606. Telephone: 82-1388

Sole Australian distributors

**INTERNATIONAL DYNAMICS
(AGENCIES) PTY. LTD.,**
 P O Box 205, Cheltenham, Vic 3192

INTERDYN

YOU DESERVE A BREAK!



If you want to build your own loudspeakers, but don't fancy yourself a master cabinet-maker, we can offer you a speaker box kit which isn't really a kit.

We've taken all the back-breaking, time consuming work out of your hands to make it easier for you.

Here's how:—

Firstly, we supply the cabinet shell ready-assembled and finished — no wood-work, edging or staining and polishing needed.

Secondly, we supply a modern "continental-styled" wood grille front which eliminates difficult and time-consuming grille cloth fixing and gives a professional "factory finish" appearance.

Thirdly, we supply front and back panels pre-cut and ready-to-mount.

Basically, all you do is mount the front and back panels and wood grille front with materials supplied and install acoustic wadding and speakers. If it was any easier, we couldn't call it a kit. We know you'll probably finish a pair of speaker boxes in less than 2 hours with our "know-it-all" instructions, so why not assemble your own speakers. **YOU CAN DO IT TONIGHT!**

SPK-10 CABINET

Popular size for all small speaker systems. Pack & Post \$2

Size — 455 x 295 x 230 mm. Cabinet Kit only — \$27.00 ea. (We supply ex stock, SPK-10 or SPK-20 kits for popular speakers as listed. Others: advise speaker size etc., available within 24 hours).

\$27 ea.

COMPLETE SPEAKER AND CABINET KITS

MAGNAVOX 6" 12 way 12 watts. \$39.00 ea. Pack and Post \$4.00. MAGNAVOX 8" 2 way 16 watts. \$41.00 ea. Pack and Post \$4.00. PLESSEY C80 8" (D) 2 way 20 watts. \$45.00 ea. Pack and Post \$4.00. MSP 8" 3 way 20 watts. (8" bass, 5" mid, 3" tweeter). \$45.00 ea. Pack and Post \$5.00. CORAL 8" 3 way 15 watts. \$42.00 ea. Pack and Post \$4.00. PHILIPS 8" (D) 2 way 20 watts. \$47.50 ea. Pack and Post \$5.00

SPK-20 CABINET

Best size for great all-round sound performance.

Size 600 x 360 x 290 mm. Pack & Post \$3.

COMPLETE SPEAKER AND CABINET KITS

PLESSEY 8" 2 way (D) 20 watts. \$53.00 ea. Pack and Post \$5.00. MAGNAVOX 8-30 2 way (D) 30 watts. \$57.00 ea. Pack and Post \$6.00. MAGNAVOX 8-30 3 way (D) 30 watts. \$65.00 ea. Pack and Post \$6.00. MAGNAVOX 12" 2 way 16 watts. \$49.00 ea. Pack and Post \$6.00. PLESSEY 12" 2 way (D) 30 watts. \$61.50 ea. Pack and Post \$6.00. PLESSEY 12" 3 way (D) 30 watts. \$69.00 ea. Pack and Post \$7.00. CORAL 10" 3 way 25 watts. \$58.00 ea. Pack and Post \$6.00. CORAL 12" 3 way 25 watts. \$68.00 ea. Pack and Post \$7.00.

All kits include crossover networks etc. (D) Signifies PLESSEY or PHILIPS 1" Dome Tweeters supplied.

\$33 ea.



KEMSTAR WIDE-BAND TUNER KIT

for music lovers everywhere
"WIDE-BAND PRINCIPLE"

The KEMSTAR Tuner employs 10 transistors in a novel circuit to provide true hi-fi performance from normal AM broadcasts. Quality approaches that obtainable with FM and, since FM transmissions are presently limited both in variety and strength, this tuner is an excellent investment for all music-lovers. A whistle filter and tuning meter is included and country listeners will appreciate the tuned RF amplifier and "Local-Distant" signal switch. The front panel is particularly attractive with back-lighted slide-rule dial and satin-aluminium trim; a walnut wood cover is included. Comprehensive assembly and tuning instructions are supplied — construction time: approx 3 hours. KEMSTAR is a registered trade mark.

By special arrangement with the manufacturers of the top selling KEMSTAR wide-band tuner, we now offer exclusively, this very fine tuner, which normally retails at about \$130, as a ready-to-assemble kit for only \$59.

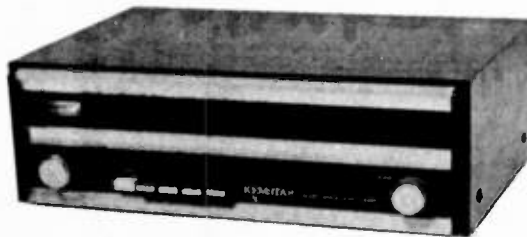

- Hi-Fi Sound
- Local or long distance
- Tuning meter
- Walnut wood cabinet
- Easy-to-builds

COMPLETE KIT

\$59 p.p.p. \$3-00

PRE-PAK electronics

SYDNEY: 718 Parramatta Road, CROYDON, N.S.W. 2132. P.O. Box 43, CROYDON, 2132. Phone: 797-6144.
SYDNEY (CITY): 432 Kent Street, Sydney.
NEWCASTLE: Shops 3-6 West End Arcade, 810 Hunter St., WEST NEWCASTLE 2300. Phone: 69-2103.

● WOLLONGONG, N.S.W. Ph: 84-9034. Hi-Tec Electronics, 265 Princes Highway, CORRIMAL 2518. ● HUNTER VALLEY, N.S.W. Ph: 33-6664. Hunter Valley Electronics, 478 High St., Maitland 2320. ● ADELAIDE: Ph: 255-2249. A. E. Cooling, 6 Trimmer Road, Elizabeth South, 5112. ● MELBOURNE: Ph: 211-4788. Flight Electronics, 1 Derby Road, Caulfield East, 3145. ● BRISBANE: Ph: 97-2509. Delsound, 103 Cavendish Road, Coorparoo 4151. ● NORTH QUEENSLAND: Ph: 78-855. Philtronic, Cnr. Grendon & Palmer Sts, North Mackay, 4740. ● WEST AUSTRALIA: Ph: 41-3427. B.P. Electronics, 192 Stirling Terrace, Albany 6330. ● CANBERRA, Ph: 47-6179. Electronics Shop, 2 Hackett Place, Hackett 2602.

C&K Switch Selector

The switch is to C & K because switches from C & K Components, Inc. (USA) are superior in every design aspect through engineering know-how and experience. Quality, craftsmanship and care make each of these switches a precision component.

The types illustrated are simply a basic cross section of the range available. The range embraces the widest possible variety of switch combinations to meet every requirement . . . Toggles, Rockers, Illuminated Rockers, Paddle Handle, Pushbutton.

Miniature, subminiature and microminiature sizes in many circuit/position configurations are available in one, two, three and four pole models. All switches feature rugged construction and simple mounting . . . long-term, trouble free operation is ensured.

Toggle switch contacts are rated 2 amps @ 240 VAC and 5 amps @ 28 VDC resistive load.

A catalogue containing full specifications, options, mounting information, panel layouts, etc., is available on request.

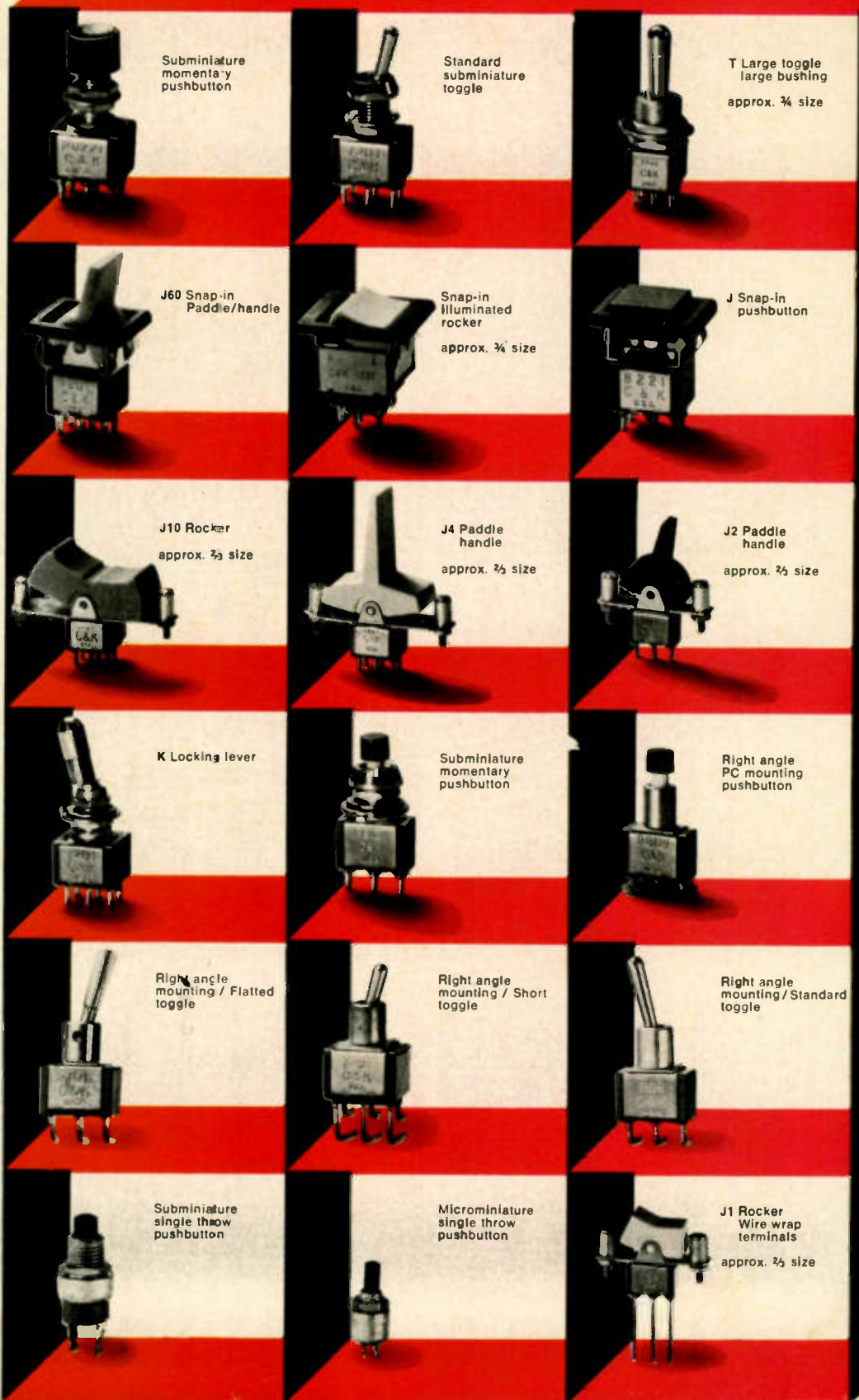

tear out and keep for easy future reference

PLESSEY 

Plessey Australia Pty Limited
Components Division
Box 2 PO Villawood NSW 2163
Telephone 72 0133 Telex 20384

MELB.: Zephyr Products
Pty. Ltd. 56 7231. ADEL.:
K. D. Fisher & Co. 223 6294
PERTH: H. J. McQuillan Pty.
Ltd. 68 7111. N.Z.:
Henderson (N.Z.) 6 4189.

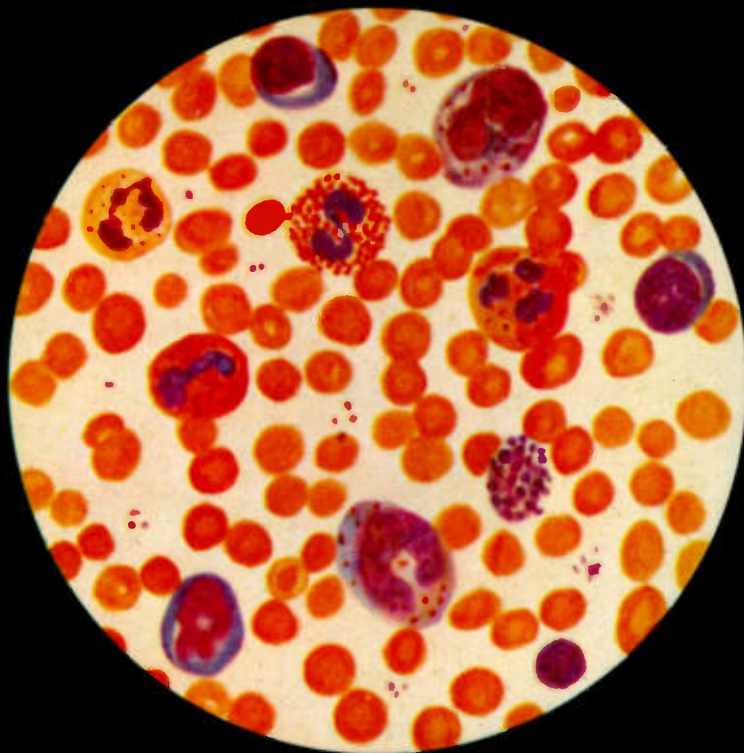

ELECTRONICS IN MEDICINE

-instrumentation down at pathology

Dr. Peter Sydenham reports.

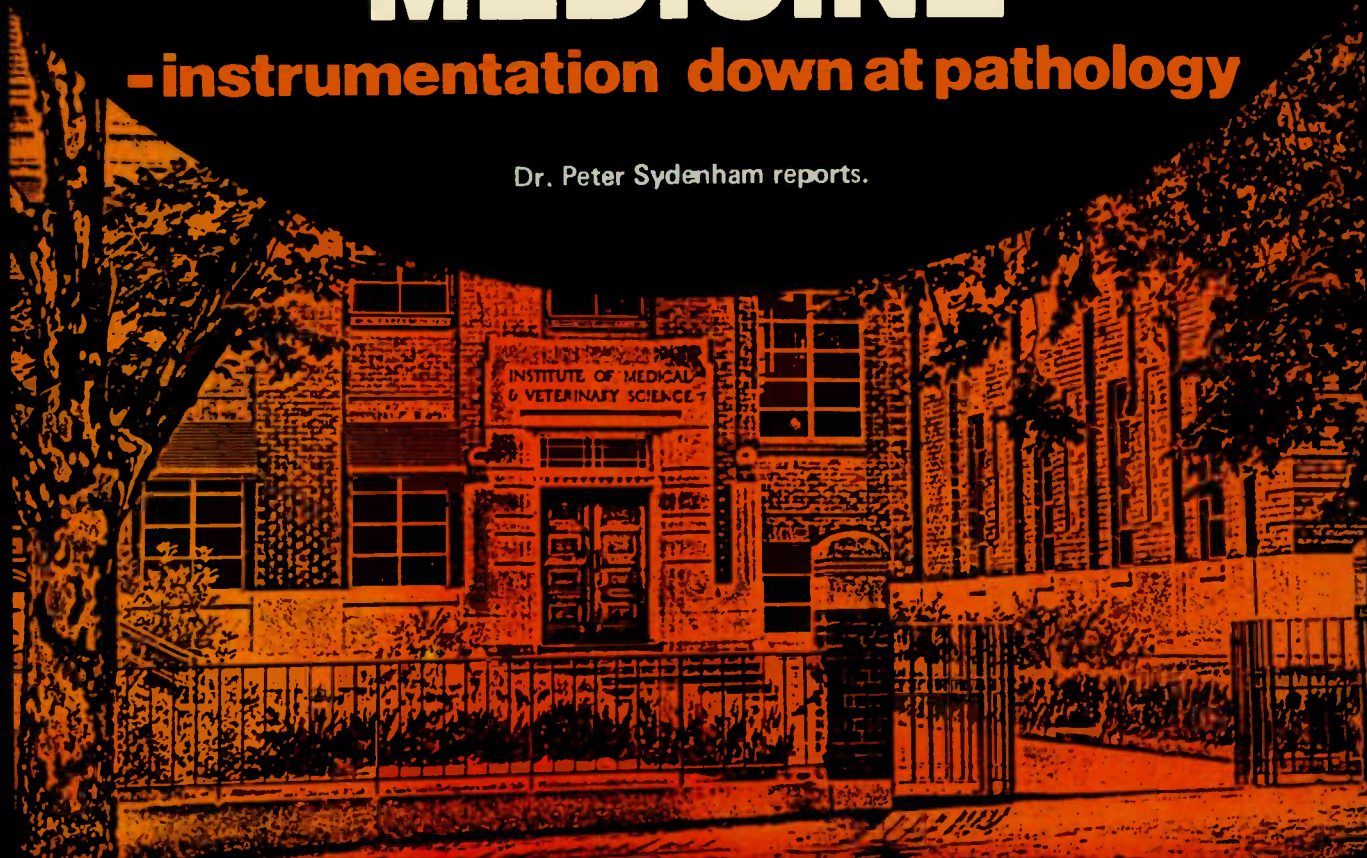

PATHOLOGY is the science and study of disease in both humans and animals. And behind the scenes of every hospital and the many GP's who service our health, there is, in one form or another, a pathology centre. As we will see, these centres play a vital and dominant part in modern medicine. It is a discipline wherein the practical knowledge of the medical professional combines with the skills and achievements of simple to advanced electronics.

Today a major part of pathology relies on sensing and measuring methods that extend the natural ability given to the surgeon or family doctor in order that they can obtain more precise diagnoses of the myriads of illnesses that can befall us.

In this two-part feature we report on the type of work that a pathology centre undertakes — and on how the many varied tests are made having due regard to adequate recognition of the precision and the timeliness required if the tests are to be of value in curing or rectifying malfunctions of the biological system of man and animals.

In Adelaide there is a notable pathology centre — the Institute of Medical and Veterinary Science, IMVS for short. This Institute is unique — it combines more diagnostic functions in one complex than are to be found collected together anywhere else in Australia.

The senior staff alone total over 250 professionally trained persons and the instruments (over 10 000 individual units) are worth millions of dollars. Over two million tests are performed routinely each year.

Another unusual feature of this Institute is its involvement in veterinary work. At an early time in its history (it was founded in 1937) it was decided that the same organisation could handle the tests needed in animal science, as well as for human patients. The equipment and skills needed are similar. This has been advantageous, for few places elsewhere are able to bring to bear the services of persons skilled in animal diseases when an unusual case occurs in a human — on many occasions it has been proved that animal diseases are not always confined to animals!

Furthermore, there is a continually growing need for in-depth pathological studies for animals such as prize racehorses, trotters and domestic pets.

At the IMVS they are now able to breed and supply specific pathogen-free animals (bred in conditions known to be free of vital unwanted germs) which are used for better controlled experiments in biosciences. Veterinary work, however, only accounts for a small proportion of tests carried out.

WORK FLOW IS COMPUTER CONTROLLED

We begin our study by considering what happens to specimens entering the system for analysis. These originate either in a hospital or the surgery of the local medical practitioner. The specimens are then conveyed to the Institute by the most appropriate method that ensures that the necessary characteristics of the sample are retained. In the reception

office the samples are sorted and distributed to the appropriate divisions for processing. The flow chart for tests is shown in Fig. 2. After each division has obtained its individual results from the tests it has carried out, the values, code numbers, names, age, sex, requesting doctor are inserted into the computer system at the time of receiving the specimen into the medical division. Results are keyed in through C.R.T. terminal or by on-line reporting from analysing equipment later.

Some tests carried out are done on the patient direct (called "in vivo") — this happens in a large part of the Nuclear Medicine Division for example. In these cases the in-clinic patient is the starting point for the data flow, for at our current stage of technology it is rarely practicable for

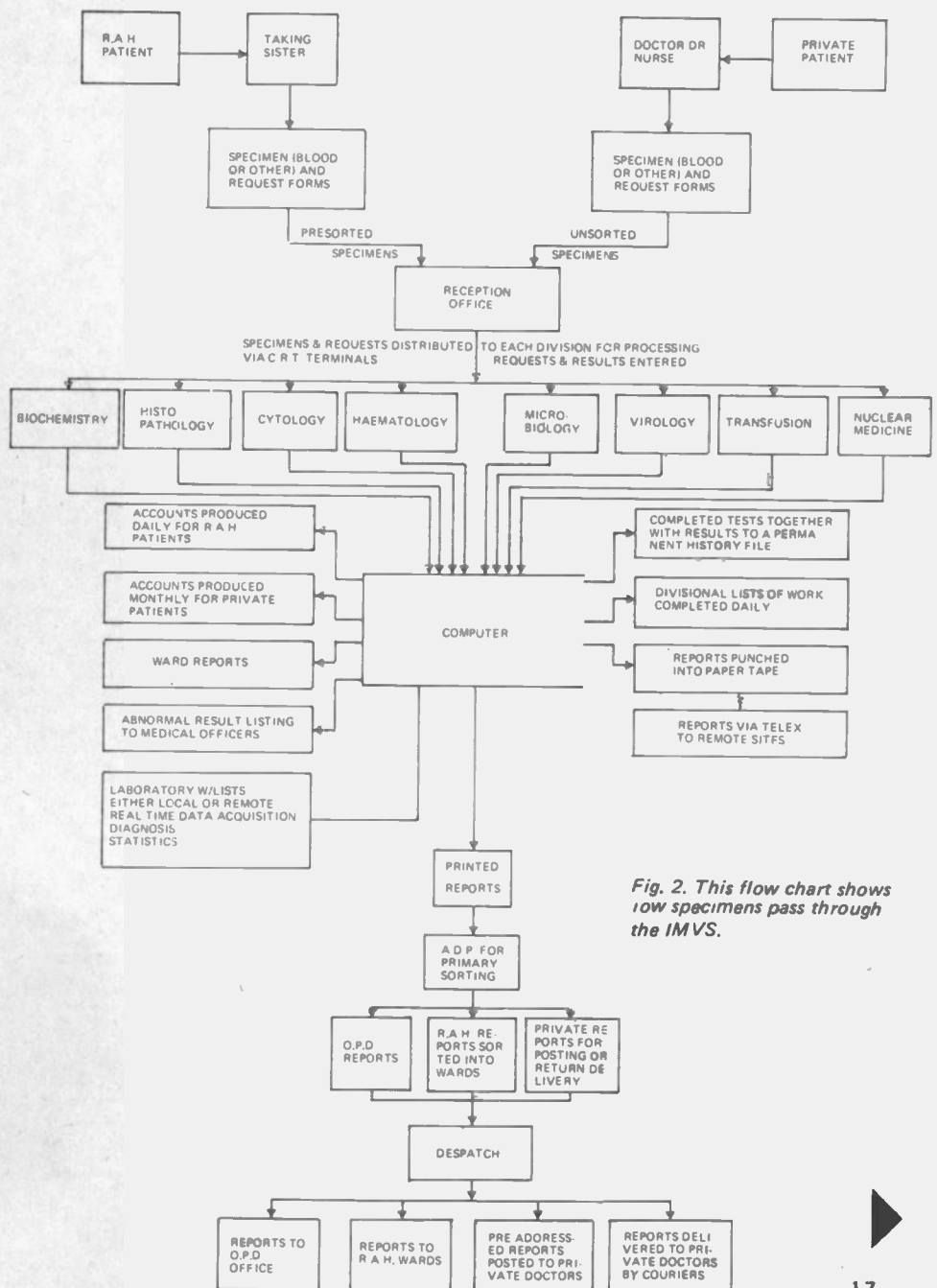

Fig. 2. This flow chart shows how specimens pass through the IMVS.

Blood serum enlarged — the small red patches are red cells, the larger more varied cells are various kinds of white cells stained to increase their contrast. The tiny specks are platelets.

Fig. 1. This lithograph shows the original entrance to the Institute of Medical and Veterinary Science, Adelaide which was founded in 1937.

ELECTRONICS IN MEDICINE

nuclear medical instruments to go to the patient.

A large part of the computer's task is to provide reports ready for mailing to the hospital wards, outpatients departments, doctors in their surgeries, and to supply accounts to patients. As some tests, those performed on blood for instance, are amenable to total machine diagnosis it is also possible in some cases to provide flagged data in the case of abnormalities. Sometimes a suggested treatment can be given in the report thus fully automating the diagnosis.

Some twenty percent of all measurements made are fed direct to the computer data file from the analytical instrument system. These are mainly from one machine-complex handling blood analysis — the other 650 odd tests are manually entered. (In the far future we can envisage the

whole process being totally automated but that will not occur until the cost per test can be kept down to an acceptable value by the use of automatic methods).

The flow diagram (Fig.2) shows the Institute's eight divisions. These are Biochemistry, Histopathology, Cytology, Haematology, Microbiology, Virology, Transfusion and Nuclear Medicine.

Each of these divisions uses measuring equipment in some form or other, but it is in the Divisions of Biochemistry, Haematology and Nuclear Medicine that the majority of instruments are to be found: the variety has to be seen to be believed!

In this first part we consider instruments used in Biochemistry and Haematology which, in the main, are concerned with blood serum measurements. In the following part

we look at the role of Nuclear Medicine.

CHEMICAL ANALYSIS OF BLOOD

The greater part of effort in the Biochemistry division is to analyse blood, determining the concentration of over eighteen constituents. These measurements comprise the greatest proportion of individual tests made at the Institute but require the least manpower for they are almost all completely automated. Once the samples are loaded into the automatic analyser the rest is machine handled right through to the printed report.

The system that does this is known as the multi-channel Auto-Analyser. To understand multiple operation of this system let us start by looking at the basic single channel system used (Fig.3). Small specimen cups filled with blood are arranged in a rotating turntable. Interlocked mechanical drives advance the table one phial at a time and lower a sampling tube into each in turn. A peristaltic metering pump (liquid is conveyed by squeezing a flexible tube with a moving roller) transfers the extracted sample into the entrance tube of the analyser unit — placing a small air bubble between successive samples in order to separate them. Diluent may also be added at this stage.

The train of samples then moves around spirals that mix the sample and added fluids ready for the next step which is to dialyse out the chosen constituents. Dialysis is a process of chemical separation which relies on the various molecular sizes passing, or not passing, through semi-permeable membranes. Using the appropriate choice of membrane the fluid stream is chemically separated as desired. The required fluid, that remains after dialysis or that dialysed out, is then transferred to the analytical measuring device to be used. When agents are added it is often necessary to heat the mixture to a precise temperature at the appropriate part in the flow path.

The output of the particular analytical unit used is obtained as an electronic signal level which can be used to provide digital readout and a printed data value for each successive sample. The basic sampler system will take successive samples at a rate of 60 per hour with the complete pass through the auto analyser taking around eight minutes.

To increase the throughput the company marketing these systems (Technicon Equipment Pty. Ltd) developed a sequential multiple analyser, (SMA 6/60), which provides six different tests (compared with just

Fig. 3. Schematic diagram of a single channel auto analyser system showing components that might be used.

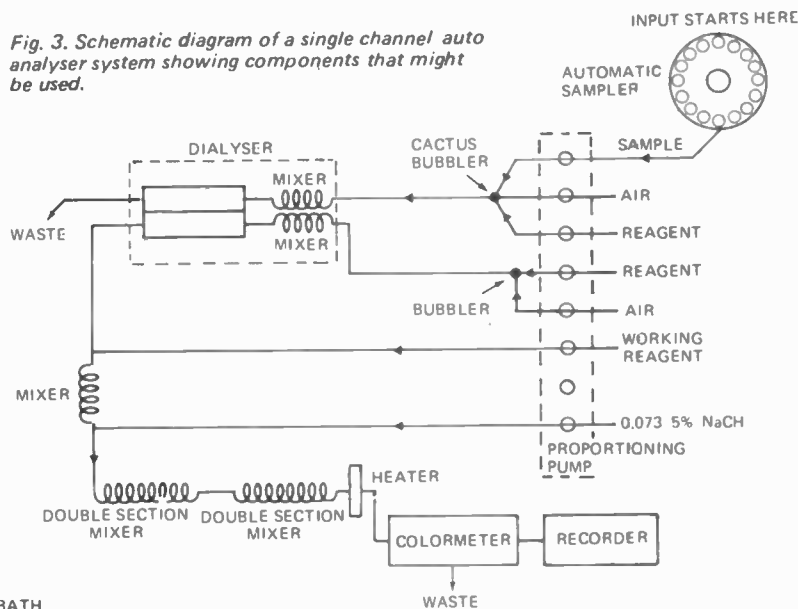
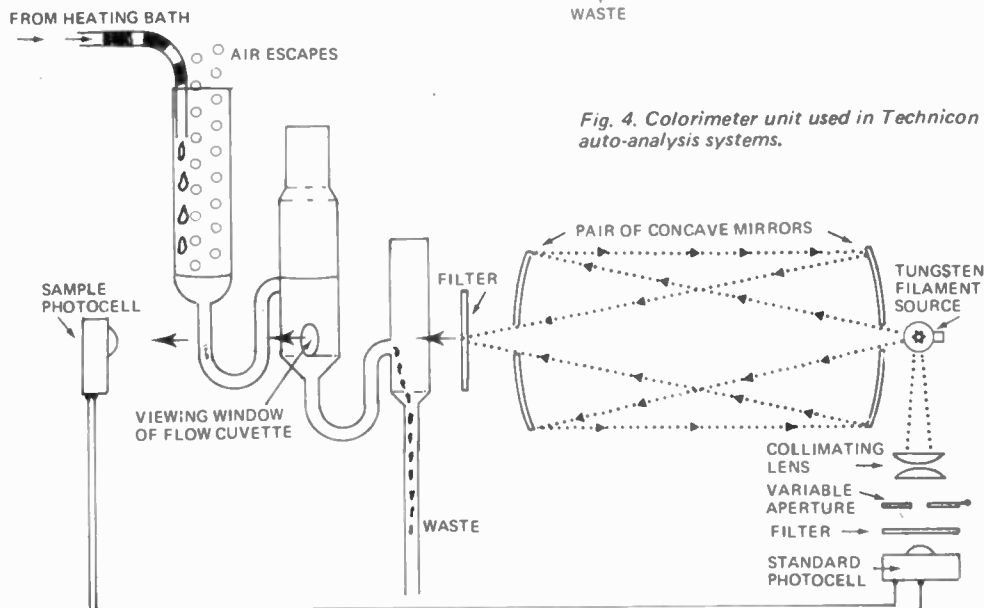

Fig. 4. Colorimeter unit used in Technicon auto-analysis systems.



one in the basic device) on each sample at the rate of 60 samples per hour.

The sampler unit of this system similarly dips each serum phial in turn but the samples are then split into five separate streams that feed six analytical units (two results come from one stream) each determining different blood chemistry parameters.

Four streams go to colorimeters, one to a flame photometer which has three photo cells with specific pass filters for detection of Na & K against a constant background level of Li.

Colorimeters are photoelectric units designed to monitor the difference between a standard colour and that of a sample solution. Provided the sample has been accurately diluted and suitably chemically treated and separated before the measurement, the colour density will be directly proportional to the concentration of the required parameter in the solution. Colour density is determined by photoelectric comparison of the sample solution with a standard solution. If the colour density is increased, the process is said to be of positive colorimetric result. A blood urea nitrogen test is positive; the glucose test negative. The now treated sample flows through the viewing cuvette altering the transmission of the light source radiating through to the measuring photo cell. This value is automatically compared with the standard cell to indicate the concentration as an equivalent electrical signal. (The block diagram of the Auto Analyser Colorimeter is given in Fig. 4).

Colorimetric methods enable many different concentrations of serum to be assessed — chloride, bicarbonate, protein, albumin, calcium, alkaline phosphatase, bilirubin, urea nitrogen, glucose, cholesterol, uric acid, plus others depending on the reagents added and the dialysing membranes used in each channel.

Flame photometry, the second sensor used at the end of the autoanalyser system is also based on colour comparison but in the form of colour measurement of a standard flame burning the treated solution. As the flame burns the unknown element the emission spectra is altered. The colour produced in this way is compared with a control flame burning a known substance; lithium in this case. Flame photometry is used to measure sodium and potassium concentration in the serum.

So that several flame photometric tests can be carried out on a sample at one time, flame photometers are available in multi-test form. The Institute's unit is a twelve-test device. One interesting feature of this is a

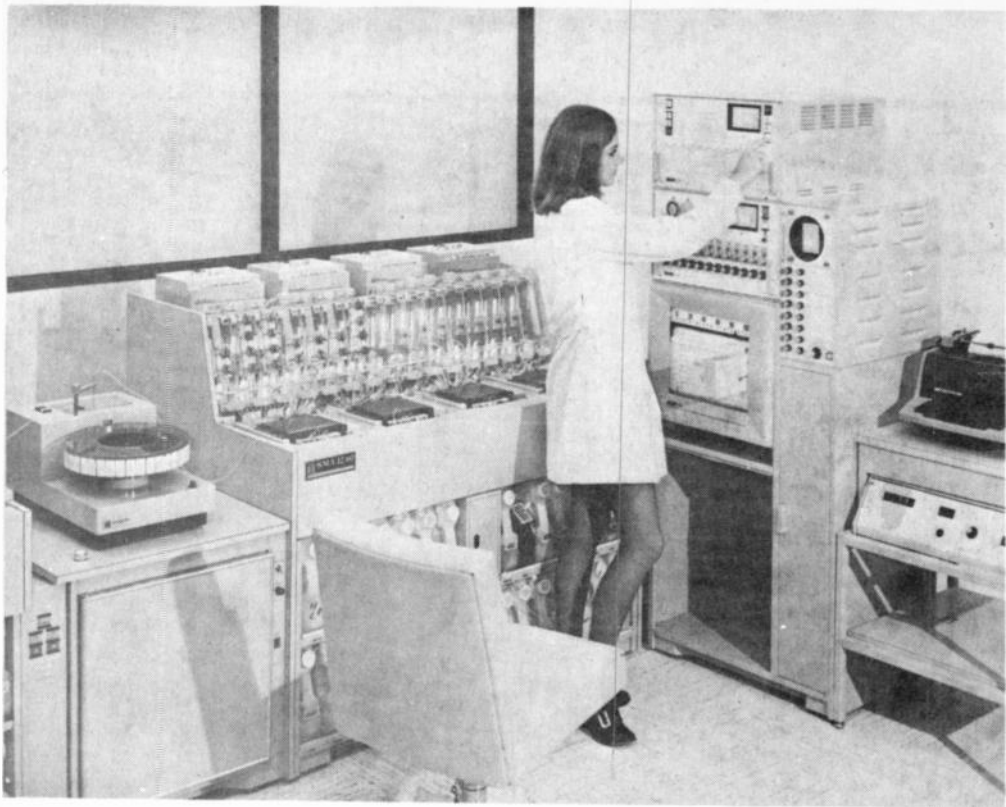

Fig. 5. Twelve tests on sixty samples an hour are performed by this automatic serum analyser from Technicon.

multiple oscilloscope display that shows the state in time of each of the twelve tests being carried out on each sample. In setting up the machine the operator has to carefully select the mixing spirals so as to add in the correct amount of time delay. This is necessary if the results are to be obtained in the correct sequence at the output.

Output comes in two forms from this unit. First, as an analogue chart record like that shown in Fig.6, where the pen traces across the appropriate scale at the level of concentration measured — this should demonstrate the reason for needing accurate phasing of the recorder and the twelve tests! The second output form is for a direct line to the central computer centre.

In a single day 250 samples are analysed for twelve parameters and 200 samples for six parameters. The two Auto-analyser units are set up differently to provide 18 different blood parameters if needed. It is considerably cheaper to carry out all 12 tests than to run just one on the single channel unit. This equipment revolutionised analysis. For all its complication and sophisticated electro-mechanical design the unit reliably performs tests at a few cents a parameter.

Multichannel analysers such as these are now just over a decade old in concept and advances are now available that enable the system to be further automated. The next step in

development would be to add a mini-computer that will control daily self checks of electronic performance, calibrate itself and provide maintenance instructions for the technicians' use.

MORE BLOOD MEASUREMENTS

Very much related to the chemical measurements performed on the multi-analyser are other blood parameters determined in the Division of Haematology. These tests include estimation of cellular properties of blood-number and size of red and white cells, concentration of haemoglobin (the colouring matter of red corpuscles of the blood which serve to convey oxygen to the body tissues) in red cells and its level in the serum.

Colorimetry is used extensively in the measurement of haemoglobin, for its concentration is proportional to optical density. A haemoglobinometer (or haemochrometer) is an extremely old instrument concept. The whole blood is first diluted with a pure diluent, such as distilled water, in an accurate proportion. The colour of this fluid is then compared with coloured papers in the simplest technique. More precise methods make use of photo-electronic colour matching. The Unicam SP300 colorimeter developed over 40 years ago still serves a useful purpose in this Division. A light source, see Fig. 7, shines on a large area selenium barrier

ELECTRONICS IN MEDICINE

PRINTED IN AUSTRALIA FOR TECHNICON EQUIPMENT PTY. LTD.

SMA 12/60

CHART No. Z3-0033
I.M.V.S. ADELAIDE

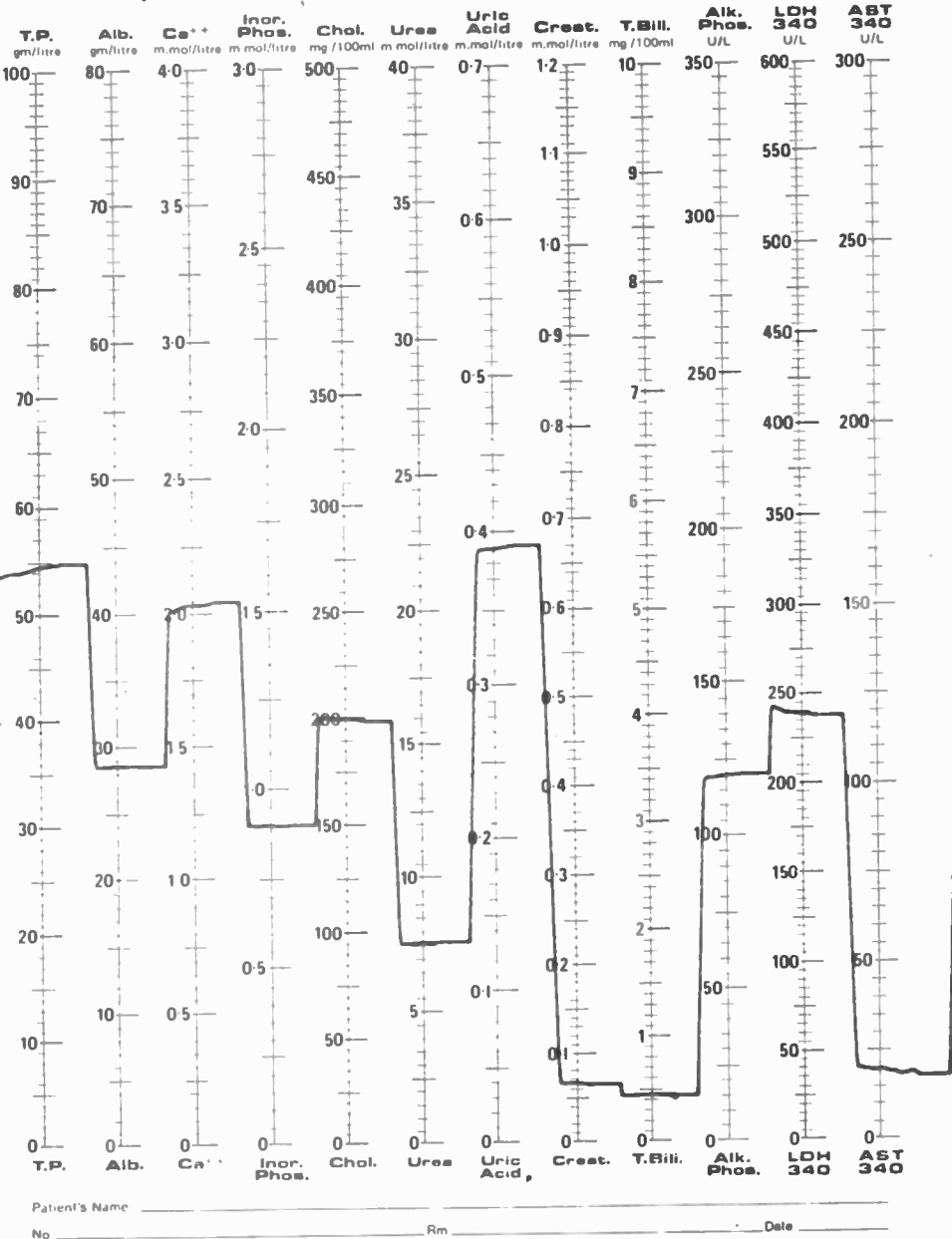

Fig. 6. Typical record format produced by the SMA 12/60 Multi analyser unit. Each scale represents the expected range of concentration of twelve basic serum constituents.

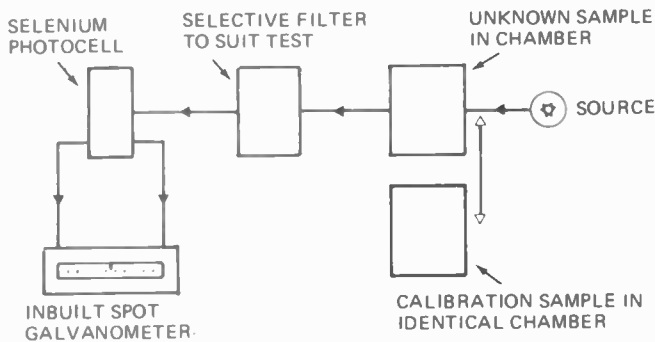

Fig. 7. Schematic of simple photo-electric colorimeter.

through an optically selective filter and a standard size cuvette.

The output of the photocell drives a mirror galvanometer that is self-contained within the equipment. In use the appropriate filter is inserted along with a standard, suitably filled container which acts as the reference optical density. The galvanometer is then balanced to the datum value and the reference changed for the unknown which, due to greater optical density, produces a different deflection value that is related to concentration. These give a measure of haemoglobin concentration in grams per hundred millilitres of whole blood. Checks on these devices are made using purchased standard "blood" solutions which have the right optical density for various concentrations. More advanced instruments perform the reference-unknown changeover process by comparing the relative signals produced by alternately or simultaneously viewing each with the same common source. This was shown earlier in Fig. 4.

Another simple test to do with whole blood cells is the determination of packed cell volume PCV. The whole blood sample is placed in a slender tube container of fixed volume and length. This is placed on a small centrifuge that rotates at speed, packing the more dense blood particles on the outer radius. After centrifuging, the phial is compared with a graduated chart that, by way of measurement of the distance along the tube, reads the PCV value. Simple - yet quite adequate.

Prior to the early 1950s the often necessary diagnostic task of counting and sizing blood cells (red, white and platelets), was extremely arduous for the operator had to view a smear on a microscope and literally count what was seen in a standard area. There is still need for direct observation of this nature for other reasons, but fortunately there is now an automatic machine that performs the bulk of the counting requirements. In a cubic millimetre of blood there are around 5 million red corpuscles and they account for 98.5% of the corpuscular mass. In the same volume there are typically 10 000 white cells and 400 000 platelets.

Around 1956 Coulter marketed a basic instrument that, as their patent described, used "an electric current path of small dimensions modulated by the passage of individual particles". As the particles (not only blood cells can be counted of course) pass through a small orifice containing electrodes (see Fig.8), the conductivity changes each time a particle passes

thereby producing an electric pulse suitable for counting. Furthermore, the magnitude of the pulse is related to the size of the particle. It was able to count cells at the rate of 50 000 cells in 20 seconds. And it didn't get tired!

Today, Coulter counters can be most sophisticated as the following description of the multiparameter Model S unit (installed at the IMVS) will show. This unit, shown in Fig. 9, accepts one millilitre samples which are fed in by the technician along with diluent. It processes these samples to provide seven blood parameters — more again on top of the 18 obtainable from the Auto-analyser systems. The values are printed on a report card. Soon they will go direct to the computer. This machine is a marvel of automated fluid transport combined with sophisticated electronic data-processing. To see how this system operates we will trace the path of the serum sample using the flow chart given in Fig. 10.

The first step is to draw blood plus diluent into a dilution module that accurately mixes the two in a one in 224 ratio — which suffices for white cell counting. Some of this diluted serum passes back for a second 1 in 224 ratio dilution ready for red cell counting after lysing. Lysing is the process whereby a reagent is added that destroys the red cells still existing in the one in 244 first dilution picked off from the white cell channel. Both channels are now ready for counting: one contains predominantly red cells and the other predominantly white cells.

The counting bath in each path contains three counting sensors each having typically 100µm diameter orifices. Triplication is used to provide redundancy and averaging of values. Before the white cell fluid is expired to waste, it passes into a colorimetric style of haemoglobinometer which provides the raw data for the seventh parameter which is not a counting value.

The pulses selected from the appropriate height representing the sizes needed are produced by the two

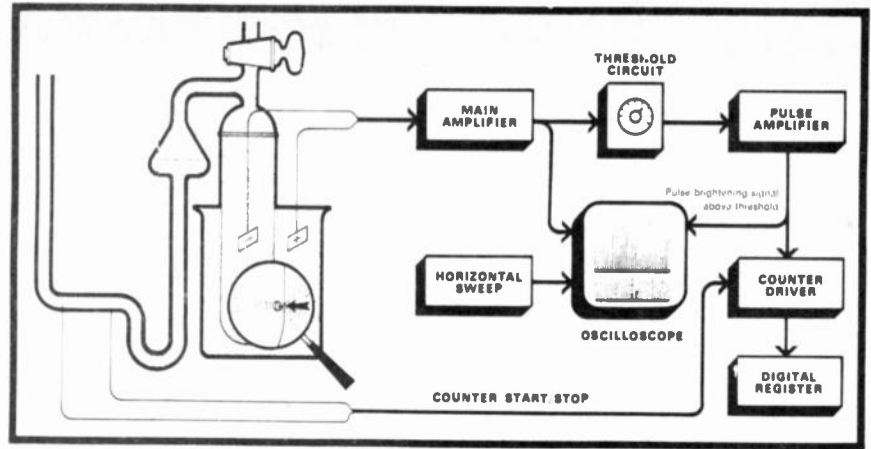

Fig. 8. Particles, blood cells in this case, pass through the small orifice (shown under the eyeglass) producing pulses that are counted. This is the basis of the Coulter Counter.



Fig. 9. Multiparameter Model S Coulter Counter with covers removed.

sets of three count-generating sensors. These pass to proceeding units that decide if the counts are indeed valid — if one channel is unduly different from the others it records a failure — as happens when an orifice blocks. The

reds are counted with the fewer whites still remaining, for statistically the latter are too few to be of any consequence. Knowing the dilution ratios, volumes and averaged counts for each channel, the computing

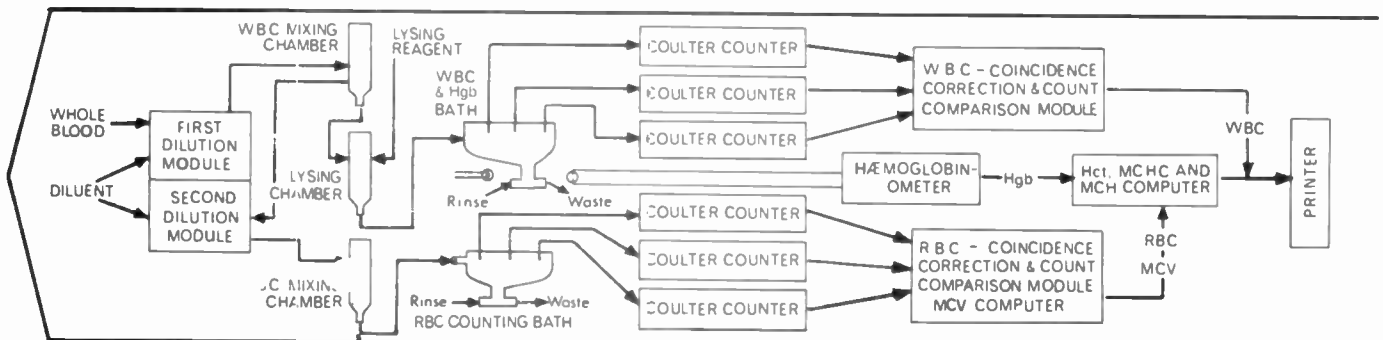

Fig. 10. Flow chart of a specimen passing through the Model S counter.

circuits provide the seven parameters to the report and printer — total haemoglobin Hb mean cell haemoglobin concentration MCHC, mean cell haemoglobin MCH, mean cell volume MCV, haematocrit Hct, red cell count and white cell count. The printer is seen on the right-hand of the unit.

ELECTRON MICROSCOPY

Whereas a large amount of diagnostic results are obtainable by viewing suitably prepared slides in the optical microscope, the useful magnification, being limited to around X 2000, is often inadequate. If greater detail is needed the study must be made using an electron microscope. The IMVS possess two units, a Hitachi HU11E and a Jeol JEM100c analytical electron microscope. These can provide magnifications to X 10 000 000 if required, being able to resolve detail about 0.5 nM dimensions.

With these, pathologists are able to study mounted specimens from numerous sources — tumours, kidney, lung, intestines — taken both from humans and animals.

Interesting here is the sophisticated preparation of specimens that is often required. In the simplest case the specimen is mounted onto a platen grid (a supporting mesh is used to support the microtomed (very thin) slice, for a glass support is not practical in transmission electron microscopy). To improve the contrast the specimen maybe treated with heavy-metal chemicals.

The extreme situation occurs when the specimen will not endure the bombardment of the electron beam,

exposure to atmosphere or the ultra-high vacuum. It may also lack adequate contrast to the electrons probing it. In such cases a special freeze-etching machine is used to prepare a suitable specimen. First, a small piece of sample is placed in the machine which freezes the slice in an incredibly short time. The frozen sample is then sliced (really a progressive surface fracture for it is ice that is being cut) to expose a uniform flat surface. This process ensures dimensional and chemical stability of the sample. But the sample must still be placed into the vacuum chamber of the electron microscope. And even though the sample is frozen it would still melt and be destroyed unless it is further protected.

The next stage, therefore, is to etch the frozen sample by controlled melting of the sliced surface. Using vacuum deposition, a layer of platinum and carbon is then deposited onto the specimen taking up the contours produced by etching. The original material is then digested away leaving the replicated sample which is suitable for use in the electron microscope. To complicate matters the whole preparation process must be carried out at high vacuum (0.0005 Torr). The average preparation time for a sample is around 90 minutes so samples needing this much pre-treatment are not done in large quantity.

Whereas the Hitachi instrument is a reasonably standard electron-microscope, the Jeol model incorporates a scanning facility and the

ability to carry out chemical analyses of the various parts of the specimen whilst it is mounted in the microscope. Generally speaking the scanning style of electron-microscope sacrifices resolution (about 10 nM is the normal limit) in exchange for the ability to picture the specimen with remarkable depth of focus. There are other advantages, however, which are the merits needed in pathological work. Here the scanning mode enables the operator to view specimens that are less loaded with heavy metal chemicals and to use a lower operating voltage, thereby obtaining longer life from the specimen: the reduced contrast of the specimen can be counteracted by the ability to brighten and increase the contrast in the reconstructed scanned image output. It also enables thicker sections, that are easier to cut, to be used. This particular electron microscope incorporates a mini-computer which is programmed to increase the wanted image quality by automatically removing a predetermined unwanted signal background from the video waveforms before the image is reconstituted.

THE COMPUTER CENTRE

As we have seen earlier, a large proportion of measured data (or serum in the main) is fed directly to the computer facility. The computer system itself is represented in Fig.11. The Auto-analysers are interfaced using analogue to digital interfaces, with one of the two CDC 1700 units used. Data not automatically entered is fed in through 20 remote terminals

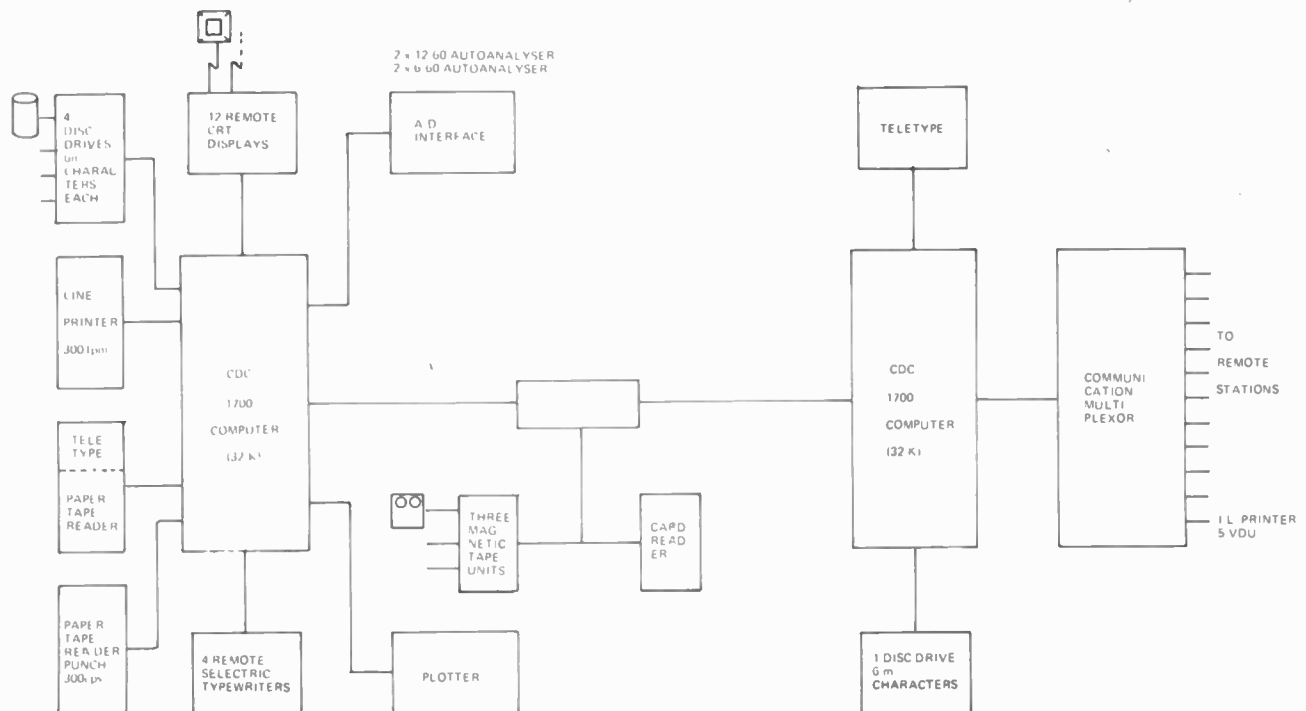

Fig.11. The computer facility.

which comprise visual display units with their combined keyboards. These terminals are situated in suitable places throughout the Institute, in the Royal Adelaide Hospital and in the Modbury Hospital placed some 20 km away.

Reports are prepared, either routinely or on demand, on the line printer ready for posting. Facility is also available for direct transmission of report data by teletype to hospitals far out of town.

Storage is vital, for the centre turns over around 3000 individual tests per day with data being retained on the active storage files for periods ranging from two days to ten weeks. After this period data is transferred to permanent storage on magnetic tape.

At any one time there exists around 15 000 test results in the active file records — it is not uncommon for there to be 100 test reports on a single person. At present the system has around 36 000 000 character storage in its disk and core stores. By the time this article appears the computer will have been upgraded to a CDC 1784 unit having 65 K core storage.

It has taken five years to develop the system to the current capability. Due to this unusually large range and size of the IMVS system as a whole, this

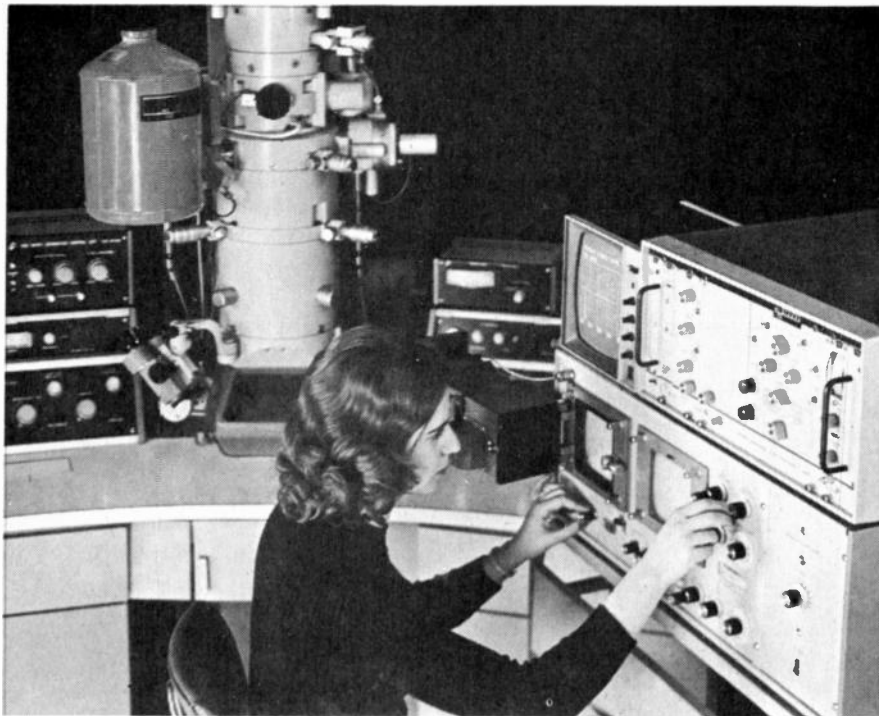

centre has been used by others as a basic model on how to accomplish such a task.

In the second part to follow we take a look at the instruments and

techniques used in another branch of the Institute, those of Nuclear Medicine — how nuclear techniques assist diagnosis on both specimens and patients. ●

PROTECT YOUR MAGAZINES

et BINDERS

HOLDS 12 COPIES OF

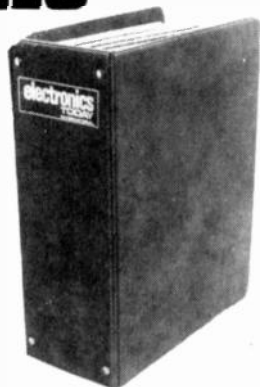

electronics
TODAY
INTERNATIONAL

ONLY \$4-50

INCLUDING SALES TAX & POSTAGE

CONTACT: SUBSCRIPTION DEPT,
MODERN MAGAZINES, 15 BOUNDARY ST,
RUSHCUTTERS BAY, 2011.



ELECTROLUBE

REGD.

- Electrical Contact Treatments
- Maintenance Chemicals ● Specialised Lubricants ● Contact Lubricants ● Contact Cleaning Strips
- Preclene ● Freezer Spray ● Printed Circuit Lacquer.

RF.1985

Information on ALL Electrolube Products is available from Australian Agents:
RICHARD FOOT (AUSTRALIA) PTY. LTD.
63 HUME STREET, CROWS NEST,
N.S.W. 2065. Telephone: 43-0326.

**Two things
Albert Einstein
could have put
to good use.**



Albert Einstein had a hair problem. And a lot of mathematical problems.

The hair he could have fixed with a good brush. And with a lot of his other problems, 'Eveready' Gold Alkaline batteries could have helped out.

Just think what a man like Einstein could have done with a battery that out-performs all others in high drain electronic equipment.

A battery that delivers full and consistent power, even after being left idle for long periods.

A battery that isn't bothered by extreme changes in temperature.

Albert, we only wish we'd been there to help.

EVEREADY BATTERIES Products of **UNION CARBIDE**

'Eveready' & 'Union Carbide' are registered Trade Marks.

RAMBLER

Starts you off on the right track.

The BDP-100 Turntable and the SA-8200 amplifier are two fine examples from the Rambler Range of Hi-fidelity audio equipment.

The BDP-100 2-speed turntable is quality engineering throughout, featuring a diecast platter, belt driven from a synchronous motor.

An "S"-shaped, low tracking error arm with adjustable anti-skate and lateral balance. Auto cut and return arm with independent dampened arm lifter. Magnetic cartridge with diamond elliptical stylus. Spring loaded detachable lid. Shock absorbing felt based feet. Sprung, heavy gauge metal motor board and wired ready for CD-4.

Channel it through our SA-8200 multi-purpose, stereo amplifier with its 55 watts RMS per channel output. Harmonic distortion of less than 0.2% at 45 watts RMS per channel. Inputs:— 2 phono, 2 AUX, 2 tape, tuner and mic. Separate base and treble controls on each channel. High and low filter switches and loudness control. Provision for 2 pairs of speakers. These are just some of the many value packed features in these two superb pieces of Rambler Hi-Fi equipment.



BDP100

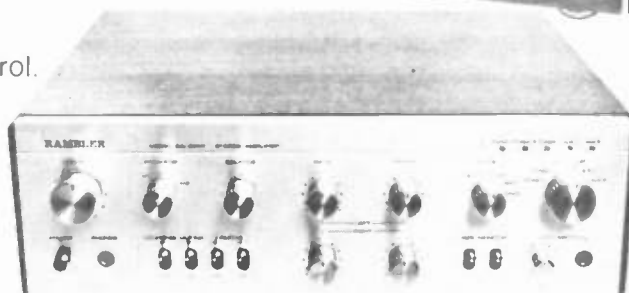

SA8200

“Rambler — The Best Thing That Has Happened to Music.”

See and hear the Rambler range of sound equipment at your Rambler dealer now and compare the outstanding performance and value.

Distributed and serviced throughout Australia by Sun Electric Co. Pty. Ltd. Melbourne, Sydney, Brisbane, Perth, Adelaide, Hobart and Canberra.

MR 160

PART 2

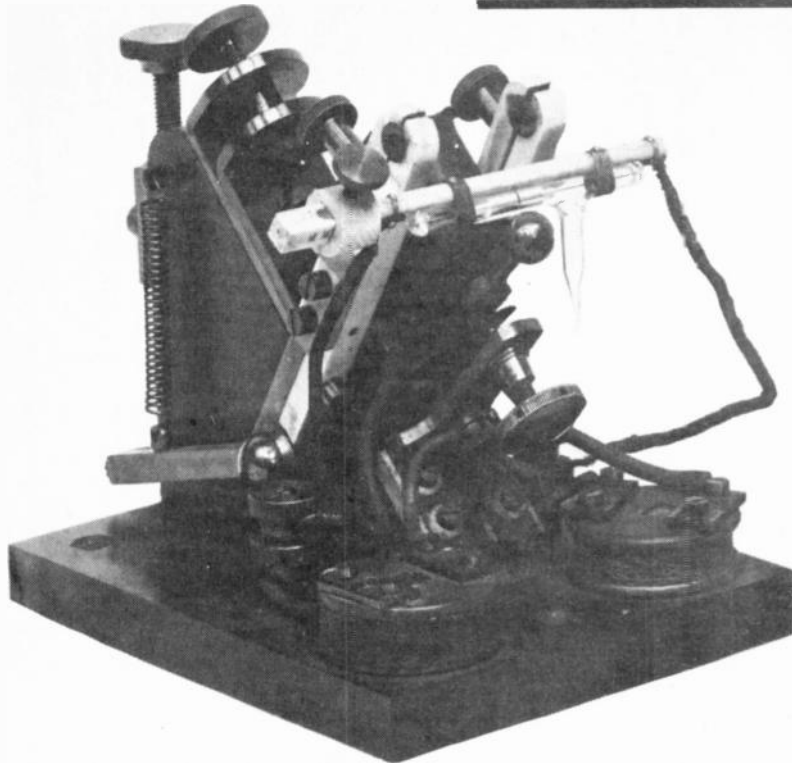

Early coherer, electromagnetically actuated hammer taps coherer tube to 'reset' detector.

EARLY RADIO PATENTS

— a pot-pourri of early ideas and patents in 'wireless' and telecommunications.

BEFORE 1896, experimenters in wireless had one thing in common. Their interest was primarily academic.

But one person at least had seen the practical and commercial implications — and in 1896 British patent 12039 was granted to Guglielmo Marconi for 'improvements in transmitting electrical impulses and signals'.

The patent describes the basic concept, of using a transmitter

comprising an induction coil having in its primary circuit a telegraph key and a battery, and a spark gap in its secondary circuit, and a receiver comprising a coherer in series with a telegraph receiver.

From this starting point the specification goes on to discuss the use of an aerial and earth and to describe modifications to the coherer all directed *not* towards the academic

study of the properties of 'Hertzian' waves but the realisation of a practical long distance wireless telegraphy system.

Marconi definitely led the field in the patent stakes: he was the first to seek patent protection for a system of wireless telegraphy using Hertzian waves.

The runner up was not far behind. Six months after Marconi applied for his patent, in December 1896, A.C. Brown and G.R. Neilson applied for patent 28955 for a wireless system "It has been known for some years past" they openly admitted in their patent specification "that Hertzian waves are capable of being radiated or projected so as to act on other circuits placed at a distance and produce certain effects therein, such as sparking between disconnected conductors, and the alteration in resistance of 'coherers' etc. It has been known too that these effects are manifested through considerable distances in space and through various media which are in some cases opaque to ordinary light."

Having thus acknowledged the state-of-the-art, Brown and Neilson went on to describe their invention

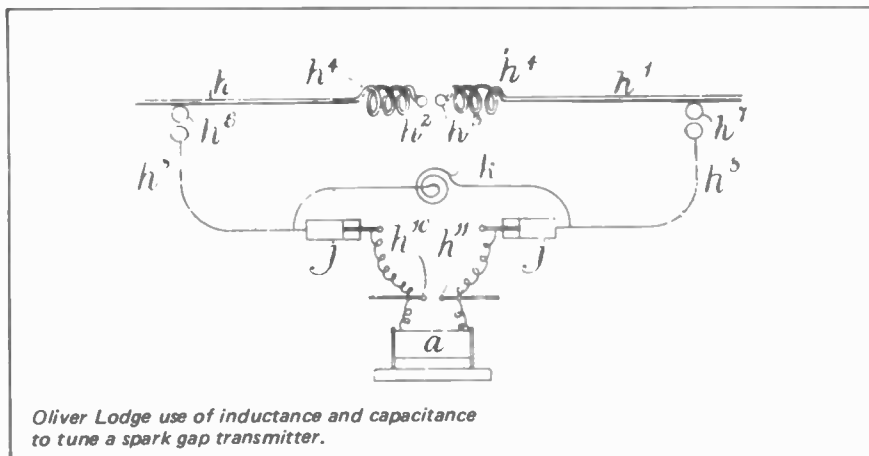

Oliver Lodge use of inductance and capacitance to tune a spark gap transmitter.

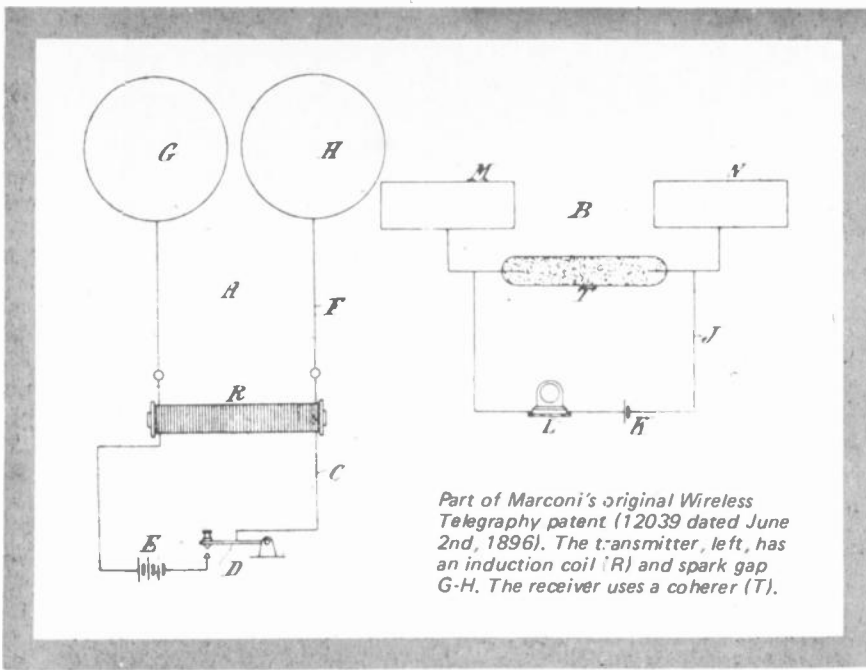

which was essentially concerned with an improvement to the construction of the oil-immersed spark gap of a Righi-type oscillator. They also however discussed the major problems which, in 1896, stood in the way of the development of practical wireless telegraphy and telephony systems.

PROBLEMS

One such problem, consequent upon the use of a spark gap transmitter and vertical aerial, was that the signals were transmitted in all directions and over a wide range of frequencies. This was obviously inefficient and gave rise to the serious problem of interference in the case where different transmitters were operated simultaneously close to each other. Brown and Neilson referred to this problem and suggested enclosing the transmitter in a metal box, generated waves being allowed to escape in a narrow beam through a hole in one side of the box. They also suggested tuning "by inductive paths".

The nature of the transmissions produced by a spark gap oscillator also raised problems in connection with telephony. In order to be able to carry audio frequency signals, a carrier wave quite unlike the intermittent damped oscillations obtained from the spark gap is required, in other words — a continuous wave. As Brown and Neilson put it: "It is desirable for the vibrating make and break in the primary circuit of the generating induction coil to be of high rate and the transmitting oscillating circuit designed to give a considerable number of oscillations for each break." They suggested connecting across the spark gap a loop of wire of 'some length' whereby the

oscillations might be "less damped although less powerful".

A further problem was that of devising a suitable means of detection of the radio waves. The metal filings coherer used by Marconi and also Brown and Neilson was unsuitable for use in the detection of telephonic transmissions since it had to be reset after receiving a signal by mechanical agitation, for example by tapping, and was therefore incapable of responding to rapidly varying signals. Brown and Neilson tried alternative forms of detectors, in particular a detector employing a triangle of platinum or aluminium wire resting lightly across two conductors in an evacuated vessel, but in the end they recommended a variation on the conventional coherer, using carbon granules instead of metal filings, which they said did not need resetting and was therefore particularly suitable for telephony.

In the years that followed, many inventors directed their efforts towards finding satisfactory solutions to these three problems considered by Brown and Neilson.

Leading the field, in 1897, was Lodge with patent 11575 for a means of avoiding interference between nearby transmitters. His idea involved the use of inductance and capacitance to 'syntonise' the transmitter and the receiver, that is, to tune them to the same unique frequency. The use of inductive and capacitive elements in the transmitter circuitry also acted to reduce the damping of the oscillations and thereby to reduce the range of frequencies generated. At this stage, of course, the future for wireless systems using Hertzian waves was by no means clear cut and Lodge, for one, was

certainly hedging his bets. Thus, in patent 29505 of 1897 he described the use of 'syntonising' circuitry and coherers in an inductive telegraph system.

Marconi was following close on the heels of Lodge and in for example patent 5387 of 1900 and 7777 of 1900 he described 'syntonic' circuitry employing aerial coils. J.S. Stone, an immensely prolific patentee also did much work in this field as is demonstrated for example by patent 27253 of 1902 which describes the use of a closed resonant circuit coupled to the aerial for producing in the aerial forced oscillations of a single desired frequency.

The efforts of these inventors produced significant improvements but by no means totally solved the problem because it is difficult to eliminate completely unwanted frequencies from the oscillations of a spark gap transmitter.

Tesla's Patent 14579 of 1901 was one ingenious attempt to obtain absolute selectivity. The transmitter produced signals on two different frequencies and the receiver had two reception circuits tuned respectively to the two frequencies and coupled to a common relay. The idea was that the relay would only be actuated when both reception circuits were receiving simultaneously.

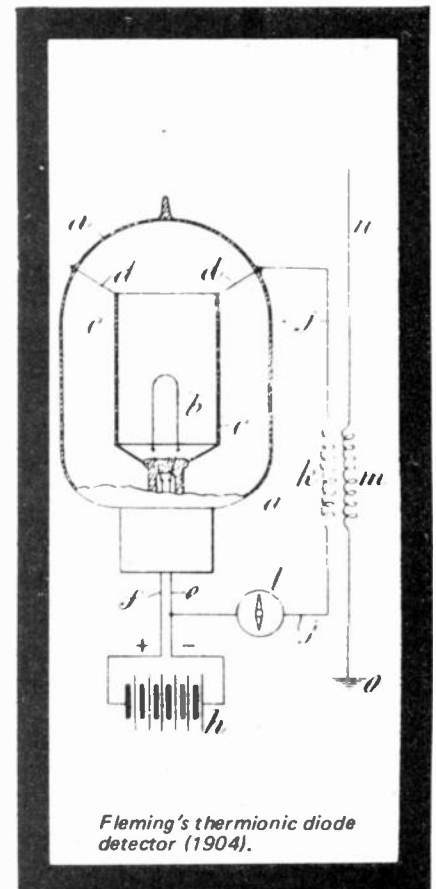

EARLY RADIO PATENTS

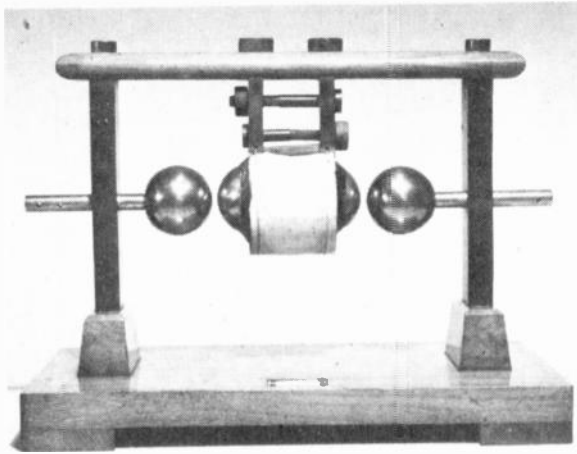

This spark-gap was used by Marconi in many of his early experiments.

Other patents were concerned with improving the method of spark production. Patent 29142 of 1904 (J.S. Stone), for example, describes one kind of multiple spark gap used to facilitate 'quenching' of the spark whereby a more rapid rate of sparking could be achieved. In patent 17706 of 1902, Fessenden described a system for "continuous transmission and reception of electromagnetic waves or impulses and modifying or changing the character of such waves or impulses without interruption of continuity", in other words telephony using a continuous wave carrier. Fessenden produced his 'continuous' wave by replacing the usual induction coil and 'trembler' of the transmitter with a high frequency alternator and a transformer. With Fessenden's system the goal of continuous wave production was closely approached and it therefore became possible to achieve sharper tuning and to transmit telephonic messages satisfactorily. By

1907 Fessenden was able to broadcast over 160 km with his system.

The key to an alternative method of approaching the goal of continuous wave production was given patent 21629 of 1900. In this patent, Duddell described the use of an electric arc to convert dc into ac. This came to be known as the 'musical' or 'singing' arc. This idea was taken up by Poulsen (in patent 15599 of 1903) for use in generating radio waves and was soon competing for popularity with the Fessenden system. By 1910 telephonic signals had been transmitted 800 km using the Poulsen system.

IMPROVING THE DETECTORS

At the same time, inventors were directing their attention to the development of improved detection devices and in particular to the development of detection devices suitable for receiving telephonic transmissions.

Popov was an early contender. In his

patent 1797 of 1900 he described an improvement on the Branly coherer.

In 1902 in patent 10245, Marconi described his famous magnetic detector which worked on quite different principles from the coherer. In one form of the magnetic detector, an endless iron band is moved through two adjacent coils in a magnetic field. One of the coils is connected to an aerial and earth and the other is connected to a telephone receiver. Received signals act to vary the magnetic coupling of the coils and thereby produce a current flow in the telephone receiver.

Patent 12119 or 1903 describes the use of an electrolytic cell comprising (for example) platinum wires immersed in sulphuric acid. Received signals disturb the cell equilibrium and vary the resistance of the cell. This idea also appeared in Fessenden's patent 28291 of 1903 and Fessenden's device, known as a liquid barreter, became widely used. The electrolytic detector was important because of its great sensitivity.

Patent 17396 of 1902 relates to an arrangement of steel rods with oxidised tips resting on a steel plate. Patent 8659 of 1906 describes a crystal type detector using a natural manganese compound such as psilomelane. Patent 5332 of 1907 is concerned with a carborundum detector, patent 18842 with silicon, patent 21408 of 1907 with copper oxide, patent 10772 of 1909 with iron pyrites and patent 22164 of 1910 with lead ore. The list is virtually endless, these are but a few examples.

In patent 29143 of 1904, J.S. Stone describe the use of a bolometer and patent 25645 of 1904 is concerned

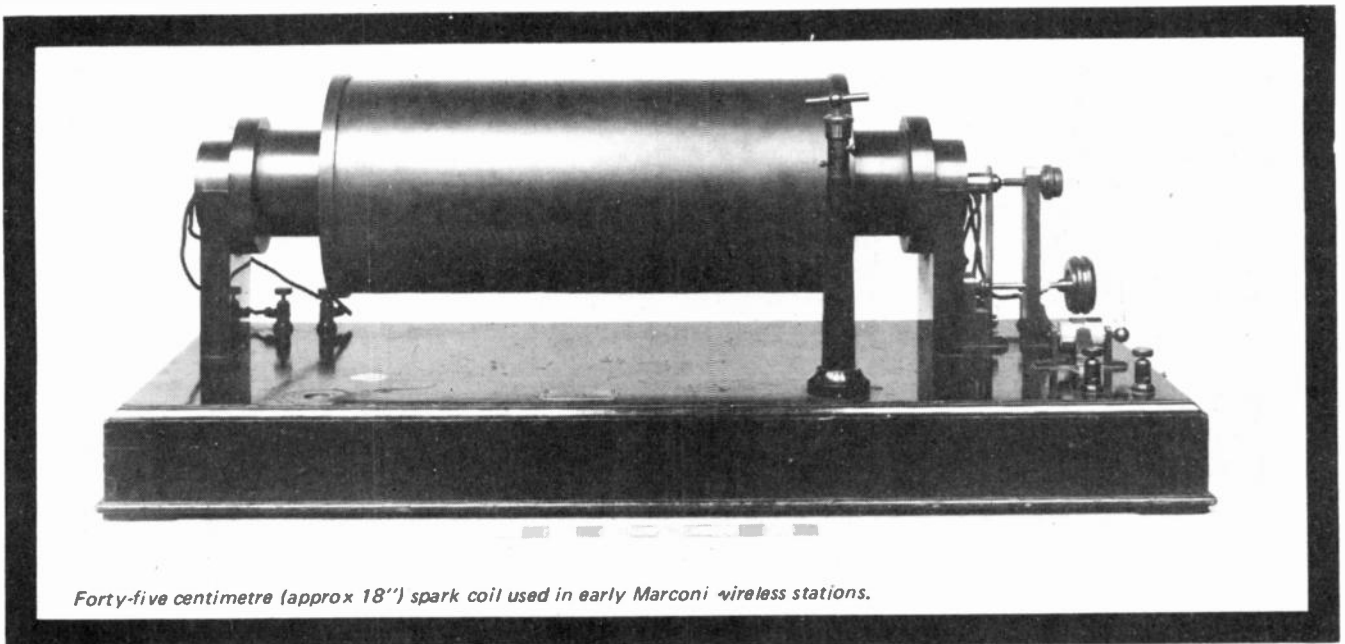

Forty-five centimetre (approx 18") spark coil used in early Marconi wireless stations.

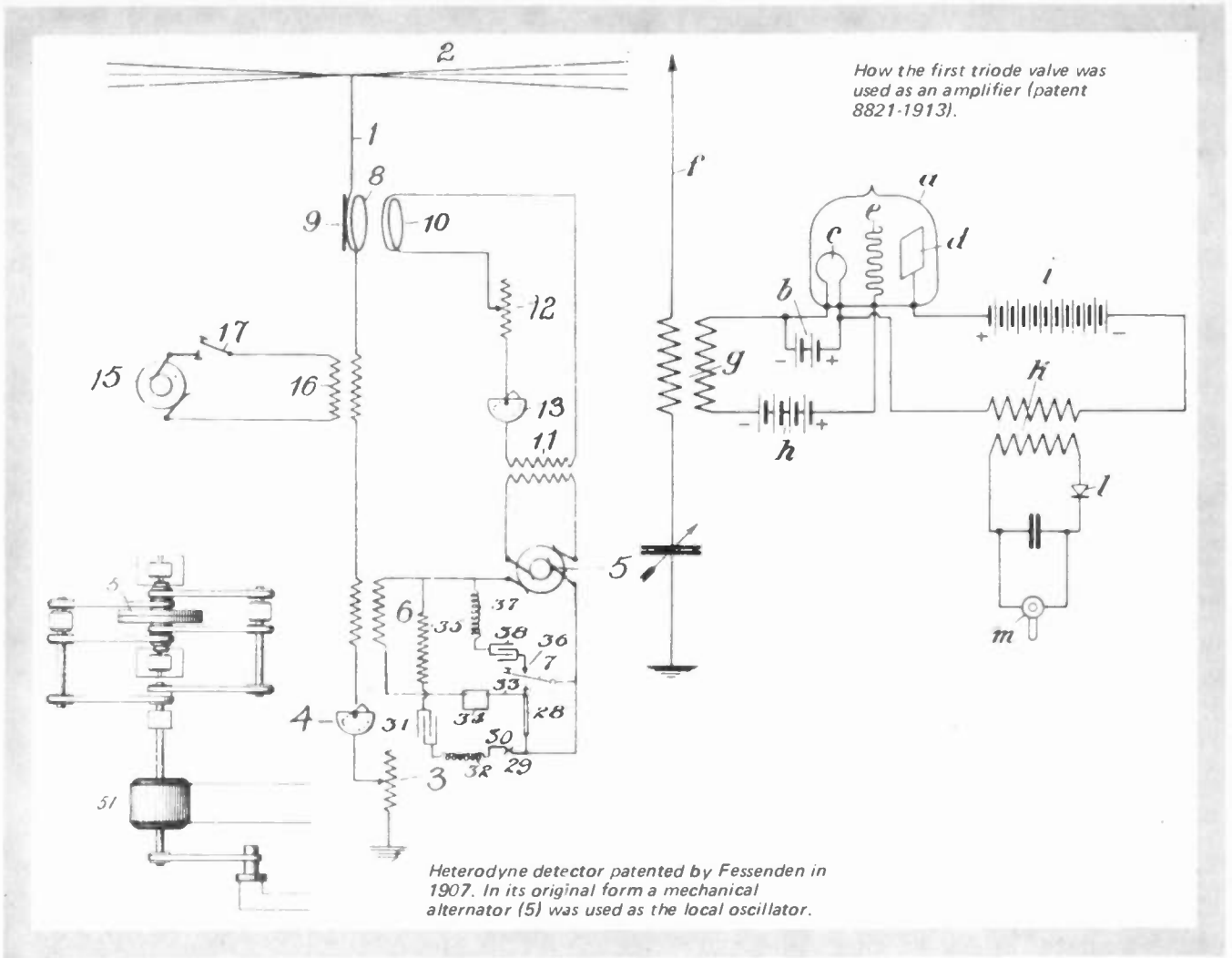

with the use of a thermocouple as a detector.

In patent 6203 of 1907, far before its time, Fessenden described a heterodyne detector in which locally generated oscillations beat with the incoming signal to produce an audible tone. Fessenden had to wait another six years for the thermionic valve as a generator of oscillations to be developed before this became a practical proposition.

VALVES

In 1904 vacuum tube devices were being investigated as a means of detection. Patent 27887 of 1904 describes the use of a mercury arc lamp, received signals being used to trigger the arc, and patent 13736A of the same year relates to the use of a neon lamp. In patent 24850, following the discovery of the 'Edison Effect' some 20 years earlier, Fleming described the use of a high vacuum thermionic diode, the first true valve. Two years later, in patent 5258, de Forest described a circuit employing a diode type 'ionized gas' detector and subsequently, in 1908 he described in

patent 1427 a circuit using not a diode but a modified form of the diode having an additional grid-like electrode between the anode and cathode.

The triode was born.

The triode was critical to the development of radio communications: it provided a convenient and effective means of generating oscillations and of amplifying weak signals. These possibilities were however by no means immediately recognised. The triode was originally devised as an improved means of detecting signals and it was some years later before its amplifying and generating properties were realised.

Insofar as amplification is concerned, this was a much considered problem and several proposals were made, before the triode was used as an amplifier, to achieve amplification by causing small electrical variations in one circuit to give rise to large electrical variations in a separate circuit.

In patent 4715 of 1907, for example, Fessenden proposed an amplification system using telephone receivers,

received oscillations "producing mechanical motion and said mechanical motion being caused to vary the resistance of contact of normally conducting contact surfaces." In patent 300 of 1911 an amplification system using a discharge tube is described, the discharge being influenced by a magnetic field the intensity of which is varied by the received signals. Patents 1482 and 2111 of 1911 relate to the use of a cathode ray tube for amplification purposes, the electron flow being influenced by the received signals. The use of the triode for amplification purposes is mentioned in Patent 8821 of 1913 which was granted to Gesellschaft fur Drahtlose Telegraphie mbH.

"The object of the present invention", asserted the patentee, is to provide an arrangement whereby vacuum tubes having glowing cathodes serve the purpose of strengthening the electrical oscillations without thereby giving rise to a change in their waveform owing to the valve action".

At about the same time, the idea of feedback was conceived and a number

[Advertisement]

BECOME A COLOR TV TECHNICAN

AND EARN MONEY THAT WILL MAKE YOUR FRIENDS GREEN WITH ENVY

Within months colour TV will be coming to Australia. It's a chance for you to get in on the ground floor, because there will be a huge demand for new sets and technicians specially trained in the field of colour TV servicing. Through ICS you'll get the necessary training to break into the industry. However, if you're already in the TV servicing field, you'll receive all the instruction necessary to prepare you for this coming revolution in home entertainment. As an engineer, technician or serviceman, there's a whole profitable new future about to open for you.

If you start learning now

With an ICS course you'll get expert tuition at home, in your own time. Mail the coupon and we'll send you a FREE ICS career program kit on this or any of the courses below. Mail the coupon TODAY.

- Hotel Motel Management
- TV Servicing - Colour
- Accountancy
- Bookkeeping, Costing
- Computer Programming
- Electronics
- Building & Architecture
- Quantity Surveyors,
- Carpentry
- Engineering
- Mechanical & Civil
- Chemical & Industrial
- Electrical
- Automotive
- Mechanical Engineering
- Panel Beating I.A.M.E.
- Business Management
- Small Business
- Industrial/Personnel
- Air Conditioning
- Refrigeration & Heating
- Sales & Marketing
- Creative & Professional
- Writing
- Secretarial
- Art

ICS Career Programs

International Correspondence Schools,
400 Pacific Hwy. Crows Nest,
N.S.W. 2065. Tel: 43-2121

*I am genuinely interested in starting
my new career as soon as possible.
Please express Career Program Guide
ticked.*

- TV Servicing Air Conditioning &
- Refrigeration Automotive Engi-
- neering Drafting Electronics
- Building & Architecture Writing
- Art

Mr./Mrs./Miss

Address

.....Postcode

Occupation

Age 06.01.26.UX

CONFIDENTIAL

EARLY RADIO PATENTS

of patents were granted, as for example 13636 of 1913, 28413 of 1913, 252 of 1914 and 24231 of 1914 which describe the use of feedback either to reinforce the amplification or to generate local oscillations for use in a heterodyne type detection system. In patent 13248 of 1914 the use of a triode to generate transmitting oscillations is described.

The valves used up to this time were quite different from those which eventually came into widespread use. They were not highly evacuated, and indeed patent 8821 of 1913, already

mentioned, refers to the triode as an 'ionized gas relay'.

Patent 15788 of 1914 sets the stage for the birth of modern radio with its description of the manufacture of 'hard' vacuum valves using the Gaede pump which was specially suited to the purpose and also chemical absorbants such as magnesium to remove the last traces of gas (and which produce the characteristic shiny metallic patches on valves).

(Drawings and photographs used in this article have been reproduced by courtesy of the Science Museum, London).

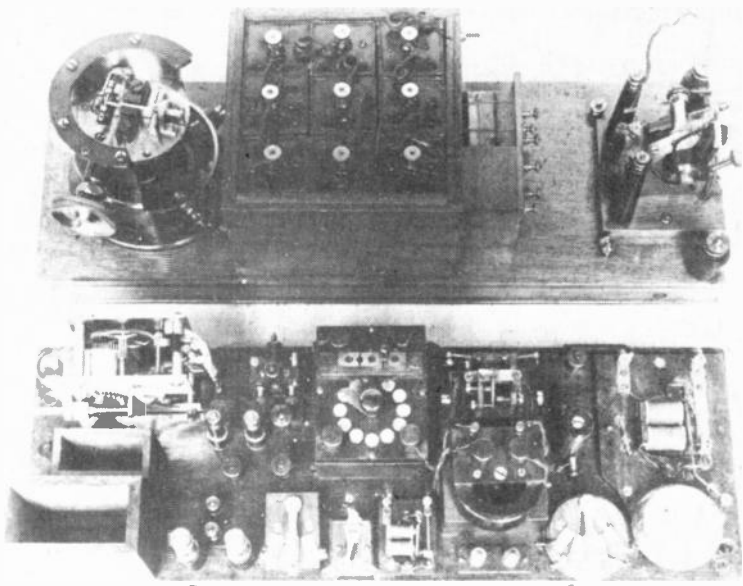
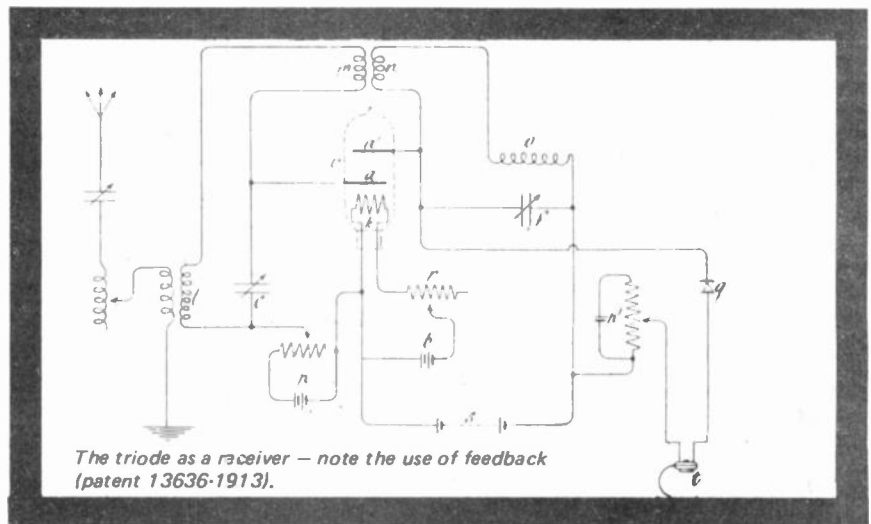

Marconi's & Lodge-Muirhead's early receivers.

The best of three worlds

Partners in Perfection



SHURE V15 Type III Super-Track Plus Cartridge

The sound of the V-15 Type III, paradoxically, is due in no small part to an absence of a sound of its own. In no way does it interpose itself upon the music. Thus, the resultant sound of the Type III is not "sweet," "mellow," or "brilliant"...it is the sound of the recording itself! Its truly flat, unaccented frequency response and extended dynamic range mean a hearable difference in all your recordings, old and new.

SHURE **SME**

Series II Pick-up Arm

No wonder it has been called "the best pickup arm in the world." The Shure SME Series II Improved combines flawless craftsmanship and unmatched precision with design improvements that reduce tone arm/cartridge system mass and friction to significantly lower levels. Ultra-low friction pivot points, with high-precision protected ball and knife edge bearings; arm deflects either vertically or horizontally with less than .020 gram force applied at stylus tip. Precisely accurate adjustments for every factor related to perfect tracking, including height, overhang, length, tracking force and bias (anti-skating).

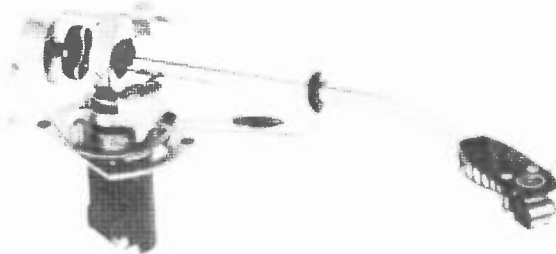

Technics SL120 ... the turntable with a heart

Unlike conventional turntables, the Technics SL120 has no mechanical speed reduction system such as fluttering idler wheels or vibrating belts which help cause annoying wow and flutter. Instead, the Technics SL120 turntable has a 'heart', a direct drive, 36 pole D.C. brushless motor rotating at exactly 33-1/3 and 45 R.P.M., which guarantees a wow and flutter less than 0.03% WRMS and a rumble better than - 65 dB (DIN A) - 70 dB (DIN B). The Technics SL120 is a true professional high fidelity turntable using a 13" dynamically balanced 3.9 lb aluminium diecast platter set directly on to the motor (the heart) assuring glide smooth rotation. Variable pitch controls, built in stroboscope speed indicator, deluxe plexiglass dust cover, adjustable audio insulated legs supporting a cast aluminium base, are just some of the advanced features. Without a doubt this is the finest turntable available today.

Arrow Electronics are proud to be associated with the "BEST OF THREE WORLDS". Indeed they are the "PERFECT PARTNERS" and an unbeatable combination for precision record playback.

All items may be purchased separately at "ARROW'S" usual keen prices, but do yourself a favour - purchase all three units and save even more.

Don't delay. Call, phone or write to us NOW.

Write now for details and your "Arrow Quote"

ARROW ELECTRONICS PTY. LTD.

342 Kent Street, SYDNEY — Telephone 29.6731.

For \$913.50* you can have music that sounds like a million.



SX-1010

Why the big price tag?

The SX-1010 is the most powerful two-channel receiver we've ever built. Designed to deliver an earth-moving 100 watts RMS per channel, the SX-1010 was created to surpass the demands of the most discriminating audiophile. In doing this, we've elevated music listening to an experience that goes beyond all previous norms. But, of course, the man who chooses this unit is above average as well.

Why the big power?

To deliver really big sound. Not just in loudness—that only hurts the ears. But, big in

realism of tonal quality. Big in purity of reproduction. And big in faithfulness to the original performance. A skillful blend of advanced electronic engineering and a delicate sensitivity to the needs of the inner man. After all, isn't that what you really expect from a piece of Pioneer audio equipment?

At Pioneer, we uphold that trust with almost 40 years of exclusive commitment to audio excellence. And from our vast resources as one of the world's largest audio companies, we are privileged to offer seven new two-channel receivers. They're all great. It's just that some of them are greater (and naturally more expensive). Which one you choose depends on how

demanding you want to be. Stop by and see your local dealer for a demonstration. You don't have to be a millionaire to listen to music like one. But, it helps.

PIONEER ELECTRONICS AUSTRALIA PTY, LTD.
256-8 City Road, South Melbourne, Victoria 3205
Phone: 69-6605
Sydney 93-0246, Brisbane 52-8213, Adelaide 433379, Perth 76-7776.

PIONEER
leads the world in sound.

*Recommended retail price

Career Opportunities for COLOUR TECHNICIANS

Large international marketing organisation with offices in all states invites applications from experienced Television Technicians with some knowledge of colour.

Company specialises in colour television only and is building a large comprehensive national sales and service network.

Opportunities will exist in each capital city but immediate requirement is for cities of Sydney, Melbourne and Brisbane.

For Sydney, workshop technicians will be required to work at area service centres located at Pagewood, Rydalmere and Greenwich.

For Brisbane area location will be Albion, and Melbourne location, Richmond.

Field Technicians will be required to operate from area service centres and will be provided with suitable vehicles.

- Training will be provided.
- Colour work on y
- Best salaries in industry.
- Immediate life cover and superannuation after qualifying period.
- Successful applicants will be brought to Sydney for training.
- Within reason candidates may choose location.

For interesting career opportunity apply:

Mr. "Berry" Beresford,
TRIDENT TELEVISION PTY. LTD.
152 Bunnerong Road,
Pagewood 2035. (Phone: 349-8888)

*trident colour
television* 

TAPE BIAS

What does it really mean?

by Len Feldman

THE INCREASING popularity of tape recorders as a high-fidelity programme source is not difficult to understand. Unlike other programme sources, such as FM radio and gramophone records, tape offers the audio enthusiast the sense of involvement that makes the hobby all the more worthwhile. In addition, today's open-reel tape decks have performance which is often indistinguishable from that afforded by professional studio tape recorders, and the once looked down upon cassette deck has been transformed from a portable "dictating machine" to a high-fidelity component.

With such a wide interest in tape and tape recording, it is surprising how little most users of these products know about their operation. Unlike purely electronic products, such as amplifiers, tuners or receivers, tape decks involve an inter-relation of mechanical, magnetic and electronic systems.

Today, most audiophiles have a fairly clear understanding of what record equalization is all about. In essence the bass is attenuated and treble accentuated during recording — the opposite takes place during reproduction. The overall effect is to reduce groove amplitude and increase record playing time. It also improves signal/noise ratio. The record industry

have an agreed standard for equalisation. This is called the RIAA curve (Fig. 1). The amplifier or preamplifier spec sheet has drummed home the idea that the closer a phono preamp adheres to the RIAA playback curve, (shown in Fig. 1), the better the product.

Equalization is also required for tape recording. But there is no one standard here, each tape requires different equalization for optimum results. Why should this be so? Why cannot the industry "get together on a single, standard equalization" for tape recording and playback. Why, in fact, are better recorders (both open-reel and cassette) equipped with multiple equalization settings? And what about those multiple bias settings on some of those same recorders?

EQUALIZATION

To begin with, a tape recorder does not reproduce signals with a flat frequency response. A tape playback head, being sensitive to the rate of change of a magnetic field, produces a greater output as frequencies increase. (At higher frequencies, alternations of magnetic field become more rapid). Thus the output voltage increases with frequency as illustrated in Fig. 2. Eventually, the level ceases to increase with frequency and, in fact, begins to drop off fairly rapidly.

Two factors are responsible for this drop off. As the frequency to be recorded increases, the wavelength decreases. In addition, as magnetic variations increase in intensity, a point is reached where the tape begins to be saturated — it cannot accept greater and greater amounts of magnetization — and level begins to drop. The second of these factors is, to some degree, governed by the formulation of the tape itself, while the first is governed primarily by tape speed and the gap length of the tape head. Figure 3 illustrates how the linearly increasing voltage output varies with popular tape speeds for a given tape head gap (4 microns), while Fig. 4 shows how linear output can be extended to higher frequencies at a given tape speed by decreasing the tape head gap.

Obviously, none of the curves of Figs. 2, 3 or 4 would be acceptable for high-fidelity reproduction. The process used to restore "flat" response in tape recording and playback is called

equalization. Equalization can be applied both during the record operation and during playback. Referring again to Fig. 2, if during playback the response curve of Fig. 5 is used, the resulting overall record/playback response will be as shown in Fig. 6. Note that there is still some roll-off at low and high frequencies.

RECORD EQUALIZATION

In order to realize optimum high-frequency response, equalization is used in the record process, too. Record equalization can offset high-frequency roll-off to some degree, but if too much high-frequency pre-emphasis is used, the tape will become saturated at lower nominal recording levels and distortion and roll-off will occur anyway. Playback equalization can in theory, be used to extend high-frequency response but if highs are boosted too much during playback, increased tape hiss will be heard. The record and playback curves must therefore strike a balance to minimize problems of each.

In professional recording work,

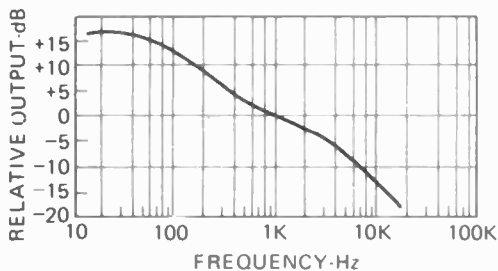

Fig. 1. Standard RIAA playback curve used for phono disc reproduction.

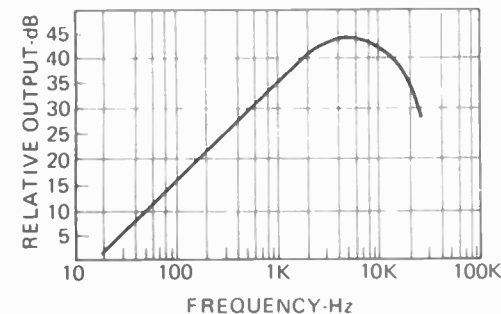

Fig. 2. Typical tape playback head output with constant-level signal recorded on tape.

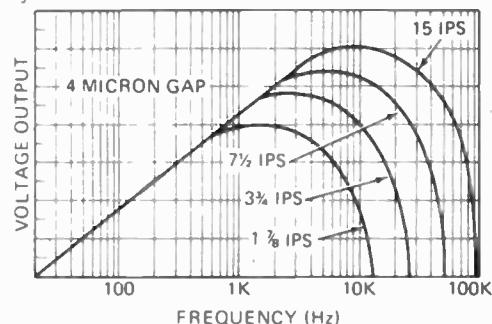

Fig. 3. Linear increase in output voltage extends to higher frequencies at increased tape speed.

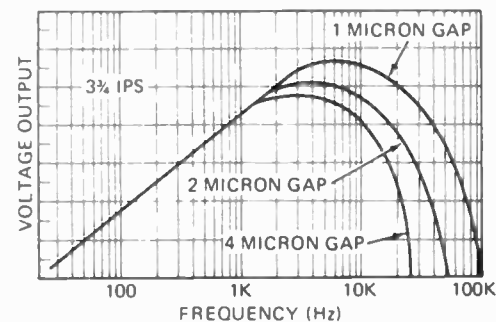

Fig. 4. Reducing playback head gap while maintaining constant tape speed will extend the high-frequency response.

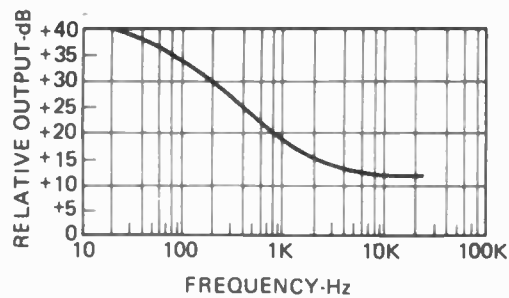

Fig. 5. Typical playback equalization in tape deck preamp circuitry.

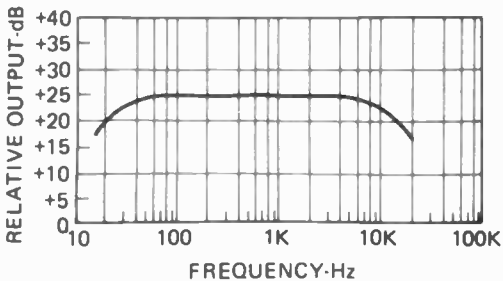

Fig. 6. Combining recording response (Fig. 2) with equalized playback response (Fig. 5) results in overall record/play response shown.

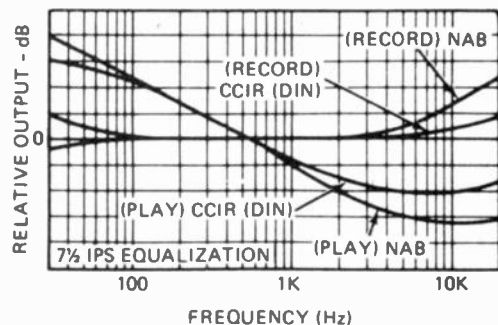

Fig. 7. Record and playback equalization standards adopted by the NAB and European standards organizations.

standards of record and playback equalization were developed by the NAB (National Association of Broadcasters) and the German Standards organization known as DIN. These standardized curves are plotted in Fig. 7. The DIN or CCIR curves tend to strive for higher frequency response. By using a bit less record equalization, tape saturation is not reached as soon. But this requires more playback equalization which results in higher tape hiss.

In the consumer audio field, manufacturers often change their equalization curves to offer "extended response" which seems to be the sole criterion by which many audiophiles judge tape deck performance. With a given tape speed and a given head gap, however, such "improvements" are invariably accompanied by either reduced level of recordings or increased tape hiss or combinations of both.

In general, frequency response curves for tape equipment are plotted not at 0 dB level on the record level meters but at a level of -10 dB or even -20 dB in the case of open-reel machines

and at -20 dB or even -30 dB in the case of slower-speed cassette decks (which require greater high-frequency boosting during recording to compensate for reduced tape speed.) Some years ago, the industry introduced chromium dioxide tape. It delivers somewhat higher frequency before saturation drop-off occurs. This characteristic produces a slight increase in high-frequency response or for improved signal-to-noise ratio (reduced tape hiss) or a combination of both.

Today, there are a great many different tape formulations, each of which requires a different record and playback equalization. Multiple switch positions are provided on many open-reel and cassette decks which adjust equalization to suit the various popular formulations. Actually, professional machines used in recording studios are often adjusted to work best with one and only one brand and type of recording tape. Conscientious studio engineers may even re-calibrate or adjust equalization when different production batches of the same brand and type of tape are used. The very least that a home user can do to ensure optimum results with an open-reel recorder or better cassette unit is to follow the manufacturer's recommended equalization settings for the type of tape being used. Most owner's manuals list a variety of tapes and their appropriate settings for machines equipped with more than one equalization switch position.

BIAS

Assuming that both recording and playback equalization have been optimized with respect to each other in a given recorder, one would expect that the magnetic pattern recorded on the tape will now correspond exactly to the strength of magnetic fields generated by the record head. Unfortunately, magnetic tape is basically a non-linear medium. The magnetic pattern left on the tape is not always proportional to the instantaneous current in the recording head. The greatest amount of non-linearity occurs as the audio waveform passes through the zero axis, as shown diagrammatically in Fig. 8. Hysteresis effect, a sort of magnetic inertia, acts upon the particle as magnetization begins. After this initial reaction, the particle responds linearly to the applied field. If nothing were done to offset this effect, a sine wave recorded onto tape as shown in Fig. 8a would take on the appearance of Fig. 8b when played back. Obviously, this is a form of distortion and, what is worse, it is a very annoying form of distortion containing high order harmonics. Furthermore, it is a form of distortion that actually is more

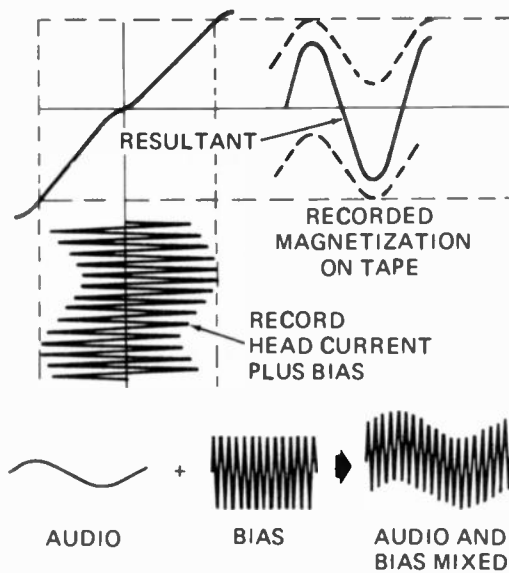

disturbing at low recording levels than at high signal levels, since the distortion components remain constant and therefore constitute a higher percentage of the total signal at lower recording levels.

High-frequency bias current is used in all modern recorders to overcome this problem. Generally, this super-audible frequency should be at least four times the frequency of the highest audio signal to be recorded,

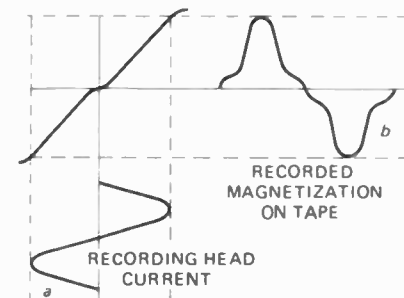

Fig. 8. Distortion caused by non-linear magnetization characteristics of tape is similar to crossover distortion encountered in improperly biased Class B audio amplifiers.

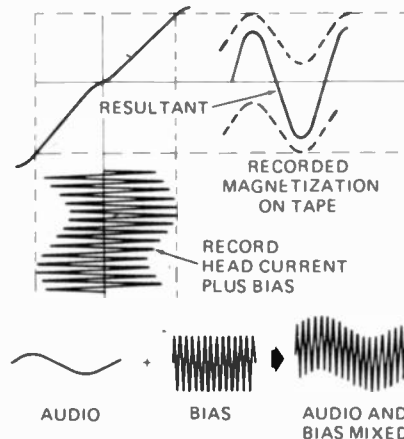

Fig. 9. Combining high-frequency bias with desired audio signals during recording shifts audio magnetization of tape to its linear undistorted region.

TAPE BIAS

but open-reel recorders will often employ bias frequencies of the order of 100 kHz to 125 kHz while modern high-quality cassette units use frequencies in the range from about 80 kHz to 105 kHz.

The combined action of the desired audio signal and inaudible bias signal can best be understood by referring to Fig. 9. The bias current magnetizes the oxide particles through the non-linear segment of the curve. Then the audio signal actually demagnetizes the

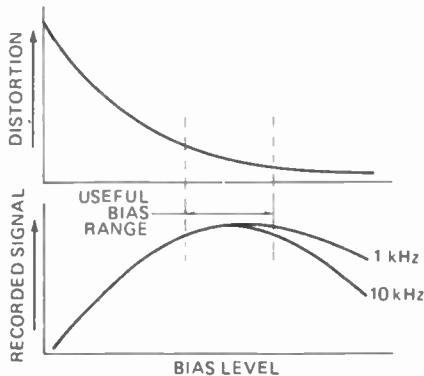

Fig. 10. Increasing bias level reduces distortion, but overbiasing will reduce high-frequency response.

particles to a level which is proportional to the signal.

Bias level changes will affect distortion level. Generally, as bias level is increased (starting from no bias) distortion will decrease rapidly at first. With further increase of bias level, distortion decreases more slowly. If bias is increased much beyond this desired point, high-frequency response will get poorer. Ideally, bias should be set as high as possible without causing severe high-frequency losses in the recorded tape. The action of bias in relation to distortion and high frequency response is shown in the general curves of Fig. 10.

Audiophiles who learn of bias for the first time often wonder why the high-frequency bias signal is not recovered as part of the playback signal. In fact, the bias signal does record a series of magnetic fields of its own, but their wavelength is so short that no playback head, however narrow its gap, can significantly respond to these high frequencies. Some small high-frequency energy is picked up by the playback head (however many dB down it may be compared to desired audio signals) and is one of the reasons why higher than necessary frequencies are now used for bias.

Much home recording is done of

stereo FM programmes and stereo composite signals contain varying amounts of 38 kHz signals in their output. If, for example, 45 kHz were used as a bias frequency in tape decks, a distinct 7 kHz "whistle" might be heard when playing back such recorded stereo FM programmes, resulting from the beat or difference between the two otherwise inaudible high-frequency signals.

Since oxide formulations vary greatly from one tape type to another, each requires a different bias level. For this reason, home tape recorders now come equipped with separate bias switches to match the various bias requirements of different tapes. In the case of professional machines, bias adjustment is usually continuously variable and professionals will often apply a slight amount of excess bias. This practice can reduce recording drop outs that sometimes occur because of poor or non-uniform dispersion of oxide particles on the tape surface. Again, the professional recording engineer will often choose a slight reduction of high-frequency response if that choice means reduced overall distortion and the elimination of other bias related problems.

Reproduced by arrangement from Radio Electronic's, May 1975*

6 EASY STEPS TO GOOD AUDIO!

TYPE	min.Watts		SUPPLY volts	Printed Bd. numbers
	4 Ω	8 Ω		
TA3C	3	-	13.2	370105
TA5B	8	5	25	339250
TA10B	13	10	32	339250
TA15B	18	15	38	339250
TA20C	30	20	±22	339771
TA25C	35	25	±24	339771
Preamp	-	-	-	339251

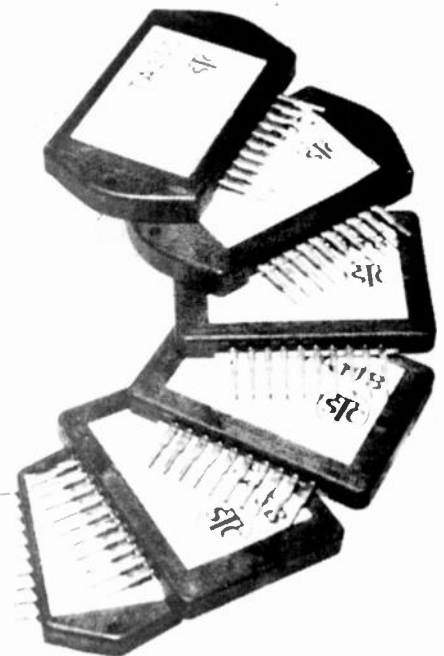

Semiconductor Division

STC-CANNON COMPONENTS

Moorebank ave. Liverpool NSW 2170

6020333
SYDNEY

951566
MELB.

FANE



HI-FI LOUDSPEAKERS FROM ENGLAND

10" The model B101/10LR is a 10" loudspeaker with a 2" voice coil working within a 10,000 gauss magnet structure, total flux 100,000 maxwells. The free air-resonance of the loudspeaker is 25Hz thus making it suitable for a small sealed cabinet of between 1½ and 2 cu.ft.

Efficiency is higher than might be expected from a sealed cabinet and power handling is 20-25 watts r.m.s. **\$34.50**

12" The model B122/10LR is a 12" bass speaker featuring a rubber suspension which allows a fundamental resonance of 17Hz in free air. This low-resonance, combined with a 2" voice coil working within a carefully selected magnet structure makes the speaker ideal for a sealed cabinet of about 2 cu.ft. capacity. Efficiency of the B122/10LR is surprisingly high for this type of loading and the speaker is ideal for amplifiers with an output of 20-25watts r.m.s. per channel at 8ohms. **\$39.50**

12" The model B122/12LR, like the B122/10LR described above, is also suitable for sealed cabinets but because of its more powerful magnet structure a volume of about 3 cu.ft. is required to ensure the speaker gives its optimum performance. **\$49.50**

15" The Fane model B152/12LR is a 15" bass driver with a fundamental resonance of 15Hz in free-air. Once again a sealed cabinet provides ideal loading for this unit and the volume can be varied from 3 to 5 cu.ft. The performance in 5 cu.ft. is particularly outstanding as the resonance is kept in the region of 30Hz. This results in firm, non-resonant bass without any of the "boxiness" often associated with conventional speakers. Efficiency is reasonably high and power-handling is up to 30watts r.m.s. at 8ohms. **\$59**

5" The Fane 505 x 5" mid-range loudspeaker employs a special cone material which is doped to remove any irregularities in response. Useful frequency range is 400-4,000Hz and sound quality is very neutral. **\$24.50**

1" The Fane 1" Dome Tweeter DD1 is a newly developed soft-dome tweeter with a useful frequency response from 4,000Hz to 20,000Hz. Efficiency is medium to high. **\$23.50**

FANE PUBLIC ADDRESS & MUSICAL INSTRUMENT UNITS

12" CRESCENDO 12A — Super High Efficiency, Wide Frequency Response and 100 Watt r.m.s. power handling. This beautifully finished loudspeaker is particularly suitable for lead guitar, organ and public address work. VOICE COIL DIAMETER: 2", FLUX DENSITY: 20,000 Gauss, IMPEDANCE: 8 ohms. **\$79.00**

15" CRESCENDO 15/100 BASS. Specially designed for high power, high efficiency bass performance. This magnificent unit is rated at 100 watts r.m.s. and has a resonant frequency of 40Hz. VOICE COIL DIAMETER: 3", FLUX DENSITY: 15,000 Gauss, IMPEDANCE: 8 ohms. **\$99.00**

920 HORN UNIT. This unit has just been released on the Australian market and features super high efficiency of 109 dB and power handling of 100 Watts r.m.s. above 600 Hz. VOICE COIL DIAMETER: 2", FLUX DENSITY: 20,000 Gauss, IMPEDANCE: 8 ohms. **\$149.00**

12" POP 50. A general purpose 50 watt r.m.s. loudspeaker of high efficiency, but economically priced. VOICE COIL DIAMETER: 2", FLUX DENSITY: 13,000 Gauss, IMPEDANCE: 8 ohms. **\$39.50**

18" POP 100 An outstanding 18" bass loudspeaker for musical instruments, the POP 100 handles 100 watts r.m.s. at high efficiency. Resonant frequency is 55 Hz. VOICE COIL DIAMETER: 3", FLUX DENSITY 14,000 Gauss, IMPEDANCE: 8 ohms. **\$79.00**

NEW 'CHALLENGE FLH SPEAKER SYSTEMS

Based on the range of Fane low-resonance bass speakers from England, this new series of Challenge loudspeaker systems is characterised by clean, firm, non-resonant bass, and clear, open mid-range as well as crisp, widely dispersed high frequencies. Crossover frequencies are 500 Hz and 5 KHz and the rate of roll off is 12 dB/octave. A special feature incorporated in all models is the twin L-pad constant impedance volume controls which allow the listener to adjust the mid-range and treble response individually to suit the acoustics of the room. The 5" mid-range loudspeaker is manufactured by a leading German company and is of the highest quality. The 1" aluminium dome tweeter is produced by a progressive Japanese manufacturer and is very flat in response as well as exhibiting excellent dispersion characteristics. The FLH series are guaranteed against faulty workmanship for 12 months.

CHALLENGE FLH-1

10" Bass, 5" mid, 1" dome. Cabinet size: 25" (H) x 14½" (W) 12½" (D). frequency response: 30 — 20 kHz; power rating: suitable for amplifiers with a power output up to 30 watts rms per channel at 8 ohms, 1000Hz.

price: **\$269** per pair



CHALLENGE FLH-2

12" bass, 5" mid, 1" dome. Cabinet size: 29" (H) x 17½" (W) x 12" (D). frequency response: 25 — 20 kHz. power rating: suitable for amplifiers with a power output up to 30 watts rms per channel at 8 ohms, 1000 Hz.

price: **\$299** per pair



CHALLENGE FLH-3

15" bass, 5" mid, 1" dome. Cabinet size: 32½" (H) x 20½" (W) x 15 3/4" (D). frequency response: 20 — 20 kHz. power rating: suitable for amplifiers with a power output up to 35 watts r.m.s. per channel at 8 ohms, 1000 Hz.

price: **\$399** per pair



NEW CHALLENGE TURNTABLE SEMI-AUTOMATIC BELT-DRIVE

\$129



- * The automatic arm return is achieved by a very simple and effective mechanism which ensures years of trouble free operation.
- * Oil damped cueing lever permits instant selection of any record track without having to reject the tone arm.
- * Heavy cast platter, belt-driven by a synchronous motor, reduces rumble, wow and flutter to negligible proportions.
- * Tone arm features anti-skate, lateral balance and removeable headshell fitted with magnetic cartridge. Fully adjustable counter balance weight with independent scale allows easy adjustment of stylus pressure.
- * All connecting cables and plugs are fitted to the turntable.
- * 12 month guarantee.
- * Supplied with walnut base and hinged tinted perspex cover.

SPEAKER GRILLE CLOTH

An attractive selection of speaker grille cloths are available ex stock at very reasonable prices. Free sample pieces are available on request and will be forwarded per post anywhere in Australia together with our price list.

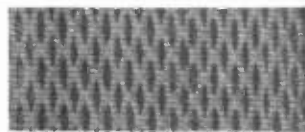

Challenge

HI-FI STEREO PTY LTD

96 PIRIE ST.
ADELAIDE
Sth. Aust. 5000
PHONE: 223 3599

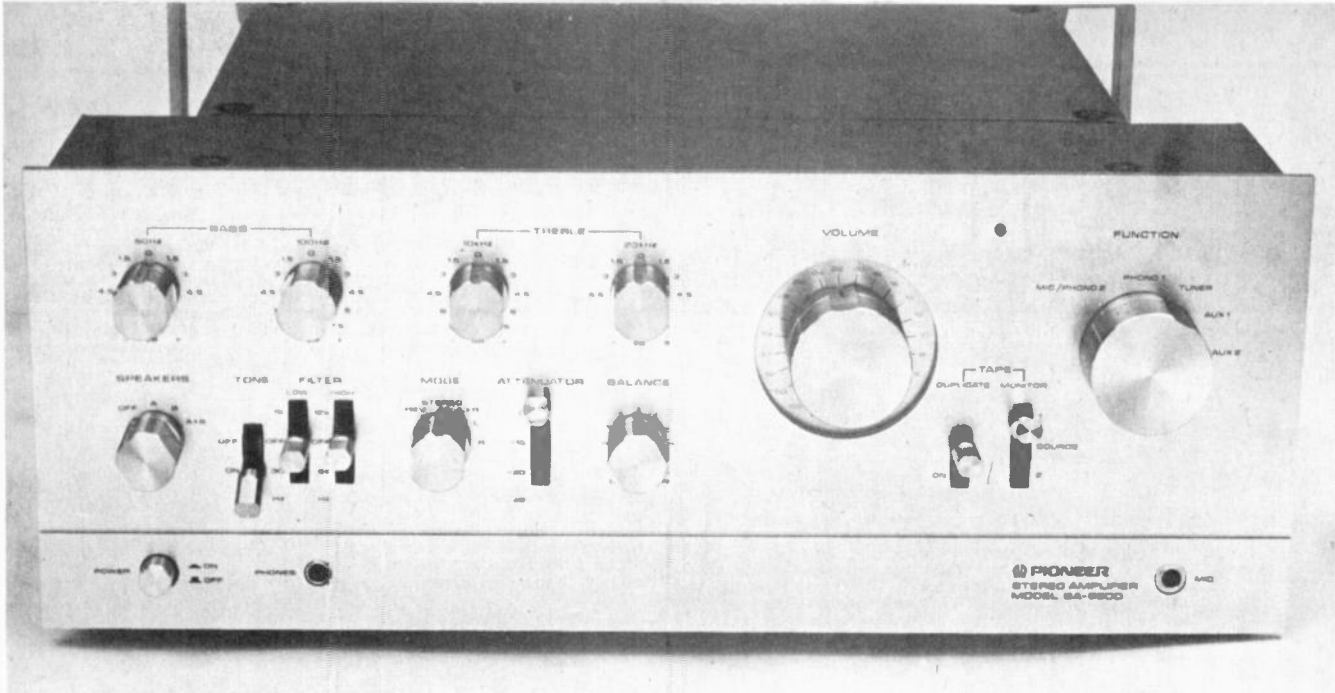

ET PRODUCT TEST

Price: \$929
Recommended Retail.

PIONEER SA 9900 AMPLIFIER

120 watts per channel and many new features

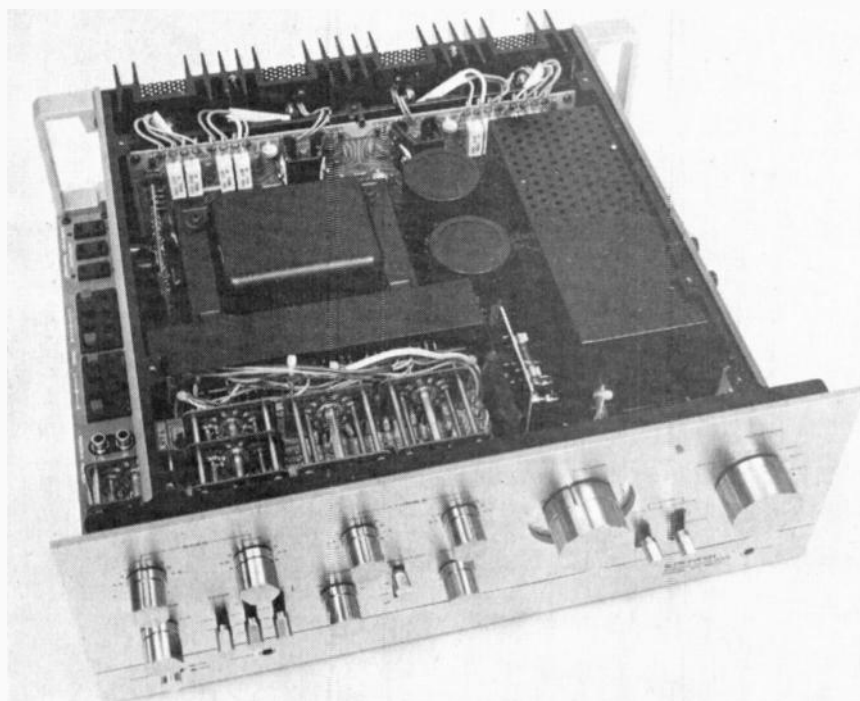

The amplifier is extremely well engineered as this photo shows. Note the outlets and inputs down each side.

THE TREND over the past three years amongst the biggest and best known names in high fidelity equipment has been to produce bigger, and most certainly better, amplifiers. The SA9900 is undoubtedly Pioneer Electronic Corporation's answer to such amplifiers as the Crown, Phase Linear and Marantz.

Previously, the most powerful amplifier Pioneer produced was the SA1000 which was undoubtedly, as we have found in our own laboratory, a particularly good amplifier. It has excellent characteristics including that very essential ability to stand up to continuous overloads and short circuits.

Whilst the Pioneer SA1000 and many other similar types of integrated preamplifier/amplifiers are obviously designed for a consumer market, the SA9900 stands head and shoulders above its predecessor, and many of its contemporaries, as being only what we can describe as an engineer's amplifier.

The reasons for this statement may appear, at first sight, hard to justify,

but in fact a close look at the ergonomic design, facilities provided, and precision with which the inbuilt characteristics are maintained, make this a state-of-the art amplifier.

Obviously, the heart of the system is the power amplifier whose noise, distortion, intermodulation distortion, and overall power capacity are particularly good and conservatively rated. What the intending user sees are the frontal controls which would be equally well suited to an acoustics laboratory, sound studio, or a high-fidelity enthusiast's home.

APPEARANCE

The SA9900 has a most unusual appearance. Firstly, unlike previous Pioneer amplifiers, it has apparently been designed for building in, or for shelf mounting, rather than as a decorative item in a furniture finish cabinet. The second thing that one notices is that this is a particularly large amplifier with dimensions of 420 mm wide, 165 mm high, and 403 mm deep. The third and most significant difference between it and other amplifiers is its rear appearance which is all heatsink. As the photograph shows, the unit has lead wire guides (that double as lifting handles, although the handbook says they shouldn't) on either side of the rear of the amplifier. On the shelf on each side, are two rows of input and output terminations which overcome the nasty problem, from which we have all suffered, in trying to make connections to an amplifier on a bookshelf where all the terminations are at the rear. This clever piece of ergonomic design in an integrated amplifier is sensible and should be highly lauded — (Why didn't somebody think of it before?)

THE CONTROLS

The designer or designers of this amplifier have spared no effort it would appear, in overcoming the major deficiencies which have been a feature of power amplifiers for many years.

The front panel features a satin aluminium finish similar to the old Pioneer SA900 series amplifier with black engravings instead of the more common paint-stencilling type process which looks almost the same but is not nearly as durable.

The controls are arranged in three rows, which from left to right for the top row are: two bass controls with respective cut-off frequencies of 50 Hz and 100 Hz calibrated 1.5 decibels per step (0, ± 1.5, ± 3, ± 4.5).

Next to these are two treble controls with 10 kHz and 20 kHz cut-off

MEASURED PERFORMANCE OF PIONEER MODEL SA9900 SERIAL NO: VB9300232M

POWER OUTPUT (at clipping point)	166.5 watts (L) 190.1 watts (R) (both channels driven into 8Ω loads)
FREQUENCY RESPONSE:	20 Hz — 20 kHz ± 0.2 dB at all power levels
HUM & NOISE:	Phono 1 & 2 — 70 dB Tuner, Auxiliary — 95 dB (A-weighted)
TOTAL HARMONIC DISTORTION:	At rated output, both channels driven
	100 Hz 0.031%
	1 kHz 0.021%
	6.3 kHz 0.025%
	At 1 watt output
	100 Hz 0.049%
	1 kHz 0.020%
	6.3 kHz 0.028%
N.B. Measuring System Distortion	100 Hz 0.030%
	1 kHz 0.018%
	6.3 kHz <0.010%
DIMENSIONS:	420 mm x 165 mm x 403 mm
WEIGHT:	19.6 kg

frequencies, five steps of 1.5 decibels for the 10 kHz and three 1.5 decibel steps for the 20 kHz tone control. The accuracy of these controls was measured and found to be accurate to better than 0.2 dB.

In the row immediately below these four tone controls are the speaker switch having an off-position (which still allows listening through headphones) and three positions of Speaker System A, Speaker System B, and A + B. Next to this is the tone control on-off switch which defeats the settings of the four tone-control knobs, immediately above, so that a true flat response can be achieved at the flick of a switch.

On the right hand side of this is a high-pass filter with roll-offs of 12 decibels per octave for selectable cut-off frequencies of 15 Hz or 30 Hz. This helps overcome rumble problems and protects the amplifier or speakers from low frequency transients (like dropping your tone arm on top of a record).

Adjacent to this is a low-pass filter with 12 decibels per octave attenuation for selectable cut-off frequencies above 8 kHz or 12 kHz. Next in line is a mode switch for reverse, normal stereo, left channel combined with right channel, left channel, or right channel.

Adjacent to this is an attenuation switch with zero attenuation, —15 dB

and —30 dB position. The last control in this row is a balance control providing full balancing control for either channel in the stereo mode (+3 to —90 dB).

On the left hand side of the centre line is a rather large and obvious volume control which has calibrated settings from infinity to 0 dB insertion loss and indent positions to correspond with each of the calibrations on the dial. The actual figures achieved show a remarkably good correlation with quoted attenuation settings, being a maximum of 2.6 dB out at any single position and a relative error of less than 0.2 dB at most positions.

Between this and the major function control on the extreme right hand side of the amplifier is a tape duplicate switch which is employed when two tape recorders are used to duplicate or edit tapes, together with a tape monitor switch to allow monitoring of the output of tape recorder 1, source material, or tape recorder 2 when utilising one or two tape recorders. At the extreme right hand side is the function switch which provides for inputs from microphone or Phono 2 input, Phono 1 input, tuner input, or two auxiliary inputs.

The bottom row of the amplifier has at one end, an on-off pushbutton switch and a headphone output for tip

PIONEER SA 9900 AMPLIFIER

ring and sleeve standard headphones, whilst at the extreme right-hand end is a microphone jack to accept an input from a tip-and-sleeve microphone having an input impedance of up to 85 k Ω .

FACILITIES

On the right hand side of the amplifier there are coaxial inputs for the two phono inputs, tuner, two auxiliaries, and two tape recorder input and output lines, together with an impedance adjusting control for impedances of 35, 50, 70 and 100k Ω , and a level control having 0 to 12 dB

attenuation for Phono 2 or microphone input.

On the left hand side from rear to front are respectively, one unswitched and two switched mains sockets of the parallel pin type, the eight speaker lead terminations for the four loudspeakers that can be connected to the amplifier, and a pair of left channel, right channel coaxial input outputs on the main power amplifier input and the preamplifier output, together with a switch for separate or connected preamplifier, main power-amplifier connection.

Pioneer have dropped the use of

polarised plugs and sockets for connecting speakers, and have converted to the system that other manufacturers have utilised. That is, a captive receptacle system and release buttons for making electrical connections to bared speaker leads.

The back of the amplifier is taken up by a large, single-piece heat sink which is so obviously necessary to cope with the extremely-high thermal dissipation with which this amplifier has to cope at peak output. The design of this heat sink is particularly novel as, in addition to catering for the eight large power transistors, type numbers 2SC116A and 2SA747A, it also forms the back panel of the amplifier. Even the transistors themselves, which are of course live, are protected by clever perforated-metal inserts which are retained by slots in the heat sink in the lateral plane, and by the top and bottom covers of the amplifier in the vertical plane.

Immediately behind these are located the two main power amplifier stages which are directly connected to the transistors on the heat sink.

The driver transistors and their thermal cut-out protection circuits are mounted on unusually shaped heat sinks in such a way as to provide good thermal equalisation between each of the individual transistors.

In typical Pioneer manner the printed circuits show the position of transistors, copper laminate, and components with extreme clarity on the reverse side of each board, and maintenance would be particularly simple.

In the centre of the chassis is mounted a very large power transformer, two large electrolytic capacitors, and two relays. One of these relays is incorporated in the electronic circuitry that protects the output stage in the event of inadvertent short circuit or continuing overload. The other is part of a circuit which delays the connection of the load to the amplifier until the operating conditions have stabilised, thus eliminating those annoying loudspeaker "thumps".

The preamplifiers are located on the right hand side of the chassis immediately behind the input sockets in a screened cover. At the front of the chassis behind the front panel are located the extremely neat and well-designed tone-control circuits. Their two layers of printed-circuit card attenuators are linked to the switch bank contacts by printed circuit switches.

The main rectifier power supply is worthy of comment as it features dual diodes in a common package to facilitate mounting on a particularly simple heat sink.

The main attenuator comes in a fully

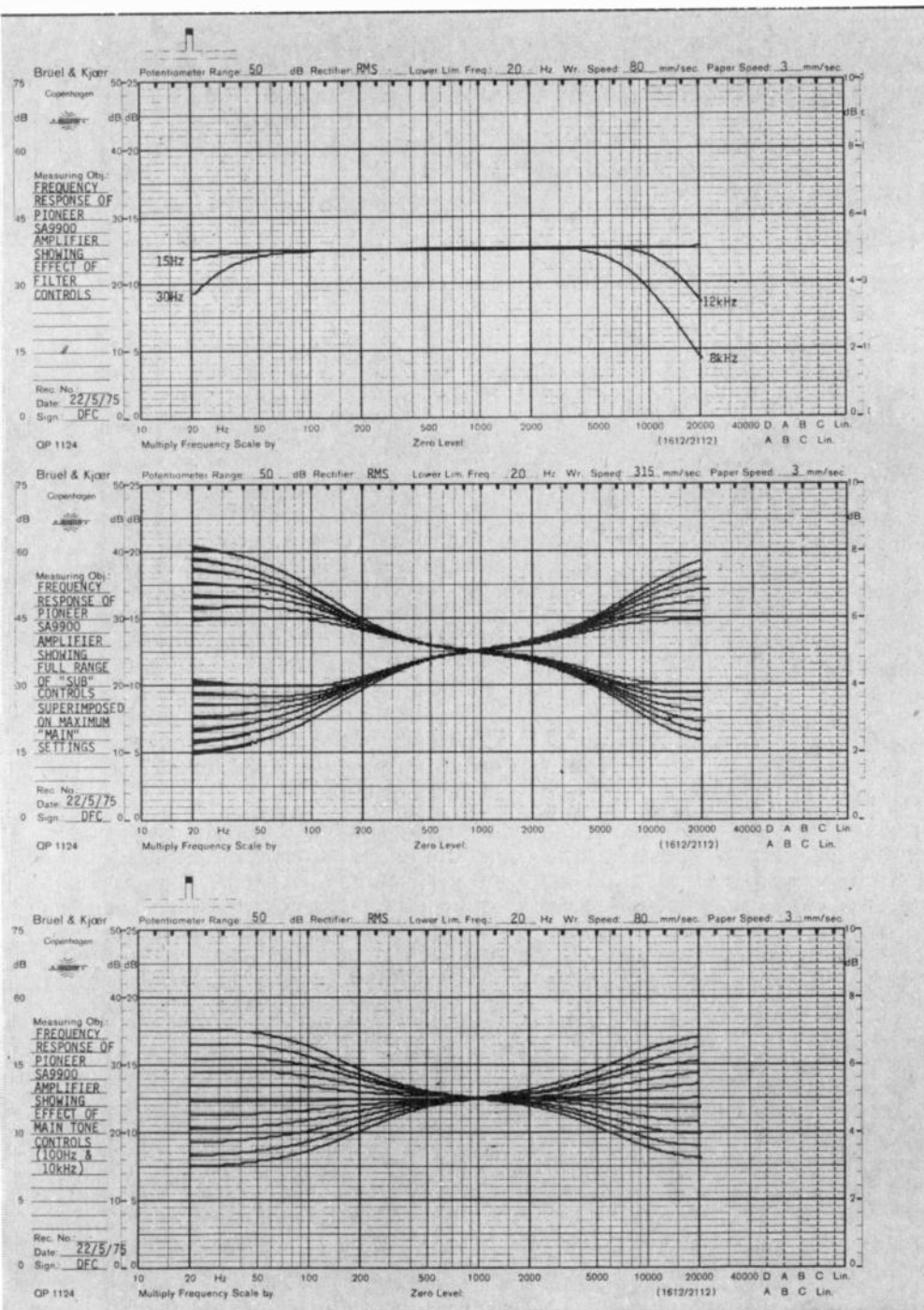

sealed plastic moulding and the preamplifier chassis card is extended right through to the front panel to pick up the control function switch again in the form of a printed circuit connection.

The overall impression that we gained from the inspection of inside of this unit is that it has been designed to full professional standards.

HOW IT PERFORMED

The technical performance of the amplifier is absolutely above reproach. We could not fault any of the manufacturer's specifications, and if anything the majority of the specifications in the sixteen page handbook were being deliberately conservative to cope with the latest United States requirements for testing amplifiers and other high fidelity equipment.

Thus, by way of example, the continuous power output, stated for both channels driven at 1000Hz, measures at 126.5 watts while the manufacturer only claims 120 watts. We found that the amplifier is fully capable of 150 watts output before the onset of clipping (but obviously not at 0.1% distortion.)

The manufacturer claims that the 120 watt rating per channel into 4Ω is still 120 watts whereas we found it to be 150 watts. The distortion which they conservatively claim as 0.04% for 1 watt and for 55 watts per channel is typically 0.03% at any power with

This view of the amplifier shows the input connections.

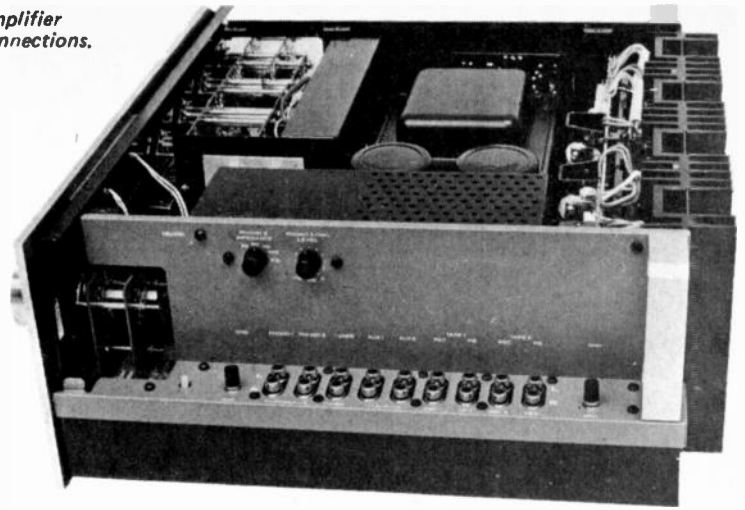

both channels driven. The intermodulation distortion is equally as good. The main attenuator shows such a close agreement with the settings on the dial that even we were surprised. The hum and noise was better than 90 dB on the auxiliary inputs and better than 70 dB on Phono 1 and Phono 2 inputs.

Unlike previous Pioneer amplifier handbooks, this unit does not provide circuit diagrams allowing intending users to carry out their own maintenance and repairs. The amplifier does feature an individual factory computer print out of the continuous power output for both channels into 8Ω load at 0.1% distortion, which

agrees extremely well with our own measurements. As if to prove their point even the minimum distortion limits of their own measuring equipment are presented, which are of course only slightly lower than the actual distortion measurements presented on their computer read out.

CONCLUSION

Our impression of this amplifier is that it is a piece of consumer equipment constructed and designed to professional standards. It has enough power to cope with a rock band, major public address amplifier system, or a hard of hearing high-fidelity fanatic.

University MULTIMETERS

A Model designed for every purpose. Guaranteed after sales service Lowest Prices – Highest Quality. All fitted with overload protection.



"De Luxe"
MVA-100CN 100,000
ohms/Volt
\$35.00 + 15% tax

6 ranges DC Volts to 1 kV
5 ranges AC Volts to 1kV
6 ranges DC Amps to 10A
1 range AC Amps to 10A
5 ranges Resistance to 200M
5 ranges dB to +62 dB
4mm Terminal Sockets
Polarity Reversing Switch



"Professional"
MVA-50 50,000
ohms/Volt
\$25.00 + 15% tax

12 ranges DC Volts to 1kV
10 ranges AC Volts to 1kV
10 ranges DC Amps to 10A
4 ranges Resistance to 16M
5 ranges dB to +62 dB
4mm Terminal Socket
OFF position on switch



"Pocket"
MVA-5/73 20,000
ohms/Volt
\$13.50 + 15% tax

6 ranges DC Volts to 2.5kV
5 ranges AC Volts to 1kV
3 ranges DC mA to 250mA
2 ranges Resistance to 6M
Decibels 1 mW in 600 Ω
Unbreakable case
2mm Terminal Sockets

All units are supplied with leads, batteries and instructions.

To Mr.
Address
..... Post Code
Qty..... Model

I enclose cheque/Postal Note for above unit, or send C.O.D. Post.

ET 7/75

A complete range of test instruments may be inspected at our Showroom and are available either direct from our Riverwood office, any leading wholesalers or ordered on the enclosed coupon. Please allow \$1.50 for packing, post and insurance.

University Graham Instruments Pty. Ltd.,
106 Belmore Road, Riverwood, 2210.
Phone 53-0644

MULTIMETER SURVEY

How to choose a meter to suit your needs.

THE BUDDING experimenter, after purchasing a basic set of tools, commences building small circuits at the earliest opportunity. Very rapidly he meets the situation where a circuit, as built, does not work. So what now? If all wiring has been done correctly then it must be a faulty component — but which one? The simplest way to find out is to use a meter to measure voltages around the circuit.

Thus the first instrument that an electronics experimenter will buy will be some kind of multimeter capable of measuring the common ranges of voltage, current and resistance found in usual circuitry.

Upon investigating what is available the experimenter discovers that multimeters range in price from simple analogue meters at \$8 to sophisticated, highly-accurate digital instruments costing several hundreds (if not thousands) of dollars.

The experimenter must ask himself — which is the most suitable for his class of work? Is it really necessary to spend several hundred of dollars? Are \$8 multimeters worth having at all?

In this article we examine the factors

which must be considered when selecting a multimeter in order to satisfy the conflicting requirements of minimum expense and suitability. We also give comparative details of some typical multimeters. This list does not by any means contain all that are available but is fairly representative of the range suitable for experimenters.

When selecting a multimeter the following factors are of importance:

- Input impedance
- Accuracy
- Resolution
- Ruggedness
- Number of ranges
- Frequency response
- Portability.

INPUT IMPEDANCE

A multimeter must have as high an input impedance as possible if the circuit under test is not to be severely loaded. Loading leads to substantial errors in the measurement and, if severe, may even damage components.

The input impedance of analogue meters is usually expressed in ohms per volt. Thus the impedance depends on the voltage range selected. Typical

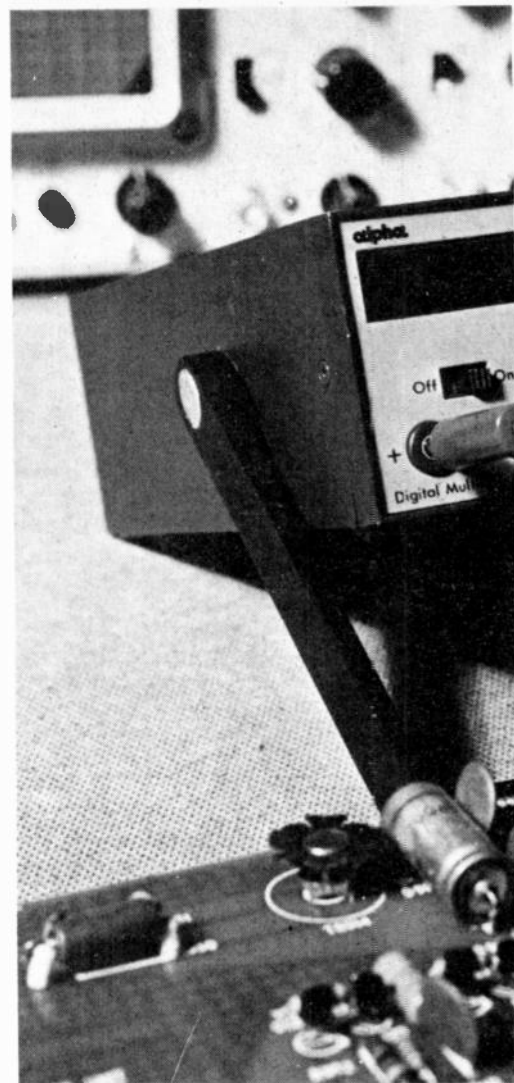

inexpensive meters have impedances of 1000 to 100,000 ohms per volt. Thus when measuring voltage a multimeter is in effect a resistor in parallel with the resistor (across which the voltage is being measured) within the circuit and it reduces the effective value of both — to something lower than the value of either. Thus, as a voltmeter is in effect a resistor, connecting it across a circuit will inevitably change the resistance of that circuit, and the meter must shunt current away from the circuit.

This brings us back to the reason for quoting the sensitivity of voltmeters in ohms per volt. Multiplying the sensitivity by the fsd range in use, gives the resistance of the meter circuit that will be shunting the component. Cheaper multimeters will have sensitivities ranging from as low as 1000 Ω /volt to as high as 100k Ω /volt.

To illustrate loading effects, consider the circuit in Fig.1. By Ohms law we know that the voltage between points A and B is 0.75 volts.

Now let us see what happens when we use a 1000 ohms/volt meter on the 1 volt range to measure this voltage. The 1000 ohms of the meter in

THE MOVING-COIL METER

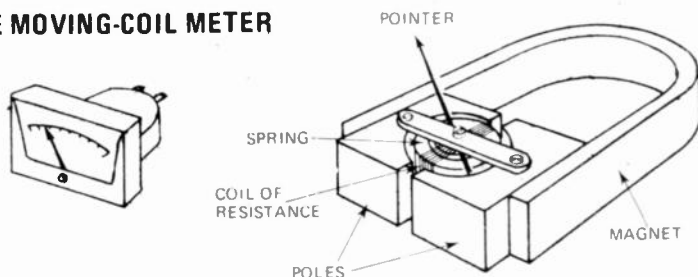

Fig. A.

If an electromagnetic coil is suspended in the field of a permanent magnet, it will be caused to rotate, when energized, by a force proportional to the energizing current.

In the moving-coil type of meter, as Fig.A shows, the field of the permanent magnet is arranged to pass across a cylinder in which hangs the coil of the meter. A fine spiral tension-spring restrains the

rotation by providing a linearly increasing torque as the coil rotates. Attached to the coil is a pointer that moves across a scale, thus indicating current.

As the number of turns is increased, to improve sensitivity, the designer must use finer wire to keep the mass of the coil small. As a consequence of this requirement, sensitive meters usually have a higher resistance, and are more delicate.

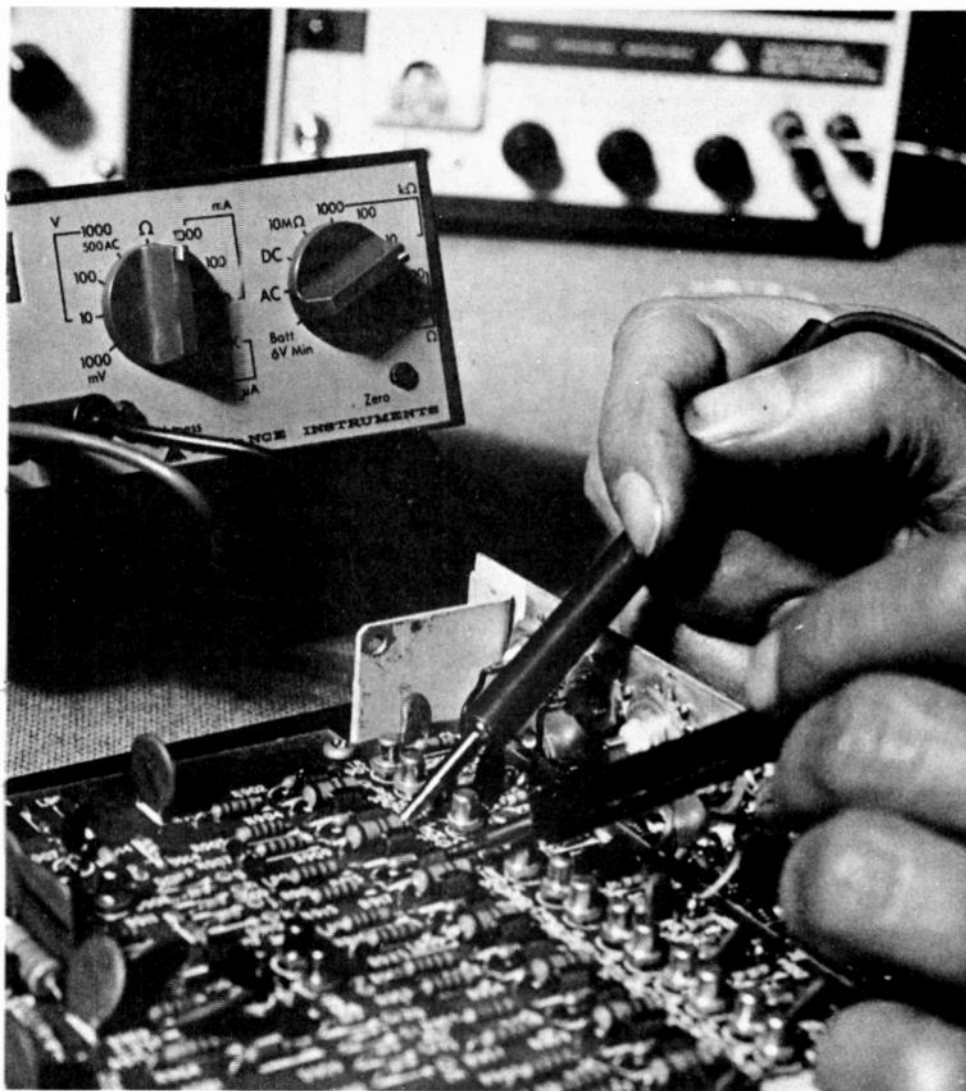

parallel with R2 will produce a combined value of 500 ohms. Thus the voltage read by the meter will be 0.5 volts instead of 0.75 volts – an error of 33 per cent!

It is the degree of this shunting effect that is important – in theory it can never be completely avoided, for some

energy must flow into the measuring system from that being measured. In electronic measurements the rule of thumb is that for accuracy, the resistance of a voltmeter should be at least ten times that of the circuit – a hundredfold is better still.

However with the simple moving-coil

When using any meter with switched ranges, always start off by selecting a meter range much higher than your estimate of the quantity to be measured.

This precaution safeguards the meter should the quantity be much larger than expected.

type of meter a higher input impedance also requires a delicate meter movement which is relatively easily damaged. A good compromise would seem to be a meter having an ohms/volt rating of between 10 000 and 50 000.

In more expensive meters – those employing electronic amplifiers and those using digital techniques, input impedances are usually at least one megohm and hence loading of the circuit is seldom a problem.

ACCURACY

The typical cheap multimeter has an accuracy of the order of 3 to 5% and this is further reduced by parallax reading errors. Better quality analogue instruments have 1% accuracy and mirror backed scales to reduce parallax reading errors.

Digital multimeters are at least 1% or better, with 0.2% being typical. Sophisticated units costing several thousand dollars may well have accuracies down to 0.001%. The way accuracy for a digital meter is quoted is far from being as simple as given here, but for our present purposes the simple statement given suffices.

As to what accuracy is needed, it is seldom that an experimenter, even one at fairly advanced level, needs an accuracy better than 1% and, mostly, even the 3 to 5% of a simple meter is good enough. So don't get carried away by accuracy, if you can afford 1% or better – great. But you will not be too badly off if you can't.

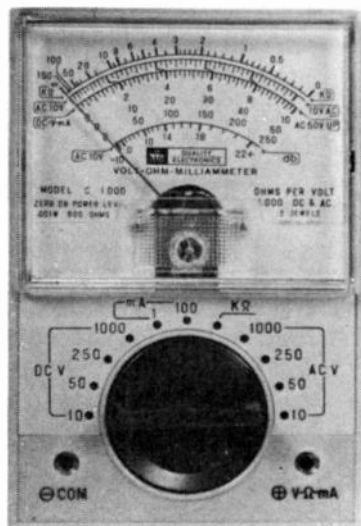

Typical of the inexpensive multimeter available this 1000 ohm/volt unit is suitable for general electrical work.

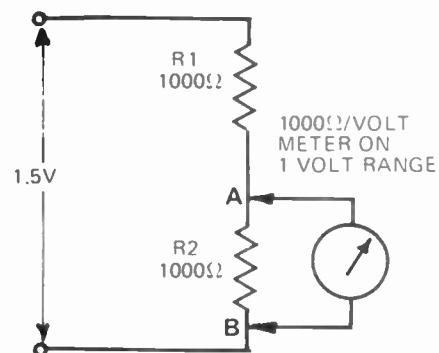
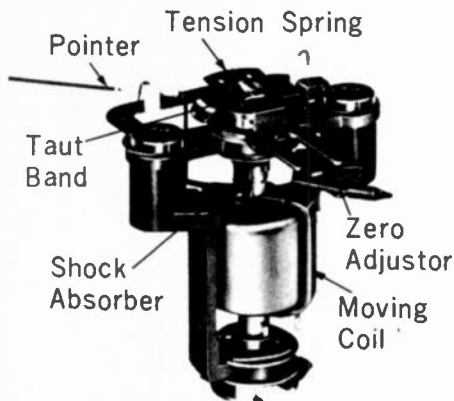

Fig. 1. Meter loading of the circuit can drastically increase reading error.

MULTIMETER SURVEY

TAUT BAND SUSPENSION SYSTEM



Better quality analogue multimeters usually employ a taut band suspension system in the meter movement. This system, although more

expensive, has several important advantages over conventional moving coil movements.

The movement still employs the moving coil principle but now the coil is suspended by means of a platinum alloy band. Since, now, no pivots, jewels or hair springs are used errors due to pivot friction and roll of the jewel are completely eliminated. Additionally the meter will maintain correct reading regardless of orientation.

A shock absorber is usually fitted to the movement that incorporates dual bumper stops. Thus the movement is rendered insensitive to mechanical shock.

The use of a taut band movement ensures good linearity, freedom from backlash, freedom from effects of vibration and shock and much greater instrument reliability.

meter has 1, 10 and 100 volt ranges and is quoted as having an accuracy of 3% of full scale. Now let us suppose we are trying to measure 1.1 volts. We cannot read it on the one volt scale as the meter would read over range. On the ten volt scale we read about one volt but our accuracy on the ten volt range is 3%, that is, ± 0.3 volts. So the best we can say is that the voltage is between 0.7 and 1.3 volts. Hardly satisfactory for working on transistor amplifiers for, with this measurement, we would not be sure whether it was one or two base emitter junctions (0.6 to 0.7 volts per junction for silicon).

Had we a meter with a 3 volt range we would have read around 1.1 volts with an accuracy of ± 0.09 volts and the degree of ambiguity would have been vastly decreased.

RUGGEDNESS

Drop an \$8 multimeter and you may as well not bother to pick it up. The case will probably shatter and the meter movement will almost certainly be ruined. The more expensive units have poly-carbonate cases which could be bounced off a concrete floor (if you are game enough). The more expensive units will also probably use a taut-band meter movement rather than the simple moving-coil variety. Taut-band movements are virtually impervious to shock.

Some years ago we bounced such a

RESOLUTION

Resolution is often more of a limitation than is accuracy for, if the meter movement is small, it is difficult to read accurately. For example, when trying to read 1.5 volts on a 10 volt full scale meter, it may only be possible to say that it is somewhere between 1 and 2 volts. Hence the bigger the movement the better.

In the case of a digital meter the resolution is a function of the number of digits in the display. Thus a three digit display (999) can resolve to one part in 1000 and hence the accuracy must be better than 0.1% to make full use of the available resolution. Conversely it is little use having more than three digits in the display if the accuracy is only 1%.

RANGES

Any meter must be able to measure dc volts and current, ac volts and current and resistance to really qualify as a full multimeter. Some instruments also include dB calibration and the facility to measure capacitance.

DC voltage should have ranges from 1 to 2.5 volts full scale to 500 and preferably 1000 volts full scale. AC volts should cover from 2.5 volts full scale to at least 300 volts full scale. The lowest current range should be 1 mA full scale, or better, and the maximum reading should be at least one ampere.

Resistance scales should enable you to read from one ohm to at least one

megohm with reasonable accuracy. Note that on cheaper meters cramming at the top of the ohms scale will prevent reading values in excess of 100k ohm at all.

Finally the ranges should ascend in the 1, 3, 10 ratio at least. Ten to one scale ratios lead to some difficulty in reading voltages that are just in excess of one range. For example assume a

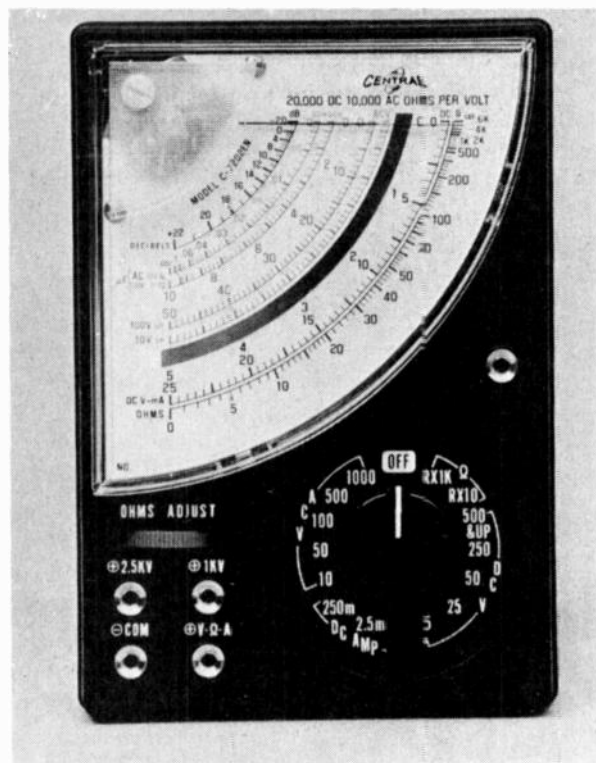

This 20,000 ohms/volt unit has a corner meter movement which allows a much greater scale length to be obtained in a small meter.



This unit from University and its specifications show just how much capability can be obtained with a meter costing around \$30.

Features:

- 46 Ranges
- D.C. Current up to 10A
- 50K Ω /Volt sensitivity
- Diode overload protection
- 4mm terminal sockets
- Unique handle forms bench stand
- Shock Resistant Movement

taut-band meter off the floor hundreds of times (in order to take photographs) without any damage occurring to the meter whatsoever (a Weston 660 series multimeter).

Ruggedness is very much a function of price. The more you pay the better the case and the movement used. The switches will also be larger, more robust and with silver-plated contacts. So although an \$8 meter may appear to offer the same facilities as a more expensive unit it will certainly not last as long.

Steer clear of ultra-miniature meters. These are very fragile as well as being difficult to read. If you can afford it buy a meter with a taut-band movement — they are expensive but will be worth the money.

FREQUENCY RESPONSE

The ac ranges of a multimeter are of little value if the frequency response of the instrument only extends to a few hundred hertz. Such an instrument would only be useful for measuring 50 Hz mains voltages.

If possible obtain a meter that has a frequency response that at least covers the audio spectrum. This is almost indispensable if you are working on audio equipment and do not have a cathode-ray oscilloscope.

PORTABILITY

Most multimeters are portable as the simple kinds only require a couple of dry cells to power the resistance measurements. Multimeters that have amplifiers built in are sometimes restricted to mains only operation.

For the experimenter a multimeter should definitely be capable of battery operation. Therefore if a transistorized or digital multimeter is to be purchased make sure that it has rechargeable cells or is capable of running for extended periods on dry cells. Mains only types are fine for the laboratory but not for the hobbyist.

ANALOGUE OR DIGITAL

An analogue measurement is essentially one that is made continuously. A digital measurement on the other hand is made in a series of discrete steps.

The same basic quantities can be measured by both digital and analogue methods. For example, a conventional clock has a pair of hands which traverse a calibrated dial in a continuous sweep, and there is a theoretically infinite number of steps between any two calibrated points on the clock face — measurement is continuous and is therefore an analogue process.

A digital clock on the other hand indicates the time in discrete steps, each of one minute (or one second).

MVA - 50

Specifications

D.C. Volts:	0.25, 1.25, 5, 125, 500V (50 K Ω /V) 0.5, 2.5, 10, 50, 250, 1000V (25 K Ω /V)
A.C. Volts:	1.5, 5, 25, 125, 500V (10K Ω /V) 3, 10, 50, 250, 1000V (5K Ω /V)
D.C. Amps:	25 μ A, 50 μ A, 2.5mA, 5mA, 25mA 50mA, 250mA, 500mA, 5A, 10A.
Resistance:	Rx1 0-16K Ω 100 Ω centre Rx10 0-160K Ω 1K Ω " Rx100 0-1.6M Ω 10K Ω " Rx1000 0-16M Ω 100K Ω "
Decibel:	-20db to + 62db (5 ranges) Ref. 1mW in 600 Ω
Accuracy:	D.C. \pm 2% A.C. \pm 3%
Batteries:	1.5V, type 1015 2 off.
Size:	160x120x60mm H.W.D.
Weight:	530 kg.
Leads:	60 cm long with 4mm plugs.
Accessories:	Leather case Temperature probe



The model A 10/P multimeter has an easily readable 125 mm scale length.

MULTIMETER SURVEY

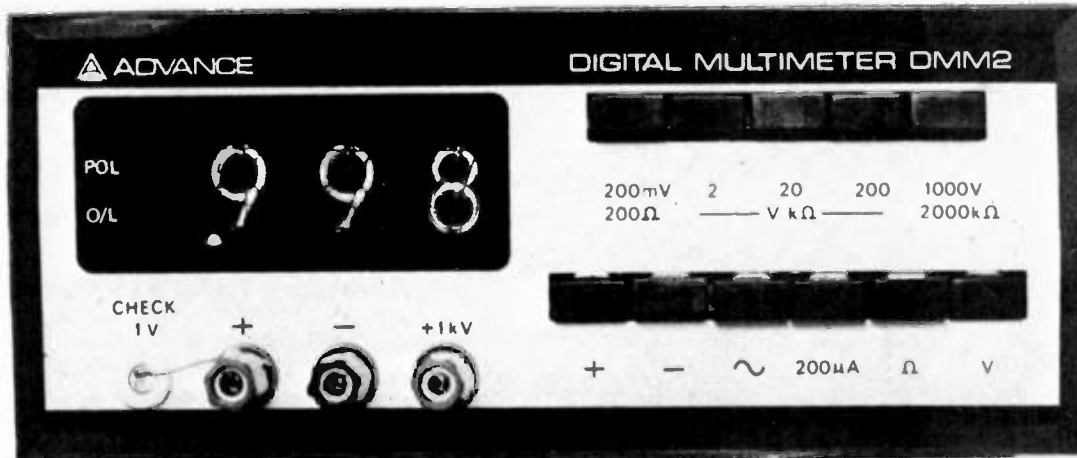

For \$200 you can have this digital multimeter from Advance. It has 0.2% accuracy.

DUAL SLOPE A/O CONVERSION

There are several modes of operation of digital multimeters but by far the most commonly used in cheaper

instruments is the DUAL SLOPE technique. The system, assuming a 3 digit display, works as follows:—

Initially when an unknown voltage is applied to the input a 'start conversion' pulse is generated and simultaneously all the counters are set to zero.

The integrator, which may be a simple operational amplifier design, begins to ramp up with a slope which is proportional to the magnitude of the input voltage. At the same time clock pulses are gated to the counters which commence to count up.

Control logic detects when the count reaches 999 and gates off the input voltage and gates on a reference voltage. The reference voltage is opposite in polarity to the input voltage and the integrator therefore begins to ramp down with a slope proportional to the reference voltage and the counter reverses. The process continues until zero voltage is reached.

At this zero point a comparator closes the clock pulse gate, the counter stops and now holds a count proportional to the input voltage.

Design requirements for the integrator and clock accuracies are much less stringent with this technique than with others because both input ramp and reference ramp use the same circuitry. Hence component inaccuracies tend to cancel out and accuracy becomes dependent mainly on the stability of the reference voltage and, if used, the input attenuator and amplifier. The dual slope method provides good rejection of normal-mode noise.

The dual-slope conversion provides the basic voltage measurement capability additional circuitry being added to measure resistance, dc current and ac voltage and current.

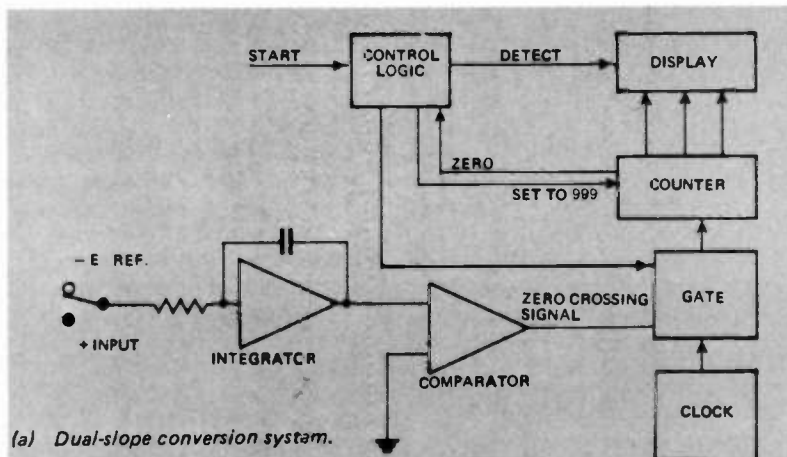

(a) Dual-slope conversion system.

(b) The counting procedure.

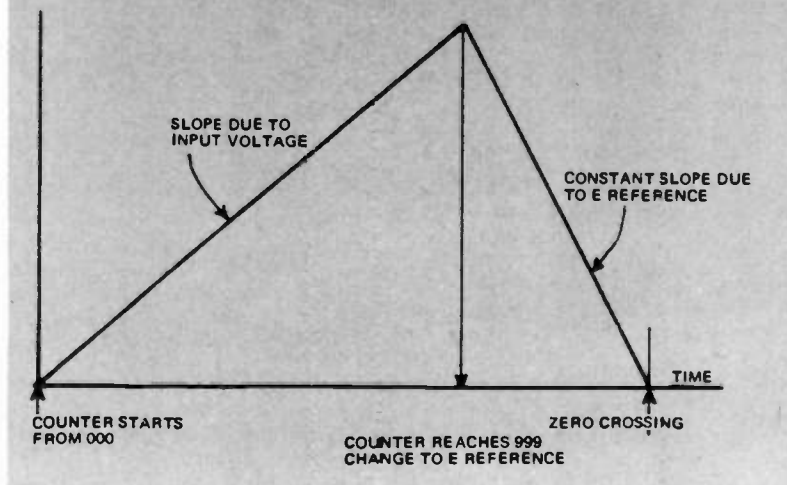

There is no ambiguity of reading. It is either 8:23 or 8:24 one cannot misread it.

This is one of the great advantages of digital readouts. There are no reading errors due to parallax or scale resolution, and in the case of electronic digital instruments no friction or hysteresis to cause mechanical errors.

Hence even the cheapest of digital multimeters has better than 1% accuracy, (actually accuracy should be stated the other way – a meter is 99% accurate, not 1%). whereas an analogue meter with a mechanical movement of 1% accuracy is quite

expensive and still subject to further reading errors caused by parallax and scale resolution.

Until recently digital multimeters were priced beyond the reach of the amateur experimenter the cheapest being three or four hundred dollars. Now however some multimeters are being priced below \$100 and other excellent 0.2% instruments at around \$200 to \$250.

Such prices make the digital instrument competitive in price with the best of analogue transistorized multimeters and – they have better accuracy.

All digital multimeters have input

impedances of one megohm or better and hence loading is seldom a problem with such instruments.

Digital instruments are sensitive to noise and a dc voltage with superimposed hum and noise may give incorrect and/or jittery readings on some instruments. Analogue instruments on the other hand tend to reject and average out superimposed noise.

It is doubtful that digital meters will ever completely replace analogue meters. But they will almost certainly replace those at the higher priced end of the analogue range.

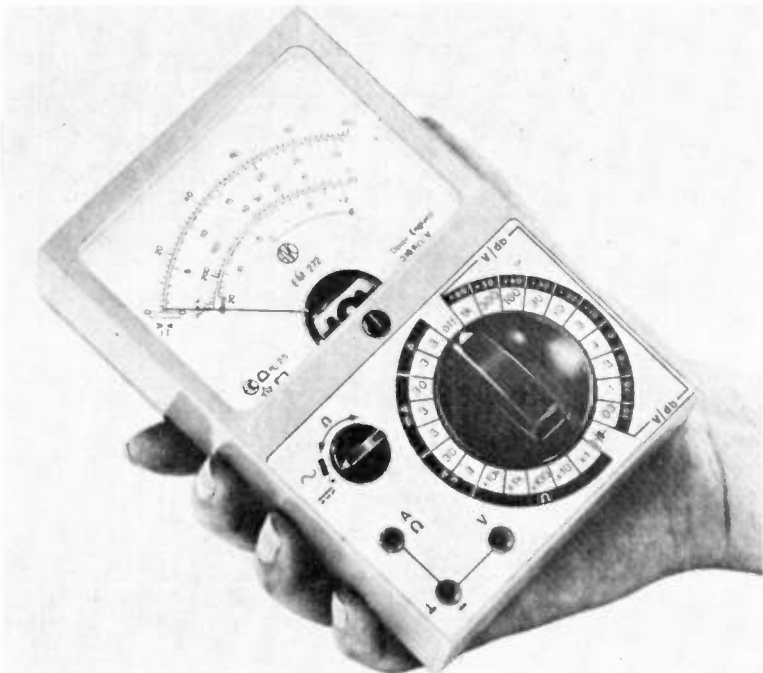
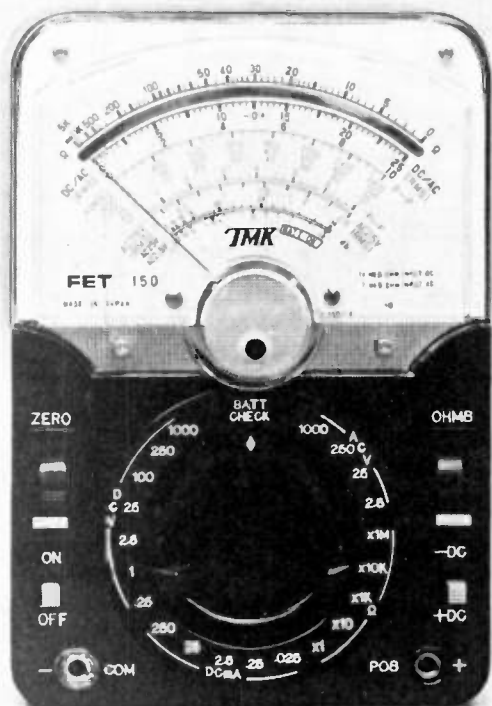

This electronic multimeter from AVO features 10 Meg impedance on dc and 316 k/v on ac. The 39 ranges of this instrument cover all the measurements you are likely to need.

The addition of a FET amplifier greatly improves performance. In this meter from Dick Smith Electronics dc input impedance is 11 megohms.

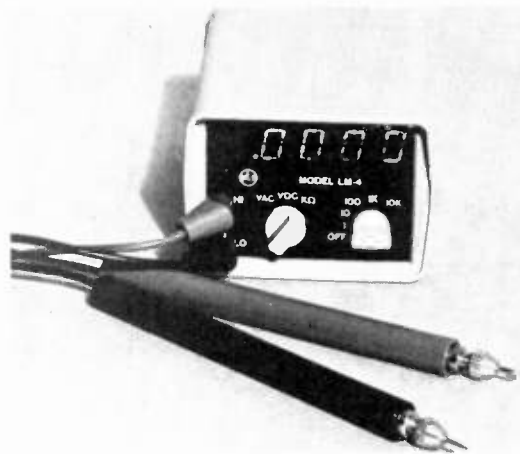

New on the Australian market are the LM3 (3 digit) and LM4 (4 digit) digital multimeters. The 3 digit unit at \$99 plus tax (including Ni-Cad batteries and charger) is particularly good value and ideal for service in the field.

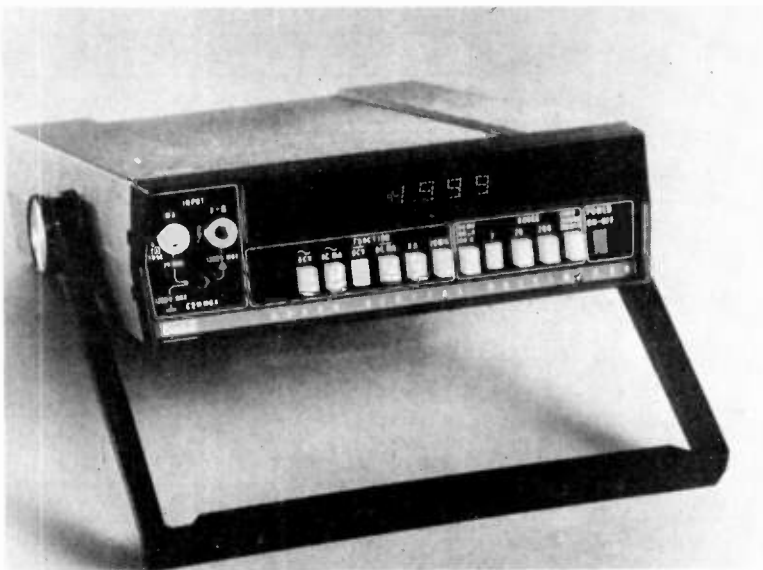

The Fluke 8000A digital multimeter offers 0.1% accuracy, has three and a half digits and sells for under \$300.

MULTIMETER SURVEY

Not a complete listing,
representative range only.

	DC VOLTAGE					AC VOLTAGE						DC CURR	
	MIN RANGE V	MAX RANGE V	NUMBER OF RANGES	INPUT IMPEDANCE OHMS	ACCURACY ± %	MIN RANGE V	MAX RANGE V	NUMBER OF RANGES	TYP MAX. FREQUENCY Hz	INPUT IMPEDANCE OHMS	ACCURACY ± %	MIN RANGE mA	MAX RANGE A
D.S.E. LT 101	10	1K	5	1k/V		10	1K	5				1	0.25
UNIVERSITY MVA 1K	10	1K	4	1K/V	3	10	1K	4		1K/V	4	1	0.1
D.S.E. LT 601	5	2.5K	6	20K/V		10	1K	5		10K/V		0.05	0.25
UNIVERSITY MVA 5/73	5	2.5K	6	20K/V	3	10	1K	5		10K/V	4	0.05	0.25
D.S.E. C 7202 EN	5	2.5K	6	20K/V		10	1K	5		10K/V		0.05	0.25
UNIVERSITY CTN 500 MP	2.5	5K	6	20K/V	3	10	1K	5		10K/V	4	0.05	0.5
MICRONTA	5	1K	5	20K/V	3	1	1K	5		10K/V	4		0.25
UNIVERSITY MVA 80	0.5	1K	6	80K/V	2	2.5	1K	5		10K/V	3	0.015	0.5
MICRONTA 22-202	0.6	1.2K	7	20K/V	3	15	1.2K	5		10K/V	4	0.6	0.3
UNIVERSITY MVA 50	0.25	500	5	50K/V	2	1.5	500	5		25K/V	3	0.025	10
MICRONTA 22-203	0.3	1K	7	30K/V	3	10	1K	5		10K/V	4	0.1	10
D.S.E. C 7081 GND	0.25	1K	6	25K/V		0.15	1K	5		10K/V		0.025	10
MICRONTA 22-204	0.25	1K	6	50K/V	3	1.25	500	5		10K/V	4	0.05	10
JAYEM 50K	0.3	1.2K	12	50K/V	3	3	1.2K	9		5K/V	4	0.03	12
UNIVERSITY MVA 100 CN	0.5	1K	6	100K/V	2	2.5	1K	5		10K/V	3	0.01	10
D.S.E. HT 100B4	0.5	1K	7	100K/V	3	2.5	1K	5		12K/V	4	0.01	10
D.S.E. 360 TR	0.5	1K	6	100K/V	3	5	1K	5	5K	10K/V	4	0.01	10
UNIVERSITY M 770	0.25	5K	8	20K/V	3	2.5	5K	6	100K	5K/V	4	0.05	10
MICRONTA 22-205	0.5	1K	5	100K/V	3	5	1K	5		10K/V	4	0.01	10
D.S.E. 150 (FET)	0.25	1K	7	11 M		2.5	1K	4		1 M		0.025	0.25
AVO MULTIMINOR MR5	0.1	1K	7	10K/V	2.3	10	1K	5		1K/V	2.8	0.1	1
MICRONTA 22-206	3	1K	5	10 M	3	3	1K	5		10K/V	4	0.1	0.3
KYORITSU K 200 (FET)	0.3	1K	8	10 M	3	0.3	1K	8	1 M	10 M	4	0.03	0.3
YEW 3201	0.3	1.2K	8	100K/V	2	3	1.2K	6		10K/V	3	0.012	1.2
AVO MODEL 72	0.1	1K	7	20K/V	2	10	1K	5	30K	1K/V	2	0.05	1
TRIO VT-108	0.5	1.5K	8	11 M	3	1.5	1.5K	7		1 M	5	No	
AVO EM 272	0.03	1K	10	300K/V	2.5	0.03	1K	10	1K	300K/V	2.5	0.003	3
PHILIPS PM 2412	0.3	1K	8	40K/V	2	3	600	6	1K	4K/V	3	10	6
N.L.S. LM-3	1	1K	4	10 M	1	1	1K	4	5K	10 M	1	NO	
YEW 3223	0.3	1.2K	8	11 M	3	3	300	5		500K	4	0.12	1.2
SINCLAIR DM2 (DIG)	2	1K	4	10 M	0.5	2	500	4	3K	10 M		2	1
PHILIPS PM 2503 (FET)	0.1	1K	9	10 M	2	0.1	300	8	30K	10 M	3	0.001	1
AVO MOD 8 MK.5	0.1	3K	9	20K/V	1	3	3K	8	15K	1K/V	2	0.05	10
ADVANCE DMM2 (DIG)	0.2	1K	5	10 M	0.2	0.2	1K	5	20K	1 M	0.4	0.2	
DANAMETER 2000 (DIG)	2	1K	4	10 M	0.5	2	1K	4	2K	2 M	2.5	0.02	2
PHILIPS PM 2513 (DIG)	0.1	1K	5	10 M	0.3	0.1	600	5	10K	10 M	1	0.1	1
FLUKE 8000 A (DIG)	0.2	1K	5	10 M	0.1	0.2	1.2K	5	20K	10 M	0.5	0.2	2
VALHALLA 4440 (DIG)	0.2	2K	5	10 M	0.05	0.2	2K	5	10K	10 M	0.25	0.2	2

ENT	AC CURRENT						RESISTANCE				PRICE (REC. RETAIL) \$ (INCLUDING S. TAX 15%)	DIGITAL	AUTO-POLARITY	DECIBEL SCALE	DISTRIBUTOR
	NUMBER OF RANGES	ACCURACY ± %	MIN RANGE A	MAX RANGE A	NUMBER OF RANGES	TYP. MAX. FREQUENCY Hz	ACCURACY ± %	MIN RANGE OHMS	MAX RANGE OHMS	NUMBER OF RANGES					
3		NO					15K	150K	2		10	NO	NO	YES	DICK SMITH
2	3	NO					150K		1	3	10	NO	NO	YES	UNIVERSITY GRAHAM
3		NO					50K	5 M	2		14	NO	NO	YES	DICK SMITH
3	3	NO					60K	6 M	2	3	15	NO	NO	YES	UNIVERSITY GRAHAM
3		NO					60K	6 M	2		16	NO	NO	YES	DICK SMITH
4	3	NO					10K	10 M	4	3	18	NO	NO	YES	UNIVERSITY GRAHAM
2	3	NO					2K	2 M	3		19	NO	NO	YES	TANDY
4	2	NO					10K	10 M	3		23	NO	NO	YES	UNIVERSITY GRAHAM
4	3	NO					2K	2 M	4		25	NO	NO	YES	TANDY
10	2	NO					16K	16 M	4		29	NO	NO	YES	UNIVERSITY GRAHAM
5	3	NO					1K	10 M	4		30	NO	NO	YES	TANDY
5		NO					16K	16 M	4		30	NO	NO	YES	DICK SMITH
5	3	NO					1K	20 M	5		33	NO	NO	YES	TANDY
10	3	NO					3K	30 M	4		38	NO	NO	NO	JACOBY MITCHELL
6	2	10		1	5K		2K	200 M	5		40	NO	NO	YES	UNIVERSITY GRAHAM
6	3	10		1		4	20K	20 M	4		42	NO	NO	YES	DICK SMITH
7	3	10		1		4	5K	50M	4	3	45	NO	NO	YES	DICK SMITH
6	3	NO					2K	20 M	3		46	NO	NO	YES	UNIVERSITY GRAHAM
6	3	NO					1K	100 M	5		50	NO	NO	YES	TANDY
5		NO							5		58	NO	NO	YES	DICK SMITH
5	2.3	NO					20K	2 M	2		58	NO	NO	NO	ELECTRICAL EQUIP. OF AUST.
4	3	NO					1K	100 M	5		60	NO	NO	YES	TANDY
8	3	0.03	0.3	8		4	2K	20 M	7	3	75	NO	NO		JACOBY MITCHELL
6	2	NO					2K	20 M	3	3	77	NO	NO	YES	PARAMETERS
5	2	NO					2K	20 M	3		81	NO	NO	NO	ELECTRICAL EQUIP. OF AUST
		NO					10	1000 M	7	5	84	NO	NO	NO	PARAMETERS
7	2.5	0.003	3	7	1K	2.5	4K	40 M	5		107	NO	NO	YES	ELECTRICAL EQUIP. OF AUST.
6	3	0.1	6	4		6	1K	10 M	3	5	113	NO	NO	NO	PHILIPS
		NO					1K	10M	5	1	115	YES	YES	NO	EXPLOSIVES RESEARCH & DEV.
5	3	NO					2K	200 M	6	3	127	NO	NO	YES	PARAMETERS
4	1	0.002	1	4	1K	1.5	2K	2 M	4	1	139	YES	YES	NO	DICK SMITH
12	2	0.001	1	12	5K	3	100	10 M	6	3	174	NO	YES	YES	PHILIPS
7	1	0.01	10	4	15K	2	2K	20 M	3	3	199	NO	NO	YES	ELECTRICAL EQUIP. OF AUST.
1	0.3	0.0002		1	10K	0.5	200	2 M	5	0.3	201	YES	NO	NO	JACOBY MITCHELL
4	2	NO					200	200 M	4	3	225	YES	YES	NO	JACOBY MITCHELL
5	1.5	0.001	1	5	1K	1.5	100	2 M	5	1.5	229	YES	YES	NO	PHILIPS
5	0.3	0.0002	2	5	10K	1	200	20 M	5	0.2	299	YES	YES	NO	ELMEASCO
5	0.3	0.0002	2	5	10K	1	200	20 M	5	0.1	368	YES	YES	NO	PARAMETERS

MULTIMETERS

LT101

Beamers, 1K/V, safety "off" position. Ranges Vdc 0-10-50-250-1kV; Vac 0-10-50-250-1kV; Idc 0-1-100mA; Ohm 0-150K; 90x60x30
\$8.90
 P&P \$1.00



LT601

Top value, 15 range, 50uA movement. Ranges Vdc 0-5-25-50-250-500-1kV; Vac 0-10-50-100-500-1kV; Idc 0-50u-5-50-500mA; Ohms 0-10-100K-1-10M; 128x90x40
\$13.50
 P&P \$1.00



CZ702EN

24 ranges, 35uA, off posn. Ranges Vdc 0-2.5-10-50-250 (Vac) 0-10-50-100-500-1kV; Idc 0-50u-5-50-500mA; Ohms 0-10-100K-1-10M; 128x90x40
\$15.50
 P&P \$1.50



C/201EN

20 K/Vd.c. Capacitance Mirror scale. Ranges Vdc 0-5-25-50-250-500-1K-2.5kV; Vac 0-10-50-100-500-1kV; Idc 0-50u-2.5-250mA; Ohms 0-6K-6M; Cap 10pF to 0.1uF; 150x110x50
\$19.50
 P&P \$1.50



C7081GND

18uA, 46 ranges doubler mirror scale protected. Ranges Vdc 0-0.5-2.5-10-50-250-1K; Vac 0-3-10-50-250-1kV; Adc 0-50u-5-50-500mA-10A; Ohms 0-16-160K-1.6-16M. Note all these ranges may be halved by V/A/2 switch; 165x118x60
\$29.75
 P&P \$1.50



HT100B4

Overload protection 9.5uA movement 10A a.c. & d.c. 100K/V sens. Shockproof mech. Ranges Vdc 0-0.5-2.5-10-50-250-500-1kV; Vac 0-2.5-10-50-250-1kV; Idc 0-10-250uA-2.5-25-250mA-10A; Aac 0-10A; Ohms 0-20-200K-2-20M; 180x130x80
\$42.00
 P&P \$2.00



360TR

Transistor checker/multimeter, 34 ranges, 5" mirror scale, 8.5uA, 10A a.c. & d.c. Hfe to 500 ranges Vdc 0-0.5-2.5-10-50-250-1kV; Vac 0-10-25-500A-5-50-500mA-10A; Iac 0-10A; Ohms 0-50k-5-50M; 180x135x85
\$45.00
 P&P \$2.00



150FET METER

11M d.c. input, direct peak to peak reading on AC, 21 ranges, transistor bias measurement. Ranges Vdc 0-0.25-1-2.5-25-100-250-1kV; Vac 0-2.5-25-250-1kV and p-p 7-70-700-2800V; Adc 0-25-250uA-2.5-25-250mA; Ohms 0-5-50K-5-50M-500hm-5-50K; 160x110x50
\$57.50
 P&P \$2.00



MITSUI SIGNAL INJECTOR

Handy service aid. Transistorised. Operates well into H.F. bands. Simply prod into circuit from output stage forward to locate fault. Complete 160x100ia with 1.5V battery.

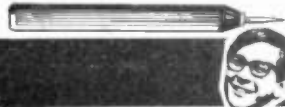

MITSUI SIGNAL GENERATOR

Ideal for beginners. Aligns IF's and broadcast band. Covers 400-550 kHz for IF's and 550-1600kHz broadcast band. Excellent value. 125x60x40
\$9.95
 P&P 75c



SE360 Sig Injector/Tracer

Deluxe instrument for TV, AM & FM, Audio, servicing etc. Meter or audio readout. Output for VM or Scope. Calibrated VU meter. Built-in injector Sig frequency 1kHz 0.5V. Gain 60db Input 2.75k; Output 8 or 600 ohm; Meter 200 uA V.U. Speaker 24"; Power 9V; 155x85x65
\$38.00
 P&P \$1.00



TE20D R.F. Sig Gen

Dual r.f. output terminals. Separate Audio control. Crystal socket for calibrator. Range 120kHz to 500MHz Accuracy 2%. Modulation 400Hz Audio output BV. 240V operated Variable RF attenuator. 140x215x170
\$55.00
 P&P \$2.00



TE22D Audio Gen

High accuracy at low price. Sine and Square wave outputs frequency range 20Hz to 200kHz (Sine), 20Hz to 30kHz (square) Response ±1.5db Output 1k, 7Vrms sine, 7V p-p square Distortion 2% Accuracy 5%; 215x170x140
\$64.00
 P&P \$2.00



ENGINE ANALYSER

Versatile, checks performance, tuning etc. on 4, 6, 8 cyl engines. Ranges. RPM 0-1200-6000 VO 3-15-30 Ohms 0-100k Diode test Dwell 0.45-60° 50° 10-90A Spark Capacitor test 4" movement. With leads and current shunt 180x130x80
\$49.00
 P&P \$2.00



SINCLAIR D.V.M.

Lowest price digital Multimeter. 3 1/2 digit Dual Slope. Auto polarity 60hr battery operated MOS, LSI. Ranges Vdc 0-1-10-100-1000V Vac 0-1-10-100-1000V Idc 0-1-10-100-1000mA Iac 0-1-10-100-1000mA Ohms 0-1-10-100-1000K Stability 0.03% Guaranteed



SWR/Power meter

SWR 200 Professional through line 3MHz to 200MHz. 50 or 75ohm UHF connectors. 4 power ranges 0-2-20-200W. 2kW. Calibration chart supplied. VSWR 1:1 to 1:10 and infinity. Movement 95uA, 76mmx110mmx220mm.

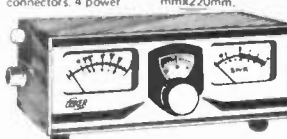

\$48.50
 P&P \$1.00

SWR3 SWR Meter

Compact yet measures SWR and power at once. Power 0-10-100W-SWR 1:1 to 1:3. Frequency response 3MHz to 150 MHz. 50 or 75ohm impedance. 160x85x98mm
\$15.00
 P&P \$1.00



F55 SWR/Power Meter

Compact yet measures SWR and power at once. Power 0-10-100W-SWR 1:1 to 1:3. Frequency response 3MHz to 150 MHz. 50 or 75ohm impedance. 160x85x98mm
\$29.50
 P&P \$1.50



FS1 Field Strength Meter

Simple low cost instrument for field checks. Covers 2 to 200 MHz. Ideal AM, Marine, VHF unit. Requires no tuning
\$7.90
 P&P 75c

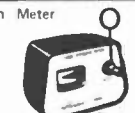

FS117 27MHz Test Set

Multipurpose 27MHz test set for handheld walkie talkies & base stations to 50W. Measures Power to 5W VSWR 1:1 to 1:3 mod 0-100%. Field strength Generates 27MHz for Rx alignment checks crystals modulated 27MHz generator 1000Hz audio output 5W dummy load With telescopic antenna, leads etc. 180x115x80
\$49.50
 P&P \$1.50

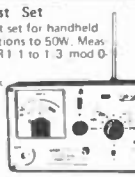

TE15 Grid Dip Meter

Transistorised Operates as G.D.O. Absorption wavemeter, oscillating detector. Frequency range 440kHz to 280 MHz; 6 coils; 500 uA movement; 9V battery operated 180x80x40mm
\$41.50
 P&P \$1.00

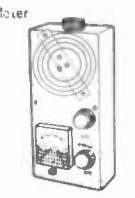

WB200 Grid Dip Meter

FET transistorised Professional instrument with no spurious dips. Operates from 400kHz to 200MHz in 7 bands Tone modulation, AF output High accuracy and stability. Ideal parasitic sniffer, Wavemeter, Sig gen etc. etc. 165x75x85
\$142.00
 P&P \$1.75



TH71 Transistor Tester

Simple to use NPN and PNP. Ranges Hfe 0-100-500 at Ib of 50uA and Vce. of 6V. Lamp indicates faulty devices. Big scale movement. Battery operated. 160x115x80
\$26.50
 P&P \$1.50



J1194 R/C Sub. Box

J1194 12 steps in 2 ranges Resistance: 15ohm to 10k and 15k to 10 Meg. Capacitance: 0.0001 to 0.22 uF (600V working) Handy unit for experimenters. 130x70x65
\$7.50
 P&P 75c



TC2 Valve Tester

Checks shorts, open circuits, filaments, emission etc. 4 popular bases and instructions for 1500 valve types Large movement. Sturdy metal case.
\$45.00
 P&P \$1.75



MULTI LIGHTMETER

Special 'lux' scale used with extra probe 1000ohm/V 11 ranges, mirror scale. Ranges Vdc 0-50-250-1000; Vac 10-50-250-1000; Acdt, 100mA, Ohms 150K Lux Probe. \$6.00 90x60x30
\$8.50 P&P 75c



SM7 SOUND LEVEL METER

Compact 6 range high sensitivity. Ranges 40-110dB. Tau band type movement. Scale 100+10dB; Electret. Mic. Response 31.5-8000Hz 10 6Lx6 6Wx3 6Hcmx150gm
\$47.50
 P&P \$1.75



Mini Z Thermometer

Low cost Thermometer Instruments Inc. Case. Probe, Lead etc. Remote operation to 30M Model C +32 to +42°C - 0 °C (body temp. range) Model 2N - 10 to +80°C ±1.5°C 145x95x35
\$29.75
 P&P 75c



TEW PANELMETERS

MRA458 (49mm H x 52mm W)
 0.1mA \$6.50
 0.50uA \$6.90
 0.5Adc \$6.90
 0.20Vd.c. \$6.90
 VU \$6.90
 MRA658 (82mm H x 100mm W)
 0.1mA \$7.20
 0.100uA \$7.90



Huge Savings on Special D.S.E. "EICO" Transformers

Manufactured for Dick Smith Electronics Full satisfaction guaranteed
 DSE 2851 240V AC at 12.6V at 15A centre tapped **\$3.50**
 DSE 2155 240V AC to 6.3, 7.5, 8.5, 9.5, 12.6, 15V at 1 amp an ideal multi purpose power transformer **\$4.75**
 DSE 6672 240V AC to 30, 27.5, 24, 20, 17.5, 15 or 30V C.T. at 1 amp **\$6.50**

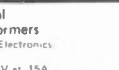

Upated LM380N ICs

The upated LM380N is selected by the manufacturer to operate on 22V instead of 20V. Max output is 6W. See article in ETI Dec 74. Completely interchangeable with usual LM380N. Type No: SL60745

Only \$1.75 each or 10 for \$15.00

ALL PRICES INCLUDE SALES TAX
 For special Tax Free prices send SAE

P&P shown for each item please total up on your order we will credit you for difference



bankcard welcome here



Apan

APAN BELT-DRIVE TURNTABLE SENSATION

We have purchased a huge quantity of the best unit from Apan - Fully automatic and complete with cartridge. See page 8 of our catalogue for details.

Normally the Trade price of this magnificent unit complete with timber base and lid is \$146.50 - We save you \$27.50 at our price

OUR PRICE \$119.00 (p&p freight on)

Unit alone without base and lid only **\$100.00**
Don't delay, knowing how well Apan gear sells we won't have these around for long

- Tracking weight 2gm
- Output 4.4mV
- Frequency response 20-16kHz ± 6db
- Wow & Flutter 0.12% rms
- S/N ratio -52db
- X talk -20db at 1kHz

WSV8 EXTENSION SPEAKER

Ideal for wall or shelf mounting. Handy 8" speaker in walnut cabinet with black grill cloth. Built in volume control so that sound can be adjusted independently. Measures 11.1x9.1x4.1D approx



(P&P \$1.50) **\$12.50**

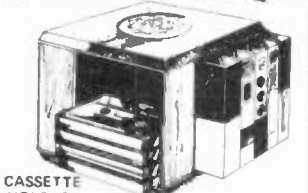

CASSETTE HOLDER

Keeps 'em handy and saves losing your favourite recordings. Holds cassettes in or out of cases. Spring grips prevent them sliding out. 15cm cube with revolving base and timber look finish. Capacity 32 cassettes without case or 20 in cases.

special price \$3.99 p&p 75c

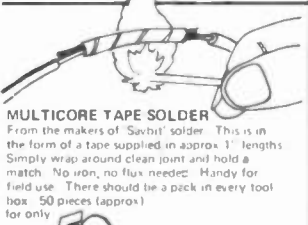

50c Yes... 1c per joint!

Molex Pins from 1cent

We've slaughtered the price of Molex pins with this huge purchase. Why risk damage to delicate IC's when you use this professional socket strip (which also helps when servicing)? Available in following lengths:

- 50 lugs \$1.25
- 100 " 2.00
- 150 " 9.00
- 1000 " 12.00
- 5000 " 50.00

Manufacturers get us to quote on larger quantities

TECHNOLOGICAL MIRACLE DEVELOPED BY U.S. SPACE SCIENTISTS!

MAKES VIRTUALLY EVERY OTHER TYPE OF WATCH IN THE WORLD OBSOLETE!

THE GREATEST TECHNOLOGICAL ADVANCE SINCE THE INVENTION OF THE CHRONOMETER

THE SYSTEM EXCELLED IN ACCURACY ONLY BY THE ATOMIC FREQUENCY STANDARD!

QUARTZ CRYSTAL DIGITAL WATCH WITH FULL L.E.D. READOUT

NO MOVING PARTS - FULLY ELECTRONIC.

INCREDIBLE "MINUTE A MONTH" ACCURACY AND RELIABILITY.

COMPLETE WITH BATTERY AND BAND

FULL 12 MONTH GUARANTEE

TIME IN HOURS, MINUTES AND EVEN SECONDS.

LIGHTS UP LIKE A NEON SIGN - EASY TO READ IN THE DARK

TIME IN HOURS, MINUTES AND EVEN SECONDS.

GUARANTEED MONEY REFUNDED IF NOT SATISFIED.

\$97.50 (REG PDST \$7.00 EXTRA)

CRAB WHATSIT has a crab claw, works by syringe action \$1.65

MAGNET WHATSIT has a magnet & universal \$1.90

MIRROR WHATSIT has a mirror & uni-versal \$1.70

TL8C COILED TEST LEADS
A versatile set of leads, fully insulated 6' probes (inc. tip) are slim enough to reach awkward test points. Phasetip meter plugs have fully insulated handles. Extend to 96" (Yes - 8feet!) retract to only 15" Pair - red and black

PH58 INDOOR/OUTDOOR PAGING HORN Here's a real de luxe Weatherproof Horn Speaker with diecast metal horn. As used extensively in factories etc. Handles 15W peak and matches 8-16 ohms. Frequency response from 360-7000Hz with a special rubber edge dampening to eliminate resonances. Complete with swivel bracket and measures 5" x 8"

Highly recommended at \$22.50 p&p 75c

F.M. ANTENNA
The latest 2 element V.H.F./F.M. aerial with vertical & horizontal polarisation. A must for good reception. Ideal for roof or outdoor mounting and only **\$13.53** road freight \$1.50

200MHz Counter Kit
Special purchase of components enables us to **REDUCE** the price of this kit. Presented in two stages.
Basic 20MHz Counter has 4 1/2 decade LED readout with leading zero suppression. Crystal timebase for self calibration or ext. cal. IM 50pF input impedance and 50mV to 10V rms sensitivity. There can't be a better, cheaper instrument anywhere. Now reduced to **\$98.00**
200MHz Prescaler extends the capability of the basic 20MHz by a factor of ten. Well worth buying the complete kit for just **\$120.00**

NOTE: All our kits use top quality components, where possible to the specs given in articles. Occasionally we are forced to substitute alternate components because of availability problems, but these are checked out with magazines concerned.

PT2 TERMINAL STRIP
A handy strip for loudspeakers, power supplies etc. 2 push type terminals to grip wires for quick disconnect. Only **50c**

BATTERY HOLDERS
Give projects that professional look and sound. More convenient than soldering batteries into circuit. All have leads for connection to PCB etc.

- 1 x AA pentlight cell (6V) BH 4W **45c**
- 2 x 2AA (6V) BH 4L **45c**
- 4 x C cell (6V) BH 4C **60c**
- 1 x D cell BH 1D **40c**

MAGNETIC MIC HOLDER MH-1
Handy for amateur mobiles and a host of other uses. Magnetic base saves drilling holes and is easily shifted. Could save expensive damage to your mic. **for only 75c**

DUCTED HORN SPEAKERS
SP625 6 1/2" woofer, 2" tweeter. 14 1/2" x 9" x 5 1/2" deep. Handles 10W. 10 to 16,000 Hz. Ideal for use with Project 250 amp. **only \$16.95** p&p \$2.00

inadequate Heat sinks? you need one of these by your workbench. Complete with clip 575 p&p 75c

SUPER SENSITIVE METAL DETECTOR
Just tell a builder or handyman about this fantastic gadget - locates any metal object - wires, pipes, reinforcing steel, even nails, inside walls and plaster etc.
• Light comes on in presence of metals
• Penetration/sensitivity control locates metal 6" away
• Supersensitive electronic circuit pinpointes even small nails
• Easy to operate from 9V transistor battery
Range depends on size of metal object. Ideal for electricians who once had to pay \$30-\$40 for such a unit. And only (9V battery 75c extra) **\$6.90** p&p 75c

Try one on the beach - you could find a fortune!

SM7 SOUND LEVEL METER
Latest addition to our instrument range, the SM7 is ideal for office, factory and many other uses. Fully solid-state and miniaturised for convenience. 6 ranges cover 40 to 110db. Uses 'A' weighting network. Taut band type meter movement graduated from -10db to +10db with battery check. Mic is electret type covers 30 - 8000 Hz. 150 hour battery life. Measures 10.6 (L) x 6.6 (W) x 3.6 (H) cm and weighs only 150g. Complete with free earpiece for checking sound being monitored. This is a full 6 range instrument (most have 5) for **only \$157.50** p&p \$1.75

ALARMS to protect your family and home

Powerful torch with alarm. Operates from 3 pencils \$3.98 p&p 75c

Lip-stick sized yet will produce a terrific wail when pressed. For pocket or purse. \$3.98 p&p 75c

Automatically sounds a cont. alarm when temp reaches 57°C. p&p \$1. 5.95

Wedge shaped to prevent door opening. Gives ear-splitting continuous alarm. p&p 75c \$3.98

Operates from 2 pencils. Ideal for doors, windows etc. Take out pin for shattering sound. p&p 75c \$2.98

KITS

KIT56 High Power Strobe (E.T. Aug 71/25 Top Projects) Ideal for parties, dances etc. to create dazzling effects. Uses large 7" satin finish reflector exactly to original specs. Single tube can easily be converted for 2 tube operation. Don't confuse with cheap, less powerful units. Now only \$22.50 (p&p \$1.00) Strobe Caps 6.5 of 250V ac \$3.50 each.

KIT 79 ET702 Radar Intruder Alarm
Uses microwaves to detect movement within 10M range by the Doppler principle. Now you can build a unit that operates on the same principle as the professionals use. Even works through timber and plastic wall panels and screens!! Operates from mains or batteries (extra). Complete kit \$54.00 (p&p \$1.00) CL 8960 Radar module \$32.00 (p&p \$1.00) ET702 PCB \$1.75. Kit for mains PSU (PS2VA) \$4.95

DON'T FORGET OUR AMP KITS
Playmaster 143 \$69.90 ET1422 \$118.00 (no rear panels now)

SEE E.T. MAY 75

DICK SMITH ELECTRONICS CENTRE
Head Office & Mail Orders P&P 50c min

160-162 Pacific Hwy Gore Hill N.S.W.2065 tel:439 5311

Also at CITY 125 York St tel:291126

BANKSTOWN 361 Hume Hwy tel:709 6600

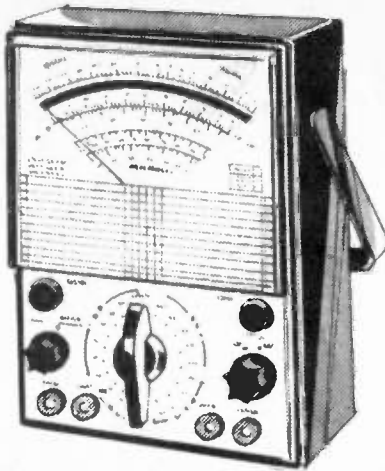

COMPLETE YOUR TEST BENCH WITH

59.95

- Dual FET for Drift-Free Accuracy!
- 1% Precision Resistors!
- Burnout Protected!
- 5" Mirrored Scale!
- Battery Check Switch!

MICRONTA EQUIPMENT

The accuracy and high input impedance of a VTM now in a portable FET VOM Ultra-sensitive 40µA meter has Double Overload Protection to guard against burnout Mirrored scales eliminate error-causing parallax for exact readings on ALL ranges. Also features a polarity reverse switch, zero adjust, single-knob range selector. DC Volts: 0-3-30-100-300-1000 at 10M ohms/volt AC Volts: 0-3-30-100-300-1000 at 10K ohms/volt DC Current: 0-100 µA, 3-30-300 mA Resistance: Rx1, Rx10, Rx100, Rx10K, Rx1M (10 center scale) Decibels: -20 to -62 in 5 ranges Accuracy: ±3% DC, ±4% AC. 7 x 5 1/2 x 3 1/2" With leads, batteries, instructions. 22-206

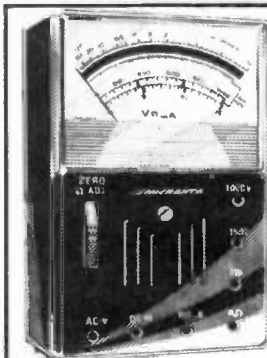

9.95

1000 Ohms/Volt AC-DC Pocket Tester — 8 Ranges. Handy for home and workshop. Features an easy-to-read 2" meter, a 2 color scale that's mirrored to prevent parallax, a thumb-wheel zero adjustment, and pin jacks for all ranges. AC and DC Ranges: 0-15-150-1000. DC Current: 0-150 mA. Resistance: Rx1000 (100,000 ohms full scale). Accuracy is ±3% on DC ranges and ±4% on AC. Uses 1% precision resistors throughout. Ultra-compact black bakelite case is only 3 1/2 x 2 1/4 x 1 1/4" deep. Complete with leads, battery, instructions. 22-027

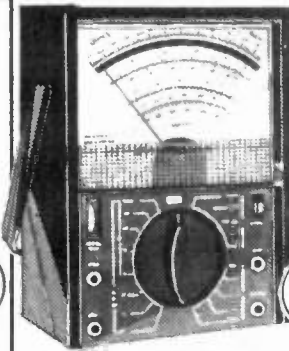

29.95

30,000 Ohms/Volt — 27 Ranges. A super-sensitive VOM for high accuracy measurements. Color-coded 4" meter, four banana jacks including output jack, polarity reverse switch, thumbwheel zero adjust, combined carry handle/stand. Ranges: DC Volts: 0-0.3-1-3-10-30-100-300-1000 at 30,000 ohms/volt; AC Volts: 0-10-30-100-300-1000 at 10,000 ohms/volt; DC Current: 0-100 µA, 3-30-300 mA, 10 amps. Resistance: Rx1, Rx10, Rx100, Rx10,000 (10 center scale); Decibels: 10 to +62 in 5 ranges. Accuracy: ±3% AC, ±4% DC. Size: 6 1/4 x 4 1/2 x 1 1/4". With leads, battery, instructions. 22-203

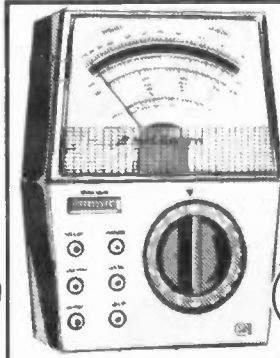

24.95

20,000 Ohms/Volt — 25 Ranges. A sensitive, full range VOM with single knob range selector, big 4" meter with mirrored and color coded scales. Has 6-pin jack connections including an output jack. Ranges: DC Volts: 0-0.6-3-15-60-300-500-1200 at 20,000 ohms/volt; AC Volts: 0-15-60-150-600-1200 at 10,000 ohms/volt; DC Current: 0-60 µA, 3-30-300 mA. Resistance: Rx1, Rx10, Rx100, Rx1000 (24 center scale); Decibels: -20 to +63 in 5 ranges. Accuracy is ±3% DC and ±4% AC. Size: 5 1/2 x 3 1/2 x 1 1/2". With leads, battery, instructions. 22-202

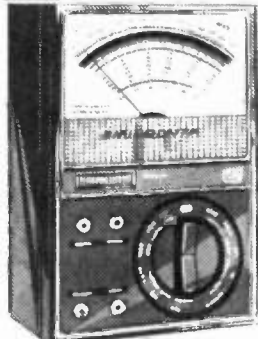

18.95

20,000 Ohms/Volt — 18 Ranges. A low-priced VOM with "super-sensitive" features. Single-knob range selector with separate "off" position, 3" meter with easy-to-read color-coded scales, four pin jack connections including an output jack. Ranges: DC Volts: 0-5-25-125-500-1000 at 20,000 ohms/volt; AC Volts: 0-10-50-250-1000 at 10,000 ohms/volt; DC Current: 0-50 µA, 0-250 mA; Resistance: Rx1, Rx10, Rx1000 (24 center scale); Decibels: -20 to +62 in four ranges. Accuracy is ±3% on DC ranges and ±4% on AC ranges. Large thumbwheel for easy zero-adjust. Size: 5 1/4 x 3 1/2 x 1 1/2". With leads, battery, instructions. 22-201

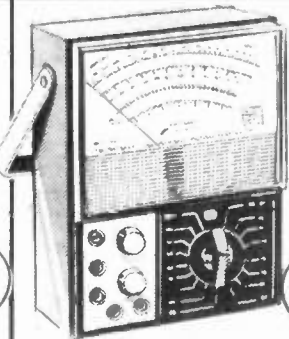

49.95

100,000 Ohms/Volt — 27 Ranges. Double jewel D'Arsonval 5" meter, mirrored scale, reverse polarity switch, overload protected meter. Carry handle tilt stand. DC Volts: 0-0.5-2.5-10-250-1000 at 100k ohms/volt; AC Volts: 0-5-10-50-250-1000 at 10k ohms/volt; DC Current: 0-10 µA, 50-500 mA, 10 A. Resistance: Rx1, Rx10, Rx100, Rx1000, Rx100,000 (2 center scale); dB: -20 to +62 in 5 ranges. Accuracy: ±3% DC, ±4% AC. 8 1/4 x 5 1/4 x 3 1/4". With leads, batteries, instructions. 22-205

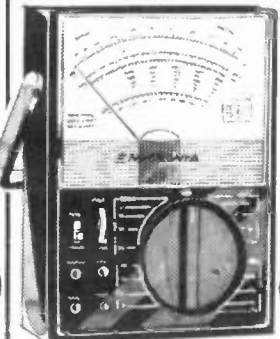

32.95

50,000 Ohms/Volt — 43 Ranges. Current and voltage "Range Doubler" — great for low voltage work! 4 1/4" mirrored scale, single-knob function switch with "OFF", overload protected meter. DC Volts: 0-250 mV, 2.5-10-50-250-1000 at 50 k ohms/volt; 0-125 mV, 1.25-5-25-125-500 at 25k ohms/volt; AC Volts: 0-10-50-250-1000 at 10k ohms/volt; 0-5-25-125-500 at 5000 ohms/volt; DC Current: 0-50 µA, 50-500 mA, 10 A at 50k ohms/volt; 0-25 µA, 2.5-25-250 mA, 5 A at 25k ohms/volt. Resistance: Rx1, Rx10, Rx100, Rx1000, Rx10,000 (10 center scale); dB: -20 to +62 in 8 ranges. Accuracy: ±3% DC, ±4% AC. 6 1/4 x 4 1/2 x 2 1/2". With leads, batteries, instructions. 22-204

OVER 60 STORES IN

SYDNEY, ADELAIDE, BRISBANE, CANBERRA, COFFS HARBOUR, DUBBO, GOULBURN, MELBOURNE, NEWCASTLE, ORANGE, TAREE, TAMWORTH, WAGGA

TANDY ELECTRONICS

THE WORLD WIDE SUPER MARKET OF SOUND FOR 52 YEARS

POST COUPON NOW FOR
FREE 116 PAGE
1975 CATALOGUE

TANDY INTERNATIONAL
ELECTRONICS PTY. LTD.

RYDALMERE /80-316 Victoria Road

PLEASE PRINT

Name _____

Address _____

Post Code _____

TIEET675



Jensen stomps their own grapes

Some people make their own wine. Jensen starts from the ground up, too. We've been stomping around in the speaker field for 46 years, here, in America. Built into every Jensen speaker system is our Total Energy Response which provides distortion-free response over a wide performance range. Jensen's cabinet design is a refreshing treat finished in hand-rubbed walnut with removable, textured fabric grills.

Our Models 4, 5, and 6 are only samples picked from Jensen's vintage line. Try a sip of any of our High Fidelity Speakers. Juicy.

**AUSTRALIAN
DISTRIBUTORS:**

BJD Electronics Pty. Ltd.

202 Pelham St., Carlton, 3053 Vic. Ph. 347-8255
65 Parramatta Rd., Five Dock 2046 NSW, Ph. 799-3156

DIGITAL DISPLAY

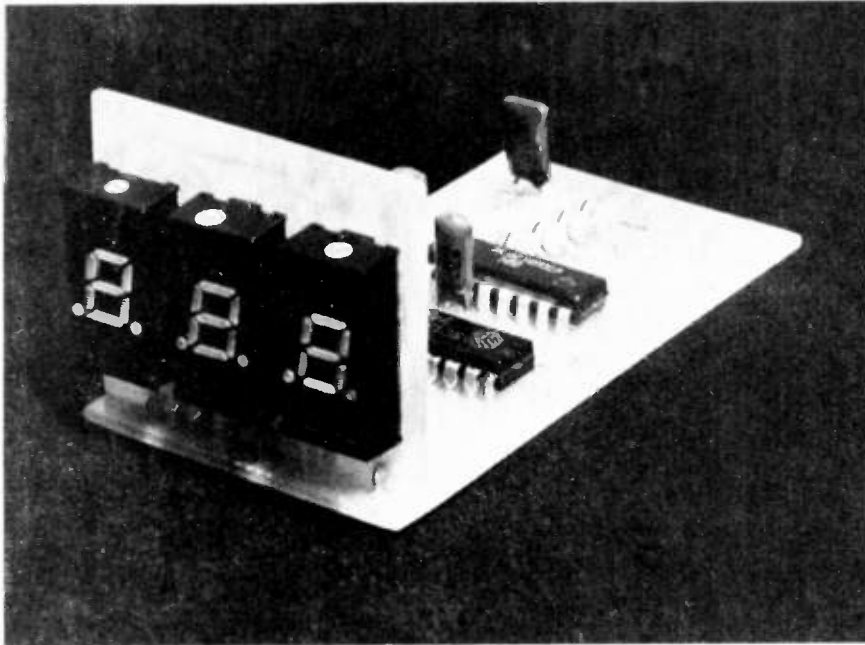

Three digit module for experimenters.

ALL digital instruments have a common assembly in the display system. Again, almost all instruments require decade counters, stores and decoder-drivers for the display.

Normal systems using TTL logic generally have a 7490, a 7475 and a 7447 to drive each 7 segment LED display digit. Hence to build a three-digit display nine ICs are required in addition to three display ICs.

Complex logic functions are available in CMOS which allow a 3 digit display to be built using only two ICs – and such ICs are available at reasonable cost. One of the devices is a three-digit, decade-counter, store and the second is a three-digit decoder-driver. Thus three digit displays can be built which have the following advantages.

1. Small size
2. Low power consumption (120 mA compared to 600 mA in TTL)
3. Wide power supply range (5-15V unregulated).

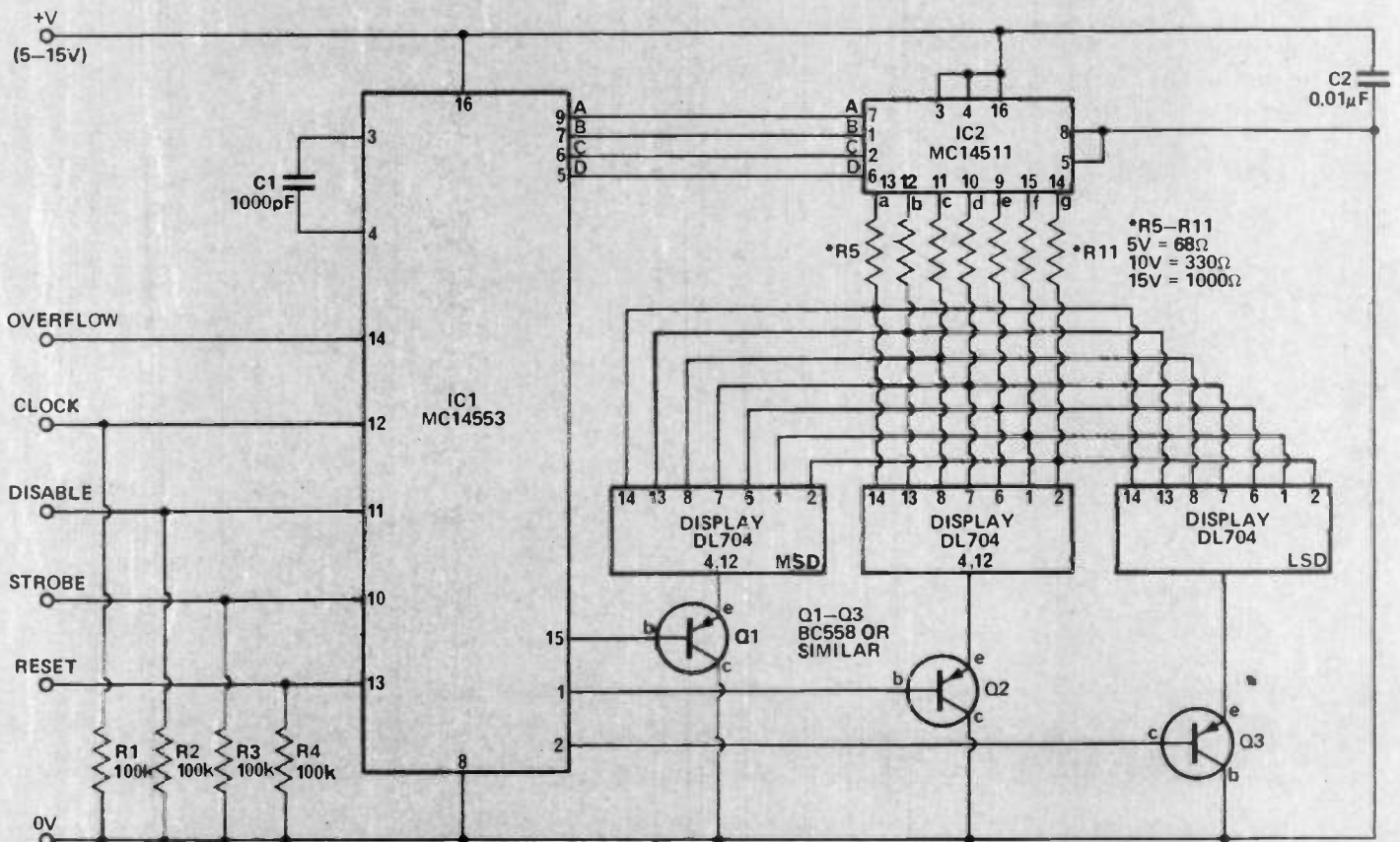

Fig. 1. Circuit diagram of the three digit counter module.

FOR DECIMAL PT. (RIGHT HAND)
ON DISPLAY CONNECT
PIN 9 TO +V VIA RESISTOR
(OF SAME VALUE) AS ABOVE

4. Cost about same as TTL but rapidly decreasing.

5. Immunity to noise is greatly improved.

Disadvantages

Maximum frequency about 1 MHz compared to 15 MHz for TTL..

CONSTRUCTION

Construction is quite straightforward especially if the printed circuit boards described are used. Since both ICs are CMOS devices, they can be easily damaged by static charges. Hence they should be handled as little as possible, fitted to the board after all other components and soldered using a minimum of heat.

Using the component overlay assemble the three DL704 displays to the display board (533B). Next solder the links onto the copper-side of the display board and form them so that they are clear of other tracks by at least one millimeter.

Next fix lengths of tinned copper wire to each of the six holes on the bottom of the display board. Allow approximately 10 mm of wire to extend from either end of the holes. Bend each wire so that they lie parallel and flush to the surfaces of the display board – do not solder as yet.

On the main printed-circuit board (533A) fit resistors R7, 8, 9, 12, 3 and 4 and capacitors C1 and C2. Now mate the display board to the main board by inserting each of the previously bent wires into its corresponding pair of holes on the main board.

Apply gentle force to the display

Rear view of the completed module. Note resistors and links at rear of display board.

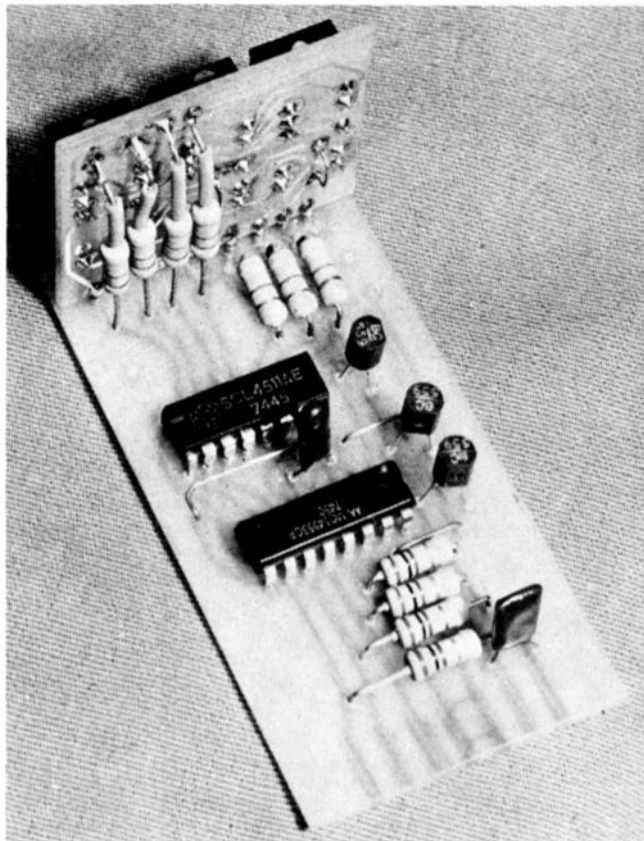

board until its bottom edge fits snugly against the main board. Solder each of the wires to both the supply and main boards to make a sound electrical and mechanical support for the display.

Fit R5, 10 and 11 and, taking care to orientate them correctly, fit Q1, 2 and 3 and IC1 and 2.

Lastly check that all components

have been correctly fitted and all solder joints are good. If possible get someone else to check your final circuit as a final safeguard.

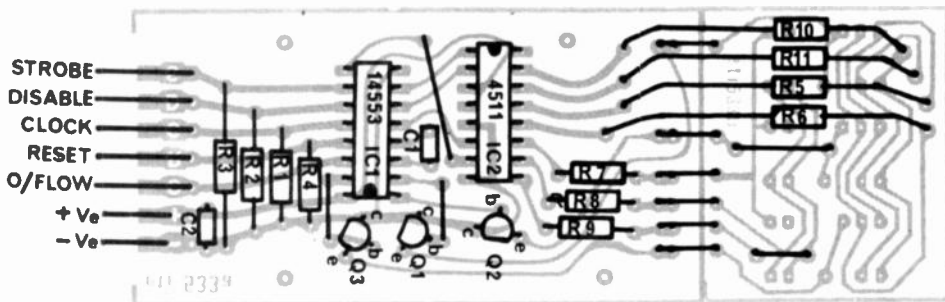

Fig. 2. Component overlay-logic board.

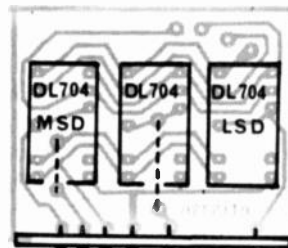

Fig. 3. Component overlay - display board.

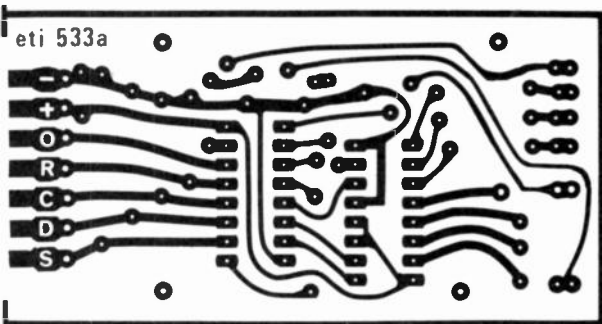

Fig. 4. Printed circuit layout for logic board. Full size 80 x 42 mm.

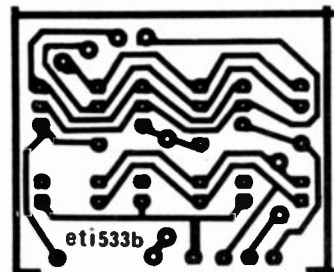

Fig. 5. Printed circuit layout for the display board. Full size 41 x 35 mm.



INSTRUMENTS

*Symbol
of quality*

Available from:

● **New South Wales**

**ELECTRICAL EQUIPMENT
OF AUSTRALIA LTD.**

86 Liverpool Street, Sydney
(Phone: 61 8321)

● **Victoria**

**ELECTRICAL EQUIPMENT
OF AUSTRALIA LTD.**

2 Palmer Street, South Melbourne
(Phone: 699 1288)

● **Queensland**

**ELECTRICAL EQUIPMENT
OF AUSTRALIA LTD.**

25 Maud Street, Newstead
Queensland (Phone: 52 3962)

● **South Australia**

ARTHUR H. HALL LIMITED
1-3 The Parade West, Kent Town
S.A. (Phone: 42 4506)

● **Western Australia**

RABLEC PTY LTD
255 Hay Street, Subiaco W.A.
(Phone: 81 2866)

● **Tasmania**

**GEORGE HARVEY
ELECTRIC PTY LTD**
76 York Street, Launceston Tas.
(Phone: 31 6533)

DIGITAL DISPLAY

PARTS LIST — ETI 533

R1,2,3,4 Resistor	100 k
R5-11	see text.
C1 Capacitor	0.001 μ F Polyester
C2	0.01 μ F Polyester
IC1 Integrated Circuit	MC 14553 (CMOS)
IC2	14511 or 4511 (CMOS)
Q1,2,3 Transistor	BC 558 or similar
DISPLAYS	DL704 or similar three required
PC boards	ETI 533A and ETI 533 B

HOW IT WORKS — ETI533

The heart of the counter is IC1, this LSI CMOS chip contains a three-digit decade counter, three sets of latches, and a three-digit multiplexer with an internal oscillator. C1 is used to set the frequency of this oscillator.

The four input lines to IC1 are used to control the operation of the counter. Since IC1 is a CMOS device R1-4 are used to protect its inputs. Pulses to be counted are fed to the clock input and on a negative transition the value in the counter is increased by one. The schmitt-trigger action of the clock input allows any value of transition time of the input pulse.

The counter operates when there is a low at the disable input (pin 11).

To ensure accurate counting the clock should be low when the disable is brought from a high to a low level. The strobe input controls the loading of the latch. When it is low, data can be accepted for display. However the strobe input has no effect on the counter, i.e., even with the strobe input high, the counter can still be incrementing.

A high on the reset input clears the counters (to a 000 state) and stops the internal multiplexing oscillation of IC2, and so — blanks the display. Returning the reset to a low allows the internal oscillator to start up and all zeros to be displayed. This feature could be used in portable equipment to conserve power.

All inputs are standard CMOS inputs and require a minimum voltage change of from 30% to 70% of supply volts. However it is recommended that a swing from 0V to supply be used to give a satisfactory noise margin. Each input can be considered to be 100k shunted by 8-10 pF. Voltage swing below 0V and above supply are also to be avoided.

The one output available is the overflow (pin 14). This goes positive when the counter is 999 and the clock input is high. When the clock input goes low and advances the

counter to all zeros the overflow goes low. This is a CMOS output and will swing between supply rails. It is not recommended that the overflow output be used to drive TTL directly.

The internal multiplexer of IC1 allows considerable saving in parts and board space. It allows a three-digit number to be transmitted over a single set of lines and it does this by leaving each digit on the output lines for a short length of time, before replacing it with the next digit. Then after presenting all the digits once, it starts over again and repeats the operation.

IC2 is a CMOS, latch BCD to seven-segment decoder and driver, however for this application the latch is not used. It converts the 4-bit BCD code into the seven-line code necessary to drive the display segments. It also provides sufficient current to drive the display. Although IC2 is coupled to all three displays, only one display is lit up at any one time. Thus when it is the turn of the most significant digit to be displayed IC1 presents that number to IC2 which decodes the number and presents it to the three displays, but only Q1 is turned on, so only the left most display lights.

Note that IC1 controls which number is being presented and which transistor is turned on. This is called multiplexing. The switching between displays occurs so quickly that to our eyes the light appears continuous.

Resistors R5 to R11 limit the current to each LED display to a safe level. Three different values have been given for these resistors. Select the value appropriate to the supply voltage that you decide to use, 68 ohms for 5 V, 330 ohms for 10 V and 1k for 15 V. Transistors Q1, Q2 and Q3 also act as current amps since only a limited amount of current can be taken from IC1.

Any voltage from 5 V to 15 V can be used to supply the counter, however, a supply voltage of 15 V allows the counter to operate at its highest speed.

EEA/1

KITSETS



KIT'S KOLUMN

This, gentle electronic brothers is our new Retail Buying Guide - a sort of stop-gap until our new super catalogue comes out. Of course, there isn't room to put in everything you want, just write or ring - or call in. OK? Frankly, to produce our catalogue as we did last year would have cost an arm and a leg. When Expense-Account found out how much, you could have heard the shrieks a block away.

He thumped his intercom until the buttons fell off, but no-one would go near him. (We might be loyal, but we're not foolhardy).

Increased printing and production costs would have meant we'd have raised our prices. And that's something Expense-Account just won't do. He's got this bee in his bonnet about keeping prices low. Says that everybody should be able to enjoy electronics without being slugged for it like they are for everything else in life.

Every now and again he sounds positively human.

Anyhow, we're working on the problem, and this is what we're doing in the meantime. Talking about what we're doing, Steve (our resident jet setter) will be yong-tiddling in Japan about the time this is printed.

He'll also be buying up everything and anything that is new, amazing, great, splendiferous and exciting in electronics. So we'll have some surprises for you when he gets back.

So to John who writes to me from Katmandu (truly) and to Dean from Chippendale and all those guys who keep asking what's happening (and even to Alfred E. who wouldn't know if it did, and Yankee Doodle who wouldn't care unless it was chrome plated and 20 in a bag) - hang on gentlemen - you ain't seen nuthin' yet!

Keep your iron hot,

KIT

Unfortunately time allowed us to list only most of the range of Kitsets products in general usage. The remainder of the products - such as transformers, loud speakers and a comprehensive listing of all kits available will be featured in the August issue of this publication.

RESISTORS

Wattage ratings refer to the power that can be dissipated, so using a higher wattage than specified does not matter apart from the space taken up.

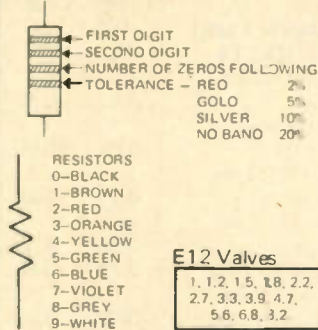

E12 Valves

1, 1.2, 1.5, 1.8, 2.2, 2.7, 3.3, 3.9, 4.7, 5.6, 6.8, 3.2

HIGH QUALITY CARBON RESISTORS

Valves	Each up to 99	Each 100 or more
½ watt (E12 tolerance 10ohm - 10ohm)	.04	0.03
1 watt (E12 valves) 5% tolerance 1ohm - 10ohm	.07	0.05

WIRE WOUNDS

Wattage	Each 10 or more
2 watt W.W. 10% tolerance 0.1, 0.22, 0.47 ohm	.40
5 watt W.W. 10% tolerance 0.1, 0.22, 0.47, 1.0, 1.5, 2.2, 3.3, 5.6, 6.8, 8.2, 1.0 ohm 12ohm - 12ohm - 1.5ohm	.84
10 watt W.W. 10% tolerance 0.1, 0.22, 0.47	.55
1.0 ohm	.40
1.5, 2.2, 3.3, 4.7, 5.6, 6.8, 8.2	.40
1.0ohm	.80
12ohm - 1.5ohm	.65

THERMISTORS

Resistance	Each	Each 10 or more
R53 (5000 ohm Standard Restr. Resistance)	2.90	2.75
R24 (20000 ohm Standard Resistance)	2.90	2.75

1/2 W RESISTOR PACK

Computer sel. values 220 Restrs	6.00	5.75
---------------------------------	------	------

1 W RESISTOR PACK

Computer sel. values 220 Resistors	6.00	5.75
------------------------------------	------	------

POTENTIOMETERS

SINGLE GANG LINEAR

Value	Each up to 9	Each 10 More
1K	.60	.50
5K	.60	.50
10K	.60	.50
25K	.60	.50
50K	.60	.50
100K	.60	.50
250K	.60	.50
500K	.60	.50
1M	.60	.50

SINGLE GANG LOG

Value	Each up to 9	Each 10 More
1K	.60	.50
5K	.60	.50
10K	.60	.50
20K	.60	.50
50K	.60	.50
100K	.60	.50
250K	.60	.50
500K	.60	.50
1M	.60	.50

SINGLE GANG LOG SWITCHED

Value	Each up to 9	Each 10 More
1K	1.20	1.10
5K	1.00	1.10
10K	1.20	1.10
25K	1.20	1.10
50K	1.20	1.10
100K	1.20	1.10
250K	1.20	1.10
500K	1.20	1.10

DOUBLE GANG LINEAR

Value	Each up to 9	Each 10 More
10K	1.50	1.40
25K	1.50	1.40
50K	1.50	1.40
100K	1.50	1.40
250K	1.50	1.40
500K	1.50	1.40
1M	1.50	1.40

DOUBLE GANG LOG

Value	Each up to 9	Each 10 More
10K	1.50	1.40
25K	1.50	1.40
50K	1.50	1.40
100K	1.50	1.40
250K	1.50	1.40
500K	1.50	1.40
1M	1.50	1.40

TRIMPOTS VTU VCS C

Value	Each up to 9	Each 10 More
1K	0.22	0.20
5K	1.20	1.10
10K	1.20	1.10
25K	1.20	1.10
50K	1.20	1.10
100K	1.20	1.10
250K	1.20	1.10
500K	1.20	1.10
1M	1.20	1.10

SLIDE POTS 45m.m. LINEAR SINGLE GANG

Value	Each up to 9	Each 10 More
1K	.80	.75
5K	.80	.75
10K	.80	.75
50K	.80	.75
100K	.80	.75
250K	.80	.75
500K	.80	.75
1M	.80	.75

LOG SINGLE GANG

Value	Each up to 9	Each 10 More
1K	.80	.75
5K	.80	.75
10K	.80	.75
50K	.80	.75
100K	.80	.75
250K	.80	.75
500K	.80	.75
1M	.80	.75

LINEAR DOUBLE GANG

Value	Each up to 9	Each 10 More
50K	1.30	1.20
100K	1.30	1.20
250K	1.30	1.20
500K	1.30	1.20
1M	1.30	1.20
VSG45C		
50K	1.30	1.20

LOG DOUBLE GANG

Value	Each up to 9	Each 10 More
50K	1.30	1.20
100K	1.30	1.20
250K	1.30	1.20
500K	1.30	1.20
1M	1.30	1.20

3W WIRE WOUND POTS

Value	Each up to 9	Each 10 More
10 ohm	1.95	1.85
25 ohm	1.95	1.85
50 ohm	1.95	1.85
100 ohm	1.95	1.85
250 ohm	1.95	1.85
500 ohm	1.95	1.85
1000 ohm	1.95	1.85
2.5K	1.95	1.85
5K	1.95	1.85
10K	1.95	1.85

TRIMPOTS (VERTICAL)

Value	Each up to 9	Each 10 More
100 ohm	0.22	0.20
250 ohm	0.22	0.20
1K	0.22	0.20
2K	0.22	0.20
5K	0.22	0.20
10K	0.22	0.20
25K	0.22	0.20
50K	0.22	0.20
100K	0.22	0.20
250K	0.22	0.20
500K	0.22	0.20
1M	0.22	0.20

TRIMPOTS (HORIZONTAL)

Value	Each up to 9	Each 10 More
100 ohm	0.22	0.20
250 ohm	0.22	0.20
500 ohm	0.22	0.20
1K	0.22	0.20
2K	0.22	0.20
5K	0.22	0.20
10K	0.22	0.20
25K	0.22	0.20
50K	0.22	0.20
100K	0.22	0.20
250K	0.22	0.20
500K	0.22	0.20
1M	0.22	0.20
VC1	0.60	0.50
VC4	0.80	0.70

SEMI CONDUCTORS

TRANSISTORS - INTEGRATED CIRCUITS AND S.C.R.'S ETC

All transistors and devices are new first grade branded stocks with their manufacturer's numbers. New types are brought into stock as required for popular projects in the leading electronics publications enquiries invited for types not listed.

TRANSISTORS		
ASZ15	4.00	4.00
ASZ18	3.90	3.75
BC107 Plastic		
sup. equiv.	.25	.20
BC108 " "	.25	.20
BC109 " "	.25	.20
BC177 " "	.30	.25
BC178 " "	.30	.25
BC179 " "	.30	.25
BC109C " "	.45	.40
BD139	.90	.80
BD140	.90	.80
BF115	.80	.75
BF337	1.50	1.40
BFY50	.80	.70
BFY51	.80	.70
BFY52	.80	.70
D13T1 2N6027	1.40	1.30
NSD106	1.00	.95
NSD107	1.00	.95
MPF121	.90	.85
TIP31B	.95	.90
TIP32B	1.00	.95
TIP33C	1.70	1.65
TIP34C	1.75	1.70
TIP35C	3.70	3.60
TIP36C	3.75	3.70
2N301	2.80	2.60
2N3055	1.20	1.10
2N5871	2.30	2.20
2N2646	1.40	1.30
2N2904A	.85	.82
2N2905A	.90	.88
2N3053	.93	.90
2N3564	.55	.50
2N3566	.65	.65
2N3568	.75	.70
2N3569	.65	.60
2N3638A	.55	.50
BPX66	2.42	2.40
BPX25	3.15	3.10
ORP12	.85	.75
MPF102	.60	.50
MPF103 (5457)	.60	.50
MPF104 (5458)	1.10	1.00
MPF105 (5459)	.60	.50
MPF106 (5485)	.60	.50
SC146D	2.10	2.00
C122D	2.20	2.00
C106D1	1.50	1.30
C106Y1	1.00	0.95
ST4	.95	.85
C103Y	1.75	1.70
400MW 3.3-33VE	.35	.30
1.7W 5.6-56VE	.89	.85
BYX21L/200	2.15	2.00

BYX21L/200R	2.15	2.00
BA219 E	.26	.22
BA91E	.24	.20
BA202E	.33	.32
BA95E	.24	.20
IN914 E	.12	.10
EM404	.14	.13
EM410	.29	.25
A15A	.65	.60
MB4	1.40	1.20
MB10	3.20	3.00
PA 40	6.00	5.75
LED-Red/Green	.40	.38
FND 70		
(or similar)	5.00	4.75
MAN 1		
(or similar)	2.81	2.75
MAN 7 (0.6")	3.57	3.25
SN7400	.40	.35
SN7402	.45	.40
SN7404	.45	.40
SN7410	.45	.40
SN7413	.60	.55
SN7420	.45	.40
SN7430	.45	.40
SN7440	.45	.40
SN7441	1.40	1.35
SN7442	1.20	1.10
SN7446	1.70	1.65
SN7473	1.00	.95
SN7475	1.15	1.10
SN7483	1.60	1.50
SN7490	.95	.90
SN7491	1.40	1.30
SN7492	1.00	.90
SN7493	1.00	.90
SN74121	.75	.70
LM709-Metal		
Can	1.00	.90
LM301-8DIL	1.00	.90
1m709-Metal		
Can	1.00	.90
LM709-14DIL	1.00	.90
LM723-Metal		
Can	1.20	1.10
LM723-14DIL	1.20	1.10
LM739	2.40	2.25
LM741-Metal		
Can	.95	.90
LM741-8DIL	.95	.90
LM741-14DIL	.95	.90
LM308	2.45	2.25
LM309K	3.30	3.10
LM381N	3.20	3.00
LM3900	1.75	1.60
uA7805	2.40	2.30
uA7812	2.40	2.30
uA7815	2.40	2.30
NE555	1.00	.95
NE556	2.75	2.50
TAA300	2.90	2.70

PLUGS & SOCKETS

PRODUCT	Each up to 9	Each 10 or More
TERMINALS		
Screw Terminals	0.30	0.26
Spring Terminals	0.25	0.20
Banana plug	0.15	0.13
Banana socket	0.20	0.18
COPI (L734/P)	0.57	0.50

PL COAXIAL PLUGS & SOCKETS		
COS1 (L734/J)	0.90	0.80
COS2 (L604/S)	0.50	0.40
COS3	0.40	0.35
COS5	0.57	0.50
IC SOCKET		
8 mini dip	0.44	0.40
14 pin dip	0.50	0.45
16 pin dip	0.55	0.50
HEATSINKS		
WBF003 3"	3.10	2.90
WBF0034"	3.75	3.60
WBF003 6"	5.30	5.10
TV3	0.75	0.65
5F	0.33	0.30
AC1	.08	.07
AC2	.08	.07
MAINS PLUGS & SOCKETS		
439D Mains Plug	0.40	0.38
412A Mains Socket	0.60	0.55
JC4317 2 pin socket	0.45	0.40
AR611 2 pin plug	0.35	0.30
Piggback plug	0.70	0.65
438 Surface mount socket	0.60	0.55
MULTIWAY CONNECTORS		
1228-01-02 8w plug	0.80	0.75
1338-11-02 8w plug	0.80	0.75
1473-01-11 cover to suit		
1338	1.80	1.60
1475 clamp to suit 1338	0.90	0.80
0.1" 16 way Redline	1.40	1.20
0.15" 16 way Redline	1.40	1.20
PLUGS & SOCKETS		
L8/USPI Octal Line plug	0.40	0.35
B8/USSI Octal Line socket	0.35	0.32
NB/FU Octal Chassis socket	0.26	0.24
C8/USP Octal Chassis plug	0.35	0.32
L8 cover	0.26	0.24
U8	0.26	0.24
2QS/NF 2 pin socket	0.23	0.20
2QP/B 2 pin plug	0.18	0.16
5QP/B 5 pin plug	0.23	0.20
5QS/NF 5 pin socket	0.23	0.21
5QS/B 5 pin line socket	0.23	0.21
Q5 Cover to suit 5Q S/B	0.12	0.09
PHONO		
P1 2.5 mm plug	0.15	0.13
J1 2.5mm socket	0.15	0.13

P33.5mm plug	0.25	0.20
J3 3.5 mm socket	0.20	0.18
C3 3.5mm line socket	0.18	0.15
P4M 6.5mm me metal plug	0.50	0.40
J46.5mm panel mount socket	0.34	0.25
C4M 6.5 socket metal line	0.46	0.40
PS4M 6.5 mm stereo metal plug	0.65	0.50
JS4 6.5mm panel mount stereo socket	0.44	0.40
JS4M 6.5 mm stereo line metal socket	0.55	0.45
RCA		
LC1 RCA line socket	0.25	0.20
LC2 hard capped plug	0.24	0.20
LC3 panel mount singleterminal (uninsulated)	0.18	0.16
M698 insulated	0.18	0.16
M423 twin bank terminal	0.20	0.17
AT634 4 bank terminal	0.40	0.36
POWER SUPPLIES PLUGS & SOCKETS		
DC1 2.5mm hole plug	0.30	0.25
DC2 2.1mm hole plug	0.30	0.25
DJ1 2.5mm Jack	0.50	0.45
DJ2 2.1mm Jack	0.50	0.45
1289-21-01-DC supply plug	0.49	0.45
1290-24-01 DC supply socket	0.69	0.65
DIN		
DP2 2 pin din plug	0.25	0.21
DL2 2 pin din line socket	0.30	0.25
DS2 2 pin din socket	0.20	0.17
DP3 3 pin din plug	0.32	0.28
DL3 3 pin din I line socket	0.36	0.32
DS3 3 pin din socket	0.25	0.23
DP5 5 pin din plug	0.43	0.39
DL5 5 pin din line socket	0.48	0.45
DS5 5 pin din socket	0.30	0.28
ACCESSORY PLUGS & SOCKETS		
Car cigarette lighter	0.50	0.45
T03 Mounting Kit	0.15	0.14
T03 Insulating Cap	0.30	0.28
T03 Socket	0.30	0.28
H252 Plug	0.02	0.02
H906 Cable Clamp	0.08	0.07

MICROPHONES

PRODUCT	Each up to 9	Each 10 or more
MICROPHONES		
CM62 (small crystal lapel type)	1.95	1.90
CM90 (crystal with stand)	6.90	6.50
DM401	10.90	10.30
AD1095	3.90	3.60
UDM104	17.50	17.00
DM108	27.50	26.00

CABLES

PRODUCT	Each up to 9	Each 10 or More
CABLES		
Fig. 8 Speaker wire	0.15	9.50
Rainbow cable	0.90	80.00
7/0076 Hookup	0.05	4.00
10/010 Hookup	0.07	5.50
23/0076 "	0.08	7.00
ICSI Single Shielded	0.20	18.00
2CS2 Fig.8 Shielded	0.35	30.00
4CS1 Four core Shielded	0.60	50.00
23/0076 Three core mains flex	0.30	25.00
23/0076 Fig. 8 mains flex	0.14	12.00

TEST EQUIPMENT

PRODUCT	Each up to 9	Each 10 or More
TRIO TEST EQUIPMENT		
DT1001 Pocket 11 range 1000 ohm per V	9.50	9.03
DT1301 Compact 13 range 20,000ohm perV	15.52	14.75
DT1302 Rugged 16 range 20,000ohm perV	20.00	19.00
DT1305 Range doubler 36 range 5K ohms per V	30.00	28.50
DT1306 22 Range Deluxe 100,000ohm per V	40.00	38.00

DT1307 19 Range FET Metre 12meg ohm prof.	50.00	47.50
TEST EQUIPMENT		
TE20D RF Signal Gen.	55.00	52.75
TE22D AF Signal Gen.	65.00	61.75
SE360 Sign. Injector/Tracer	38.00	36.50
TE15D Grid Dip Oscillator	41.50	40.50
Trans. Tester	19.00	

VALVES

Special quantity prices will be quoted on request

PRODUCT	Each up to 9	Each 10 or more
1B3	1.84	1.75
1S2	1.84	1.75
5AS4	1.87	1.75
6AL3	1.95	1.85
6AL5	1.51	1.45
6AU6	1.72	1.65
6BE6	1.82	1.75
6BL8	1.86	1.76
6BQ7A	1.95	1.85
6BM8	1.99	1.85
6GV8	2.14	2.00
6GW8	2.14	2.00
6BX6	1.76	1.60
6CA7	4.30	4.10
6CA7	4.30	3.10
6CM5	2.68	2.55
6CW5	1.76	1.65
6DQ6A	2.68	2.50
6EA8	1.95	1.85
6ES8	2.20	2.10
6EM5	1.72	1.65
6M5	2.31	2.25
12AT7	2.20	2.15
12AU7A	1.80	1.70
12AV7	4.21	4.15
12AX7	2.03	2.00
EF86	3.00	1.85
6AU4GT	1.95	1.85
6BQ5	1.84	1.75
6BW6	4.40	4.25
6CS6	1.68	1.60
6HG8	2.39	2.30
6JW8	2.05	1.85
6X9	2.43	2.35
6Y9	2.49	2.40

MODULES

All modules assembled and ready for power and wire connections. Amp modules have heat sinks.

PRODUCT	Each up to 9	Each 10 or more
Modules AM Tuner	19.50	18.00
Modules FM/		

AM Tuner	49.50	45.50
Stereo Mag. Cart.-Preamp.	12.50	12.00
Stereo Tape Head Preamp.	12.50	12.00
Stereo Lo imp Mic. Preamp.	12.50	12.00
Stereo Hi imp Mic. Preamp.	12.50	12.00
Stereo Guitar Preamp	12.50	12.00
15W Stereo	29.50	27.50
30W Stereo	39.50	37.50
60W Mono	39.50	37.50
120W Mono	49.50	45.00
Mon Scratch & Rumble Filter	9.50	9.00
Stereo Control Unit	29.50	27.50
15W Mono	16.50	15.00
30W Mono	21.50	20.00
Stereo mute boards	12.50	12.00
Stereo Ceramic Preamp.	12.50	12.00
Stereo Meter Amplifier	12.50	12.00
Home Alarm Module	12.50	12.00
Car Alarm Module	12.50	12.00
Siren Module-1	12.50	12.00
Siren Module 2	12.50	12.00
Stereo VU Meter Driver	12.50	12.00
Alarm Speaker	10.50	10.00

SWITCHES

PRODUCT	Each up to 9	Each 10 or More
MINATURES TOGGLE SWITCHES		
SPDT	1.25	1.20
SPDT with centre off	1.47	1.40
DPDT	1.74	1.65
DPDT with Centre off	2.13	2.00
DPDT Push on/ Push off	3.33	3.00
OAK SWITCHES		
1 12 1	2.20	2.00
1 6 1	2.20	2.00
2 5 1	2.20	2.00
3 4 1	2.20	2.00
3 3 1	2.20	2.00
6 2 1	2.20	2.00
1 12 2	3.70	3.50
2 6 2	3.70	3.50
2 5 2	3.70	3.50
3 4 2	3.70	3.50
4 3 2	3.70	3.50
6 2 2	3.70	3.50
1 12 3	5.50	5.00
2 6 3	5.50	5.00
2 5 3	5.50	5.00
3 4 3	5.50	5.00
4 3 3	5.50	5.00
6 2 3	5.50	5.00
TOGGLE SWITCHES		
DPDT 6A/ 240V	0.95	0.90

SOLDERING IRONS

Choose from either the Mico or well proven Weller range listed below.

PRODUCT	Each up to 9	Each 10 or more
TOOLS		
Mico 10w 6V 12V	7.50	7.20
10w TIPS	6.25	5.75
Weller SP25D	0.65	0.60
JW60D	8.35	8.00
Weller WTCPI (240V)	22.60	21.60
Weller TCPI (24V)	46.50	45.00
PTA6 Dble flat tip 1/16"	2.00	1.80
PTCC6 Sngle flat tip 1/8"	2.00	1.80
PTA7	2.00	1.80
PTCC7	2.00	1.80
PTA8	2.00	1.80
PTCC8	2.00	1.80
CT5EE6	2.00	1.80
CT5CC6	2.00	1.80
CT5EE7	2.00	1.80
CT5CC7	2.00	1.80
CT5EE8	2.00	1.80
CT5CC8	2.00	1.80
SP25D tip		
MT1	1.00	0.90
MT4	1.00	0.90

TOOLS

Tools are of high quality.

PRODUCT	Each up to 9	Each 10 or more
Pliers (needle)	4.95	4.50
Cutters	4.95	4.50
Pliers (blunt)	4.95	4.50
Nibbling Tool	6.95	6.50
Alignment Set	4.50	4.20
Punch Set	10.50	10.00
Screwdriver 1	1.50	1.20
Screwdriver 2	1.50	1.20
Phillips Screwdriver	1.50	1.20
Neon Screwdriver	1.50	1.30
Resoldering Tool	6.95	6.50
Dip loading Tool	3.50	3.20

P.C. BOARDS

These boards are for EA and ET projects (check the prices of components before building your kit).

PRODUCT	Each up to 9	Each 10 or More
PC Boards		
ET		
003B	1.54	1.40
00Y	0.90	0.80
005A	1.14	1.00
006	1.91	1.75
008	1.78	1.60
012	1.28	1.10
014	1.78	1.68
017	1.28	1.10
018	1.92	1.75
019	1.74	1.60
021	1.28	1.10
022	1.54	1.40
023	1.40	1.20
025	1.74	1.60
026	1.28	1.10
029	1.28	1.10
033	3.40	3.20
034	1.56	1.40
034/TA25C	1.56	1.40
111	1.28	1.10
113	1.78	1.60
114	1.76	1.60
116	1.74	1.60
228	0.90	0.80
309	1.28	1.10
311	1.74	1.60
312	1.92	1.75
313	1.14	1.00
314	1.02	0.90
315	1.10	1.00
413	1.56	1.40
414A	2.30	2.10
414B	2.04	1.90
414C	1.56	1.40
524	1.40	1.20
526	0.76	0.70
527	1.40	1.20
528	1.40	1.20
530	0.76	0.70
601j	2.80	2.60
601A	1.48	1.40
601B	2.04	1.90
601C	1.78	1.60
601D	0.90	0.80
601E	2.42	2.20
601F	1.54	1.40
601N	2.30	2.10
701	1.14	1.00
414d	0.76	0.70
414D	1.56	1.40
414E	2.04	1.90
416	3.58	3.00
417	1.02	0.90
419	1.28	1.10
420A	1.40	1.30
420B	1.92	1.75
420C	1.14	1.00
420D	1.78	1.60
420E	2.04	1.90
422	3.44	3.20
424	1.74	1.60
426	0.72	0.70
427	2.04	1.90
428	2.30	2.10
429	1.40	1.30
430	0.90	0.80
518	1.14	1.00
520A	3.58	3.20

520B	0.76	0.70
EA		
521	4.08	3.80
71C12	3.82	3.70
71TV2	1.28	1.10
72C2	4.46	4.10
721F6	0.76	0.70
72C8	1.74	1.60
725A9	2.04	1.90
72R9	1.78	1.60
72G7	1.02	0.90
72P3	1.02	0.90
72510	1.74	1.60
72511	1.74	1.60
72T10	0.90	0.80
72SA10	2.94	2.80
72T11	3.40	3.20
72M12	1.78	1.60
73V1A	3.70	3.50
73V1B	2.04	1.90
73D1	0.52	0.50
7356	0.76	0.70
73C3	3.20	3.10
73TV3	1.40	1.20
73TIJR	3.20	3.10
73SA9	1.78	1.60
73P11	1.74	1.60
73TV11	1.74	1.60
7312T	2.80	2.60
73C12	5.10	5.00
73TU7	1.78	1.60
74MPI	1.14	1.00
74A1	1.54	1.40
74SAS	2.30	2.10
74D8	3.40	3.20
74MX8	1.54	1.40
74TU8	1.74	1.60
74C9	3.40	3.20
E8C	5.80	5.60
E8F	5.80	5.60
E8T	6.12	6.00
E8D	6.00	5.80
E8A	6.12	6.00
E810T	6.64	6.50
E8K1	6.38	6.10
E8S	6.38	6.10
E8P	6.64	6.50
E8M	6.50	6.40
Dauble State (1)	3.10	3.00
State (11)	1.02	0.90
755D4	1.78	1.60
75AC1	1.92	1.75
6"x3" Phenolic	0.40	0.45
6"x6" Phenolic	1.00	0.90
12"x3" Phenolic	1.00	0.90
12"x12" Phenolic	2.50	2.40
6"x3" Glass	0.90	0.85
6"x6" Glass	1.60	1.50
12"x3" Glass	1.60	1.50
E8C	5.80	5.60
E8F	5.80	5.60
E8T	6.12	6.00
E8D	6.00	5.80
E8A	6.12	6.00
E810T	6.64	6.50
E8K1	6.38	6.10
E8S	6.38	6.10
E8P	6.64	6.50
E8M	6.50	6.40
Dauble State (II)	3.10	3.00
State (III)	1.02	0.90
755D4	1.78	1.60
75AC1	1.92	1.75
Copper Laminated Boards		
6"x3" Phenolic	0.40	0.45
6"x6" Phenolic	1.00	0.90
12"x3" Phen.	1.00	0.90
12"x12" Phen.	2.50	2.40
6"x3" Glass	0.90	0.85
6"x6" Glass	1.60	1.50
12"x4" Glass	1.60	1.50
12"x12" Glass	6.40	6.30

Coated Boards For Photo Use

6"x3" Phen.	0.74	0.70
Special Coated		
6"x6" Phen.	1.26	1.20
Special Coated		
12"x3" Phen.		
Special Coated	1.16	1.00
12"x12" Phen.		
Special Coated	3.52	3.40
6"x3" Glass		
Special Coated	1.20	1.10
6"x6" Glass		
Special Coated	2.18	2.00
12" x 3" Glass		
Special Coated	2.18	2.00
12"x12" Glass		
Special Coated	8.00	7.50
Register Strips		
12"x½" Glass	3.58	3.20
12"x½" Phen.	2.04	1.90

BOOKS

Choose from the many books listed below to help you with your current problem or project.

PRODUCT	Each up to 9	Each 10 or More
BOOKS		
Radio & Electronic Lab. Handbook.	16.80	16.80
Radio Valve & Trans. Data Book	3.00	3.00
Newnes Radio Eng. Pocket Book	3.50	3.50
Foundation of Wireless & Electronics	6.10	6.10
Basic Electronics Fundamentals of Solid State	3.00	3.00
Digital Elect.	3.00	3.00
G'E' Trans. Manual	4.95	4.95
G.E. Exper. Manual	3.90	3.90
Phillips Pocket Books	3.45	3.45
Phillips Hi-Fi Speaker Systems	3.75	3.75
G.E. Semi Data Book	9.50	9.50
Projects & Circuits from Elec. Aust.	2.00	2.00
Elect. Aust.	0.75	0.75
Elects. Today	0.70	0.70
Wireless World	0.70	0.70
Practical Elects.	0.50	0.50
Telefix Calculator	2.50	2.50
BEGINNERS KITS		
Crystal Radio Kit	4.55	4.30
10 in 1	10.50	9.00
20 in 1	13.25	12.00
65 in 1	22.40	21.00
100 in 1	25.40	23.00
150 in 1		
Attache	36.95	34.00

HI FI EQUIPMENT

Only top quality brand names for top of the line sound reproduction.

L & G		
R3600 am/fm tuner amp	279.23	248.14
R3400 am/fm tun	231.42	205.66
L2600 Ampl.	195.08	173.36
L2400 Ampl.	177.87	158.07
AP13 Manual Turntable	168.30	149.56
FP15 Auto Turntable	198.90	176.76
S20 Speaker	112.85	100.28
S25 Speaker	143.60	127.61
STEINTRON SPEAKERS		
V120	119.00	110.00
V100	99.00	95.00
Cube 55	19.50	17.50
SONY		
TA1055	239.00	239.00
TC131SD	279.00	279.00
TC121	159.00	159.00
TC377	449.00	449.00
CF1505	129.00	129.00
TFM3750W	†39.00	39.00
PHODIS		
CE600	139.00	129.00
DEITRON		
DSA1212	125.00	125.00
DSA1515	152.00	152.00
DSA2525	175.00	175.00
DSR2222	225.00	225.00
DQA4005	215.00	215.00
DQA4010	259.00	259.00
DSS62	85.00	
ROTEL		
RA212-211	109.16	--
RA312-311	153.91	--
RA612-611	218.35	--
RA812-810	272.04	--
RA1212-1210	327.50	--
BSR		
P128 with base/cover cartridge	84.00	79.00
C142 A5	53.33	49.00
C141 ceramic cartridge	44.00	41.00
C129 ceramic cartridge	35.76	33.00
COLOUR ORGANS		
V3050	49.50	45.00
V4050X	84.00	75.00
SPEAKER BOX KITS		
System 1 - 12"x5"x1" (approx. 2.5 cu.ft.)	27.50	25.00
System 2 - 8"x1" (approx. 1.6cu.ft.)	23.50	22.00
System 3 - 8"x5"x1" (approx. 1.0cu.ft.)	19.50	18.00
Cartridges & Styli		
Shure M55	21.00	20.00
M75	19.00	18.00
M91	38.00	37.00
V15	99.00	95.00

Goldring ES70E	21.50	20.00
ES70S	11.50	11.00
Tone Arms Excel E.S. 801	39.50	37.50
Audio Technica Cartridge		
AT10 (.7 mil)	8.00	-
AT12E (.4 x .7 mil)	17.00	--
AT13E (.2 x .7 mil)	31.00	-
AT14S (Shibata)	69.00	--
AT15S (Shibata)	69.00	-

PC97 Stereo plug to 2xStereo SJocket	3.20	3.10
PC101 5 Pin Din plug to 5 pin din Inline socket	2.80	2.70
PC127 6.5 plug to 6.5 Plug	2.10	2.00
PC128 6.5 plug to 6.5 Inline Socket	2.20	2.10
PC125 6.5 plug to 6.5 Inline Socket (Curly Cord Ext.)	2.00	1.90
PC126 6.5 Plug to 6.5 plug Short Adaptor Leads	3.50	3.40
PC96 Stereo plug to 2x Stereo Socket	2.80	2.70
PC82 Stereo Socket to 5 pin din plug	2.80	2.70

PS 6/300 (6 volts at .3 amps)	7.75	7.50
PS 9/300 (9 volts at .3 amps)	7.75	7.50
Charge 4 for car batts.	27.50	25.00

AUDIO LEADS

These Patch Cords are for hi-fi use, with full shielding.

PRODUCT	Each up to 9	Each 10 or More
PC33 5 Pin din Plug to 5 pin din plug	2.75	2.65
PC30 5 Pin Din Plug to 4x3.5 plug	3.00	2.90
PC32 5 pin Din Plug to 4x6.5 plug	3.60	3.50
PC31 5 Pin Din Plug to 4xR.C.A. plug	3.20	3.10
PC51 5 Pin Din Plug to 2x3.5 plug	2.40	2.30
PC21 RCA Plug to RCA plug	0.85	0.75
PC49 RCA plug to RCA socket line	0.85	0.75
PC41 RCA plug to 2 clips	1.15	1.15
PC43 2xRCA plug to 2xRCA plug	2.00	1.90
PC95 4xRCA plug to 4xRCA plug	3.50	3.40
PC99 4xRCA plug to 4x3.5 plug	4.00	3.90
PC24 3.5 plug to 3.5 plug	0.85	0.75
PC98 3.5 plug to 3.5 socket line	0.95	0.85
PC22 3.5 Plug to RCA plug	0.85	0.75
PC42 3.5 Plug to 2 clips	1.25	1.15
PC25 3.5 plug to 6.5 plug	1.10	1.00
PC86 3.5 plug to 2x3.5 plug	1.80	1.70
PC87 3.5 plug to 2xRCA Plug	1.80	1.70
PC44 2x3.5 plug to 2x3.5 plug	2.00	1.90
PC80 Stereo S Jocket to 2x3.5 Plug	2.30	2.20

VEROBOARD ETC.

This is a multi-purpose board to accommodate all types of constructional projects.

PRODUCT	Each up to 9	Each 10 or More
VEROBOARD		
0.1" Pitch 18"	4.50	4.00
0.15" Pitch 18"	4.00	3.60
0.2" Pitch 18"	4.10	3.70
Pins TP2141 (1000)	.03	2.00
TP2141 (1000)	.03	2.00
Spot face cutter	1.80	1.75
MATRIX BOARD		
0.25" Pitch 296	1.20	1.10
Pin 250	0.02	1.60
Eyelet 280	0.01	7.00
0.1" Pitch 6"x6"	2.50	2.40
Turret Pin 314	0.02	1.50
Eyelet 285	0.03	2.00

POWER SUPPLIES

PRODUCT	Each up to 9	Each 10 or More
PS293 for 12 volt systems	5.50	5.35
PS164 reduces voltage to 4.5, 6, 7.5, 9volts at .3 amp	18.36	17.50
PS203 reduces volt. to 4.5, 6, 7.5, 9 volts, and 12 volts - .5amps	38.70	37.50

MISCELLANEOUS

PRODUCT	Each up to 9	Each 10 or More
INNERBOND	\$2.00 sq.yd.	\$40.00 roll
BEZELS		
B6 includes 6.3V globe	.50	.47
BF B6 Miniature 6V	.75	.70
BF B14 Miniature 12V	.75	.70
BI Mes type Bezel	.80	.75
BN3801 Neon	.75	.70

NUT AND BOLTS

PRODUCT	Each up to 9	Each 10 or More
1/8" WHITWORTH BOLTS		
Roundhead: Av. in the following lengths: 1", 3/4", 5/8", 1/2", 3/8", 1/4"	lc	
Countersunk: Ava. in the following lengths: 1", 3/4", 5/8", 1/2", 3/8", 1/4"	lc	
Washers: Flat & shakeproof types, 5/16" I.D.	lc	
Hexagonal Nuts to suit above	lc	
B.A. STANDARD BOLTS		
2BA: Cheesehead and countersunk available in 1/2", 1, lengths	1c	
4BA: Cheesehead & countersunk ava. in 1/2", 1" lengths	1c	
6BA: Cheesehead and countersunk ava. in 1/2", 1" lengths	1c	
8BA: Cheesehead & countersunk ava. in 1/2", 1" lengths	2c	
Hexagonal Nuts All sizes to suit above bolts.	1c	
Washers: Flat & shakeproof types to suit 4BA & 6BA		

bolts (5/16" ID) Shakeproof type to suit 2BA bolts	1c	2c
CAPACITORS GREEN CAPS 100V		
.001, .0015, .0022, .0033, .0039, .0047, .0056, .0068, .0082, .01, .015, .022, .033, .039, .047, .056, .068, .082		.15 .13
0.1, 0.15, 0.22		.20 .16
0.27, 0.33, 0.39		.25 .22
0.47		.30 .28
1.0		.60 .55
2.2		1.20 1.10
3.3		1.40 1.20

PRODUCT	Each up to 9	Each 10 or More
GREEN CAPS 630V		
.001, .0022, .0047, .01, .022, .033		.20 .18
.047, 0.1		.25 .22
0.22		.40 .38
0.47		.70 .65

PRODUCT	Each up to 9	Each 10 or More
CERAMICS 630V		
10, 15, 22, 33, 47, 56, 68, 82, 100, 150, 220, 330, 390, 470, 560, 680, 820, .001, .0015, .0022, .0033, .0068		.14 .12
.01, .015, .022, .033, .047, .068, .1 uF		.11 .09

PRODUCT	Each up to 9	Each 10 or More
PRINTED CIRCUIT BOARD ELECTROLYTIC 25V		
2.2, 3.3, 4.7, 10, 22, 33, 47, 100, 220, 330, 470, 1000		.14 .12 .20 .16 .55 .50 .70 .65

PRODUCT	Each up to 9	Each 10 or More
63V		
2.2, 3.3, 4.7, 10, 22, 33 (50V), 47, 100, 220, 330, 470, 1000 (35V)		.30 .25 .70 .45 .70 .65

PRODUCT	Each up to 9	Each 10 or More
PIGTAIL ELECTROLYSTIC 25V		
2.2, 3.3, 4.7, 10, 22, 33, 47, 100, 220, 330, 470, 1000		.16 .14 .20 .18 .66 .60 1.40 1.20

PRODUCT	Each up to 9	Each 10 or More
63V		
2.2, 3.3, 4.7 10, 22, 33 (100V), 47, 100, 220, 330, 470, 1000, 2500		.16 .14 .26 .24 .72 .68 .90 .80 1.40 1.20 1.90 1.80
315V		
2.2, 3.3, 4.7 10 (350V)		.35 .30 .50 .45

KITSETS

RETAIL BUYING GUIDE 1975-6

22	.65	.50
33 (350V)	.70	.65
47	.85	.80
100 (350V)	1.20	1.10
500V		
3.3	.30	.25
4.7	.40	.35
8.0	.50	.45
10.0	.60	.55
16.0	.65	.60
24.0, 33.0	.90	.85

CAN ELECTROLYTICS

100 uf 200V	1.40	1.20
100 uf 350Vq	1.60	1.40
100 uf 350V	2.40	2.20
1000 uf 100V	2.40	2.20
2500 uf 75V	2.70	2.60
3300 uf 75V	3.40	3.20
4000 uf 75V	4.50	3.80
8000 uf 75V	8.80	7.80

BIPOLAR (B.P.)

4.7 uf 50V	0.50	0.45
6.8 uf 50V	0.50	0.45
10uf 50V	0.50	0.45
22 uf 50V	0.50	0.45
47 uf 50V	0.70	0.65
100uf 50V	0.70	0.65

TANTALUM CAPACITORS

35V		
0.1, 0.15, 0.22, 0.47, 0.68, 0.68, 1.0, 1.5, 2.2	.33	.30
25V		
3.3, 4.7, 6.8, 10	.33	.30
16V		
15	.33	.30
10V		
22, 33,	.33	.30
6.3V		
47	.33	.30
3.15V		
100	.33	.30

Convert your car to ELECTRONIC IGNITION

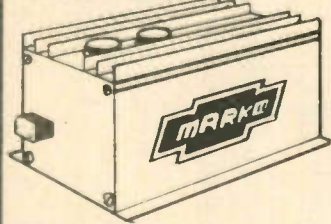

This is not a kit. No assembling to do. Just hook it up and you've got CDI ignition. Improves fuel consumption, makes plugs and points last far longer. Can pay for itself in less than a year. Easy to check improved performance — simply press red button to change back to ordinary ignition, then press again for CDI. A beautifully finished unit, supplied complete with all necessary hook-up and mounting hardware. Suits all 12V negative earth cars. P&P \$1.50.

\$29-50

Here are just a few of our top selling kits - A comprehensive listing of all kits available will be featured in the August issue of this publication. The full range of components to suit all EA and ET kits are available from any of our branches.

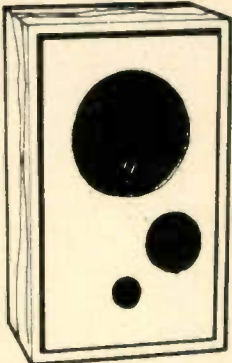

TOP QUALITY SPEAKER KITS FROM \$59

Pre-assembled & pre-veneered speaker boxes — all containing high quality PEAK speakers. SYSTEM I 1.6 c/ft 2 way system 12" woofer & 1" dome tweeter 20 watts handling power \$59.00 p.p. \$4.00. SYSTEM II 2.6 c/ft. 3 way system 12" woofer & 5" mid range & 1" dome tweeter 20 watts handling power \$79.00 p.p. \$5.00. With each kit your choice of dome or sealed back cone mid range speakers — and dome or cellular horn tweeters.

AS DESCRIBED IN ELECTRONICS AUSTRALIA — DEC. 73 TO MARCH 74.

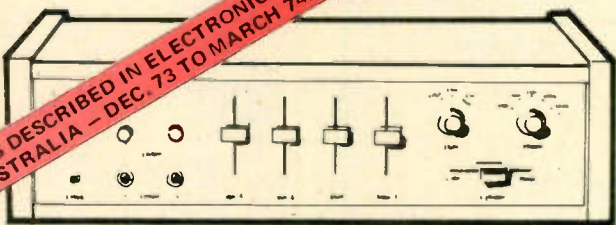

PLAYMASTER 140 4CH. AMP WITH EXCLUSIVE SQ DECODER

In our opinion, one of our best kits. Any ready-made amp remotely like it would cost a bundle more. Uses the famous CBS MC1312 SQ decoder IC. A true Hi-Fi quad amp kit with synthesising and decoding facilities it will accept discrete from tape or CD. 15 watts per channel RMS with 2 channels driven. SN ratio better than 60dB; less than 0.4% distortion at typical listening levels. Sorry, MC1312P not sold separately. Complete kit down to last nut and bolt (includes teak cabinet) P&P \$3.

\$142

AS DESCRIBED IN ELECTRONICS AUSTRALIA TODAY — MAY 1975.

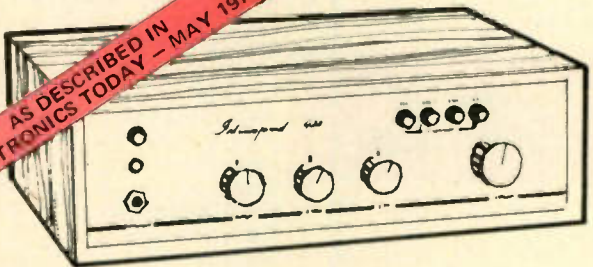

INTERNATIONAL 422 U-BUILD STEREO AMP HUGE 50 WATT PER CHANNEL \$115

Hang on to your house when you build this beauty. Superb ET circuit gives genuine 50W RMS per channel with both channels driven into 8 ohms at typically less than 0.2% distortion. Ideal for nerve-shattering jokes on your mother-in-law. Complete with real teak cabinet. P&P \$3.

AS DESCRIBED IN ELECTRONICS AUSTRALIA — SEPT. 1974.

PLAYMASTER 143 AMP KIT

EA's latest (Sep. '74). Virtually a new and advanced version of the Playmaster 136. Includes stereo phone socket and more flexible quad simulation. 16.5 watts RMS per one channel into 8 ohms + 2dB from 20-20k Hz SN ratio better than 60dB. Distortion at typical listening levels 0.4%. No hum. While you know who expects you to pay \$3 + \$79, what is our price? **\$75** P&P \$2

AS DESCRIBED IN ELECTRONICS AUSTRALIA — AUG. TO OCT. 74.

BUILD YOUR OWN CASSETTE DECK \$99

Playmaster 144 as described in EA August and October '74. 80Hz-90k Hz S/N ratio, minus 42dB Separation better than 30dB. 100Hz 10k Hz 2x200uV mike inputs, line input 120mV into 330k. Complete kit. All you supply is low imp. mike and cassette. P&P \$4.50

12V negative earth AS DESCRIBED IN ELECTRONICS AUSTRALIA TODAY — DEC. 74 TO JAN. 75.

ELECTRONIC TACHO. IGNITION, & REV LIMITER KIT

Overcomes serious failings of lesser types, gives same benefits like extra long point and plug life, plus handy protection against over-rev blow-ups. Kit complete with instructions and diagrams, the critical recommended capacitors (no makeshift substitutes) all screws, nuts, plugs, sockets and so on as well as the required meter for tacho operation. P&P \$2.50.

\$53-50

AS DESCRIBED IN ELECTRONICS AUSTRALIA TODAY — DEC. 72.

INTERNATIONAL 420 4 CHANNEL AMPLIFIER

An attractive, top performing 4-channel amplifier which incorporates the latest in patented SQ plus ambience decoding, which is simple to construct and produces 15 watts per channel! 2 Channel driven and 12.5 per channel, 4 channels driven with typically less than .2% distortion. SN ratio better than 70 dB. A fabulous amplifier for the do-it-yourself enthusiast! PRICE ONLY \$129.00 COMPLETE COMPLETE P/Post \$2.50 COMPLETE DECODER SECTION (Less pots) WITH MC1312P \$17.00 (Sorry, licence prevents us selling MC1312P separately).

SEE WHAT COLOUR YOUR MUSIC IS

NOT a kit. These are the spectacular SECO colour organs. Connect to any speaker and the colour lamps flicker and glow with varying brightness in relation to volume, pitch, and rhythm. Why put up with colour TV? Works even with small transistor radios. Leaves fibre-optic lamps for dead. V3050: Domestic unit. 30 lamps, 3 channels, 5 colours. Diamond pattern. 18½" x 11½" x 7 3/8". 3.5kg. P&P \$2. **\$49-50**

4050X: Professional monster. 32 lamps, 4 channels, 4 colours, individual colour mixing controls and a host of other features. Ideal groups. About 30½" x 15½" x 9 1/8". P&P \$3. **\$84**

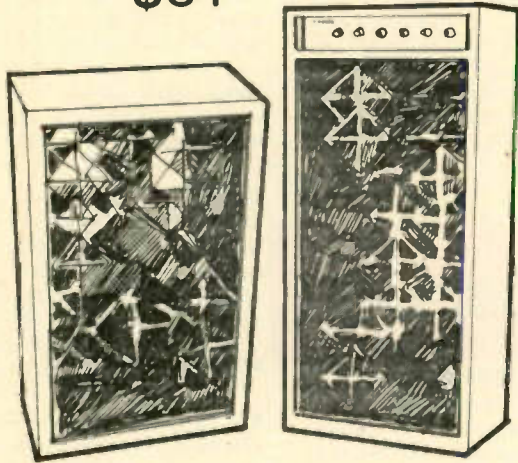

\$65 COMPUTER



Not just an arithmetical calculator but a professional scientific tool: You will be asked to pay \$100 and more for similar instruments.

The Hornet SR30 is an algebraic-mode, 8-digit unit with the normal +, -, X and functions plus Memory with 4 operations (M+, MR, X-M, CM) and 6 command functions (+/-, F, DR, X-Y, rad/deg, CL). 12 Scientific functions.

These are 1/X, ex, ln, log, sin-1, cos-1, tan-1, sin, cos, tan x, and xy. Trig and log functions are calculated to 6 dec. places. The unit comes complete with batteries (4 penlight cells) and handbook. A socket is fitted for external DC power.

Supply is limited, and orders will be filled in strict rotation. Price includes registered post and packing cost.

Note: This unit has a blue fluorescent display.

Where post and packing charges are not shown, you can use this as a guide. Costs shown are averages, and do not include registration. It's better to send too much than too little, as we can always give you a credit for any excess, but an underpaid order gets held up while we write back to you.

Audio leads 50c
Books 50c
Cables 50c
Hi-Fi Equipment \$2.00
Microphones \$1.00

P.C boards 50c
Plugs & sockets 50c
Potentiometers 50c
Power supplies \$1.00
Resistors 50c
Semi-conductors 50c
Soldering irons 75c
Switches 50c
Test Equipment Road Freight
Tools 50c
Valves 50c
Veroboard 50c

If you're not sure about how much to add, just phone us.

**KITSETS
GOOD-FOR-SOMETHING
VOUCHER**

You know how it is when you clean up your workshop and you find all sorts of odds and sods? Well, it's the same way in our warehouse, only on a bigger scale. Every year we end up with boxes full of ones and twos of brand new components and stuff. SO - if you make your order for \$10 or more, we'll toss in a handful of assorted surprises at no extra charge. You might even get old Minties wrappers. It's for orders on these forms only and for as long as our junk lasts. (Actually, some of it is quite pricey).

THIS OFFER EXPIRES WHEN WE DO. PLEASE DON'T SEND JUNK BACK AS THIS IS THE ONLY WAY WE CAN GET RID OF IT.

**KITSETS
GOOD-FOR-SOMETHING
VOUCHER**

You know how it is when you clean up your workshop and you find all sorts of odds and sods? Well, it's the same way in our warehouse, only on a bigger scale. Every year we end up with boxes full of ones and twos of brand new components and stuff. SO - if you make your order for \$10 or more, we'll toss in a handful of assorted surprises at no extra charge. You might even get old Minties wrappers. It's for orders on these forms only and for as long as our junk lasts. (Actually, some of it is quite pricey).

THIS OFFER EXPIRES WHEN WE DO. PLEASE DON'T SEND JUNK BACK AS THIS IS THE ONLY WAY WE CAN GET RID OF IT.

WHERE WE ARE

KITSETS SHOWROOMS

SYDNEY: 400 Kent St. Sydney 29 1005 657 Pittwater Rd. Dee Why 982 9790 **MELBOURNE:** 271 Bridge Rd. Richmond (Gallery Level, Church St. ent.) 42 4651. 985 Whitehorse Rd. Box Hill. 89 8371 **BRISBANE:** 293 St. Paul's Terrace, Fortitude Valley. 52 8391 **ADELAIDE:** 12 Peel St. Adelaide. 87 5505 **PERTH:** 557 Wellington St. Perth (opp. new bus terminal) 21 3047.

HOW TO ORDER

PRINT ALL details clearly. Give your phone number for quick checking if there are any problems or delays. Send cheque or postal order (NOT cash) to Kitsets (Aust) Pty. Limited, PO Box 176 Dee Why 2099. For urgent queries or PMG/COD ring us on 982 7500. Area code 02 (24 hour open line service).

BANKCARD:

Obviously, you can't order by mail with it, but it's as good as cash when you're buying at any of our showrooms.

KIT'S FAN MAIL:

Being a supreme egotist, Kit likes to get fan mail, but please be moderate with your requests. Also, please don't ask for autographed pictures as we have kept it for Alfred E. Kit does NOT make personal appearances.

RAIL/ROAD/AIR:

If you order something too big to mail, we will send it to your nearest railway station, or by road transport. When you're ordering things like speaker boxes, please indicate on your order how you want them sent. We can also send by air freight, and the applicable rate can be obtained from your nearest air freight office. Please ensure that you forward sufficient remittance to cover these costs with your order.

DESPATCH:

Our national mail order warehouse is just a few hundred yards from a major post office. This means we are in a beautiful position to catch the last mail and so on. When your order arrives, it will be packed and despatched with 24 hours.

CONDITIONS

GUARANTEED QUALITY

We stock only new, first grade quality components. No disposals, seconds, or rejects. You can buy with complete confidence as all parts and equipment sold by us are fully guaranteed.

PRICES:

We confidently claim that our prices are generally lowest on quality components. However, should you be offered a genuinely lower price elsewhere, please tell us and we will match or better that price on goods of a comparable quality. Please note that prices quoted in this Buying Guide are current as at June 1975, but due to economic conditions over which we have no control, are subject to change without notice.

TECHNICAL SERVICE:

We can provide a complete first class technical advisory and repair service. All technical enquiries and repairs will be attended to promptly although enquiries should be accompanied by a stamped addressed envelope.

ERRORS:

We try not to make mistakes. However, every now and then we pull a boner. It's human nature and it embarrasses us. We'll always try to make good any boo-boo. If you find any errors in this Buying Guide, please let us know.

SALES TAX EXEMPTION:

All prices shown here include sales tax. However, we can supply goods exempt sales tax for manufacturers and resellers who quote their sales tax number or to schools and institutions submitting an approved exemption certificate. Customers wishing to obtain goods exempt sales tax should make their order out to "Contronic Distributors Pty. Ltd", which is our wholesale company.

FINALLY, THE END.

Look, we have a lot of fun here at Kitsets, and we really try hard to do the right thing by you. If there's ever anything you need in electronics, or anything you want to know, or if you've fouled something up and you want a sympathetic ear, drop in and see us. We've been through the mill, and we know what it's like. Besides, we like having a yarn about anything to do with electronics. It mightn't be the way other people do their business, but it's the way we do ours, and we figure it's one of the things that has helped us grow so large. The other thing, of course, has been you. And we thank you all from the bottom of our diodes.

GRAB BAG FREE WITH ANY ORDER OVER \$10! VOUCHER ON BACK.

Use this coupon for mail order. Please don't send cash Remit by Postal Order or crossed cheque, made payable to Kitsets (Aust) Pty Ltd. Send to P.O. Box 176 Dee Why 2099 For PMG/COD delivery, call 982 7500 (Area code 02) anytime (24 hour service) and tell us what you want. Orders are despatched within 24 hours. Please fill out form carefully and PRINT all details NEATLY. If your order comes in looking like a second hand paperback ticket, we have to hang on to it until you send us a turn-out letter. And that doesn't do either of us any good.

SEND TO ADDRESS

P code

Phone

A

H

C

O

E

NAME OF GOODS AND CODE NUMBER IF GIVEN

PRICE EACH

P & P EACH

SUB TOTAL

HOW MANY

NAME OF GOODS AND CODE NUMBER IF GIVEN

PRICE EACH

P & P EACH

SUB TOTAL

SEND TO ADDRESS

P code

Phone

A

H

C

O

E

HOW MANY

NAME OF GOODS AND CODE NUMBER IF GIVEN

PRICE EACH

P & P EACH

SUB TOTAL

ITEM TOTAL add column A

If you want your order sent registered (advisable) add 75c

REMITTANCE TOTAL Add Column E

Copyright 1974 Kitsets Aust Pty Ltd

ITEM TOTAL add column A

If you want your order sent registered (advisable) add 75c

REMITTANCE TOTAL Add Column E

Copyright 1974 Kitsets Aust Pty Ltd

The magnificent Imperials

Have a really close listen to Marantz Imperials. Make a direct comparison, side by side with speakers two and three times the cost, and chances are the only difference you'll notice is in the price tags! And why not? After all, the name of Marantz has always been associated with the very best the State of the Art has to offer.

'The Imperial 4 would make an excellent partner to an amplifier of modest power...'

'Taking the price into account, the Marantz Imperial 4's are quite magnificent: truly remarkable performers'. Stereo Buyers Guide.

'The Imperial 6 can be recommended to those who require a bookshelf system with above average performance'.

'The first impression was of a better-than-average transient response and a clean bass with a commendable freedom from colouration'.

'White-noise tests confirmed the smooth overall response...'. Audio Magazine.

'The Imperial 7 is an unusually linear system whose efficiency is well above average...'

'Marantz... has given us a welcome addition to the catalogue of speakers available for more commercial purposes'. High Fidelity Magazine.

We could quote many more glowing reviews from authoritative home and overseas magazines, but we believe the proof of the hearing is in the listening. So ask your nearest Marantz dealer for a comparative demonstration of your own.

There is a range of six Imperials from the 15 watt Imperial 4 to the magnificent, floor-standing 75 watt Imperial 8 and 100 watt Imperial 9.

For further information write Auriema (A'asia) Pty Ltd, Box 604, Brookvale NSW 2100. Phone 939 1900.

marantz.

WE SOUND BETTER

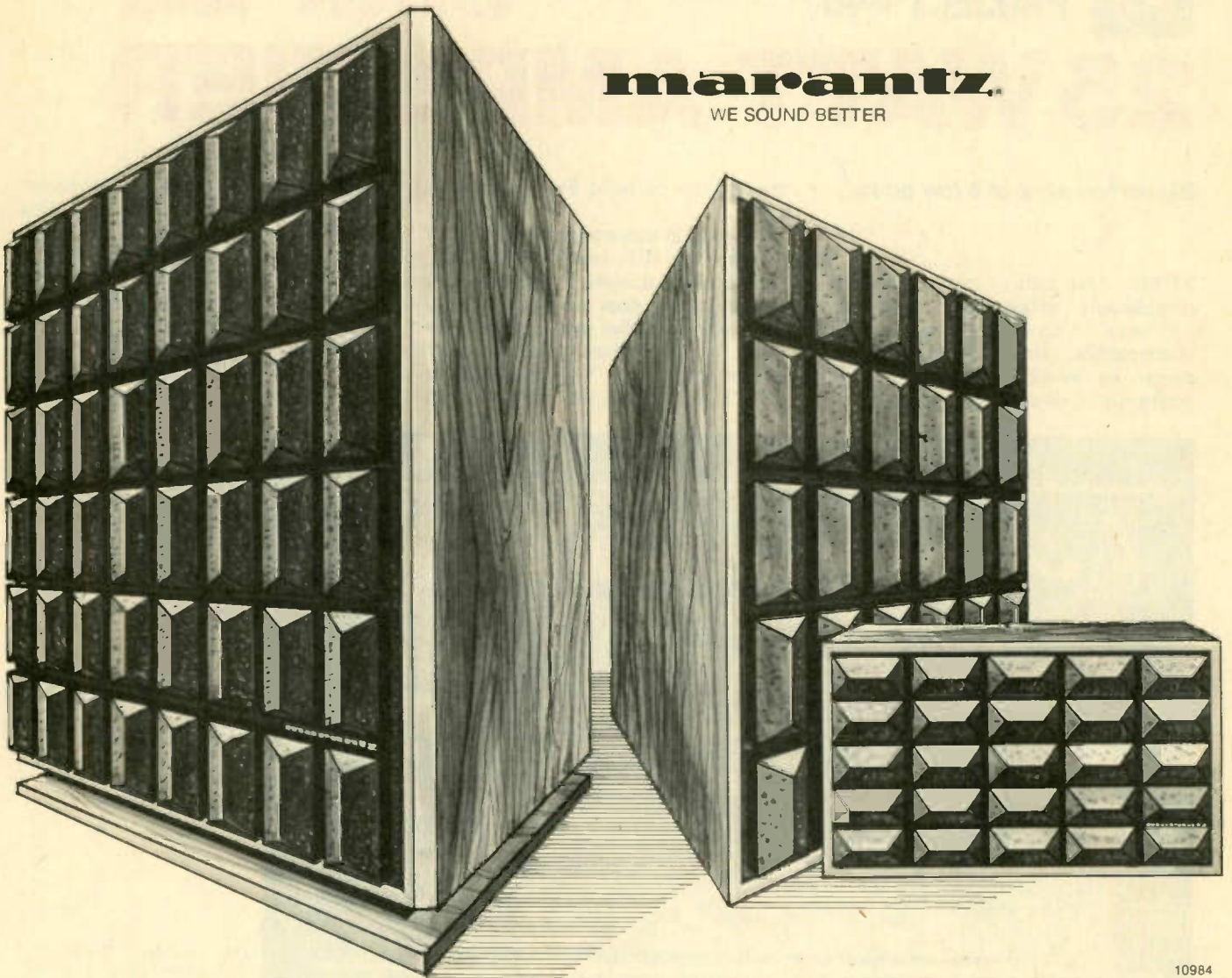

10984

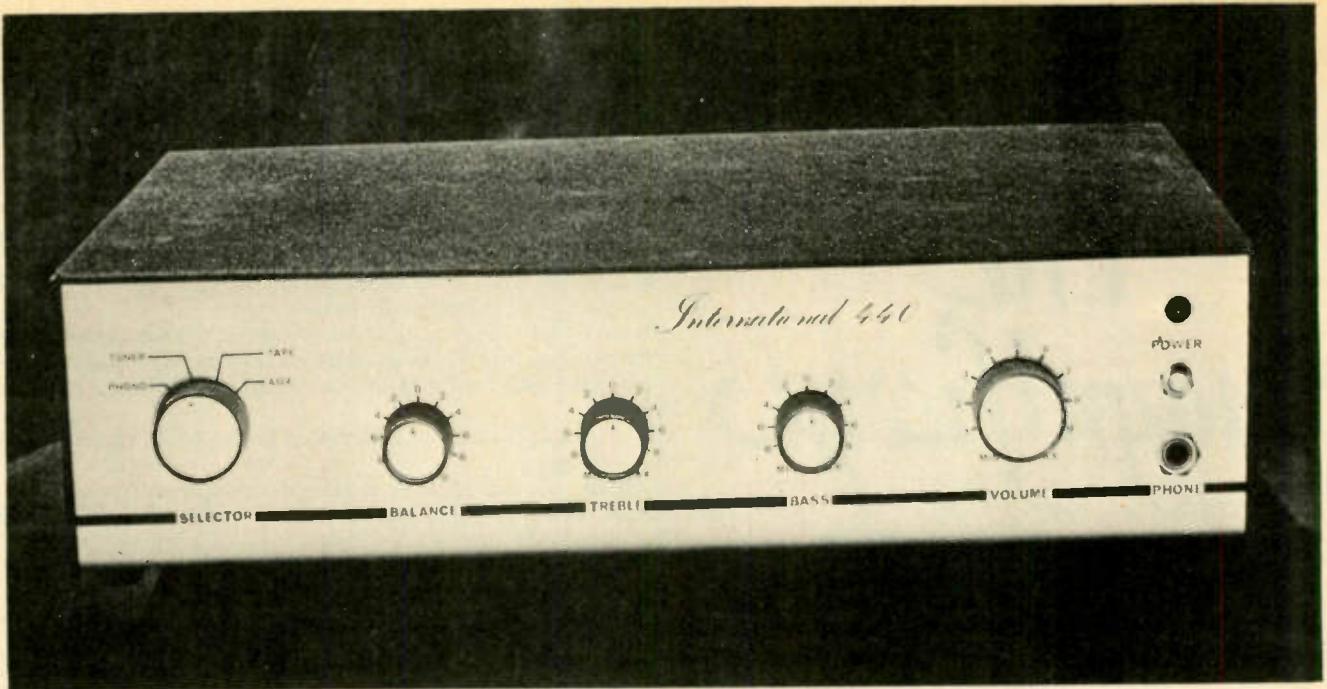

ETI PROJECT 440

SIMPLE 25 WATT AMPLIFIER

Big performance at a low price.

WHEN designing this amplifier considerable effort was made to achieve several, generally incompatible, aims. These were to design an amplifier that gave high performance, was simple enough for

the beginner to build BUT, was low in cost.

Since a high percentage of the cost of an amplifier is in the hardware, (e.g. chassis, potentiometers, switches etc) and this cost does not vary greatly relative to amplifier power output, we aimed at the highest possible power for reasonable cost. Thus the amplifier gives 25 watts RMS per channel which

is about as much as can be obtained without component costs increasing dramatically.

To gain the required simplicity we used a single printed circuit board, to hold as much as possible of the electronics, thus keeping external wiring down to a minimum.

The result is a 25 watt-per-channel amplifier which is extremely easy to

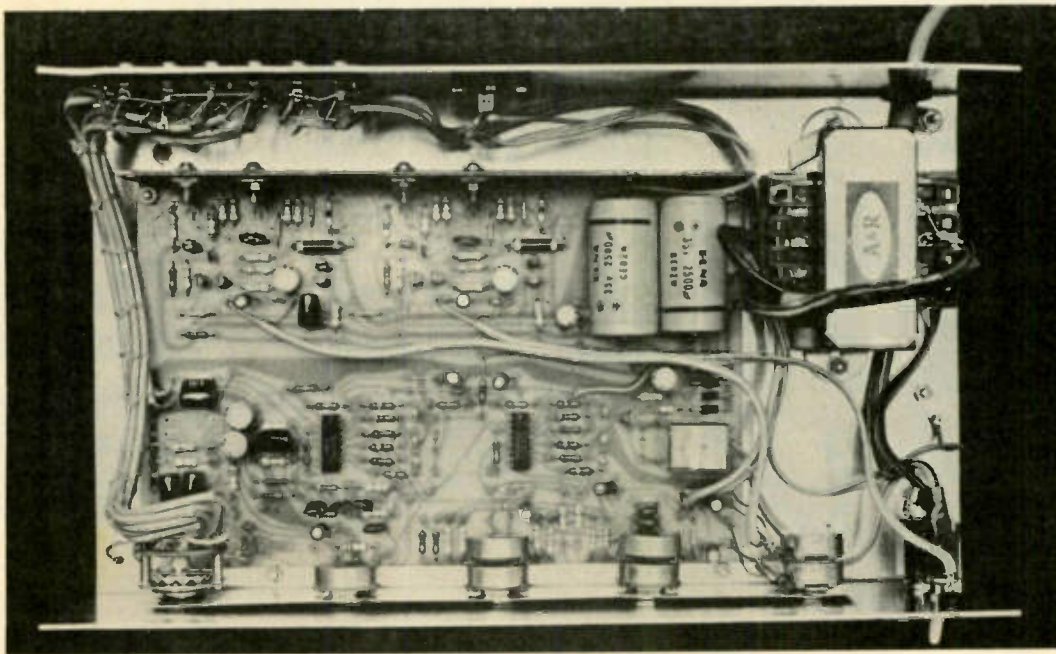

Internal view of the amplifier showing location of the major components.

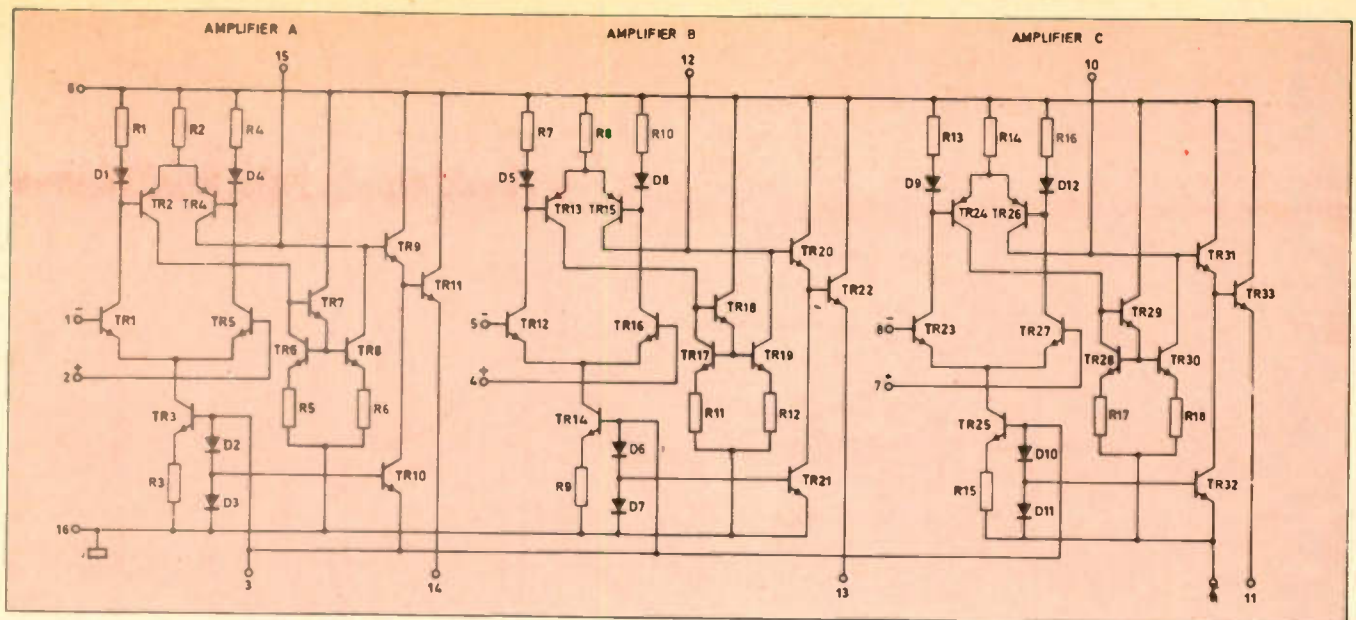

Fig. 1. Circuit diagram of the TCA220 triple-operational amplifier.

build and set up, which has a distortion of around 0.1% and costs about the same as a 12 watt per channel kitset at present on the market that is much more difficult to build.

CONSTRUCTION

The single printed-circuit board construction greatly simplifies things for the beginner. A heatsink is attached to the rear of the board to hold the power transistors, and a bracket at the front holds the potentiometers. Before attaching these brackets assemble the components to the printed circuit board, as shown in the component overlay diagram Fig.

3, doing all the linking required first. There are two links which go under resistors R49 and R50 in the power amplifier and these should be insulated with 1 mm spaghetti. All other links may be tinned copper provided that they are kept straight and flat on the board.

Although the components can be mounted in any order it is usually easier to mount the smallest (lowest height) components first, ie, resistors and diodes. These should be mounted flush on the surface of the board. The capacitors may now be mounted taking care not to damage the small ceramic capacitors by bending the leads too close to the body of the device. Make sure that electrolytic

capacitors are orientated correctly, i.e., the polarity is correct.

The transistors, apart from Q7,8,9,10,15,16,17 and 18 (which are on the heatsink) may now be fitted to the board. With the BC548 there are two different lead connections. The Philips type has a bent centre leg (the base) and these are the types shown on the overlay. If a different brand is used, ie one with the pins all in line, they must be inserted 180° around from that orientation shown. Transistors Q7,8,9 and 10 MUST be the Philips type. Hence, if you have a mixture, keep the Philips types for

(Text continued on page 70)

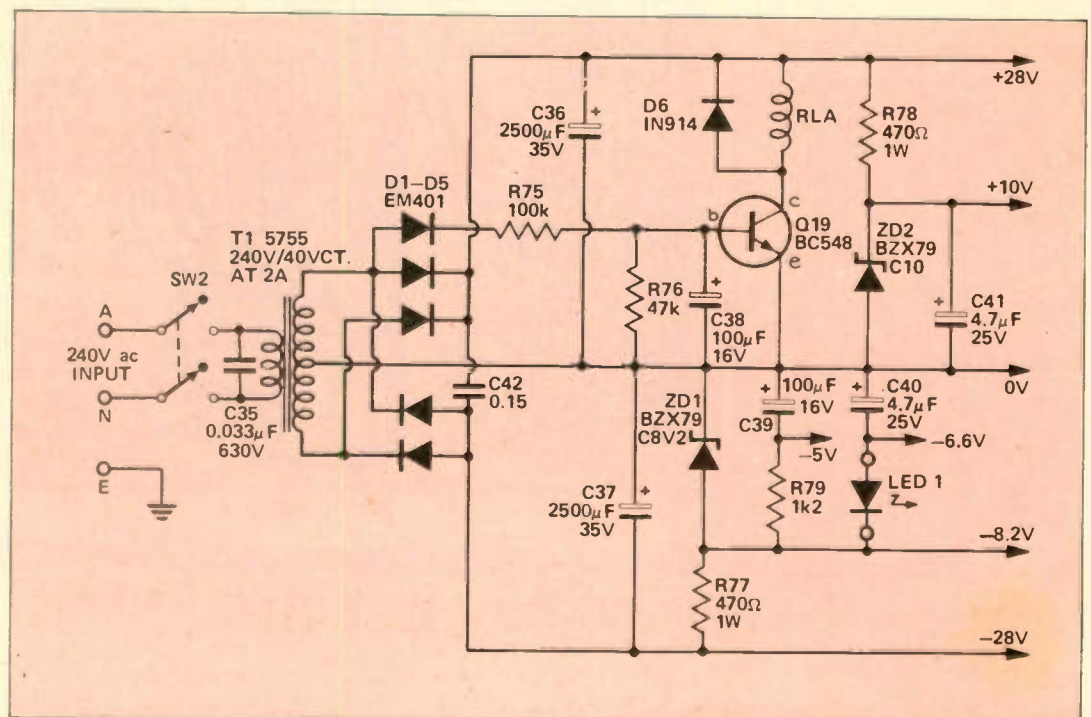
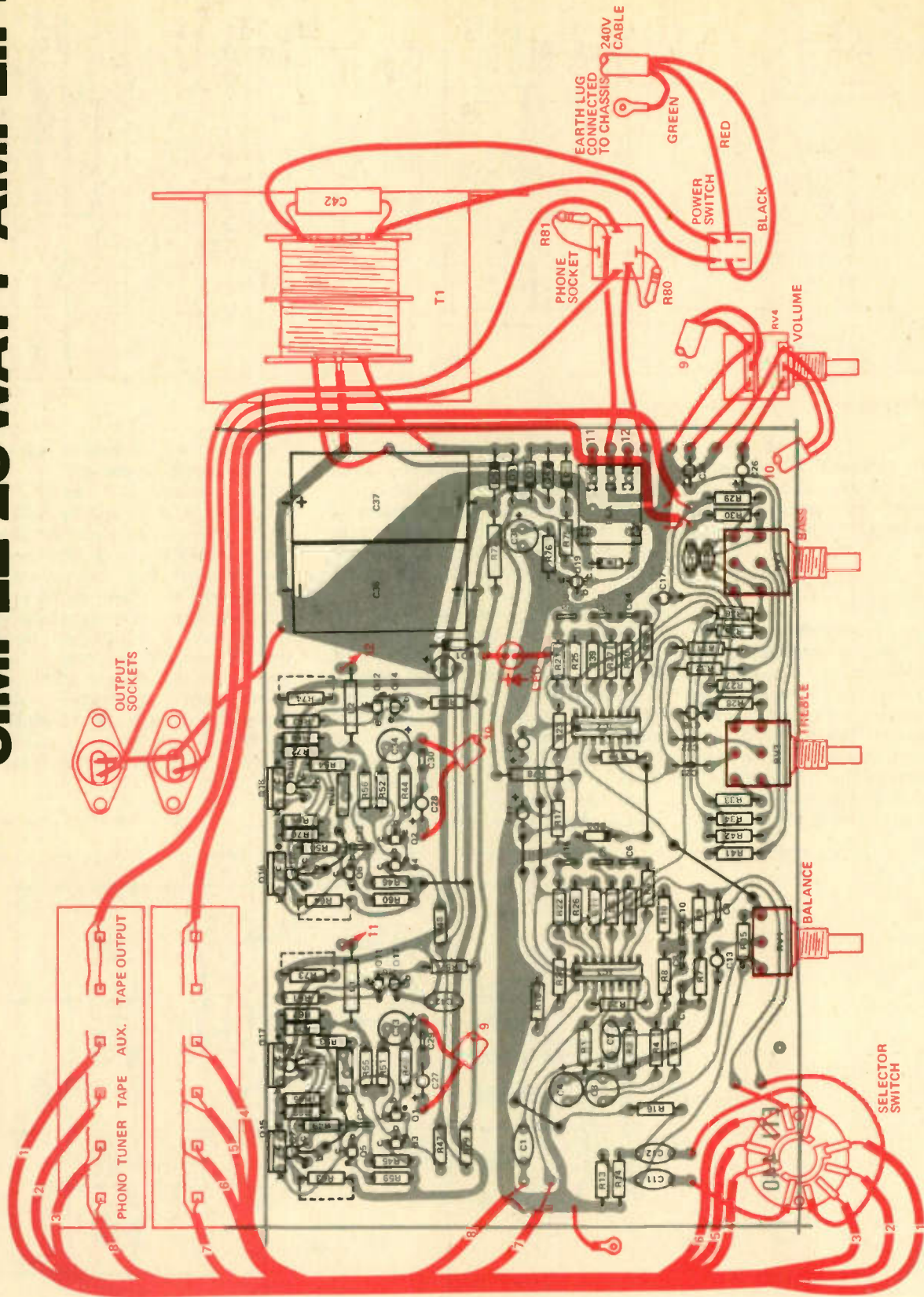
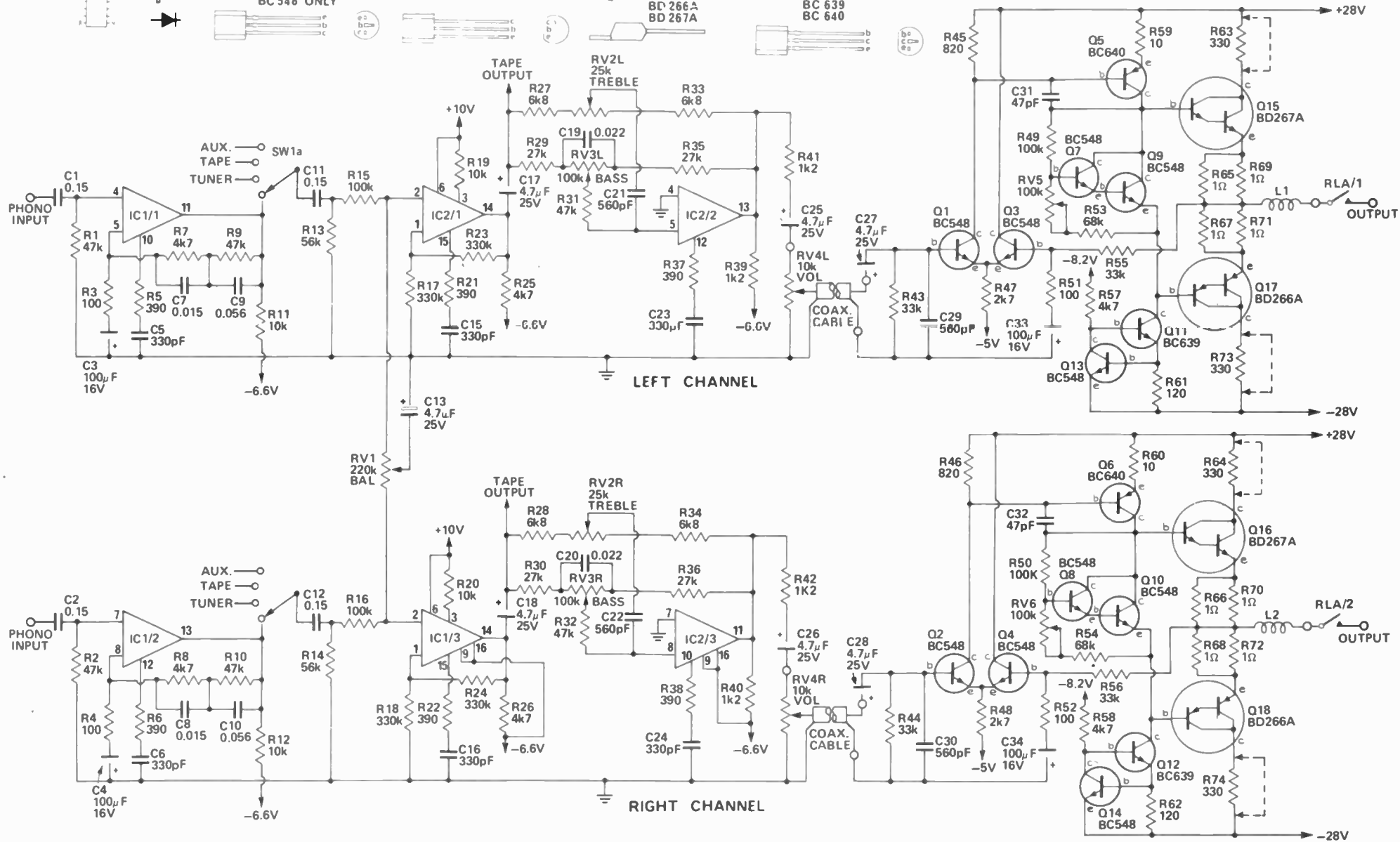
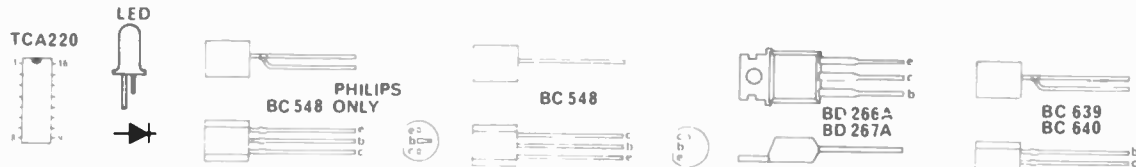

Fig. 2. Power supply for the 25 watt amplifier.

SIMPLE 25 WATT AMPLIFIER





SIMPLE 25 WATT AMPLIFIER

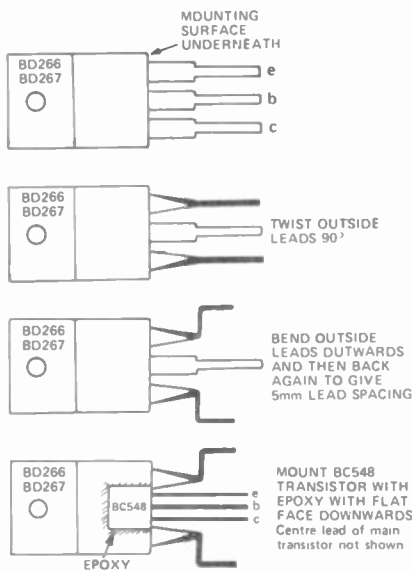

Fig.5. How to prepare the power transistor leads for installation.

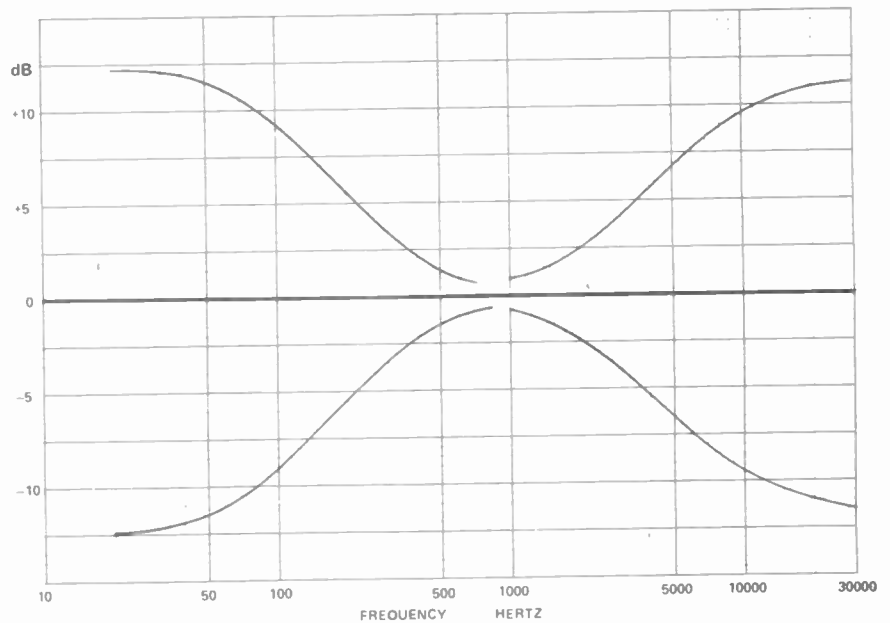

Fig.6. Tone control characteristics of the amplifier.

MEASURED PERFORMANCE OF ETI 440 AMPLIFIER

POWER OUTPUT	25 + 25 watts into 8 ohms					
FREQUENCY RESPONSE	+ 0	30 kHz				
	- 0.5 dB					
	+ 0	6 Hz - 80 kHz				
	- 3 dB					
CHANNEL SEPARATION	1 kHz - 46 dB					
HUM AND NOISE (with respect to 25W)	Phono (10 mV)					
	67 dB (unweighted)					
	Other inputs					
68 dB (unweighted)						
INPUT SENSITIVITY	Phono		2.5 mV 47k			
	Other inputs		200 mV 47k			
TOTAL HARMONIC DISTORTION	Power	Frequency	One channel only	Both channels		
			12.5W	100 Hz	0.1%	0.13%
			1 kHz	0.08%	0.16%	
		10 kHz	0.12%	0.17%		
	20W	100 Hz	0.14%	0.5%		
		1 kHz	0.12%	0.6%		
		10 kHz	0.17%	0.8%		
	25W	100 Hz	0.5%	5.2%		
		1 kHz	0.6%	4.8%		
		10 kHz	0.7%	4.3%		
	TONE CONTROLS	Bass	12 dB boost at 50 Hz			
			12 dB cut at 50 Hz			
Treble		9 dB boost at 10 kHz				
		9 dB cut at 10 kHz				
DIMENSIONS	340 x 88 x 210 mm					

these positions. If a substitute is used for the BC639 and BC640 carefully check the pin connections as these types are unusual.

The integrated circuits may now be installed making sure that orientation is correct as indicated by the mark on the IC which is at the pin 1 end of the IC. Then mount the relay by passing the pins through the holes provided in the board and then bend the leads flush with the copper and solder them to the tracks.

The chokes L1 and L2 are made by winding about 25 turns of 0.4 mm copper wire (insulated) onto the body of a 10 ohm 1 watt resistor terminating the ends of the wire on the resistor leads. These may now be mounted on the board.

The balance, treble and bass controls should now have lengths of copper wire soldered to each of the terminals. They are then mounted, by passing the leads through the holes in the board, but are not soldered in position as yet. The front bracket should now be attached to the component side of the printed-circuit board and the potentiometers mounted to the panel. The leads from the potentiometers should then be drawn through the board as far as possible and then soldered in position. Then mount the heatsink bracket to the rear of the board using 9.6 mm spacers and countersunk screws.

The output transistors have to be prepared in a couple of ways before installation. The leads are too close

HOW IT WORKS — ETI 440

PREAMPLIFIER

In the preamplifier we have used two TCA220 integrated circuits each of which contain three identical operational amplifiers. These work similarly to the conventional op amp like the 709, 741 or 301 except the output is an emitter follower and needs a pull down resistor. An internal schematic diagram is given in Fig. 1, for those interested. Frequency compensation is accomplished by a 390 ohm resistor in series with a 330 pF capacitor connected to the appropriate terminal. The maximum voltage allowed on this IC is 18V. Since the output swing in the positive direction is less than that in the negative direction we have used +10V and -6.6V supplies.

The magnetic pickup used on most good turntables has a low output and also needs equalization to perform correctly. We used part of the TCA 220 (IC1-1 and IC1-2) to amplify this signal (about 60 times or 35 dB at 1 kHz) and to provide the equalization required (+13 dB at 100 Hz and -14 dB at 10 kHz referred to the gain at 1 kHz). The output of this amplifying stage connects to the switch SW1 which selects the desired input. The signal from the cartridge is amplified before the selector switch to improve the signal-to-noise ratio.

After the selector switch we have the balance control (RV1) which attenuates either left or right channel as desired. The signal is then amplified, by a factor of two, to recover what is lost in the balance-control network and also to buffer the signal to give a low impedance output. The output drives the tone-control network and also the tape-output sockets.

The tone-control section uses the last sections of the TCA220 (IC2/2, IC2/3) with the bass and treble controls in the feedback network. These controls provide about 10 dB of boost and cut of both bass and treble. Resistors R27 and R33 set the limit of the treble boost and cut, while C21 controls the actual frequency where the treble control starts. Resistors R29 and R35 control the bass limits while C19 sets the frequency. The output of the stage is connected to the volume-control potentiometer RV4.

POWER AMPLIFIER

The power amplifier is of conventional design using a differential pair Q1 and Q3 followed by a common-emitter amplifier stage, Q5, working at a constant current (5 mA) supplied by Q11 and Q13. The output of Q5 is buffered by the output transistors Q15 and Q17. These are carlington transistors and have a current gain (Hfe) of over 750 at 3A. These transistors are biased

on slightly (10 mA) to remove cross-over distortion and the bias is set by measuring the voltage across R63 or 73 (3V) while adjusting RV5. After bias adjustment is completed these resistors are shorted out to allow full power capability. Transistors Q7 and Q9 are physically joined onto Q15 and Q17 to provide accurate temperature indication and to ensure thermal stability.

The gain of the power amplifier stage is 100 and is set by the ratio of R55/R51. The earth reference for the power-amplifier input stage is supplied via the coax cables connecting to the preamplifier.

POWER SUPPLY

The power supply is a full wave rectifier with a centre-tapped transformer supplying $\pm 28V$ to the main amplifiers. The supplies for the preamplifier are obtained from a 10 V zener ZD2 and a 8.2V zener ZD1. The actual negative supply to the preamplifier comes via the LED on the front panel and is about -6.6 volts (1.6V across LED). A smooth -5V is also derived from the -8.2V and is used for the differential pair in the main amplifier.

The relay RLA is used to prevent the switch on transient reaching the speakers. After switch on there is a delay due to C38 of about 4 seconds before the speakers are connected. On switch off the delay is only about 1 second.

together, and since they are mounted close to the board the transistors may be damaged if the leads are just pulled apart. Figure 5 shows the lead bending process which should be done carefully with a pair of long nose pliers. After bending, a BC548 (Philips only) should be epoxyed with flat side onto the face of these transistors.

It is preferable to use one of the slow dry epoxies as they appear to withstand the elevated temperature better. If such epoxy is dried in the 100-130° range it will normally dry in about 30 minutes. Before gluing, however, it is best to scratch the type number on to the side of the output transistor to aid later identification.

When dry, the transistors can be mounted using insulation washers and a smear of silicon grease if available. The leads of the BC548 have to be bent out a long way but they should be long enough. If a small soldering iron is used these transistors can now be soldered in without removing the heatsink.

The rotary switch and volume control can now be mounted on to the front bracket. There are four links from the board to the rotary switch as shown in Figure 4, the rest of the connection going to the rear panel. There are also four links to the volume control and two coax cables which go

PARTS LIST			
R65,66	Resistor	10	1/2W 5%
R67,68	"	10	" "
R69,70	"	10	" "
R71,72	"	10	" "
R59,60	"	10	" "
R3,4	"	100	" "
R51,52	"	100	" "
R61,62	"	120	" "
R80,81	"	220	1W "
R63,64	"	330	1/2W "
R73,74	"	330	" "
R5,6,21	"	390	" "
R22,37,38	"	390	" "
R77,78	"	470	1W "
R45,46	"	820	1/2W "
R39,40,41	"	1k2	" "
R42,79	"	1k2	" "
R47,48	"	2k7	" "
R7,8,25	"	4k7	" "
R26,57,58	"	4k7	" "
R27,28	"	6k8	" "
R33,34	"	6k8	" "
R11,12	"	10k	" "
R19,20	"	10k	" "
R29,30	"	27k	" "
R35,36	"	27k	" "
R43,44	"	33k	" "
R55,56	"	33k	" "
R1,2,9,10	"	47k	" "
R31,32,76	"	47k	" "
R13,14	"	56k	" "
R53,54	"	68k	" "
R15,16,49	"	100k	" "
R50,75	"	100k	" "
R17,18	"	330k	" "
R23,24	"	330k	" "
RV1	Potentiometer	220k	lin single gang rotary
RV2	"	25k	lin dual gang rotary
RV3	"	100k	lin dual gang rotary
RV4	"	10k	log dual gang rotary
RV5,6	"	100k	trim pot
C31,32	Capacitor	47pF	ceramic
C5,6,15	"	330pF	" "
C16,23,24	"	330pF	" "
C21,22	"	560pF	" "
C29,30	"	560pF	" "
C7,8	"	0.015 μ F	polyester
C19,20	"	0.022 μ F	" "
C35	"	0.033 μ F	630 V
C9,10	"	0.056 μ F	polyester
C1,2	"	0.15 μ F	" "
C11,12,42	"	0.15 μ F	" "
C13,17,18	"	4.7 μ F	25V electro
C25,26,27	"	4.7 μ F	25V "
C28,40,41	"	4.7 μ F	25V "
C3,4,33	"	100 μ F	16V "
C34,38,39	"	100 μ F	16V "
C36,37	"	2500 μ F	35V "
L1,2	Choke	25 Turns	0.4mm Cu Wire on a 10 Ω 1W Resistor
D1 - D5	Diode	EM401	or similar
D6	"	IN914	" "
LED1	"	"	" "
Q1,2,3	Transistor	BC548	" "
Q4,13,14,19	"	BC548	" "
Q7,8,9,10	"	BC548	Philips only
Q5,6	"	BC640	" "
Q11,12	"	BC639	" "
*Q15,16	"	BD267A	or B
*Q17,18	"	BD266A	or B
*insulation washers needed			
IC1,2	Integrated Circuit	TCA220	
RLA	Relay	2c/o contacts	1250 Ω coil
T1	Transformer	40V ct @ 2A	A&R 5755
SW1	Switch	Rotary 2 pole 4 position	
SW2	Switch	miniature toggle	240V
Stereo Phone Socket			
Two 6way RCA sockets			
Two 2pin DIN sockets			
CHASSIS			
HEAT SINK			
POT: SUPPORT BRACKET			
COVER			
ESCUTCHEON - rear panel			
escutcheon - 3 small knobs - 2			
large knobs - 4 rubber feet - 2			
9.6mm spacers - 3 core flex & plug			
rubber grommets.			

SIMPLE 25 WATT AMPLIFIER

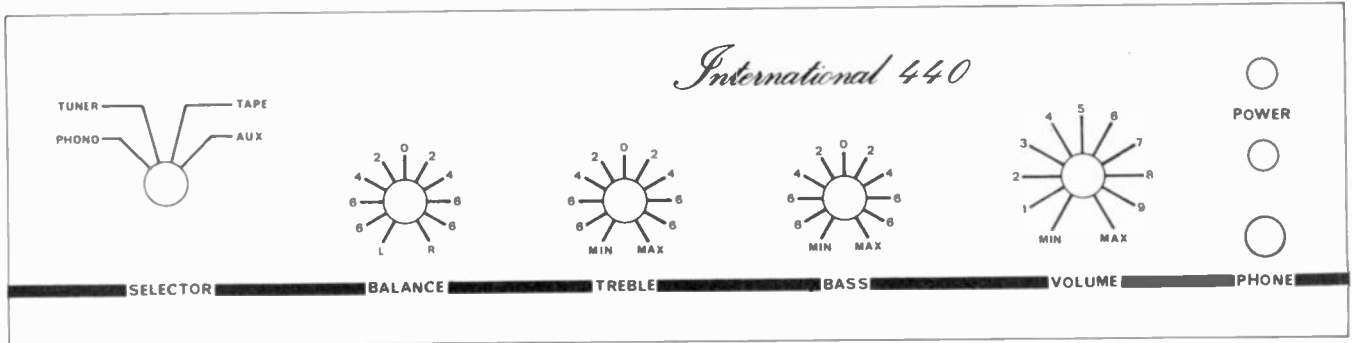

Fig. 7. Front panel artwork. Full size 335 x 83 mm.

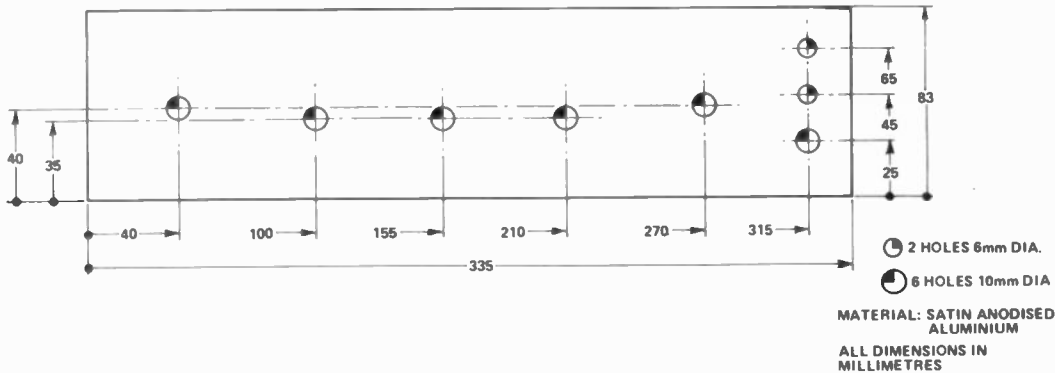

Fig. 8. Front panel details.

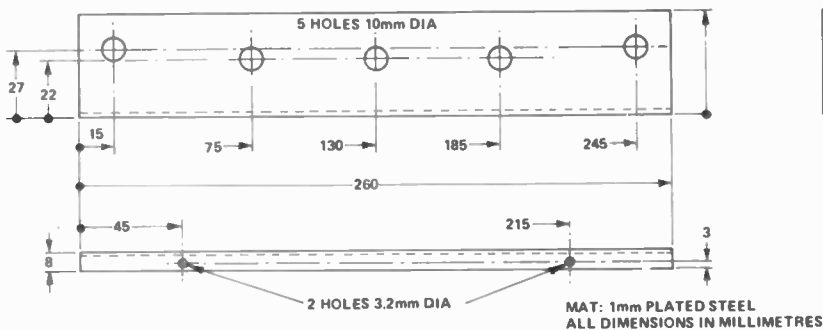

Fig. 9. Potentiometer support bracket.

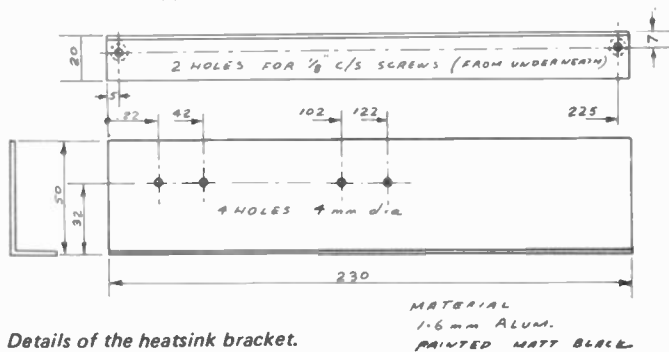

Fig. 10. Details of the heatsink bracket.

from the volume control to the main-amplifier inputs.

The chassis can now be assembled by mounting the transformer (terminals on the outside), the front panel, the phono socket, LED, speaker sockets, the 6-way RCA sockets, the rubber feet, the grommet for the power cord and the power cord itself. The screw for the cable clamp also mounts one of the rubber feet.

The printed-circuit board module can now be temporarily installed. If the potentiometers used have a long threaded portion (this depends on the brand) there may be room for extra nuts to hold the module and front panel on. If not, the nuts will have to be removed and refitted on the outside of the front panel. The module is held in by the potentiometer and by two self-tapping screws into the heatsink from the underside. Due to the variations in alignment of the mechanical parts, the location of the holes in the heatsink cannot be accurately determined. Therefore these holes have been left undrilled and can now be marked through the holes in the chassis. The unit can now be removed to facilitate drilling these holes to a size suitable for the self

Detail of power transistor assembly and installation. Note compensation transistors glued to output transistors (see text) and mica insulators between power transistors and chassis.

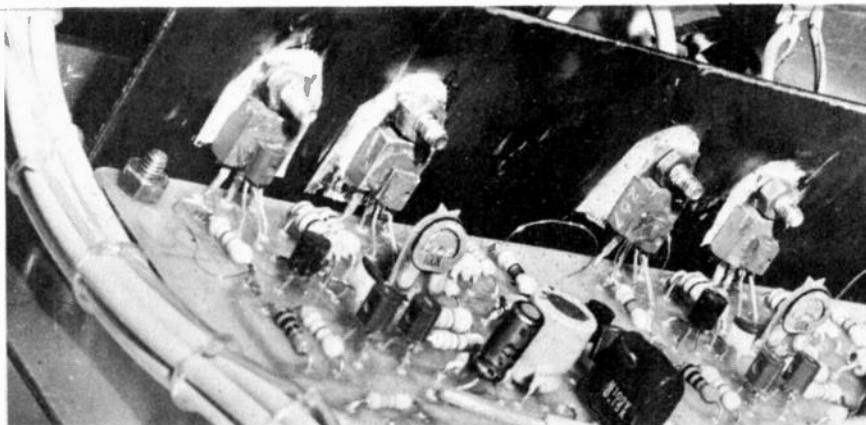
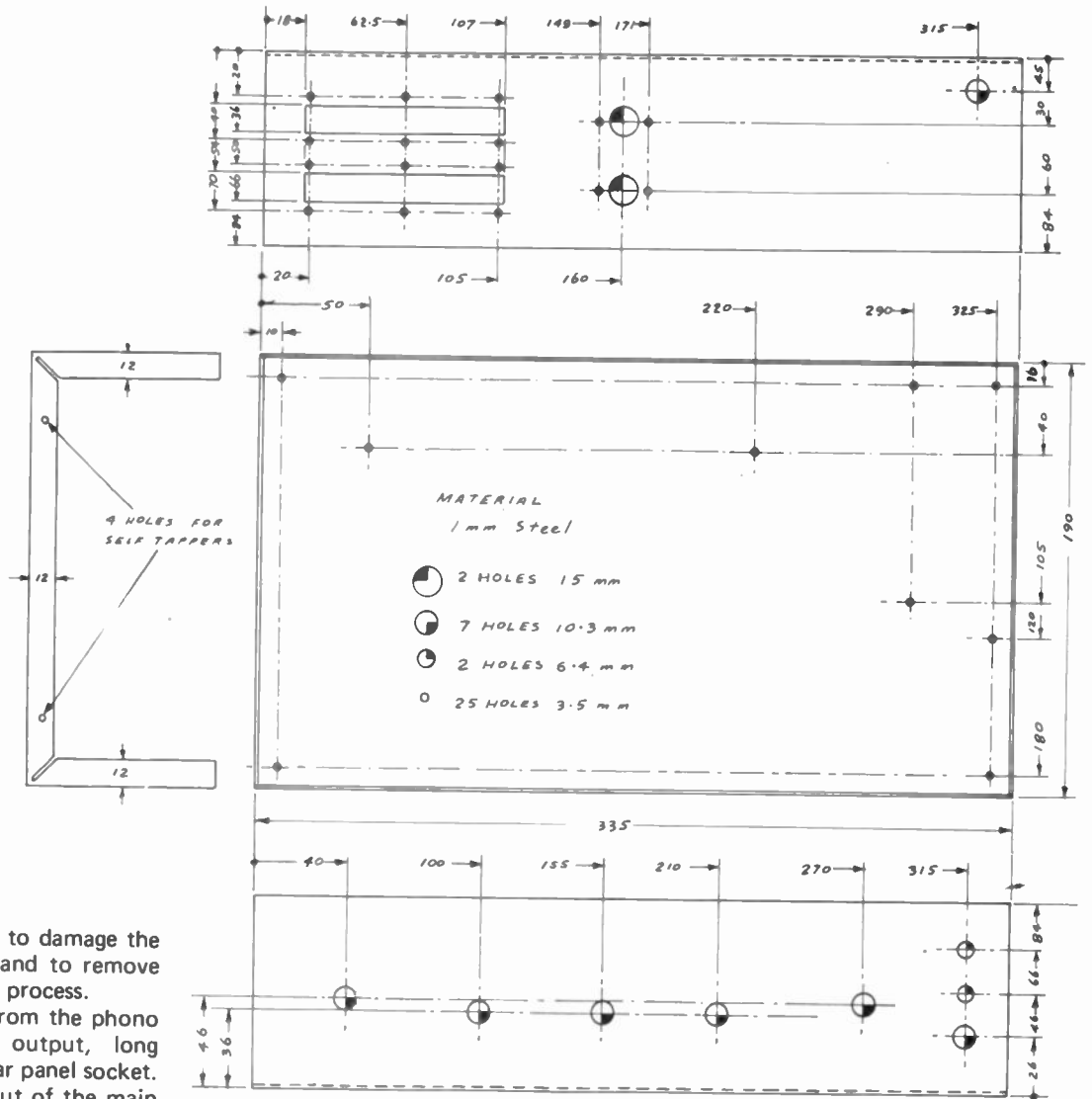

Fig. 11. Chassis details



tappers. Be careful not to damage the printed circuit board, and to remove any shavings during this process.

Connect coax cable from the phono input and the tape output, long enough to reach the rear panel socket. Leads to join the output of the main amplifier to the relay, and leads from the relay long enough to reach the phono socket can be installed along with the lead from the speaker common and the LED leads. To facilitate the assembly pins should be installed to the board where the transformer is connected.

The 240 V input cable can now be joined to the switch and then to the transformer primary along with the capacitor C35. The earth wire shall be bolted directly onto the chassis as shown. To prevent possible personal injury the switch and the transformer primary terminals should be taped up with insulation tape.

The printed-circuit board module can now be permanently reinstalled. The transformer secondary can now be connected and the rest of the wiring installed. The phono socket along with R80 and R81 can be wired according to Fig. 3.

This completes the assembly of the unit which is now ready for testing.

TESTING

Providing all components are in the correct place and all interconnections

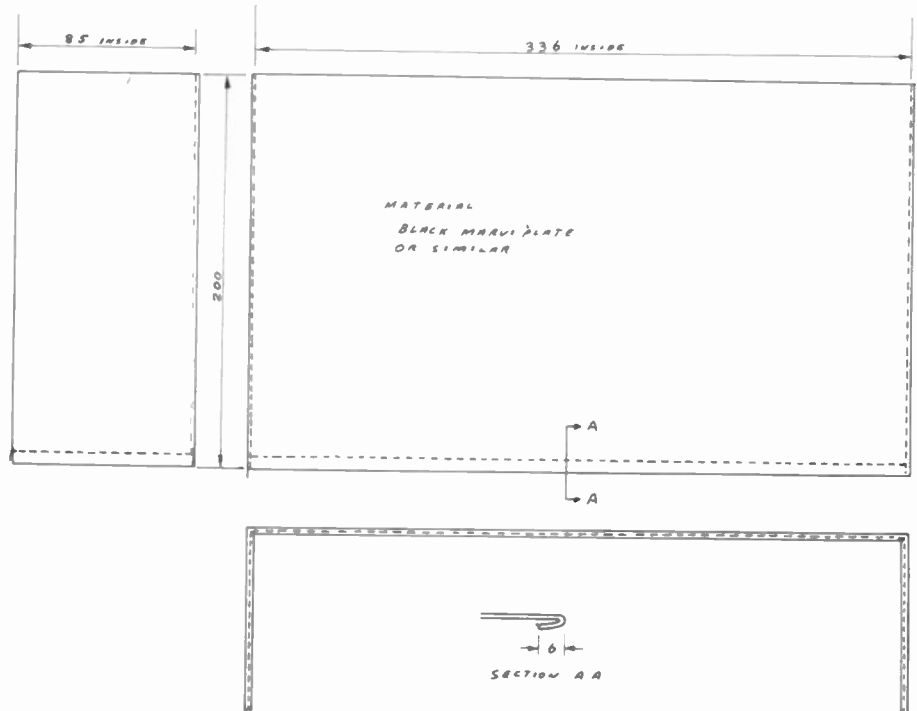

Fig. 12. Cover for the amplifier.

SIMPLE 25 WATT AMPLIFIER

are correct the only adjustment is that to set the bias current in the output transistors.

Before switching on rotate the trim potentiometers, RV5 and 6, fully clockwise i.e. toward the transformer. Switch on without speakers connected and measure the voltage across R63 and adjust RV5 to give about 3 volts. Repeat the process with the other channel and R64 and RV6. The resistors R63, 64, 73 and 74 can now be shorted out (after switching off) by short links of wire soldered onto the leads of the resistor.

If a fault exists in the output stage, either a transistor is shorted to the heatsink or the bias setting is faulty etc. In such a case the resistors R63, 64, 73 and 74 will overheat and may burn out. This effectively protects the output transistors.

FAULT FINDING

PROBLEM	POSSIBLE FAULT AND CHECKS
R63 or R73 gets hot (only one)	shorted insulation on Q15 or Q17
R63 and R73 gets hot (both)	bias current too high
Bias current not adjustable down to within limits	Q7 and/or Q8 faulty or wrong polarity. Voltage between base of Q15 and base of Q17 should be about 2.3 Volts
Bias current too low or zero	check output voltage, if about 0V then possible shorted Q7 or Q8
Output voltage high (near supply rail)	check current source Q11 is working Voltage across R61 should be about 0.65V. Check voltage across R45 it should be almost 0V (output high) if it is suspect Q5. If not check voltage at base of Q1 and Q3. Q3 should be higher than Q1 if so suspect Q1 or Q3
Output voltage low	check voltage across R45 should be about 0.7V if >0.7V suspect Q5. If less than 0.5V measure voltages at base of Q1 and Q3. Q3 should be lower than Q1 if so suspect Q1 or Q3
Main amplifier has no gain	faulty or disconnected C33, R51 or R53 wrong value
Main amp appears OK but pre amp does not work	check supply voltages on pin 6 (+10 V) and pins 9 and 16 (-6.6 V) Check output voltage of each individual amplifier. They should all be about 0V if not check components in local area.

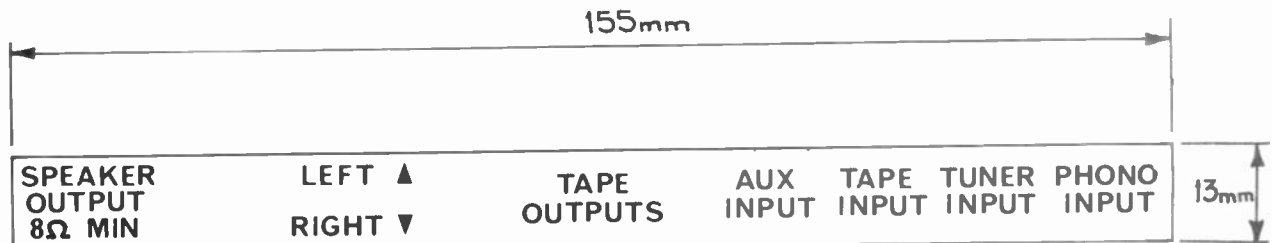

Fig. 13. Artwork for rear panel.

FERGUSON

Manufacturers of: Electrical/ electronic equipment, wound components and lighting control equipment.

BRANCHES IN ALL STATES

FERGUSON TRANSFORMERS
PTY. LTD.
HEAD OFFICE:
331 High St., Chatswood. 2067
P.O. Box 301,
Chatswood, NSW, Australia 2067
Phone: 02-407-0261



FAST **DESOLDERING**

SAFE with **Soder-Wick**

EASY

1. Hold Soder-Wick on termination with hot soldering tip. Wicking action soaks up solder.
2. Remove tip and braid. Termination is left clean and free of solder.



Soder-Wick is a specially treated copper braid which soaks up molten solder like a sponge. Desolders a P.C. pad in a second or so: acts as a heat sink to protect circuits and components.

In a range of sizes from your wholesaler or

ROYSTON ELECTRONICS

02-709 5293
03-848 3777

RE475



Non-Linear Systems, Inc.
Originator of the digital voltmeter.

LM-3

DIGITAL MULTIMETER

Full three digits.
Less than 2" high.
Automatic zeroing.
Automatic polarity.
Battery powered.
MOS/LSI construction.
Low, low price.
Drop-proof.

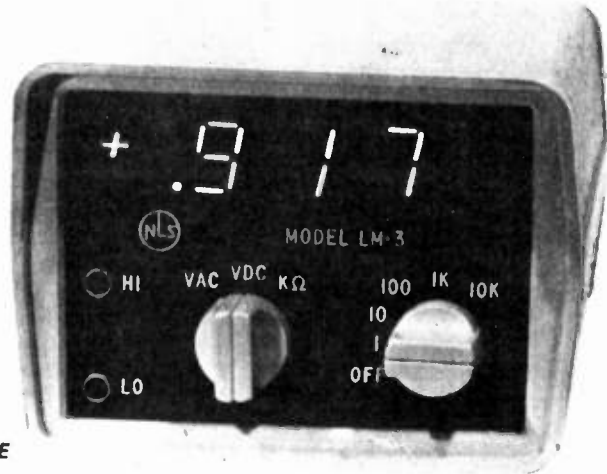

ACTUAL SIZE

SPECIFICATIONS

MODE	RANGE	ACCURACY	RESOLUTION	INPUT RESISTANCE	TEST CURRENT
VOLTS DC	*1	±(0.1% F.S. + 1% Rdg.)	1 mV	10 MEGΩ	
	*10		10 mV		
	*100 *1000		100 mV 1 V		
VOLTS AC	*1	±(0.1% F.S. + 1% Rdg.) 50/400 Hz	1 mV	10 MEGΩ, 30 pF	
	*10		10 mV		
	*100 *1000		100 mV 1 V		
KILOHMS	1	±(0.1% F.S. + 1% Rdg.)	1 Ω		1 mA
	10		10 Ω		100 μA
	100		100 Ω		10 μA
	1000		1 KΩ		1 μA
	10000		10 KΩ		100 nA

*500 VDC or RMS AC maximum any voltage range.
5 VDC maximum test voltage in KΩ mode.

Range Selection: Manual
Polarity Selection: Automatic
Decimal: Positioned by range switch
Zero Stability: Automatic Zero
Overload Indication: 1000, with the numeral "1" flashing, is displayed for all inputs exceeding full scale.

Operating Temperature Range: 0° to 45°C
Overload Protection in KΩ Mode: Up to 120 VDC or RMS AC may be applied (not to exceed 30 seconds).

Size: 1.9"H x 2.7"W x 4.0"D
Weight: 9.2 ounces (with batteries)
Power: 3.6V (nominal) at approximately 200 mA, <1W (less than 3W when batteries are being charged).
Battery Operation:

ON SALE
NOW
EVERYWHERE

\$99*

Rechargeable batteries with charger are now included in this low price.

* All prices plus 15% sales tax if applicable. Each unit carries a full one year factory warranty.

The LM-3 is now available throughout Australia at your local distributors, radio shops, hobbies and electrical stores.

OPTIONAL FEATURES

- A High Voltage Probe – To 30 KV (1000:1 Reduction) \$26.00
- B Leather Carrying Case – Belt and Neck Strap .. \$11.00
- C Carrying Handle/Tilt Stand \$2.40
- D Current Shunts – 100μA, 1mA, 10mA, 100mA & 1A range \$4.10 ea.

Now you can put away that old VOM and that old VTVM with the pointer meter application. At last everyone can afford to make measurements at new levels of accuracy with NLS's modern new digital multimeter. The Lm-3 is designed to be a more reliable and rugged replacement of delicate pointer meters. With its strong abrasion resistant case the Lm-3 can withstand severe shocks and rough tool box handling.

Non-Linear Systems (Australia)

P.O. Box 122, Glen Waverley.
Telephone: 232-4506 Vic. 3150 Australia.

Non-Linear Systems  20 Years of Progress

CONTROLLED TEMPERATURE SOLDERING

What does it have to offer?

CONTROLLED temperature soldering tools have been used for quite a while, though until recently their use was largely confined to critical applications such as life support equipment, communications, weapons, aero-space, etc.

They are more expensive than the conventional 'single-temperature' tool; so what does the man who simply wants to build an amplifier or repair the neighbour's TV get for the extra money?

Firstly, let us go back a few years to the pre-printed circuit, pre-integrated circuit era. Then electronic gear was like the motor car of that era — built like a tank. Resistors and capacitors (called condensers then) were soldered, via heavy pigtailed, to terminal pins on valve and coil bases large enough to anchor a small boat, other components were mounted on tag strips strong enough to support a house — or that's the way it seems, in retrospect.

In those days the soldering iron bit (why do we persist in calling it a soldering *iron* and a soldering *bit*?) was a great lump of copper rod, little different from that used by a plumber.

With the steady reduction in sizes of components, and the advent of printed

wiring and integrated circuits, the heat requirements for soldering have shrunk in proportion. At this point, however, we must define what we mean by 'heat'.

HOW MUCH HEAT?

Just as high electrical power can be obtained from low voltage and high current, so can high thermal power be obtained with low temperature and high thermal capacity. So when we say 'more heat', we don't necessarily mean 'higher temperature'. We may simply mean *more heat volume* at a temperature high enough to rapidly melt solder... and 60/40 solder at that, since we are talking electronics. As a matter of interest, the optimum working temperature range for 60/40 solder is 245°C to 272°C. (This should not be confused with the melting point, which is 188°C).

HEAT ABSORPTION

Every time a soldering tip is placed on a termination, heat is absorbed by that termination, and the temperature of the tip drops. The ability of the soldering tool element to replace that heat determines its recovery rate. Obviously, a heavy chassis joint or a long sequence of joints will draw a

substantial amount of heat from the tip, with the result that the temperature may drop too low for satisfactory soldering — particularly with a small, low mass tip.

Without some form of temperature control, there is inevitably a wide variation in the tip temperature, depending on the mass of the terminations and the frequency of soldering.

This problem was overcome in the blunderbus era by that massive big 'bit' we mentioned, but this is quite impossible with today's high density circuitry and miniature componentry. The only answer, therefore, is some means of rapidly replacing the heat as it is drawn out.

HIGH IDLING TEMPERATURES

In an attempt to compensate for the inevitable temperature reduction, particularly in production soldering, higher initial (idling) temperatures were frequently used, on the principle that the average operating temperature would be more acceptable. So it was — but the first few joints of every soldering sequence were then exposed to an excessively high temperature.

The penalties of elevated temperatures can be quite severe, and

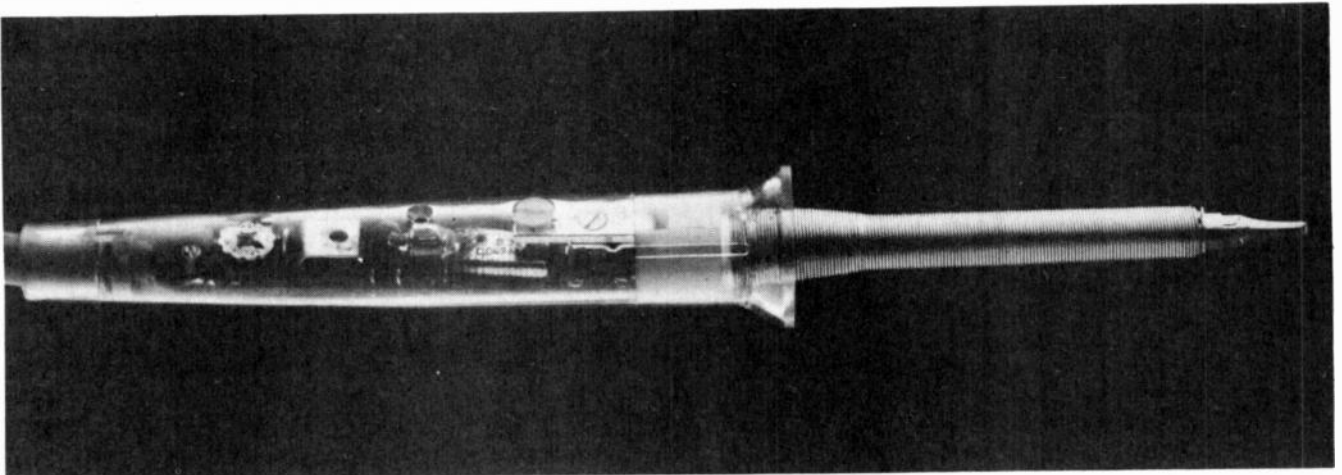

The Adcole 'Thermatic' soldering iron has electronic temperature sensing and switching circuitry within the handle.

they are not all immediately obvious: insidious latent faults in circuits and components frequently result in call-backs.

HIGH TEMPERATURE PENALTIES

Some of the more obvious results of excessive temperatures include:

- * Flux preactivation: the flux vaporises and fails to do its job.
- * Solder spatter: a short circuit hazard in high density circuitry.
- * Printed circuit track and pad delamination: a fault which may not be immediately obvious.
- * Excessive oxidation of tip and destruction of tip tinning: makes soldering harder instead of easier.
- * Reduced element life: element wire oxides rapidly.
- * Damaged insulation: plastic insulation can be damaged, or will 'shrink back', even from the radiated heat.
- * Component damage: this is the greatest hazard in today's circuitry, due to the predominance of solid state componentry.

COMPONENT DAMAGE

Both the electrical and mechanical properties of semi-conductor devices are temperature dependent and excessive heat, even if it does not cause immediate failure, will generally accelerate ultimate failure. It can, for example, cause shear stress along the bonded interface between two dissimilar materials (silicon to ceramic for example) due to their different coefficients of expansion. Integrated circuits based on MOS or CMOS technologies are particularly susceptible to thermal damage during soldering. Excessive soldering temperature, therefore, may well ruin relatively expensive components; or at least reduce component life, undermine reliability, and degrade performance.

Even abnormally low temperatures do not remove this hazard. This simply entails leaving the soldering tip on the termination for an unduly long period, during which the component can soak up more heat than with a hotter tip and a quicker soldering operation.

TOOLS AVAILABLE

Two basic types of controlled-temperature soldering tools are readily available. One of these, the Weller, operates on the Curie principle, whereby a mechanical switch is operated by a magnetic pull. A tip with a specified temperature is first inserted in the tool. Below this specified temperature, the tip attracts the magnetic switch assembly, closing the element circuit. On reaching the elected temperature the magnetic force is reduced and the switch

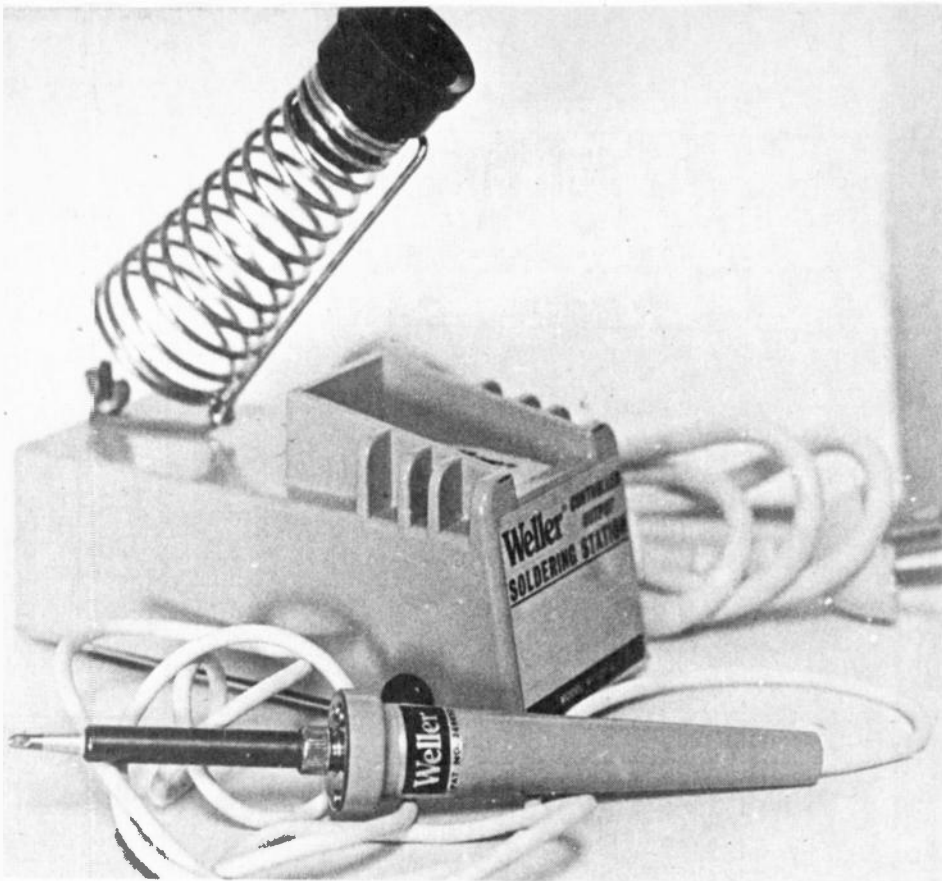

Weller temperature controlled iron. The stand incorporates a transformer in the box. Operating temperature is selected simply by changing the tip.

mechanism, via the spring, is released. To change temperature another tip, with the required Curie point, is substituted.

The recently developed Thematic tool, from Adcola, is entirely electronic. All solid state sensing and switching circuitry is contained within the slim handle.

A small screwdriver slot control permits variation of the temperature throughout the range of 200°C-400°C, independent of the tip, which can be a standard type selected for its size and profile only. The Thematic operates directly on mains voltage, and has a thermal work capacity comparable with conventional tools of more than twice, and up to four times, the rated power.

For critical applications, soldering units are produced with the

temperature selection circuitry in a separate control unit. Low voltage, zero tip potential, zero voltage switching, and an even closer temperature tolerance are provided with these units.

The major benefits of controlled temperature soldering tools will now be evident. In addition to the temperature control aspect, there are obvious benefits associated with the temperature selection feature. Low temperatures can be selected for specially critical work with low-melting-point solders. Higher temperatures can be selected for desoldering for a given termination mass, where surface oxide retards heat flow at soldering temperatures. For long sequences of heavy chasis joints, higher temperatures may also be permissible. ●

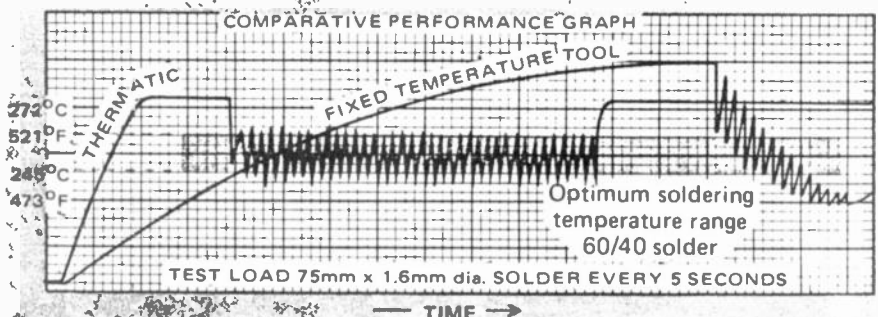

The graph compares the Thematic controlled temperature tool with a conventional tool. Note that the heat up time is only a fraction of that required for the fixed temperature tool, which also cools down progressively under identical load conditions.

MODEL MAIL ORDER
JB Electronics & Co.

• R/C Models • F.F. Models • Engines • Boat and Cars • Tools • G/L Models • Sprayers • Accessories • Books • Plans

Australia's Model Centre, 115 Gouger St., Adelaide, S.A. 5000. Phone: (08) 87-3119

RACING CARS

1/8 scale. Capable with radio to control steering, speed and braking. Front suspension.

three models available:

PORSCHE 917
 McLAREN ELVA 8D
 LOLA T-70

SALE
\$95.00

p&p \$5.00
 Order No. 120

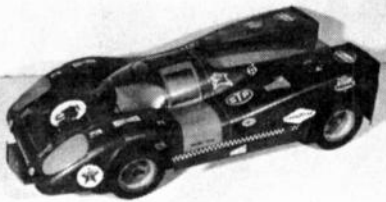

POP BUGGI

1/8 scale. Capable with radio to control steering, speed and braking. Front and rear suspension. Hand-pull starter for engine built-in.

SALE
\$98.00

p&p \$5.00
 Order No. 121

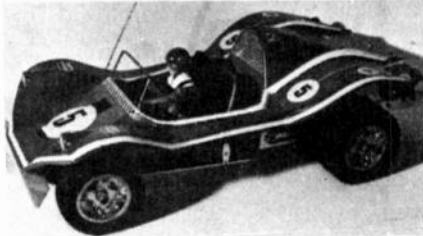

CAPRI MOTOR BOAT

Including 2 electric motors and fittings
 Length 33"

SALE
\$45.95

p&p \$5.00
 Order No. 100



ARE YOU THINKING OF TAKING UP MODEL BUILDING? IF SO: YOU CAN'T GO WRONG IF YOU PHONE, WRITE OR CALL ON US NOW AND GET THE BENEFIT OF THIS SERVICE.

• Make sure you buy the right equipment • Make sure you are building your model correctly • Make sure you are installing your radio gear correctly • Supply you with mail order catalogue (send S.A.E.) cost \$0.75 • Make sure we stay friends • Any overpayments on P&P will be credited immediately.

PILOT SIROCCO 20

Straight and Heat racing
 Length 620 mm. Capable of doing speeds up to 90 km/h.

SALE
\$39.95

p&p \$3.00
 Order No. 122



NEWPORT YACHT

With all fittings suitable for 2 channel R/C, height 47", length 32"

Retail \$64.00

SALE
\$55.95

p&p \$6.00
 Order No. 104



Famous brand name 2 channel radio control equipment. Consisting of transmitter receiver, 2 servo's, 1 battery pack, 2 crystals.

Retail \$139.00

Our price
 While stock lasts

\$99.95

p&p \$3.00
 Order No. 123

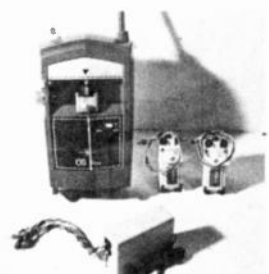

CORDLESS POWER DRILL SET

Drills plastic, wood, light metal, grinds, d'fills, polishes, carves, deburs.

Special at
\$13.50

p&p \$2.00
 Order No. 125



FOX ENGINES SERIES '75

Order No. 118,
 P&P \$1.60



	Standard	R/C
FOX-15	19.23	24.90
FOX-19	20.90	31.45
FOX-25	20.90	
FOX-29	23.85	31.45
FOX-35	stunt	28.30
FOX-36	23.85	36.70
FOX-50	72.15	79.35
FOX-78	96.40	111.50

FOX COMBAT SPECIAL
\$52.45

MULTIMETER SALE OF THE YEAR

Compare these prices!

It's Time!
 Delivery:
 Service:
 Protection:

to buy a famous University Multimeter
 Ample stocks, but don't delay
 90 day guarantee and 24 hr. Service
 All multimeters are fitted with overload protection

V.T.V.M. FET-74
 Price only \$55.20
 tax paid.

Input Impedance 12MΩ
 Solid State, Battery operated. DC Volts, 8 ranges to 1.5kV. AC Volts, 7 ranges to 1.5kV. P-P Volts, 7 ranges to 4kV. dB, 6 ranges to +66 dB. DC mA, 8 ranges to 500 mA. Resistance, 4 ranges to 1000M. (30kV Probe available \$23.00)

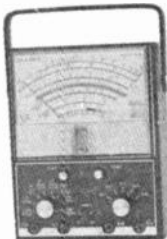

Model MVA-80

DC Volts, 6 ranges to 1 kV (80KΩ) per Volt. AC Volts, 5 ranges to 1kV. DC mA, 4 ranges to 500mA. Resistance, 3 ranges to 10M dB, 5 ranges to +62 dB.

Price: \$16.10
 tax paid.



Mighty Midget MVA-1K

1000 ohms/Volt. AC/DC Volts to 1kV. DC mA to 100mA. Resistance & dB.

Price only \$6.44
 tax paid.



COMPONENTS

Resistors — Philips 1W 500 Mixed Values \$6.00.
 Condensers Polyester 400V 200 Mixed Values \$6.00.
 Valves. All new. 10 for \$6.00. 12AN7, 6AL5, 6AN7, 12BA6, 6X4, 6BA6.
 Lever Meter \$3.22 22 x 54 mm. VU, Battery, Balance or S Scale.

Please use Mail Order Coupon or write direct to:
ELECTRONIC PARTS
THE MAIL ORDER SPECIALISTS
 P.O. Box 60, Mortdale, 2223.

All prices are TAX PAID
 Allow \$1.50 for packing, post and insurance

Mr.
 Address
 Post Code
 Qty. Model
 Enclosed Postal Note/Cheque for \$
 or send C.O.D. Post to above

One year from now you'll be able to read this circuit as easily as the back of a cornflakes packet.

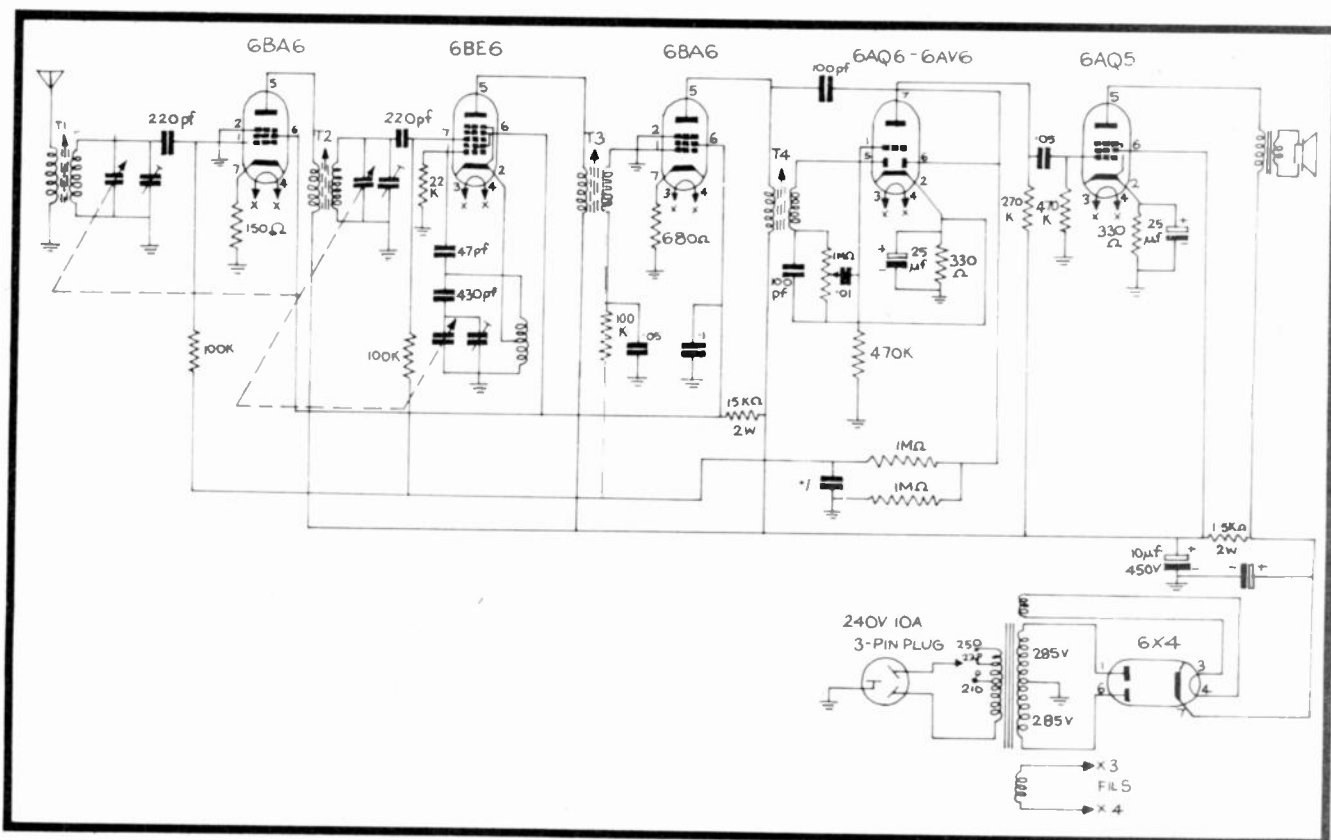

You don't need to be an Albert Einstein to learn about electronics.

All you need is youth, enthusiasm, and someone who'll give you the chance to learn at the right speed.

That's what an electronics apprenticeship in the army will give you.

A year from now you'll be able to read this circuit standing on your head. And you'll be well on the way to gaining qualifications that will make you valuable to employers everywhere.

So if you're between 15 and 17 in January and you want to get into electronics, this is probably the best opportunity you'll ever get.

Fill out the coupon and we'll send you more details. Or pick up the nearest phone and call the Army Careers Adviser in your city. (Closing date 13th August.)

Townsville 71 6784,
Brisbane 31 1031,
Newcastle 2 5476,
Sydney 212 1011,
Wollongong 28 6492,
Canberra 47 6530,

Melbourne 61 3731,
Launceston 31 1005,
Hobart 34 7077,
Adelaide 223 2891,
Perth 22 4355,
Darwin 89 0911.

To Army Careers Adviser
G.P.O. Box XYZ in your
nearest State Capital City.
Please send me information
about Apprenticeships in
the Army.

Name

Address

Post Code

Date of Birth

army
It's a great life

ELECTRONIC AGENCIES

BIG SAVINGS on CCTV...

APECO CAMERAS

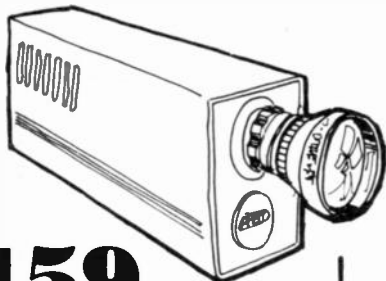

\$159

Complete with high quality universal lens — no extras needed. Works with any ordinary TV set; automatically adjusts to suit different light conditions and uses standard interchangeable lenses. Ideal for experimenting, Professional or security use. Proven, Tested and guaranteed.

CC TV ACCESSORIES

- 7" 2400' x 1/2" Sony tapes. \$22.00
- Signal booster/amplifier 240v. \$89.00
- Mounting brackets, from \$12.50
- Close up lens (macro). \$45.00
- Wide-angle lens. \$49.00
- Telephoto lens 70mm. \$93.50
- Zoom lens 12.5-70mm. \$42.00

115-117 Parramatta Rd. (Cnr Lloyd George Ave.,)
CONCORD NSW 2137
TELEPHONE (02) 747 6472

Trading Hours: 12:00 to 6:00 pm. Mon-Fri 8:30 to 1:00 pm Sat
NOTE: Add Postage rated 10% order value. C.O.D.'s send \$2.00 prepayment.

VIDEO TAPEREORDER \$595

Sanyo VTR-2000. Records video and audio signals on 1/2" tape (1hr) — features auto level controls for easy operation. Record from home TV or camera, play back on home TV. Completely portable (29lbs).

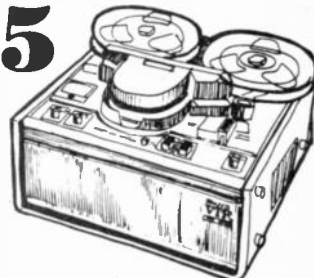

CONCORD TV CAMERA

With in-built monitor/viewfinder. Lets you see what the camera sees — great when you have to follow a moving target as in sport, etc. Use as playback monitor with Video Tape Recorder etc. Normally \$850.

\$425



Garrard MINI-CHANGER

3 Speed 240v compact record changer. Plays all records, with ceramic cartridge. BRAND NEW AND FULLY GUARANTEED.

\$21

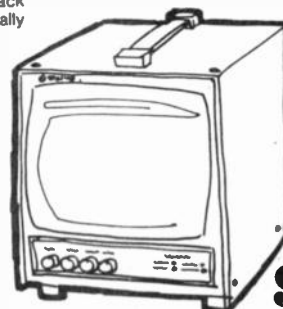

\$219

AC-DC 9" MONITOR

240v AC or 12v DC operation — may be connected directly to TV camera or VTR; simplified controls and light weight make for easy portable use.

AUTOMATIC SCANNERS

With remote controller. Easily adjustable from 45 deg. to 360 deg.; sweeps desired area and reverses automatically. Remote controller permits manual operation from a distance.

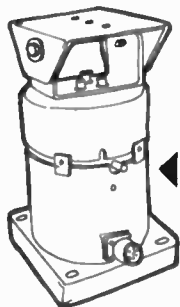

\$190

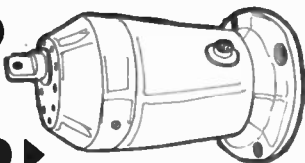

\$140

PANEL METERS



Large 5" size — Best quality high accuracy meters with various scales. For 100UA, 200UA, 500UA, 12MA.

\$7.50

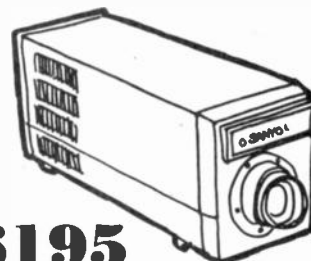

\$195

SANYO has a complete line up of CCTV Cameras and VTR's. The model VC1120 (illustrated) provides for RF or VIDEO output and automatically adjusts to a wide range of light conditions. Uses std. interchangeable lens — 240v operation.

WE'VE GOT MORE SPEAKERS

(1) Woofer-Tweeter. Package Deal. 8" 3" 20W RMS 8 ohms, by MSP.

\$14.50 ea.

(2) Plessey 12" 2 way package deal C12P/&X-20 30W RMS 8 ohms.

\$24.95 ea.

(3) Imported 8" De-luxe 2 way. 8" 2" 25W RMS 8 ohms.

\$16.50 ea.



(4) MSP 3 Way 8" Package Deal. 8" 5" 3" 20W RMS 8 ohms.

\$18.50 ea.

(5) Plessey 12" 3 Way package deal. C12P KC5NR X-30. 30W RMS 8 ohms.

\$34.90 ea.

(8) Imported 10" De-luxe 3 Way. 10" 4" 2" 30W RMS 8 ohms.

\$25.50 ea.

(7) De-luxe Dome System 3 Way. Imported 8" dome mid/tweeter 20W.

\$33.00 ea.

(8) De-luxe Dome System 3 Way. Imported 12" plus dome mid, tweeter 30W.

\$48.50

(9) Imported 12" 3 Way system. 12" 8" 3" (x2) 30W RMS 8 ohms.

\$34.90

All kits include cross over components and wiring diagrams.

PA, CB or ham BASE STATION MICROPHONE KIT



50 ohms impedance (10K with transformer \$8.50) and includes press-to-talk switch DPDT, spring return.

\$13.50

STEREO 30 \$30

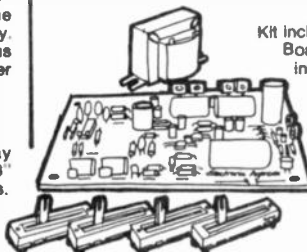

Kit includes transformer, labelled and numbered P.C. Board, all Resistors and Capacitors, 4 pages instructions. Amazing offer for "hi-fi-ers" — Stereo amplifier kit, giving 15W RMS in 4 ohms, 10W RMS in 8 ohms (per channel) with 5 mV magnetic cartridge input VOLUME, BALANCE, BASS and TREBLE controls supplied — latest integrated circuit pre-amp and driver stages, complementary "flat-pack" output transistors — all on one P.C. Board for easy assembly. Hi-Fi performance with 20Hz to 50kHz response, low distortion and low hum level ensure compatibility and the best turntables and speakers. Complete Kit \$30 plus post.

Build your own



Peerless

Stereo Loudspeakers

Five pieces of chipboard and a number of lists are glued together to form a cabinet which can be later painted, veneered or simply covered with an imitation-wood paper. The cabinet is filled with sound absorbent.

Simple instructions on how to make the speaker cabinet and a description of the wiring and mounting of the speaker units are included with all Peerless Kits.

How to choose the right Peerless Kit

All Peerless Kits are of excellent Hi-Fi quality and are able to deliver more than ample output to fill the normal sized living room.

Loudspeakers and amplifiers may have different power capacities yet still work excellently together. However, due to different efficiencies within the speaker systems, the following Kits are recommended for amplifiers with at least 2x10 watts output: Kit 10-2, Kit 20-2, Kit 20-3, Kit 50-4.

The other Peerless Kits may also be used with advantage with lower powered amplifiers.

If you want a greater bass reproduction

you ought to know that the Kits containing woofers with rubber roll surround (Kits 10-2, 20-2, 20-3 and 50-4) give a cleaner and greater bass reproduction, require smaller cabinets but have at the same time, a lower efficiency than the corresponding Kits with woofers with special impregnated paper surround (Kits 2-8, 3-15 and 3-25). In each of the two categories you get a better bass reproduction the bigger the recommended cabinet is. Cabinet drawings included give the optimum size for the woofers involved.

If you like mid-range

you ought to know that you get a cleaner reproduction, better sound distribution and a slight boost (so-called presence effect) in this range when you choose a Kit with separate mid-range speaker (Kits 3-15, 3-25 and 20-3). For Kit 50-4, a neutral reproduction has been aimed at (ie: without presence effect).

Peerless world-famous tweeters

are included in all Peerless Kits. This means that you get distortion-free reproduction and good sound dispersal, no matter which Peerless Kit you choose.



Further information from . . .

Victoria — Danish Hi Fi. Western Australia — Danish Hi Fi.
Queensland — Brisbane Agencies. N.S.W. — Convoy.

UNDERSTANDING COLOUR TV

The line output stage

by Caleb Bradley B.Sc.

THE previous parts of this series have described every part of a colour receiver's circuitry except the stage which drives the horizontal deflection coils. This is known as the line output (LOP) stage. Its description has been left until now because its design is closely linked with the requirements of the shadowmask tube, described last month.

Both the vertical and horizontal deflection coils are fed with sawtooth-waveform currents to cause the focussed electron beam to scan in the raster pattern, but some ten times more power is needed to drive the horizontal coils because of the higher

scanning frequency in this direction (i.e. 15 625 Hz compared to 50 Hz). It is especially difficult to obtain an adequately fast 'flyback' from the end of one line to the start of the next, demanding a near-instantaneous reversal of current in the deflection coils. The inductance of the coils becomes significant at this point and a large driving voltage is required. Because of this it would be impractical to design the line output stage along the same lines as the field scan circuit (described in Part 6) where a low-power sawtooth generator is followed by a linear output stage.

The same problem exists for

monochrome receivers although here the scan power needed is less because the small-diameter neck of a monochrome cathode ray tube allows the deflection coils to be closer to the electron beam.

ENERGY RECOVERY

The solution is to turn the inductance of the horizontal deflection coils to advantage by making them part of a resonant circuit during the critical flyback period. This allows minimum driving voltage to cause the fast reversal of current which follows the 'up' slope of a sinusoidal waveshape. The next trick is to *recover*

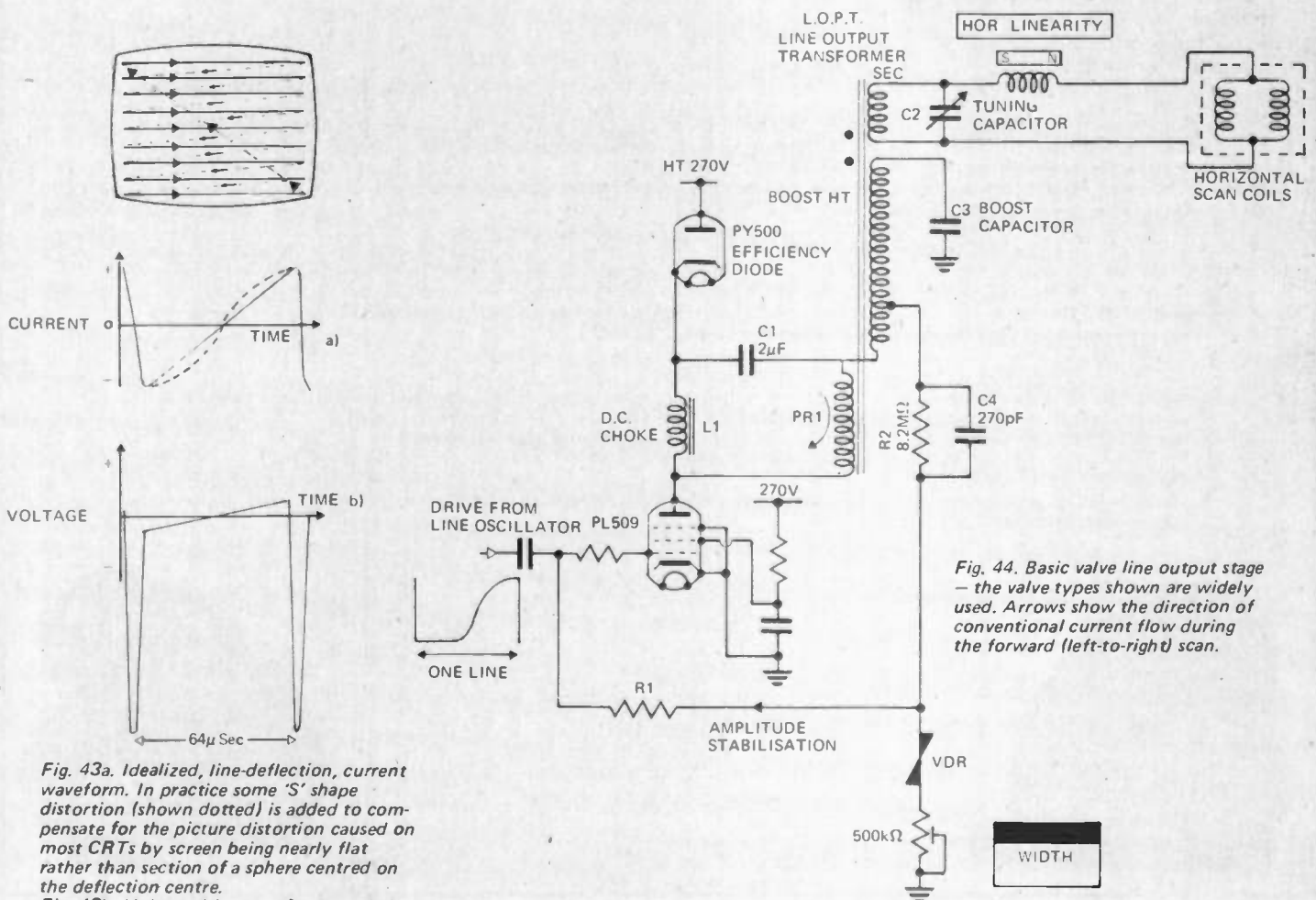

Fig. 43a. Idealized, line-deflection, current waveform. In practice some 'S' shape distortion (shown dotted) is added to compensate for the picture distortion caused on most CRTs by screen being nearly flat rather than section of a sphere centred on the deflection centre.
Fig. 43b. Voltage drive waveform needed to produce (a).

Fig. 44. Basic valve line output stage — the valve types shown are widely used. Arrows show the direction of conventional current flow during the forward (left-to-right) scan.

backswing energy from the resonant circuit (i.e. all the energy which was put into the circuit minus small resistive losses) for future use! This is achieved by an 'efficiency diode' which can be found in every modern television receiver. The circuit operation depends on whether a valve or a transistor driver is used, and since the former is still preferred by many manufacturers we shall describe both arrangements.

VALVE LINE OUTPUT

A typical stage, minus the frills, is shown in Fig. 44. It contains a high-power pentode valve (PL509) which switches current flowing in the primary of the line output transformer (LOPT). This transformer is wound on a high efficiency ferrite core and is heavily insulated to withstand high peak voltages.

Current flows into the circuit via the PY500 efficiency diode from the high tension rail — which can be merely the mains voltage rectified and smoothed. In monochrome circuits all the current passes through the transformer. Here, for greater scan power, a large choke L1 provides a dc route from ht to the pentode; the alternating voltage appearing across it is coupled into the transformer by C1. This removal of dc from the transformer allows the use of a smaller more efficient core.

The secondary of the LOPT drives the horizontal scan coils and the combined inductance of transformer and coils is tuned to about three times line scan frequency by C2. From an ac point of view it is convenient to regard L1 as an open circuit and C1 as a short circuit.

The sequence is best understood by starting half way through a line where the deflection current (Fig. 43a) is zero. At this point the pentode is switched on by positive drive to its control grid and current builds up in the LOPT primary, and therefore in the scan coils, in the direction shown by the arrows.

At the end of the scan the pentode is abruptly turned off by the negative swing at its control grid. The tuned secondary circuit has a large amount of energy stored in it in the form of forward current and this continues to flow into C2, decaying towards zero as C2 charges up and then reversing as C2 discharges back into the inductance. As C2 charges a large positive pulse appears at the pentode anode but no current flows in the primary. The energy recovery bit happens as C2 drives current in reverse direction through the secondary. By transformer action in reverse the upper (dotted) end of the primary is induced positive with respect to the tap connected via C1 and PY500 to ht. Therefore

Fig. 45. Transistor line-output circuit.

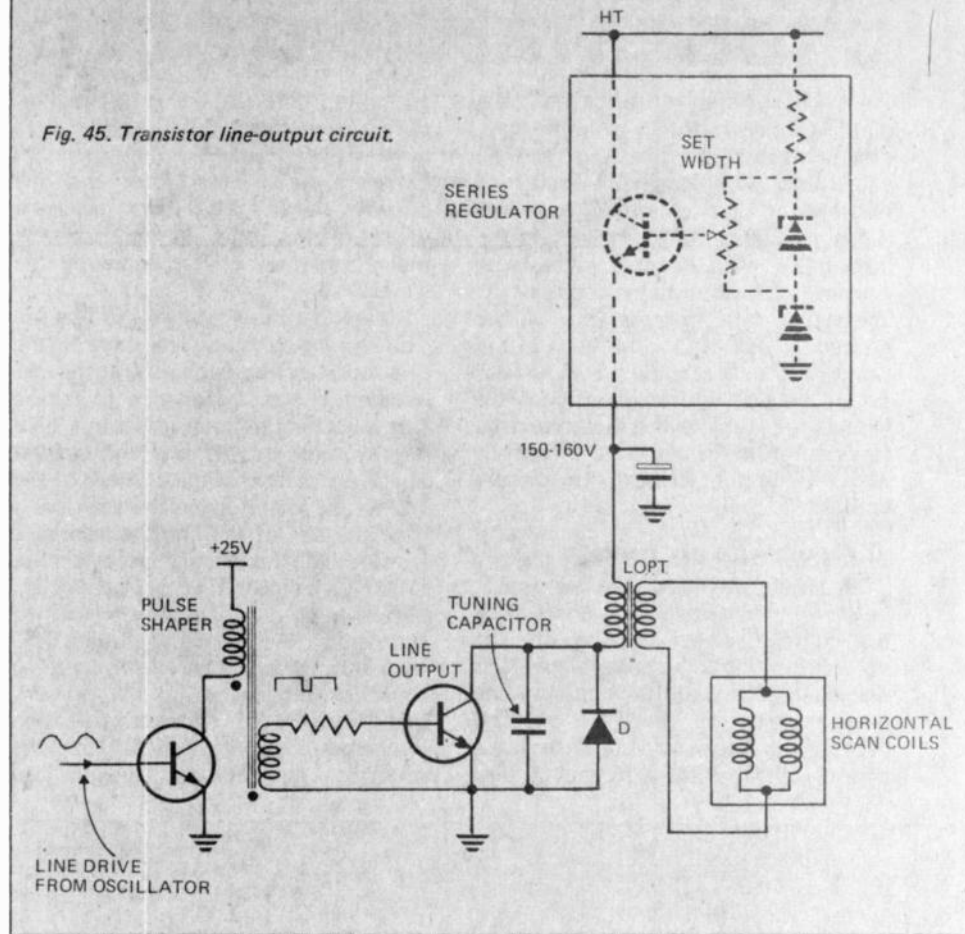

current is drawn from ht and the resonant energy is recovered by charging the 'boost reservoir' C3 to a voltage as much as 500 V more positive than the ht rail.

Thus at the end of flyback the correct current (opposite to the arrows) is flowing in the scan coils and a 'bonus' packet of high voltage energy has been accumulated on C3. As the first half of the scan proceeds, the primary current into C3, and hence the reverse current in the scan coils, linearly decays to zero to reach the point where we began. However it can now be seen that when the pentode turns on, the source of current will be the high voltage and C3 and the efficiency diode serves to prevent C3 discharging back into the ht rail. In short, the efficiency diode conducts during the left half of the picture, the pentode during the right half.

Also, C3 is a useful source of high voltage, albeit at low current, for other circuits in the receiver. The 'boost ht' rail usually feeds one end of the potentiometers which set the voltages of the tube first anodes, and may also be the charging source for the vertical scan sawtooth generator.

SCAN STABILISATION

The field scan circuit contained a thermistor to stabilise the picture height against supply voltage changes

and component ageing. Valve line output stages are also stabilised by means of a special component — a Voltage Dependent Resistor (VDR in Fig. 44). This is a non-linear resistor which passes virtually no current until several hundreds of volts are applied across it whereupon its resistance drops and current flows. It behaves like a high-voltage (950 V approx.) zener diode except that it is not polarity sensitive.

In Fig. 44 positive-going flyback pulses are applied to VDR by C4 from a tapping on the transformer. VDR conducts only on the tips of the pulses causing C4 to charge. This causes the pentode control grid to be held further negative via R1 during the next scan line. It therefore switches on later on the positive swing of the drive waveform so less energy is stored in the tuned circuit on this line and the width is reduced. To prevent the valve eventually cutting off entirely the negative supply due to the VDR is opposed by positive current from R2 and the circuit stabilises at a particular scan width. The effectiveness (gain) of the stabilisation feedback depends on the drive waveform having a fairly steep rising edge. The 500 kΩ control (variously labelled 'width', 'set eht' or 'line amplitude') allows the VDR conduction to be reduced by inserting resistance in series with it, which results in increased width.

UNDERSTANDING COLOUR TV

The horizontal linearity of the picture is controlled in a simple way. The control (L2) consists of a small coil wound on a core small enough to saturate at the deflection currents involved. Before saturation occurs the inductance of L2 restricts the scan current; as saturation occurs its inductance falls towards zero. A bar magnet is mounted close to L2 and can be rotated to apply a steady field to the core in either direction. This renders unequal the critical currents for saturation in opposite directions with a useful effect on picture linearity.

TRANSISTOR LINE OUTPUT

The efficiency diode principle cannot be used in the same way in a transistor line output stage because of the excessive flyback voltage. Also it is undesirable to stabilise transistor line output stages by the VDR method because the transistor should receive a base drive waveform with near vertical

edges to minimise power dissipation during switching. Because of this a pulse shaper stage is usually included between the line oscillator and line output stages. The only available means of stabilising the width against mains variation is by regulating the supply rail.

A typical circuit is shown in Fig. 45. The rectangular switching drive to the line output transistor is transformer coupled at low impedance to ensure fast switching. The transistor is held on for most of the line and current builds up linearly in the primary of the LOPT and therefore in the scan coils. Near the end of the line the transistor is switched off and a high voltage pulse (1000 V) appears at its collector, necessitating a specially designed transistor. As before, the LOPT inductance resonates with a tuning capacitor (connected in the primary this time) which first charges, then discharges back into the LOPT. As the resonant current backswings into

reverse the diode D conducts. It is interesting to note that D can be omitted (and sometimes is) because the base-collector junction of the line output transistor also forms a route by which current can flow from earth to the LOPT. There is no boost ht rail in Fig. 45 although auxiliary supplies can easily be obtained by tapping off flyback pulses from the LOPT, rectifying and smoothing them. In some receivers quite remote circuits are powered in this way, e.g. the IF strip, and this can lead to some misleading fault symptoms.

Width adjustment is by setting the ht regulator output. The regulator may be a conventional series type as shown in Fig. 45 or it may be the 'chopper' type where the incoming mains is rectified and passed to an integrating filter via a series switching transistor or SCR (thyristor) which is driven by pulses of controlled mark/space ratio.

HORIZONTAL SHIFT

Neither of the simplified line output circuits include a means for shifting the picture horizontally — which is often necessary after setting the purity magnets. Arrangements for this vary, but all basically involve breaking the dc continuity between the LOPT and the scan coils by inserting a capacitor at some point and setting a dc bleed current through the coils by means of a potentiometer. The source of current may be rectified flyback pulses or the cathode current of the line output valve. Often a two-position link is found which must be set according to whether shift to the right or left is required.

EHT

The shadowmask tube requires an extraordinarily high eht supply (25 kV) to its third anode and this is normally obtained by rectifying pulses from an extra many-turn overwinding on the LOPT. Early colour receivers used simple valve rectification as in Fig. 46a. Here the stepped up pulses are rectified by the GY501 diode whose heater is supplied by an isolated winding on the LOPT to avoid impossible demands on its heater-cathode insulation. The capacity between the inner and outer (earthed) conductive coatings on the tube makes a reservoir capacitor unnecessary.

The inherent output impedance of this simple supply is rather high and would allow the eht level to vary with changing beam current (picture brightness). This would upset the critical focus, purity and registration settings for the tube. Therefore a

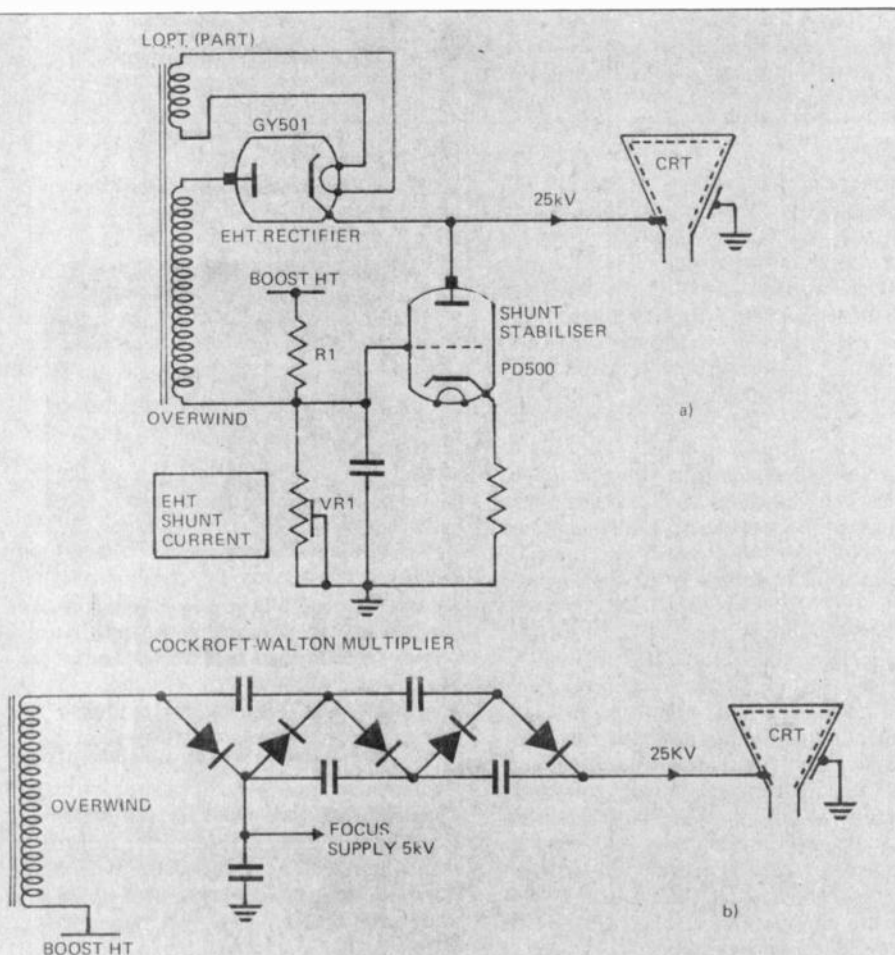

Fig. 46. Old (a) and new (b) methods of obtaining 25 kV third-anode supply from the line output stage.

shunt stabiliser employing a special high-voltage triode PD500 is used to reduce the output impedance. Its operation is simple:

With no beam current (black picture) the divider R1/VR1 is adjusted to bias the PD500 to draw a specified current (1.2 mA) from the eht line, checked by a voltmeter connected to its cathode resistor. After this, any beam current flowing in the overwind will drive the PD500 grid in a negative direction which reduces its cathode current and counteracts the voltage drop in eht.

While the performance of this circuit is hard to match it has the shortcomings of (1) needing a massively insulated overwinding, which can be a source of expensive burnouts, and (2) running two valves at such high voltage that they emit dangerous X-rays and *must* be shielded for safety. These disadvantages are overcome by using a voltage multiplier to provide eht from a relatively small overwind (typically 7 to 8.5 kV pulse output) as in Fig. 46b. Both tripler and quadrupler multipliers are used. The first multipliers using selenium stick rectifiers were sometimes unreliable (the bad-egg odour of a burnt-out selenium stick is once-smelt, never forgotten!) but silicon diode multipliers are more satisfactory. The

first stage of the multiplier is a convenient takeoff point for the tube focus (A2) supply which would otherwise be obtained from line pulses by a separate rectifier and reservoir capacitor.

FRILLS

This part has shown that the line output stage does much more than just drive the scan coils. For example it generates radio interference at short range, and magnetostriction of the LOPT core produces a whistle at line frequency (15 625 Hz) — deafness to which separates men from boys! The line output circuit of a commercial receiver always appears complex with a multiplicity of windings andappings on the LOPT. The reason is that line pulses are tapped off the LOPT and shaped if necessary for a variety of odd jobs throughout the receiver. These jobs include:

- driving the line flywheel discriminator,
 - operating gated a.g.c. in the IF strip,
 - blanking the luminance signal during line flyback
- and in the decoder department:
- gating the burst,
 - 'togglng' the PAL bistable,
 - and clamping the decoder outputs.

... to be continued

CCTV CLEARANCE SALE



Ideal for Hams, Experimenters or Security.

Concord CCTV camera with 5" inbuilt electronic viewfinder. Features... 500 line resolution, RF or video output (switchable), takes standard C mount lens, auto or manual light compensation, internal sync. generation, high level output signal. Retail \$650.00 limited stock to clear at \$425.00 inc. tax.

HI-FI HOUSE

118 Keira St., Wollongong,
N.S.W. 28-6661
127 Forest Rd., Hurstville, 579-4673

electronics TODAY

INTERNATIONAL Make sure of your

copy of ELECTRONICS TODAY INTERNATIONAL every month. Post coupon now to ensure regular home delivery of each feature packed issue. If you prefer not to cut up your copy of ETI, just send relevant details on plain paper.

For yourself

as a gift subscription

To Subscription Dept, Electronics Today International
15 Boundary St., Ruscutters Bay 2011.

I enclose cheque/postal order for \$

12 issues \$9.60 (surface mail rate for Australia)

12 issues \$10.20 (surface mail rate o'seas)
tick appropriate box

Name

Address

Postcode

Please start my subscription with issue.

To Subscription Dept, Electronics Today International
15 Boundary St., Ruscutters Bay 2011.

I wish to send Electronics Today as a gift subscription to:

Name

Address

Postcode

Electronics Today will advise your friend of his/her gift.

I enclose cheque/postal order for \$

12 issues \$9.60 (surface mail rate for Aust.)

12 issues \$10.20 (surface mail rate o'seas)
tick appropriate box

My Name and Address is:

Name

Address

Postcode

BUY STATE OF THE ART SOLID STATE COMPONENTS— Direct from the United States!

All listed prices are in Australian dollars. International Postal Money Orders (please send PO receipt with order for immediate shipment). Banque Chasiere check (preferably in US funds) and rated company cheques (with foreign exchange stamp approval affixed) will be accepted. Due to recent Australian government restrictions we are not able to clear personal checks... All goods are new unused surplus and are fully guaranteed. Orders will be shipped within two workdays of receipt of same. All customs forms will be attached. Minimum order amount is \$5.00. do not add postage - we pay postage. Surface mail for orders under \$10.00 and Air Mail for orders over this amount.

DATA SHEETS ARE PROVIDED FOR EACH ITEM PURCHASED

7400 SERIES TTL	DIP
7400	Quad 2-input NAND gate.....\$.20
7401	Quad 2-input NAND gate..... .20
7402	Quad 2-input NOR gate..... .22
7404	Hex inverter..... .22
7405	Hex inverter*..... .20
7406	Hex inverter buffer/driver*..... .35
7408	Quad 2-input AND gate..... .22
7410	Triple 3-input NAND gate..... .20
7420	Dual 4-input NAND gate..... .20
7430	8-Input NAND gate..... .20
7440	Dual 4-input NAND buffer..... .20
7442	BCD-to-decimal decoder..... .80
7447	BCD-to-7 segment decoder/driver. 1.00
7448	BCD-to-7 segment decoder/driver. .80
7450	Expandable dual 2-wide 2-input AND-OR-invert gate..... .20
7451	Expandable dual 2-wide 2-input AND-OR-invert gate..... .20
7472	J-K master-slave flip-flop..... .30
7473	Dual J-K master-slave flip-flop. .40
7474	Dual D-type edge-triggered flip-flop..... .40
7475	Quadruple bistable latch..... .75
7476	Dual J-K master-slave flip-flop with preset and clear..... .40
74L78	Dual J-K master-slave flip-flop. .40
7483	4-Bit binary full adder (look ahead carry)..... .80
7489	64-Bit read-write memory (RAM).. 3.00
7490	Decade counter..... .90
7492	Divide-by-12 counter (divide by 2 and divide by 6)..... .60
7495	4-Bit right-shift left-shift register..... .75
74193	Synchronous 4-bit binary up/down counter with preset inputs.... 1.00

*With open collector output

LINEARS	
NE540	70-Watt power driver amp.....\$1.00
NE555	Precision timer..... 1.00
NE560	Phase lock loop DIP..... 2.00
NE561	Phase lock loop DIP..... 2.00
NE565	Phase lock loop TO-5..... 2.00
NE566	Function generator TO-5..... 2.00
NE567	Tone decoder..... 2.50
NE5558	Dual 741 op amp MINI DIP..... .90
710	Voltage comparator DIP..... .60
723	Dual comparator DIP..... .25
723	Precision voltage regulator DIP. 1.00
741	Op amp TO-5/MINI DIP..... .55
747	Dual 741 op amp DIP..... 1.00
748	Op amp TO-5..... 1.00
CA3018	2 Isolated transistors and a Darlington-connected transistor pair .75
CA3045	5 NPN transistor array..... .75
CA3026	Dual differential amp..... .75
LM100	Positive DC regulator TO-5..... .50
LM105	Voltage regulator..... 1.00
LM302	Op amp voltage follower TO-5.... 1.25
LM311	Comparator DIP..... 1.00
LM370	AGC amplifier..... 1.00
LM703	RF-IF amp epoxy TO-5..... .25
LM1595	4-Quadrant multiplier..... 1.00
8093-8094	Tri-state quad buffer DIP.....\$1.00
8950-9601	One-shot multivibrator DIP.... 1.50
8811	Quad 2-input MOS interface gate 15V open collector DIP... .30

POTTER & BRUMFIELD



Type KHP Relay 4 PDT 3A Contacts

24 VDC (650 coil).....\$1.00 EA.
120 VAC (10.5 MA coil).....\$1.00 EA.

LSI CALCULATOR ON A CHIP

This 40-pin DIP device contains a complete 12-digit calculator. Adds, subtracts, multiplies, and divides. Outputs are multiplexed 7-segment MOS levels. Input is BCD MOS levels. External clock is required. Complete data is provided with chip (includes schematic for a complete calculator).
Complete with data \$7.00
Data only \$1.00



SLA-1 OPCOA

Pin compatible with MAN-1.
Large .334" character.
Mounts on .4" centers.
Left-hand decimal point.
\$2.00 Each; 10 For \$16.00



FAIRCHILD "TRIMPOTS"



Brand new 20 turn precision trimmers. These are prime parts, mostly individually packed in sealed envelopes.
Each Only 89¢
Ten for \$7.50
Please specify P or L (PCB or wire leads).
Order NOW, these won't last!

FOLLOWING VALUES IN STOCK:			
10 Ohm	1K	50K	
20 Ohm	2K	100K	
50 Ohm	5K	200K	
100 Ohm	10K	250K	
200 Ohm	20K	500K	
500 Ohm	25K	1 Meg	

COUNTER DISPLAY KIT—CD-2

This kit provides a highly sophisticated display section module for clocks, counter or other numerical display needs.
The RCA DR-2010 Numitron display tube supplied with this kit is an incandescent seven-segment display tube. The .6" high number can be read at a distance of thirty feet. RCA specs. provide a minimum life for this tube of 100,000 hours (about 11 years of normal use).
A 7490 decade counter IC is used to give typical count rates of up to thirty MHz. A 7475 is used to store the BCD information during the counting period to ensure a non-blinking display. Stored BCD data from the 7475 is decoded using a 7447 seven-segment decoder driver. The 7447 accomplishes blanking of leading edge zeroes, and has a lamp test input which causes all seven segments of the display tube to light.
Kit includes a two-sided (with plated through holes) fiberglass printed circuit board, three IC's, DR-2010 (with decimal point) display tube, and enough Molex socket pins for the IC's.
Circuit board is .8" wide and 4 3/8" long. A single 5-volt power source powers both the IC's and the display tube.
CD-2 Kit Complete Only \$10.95
Assembled and Tested \$13.00
Board Only \$2.50



RCA DR2010 NUMITRON



RCA DR2010 Numitron digital display tube. This incandescent five-volt seven-segment device provides a .6" high numeral which can be seen at a distance of 30 feet. The tube has a standard nine-pin base (solderable) and a left-hand decimal point. Each \$4.00
SPECIAL 4 for \$17.50

COUNTER DISPLAY KIT—CD-3

This kit is similar to the CD-2 except for the following:

- Does not include the 7475 quad latch storage feature.
- Board is the same width but is 1" shorter.
- Five additional passive components are provided, which permit the user to program the count to any number from two to ten. Two kits may be interconnected to count to any number 2-99, three kits 2-999, etc.
- Complete instructions are provided to pre-set the modulus for your application.

CD-3 Board Only \$2.25
IC's, 7490, 7447 \$2.75
RCA DR2010 tube \$5.00
Complete kit includes all of the above plus 5 programming parts, instructions, and Molex pins for IC's. Only \$9.25



LM309K: 5-VOLT REGULATOR



This TO-3 device is a complete regulator on a chip. The 309 is virtually blowout proof. It is designed to shut itself off with overload of current drain or over temperature operation. Input voltage (DC) can range from 10 to 30 volts, and the output will be five volts (tolerance is worse case TTL requirement) at current of up to one ampere.
Each \$1.50 5 for \$7.00

Babylon Electronics Inc.

Post Office Box J, Carmichael, California. 95 608 U.S.A.

ELECTRONICS

-it's easy!

PART 20

More about filters

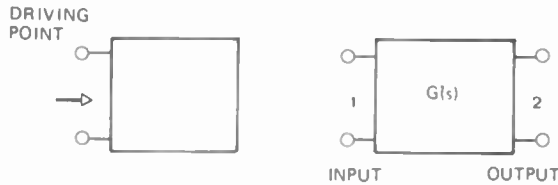

Fig. 1. Basic filter system block diagram.

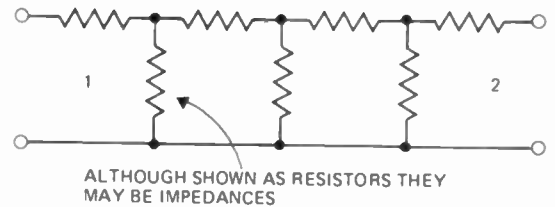

Fig. 2. Ladder network.

AS WE saw in the previous section resistor-capacitor filters can only provide roll-offs of 6 dB/octave (20 db/decade). On the other hand combinations of inductors and capacitors can provide much steeper rolls-offs and a response at the turn-over point which can be tailored to a desired shape.

The variety of LC component combinations that can be employed is great indeed and, to the uninitiated, the design of such filters can seem to be very confusing. However, circuit analysts have established design procedures which enable a filter having any practical characteristic to be designed in a logical, formalized manner. The method is based on the use of cascaded basic sections.

TWO-TERMINAL PAIR NETWORK CONCEPTS

As we have seen at various times in the course so far, filters can be circuits having just two terminals — a resonant circuit for example, or they can have two input and two output terminals — the so-called two-terminal pair networks. (The RC filter is of the two-terminal pair kind). The two different types are illustrated as system blocks in Fig. 1. Note that it is conventional to show input on the left and output on the right.

As said before many possible circuit configurations exist for filters, and the designer has to make a compromise between using a simple arrangement of many components that can be easily handled mathematically, or, a few components in a more complex network that cannot be treated by general formulae. Here we will examine the approach based on grouping numbers of simple and similar networks, to obtain the desired

response, by the methods originally proposed by Zobel in 1923.

The simplest type of network is the LADDER, as illustrated in Fig. 2, the defining feature being that it has a common line. When the lower line also includes impedances (resistor elements are used to represent what are usually reactances) the network is called a LATTICE; these are much harder to design and are less commonly used. Let us examine how a ladder network is broken down into even more basic structures.

By convention the series elements of a ladder are labelled Z_1 , and the shunt elements as Z_2 . These elements will be either capacitors or inductors and, it is assumed that the filter is driven from, and drives into, pure resistances.

Within the ladder arrangement, shown in Fig. 2, can be seen three basic building structures — called the L section (inverted L to be absolutely correct), the T section and the π section. The three are shown separated in Fig. 3.

In Fig. 4 we see how standard T or π sections can be connected to provide the same effective ladder network. Conversely a ladder network may be subdivided into standard T or π networks by breaking the values up as shown.

The interesting and quite vital point

is that the T or π stages have the same input and output impedance. That is they are *symmetrical*. The L section, however, is *unsymmetrical* in that input and output terminal pairs are not interchangeable. Two L sections in series will produce a T or a π section.

When two identical T or π sections are cascaded they are matched into the same impedance — maximum energy is transmitted and no reflections occur. Each terminal sees an image of itself, this property giving the name *image-parameter* design to this filter design method.

CONSTANT-K FILTERS

Even though a quite simple configuration has been used there can still be a wide range of combinations each with complicated mathematical solutions.

By introducing another assumption we can make some headway toward realising a wide range of characteristics with a reasonable degree of mathematical simplicity. This assumption is that $Z_1 \cdot Z_2 = R_0^2$ where R_0 is a true resistance called the characteristic resistance. (This may seem strange but the multiplication of capacitive reactance with inductive reactance yields just that). Hence Z_1 and Z_2 must be a combination of capacitor and inductor giving us

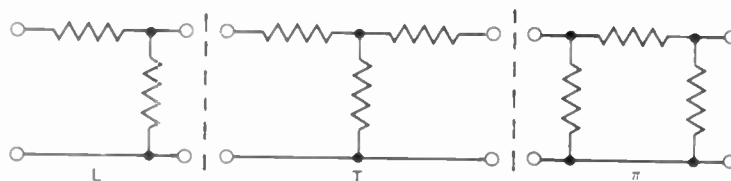

Fig. 3. The basic filter section.

ELECTRONICS -it's easy!

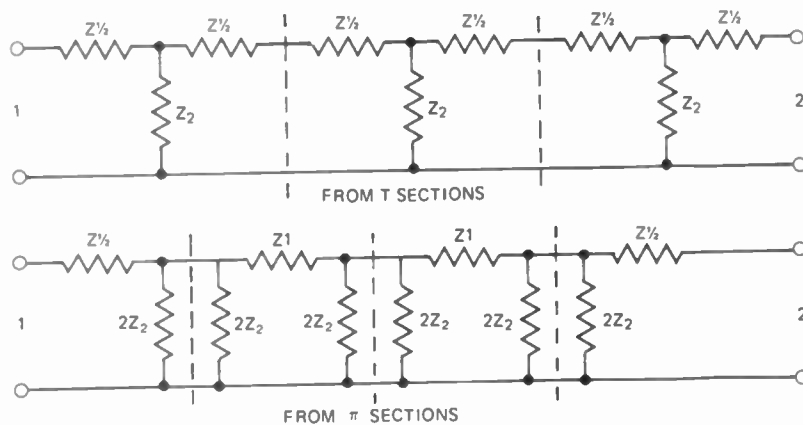

Fig. 4. Building up the ladder network from basic sections.

whichever gives a value greater than one.

The following example shows how a constant-K filter is designed to given response requirements.

The basic design formulae are:

$$L = \frac{R_0}{2\pi f_c} \quad C = \frac{1}{2\pi f_c R_0} \quad n = \frac{a \text{ dB}}{8.7 \alpha}$$

The values given at the start will be R_0 , f_c , α and a dB. We need to establish, in the synthesis situation, the values of L , C and n . The necessary configuration is established by logical deduction of the appropriate placement of components in the sections.

Example: Design a high-pass filter having a cut-off frequency of 10 MHz and a signal attenuation of 100 dB at 5 MHz. The characteristic resistance is to be 50 ohms in order to match the existing system into which the filter is to be fitted.

$$L = \frac{R_0}{2\pi f_c} = \frac{50}{2\pi \cdot 10 \cdot 10^6} = 0.769 \mu\text{H}$$

$$C = \frac{1}{2\pi f_c R_0} = \frac{1}{2\pi \cdot 10 \cdot 10^6 \cdot 50} = 318 \text{ pF}$$

To determine α

$$\frac{f_c}{f} = \frac{10 \cdot 10^6}{5 \cdot 10^6} = 2$$

From the chart $\alpha = 2.64$.

$$\text{Number of stages required, } n = \frac{a \text{ dB}}{8.7 \alpha}$$

$$= \frac{100}{8.7 \times 2.64} = 4.35$$

We cannot however have 0.35 of a stage and therefore must use five stages to obtain at least 100 dB attenuation at 5 MHz.

The formulae for L , C are for the basic section so we have halve values accordingly, giving us the circuit of Fig. 8. We could just as correctly divide the system into a π rather than a T configuration. Design of a low pass stage proceeds in just the same way.

equivalent stages with L and C proportions as shown in Fig. 5. The rule holds true for an L section provided we treat full shunt or series reactance as $2L$ or $2C$.

The name constant-K arose from the original terminology where Zobel, in 1923, used K instead of our now accepted R_0 . Filters designed to this rule are hence called *constant-K* filters.

Regardless of whether the stage is designed to be high pass or low pass — the cut off frequency will be the same, that is, at the resonance point of the LC values of the standard equivalent L section.

$$\text{That is cut-off frequency } \frac{1}{f_c} = \frac{1}{2\pi\sqrt{LC}}$$

For example in the π section of Fig. 6 the equivalent L section networks have L of 1 mH and a C of 0.5 microfarad.

That is cut-off frequency

$$f_c = \frac{1}{2\pi\sqrt{10^{-3} \times 0.5 \times 10^{-6}}} = 7.1 \text{ kHz}$$

$$\text{Also from } Z_1 \cdot Z_2 = R_0^2$$

$$\text{characteristic resistance } R_0 = \sqrt{Z_1 Z_2}$$

However the capacitive reactance must be written as a reciprocal and in Fig. 6 this is Z_2 . Hence:—

$$R_0 = \sqrt{\frac{Z_1}{Z_2}} = \sqrt{\frac{10^{-3}}{0.5 \times 10^{-6}}} = 45 \text{ ohms}$$

Thus we see that the source and load impedances used with this network must be 45 ohms, if maximum power is to be transferred, and the network is a low-pass stage having a cut-off

frequency of 7.1 kHz.

If L and C were reversed the filter would have identical R_0 and f_c but it would now be a high-pass stage.

An important feature of image-parameter design is that image-matched stages can be cascaded without altering the cut-off frequencies or the characteristic resistances. Each additional stage improves the roll-off, thereby giving a powerfully reliable way to obtain the desired rapidity of attenuation without having to re-design the whole system as extra stages are added.

It can be shown that the attenuation, a , in the stop band, expressed in decibels, is $a \text{ dB} = 9.7 n \alpha$ where n is the number of standard $-T$ (or standard $-\pi$) sections cascaded, and α is $2 \text{ Cosh}^{-1} f/f_c$. Cosh^{-1} means the cosh function (a hyperbolic trigonometric expression) whose ratio is f/f_c . As most readers will not be familiar with the coshine function Fig. 7 gives the relationship between values of α and frequency ratios normally encountered. Note that either f/f_c or f_c/f is used depending on

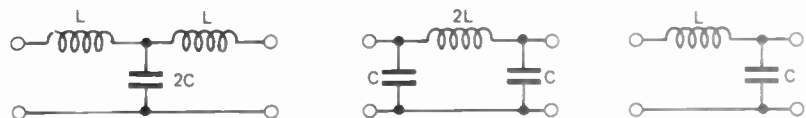

Fig. 5. Convention used in this explanation of LC filter design.



FIG. 6

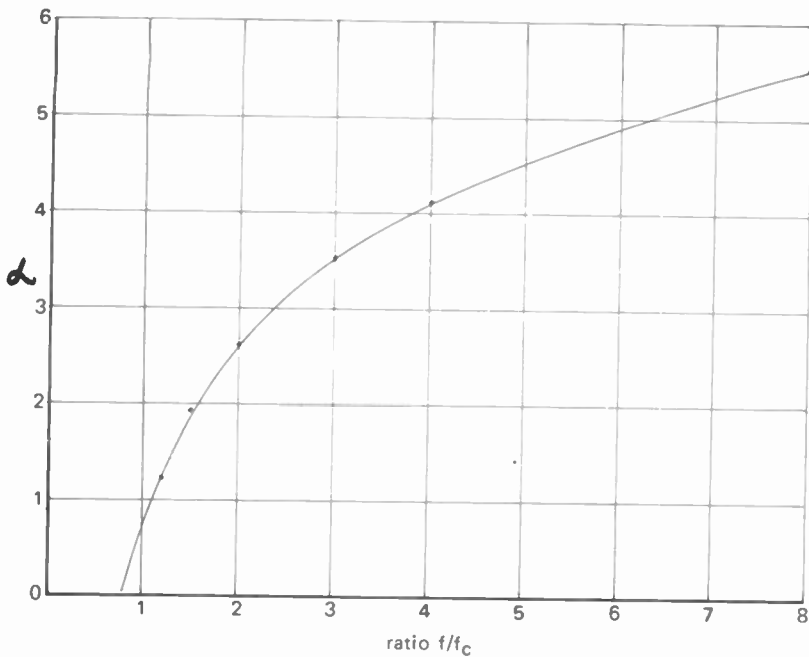

Fig. 7. Chart relating value of α and frequency ratio.

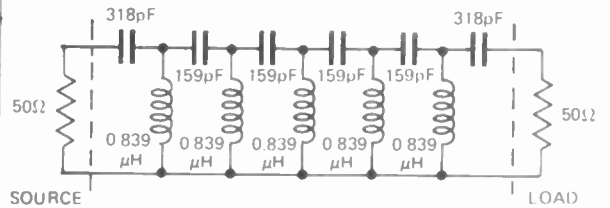

Fig. 8. 5 section, constant-K, high-pass filter with cut-off of 10 MHz.

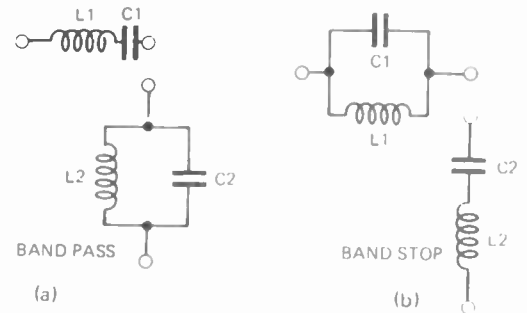

Fig. 9. Basic elements of band-pass constant-K filters.

The design of band-pass and band-stop stages is more complicated going beyond the scope of this course. Suffice to say that the components in the arms now become series or parallel resonant combinations. The basic L-section for a constant-K band-pass is shown in Fig. 9a and the basic L-section for a band-stop in Fig. 9b. Readers who wish to pursue these can obtain guidance from the reading list.

M-DERIVED SECTIONS

As can be expected the simplifying assumptions made in the constant-K design, to obtain a reasonably straight forward mathematical procedure, also create practical disadvantages. The first defect is that the image impedance does not remain constant and varies in such a way that noticeable reflections occur near the cut-off points. The second defect is that the roll-off is slow just near the cut-off point: it is adequate further away from that point.

Zobel's concept to overcome this involved additional cascaded stages that, in effect, flatten out the passband response and sharpen up the cut-off point attenuation. These extra stages are called M-derived sections: one is usually added on each end of the ladder designed by the constant-K method.

We can only give an example circuit to illustrate this — Fig. 10. Although the formulae for arriving at the values are simple they must be applied with great care, the user having adequate experience in order to know the

correct procedures. Again we must leave it to the reader to take this up in more specialized texts. The design of a full M-derived system requires extensive effort and training and is much more the task of a professional circuit designer than the reader for which this course is designed. The most extensive application of M-derived filters has been in communications engineering — telephones, telegraphy and multiplexed radio links. Voluminous books have been compiled that list tables giving values for chosen designs. Special computer programmes have also been developed to provide automatic constant-K and M-derived section filter designs.

ACTIVE FILTERS

The basic active RC building blocks

Passive filter designs had reached their present sophistication as much as 50 years ago and in the absence of anything markedly better they continued to be the most used design until the mid 1950's. Amplification was added to make up for the attenuation that usually is experienced

with passive designs.

With the introduction of reliable and less power-thirsty solid-state amplifiers in the late 1950's came the so-called active-RC filters. These combine an operational amplifier with passive RC components thereby producing filtering action more efficiently than the more obvious passive network followed by an active stage. One very valuable feature is that the effective value of, say, a capacitor can be multiplied up many times on its actual value thereby saving space and enabling designers to build circuits needing large effective values. It is also possible by active filter design to avoid the need for inductors in filter circuits. Inductors are best left out, if possible, for they are usually bulky, expensive and very lossy — they are nowhere as "ideal" as capacitors. They also are non-linear in operation and can be saturated by excessive current.

The basis of an active RC network is more often than not a reasonable quality operational amplifier set up to provide one of the following four basic circuit concepts.

1. The high gain (60 dB or more)

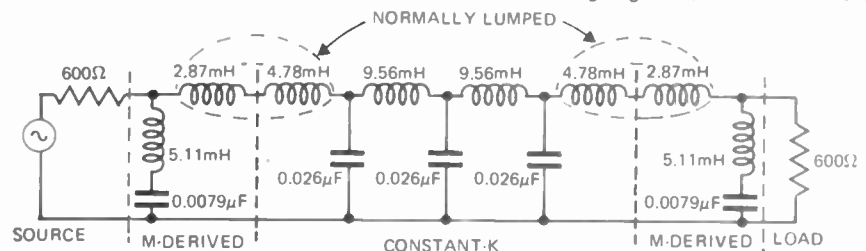

Fig. 10. Example of constant-K filter with M-derived end sections.

ELECTRONICS -it's easy!

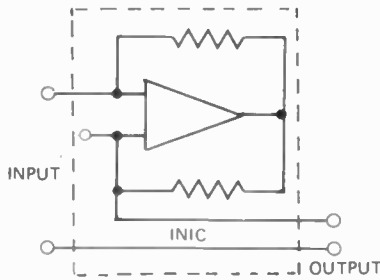

Fig. 11. Realising an INIC with an op-amp.

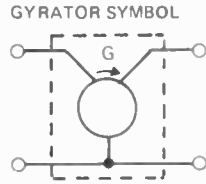

Fig. 12. The gyrator.

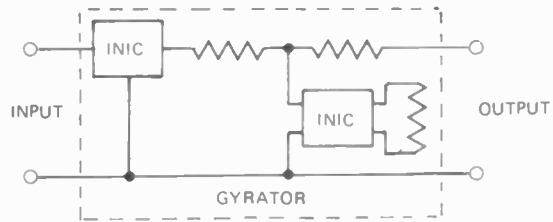

Fig. 13. Single-loop feedback active filter schematic.

voltage amplifier with close to infinite input impedance and almost zero output impedance – in short, the normal mode of an op-amp as we have discussed previously.

2. The low gain (20 dB or less) voltage amplifier, also referred to as a voltage-controlled voltage source or just VCVS.

3. The negative-emittance or negative impedance converter NIC. This is a most interesting system block for it enables positive value capacitance or resistance (that obtained with normal capacitors and resistors) connected at its input to appear as negative value capacitance or resistance at its output. It enables circuit designers to physically build circuits requiring non-physical negative capacitors and resistors. (INIC indicates an ideal current-inversion NIC, and VNIC indicates an ideal voltage – inversion NIC). A typical realisation is shown in Fig. 11.

4. The Gyrator. This is another intriguing unit for the output appears

as the reciprocal of any impedance connected to its input. Thus a capacitor at its input appears as an inductor at the output. The gyrator, therefore, eliminates the need to use physical inductors and what is more, can provide more "ideal" inductors than real units. It can be realised using op-amps as shown in Fig. 12.

With these four basic possibilities available the circuit designer is rarely restricted by having synthesised a circuit needing non-physical components.

CHOOSING AN ACTIVE FILTER DESIGN

Given the above four system blocks

it is possible to produce an incredible variety of active filters. As with advanced passive designs, few people have enough training to be expert active-filter designers. Here we can only give a guide that provides the necessary awareness of what to look for, along with words of caution as to what it is reasonable to expect from an actual active-filter design.

The voltage amplifier can be used in its simplest conceptual way with a *single-loop feedback path* (SFP) as shown in Fig. 13 – remember how we have already seen that an op-amp integrator acts as a low-pass filter and how a notch-rejection filter, introduced into the feedback path, produces a notch-acceptance response instead.

Alternatively, we can make use of *multiple feedback paths* (MFD) as depicted in a general sense in Fig. 14, the design using minimum component count. These, somewhat surprisingly, use fewer passive elements than single-loop circuits. For this reason this form of active filter is the configuration most often used.

The other options open to us are to use an op-amp set up as either a controlled source with added elements – see Fig. 15, or as the negative-impedance converter shown schematically in Fig. 11. These can offer certain advantages over the voltage-amplifier designs but suffer some disadvantages. NIC devices, for instance, do not give the ideal zero output impedance. Stages must be buffered to retain designed

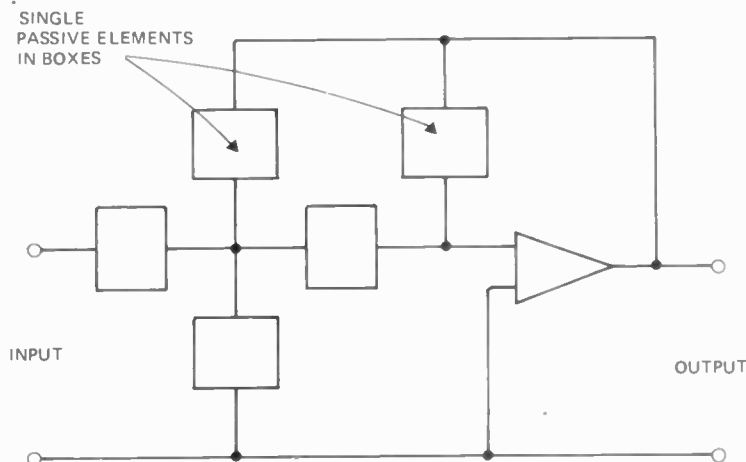

Fig. 14. The multiple-feedback-path active filter.

ADDITIONAL NETWORK TO FORM ACTIVE FILTER

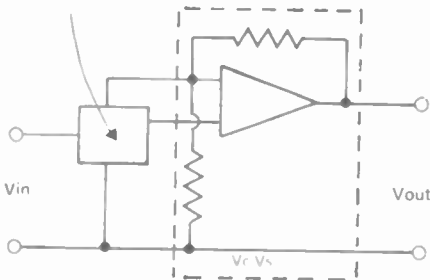

Fig. 15

performance, for example, when they are cascaded to obtain higher orders. On the good side is the small number of passive elements needed. Fig. 16 compares the four alternatives showing that no one type is exclusively the best choice.

At this stage we can only suggest that details of designs can be found in the many text books and application notes now available. Very few people would attempt (or even could) design an active filter from basic theory today. There are now available many well-prepared circuit design guides — we heartily recommend the Burr-Brown "Handbook of Operational Amplifier Active RC Networks". This contains twelve basic circuits, along with quite manageable design procedures for each, in which desired values are put in formulae to arrive at circuit values for low-pass, band-pass and high-pass requirements. Further guides are listed at the end of this section.

FILTER CHARACTERISTIC TERMINOLOGY

The ideal edge on a filter characteristic is usually a sharp

Property	Realization Technique			
	Infinite-Gain Single-Feedback	Infinite-Gain Multiple-Feedback	Controlled Source	Negative-Immittance Converter
Minimal number of network elements	-	+	+	+
Ease of adjustment of characteristics	-	0	0	+
Stability of characteristics	+	+	-	-
Low output impedance	+	+	+	-
Presence of summing input	+	-	-	-
Relatively high gain available	+	-	+	+
Low spread of element values	+	-	+	+
High-Q realizations possible	+	-	+	+

+ indicates the realization is superior for the indicated property
 0 indicates the realization is average for the indicated property
 - indicates the realization is inferior for the indicated property

Fig. 16. Comparison table for various kinds of active filter realisations (from Burr-Brown handbook).

"square" response with attenuation occurring instantly as the frequency passes through the corner point. It should also have a constant response level at all points in the pass-band regions. As well as the rudimentary RC filter characteristic which falls off at 20 dB/decade from a breakpoint, two

other kinds of response are commonly encountered. These are Butterworth and Chebyshev responses. Both derive their names from persons who developed the mathematics involved — (Butterworth designed filters around 1930, Chebyshev developed certain mathematical theory in his study of steam-engine linkages around 1850).

The Butterworth response is said to be maximally flat (that is as flat as possible) in the pass-band region. It has the optimum constancy possible with a given number of available peaking resonances (the complex passive or active filter circuits can be regarded as a group of staggered-tuned resonating sections, each arranged to peak just aside of the others, thereby, providing a broadened response band and a reject region). Fig. 17 shows the kind of Butterworth responses obtainable. Note that each passes through the 3 dB, down half power, point. The order (a mathematical term denoting the number of resonances available) of the filter is denoted 'n' in the chart. A typical roll-off rate is 20 n dB/decade so a fourth-order Butterworth response filter (which can

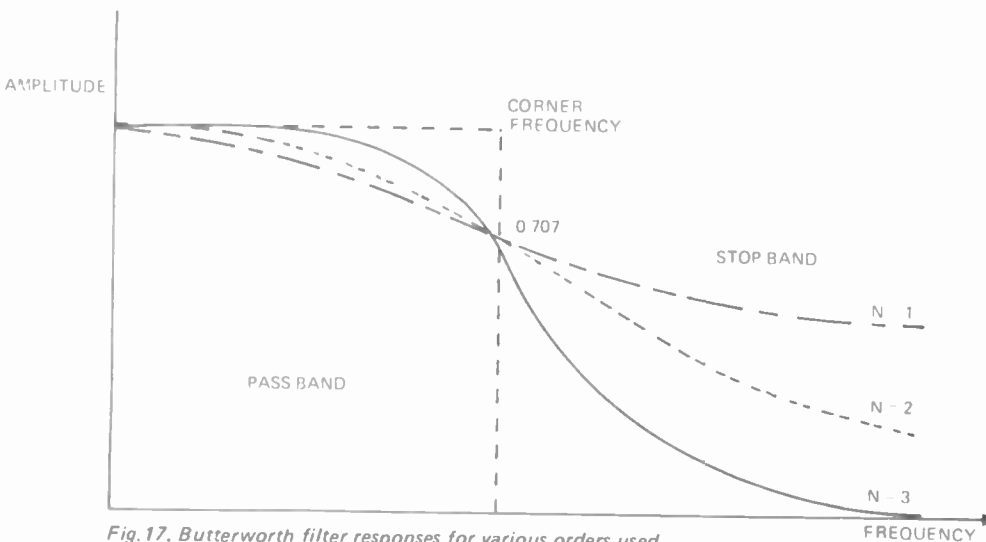

Fig. 17. Butterworth filter responses for various orders used.

ELECTRONICS -it's easy!

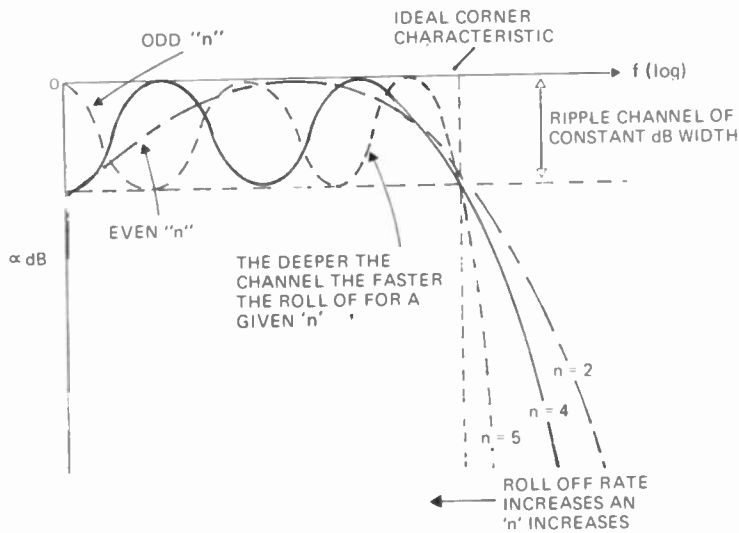

Fig. 18. Chebyshev filter responses for various orders.

be realised by either passive or active methods) will attenuate at around 80 dB/decade.

Whereas the pass-band response is reasonably constant, the rate of roll-off is not as good as can be obtained if the resonating sections are staggered differently. Other criteria of staggering the resonances can provide higher roll-off rates but only by introducing "ripples" in the pass-band response. When these individual ripples have equal amplitude across the pass-band response Chebyshev polynomials describe the shape, thus giving the name to an alternative response situation. As with Butterworth designs the higher the order the better the roll-off rate as can be seen diagrammatically in Fig. 18. The depth of ripple that can be tolerated also influences the roll-off rate — the smaller the variation that can be allowed the less the roll-off rate. (This can be readily seen by sketching in the required number of

ripples of given depth at the appropriate scale).

Normally Butterworth or Chebyshev response filters will be of order 1 to 4 but higher orders are possible. These two forms are not the only sophisticated filter responses available: other mathematical criteria could be used to set up workable mathematical equations for designing other networks. These two will, however, meet most demands required and all filter design, as we have seen, is dominated by need to compromise between what is needed and what can be handled mathematically.

PHASE SHIFT AND DELAY FILTERS

These act to provide a phase shift to a signal without selectively attenuating the frequency content. They are sometimes called all-pass filters. The amount of phase shift of practical circuits, however, usually varies with the frequency of the signal even

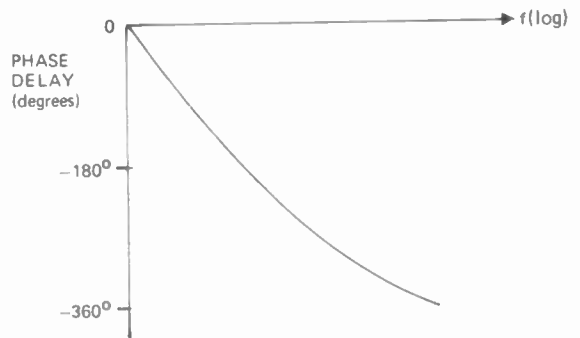

Fig. 19. Phase response of phase-linear all-pass filter.

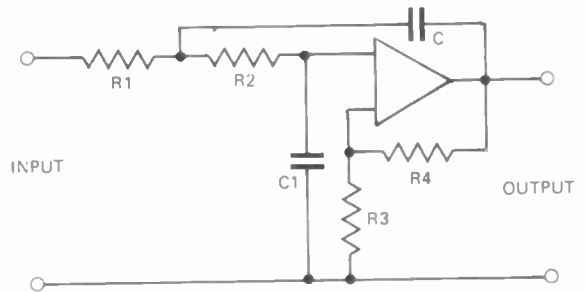

Fig. 20. General configuration of constant time-delay Bessel all-pass filter.

though the amplitude response is invariant. Constant time-delay or linear-phase filters have a reasonably straight (linear) phase response as shown in Fig. 19. The so-called Bessel filter approximates this response using a workable mathematical formulation. Fig. 20 gives the general configuration of such a method realised as an active filter design.

COMPONENTS TO USE

Resistors — In non critical applications the normal 20% tolerance carbon composition resistor may be acceptable. If tighter filter characteristics are needed then one must resort to more expensive resistors such as 5% or closer tolerance carbon composition. Even better, use metal-film or wirewound types. It is sometimes permissible to hand choose values from wide tolerance groups in order to produce specific values, but it must not be forgotten that wide tolerance resistors often lack the same

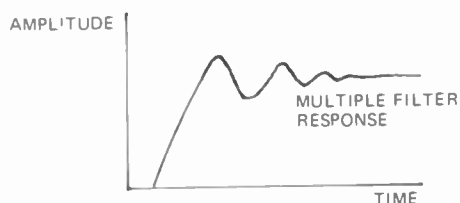

Fig. 21. Multi pole filters resonate with transient excitation.

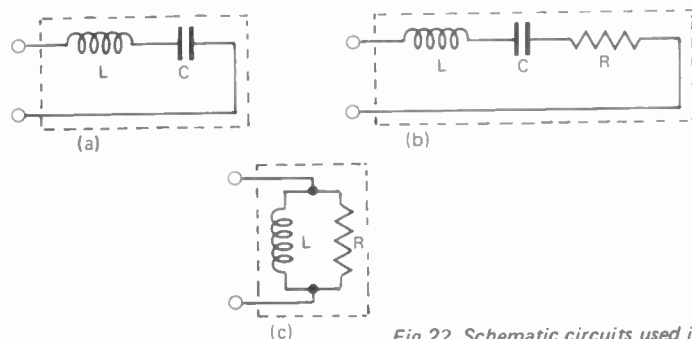

Fig. 22. Schematic circuits used in examples.

degree of time and temperature stability as the more expensive types.

Capacitors — Ceramic disk capacitors can be employed but they are best avoided. Nylon film, polystyrene and Teflon capacitors are much the better to use. When especially long-period filters are needed the capacitance value will be large. In such cases the leakage current due to losses in the dielectric is extremely critical and this rules out, in the majority of cases, using electrolytics.

Op-amp — It is easy to assume all op-amps will provide good active filters but this is not so. The main factor is a low offset current, this being especially important in long-period filters. As a general rule the more critical the need the better the op-amp should be. When op-amp filters also add gain they should have an open-loop gain at least 50 times the filter gain. Many active-filter design procedures enumerate the requirements of the op-amp.

RESPONSE TO TRANSIENTS

Filters of second order and higher invoke the characteristics of resonating circuits for their operation. In passive filters we can readily identify the inductance and capacitance; in active circuits these may not be so obvious, the mathematical expression showing that resonances do occur.

When a step change in signal is applied to a resonant circuit, the circuit 'rings', that is, the output rises rapidly but then oscillates with decreasing amplitude to the final value as indicated in Fig. 21. The extent to which a resonant circuit rings is decided by the damping provided — the higher the Q of the resonant configuration the greater the ringing effect.

It is not hard to see that higher order filters, therefore, will tend to ring more than the lower order designs when transient signals appear at their input terminals. Transients occur in practice as noise spikes, switching spikes, sudden signal appearance and departure.

THE S-PLANE, POLES AND ZEROS (For the advanced reader)

S-Notation

The above study of filters can only act as a guide to filter selection. From there one must turn to the many articles and books available for details. To make good use of such material it is necessary to have a basic understanding of the mathematical methods used. This section is given to assist the more advanced reader. It is possible to get by without this information, provided a suitable configuration and design procedure can be located. Therefore do not be

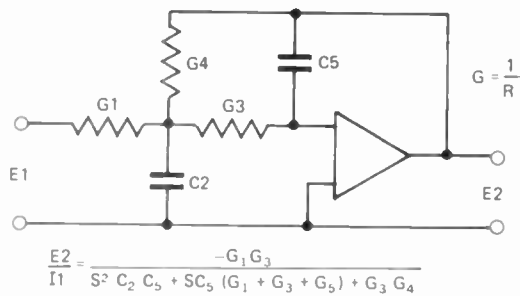

Fig. 23. Typical low-pass active filter with its transfer function in s-notation form.

$$\frac{E_2}{I_1} = \frac{-G_1 G_3}{S^2 C_2 C_5 + S C_5 (G_1 + G_3 + G_5) + G_3 G_4}$$

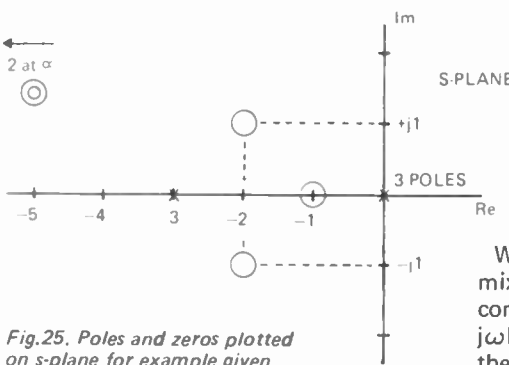

Fig. 25. Poles and zeros plotted on s-plane for example given in text.

concerned if you are unable to understand this section.

Scanning through even basic, well-organised books on filter (and feedback amplifier design) the terms transfer function, s-plane, poles, zeros and root-locus will be encountered. Sadly, most books omit to provide the background explaining what this is all about. The concepts are not difficult to grasp, any confusion arising almost certainly from the number of synonymous terms used and the fact that the concepts are, perhaps, quite alien to begin with.

We have seen how reactive elements (capacitance and inductance) have apparent resistances of $2\pi fL$ for inductance and $1/2\pi fC$ for capacitance. These terms, however, do not provide information about the phase changes produced with these reactance elements.

Electronic circuit designers use the operator symbol j (mathematicians use i) to denote a phase change of 90° hence, $j2\pi fL$ represents both the reactance value and the phase change. Furthermore $j = \sqrt{-1}$. For capacitive reactance the complete notation is $-j2\pi fC$, as the capacitor introduces a 90° phase shift of opposite sign to inductance. Resistance, having no phase shift, nor being frequency dependent is merely R . We can be a little more basic still and use ω instead of $2\pi f$, ω is the angular frequency being expressed in radians $\cdot \text{sec}^{-1}$. (There are 2π radians in one cycle).

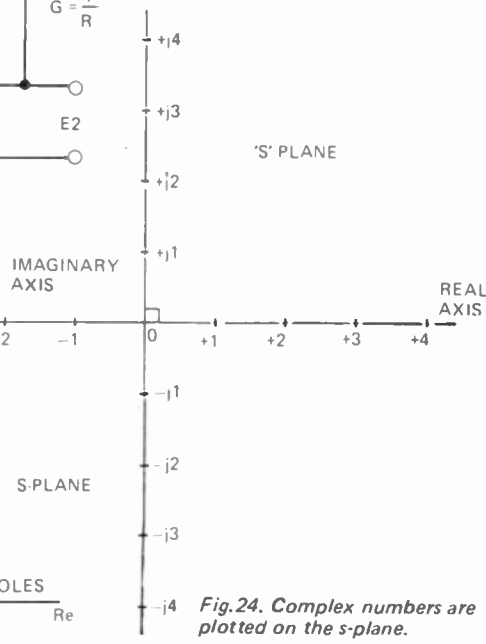

Fig. 24. Complex numbers are plotted on the s-plane.

When reactance and resistance are mixed we represent the value as a complex number as, for example, $R + j\omega L$. The left-hand part is known as the Real part, the other (that after j) the Imaginary part, the whole forming what is called a complex number.

Where the circuit element is only reactive the complex number representing the impedance reduces to $j\omega L$ or $-j\omega C$ for which the symbol 's' is used instead of $j\omega$. (In some books 'p' is used instead of 's'). A trap can occur here for the $-j$ of $-j\omega C$ indicates a 180° phase shift over j , not a negative quantity in the normal way. To avoid confusion we rewrite $-j\omega C$ as $1/j\omega C$ (which is valid — it comes from multiplying both numerator and denominator $-j\omega C$ by j). Hence we obtain sL and $1/sC$ as the shorthand way of writing inductive and capacitive reactance in which frequency dependency and phase information are both retained.

Once these terms and concepts are mastered it becomes much more straightforward to write down the transfer function for a frequency dependent network. For example, consider finding the impedance presented by a series, lossless, resonant circuit shown in Fig. 22a.

$$Z = sL + 1/sC = \frac{L(s^2 + 1/LC)}{s}$$

(The individual components of the expression are put on a common denominator, dividing out to get the s^2 terms with unity coefficients).

For the series resonant lossy circuit of Fig. 23b.

$$Z = sL + 1/sC + R = \frac{s^2 + R/L \cdot s + 1/LC}{s \cdot 1/L}$$

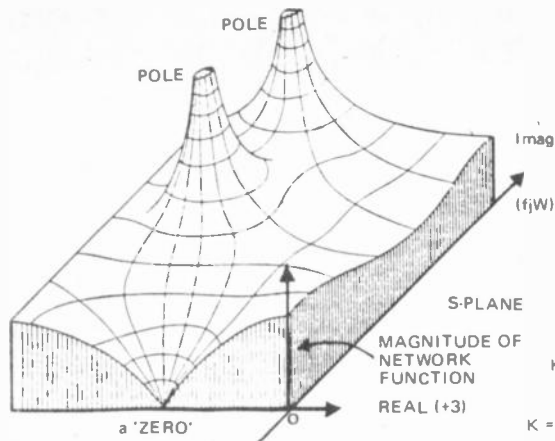

Fig. 26. Topographical representation of poles and zeros in s-plane.

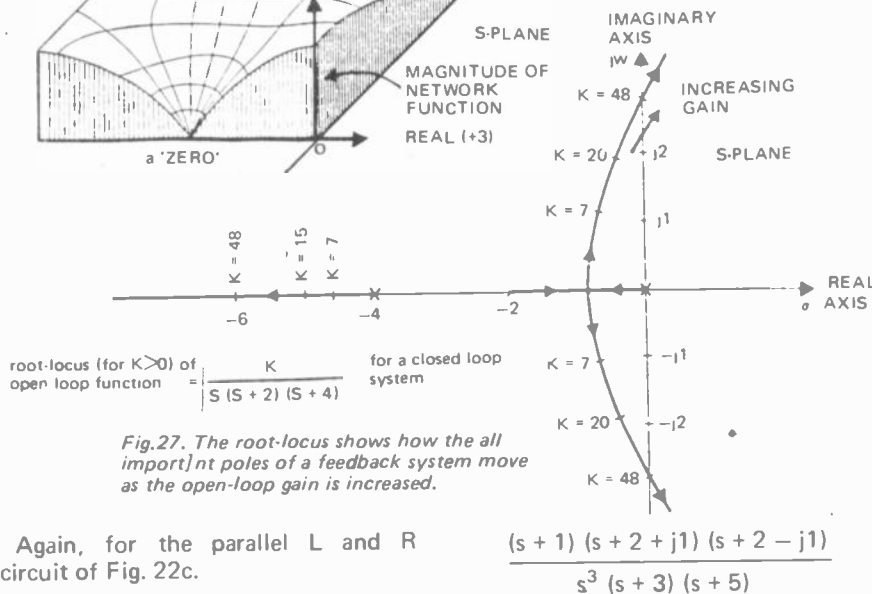

Fig. 27. The root-locus shows how the all important poles of a feedback system move as the open-loop gain is increased.

Again, for the parallel L and R circuit of Fig. 22c.

$$1/Z = 1/sL + 1/R \text{ from which } Z = \frac{R \cdot s}{(s + R/L)}$$

It is these forms of expression that are quoted in circuit design books. The form of expression is not restricted to two terminal networks — it applies for all frequency dependent reactive networks. Fig. 23 gives the circuit of a low-pass multiple feedback active filter along with its derived transfer function expressed in 's' notation form.

As these complex numbers possess two parts we must use a two-axis graph to represent them in which the two axes are mutually perpendicular. Thus complex-number quantities need a plane rather than a line to depict a unique number. This plane is known as the s-plane (see Fig. 24). The two axes are usually labelled Re, R or σ for the Real axis and Im, I or $j\omega$ for the Imaginary axis, each pair being used respectively.

POLES AND ZEROS

We have seen above how a network of passive elements (active designs also apply) produces a mathematical expression in terms of s notation. As s merely represents $j\omega$ and j denotes only phase information we can, whenever s appears, substitute ω (or $2\pi f$) to see how the expression varies in magnitude with varying frequency.

Consider the case where a function is given by the numerical example:

When $s = -1, -2 - j1$ or $-2 + j1$, the numerator becomes zero for one of the bracketed terms becomes zero. Hence at each of these frequency values the expression becomes zero. We say it has 'zeros' at these points. Zeros also exist when the singular s term goes to infinity in the denominator. When $s = 0$ (three times, as it is from $s^3 = s \cdot s \cdot s$), -3 or -5 , we get the reverse situation for at all of these values of ω the denominator goes to zero making the function rise to infinity. These frequency points are called 'poles'.

Thus the poles and zeros express the peaks and hollows of the function. The position of these can be plotted on the s-plane diagram as shown in Fig. 25. 0 is used for zeros, a cross X for poles. In realisable networks there must be as many poles as zeros — including those at zero and infinity.

Another way to imagine the network characteristic is to draw a topographical representation giving relative height to poles and zeros on the s-plane placed horizontally as shown by the example of Fig. 26. This makes the terms poles and zeros more meaningful in a physical sense.

In the numerical example we avoided, in that case, using a quadratic or higher order term such as $s^2 + 4s + 5$. When these are encountered they must be factorized by finding the

roots of the expression — giving the two terms $s + (2 + j1)$ and $s + (2 - j1)$ in this case. These are the individual roots, i.e., poles and zeros, of the expression. Note that quadratic elements involving an Imaginary part form mirror image pole or zero pairs — called a conjugate pair. If these are lossless (no Real part) they lie on the imaginary axis, if lossy (with Real part) they will be displaced out into the s-plane depending upon the resistive value. Positive values of resistance result in displacement into the left-hand plane, negative resistance gives poles or zeros in the right-hand plane, these halves being denoted LHP and RHP respectively.

Mathematics of complex numbers show that resonant systems with roots lying in the LHP are stable systems, their oscillations die down because to be in the LHP they must contain resistive damping. If the roots lie on the Imaginary axis itself the system is marginally stable — transients will undoubtedly create unstable situations at times even though the system is not absolutely unstable. Note that this situation only arises if the resistive component occurs as negative resistance — oscillators create this condition by the use of an active element.

ROOT LOCUS

When considering the behaviour of feedback systems, such as amplifiers, controllers and active filters, it is highly valuable to plot the changes in position on the s-plane of the closed-loop poles of the system transfer function as the open-loop gain changes. The path traced by the movement of the poles in this way is called the root-locus. These are often referred to in amplifier and other feedback-mechanism designs and it is, therefore, helpful to at least appreciate what they are. It is, however, not a simple matter to produce them from an original expression; lots of experience is vital.

By way of example the root-locus for a relatively simple transfer function is given in Fig. 26. This tells us that an open-loop gain in excess of 48 places some of its poles in the RHP establishing an unstable situation. The value of the root-locus is that we can "see" the behaviour of the system as the gain is increased and, more importantly, what we should do to the position of the poles most influencing an unstable situation. By altering the transfer function we can place the locus in more favourable situations. This is done by altering original component values where possible or by adding other networks that reduce the effect of the dominant poles — those lying close to the RHP.

MEASUREMENT & COMPUTATION: WORKING FOR YOU — YOUR WAY

LET HP SHOW YOU THEIR BRIGHT LIGHTS.

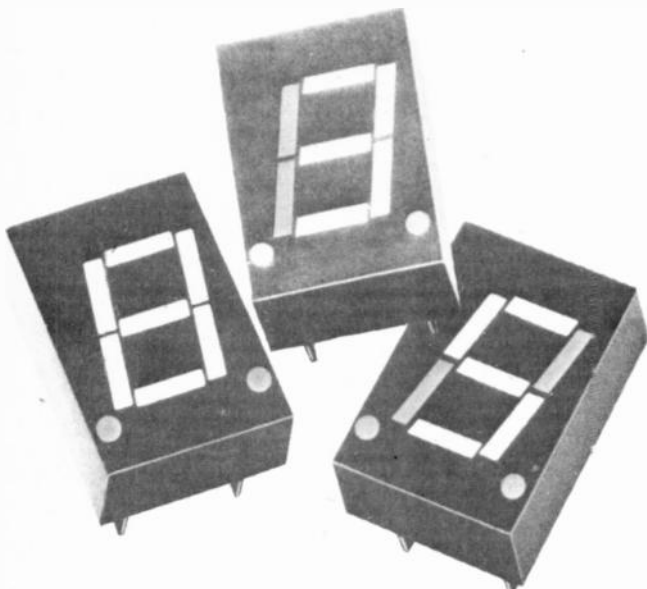

Large seven-segment
numeric displays in three colours—
red, yellow and green.

Now HP have numeric displays that are bright enough even for outdoor viewing. No more squinting. No more mistakes. In fact their high brightness makes them ideal in high ambient light conditions such as point of sale displays and in avionics. Also, at lower brightness, they can be operated at only 3mA current, so they're excellent for battery-powered portable instruments. HP model 5082-7650-7660 and 7670 are yellow and green common anode, seven segment displays with left hand decimal point. Common cathode versions are also available.

Make sure you see HP's new numeric display at the following distributor:—

AMPHENOL-TYREE

1100 Toorak Road,
HARTWELL, VIC.
Phone 29-2338

17 Botany Street,
WATERLOO,
N.S.W. 2017
Phone 69-5264

HEWLETT  PACKARD

Sales and service from 172 offices in 65 countries.
Australia, 31 41 Joseph Street, Blackburn, 3130 Victoria Telephone
89 6351 Other Offices Adelaide, Brisbane, Canberra, Perth and
Sydney Also Auckland and Wellington, New Zealand

90564

TANNOY

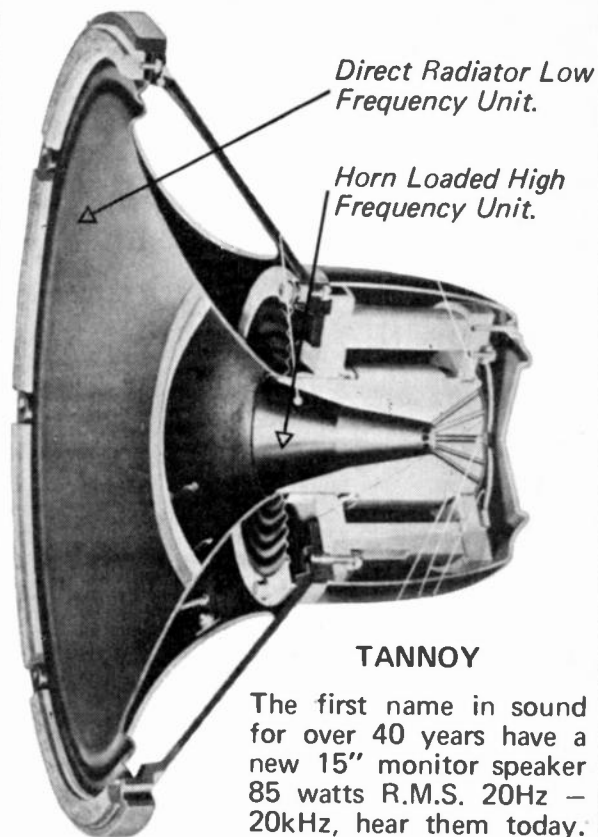

TANNOY

The first name in sound for over 40 years have a new 15" monitor speaker 85 watts R.M.S. 20Hz — 20kHz, hear them today.

THE LOUDSPEAKER BY WHICH OTHERS ARE JUDGED

PHILIPS

DUTCH
PHILIPS
COMPONENT
SPEAKERS

- See and hear the whole 15 systems in the range
- 40 watts R.M.S. handling
- buy in kit form or made up in quality enclosures
- we are experts in giving helpful advice
- expert repairs to all Hi-Fi gear

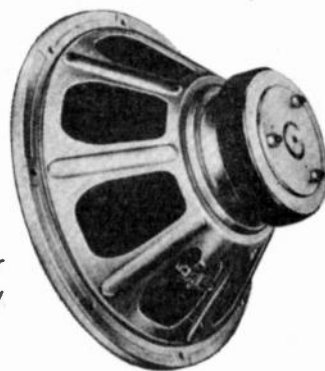

G.H.E.
GEORGE HAWTHORN ELECTRONICS

HIGH FIDELITY
SOUND EQUIPMENT
— ELECTRONIC &
C O M P O N E N T
S E R V I C E

966-968 High Street, Armadale, 3143
Phone: 509-0374, 509-9725

electronics

-it's easy

Volume 1

-FROM
ELECTRONICS TODAY
INTERNATIONAL

ON SALE NOW!

at ALL LEADING NEWSAGENTS

Published by Modern Magazines (Holdings) Ltd.,
The Publishers of Electronics Today International.

Take the mystery
out of electronics with
this straightforward
logical course

\$3.00*

B&W

the royal family
of sound

What makes B & W speakers different from every other speaker? It is the visual assurance that not only do they sound good, but they are, in fact, without unexpected peaks and valleys. Each B & W is checked in the factory on a special anechoic test section so that the handling performance of your speaker is plotted by B & K instruments from lowest to highest frequency. See the response of your speaker before you buy.

*recommended retail price



The best value DM2 A Monitor Acoustic Line

For those who would like the crisp realism of the DM70 but in a smaller package, there is the DM2 Monitor, also less expensive. It is worth your while to make the comparison between the superb DM70 and the DM2 Monitor with its third order Butterworth cross-over network and 8th wave acoustic wave line system in an internal folded tapered pipe. Three speakers with superb straight line frequency response across the whole spectrum. In teak, white and walnut. **\$475 per pair***

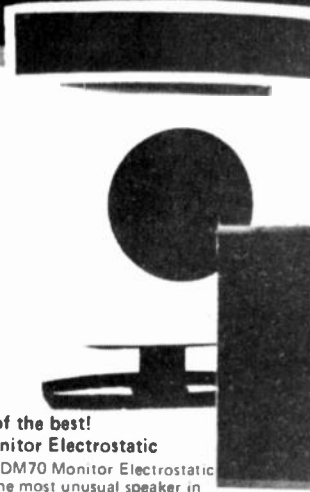

The best of the best! DM70 Monitor Electrostatic

The B & W DM70 Monitor Electrostatic speaker is the most unusual speaker in the world. It combines a bass pump with a 30.5 cm piston with a free air resonance of 18 to 22 Hz. in a baffle type chamber which produces high power, low frequency wave forms with exact fidelity below 400 Hz. On top is a free standing electrostatic semi-circular array of 9 speaker units that have no moving parts. From 400 cycles up to well beyond human hearing levels, these exclusive B & W units reproduce sound just as it is at the microphone. You must hear these speakers to credit their faithful reproduction. In white and walnut **\$1100 per pair***

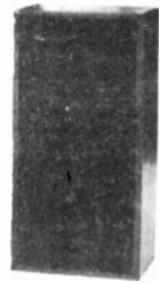

B & W D5 Sound Value

A small speaker but a wonderful performance and at an extraordinarily keen price for those who want B & W quality on a budget. This speaker is a remarkable investment in quality sound. Only a little above the budget priced speaker but its fidelity and real timbre has to be heard. Walnut. **\$199***

The mighty atom DM4 Monitor

So small in size, but enormous in sound reproduction from high to low frequency. This is the speaker that has just astounded critics all over the world. They said this type of sound could not come from a speaker just over one cubic foot. Walnut. **\$366 per pair***

B & W DISTRIBUTORS — VICTORIA: buy — rite Electronics, Geo. Hawthorne, Southern Sound, Toms Hi Fi, Tivoli Hi Fi. SYDNEY: Technocentre, Insound, Arrow, U.R.D., Milversons — Chatswood & Parramatta. SOUTH AUSTRALIA: Sound Spectrum. A.C.T.: Duratone.

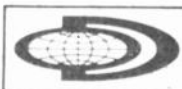

DRAKE

4

LINE - Superior performance

COMMUNICATIONS EQUIPMENT AVAILABLE FROM STOCK OR SHORT DELIVERY:

R-4C	Receiver with crystals for ham bands plus provision for 15 additional crystals	\$638.00	RV-4C	Remote VFO for TR-4C	\$112.00
T-4XC	Transmitter with crystals for ham bands. Transceivers with R-4C	\$609.00	MN-2000	Matching network/Wattmeter/S.W.R. Meter Antenna switch	\$210.00
TR-4C	Transceiver with crystals for ham bands (photostat of licence required for duty free entry)	\$630.00	W-4	Wattmeter/S.W.R. Meter 1.8 — 54MHz	\$65.00
AC-4	Power Supply 240 volts AC Input for T-4XC or TR-4C	\$148.50	WV-4	Wattmeter/S.W.R. Meter 20 — 200MHz	\$78.00
MS-4	Speaker (houses AC-4)	\$37.00	TV-42-LP	Low Pass Filter to 30MHz 100 watts	\$11.50
DC-4	Power Supply 12 volts DC input for TR-4c	\$167.00	TV-1000	Low Pass Filter to 30MHz 1000 watts	\$22.50
			SPR-4	Solid State Communications Receiver	\$674.00

Nippan model FC3A Frequency Counter 15 Hz to 250 MHz — **\$247.25**

Fluke model 8000A digital Multimeter — **\$299.00**

ELMEASCO

Instruments Pty. Ltd.

P.O. Box 334, Brookvale, N.S.W. 2100 — **939-7944**

Melbourne: 233-4044; Adelaide: 264-3296

Brisbane: 36-5061; Perth 25-3130,

Wellington N.Z. 69-7566.

SYNTHESISED SIGNAL GENERATOR CAPABILITY FOR 1 - 2600 MHz

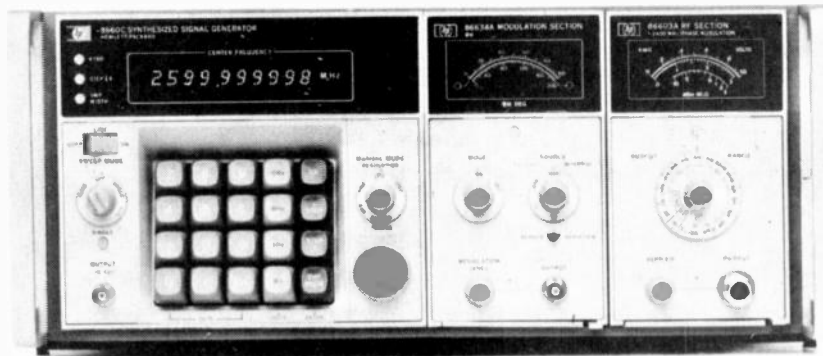

A new synthesised signal generator, Model 8660C from Hewlett-Packard, spans the range 1 MHz to 2600 MHz in steps as small as 2 Hz. Two new modulation plug-ins now offer calibrated phase modulation. Added range (earlier models reached 1300 MHz only) and phase modulation (earlier models had AM/FM only) provide the precision signals needed to test satellite and space telemetry and communication links. The instrument's broad range, stability, and 2 Hz resolution also suit it for consideration as a local oscillator in certain frequency-agile transmission systems.

The HP 8660C Frequency Synthesiser is a new mainframe with several new plug-in modules. A new RF Section (86603A) generates output from 1 MHz to 2600 MHz at levels from +7 dBm to -136 dBm. A 20-key keyboard provides digital entry of centre frequencies, steps, or sweeps. Settings are entered with a resolution of 2 Hz.

The synthesiser's digital sweep mode is particularly useful in testing extremely stable or sharply tuned components, such as crystal filters. In sweep operation, the generator steps digitally, in preset increments, across a preset band in a simulated sweep which is highly linear. Sweeps up to the full 2600 MHz band may be set.

An internal crystal standard determines accuracy and stability. Aging rate is 3×10^{-8} per day. 3×10^{-9} per day is optional. The 8660C uses an indirect synthesis technique, so watching times are typically 6 ms (to settle within 100 Hz).

Model 86634A is a phase modulation plug-in which provides calibrated, linear phase modulation at rates to 10 MHz. (Accompanying RF Sections must be equipped with Phase-Modulation Option 002). An internal source modulates at 400 Hz to 1 MHz to peak deviations of 0-100 degrees, or 0-200 degrees for RF frequencies above 1300 MHz. External phase modulation is possible at rates from dc to 10 MHz for carrier frequencies above 100 MHz.

Since modulation input voltage requirements are approximately 1 V, it is conveniently possible to modulate with

external fast pulse or word generators to obtain bi-phase modulation. This is a form of phase-shift-keyed (PSK) modulation popular in certain communications systems.

Another new modulation plug-in (Model 86635A) provides the same phase modulation abilities plus frequency modulation. External modulation rates are from dc to 1 MHz (at low deviations) with FM deviations up to 200 kHz peak (400 kHz above 1300 MHz).

The 1300 - 2600 MHz extended range is achieved in the 86603A Plug-in with an internal doubler. Fundamental frequencies from 650 MHz to 1300 MHz are applied to the doubler, followed by a tracking filter, broadband amplifier, and levelling circuitry. Switching to fully automatic and the logic determines band-switch points.

All operation is internally contained including levelling and filtering. Frequency inputs are keyed in directly even in the doubled band since the digital logic compensates for doubling. Modulation deviations are likewise direct-reading in the doubled band.

In the RF section, output frequency is the result of mixing two signals. An RF circulator in one signal path has two voltage-variable-capacitance diodes terminating two of the side arms. Phase modulation is achieved by biasing the diodes at different values, changing the phase of the branch arm reflected signals and thereby the phase of the output signal from the circulator.

A special conditioner/driver provides compensation and shaping for the modulation signals. Since phase modulation is already performed on the 3.95 - 4.05 GHz signal branch, good stability and accuracy of calibration are assured.

The new Model 8660V, like the earlier 8660A, may be equipped with a programmable interface (Option 005) to the recently announced Hewlett-Packard Interface Bus. Thus the generators may readily be connected as programmed signal source for a variety of user-assembled mini-systems for lab and production uses.

Hewlett-Packard Australia Pty Ltd, 31-41 Joseph St., Blackburn, Vic 3130.

TV DISTRIBUTION EQUIPMENT

Tecnico Electronics announce that the complete line of Labgear TV Distribution Amplifiers and accessories will shortly be available in Australia.

A major feature of the range is that all units cover the existing VHF TV channels as well as the proposed UHF channels and FM radio. The range includes models for single and multiple installations. There are also professional high grade amplifiers with up to 40 dB gain for MATV/CATV applications.

Mr S. Kharbanda, Managing Director of Labgear Ltd, of Cambridge said on his recent visit to Australia, "It appears that colour TV is already putting more emphasis on the quality of local aerial distribution systems. Labgear have specialised in this field for over thirty years and we are already exporting to countries with some of the toughest field conditions in the world. We expect our TV distribution equipment to be as successful in Australia as our colour bar and pattern generators."

Tecnico Electronics, Premier St, Marrickville, 2204, NSW

DISC MEMORY AND CONTROLLER FOR PDP-11

The Librascope Division of The Singer Company has released a controller and memory package compatible with the DEC PDP-11.

The chassis, a rack 480 mm (19") wide by 400 mm high by 6600mm deep, contains the one megaword capacity model L107SB hermetically sealed, fast access rotating disc memory, the controller electronics, motor controller, line filter and power supplies. Designed for rugged industrial environments, the unit is equally useful in applications aboard ships, aircraft and rough terrain transport vehicles. The disc controller allows the PDP-11 to access two L107 disc memories.

Software compatible to DOS-4A; DOS-8.02, DOS-9 and RSTS-4A, the controller and disc unit is delivered ready to install and operate.

British Merchandising Pty Ltd, GPO Box 3456, Sydney NSW 2001.

TM 500 POWER SUPPLY

Tektronix, have introduced the PS 503A Triple Power Supply, with plus and minus 0-to-20 Vdc constant-voltage, current-voltage, current-limited, floating power supplies with a common terminal and an auxiliary +5V-at-1A supply. The instrument is the 30th in the growing family of Tektronix TM 500 Modular Test and Measurement Instruments.

The power supply provides a floating 0-to-±20 Vdc at 1 A when used in the high-current compartment of the new four-hole Tektronix TM 504 power mainframe. Operated in the standard compartments of the Tektronix TM 501,

TM 503, or TM 504 power mainframes, the PS 503A supplies a floating 0-to-±20 Vdc at 400 mA.

The PS 503A was designed to power complementary and linear-integrated circuits, such as operational and differential amplifiers and differential comparators. The PS 503A's ground-referenced, +5 V-at-1 A auxiliary supply is ideal for use in testing DTL and TTL bipolar devices, light-emitting diodes (LED's), incandescent displays and in similar applications. The module's floating supply can power discrete interface circuits as well as level-shifting for many digital and analogue applications.

The plus and minus outputs of the instrument's floating power supplies are either independently variable or both dependently variable in dual-tracking mode, adjusted by a common control. In the dual-tracking mode, the plus and minus output voltages need not be equal. They can first be independently set to any arbitrary ratio and will then track at that ratio when dual-tracking. With connections across the + and - terminals, the module can also provide 0-to-40 Vdc. Either terminal can be grounded or floated to 350 V (dc and peak ac). Outputs are remotely programmable on either an external resistance or external voltage basis.

The drift stability of the supply is 0.1% ± 5 mV or less in eight hours at constant line, load, and temperature. Ripple and noise is held to within 0.5 mV or less peak-to-peak with a 400 mA load in standard current compartments of the TM 501, TM 503, or TM 504 power mainframes; in the high-current compartment of the TM 504, it is 3 mV peak-to-peak or less with a 1 A load. Overload protection, automatic current limiting, and over-temperature shutdown are features built into this power supply.

The PS 503A brings to 30 the number of instruments available in the TM 500 line of test and measurement instruments. TM 500 includes, electronic counters, and other single and dual power supplies, plus three power mainframes, which hold one, three or four of the modular instruments.

Tektronix Australia Pty Ltd, 80 Waterloo Rd., North Ryde, NSW 2113.

PRECISION VOLTAGE/CURRENT SOURCE

As part of the expanding line of HT Series (High Technology) instrumentation, DigiTec introduces the Model 3110 Precision Voltage/Current Source. This unit has been designed to function as either a constant voltage or constant current source.

Conventional dial settings have been replaced by solid state readouts. The Model 3110 utilizes five large, easy-to-read, amber Monsanto MAN 82 LEDs. This display is claimed to provide, trouble-free operation and offers the user the convenience of precision output settings. Light-emitting

HITACHI TAPES

Mail Order Specials

	Each	12 of	36 of
C 90	2.95	1.85ea.	1.75ea.
C120	3.65	2.25 "	2.10 "
VDC60	2.95	1.75 "	1.60 "
VDC90	3.95	2.35 "	2.20 "
VDC120	4.95	2.70 "	2.50 "

BASF chrome C90
10 for \$33 30 for \$90

Postage
NSW 70c plus 10c per 10 or doz.
Other states \$1.05 plus 15c per 10 or doz.

Logan Brae Audio Sales

P.O. Box 24, Carlton, 2218. NSW
Telephone: 587-3475



EMONA

Still gives the best value in Electronic calculators

"SCIENTIFIC",
ELCON SC-40
Now at \$95.95

(Including charger)



"SLIDE RULE", ELCON
KP-200 at \$52 (including
charger).

"MICRO ALGEBRA",
ELCON E413 at \$25.

"SUPER MEMORY", ELCON KP-300 at
\$40. (Incl. charger)

"METRIC CONVERTER", ELCON
KP-60 at \$40 (Incl. charger)

OTHER MODELS AVAILABLE
SHORTLY

To above prices add 15% sales tax if
applicable.

All models are guaranteed for a period of
one year. Serviced locally.

MAIL ORDERS: P&P by reg. air mail to
all states - \$3.50, except NSW - \$2.50.

NEW

EMONA E-2, ALL ELECTRONIC
AM/FM DIGITAL CLOCK RADIO



This 24-hour Digital Clock Radio is
completely electronic - no moving parts
- 100% solid state. You can listen to FM
or AM, wake up to music or alarm, or
preset the radio program. It can be used
as an accurate stopwatch. And there is
even an indicator that blinks whenever
there has been an AC power interruption.

MAIL ORDERS: P&P to all states by reg
air mail \$4.50, except NSW - \$2.50.

For further information: Write, phone or
call at

EMONA
ENTERPRISES,

21 Judge St., Randwick,
NSW 2031. Phone: 399-9061

ELECTRONIC DISPOSALS

297 Lt. Lonsdale St.,
Melbourne. 3000

GARRARD

S.L. 65B Automatic
Stereo Turntable

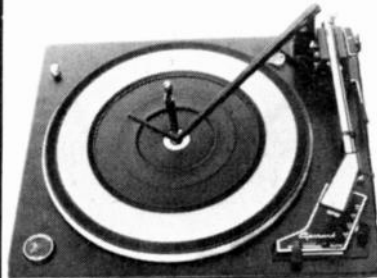

with laboratory balanced synchronous
motor. Adjustable balance - anti-skate
- lift and heavy platter including
Shure magnetic cartridge. Less than 1/2
price at only \$47.50ea. P/P \$3.00.

TRANSFORMERS. 30V - lamp C.T.
secondary 240V A.C. primary. \$4 ea.
P/P 75c. 60V C.T. and 6.3V at 1 amp
secondary 240V A.C. primary. \$4 ea.
P/P 75c.

LEVEL METERS 200 micro amp
sensitivity size 1" x 1" x 3/4" \$1.50
1 1/2" x 1 1/2" x 3/4" \$2 ea, P/P 20c

SOLENOIDS - tape recorder type.
12V D.C. 5.5Ω coils. 1 1/2" x 1 1/2" x 3/4"
\$2 ea. P/P 30c.

5 Push Button Permeability Tuners.
Complete with coils \$3 ea. P/P 75c

TRANSISTOR RADIO. 5k miniature
switched pots. 30c ea. P/P 15c.
Miniature 2 gang variable capacitors
30c ea. P/P 15c.

M.S.P. 8" x 4" 15Ω heavy duty
speakers \$3.50 ea. P/P 50c. M.S.P. 5"
15Ω dual cone tweeters \$4 ea. P/P 50c.

2 position 3 pole rotary switches 50c
ea. P/P 20c

Ferrite Loopsticks 8" x 3/8" complete
with broadcast coil. 70c ea. P/P 30c

Dual Ganged Carbon Pots. 50K.A. -
50 K.C. - 2 meg and 1 meg. 60c ea.
P/P 20c. Single Carbon Pots. 500Ω 1
K.A. and 250K.A. 30c ea. P/P 20c

Valves - New in Carton. 5Y3GT -
5V4G - 6N7G - 6SF5GT and 807 \$1
ea. P/P 25c

Battery Leads 30" long. Complete with
2-25 amp crocodile clips 30c ea. P/P
20c

SLIDE POTS. 50K.B - 200 K.B
500K.B - 1 Meg. 35c ea. P/P 20c.

DUAL GANG slide pots. 50 K.A - 50
K.B - 250 K.B 60c ea. P/P 20c.

T.V. Legs. 10" long. Teak wood. Taper
square section. 80c set of four P/P 50c

LARGE RANGE OF COMPONENTS
- GOVERNMENT AND
MANUFACTURERS DISPOSAL
EQUIPMENT, ALSO STEREO AND
HAM GEAR ALWAYS IN STOCK.

YOUR INSPECTION VERY WELCOME



AT LAST!

A HI-FI MAGAZINE FOR NON-EXPERTS

IT'S CALLED HI-FI REVIEW and you don't need a degree in acoustics to understand it!

HI-FI REVIEW tells you what to buy, how to buy it -- which gear is good and which gear is better. Whether it will meet your requirements -- and whether it does what its maker says it does.

Australia's monthly hi-fi magazine -- for people to read, enjoy, understand -- and above all -- believe.

hi-fi
REVIEW
ON SALE NOW --
ALL NEWSAGENTS

TOP AUDIO PROJECTS

from Electronics Today

All together in one volume

\$2.00* -- on sale at most newsagents

In the event of difficulties, Audio Projects can be obtained directly from us for \$2.50 (including postage & packing).

Please address orders to Subscription Dept.,
MODERN MAGAZINES (Holdings) LTD.,
15 Boundary St., Rushcutters Bay,
NSW, 2011.

* Recommended retail price only.

AUDIO PROJECTS

-FROM
ELECTRONICS TODAY
INTERNATIONAL

Volume 1 \$2.00

- 650 WATT STEREO AMPLIFIER
- 100 WATT AMPLIFIER ● MIXER
- PRE AMP ● FOUR CHANNEL
- SQ 15W ● 1715 ● STE 10-
- FOUR CHANNEL / CONVERTER
- FOUR CHANNEL FOR ● 101
- GRAPHIC EQUALIZER ● FOUR
- INPUT MIXER ● EIGHT CHANNEL
- MASTER MIXER ● SPRING / RE-
- VERB UNIT ● STEREO RUMBLE
- FILTER ● CLIPPING INDICATOR
- DESIGNING BASS REFLEX
- CABINETS ● CONNECTING EX-
- TENSION SPEAKERS ● DIN CON-
- NECTIONS ● AUDIO SIGNAL GEN-
- ERATOR ● AUDIO ATTENUATOR

diodes, indicating standby or operate modes, output range, decimal point position, high voltage and limit conditions, round out the complete, solid state display design.

A unique feature of the Model 3110 is its capability for "Compliance Voltage" limiting. This adjustment provides control of the maximum open circuit voltage that can appear across the milliamp or voltage output terminals. When testing operational amplifiers, this control is extremely useful in preventing potentially damaging voltages from being applied to the test device.

Output transients normally induced by range changing are eliminated by utilizing make-before-break switching. This feature protects the test circuit or component.

Separate output terminals are provided for the "mA", "mV" and "V" ranges - which may be short circuited without damage to the instrument. This protection, combined with a clamping output, is claimed to make the Model 3110 almost indestructible, while protecting the device under test from operator error. Further, a "Hi Volt" warning light indicates that the selected range has the capability of producing hazardous high voltage.

As with all of the HT Series instruments, the Model 3110 is housed and protected by a compact half-rack case, of extruded and die cast aluminium.

NIC Instrument Company, A Division of Ansett Transport Industries (Operations) Pty Ltd.

DOPPLER RADAR MODULE

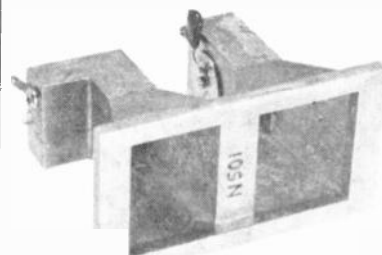

For use in 'Radar Intruder Alarm' and other X band applications.

Integral 12dB antenna 10mW output low noise mixer.

\$28

plus 15% sales tax

post and packing \$1.50

**ASSOCIATED CONTROLS
PTY. LTD.**

55 Fairford Rd., Padstow. 2211.

'SMART' DIGITAL MICROWAVE POWER METER

A new digital microwave power meter, Model 436A from Hewlett-Packard, has built-in firmware 'intelligence' to switch automatically among its five power ranges, to translate its reading into watts, dBm or dB relative, as desired, to locate the displayed decimal correctly, and to recognise which of several possible sensors is connected, and calibrate its display accordingly. Instrumentation uncertainty is less than 0.5% of reading. Power and frequency range depend on sensor used; it may be from 100 kHz to 18 GHz in a power range from -30 dBm to +35 dBm.

Logically organised and uncluttered, the 436A front panel has pushbuttons to control functions, a big (9.5 mm high) 4-digit LED display to compare readings with specs, and an auxiliary analogue meter for peaking adjustments. Choose absolute measurements in watts or dBm. Unique is the dB REF button; press it and subsequent readings will be in dB relative to that level, ideal for frequency-response testing. Resolution in this mode is 0.01 dB. A built-in power calibrator is engaged simply by pushing the POWER REF button. To zero the display, just push the SENSOR ZERO BUTTON. Autoranging makes operation 'hands off'.

The 436A is fully programmable. All front-panel functions (except CAL FACTOR) may be removed. Interface for control and readout may be via the HP Interface Bus (model for the proposed IEC international standard) or by BCD. Interfaces are optional and retrofittable.

Mismatch uncertainty, usually the largest source of error in microwave power measurements, is minimised in the family of available power sensors, in part through the use of silicon thermocouple elements less than one-quarter to conventional size. Typical of the group is the 50-ohm 100-mW model 8481A Sensor; its SWR is below 1.1 from 50 MHz to 2 GHz and below 1.28 over its whole range, 10 MHz to 18 GHz. There is lower-band model, 8482A (100 kHz to 4.2 GHz), and 75-ohm Model 8483A, mainly

for communications. Well-matched higher power versions are available to 3 watts.

Hewlett-Packard Australia Pty Ltd, 31-41 Joseph St., Blackburn, Vic 3130.

ACTIVE RECEIVING ANTENNAS

The integration of active components into HF receiving antennas permits antenna dimensions to be considerably reduced for a given SNR in comparison with conventional systems.

Rhode & Schwarz has developed a cost-effective modular system of active receiving antennas for the range from 1.5 to 30 MHz. The dimensions of these antennas could be reduced by a factor of three as against passive antennas with the same sensitivity. The antenna modules can be combined to meet all possible requirements and to suit the various propagation conditions in the shortwave range.

Whereas the active Vertical Antenna HF 001 with a height of only 1.5 m is particularly suitable for the reception of ground waves and of vertically polarized space waves arriving at low elevation angles, the active Receiving Dipole HF 002, 3 m in length, is preferably used for radio operation over short and medium distances. Reception from any direction and any distance is possible by combining two crossed Receiving Dipoles HF 002 and one Vertical Antenna HF 001 on a single mast. Since one of the antennas of this triple-antenna System HF 003 is always optimally suited for the incoming signal irrespective of its polarization, polarization-diversity operation is possible. With minimum space requirement it is thus possible to attain an improvement of reception which is about the same as with space diversity using two antennas set up at distance of approximately ten wave-lengths from each other.

The operating voltages are delivered by the Power Supply IN 014, which can be inserted in the connecting line between antenna and receiver at the most convenient point.

Jacoby Mitchell Ltd, 215 North Rocks Rd, North Rocks, NSW 2151.

BURGLAR ALARMS

Alarm Modules, Electronic Eyes, Photo Sensitive Cells, Sonar, Gas/Heat/Smoke Sensors, Sirens, Bells, Pressure Mats, Door Monitors, Car/Caravan/Home/Office hold-Up Factory Alarms, Key Switches, Reed Switches Relays, Shock Recorders Aluminium Tape. You Name It We Have It.

N.S.W. Agent for

NIDAC

Manufacturers of superior and reliable equipment.

Phone 977-6433 For information or send 50c in stamps for illustrated catalogue.

PROTECTOR R.C. ALARM SYSTEMS CO.
119-121 Pittwater Rd., Manly, N.S.W. 2095

- FAST SERVICE – ALL ITEMS DESPATCHED AT TOP SPEED
- ALL NEW ITEMS – UNUSED AND CARRY MANUFACTURER'S GUARANTEE
- SATISFACTION OR MONEY BACK (IF GOODS RETURNED WITHIN 7 DAYS)
- PRICES INCLUDE SALES TAX, CUSTOMS DUTY, POSTAGE & PACKING
- 10% DISCOUNT ON ORDERS OVER \$25.00
- DATA SHEETS AVAILABLE – 20c EXTRA

INTRODUCTORY SPECIALS

741 op amp (mini DIP) 5 for \$3.00
 555 timer (mini DIP) 2 for \$1.80
 LM3900 quad amp (DIP) 3 for \$3.00
 1N4148 (1N914) signal diodes 10 for \$0.75

Digital Experimenters Pack TTL 1 \$5.00
 Comprises 7490 decade counter 7447 driver plus NSN71 0.3" LED readout complete with circuit/data sheets.

Memory Pack – 2102 \$8.95

MM2102 1024 bit static RAM Build yourself add-on memory. The 2102 is an incredible device featuring single positive 5V supply, DTL/TTL compatible inputs and outputs, static operation (NO CLOCKS OR REFRESHING REQUIRED!) and low power (150mW – typical). Chip enable allows simple memory expansion. MM2102 complete with data sheets and application notes.

Update your knowledge by experimenting with the fascinating world of CMOS. Pack comprises 2 NAND, 2 NOR gates, INVERTER/BUFFER, DECADE counter and QUAD SWITCH. Complete with data sheets, suggested circuits and handling instructions.

DIGITAL

4000 Series CMOS	\$	c
4001 Quad 2 Input Nor Gate	.35	
4002 Dual 4 Input Nor Gate	.35	
4006 18 stage static shift register	\$3.20	
4009 Hex Buffer (inverting)	1.00	
4010 Hex Buffer (non inverting)	1.00	
4011 Quad 2 Input Nand Gate	.35	
4012 Dual 4 Input Nand Gate	.35	
4013 Dual D Flip/Flop	1.30	
4016 Quad Bilateral Switch	1.25	
4017 Decade Counter/Divider	2.95	
4020 14 Stage Counter/Divider	3.20	
4027 Dual J-K Flip Flop	1.40	
4049 HEX BUFFER/TTL DRIVER	\$1.30	
4511 BCD to 7 segment latch/decoder/driver	\$4.55	

74 Series TTL	\$	c	\$	c
7400	.35		7460	.35
7401	.35		7470	.50
7042	.35		7472	.60
7403	.35		7473	.90
7404	.35		7474	.90
7405	.35		7475	1.00
7408	.35		7476	.80
7409	.35		7480	1.70
7410	.35		7482	1.80
7413	.85		7483	1.40
7420	.35		7486	.60
7430	.35		7490	.80
7437	.60		7491	1.20
7440	.35		7492	.80
7441	1.20		74121	.60
7442	1.00		74123	.85
7447	1.50		74154	2.60
7450	.35		74164	2.40
7451	.35		74165	2.40
7453	.35		74192	2.50
7454	.35		74193	2.50

ETC

	\$	c
1N4148 (1N914) Signal Diodes	10 for	.80
1N4004 1A Diodes	5 for	.50
2N3055 NPN Power Transistors T03 (Metal)		1.20
C122D 8A SCR		2.25
IC Sockets 8 pin mDIP		.45
14 pin DIP		.50
16 pin DIP		.55

LINEAR

		\$	c
301 op Amp	mDIP	.70	
309K 5V 1A Regulator	T03	2.50	
340 T0220 1A Positive Regulators (5V, 6V, 8V, 12V, 15V, 18V, 24V – specify voltage required e.g. LM340T – 12V)		\$2.50	
380 2W Audio Amp	DIP	1.75	
382 Low Noise Dual Preamp	DIP	2.00	
555 Timer	mDIP	.95	
565 Phase Locked Loop	DIP	2.50	
566 Function Generator	mDIP	2.75	
567 Tone Decoder	mDIP	3.50	
723 Voltage Regulator	DIP	1.00	
741 Op Amp	mDIP	.65	
3900 Quad Amplifier	DIP	1.10	

OPTO ELECTRONICS

	\$	c
5023 or equivalent red LED	.30	
NSN71 (DL707 equivalent) C Anode 7 segment LED display	2.40	
NSN61 (DL747 equivalent) C Anode 7 segment LED display	3.50	
NCT200 opto isolator	1.50	



MINIMUM ORDER \$5.00

Send Cheque/Postal Order to

THE ELECTRONIC MAILBOX,

P.O. Box 355, Hornsby, NSW 2077



EQUIPMENT NEWS

LOW COST, RUGGED, 50 MHz PORTABLE OSCILLOSCOPE

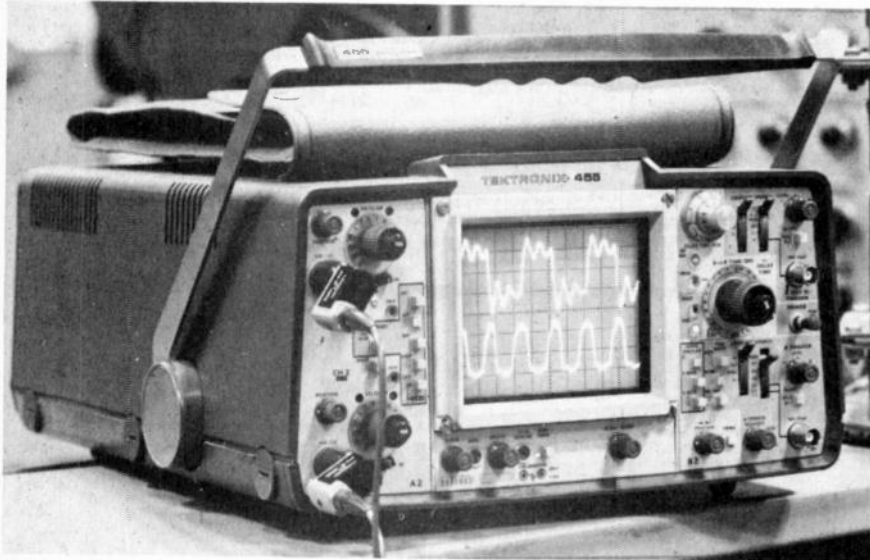

Tektronix, new model 455, lightweight portable oscilloscope has dual channel operation with 50 MHz bandwidth, vertical sensitivity ranging from 5 mV/div to 5 V/div, delayed sweep, and sweep rate to 50 ns/div (extended to 5 ns/div by a 10X magnifier). Other features include trigger view, lighted deflection factor indicators (1X or 10X probe attenuation automatically accounted for), probe coding and a full 80 x 100 mm display. True portability is assured by light weight and an optional clip-on battery pack (for 455 with option 7). The shock resistant, reinforced plastic case of the 455 is suitable for operation in hostile industrial and field environments. All accessories for the 465 and 475 portable oscilloscope fit the 455.

For ease of service, the number of calibration adjustments is minimized by use of actively trimmed hybrid networks. Although the 455 is a monolithic portable oscilloscope, it consists of distinct display, vertical amplifier, and sweep generator modules. This modular construction contributes further to ease and speed of service.

Modular construction of the 455 probes (compensation unit, cable, and probe tip) means easy, inexpensive repair in the event of damage.

Present options for the modular 455 include emi protection, a tv syn separator, and battery operation.

Tektronix Australia Pty. Limited, 80 Waterloo Road, North Ryde, NSW 2113.

512 MHZ PORTABLE COUNTER

The TC18 frequency counter from Gould Advance is a compact, lightweight instrument capable of measuring frequencies from 10 Hz to 512MHz. Designed for mobile or laboratory applications, the TC18 can be operated from external 12V dc or standard ac supplies.

The instrument incorporates a 6-digit dot-matrix light-emitting-diode display with storage; a choice of three gate times gives direct readings in Hz, kHz or MHz. The time interval between successive measurements is 100ms plus the gate time (1ms, 1s or 10s). The display also indicates 'gate open' and overrange.

The internal crystal requires no warming-up time, and for more exacting applications an optional temperature-controlled crystal oscillator is available. A rear-panel input allows the use of an external frequency standard between 1 kHz and 2 MHz.

There are two inputs, covering 10 Hz-100 MHz and 10 MHz-512 MHz, respectively,

and direct readings are made at all frequencies; there is no prescaling. This feature gives readings in at least half the time taken by most other 512 MHz instruments. A direct reading of the frequency ratio may also be obtained. The addition of a small aerial or inductive loop makes it possible to measure rf carrier frequencies.

The TC18 measures 83 mm high x 203 mm wide x 188 mm deep, and weighs only 2.3 kg. Operating temperature range is 0°C to 45°C.

Further details from: Jacoby Mitchell Pty Ltd, 215 Nth Rocks Rd, Nth Rocks, 2151 ●

Tandy Electronics operate over 60 stores in Australia plus over 3000 overseas. We offer a profit sharing shop management programme requiring a security deposit of between \$15,000 and \$18,000. For further information please write to S.M.I.A. Department, Tandy Electronics, P.O. Box 229, Rydalmere, N.S.W. 2116.

BRIGHT STAR CRYSTALS

ESTABLISHED FOR THE PAST 35 YEARS FOR ALL YOUR REQUIREMENTS
★ STILL ON TOP ★

CRYSTAL FILTERS

- 9 MHz side band with carrier crystals 4 & 8 pole type
- Specialised monolithic filters, 10-100 MHz
- Front end filters to 190 MHz

ELECTRONIC UNITS

- Decade Counting units to .1 Hz
- Wide band amplifier for your counter, 1 MV sensitivity, band width 1-250 MHz

DEVOTED EXCLUSIVELY TO THE MANUFACTURE OF

PIEZO ELECTRIC CRYSTALS

Contractors to Federal & State Government Departments.

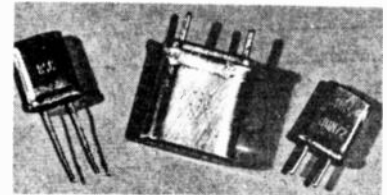

"All Types of Mountings"

REPRESENTATIVES —

S.A. Rogers Electronics
P.O. Box 3,
Modbury North, S.A.
Phone: 264-3296

N.S.W. Paris Radio Electronics,
7A Burton Street,
Darlinghurst, N.S.W.
Phone: 31-3273

QLD Fred Hoe & Sons Pty Ltd,
246 Evans Road,
Salisbury North, Brisbane,
Phone: 47-4311

W.A. W.J. Moncrieff Pty Ltd.,
176 Wittenoom Street,
East Perth, 6000
Phone: 25-5722

Tasmanian Representative Required

Write for a free comprehensive price list or quote for your requirements.

BRIGHT STAR CRYSTALS P/L.
35 EILEEN ROAD, CLAYTON,
VICTORIA, 546-5076

LOW COST, HIGH RELIABILITY TRIMMERS.

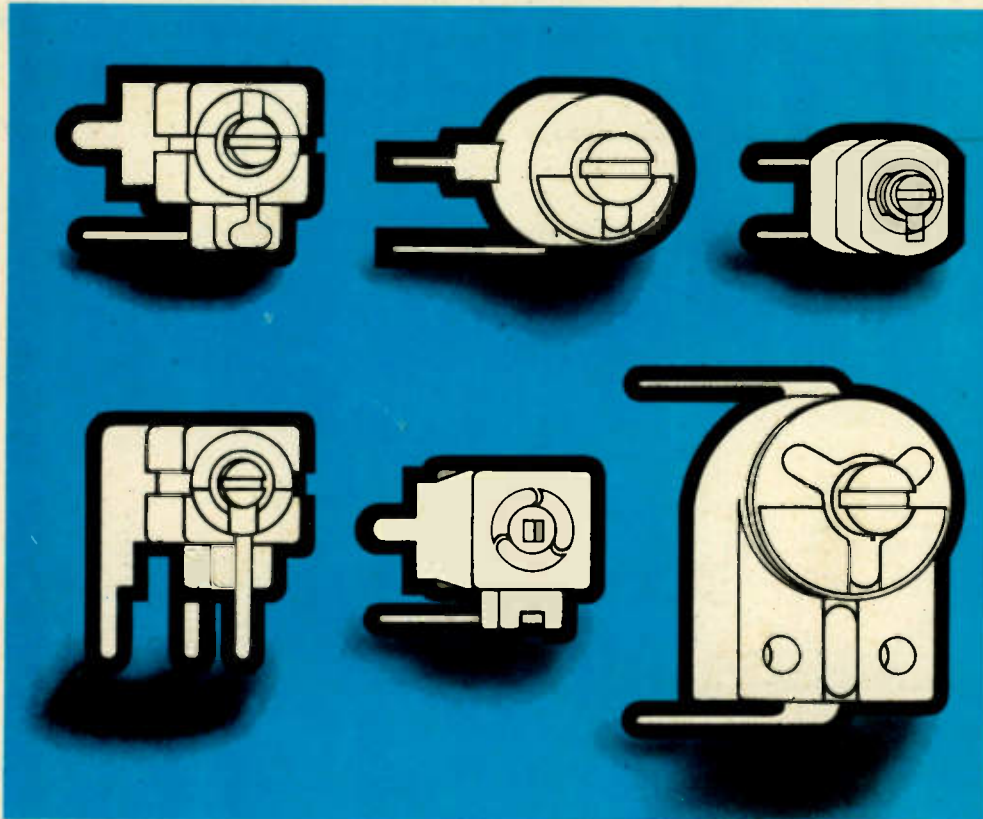

The outstanding physical qualities of ceramic have been recognised for thousands of years . . . today, high density, stable and low loss ceramics of foremost quality are employed by Kobayashi (Japan) in the production of these rotary trimmer capacitors to ensure highly reliable, static-free operation.

These compact, lightweight capacitors provide design engineers with an economical solution to circuit design improvement in radio, television, communication and industrial equipment.

Plessey take pleasure in offering these capacitors of which there are 27 types with capacitances ranging from 1.5 to 100 pF and working voltages of 200, 250 and 350 VDC.

Comprehensive technical literature is available on request to the Professional Components Division.

PLESSEY 

Plessey Australia Pty Limited
Components Division Box 2 P.O.
Villawood NSW 2183
Telephone 72 0133 Telex 20384

MELBOURNE Zephyr Products Pty Ltd 56 7231
ADELAIDE K. D. Fisher & Co 223 6294
BRISBANE L. E. Boughen & Co 70 8097
PERTH H. J. McQuillan Pty Ltd 68 7111
NEW ZEALAND Henderson (N.Z.) 6 4189

AC125HOLT

How to upgrade your speakers for a few extra cents

The sound that comes out of those beauties is the sound that's on the cassette. No better, no worse. And if you're using discount cassettes, chances are you're hearing discount sound, delivered with breathtaking clarity.

A classic case of pennywise and sound foolish. Drop a TDK cassette in there next time and hear the difference.

Vibrant sound, rich in colour and detail, with the depth and harmonics that were there when the music happened.

One TDK cassette. One time. One listen. That may be the *first* time you'll *really* hear your speakers. And all for as little as a few extra cents. A few extra cents more than the cassette you're probably using now.

Wait till you hear what you've been missing.



TDK

For the sounds you feel as well as hear. Available at all good hi-fi dealers and record shops.

sole Australian agents Convoy International Pty. Ltd.
4 Dowling St., Woolloomooloo 2011

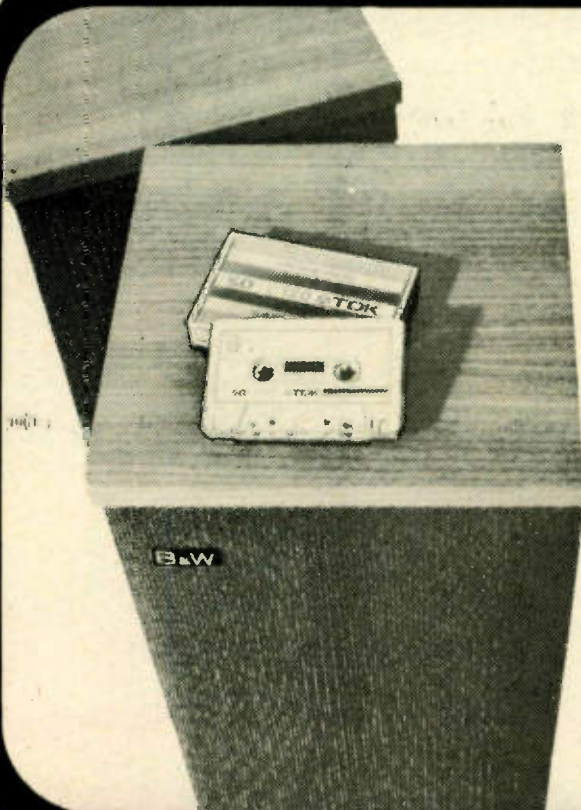

For Those Who Take Music Seriously Only AMCRON will do!



If the reproduction of music to you is too important to settle for anything less than totally realistic sound, you need Amcron audio components. Amcron's experience in producing professional studio equipment, where absolute faithfulness to the original performance is a demand, has assured that each Amcron component is designed to reproduce the purest, most realistic, 100% *honest live sound* that is as accurate as the most advanced engineering can make it.

Your Amcron audio specialist will help you select the models that will best fit your needs and price range.

Whichever you choose, you can be sure they are all superbly matched pieces for a totally compatible system. And all are professional quality components built with painstaking craftsmanship. Anything less just wouldn't be Amcron. Write for full descriptive literature and reviews.

Amcron 

Crown International U.S.A.

Made only in America

AUSTRALIAN DISTRIBUTORS:

BJD

Electronics Pty. Ltd.

202 Pelham St., Carlton, 3053 Vic. Ph. 347-8255

65 Parramatta Rd., Five Dock 2046 NSW, Ph. 799-3156

COMPONENT NEWS

SEVENTEEN MILLIMETRE PLUMBICON TV CAMERA TUBE

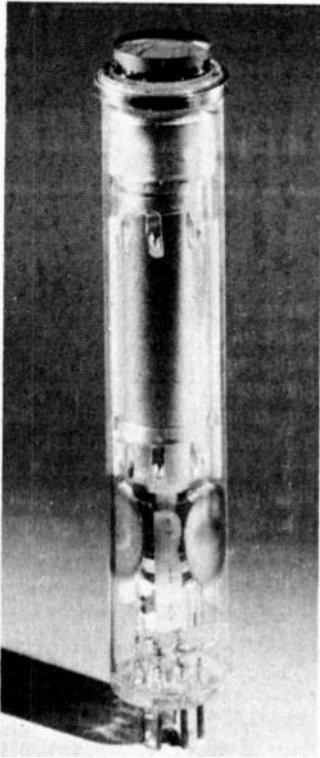

Elcoma have released the Philips 37XQ Plumbicon TV camera tube for small black/white and colour cameras. The 37XQ is a 17 mm (2/3rds inch) low-cost version of the well-known 1-inch and 1¼-inch Plumbicon camera tubes used in professional broadcast colour cameras.

The 37XQ requires magnetic focusing and deflection, and is provided with separate mesh construction, employs a high resolution photoconductive target and features fast response, high sensitivity and a low heater power consumption. It is therefore the ideal TV camera tube for small hand-held colour cameras in sub-broadcast applications such as electronic journalism and industrial and educational applications.

Temperature stability over a wide range is a further practical advantage of the Plumbicon camera tube; which means that camera design and operation are both simplified. The 37XQ is both mechanically and electrically interchangeable with 17 mm vidicons such as the QX1271.

MINI RACK AND PANEL CONNECTORS FEATURE CRIMP-ON SNAP-IN CONTACTS

Elcoma (The Electronic Components and Materials Division of Philips) have released a series of subminiature rack and panel connectors with crimp-on snap-in contacts that can be removed with a simple tool without damage to either the contact itself or the body of the connector.

These connectors, designated the F

161-series, consist of a cadmium-plated steel shell, passivated with a yellow finish, and a red glass-fibre filled polycarbonate insulating block. Contact pins and sockets are made of copper alloy gold-plated on a nickel layer, and are supplied as loose parts. The pins and sockets are crimped to the ends of the cables with a MIL-standardised crimping tool and inserted into the holes in the block where they snap into position. A solder-contact version will be announced shortly.

Contacts can be removed at any time with a simple plastic tool which is pushed into the rear of the connector thus disengaging the contact. The connectors have been designed to meet the dimensional requirements of MIL-C-24308; they can be supplied with 9, 15, 25, 37 and 50 connections.

Elcoma, 67 Mars Road, Lane Cove, NSW.

NATIONAL MAKES TRANSDUCER SELECTION QUICK AND EASY

A handy, short form, quick-reference guide to all of National Semiconductor's IC pressure and temperature transducers is now available. The transducer selection guide lists the major characteristics of NSC's LX1400, LX1600, LX1700, LX3700 and LX3800 series pressure transducers and barometers, and of the LX5600 and LX5700 temperature transducers.

The Transducer Selection Guide is easy to use and lets its user immediately spot the transducer he or she needs, categorizing them first as absolute, gauge or differential pressure transducers, or temperature transducers. Within each category, the classification scheme is per the transduction range of pressure or temperature.

Principal specification of each transducer are listed, including the calibrated output voltage range, temperature coefficient, linearity and hysteresis, repeatability and so forth. Package codes and outline drawings are also shown.

The Transducer Selection Guide may be obtained by writing the marketing services department of NS Electronics Pty. Ltd., Cnr Stud Rd & Mountain Highway, Bayswater, Vic. 3153.

REDUCTION DRIVE

A new style 10:1 Reduction Ratio Ball Drive, Cat No. 6020 has been released by Jackson Brothers (London) Ltd. The output torque is 10 oz ins. (720 gm. cms) which is more than enough for most potentiometers or variable capacitors.

This low priced reduction drive is readily fitted to a panel by two 8BA (or 2.5 mm) screws. Input shaft can be ¼" or 6 mm diameter whilst the bore of the output shaft can also be made to suit either diameter.

A copy engineering drawing of the ball drive together with price and availability is available from the sole Australian agents, British Merchandising Pty Ltd., GPO Box 3456, Sydney, NSW, 2001.

SINGLE CHIP 16 BIT MICROPROCESSOR

A new single chip 16-bit microprocessor from National Semiconductor Corporation provides for the first time all of the basic features of a complete 16-bit processor unit at the price of a single chip microprocessor. An internal interrupt system, with an on-chip jump-condition multiplexer greatly simplifies system design.

NS Electronics Pty Ltd, Cnr Stud Road & Mountain Highway, Bayswater, VIC. 3153.

POWER SUPPLY CATALOGUE

A new four-page short-form catalogue from Teledyne Philbrick presents detailed electrical and mechanical specifications on 30 modular p.c. and chassis-mountable power supplies.

Teledyne Philbrick power supplies, including three new dc-to-dc converters, are designed for logic networks and circuit modules such as operational amplifiers, digital-to-analogue and analogue-to-digital converters, and non-linear circuit modules.

All power supplies are complete and self-contained. No external transformers or filters are required for stable accurate operation. This one unit construction is easier to use, and reduces component and assembly costs of the equipment being manufactured. All Teledyne Philbrick power supplies are protected against overheating from direct short circuits to ground. The dual supplies will track each other so that a short on one output will automatically reduce the other output to prevent damage to the load circuitry.

Elmeasco Instruments Pty Ltd.

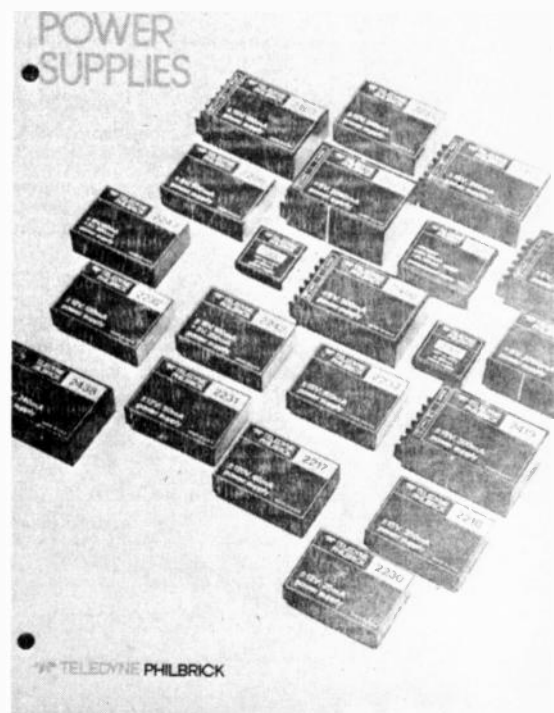

Which man are you?



Today's electronic equipment varies widely in its sophistication, and in the demands it makes . . . on soldering equipment, and the man who uses it. Which man are you?

■ Involved with **COMPLEX OR SENSITIVE CIRCUITRY?**

Sophisticated solid state components, multi-layer and high density circuitry as found in colour TV, industrial instrumentation etc. need the controlled temperature, slim profile and high power of the mains voltage **THERMATIC**.

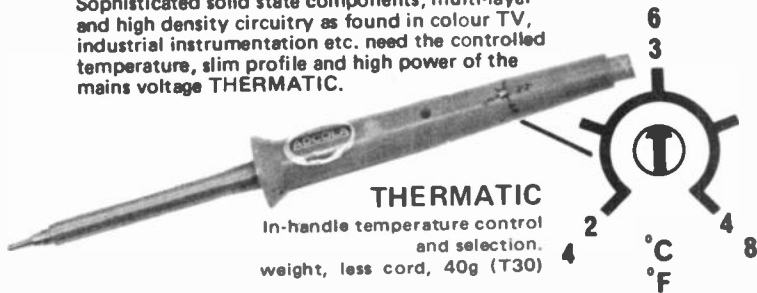

THERMATIC
In-handle temperature control and selection.
weight, less cord, 40g (T30)

■ Handle **GENERAL ELECTRONIC EQUIPMENT?**

Radio, stereo, black and white TV service, and general commercial electronics work require fast heat-up and maximum versatility. The **DUOTEMP** idles at soldering temperature, and doubles its power for heavy or sequence soldering.



DUOTEMP
Push button control doubles thermal power
weight, less cord, 40g (D30)

■ Keen on **HOBBIES & HANDYMAN JOBS?**

For broken toys, appliances, automotive wiring, door chimes, jewellery, and a hundred jobs around the home, a soldering tool is a must. The inexpensive, single-temperature **STANDARD** tool handles these jobs with ease.



STANDARD
weight, less cord, 36g (S30)

■ Responsible for **HIGH RELIABILITY EQUIPMENT?**

Life support, communication, aero-space, weapons etc. make critical demands on solder joints. **ECT SOLDERING STATIONS** provide extremely accurate temperature from direct reading control: low voltage for safety: zero tip potential. Elements, about 4 times normal power, give fast heat up and recovery. The ultimate in accuracy, speed, thermal capacity and component protection.



ECT 6724 SOLDERING STATION

CT7 tool: weight less cord 50g
CT6 tool: weight less cord 23g

Whichever man you are, Adcola equips you better for faster, easier, more reliable soldering . . . and there's an Adcola consultant in each capital city to lend a professional hand.

ADCOLA

MA 752

VIC.: 848 3777
N.S.W.: 709 5293
S.A.: 42 2583
QLD.: 52 3166
W.A.: 81 5500

COMPONENT NEWS

LARGE SEVEN-SEGMENT NUMERIC DISPLAYS IN THREE COLOURS

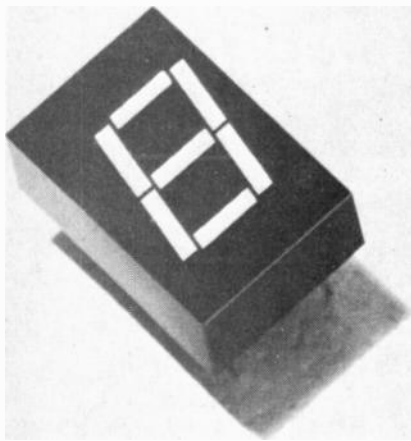

New high-efficiency solid-state numeric displays from Hewlett Packard are as much as five times brighter than other currently available IIP displays at the same operating current. At one-fifth the current, they are equal in brightness to these same displays. At an operating current of 20 milliamperes per segment, luminous intensity per segment is 1720 microcandelas. This high brightness plus their 11-millimetres height makes them ideal for applications in high ambient light conditions such as point-of-sale terminals and in avionics. Operating at currents as low as 3 mA, these large displays become practical for use in battery-powered portable instruments. They may be operated in the strobe mode at currents up to 60 milliamperes peak.

Hewlett-Packard Models 5082-7650, -7660 and -7670 are red, yellow and green common anode, seven segment displays with left hand decimal point. LED chips are optically magnified to form evenly-lighted segments. The diodes in these displays use a Gallium Arsenide Phosphide junction on a Gallium Phosphide substrate for high-efficiency red and yellow spectra, and a Gallium Phosphide junction for green. The emission wavelength of the red has been shifted from the standard 655 nanometres to 635 nanometres for easier reading.

The new Hewlett-Packard 5082-7600 Series devices use a lead frame in a standard DIP package. For improved on-to-off contrast, the bodies of the displays are coloured to match the appearance of the unlighted segments.

Hewlett-Packard Australia Pty Ltd, 31-41 Joseph St., Blackburn, Vic 3130.

OPTO-ISOLATED SOLID STATE RELAY

FR Electronics have now released their latest opto-isolated solid state relay for sale

on the world market after extensive life testing and evaluation by selected customers.

The basic unit is designed for ac loads up to 13 amps at mains voltages. An integral heat sink protects the device by ensuring that dissipation is sufficient in all environments.

Input control is by a dc signal of 3 volts or more with a current drain approx. 2 mA, ensuring operation from low power logic systems.

Switch on point is synchronised to the zero voltage level by a unique detection and triggering circuit, thus ensuring freedom from rfi. Switch off is synchronised to the zero current crossing point.

Further details may be obtained from NS Electronics Pty Ltd, Cnr Stud Road & Mountain Highway, Bayswater, Vic. 3153.

SUBMINIATURE REED RELAYS

Alma Components Limited of the United Kingdom, one of the world's leading manufacturers of specialised reed relays and reed switches, have announced the release of the HPA range of subminiature reed relays.

These new subminiature reed relays have been designed for mounting on one half of a dual in line socket or punching, i.e. two relays can be mounted side by side on a single socket. The relays are magnetically screened and are available at five voltages including 5 V and 15 V for logic circuits, the relays can also be supplied with built-in diode suppression. A high power capsule version is offered which can switch mains voltages.

British Merchandising Pty. Ltd., GPO Box 3456, Sydney, NSW.

NATIONAL MM4030 4K RAM

National Semiconductor has enlarged its memory products line once more, with the addition of the MM4030 - a 22-pin, 4096-bit, random access memory.

The new 4096 x 1 Read/Write RAM is an N-channel, silicon gate device. It is fully decoded, with on-chip registers for addresses and Chip Select, and features an access time of 200 ns and a cycle time of 400 ns. All inputs are TTL compatible, (except Chip Enable), as are the Tri-State^R outputs, which may be OR'd with other 4K RAMS.

Production-quantity deliveries of the MM4030 will start in mid '75.

The MM4030 is the second 4K RAM from National Semiconductor. The Company recently announced its Tri-ShareTM MM5270, an 18-pin N-Channel RAM. The MM5270 offers 4K RAM users the opportunity to nearly double the usual PC-card memory density that is possible with 22-pin RAMs, and to save money while doing so.

For further information contact, NS Electronics Pty Ltd, Cnr Stud Road & Mountain Highway, Bayswater, Victoria 3153.



COLOUR BAR GENERATOR

PUSH BUTTON MODEL COLROSE - RBC 111

- Provides the THREE COLOUR BAR STANDARDS as used in Aust. (100% Amp. 100% Sat., 100% Amp. 95% Sat., & 75% Amp. 100% Sat.)
- Provides THREE 8 STEP GREYSCALE PATTERNS
- Accurately centred CROSSHATCH pattern for precise adjustment of picture height, width and linearity.

Other features include:

- DOTS ● VERTICAL LINES ● HORIZONTAL LINES ● VERTICAL BARS ● RED SCREEN ● WHITE SCREEN ● PAL/NTSC COLOUR BARS ● PAL/NTSC GREYSCALES ● VARIABLE BURST AMPLITUDE ● VARIABLE VIDEO OUTPUT - pos. or neg. polarity o VHF OUTPUT - turntable ● SOUND CARRIER - modulated (1 kHz) or unmodulated ● CANCEL Y (Luminance) U (B-Y) and V (R-Y) switches ● SYNC OUTPUT for triggering C.R.O. ● ALL PATTERNS ACCURATELY CENTRED

Introductory Price:

ONLY \$350.00 +15% S/T
COLROSE ELECTRONICS

13 FRED A STREET, NETLEY,
S.A. 5037 Phone 293-5617

HI-FI EXPLAINED

*- an expert book
written with
non-experts in mind*



how, why, which, where, how much -
HI-FI IN AUSTRALIA - 1975

- THE AIM OF HI-FI
- WHAT IS STEREO
- RECORDS OR TAPES
- RECORD PLAYERS
- TAPE RECORDERS
- AMPLIFIERS
- FREQUENCY MODULATION
- LOUDSPEAKERS
- HOW TO BUY HI-FI
- SETTING UP THE GEAR
- ROOM ACOUSTICS
- UPGRADING
- FAULT FINDING
- RECORD CARE
- GLOSSARY OF TERMS
- WHO SELLS WHAT

\$2-50

HI-FI EXPLAINED — written by Collyn Rivers, Editorial Director of Hi-Fi Review and Electronics Today International, Published by Modern Magazines (Holdings) Limited, 15 Boundary St., Rushcutters Bay, NSW, 2011.

On Sale Now - All Newsagents

* Recommended
retail price

Introducing
**Ferric Oxide's
 finest
 hour...**



...hour and a half, and two hours

New BASF LH Super Cassettes with finer, more highly refined ferric oxide particles to give a 50% increase in volume without distortion.

Introducing a new standard of recording for all cassette recorders and decks without a CrO₂ bias switch. BASF LH Super cassette tape represents the ultimate in ferric oxide tape technology. Utilising a pure Meghemite oxide as well as a totally new binder system, LH Super features higher magnetic density and improved particle orientation.

This means more magnetic energy from the same tape surface area. The result: 50% increase in volume without distortion, across the full frequency range. An added 4 dB of low frequency, distortion-free dynamic output. A higher level of high reproduction is attainable flat to 20 kHz with a lower compression factor.

Low Noise characteristics are even lower than standard Low Noise tape.

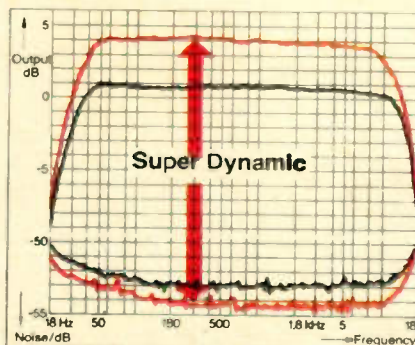

Performance specifications of the higher quality cassette decks are exceeded, the reproduction of any recorder is improved.

No special bias switch is required. BASF LH Super provides professional results with standard bias settings found on all cassette recorders and decks.



BASF
 the best in
 cassette sound

© BASF Aktiengesellschaft, 6700 Ludwigshafen/Rhein, Federal Republic of Germany.

Sole Australian Distributors: MAURICE CHAPMAN & COMPANY PTY. LTD. Sydney: 276 Castlereagh Street, Sydney 2000. Melbourne: 146-150 Burwood Road, Hawthorn, Vic. 3122. Brisbane: 123 Abbotsford Road, Mayne, Qld. 4006. Agents:—Newcastle: W. L. Redman & Co. Pty. Ltd.; Canberra: Sonney Cohen & Sons. State Distributors:—Adelaide: Neil Muller Pty. Ltd.; Perth: M. J. Bateman Pty. Ltd.; Launceston: P. & M. Distributors; Darwin: Pflitzners Music House.

BA4472

AWA

announce
arrangements
to market the
highly successful
range of
etone
HIGH PERFORMANCE SPEAKERS



STOCKS AND COMPLETE
DETAILS AVAILABLE FROM:



AMALGAMATED WIRELESS (AUSTRALASIA) LIMITED

BRANCHES:

NEW SOUTH WALES Sydney: MSP DIVISION, 554 Parramatta Road, Ashfield 2131. Phone 797 5757. Telex 24530.
Newcastle: Cnr. King & Darby Streets, 2300. Phone 25166. Telegrams "Expanse".
Canberra: Suite 3, TNT Building, 23 Barrier Street, Fyshwick 2609. Phone 953431. Telegrams "Expanse".
VICTORIA Miles Street, Mulgrave 3170. Phone 560 4533. Telex 32095.
QUEENSLAND Brisbane: 73-75 Jane Street, West End 4101. Phone 44 1631. Telex 40607.
Townsville: 2B The Market, Keane Street, Currajong 4812. Phone 796155. Telex 77008.
SOUTH AUSTRALIA 48 King William Road, Goodwood 5034. Phone 2722366. Telex 82817.
WESTERN AUSTRALIA 33 Railway Parade, Mt. Lawley 6050. Phone 71 0888. Telex 92121.
TASMANIA 44-46 Garfield Street, Launceston 7250. Phone 44 5155. Telex 58652.

OKI dry reed inserts are one of the simplest and most economical switching devices available. Contacts of either gold diffused or rhodium material are hermetically sealed in a glass tube to provide reliable high speed operation.

Long life and freedom from corrosion are prime characteristics of the OKI range. Operation is activated by the presence of a magnetic field generated by either a coil or permanent magnet. The combination of a coil and reed insert forms a relay of the highest professional standard.

OKI reed inserts are unaffected by operation in grossly unfavourable environments and use in alarms, control systems and fail-safe devices of every kind is common. Typical applications include control and indication monitoring of position, liquid level, pressure, flow etc. Their high operating speed of typically 0.5 mS makes them also suitable for tachometer applications.

A standardised range is available ex-stock. Comprehensive literature is available on request to the Professional Components Division.

Plessey Australia Pty. Limited
Components Division
Box 2, P.O. Villawood, N.S.W. 2163
Telephone: 72 0133 Telex: 20384
Melb: Zephyr Products Pty. Ltd. 56 7231
Adel: K. D. Fisher & Co. 223 6294
Perth: H. J. McQuillan Pty. Ltd. 68 7111
N.Z.: Henderson (N.Z.) 64 189

OKI DRY REED INSERTS

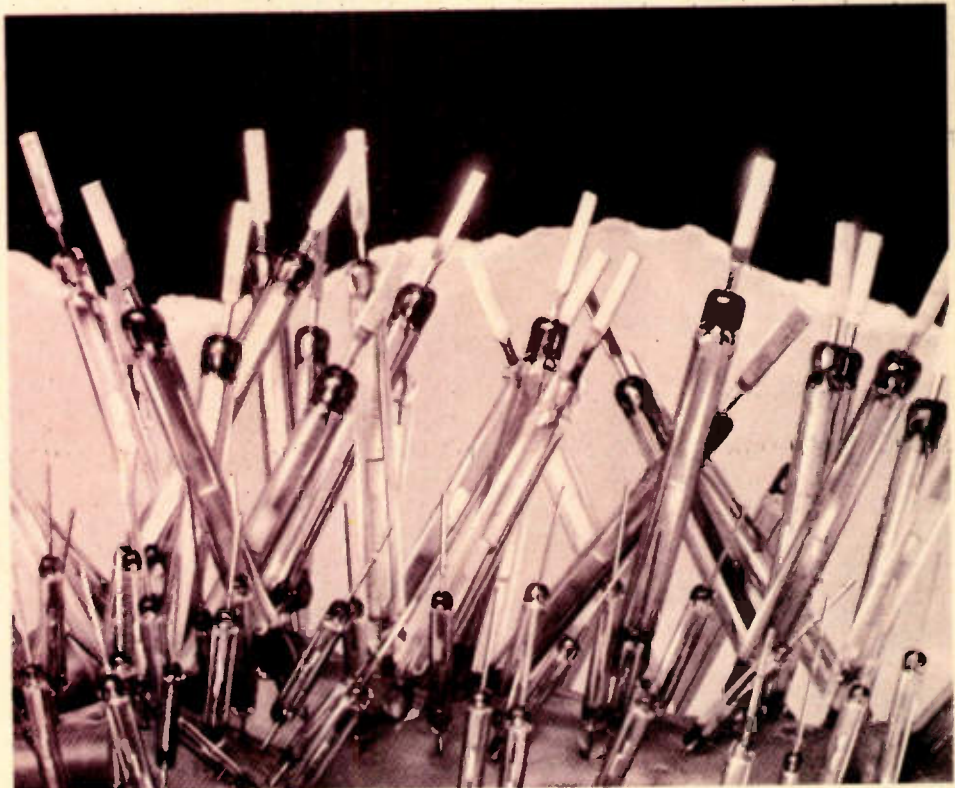

PLESSEY



AC102/R1

Super Buys
from the Super
STORE

M.S. COMPONENTS
(ELECTRONICS) PTY. LTD.
95-97 REGENT ST., REDFERN N.S.W. 2016
P.O. Box 156 REDFERN 69-5522

HOURS OF TRADING:
MON-TUES-WED & FRI: 9am - 5.30pm. THURSDAY: 9am - 7pm.
SAT: 9am - 1pm. C.O.D.'s: Please add \$1.20 to Posting fee. NO ORDERS UNDER \$3.00 accepted.
S.A.E. FOR REPLIES PLEASE.
Post & Packing 50c where not included. PLEASE PRINT YOUR NAME & ADDRESS.

THE GREAT NAME FOR ELECTRONIC COMPONENTS IN AUSTRALIA

SILICON DIODES - SPECIAL CRASH OFFER OF 'TOP-HAT' TYPE WIRE ENDS.



TYPE NO: 1S94. Rated at 500 volts 500 mA. All as new and unused. 6 for \$1.00 P&P 20c.

2 S B 3 3 7
(A S Z 1 1 6)
GERMANIUM
PNP POWER
TRANSISTOR.
Sim. to OC28. Complete with mounting kit. Now only from M.S.C. \$1.10 or 10 for \$10. P&P 1 to 5 30c 10 up 48c.

PRICE
CRASH!

PRICE
CRASH



2N3055 ... the ever popular NP N power transistor by Philips & Fairchild only from M.S.C. \$1.15 each or 10 for \$11.00 Complete with Mica washers P&P 20c or 10 for 40c.

SPECIAL OFFER!
LIMITED QUANTITY

In I.C.'s & Semi-Conductors

Please note: No Hong-Kong 'GARBAGE' is sold by US. ONLY reputable and tried products from SIGNETICS - N.S. - FAIRCHILD - S.T.C. - PHILIPS & MOTOROLA.

INTEGRATED CIRCUITS

7400, 7401, 7402, 7403, 7404, 7405, 7406, 7408, 7410, 7413, 7420, 7430, 7440. All 40c each or ANY 10 at 38c each. P&P 11c per unit or 10 for 25c.

NE566 FUNCTION GENERATOR
\$3.20 each, 10 for \$31

LM 709 95 each or 10 for \$8.50
LM 747 \$1.75 each or 10 for \$16.50
LM3900 \$1.75 each or 10 for \$15.80
OM802 \$2.15 or 10 for \$20.00
TAA300 \$2.75 each or 10 for \$26.00

SPECIAL PURCHASE!!

LM741 operational (OP-AMPS) amplifiers in min dip case. 80c each or 2 for \$1.50. 10 for \$6.95. Post Free.



"VORTEX"

Stereo Cassette Deck mechanism with tape eject facility and resettable counter. Easily operated by 5 push-button (piano key) controls, and includes high quality 'ALPS' recording, play-back and erase heads. Tape speed 4.7cm (1-7/8") sec. Plus or minus 1.5%. Wow and flutter less than 0.25%. Operates on 240VAC. Full data and specifications supplied with each purchase. Our price now only \$27.50 P&P \$1.00



SCOOP

7 TRANSISTOR

+ 2 DIODE RADIO BY BENOIX

Completely ready wired with volume control and switch. Large tuning dial and complete with 3 1/2" 8 ohms .6 watt speaker. Battery container included. (Batteries not included) - READY TO GO!!

\$3.85 EACH

PLUS P & P 85c

M.S.C.'s

CRAZY PRICE!!



NEW SUPERIOR QUALITY
PRECISION MADE NEW
POWER RHEOSTATS
by MALLORY

NEW CERAMIC CONSTRUCTION, VITREOUS ENAMEL EMBEDDED WINDING, HEAVY DUTY BRUSH ASSEMBLY, CONTINUOUSLY RATED, 25 watt type:

In the following values ... 2Ω - 4Ω - 10Ω - 25Ω - 75Ω - 500Ω - 2.5Ω \$5.00 each Post & Packing 75c. 50 watt type: In the following values 4Ω - 6Ω - 22Ω - 50Ω - 125Ω - 150Ω - 300Ω - 2.5kΩ and 8kΩ \$6.00 each. Post & Packing 85c. 75 watt type: In the following value ... 1kΩ only. \$7.00 Post & Packing. \$1.00. 100 watt type: In the following values ... 1Ω and 25Ω \$8. P&P \$1.00 (Limited quantity). 300 watt type: 50Ω only \$24.00 P&P \$2.00 (Limited quantity). 500 watt type: 500Ω only. \$28.50 P&P \$2.00 (Limited quantity). Please note: With the exception of the 75 watt Rheostat, ALL have Fluted knobs and Calibrated Dials.



SUNDAY OPENING *** DUE TO CUSTOMER DEMAND, FOR A TRIAL PERIOD ONLY WE WILL BE OPEN EACH SUNDAY COMMENCING THE 26th May, 1975, FROM 10 a.m. to 1p.m.

The GOLDRING DC-DC CAR CONVERTER

High rating at 800mA. For use with cassette tape recorder - transistor radio - transistor transceivers and other electronic devices requiring low voltage D.C. power such as 6V - 7 1/2V - 9V. Complete with 4-way D.C. Output plug & polarity reverse cord. All new and cartoned at the fantastic price of \$4.95 only. P&P 50c.

800
MA

LOOK AT THIS ... OAK
MINIATURE ROTARY
SWITCHES ... Precision
engineered for precision work.
ONCE IN A LIFE-TIME OFFER
... compare M.S. C.'s Prices with
our nearest cheapest competitor,
and save yourself a BOMB. ALL

NEW ... ALL PERFECT. Standard 1/4" shaft. 2 Section, 8 Pole 2 Position or 6 Pole 4 Position. \$1.75 each or 2 for \$3.00. P&P 40c.



ANOTHER
SMASH HIT
FROM M.S.C.

Special purchase of genuine motorola F.M. Stereo multi-plexer in 14 pin D.I.L. package.

MC1310P

(As used in APRIL 1975 E.A. project for F.M. stereo decoder). ONLY \$5.80 each post free.

KNOCK-OUT
CLEARANCE
OF
INTEGRATED
3 WATT AUDIO
POWER
AMPLIFIERS

Type M5102, complete with necessary Diode, 10 pin I.C. in modified JEDEC T03 Case. Vcc + 13.8 volts. Max 18 volts. Full data sheet and layout wiring supplied. ONLY LAST FEW REMAINING TO CLEAR. Only \$2.95 each P&P 30c. P.C. Boards to suit \$2.00 each post free if purchased with I.C.



SCOOP PURCHASE OF DIGITAL CLOCK MECHANISM'S

All new and unused ... fully imported. Complete with Time-setting control, denoting HOURS, MINUTES & SECONDS. Clearly visible figures of 5/16" Ht. Also incorporated is two remote micro-switches for setting Alarms, Radio's or Television etc. With 240V 50Hz Motor. AMAZING VALUE AT \$10.25 each P & P \$1.00.



NEW



RELIANCE CONTROLS
MULTI-TURN WIRE-WOUND TRIMPOTS.

Extremely small size coupled with precision engineering make these Trimpots a worthwhile purchase. ONLY OBTAINABLE FROM US. All 20 turn, and in the following values: 15Ω - 20Ω - 25Ω - 100Ω - 200Ω - 250Ω - 300Ω - 500Ω - 1KΩ - 2.5KΩ - 25KΩ - 50KΩ - 100KΩ. All above at 95c each P & P 30c (up to 10).

PYE (Magnetic Devices) RELAY. 240VAC 2 pole Changeover with 6amp Contacts. 250Ω Coil. Sturdily constructed, new in original cartons. \$1.25 each p & p 38c.



PRICE
CRASH



SIGNETICS LINEAR I.C. TIMERS

NE555 TIMER. As recommended in the ELECTRONICS TODAY project features, in the November issue. Owing to an enormous purchase of these very versatile linear I.C.'s we can now offer them at the very low price of \$1.00 each or 10 for \$9.50
FEATURES: Timing from Microseconds through Hours; Operates in both Astable and Monostable modes; Adjustable Duty cycle; High current Output can source or sink 200 mA; Output can drive T.T.L.; Temperature stability of 0.005% per °C Normally ON & OFF output. Also special offer of Signetics NE556 Timer (Replace 2 NE555 Timers). Same features as above but in a 14pin D.I.L. package \$2.15 each or 10 for \$20.00. NE553 4 Timers in one 14pin D.I.L. package ... Only \$3.60 each or 10 for \$32.00

bankcard
welcome here

IRH COMPONENTS

Established 40 Years and here to stay.

Metal Glaze Resistors

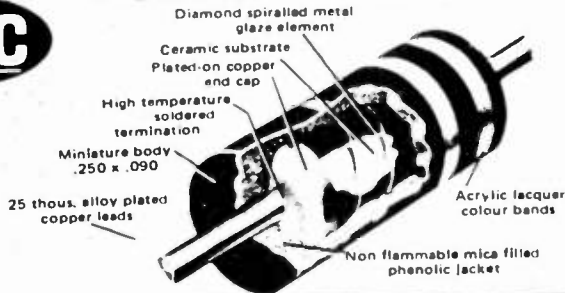

1/2 watt @ 70°C .250" x .090"
Miniature Body Size

- Plus! Lower Temperature rise (40°C)
 - Plus! Thick Film Reliability
 - Plus! Generous Power Safety Factor
 - Plus! Fully Insulated Non-flammable Mica Filled Phenolic Jacket
- Result! THE SAFE ONE

Wire Wound Resistors



Inorganic **Fireproof**
Rectangular Ceramic Construction
or ... Precision Wound Non-flammable
Resin coated Tubular Styles

Pots and Presets



Standard and Miniature
Carbon track Volume
Controls and Pre-sets
Wire Wound Potentiometers

Ceramic Filters



SFC-5.5MA for SOUND I.F. in TV
SFC-10.7MA for FM I.F.
SFD-455B for 455KHz I.F.

All these components are available through most electronic suppliers
but for detailed technical information complete the coupon and post to-day

METAL GLAZE WIRE WOUND POTS & PRESETS MURATA

IRH COMPONENTS DIVISION
NATRONICS PTY. LIMITED
The Crescent, Kingsgrove, N.S.W. 2208

Wholly Australian owned, and the largest manufacturer
of resistive components in the Southern Hemisphere

NAME

ADDRESS

POSTCODE

IDEAS FOR EXPERIMENTERS

All ideas this month, except where otherwise noted, were contributed by Roger Harrison

ADJUSTING POWER SUPPLIES

When the output voltage of a power supply comes out a little higher than expected it can be adjusted by making the simple addition illustrated above.

R1 is a 500 ohm or 1000 ohm potentiometer (10 watt rating) inserted in series with the input filter capacitor. Adjust it to give the correct

voltage under load.

For low voltage supplies (i.e. up to 50 V or so) a 50 ohm or 100 ohm pot might be more suitable.

The pot could be connected between the negative lead of C1 and ground and would not then need to be insulated.

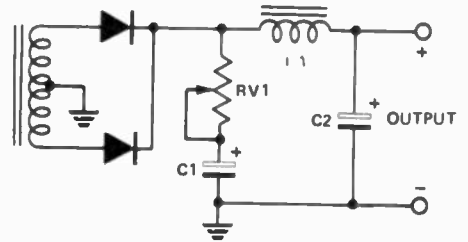

SIMPLE RF PREAMP

Many shortwave receivers of the cheaper variety and old surplus general coverage receivers (i.e. RBZ, AR8 etc) don't have a great deal of sensitivity, and are prone to image problems due to poor front-end selectivity.

This circuit considerably improves matters, providing a worthwhile increase in sensitivity and considerable improvement in front-end selectivity.

The transistor, Q1, can be any of BFY90, 2N3653, BF115, SE3001, TT3001, BC108 or any good RF amplifier transistor.

The tuning capacitor can be any standard broadcast-type (i.e. Roblan

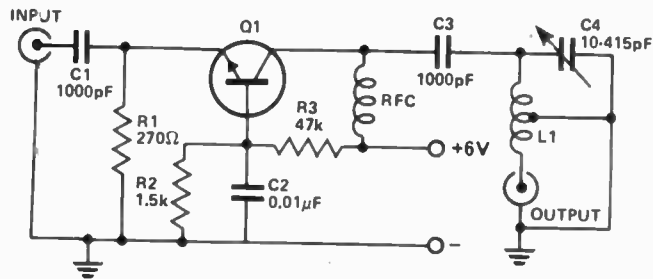

RMG-1). The RFC can be either 1 mH or 2.5 mH (i.e. Aegis C13 or C4 or C2).

The coil, L1, can be 20 turns on a

suitable toroid tapped at 4 turns (try also tapped at 7 turns). Alternatively it could be any suitable coil tapped at about one fifth of the total turns.

100 KHZ MARKER GENERATOR

The above marker generator will produce strong signals every 100 kHz from 100 kHz to over 200 MHz. It is very useful for calibrating receivers and for use as a signal generator.

Cheap transistors type BC108 give good results but almost any PNP or NPN transistor having a gain-bandwidth product greater than the desired frequency range will give good results.

The oscillator should be calibrated by adjusting it to zero-beat with WWV at 10 MHz, or 15 MHz, on a

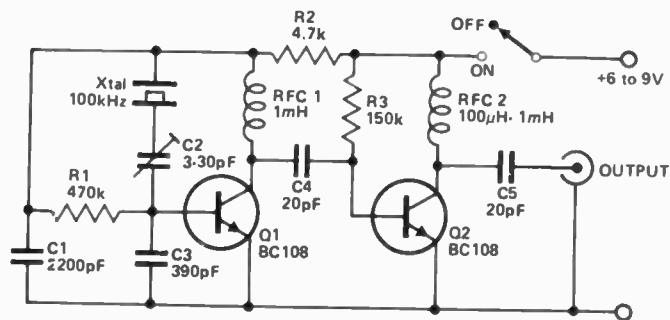

communications receiver, or with a digital-frequency meter.

The choke, RFC1, can be any

suitable small RFC (i.e. Aegis C13), the same for RFC 2 (i.e. Aegis C13 or UPC 100 to UPC 560).

REGULATED VOLTAGE DIVIDER

IC's requiring 3.6 or 6 volts can be run from a battery or fixed-regulated supply of a higher voltage by using the circuit shown.

The transistor should be mounted on a heatsink as considerable power will be dissipated by its collector.

Additional filtering can be obtained

by fitting a capacitor (C1) as shown. The capacitance is effectively multiplied by the gain of the transistor. A ripple of 200 mV (peak to peak) at the input can be reduced to 2 mV in this fashion.

Maximum output current depends on the supply rating and transistor type (with heatsink) used.

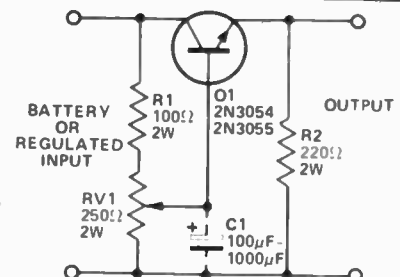

hi-fi REVIEW

from the publishers of
Electronics Today International

ON SALE NOW
at all newsagents

"OXFORD"

RADIO CHASSIS
INSTRUMENT CASES
ENGRAVED & PRINTED PANELS
"MINI BOXES" (Aluminium)
Speaker Cases
Rack & Panels (To Order)
Stainless Steel Work (To Order)

Wardrobe and Carroll
Fabrications Pty. Ltd.
Box 330 Caringbah 2229
Phone 525 5222

RADIO CONTROL MODELLERS



Silverstone

For expert advice in all phases of radio control modelling HELICOPTERS — AIRCRAFT — BOATS — CARS — YACHTS — SAILPLANES. All popular brands of radio control equipment stocked. SILVERTONE — FUTABA — KRAFT — SPACE COMMANDER — MICRO ELECTRONICS

Also a very large variety of accessories, motors, and general modelling items. Guaranteed one week service turn-around on Silverstone, Space Commander and Micro Electronics R/C gear. Manufacturers of the Silverstone range of R/C equipment, as used in almost every successful Australian R/C model aircraft record attempt during the past 14 years.

(Gregory's reference 31 O 15).

SILVERTONE ELECTRONICS
6/2 Schofield St., Riverwood, N.S.W.
Ph 553-3517
FREE PRICE LIST
9 x 4 SAE (12c) PLEASE

IDEAS FOR EXPERIMENTERS

CLIPPER PREAMP

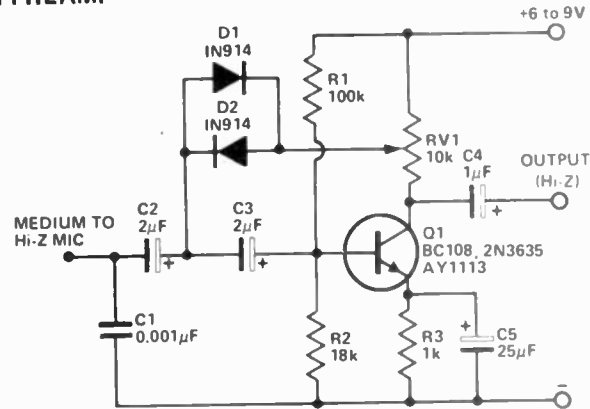

Maintaining a high average modulation level for mobile communications transmitters considerably improves the effectiveness of a transmitter, especially under difficult conditions.

This circuit provides a small amount of preamplification as well as variable

clipping level (preset).

The two diodes should be a matched pair or clipping will not be symmetrical.

It is possible to mount the complete unit in many styles of hand-held microphone cases.

DC TO DC/AC INVERTER

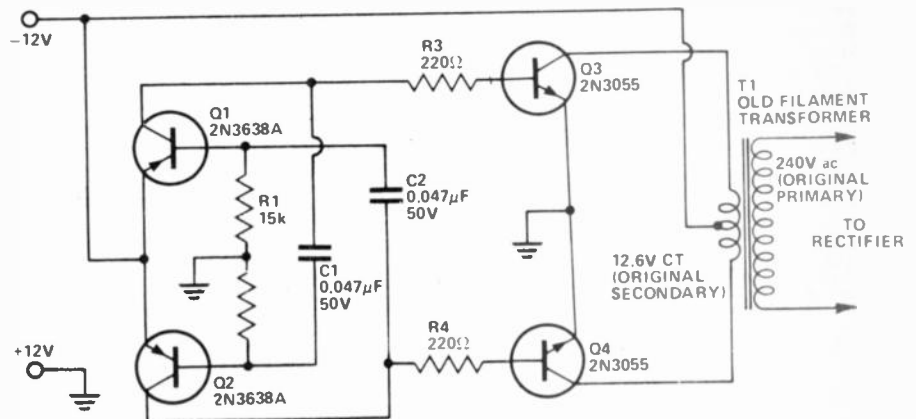

This inverter uses no special components such as the toroidal transformer used in many inverters. Cost is kept low with the use of cheap, readily available components.

Essentially, it is a power amplifier driven by an astable multivibrator. The frequency is around 1200 Hz which most 50 Hz power transformers handle well without too much loss. Increasing the value of capacitors C1 and C2 will lower the frequency if any trouble is

experienced. However, rectifier filtering capacitors required are considerably smaller at the higher operating frequency.

The two 2N3055 transistors should be mounted on an adequately sized heatsink.

The transformer should be rated according to the amount of output power required allowing for conversion efficiency of approx. 60%.

GENERAL PURPOSE RF DETECTOR

When constructing or developing communications equipment, such as transmitters, receivers etc, a very handy gadget is this general purpose RF detector. It provides dc output to

a meter and audio output (if necessary) for checking transmitters or modulated signals.

It can be used also as a field strength meter or transmitter monitor.

The values of C1 and RFC vary

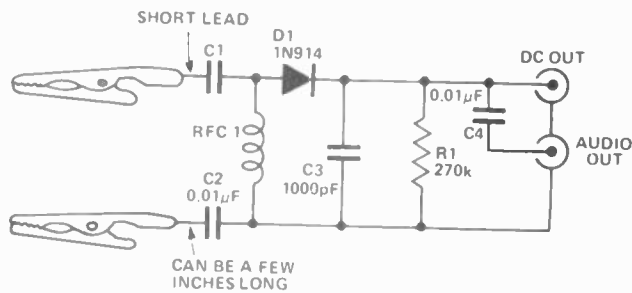

depending on the frequency range in use. Below 1 MHz, C1 can be .001 μF and RFC at 2.5 mH or 5 mH RFC (i.e. Aegis C2, C4 or C9). In the HF region to 30 MHz, C1 can be 20 pF or a 5-40 pF trimmer while RFC1 can be a 2.5 mH choke (i.e. Aegis C2 or C4) or any choke down to 470 μH (i.e. Aegis C13, UPC560 or VPC470). In the VHF range C1 can be a 2 to 10 pF capacitor or 0.8 to 7 pF trimmer. RFC1 can be

between 47 μH and 150 μH (i.e. Aegis VPC 150, UPC120, VPC100, VPC82, VPC68, VPC56 or VPC47).

Diode D1 can be almost any germanium diode or a hot-carrier diode. Mixer diodes such as the IN21 and IN23 series are also excellent. Use a diode with a high reverse-voltage rating if working with valve transmitters.

NOISE LIMITER

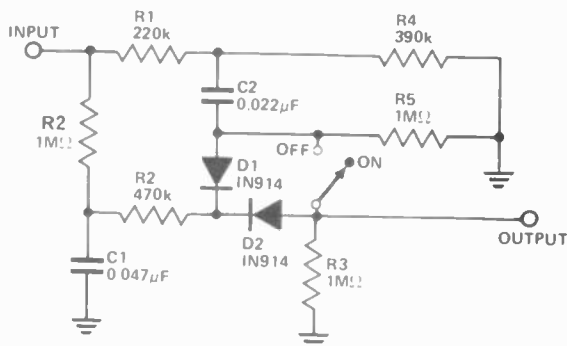

Noise pulse interference from motor vehicle ignition systems (another form of pollution — cars just can't win) can render a communications or shortwave receiver unuseable, completely blanketing reception of all signals except the very strong ones.

The limiter shown will very effectively improve the signal-to-noise ratio so that even quite weak signals can be copied.

It is connected between the detector output and the audio input (if high impedance) or at some relatively

high-impedance section between two audio stages — preferably the low level stages.

The diodes, D1 and D2 can be any diode having relatively low forward resistance and very high back resistance. Types OA202, IN457, IN458 or IN459 are suitable. Resistors of ¼ watt or 1/8 watt rating can be used if miniaturization is desired.

The circuit is excellent for receivers having bandwidths down to 2 or 3 kHz. Increase the value of C1 for receivers having narrower bandwidths.

HIGH IMPEDANCE BRIDGE AMPLIFIER

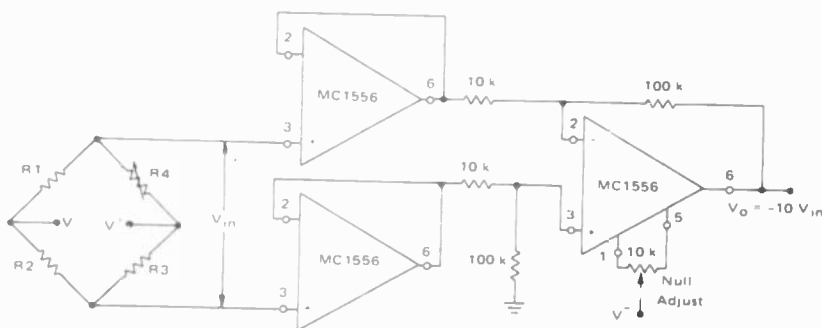

ETI by jaycar

PTY. LTD.

The new standard in professional sound

SYNTHESISER

ETI 4600 MUSIC SYNTHESISER
KIT PRICE \$869 Build and tested \$1590. ETI 3600 PRICE AVAILABLE SHORTLY.

KITSETS NOW AVAILABLE ETI GRAPHIC EQUALISER

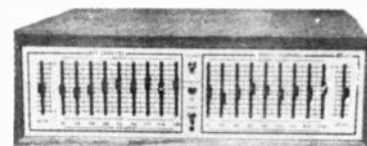

Stereo 9 adjustable frequencies per channel at octave intervals giving ±10 dB cut or boost. Distortion typically less than 0.1%. Ideal for P.A. Recording or Hi-Fi.

Complete kit price \$96

STAGE MIXER

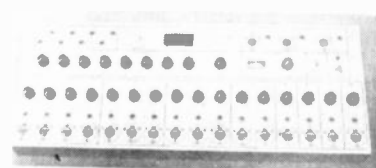

16 to 8 channel microphone sub mixer, cannon and 6-5mm Input sockets Vu monitoring switchable on all master channels, stage foldback facility can be used as a separate mixer or used with ETI 414 master mixer.

Complete kit price, \$195

414 MASTER MIXER

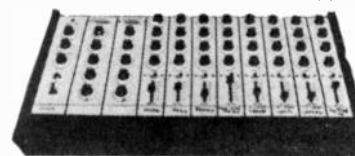

Kit price \$225

ETI 413 100 Watt amp
Kit price \$75

jaycar

PTY. LTD.

Telephone 211-5077
P.O. BOX K39, HAYMARKET
N.S.W. AUSTRALIA 2000
405 Sussex St. Sydney
ENTRANCE OFF LITTLE HAY ST.

PRICES SLASHED!!!

THIS MONTH'S SUPER SPECIALS FROM MICRONICS!!! (15188 (OA90) GERMANIUM SIGNAL DIODES - 10 for 80c, BC557 (BC177, BC157) - 10 for \$1.50, BC558 (BC178, BC158) - 10 for \$1.50, BC559 (BC179, BC159) - 10 for \$1.50. STOCK UP NOW!!! GIMA RECTIFIER equivalent to EM410 (100V, 1A) (A Superior Glass type) - 10 for \$2. ELECTROLYTICS: Pigtails 16µ (300V) - 10 for \$2. STOCK UP NOW!!! TRANSISTORS AT INCREDIBLE PRICES: BC328 - 10 for \$2, AS205 (BC107) - 10 for \$1.50, AS147 - 10 for \$2. DIODES: EM402 - 10 for \$1.20. INTEGRATED CIRCUITS: DIGITAL T.T.L. 7400, 7401, 7402, 7410, 7420, 7430, 7440 - 40c ea., 7404 - 45c, 7408 - 50c, 7413 - 80c, 7473, 7474, 7475 - \$1.05 ea., 7441, 7442 - \$1.75 ea., 7447 - \$2.20. LINEAR OP AMPS 709 (D.I.P.) - 80c, 741 (D.I.P.) - 85c. AUDIO AMP PA234 1w R.M.S. (incl. Cct Diagram) - 95c ea. COPPER CLAD BOARD - 6" x 3" - 5 for \$1. SLIDE SWITCHES (18 pin) - 4 for \$1. ELECTROLYTICS - AMAZING DISCOUNTS: Top Quality Pigtails 47µ/100v - 10 for 60c, 2µ/300v - 10 for \$2.50, 50µ/125v - 6 for \$2, 1000µ/200v - 3 for \$2, 200µ/70v - 4 for \$2, 1000µ/6.5v - 6 for \$2, 1000µ/18v - 5 for \$2, 2000µ/18v - 4 for \$2.50.

SUPERBARGAIN PACKS. A MUST FOR THE AMATEUR, HOBBYIST or SERVICEMAN POLYESTER CAPS: All 10% Tol. in volt. of 160v, 270v, 400v (Mixed) - 100 for \$3. RESISTORS: Mostly 5%, 10%, 1/4w, 1w, No Short Lead Rubbish (Mixed) - 100 for 90c. TRANSISTORS, NEW, BRANDED pnp and npn germanium types (Mixed) - 10 for \$1.75. POWER RESISTORS: 3w-7w, 5%, 10%. ELECTROLYTICS: Top Quality Pigtails incl. low volt. and high volt. - 25 for \$1.90. CERAMIC CAPS: Low and high volt. Types - 50 for \$1. TANTALUMS: Miniature - 20 for \$1.90. ZENER DIODES: (Mixed) 400mw, 1w, 10w types - 10 for \$2.95 TAG STRIPS: (Mixed) - 40 for \$1.95. COILS: Miniature for coils Osc. I.F. (mixed) unmarked - 20 for \$1.50. STYROSEALS: Top grade (Mixed) - 25 for \$1. POTENTIOMETERS: including dual single, switch and preset pots - 20 for \$2.95. SWITCHES: Including rotary, slide and P.B. Switches - 10 for \$3.50. SILICON DOUBLE DIODES: (20v, 30ma) TD772: for making up AND GATES - 20 for \$1.00 µ/100v Poly Greencaps - 20 for \$1.00 µ/100v Poly Greencaps - 20 for \$1.20. FEED THROUGH CERAMICS 1000pf/350v - 10 for \$1. Post and Pack 30 or extra for heavy parcels. MICRONICS, P.O. Box 175A, Randwick, NSW, 2031.

ADVERTISERS INDEX

Adcola	108
Applied Technology	102
Arrow Electronics	31
Associated Controls	101
Auriema	7, 65
Babylon Electronics	86
B.J.D.	53, 106
Bright Star Crystals	103
Challenge Hi Fi	37
Colrose Electronics	97, 109
Convoy	81
Danish Hi Fi	50, 51
Dick Smith	10
Edge's Electronic World	10
Electrical Equipment	56
Electronic Agencies	80
Electronic Disposals	99
Electronics Parts	78
Elmeasco	97
Emona	99
Ferguson Transformers	74
Geroge Hawthorn	95
Haco	2
Hewlett Packard	95
Hi Fi House	85
I.C.S.	30
International Dynamics	12-13, 119
International Electronics	104
I.R.H.	114
J.B. Electronics	78
John Carr	117
Kitsets	57, 64
Logan Brae	99
Maurice Chapman	111
Micronics	118
Miranda	8-9
M.S. Components	113
M.S.P.	112
Non Linear Systems	75
Pioneer	32
Plessey Australia	15, 105, 112
Pre-Pak	14
Protector Alarms	101
Rank Industries	120
Recruiting (Army)	79
Richard Foot	23
Royston Electronics	74
Silvertone	116
Sun Electric	25
S.T.C.	36
Tandy Electronics	52, 103
Trident TV	33
Union Carbide	24
University Graham Instruments	41
Video, Hi Fi	11
Wardrobe & Carroll	74
Wedderspoon, W.C.	4

IDEAS FOR EXPERIMENTERS

The MC1556 operational amplifier may be used as a voltage follower in a bridge amplifier application. The high input impedance avoids loading effects on the bridge and transforms the impedance down to a level where a third amplifier used in a differential mode can provide voltage gain, 10 in this case. The third amplifier employs the standard offset adjust circuit to provide nulling capability for the configuration.

Although the circuit is shown for complementary supply voltages, it lends itself well to operation from a single supply since the bridge can be operated just as well from the single supply. One must, however, provide for biasing the now-grounded 100 kΩ resistor to half the supply voltage using a simple resistive divider. Also, of course, the output is no longer referenced to ground, but to half the supply voltage. MOTOROLA-AN531.

LOGARITHMIC AMPLIFIER

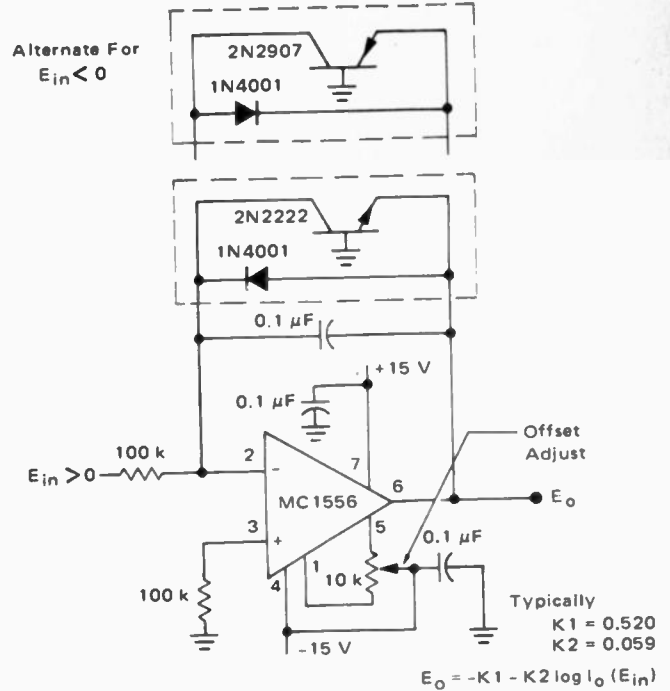

A logarithmic amplifier may be constructed using the MC1556. The principle of operation relies on the exponential relationship between the base-emitter voltage and collector current of a transistor. Use of an NPN transistor implies operation with only positive input voltages. A PNP can be used just as successfully to accept negative input voltages. A diode is employed across the collector to emitter to protect the base-emitter junction from degrading effects of reverse breakdown resulting from accidental reversal of the input voltage polarity. Noise pick-up is eliminated by the 0.1 µF capacitor across the diode by reducing the closed loop ac gain. Offset adjust is used to eliminate errors due to the input offset voltage.

The advantage of the MC1556 is this circuit is its low value of input bias current which permits operation down to 1 mV input voltage with 1½% accuracy without bias current compensation. MOTOROLA-AN531.

As the name of this section implies, these pages are intended primarily as a course of ideas. As far as reasonably possible all material has been checked for feasibility, component availability etc, but the circuits have not necessarily been built and tested in our laboratory.

Because of the nature of the information in this section we cannot enter into any correspondence about any of the circuits, nor can we produce constructional details.

Electronics Today is always seeking material for these pages. All published material is paid for - generally at a rate of \$5 to \$7 per item.



Precision designed and engineered high fidelity record playing equipment

The world of Micro is created by a talented team of engineers skilled acoustic technicians and expert designers.

Micro tone arms, cartridges (moving coil and moving magnet) belt drive and direct drive turntables are the culmination of many years of research in high fidelity playback components.

The Micro trademark symbolising an elliptical stylus tracing the record groove is the slogan of the company. An integrated manufacturer specialising in the production of record playing equipment that challenges the ultimate in faithful reproduction of the original sound. Each unit is assembled with skill, craftsmanship and pride and tested before delivery to you to ensure dependable trouble free performance.

sound quality
starts with
MICRO



Sole Australian distributor

**INTERNATIONAL DYNAMICS
(AGENCIES) PTY. LTD.,**
P.O. Box 205, Cheltenham, Vic. 3192

INTERDYN

Available from:

N.S.W.: M & G Hoskins Pty Ltd, 37 Castle St, Blacktown 2211, Telephone: 846-1884
QLD.: Stereo Supplies, 95 Turbot St, Brisbane 4000, Telephone: 21-3613
S.A.: Challenge Hi Fi Stereo, 95 Pine St, Adelaide 5000, Telephone: 225-0599
TAS.: Audio Services, 44 Wilson St, Burnie 7320, Telephone: 31-2190
VIC.: Ence Electronics Pty Ltd, 431 Bridge Rd, Richmond 3121, Telephone: 42-3762
W.A.: Albert TV & Hi Fi, 282 Hay St, Perth 6000, Telephone: 25-2699
A.C.T.: Duratone Hi Fi, Cnr Botany St & Aitree Crf, Phillip 2600, Telephone: 82-1388

MUSICALITY.

As Japan's leading audio-only manufacturer, Sansui has always provided the vanguard in amplifier technology, design, and development.

Three new models — the AU-5500, AU-6600 and the AU-7700 — combine the latest developments in design with electronic circuitry which produces an audio transparency — **musicality** — impossible to write into technical specifications. This abstract quality must be heard.

Power output of the three models range from 70 to 110 watts RMS into 8 ohm speaker systems. Total harmonic distortion is less than 0.15% — the figure for the AU-7700 being less than 0.1%. Frequency response figures are equally outstanding.

Your hi-fi specialist will gladly tell you of all the technical innovations in the new Sansui AU range. Listen critically to these new Sansui amplifiers. **Please be quite analytical.** We believe you will confidently select Sansui.

Here are abridged technical specifications:

SANSUI — AU-5500.

Output: 35 watts RMS per channel into 8 ohm speaker systems. THD: Less than 0.15%. Frequency response: 10-35,000 Hz. +0.5, -1 dB. Sensitivity suits magnetic cartridges, tuners, tape decks, etc. Recommended list price: \$419.

SANSUI — AU-6600.

Output: 45 watts RMS per channel into 8 ohm speaker systems. THD: Less than 0.15%. Frequency response: 10-40,000 Hz. +0.5, -1 dB. Sensitivity suits magnetic cartridges, tuners, tape decks, etc. Recommended list price: \$469.

SANSUI — AU-7700.

Output: 55 watts RMS per channel into 8 ohm speaker systems. THD: Less than 0.1%. Frequency response: 10-50,000 Hz. +0.5, -1 dB. Sensitivity suits magnetic cartridges, tuners, tape decks, etc. Recommended list price: \$549.

TWO YEAR WARRANTY. All Sansui amplifiers carry a full 2 year warranty. Effective service facilities are available throughout Australia.

The key to
the Success
of **SANSUI'S**
New **AU.**
Series Stereo
Amplifiers.



**RANK INDUSTRIES
AUSTRALIA
PTY. LIMITED.**

Sydney Office: 12 Baroco St., East Roseville, N.S.W.
Tel. 406 5665. Melbourne Office: 52 Queensbridge St.,
South Melbourne, Vic. Tel. 42 0031. Canberra Office:
25 Molonglo Mall, Fyshwick, A.C.T. Tel. 95 7144.
Adelaide Office: 2 Bowen St., Kensington, S.A.
Tel. 332 4288. Brisbane Office: 14 Pine St., Fortitude
Valley, Qld. Tel. 52 7353. Perth Office: 27 Oxford St.,
Leederville, W.A. Tel. 81 4989. INTERSTATE REPRESENTATIVE: N. T. Piltzner's Music House, Smith St.,
Darwin, Tel. 5891.
W.A. Distributors for Sansui:
Adina Carlysle Limited, 1-3 Milligan St., Perth, 6000
Tel. 52 0181.
Sansui equipment is manufactured by:
Sansui Electric Co. Ltd., 14-1, 2-chome, Izumi,
Sugimoto-ku, Tokyo, Japan.

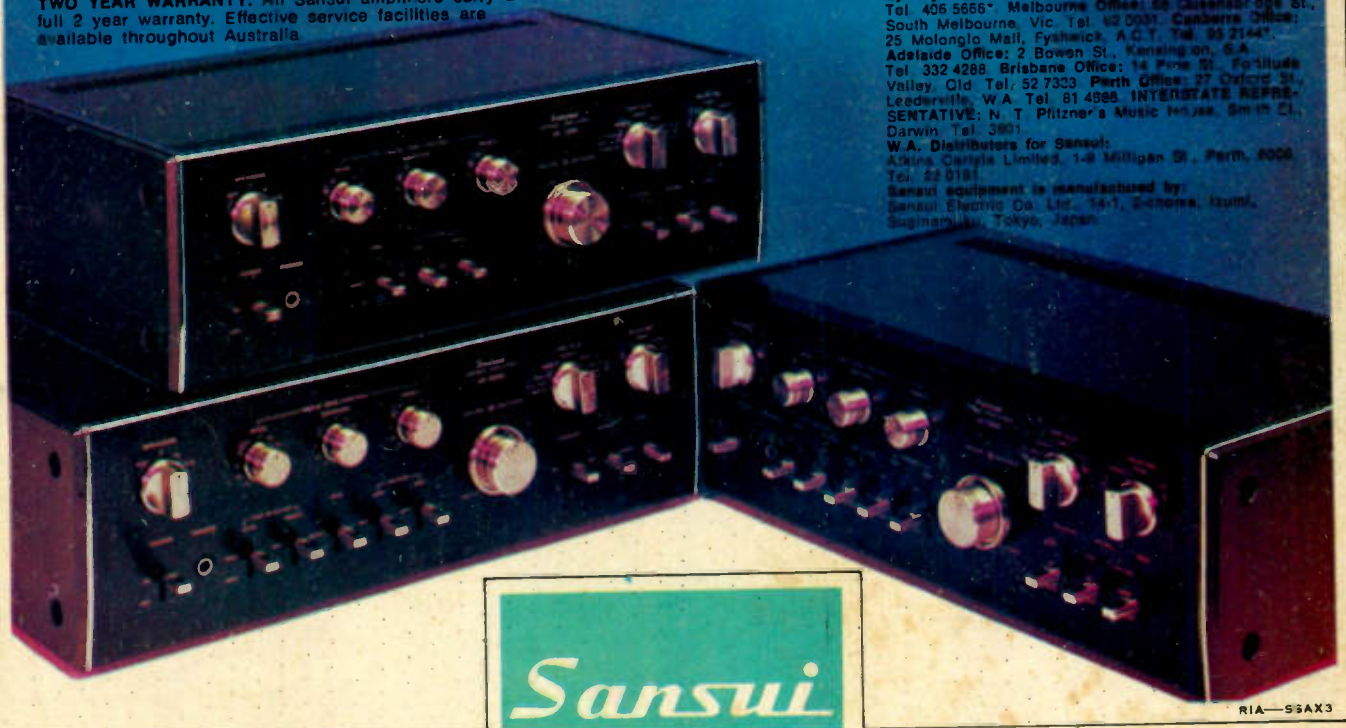

Sansui

RIA—S5AX3