

MAY, 1973
50c*

electronics

TODAY
INTERNATIONAL

Tosson

HI-FI

3 HI-FI TESTS

-273°C
QUEST FOR ABSOLUTE ZERO



THE AMAZING MAZE—ALL ABOUT TRANSMISSION LINE SPEAKERS

Registered for posting as a periodical — Category C

TEAC

If you'd like to know more
write to us for the TEAC Catalogue,
price list and franchised dealer list.

Sole Australian Distributors:
Australian Musical Industries Pty. Ltd.,
155 Gladstone Street, South Melbourne, Vic. 3205.
Phone: 69 5888 Telex: AA 33037
619 Pacific Highway, St. Leonards, N.S.W. 2065.
Phone: 439 5752

The sound of perfection



electronics TODAY INTERNATIONAL

MAY 1973

Vol. 3 No. 2

main features

- CRYOGENICS**16
Cryogenics and superconductivity – the search for the coldest cold
- THE AMAZING MAZE**24
Transmission line speakers are in the news – special report tells why
- EXPLORATION ARCHAEOLOGY**36
Electronics in the search for our past – John Stanley reports
- USING AN EARTH RESISTIVITY METER**45
Simplified method of interpreting earth resistivity data
- ELECTRICITY FROM WINDMILLS**48
Interest in windmills reawakens following Environment Conference
- STATE OF THE ART**51
Technological developments and achievements in amateur radio
- TRANSDUCERS IN MEASUREMENT AND CONTROL** .72
In this article, Dr Sydenham concludes his discussion of pollution
- SENSORS ON**86
Measurement notes – new regular column by 'Talus'
- DIGITAL STANDARDS CONVERTER FOR TV**91
New digital system converts NTSC programs to PAL or SECAM
- TELEPHONE RATE INDICATOR**94
Inbuilt unit monitors cost of phone calls as they are made
- MULTI-PROJECTION**114
How to impart a lot of information in a short space of time

projects

- EARTH RESISTIVITY METER**43
From gold to early remains – this instrument will help your search
- AUDIO FREQUENCY METER**54
ETI's simple unit approximates frequency from 50Hz to 10kHz
- ETI MASTER MIXER**59
Obtaining optimum performance, and modifying for individual needs

product tests

- EMPIRE CARTRIDGE TYPE 1000 ZE/X**22
Latest Empire phono-cartridge has excellent trackability
- TRANS-STATIC I LOUDSPEAKERS**32
First Australian review of these superb transmission-line units
- OTARI MX 5500 TAPE RECORDER**64
This compact deck has solenoid operated three-motor drive

reviews

REVIEWS – Classical, 112; BOOK REVIEWS, 109.

news & information

NEWS DIGEST, 13, 14, 125, 126; COMPONENT NEWS, 96; EQUIPMENT NEWS, 98; AUDIO NEWS, 107; INPUT GATE (READERS' LETTERS), 120; TECH TIPS, 123; SUPPLIERS GUIDE, 123; ADVERTISERS INDEX, 124.

COVER: Emphasizing the international aspect of ETI, this month's cover picture – by French photographer Dominique Sarraute – is also featured in our current French issue 'Electronique pour vous'.

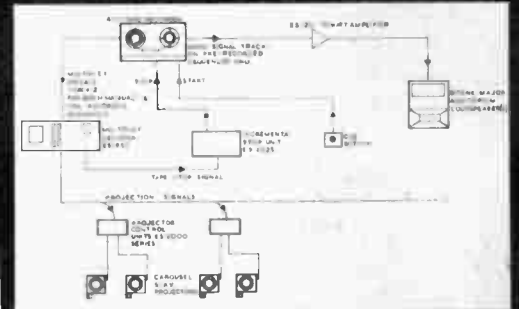
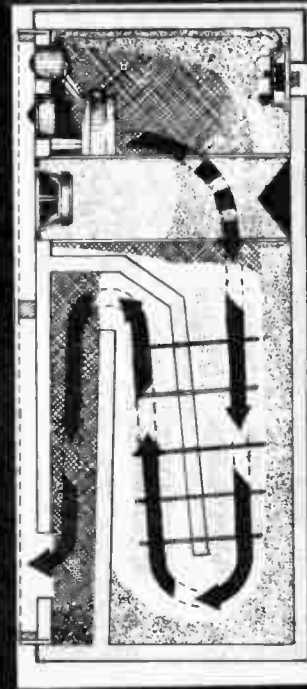

Published by MODERN MAGAZINES (HOLDINGS) LIMITED, 15 Boundary Street, Rushcutters Bay 2011. Phone: 33 4282. Cables: MODMAGS SYDNEY. Managing director: Jules Feldman. Advertising director: Max Press. INTERSTATE advertising – Melbourne: Clarrie Levy, Suite 23, 553 St. Kilda Rd. (51-9836). Adelaide: W.J. Parkinson, A.C.P., 24 Halifax St. (8-4121). Brisbane: David Wood, Anday Agency, 11-14 Buchanan St, West End (44-3485) OVERSEAS – United Kingdom: A.C.P., 107 Fleet St., London EC4, U.S.A.: A.C.P., Room 401, 1501 Broadway, New York. Printed by Compress Printing Ltd., O'Riordan St., Alexandria. Distributors: Australian Consolidated Press. (* Recommended and maximum price only.) COPYRIGHT.

Silicon Transistors

Choose the best technique to suit the application

- Alloy junction
- Diffused junction
- Mesa
- Planar
- Planar Epitaxial

Germanium Transistors

- Wide range of special and general purpose types.

Silicon Power Diodes

- Crest working reverse voltages to 1200V
- Average forward currents to 150A.

Power Transistors

- Germanium and silicon
- Dissipation to 125 watts
- Operation to 400 MHz

Integrated Circuits

- Digital
DTL — CML — TTL
(Interchangeable with SN74 Series) and MOS
- Linear
Op Amps, Voltage Regs., Audio, Receiver types.
- DIL, Flat Pack, QUIL and TO-74/99/100
- Available to MIL Specs.

Silicon Zener Diodes

- Voltage range 3.3V to 75V
- Dissipation 400mW to 75W

Small Signal Diodes

- Silicon and Germanium
- Point contact
- Diffused junction
- Gold bonded
- Planar
- Planar Epitaxial
- Oxide Passivated

Silicon Controlled Rectifiers

- Repetitive peak off-state voltage to 1600V
- Crest working reverse voltages to 1600V
- Average forward currents to 250A
- Maximum junction temperatures to 125°C.

Transmitting Transistors

- VHF
- UHF
- SSB

High Voltage Diodes

- with controlled avalanche breakdown characteristics.
- Crest working voltages to 150,000V
 - Current up to 50mA



Australia's largest range of semiconductors. The brand-*"Miniwatt"*

Australia's most experienced manufacturer in Semiconductor techniques, provide for the Industry

- Devices suitable for all applications
- Comprehensive applications laboratory services
- Ready availability via branches in all States
- Stringent quality control

PHILIPS

38.2234

ELCOMA

ELECTRONIC COMPONENTS AND MATERIALS
DIVISION OF PHILIPS INDUSTRIES LIMITED
Sydney Melbourne Brisbane Adelaide Perth Canberra

OMEGA

Collyn Rivers
Editorial Director

Brian Chapman
Technical Editor

Wendy Roy
Assistant Editor (Hi-Fi)

Barry Wilkinson
Engineering Manager

Clive Davis
Art Director

Bob Izzard
Production Manager

Howard Jenkins
Advertising Manager

Terry Marsden
Advertising (Sydney)

Clarrie Levy
Advertising Manager
(Melbourne)

Louis A. Challis
and Associates
(Acoustical Consultants)

Electronics Today International
Ryrie House
15 Boundary Street,
Rushcutters Bay 2011
Tel: 33-4282

UK EDITION

Shaun Kannan
Editor

Alex Mellon
Advertising Sales

Electronics Today International
Australian Consolidated Press,
107 Fleet St., London, E.C. 4.
Telephone: 01-353-1040

FRENCH EDITION

Denis Jacob
Editeur

Christian Darteville
Directeur de la Redaction

Edouard Pastor
Directeur de la Publicite

Electronique Pour Vous
International
17, rue de Buci, Paris.
Telephone: 633-65-43

TESTIFYING before the US Congressional committee on OMEGA finance, a US Defense Department witness stated categorically that the OMEGA navigational system will be used by nuclear missile submarines. Confirmation of this was given at the recent US Institute of Navigation when it was stated that 'the military aspects of Omega are of prime importance'.

Yet despite this and other practically overwhelming evidence, our newly elected Ministry for Transport insists, as did its predecessors, that OMEGA is a new type of navigational aid with no military significance.

It will be interesting to see how the Ministry proposes to reconcile this extraordinary line with the statement made in Wagga last July by the now Defence Minister, Mr. Barnard.

Mr. Barnard said "the previous government, in the face of mass evidence to the contrary, has persistently denied that an OMEGA station would be a nuclear target... OMEGA's military significance derives from its importance as a supporting navigational aid for nuclear submarines"... there is, he went on to say, "overwhelming evidence to suggest that this side of OMEGA is more significant than its use as a general-purpose navigational aid".

Whatever the outcome of this semantic farce, it is now unlikely that this base will ever be built, for, on March 25, the Victorian branch of the ALP adopted a resolution specifically opposing the siting of this base in Australia. It is almost certain that the resolution will be endorsed by the Federal Conference of the ALP when they meet in July.

It should be clearly understood that the siting of a base in the Australia-New Zealand area is essential to the viability of the whole OMEGA project.

Because of this, it is now absolutely essential that those concerned with formulating or influencing government policy be given every opportunity to establish for themselves the system's primary purpose and implications, for OMEGA's possible rejection by the Australian government will have far-reaching and very serious consequences.

Collyn Rivers



Our new 60-watt receiver. For people who want more power than a 100-watt receiver.

It isn't hard for some high fidelity companies to turn a 40-watt receiver into a 100-watt receiver. All they have to do is overestimate their own power.

Instead of testing their receivers at every audible frequency, for instance, they use one easy-to-reproduce frequency. Or they use "peak power" or "IHF" watts instead of true RMS watts. Or omit distortion figures.

This is similar to computing a golf score by counting only the best holes. The results look terrific but they don't correspond with reality.

You can avoid this sort of inflation by buying the new Harman-Kardon 630 receiver.

The 630 produces 30/30 RMS watts at less than 0.5% total harmonic distortion from 20Hz to 20kHz, both channels driven simultaneously into an 8-ohm noninductive load at standard line voltage.

Which is more than many 100-watt receivers can say, and that's why they don't. (If the power rating of a receiver isn't phrased exactly this way, you owe it to yourself to be suspicious.)

But the 630 not only gives you more power than

so-called 100-watt receivers; it makes better use of the power.

The 630, like our 90-watt receiver (the 930), uses a unique system called "twin power."

Other receivers have only one power source, which lets them function perfectly well with quiet musical passages. But when a sudden tone burst comes along, one channel robs the extra power it needs from the other channel—weakening both and creating distortion in the process.

The 630 eliminates this in-fighting between channels by having an independent power supply for each. So no matter how difficult the musical passage, both channels can handle it flawlessly.

Of course, all of this has a price. Fortunately, it's a moderate one: \$398.

For that, you can buy a receiver with more watts than ours. But you can't buy one with more power.

For more information, write to
Jervis Australia, P.O. Box 6, Brookvale, NSW 2100
or phone 939-2922

harman / kardon
The Music Company



DOUGLAS

SELLS SOUND FOR LESS!

...not just an idle statement, Douglas Trading want you to save money. Look at these examples...



FANTASTIC SAVINGS!



AKAI 1720L

4 track stereo tape recorder

Complete with tape, spool and 2 microphones * 4 track stereo/monaural recording and playback system * 3 speeds * Track selector * Automatic Shut-Off; Pause control * Tape cleaner * Tone controls * Speaker Switch

TOP QUALITY FOR ONLY

\$185

AKAI X-2010

Stereo tape deck

Incomparable 3 motor crossfield head recording system. Automatic and Manual Reverse, Automatic Stop and Shut-Off, Pause Control. Two large VU Meters. Response: 40-22,000 Hz (± 3 dB) at 7 $\frac{1}{2}$ i.p.s. 40-18,000 Hz (± 3 dB) at 3 $\frac{1}{2}$ i.p.s.

SAVE NOW AT JUST

\$319



AKAI GXC 46D

HI-FI cassette stereo tape deck

* Revolutionary GX head guaranteed for life * Automatic distortion reduction system (ADR) * DOLBY noise reduction system * Epoch-making O.L.S. switch * Amazing HI-FI response: 30-18,000 Hz at 58dB (with Dolby).

A SUPER SAVING! NEW SHIPMENT

\$269

UNBEATABLE VALUE!



AKAI GX 1900D

HI-FI reel/cassette combination stereo tape deck

* Both way transfer * Cassette to reel * Reel to cassette * GX wear-free head - lifetime guarantee * Response: 30-22,000 Hz at 7 $\frac{1}{2}$ i.p.s. (reel) * Response: 40-15,000 Hz ± 3 dB (cassette)

SPECIAL PRICE

\$479

* POST YOUR CHEQUE OR ORDER TODAY!

DOUGLAS for HI-FI sound

185-191 BOURKE ST., MELBOURNE 63-9321



Rodan The key to subminiature lamps and indicators

Rodan incandescent subminiature lamps and indicators are as modern as tomorrow's domestic appliance or professional equipment and are employed by leading designers throughout the world.

Advanced manufacturing techniques and experience ensure a product range providing reliable long life operation (up to 100,000 hours), simplified one-hole

mounting, front-of-panel lamp replacement and space-saving physical size.

Indicators provide models with insertable lens suitable for symbol adaption, particularly for digital readout application, while lens colours of red, yellow, green, blue and white may be selected to suit your requirements.

Lamps are available in eight voltage

ratings ranging from 5 to 48V. Indicator housings are of chrome-plated bronze or moulded plastic... lamps are available in either wire-ended or capped styles.

A standardised range is available ex-stock, including lamps which comply to International Industrial Specifications.

Literature is available on request to the Professional Components Division.

Plessey Ducon Pty. Limited
Box 2 PO Villawood NSW 2163
Telephone 72 0133 Telex 20384

Melb: Zephyr Products Pty. Ltd. 56 7231
Adel: General Equipments Pty. Ltd. 63 4844
Bris: Douglas Electronics Pty. Ltd. 97 8222
Perth: H. I. McQuillan Pty. Ltd. 68 7111
Everett Agency Pty. Ltd. 8 4137

Henderson (N.Z.) 6 4189

PLESSEY
Ducon



salute the Sansui models

210A and AU-101

SIMPLY THE MOST OUTSTANDING (AND BEST VALUE) STEREO AMPLIFIERS AVAILABLE IN AUSTRALIA TODAY.

Both are in great demand — both have received "rave" reviews in highly respected technical publications . . . and it's not surprising, for in terms of sheer performance, the Sansui models outclass similarly priced equipment, and even effectively penetrate the market of some products twice the Sansui price.

MODEL 210A.

Sansui designed and manufactured the Model 210A stereo tuner/amplifier specifically for Australian conditions — yet the maximum price you will pay is \$213.50. Output is 25 watts R.M.S. into 4 ohm speaker systems and the conservatively quoted frequency response is 25-30,000 Hz. ± 2 dB. Distinct stations are received easily, for the 210A is the most selective tuner/amplifier ever made by Sansui.

See all the features and listen critically when you visit your franchised Sansui dealer!

HEAR — COMPARE — AND BE MORE SATISFIED WITH SANSUI!

MODEL AU-101

In the review in "Electronics Australia" (August, 1971) you will read . . . "The best comment we can make about the AU-101 is that few amplifiers, regardless of price, give an overall test result as good as this". *Need we say more?*

The most you will pay for the AU-101 is \$148, and it could well be less than this when you visit your franchised Sansui dealer . . . for trade-in valuations can make a world of difference.

Now look at the AU-101 specifications—
Power output: 35 watts R.M.S. at 4 ohms, 30 watts R.M.S. at 8 ohms.
Frequency response: 20-60,000 Hz. ± 2 dB.
T.H.D.: Less than 0.8% at full rated output.
Channel separation: Better than 45dB. Input sensitivity: 3mV.

SANSUI DISTRIBUTORS: Australia, excepting W.A.:— Bleakley Gray Corporation Pty. Limited, Head Office: 28 Elizabeth St., Melbourne, Vic. Tel. 63 8101*. Telex 31904; Sydney Office: 177 Salisbury Rd., Camperdown, N.S.W. Tel. 519 3335*; Canberra Office: 25 Macquarie Mall, Fyshwick, A.C.T. Tel. 95 2144*; Adelaide Office: 301 South Terrace, Adelaide, S.A. Tel. 33 6219; Brisbane Office: 3 Prospect St., Bowen Hills, Qld. Tel. 32 7233; Perth Office: 27 Oxford St., Leederville, W.A. Tel. 81 4988. **INTERSTATE REPRESENTATIVES:** N.T.: Pfitzner's Music House, Smith St., Darwin. Tel. 3801. Tas.: K. W. McCulloch Pty. Ltd., 57 George St., Launceston. Tel. 2 5922.

Bleakley Gray Corporation Pty.
28 Elizabeth Street, Limited,
Melbourne, 3000.

Please send me complete technical details on the Sansui Model 210A/AU-101 and the name of my nearest Sansui dealer.

NAME.....
ADDRESS.....
POSTCODE.....



Sansui®

W.A. Distributors:
Atkins Carbye Limited, 1-3 Milligan St., Perth. Tel. 22 0191.

Sansui equipment is manufactured by: Sansui Electric Co. Ltd., 14-1 2-chome, Izumi, Sugnamiku, Tokyo, Japan.

AUTEL SYSTEMS PTY LTD

AUSTRALIA'S ONLY FOUR CHANNEL SPECIALIST.

Presents the largest, most comprehensive of top class 'Four-Channel' Equipment available — including the TEAC-A1340—'Four-Channel' Simul-trak stereo tape deck.

Why Four Channel?

Simple enough, the use of the four channel discrete recording and playback method represents as great an advance over existing stereo systems as did the stereo systems over proceeding monaural music systems.

Four channel sound provides a realism, a fullness, a YOU ARE THERE effect simply not available with stereophonic reproduction.

This unparalleled realism is created by reproducing both the direct and indirect sounds heard in the concert hall, at a night club or a theater.



Unlimited flexibility

In addition to the above, all the conventional methods of recording are yours with the A-3340; monophonic, stereophonic or quadriphonic recording is readily accomplished. The increasing popularity of discrete four channel material provides an added incentive to use the A-3340. 4 channel material may be recorded directly from the source. In addition 4 channel matrixed material may be rerecorded in a live room atmosphere to give added depth and presence to the matrixed material.

We're not biased — complete 'Four-Channel' range of Pioneer, Kenwood, Akai, Lafayette, Sansui, etc. in stock.

AUTEL SYSTEMS PTY LTD

20 PITWATER ROAD, GLADESVILLE, 2111
OPEN THURSDAY NIGHT

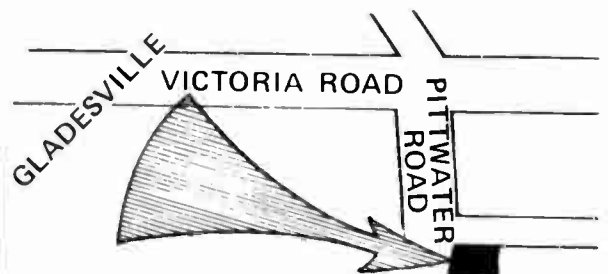

AUTEL SYSTEMS PTY LTD

AUSTRALIA'S ONLY FOUR CHANNEL SPECIALIST.

Sets the pace in 'Four-Channel' sound. 'Four-Channel' amplifiers that require no additional units to play Matrix Systems and will accept CD4 Demodulator Unit for discreet records.

JVC 4 VN-770

100 Watt 'Four-Channel' integrated amplifier complete with all facilities. This unit in a 'Four-Channel' system from \$650.00

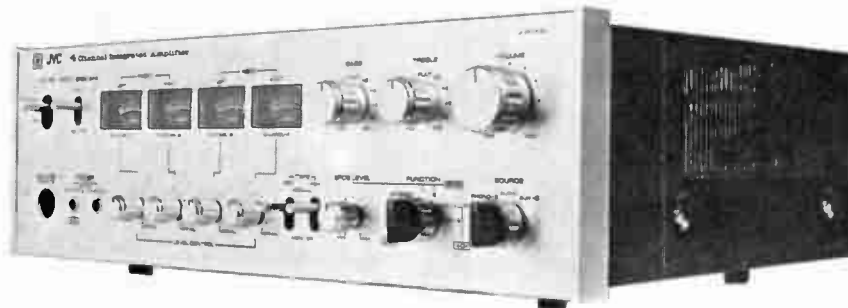

JVC 4 VN-990

The ultimate in 'Four-Channel' reproduction giving 280 watts of power complete with built-in S.E.A. equalizer and the most unbelievable range of facilities imaginable.

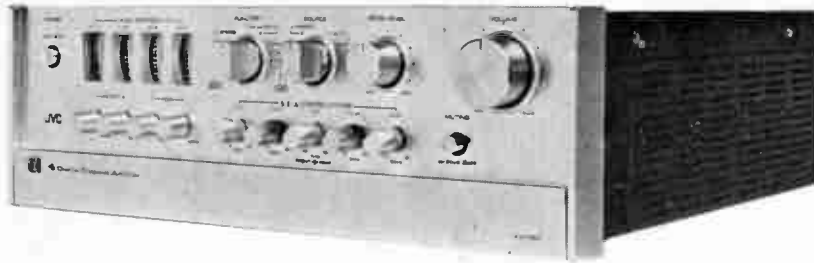

JVC 1205 U

Superlative 'Four-Channel' cartridge machine complete with eight track stereo facilities.



SYDNEY'S LARGEST STOCK OF FOUR CHANNEL RECORDS, PRE-RECORDED REEL TO REEL TAPES AND CARTRIDGES.

AUTEL SYSTEMS PTY LTD

20 PITTWATER ROAD, GLADESVILLE, N.S.W., 2111 — TELEPHONE 89 0663

Authorised JVC and TEAC Service Centre

waive the high cost factor...

the new \$199* HP function generator forms most waves you want, and more

With specifications which exceed those of many more highly priced units, the new HP 3311A Function Generator represents a significant step forward in the field of low cost electronic instrumentation.

The exceptionally low cost of the HP 3311A is made possible by new highly automated production techniques which together, with extensive testing during assembly, account for the 3311A's extreme reliability and accurate performance under all conditions.

HP 3311A Features: Seven decades of frequency 0.1 Hz — 1 MHz square wave, sine wave and triangle wave. DC offset. 10V P-P across 600 Ohms. 30 db amplitude control.

Bonus Features: Pulse output (TTL Compatible). External frequency control (for sweeping and FM). For full details and specifications of the HP 3311A, contact Hewlett-Packard.

*DUTY FREE

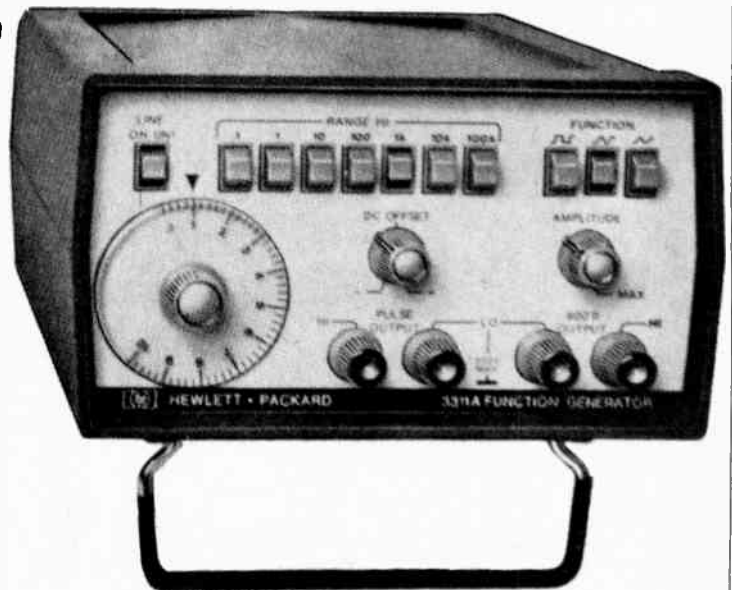

HEWLETT  PACKARD

Sales, service and support in 172 centres in 65 countries.
Australia, 22-26 Weir Street Glen Iris 3146 Victoria Telephone 20 1371
Other offices Adelaide, Brisbane, Canberra, Perth and Sydney. Also
Auckland and Wellington, New Zealand

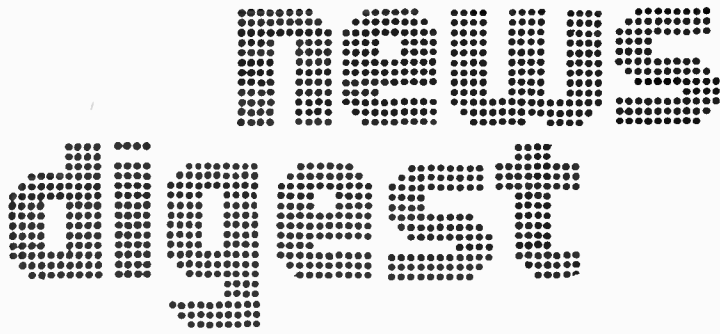

OCEANIC COMMUNICATIONS BY ULTRA-SHORT WAVES

The Nippon Telegraph and Telephone Public Corporation (NTT) is carrying out a research and development project on an original communication system called the "oceanic ultra-short wave system."

The project is to develop a system that will eliminate the need for underwater communication cables to run directly from land into the sea — a section of communications cable that is particularly prone to damage from trawlers or ships' anchors.

Nippon's proposal is to use giant ocean-based repeater stations linked to the mainland by ultra-short (4-6 GHz) wave transmitters.

The roof of the room forms a deck (18m in diameter) which serves as a

heliport for the transport of maintenance and operating staff.

To protect the repeater station from rocking by waves, more than 70% of its total height (100m) is submerged. Even in very bad weather with gales blowing at 60 m/s, waves 15m high or tides at 5 knots, the station is so designed that rocking will not exceed a 10° limit, vertical movement a maximum of 5m and drift maximum of 50m.

The oceanic repeater station is a gigantic, cylindrical and vertical buoy moored to the bottom of the sea. Its displacement is 1600 tons, it is 135m high and its main shaft is from 4 to 5m in diameter. Thirty-five metres of the total height are above the sea. A machine room 15m in diameter is placed at the top of the buoy to accommodate the antennae, the communication apparatus, the generator and the rest of the equipment.

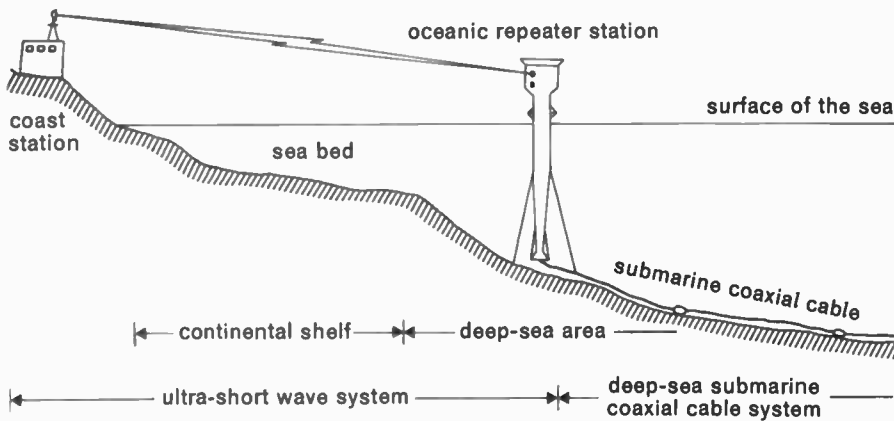

GREEN LIGHT FOR BUSES

A computerised system that enables bus drivers to hold traffic lights at green for short predetermined periods is currently being evaluated in Washington DC.

The system uses a bus-mounted dual-frequency transmitter, an antenna embedded in the road surface, a solid-state switching module in the traffic light control cubicle and a Xerox Data Systems Sigma 5 computer that correlates the bus signals with overall signal light operation.

If a bus is within a couple of hundred

feet of the intersection whilst the traffic lights are green, a signal from the driver will hold the lights at green if they are within 10 seconds of changing.

A second antenna on the far side of the intersection advises the computer that the bus has cleared the intersection.

Overall contractors for the system is Sperry Rand, software has been prepared by TRW.

LIGHT TOUCH

In much the same way that a magnetic material retains a magnetic

charge, an electret retains an electrical polarizing voltage — almost indefinitely.

So far mainly used for microphones, the electret principle is currently being researched by Bell Telephone Laboratories for possible incorporation in their 'Touch Tone' dialling system.

Instead of mechanical switches that require finger pressure for their operation the new technique uses paper-thin electret foil that provides electrical signals merely at the touch of a finger.

HP ADOPT FLEXTIME

Hewlett-Packard, at their Palo Alto (California) plant have adopted a program permitting their workers to arrange their own working hours.

The program has been designed to enable Hewlett-Packard staff to begin work at any time they choose within a specified two-hour period and to leave after they have then completed an eight hour working day.

Approximately 70 percent of Hewlett-Packard's staff are able to take advantage of the scheme. (The basic principles of the scheme — known in Europe and Australia as 'Flexitime' were described in ETI, August 1972).

LIQUID CRYSTAL READOUT IN NEW pH METER

Believed to be the first instrument in the world to incorporate a liquid crystal read-out, Beckman Instruments of Fullerton, California have introduced it as part of their new digital pH meter — pHasar I.

The liquid crystal display is in fact part of a digital panel meter — made by Digilin of Glendale, California.

NS ELECTRONICS APPOINTMENT

NS ELECTRONICS PTY. LTD., have announced the appointment of Mr. Geoff Drury as manager of their newly established "Systems Division".

Mr. Drury, who has had wide experience in the Australian electronics industry will be responsible for the expansion of the Companies activities in the minicomputer, point of sale and data peripheral area and in addition is able to offer customers systems design and manufacturing capability.

For further information contact NS Electronics Pty. Ltd., cnr. Stud Rd. & Mountain H'Way, Bayswater, 3153 or telephone Melb. 729 0731.

N.A.T.A. REGISTRATION

Ferguson Transformers Pty. Ltd., manufacturers of transformers, dis-

Turn to page 14.

news digest

(Continued from Page 13)

charge lamp control gear and power supplies have announced their registration by the National Association of Testing Authorities, Australia as a N.A.T.A. Laboratory in the field of Electrical Testing.

N.A.T.A. registration requires trained personnel, periodic equipment recalibration, laid down laboratory procedures and regular inspections by N.A.T.A. officers to ensure continuance of registration conditions. As such, Test Reports issued under the N.A.T.A. Emblem are universally accepted throughout Australia as being factual and accurate.

Ferguson Central Research Laboratories are situated in a modern building of 9,000 sq. ft. at Chatswood N.S.W. The main laboratory area occupies 4,000 sq. ft. and contains a variety of precision equipment for the accurate measurement of voltage, current, power, resistance, temperature etc.

N.A.T.A. testing by Ferguson's is now available to customers and other interested parties (within the terms of registration).

SPACE ENGINE TEST CENTRE

Ion engines (i.e. reaction engines that electrostatically reject metallic ions) that could be used for propelling satellites, are to be tested in this large high vacuum chamber built for the Royal Aircraft Establishment (RAE), Farnborough, by Edwards High Vacuum (Plant), in southern England.

Ion engines have a very small controllable thrust and this vacuum chamber will enable RAE to investigate them and to determine their performance in outer space conditions. The outstanding characteristic of the new vacuum chamber is that it has been designed for continuous operation for up to a year at a pressure less than one ten-millionth of a Torr. A Torr is a unit of measurement of pressure used in the field of high vacuum. The vacuum chamber is a polished stainless steel horizontal cylinder with the engine mounted on a door at one end. The unit is evacuated by two high capacity vapour diffusion pumps backed by three rotary mechanical pumps, any one of which can be isolated for servicing. Mercury vapour from the ion engines is collected by a liquefied gas trap that can be removed through a vacuum lock which — together with its independent pumping system — can be rolled clear when not in use. The major controls are mounted on a remote instrumentation panel, and safety interlocks are provided.

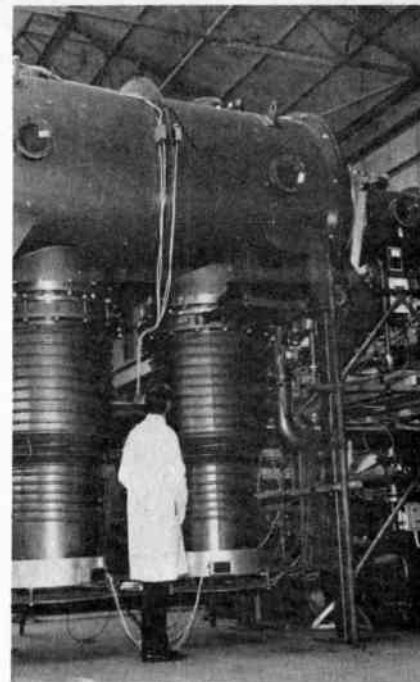

TWO-WAY RADIO WITH A DIFFERENCE

Philips new high performance VHF FM 2-way radio model FM806 incorporates a new device that overcomes the constant chatter of other users on the same channel. The device eliminates this problem for both the base station operator and the vehicle driver. The result is that the base station operator only hears calls from his vehicles, and the vehicle operators only hear their own base calls.

Philips claim that whilst the basic idea of the feature is not new, the device represents a considerable advance on any other system in that it is

automatic. It can also provide further facilities including selective calling, group calling, alarm signalling and call received indication. The device is also available for all other Philips models.

Fully solid state, the new receiver incorporates integrated circuitry, silicon transistors and printed wiring, it is available for operation in the 70-85 MHz or 148-174 MHz bands from 12 volts dc. Optional convertors allow operation from 6 volts dc, 24 volts dc or 240 volts ac main supply. High or low power, single or multi channel models (up to 10 channels) are available.

(Continued on Page 125)



Sonab

Dealer of the Month

Talk to PHIL HARRISON at CONVOY TECHNOCENTRE

CNR PLUNKETT & MACLEAN STS WOOLLOOMOOLOO, NSW
TELEPHONE: 357-2444

**When second
best is not quite
good enough....**



think of Sweden...and Sonab

SONAB of Sweden Pty. Ltd., 114 Walker Street, North Sydney, N.S.W. 2060. Ph 929-4288/4554.

Cryogenics and superconductivity

THE SEARCH FOR THE COLDEST COLD.

by Dr. Peter Sydenham Ph.D., M.E., M.Inst. MC.



PURE RESEARCH involves expeditions into the unknown — to be somewhere or do something never accomplished before always carries with it the chance of a significant discovery that will eventually alter the current practice for the better.

The story of cryogenics and the quest for the coldest cold is such a tale. Its commercial benefits, many of which were discovered without expectation of the remarkable and useful effects found near absolute zero, are just being realised after a century or two of patient and devoted research by many scientists. They each investigated some aspect of science not knowing the full implications of the collective nature of the whole.

Lavoisier, Callletet, Charles, Amontons, Boyle, Maxwell, Boltzmann, Carnot, Claude, Wroblewski, Faraday, Kelvin, Onnes, Van der Waals, Andrews, Dewar, Plank, Einstein, Nernst, Joule, Thomson, Dulong, Petit, Weber, Debye, Bohr, de Broglie, Heisenberg, Born, Fermi, Dirac, Bose, Sommerfeld, Glaque, Curie, Mendelsohn, Simon, Shubnikov, Lazarev, Meissner, de Hass, Voogd, Frollich, Bardeen, Cooper, Schrieffer, Bogolyubov, London, Keesom, Kapitza, Landau (apologies to those others omitted), each in his own way assisted the development of what was once pure research — the search for the coldest temperature — into a group of knowledge enabling technological science-fiction devices to be realised.

The uses of techniques that provide extremely low temperatures near the absolute zero are widespread, but it is only recently that far-reaching applications have been seriously considered. Fast logic for computers, suspension systems for high speed trains, magnets of enormous field strength for research, scope to build large capacity but smaller size power generators, determination of physical constants to increased precision, improved particle accelerators, a

Fig. 1. The method of cascades devised by Pictet can produce liquefied oxygen.

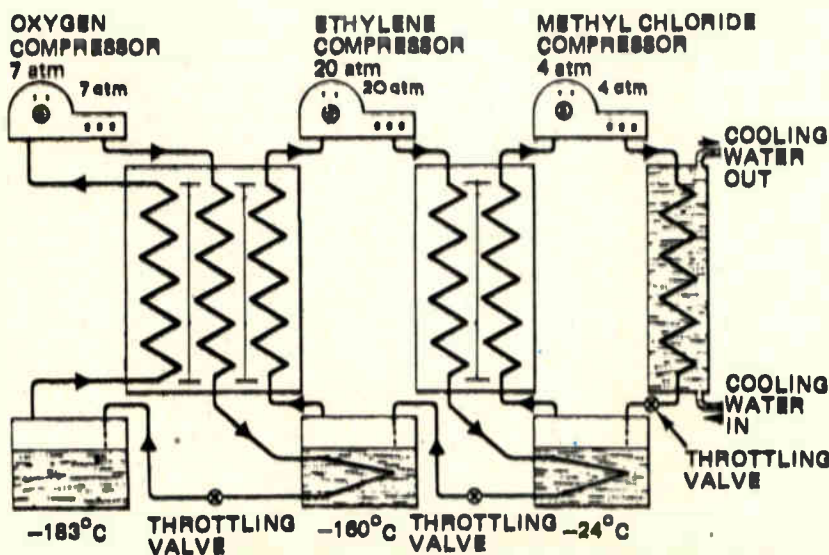

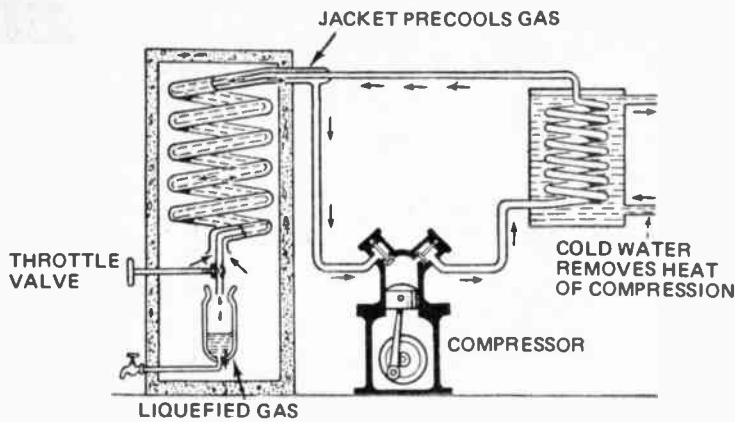

Fig. 2. Liquefaction obtained by the cooling of the release of pressure in the Linde-Hampson process is based on a principle devised by Joule and Thomson. They used a wad of silk instead of the modern expansion valve shown.

suspension system for a gravity meter, low-loss small-size dc transmission lines, greater detection in missile seeking trackers, cauterizing and incising in medicine — these examples each make use of cryogenic techniques originally devised and improved by scientists and engineers.

COLDER AND COLDER AS THE DECADES PASS

In the 18th century Lavoisier (the scientist who demonstrated that teams of horses could not part two half-spheres held together by the effect of an internal vacuum) predicted from intuition that gases could be liquefied as the temperature was lowered. He was unable to prove this experimentally — that was the accomplishment of Cailletet and, independently, Pictet in 1877. Previous to this, most attempts to liquefy gas had been by increasing the pressure — not an easy method. Cailletet discovered the cooling effect of a gas expanding suddenly from a high pressure condition. Pictet devised a method, known now as cascade cooling, by which a liquefied gas was used to pre-cool another (with a lower boiling point) before the pressure was increased. Both Cailletet and Pictet managed to liquefy oxygen and thereby obtain 119°C of cold. This was a big step from the freezing mixtures that produced only 60°C of cold.

The cascade method is shown in Fig. 1. Compressed methyl chloride is cooled by a water jacket; it then expands through a throttle, cooling down to -24°C. This is then used to extract the latent heat of compression of the next, ethylene, cycle that in the same way produces a liquid at -160°C. Finally oxygen is used, being liquefied at -183°C. The method cannot be continued, for there is no

substance having the necessary critical temperature and triple points to span to hydrogen.

Even before this time, Amontons, in the 17th century, had realised from observations made with an air thermometer (in which volume is related to temperature), that there seemed to be a lower temperature that could not be exceeded by any method.

It was a century before the concept was accepted after being formulated by Charles and Gay-Lussac. This lowest value was shown to be -273°C, and was subsequently called 'absolute zero'. A temperature scale — the Kelvin scale, starts with zero at this point and has the same subdivision sizes as the Celsius scale. Because this degree of cold had not been realised — liquefied oxygen was the best so far at around 90K — the search for means to liquefy other gases continued. However, it is doubtful that anyone expected to find the extraordinary behaviour of electrical conductors when the temperature came with a few degrees of absolute zero. At around 5K many conductors lose all trace of resistance to current flow and become superconductors.

A little time before the liquefaction of oxygen, Joule and Lord Kelvin (Thomson) had conducted experiments in which a highly compressed gas was allowed to lose its pressure by passing through a porous plug. An apparatus using the principle is shown in Fig. 2. They found the gas flow emerged from the plug at a reduced temperature — this is now known as the Joule-Thomson effect. The extent of the cooling for each pressure change is not large, but by continued recycling of the gas it becomes progressively cooler. Linde and Hampson realised this in 1895 and Linde separated oxygen from liquefied air shortly after.

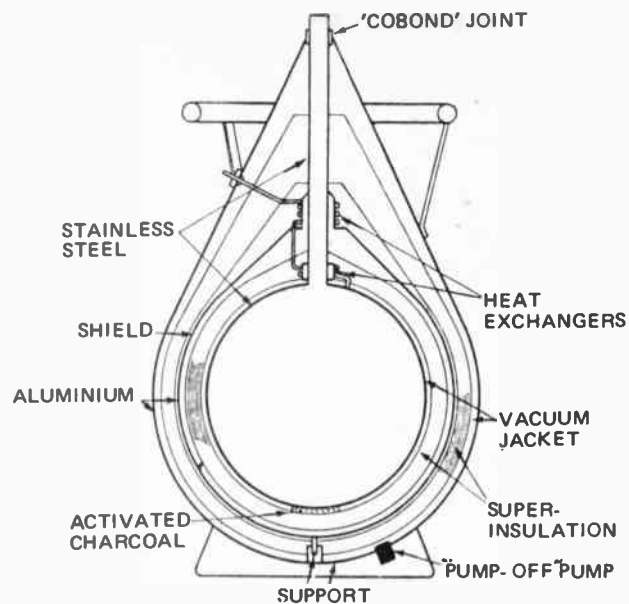

Fig. 3. A modern helium dewar. It holds 35 litres and loses only 1% per day.

In this period — the late 19th century — the interest in cold was mainly for commercial reasons — refrigeration in ships (-40°C) for the Australian-British meat trade. Liquefaction of air (-185°C is needed) by Claude in 1902 and Linde was for the oxygen needed mainly in acetylene welding and cutting. In the 1920s Claude-designed expansion engines produced temperatures of -200°C, leaving only 73 degrees to go to absolute zero.

Mendelssohn — (whose book provided much of this historical detail — (see reading list) said that even in the 1930s there was little scientific application of these engines in industry. By 1946, however, the lowest critical temperature gas, helium (5K) succumbed to the expansion method at the Massachusetts Institute of Technology in the United States. This achievement followed the liquefaction of hydrogen at 33K. But this was not the first time helium had been liquefied. That honour goes to Professor Kamerlingh Onnes of Leiden, for in June 1908 he produced a test tube containing a little liquid helium. The attempt used 75 litres of liquid air to liquefy 20 litres of hydrogen that in turn was used to precool helium producing 60 cubic centimetres of liquid.

The work of another scientist, James Dewar, paved the way to absolute zero by providing an efficient container for these cold liquids. Prior to 1892, when Dewar demonstrated the first evacuated jacketed flask, scientists had to put up with the rapid evaporation of their liquefied gases. Before this, liquid ethylene was used as a jacket around liquid oxygen — such containers became known as cryostats and the science of cold production as cryogenics. The vacuum flasks are now called Dewars in science. The cross

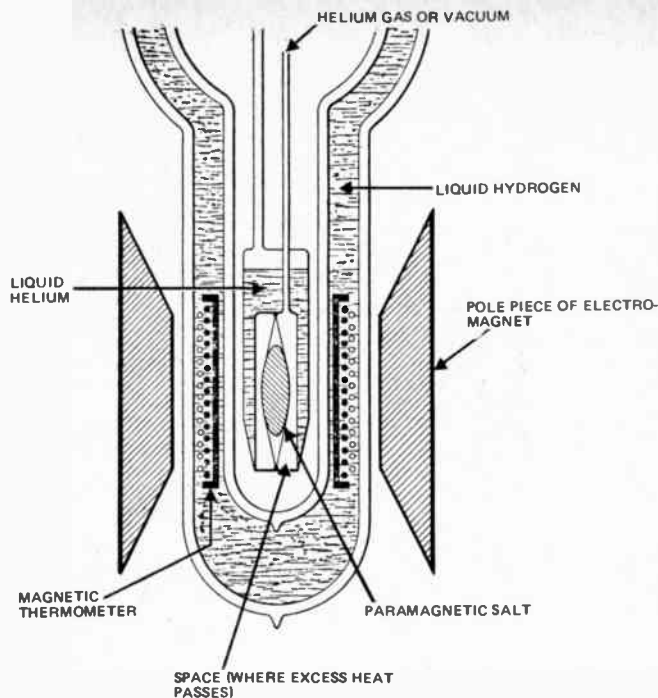

Fig. 4. Arrangement used in magnetic cooling. The salt and gas-surround are allowed to cool to liquid helium temperature. Magnetic field is applied aligning the electron spins. The gas is evacuated to remove excess heat. The field is then removed.

Cryogenics and superconductivity

section of a modern unit incorporating heat exchangers to further reduce the heat loss to only 1% per day, is shown in Fig. 3.

By the start of this century it was well established that OK was the lowest temperature attainable, and with only 5 degrees to go, many pure scientists continued their excursions into the unknown. Actually Onnes had obtained 1K by reducing the pressure on his small quantity of liquefied helium but he did not know it at the time. The unexpected property of superconduction had been observed but the lack of theory to predict such a departure must have deterred many a scientist from reporting his findings. Before considering superconductivity let us first complete the history of the search for ways to produce colder temperatures.

By reducing the pressure of helium its boiling point is lowered. In this way, using massive vacuum pumps, Onnes obtained 0.83K in 1922. This, most people thought, was the end for no lower boiling point gas exists. Onnes, however, did not hold that view, and he was soon proven correct. While Onnes was on his death bed in 1926 (and unbeknown to him), Giaque was experimenting at the University of California with an entirely new way to further reduce the temperature. It is now known as magnetic cooling.

MAGNETIC COOLING

In essence, magnetic cooling involves aligning the spins of the electrons

orbiting the nuclei to obtain a more than usual degree of alignment. Salts of rare earths are suited to this; examples being gadolinium sulphate, cerium fluoride, iron ammonium alum, chromic methylammonium alum (CMA for short) and manganous ammonium sulfate (MAS). As shown in Fig. 4, the bath of salt is immersed in liquid helium which is held in a hollow enclosure that can be evacuated. The pole pieces of a powerful electromagnet are placed on each side, and the field used to align the spins. Theory predicts that heat must be liberated by the salt when the electron spins are so aligned for this is a state of less entropy (the degree of state of disorder). The spare heat goes into the gas around the jacket containing the salt; pumping then removes the gas and therefore the heat. The field is then removed and the evacuated chamber now acts as a cryostat holding the salt that is cooled to around 10^{-2} K or a little less. The method is also known as paramagnetic cooling after the magnetic property of salt.

In 1936 Shubnitkov and Kazarev discovered the existence of a similar paramagnetism involving the nuclei as well as the electrons. The effect is minute, so great effort was needed to invoke nuclei spin alignment as well, thereby obtaining even lower temperatures. In 1956, 2×10^{-5} K was reached with apparatus using the principle shown in Fig. 5. In 1969 a temperature of 5×10^{-7} K was obtained by Professor Abragam.

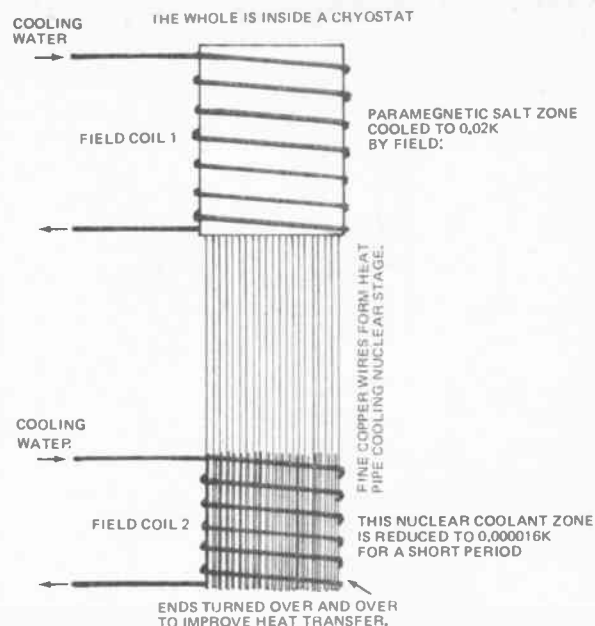

Fig. 5. Schematic of cooling method in which the spins of the nuclei are aligned (as devised at Oxford). The top stage is the electron-spin cooling stage; this cools the lower to 0.02K in readiness for nuclear cooling. The fine copper wires act as the cooling link. The second field is applied to align the nuclei spins.

THE SUPPLY OF HELIUM

Where does helium come from? It is an inert gas that got its name from the method of its discovery. In 1868, Lockyer realised it existed from his studies of the optical spectrum of the sun's corona or helios. It is distributed uniformly in the atmosphere but only at some five parts per million by volume; the low concentration makes it expensive to concentrate from this source. There are a few natural wells containing it in the United States, Canada and U.S.S.R. but even these sources are dwindling to such an extent that sales are restricted. For this reason processes needing helium aim to use recirculation systems to reliquefy the same gas.

Its common non-reuseable uses are as a mix gas (with oxygen) in deep-sea diving breathing supplies, as a gas-shield in welding, in lamps and as the non-inflammable gas for balloons.

Helium, as well as other liquid gases such as nitrogen, is invaluable as the cooling medium for extremely sensitive photo detectors used in infrared thermal sensing and missile trackers: cooling the detector element reduces the thermal Johnson noise, thereby increasing the signal-to-noise ratio. Helium is the coldest liquid gas available but the comparative difficulties of supply and storage restricts its use to applications where the higher temperatures of other liquid gases will not suffice.

Today, liquid helium is used in vast quantities. The nuclear research plant

CERN at Geneva, produces an average 40 000 litres/year for research purposes. Plants to liquefy it are reasonably common — the one shown in Fig. 6. is installed at the Division of Chemical Physics of the CSIRO in Victoria.

SUPERCONDUCTIVITY AND SUPERFLUIDITY

The disappearance of resistance in electrical conductors at a temperature of 5K, or thereabouts, was not expected. Many gases had been liquefied without departing from the normal laws of resistance. Only helium produces a low enough temperature for the phenomenon to occur.

SUPERCONDUCTIVITY:

After Kamerlingh Onnes liquefied helium in 1908, scientists were able to investigate the properties of materials at lower temperatures than before. In what was a most routine kind of test — the measurement of the electrical resistance of mercury — the Onnes team found that at 4.2K its resistance dropped sharply to an extremely low value, near enough to zero resistance in fact. This change is shown dramatically in Fig. 7. It would have been thought that the resistance would have reduced gradually, being zero only at the absolute temperature zero ($10^{-\infty}$ K). Dewar also noticed this peculiarity but did not follow it up.

Onnes continued the research and devised a way to measure the incredibly small resistance — quite out of the range of resistance bridges in use. The method chosen was to set a current going in a loop of superconducting metal deep in a liquid helium bath and then monitor the decay of field strength of the magnetic field thus produced. There was no detectable reduction after many hours, the duration of the test being limited by the then scant supply of liquid helium. Other experimenters since then have suspended a ball in the field of a superconducting loop. One such ball remained supported for two years — only dropping when the helium supply failed and the loop lost its superconducting condition. (This is not perpetual motion: but is simply a system where energy is not lost).

When superconductivity was first noticed there was little interest in the phenomena. No theory existed to explain it, so many scientists probably concluded that there was a fault in their apparatus. It was only in 1957 that a reasonably adequate theory was put forward. (Many had been proposed). This is called the BCS (after Bardeen, Schrieffer and Cooper) theory. These scientists shared the 1973 Nobel prize for Physics for this achievement. In essence, it is believed

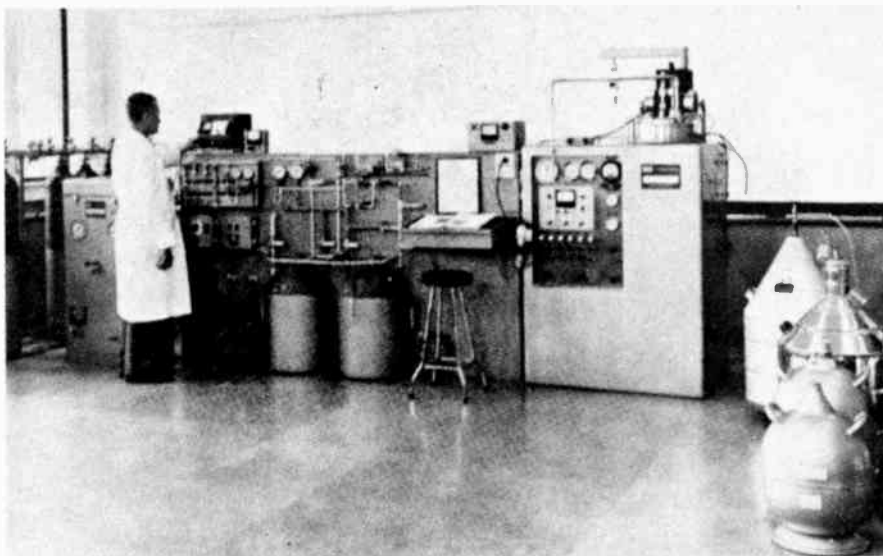

Fig. 6. Helium liquefier plant installed at the Division of Chemical Physics at the C.S.I.R.O. Helium is recovered from experiments. Note the dewars on the right.

that the vibrations of the lattice become so ordered that electrons can flow freely through without being impeded by random vibrations. Fortunately, to understand the applications of superconductivity there is no need to be familiar with the complicated physical theory.

Magnetic field strength depends upon the product of amperes and turns, so the higher the current the stronger the field, provided the medium does not saturate magnetically. At first sight this implies the production of unlimited strength fields, for enormous currents can be caused to

flow in a superconducting ring. But a limitation was soon found, for the field so produced in fact inhibits the current flow and the superconductivity is degraded. The main problems, therefore, have been to discover metals with a high superconductivity transition temperature, and to realise means by which large field strength can be obtained in a stable manner.

Over thirty metal elements and hundreds of alloys have been found to be superconductors. At liquid-helium temperature there is lead, mercury, tin, vanadium, thallium and indium.

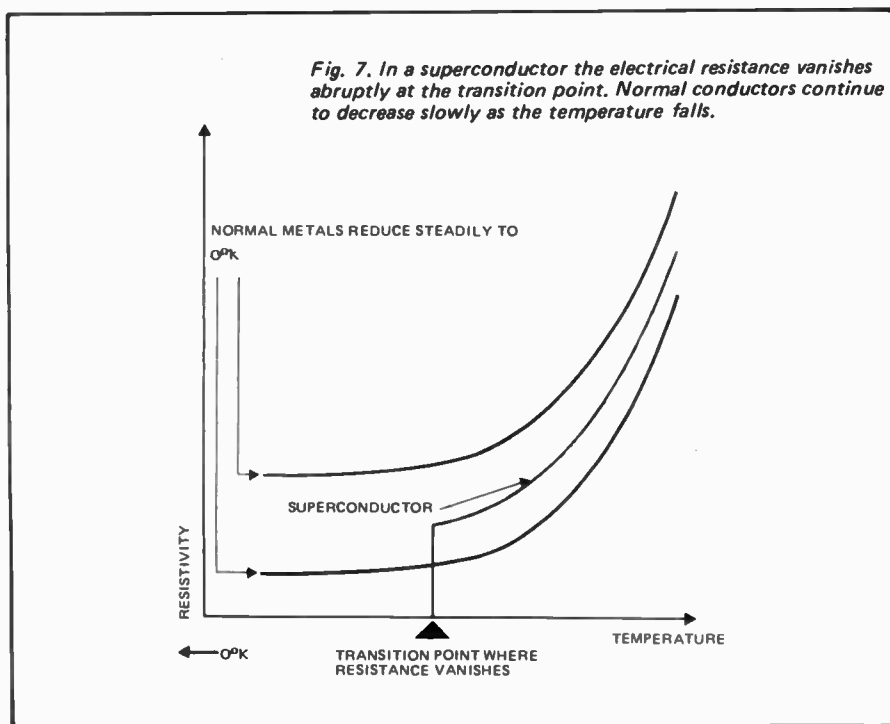

Fig. 7. In a superconductor the electrical resistance vanishes abruptly at the transition point. Normal conductors continue to decrease slowly as the temperature falls.

ECSTASY

IS



**WHEN YOU'VE GOT NOTHING
ON BUT
marantz.®**



Musical Ecstasy — that's what you'll enjoy with a Marantz Hi-Fi system, and Miranda Hi-Fi take the agony out of selecting a system right for you and your budget. Miranda Hi-Fi have a big range of Hi-Fi stereo and quadrasonic systems from just \$199, to satisfy every taste and need in Hi-Fi. Call in and experience the ecstasy of true high-fidelity sound, and discuss your needs with our friendly staff specialists.

FOR FULL SELECTION OF ALL HI-FI SYSTEMS, TAPES & ACCESSORIES
visit

MIRANDA HI-FI STEREO CENTRE

shop 67, top level Miranda Fair, NSW Phone 525-6745

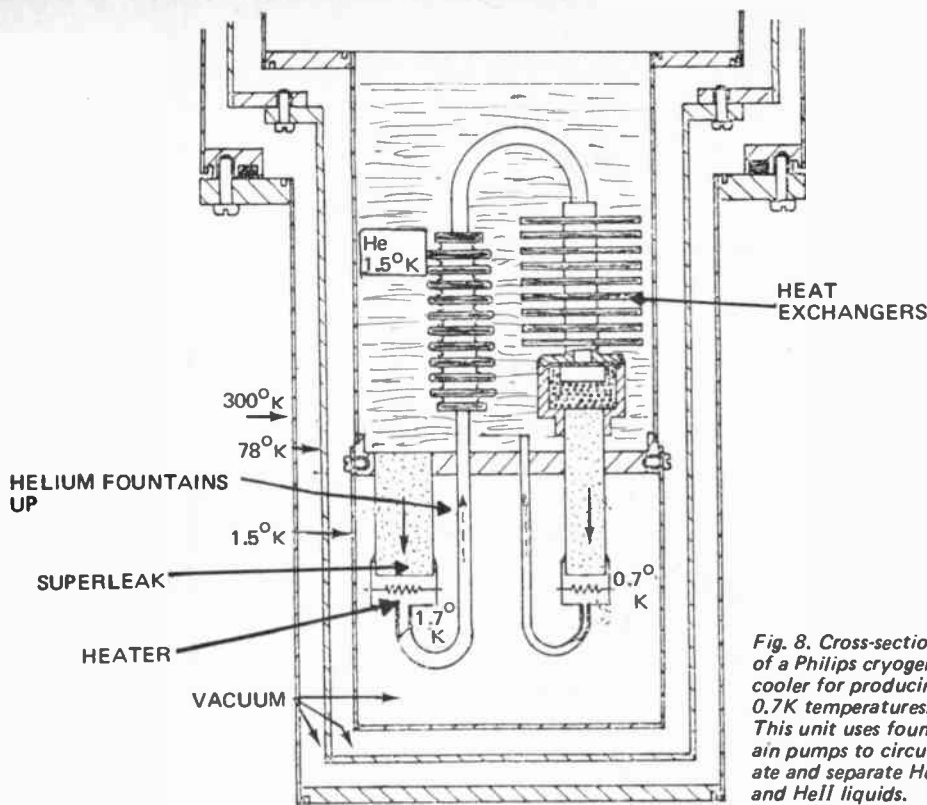

Fig. 8. Cross-section of a Philips cryogenic cooler for producing 0.7K temperatures. This unit uses fountain pumps to circulate and separate HeI and HeII liquids.

Cryogenics and superconductivity

Aluminium, zinc, cadmium, iridium and titanium are superconducting at temperatures in the magnetic cooling region around 1K. The metal with the highest transition temperature is technetium at 11.2K. (Nb_3Sn , a compound, has a critical temperature of 18.2K). There appears little likelihood of superconductors existing at room temperature.

Over the years, patient research and development has steadily produced ways to obtain greater field strengths. In 1934, Heinz London published calculations leading on from the work of others showing that in certain alloys the magnetic field penetrated to a very small depth, and, within this depth, it did not destroy superconductivity. The distance is only $10^{-7}m$ so wires have to be extremely fine. By 1937, fine wires of lead had been made and tested, with the gratifying result that increased field strengths were obtained that also agreed with calculations predicting them.

Today, superconducting magnets use mainly niobium-titanium and niobium-tin wires and tapes. The Imperial Metal Industries' Niomax, has 61 filaments supported in a normal metal matrix, the whole wire being 0.5mm in diameter. This wire can pass currents to $7 \times 10^6 A/mm^2$ (in this case, therefore, roughly 10^6 amps) and produce a field strength of 50kG (the new metric unit, the Telsa, equals 10kG) before the field degrades itself. Other forms are thin tubes to enable

the liquid helium to be pumped through, thereby obtaining more efficient cooling. Plessey produced a niobium-tin tape which has been used to build a magnet producing a 100kG field. Iron circuits are not used, for the iron would saturate well before this value is reached. A copper matrix for the filaments is not satisfactory in alternating current work; instead cupro-nickel is used as a support. It is the lossless field generation that attracts technological interest for, in the design of electromagnet devices — transformers generators, motors and magnetic suspension systems — this characteristic can be used to reduce the size of the machines without loss of output capacity.

SUPERFLUIDITY:

Another unexpected property of liquid helium occurs as it is cooled through 2.17K (called the λ point). Below this point the fluid loses all evidence of normal fluid behaviour. The heat conductivity rises enormously, conducting heat a million times better than helium above 2K. Above the transition point, the helium is called HeI, below, HeII to distinguish between them. In the region below 2K, helium takes on extraordinary properties.

Firstly, in the film transfer effect the liquid will rise up the outside of an empty flask floating in HeII, pass over the top and keep filling. Secondly, a

small source of heat placed in a tube filled with the liquid gas will pump the helium around. This is scientifically called the thermo-mechanical effect. It is, however, often referred to as the fountain effect, for when a porous plug is placed in the flow of this type of pump, the HeII actually fountains from the top in a spectacular manner. Curiously, the finer the pores or tubes used in the plug (a super leak) the easier the liquid flows — quite the opposite to normal viscous fluid flow laws.

In Fig. 8. is a diagram of a cooler for producing 0.7K temperatures that exploits the behaviour of superfluid helium. It uses a fountain pump to circulate the helium. (All that is needed is the porous plug, a small chamber and a heater.) Cooling occurs by continuously circulating the mixture of the HeI and HeII. The superfluid will be pumped around, but not the normal and higher temperature fluid. In this way there is a gradual increase in the amount of HeII in the chamber, resulting in a colder temperature.

Conversely, if HeII is allowed to flow by gravity through a porous plug it will lose heat, emerging cooler. This is the mechano-caloric effect. These two processes show there is a reversible process between heat and the flow of mass.

To date, technological interest has been with the superconductivity aspects. In the next part, the now many applications of cryogenic methods will be discussed.

FURTHER READING:

"The Quest for Absolute Zero"

K. Mendelssohn, World University Library, Weidenfeld, London, 1966. (A highly interesting book describing this development amongst scientists; many personal details enhance the description. Mathematical explanation has been avoided).

"For Explaining away Resistance"

P. Stubbs, New Scientist 1972, 56, 817, p212.

"Intrinsically Stable Conductors"

Rutherford High Energy Laboratory, Reprint No. RPP/A43. 1968.

"Expansion Engines for Low Temperature Processes"

S. C. Collins and R. L. Cannaday, Oxford University Press, 1958, London.

"Low Temperature Techniques"

F. Dinand A. H. Cockett, Newnes, 1960, London.

"An Introduction to Liquid Helium"

J. Wilks, Clarendon Press, 1970, Oxford.

"Superconductivity"

E. A. Lyton, Methven, 1969, London. (Has extensive bibliography).

Empire 1000ZE/X phono-cartridge



Latest Empire cartridge has excellent trackability and good frequency response.

electronics
TODAY
INTERNATIONAL
product test

THE DESIGNERS of record players and cartridges are faced with a number of difficult tasks, not the least of which is to faithfully transform the mechanical motion of the stylus point into a directly equivalent electrical signal. This complicated conversion is known as "tracking", and with modern music is no easy task.

To be able to perform this task faithfully, the mass of the stylus and all of the associated moving parts must be kept as low as possible, because the

greater the moving mass, the higher its inertia, and its consequent resistance to rapid movements. In addition, it is necessary that sufficient downwards force is applied to the stylus to keep it in the record groove no matter how severe are the forces tending to throw it out. This force is known as the *tracking force*, and if too high, results in accelerated wear rates for your precious records.

For good "trackability", the stylus assembly must have good compliance, which means freedom of movement — or controlled physical resistance.

It is this compliance, or the lack of it, that, amongst other factors, separates good cartridges from average cartridges.

Three main types of cartridge are in common use. These are, moving magnet, moving coil and induced magnet cartridges.

Moving magnet cartridges incorporate a tiny permanent magnet at the centre of the stylus bar. Because this is pivoted in a flexible surround, the magnet follows the motion of the stylus and induces a magnetic field between the pole faces of the pick-up coils (Fig. 1). This type of cartridge is characterized by high signal efficiency and a relatively high output, together with excellent linearity and good channel separation.

With the moving coil system, the magnets are fixed and the two coils move in the magnetic field, thereby having a voltage induced in them. The moving mass of a moving coil cartridge is usually (but not always) lower than that of a moving magnet system, but by contrast its output is so low that a special high sensitivity input has to be provided to boost the signal level. Moving coil cartridges generally provide good frequency response and adequate channel separation, and many of them have built up a reputation for excellent performance.

Induced magnet cartridges are not necessarily the least loved, but it is seldom that much is written about them. They use a simple system (Fig. 3) with two fixed coil assemblies and a fixed magnet. The inner end of the stylus assembly has two minute iron plates attached and these move in the magnetic field thereby causing variations in the magnetic flux. This

results in a modification of the induced voltage in the coils. The protagonists of the induced magnet cartridge claim that it can provide lower mass, higher linearity and improved trackability, although this is generally at the expense of sensitivity and signal to noise ratio.

Notwithstanding, a number of well respected manufacturers have changed from moving magnet systems to the induced magnet system for their top of the line cartridges.

The Empire Scientific Corporation of New York have been producing induced magnet cartridges for years, and it was with real interest that we embarked on reviewing their top of the line model, the 1000ZE/X.

The 1000ZE/X is meant to track in the range 0.25 to 1.25 grams, and is fitted with a 0.2 x 0.7 hand polished bi-radial stylus.

The cartridge uses a black plastic mounting assembly, with the standard 1/2 inch mounting centres, into which is inserted a gold finished metal screen containing the induced magnet assembly. The stylus assembly is inserted into this, and, like a number of other better class cartridges, comes complete with its own flip-down stylus protector. This feature is essential when stylus cost more than half the price of the cartridge.

Our first test was to measure the frequency response of the cartridge. This exhibited an essentially flat response to 1kHz, and dropped to -4dB between 8kHz and 12kHz. Not by any means the flattest we have seen, but generally acceptable. Channel separation was 25dB at 1kHz — and always better than 20dB decibels. This is adequate.

We then measured the square wave response of the cartridge at 1 gram tracking weight and at 0.5 grams. The response was quite good, and improved considerably when we used a better tone arm and head shell assembly instead of the heavier one fitted to the automatic turntable required for the automated frequency response curves. This bore out the supplier's comments that the cartridge performs best in an Empire arm.

The measured square wave response in the light-weight transcription arm was equal to the best that we have seen and augured well for the trackability tests that followed.

The trackability tests at 1 gram showed that the 1000 ZE/X is indeed an excellent cartridge and worthy of the title "top of the line". It had no difficulty coping with most program content.

We tried the cartridge out on a number of new records including "The

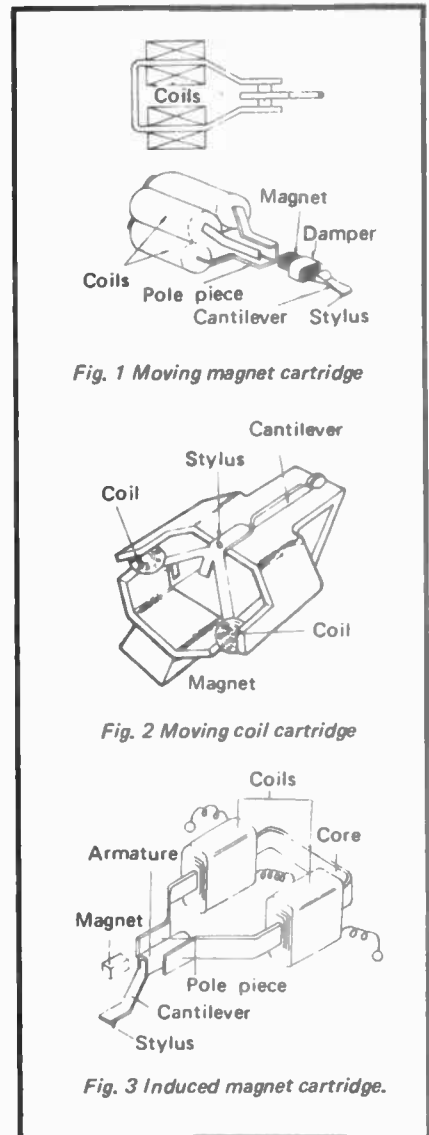

Fig. 1 Moving magnet cartridge

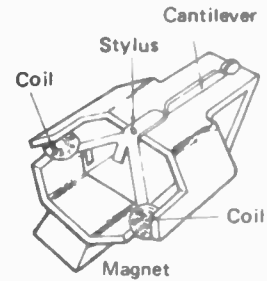

Fig. 2 Moving coil cartridge

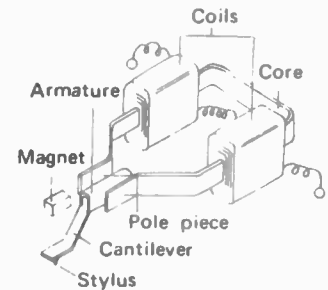
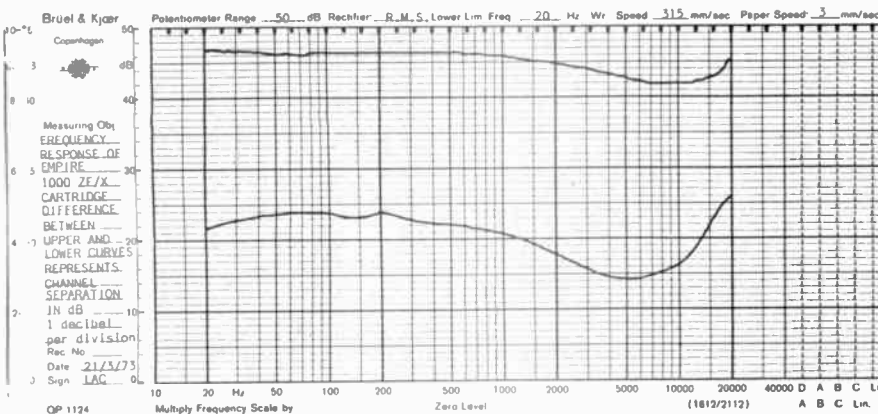
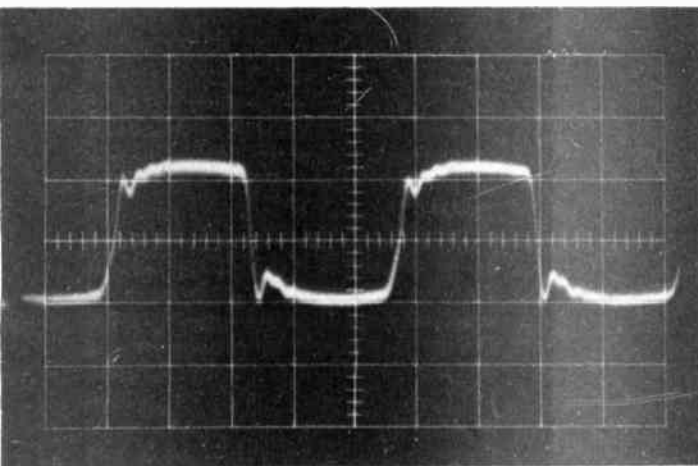

Fig. 3 Induced magnet cartridge.

Response of Empire 1000 ZE/X cartridge to 1000 Hz square wave recorded on special test record.



Music of Neil Diamond" by The Tiffany Singers (EMI 50ELP 9968), and were gratified to find that this cartridge could follow and reproduce the most difficult passages of this excellent record — some other good cartridges that we tried put up a rather poor showing by comparison. Following this we tried the Acoustic Research Demonstration Record, and the cartridge had no difficulty in following the many difficult passages in this record (Ensayo ENY/AR-1).

Our overall impression is that the 1000ZE/X is a fine cartridge offering excellent trackability at low tracking weights and a reasonably good frequency response.

Recommended selling price \$99

MEASURED PERFORMANCE
Frequency Response
20 to 20kHz ± 4 dB
Sensitivity
(Re 1kHz at 5cm/sec) 5.4mV
Channel Separation 25dB
(At 1kHz)

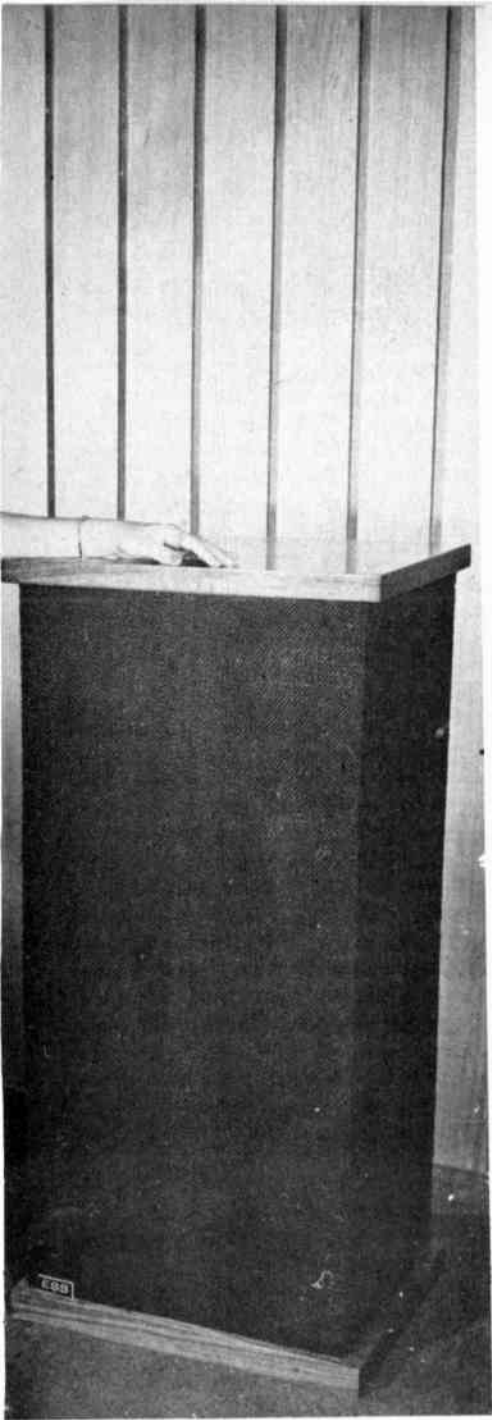

radiation over a selected band of low frequencies.

There were, of course, at least two other "classic" systems for bass loading. One was the large horn — very efficient, but even more complex and expensive to produce than the labyrinth. The other was simply a totally closed large box. The closed box (also known as the "infinite baffle") raised the resonant frequency of the speaker, and also suppressed its back wave entirely. To sound good, therefore, this type of enclosure required low-resonant woofers of rugged construction that could handle relatively high amplifier power.

Then came the revolution known as "acoustic (or air) suspension." During the 1950's the low-resonance woofer arrived, a speaker with a cone of such high compliance that it was useless in the conventional large box. But in a small sealed box the cone's lack of mechanical restoring force was replaced by that of the air in the box. The subsonic resonance of the speaker was brought up to a predetermined point in the audio band, and speaker parameters were adjusted for linear output in the little "pressure box." Since then the acoustic-suspension speaker system has largely dominated the marketplace. Its opponents say that the small size (vis-a-vis the older types) is all that recommends the air-suspension speaker; its proponents insist that size notwithstanding, the air-suspension speaker is a more linear, lower-distorting sound reproducer than the older types.

Throughout these developments and the controversies surrounding them, some audio workers — mostly amateurs but including some engineers in England — continued to play with the labyrinth. American manufacturers ignored it on the grounds that its potential advantages in bass range were too slight to justify its cost. But some experimenters didn't stop at juggling tube dimensions; they began to stuff the tube with various kinds of damping material and the transmission line was born. The labyrinth, a potentially resonant pipe, became one of the least resonant enclosures known. The men who build transmission lines today talk as much about the quality of their bass as its range.

Arthur Radford is one. He began building lines around 1950, but he marketed his first model, the Radford Studio loudspeaker, in 1964. A.R. Bailey, of Bradford Institute of Technology, called general attention to the new work on labyrinths in a 1965 issue of *Wireless World*. Bailey filled his labyrinth with long-fibre wool that damped the tube resonances and reflections more effectively than

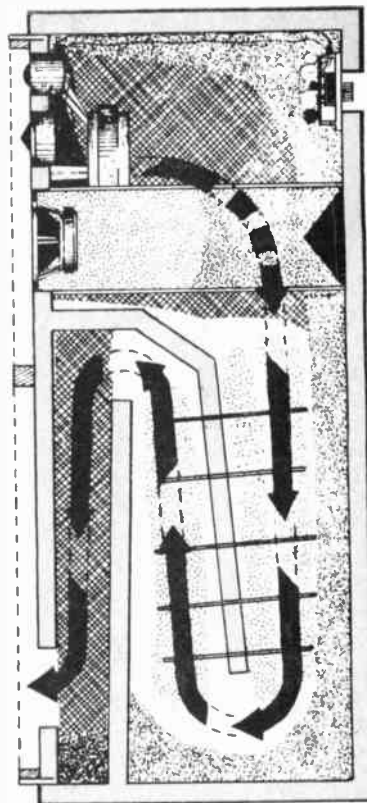

This interior design view of the three-way IMF system shows how a transmission line speaker works. Except for the lowest frequencies, the sound from the back of the woofer is lost in the filtering and bends of the tapered tube. The tapered plug at the end of the midrange line helps to break up the sound from the back and increases the effectiveness of the stuffing.

Labyrinth systems met their first competition from the bass reflex cabinet which was simpler, lower in cost, and yet offered the same resonance control as the labyrinth. The bass reflex typically was a box with a port whose area was roughly that of the speaker installed in it. The air in such a box (also known as a "vented baffle" or a "Helmholtz resonator") acted like a huge spring which was compressed and relaxed between the piston effect of the speaker cone and the piston effect of the port air. When properly "tuned" (i.e., precise port dimensions for a specific speaker) the air acted in opposition to the cone at the speaker's resonant frequency, controlling its tendency to move excessively. Again, port radiation supplemented cone

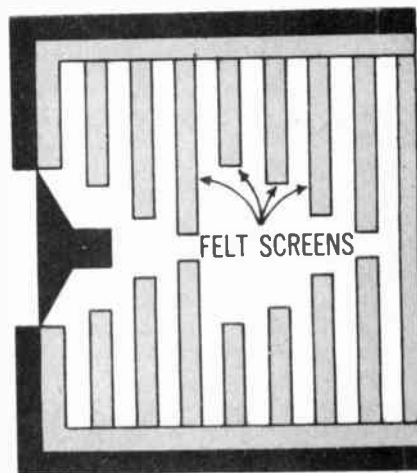

An enclosure of the 1950s, which in some ways resembled today's transmission lines, was the Hartley "Baffle." Its designer, H. A. Hartley, was opposed to reflex or other "resonant" systems. The baffle acted as a low-pass filter. Hartley considered the possibility of bringing the rear bass into phase with that from the front of the speaker but never did so.

THE AMAZING MAZE

Olney's lined walls of thirty years before. Bailey compared his stuffed labyrinth to the ideal electrical transmission line, which is also free of signal reflections, and he showed test results that indicated smooth, extended low frequencies and superior impulse (or transient) response.

Commercial transmission lines development commenced in the U.S. when Irving M. Fried (IMF Products) demonstrated one at the 1965 New York Hi-Fi Show. Fried, who earlier had espoused full-range electrostatic speakers, was won over to transmission lines in the early 1960's after Arthur Haddy and K.S. Spenser of Decca recommended a bass line to match the frequency and dynamic range of their new recordings. Fried followed up the 1965 demonstration with his well-known IMF Monitor and Studio models, speakers that were viewed by the makers of conventional systems as noncommercial novelty items. Until recently.

Looking over this history, one is tempted to seek a single compelling reason for the labyrinth's resurgence. In fact the manufacturers of transmission lines do offer a single factor, a partisan one.

"We use the transmission line principle for one reason," says Victor Comerchero, President of ESS. "It is the most faithful bass propagation method available." To be specific, he mentions superior transient response and high definition. Transmission line zealots say that most high fidelity sound is "boxy." They claim that box speakers produce muddy bass, particularly at the lower end of the audio range, due to resonances. Here, they say, is where the transmission line is supreme because its resonance may be put below the audio band. And the port output of a properly designed line will cross over with the output from the front of the cone to maintain a flat response well below that of the speaker alone.

This proficiency of the labyrinth in the low bass may be a factor in the timing of the enclosure's comeback.

As the frequency and dynamic range of recordings improved, better speakers were needed to realize that improvement. The fact that representatives of a recording company were recommending transmission lines in the early 60's, before their current vogue, may be significant.

Another plausible explanation for

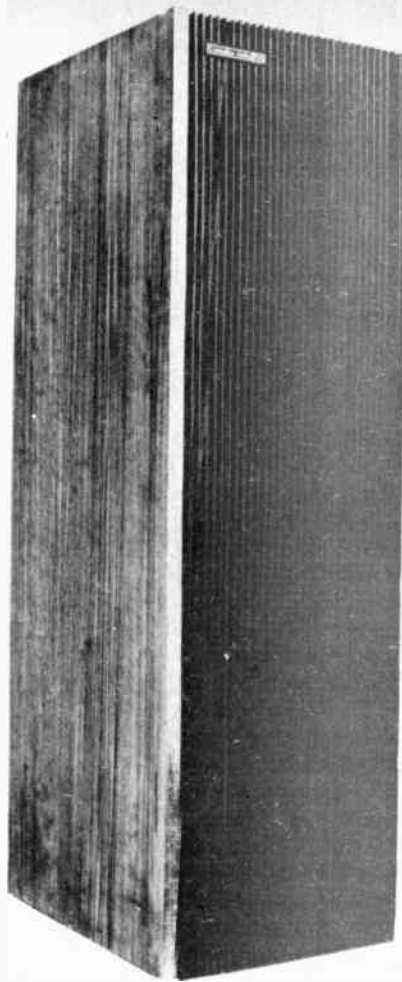

*Cambridge Audio R 50
Monitor speakers*

the revival is the development of drivers that complement the labyrinth's characteristics. Today's transmission line manufacturers stress the importance of good drivers in a nonresonant system because, they say, while poor drivers will sound bad in any kind of enclosure, the colorations of poor drivers are mercilessly exposed in the transmission line system.

Looking again at hi-fi history, there seems to be a parallel between the final triumph of compact speaker systems and the emergence of the transmission line. On the surface this appears to be a coincidence. A causal relationship between the two apparently opposite types doesn't make much sense, but under the skin they have one trait in common. Both are inefficient. One factor that enabled the compact sealed box to conquer the large bass reflex was the development of high-powered amplifiers at reasonable prices. In fact the power demands of the compacts helped to stimulate the development of low-cost electrical power for music reproduction. Now the transmission line people have seized the opportunity given them to produce a speaker system that seems to be,

philosophically anyway, an anachronism since it is both large and inefficient.

Finally, there may be more well-heeled audiophiles today who can pay the kind of costs incurred in the manufacture of transmission lines. This brings up a related question. If we admit the claimed bass superiority of transmission lines, and both tests and careful listening prove that they are good (if you listen for true fundamental bass rather than the fuller-sounding prominent mid-bass of some systems), how much is this kind of bass worth in dollars and cents?

However one answers that question, the advocates of transmission lines insist that it's not just a matter of improved bass; the transmission line is better for midrange too.

"The ear," says Irving Fried, "will forgive many more distortions at the bottom and at the top of the musical scale than it will in the midrange where the critical ear hears distortions that are frankly unmeasurable by ordinary laboratory techniques

Indeed, the IMF speakers, as well as the ESS and the Cambridge models, use two transmission lines — one for bass and another behind the midrange driver. Radford uses a separate compartment for its midrange driver that operates as a closed-end acoustic line. These midrange lines, like the bass lines, are stuffed with absorbent material to kill reflections. Makers of line systems see reduction of reflections as one of the significant advantages of line enclosures over simple enclosures. They say that the stuffing in a shallow box (one without a transmission line) produces reflections at certain frequencies, particularly if the stuffing is a roll material with a flat surface exposed toward the driver.

One of the points of diversity between different makes of transmission lines is in the kind of stuffing employed. Radford and Cambridge use the same long-fibre wool that was recommended by Professor Bailey. IMF installs fibre-glass and end-suspended filters and English hemp. ESS and Infinity add Dacron to their mix of materials. Both IMF and ESS employ variable-density filtering which requires careful adjustment. This variable damping in the tapered tube attenuates the sound from the back of the driver in steps until only the lowest frequencies emerge from the

Sonab's Sound Surrounds You



Sonab..... just listen to it

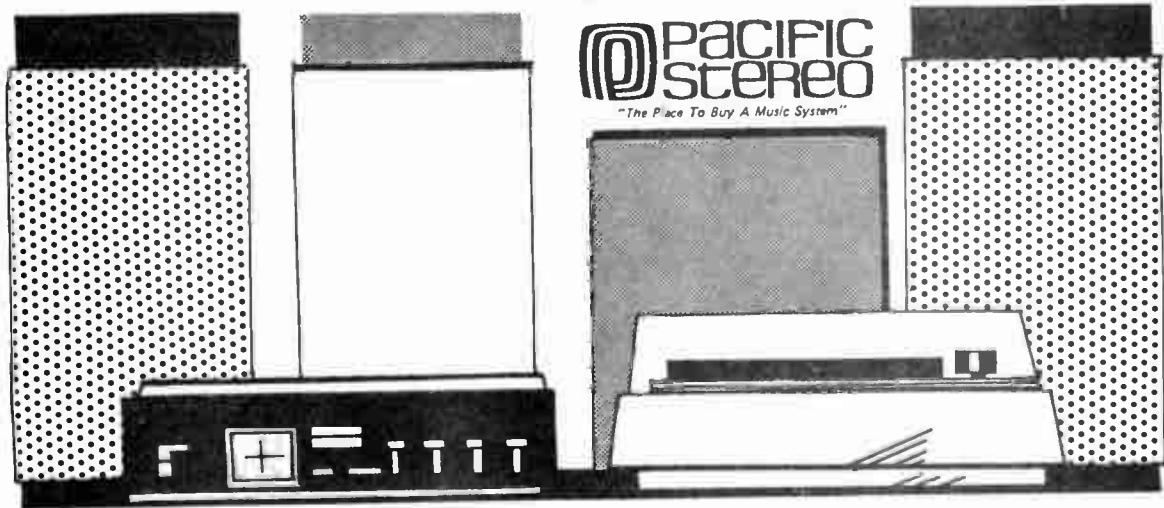

PACIFIC STEREO **IN CANBERRA A.C.T.**
...Upstairs in Style Arcade, Manuka (opp. Post Office in Franklin Street)

SEMICONDUCTOR SALE!

BRAND NEW

FACTORY TESTED & GUARANTEED

SILICON NPN TRANSISTORS									
TYPE	V _{ce}	I _c mA	H _{fe}	P _t * mW	F _t MHz	Description & Similar Types		Price	
AT322	20	100	40 min	250	230	Epoxy	GP Audio/RF	BC148	30c
AT327	25	30	200-1K	250	220	Epoxy	Lo-noise Hi-gain NF = 4db	BC108, SE4010	32c
AT338	15	50	20 min	250	1000	Epoxy	VHF Oscillator		52c
AT339	60	100	100-400	250	230	Epoxy	IF Amp	2N3568	54c
AT346	45	20	35-200	180	550	T0104	RF Amp	BF115	60c
AT350	200	100	30-250	750	40	T039	Video O/P	BF336 SE7001	63c
AT360	60	3A	30-120	800	45	T039	Power Switch	2N2854	1.00
AT361	60	3A	30 min	800	45	T039	Power Switch	2N2855/6	96c
AT381	60	1A	40-125	400	60	T018	Switch		57c
AT385	80	1A	100-400	400	60	T018	Switch		71c
AT402	45	500	30-120	300	250	Epoxy	Switch	2N3643	43c
AT427	45	500	100 min	360	250	T018	Switch	2N3566, 2N708	53c
AT475	80	1A	100-400	800	60	T039	Switch	40361	96c
AT478	80	1A	40 min	800	60	T039	Switch TT801	2N3053, BFY50	87c

SILICON PNP TRANSISTORS									
AT331	20	500	30-160	300	200	Epoxy	Audio O/P		30c
AT393	40	1A	100-400	400	100	T018	Switch		57c
AT412	45	500	30-125	300	200	Epoxy	Switch	BC177, 2N3638	44c
AT413	45	500	100-400	300	200	Epoxy	Switch	BC157	50c
AT414	30	500	100-400	300	200	Epoxy	Switch	BC179, 2N3638A	46c
AT433	45	500	100-400	360	200	T018	G.P.		59c
AT451	30	50	200-1K	200	20	Epoxy	Lo-noise AF NF typ 1db max 2db		50c
AT455	45	50	60 min	200	20	Epoxy	Lo-noise AF NF typ 2db		63c
AT461	60	1A	40-120	800	100	T039	Switch		91c
AT467	60	1A	40 min	800	100	T039	Switch	TT800, 40406	90c
AT480	30	500	30-120	700	200	T039	Switch		57c
AT481	45	500	30-120	700	200	T039	Switch		70c
AT483	45	500	100-400	700	200	T039	Switch		81c

*in free air

SILICON DIODES			
	PIV	I (RMS)	
AD4003	200	1A	23c
IN3255T	600	.75A	30c
IN3256T	800	.75A	40c

BRIDGE RECTIFIERS			
	PIV	I (RMS)	
AB1	50	2A	1.00
AB2	100	2A	1.10
AB3	200	2A	1.40
AB6	800	2A	2.50
AB7	1000	2A	3.50

SOLITRON 2N3054. 1.30

SILICON NPN TRANSISTORS	
V _{ce} : 20volts	10 for 1.50
I _c : 100mA	
H _{fe} : 40 - 220	
F _t : 230MHz	

DISCOUNTS FOR QUANTITIES OVER 100 AVAILABLE ON REQUEST

AND MANY OTHER SILICON & GERMANIUM TRANSISTORS & DIODES

- WRITE FOR CATALOG & PRICE LIST

ADD 25c TO ALL ORDERS UNDER \$5 TO COVER POST AND PACKING.

SEMICONDUCTOR SALES DIVISION

WRIGHT AUDIO DEVELOPMENTS

P.O. BOX 26 BEROWRA HEIGHTS, N.S.W.

THE AMAZING MAZE

port. Some companies, Bowers and Wilkins for one, substitute heavy damping for tube length. The amount of damping material used must be correlated to the cross-sectional area of the pipe so that the line is not "choked." Fried says that the proper combination of pipe area and damping material provides what he calls "free-flow filtering" for the IMF lines. The filtering critically damps three resonances, those of the air in the top chamber, the tube, and the driver itself.

Although most designers aim at using port radiation to augment cone output at low frequencies, Infinity Systems pursues a different goal. The Infinity lines are stuffed with Dacron, in increasing density toward the port, so that they operate without reflections but also without radiation. This method of loading results in some loss of energy (lower efficiency) which Infinity apparently accepts as the cost of obtaining the kind of results it wants.

Another difference between competing lines is in the driver systems. IMF uses a four-way system of cone drivers. The cones are made of chemically derived material and include a rectangular woofer in the Monitor models. Cambridge also uses a four-way system of cone drivers. Radford has recently changed from a four-way system to three-way, but the three-way system is made up of ten drivers. Two 12-inch woofers drive a single bass line and are crossed over to four 4-inch midrange and four 1-inch soft dome tweeters. The midrange and tweeter units are arranged as a pair per side of the enclosure for 360-degree sound (270-degree against a wall). ESS mixes dynamic speakers with electrostatic tweeters. The bass is handled by a rectangular flat plastic-coned woofer, the midrange by a 5-inch plastic cone, and the highs by three electrostatic tweeters. Infinity also makes use of electrostatic tweeters in its Model 2000A, in addition to the 12-inch mass-loaded woofer and 4-inch midrange cone drivers, but the tweeters radiate both front and rear.

In most transmission line systems the drivers are located near the top of the enclosure while the maze itself exhausts into the room at floor level. One ESS model, the Trans-Static 1,

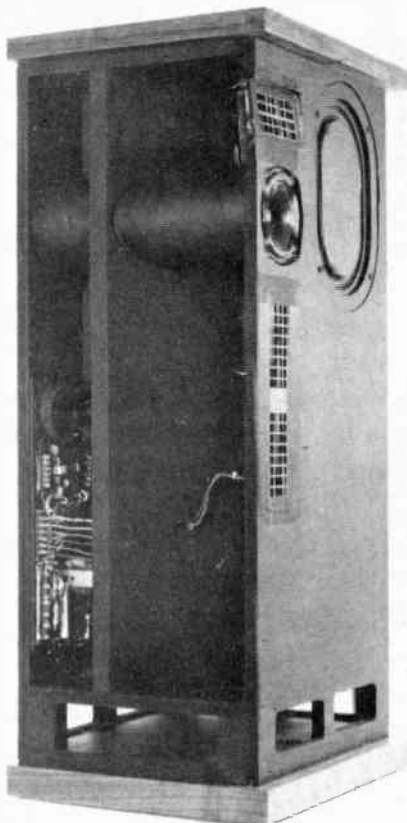

ESS Trans-Static speaker with grille cloth removed.

terminates its line with slots on all four sides of the enclosure, rather than the usual single front port. Victor Comerchero says that the difference between the two types of loading is clearly audible. If you move in close to a line speaker and put your ear to the port, you would hear nothing but the rumble of the lowest frequencies. In the case of the large Cambridge system, you would hear the rumble at the top, for the port is above the tweeters.

Whether the high quality of these systems is due to their use of the transmission line may be debatable, but the makers of conventional systems can no longer pretend that the transmission line doesn't exist. And it doesn't seem to be going away. Perhaps the labyrinth will eventually be adopted by some of the large manufacturers.

One straw in the wind is the recent development of the Aquarius 4 by James B. Lansing Sound, Inc. While not strictly a transmission line system (JBL does not recognize the term as a valid name for a loading technique),

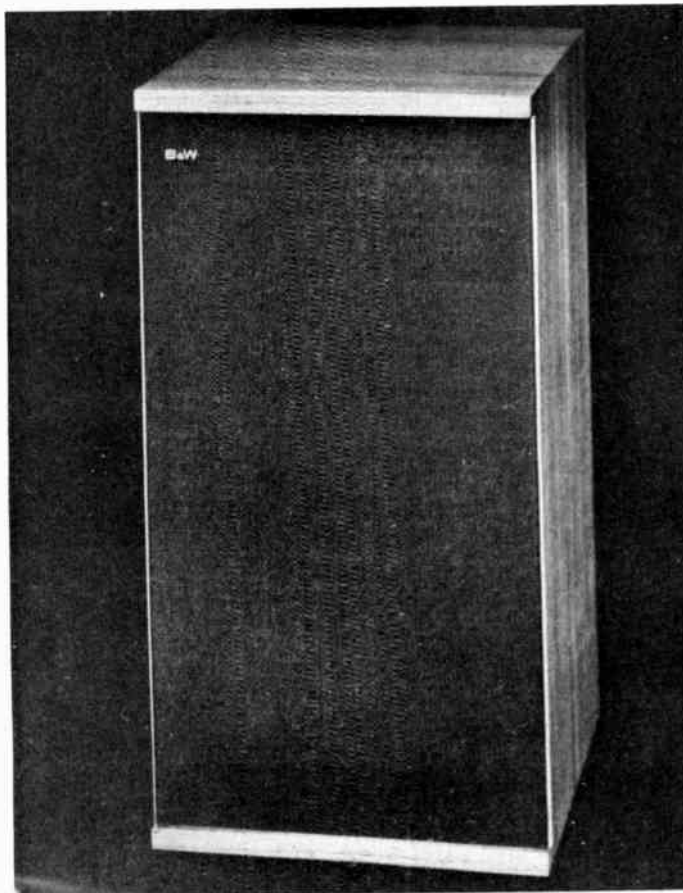

Bowers and Wilkins Model DM2 speaker enclosure uses transmission line loading.

Memorex makes tape that can shatter glass.

So what?

Sure, that proves our tape records and plays back with the precision necessary to shatter a glass.

But, you buy tape to record and play back your favourite music.

So, it's also important you know that hiss is less noticeable with Memorex. That's because we've increased high frequency response so you can decrease treble on playback.

You'll also notice less distortion at high volumes with Memorex. That's because Memorex is more sensitive than

the tape you're probably using now.

It's all because of the way we coat our tape.

First, we use smaller gamma ferric oxide particles. That means there are more of them on any given inch of tape. More places to pick up and play back sound.

Now anybody could come along and use smaller particles just like us; except for one thing. It's a tough job to coat small particles in a smooth, uniform manner. But Memorex does it. And, just how we do it is a little secret we can't even tell you.

There's one other thing we can't tell you: how Memorex Tape sounds when you use it. You'll just have to listen. Please do.



MEMOREX Recording Tape
Reproduction so true it can shatter glass.

Sole Australian distributors

LEROYA INDUSTRIES PTY. LTD.
266 Hay St., Subiaco, Western Australia 6008

VIC.: BJD Electronics P/L, 191 Bourke St., Melbourne 3000.
QLD.: Brisbane Agencies, 72 Wickham St., Fortitude Valley,

N.S.W.: Linier Sound P/L, 20 Pittwater Rd., Gladesville, 2111.
S.A.: Sound Spectrum, 33 Regents Arcade, Adelaide, S.A. 5000.
A.C.T.: Pacific Stereo P/L, 17 Style Arcade, Manuka, 2603.

LER 038

THE AMAZING MAZE

the design of the Aquarius 4 shows similarities to some transmission line techniques. The bass range is reproduced by an upward-facing 8-inch woofer front loaded for 360-degree dispersion. Behind, or rather below in this case, the woofer is a damped pipe. The pipe terminates in an acoustic filter in a second chamber which in turn vents out of a ducted port. JBL classifies the Aquarius 4 as a modified reflex enclosure, but allows that it could be considered a variation of a highly damped labyrinth. One definition of transmission line, as accepted by people who use the term, is "damped labyrinth."

The Aquarius 4 was developed when the firm's marketing staff requested a high-fashion speaker system that would be flexible in its room placement requirements. JBL's engineering department designed the system for omnidirectional sound and minimum floor space requirements; as such it could fit readily into quadraphonic installations.

Fairfax is now producing a large but shallow (52 by 30 by 6½-inch) labyrinth system. This model, the "Wall of Sound," is a four-way system using six 8-inch woofers, two 5-inch

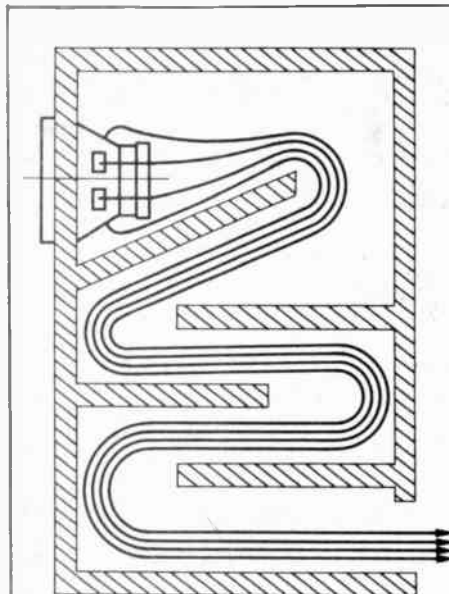

Cutaway drawing shows the construction of the Akai SW 35 unit.

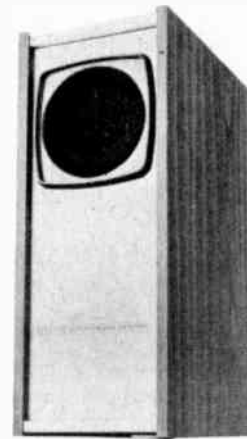

The Akai SW 35 is a miniature labyrinth driven by a single 5¼" diameter speaker.

midrange, two 3½-inch midhigh and two ultrahigh frequency dome tweeters. Fairfax calls the enclosure an integrated labyrinth. It is subdivided into six compartments that feed a labyrinth that is terminated by three round ports. The Fairfax L-34A is a compact (24 by 14 by 12 inch) labyrinth driven by two 8-inch woofers. Other companies that

produce labyrinth-type enclosures are Whiteley (available only in England), Admiral, Akai, Crisman, and V-M.

The Admiral "Tunnel Reflex" systems, the V-M "Spiral Reflex" speakers, and two Akai models represent a special kind of small labyrinth or semi-labyrinth. In most of these models the entire music range is covered by a single cone, a high-compliance wide-range speaker. Labyrinth loading was chosen for these models to enable them to reproduce an extra octave of bass over that of a sealed box with the same speaker.

The latest news on labyrinths is the announcement by Audionics of a kit of Radford components for those who want to build their own transmission lines. The kit will consist of a woofer, a midrange driver, a tweeter, a crossover network, and the hard to find long-fibre wool. The kit is designed to work in a transmission line enclosure which was described by Professor Bailey in the May 1972 issue of *Wireless World*.

A few years ago many observers of the high fidelity scene were predicting an ever more narrowing choice of speaker systems. It seemed that the only variety we could expect would be competition between different brands of compact boxes. Instead the last five years have brought us a diversity in kinds of speakers that makes the selection of a system more challenging than ever before. And one of the most important new types is the transmission line. It looks as if the labyrinth is back to stay. ●

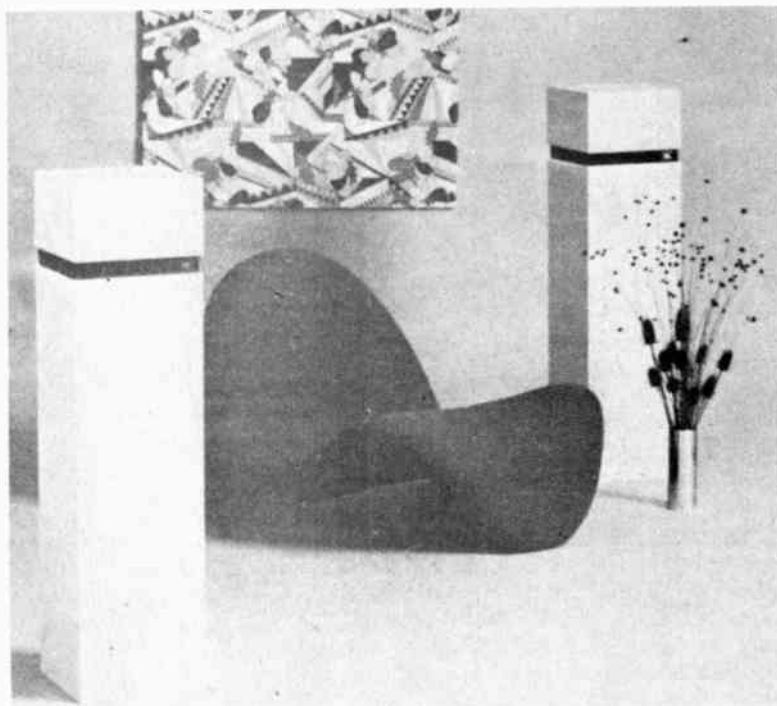

JBL Aquarius 4 speaker system incorporates a damped pipe that is similar in its loading effect to a short transmission line.

Text reprinted by permission from the Winter 1973 issue of Stereo.

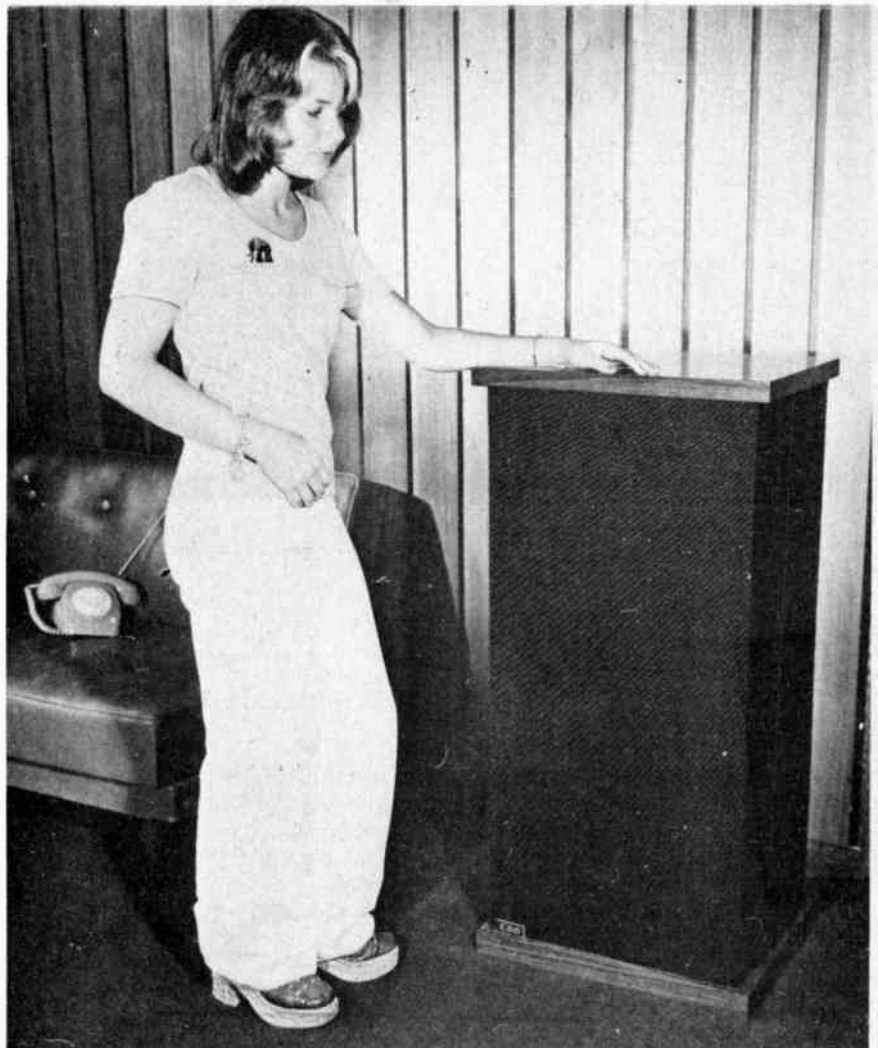

Recommended retail price —
about \$2000 a pair

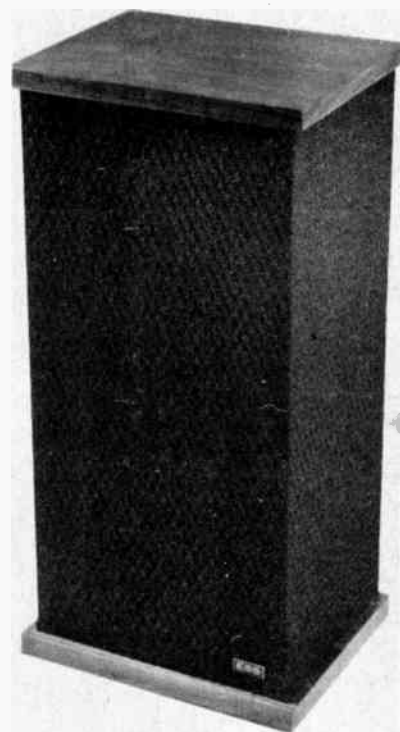

TRANS-STATIC I LOUDSPEAKERS

ALL too many hi-fi exhibitions degenerate into a 'battle of the sounds' with exhibitors vying with each other to produce the loudest and purest sound — possibly in an attempt to stun their listeners into believing that the loudest is always the best.

There is usually no outright winner of such pointless contests and, happily, a number of contestants' units end up with distorted diaphragms and blown fuses.

One exception to this all too common practice was a pair of ESS Trans-static speakers heard at a recent exhibition — for whilst these speakers were driven by a pair of 700 watt Phase Linears — the resultant sound

quality was quite out of the ordinary, despite being driven at realistic yet not excessive levels.

The ESS Trans-static speakers are built by a small but dynamic company in California. At first glance the enclosure bears a striking resemblance to the monolith in the film '2001'. Its enclosure is not attractive in the conventional manner. Impressive, is a more accurate description. Standing 42 inches high, the enclosure is surrounded by black speaker cloth on three sides, whilst the base and top have oiled rosewood or teak surfaces.

The woofer is a modified KEF 139 unit measuring 12 inches by 9 inches. This is loaded by a transmission line

labyrinth (see preceding article for details of this principle) tuned to optimize the bass response from 25 Hz to 40 Hz. The degree of tuning required is not particularly critical and the manufacturers achieve it simply by the addition or removal of acoustical infill from the far end of the quarter wave length transmission line.

The woofer covers the frequency range from approximately 30 Hz to 300 Hz. It should be noted that whilst it is not difficult to produce a speaker with *loud* bass, to produce one with *pure* bass as well, is much more difficult. This is what ESS aimed for — and have achieved.

This, say ESS, has been achieved by

Transmission line bass and mid-range drivers combined with electrostatic tweeters provide truly excellent results

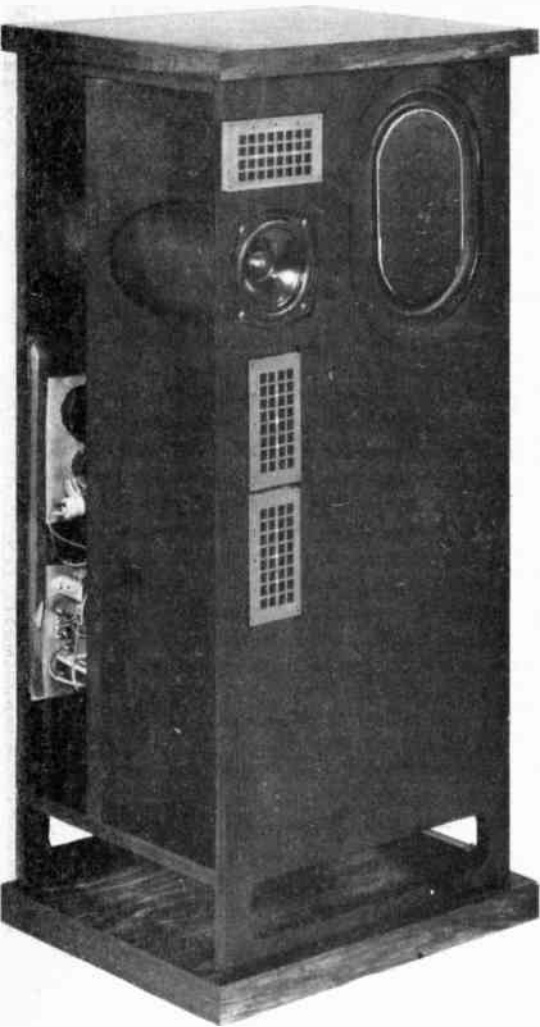

MEASURED PERFORMANCE OF E.S.S. TRANS-STATIC I SPEAKER SERIAL NO: F 333 A

Frequency Response on Axis:	30Hz to 20 kHz \pm 9 dB		
Total Harmonic Distortion:	100Hz	1 kHz	6.3 kHz
100dB SPL at 1 metre on axis	8%	0.1%	—
Electro-Acoustic Efficiency at 1kHz:	0.08%		
Cross-over Frequencies:	300Hz and 1300Hz		
Measured Impedance:	100Hz	6 Ω	
	1kHz	10 Ω	
	6.3kHz	6 Ω	
Enclosure Volume:	21.8 x 10 ⁴ cubic cm.		
Dimensions:	Height	106.5 cm	
	Width	50.5 cm	
	Depth	40.5 cm	
	Weight	63.2 kg	

electronics
TODAY
INTERNATIONAL
product test

'propagating the energy forward', Bass boom and cabinet flexing has been overcome by making the enclosure from a special high density laminate board 3/4" thick. As would be expected the enclosures are very heavy — 139 lbs to be precise. Handling is definitely an unwanted chore!

The mid-range speaker, which is a 5" plastic-coned unit, covers slightly more than the two octaves from 300 Hz to 1300 Hz and is thus readily able to provide optimum performance without being compromised by the need to cater for too wide a frequency range. Like the woofer, this speaker is provided with a small transmission line located in the horizontal plane

immediately behind it. This opens to the rear of the cabinet and provides excellent clarity in the mid-frequency region.

The high frequency region is covered by two excellent electrostatic units. These add a natural clarity that few other speaker systems can ever hope to match.

The designers have cleverly designed the cabinet so that the rear radiation from the electrostatic speakers is reflected from an angled board and dispersed to the rear side of the cabinets. Whilst this does not minimise the frontal beaming effect, it does provide sufficient side dispersion for most listeners to believe that the speakers have good high frequency diffusion.

The cross-over unit and the power supply for the electrostatic speakers is mounted inside the enclosure immediately above the bass speaker, labyrinth ports (which are positioned on all four sides at the bottom of the unit). The cross-overs networks are provided with level controls for the mid-range and electrostatic tweeters' output. Each enclosure is provided with a power cord to energise the high voltage supply for the electrostatic speakers.

SUBJECTIVE TESTING

For our subjective testing we placed the Trans-statics close to one wall (30cm away and 2.5 metres apart) of our studio area and listened to some of our better records. The first that we tried was the Australian recording of "Jesus Christ Superstar" (EMI 50 ELP 9916). Through the ESS speakers this record has a depth and clarity which is truly remarkable. It is so incomparably better than the stage production that we can understand why the producers were so pleased with the record. If they had listened to it through these speakers, they would have been ecstatic.

The next record that we played was the awe inspiring Stravinsky "The Rite of Spring" (Deutsche Grammophon 2530-252). This record has a dramatic dynamic range and tests the full breadth of the frequency spectrum. Next, for good measure, we tried the newly released Acoustic Research Demonstration Record (Ensayo ENY-AR1) which is an extremely well produced test record. We then ran comparison AB tests against four other 'state-of-the-art' conventional medium and high priced speakers, all of which have excellent performance in practically all respects.

The Trans-statics excelled in each and

TRANS-STATIC I LOUDSPEAKERS

every respect — excluding efficiency. However for domestic high fidelity listening, efficiency is of little consequence, and with amplifier dollars per watt costs dropping the way they are at the moment, no-one who can afford the Transtatics \$2000/pair price tag would blanch at the thought of a 300 watt to 700 watt amplifier to drive them.

The Trans-static speakers are none the less *very* inefficient, and whilst we started off using a Pioneer SA 1000 amplifier (2 x 80 watts average continuous power into 4 ohms) we completed our distortion tests with a Phase Linear 700 watt amplifier (See Review E.T. March 1972).

One thing that is abundantly clear from listening to these speakers is that the manufacturers have overcome most of the problems associated (rightly or wrongly) with electrostatic speakers. For years many people in the audio industry have said that electrostatic speakers are unreliable, have poor dispersion, are costly, complex and inefficient, and present complex reactive loads to the amplifier.

But if one accepts some of these limitations, and puts the necessary development work to overcome the others, then the superior results more than justify the efforts expended.

OBJECTIVE PERFORMANCE

Having satisfied ourselves of the remarkable subjective performance of the Trans-static speakers, we embarked on a series of exhaustive laboratory measurements.

The directionality of the electrostatic tweeters presents a number of problems when attempting to measure the frequency response on axis in the normal manner. This manifests itself as a particularly "spikey" frequency response when off-axis (see results for 22½° off-axis). However, with the microphone on the direct axis of the lower electrostatic tweeter, the response, whilst not being dead flat, is relatively free of non-linearities and presents a graphical impression of the subjective impressions which we observed.

Even at 22½° off axis, the frequency response is still quite good up to 15 kHz. In a room with sufficient reflecting surfaces to provide diffusion, the directionality would present few problems.

The next parameter that we measured was the impedance curve. Without exception, this curve was the most non-linear that we have seen, being slightly under 4 ohms between

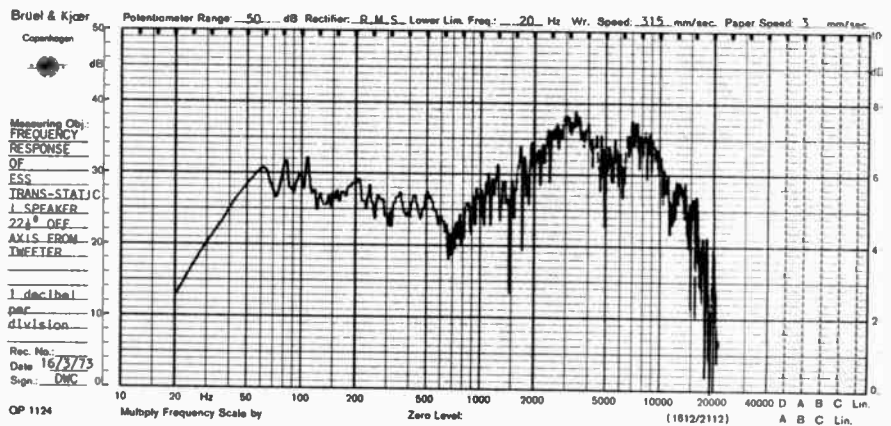
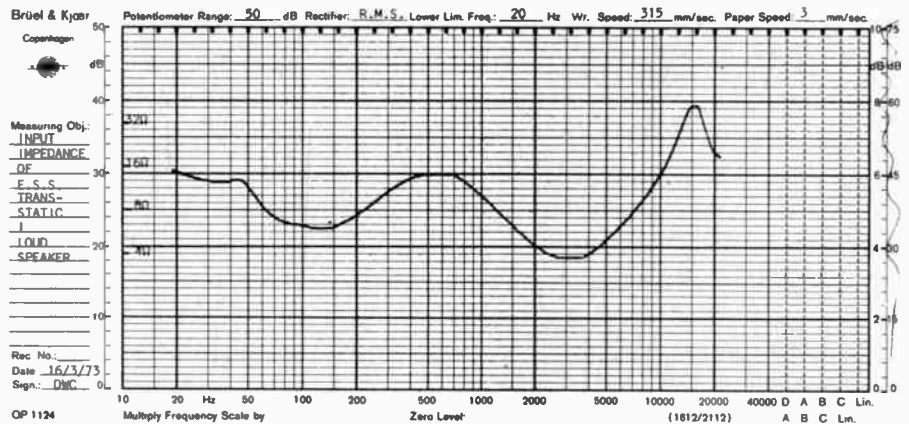
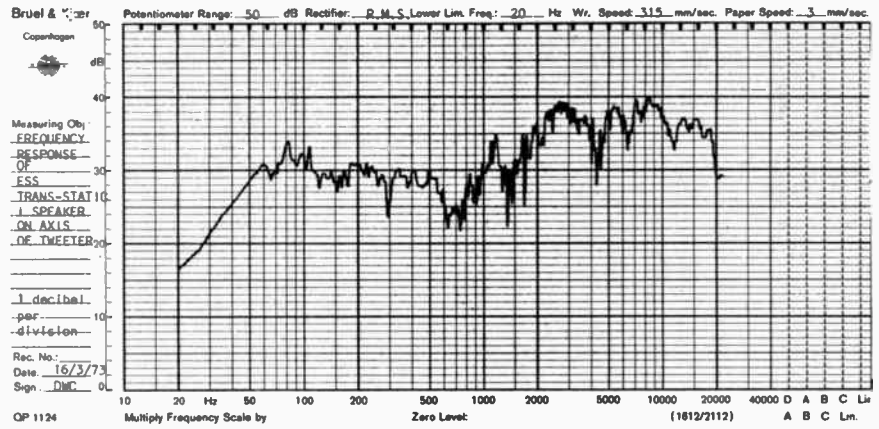

2.5 and 4 kHz, and reaching a peak of 40 ohms at 15 kHz. This is much what one would expect from a hybrid system of mixed dynamic and electrostatic speakers.

The distortion results were possibly the most interesting for with 100dB sound pressure level at 1 metre on axis, the distortion at 100 Hz was 8%. At 1 kHz it was only 0.1%.

These distortion figures are not dramatically superior to those obtained from other speakers yet are adequate considering the extremely high energy being absorbed.

The overall impression that we have obtained from these speakers is that they have a smooth natural quality, equal to or slightly better than any other system we have so far tested.

Whilst the tweeters are very directional, the dispersion is adequate enough to result in an exciting sound. In fact with good program material one can readily believe that one is at a live performance. We cannot recall hearing any other speaker that provides a cleaner sound or offers a more realistic electro-acoustic conversion.

"RAPAR" UD147 SERIES

DYNAMIC CARDIOID PROFESSIONAL MICROPHONE

For Recording, Broadcasting, Public Address, Musical Groups and Soloists —



- Impedance: Model UD147 200 ohms balanced
 Model UD147D 50K ohms
- Frequency Response: 50 — 15,000Hz
- Sensitivity: -80db ± 3db at 1,000Hz
- Polar Pattern: Cardioid
- Cable: Cardioid
- Switch: 20 ft. 2 conductor shielded
- Quick Release Holder for attachment to stand

*SIDE SOUND IS LESS AUDIBLE, SO FEEDBACK IS NOMINAL
CARDIOID MICROPHONES GIVE PREFERENCE TO FRONTAL
SOUND*

\$25.30* TAX PAID
Stand — optional extra

RAPAR ELECTRET CONDENSER MICROPHONES

SPECIFICATIONS:



- Output Impedance: 600 ohms or 50K ohms
- Frequency Response: 20 — 18,000Hz
- Sensitivity: -68db ± 3db
- S/N Ratio: 50db or above 1000Hz 1 Bar
- Maximum Input Sound Level: 132db S.P.I.
- Operation Voltage: 1.5V (1015) pen battery
- Switch: On/Off
- Accessories: Quick release stand holder
 20 ft. cable with connector
 Wind screen

MODEL ECM-1001 — Omni-Directional; Broad pattern suitable for bands. Omni-Directional means microphone receives with equal sensitivity from all directions. \$22.42* tax paid.

MODEL ECM-1011 — Uni-Directional Cardioid. Suitable for singing groups — public address. Uni-Directional means sensitive to frontal sound only. Eliminates feedback. \$28.17* tax paid.

Please post Public Address Catalogue

NAME

ADDRESS

.....POSTCODE.....

Sole Australian Agents

Radio Parts
GROUP

Registered Office: 562 Spencer Street, West Melbourne, 3003.
Phone 30-1251 (7 lines) 329-7888 (7 lines) Phone Orders 30-2224.
Southern Depot: 1103 Dandenong Rd., East Malvern. Phone
211-8122.
City Depot: 157 Elizabeth St., Melbourne. Phone 67-3263.
Postal Address: P.O. Box 124 Nth. Melbourne, 3051. Telegrams:
"SWANRAD" Melbourne Telex: 32980.
Adelaide Distributor: CHALLENGE HI-FI STEREO, 6 Gays
Arcade.

EXPLORATION ARCHAEOLOGY -searching for our past

by John M. Stanley, Dept. of Geophysics University of New England, Armidale, N.S.W.

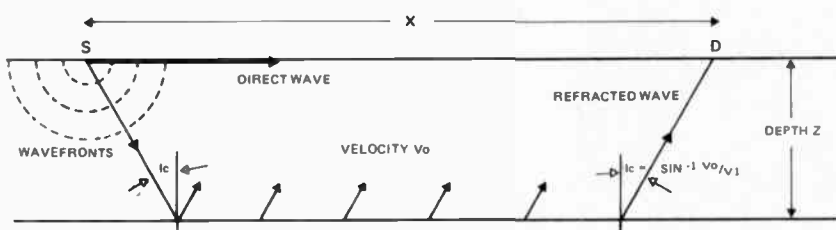

Fig. 1. Paths taken by the direct point S to detector D in two layered earth.

TREASURES sought after by archaeologists differ between Europe and Australia due to the nature of the respective civilizations.

European communities produced lasting hardware of baked clay or metals. They built cities of permanent materials with considerable use of stone and bricks, and they often fortified these with substantial walls. Although their civilizations have decayed, they left many remnants now submerged beneath windswept sands or buried by alluvial flood plains. Yet others have been built over by later communities. In common, these folk

considerably altered the landscape where they built their cities. They left permanent relics of their handcraft and they frequently left written evidence of their existence.

The scene in Australia is very different from this. The aborigines rarely altered their habitat with permanent constructions, and rarely if ever, made use of bricks or metals. Consequently, the only lasting remains of their campsites are fireplaces, shell concentrations and humus-rich deposits where wandering tribes made seasonal camps when food was abundant. These "middens", as they

are generally termed, do however contain small items, usually of chipped stone, which are of interest to our natural historians.

These differences require new exploration procedures. In the pursuit for remains of a highly developed community, it is logical firstly to search historic writings for clues as to where a township may have been situated. Aerial photography may then disclose surface formations not normally visible from the ground.

In the past it has been necessary to follow these activities with tedious drilling and trenching, but a great deal

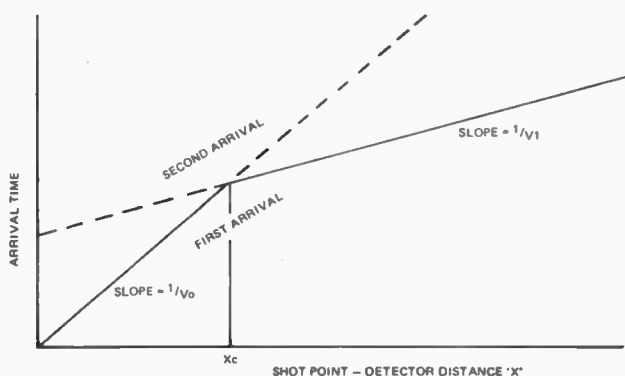

Fig. 2. Plot of first and second arrival times at a detector a distance X from the shot point. Xc corresponds to the point where the refracted wave overtakes the direct wave.

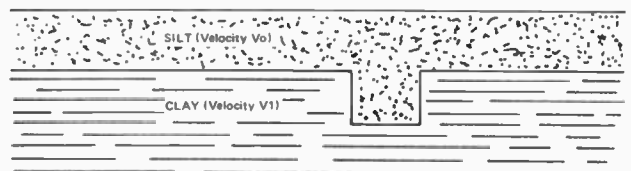
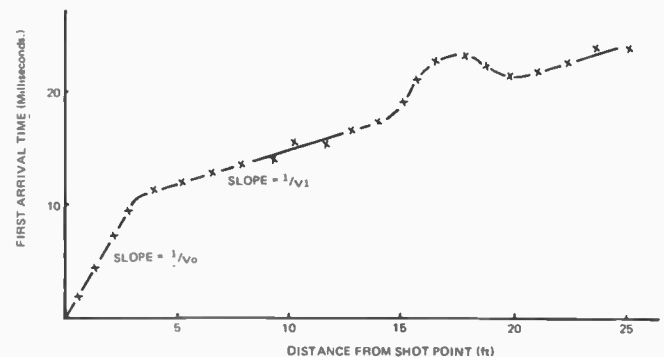

Fig. 3. Experimental refraction plot over a trench filled with silt.



Earth Resistivity meter in use



of this laborious work may now be replaced by the refined use of geophysical methods, and the final excavations commenced with greater confidence of success.

Our aborigines left no writings or photographable surface features indicating the whereabouts of their campsites. Fortunately for the archaeologist, much of the countryside in Australia has not changed very much since aboriginal occupation and it is logical that middens be associated with features providing a regular source of food. Lakes, river estuaries, rocky shorelines, natural springs and waterholes are our clues to past occupation. They are virtually the only means we have of confining the area of our search. In fact excavations have only been made in Australia in places where surface evidence of middens has been observed. But if geophysics can be employed successfully, then much older middens may be located buried at greater depths. The author is at present concerned with this possibility.

GEOPHYSICAL METHODS IN PRESENT USE

There are three principle geophysical methods which have been applied to archaeological studies. They are: seismology, resistivity and magnetics. Their use depends upon the nature of the particular environment, the amount of finance available for equipment, and upon the experience of the operating crew.

Combining technology with the classical arts, today's archaeologist is a refined crossbreed of historian and geophysicist.

SEISMOLOGY

The principle of seismology is that shock waves travel at particular and well-defined velocities through material of different types. The denser the material, the faster the speed that shock waves will travel through it. The velocities vary from as low as 600 ft/sec in light and dry top soil, to 20 000 ft/sec in unseamed granite.

If the speed of the shock wave is measured, then the type, hardness and depth of the various strata can accurately be determined. This is relatively easy to do, for when a shock wave strikes an interface between two different types of material it will be refracted along that interface.

With the simplest types of seismographs the shock wave is initiated by striking the ground with a hammer. Figure 1 shows how the shock wave thus generated (at point 'S'), travels out in hemispherical wavefronts. If a detecting instrument is at point 'D' — a distance of 'X' feet from 'S' then the shock wave travelling horizontally through the top material (the 'direct wave') will reach the receiving instrument before any other wave — as long as 'X' is small. For longer distances, the wave travelling along the lower strata (which has a higher characteristic velocity) will

arrive at the receiver before the direct wave.

Angle i_c is the 'critical angle' at which the shock wave is refracted along the interface. It is in fact the angle where $\text{Sine } i_c = V_0/V_1$.

The most convenient way to represent this data is to measure and plot the arrival time of the first refracted wave vs the short distance 'X'. For example with two layered stratum (Fig. 1) we would have the plot shown in Fig. 2. From the gradient of the first arrival segments we can deduce the velocities V_0 and V_1 and hence calculate the depth to the interface. Figure 3 shows the experimental data plotted over a trench buried under a layer of silt.

In the far more complex situation of identifying echos from irregular archaeological objects, interpretation becomes a job for the expert. However, there are many cases when seismology is quite practical to use. These include buried tombs and building sites containing walls or similar large structures. Seismology has been successfully used to locate underground passages and tomb cavities within the Egyptian pyramids, and is ideal for sounding the depth of deposits in caves and rock shelters.

Portable instrumentation has

recently become commercially available, but at a cost of about \$3,600! Quite prohibitive for the amateur treasure seeker! Such a "signal enhancement seismograph" is battery operated, weighs only 17 lbs and is exceeding accurate and easy to use. The seismic disturbance is made by simply hitting the ground with a 10 lb hammer.

RESISTIVITY

Another characteristic of differing strata is electrical resistivity — in fact the range of electrical resistivities is enormous. It extends from 10^{-1} ohm/metre to 10^{19} ohms/metre. It follows that if we can measure vertical and horizontal resistivity profiles of the ground, we must be able to detect changes in composition, and hence deduce the existence of buried objects. There are many ways of doing this, some involving ac measurements and others using dc. Generally, the resistivity is far from uniform and so the measurement used is one of "apparent resistivity" — in effect it is a mean value depending on the distribution of rocks and their individual resistivities.

One of the most common electrode arrangements for measuring apparent resistivity is that known as the Wenner Array (illustrated in Fig. 4). Using a Wenner Array (with electrode separation a) on the surface of a semi-infinite solid with uniform resistivity p , then $p = 2\pi a V/I = 2\pi a R$ (where R is the resistance between the inner electrodes).

There are two applications of this formula. We may perform "electrical drilling" or "electrical trenching". In the former, a vertical profile of the resistivity may be measured by plotting p as the separation of electrodes a is varied. The depth at which p is measured is approximately $0.6 a$. Apparent resistivity profile curves may be generated by a computing for different models of ground structure. Volumes of standard curves of this type have been published and these facilitate the

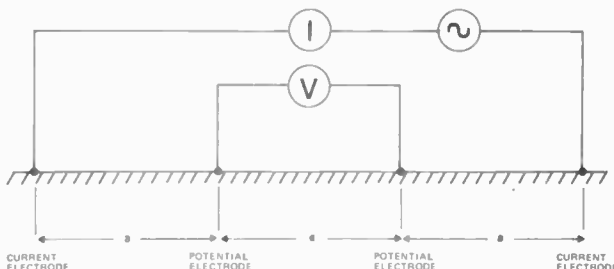

Fig. 4. The Wenner configuration of electrodes used in both "electrical drilling" and "electrical trenching". The electrode spacing used in resistivity calculations is the distance a .

Fig. 5. A typical resistivity traverse over a sandstone wall buried under dry sand.

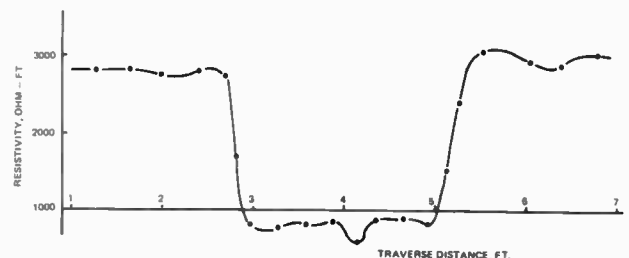

TABLE 1

Material	Magnetic Susceptibility 10^{-6} emu	Resistivity Ohm. M.	Seismic Compressional Velocity M. Sec ⁻¹
Air	0	Infinite	330
Water (fresh)	0	50	1450
Sand (dry)	-1.2	$>10^{10}$	300 - 800
Limestone	5	120 - 400	3,500 - 6,500
Granite	500	$5,000 - 10^6$	4,600 - 7,000
Clay	Variable	1 - 120	1,000 - 3,000
Sandstone	10	35 - 4,000	1,500 - 4,500
Marble	-0.75	$>10^{12}$	-
Basalt	2,000	-	5,000 - 6,500
Alluvium	2,000	Variable	500 - 600

Approximate values of magnetic susceptibility, electrical resistivity and seismic velocity for archaeologically relevant materials. All values tend to be highly variable depending on moisture content and mineral composition.

interpretation of resistivity drilling.

Electrical trenching is achieved by selecting an electrode separation corresponding approximately to the depth of interest, and moving the whole array along the traverse line. Fig. 5 shows a typical set of results plotted over a buried wall.

Resistivity methods are applicable to similar situations as the seismic method. The field skills and interpretation complexity are comparable to those required for seismology but the cost of equipment is very much less. A quite effective ac resistivity meter may be purchased for less than \$500 — and a dc operated meter — such as that described immediately following this article — may be home assembled for very much less.

MAGNETICS

The Earth's natural magnetic field is perturbed by the magnetic properties of materials within its influence. If the Earth's field may be measured to an accuracy of the order of 1 part per 1,000 this perturbation can be detected. Information concerning dimension, location and composition

of the perturbing body may be extracted from carefully compiled maps of anomalies in the magnetic field.

During the mid 1950's, a team at Cambridge University developed a magnetometer, having a sensitivity of 1 part per 100,000, specifically for archaeological work. This instrument measured the frequency of protons in an organic fluid as they precessed about the Earth's field. The precession frequency was linearly related to the intensity of the magnetic field. The "proton precession" magnetometer is available now at a cost of about \$500. More recently an instrument has been developed which measures the electron-nuclear spin of atoms in an alkali metal vapour. This spin frequency is also linearly related to the magnetic field, but yields an accuracy of 1 part in 1 million (ETI, Jan, 1973). At present these instruments are expensive — in excess of \$1,000 — but as refining developments progress, this cost may be expected to decrease substantially.

The magnetic field on the Earth's surface is almost entirely (95%) due to stable sources within the core. The

MS COMPONENTS

EVERYTHING IN ELECTRONICS



SALE CENTRES: 95-97 Regent Street, Redfern, N.S.W. 2016.
Telephone 69-5922.
188-192 Pacific Highway, Gore Hill, N.S.W.
2065. Telephone 43 5305.

HEAD OFFICE: &
M.O. DEPT.: 1st floor, Suite 2, 168 Redfern Street, Redfern,
N.S.W. 2016. P.O. Box 156, Redfern 2016.

SCOOP PURCHASE!!

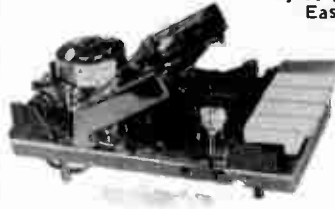

'VORTEX' Stereo Cassette Deck mechanism with Tape eject facility and resettable counter. Easily operated by 5 push-button (Plano key) controls, and includes High Quality 'ALPS' recording or play-back head and erase head. Tape speed 4.75cm (1-7/8") sec. Plus or minus 1.5% Wow and flutter less than 0.25%. Operates on 250VAC. Fantastic value at only \$28.00 post free.

AND NOW FROM MSC!!

"STAR-PACS"

THE GREATEST COMPONENT VALUE EVER OFFERED. ASTOUNDING SAVINGS BROUGHT TO YOU THROUGH OUR BULK PURCHASING...



'TRIMPAC' Plessey miniature trimming Potentiometers, Types V10k5 & PMD. 21 different values from 100 ohms to 2 megohms. All P.C. mounting. ONLY \$2.50 plus 15c post.

'OHMPAC' 200 assorted 5% & 10% resistors in 1/4-1/2 & 1 watt. All branded makes. Only \$2.50 plus 25c post.

'POLYPAC' 50 assorted High grade polyester capacitors in 50v, 100v & 400v. We guarantee at least 20 different values by some of the best known manufacturers. ONLY \$4.75 plus 25c post.

'CAP-PAC' 50 assorted High grade electrolytic capacitors. All useful values & voltages. Guaranteed quality. ONLY \$6.50 plus 30c post.

'REEDPAC' 5 each of the following REED switches, Type XS14 Normally Open, 150v AC, 250V DC, 3 watts resistive load. Type XS4/2 Normally Open, 200v AV, 250v DC. 5 watts resistive load. Normal value of these is \$13.00. OUR PRICE ONLY \$4.75 plus 20c post.

'SWITCHPAC' 20 ARROW toggle switches S.P.D.T. Packed in their original cartons of 20. Beautifully made and sturdily constructed. ONLY \$3.00 plus 25c post.

'TRANSPAC' All the components you require for a 9 Transistor Radio. Does not include Speaker, case or circuit. All components with their respective data's are included. Tremendous value at ONLY \$7.50 plus 25c post.

'SEMI-PAC' 50 assorted NPN & PNP Silicon & Germanium transistors, Signal diodes, Zener diodes & Rectifiers. \$20 value for ONLY \$9.00 plus 25c post.

'VARIPAC' 7 High grade Wire-wound potentiometers, in the following values - 5, 10, 20, 50, 200, 250 & 500 ohms. ONLY \$3.00 plus 25c post.

'KNOB-PAC' 20 assorted GOLD & SILVER finished knobs. Mainly Radio & Television types. ONLY \$2.00 plus 20c post.

'ZENAPAC' 15 different values of the BZV88 series Zeners by Mullard. Rating 400 mW. The following voltages are available: 3.6v, 3.9v, 4.3v, 4.7v, 5.1v, 5.6v, 6.2v, 6.8v, 7.5v, 9.1v, 8.2v, 10v, 12v, 20v & 30V. Complete Pac ONLY \$7.00 plus 12c post.

'JACKPAC 1: 20 3.5mm Jack Sockets. ONLY \$1.60 plus 12c post.

'JACKPAC 2' 10 3.5mm Jack Sockets, shrouded. ONLY \$1.00 plus 12c post.

'JACKPAC 3' 10 2.5mm Jack Sockets, shrouded. ONLY \$1.25 plus 12c post.

ALL THE ABOVE COMPONENTS ARE GUARANTEED NEW & UNUSED... NO REJECTS.

EXTENDING AERIALS

Transistor or Television type. Sturdily made & finished in heavy chrome. Extends from 6" to 36". Totally directional due to the integral swivel base. Only from M.S.C. can these be bought at the fantastic price of 95c each or 2 for \$1.75. Post & Pkg. 25c.



LAST FEW LEFT!!



M.S.P. DEFLECTION YOKES

Manufactured to stringent specifications. Suitable for all Television tubes of 110 degrees. 28mm. Torroidal Parallel Horizontal winding. Type No. 43663/001. Only \$4.50 plus 50c post.

NOW!

The CHEAPEST OF 'EM ALL SEMICONDUCTORS AT UNBEATABLE PRICES

Manufactured by S.T.C., NATIONAL SEMICONDUCTORS PHILIPS & MOTOROLA

BZ88 Series Zener Diodes50
C3V6 to C12 400 m/w65
C13 to C30 400 m/w1.95
BC 107 6 for1.95
BC 108 6 for1.95
BC 109 6 for1.95
2N3055 2 for\$2.75
2N5459 F.E.T. 2 for1.95
2N5485 F.E.T. 2 for\$2.25
2N3638 3 for1.95
TC1102 400V 6A TRIAC\$2.75
complete with Dioc\$1.95
EM401 100V 1A Rectifier 10 for\$1.95
EM404 400V 1A Rectifier 8 for\$1.95
EM408 800V 1A Rectifier 5 for\$1.95
EM410 1000V 1A Rectifier 4 for\$1.95
OA95 115V Signal Diode 10 for\$1.50
All above plus 12c post	

All NEW • All GUARANTEED
Real Unbeatable VALUE from the
SQUARE DEAL Firm.

NOW OPEN!!

OUR NEW NORTH SHORE SHOP
188-192 PACIFIC HIGHWAY
GORE HILL 2065
TELEPHONE 43-5305
(ABOVE SMITH SONS & REES)
entrance Bellevue Avenue
(OPP. NTH' SYD. TECH. COLLEGE)



THE GREAT
NAME FOR ELECTRONIC
COMPONENTS IN AUSTRALIA

STEREO TAPE ADAPTOR KIT



Kit consists of all necessary components and instructions to construct this Unit which is designed to operate with the 'VORTEX' Stereo Cassette Deck. Technical Data: 2 channel amplifier internally equalised to accept signals from tape heads and converts it to feed any amplifier system. Max. output 200 mV. Freq. response 25Hz. Power requirements are 18 volts at 6mA, which can be supplied by 2 x 9v batts. Complete kit of parts \$6.25 plus 25c post.

LAST FEW!!

C.D.I. KIT (Olims)

Complete kit of parts to



build this superior commercially made Capacitor for Discharge Ignition system. All high grade components with the pre-wound transformer, P.C. board, case, instructions, etc., 12V neg & 12V pos - earth only. For improved performance, fuel saving, less pollution and less points wear this is a MUST. ONLY \$19.00 plus 50c post.



I.T.T. 20 & 25 WATT HYBRID AUDIO POWER AMPLIFIERS. Now the lowest price in the Country. Outstanding features:- Single-ended push-pull circuit... Can withstand a 5 second short-circuit across the output terminals... No external components required, full protection & temperature compensation... Harmonic distortion less than 0.5% at full power... Frequency range 20Hz to 100KHz at 1W output, 20Hz to 20KHz at full power output.

TA20 42v/55v \$6.50 plus 25c post
TA25 48v/55v \$7.50 plus 25c post
TA20C 22v/29v \$12.00 plus 25c post
TA25C 24v/32v \$14.50 plus 25c post

Data sheets supplied for each amplifier

ANOTHER SMASH HIT FROM M.S.C. . . .

Special purchase of INTEGRATED 3 WATT AUDIO POWER AMPLIFIERS. Type M5102AY complete with necessary diode. 10 pin i.c. in modified JEDEC T03 Case. Vcc + 13.8 volts Max 18 volts. Full Data sheet and layout wiring supplied. ONLY LIMITED QUANTITIES AVAILABLE... ONLY \$3.25 each plus 12c post or 2 for \$6.00 plus 15c post.



Yamaha Natural Sound the music of the *Maestro* not the *Mechanic*

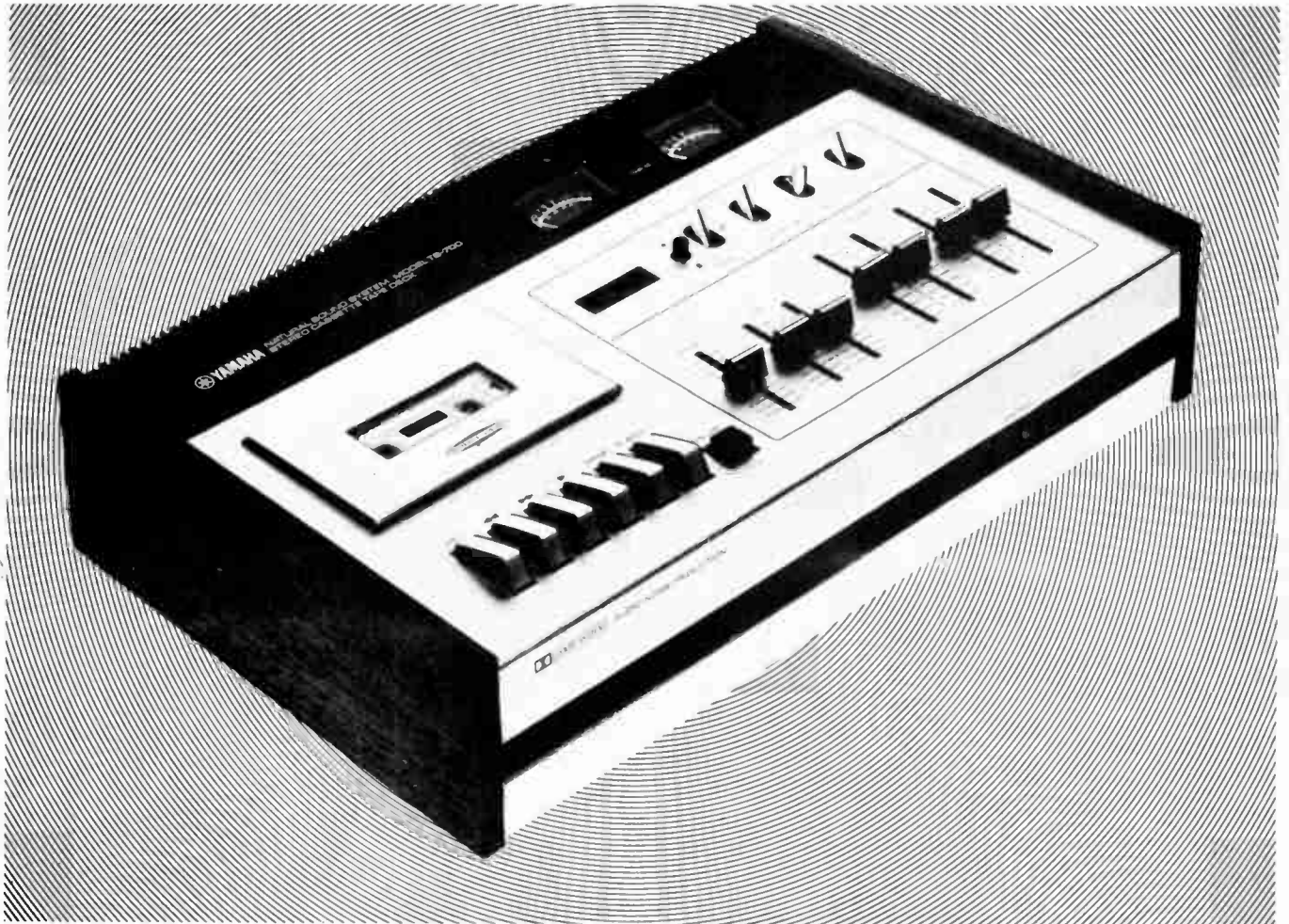

Yamaha Dolby System TB 700

When the Conductor subdues the Bass, and accents the Strings he does it to produce the total musical effect demanded by the Composer. Yamaha Natural Sound Stereo reproduces the Sound as it was played in its natural harmonic balance then leaves it to you to vary according to your own individual musical taste.

The Yamaha TB700 Tape Deck with variable speed plus a built-in DOLBY NOISE REDUCTION system, ensures the most perfect reproduction of sound yet achieved in Cassette Recorders.

For the first time you can enjoy the perfection of Yamaha Natural Sound in a Tape Deck.

Specifications:

Dolby noise reduction system
S/N ratio better than 58 dB with
Dolby Hot pressed ferrite head.

D.C. Servo motor
Wow and flutter less than 0.15%
Frequency response 30-16,000 Hz
(chromium dioxide tape).
Line input and mic mixing
Line input selector.
Three position tape selector
(chrome, hi-energy/low noise, stan-
dard).
Recording limiter Permits undistorted recordings.
Playback pitch control $\pm 5\%$
Auto stop
Pause switch Thin film IC's
Expanded Vu meters—up to ± 6 dB
OTL head phone amp, stabilised
power supply.
Three digit tape counter, din connector.
Studio console layout real wood
side panels

SUGGESTED RETAIL PRICE — \$299.00.

To Rose Music Pty. Ltd.,
17-33 Market Street,
South Melbourne, Vic. 3205.

(TICK APPROPRIATE SQUARE)

Please send me details of Yamaha Cassette Deck

Yamaha Turntables Yamaha Amplifiers

Yamaha Speakers Name of my nearest Yamaha Dealer

NAME _____

ADDRESS _____

STATE _____

POSTCODE _____

ANOTHER ROSE MUSIC SPONSORED PRODUCT



ET 7314

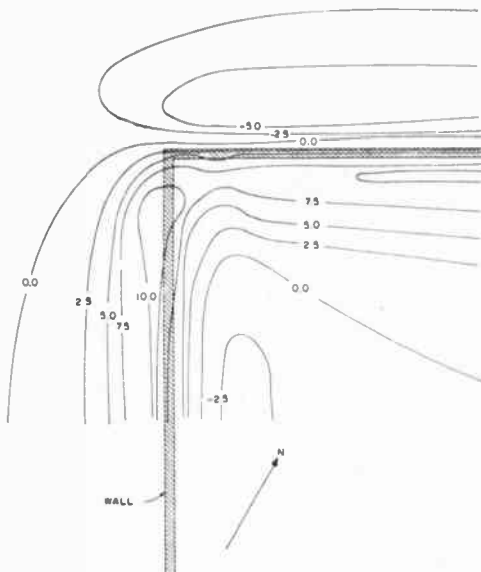

Fig. 6. This is a magnetic contour map over a corner of a stone wall buried at a depth of five metres. The plot was made using a differential magnetometer pair during the search for the lost city of Sybaris in southern Italy.

remaining 5% originates from variable causes, and may be divided into "temporal" (time) or "spacial" (position) variations. The temporal changes result principally from solar-induced currents in the Earth's crust, and magnetic pulsations in the magnetosphere. They range in frequency from a fraction of a second to diurnal. The amplitude of such variations is typically a few gammas but under severe conditions magnetic storms of several hundred gammas may be encountered.

Spacial variations arise principally from the degree of magnetism induced in materials of the Earth's crust. Different rocks and minerals exhibit a range of susceptibilities to magnetization in the Earth's field and this magnetization can readily be detected with modern instruments. A second very significant cause of spacial anomalies results from "remnant" magnetism exhibited by objects containing ferromagnetic minerals which have been heated strongly at some time. Within the crystals of the mineral are small, randomly orientated regions of uniform magnetizations, called domains, which become mobile above the Curie temperature of about 600°C. During cooling, many of the domains align themselves parallel to the Earth's magnetic field and are thus frozen in this alignment. Since they

are parallel to the Earth's field they are also parallel to each other, thus creating a net magnetic effect. Pottery, kilns, hearths and baked rocks will frequently exhibit a measureable remnant magnetism.

If the archaeologist is to distinguish between temporal and spacial anomalies it is usual to use two magnetometers. Both will respond to temporal changes simultaneously so if the difference in field value between the two is measured while one instrument is kept stationary, then only the spacial changes will be recorded. Since the development of the extremely high resolution "alkali vapour magnetometers" it has been possible to use such two instruments as a "gradiometer". Both field sensors are mounted with a fixed separation on a vertical staff. Again, both respond simultaneously to temporal changes and so the field value difference between the sensors yields the vertical spacial field gradient.

This data is of particular value to the archaeologist who is usually looking for objects buried under a quite shallow layer of sediments. This is because it effectively filters out background magnetic anomalies that originate in the deeper underlying geologic strata. It does this because the magnetic field of a dipole is inversely proportional to the cube of the distance from it. The significance of the inverse cube factor is apparent if we compare the anomalous intensities, at each of two sensors, from a buried wall overlying a geologic magnetic disturbance. Let us suppose that the two sensors are directly above the wall at distances of one and two metres, and that the wall overlies the geologic source at a distance of 10 metres. Then, if the geologic anomaly were even as large as the wall anomaly at the site of the lower sensor, the differential anomaly of the wall would be almost four times that of the geologic strata.

The interpretation of magnetic field and gradient data is certainly a task for the expert if full value is to be extracted from the data. The nature of the anomaly will depend upon a large number of factors such as size, shape, depth, magnetic susceptibility of the object, and its orientation relative to the Earth's field. Mineral and oil exploration research has developed computing prowess in this field and it is now possible to achieve exciting successful results if the right skills are applied to the data. Figure 6 shows an actual magnetic contour map over a corner of a stone wall buried at a depth of 5m. This data was measured with a differential magnetometer pair during the search for the lost city of Sybaris in southern Italy.



**KA-ZAP
RECORDS
PTY. LTD.**

**SYDNEY'S ONLY RECORD
BAR AND HIGH FIDELITY
CENTRE.**

**STOCKIST OF SUCH
FAMOUS NAMES AS
YAMAHA, PIONEER,
SONAB, JVC NIVICO,
KENWOOD, DUAL.**

**KA ZAP SPECIAL OF THIS
MONTH: YAMAHA
MC40Z.**



**Double float belt drive turntable
15/15W RMS amplifier only
\$255.**



**619-621a Princes
Highway Blakehurst
Phone 546-7462**

*For further information please
return coupon to above address.*

NAME

.....

ADDRESS

.....

THE BEST PRODUCTS GET THE BEST REVIEWS

marantz. Imperial 7 Speaker System



High Fidelity
Magazine says ...

**Marantz
Builds a
Better
Soundtrap**

THE EQUIPMENT:

Three-way Bookshelf System 12" woofer, 3 1/2" midrange, 1 1/4" tweeter with three-position high-frequency level selector switch and three-position midrange level selector switch

The Imperial 7 is an unusually linear system whose efficiency is well above average for a bookshelf model. In pulse testing the speaker handled up to about 70 watts (139-watts peak) with aplomb. Any really good amplifier delivering between, say, 10 and 30 watts of continuous power per channel should be well mated to the Imperial 7. Driven by such a unit the speakers produce wide-range sound at low distortion. The average omnidirectional response curve is usually flat, being within ± 2 dB over much of the range. The over-all sound of the Imperial 7 is free, alive and transparent. Marantz tells us that one of its design objectives was to build a speaker that would produce wide-range sound at high acoustic levels even with amplifiers of relatively low per-channel power — the sort that are likely to be common in quadraphonic equipment. It certainly has met that objective, and at the same time has given us a welcome addition to the catalogue of speakers available for more conventional purposes.

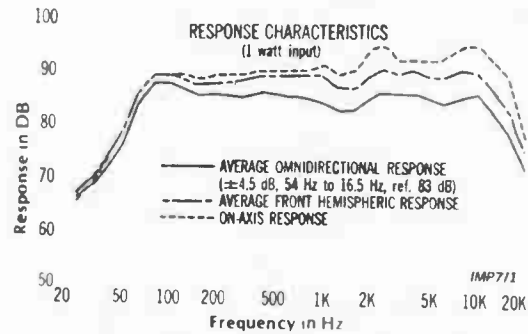

marantz. Imperial 6g Speaker System



MARANTZ IMPERIAL 6G:
Two-way Bookshelf System
10" woofer, 1 1/4" tweeter with
three-position high-frequency
level selector switch

Audio Magazine says ...

The Marantz Imperial 6 is a new two-way system using a 10 in. bass unit with a 2 in. cone tweeter. This latter is fitted with a hard dome at the center to smooth the response and obtain a wide dispersion. A heavy paper cone is used in the bass speaker, and the surround is a plasticized cloth. The voice coil is unusually large at 2 in., and the magnet structure weighs 2 lbs. Crossover is about 3000 Hz (an octave above the tweeter resonance point) and a three-position switch gives a choice of lift or cut. Instead of the usual acoustic suspension or infinite baffle arrangement, the 6 uses a tuned port and the enclosure itself is filled with fibreglass.

White noise tests confirmed the smooth overall response and colouration was quite small. Sensitivity was somewhat above average, quoted efficiency is 95 dB SPL from one watt input at 400 Hz. An amplifier with 15 to 25 watt rms per channel capacity would be sufficient for most people when used with Imperial 6 speakers in a medium-sized room. Listening Tests: The first impression was of a better-than-average transient response and a clean bass with a commendable freedom from colouration — especially in the 80 to 200 Hz region, which can give that 'voice-in-a-barrel effect'. Extended listening tests over a period of three weeks confirmed these opinions. The center or normal position of the treble control was found to be the best for my room unless the speakers were angled inwards when the highest position was preferred.

Summing up: The Marantz 6 can be recommended to those who require a bookshelf system with above average performance.

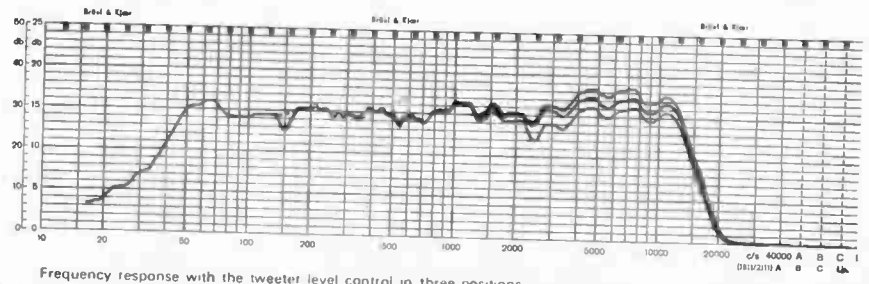

IT'S NICE TO KNOW YOU'RE THE BEST!

For brochure and dealer list write: **Auriema (A/asia) Pty. Ltd.** P.O. Box 604, Brookvale N.S.W.

EARTH RESISTIVITY METER

From gold to archaeological remains — this simply constructed instrument will assist your prospecting.

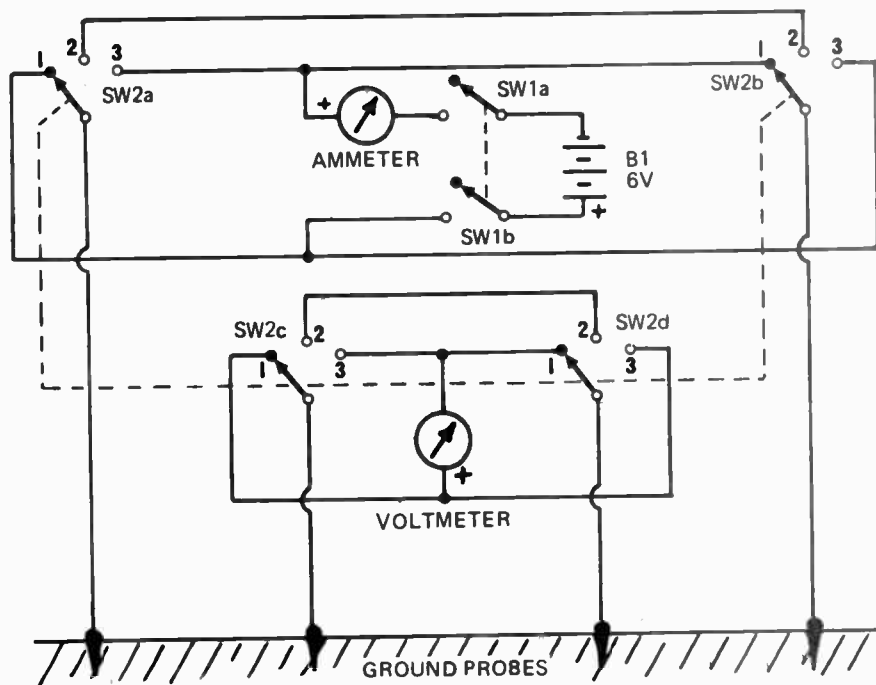

Fig. 1. Circuit diagram of resistivity meter.

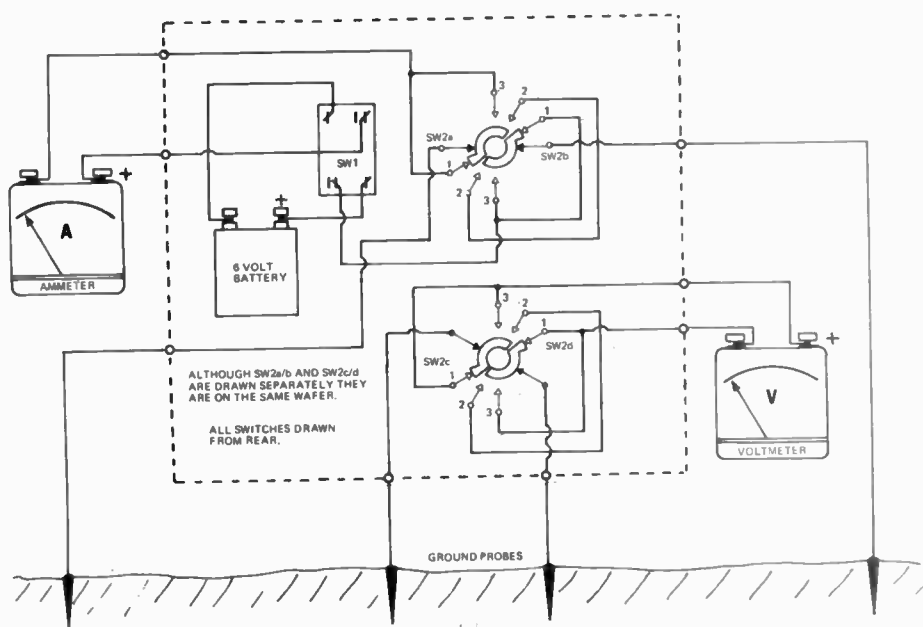

Fig. 2. How the components are interconnected.

AS John Stanley's article explains (pages 36-41 of this issue), an earth resistivity meter can be used to identify the composition of various earth strata — and the depth at which each strata occurs — and by detecting changes in earth composition, to point to the existence of buried objects.

An earth resistivity meter may be used to locate archaeological objects — to assist in finding conditions favourable for alluvial gold or gestones, or even for such prosaic duties as determining where to locate a septic tank!

These instruments are not expensive compared with most electronic instrumentation. Nevertheless at \$500 or so they are way above the budget of most amateur archaeologists or rock-hounds.

But for such people all is not lost — it is possible to construct a simple dc operated resistivity meter for a mere fraction of the price of commercial units.

For this to be possible we have to accept a few operating limitations — primarily of operating depth — for whereas a commercial unit may be used to depths of several hundred feet our unit is limited to fifty feet or so. But unless you are hoping to locate oil bearing deposits in your backyard the limitation on operating depth should not be a problem.

The basic instrument is extremely simple — four equally spaced

PARTS LIST

Double pole on/off switch — MSP 625 or similar. Four pole three way rotary switch — OAK type AK 52259 or similar. Six or twelve volt dry cell battery. Knob for rotary switch. Earth probes and cables. Voltmeter — see text. Ammeter — see text.

HERE IN ONE VOLUME

**THE TWENTY
FIVE MOST
ASKED FOR
PROJECTS
FROM ELECTRONICS
TODAY
INTERNATIONAL**

*Available from
your local newsagent*

\$1.50

** recommended retail price only*

*or in case of difficulty
direct from the publisher*

**Modern Magazines (holdings) Ltd.
21-23 Bathurst St., Sydney 2000.**

Price \$2.00 including postage and packing.



EARTH RESISTIVITY METER

electrodes are placed in line in the earth. An accurately known current is caused to flow from one outer electrode to the other — and a measurement is taken of the voltage between the two inner electrodes.

Having measured both voltage and current, a simple formula (explained on page 46) is used to establish depth and composition of the strata.

Professional earth resistivity meters use alternating current across the earth electrodes in order to eliminate the effects of the small galvanic voltages caused by the earth.

This effect cannot be totally eliminated with dc instruments but it can be minimized by switching the battery across the electrodes in alternate polarities — a centre position of the switch (SW2) meanwhile short-circuits the two centre electrodes between readings to discharge the galvanic potential.

Figure 1 shows the circuit diagram of the instrument. A connection diagram is reproduced in Fig. 2.

We have not provided any mechanical assembly drawings, for this will depend almost entirely upon the meters used. A pair of cheap multimeters are ideal — but if these are not available then a voltmeter and a milliammeter with switchable ranges should be used. The milliammeter should be capable of measuring from microamps to a maximum of 100 milliamps or so, the voltmeter should cover a range from approximately 100 microvolts to three volts or so and should have a sensitivity of about 20,000 ohms per volt.

Switch SW2 is a three-pole four-way wafer switch. All switching contacts are located on one wafer. Each of the four segments shown in the wiring diagram (ie. SW1 SW2 etc) consists of a wiping contact and three fixed contacts — the connections will be readily apparent when the wiring diagram is compared with the switch.

The ground probes should ideally be made of copper coated steel or brass — however electrodes made from 1/2" to 1" steel tubing or rod will work quite well as long as they are kept clean. It is of course essential that they make the best possible contact with the surrounding earth. Electrode cable connections must be securely made using proper terminals — remember that you are looking for fairly minor changes in earth resistance.

Operating voltage is not critical — a six or twelve volt dry cell is adequate for most applications.

Using a resistivity meter

JOHN STANLEY EXPLAINS

MEASURING EARTH RESISTIVITY

THERE are several methods of measuring soil resistivities, mostly variations of the original method devised by Wenner. This consists of driving four metal spikes (commonly called electrodes), into the ground, at equal intervals along a straight line as shown in Fig. 1.

A current is passed through the outer electrodes C_1 and C_2 and the resulting voltage drop across the earth resistance is measured across the inner pair ρ_1 and ρ_2 .

If the ground has a uniform resistivity ρ then

$$\rho = 2\pi a^2 V/I = 2\pi a R$$

where 'R' is the apparent resistance measured between the inner potential electrodes.

Generally the current will flow in an arc between the electrodes and hence the depth penetrated will increase as the electrode separation is increased. The effective depth at which R is measured is usually taken as 0.6 times the separation 'a'.

For the greatest accuracy in determining the ratio V/I it is desirable that the current flow I be maximized and hence in dry surface conditions it is common to moisten the soil about the electrodes to reduce the contact resistance. The depth to which the electrodes are inserted must not

exceed 1/20th of their separation. This is important if standard curves are to be used for the interpretation of the experimental data.

Having inserted the four electrodes an average value for both V and I must be determined for both polarities of the battery. Reversing the polarity removes the possibility that the earth may have its own potential due to galvanic reactions underground. From these measurements the resistivity ρ can be calculated.

RESISTIVITY DEPTH SOUNDING

Consider for example the problem of measuring the depth beneath the ground of the water table or perhaps the thickness of soil overlying the bedrock. This type of situation is by far the most common — where a layer of resistivity ρ_1 and thickness 'd' is overlying a layer of different resistivity ρ_2 .

We can determine the depth 'd' with the aid of 'standard curves'. The procedure is to measure the resistivity of the ground each time the electrode separation 'a' is increased about a central point. To use the standard curves provided it is necessary to plot the measured resistivity (ρ) on the vertical axis, against the electrode separation distance on log/log graph paper.

Continued overleaf

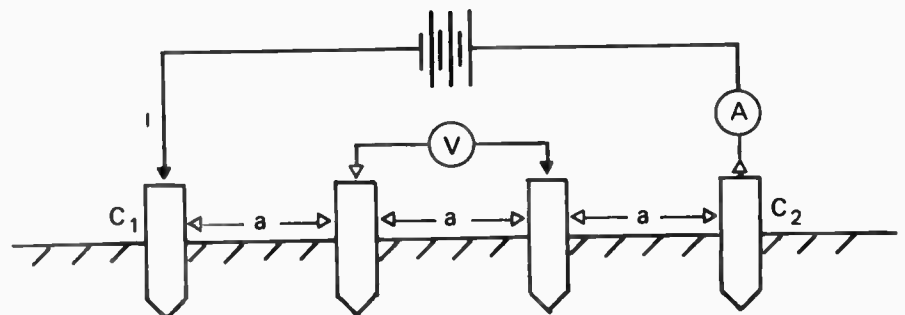

Fig. 1. The electrodes are driven into the ground at equal intervals and in a straight line.

Using a resistivity meter

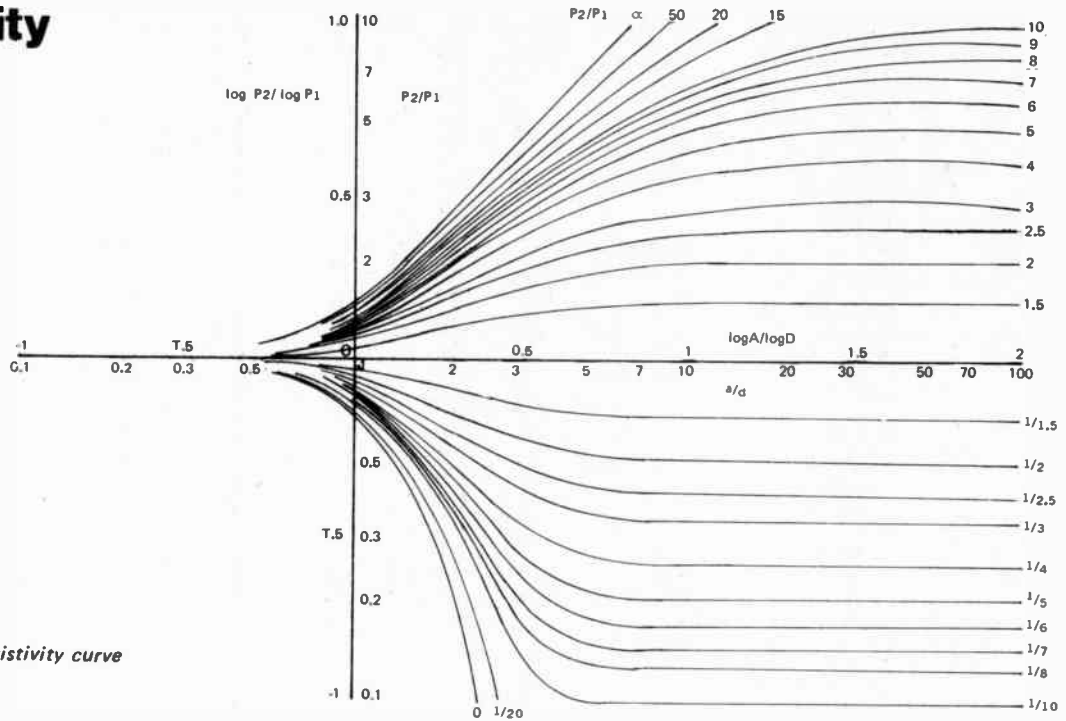

Fig. 2. Standard resistivity curve

The standard curves provided (Fig. 2), are also constructed on log/log graph paper i.e. graph paper that is ruled in both directions at logarithmic intervals. Each major division on the paper corresponds to a power of 10 and is therefore called a decade. We suggest that for plotting your data you purchase semi-transparent paper that has three decades on either axis and a decade separation of 2½ inches. The 2½ inch decade separation is most

important as paper having other decade separations will not allow your plotted results to be overlaid on the standard curves. This paper should be readily available from major stationary suppliers such as John Sands or Dymocks.

Figure 3 shows a typical plot of field data overlaid onto the standard curve.

To do this, place your plotted curve over the standard curve and slide it

horizontally until you find the standard curve that best matches your plotted curve.

When the best matching curve has been found, note where the vertical axis of the standard curve intersects the 'ab' curve of your plotted data. This line extended vertically downwards to intersect the 'electrode separation' axis of your plotted data will show the depth of the first layer – in our example this is 4.25 metres.

Fig. 3. Typical field data plot superimposed over standard curve shown in Fig. 2.

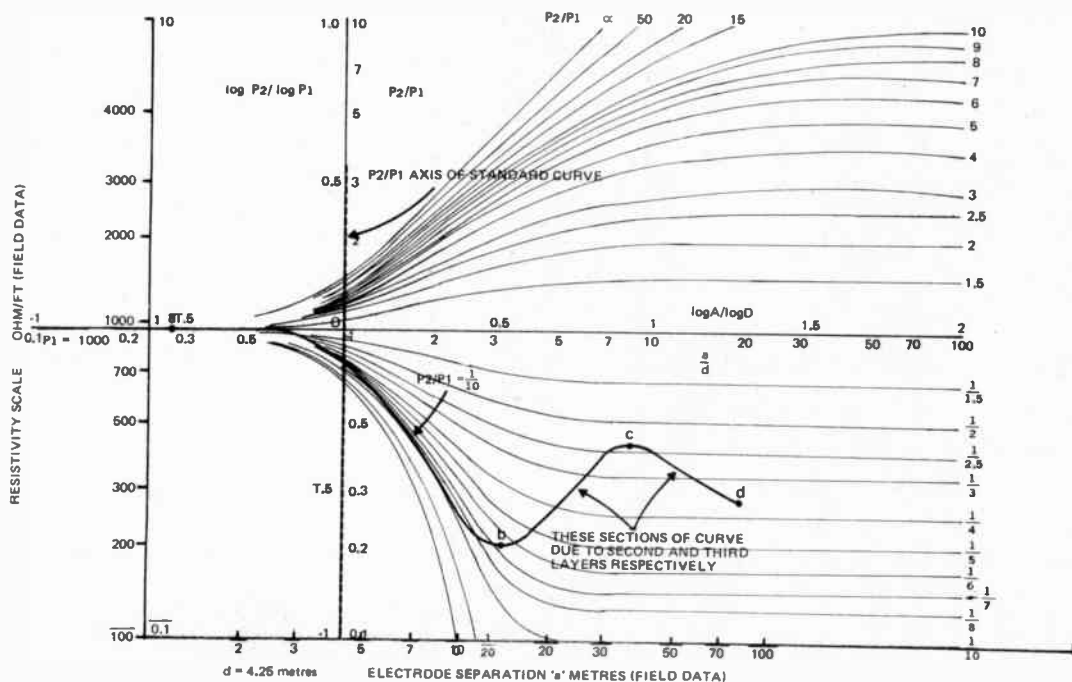

TABLE I

Material	Resistivity (ohms/metre)
Clay	1-120
Water (fresh)	50
Sandstone	35-4000
Limestone	120-400
Granite	5000-10 ⁶
Sand (dry)	>10 ⁶
Marble	>10 ¹²
Alluvium	Variable
Air	Infinite

We know from our plotted data that the resistivity p_2 is about 1000 ohms/metre and the standard curve that is a best match shows a p_2/p_1 ratio of one tenth, that is p_2 equals $0.1 p_1$.

Thus p_2 is approximately 100 ohms/metre. Relating these figures to Table II we see that the most likely strata formation is two layers of sandstone of different densities — or a top layer of sandstone and a lower layer of limestone.

From the section bc it is possible to calculate the resistivity and depth of the second layer but this requires the use of a second set of auxiliary standard curves. These are very complex and beyond the scope of this

article. Similarly section cd provides data on the third layer and so on. There are a number of standard texts on such measurement and the interested experimenter should refer to these for further information.

RESISTIVITY TRENCHING

Another common application of the resistivity meter is in searching for buried objects such as large water mains, buried stream beds or underground sewerage tunnels. The method used is simply to decide approximately at what depth the object is likely to be found, and divide the distance by 0.6 to give a suitable electrode separation. Maintaining this same separation, the array of all 4 electrodes should be progressively moved in a line over the ground being explored. Readings of resistivity should be made at each point and the value plotted against distance moved. (See Fig. 6 page 41) The distance

between each reading point should be no greater than half the dimension of the object to be located; in fact the closer the readings are taken, the greater will be the resolution.

If it is desired to follow the depth of bedrock beneath the surface, it is best to first carry out a vertical depth sounding to locate the bedrock. Then divide this depth by 0.6 to give the most suitable electrode separation. The depth sound will also tell you whether the bedrock has a higher or lower resistivity (from the ratio p_2/p_1). If p_2 is greater than p_1 then an increase in your measured resistivity will tell you that the basement is getting shallower and vice versa. Alternatively, if p_2 is less than p_1 an increase in resistivity will indicate that the basement is becoming deeper. This method is most suitable for looking for alluvial gold or heavy gemstones which tend to be concentrated in the hollows of the bedrock along alluvial creekbeds. ●

Earth electrodes should not be inserted into the ground to a depth greater than $1/20$ th of the probe separation. Because of this, poor electrode/ground contact may result at close spacings. This problem can be reduced by using porous pots filled with copper sulphate solution. Electrodes specifically intended for such work are available from geophysical supply houses.

Eliminate damage to your I.C.'s and save 75% in assembly time.

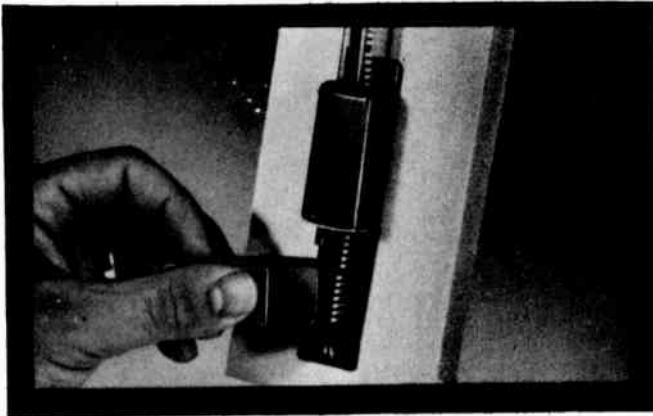

You know how difficult it is to insert .350" splayed D.I.L. leads (as supplied) into .300" pitch holes in P.C.B.'s or sockets without damaging or stressing delicate lead bonds or adjacent components. Our DIPINJECTOR and loading base will eliminate this danger whether you are a large or small user of I.C.'s and will pay for itself over and over.

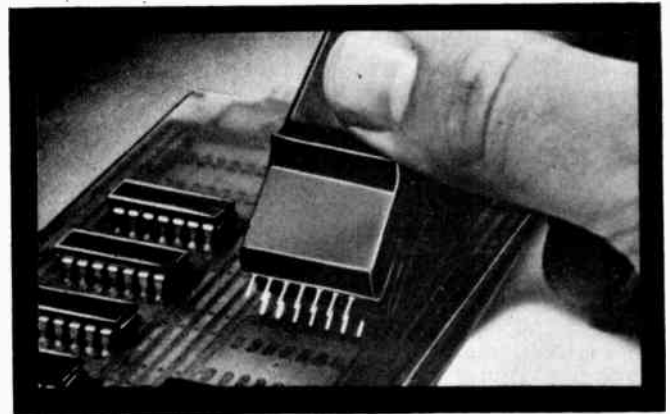

The base accepts all I.C. manufacturers tube carriers and feeds I.C.'s one at a time to be picked up by the non-conductive DIPINJECTOR. Several bases can be used with the one tool or the tool by itself. Only \$3.90 each Plus Sales Tax (if applicable). Send your cheque or purchase order for a 7 day trial.



MCMURDO (AUSTRALIA) PTY. LTD.

Head Office and Factory:
17-21 Carinish Road, Clayton, Victoria, 3168. Tel. 544 3033
N.S.W. 242 Blaxland Road, Ryde, 2112. Tel. 807 1944
S.A. 346-348 Carrington Street, Adelaide, 5000. Tel. 23 1535

AGENTS
QUEENSLAND: Douglas Electronics Pty. Ltd
Tel. 97 8222, 97 8655, Walton Electronics Tel
38 3275 WESTERN AUSTRALIA: W. J. Man-
crown Pty. Ltd. Tel. 23 1194, 25 6140 A.C.T.
Electronic Components Pty. Ltd. Tel. 85 6811
TASMANIA: W. & G. Genders Pty. Ltd. Tel.
31 2511, 34 4311.

73/3/DS

ELECTRICITY FROM WINDMILLS

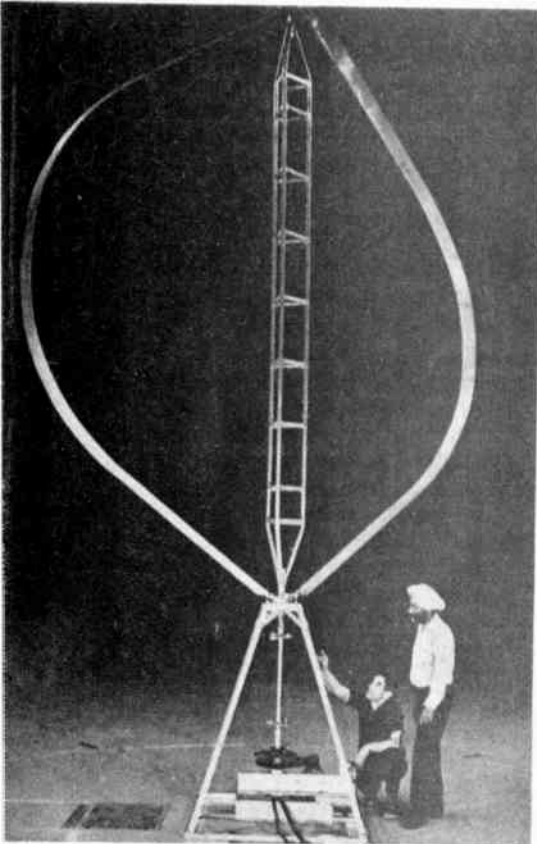

Raj Ranji and Peter South of Canada's National Research Council have developed a wind turbine that rotates around a vertical axis. This avoids gears and shafting. The hope is to provide heating and lighting for Arctic homes.

WITH the world's developed nations becoming more and more worried about diminishing supplies of fossil fuels, engineers in several countries are trying to improve the efficiency of wind-driven power generation, mainly with the aim of providing limited amounts of electricity to isolated settlements and unattended military and scientific outposts, but also with one eye on large-scale power production in the future.

At the Electrical Research Association's Environmental Sciences Research Unit at Cranfield, in Bedfordshire, interest in wind power has been strongly reawakened since arrangements began to be made for the Stockholm Conference on the Human Environment. Ian Harris, in charge of the unit, is already looking at four proposals put to ERA within the past

"The answer my friends is blowing in the wind" — Bob Dylan

two years to design and build wind turbines of varying sizes.

In the developed countries, interest in wind-power last blossomed in and shortly after World War II, with the biggest machine being built by the Americans. Capable of generating 1250 kilowatts of electricity, the project was abandoned after 1000 hours of operation because the blades of the windmill began to crack up. Similar (but generally less spectacular) mechanical misfortunes befell most other wind turbines developed at this time.

Now engineers believe that our knowledge has improved sufficiently to avoid such failures and still squeeze a high amount of energy out of gusts of wind.

The power output of a windmill depends on the wind velocity and the area of blade presented to the wind. In order to maintain continuity of momentum, the maximum amount of energy that can be extracted from the system is just under 60% of the energy flow in the wind. Conventional windmills lose efficiency because their sails can never present an optimum amount of blade area to the wind and because their power generation usually involves some form of mechanical energy transmission by gears and cogs. If X is the maximum that can be extracted from the system, conventional windmills have an efficiency rarely above 15 per cent of X.

The best of more recent designs of windmill, however, can achieve as much as 35 per cent of X. ERA, which has 25 years experience testing other people's wind turbine designs (and some of its own) emphasises that wind turbines have to be built to suit the conditions in which they are to be used. It is of little use to install a windmill designed to give its full rated output in 15 mph winds in an area where the wind speed rarely rises above 10 mph.

Ian Harris explains that almost any cost range is possible with wind turbines, depending mainly on the

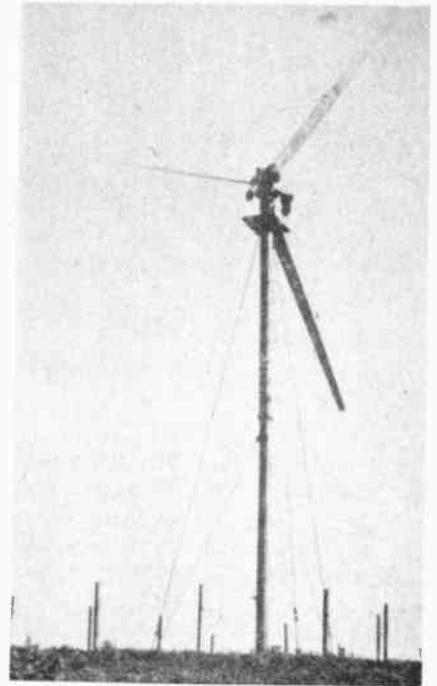

8 kw Allgaier experimental windmill built to supply an isolated croft in the Cairngorms, Scotland.

efficiency required: A straight-bladed turbine is simple (and hence cheap) to make, but an aerodynamically more efficient blade has to be twisted along its length and requires considerably more manufacturing skill. At present ERA is looking at three sizes of turbine, all in the low power range and generally suitable for underdeveloped countries. The smallest, capable of producing 250 watts, is intended mainly for charging batteries for telecommunications uses and is ideal for, say, powering a radio telephone in the bush. The intermediate machines, with an output of 500 to 1000 watts, is just large enough to provide lighting. Harris expects this size of wind turbine to sell well in isolated areas in developed countries, where mains electricity supplies have passed small hamlets by and are unlikely to call again.

The largest wind turbine under consideration at ERA will provide an output of 10 to 20 kilowatts — adequate for most household needs, including lighting, heating and driving power-tools. This kind of system can include an arrangement to give pre-selected priorities to certain tasks as power becomes available.

Because the wind does not blow all the time, all of these machines need some form of power storage. For the low-power generating turbine, batteries are adequate. Not lead-acid batteries, explains Harris, because they are not well suited to intermittent duty. The battery should preferably be an alkali cell of some type — perhaps nickel-cadmium, which the National Research Council of Canada favours for the wind turbines it is developing for use in the far North.

SCOPE

soldering irons

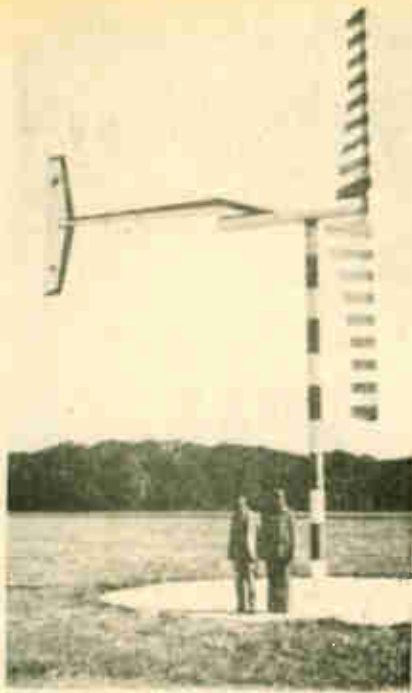

Another shape to wind power: the 40-foot-high Princeton sail-wing.

Above a few hundred watts, however, batteries become cumbersome. Moreover they require the kind of maintenance that is not always available in underdeveloped countries. However, the main power need in underdeveloped countries is for pumping water: hence 'One neat solution' says Harris, "uses the wind turbine for both electricity generation and irrigation. During the day energy from the windmill is used to pump water uphill to a storage tank. At night the water runs back downhill through a small water-turbine generator, giving power when it is wanted for lights. This is an ideal solution for many isolated communities'.

Another solution to the storage problem is most suitable for large wind turbines. Electric current from the turbines. Electric current from the turbine's generator is used to electrolyse water. The hydrogen given off (and possibly the oxygen as well) can be stored to be used later as the fuel to provide heat to drive a conventional gas- or steam-turbine. Alternatively, developments in fuel cell technology might make it possible to recapture the electricity direct by recombining the hydrogen and oxygen.

Conventional windmills are still in use in many parts of the world, and it is there that the new designs of windmill might best make their initial impact. While the capital cost per kilowatt of installed capacity would now be between \$1000 and \$2000 for an advanced wind-turbine prototype, the price would fall greatly with mass production. And, of course, operating costs are almost nil, for the fuel to drive the wind turbine is free.

Buy a SCOPE and join the club of satisfied **USERS**—you need not keep it a secret, others don't. That's why SCOPE IS KNOWN AT ALL THE BEST PLACES—in the tool kit, on the bench, in the boot, on the kitchen table, in the garage, on the service truck, in the engine room, even on the roof... Wherever SCOPE goes it gives you the best service—and a host of satisfied users will agree it is the **QUICKEST**, the **EASIEST**, the **SAFEST**... THE BEST OF ALL **SOLDERING IRONS**.

ECONOMICAL

Consumes current only whilst in use. Scope performs all the functions of other irons from 40 to 150 Watts. (Miniscope—up to 75 Watts).

FAST

Fast heating due to the unique replaceable carbon element. Only 5 to 6 seconds' initial heating up time from cold, then practically instantaneous.

VERSATILE

Copes with all soldering jobs—from miniature components to large solder lugs. Temperature control at your finger tips. Heat only when, where and as much as needed.

SAFE

Low voltage operation. Scope irons operate from 2.5V to 6V.

For your complete protection and the satisfactory operation of your Scope iron, demand and use **THE APPROVED SCOPE**

natronic

TRANSFORMER which incorporates a specially designed **ELECTRO-STATIC SHIELD**.



* Approved by electricity authorities APP. No. N/360/6894-5

CONVENIENT

Ideal for those almost inaccessible spots. No burning of adjacent insulation.

LIGHT WEIGHT

Scope De Luxe weighs only 3½ ozs. Miniscope 1¾ ozs.



All irons are supplied complete with a spare tip and two elements and suitably packed for presentation as a gift.

SPARE PARTS

No expensive resistance wire heating elements to replace. Maintenance without special tools. Spare tips, carbon elements and other parts readily available from your Scope Distributor.

Scope products are available from all major electrical wholesalers and Hardware Stores throughout Australia and from H. W. Clarke, Wellington and Auckland, New Zealand.

SCOPE MEANS A LIFETIME OF SATISFACTION



IRH Components Pty. Limited

THE CRESCENT, KINGSGROVE, N.S.W. 2208. PHONE: 50-0111

74 RAGLAN ST., PRESTON, VIC. 3072. PHONE: 44-5021

Interstate Agents

HOB. TAS. 342811
LAUN. TAS. 22844
PERTH W.A. 82271
ADEL. S.A. 231971
BRIS. QLD. 211933

New Zealand
H. W. CLARKE
(N.Z.) LTD.



Please Post free SCOPE literature

NAME

ADDRESS

CITY POSTCODE

we give you the auto features the rest try to sell

fully automatic
stereo turntable
BFU-121



apan MUSIC MAKER

The BFU-121 boasts perfect record tracing; quiet, constant speed, 4-pole synchronous motor; feather-touch cue-control lever; 12 months warranty and after sales service.

And all for around \$125 . . . ready to operate, with no hidden extras. All the auto features that you normally associate with a much higher priced unit. All the quality that a discerning hi-fi enthusiast demands.

AUTO PLAY: Flip the lever to auto and the turntable begins to rotate. Upon reaching the required rpm, the arm leaves its rest and gently lowers the stylus to the disc.

AUTO RETURN: On completion of the record an oil-dampened precision lifter is actuated to automatically return the arm to the rest, switching off the power.

AUTO REPEAT: When the repeat button is depressed slightly, the arm will repeat automatic operation. By pressing the reject button, the auto-repeat function is released, thus stopping the record wherever required.

AUTO CUT: When it is desired to stop the record midway through, gently touch the reject lever and the arm will return to its rest, cutting off power.

Manual and semi-auto models also available.

RALMAR

agencies pty. ltd.

431 Kent Street, Sydney Tel.: 29 4338

AGENTS:

QLD: Tallerman & Co. Pty. Ltd., Robertson St., Valley, Brisbane
VIC: K.J. Kaires & Co. Pty. Ltd., 4 Hill Court, Macleod
S.A.: Wm. M. Matthew & J.A. Dunn Pty. Ltd., 251 Hutt St., Adelaide

STATE DISTRIBUTORS:

W.A.: G.K. Cameron & Co. Pty. Ltd., 246 Churchill Ave., Subiaco
A.C.T.: Sonny Cohen & Son, 20 Isa St., Fyshwick
TAS: W. & G. Genders Pty. Ltd., Launceston, Burnie, Hobart
N.T.: N.T. Musical & Electrical Wholesale Pty. Ltd., 54 Cavenagh St., Darwin

AMATEUR RADIO

Roger Harrison VK2ZTB



THE STATE OF THE ART

AUSTRALASIAN BEACONS

THERE are a number of beacons in and around Australia which can provide useful data for propagation research or as indicators of abnormal or special propagation conditions. A list of the currently operating beacons in Australia (and Australian territories) and New Zealand is reproduced in this article. The coverage of these beacons is very good and will quickly improve as further beacons are commissioned.

Interest in beacons as propagation indicators and research tools is increasing; in fact the Ionospheric Prediction Service constructed two six-metre beacons in 1971 for commissioning at Casey and Mawson stations on the Antarctic Mainland. The Casey beacon, VKΦGR, has since been heard in Tasmania, South Australia, Victoria and New South Wales (the writer has a tape available of this event) last December.

Two recently commissioned beacons have proved of great use and stimulated a great deal of activity. These are VKΦWI on Macquarie Island and VK2WI in Sydney. Their frequencies are given in the beacon list. VKΦWI has been heard (together with stations on Macquarie being worked) on quite a number of occasions over the months of December, January and February. Stations in Tasmania, Victoria, South Australia, New South Wales and Queensland have worked Macquarie Island stations VKΦWW and VKΦVS. The beacon has been heard in all states except the Northern Territory. The Sydney beacon VK2WI has been heard in all states of Australia and some areas in New Zealand. The collation of data from these beacons and from amateur contacts can provide some useful data in sporadic E ionospheric research.

The Beacon Committee of the NSW

Division of WIA put forward a number of recommendations concerning beacons, in April last year. These recommendations included specifications of ERP (100 watts minimum) a frequency stability of 1 in 10^7 or better, and an exclusive beacon segment on each band, with beacons allocated on a frequency/area basis to

ensure propagation to the possible areas with a minimum of co-channel or adjacent channel interference — some frequencies being shared. The considerations are worth noting as they provide a basis for rationalising the present — more or less haphazard — system and future additions and expansions.

(Continued on page 53)

BEACON LIST

Area	Frequency	Call Sign	Location
Antarctica (VKΦ)	52.161MHz	VKΦWI	Macquarie Is.
	53.100MHz	VKΦMA	Mawson
	53.200MHz	VKΦGR	Casey
NSW (VK2) Victoria (VK3)	52.450MHz	VK2WI	Dural
	144.700MHz	VK3RTG	Vermont
Queensland (VK4)	144.925MHz	VK3QZ	Traralgon
	52.400MHz	VK4WI/2	Townsville
	144.390MHz	VK4WI/R1	Toowoomba
South Australia (VK5)	53.000MHz	VK5VF	Mt. Lofty
	144.800MHz	VK5VF	Mt. Lofty
West Australia (VK6)	52.006MHz	VK6VF	Bickley
	52.900MHz	VK6TS	Carnarvon
	52.950MHz	VK6VE	Mt. Barker
	144.500MHz	VK6VE	Albany
Tasmania (VK7)	145.000MHz	VK6VF	Bickley
Northern Territory (VK8)	144.900MHz	VK7VF	Devonport
	52.200MHz	VK8VF	Darwin
NEW ZEALAND			
ZL1	145.100MHz	ZLIVHF	Auckland
ZL2	145.200MHz	ZL2VHF	Wellington
	145.200MHz	ZL2UHF	
ZL3	431.850MHz	ZL2UHP	Palmerston North
	145.300MHz	Z12UHF	Palmerston North
ZL4	145.400MHz	ZL3VHF	Christchurch
		ZL4VHF	Dunedin

Hear Here.



The incomparable BSR TD8S 8-track stereo tape cartridge player.

This superb machine literally speaks for itself. This cunningly designed and engineered unit produces an extremely high quality stereo sound reproduction from an eight track cartridge. One cartridge will provide four separate stereo programmes of up to one hour and twenty minutes in length. The machine will then repeat the programme indefinitely. Track switching is completely automatic or can be selected by a simple push button selector. Each track is indicated as it is being played.

An integral solid state pre-amplifier gives a fully corrected frequency response ideal for feeding into the auxiliary input on a suitable power amplifier. Motor temperature is controlled by an integral force-ventilation system. The heart of the machine is a four pole dynamically balanced synchronous motor which delivers an unwavering constancy of speed independent of normal voltage fluctuations. The TD8S is undoubtedly the highest

quality 8 track cartridge player available. But why not hear the superior sound of this brilliant machine for yourself at your nearest retailer of sound equipment, because as we said before, the TD8S literally speaks for itself.

Technical Data

Number of tracks: 8 (4 stereo channels);
Tape Speed: 3 $\frac{1}{2}$ in. per sec. (9.6 cm/sec);
Programme Selector: Automatic and manual; Tape Head: Nortronics 4 track with hyperbolic face; Pre-amp Output: 750 mv (nominal) 1 Kc Standard Reference Level Tape; Track Playback Sequence: 1 and 5, 2 and 6, 3 and 7, 4 and 8 and infinite repeat; Wow/Flutter: Less than 0.3% total; Frequency Response: Better than 50-10,000 Hz; Power Supply: 210-250 volts, 50 Cycle AC; Dimensions: Cabinet: 261 mm x 206 mm x 99 mm; Net Weight: 5 $\frac{1}{2}$ lbs.; Cartridge Dimensions: This unit will accept standard 8 track cartridges measuring 139 mm x 101 mm x 22.5 mm.

BSR (A/asia) Pty. Limited.
Anne St., St. Marys. 2760
TELEGRAMS "BSR" St. Marys. 2760
TELEX 23159 PHONE 623 0375

NSW: Goldring (NSW) Pty. Ltd.,
26-28 Ricketty St., Mascot 2020
PHONE 669 6088

VIC: Goldring (Vic) Pty. Ltd.,
162 Pelham St., Carlton. 3053
PHONE 347 5177

QLD: Goldring (Qld) Pty. Ltd.,
35 Balaclava St., Woollongabba. 4102
PHONE 91 4972

SA: Goldring (SA) Pty. Ltd.,
76 McLaren St., Adelaide. 5000
PHONE 23 3488

WA: Goldring (WA) Pty. Ltd.,
32 Northwood St., Leederville. 6007
PHONE 84 988

BSR McDONALD
TD8S

BSR 118R

AMATEUR RADIO

Dr. Peter Hammer VK3ZPI, who built the command system for Oscar 6 (presently in orbit), visited AMSAT headquarters in Washington in January to discuss plans for future Oscar satellites and the following details emerged from these discussions:—

OSCAR 7

The orbit will be similar to Oscar 6 with the possibility that the orbit time may be 3am/3pm rather than 9am/9pm.

A 2/10M translator similar to that carried on Oscar 6 will be installed but with a power output of 5W. A backup 2/10M translator with a 1W output will also be carried. Also to be used will be the EUROSCAR linear translator with input centred on 435.15 MHz and output centred on 145.95 MHz. Bandwidth will be 45 kHz. Power output will be 10W PEP.

Beacons will operate on 145.98 MHz (when the 2/10M translator is off) and 435.1 MHz (when the EUROSCAR translator is off).

The 24 channel morse code telemetry system (similar to Oscar 6) will be flown as well as Peter's 60-channel RTTY telemetry system, which had limited success on Oscar 6 owing to switching problems.

Launch date is planned for mid-1974.

Design life is planned to be 3 years and the unit will be able to operate seven days a week. Dr. Hammer's highly successful command system will again be used.

OSCAR 8

This could possibly be a completely Australian built satellite. Launch date probably in 1975. Further details will be published as they come to hand as plans have not been finalised for this satellite.

OSCAR 6 OPERATIONS CHANGES

Oscar 6 is now operative from 0000 GMT Fridays to 0000 GMT Tuesdays, inclusive. This extension of operating times has been made possible by the failure of the 435.1 MHz beacon with a consequential increase in available power.

Apart from the beacon failure Oscar 6 continues to function well. Some temperature increases were noted during the southern hemisphere summer, the downlink power amplifier rising to 60°C at times. The slow rotation of the satellite now accounts for this as one face will spend considerable time in the sun. ●

100 tips for superior soldering

Adcola Australia lead the world with over 100 different standard tips, covering the entire field of production and servicing. Micro-miniature and instrument work; printed circuits; heavy tag, chassis and wire soldering. All are sealed to prevent seizing in the barrel.

Each tip is matched to one of the seven long-life, fast-heating Adcola 'M' Series soldering tools — from ¼ oz. to 5 ozs. — each of which is available in at least three temperature ranges.

Benefits — swift work, durable joints, no damage to components, no joint embrittlement, lower soldering and maintenance costs. When it comes to soldering, the best tip is Adcola.



ADCOLA

Selection is simple; from our brochure. Yours for the asking.

VIC: 22 Firth St., Doncaster, 3108
NSW: 59 Moxon Rd., Punchbowl
S.A.: Graphic Electronic Industries
Pty. Ltd., Adelaide
QLD: T.H. Martin Pty. Ltd., Brisbane
W.A.: Everett Agency Pty. Ltd., Perth

ADCOLA PRODUCTS PTY. LIMITED

(Tel. 848 3777)
(Tel. 709 5293)

(Tel. 51 4208)
(Tel. 21 5644)
(Tel. 8 4137)

RA5A

Audio frequency

ETI PROJECT 211

Simple unit measures frequencies from 50 Hz to 10 kHz

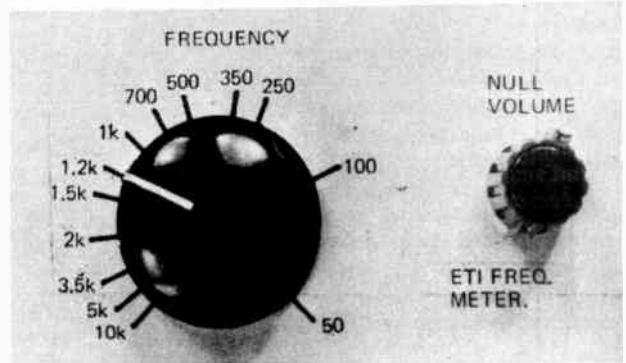
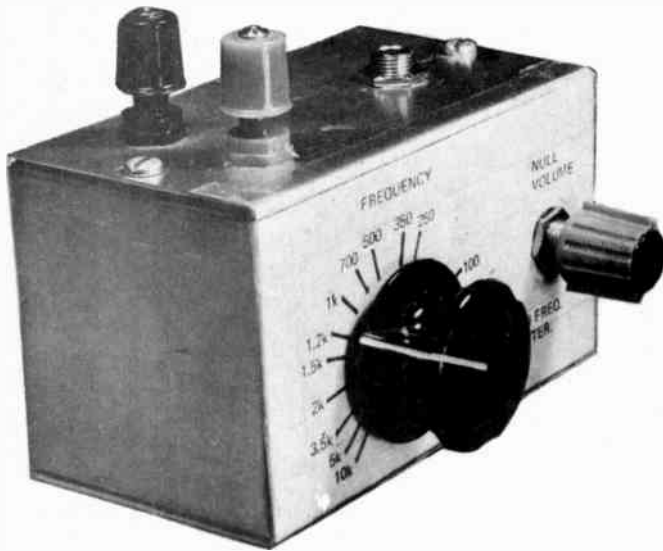

Fig. 1. Circuit diagram of the audio-frequency meter which is based on the Wien bridge.

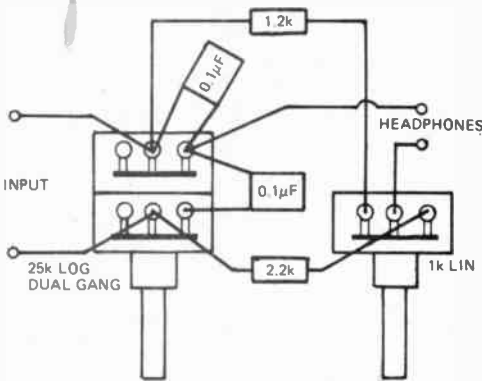
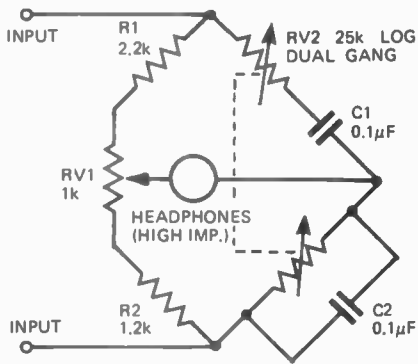

Fig. 2. Follow this diagram to wire the unit.

PART LIST

R1 resistor 2.2 k ohm 5% ½ watt
 R2 resistor 1.2 k ohm 5% ½ watt
 C1 capacitor 0.1µF 100 volt polyester
 C2 capacitor 0.1µF 100 volt polyester
 RV1 potentiometer 1 k ohm linear
 RV2 potentiometer 25 k ohm log dual gang
 Input terminals 2 banana post
 Output socket to suit headphones
 Metal box aluminium mini box
 Headphones earpiece or headset preferably high impedance — 1 k ohm or more.

CALIBRATION CHART

FREQUENCY HZ	RV1 RESISTANCE (one section)
75	21.2 kohm
100	15.9 kohm
150	10.6 kohm
200	8.0 kohm
300	5.3 kohm
400	4.0 kohm
500	3.18 kohm
600	2.65 kohm
750	2.12 kohm
1000	1.59 kohm
1500	1.06 kohm
2000	800 ohms
3000	530 ohms
4000	400 ohms
5000	318 ohms
6000	265 ohms
7500	212 ohms
10 000	159 ohms

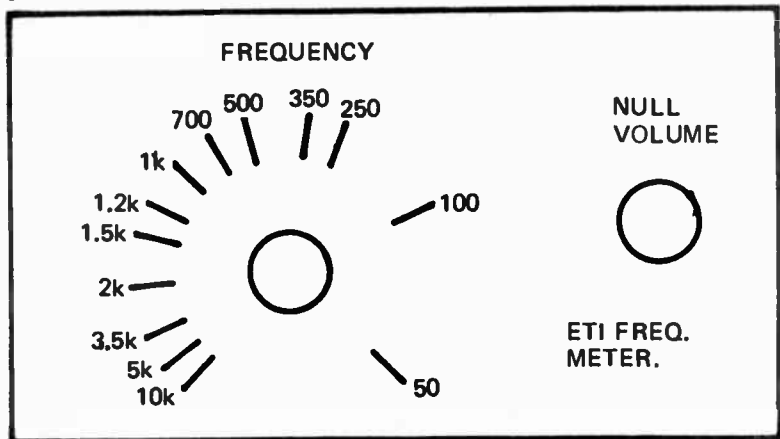
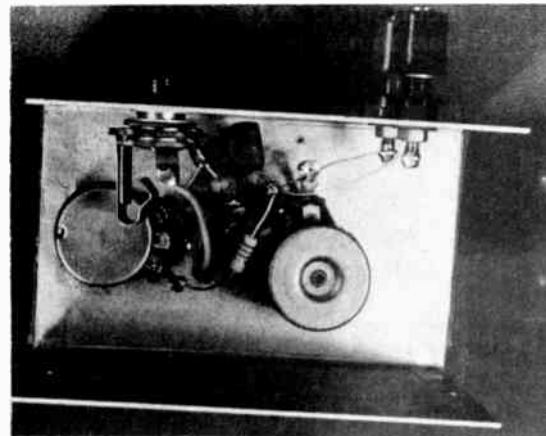

Fig. 3. Front panel of our meter shown for information only — calibration may not suit all potentiometers.



meter

AUDIO FREQUENCY METER

ON MANY occasions it is useful to be able to determine the frequency of an audio signal. Often, the accuracy and expense of a commercial frequency meter is not justified.

This little circuit, using only a few components will provide an indication of frequencies from 50Hz to 10kHz with an accuracy primarily determined by the calibration of the instrument.

The audio signal — of which the frequency is to be established — is fed into the input terminals of the unit and the calibrated dial adjusted until a 'null' is obtained whilst listening to the signal through a pair of headphones, or even a single crystal earpiece.

We suggest that the components be mounted in one of the small aluminium miniboxes which are available readily at low cost. Our prototype unit had a 4" x 2½" front panel, but a larger box will enable a larger frequency scale to be used hence providing better resolution. Apart from this a larger box will allow input terminals and output socket to be mounted on the front panel together with the frequency-null controls.

Note that the dual potentiometer is a

logarithmic type and is wired such that the frequency scale *increases* with anti-clockwise rotation. This results in a more linear scale (less cramped at the high end) than if wired conventionally.

Any type of earpiece or headphone may be used to detect the null but best efficiency will be obtained with those having an impedance of around one thousand ohms.

The best way to calibrate your meter is to compare it with a good quality oscillator and mark your scale to suit. Remember that most potentiometers have a manufacturing tolerance of ±20% and hence our front panel drawing may not be correct for your potentiometer.

If an oscillator is not available, but you do have an ohm-meter, then calibration may be carried out by measuring the settings of RV2 (disconnected from the circuit) and marking the scale as shown in Table I.

To use the meter, couple the audio signal into the input terminals and adjust RV2 to a point where the signal drops off. Adjust RV1 to increase the null and RV2 again for the final setting. The frequency of the incoming signal is then read from the front scale. What could be simpler? ●

HOW IT WORKS

The circuit is that of a Wien bridge which when used for frequency measurement has the form shown below:—

If $C_x = C_s$, $R_x = R_s$ and $R_b = 2 R_a$, then $f = \frac{1}{2\pi C_s R_s}$ or, $R_x = R_s = 0.628 f$

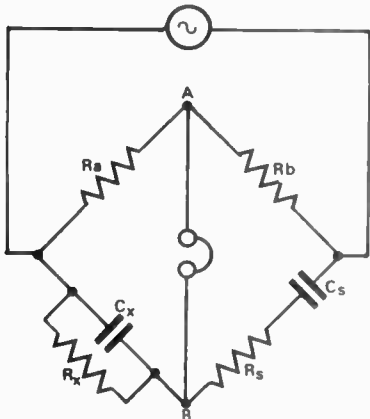

where $C_x = C_s = 0.1\mu f$. Our calibration chart was calculated from this last formula.

At the frequency where the reactance of C_s equals R_s and also $C_x = R_x$, the series network has an impedance of 1.414R and phase angle of 45%. The parallel network has an impedance of 0.707R and the same phase angle. The signal at point B will therefore be in phase with the input level, but attenuated to 1/3 of that level. If $R_b = 2R_a$ the signal at A will also be attenuated to 1/3 of the input. Thus the bridge is balanced and the signals at A and B will be equal in amplitude and phase and a null will occur at that frequency.

At any other setting of the potentiometer the phase angle and amplitudes will be such that an increased output is obtained.

The respective sections of the dual gang potentiometer never track each other perfectly and hence RV1 has been included to obtain best null at any point on the scale.



CHECK THESE FEATURES!



- 1 "S" METER—
Signal Strength Indicator
- 2 FINE TUNING CONTROL
for improved Selectivity

2 SPECIAL REASONS

Why YOU Should Choose

EDDYSTONE EC10 Mk. II. Communications Receiver

Everyone knew the EC10 and NOW Eddystone introduce the NEW Extra Value EC10 Mk. II. The same reliable performance PLUS Two NEW features. The hard-to-get contacts become NOT-SO-HARD! Frequency coverage is continuous from 550 kHz to 30 MHz. Order YOUR EC10 Mk. II TODAY . . . why not NOW! \$205.00 plus sales tax. (Price subject to change without notice.)

Available ex-stock from . . .
Wholesalers or Aust. Agents

R.H. Cunningham
PTY. LTD.



VIC.: 493-499 Victoria St., West
Melbourne. Phone: 329-9633.
N.S.W.: Sydney. Phone: 929-8066.
W.A.: Perth. Phone: 49-4919.
QLD.: L. E. BOUGHEN & CO.,
Auchenflower. Phone: 70-8097.

TELEX: Melb. 31447, Sydney 21707

EDDYSTONE EC 10 Mk II ET 5:73

Name.....

Address.....

MAIL THIS COUPON TODAY

INSTROL

SLASHES A.D.C. PRICES

ADC STEREO CARTRIDGES — AMERICA'S QUALITY CARTRIDGE

ADC 220X . . . \$17.00

ADC 220X. Type: Induced Magnet; Output: 6 mV at 5.5 cms / sec. recorded velocity; Tracking Force: 1 to 2½ grams; Frequency Response: 10 Hz to 18 kHz +3dB; Channel Separation: 20dB from 50 Hz to 10 kHz; Compliance: 20 x 10⁻⁶ cms / dyne; Spherical Stylus Tip Radius: .0007" Vertical Tracking Angle: 15°.



ADC 220XE . . . \$22.00

ADC 220XE. Type: Induced Magnet; Output: 6 mV at 5.5 cms / sec. recorded velocity; Tracking Force: 1 to 2½ grams; Frequency Response: 10 Hz to 18 kHz ± 3 dB; Channel Separation: 20 dB from 50 Hz to 10kHz; Compliance: 20 x 10⁻⁶ cms / dyne; Elliptical Stylus Tip Radii: Contact radius .0003". Lateral radius .0007"; Vertical Tracking Angle: 15°



ADC 10E mk4 . . . \$51.00

Type: Induced Magnet*
Output: 4 mV at 5.5 cms / sec. recorded velocity
Tracking Force: .7 gram
Frequency Response: 10 Hz to 20 kHz ± 2 dB
Channel Separation: 30 dB from 50 Hz to 12kHz
Compliance: 35 x 10⁻⁶ cms / dyne
Elliptical Stylus Tip: Contact radius: .0003"; lateral radius: .0007"
IM Distortion: Less than ½% — 400 & 4000 Hz at 14.3 cms / sec. recorded velocity
Vertical Tracking Angle: 15 degrees
Recommended Load Impedance: 47000 ohms nominal

ADC 550XE . . . \$30.00

ADC 550XE. Type: Induced Magnet; Output: 5 mV at 5.5 cms / sec. recorded velocity; Tracking Force: ¾ to 2 grams; Frequency Response: 10 Hz to 20 kHz ± 2 dB; Channel Separation: 20 dB from 50 Hz to 12 kHz; Compliance: 35 x 10⁻⁶ cms / dyne; Elliptical Stylus Tip Radii: Contact radius .0003". Lateral radius .0007"; Vertical Tracking Angle: 15°.



SPECIAL INTRODUCTORY ADC OFFER . . . SAVE \$\$\$\$

J. H. TURNTABLE (complete) This outstanding turntable value consists of:—



ALL THE ABOVE FOR ONLY

(A) J.H. TURNTABLE

Belt drive, synchronous motor, unmeasurably small rumble, wow and flutter of better than 0.04%, negligible hum radiation, with 12" diameter of platter.

(B) SANSUI TA1050 ARM

A high precision universal arm. Oil damped cueing lift is fitted. Anti skate. Separate stylus pressure gauge.

(C) A.D.C. 220X

Magnetic cartridge. Tracking force 1½ to 3 grams, extremely linear and smooth frequency response.

(D) INSTROL 44 STAND PLUS HINGED 'PERSPEX' COVER.

This acoustically sprung player stand is available in either oiled teak or walnut, complete with moulded perspex cover and "stay-up" hinges.

\$105.00

(fully assembled & packaged)

COMPLETE FULL-COLOUR HI-FI CATALOGUE AND PRICE LIST . . . ONLY 50c

Contains full specifications, gloss colour illustrations and special Instrol discount pricing on the following items—: Turntables, cartridges and styli, Amplifiers, Amplifier kits and Dynakits, Speaker system, Speaker kits, Speaker enclosures, Tuners, Four channel equipment, Tape decks and recorders, Dolby cassette decks, Record Storage cabinets and kits, Equipment Cabinets (Built and Kits) for hi-fi, Hi-Fi accessories, Guitar amplifiers and guitar speaker systems (Built and kits), Technical Books, Instrol products, etc.

Please send me your complete hi-fi catalogue and price list. I enclose herewith postage stamps or money order to the value of 50c. I understand that the 50c will be refunded on my first purchase.

NAME
ADDRESS
. P.C.

T305

INSTROL **SPEAKER SYSTEMS KITS**

All the systems below are available in kit form. The cabinet kits come in either unpolished walnut veneer or unpolished teak veneer. All kits are complete, and include speakers, crossover networks (where applicable), cabinet kits, grill cloth and innerbond.

MAGNAVOX 8-30 SYSTEM at reduced prices.

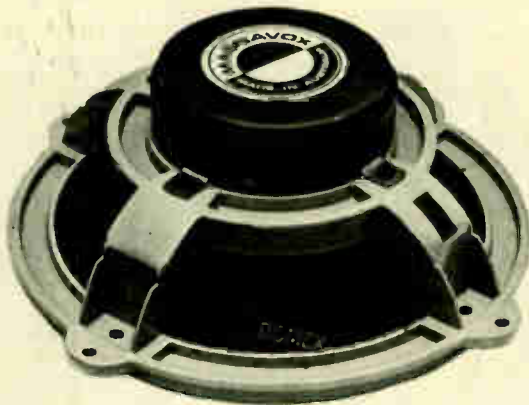

Featured in "Electronics Today". It handles 30 watts RMS, features a new high performance 8" speaker, two 3" tweeters, and is available in cabinet 20 7/8" x 12 7/8" x 8 7/8" (1 cu. ft.) or 23 7/8" x 15 1/2" x 10 7/8" (1.6 cu.ft.). Available in teak or walnut veneer.

COMPLETE SYSTEM

Kit of Parts \$42.00 (1 cu ft) \$52.00 (1.6 cu ft)
Built and Tested \$55.00 (1 cu ft), \$65.00 (1.6 cu ft)

SEPARATE COMPONENTS

Enclosure kit (1 cu ft) \$17.00
Enclosure kit (1.6 cu ft) \$27.00
Built Enclosure (1 cu ft) \$30.00
Built Enclosure (1.6 cu ft) \$39.00
speakers & crossover only \$26.00 (one side only)

NEW E.T. MAGNAVOX 8-30 DESIGN

A revised version of the popular Magnavox system was featured in July 1972 edition of Electronics Today. It featured a Philips tweeter and improved crossover

COMPLETE SYSTEM

Kit of Parts \$62.00 (1 cu. ft.) \$72.00 (1.6 cu. ft.)
Built and Tested \$75.00 (1 cu. ft.) \$85.00 (1.6 cu. ft.)

SEPARATE COMPONENTS

Speakers and crossover only \$45.00 (one side only)

WHARFEDALE AND KEF KITS

The Wharfedale Super Linton, Melton and Dovedale 3 are now available as build-yourself kits, featuring INSTROL quality cabinet kits in choice of walnut or teak veneer.

Similarly the KEF range of speaker systems are now available as build-yourself kits, the Concerto, Concorde and Chorale all being available complete with INSTROL cabinet kits (teak only)

The Super Linton kit employs an 8" bass and 3" tweeter.

The Melton kit employs a 12" bass and tweeter.

The Dovedale 3 kit employs a 12" bass, 5" mid-range and 1" tweeter.

The Chorale kit employs the B8200 bass and T27 tweeter

The Concorde kit employs the B139 bass unit and T15 tweeter.

The Concerto kit employs B139 bass, B110 mid-range and T27 tweeter.

COMPLETE SYSTEMS

Wharfedale Super Linton kit (Unit 3)	\$52.00
Wharfedale Melton kit (Unit 4)	\$93.00
Wharfedale Dovedale 3 kit (Unit 5)	\$128.00
KEF Chorale kit	\$79.90
KEF Concorde kit	\$99.90
KEF Concerto kit	\$169.00

INSTROL and SEAS COMBINE to present 2 NEW speaker systems the BROADWAY 201 and BROADWAY 251

BROADWAY 201 — This system features the SEAS wide range 8" speaker, 21TV.GD, in your choice of teak or walnut enclosure. The attractive cabinets, which feature bevelled fronts, measure 16-7/8" x 11" x 9".

BROADWAY 251 — This system uses the 25 TV.ED, a 10" wide range speaker by SEAS. In teak or walnut cabinets. Featuring bevelled fronts, the enclosures measure 21" x 12" x 11 1/2".

COMPLETE SYSTEM

Kit of Parts (Broadway 201)	\$26.00
Kit of Parts (Broadway 251)	\$33.00
Built and Tested (Broadway 201)	\$36.00
Built and Tested (Broadway 251)	\$46.00

SEPARATE COMPONENTS

BROADWAY 201 encl. kit only	\$14.50
Broadway 251 encl. kit only	\$19.00
8" SEAS (21 T.V.GD) speaker only	\$12.50
10" SEAS (25 TV.ED) speaker only	\$14.50

INSTROL HI-FI & ELECTRONICS CENTRE

91A YORK ST., (between King & Market Sts.),
SYDNEY, N.S.W. 2000. Phone 29 4258

Please send me the following speaker systems or turntable system. These will be sent by road transport or passenger rail, freight payable on receipt of goods. (Cartridges will be sent freight free).

..... at \$.....
..... at \$.....
..... at \$.....

I enclose my money order/cheque for \$

NAME

ADDRESS

..... P.C.....

MATCHING COMPATIBLE STEREO... THANKS TO WHARFEDALE



True. You can get yourself into a lot of strife if you buy stereo components from seven different manufacturers and an equal number of hi-fi dealers. And matching stereo equipment is a job for an audio expert.

To save you the trouble (and the unnecessary expense) Wharfedale's engineers have designed an electronically balanced range of fully compatible stereo equipment. With Wharfedale's experience and "know-how" how can you go wrong? After all, Wharfedale have been marketing

high fidelity equipment for a longer time than any other recognised manufacturer! For over forty years!

In the new Wharfedale range you will find:—

- THE LINTON STEREO AMPLIFIER
- THE LINTON TURNTABLE • THE

DC9 CASSETTE RECORDER • MODEL DD-1 STEREO HEADPHONES

• YOUR CHOICE OF NO LESS THAN EIGHT HIGH QUALITY SPEAKER SYSTEMS RANGING FROM 20 TO 40 WATTS DIN RATING.

See and hear the Wharfedale range at your nearest Bleakley Gray franchised dealer. Listen carefully and critically. You can depend on Wharfedale quality absolutely.

Bleakley Gray Corporation Pty. Limited.

Australian National Distributors:

INTERSTATE REPRESENTATIVES:
N.T.: Pfitzner's Music House, Smith Street, Darwin. Tel. 3801.
Tas.: K. W. McCulloch Pty. Ltd., 57 George Street, Launceston. Tel. 2 5322.



Head Office: 28 Elizabeth St., Melbourne, Vic. Tel. 63 8101*. Telex: 31904
Sydney Office: 177 Salisbury Rd., Camperdown, N.S.W. Tel. 519 5555*
Canberra Office: 25 Molonglo Mall, Fyshwick, A.C.T. Tel. 95 2144*
Adelaide Office: 301 South Terrace, Adelaide, S.A. Tel. 23 6219
Brisbane Office: 3 Prospect St., Bowen Hills, Qld. Tel. 52 7333
Perth Office: 27 Oxford St., Leederville, W.A. Tel. 81 4988

MASTER MIXER

How to use the master-mixer in the most effective way — and how to modify it to suit individual requirements.

ETI PROJECT 414

HAVING built the ETI Master-Mixer you will wish to use it in the most effective way, and perhaps modify its performance to suit individual requirements. We cannot possibly cover all eventualities, but this article provides details of a typical installation and some commonly-needed alternative configurations.

BASIC PHILOSOPHY

The unit has been designed to provide master-mixing for the average sized group (which is usually similar to that shown in Fig. 1). It provides a stereo output which may be used to drive the main amplifiers for an auditorium, or may be used for recording purposes. We have taped major performances using our own prototype master-mixer and have achieved very pleasing results indeed. Remember however that a system configuration suitable for recording is not necessarily suitable for auditorium use and vice versa.

Basically the unit should be located in the auditorium so that the operator may judge acoustic quality as the audience hears it — and to make appropriate adjustments as necessary.

Most groups nowadays use half acoustic and half electronic instruments. Instruments such as drums may not need 'miking' at all except in a very large auditorium or out-of-doors. Naturally when making recordings, all instruments have to be 'miked'. In such cases four microphones are usually needed adequately to cover the drums and these are best combined in a sub-mixer. Similarly, an electronic organ with Leslie is perhaps best handled by a sub-mixer. All other inputs will of course go direct to the master mixer.

One of the main problems within the group is that of monitoring. Each player of an electronic instrument needs to be able to hear himself and the drummer particularly needs to hear the bass guitar but there is so much noise on stage that this is usually not possible. As each player usually has his own amplifier/speaker for use in practice, these may be used on stage to provide the necessary monitor facilities. To split the instrument

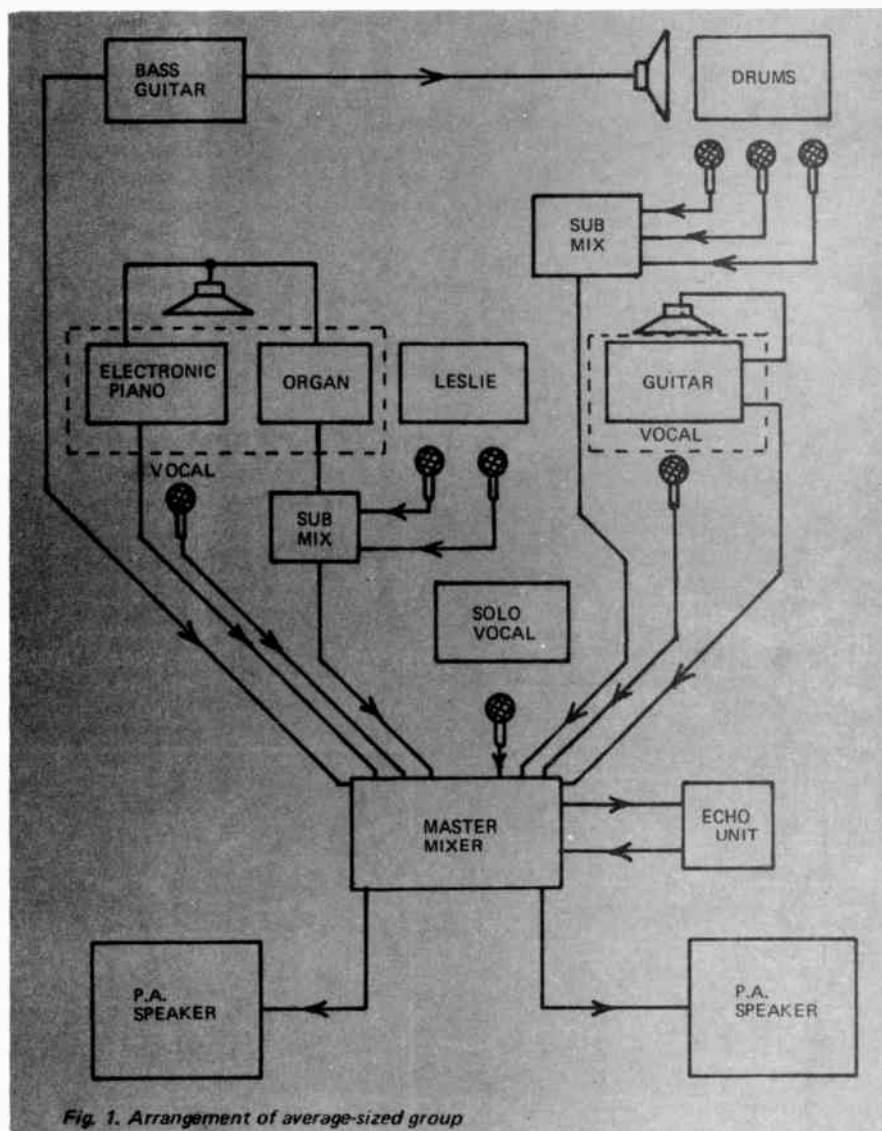

Fig. 1. Arrangement of average-sized group

output for both monitor amplifier and master mixer a simple plug to twin socket adapter may be used. Another method is to use a separate monitor box, as shown in Fig. 2, or monitor outputs may be fitted to the mixer unit itself as explained later.

It is of course possible to 'mike' the output of monitor speakers but this usually results in loss of fidelity. On the other hand such a procedure, together with deliberate overloading, is often used to provide special effects by distorting the output.

SETTING UP THE MIXER

Before connecting any inputs, set each input channel sensitivity switch to low, volume controls to zero, tone controls to centre position.

Switch on, connect the instruments one at a time and perform the following adjustments. Adjust both master-volume and channel volume to position 7 and then switch channel sensitivity for maximum desired level at these settings.

Then adjust the tone controls for the

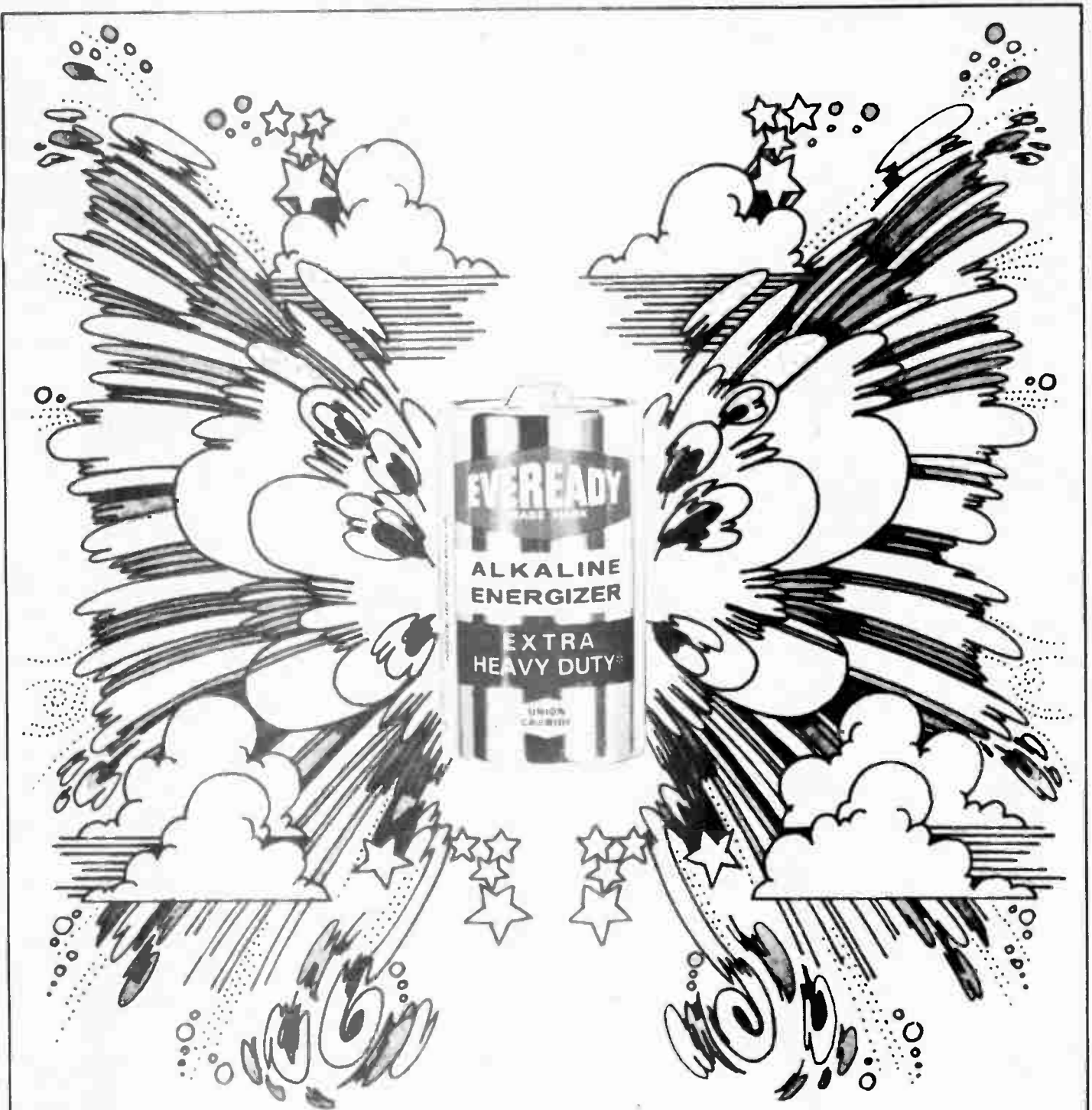

To Dream the Impossible Battery.

Why impossible?

Well, a battery which outperforms all others, with continuous use in high drain equipment; a battery to operate over a wide range

of temperatures; remain utterly sealed; deliver a more consistent voltage at all times; give low impedance and resultant fidelity improvement in sound equipment.

Whew. But, we built it.

'Eveready' Gold Alkaline Energizer. Against all odds.

Spread the word.

The impossible can happen.

EVEREADY BATTERIES Products of **UNION CARBIDE**

'Eveready' & 'Union Carbide' are registered Trade Marks.

MASTER MIXER

nicest sound for each instrument — without destroying its natural sound. Bear in mind that to increase the response in mid-range it is necessary to turn down bass and treble and turn up the volume.

If echo is to be used, connect the 'Echo Send' input and output to an echo unit such as the 'Echolette', or alternatively, to a suitable reverberation unit such as the ETI project 418 "Spring Reverberation-Unit". The echo effect may be increased or decreased by using the echo-send control.

Audibly position each member of the group left or right, by adjusting his channel balance control. Note that a balance control at centre will make the instrument appear audibly centred as well. These controls may need some readjustment when the full group is playing. The master balance control is then adjusted to achieve overall uniformity.

The equalizers may now be used to obtain a level overall frequency response by subjective listening and appropriate adjustments. Note that a five-section equalizer cannot correct major defects in auditorium acoustics, but can compensate for minor problems and for poor quality speakers.

As said before, the unit may be used for recording on stereo tape or disc and this is done by taking direct line outputs from the mixer to the recording equipment. Again, as said before, all instruments need to be 'miked'. Remember that the quality of the acoustics, particularly when recording, is affected very much by the choice of microphone. Most dynamic microphones drop off at the high end and we suggest that, providing sufficient funds are available, a good Electret microphone be used (such as the Sony ECM 22P reviewed in the March 1973 edition of ETI). It is essential that microphones should be as directional as possible to avoid problems with acoustic-feedback.

MODIFYING THE SYSTEM

Innumerable individual variations may be required — a few of those most commonly requested are dealt with here.

Some of these modifications can be performed without changing the basic wood and metal-work, others cannot. Because of the variety of combinations that may be used, details of wood and metal-work must be left to the individual constructor.

These modifications are therefore of necessity presented in a general way

and should only be undertaken after careful consideration of exactly what is needed, and only if what needs to be done is fully understood. We regret that we cannot assist in individual design requirements, however do tell us about your requirements and problems, and, if sufficient people ask for the same thing, we may be able to publish details of a modification at some later date.

Before dealing with specific modifications we will expand on the general theory previously given so that limitations may be more readily understood.

PREAMPLIFIERS

With reference to the circuit diagram on page 63 of the March issue, we see that the input amplifier IC1 has three selectable gains, the maximum gain being 500. This means that a one millivolt signal will become 500 millivolts at the output. A higher gain may be obtained by reducing the value of R4/R6 but to maintain input impedance R1/R2 will have to be increased (see How it works — Pre-amplifier page 60 March issue for gain formula). Note however that the tone-control stage is a standard feedback-type providing a maximum boost of 15 dB which corresponds to a voltage gain of approximately 6. The maximum output voltage of IC2 is 6 volts RMS and the maximum output of the preamplifier must therefore not exceed 1V RMS if clipping under maximum boost conditions is to be avoided. In addition an overload margin of 20 dB should be allowed, and this implies a maximum nominal output of only 100 mV from the preamplifier.

MIXER AND EQUALIZERS

The mixer is simply a summing

amplifier, the output voltage being the vector sum of the input voltages multiplied by the resistance of RV2 divided by 100,000. The maximum gain, one channel only driven, is 3 1/3 and although the individual gain remains constant the power level is greater with all channels driven. Overall gain is controlled by RV1, the master volume control.

Each section of the equalizer is a series LCR filter whose sharpness is determined by the circuit Q and with the coils given, the reactance at resonance is approximately 700 ohms. If more than five sections are required the filter must be made sharper and hence the reactance of the capacitor and inductor must be increased. Note however that phase shift problems limit the number of sections to seven in this type of circuit.

POWER SUPPLY

The current consumption is approximately 10 mA per channel and the power supply has adequate reserve for up to 20 channels, however if more than 10 channels are used a heatsink of about four square inches should be added to Q1.

If meter and overload indicators are required for each channel then a printed circuit board with this section only wired up should be made for each channel. If each channel is required to have a separate LED overload indicator, separate R27 and R28 (Fig. 1 page 78 April 73) and use each resistor to drive an LED.

CHANGING THE NUMBER OF CHANNELS

If less channels are required it is simply a matter of deleting the appropriate number of preamplifier/tone control boards and fitting blank panels to the cabinet in

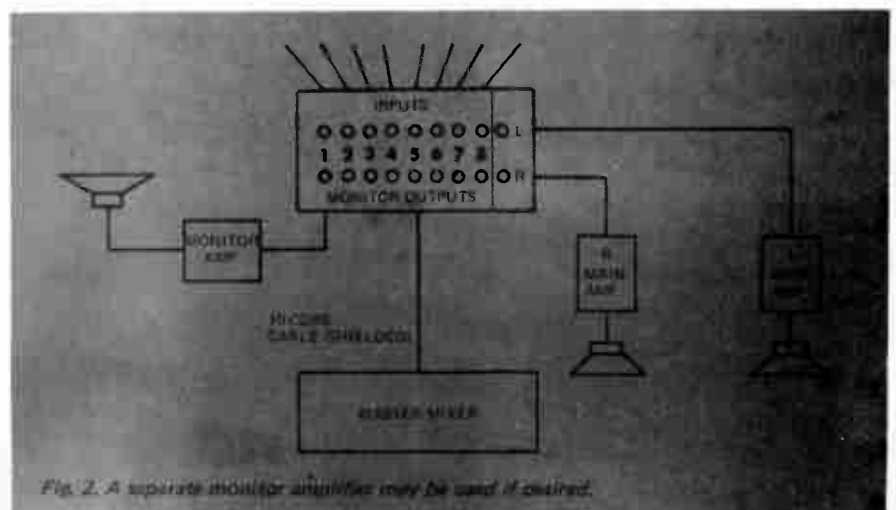

There's a place for you in the growing world of electronics

Whether you're a hobby enthusiast or have professional ambitions, a Stott's course will help you find it.

Every day the number of applications for electronics in industry, science and business increases. It's a field which offers valuable career opportunities in manufacture, installation, servicing and sales—but only for people with thorough training.

That's why Stott's have just introduced an important new course, **INTRODUCTION TO ELECTRONICS**. It combines both the theoretical and practical aspects, and includes many interesting experiments to give you experience in the construction and use of electronic equipment. Extensive kits are supplied with the course.

Other Stott correspondence courses will help you become expert in the theory and practice of radio communications, or give you the know-how to get an Amateur Operator's certificate: **RADIO FOR AMATEURS COURSE**: From radio basics, to intricate principles. Receiver design and construction. Latest techniques in electronics. Everything you'll ever need to know, made easy to understand by top radio engineers.

AMATEUR OPERATOR'S CERTIFICATE:

Gives you the background knowledge and the skills you need to pass the PMG exams and get your Certificate of Proficiency.

Make your place in the world of electronics. Start today by sending in the coupon below.

ET 5173

Stotts



TECHNICAL CORRESPONDENCE COLLEGE

159 Flinders Lane, Melbourne, 3000. 383 George St., Sydney, 2000. 290 Adelaide St., Brisbane, 4000. 45 Gilles St., Adelaide, 5000. 89 St. George's Terrace, Perth, 6000. P.O. Box 3396, Singapore 1.

Please send me, free and without obligation, full details of your courses in Radio and Electronics.

Mr., Mrs., Miss

Age

Address

Postcode

No sales counsellor will call.

STC545

MASTER MIXER

their place.

If more channels are required, the existing metalwork and woodwork will have to be extended to accommodate the extra preamplifiers.

One 100k resistor must be added to the main mixer summing network for each additional channel. These may be mounted by glueing them to the existing resistors with epoxy cement and making flying lead connections. Alternatively a small sub-board may be constructed for them.

In an exactly similar manner the echo mixer may be modified to accommodate the required extra channels. Extra input sockets must also be provided and the appropriate interwiring carried out.

SUB-MIXERS

As discussed earlier, sub-mixers may be required to implement a complete system. A simple sub-mixer may be constructed using the circuit shown in Fig. 3. This circuit is quite simple, is based on the echo mixer, and may be built on veroboard. Alternatively the echo-mixer PC board could possibly be adapted fairly readily.

As the instruments associated with each sub-mixer are usually grouped left-and-right, splitting may be performed after the sub-mixer as shown in Fig. 3. If balance is required before mixing it will be necessary to use two sub-mixers controlled by a ganged potentiometer, and to use balance circuitry similar to that in the circuit on page 59 of the March issue. The outputs of the sub-mixers are taken to the normal inputs of the main mixer.

MONITOR OUTPUTS

The need for monitoring has been explained previously, and if only one monitor channel is required, and echo is not required, the echo channel may be used to provide a monitor output. However two or more monitor outputs are often required and they may need to each have an equalizer for the elimination of microphone feedback. This may be achieved by wiring additional potentiometers in parallel with the echo potentiometers as monitor level controls. The output from these potentiometers may then be fed directly or via additional equalizer/main-mixer boards to the monitor amplifiers. A balance control is not required on monitor, hence R21 and RV7 (page 59 March) may be omitted and the output taken from terminal 19. Again, if equalization is not required, a mixer similar to that of Fig. 3 may be used.

CUEING OUTPUTS

When recording it is sometimes necessary to suppress the main output of the mixer while still monitoring the final mixed sound.

This may be done quite simply by taking an output from the junction of R20 and C8 (page 59 March) of the final mixer to a cue-monitor outlet, and using a good-quality key switch to short terminal 19 to ground.

This allows monitoring of equalizer output whilst inhibiting output to the main amplifier.

That completes our project. We trust that this versatile unit helps you become a good mixer!

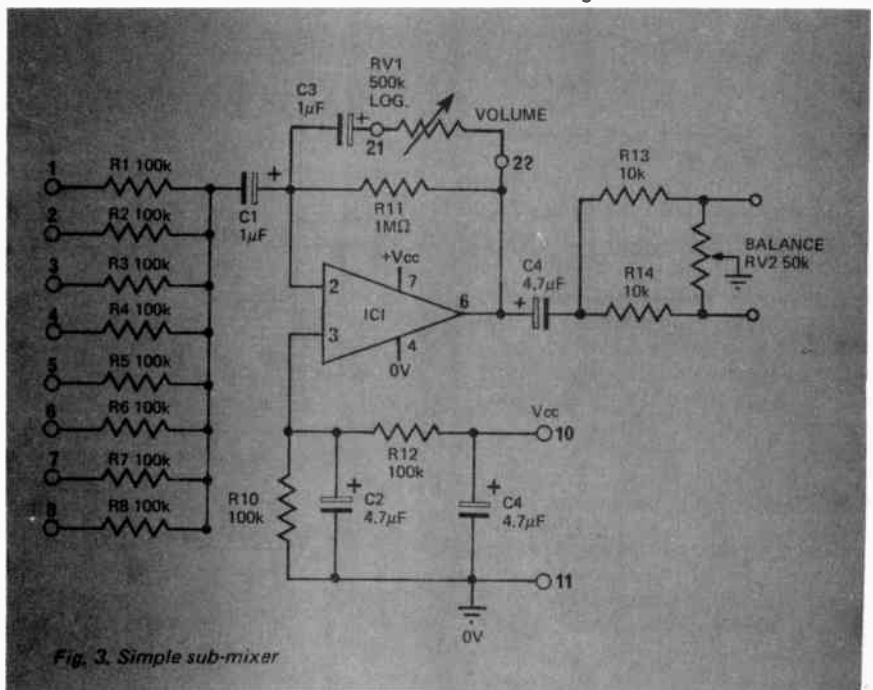

Fig. 3. Simple sub-mixer

Variations on an original theme... with Silcron!

Although it's only two years since the very first Silcron turntable was released, this economical and noise-free belt driven turntable has captured a substantial percentage of the Australian hi-fi market. The original Silcron Mk. III appeals to the hi-fi enthusiast who demands perfection yet is cost-conscious; without doubt it is the finest turntable available at the price.

Like all engineers who are also perfectionists, the designers of the original Silcron turntable have recognised the need for a deluxe model. And so we release the new Silcron Mk. IV "Isophonic" Series. It combines all the proven attributes of the Mk. III with new design and engineering features which make it the most outstanding turntable available in Australia today... no other turntable offers as much performance for relatively low cost.

FEATURES OF THE SILCRON TURNTABLES:—

SILCRON MK. III.

- Sealed 12 pole synchronous motor.
- Belt drive . . . noise-free.
- Wow and flutter — less than 0.04%.
- Lightning fast speed change.
- Two speeds — 33½ and 45 r.p.m.
- Dynamically balanced cast aluminium turntable platter.
- Only 3 moving parts.
- Anti-static mat at no extra cost.
- Height above motor board — 2".
- Precision engineering throughout.



CHOICE OF MODELS — SILCRON MK. III.

- Basic turntable only, unmounted.
- With motor board and timber base.
- With independently sprung motor board, dustproof perspex cover, professional tone arm and magnetic stereo cartridge.

SILCRON MK. IV "ISOPHONIC" SERIES.

- New sealed 8 pole 750 r.p.m. synchronous motor.
- Belt drive . . . noise-free.
- Wow and flutter — less than 0.04%.
- Lightning fast speed change.
- Two speeds — 33½ and 45 r.p.m.
- Dynamically balanced cast aluminium turntable platter.
- Four times the power of the Mk. III.
- New centre bearing shaft assembly.
- Acoustically insulated turntable platter and pick-up assembly which eliminates acoustic feedback.
- Tone arm tracking is constant.
- New vibration absorbent anti-static mat.



CHOICE OF MODELS — SILCRON MK. IV

- Basic turntable, unmounted.
- With professional quality tone arm.
- With attractive oiled teak base.
- With professional tone arm and attractive oiled teak base.

Note: Dustproof perspex covers and spring mounted timber bases are available for both Silcron models.

ASK FOR A DEMONSTRATION!

See your franchised Bleakley Gray dealer. *You'll find it costs very little to step up to Silcron!*

Service facilities and spares are available in all states, if ever required.

Australian National Distributors:

Bleakley Gray Corporation Pty. Limited.

STT-572

Head Office: 28 Elizabeth St., Melbourne, Vic. Tel. 63 8101* Telex: 31904

Sydney Office: 177 Salisbury Rd., Camperdown, N.S.W. Tel. 519 5555.

Canberra Office: 25 Molonglo Mall, Fyshwick, A.C.T. Tel. 95 2144*

INTERSTATE REPRESENTATIVES: N.T.: Pfitzner's Music House, Smith Street, Darwin. Tel. 3001.

Adelaide Office: 301 South Terrace, Adelaide, S.A. Tel. 23 6219

Brisbane Office: 3 Prospect St., Bowen Hills, Qld. Tel. 52 7333

Perth Office: 27 Oxford St., Leederville, W.A. Tel. 81 4988

Tas.: K. W. McCulloch Pty. Ltd., 57 George Street, Launceston. Tel. 2 5322.



OTARI MX5500

Compact tape deck has solenoid operated three motor drive

OTARI is a relatively new Japanese firm in the professional recording field. The company was founded in 1967 by an engineer who previously had had considerable experience in the design and manufacture of professional tape recorders.

Initially Otari specialized in the manufacture of high speed tape duplicating machines, many of which are in use throughout Australia. The company also manufacture equipment used for data storage and retrieval, and market a comprehensive range of digital recorders generally built to suit customers' specific requirements. Otari also manufacture a wide range of studio and broadcast equipment including delay loops and continuous loop recorders.

The Otari MX5500 compact professional tape deck reviewed here is the company's first product intended for the domestic market — even though the name would suggest otherwise.

We understand that Otari also expect to make a break-through into the cassette recorder market with a three motor, solenoid operated cassette tape deck in the near future).

The tape deck arrived adequately packed in a cardboard box fitted inside a second cardboard box. A tightly fitting plastic bag fully enclosed the tape deck to protect it from dust. Included in the box were the following accessories;

- (a) 7" empty reel,
- (b) reel clamps
- (c) cleaning set including cleaning

fluids for both the heads and the pinch roller

- (d) spare capstan drive belt
- (e) fuse
- (f) wrench set
- (g) sensing tape
- (h) Scotch splicing tape
- (i) patch cords
- (j) power supply cord
- (k) comprehensive twenty five page operating manual.

The tape deck is housed in a timber cabinet and fitted with four large rubber feet for vertical operation. The front panel of the deck is divided into three sections. The top section, which is brushed stainless steel, is approximately 22 cm high and contains the tape transport. Centrally located at the top of the panel are two black rectangular pushbuttons, the right-hand one for tape tension select (normal or half), and the left-hand one for 19cm/sec of 9.5cm/sec tape speed select. Below these switches are two large reel hubs which are fitted with black ribbed mats to provide accurate location of the tape reels. A tape tension arm is located below each wheel hub. A four figure tape counter is mounted in the bottom right hand corner. To minimize wow and flutter in the reverse play mode, Otari have fitted an impedance roller just to the left of the head assembly.

The next section of the front panel which houses the head assembly and all of the tape transport controls is approximately 8.5cm high and finished matt black. The head assembly is mounted on the left hand



side of this panel with a pause and cue button on the extreme left. The head assembly consists of

- (1) ¼ track erase head
- (2) ¼ track record head
- (3) ¼ track forward playback head
- (4) ¼ track reverse playback head

A cue button allows monitoring of the tape in the fast forward or reverse mode by raising two guide arms which normally hold the tape clear of the heads. The pause button provides instant stopping of the tape and releases the pinch roller. The right hand side of this panel contains the capstan shaft and pinch roller mounted adjacent to the head assembly and the tape transport controls. The tape transport controls consist of five push buttons arranged in a rectangular housing. The housing is divided into three vertical divisions. The centre division contains the stop button which extends for the full height of the housing and is approximately 20cm wide by 50cm high. The left and right divisions are each divided horizontally and contain two push buttons approximately 23cm wide by 20cm high. The upper left hand push button is for fast rewind

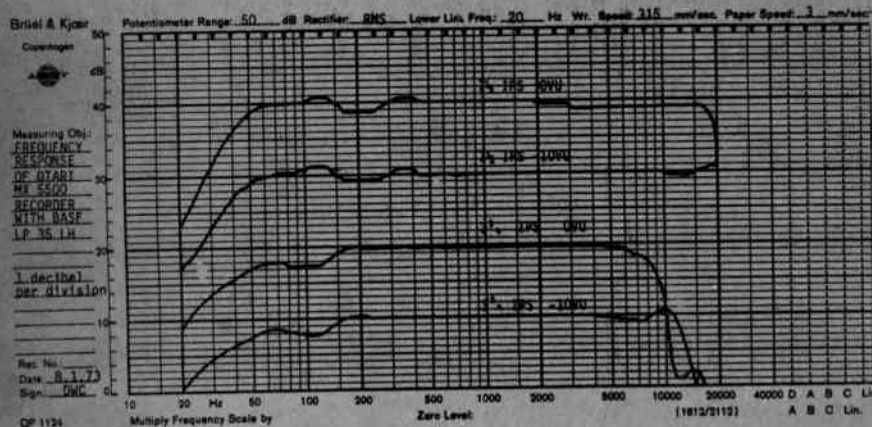

TAPE RECORDER



and the lower left hand for reverse play. The upper right hand is for fast forward and the lower right hand for play or record. This arrangement makes it possible to operate the controls with three fingers, with the centre finger always being on the stop button.

The lower panel which is brushed aluminium 120cm high contains all the electronics with its associated controls. It is divided horizontally into two equal height panels by a small raised edge in the aluminium section. The top panel contains the following facilities — from left to right;

- (a) Push on, push off power switch
- (b) Two large VU meters each 8cm by 5cm accurately calibrated at +3, +2, +1, 0, -1, -2, -3, -5, -7, -10, -20
- (c) Monitor select push button source or tape
- (d) Bias select push button high or normal. In the normal position the bias signal is fed via two internal potentiometers. These potentiometers should be set for the tape that is being used for most of the time. In the high position the bias signal is fed via two potentiometers located on the back

panel. These potentiometers can be easily adjusted to give optimum bias on any brand or type of tape without affecting the normal bias settings. We found this facility for changing the bias, by the flick of a switch, very useful, as we prefer to use two different types of tape depending on the recording quality required and the speed being used.

- (e) Separate record buttons for the left and right channels. These buttons must be depressed together or separately depending on the mode of recording required, and the forward play button pressed to select the record mode. Very small but effective raised bezel lamps above the record buttons indicate when the record mode is selected for each channel respectively.

The lower panel contains the following controls, going from left to right;

- (a) Two tip and sleeve sockets for microphone inputs (-55dB, 50k unbalanced) located one above the other.
- (b) Sound on sound or echo level control knobs. These latter controls consist of a fluted aluminium knob for the left channel and a slightly smaller black fluted aluminium knob for the right channel. These knobs are for level adjustment of the echo, or sound on sound signal.
- (c) Two push on, push off switches mounted one above the other. The top one is for echo and when selected feeds a signal from the playback head to the record head.

The level of the signal is adjusted by the level controls mentioned above. A small protruding rectangular bezel lamp to the left of the switches illuminates when the function is selected.

The lower switch is for sound on sound and will transfer the signal from one track on the playback head to the opposite track on the record head. If the left channel record button is pressed then the signal is transferred from the right channel to the left and vice versa if the right channel record button is pressed.

This switch also has a small bezel to the left of it which indicates when sound on sound has been selected. When this function has been selected the signal being transferred may be mixed with signals on the line and/or microphone inputs.

- (d) Dual concentric microphone input level control knobs
- (e) Dual concentric line input level control knobs
- (f) Dual concentric line output level control knobs
- (g) Ring tip and sleeve head phone socket for monitoring the source or tape signal.

The rear of the tape recorder has two recessed panels, one large one across the bottom and a smaller one midway up the left hand side.

The larger panel across the bottom has a pair of RCA sockets for line input, a combination DIN, record/playback socket, a pair of RCA line output sockets, a large knurled captive earth terminal, and two

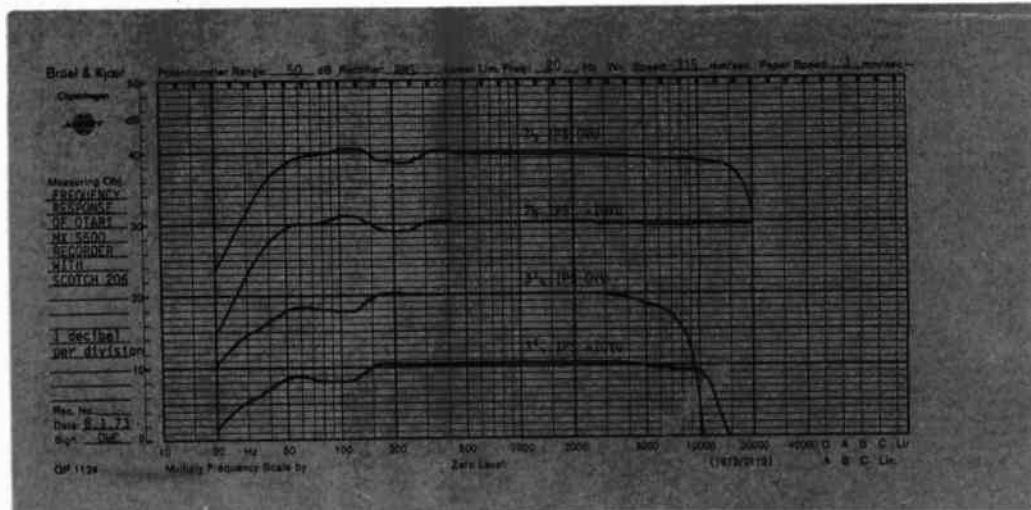

BUY STATE OF THE ART SOLID STATE COMPONENTS— Direct from the United States!

All listed prices are in Australian dollars, International Postal Money Orders (please send PO receipt with order for immediate shipment). Banque Chasiere check (preferably in US funds) and rated company cheques (with foreign exchange stamp approval affixed) will be accepted. Due to recent Australian government restrictions we are not able to clear personal checks... All goods are new unused surplus and are fully guaranteed. Orders will be shipped within two workdays of receipt of same. All customs forms will be attached. Minimum order amount is \$5.00, do not add postage — we pay postage. Surface mail for orders under \$10.00 and Air Mail for orders over this amount.

DATA SHEETS ARE PROVIDED FOR EACH ITEM PURCHASED

DIGITAL INTEGRATED CIRCUITS (dual in line package)

Signetic TTL (5 volt operation)		
8440	Dual 2/2 and or invert gate	\$0.35
8455	Dual 4 input buffer	0.40
8480	Quad 2 input NAND gate	0.40
8H16	Dual 4 input NAND (high speed)	0.35
8H70	Triple 3 input NAND (HS)	0.35
8H80	Quad 2 input NAND (HS)	0.35
8H90	Hex inverter (HS)	0.35
8H21	Dual JK flip flop (HS 60 MC)	1.10
8290	Decade counter (HS 60 MC)	3.15
8292	Decade counter (low power)	0.90
8251	BCD to decimal decoder	1.75
7480	Gated full adder	0.50
7413	Dual 4 input NAND Schmidt triggers	1.75
74181	Arithmetic logic unit	3.50
8260	Arithmetic logic unit	3.15
8261	Fast carry for above	1.35

Send for free brochure listing hundreds of bargains.

Signetic DTL (5 volt operation) dual in line

SP629	Flip flop	\$0.35
SP659	Dual 4 input buffer	0.25
SP670	Triple 3 input NAND gate	0.25
SP680	Quad 2 input NAND gate	0.25
SP690	Hex inverter	0.25

Signetic "Utilogic"

This family of logic offers medium speed combined with a greater noise margin than is available from either DTL or TTL logic. Power requirements are the same as TTL/DTL (single 5 volt supply).

"Utilogic" dual in line package

LU300	Dual 3 input expander	\$0.30
LU301	Quad 2 input diode expander	0.30
LU305	6 input NAND	0.30
LU306	Dual 3 input NAND	0.35
LU314	7 input NOR	0.35
LU317	Dual 4 input expandable NOR	0.30
LU333	Dual 3 input expandable OR	0.30
LU334	Dual 4 input expandable NAND	0.30
LU356	Dual 4 input expandable driver	0.30
LU370	Triple 3 input NOR	0.30
LU377	Triple 3 input NAND	0.30
LU387	Quad 2 input NAND	0.30

LINEAR INTEGRATED CIRCUITS

Fairchild and Signetic devices (no choice). Some of this line is not marked but it is fully tested and sold on a money-back guarantee. State first choice on package (TO-5, 8-pin dual in line, or 14-pin DIP—we will not ship flat packs).

NE526	High speed comparator	\$1.00
NE565	Phase lock loop	3.50
NE566	Function generator	3.50
NF567	Tone decoder	3.50
709	Popular operational amplifier	0.35
5558	Dual 741 op amp (compensated)	1.00
747	Dual 741 op amp	1.00

LED DISPLAY

The MANI is a seven segment diffused planar GaAsP light emitting diode array. It is mounted on a dual in line 14-pin substrate and then encapsulated in clear epoxy for protection. It is capable of displaying all digits and nine distinct letters.

FEATURES:

High brightness, typically 350ft.-L @ 20ma.
Single plane, wide angle viewing, 150°.
Unobstructed emitting surface.
Standard 14-pin dual in line package.
Long operating life, solid state.
Operates with IC voltage requirements.
ONLY \$4.00

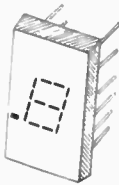

"UTILOGIC" SPECIAL

Ten (10) pieces of LU321 dual JK flip flops and four pages of application information describing ripple counters (3 to 10) and divide by 12 up/down binary and decade counters, shift registers and self-correcting ring counters.

Complete package only \$3.60

LINEAR SPECIAL

Ten (10) 741 fully compensated operational amplifiers with data sheet and two (2) pages of application notes covering the basic circuits for op-amps.

EACH \$0.65 PACKAGE \$6.00
8 pin DIL Only 35c each
\$2.75 for ten.

LM309K—5 volt regulator

This TO-3 device is a complete regulator on a chip. The 309 is virtually blowout proof, it is designed to shut itself off with overload of current drain or over temperature operation. Input voltage (DC) can range from 10 to 30 volts and the output will be five volts (tolerance is worst case TTL requirement) at current of up to one ampere.

EACH \$2.50
FIVE for \$10.00

LSI—CALCULATOR ON A CHIP

This 40 pin DIP device contains a complete 12 (twelve) digit calculator, Add, Subtract, Multiply, and Divide. Outputs are multiplexed 7 segment MOS levels. Input is BCD MOS levels. External clock is required. Complete data is provided with chip (includes schematic for a complete calculator).

Complete with data \$9.95

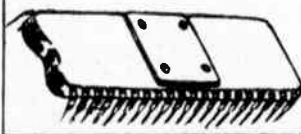

Data only \$1.00

COUNTER DISPLAY KIT—CD-2

This kit provides a highly sophisticated display section module for clocks, counter or other numerical display needs.

The RCA DR-2010 Numitron display tube supplied with this kit is an incandescent seven segment display tube. The 6" high numeral can be read at a distance of thirty feet. RCA specs. provide a minimum life for this tube of 100,000 hours (about 11 years of normal use).

A 7490 decade counter IC is used to give typical count rates of up to thirty MHz. A 7475 is used to store the BCD information during the counting period to ensure a non-blinking display. Stored BCD data from the 7475 is decoded using a 7447 seven segment decoder driver. The 7447 accomplishes blanking of leading edge zeroes, and has a lamp test input which causes all seven segments of the display tube to light.

Kit includes a two sided (with plated through holes) fiberglass printed circuit board, three IC's, DR-2010 (with decimal point) display tube, and enough Molex socket pins for the IC's.

Circuit board is .8" wide and 4 1/2" long. A single 5 volt power source powers both the IC's and the display tube.

CD-2 kit complete only \$9.95
Assembled and tested \$12.00

Board only \$2.50



RCA DR2010 Numitron digital display tube. This incandescent five volt seven segment device provides a .6" high numeral which can be seen at a distance of 30 feet. The tube has a standard nine pin base (solderable) and a left-hand decimal point. **Each \$5.00**
SPECIAL 5 for \$20

UNIVERSAL COUNTER DISPLAY KIT CD-3

This kit is similar to the CD-2 except for the following:

- Does not include the 7475 quad latch storage feature.
- Board is the same width but is 1" shorter.
- Five additional passive components are provided, which permit the user to program the count to any number from two to ten. Two kits may be interconnected to count to any number 2-99, three kits 2-999, etc.
- Complete instructions are provided to pre-set the modulus for your application.



CD-3 board only \$2.25
IC's 7490, 7447 2.75
RCA DR2010 tube 5.00
Complete kit includes all of the above plus 5 programming parts, instructions and Molex pins for IC's. **Only \$8.95**

The MAN3M is a seven segment diffused planar gallium arsenide phosphide readout. It is capable of displaying 10 digits and 9 distinct letters and is encapsulated in a high contrast red epoxy package.
• 0.127" high led 7 segment display.
• Bright red 400 ft.-L at 10ma per segment.
• Compatible with standard digital IC's.
• Compact spacing 5 digits per inch.
\$3.00 each, Ten or more \$2.50

Babylon Electronics Inc.

Post Office Box J, Carmichael, California. 95 608 U.S.A.

OTARI MX5500 TAPE RECORDER

recessed adjusting screw for bias change on the left and right channels.

The smaller panel has an ac input socket, an unswitched ac output socket, a 12 pin remote control socket with matching shorting plug, and a combination voltage selector plug and fuse assembly. The voltage selector plug had us intrigued, for although it had tapings for 240V, 230V, 220V, 210V, 117V and 100V, a quick look at the circuit diagram and the transformer showed that the latter only had four tapings for 240V, 210V, 117V, and 100V. The multipin remote control plug provides the following functions, rewind, fast forward, reverse play, normal play, stop and pause. However, in speaking with the importers we found that although a remote control module is mentioned in the manual, Otari do not manufacture one because of the prohibitive cost. (However, anyone who wanted to use this facility could do so with five normally closed micro-switches).

The tape transport assembly was generally very good — Firstly, because it was a three motor system which is invariably better than a one or two motor system, and secondly, because the motors were accurately aligned resulting in excellent spooling. In fact, it was not necessary to have flanged reels to support the tape, provided it was good quality tape accurately slit — such as Scotch 206, TDK SK 150H, or BASF LP 35LH.

The capstan motor is a four pole eight pole hysteresis synchronous unit and the reel motors are high torque induction units. A belt drive is used between the capstan motor and capstan shaft and it drives on the outer rim of a large flywheel which is stepped for 50Hz or 60Hz operation. The motor shaft also has a stepped pulley to match the flywheel. The tape reels fit directly onto the end of the reel motor shafts and are retained with well shaped rubber retainers. The heads of the rubber reel retainers are rectangular and fluted on the longer sides thereby providing an excellent finger grip for removal purposes.

A hand brake is fitted to each reel motor and the pair are activated by a common solenoid. The pinch wheel is also engaged by a solenoid. The eight relays which control the various tape transport functions, together with their respective arc quenching capacitors and diodes, are all mounted on a printed circuit board located on one side of the transport frame. This board with all the motors and transformers is electrically

MEASURED PERFORMANCE OF OTARI MX5500 TAPE RECORDER — SERIAL NUMBER 550218.

Frequency Response

	19cm/sec	9.5cm/sec
Scotch 206 — 10VU	40Hz to 25kHz $\begin{matrix} +1 \\ -3 \end{matrix}$	40Hz to 12kHz $\begin{matrix} +1 \\ -3 \end{matrix}$
TDKSD150H — 10VU	40Hz to 25kHz $\begin{matrix} +3 \\ -3 \end{matrix}$	45Hz to 12kHz $\begin{matrix} +2 \\ -3 \end{matrix}$
BASFLP36LH — 10VU	40Hz to 24kHz $\begin{matrix} +1 \\ -3 \end{matrix}$	45Hz to 12kHz $\begin{matrix} +1 \\ -3 \end{matrix}$

Total Harmonic Distortion

	100Hz	1kHz	6.3kHz
OVU	0.6%	1%	2%
-10VU	0.1%	0.2%	0.4%

Intermodulation Distortion

	1kHz & 960Hz
19cm/sec	0.5%
9.5cm/sec	0.5%

Signal to Noise Ratio

(with respect to 1kHz -0VU)

	19cm/sec	9.5cm/sec
Unweighted	45dB	42dB
"A" weighted	57dB(A)	52dB(A)

Erase Ratio for 1kHz Signal (prerecorded at OVU)

68dB

Cross Talk at OVU

	19cm/sec	9.5cm/sec
100Hz	52dB	52dB
1kHz	65dB	65dB

Wow and Flutter % RMS

	19cm/sec	9.5cm/sec
	0.03%	0.10%

Line Input Sensitivity for OVU

200mV

Line Output Sensitivity for OVU

1.4V

Microphone Input Sensitivity for OVU

3.4mV

Dimensions

424mm wide x 470mm high x 220mm deep

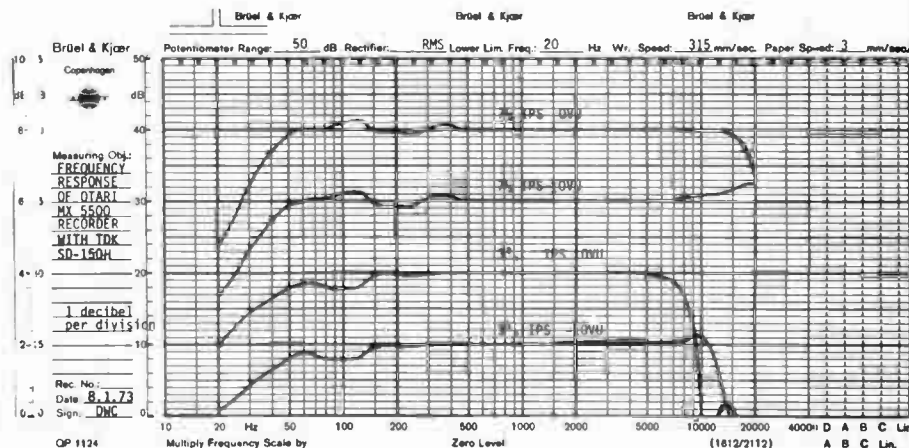

Weight

20kg.

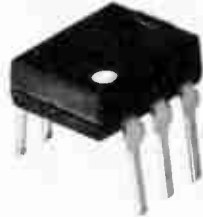

GENERAL ELECTRIC

OPTOELECTRONIC COUPLER LINEUP

			
<p>H10 SERIES COUPLERS</p> <ul style="list-style-type: none"> ● 3 hermetically packaged models offer choice of SSL-Phototransistor, SSL-Photodarlington and SSL-light sensitive SCR 	<p>H11 SERIES COUPLERS</p> <ul style="list-style-type: none"> ● 6 models offer interchangeability with popular industry types ● H11A1 and H11B1 offer 50% and 500% min current transfer ratios respectively ● 2,500V isolation 	<p>H13 SERIES INTERRUPTER MODULES</p> <ul style="list-style-type: none"> ● 4 models offer "no contact" switching for use with shaft encoders, counters, position sensing, keyboards and limit switch application 	<p>H15 SERIES COUPLERS</p> <ul style="list-style-type: none"> ● 4000V isolation ● 4 low cost models for pulse transformer replacement, SCR and TRIAC triggering ● Solid State reliability at low cost

Watkin Wynne Pty. Ltd., 32 Falcon St., Crows Nest. Tel:43-2107
 GEC-Elliott Automation Pty. Ltd., Adel: 71-7971, Melb: 387-2811,
 Syd: 439-1922, Bris: 32-0441.
 Fairchild Australia Pty. Ltd., Sydney 439-4355, Melbourne 723-4131.
 H. Rowe & Co. Pty. Ltd., Perth — 28-5444.
 PB Components, Melbourne 53-2766.
 The National Electrical & Engineering Co. Ltd., Wellington 553-709,
 Auckland 599-089.

**AUSTRALIAN
GENERAL ELECTRIC LTD.**
 86-90 BAY STREET, ULTIMO. PHONE 212-3711

OTARI MX5500 TAPE RECORDER

interconnected via multipin plugs and sockets to facilitate easy removal. All wiring throughout the tape recorder transport system is colour coded and neatly taped and strapped to the frame.

The layout and wiring to the printed circuit board containing all the electronics for the record and playback heads was less neat, and could create some problems for servicing. This board is mounted in a separate removable frame located directly behind the bottom section of the front panel.

The layout of the controls was very easy to adapt to and pleasing to operate. The unit was operated for two to four hours per day in both the record and playback mode for approximately six weeks. During long record and playback sessions the top panel supporting the reel motors became very hot and resulted in a reduction in the force exerted by the pinch roller solenoid. This resulted in tape slippage particularly in the reverse mode. A simple adjustment of the capstan solenoid eliminated the tape slippage and resetting the voltage selector from 210V (as recommended by the importers) to 240V partially reduced the temperature rise. The heat dissipation could have been improved by providing an air intake directly behind the fan on the capstan motor. The only ventilation for the reel motors was by natural circulation in through a grill in the base of the tape recorder and out through two grills at the top.

The measured performance of the tape recorder was very good and met specifications in most cases. The frequency response at 7½ cps - 10V extended past 20kHz on all tapes tested with the upper limiting frequency being approximately 25kHz

due to the width of the head gap. With Scotch 206, optimally biased, the frequency response was 50Hz to 21kHz ± 3dB. The spectrograms with the families of four curves were all obtained with the bias switch set to the low noise (or high) position. Total harmonic distortion was slightly higher than the manufacturer's specifications which was stated at an unknown level called "Standard Level". The intermodulation distortion was very good, being 0.5%. The signal to noise ratio did not quite meet the manufacturer's specifications although it was more than adequate for most semi-professional and domestic applications.

The Operations Manual gave extensive details on the various modes of operation of the recorder and included wiring diagrams for the relay circuitry and the electronic circuitry. Board layouts however were not included and tracing the circuit was slow and tedious.

As we stated earlier in the text, the machine becomes excessively warm if used for extended periods - exceeding an hour or so - we would like to stress that this is not as serious a criticism as it might at first appear, for the problem appears to be caused by the lack of a fresh air vent to the capstan motor fan. It would be only a few minutes work to cut out a suitable hole in the machine's rear panel.

At a recommended retail price of \$500, the Otari MX5500 tape recorder offers many worthwhile features including the three motor drive with solenoid operation.

The measured performance is one of the best we have ever seen and, provided the cooling modification is carried out, should satisfy even the most fastidious of enthusiasts.

Recommended retail price - approx. \$500.

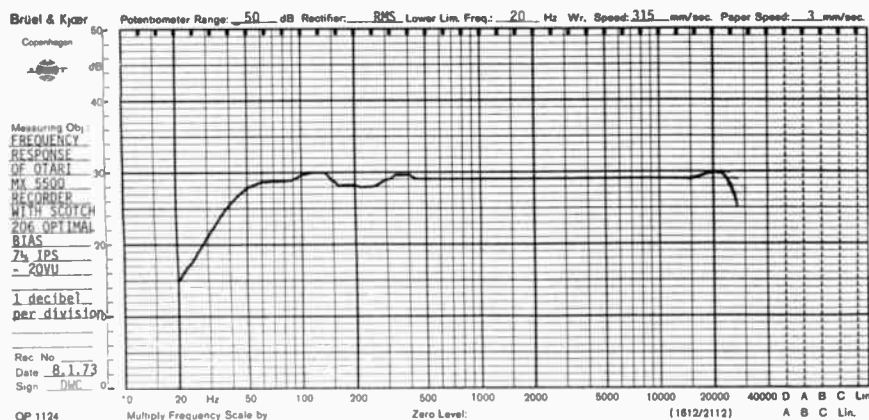

HAM RADIO SUPPLIERS

MAIL ORDER SPECIALISTS

323 Elizabeth Street Melbourne
(2 doors from Little Lonsdale Street)

SECURITY AND BURGLAR ALARM PRODUCTS

LOCAL ALARM UNIT

Once an alarm condition has been detected by ultrasonic unit, radar, infra-red beam, pressure mats, magnetic reed switches, foil tape, etc., the unit takes over. The unit holds the system in alarm condition until manually reset, or if a timer is used, until the time period has elapsed. The unit is designed to operate noise makers or mechanical bells up to 1 amp. capacity.

FEATURES INCLUDE

- Push-button test facility.
- Extremely low current drain (.2mA).
- Inbuilt key switch.
- Tamper proof housing.
- All metal case.

PRICE: \$22.50

Economy local alarm module, similar to above \$11.50

DOORWAY ALARM UNIT

An electronic eye used to safeguard stock and prevent pilfering, the unit also provides a useful customer service. Installation is made easy with all necessary hardware included in the kit, along with easy-to-read instruction sheet.

FEATURES -

- 25ft. range.
- S.E.C. approved.
- No moving parts.
- Will operate relay, bell or chime.

PRICE: \$37.00

AUDIBLE DETERRENT MODULES

A choice of four completely different noises to deter any intruder. One module will operate up to three reflex horn speakers (type RUH5), producing a loud irritating, but effective, audible deterrent.

FEATURES -

- 12V DC operation.
- Reverse voltage protection.
- No moving parts.
- Low current drain.

FOUR TYPES -

- SIREN \$17 YIP \$17
 - WARBLER \$17 WHIP \$17
- 5" reflex horn speaker to use with above modules. 5 watt 8 ohm. \$11.75

ULTRASONIC MOVEMENT DETECTOR

High frequency sound waves, well beyond the range of human hearing, are transmitted by the unit to protect an area of 400 sq. ft. The reflected signal received by the detector is the same frequency as that transmitted.

Once movement occurs, the reflected signal will change. This is known as the doppler effect. The ultrasonic detector features a proven count circuit, which discriminates between slight atmospheric changes and intruder movement.

OTHER FEATURES -

- Draft rejection filters.
- Adjustable sensitivity and range.
- Compact size 8¼" x 2½" x 2"
- Tamper-proof housing.
- 12V DC operation.
- Wooden housing available.

TWO MODELS -

- Master unit \$133.50
- Slave to Master unit \$131.50

ALSO AVAILABLE

- Magnetic reed switch. Available in grey, brown and white \$1.75
- Key switch (for internal use) \$3.90
- Aluminium foil tape, self adhesive—for window security: 36 yd. roll \$2.20
- Terminal blocks for self adhesive tape, ea. .20
- Delay entry/exit module for N/O and N/C detecting devices. Low current drain \$22.50
- Time out modules. Resets after 1-25 minutes. Adjustable \$19.25
- Pressure mat (22" x 32") for use under carpets—ultra thin \$10.00
- Modulated infra-red (blacklight) unit. 300ft. range 12V DC operation. Extremely reliable. \$118.00

POWER PACK

The most important item in any security system is the power supply. The power supply is designed to laboratory specifications to supply a constant output of 13.2V DC. The current is automatically limited to 1 amp., even in the event of a short circuit across the output terminals. Should mains power fail, the unit switches to standby batteries (wet cell or dry), without interruption to equipment.

FEATURES -

- Rejects mains spikes—the cause of many false alarms.
 - 0.5mV. ripple.
 - 0.2% load regulation.
 - Fully fused.
- PRICE \$35.50

LUX

World's most renowned amplifiers— The ultimate musical experience!



For sheer professionalism in amplifiers, look to Lux! As the world's longest-established manufacturer of amplifiers, the company's manufacturing policy accounts for the quality of sound. It first makes the amplifier to its own standards of quality, then puts a price on it. Fifty years of establishment, experience and reputation enable Lux to present units which make apparent the mystery and softness of every musical instrument. This is ultimate hi-fidelity.

SQ700X

27 transistors, 2 silicone varistors, 4 silicone diodes. Main amp section adopts a fully complementary direct coupled output with differential amplification. RMS power 25/25 watts, distortion less than 0.1%, frequency response 10 – 50,000Hz – 1dB. Other famous Lux models include: 505X, 507X, 202.

NEW! LUX LX 77 HIGH QUALITY SPEAKERS

Finally released after many years of extensive development, the Lux LX 77 3-way speaker system features the exclusive ring diaphragm tweeter which eliminates break-up vibration within the audible range. Dome-type midrange features hemispheric diaphragm for even, wide dispersion. Long voice-coil woofer eliminates non-linear distortion in the low frequency range. Constant impedance attenuator level controls for high and mid-range, are fitted on the front panel, permitting settings to suit your individual listening requirements. Frequency response 30–22,000Hz. Beautifully finished timber cabinets, 26" x 15" x 12".

Speakers: 12" high compliance woofer, 1.6" dome type mid-range, 1.3" ring type tweeter. Crossover frequency 700, 8000Hz, 12dB/oct. 60 watts 8ohm.



State agents:

N.S.W.: M & G Hoskins Pty. Ltd., 37 Castle St., Blakehurst. 2221. Telephone 54-1464. Q'LD.: Stereo Supplies, 100 Turbot St., Brisbane. 4000 Telephone 21-3623. S.A.: Challenge Hi-Fi Stereo, 6 garys Arcade, Adelaide. 5000 Telephone 23-2203. T.A.S.: Audio Services, 72 Wilson St., Burnie. 7320 Telephone 31-2390. VIC.: Encel Electronics Pty. Ltd., 431 Bridge Rd., Richmond. 3121 Telephone 42-3762. W.A.: Albert TV & Hi-Fi, 282 Hay St., Perth. 6000 Telephone 21-5004.

INTERDYN

Sole Australian distributors:

INTERNATIONAL DYNAMICS (AGENCIES) PTY. LTD.
P.O. Box 205, Cheltenham, Vic. 3192.

MICRO

the magnificent!

Long experience in fine tolerance engineering stands behind every Micro turntable! In the Micro range you'll find a turntable that gives good performance at a reasonable price, or ultimate performance regardless of price!

- For your consideration, Micro offers (with arm and lift) **MR111, MR211, MR311, MR611**. Also **MB300, MB600, MB800S** turntables only, for those who wish to use their own tone arm.



MR211 Belt-drive turntable that has made a big name for itself in Australia. 4 pole synchronous outer rotor motor assures constant speed unaffected by load or line voltage. Static balance tubular tonearm. Anti-skating device. Oil damped arm lift. Wow/flutter less than 0.08%, rumble better than 48dB.

MK311 Similar major specifications to MR211, but with 3lb, 12 $\frac{1}{4}$ " turntable. Wow/flutter less than 0.06% rumble less than 50dB. Anti-vibrator shock absorber, in timber case with smoke brown cover.

Hear the Micro range of turntables at

N.S.W. M & G Hoskins Pty. Ltd., 37 Castle Street, Blakehurst, 2221.

Q'LD. Stereo Supplies, 100 Turbot St., Brisbane, 4000.

S.A. Challenge Hi-Fi Stereo, 6 Gays Arcade, Adelaide.

TAS: Audio Services, 72 Wilson Street, Burnie, 7320.

VIC. Encel Electronics Pty. Ltd., 431 Bridge Rd., Richmond, 3121.

W.A. Albert TV & Hi-Fi, 282 Hay St., Perth, 6000.

Sole Australian distributor

INTERDYN

Sole Australian distributors:

INTERNATIONAL DYNAMICS (AGENCIES) PTY. LTD.

P.O. Box 205, Cheltenham, Vic. 3192.

Transducers in measurement and control

PART 13

In this article, Dr. Sydenham continues his description of methods used to assess pollution.

POLLUTION of water and air occurs in distinctive groups each requiring different measurement approaches. These groups are unwanted chemicals, particulate matter and radioactivity.

CHROMATOGRAPHY

In the analytical methods described last month, the various chemical constituents of a gas or liquid were identified by separating each, either directly (as in the mass spectrometer), or indirectly, (using the spectrum of radiation). They were then sensed at the different spatial locations.

Chromatography is another procedure by which the chemicals are initially separated in some way so that each may be identified. When a sample mixture, such as a gas or liquid, is passed through, or over, surfaces of another material of different chemical phase (for example, as gas passing over a solid) the transmission times of the individual components of the sample are selectively delayed. They emerge through the column (of different phase material) in a specific time sequence.

In gas chromatography the gas to be analysed is either percolated through a porous solid column (charcoal, silica gel are used) or over a large-area liquid film. The former is known as a gas-solid chromatography, GSC for short, the latter GLC. Other methods used include liquid-solid and liquid-liquid systems. Here, only gas chromatography will be discussed as this illustrates the general principles.

Chromatography had its origins in the mid 19th century. It really became established around 1905 when Ramsey devised a method to separate gases and vapour mixtures, and Tswett used the principle to extract chlorophyll from plant pigments. The latter biochemist coined the name now used because of the coloured bands he obtained down a vertical calcium carbonate column. Chromatography is formed from the Greek words for colour and write. To prevent possible confusion it must be made clear that colour is rarely a parameter in modern chromatography.

The basic essentials of a gas chromatograph (established by James and Martin in 1952) are shown in Fig. 1. An inert carrier gas passes through the separation column to a detector cell. The unknown gas sample is injected into the inert gas carrier flow prior to its entry into the column. The various constituents of the gas arrive at the detector at different times, producing peaks on the recorder chart as the paper moves with time. The sharpness of the peaks, their amplitude and relative time positions identify the sample. It is essential to hold the gas and column at a steady temperature; commercial units enclose the critical areas in a temperature-controlled oven held to 0.1°C limits. Higher than ambient temperatures also enable liquids to be vaporized and treated as gases.

Some components are strongly retained by the column, emerging only after a considerable duration. To speed up the process the temperature is often raised in sequences to follow a preset programme.

Detection sensitivity depends upon the detector used to monitor the emerging gases; it ranges from parts per thousand to parts per billion. To quote a Varian example, one form of detector can sense certain chemicals down to a molecule of sample in every 10^{10} molecules of carrier gas. Such sensitivity has enabled the method to be used in the analysis of odours in foodstuffs. Units are moderately expensive, the one shown in Fig. 2 costs around \$4,000, but less versatile,

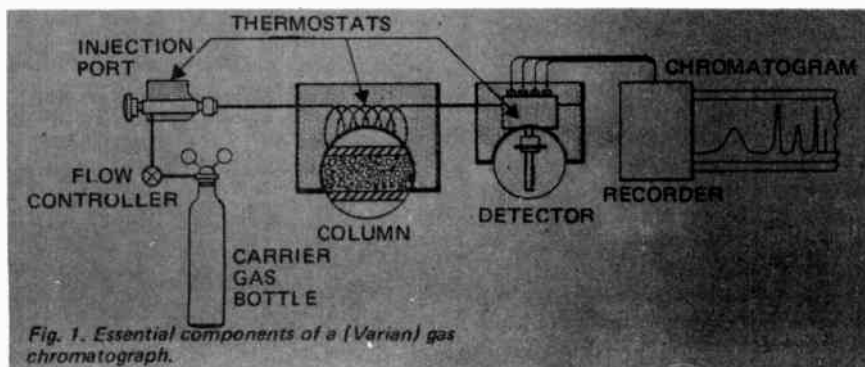

Fig. 1. Essential components of a (Varian) gas chromatograph.

cheaper, units are available.

Detectors in use are varied and numerous, the main two being the ionization detector and the thermal conductivity cell.

FLAME IONIZATION DETECTOR

When a carrier gas of hydrogen is burned it produces a colourless flame. Organic compounds cause it to burn yellow with a height and luminosity proportional to the amount of hydrocarbons present. Flames produce ionized gases in such cases and this effect is used to obtain a more accurate measure of the arrival events out of the column preceding the detector. These cells are called flame ionization detectors (FID). For reasons not fully understood, organic compounds ionize in a flame, and suitably placed electrodes (Fig. 3), detect the minute current flowing. High input impedance amplifiers are needed because the flame resistance is around 10^{12} ohms. Advantages of the FID are that it does not detect water vapour or air, is simple and has a wide response range. These characteristics make it particularly suited for pollution measurements of water and air.

THERMAL CONDUCTIVITY CELL

This detector, introduced by Claesson in 1946, is also commonly employed in chromatographs. It operates by measuring the thermal conductivity of the gas. A heated filament, suspended in the flow, will vary in temperature as the heat is conducted away by the changing conductivity gases emerging from the column, thus changing its resistance. (Very similar in operation to the hot-wire anemometers used to measure flow rates). These are also called katharometers or simply TC units. A schematic of a TC cell is shown in Fig. 4 together with the layout of a typical electrical arrangement. Note that the reference gas passing into the column before injection of the sample is fed across two detector filaments of the bridge and that the outlet gases (carrier plus separated constituent) pass over the other two. This technique makes best use of the properties of a bridge circuit to eliminate unwanted common signal effects existing in the apparatus.

With thermal conductivity cells the gas flow limits the temperature rise of the filaments. Flow is essential, when the detector is energized, to prevent burnouts. Thermistor sensors are sometimes used instead of the tungsten wires.

Flame ionization and thermal conductivity detectors are the more common types used, but others exist that might be more suited. They

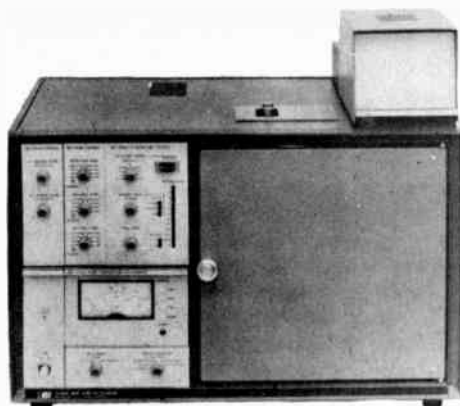

Fig. 2. Gas chromatograph marketed by Hewlett-Packard (series 5700)

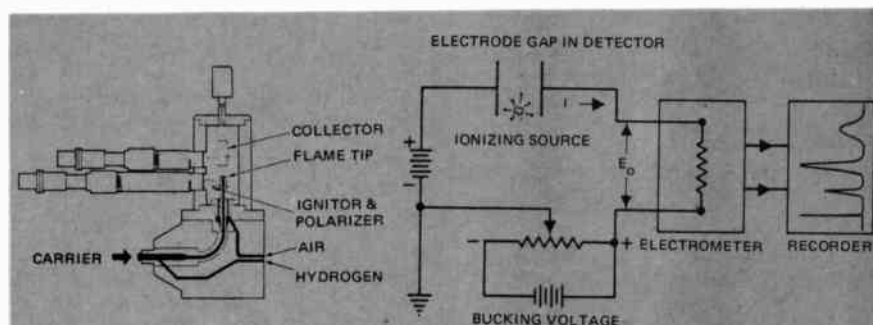

Fig. 3. Cross-section of Varian flame ionization detector and typical electronic circuit used to detect the ionization.

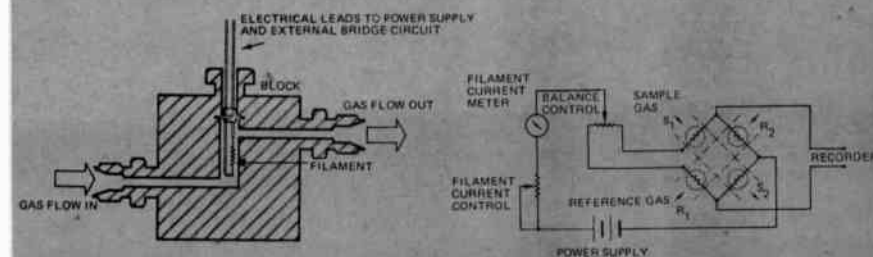

Fig. 4. Schematic diagram of one element of a thermal conductivity detector. The sample gas is made to flow across two resistances, the reference gas across the opposite pair.

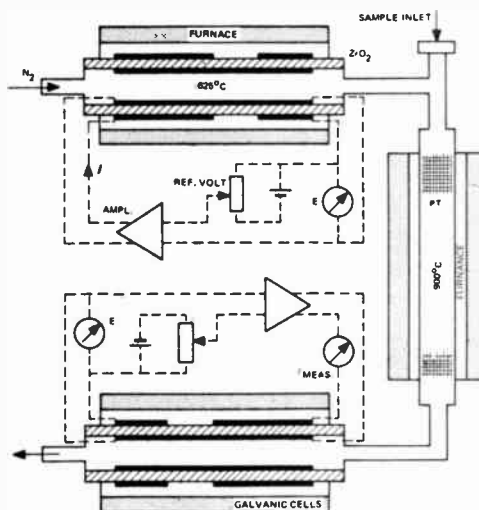
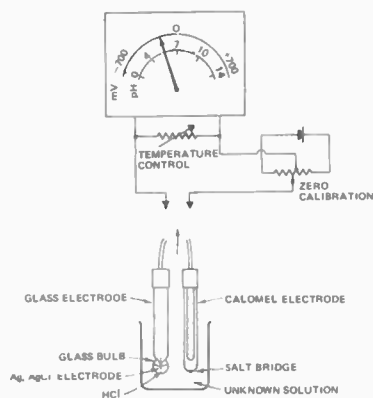
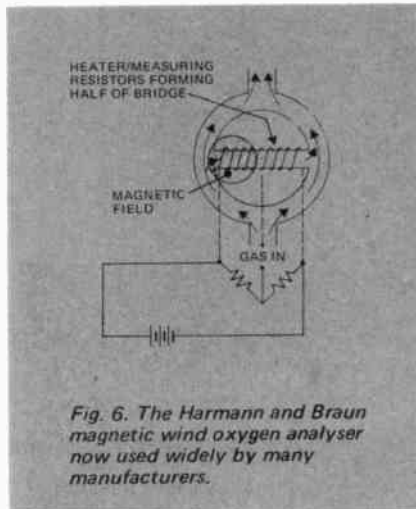

Fig. 5. Layout of a chemical oxygen demand detector using high-temperature galvanic cells.

Transducers in measurement and control

include electron capture cells for detecting alkyl halides, carbonyles, nitrides and nitrates — but not hydrocarbons (useful for pesticides). The helium detector is may be used for extremely sensitive analysis of all compounds, provided they are pure enough to begin with; the alkali-flame detector for sensing phosphorous compound (— the newer forms of pesticides that have largely replaced the now unpopular hydrocarbon forms); and the gas-density balance for the analysis of corrosive compounds. Space does not permit descriptions; they are to be found in the listed texts. Where mixture separation is not needed the column can be discarded, passing the gas through the detector only. Several specific analytical instruments operate this way.

The 'similarity between the amplitude-time recorder plots from a chromatograph and a spectrograph is striking and the use of correlation techniques appears relevant in the



detection process of chromatography (correlation was encountered earlier in the discussion of flow-meters). To date, however, there appears to be little gain when the extra difficulties are accounted for. A study made in 1968 (by Davies) showed that there were two main drawbacks. Firstly, extra gas sample was needed causing the column to operate in a non-linear mode and, secondly, the correlation process was expensive. Since 1968 the latter objection has been lessened by the introduction of commercial units. Even so, a study by Moss and Godfrey in late 1972, concluded that the case is still not strong but might expand in pollution measurements where specific equipments could be marketed thus cutting the cost.

DETECTION OF OXYGEN

Detecting oxygen levels in air, water and industrial processes is a commonly needed measurement. This has led to the development of a number of specific oxygen detectors.

By removing the oxygen (with absorbent columns) from a known volume of gas, and remeasuring the volume, it is possible to determine the oxygen content. This is an old established method but as it does not supply a continuous electrical signal the method has only limited use.

Oxygen analysers exist for use in continuous processes and are mainly of two types; those using electro-chemical principles and those making use of the magnetic properties of oxygen. In principle, one form of the first is based upon a special cell in which oxygen concentration is controlled by an input voltage.

A schematic diagram of a Philips unit devised to monitor the COD (chemical oxygen demand) of possibly polluted water is given in Fig. 5. The special cell consists of a zirconium oxide tube having porous platinum electrodes attached. When hot (the reason for the oven at 625°C) the tube develops a voltage between the electrodes that is related to the partial pressure of oxygen on each side of the tube. A current passed through the cell wall transports oxygen through the wall. With electronic feedback the oxygen partial pressure of an unknown gas can be compared with a known gas. In the COD measurement two such cells are used. The upper provides a constant concentration (p.p.m.) of oxygen in a nitrogen carrier. This enters, along with a minute sample of water to be tested, a furnace at 900°C which oxidizes and removes all oxygen. The gas then enters a second cell where the oxygen demand is met by the electric-servo oxygen transporter. The difference between this requirement and the original concentration is a

measure of the COD of the liquid. The method can measure COD values ranging from 1 to 5000 mg of oxygen per litre in just two minutes. Such detectors are termed high-temperature galvanic cells, and are specifically sensitive to oxygen, so water and carbon dioxide do not upset the analysis. Combustible pollutants, however, may consume more oxygen in the furnace indicating a false COD value.

The polarographic electro-chemical oxygen method, so called because the rate is controlled by the electrode area, uses oxygen diffusion through a Teflon membrane at ambient temperatures to produce a microampere current between two separated electrodes (26.3μ amps/p.p.m. in theory) — the Mackereth cell has a lead anode inside a silver porous cathode, the two having an electrolyte between them. Polarographic electrodes can be made as small as 2mm in diameter.

The second type of oxygen detector operates on a quite different principle — the paramagnetic properties of the oxygen molecule are used. In the O₂ molecule, two electrons are unpaired providing a strangely paramagnetic condition. Faraday discovered this in 1848, but it was not until the 1940s that an oxygen detector was produced using the principle.

The original magnetic detector used an effect known as magnetic wind. Referring to Fig. 6 the incoming gas containing oxygen, parts to both sides with some entering the cross tube. Because of the intense magnetic field, oxygen in the tube is attracted to one side. The heater raises its temperature reducing the magnetic property of the oxygen thus pumping it out; flow of oxygen results across the entire tube and this is detected by monitoring the resistance of the heater winding. Error can occur if the carrier gas is not constant in purity, for this will alter the heat-loss of the filament. The cross tube should also be horizontal otherwise gravity flow will occur. Hydrocarbons upset the method considerably. It is sometimes called a thermal magnetic analyser. In the more advanced Quincke analyser most of these defects are eliminated — at the expense of requiring a continuous supply of nitrogen.

In 1954, Linus Pauling devised another magnetic method that is less prone to errors caused by hydrocarbons. In his detector, two diamagnetic glass spheres, mounted to form a dumbbell, are suspended on a torsional suspension inside a measuring cell. A non-uniform magnetic field is applied across the cell causing the dumbbell to rotate to an equilibrium position. Changes in oxygen level in

forget our rave reviews and our research and sit in judgement on two fascinating experiments....

Take your most exacting records to your nearest Bose dealer and . . .

1 Place the BOSE 901's directly on top of any other speakers, regardless of their size or price, and make an A-B listening test with your records.

2 Place the BOSE 501's beside (with at least 2 feet clearance) any other speaker using woofers, tweeters and crossovers and perform the A-B listening test. (Don't ask the price of the 501 before the test).

Then just enjoy your records. When you finish you will know why we get much more satisfaction from our work than could ever be derived from profits alone. We enjoy telling you about our continuing research in sound reproduction and the rave reviews of our products, but the research and the reviews are of only academic interest unless the speakers really are audibly superior. YOU are the ultimate judge, for you are the one who lives with the sound you choose.

....unless they're audibly superior to you, it's all academic

You can hear the difference now **BOSE**[®]

Australian Distributors

WEDDERSPOON

W. C. WEDDERSPOON PTY. LTD.
193 Clarence Street, Sydney. 29 6681

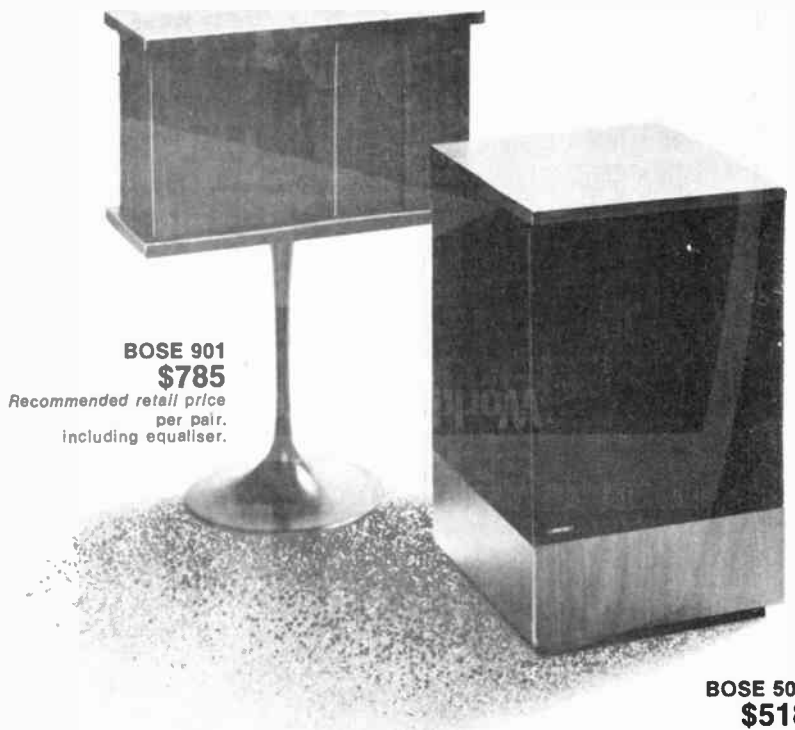

BOSE 901
\$785

Recommended retail price
per pair,
including equaliser.

BOSE 501
\$518

Recommended retail price
per pair.

Bose systems may be purchased from the following Australian dealers:

NSW: Sydney Hi-Fi Centre
83 York Street
Sydney. 2000

ACT: Homecrafts
Petrie Street
Canberra. 2600

WA: Leslie Leonard
London Court
Perth. 6000

VIC: Douglas Trading
191 Bourke Street
Melb. 3000

TAS: P. & M. Distributors
87 Brisbane Street
Launceston. 7250

QLD: Stereo Supplies,
100 Turbot Street
Brisbane 4000

SA: Sound Spectrum
33 Regents Arcade
Adelaide. 5000

Transducers in measurement and control

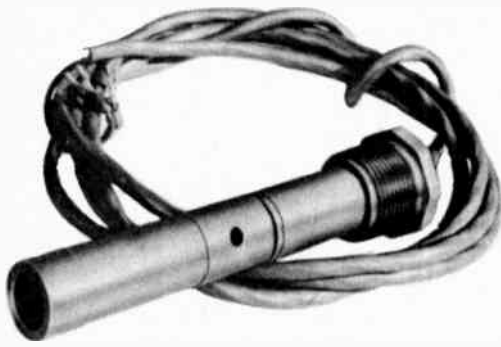
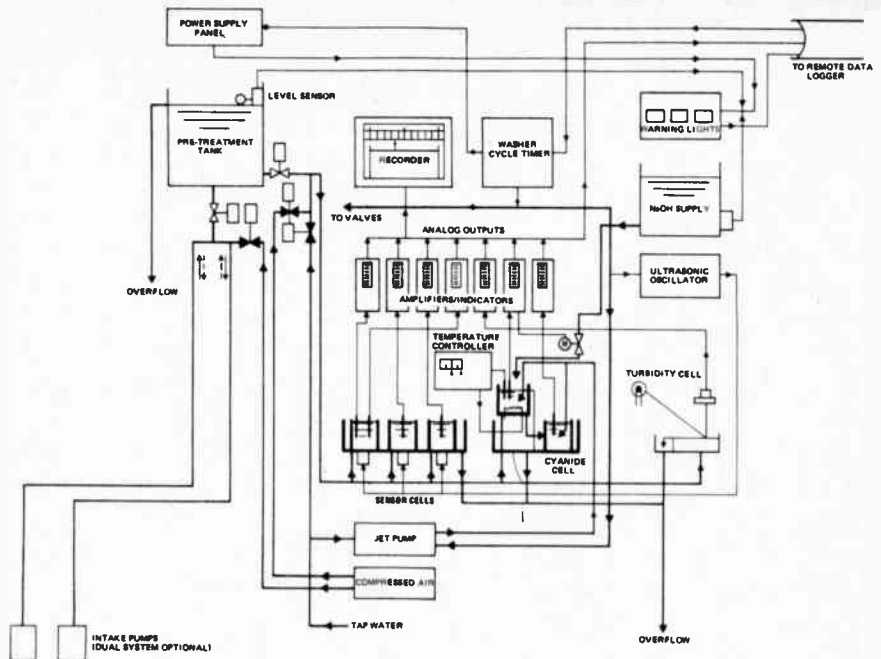

Fig. 8. Conductivity cell by Leeds and Northrup. This immersion design can be used for testing rinse waters.

Fig. 9. Water quality monitoring system (Weather Measure Corp.)



the cell alter the field, causing the beam to rotate. Movement is sensed by a microdisplacement transducer. Suspensions are made of quartz or platinum fibres. More advanced cells of this type use the force-balance technique to restore the beam to a null-position. Many gases are paramagnetic, but oxygen is only approached in magnitude by nitric oxide and nitrogen dioxide; other gases of interest being considerably less paramagnetic.

ELECTROCHEMICAL MEASUREMENTS

Two plates suspended in a liquid form a primary cell and a voltage occurs between them that depends upon the plate materials used and the liquid composition. This concept can be used in many ways to arrive at the impurity level of the solution. It can be used, firstly, as a battery, measuring the emf with no current flow (potentiometric analysis); as an electrolysis (or coulometric) cell in which current flows consuming energy; or as a resistivity (or conductivity) cell.

In potentiometric analysis, two half cells must always be used, for the voltage of a single plate to liquid half-cell is not meaningful. Quoted electro-potentials are referred against a standard cell to obtain a working calibrate arrangement, the standard hydrogen electrode (SHE) being the arbitrary value assigned for such comparisons. The SHE is not, however, entirely practical and other reference half-cells such as the saturated calomel and silver-silver chloride electrodes are used instead,

having first been calibrated against the SHE. Half-cells are connected to the liquid with salt bridges to enable ions to transfer without diffusion of the electrolytes needed in each half cell.

A common potentiometric measurement is that of pH, the measure of free hydrogen in concentration in a liquid — the degree of acidity or alkalinity. The observed potential of a cell-pair, less that of the reference cell at 25°C, equals 0.05195 times the pH value, the number coming from a simplified form of the Nernst equation explaining the electrochemical process. So called glass and calomel electrodes are used together in pH determinations as shown in Fig. 7. In the calomel electrode a saturated solution of mercurous chloride (calomel) and potassium chloride is placed over a mercury layer electrode. A salt bridge enables the ions to flow. The glass electrode has a silver wire dipping into an hydrochloric solution. This is contained inside a glass bulb that acts as a membrane separating the acid from the sample solution, as well as forming a container. Ions migrate through the glass but as the resistance of the membrane is typically 30 megohm a relatively expensive readout amplifier is needed.

In pH meters, such as that shown diagrammatically in Fig. 7, the electrode pair operate a high input impedance multivolt meter needing a scale of ± 700 mV to cover the 0-14 pH range. Compensation for temperature is essential, for the 0.059 constant is correct only at 25°C. Other electrodes available are the quinhydrone electrode useful in bio-chemical

analysis, the platinum electrode that is non-corrosive, but reads incorrectly in circumstances where chloride ions exist, the mercury electrode suited for chromium potential measurements and bimetallic electrodes made of platinum and palladium or tungsten. Operation of the latter is not completely understood.

In the electrolysis or coulometric analysis, current is made to flow either at a constant value or with a constant applied voltage. Flow is established when the voltage applied exceeds the normal (back emf) cell voltage. For example, a platinum plate and a copper plate in a solution of sulphuric acid has a back emf of 0.87V. Faraday's law states that 96 494 coulombs (a coulomb is an amp per second) of electricity are needed for each equivalent of a chemical reaction. Hence the amount of current consumed enables the substance to be analysed quantitatively. The method is easily automated and is popular for long term analyses.

Conductometry is the third electrochemical method, and, as the name implies, relies on measurement of the specific resistance of the liquid. Cells can be made of glass having platinum electrodes but more modern designs like that shown in Fig. 8 are made of high-impact strength non-corrosive plastics such as polyvinyl dichloride, PVDC, with embedded gold-plated nickel or platinum electrodes. The fluid is either made to flow through the cell or the cell is simply immersed in the sample. Alternating current bridges are usually used, operating at 1-10kHz. Ten MHz units have been marketed under the

The Final Test

BASF offer you these alternatives:

1. Spend an hour in our research laboratories, and with the aid of a frequency analyser, a spectrograph, a two-co-ordinate plotter, a level recording set and two men in white coats we will prove how much better BASF LH tape is than normal tape or even typical low-noise tape.

2. Spend five minutes with your hand on the volume control of your own tape recorder. Listen to a recording on normal or typical low-noise tape. Listen to the same thing on BASF LH tape. Twiddle the knob up and down to your heart's content.

With BASF LH tape: low noise-high output. That means that the 'noise' part of the signal on the tape is a much smaller proportion of the total output signal.

So even when you turn the volume up to maximum, although you're increasing the 'noise' by the same amount, there's less 'noise' to increase.

With the other tape, well, just listen. Now look at these diagrams.

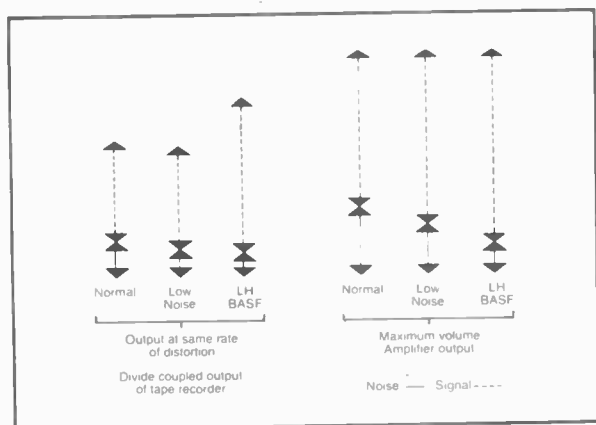

Note first that the BASF LH tape has a greater dynamic range than the normal or low-noise tape.



Distributors: Sydney (Head Office): Maurice Chapman & Co. Pty. Ltd., 276 Castlereagh St. 2000. **Newcastle:** W. L. Redman Agencies, 11 Hall St., N.S.W. 2300. **Canberra:** Sonny Cohen & Sons, 20 Isa St., A.C.T. 2600. **Melbourne:** Maurice Chapman & Co. Pty. Ltd., 146-150 Burwood Rd., Hawthorn, Vic. 3122. **Brisbane:** Chandlers Pty. Ltd., 399 Montague Rd., West End, Qld. 4101. **Adelaide:** Neil Muller Pty. Ltd., 8 Arthur St., Unley, S.A. 5061. **Perth:** Anderson-Tedco, 11-13B Belmont Ave., Belmont, W.A. 6104. **Launceston:** P. & M. Distributors, 87A Brisbane St., Tas. 7250. **Darwin:** Pfitzners Music House, Smith St., N.T. 5790.

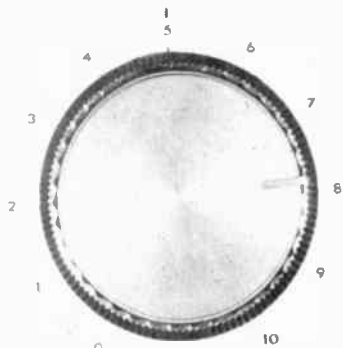

And secondly to get the same volume output as for the BASF LH you have to increase volume setting on the normal or low-noise tape, which at the same time (of course) increases the output of noise.

Now here are a few facts and figures for those of you who know what they mean. (There aren't many of us about.)

BASF LH TAPE

Sensitivity:	0dB
Frequency response:	0dB
Maximum recording level:	+9dB
Signal-to-noise ratio (dynamic):	60dB
Print-through:	51dB
Erasure:	>70dB

The measuring method corresponds to DIN standard 45512, sheet 2.

You may see what seem to be better figures quoted for other tapes. If you do—ask the manufacturer to what standards he's referring and what measuring method he's using then he'll climb down.

Still baffled?

Send the coupon for Heinz Ritter's 126-page book 'Tape Questions—Tape Answers'. It tells you everything you'll ever want to know about tape recording.

You can't spare \$1.25? Then send the coupon back for the complete BASF price list and all the figures that prove every word we've said.

To Australian Distributors:
Maurice Chapman & Co. Pty. Ltd.,
276 Castlereagh Street, Sydney 2000.

- Here's \$1.25. Please send me Heinz Ritter's book. Quickly.
- Don't send me the book, but do send me price lists and technical data. Just as quickly.

Name

Address

BA2684

Transducers in measurement and control

name Oscillometers. For dc operation, non-polarizing electrodes such as silver/silver chloride might be suitable.

Each electrochemical method can be used to monitor water quality but a number of detector cells are needed if all pollutants of interest are to be monitored. Commercial multi-sensor monitoring consoles exist — Fig. 9 is a block diagram of a versatile unit that will continuously monitor pH, conductivity, dissolved oxygen (DO), turbidity and numerous specific ion concentrations (bromine, chlorine, sodium, cadmium, iodine, cyanide, etc.). Sensing electrodes are automatically cleaned at regular intervals by ultrasonic vibration.

This outline is, by necessity, a brief resume of the chemical analytical instruments used commonly in water and air pollution measurements. Two other powerful analytical techniques, nuclear magnetic resonance (NMR for short) and neutron activation analysis, are applicable but are not used as extensively in routine pollution measurements, being limited by cost or transport factors. They are, nevertheless, worth considering. Details can be obtained in the suggested reading.

PARTICLE MONITORS

The presence of particles suspended in air or water may present a health hazard or impair visibility to such an extent that the air or water is polluted.

Fog, haze, mist, smog, call it what

you may, can be the result of optical dispersion or of suspended particles, ranging in size from smokes with $0.1\mu\text{m}$ diameters to grits of $100\mu\text{m}$. Smoke, airborne bacteria and fine fibres are in the $1\mu\text{m}$ size range, fine dusts from $1\text{--}20\mu\text{m}$ and coarse dusts $20\text{--}80\mu\text{m}$. Devices for measuring the concentration of particles are known as turbidity sensors (in water) or nephelometers (Greek for cloud) in air.

Particles may be permanently suspended by virtue of their small size compared with the molecules of the medium or may be transiently suspended by virtue of an upward velocity, for example, as found in chimney stacks. Coal and oil furnaces are the worst offenders in industrial areas, with cars adding considerably by emitting unburned hydrocarbon particles.

Average particulate concentrations in remote non-urban areas of the United States lie around $10\mu\text{gm}/\text{m}^3$; in urban areas around $100\mu\text{gm}/\text{m}^3$. The heavily polluted areas go as high as $2\text{ mgm}/\text{m}^3$. An accepted safe level of particle precipitation is around $200\text{ mgm}/\text{m}^2/\text{day}$ ($15.4\text{ tons}/\text{mile}^2/\text{month}$). Brisbane City suburban records for 1969, indicated values of $7\text{--}35\text{ tons}/\text{mile}^2/\text{month}$ indicating that some suburbs were unhealthily polluted in this way. This amount of dust is easy to produce! A 200 MW coal-burning power station operating with only 0.7 percent dust loss from the chimneys would pour out 20 tons of dust a day. In the 1950s, records for the Pittsburg area in the United States ran as high as $2\text{ gm}/\text{m}^2/\text{day}$ ($170\text{ tons}/\text{mile}^2/\text{month}$).

The cheapest method to monitor

particle fallout rates is to let them fall for a given time onto known size slides or plates which are later examined by counting the particles, using a microscope; or weighing the carrier before and after. Fans or suction are used to increase the yield.

In the airborne bacteria sampler shown in Fig. 10, a culture plate, surfaced with a nutrient solution, is slowly rotated under the dome cover. Air is drawn in by a low-vacuum pump, passing through a slit positioned above the rotating plate. Bacteria come to rest on the plate and a colony begins to grow. After the sample period is complete the plate is removed and incubated. The record obtained of the plates is also shown in Fig. 10. Up to position three the bacteria were freely moving in the air. At three an ultraviolet lamp was turned on — the record shows the diminuation of cultures after the event.

OPTICAL METHODS FOR MEASURING TURBIDITY

The most direct method is to monitor the loss of illumination intensity of an optical beam radiating through the smoke or haze. An installation devised by staff of the CERL (Central Electricity Research Laboratories) in Britain is shown in Fig. 11. Note the Everclean windows that help to overcome signal loss common to viewing windows in such dirty conditions. Air is pumped into the sampling tube at five second intervals to purge the system clean and reset the zero.

Aircraft runways can become clouded and when this happens the pilots desire a measure of the degree of visibility. The Transmissometer is the

(Continued on page 81)

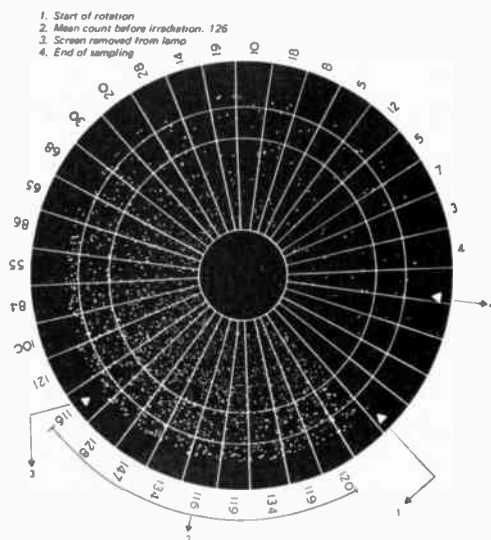
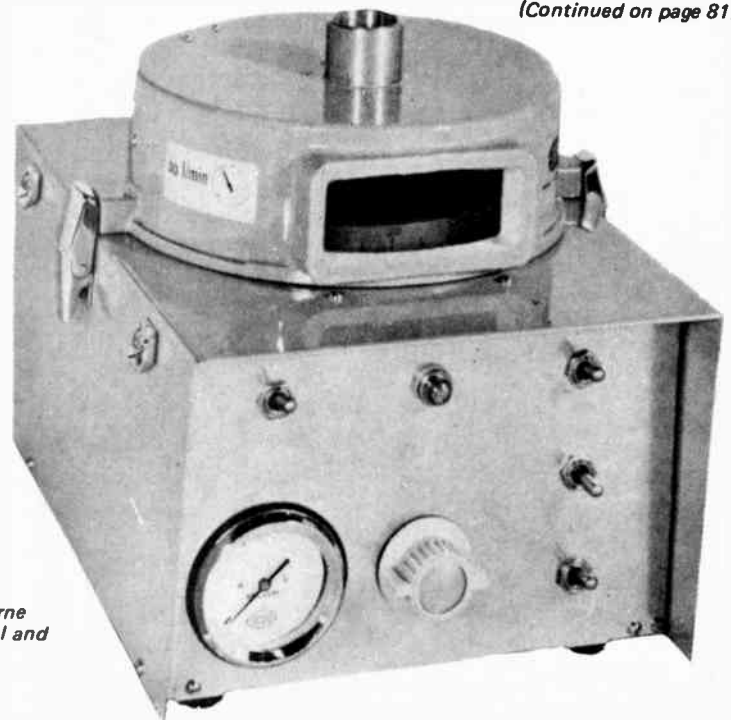

Fig. 10. Casella airborne bacteria sampler MKII and record produced.



Professional TV Service Technicians are in short supply

YOU COULD BE

ONE OF THE CHOSEN FEW!

By the mid 1970's the new and exciting field of colour television will be with us in Australia. The demand for qualified experts in colour television technology will be great. The time to enter a profession with such a promising future is right now.

Even today the number of television sets in this country runs into millions and the figure is increasing all the time. The opportunities for you as a trained technician both now and in the long term are boundless if you choose TV servicing as your career.

THE ICS "CAREER PROGRAMME" FOR TV SERVICE TECHNICIANS

ICS now offers any career-minded person with an interest in electronics the opportunity to qualify as a professional in this fast growing career field. The ICS TV Service Technician Career Programme is a complete and integrated course designed to train you to take your place in a career field where experts are really in demand.

The advantages and the security of being a trained professional in an industry where such talents are in short supply are obvious to any ambitious person. Take up the challenge and reap the rewards. Post the coupon today for your free prospectus detailing the complete Career Programme.



POST THIS COUPON TODAY TO

ICS

DEPT. 553, 400 PACIFIC HIGHWAY
CROWS NEST, N.S.W. 2065

Please provide me with information about
the TV Service Technician Career Programme:

Name (Mr., Mrs., Miss) _____ Age _____

Address _____

Postcode _____

Occupation _____

LB3.3702

Three Kings

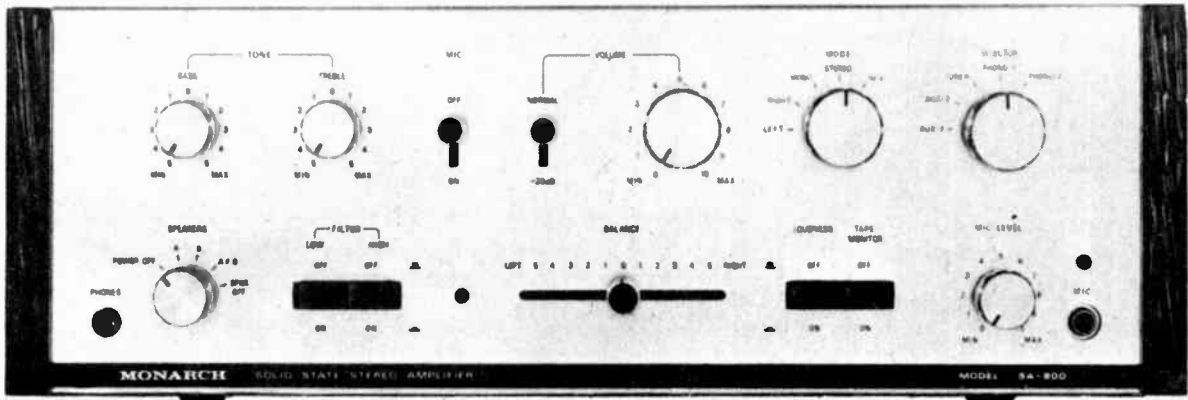

MONARCH SA 800 (80 watts RMS)
Recommended retail price \$240

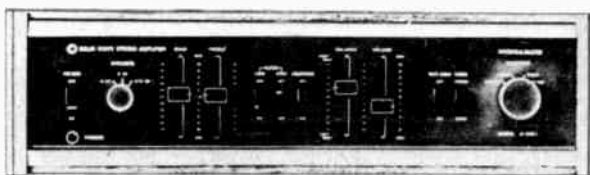

MONARCH SA 5001 (60 watts RMS)
Recommended retail price \$189

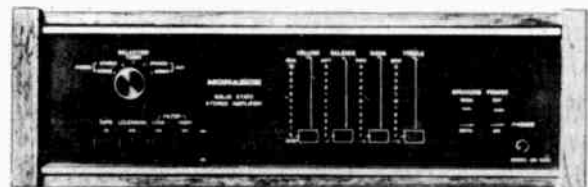

MONARCH SA 600 (34 watts RMS)
Recommended retail price \$139

Three amplifiers that stand head and shoulders above the rest. Because in the ratio of Power-to-Performance-to-Cash each Monarch amplifier gives more power, more performance for less money than any other amp in its class. No wonder Monarch is king as Australia's largest selling amplifier.

And now Monarch offers a choice of sound and power to suit *every* need with the introduction of the biggest, most advanced Monarch of all. The SA 800. 150 watts of total music power

(80 watts RMS at 8 ohms). 1m distortion of less than 0.4% at full output. Three stage direct coupled circuitry using the latest monolithic IC's for wide dynamic range, low noise and highly stabilised performance. And every other facility you could possibly need: Low and high filters; tape monitor; microphone input, and a unique microphone mixing circuit.

Try out Monarch for yourself at your nearest dealer. You'll agree, Monarch does more things better than other amplifiers costing \$100 more!

Monarch

AUSTRALIAN DISTRIBUTORS

WEDDERSPOON

W. C. WEDDERSPOON PTY LTD

193 Clarence Street Sydney 29 6681

AVAILABLE FROM REPUTABLE HI FI DEALERS EVERYWHERE

WM 1171

Transducers in measurement and control

instrument becoming accepted to perform this task, displacing personnel who make subjective assessments of visibility. In the Transmissometer, a powerful beam of light, often a spark discharge pulse source, is transmitted to a receiver. A telescope gathers the radiation arriving, directing it to a photo-tube or photomultiplier detector. The response of the detector is made to match that of the eye in visual transmission testing. There is an increasing use of this principle on freeways where fog is encountered. Another form of the same concept has the receiver mounted at the detector; back reflected light is used to determine the visible range. Visibility meters can operate over ranges from a hundred metres to 25 km.

In practice, sophistication is needed to eliminate various sources of error. Firstly, it is desirable to modulate the light to overcome the effect of ambient light. Secondly, a portion of the outgoing light is referred back to the incoming to reduce the influence of source intensity variations. Another feature often incorporated, uses the same detector to sense the outgoing and then the returned beam thus eliminating differences in photocell characteristics. The null-balance technique is shown in Fig. 12. The filter wedge attenuator is servo-controlled to obtain a balanced photocell output from each of the two paths as the mirror is rocked from side

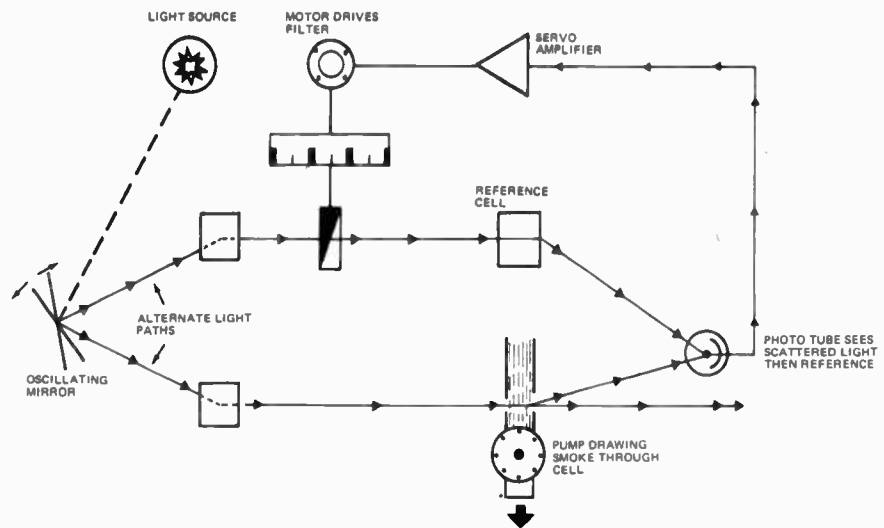

Fig. 12. Sigrist dust monitor operates from the forward scattered stray light produced by a light beam passing a smoke. It can detect concentrations as little as 0.005 mgm/m^3 .

to side at 600Hz. The sample cell is compared against a reference until a null is achieved — the position of the optical attenuator is then a measure of turbidity. In some designs light scattered at 90° to the beam is used, for this reduces the errors due to colour or shape of the particles. The turbidity of solutions can be determined in a similar manner, the solution being placed in a test tube that is placed between the transmitter and the detector.

When the particles are large it is the settling rate that is of interest. The CERL dust monitor, as shown in Fig. 13, operates on the principle that the heavy dust will fall out of the flow onto a glass collector plate reducing the transmission. Again, air is used periodically to blast the windows clean.

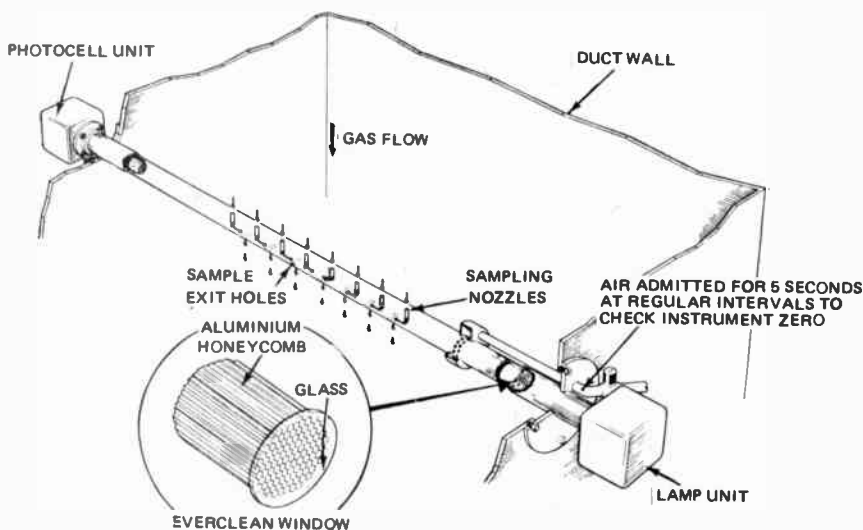

Fig. 11. Smoke density recorder designed at the Central Electricity Research Laboratories CERL in Britain. The patented Everclean windows use a long, thin aluminium honeycomb to prevent the formation of particles on the glass.

PARTICLE COUNTING

An interesting method marketed by Particle Data Inc. makes use of the change in resistance of liquid flowing between electrodes as particles flow in suspension. The particles are first added to a suitable electrolyte that is then drawn steadily through an orifice (with electrodes) that detects resistance changes. The output pulses are amplified and then integrated or distribution analysed into size time charts. Ranges covered go from $0.3\mu\text{m}$ to $300\mu\text{m}$. Flow rate is regulated to reduce coincident occurrences of the particles. As in most nephelometers output is given as a logarithmic scale. Special data processing equipment is available to perform the distribution analysis.

Other non-optical methods include measuring the charge removed from electrodes as the dust passes, and charge carrier rates between electrodes.

When the particles become very large, as in sewage and slurries, they can be detected by capacitance or electromagnetic changes. Certain flow meters (see previously) operating on this principle can yield data on particle size whilst acting as flow sensors.

RADIOACTIVITY

Corpuscular radioactive radiation occurring naturally and synthetically emits packets of energy as alpha, beta and gamma rays. These, and X-rays, lie in the electromagnetic radiation spectrum above 10^{17} Hz . Such radiations can be most harmful, especially when it is considered that small doses go undetected only producing symptoms years or generations later. Nuclear radiations have the property of decreasing in radiation strength according to an exponential law. The rate of loss of

Measure
POWER and VSWR
with the ONE
compact instrument
Freq: 3-144 MHz

**HANSEN FS-5
POWER/SWR METER**

Measures RF power 0-100 watts and VSWR from 1 to 3 - using a separate meter for each. It is designed for use with coaxial lines having an impedance of 50-52 and 73-75 ohms. The FS-5 is particularly useful for determining VSWR of an aerial system. Compact, easy to operate with clear controls, portable with self contained batteries.

\$31

PLUS SALES TAX

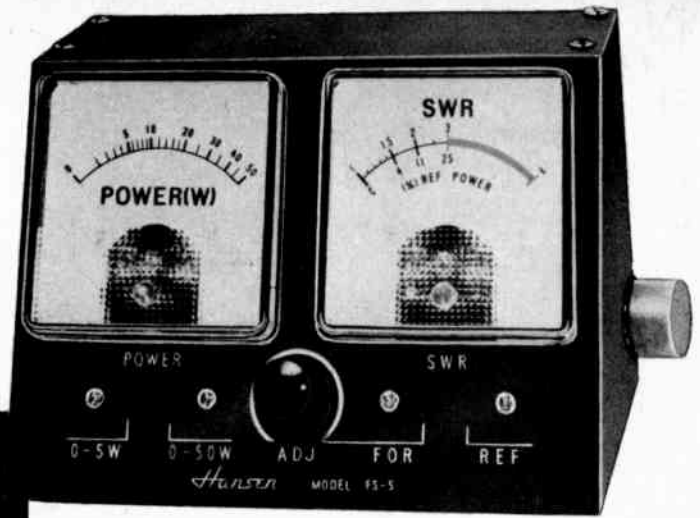

SPECIFICATIONS • Measurement Ranges - RF power: 2 ranges, 0-10, 0-100 watts. SWR: 1-3 VSWR • Adapted Circuit - 50-52, 73-75 ohm coax. line (a short cable with plugs on both ends required) • Meters - power 100 μ A DC F.S.D., SWR 50 μ A DC F.S.D. • Size 6 $\frac{3}{8}$ " W x 3 $\frac{3}{8}$ " H x 4 $\frac{1}{4}$ " D.

Distributed by:
**JACOBY
MITCHELL**
and SELECTED DISTRIBUTORS

SYDNEY	630 7400
MELBOURNE	41 7551
BRISBANE	44 4674
ADELAIDE	93 6117
PERTH	28 5725
CANBERRA	95 9138

JM/118-73

a realistic performer
—this top flight
COMMUNICATIONS RECEIVER

SW/CW
SSB/AM

TRANSISTORISED.
AM solid state.

4 BANDS
535 to 30 MHz
(includes Broadcast)

240V AC
or 12V DC
operation

REALISTIC DX150A

... a professional-looking set that appeals to amateurs and short wave listeners alike. The DX150A gives long-range, world-wide realistic reception on 4 bands, including Broadcast. Fully transistorised - all solid state - no warm-up delays; the DX150A will run on dry cells if current fails or is not available; will operate from a car's cigarette lighter or any 12V DC service. A 240V AC power supply is also built in. Over 30 semi-conductors - product detector for SSB/CW, plus fast and slow AVC - variable pitch BFO - illuminated electrical bandspread, fully calibrated for amateur bands - cascade RF stage - AHL for RF and AF - zener stabilised - DTL audio - illuminated "3" meter - built-in monitor speaker plus front panel jack for external (optional) matching speaker.

Suggested
retail price
\$234.20
... that's
realistic
too!

Weston electronics
(A division of Jacoby Mitchell Ltd.)

376 EASTERN VALLEY WAY, ROSEVILLE, 2069;
Cables and Telegraphic Address: WESTELEC.
Sydney, Phone: 40 1212

Please forward free illustrated literature and specifications on Realistic.

Name.....
Address.....

**YES WE DO BUILD
SPECIALS
AT REASONABLE PRICES!**

WE ARE EXPERIENCED AND CAPABLE OF CONSTRUCTING ANALOGUE AND DIGITAL INSTRUMENTATION, CONTROL EQUIPMENT, POWER SUPPLIES, ETC. TO YOUR SPECIFICATIONS

We would be pleased to discuss your requirements at any time. Give us a call.

**Integral
Design**

105 Hawthorn Road,
Caulfield, Vic. 3161
Phone: 53-4589

N.S.W. AGENT Vic Furnari, 23 Milner Crescent,
Wollstonecraft, N.S.W. 2065. Phone: 439-1782.

Transducers in measurement and control

activity is conveniently described by the time taken to fall to half strength; this is termed the half-life or $T_{1/2}$ and varies enormously from isotope to isotope (the radioactive form of element). For example, of those produced in an atomic reactor, Copper 64 has a half-life of 12.8 hr whilst nickel 59 has a 750,000 years half-life.

The first pollution hazard, therefore, is to be present where radiation leakage is occurring — this is relatively easy to avoid. The second hazard is where long continuous doses are endured at low levels and this is more of a problem. Atomic power stations, ships and nuclear detonations each produce radiation and only the latter is a critically dangerous source of pollution. However, large losses have occurred in power stations, so a constant need for monitoring is vital.

It is hard to believe, but in 1970 it was learned that the U.S. Atomic Energy Commission had in an underground store, some 50 10^6 gallons of radioactive waste much of which has half-lives measured in hundreds of thousands of years! Some isotopes are particularly dangerous. Strontium-90, for instance, accumulates in our bones encouraging cancer. Nuclear device testing in the early 60s did much to raise the normal background level.

Each radiation presents a different hazard, so the unit of strength is based on the biological effect it produces. This unit is the relative biological effectiveness or rem for short. Normal background levels are around 0.1 rem per annum. Small doses greater than this can cause later-appearing symptoms. Large doses (hundreds of rem) will produce fever and digestive upsets that, if overcome, will lead to tumours and certain death at some stage. It is for these reasons that there is so much opposition to the French nuclear tests in the Pacific.

Alpha particles penetrate the least and are easily shielded or absorbed; Beta rays have the largest range, but gamma are the most penetrating. The relative quantities of each emitted depends upon the isotope.

The simplest detector of radioactivity dosages is the personnel-monitor worn on the lapel. This consists of a piece of photographic film half of which is shielded by a layer of absorber such as lead or aluminium. These cannot be read without processing.

Radioactive particles cause ionization and this is the principle used in the

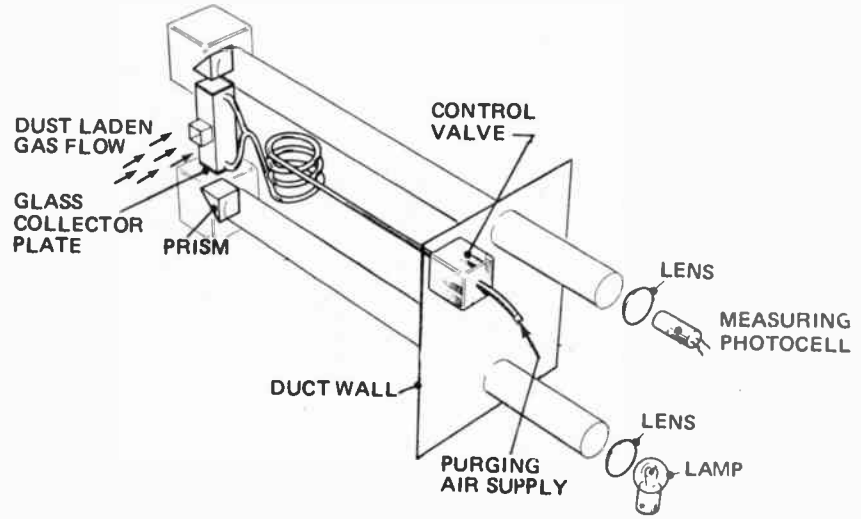

13. Flue dust monitor, developed at CERL and marketed by Kent, uses two horizontal mirrors, the lower collecting dust as it falls.

general purpose ionization detector shown in Fig. 14. Each RA particle entering the chamber ionizes the gas (air, argon, etc.) producing a current pulse that is amplified. The process is random, so a series of noise pulses are counted and averaged over a chosen time-period to be displayed on a meter or used to drive a loud-speaker unit. Certain filling gases have an amplification factor of a million. These, if used, enhance the sensitivity.

The Geiger-Muller tube is of the ionizing type and is typified by a characteristic that provides constant

pulse sizes regardless of particle type. Many variations exist, depending on the shape and the voltage operating, but all are most inefficient using only 1% of the radiation passing through to provide an output signal.

Another disadvantage of ionization cells is that time is essential (0.1-0.5 millisecond) for the anode to become sheathed by charge in readiness for the next particle event.

A superior, but more expensive, method for detecting RA is the scintillometer. Referring to Fig. 15 the incoming particle enters the crystal (of

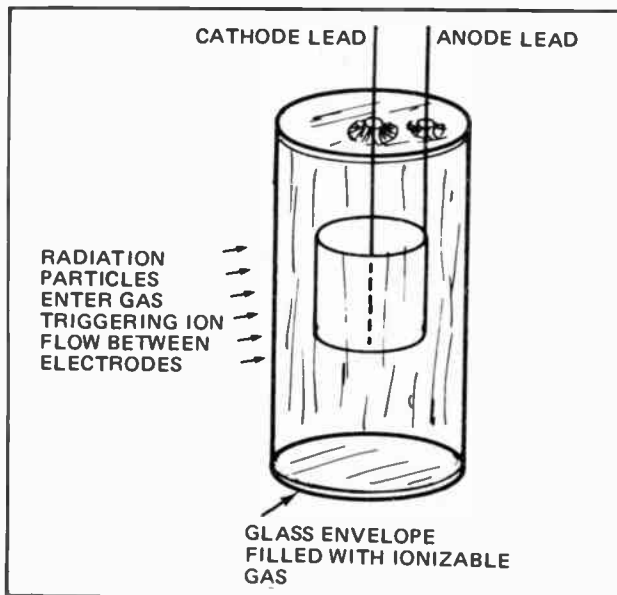

Fig. 14. Simple ionization chamber detects nuclear radiation particles.

7 Months professional training in Computer Electronics and Technology by the Education Division of one of the world's leading Computer Manufacturers

Diploma Course commences 7th August, 1973
1.00 pm to 6.00 pm
5 days a week for 7 months

Due to the growth of the Computer Industry there will be a continuing need for professionally trained computer Specialists. Control Data's professional training with student "hands on" experience on a Computer System aims to produce Computer Specialists competent to enter the Computer Industry. Through our effective employment service, Control Data graduates find these career opportunities.

CONTROL DATA 283 Alfred Street,
 AUSTRALIA PTY LIMITED NORTH SYDNEY 2060

SEND FOR INFORMATION

Mr.
 of
 Post Code Age
 Educational Standard

ET MAY

Transducers in measurement and control

stilbene or sodium iodide) where it releases photons that scintillate at visible radiation wavelengths. This energy conversion process is reasonably efficient and, furthermore, amplification of light can be had with extremely low-noise addition by the use of a photo multiplier as is shown in the figure. The time delay of scintillometers can be as small as $0.01\mu\text{sec.}$ so more particles can be detected.

Effective use of these detectors involves the use of pulse processors to discriminate between coincident pulses, to produce averaged rates, and special needs such as pulse height discriminators for the detection of the form of radiation as well as its strength.

FURTHER READING

"Modern Methods of Chemical Analysis", R. L. Pecsok and L. Donald Shields, Wiley, 1968, London.
 "Basic Gas Chromatography", H. M. McNair and E. J. Bonelli, Varian Aerograph, 1968, California.

"Practical Manual of Gas Chromatography", J. Tranchant, Elsevier, 1969, Amsterdam.
 "Correlation Techniques Applied to Gas Chromatography", G. C. Moss and K. R. Godfrey, Trans Inst. Meas. Control London, 1972, 5, 351-353.
 "Measurement of Oxygen Content in Gases", F. Tipping, as above, 1970, 3, 145-152.
 "pH Facts - The Glass Electrode; The Industrial Scene", W. Thompson and E. Gill, Kent Technical Review, 1972, 7, 16-22.
 "Variosens - Optronic Instrument for Measurement of Turbidity...", Impulsphysik GmbH, Hamburg.
 "The Transmissometer", G. W. Oddie, Weather, 1968, November.
 "The Continuous Monitoring of Particulate Emissions", D. H. Lucas, W. L. Snowsill and P. A. E. Crosse, Trans Inst. Meas. Control, (London), 1972, 5, 0-21.
 "Neutron Irradiation and Activation Analysis", D. Taylor, Newnes, 1964, London.
 "Radioactivation Analysis", H. J. M. Bowen and D. Gibbons, Oxford, 1963, Oxford.
 "Radioisotope Techniques for Measurement and Control of Industrial Pollution", J. F. Cameron, Trans. Inst. Meas. Control, 1971, 4, 303-307. ●

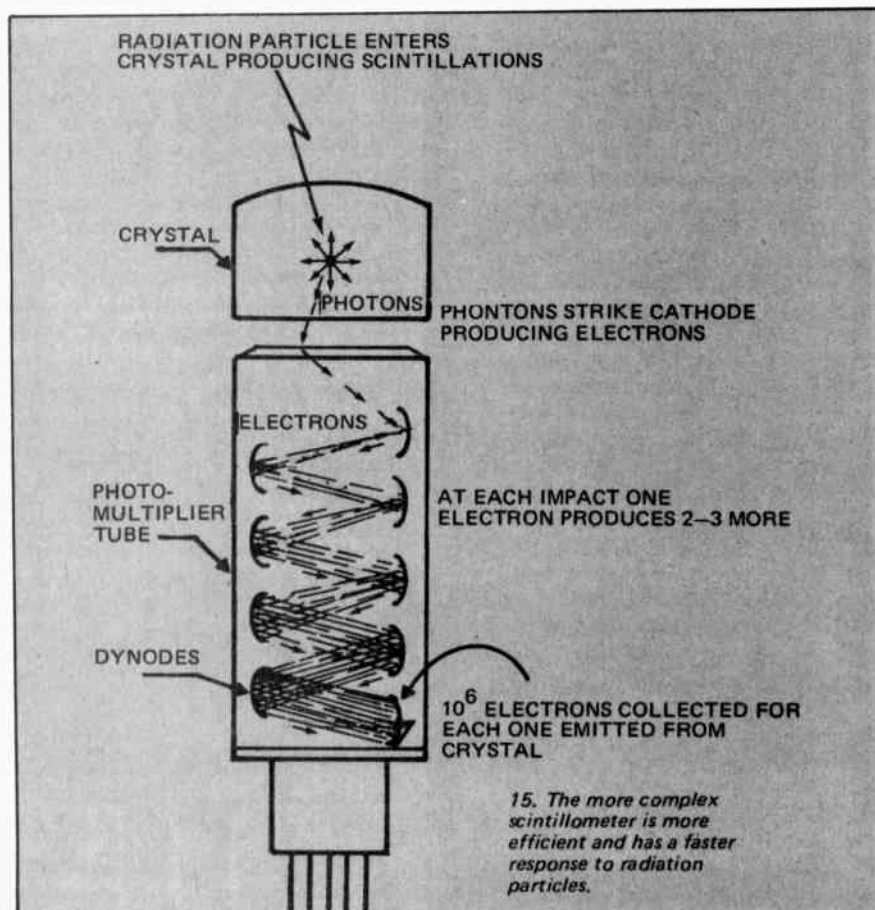

FOR THE AUDIO PERFECTIONISTS...

MORE HI-FI SYSTEMS TO CHOOSE FROM at E.A.'s

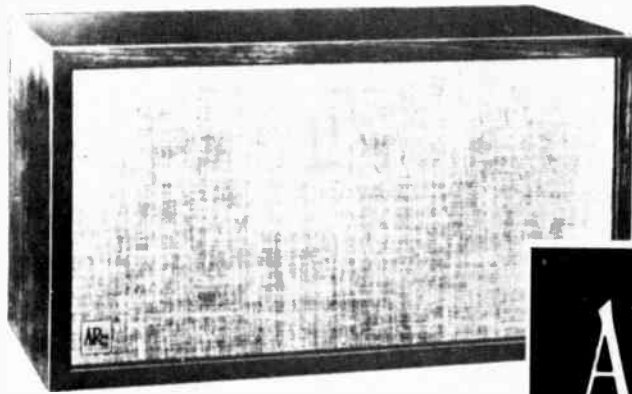

We stock every AR speaker from the tiny AR7 to ultimate Laboratory Standard Transducer.

SAVE \$100
AR Amplifier

Incredibly low distortion over all amp stages. Over 100 watts RMS. Power response 20Hz-20KHz. Phono input level control.



\$399

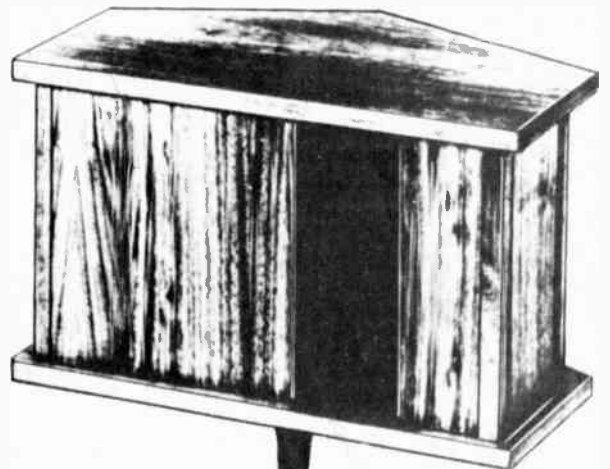

BOSE
Natick, Massachusetts



901 SPEAKER SYSTEM

Has a neutral well-balanced transparent quality on all programme material — you'll feel you've made some sort of stereo discovery when you experience the crushing realism of the world's most powerful domestic speaker — Power handling 540 watts RMS. Only \$795 Pair.

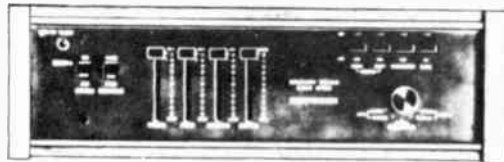

Monarch

Top left SA600, 34 watts RMS \$139. SA800 Amplifier 80 watts RMS \$240. Monarch gives you more power, more performance for less money than any other amplifier in their class. Incredible 2 Year Guarantee covers all parts and labour.

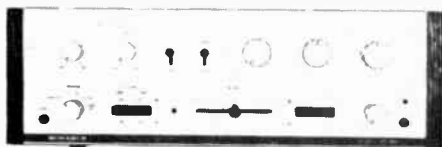

Amcron

D300 amplifier has lowest distortion level of any commercially available power amp 180 watts per channel RMS with 8 ohm loads, only \$980. IC150 pre-amp — "Audio Magazine" said "when it came time to measure IM and THD, our test set up proved to be completely useless". Only \$460.

* ACCREDITED AGENTS FOR: Pioneer, Rabco, Dynaco, Harman/Kardon, Empire, Sony, Garrard, Dual, Leak, Shure, Teac, Plessey, Nivico, National, Sharp, Onkyo, Quad, Goodmans, A.D.C., Sansui.

MAIL ORDER COUPON

Please send me particulars/goods:

Enclosed my money order/cheque for \$

NAME

ADDRESS

STATE

P/C

ERIC ANDERSON'S

ESTABLISHED 1923

FOR INFORMATION PHONE
JOHN McTAVISH 29-7491
14 BARRACK ST., SYDNEY 2000

SENSORS ON

A new, regular monthly feature by 'Talus'

DAEDALUS, the Athenian architect and inventor, lived in Greek mythology. He served King Minos and his daughter, Ariadne. His son Icarus was the first aeronaut to die in a test-flight — when his wax wings melted.

Many great inventions were credited to the mythical Daedalus — statues that seemed to walk, reservoirs and steam baths, sails for ships, the wedge and the axe. Today he lives on as the name of a company making instrumentation in the United States — and as the adviser to a resurrected Ariadne on a page like this in another magazine.

What we usually do not hear about is that Daedalus was a

"baddy". He, in the fact of the legend, left Athens in a hurry early in his career after he had murdered his talented nephew, Talus. It seems he was jealous of the equally fine inventions of Talus — an iron saw and a pair of compasses were named.

Well, of course, Talus did not die — myths go on forever! He merely left the hostile scene by climbing over the edge of the then flat world to wait in a place down-under until it began to exist when the earth became round. He is back making his comeback. This is his page and his sensors are on.

"Would'st thou hear what man can say

In a little; Reader, stay."

Ben Jonson 1573-1637

ON SPECIFICATIONS

THE implicit faith some people have in commercial instruments is amazing. If the panel is high-class and controls abound it must be good. But beware!

Several years ago a co-worker, researching the resonances of machine-tool structures, took delivery of a very sophisticated instrument for analysing the vibration of a frame as the frequency is slowly swept through the spectrum. He was unusually thorough for the first thing he did was to test the analyser. To his surprise — for it cost a lot — many of the functions did not live up to the stated specifications. The outputs drifted with time, the gains changed with time, the signal rejection was under par. His first thoughts were that perhaps he was not familiar enough with its operation and his tests were incorrect. To be on the safe side he toured the country seeing several other identical units that had been in active use for several years. Each had the same defect unbeknown to their users, who it seems, had not been careful enough to test the equipment initially.

(Continued on page 89)



The sensitive olfactory sense of specially-trained animals was recently used to detect illegal drug trafficking. (Cartoon reproduced by kind permission from the 'Australian' 24/3/73.)

"... (The Dynaco A-25) has established a new standard of performance in uncolored, natural sound."

THE HI-FI NEWSLETTER (P.O. Box 539, Hialeah, Fla. 33011)

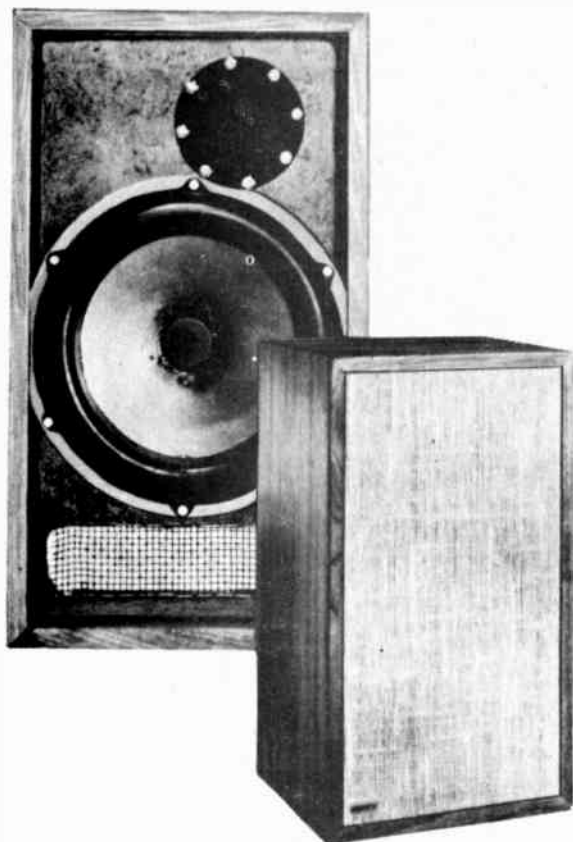

"... you'll have a hard time buying more musical naturalness at any price."

THE STEREOPHILE (Box 49, Elwyn, Pa. 19063)

The critiques from these hobbyist magazines have unusual merit as these publications accept no advertising. Their comparative evaluations are funded solely by the subscriptions of ardent audiophiles.

The A-25's sound quality is a direct consequence of its smooth frequency response, outstanding transient characteristics, and very low distortion. Its aperiodic design (virtually constant impedance over its range) provides an ideal load so any amplifier can deliver more undistorted power (and thus higher sound levels) for a given speaker efficiency.

Uniformity of impedance also makes the A-25 the best choice for adding two new speakers to an existing stereo setup using the Dynaco system* for four-dimensional reproduction. In this way, true "concert hall sound" can be enjoyed with a standard stereo amplifier.

See and hear two additional Dynaco models, the A10 and A35 with markedly similar sonics and closely matched characteristics at your Dynaco dealer now. Together with the A25, these models represent the finest value available today.

FOR YOUR NEAREST DYNACO DEALER. WRITE OR PHONE



JERVIS AUSTRALIA PTY. LTD.
P.O. Box 6, Brookvale, N.S.W. 2100
Phone: 939 2922

* * EXPO STEREO SYSTEMS * *

Give **BIG SOUNDS FOR SMALL DOLLARS**

\$2 WKLY

LOW DEPOSIT



EXPO SYSTEM 2

A MODULAR STEREO SYSTEM, FINISHED IN WALNUT COMPRISING TA-2200 AMPLIFIER, GARRARD T/TABLE AND A PAIR OF FABULOUS E-622 SPEAKERS.

\$3 WKLY

LOW DEPOSIT



EXPO SYSTEM 4

A FOUR PIECE HI-FIDELITY SYSTEM, FINISHED IN EITHER TEAK OR WALNUT CONSISTS OF TA-3100 AMPLIFIER, GARRARD 40B TURNTABLE, AND A PAIR OF EXPO SS/802 SPEAKERS.

\$4 WKLY

LOW DEPOSIT



EXPO SYSTEM 6

A TRULY SUPERB HI-FI SYSTEM, COMPRISING NEW KA-410 AMPLIFIER TRANSCRIPTION T/TABLE AND A PAIR OF H.F.S. 400 SPEAKERS HAND FINISHED.

\$5 WKLY

LOW DEPOSIT



EXPO SYSTEM 7

THE ULTIMATE IN HI-FI STEREO SYSTEM, IN HAND FINISHED TEAK OR WALNUT, COMPRISING KA-3300 AMPLIFIER, TRANSCRIPTION TABLE AND A PAIR OF SS-10265 SPEAKERS.

\$1 EXTRA WEEKLY BUYS

A FABULOUS EXPO CASSETTE DECK READY TO GO

FREE HEADPHONES WITH OUTFITS - HOME DELIVERY SYDNEY. ALL EQUIPMENT FULLY GUARANTEED

PHOTO HI-FI PTY. LTD.

367 PITT STREET, SYDNEY. TELEPHONE: 61-2049 - 26-3234
JUST UP FROM LIVERPOOL STREET

SENSORS ON

Now comes the irony. These other workers had published research papers expounding new theories based on widely incorrect measurements! The moral of this tale is clear: time spent testing a new piece of equipment is well worthwhile.

But the story doesn't end there. As the original supplier was in a land far away and had not been able to improve on the original performance after several attempts, my friend decided to see what local designers could provide. A specialist firm provided a prototype modular unit to his specified needs — this too did not comply upon testing. They offered him a job, but he declined for he was after a research degree in those days. By now the project had been changed to one of instrumentation for machine-tool testing, for many months had passed and no accurate testing of tools had resulted. He subsequently wrote a paper releasing the test findings in which the equipment manufacturers were named. The report was rejected — too controversial for the learned Institution to publish. This is but one of many such experiences showing that open criticism is fast dying in the technologies. It is so difficult to be certain of the facts.

Another incident concerning specifications comes to mind. When a large rocket range was being established in Australia, a need arose for an optical shaft encoder to record angular movements of a radar antenna. The experts on the job decided the task required about 10 arc seconds resolution. To be sure, they asked the tendering staff to advertise for 5 arc seconds resolution. The clerks in the administration section decided to call for 1 arc second resolution — to be on the safe side — and out went a call for tenders. The optical company in Switzerland who were awarded the contract thought it wise to aim at better than this, again to ensure that the product received acceptance at the commissioning time so they designed for 0.5 arc seconds or so. So the accuracy of the encoder actually delivered was far in excess of that needed. The cost of encoders rises roughly exponentially with increases in resolution so the delivered encoder cost far more than was necessary. I think I would be safe in asserting that this was not the first instance of this phenomena nor will it be the last.

Finally, on specifications, I have some medication that states "Take one tablet three times a day". I haven't thought of a way to do this yet. ●

you only have to take one a year



RECORDS



CASSETTES



REEL-TO-REEL TAPES



CARTRIDGES

Whether it's records, cassettes, 8-track cartridges or reel-to-reel 7½ or 3¾ stereo tapes, World Record Club has much to offer you in all kinds of music — classical, light and pop! And you only have to take one a year — one record or cassette or cartridge or tape. Records are \$3.39, cassettes are \$4.00, cartridges \$4.75, tapes \$4.25 and \$5.25 . . . you enjoy massive savings, whatever your choice. Send for details without obligation via the coupon below. There's no entrance fee, no catch, no hidden conditions. You order only what you want — and are sent only what you order.

TO: WORLD RECORD CLUB,
299 Flinders Lane, Melbourne, 3000

Please send me without obligation details of:

- RECORDS REEL-TO-REEL TAPES
 CASSETTES 8-TRACK CARTRIDGES

NAME Mr. Mrs. Miss

ADDRESS

POSTCODE

ET 5:73

FERGUSON

Manufacturers of: Electrical/electronic equipment, wound components and lighting control equipment.

VERSATILE RANGE OF LOW HEIGHT POWER TRANSFORMERS

These transformers comply with the requirements of Australian Standard C126, where applicable, with respect to insulation and winding construction.

If forming part of a prescribed item, to be submitted to an Electricity Authority, it is essential to ensure proper earthing facilities, adequate ventilation and segregation of primary and secondary leads.

All the transformers in this range are suitable for connecting to 240 Volts 50 Hz., single phase supply and are nominally rated at 20VA. Dimensionally they are identical, with height limited to 1 1/2", width 2-3/8", length 4-5/16" and mounting centres 23/32" by 3-27/32 inches.

Each transformer is provided with two identical secondary windings which permit series or parallel operation, are fitted with round pin terminations and are supplied with a set of six leads with shrouded receptacles.

The tabulation sets out against type numbers the nominal rating and the voltage obtained for various loads when the windings are connected in series, 240 Volts being applied to the primary winding:—



TYPE No.	NOMINAL RATING	VOLTS OUTPUT @:				
		5VA	10VA	15VA	20VA	25VA
PF3596	6V @ 10VA	13.0	12.6	12.0	11.5	11.0
	6V @ 10VA	(0.39)	(0.80)	(1.25)	(1.74)	(2.28)
PF3597	7 1/2V @ 10VA	16.6	16.0	15.4	14.7	14.1
	7 1/2V @ 10VA	(0.30)	(0.63)	(0.98)	(1.36)	(1.77)
PF3598	9V @ 10VA	19.8	19.2	18.0	17.6	16.7
	9V @ 10VA	(0.25)	(0.52)	(0.84)	(1.14)	(1.50)
PF3599	12V @ 10VA	26.4	25.6	24.6	23.5	22.4
	12V @ 10VA	(0.19)	(0.39)	(0.61)	(0.85)	(1.12)
PF3600	15V @ 10VA	33.0	32.0	30.0	28.9	28.0
	15V @ 10VA	(0.15)	(0.31)	(0.50)	(0.69)	(0.89)
PF3601	20V @ 10VA	43.5	42.2	40.7	39.1	37.3
	20V @ 10VA	(0.13)	(0.24)	(0.37)	(0.51)	(0.67)
PF3602	25V @ 10VA	54.0	52.2	50.4	48.4	46.2
	25V @ 10VA	(0.09)	(0.19)	(0.30)	(0.41)	(0.54)

Approximate current in Amps shown in brackets.

FERGUSON TRANSFORMERS PTY. LTD.

HEAD OFFICE: 331 High St., Chatswood. 2067
Telephone: 40-0261

AGENTS

TAS.
Associated Agencies Pty Ltd
25 Barrack St., Hobart, Tas, 7000
Phone: 2-1843.

A.C.T.
A.C.T.I.E.C. Pty Ltd
21 Patterson Pde.,
Queanbeyan, N.S.W., 2620
Phone: 97-3579

QLD.
Keith Party & Co Pty Ltd
Waterloo St., Newstead, Qld, 4006
Phone: 51-5461

W.A.
H.J. McQuillan Pty Ltd
57 Division St.,
Welshpool, W.A., 6106
Phone: 68-7111

S.A.
K. Farmer Sales Pty Ltd
141 Gillies St.,
Adelaide, S.A., 5000
Phone: 23-4702

VIC.
Ferguson Transformers Pty Ltd
181-183 Hawke St.,
West Melbourne, Vic., 3003
Phone: 329-7437

SOLID STATE, SINE, SQUARE WAVE AUDIO SIGNAL GENERATOR

TRIO



MODEL AG-202

The AG-202 is a Wien bridge CR-type, sine and square wave audio signal generator which is invaluable for high fidelity analyses in the lab, on service benches and in electronic educational classrooms. All solid state in construction, it produces excellent sine waves instantly with a minimum of distortion and square waves with fast rise time that are ideal for hi-fi tests. Input for synchronization with external signal sources has been provided to further enhance the versatility of this fine instrument.

SPECIAL FEATURES

1. Near-perfect sine waves, excellent square waves.
2. Instant signals, superior stability due to all solid state circuitry. No warm-up waiting time needed.
3. 10 V r.m.s. high level output at low impedance. Simple sure attenuation control.
4. Easy-to-read, single dial with frequency readings accurately calibrated in four ranges; smooth dial mechanism.
5. Input provided for external signal sources, synchronization which produces signals of the highest accuracy.
6. Frequency and output level of signals are practically unaffected by line voltage fluctuations.
7. Ideal for high fidelity analyses and test work. Also for educational purposes.

PARAMETERS

PTY. LTD.

SYDNEY 43 6577 • MELB 90 7444 • ADEL 51 6718

ACTIVE FILTERS

FREQUENCY — 0.01 Hz to 20 kHz
ZERO INSERTION LOSS * LOW NOISE
HIGH STABILITY — 250 PPM/C° * SMALL SIZE

AUDIO — CUSTOM BUILT — TUNABLE
TELECOMMUNICATIONS Tx/Rx
STANDARD CC ITT CHANNELS AVAILABLE

TELECOM RECEIVER CURVES

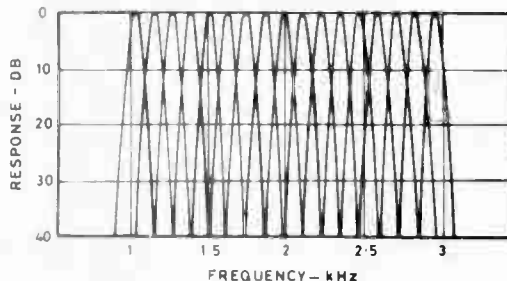

TEKNIS

PTY. LIMITED
AUSTRALIA

SYDNEY: P.O. Box 635, Crows Nest, N.S.W. 2065.
Ph: 439-1599.

MELBOURNE: P.O. Box 121, Carlton South, VIC. 3053
Ph: 347-7039.

ADELAIDE: P.O. Box 45, Kingswood, S.A. 5062.
(Head Office) Ph: 72-2355

Digital standards converter for television

New system uses digital techniques to convert NTSC to PAL or SECAM programs

ENGINEERS of the Independent Broadcasting authority (IBA) in the United Kingdom have demonstrated the world's first digital field-rate standards converter for colour television. The new equipment — designated DICE (digital intercontinental conversion equipment) — changes NTSC 525-line, 60-field colour pictures into high-quality colour pictures in the 625-line, 50-field PAL or Secam standards

Compared with earlier analog converters the new digital equipment shows marked improvement in the quality of the output colour signals and is significantly more compact; it has no line-up adjustments and is expected to prove completely stable in operation.

Although the digital converter uses some 8000 metallic-oxide semi-conductor (MOS) integrated circuits — the main storage devices alone represent the equivalent of more than 15 000 000 field effect transistors — it is believed that digital equipment of this type need cost no more than the cheapest of existing analog converters. An important

element of the design is the repetition of the printed circuit boards, reducing cost and simplifying installation and maintenance. Most of the circuit boards can be tested on plug-in "go/no-go" test sets.

Information is read out of two field stores simultaneously, at a rate depending on the required outgoing line frequency. Each field store is made up of 48 modules arranged in groups of four and each group of modules stores 21 lines of picture information using a total of 96 shift registers, each with a capacity of 1024 bits using metallic-oxide semi-conductors and field effect transistors (MOS FET) technology.

The sampling rate is three times the colour sub-carrier frequency (about 10.7 MHz) and each picture element is analyzed into one of 256 equally spaced amplitude levels to produce an 8-bit binary coded pulse train. To reduce the maximum operating speed, 8-wire parallel circuit feeds are used from this point onwards; further down the chain this is increased to 24 parallel feeds and later to 32. The converter is designed to always give a k-rating factor of better than 1%.



The new digital standards converter for television developed by a team of engineers of IBA.

The IBA Director of Engineering states: "Although the work has been undertaken as part of a long-term investigation into digital techniques for television, it opens the way to operational applications which could improve and make less critical the interchange of programmes and programme material between countries and continents. The use of computer-type metallic-oxide semi-conductor integrated circuits and simple on/off digital wave-forms is expected to eliminate many of the critical adjustments and maintenance problems of existing analog-electronic and optical-electronic standards converters. It is a significant step forward in television engineering." ●

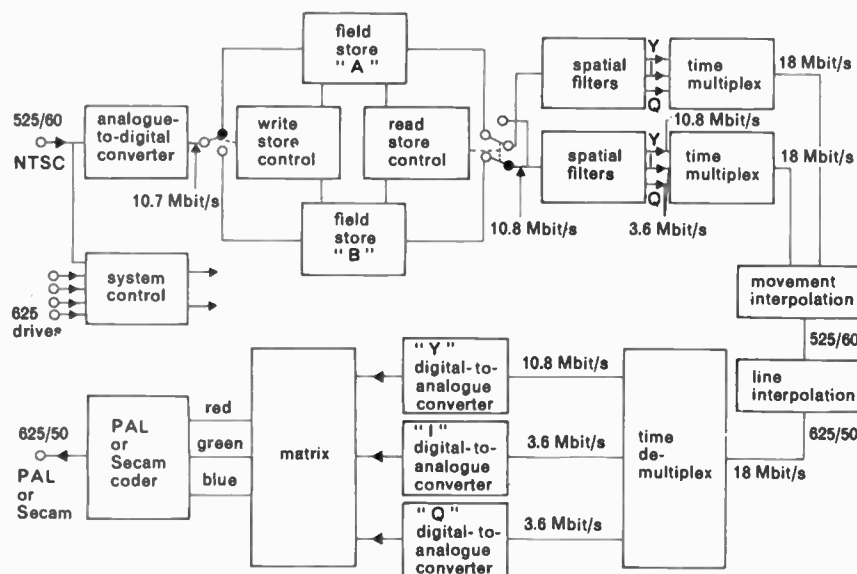

Digital standards converter 525 lines, 60 fields to 625 lines, 50 fields

CLEARANCE SALE

ELECTRONIC EQUIPMENT AND COMPONENTS

Receivers, transceivers ex-Army & Citizens Band transmitters, test equipment, oscilloscopes, sig. generators, multimeters, chassis racks, panels, computer parts & boards, power transformers up to 6.6KV, valves, transistors, potentiometers, etc., speakers, amplifiers, cables — hook/up & coaxial 50 & 70 ohm, multicore up to 50 core. Panel meters, AVO meters, valve testers and all types of electronic components.

7,000 sq. ft. of electronic gear, plenty of parking come and inspect. Open 10-5 p.m. weekdays, 9.30-12 Saturday. Wanted to buy receivers, transceivers, electronic equipment & components. Top prices paid.

SPECIAL THIS MONTH
No. 62 transceivers Army type 1.6 to 10M/C 12 Volt operation price \$39.50.
50 ohm coaxial cable 1/2" diam. new price 45c yd.

HAM RADIO (DISPOSAL BRANCH)

104 Hightett Street, Richmond, Vic.
3121. PHONE: 42-8136.

WANTED TO PURCHASE
MANUFACTURERS SURPLUS AND
REDUNDANT COMPONENTS AND ALL
TYPES ELECTRICAL AND ELECTRONIC
TEST EQUIPMENT.

EXPRESS
MAIL ORDER

HEAD OFFICE and Mail Order Dept. 718
Parramatta Rd., Croydon. N.S.W. 2132.
Ph: 797-6144.

WOLLONGONG AGENT: Hi-Tec
Electronics, 265 Princes H'way,
Corrimal. N.S.W. 2518. Ph. 84-9034.



C.D.I. KIT (Olims)

Complete kit of parts to build this superior commercially made Capacitor Discharge Ignition system. All high grade components with pre-wound transformer, P.C. board, nuts, bolts, case, instructions, etc., 12V - earth only. For improved performance, fuel saving less pollution and less points wear this is a MUST. ONLY \$19.95 plus 50c post.

NEW! IMPROVED MODEL -
Now with plug and sockets
for changeover to standard ignition

POTPAK . . .

Consisting of the following range of potentiometers: 4 Tab-pots, 2 preset pots, 3 switch-pots, 5 standard mono-pots, 2 ganged stereo pots and 4 concentric pots, a total of 20 potentiometers normally valued at \$6.00. Only now for \$2.00 plus 50c post.

FANTASTIPAK . . .

For One Month only. A Fantastic 5lb. Bargain Parcel of guaranteed NEW Electronic components. Included are Transistors, Electrolytic Capacitors, Resistors, Potentiometers, Rotary Switches, Magnetic Counter, Computer Boards, P.C. Boards, Transformers, Tag Strips, Lamp Holders, etc. We guarantee the value of this parcel to exceed \$30.00. FIRST COME, FIRST SERVED, AS WE HAVE ONLY LIMITED QUANTITIES AVAILABLE. Don't be astonished but we are only asking \$18.00. Post Free.

FANTASTIPAK No. 2.

This Pak has been designed for the discriminating Hobbyist Building Valve equipment. Consisting of quantities of Valve Holders, Standard and Modern Valves, Electrolytics, Styro-seal, Mica and Ceramic Capacitors, Trimmers, Grommets, Toggle Switches, Circuit Breaker, Rectifiers, Chokes, Turret Units, Resistors, Relays, Tuning Condenser, Tagstrips, Plugs, Cable, plus assorted quantities of plugs, sockets, fuses, coils, etc., etc. Worth at least \$20.00. Our Anniversary sure-fire value only \$10.00 plus \$1.00 post.

STEREO CASSETTE DECK



'VORTEX' Stereo Cassette Deck mechanism with tape eject facility and resetable counter. Easily operated by 5 push-button (plano key) controls, and includes high quality heads. Price \$29.00. Post Free.

New Recording and Playback Pre-Amp kit available soon. Another Pre-Pak exclusive. Please write for full details.

I.C. SIGNAL INJECTOR KIT

This useful wide-band signal injector is ideal for fault-finding in audio and RF circuits VHF. The kit is housed in a clear perspex probe housing and includes batteries. The output is a square wave signal at approx 3KHZ with harmonics extending to TV frequencies. Price \$4.50 plus 25c post.

RADIO TUNER KIT

Easy-to-build, uses Philips pre-assembled and pre-aligned tuner module and is complete with AC power supply. Output 100mV. Assemble it in just 1 hour. Chassis kit only \$22.95 post 75c. With teak case anodised aluminium front panel \$27.95 post 75c.



UNIVERSAL COUNTER DISPLAY KIT:

Model EC1. Very compact in size - uses a 7 segment MINITRON Incandescent display in 16 PIN DIL package and socket, a 7490 decade counter and a 7447 decoder driver all on 3" x 2" P.C. Board with contacts for use with a 10 way edge connector (price 55c). Facilities include built-in decimal point, blank in and out, reset, carry and count. Operating voltage - 5V D.C. Applications, circuits and instructions are supplied. This is your opportunity to experiment with digital circuits while building a fascinating electronic counter. Price: \$12.50., post 25c.

7 SEGMENT DISPLAY

This highly reliable "MINITRON" incandescent display has an average lifetime of more than 50,000 hours and is housed in a standard 16 PIN DIL package. Displays 10 digits, from 0 to 9, operates on 5V DC (power consumption 40mW per element) and has inbuilt decimal point. Connection diagrams supplied. Price: \$4.50., post 10c.

3 WATT POWER 1C

The M5102 AY 3w 1C in a T03 10 lead package is a powerful performer for use in cars, caravans, boats, etc or wherever the max voltage avail is no more than 12V DC. Applications include car radio amp, portable PA amp, loud hailer etc, etc. Price \$4.50 post 25c. Complete kit including all external components \$5.50 post 25c.

"NATIONAL NEWS"

New QUAD AMP LM-3900 - this unique I.C. from NATIONAL SEMICONDUCTORS consists of four independent, dual input, Internally compensated amplifiers which will operate from a single power supply of 4 to 36V D.C. The LM3900 has seemingly endless applications possibilities as AC amplifiers, RC active filters, pulse waveform and squarewave generation circuits, tachometers and low speed high voltage digital logic gates. Date sheets supplied free. Price - \$1.50., each, post 10c.

NATIONAL I.C.'s.

Latest price list and news bulletin now available free. Write to head office above.

SPECIAL NATIONAL offer of complete kit of semiconductors for ETI Master-Mixer. Normal price \$51.00. SPECIAL NATIONAL Price - \$35.00., tax included, post 75c.

NATIONAL I.C.'s DIGITAL INTEGRATED CIRCUITS

		1-9	10+
SN7400	NAND Gate	90c	80c
SN7401	NAND/NOR Gate	90c	80c
SN7402	NOR Gate	90c	80c
SN7403	NAND Gate	90c	80c
SN7404	Hex Inverter	90c	80c
SN7406	Buffer	\$1.95c	\$1.70
SN7408	AND Gate	90c	80c
SN7410	Nand Gate	90c	80c
SN7413	Schmidt Trig.	\$1.05	85c
SN7420	NAND Gate	90c	80c
SN7430	NAND Gate	90c	80c
SN7440	Buffer	90c	80c
SN7441	Decode/Driv.	\$2.60	\$2.30
SN7442	Decoder	\$2.45	\$2.20
SN7447	Decode& Driv.	\$4.90	\$4.50
SN7473	Flip-Flop	\$1.50	\$1.40
SN7474	Flip-Flop	\$1.50	\$1.35
SN7475	Latch	\$1.90	\$1.70
SN7476	Flip-Flop	\$1.40	\$1.20
SN7483	Binary Adder	\$2.45	\$2.20
SN7490	Counter	\$1.75	\$1.55
SN7493	Counter	\$1.75	\$1.55
SN7496	Shift Reg.	\$1.95	\$1.70
SN74121	Monostable	\$1.35	\$1.25

LINEAR INTEGRATED CIRCUITS

		1-9	10+
LM300		5-75	5-00
LM301A		1-50	1-35
LM301N		1-50	1-35
LM305		2-80	2-50
LM307		2-25	2-05
LM308H		10-75	9-50
LM308N		3-20	2-90
LM309K		5-50	4-20
LM370N		4-50	4-20
LM371H		4-20	3-80
LM372		3-75	3-35
LM373		5-20	4-80
LM380		3-00	2-70
LM381		5-90	5-50
LM709		99c	90c
LM723		2-95	2-65
LM741H		1-50	1-35
LM741N		1-50	1-35
LM1303		2-95	2-65
LM1458		2-25	2-05

A NATIONAL EXCLUSIVE

The LM380, 2W Audio Amplifier.

SPECIFICATIONS: Max. power, 2.2W RMS, Voltage 18V Max. Dist.

0.5 per cent. Current 200mA max at 18V. PRICE: LM380, IC \$3.00 P.C. Board to suit above. \$1.20.

Special Introductory offer one LM380 I.C., P.C. Board and all external components to build a complete 2W audio amplifier, suit, record player, intercom etc. . . \$4.50 post 25c.



I.C. LOGIC PROBE

This probe appeared in Electronics Australia and uses an SN7400 and two LED's giving a visual indication of the logic state of any point in a circuit using digital IC's. The kit is housed in a clear plastic housing and includes P.C. board and instructions. A simple project to build in one evening. Our special price \$7.50 Plus 25c post.

PRE-PAK electronics

AND AGENCIES

AUSTRALIA'S
BIGGEST
ELECTRONICS
DISCOUNTERS

QUEENSLAND AGENT: Proportional Systems Australia, 4 Gaythorne Rd., Gaythorne, Brisbane, Qld. 4053.

Nth. QUEENSLAND AGENT: Philtronics, Cnr Grendon and Palmer Sts., Nth Mackay, Qld, 4740. Ph: 78855.

WEST AUST. AGENT: B.P. Electronics, 192-196 Stirling Terrace, Albany. W.A. 6330. Ph. 41-3427.

VICTORIAN AGENT: Geo Hawthorn Electronics, 966-968 High St., Armadale, Vic. 3143. Ph. 509-0374.

STH. AUST. AGENT: Revolver Electronics (mail order only) 20 Essex St, Goodwood S.A. 5034.

NEWCASTLE AGENT: Scientific Supply Co: 817 Hunter St, Newcastle West 2302. Ph. 61-4611

MUSICOLOUR COLOUR ORGAN (MK 11) KIT

A pleasing colour-visual demonstration of sound for Discotheques, Parties, etc. Easily operated from any radio or stereo amplifier. The kit is supplied as described in Electronics Australia and will control 3KW of power. Instructions for assembly are supplied. Price without chassis \$38.00 Post 50c. Price (with chassis) \$45.00. Post \$1.00.

CAR RADIO/STEREO I.C. AMPLIFIER

'JUST RELEASED' Mitsu-bishi M5102A I.C. POWER AMPLIFIER in



modified Jeduc TO3 case (10 pin). Suit Car Radio/Stereo, Loud Hailer, Intercom, Record Player etc.

Specification: VCC max 18V, Quiescent current 40mA max, input - 120mV for 3W output, Input Imp - 6.5K Ohms. Data and application sheet supplied with each I.C. PRICE - \$4.50., post 25c.

POWER SUPPLY KITS

Comprising transformer, mounting plate, silicon bridge rectifier and smoothing capacitor plus screws, nuts, etc. PS3 6V, 7.5V, 9V, 12V, 15V, 1A \$5.95 post 50c. PS4 18V, 20V, 25V, 27V, 30V, 1A \$7.90 post 60c.

PS6 6V, 7.5V, 9V, 12V, 15V, 2A \$7.90 post 60c.

VARIABLE POWER SUPPLY KITS

PS8 Electronically regulated and protected, suit amplifiers etc., or general purpose use. Output adjustable 20 - 45V DC at 2 Amp maximum. Features adjustable current cut-out and good regulation. Price: \$22.50., post \$1.00

I.C. POWER SUPPLY KIT ETI III

An effective low voltage power supply using an LM723 I.C. voltage regulator to provide high regulation and current limiting facilities. The output voltage is adjustable from 1.5 to 15V DC at currents up to 1 Amp. Suitable for bench testing of radios, record players and experimental circuits. Kit Price: \$16.50., post 75c.

COMPACT RADIO TUNER

A limited quantity of these 3 transistor tuners is available at this low price. The tuner is designed for use in battery operated record players, but may be used for HI-FI applications or portable/mantel radios. Operates on 9V DC supply and is completely built except for dial-cord which is supplied separately. This offer may never be repeated - Price \$9.75., post 25c.



COMPACT 500mW AUDIO AMPLIFIER

A transformerless complementary transistor amp designed for record player or general purpose applications and ideal for use with the tuner above to build a complete radio/record player, requiring only a turntable, speaker and battery. Operates on 9V DC. Price \$3.50., post 25c.

SCR DRILL SPEED CONTROL KIT

This project appeared in Electronics Australia in May '71 and has proved very reliable. It is suitable for household electric drills and small motors to 3 amp rating. The unit is housed in a sturdy plastic case and is fuse protected. Instruction diagrams are provided. Price \$9.50. Post 40c.

"E.T." HIGH POWER STROBE

This project is a 'winner' at parties and theatrical productions and may be calibrated for checking speed of motors, etc. Light output is both high and intense, and, as an added attraction it will drive other slave units for even greater light output. The kit includes all parts, reflector and instructions. Price \$19.50. Post 60c.

E.T.I. MASTER MIXER

This kit now available at best prices. See below. Semiconductor kit \$35.00 post 75c. P.C. Boards ET414A \$1.60, ET414B \$1.75, ET414C \$1.90. Post 10c. Send SAE for complete parts list and price list to Head Office, Croydon, NSW.

ELECTRO - CAP PAKS

PAK 28: 25 miniature electrolytic capacitors, brand new, 3 volt to 12 volt; 25 useful values for just \$2.00 Post 20c.

PAK 30: 25 high grade, brand new, electrolytic capacitors, in range 10uF mfd to 500uF, from 12VW to 80VW. This special experimenters PAK includes the most common values in both pigtail and P.C. types. Price: \$3.50., post 20c.

PAK 31: 15 high grade, brand new, electrolytic capacitors in range 500uF to 3,300uF, from 12VW to 35VW. Ideal for power supplies etc. Unbeatable value at \$3.50., post 30c.

CAR TACHO I.C. - Requires only 1mA meter and may be calibrated for any type of motor engine. Data sheet supplied. Price \$2.50., Post 10c.

7 DAY TRADING AT HEAD OFFICE ONLY

We offer free technical assistance, kit demonstrations, Australia's best bargains and a superlative cup of percolated coffee to EVERY customer.

Trading hours: MON - SUN 9.00am - 5.30pm.

No Thursday night trading.

DIGITAL ELAPSED TIME INDICATOR



Computer Grade (ex IBM) Precision Instrument. Size 4" x 3" x 2 1/2". Voltage 40-48V. A.C. 50 cycles. Watts 3.5 max. Reads up to 9999 Hours and also calibrated into 10ths and 100ths of an hour. Single units \$55.00 ea. plus 25c Post and Pkg as above but with 240v to 48v Transformer \$8.00 plus 50c Post. 2 indicators plus Transformer \$23.00 plus \$1.00 post.

A NATIONAL EXCLUSIVE

The LM380, 2W Audio Amplifier.

SPECIFICATIONS: Max. power, 2.2W RMS, Voltage 18V Max. Dist. 0.5 per cent. Current 200mA max at 18V.

PRICE: LM380, IC \$3.00 P.C. Board to suit above. \$1.20.

Special Introductory offer one LM380 I.C., P.C. Board and all external components to build a complete 2W audio amplifier, suit, record player, intercom etc. . . . \$4.50 post 25c.

DECODER FOR FOUR CHANNEL SOUND

This simple Decoder Unit, which appeared in the November Issue of "Electronics Australia", will allow you to go 4 Channel without going broke. Simply connect the input terminals to your present stereo amplifier speaker terminals and the output to a second stereo amplifier or tape recorder amplifier and the decoder will then synthesize rear channel signals either from existing records or the new quadraphonic pressings. A simple kit and very easy to assemble, it is complete with P.C. Board and all components. Requires 20V supply. Price \$5.90 post 30c.



P.C. BOARDS FOR "E.T." AND "E.A." PROJECTS

ET006 Audio Signal Generator \$1.45
ET005A F.E.T. 4 Input Mixer \$1.40
ET019 Auto Car Alarm \$1.40
ET004 Vari-Wiper 90c
ET022 Wide Range Voltmeter \$1.40
ET014 Dual Power Supply \$1.40
ET1111 I.C. Power Supply \$1.40
ET003B Elec. Thief Trap \$1.40
71/C12 Musicolour 11 \$2.25
71/SA4A Playmaster 132 \$1.45
71 SA4B Playmaster 132 \$1.45
71/SA4C Playmaster 132 \$2.50
72/10 I.C. Probe 75c
72/S11 4 Channel Decoder	- \$1.30. 72/P2
Mike Pre-Amp	- \$1.20

All boards are supplied with component layout diagrams. Post 20c.

7 TRANSISTOR RADIO KIT

A very popular Pre-Pak exclusive. These normally sell in the stores at about \$14. Due to our large purchasing power, we can offer these kits at just \$7.95 each. The kit is complete, less battery (small 9v).



NEW BOOKS

CALL IN OR WRITE GIVING YOUR REQUIREMENTS. All books reviewed in 'Electronics' can be ordered from us.

JUST RECEIVED

HOW TO LISTEN TO THE WORLD New 7th Edn:	\$4.40
RADIO AMATEUR'S HANDBOOK 1973 A.R.R.L.	\$6.95
WORLD RADIO & TV HANDBOOK 1973 (Complete Guide to World's Short-Wave Stations):	\$5.95
A.R.R.L. ANTENNA BOOK	\$4.35
A.R.R.L. RADIO AMATEUR'S V.H.F. MANUAL	\$4.35
AMATEUR RADIO TECHNIQUES — Pat Hawker (RSGR)	\$6.05
BASIC ELECTRICITY — 5 volumes combined	\$14.65
BASIC ELECTRONICS CIRCUITS — 2 volumes combined:	\$7.30
BASIC ELECTRONICS — 6 volumes combined	\$16.50
BASIC INDUSTRIAL ELECTRICITY — 2 volumes combined:	\$7.30
BASIC SYNCHROS & SERVOS — 2 volumes	\$7.30
BASIC TELEVISION — Technical Press, Three volumes in one — Just out!	\$11.45
ELECTRIC GUITAR AMPLIFIER HANDBOOK	\$5.45
GENERAL ELECTRIC SEMI- CONDUCTOR DATA BOOK	\$8.75
HI-FI AND TAPE RECORDER HANDBOOK — King	\$6.80
PAL RECEIVER SERVICING BY D.J. Seal — A new book! Profusely illustrated in colour, highly recommended!	\$11.90
PIN POINT TRANSISTOR TROUBLES! IN TWELVE MINUTES	\$7.35
RADIO & ELECTRONIC LABORATORY HANDBOOK SCROOGIE. New 8th Edition	\$15.00
R.C.A. SOLID STATE POWER CIRCUITS	\$8.50
REFERENCE DATA FOR RADIO ENGINEERS 5/c (I.T.T)	\$25.00
R.S.G.B. RADIO COMMUNICATION HANDBOOK	\$13.76
SYLVANIA TECHNICAL MANUAL — Receiving Tubes/Picture Tubes and Semiconductors	\$5.15
TRANSISTOR AUDIO & RADIO CIRCUITS, Genuine Mullard circuits	\$3.50
TRANSISTOR EQUIVALENTS — European, American & Japanese	\$3.00
TV SERVICING GUIDE Arranged by Trouble Symptoms — Deane & Young. Our best seller!	\$4.00

MAIL ORDERS BY RETURN...
PLEASE ADD 50c per parcel postage, 70c
per parcel interstate.

MODERN BOOKS & PLANS,
5th Floor, 280 Pitt St.,
SYDNEY. 2000. Ph. 61-2618

TELEPHONE RATE INDICATOR



Fig. 1. Telephone with integrated rate indicator

Inbuilt unit monitors cost of calls while they are made

A TELEPHONE rate-indicator, developed jointly by Siemens and Mark — Telefonbau, enables users to monitor the cost of telephone calls whilst they are being made.

Unlike earlier rate-indicators — which were either produced as separate units, or were of such a size that a larger telephone assembly was required — the new rate-indicators are designed as an integral part of the latest type of standard telephone.

Physical design and mode of operation

The new rate indicator's assembly of index wheels, step-by-step drive motor, and lock mechanism form a self-contained unit which mounts on the bottom plate of the latest standard type of desk telephone (Fig. 2) so as

to come just below the dial. The index wheels, which are clearly visible through a window in the shell of the telephone, give a continuous reading of the number of rate units used up on the call in progress. A 16 kHz filter and all the components involved in controlling the indicator are mounted on the circuit board of the telephone.

The rate indicator is ready to start metering an outgoing long-distance call whenever its latchkey is vertical in the lock; it is reset to 0000 by turning the latchkey clockwise by 90 degrees, whereupon a spring returns the key to its middle position. Turning the key counterclockwise will lock the telephone by causing a contact to bridge the pulsing contact of the dial so that no outpulsing will occur if the dial is turned. No outgoing calls can be

HITEC

Electronics

MAIL ORDER DIVISION, P.O. Box 105 CORRIMAL NSW
2518. SALES CENTRE, 265 Princes Highway, CORRIMAL.
PHONE WOLLONGONG 84-9034

SPECIALS

13 Mixed Transistors and Diodes inc	
2 15A Power Transistors	\$2.50
6 BC 107 Transistors	\$2.00
6 BC 108 Transistors	\$2.00
6 BC 109 Transistors	\$2.00
2 TT 800 Transistors	\$2.00
2 TT 801 Transistors	\$2.00
2 TT 797 Transistors	\$2.00
2 TT 798 Transistors	\$2.00
10 DC 72 Transistors	\$2.00
10 NPN Silicone Transistors Audio or Drivers	\$2.00
2 2N 3054 Transistors	\$3.00
2 2N 3055 Transistors	\$3.00
2 2N 277 Transistors	\$2.00
10 EM 401 Diodes	\$2.00
8 EM 404 Diodes	\$2.00
5 EM 408 Diodes	\$2.00
4 IN 3491 50 PIV 18A Rect	\$2.00

Postage 20c extra

2W AUDIO AMP KIT LM 380 + PC Board
and Components. \$4.50 post 25c.

CDI KIT (olims) improved model includes
change-over facilities to standard
ignition. \$19.00 post 50c.

UNISELECTOR SWITCHES 10 Pos, 3
bank, 25 ohm coil 24/48V. \$3.00 each
post 50c.

14 Pos 6 bank 125 ohm coil 24/48 V. 3" x
2 1/4" x 1-5/8" \$4.50 each post 50c.

PAK 1 — 100 resistors, assorted 1/2 and 3/4
W. \$1.50.

PAK 2 — 100 resistors, assorted 1 to 5 W.
\$2.00.

PAK 3 — 100 capacitors, assorted
polyester, ceramic and mica. \$2.00.

PAK 4 — 25 electrolytics, mixed 1 to 100
UF, 6 to 25 V. \$2.00

TUNER KITS 240 V. plus instructions
\$22.00. post 75c.

made as long as the telephone is locked. The key can be withdrawn when in its middle position and also after locking.

Functioning and electrical data

The control circuit of the new rate indicator with transistor amplifier consumes very little power. Like the clockface rate meter with transistor amplifier, it is powered over the subscriber line without the feed current for the speech circuit being perceptibly reduced. Thus the dc insertion loss is only negligibly increased. A simple voltage transformer transforms the voltage drop of about 0.8 V across a silicon diode G1 in series with the telephone to a potential of about 12 V for driving the motor M (Fig. 3).

The indicator is advanced to the next digit in two half-steps, the motor winding being energized during the second half-step with current of opposite polarity. The 16 kHz metering pulse from the exchange passes through the filter to transistor T1, which it turns on, and a storage capacitor C1 is charged via the motor

winding T1 to cause the motor to advance the indicator by the first half-step. At the end of the metering pulse the capacitor discharges via the motor winding and transistor T2, so energizing the motor winding in the opposite sense and advancing the indicator by the second half-step. A 16 kHz rejection filter interposed in the line preceding the telephone isolates the metering circuit from the speed circuit to prevent interaction.

The significant electrical data are the low loop current of 15 mA and the low receiving level of the metering pulses, which is only -15.64 dB (-1.8 Np). Given a pulse duration between 80 and 250 ms, the shortest pulse interval will be 500 ms. This means that the rate indicator is able to keep up with the fastest pulse repetition rate used for metering intercontinental calls.

In countries where the unit is approved, the new telephone with integrated rate indicator can be connected to any subscriber line as long as the line impedance does not exceed the limits specified for local networks. ●

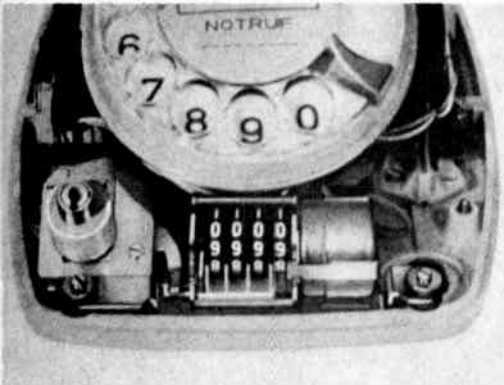

Left: Fig. 2. Rate indicator mounted on circuit board of telephone.

Below: Fig. 3. Connection diagram of rate indicator.

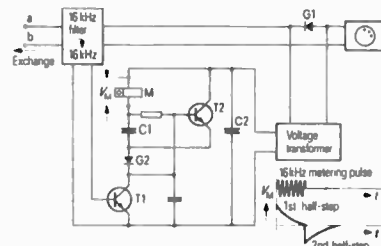

UNITED TRADE SALES P/L

280 LONSDALE STREET,
MELBOURNE, 3000
PHONE 663-3815 (Opposite Myers)

STEREO JACKS Suit PMG type plug 35c each P/P 15c
ELECTROLYTIC CAPACITORS Pack of 10 comprising 640 μ F 16 V, 500 μ F 25 V, 250 μ F 15 V, 47 μ F 350 V, \$3.50 P/P 40c
CASSETTE TAPE HEADS Mono 1/2 track \$1.50 ea. P/P 15c.
CARBON POTS Pack of 10 assorted single and dual with long shafts \$3.50 pk. P/P 40c.
CRYSTAL FILTERS. 10.7Mcs. 10 Kc. \$5.00 ea. P/P. 30 cents.
ROLA and M.S.P. SPEAKERS. 9" x 6" and 8" x 4" 15 ohms V.C. \$5.00 ea. P/P. 60 cents.
ROLA SPEAKERS. 5". 15 ohms V.C. \$4.50 ea. P/P. 50 cents.
COMPUTER BOARDS. Min. 10 Transistors plus 30 diodes, resistors and capacitors, all have long leads. \$1.75 ea. P/P. 40 cents.
SILICON DIODES. 100 P.I.V. 145 amp. \$4.50 ea. P/P. 40 cents.
COMPUTER FANS. 7" Diam. 120 V AC. Use two to run on 230 V. \$6.50 ea. P/P. \$1.00.
RCA. 8 TRACK 1/2" TAPE TRANSPORTS, complete with three 115V Motors \$125.00 ea. Freight forward.
CANNON 15 PIN Chassis Mount Socket and Lock on Plug. \$3.00 pr. 30 cents P/P.
RESISTORS. Carbon. 1/2 watt and 1 watt. Polypack of 100 mixed values. \$2.50 per pack. P/P. 30 cents.
CAPACITORS. 100 mixed values \$2.50 per pack. P/P. 30 cents.

LARGE STOCKS OF SURPLUS HAM RADIO PARTS AVAILABLE.

Wanted to buy - Test Equipment Transmitters ● Receivers

IN 3 WEEKS YOU PLAY GUITAR



Have fun, friendships with music. Play a
● GUITAR ● ELECTRIC
● GUITAR ● ORGAN ● DRUMS
● PIANO. Succeed quickly with this amazing "Learn-at-home" Method. It's alive with fast learning enjoyment. You quickly advance from beginner to popular player or pay nothing. Clip coupon now for FREE "Learn To Play" Details.

FREE BOOK COUPON

MELODY MUSIC MAKERS
405-411 Sussex Street,
Box 3689, G.P.O., Sydney, 2001.
(In N.Z. Box 2820, Auckland)

Please mail me this FREE Booklet

Name

Address

My favourite instrument is

LAFAYETTE GUARDIAN "6000" 6-Band

AM — Marine — FM — Aircraft — VHF — Portable Radio
With Radio Direction Finder

Rotatable Antenna for LW, AM and MB reception & Direction Finding

\$179-50

Including Sales Tax

Signal Strength Tuning/Battery Meter



Tunes 6 Bands

Squelch Control

BATTERY OR 240V AC OPERATION
(1) 180-380 KHz (2) 540-1600 KHz Broadcast (3) 1.6-4.0 MHz Marine (4) 88-108 MHz FM (5) 108-136 MHz Aircraft (6) 147-174 MHz FM VHF.
The Guardian "6000" is Lafayette's most advanced deluxe Portable Battery/Electric Radio for top reception plus Direction Finding.

LAFAYETTE ELECTRONICS 94 HIGH ST., ST. KILDA, VIC., 3182. Phone: 94 6036

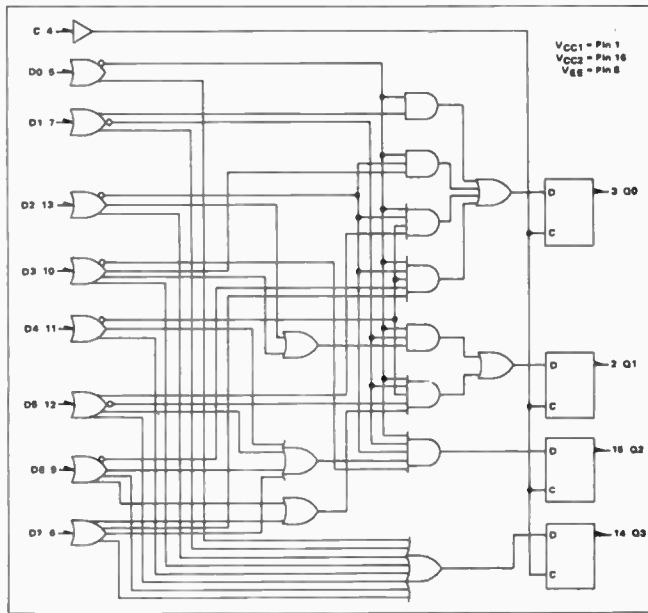

PRIORITY ENCODER

Another MSI (Medium Scale Integration) logic circuit has been announced for the MECL 10,000 logic family, by Motorola's Semiconductor Products Div., Phoenix, Arizona.

The circuit, designated MC10165, is an 8-Input Priority Encoder which operates with MECL 10,000 speed: typical propagation delay from data-input to coded-output is only 7 ns.

Priorities are assigned to each of the eight inputs by the logic circuit. In operation, an output code (3-bit binary) is produced - corresponding to the highest-priority input which is at a logic HIGH state. Simultaneous inputs of lower priority are ignored. A fourth output is HIGH whenever one or more inputs are HIGH.

Each of the four outputs incorporates a latch. This permits synchronous (clocked) operation of the encoder. When the clock is LOW, the encoder outputs follow the latch inputs. The outputs are stored in the latches when the clock goes HIGH.

The MC10165 Priority Encoder is designed for applications requiring a rapid "status report" on a system's operations. Areas of use include control processors, peripheral controllers, and logic testing systems.

Several MC10165s may be interconnected when more than eight inputs are needed. (Note: see attached data sheet.) The new circuit can also be used to develop binary codes from random logic outputs, for addressing ROMs and RAMs, or for multiplexing data.

The MC10165 is housed in a black ceramic 16-pin dual in-line package ("L" suffix to

part number).

Further details from Motorola Semiconductor Products Suite 204, Regent House, 37-43, Alexander Street, Crows Nest, NSW.

DUAL-IN-LINE RELAY

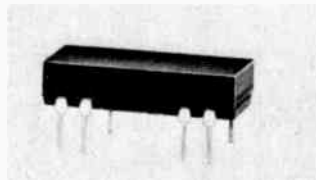

To meet the increasing demand for an inexpensive low level relay for normal IC mounting in dual-in-line packaging, Electrothermal have introduced their type GR 1441, single pole, low profile reed relay assembly for normally open or changeover switching functions. The relay operates from a 5 volt logic drive with a coil resistance of approx. 380 ohms and can switch 0.5 amps at 5 watts. Maximum height of the relay is 0.171 inches (4.32 mm).

Other types of reed relays are available to meet a very wide variety of switching functions.

Further details from NS Electronics Pty. Ltd., cnr. Stud Rd. and Mountain Highway, Bayswater, Vic 3153.

LEDs WITH BUILT-IN CURRENT-LIMITING RESISTORS

For the first time, a commercial light-emitting diode (LED) lamp is available with a current-limiting resistor chip built in with the LED chip. An external resistor is no longer necessary. These new lamps are no larger than the standard LED lamps without built-in resistors.

The new Hewlett-Packard "Resistor LED" is TTL compatible with a forward current of 16 milliamperes at 5 volts typical.

Two lamp sizes are available. The Model 5082-4860 is a standard, red-diffused, 0.200 inches in diameter (T-1 1/4 size) LED with long wire leads suitable for wire wrapping.

The Model 5082-4468 is a clear diffused, 0.125 inches in diameter (T-1 size) LED.

Luminous intensity (typical) of both lamps is 0.8 millicandelas at 5 volts. Wavelength of the light emitted is 655 nanometers.

The Model 5082-4860 can be panel mounted using a plastic mounting clip. It fits a 0.257 inch diameter hole in a 0.125 inch thick panel. Clips are available either clear or black.

Further details from Hewlett-Packard Australia Pty. Ltd., 22-26 Weir Street, Glen Iris, Vic.

THYRISTOR SUPPRESSORS

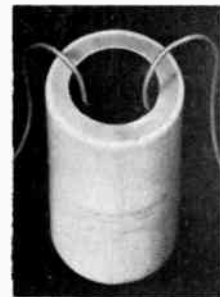

A new range of Contec suppressors, Type RCA, is introduced by Control Technology Ltd., Peacehaven, Sussex, as a "single component" solution to the dv/dt transient problems often encountered in thyristor equipment.

These heavy-duty suppressors are primarily intended for non-sinusoidal wave forms as occur in inverters.

Specified and designed on the basis of a 90° conduction sinusoid, the suppressors are available in a variety of values ranging from 0.1 to 2.0 mfd, and up to 4400 Vac. They are supplied complete with series and discharge resistors and are protected by rugged epoxy resin encapsulation.

Further details from Control Technology Ltd., Bolney Avenue, Peacehaven, BN9, 8HQ, England.

NOISE?

get the measure of DAWE

- with the Sound Level Meter type 1400G.
- Meets BS 3489 and IEC 123 standards.
- Highly stable ceramic microphone unaffected by temperature and humidity.
- Measures sound levels from 24dB to 140dB.
- Compact and portable—weighs 2¾lb.
- Filters available for every purpose—Dawe types 1461, 1462, 1463, 1464, 1465.

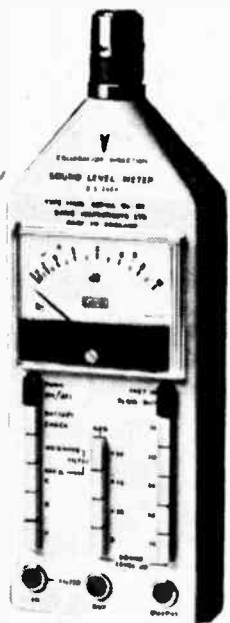

TECNICO ELECTRONICS



Premier Street, Marrickville, N.S.W. 2204. Tel. 55 0411
2 High Street, Northcote, Vic. 3070. Tel. 489 9322
Adelaide: 67 2246. Perth: 25 5722.

T8238/313



VICTORIAN DISTRIBUTOR FOR MAGNAVOX LOUDSPEAKERS

Complete speaker boxes and full range of speakers. Magnificent units for the music lover at unequalled prices.

The TVT 20
1 - 12" Woofer, 1 - 5" Mid-range,
1 - 3" Tweeter

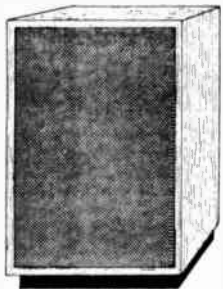
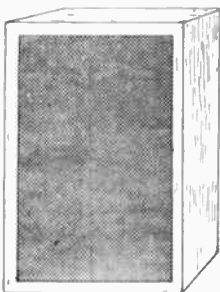

The TVT 10 This system has been especially designed for maximum performance, space saving, low cost. 1 - 8WR twin cone wide range, 1 - 3TC Tweeter. Complete range available through most wholesalers.

All completely wired with crossover and phased external connectors in large vented enclosures.

Available in Teak and Walnut.



TV TUNER SERVICE P/L.
469 ST. GEORGES ROAD,
THORNBURY, VICTORIA 3071
TELEPHONE 44-6179

TDK re-invents tape

TDK Super Dynamic (SD) Cassettes record the full range of music without missing a note or skipping a beat. Make even low-priced recorders sound great!

When we set out to make a cassette tape as true to sound as the most expensive reel tape we found we had to re-invent cassette technology. The result is TDK Super Dynamic (SD) Cassette Tape and the only combination that meets the most critical professional standards and actually improves the performance of your cassette recorder. There's nothing else like it!

Look at these TDK exclusives

Superfine tape coating for super dynamic sound

8 times as many magnetic particles as conventional tape. Superfine Gamma Ferric Oxide particles for better signal-to-noise ratio and much wider dynamic range without distortion.



Micropolished surface for better frequency response

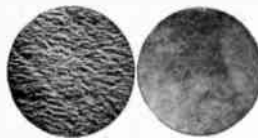

TDK particles are densely and uniformly packed into the tape coating. Mirror-smooth lubricated surface means less wear on the recorder head.

Good enough for high-speed computers

The thickness of the binder and oxide coating is controlled to within 4 hundred thousandths of an inch. No chance of signal dropouts because the coating is constantly in contact with the recorder head.

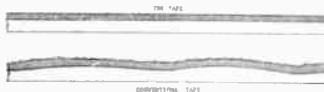

Tape rolls true, won't ride up and down

Only TDK SD tapes have a tapered flange and a stainless steel pin, (instead of plastic) for perfect head-to-head alignment.

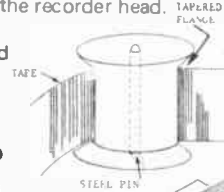

Unique TDK clamp grips at two points instead of one

Tape won't loosen or break under stress. Precision hubs reduce friction, — keep the wind steady and even.

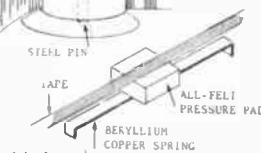
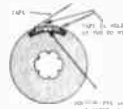

Uniform tape-to-head contact at all times

TDK CASSETTES have more than 20 precision parts to ensure peak performance even after years of use. Conventional cassettes have fewer than 10 parts.

High quality beryllium copper spring holds its tension permanently. Durable all-felt pad won't twist or yield under stress.

Don't ask for tape. Ask for TDK. If your dealer doesn't have it, phone us. We'll tell you who does.



TDK SD CASSETTES

available in C-60, C-90 and C-120 sizes. Also the remarkable value TDK Low-Noise Cassettes. C-30 from about \$1.49 and C60-C90. Also TDK SD and Low-Noise in reels.

Australian Agents: CONVOY IMPORTS

Cnr. Plunkett and Maclean Sts., Woolloomooloo, Sydney, N.S.W. 2011
phone (02) 357 2444.

CURIESTEST – QUANTITATIVE DETERMINATION OF RADIO-PHARMACEUTICALS

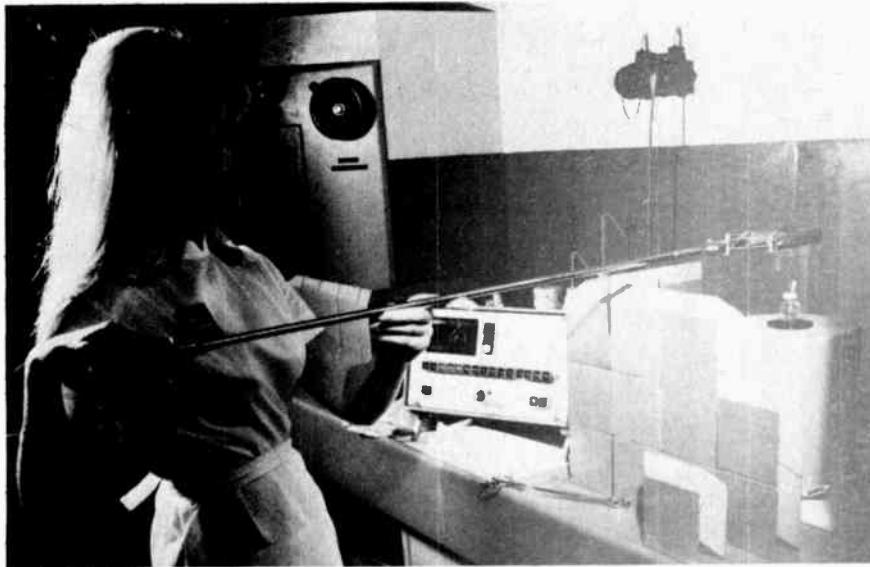

When handling radioactive preparations for diagnostic and therapeutic purposes it is essential to measure and check the activity with suitable instruments. The Curimeter developed by Siemens is particularly suitable for quantitative determination of the activity of radio-pharmaceuticals. This measuring instrument, called Curiestest, serves for rapid and exact determination of the activity in the units μCi and mCi up to a maximum measuring range of 100 mCi , particularly in nuclear-medical laboratories. The instrument consists of an ionization chamber and measuring electronics.

With the Curiestest the preparations can be measured directly in the required quantities; reliable results are available very quickly. These exact results are far more accurate than those obtained by the arithmetical method in accordance with quantity by volume. For measuring the activity the ionizing effect of nuclear radiation on a gas is employed. In an ionization chamber filled with argon, charge-carrier pairs are formed so that a current flows when a potential difference is applied between the outer sheath and internal electrode. This mean chamber current is a measure of the emissive power and, since the gas pressure, gas volume and electrical potential remain constant, is used for direct digital display of the activity.

With the Curiestest the ionization chamber and the measuring electronics are separate from each other and are connected by means of a coaxial cable. This arrangement permits the setting up of the ionization chamber behind a lead castle, whilst the measuring electronics is freely accessible outside. For rapid selection of the

radio-nuclide to be measured, 14 pushbuttons are available on the measuring electronics along with a pushbutton for "free selection". The measuring process is started with a starting button and runs automatically, beginning in the $>\text{Ci}$ measuring range and switching over to the mCi range automatically with higher values. The results are displayed digitally.

Further details from Siemens Aktiengesellschaft, ZI/Presseabteilung Technik Joachim Ullmann, D-8520 Erlangen 2, Postfach 325, Federal Republic of Germany.

STABLE, LOW-COST TEMPERATURE STANDARD

A simple type of temperature standard, which functions with an accuracy of ± 0.05 between $-30^\circ\text{C} = 243\text{ K}$ and $+60^\circ\text{C} = 333\text{ K}$, has been designed in the Siemens research laboratories. A single-crystal of vanadium dioxide is used as temperature probe which is thermally coupled with a transistor acting as a controllable heat source. Vanadium dioxide is a semiconductor, an anomaly of which is that its temperature-dependent conductivity shows a sudden resistance change of almost 10^5 at exactly 65.5°C . Below this change-over temperature vanadium dioxide is highly resistive and behaves like a semiconductor. Above this temperature it becomes low resistive and conducts like a metal. This effect is made use of in a simple circuit to stabilize the transistor to the changeover temperature with a high degree of accuracy.

The latest model is designed for an

operating voltage of between 8 and 15 V and a power consumption of 500 mW at -30°C . The quality factor of the thermostat – this is the ratio of the ambient temperature change to the maximum temperature deviation – is far higher than that of simple thermostats which function on the basis of doped barium-titanate semiconductor ceramic.

Siemens are making preparations at the present time for mass production.

Further details from Siemens Aktiengesellschaft, Presseabteilung, Joachim Ullmann, D-8520 Erlangen 2, Postfach 325, Federal Republic of Germany.

EKG RECORDER PRINTS NUMERIC DATE IN MARGIN CHART

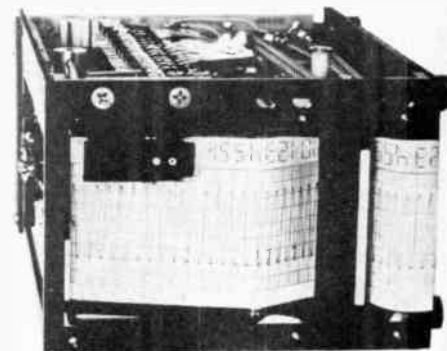

The Techni-Rite TMD-25 ID OEM recorder building block provides simultaneous printing of analog and numeric data on the strip chart via thermal means. For example, it can continuously record EKG data at 25 mm/second while at the same time printing numeric information about the patient.

Primarily used for monitoring intensive care patients, the TMD-25 ID can be programmed to print out such vital patient information as patient I.D., time, date, heart rate, blood pressure, respiration rate, temperature, weight, etc.

The recorder is connected to the monitoring equipment of one or more patients in intensive care. When an alarm condition occurs, such as the change in heartbeat of a patient, the recorder immediately actuates – recording the patient's EKG, I.D. number, time and date at which the change in condition occurred. Although the recorder is usually actuated by an alarm condition, it can be actuated on command by a nurse or doctor wishing to check a particular patient's condition.

The analog information is recorded using a heated stylus, and the numeric information is printed via an exclusive Recorder Systems

OTARI

SERIES MX 5500

Compact Professional Tape Deck



The Otari MX-5500 comes from a long line of industry-accepted high-speed tape duplicating systems and is designed for the fastidious audiophile. Three motor system mounted on heavy Aluminium Die Cast Frame. The capstan is operated by a 2 speed Hysteresis Synchronous Motor. Amplifier has a three-stage directly connected IC, in addition, extra circuits such as Sound on Sound, Echo and Auto-Reverse as well as Bias change-over are provided. The MX-5500 compact professional tape deck will satisfy the most exacting user.

SPECIFICATIONS

Tape Width: 1/4 inch
Tape Speed: 3 3/4 and 7 1/2 I.P.S.
Reel Capacity: 7 inch
Tape Heads: 4 heads, 4 track 2 channel Erase, Record, Playback and Reverse Playback
Speed Deviation: Less than ±0.4%
Wow & Flutter: Less than 0.08% W. Rms at 7 1/2 I.P.S.
..... Less than 0.12% W. Rms at 3 3/4 I.P.S.
Capstan: 2 Speed Hysteresis Synchronous Motor
Spooling: 2 High Torque Spooling Motors

Input Level: Mic. Input - 55 dB unbalanced 50 K ohm;
..... Line Input - 20 dB unbalanced 100 K ohm
Output Level: Line Output +4 dB (OVu) unbalanced
..... 100 ohms - Monitor Output 70 mV (OVu)
..... 8 ohms headphone (0 db = 0.775V)
Frequency Response: 7 1/2 I.P.S. ±2dB 40 - 20 KHz -
..... 3 3/4 I.P.S. ±3 dB 50 - 12 KHz
Signal/Noise Ratio: -60 dB below peak level (+12 dB)
Distortion: 1% at standard reference level
Cross Talk: 50 dB at 1kHz.



Please phone or write for brochures giving full specifications.

Interstate distributor enquiries invited

W.A. AGENT: Severin Distributors, G.P.O. Box E3002, Perth. 6001.

KLARION ENTERPRISES PROPRIETARY LIMITED

Regent House, 63 Kingsway, South Melbourne, 3205, Australia. Phone 61-3801 Cables Klaronmelb

A unique invitation to enjoy sound satisfaction

the Convoy Technocentre

PASSES ON \$\$\$ REVALUATION SAVINGS NOW!

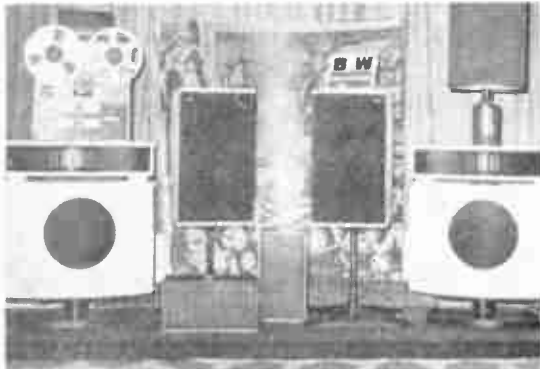

ONLY AVAILABLE FROM

Convoy Technocentre

EASY TERMS

OPEN ALL DAY SATURDAY FREE CUSTOMER PARKING AT DOOR

B & W Electrostatic MONITOR SPEAKERS

described by music critics "... perfection"

Only a few pairs of these superb British B & W Model 70 Electrostatic Speakers have just arrived and are not already sold. At the new reduced SA revaluation price of \$985 a pair they are being eagerly sought after. You must hear them to believe such sound is possible (teak, walnut, white).

B & W DM 2 Monitor Speakers

Just arrived, these speakers are smaller and less expensive than the DM 70s - also reduced in price, \$498 pair. They have a tonal response like the Electrostatics. The DM 2s are the first of a new generation of speakers using 8th wave acoustic line (a folded tapered pipe) and Butterworth 3rd order Cross-over; in all a small cabinet. (teak, walnut, white)

McIntosh Amplifiers from U.S.A.

The world's best, with exclusive polyfilar transformer output. You must see and hear these unique amplifiers, also at new reduced prices from U.S. Dollar Devaluation.

THE WHITE BUILDING AT THE
END OF PLUNKETT STREET
WOOLLOOMOOLOO 357-2444

Ever thought about efficiency?

You buy a twenty watt amplifier and go looking for a pair of speakers. You choose a pair that sound fine in the showroom but disappointing at home. Could be that they are low efficiency speakers and your twenty watt amplifier is overloading and distorting on the loud bits. So you trade your twenty watt amplifier for a forty watt job . . . and you blow your speakers. You're caught between the devil and the deep blue sea.

Unless of course you buy Rectilinear . . . The high efficiency loudspeakers that flatter your amplifier because they don't make it work so hard.

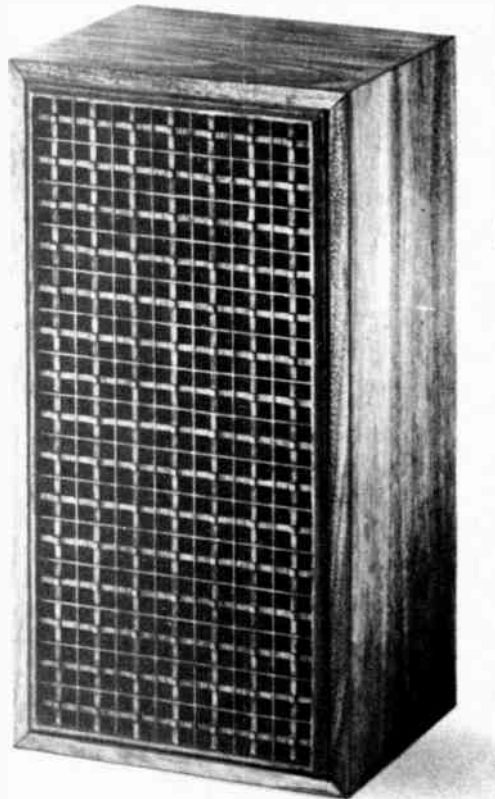

Put 10 watts in and they sound fine. Put 40 watts in and they sound fine. Put 100 watts into the big ones and they still sound fine. For once you're free of the low efficiency devil, and the low-power-handling deep blue sea.

Investigate Rectilinear—the problem solver.

Solve the money problem too—they start at \$139.

(that's the \$139 model XI above)

SOLE AUSTRALIAN DISTRIBUTORS

Leroya Industries PTY. LTD.

266 Hay St., Subiaco, Western Australia. 6008

VIC. Douglas Trading Co.,
191 Bourke St.,
Melbourne, 3000.

QLD. Brisbane Agencies,
72 Wickham Street,
Fortitude Valley, Qld. 4006

N.S.W. Sydney Hi-Fi Centre,
83 York St.,
Sydney, N.S.W. 2000.

S.A. Sound Spectrum,
33 Regents Arcade,
Adelaide, S.A. 5000

thermal printing process. In fact, the printing of the numeric display requires no moving parts – a design concept that provides high reliability and minimal maintenance.

For short intervals (2 to 5 seconds) the print head can print numeric data at a 4 to 5 character/second rate. The print head can print continuously at a 1 character/second rate.

The recorder has an anti-jamming chart drive, and the front end is a single aluminium casting. A coaxial stylus is utilized which dramatically extends operating life.

Further details from D.C. Electronics Pty. Ltd., 32 Smith Street, Collingwood, Vic. 3066.

MODEL 34750A 5½ DIGIT DISPLAY MODULE



Using the same snap-on packaging as the previously introduced modules of the 3470 Measurement System, this new low cost display will lock on to any centre section or voltmeter module to make a complete DVM. In combination with the HP Model 34701A DC Voltmeter plug-on, the unit forms a 5½ digit DVM capable of measurements from 1 volt to 1000 volts, with an accuracy of 0.025% of reading.

Combining the 34750A with the Model 34702A Multimeter module makes a complete 5½ digit ac, dc and ohms multimeter. The new display can be coupled with the new Model 34703A DC/DCA/Ohmmeter for a 5½ digit high sensitivity multimeter with fast autoranging and self test.

This new snap-on can be used with either the Model 34740A 4½ digit display or the new 34750A 5½ digit display. The basic sensitivity of the Model 34703A is 1-V on dc voltage. When using this module with the Model 34750A 5½ digit display, five full digits of resolution are provided on the 100 mV range and above. Likewise, the combination has five-digit resolution on the 10 ohm range and above. All current ranges have four full digits of resolution. Overranging of 100% is provided on all functions and ranges except 1000 volts and 10 megohms. On these, 20% overranging is provided. Besides higher sensitivity, autoranging faster than 250 milliseconds and self test are new features added to the 2470 Measurement System.

Six dc voltage ranges from 10 mV to 1000 volts full scale, six dc current ranges from 1 µA to 100 mA full scale, and eight resistance ranges from 1 ohm to 10

megohms full scale are provided, with full autoranging and overranging. DC voltage and resistance measurement accuracies vary with range, but are better than 0.04% of reading. DC current accuracy is 0.035% of reading on the highest range.

In the self-test mode, sixteen different tests will check the internal circuitry of the Model 34703A. These tests verify proper operation, and can be used for trouble shooting.

With the addition of the two new modules, the HP 3470 Measuring System now has a total of six different combinations. Each of these can be converted to battery operation using the Model 34720A Battery Pack that fits as the centre section between the modules. Another section, the Model 34721 BCD Module provides non-isolated BCD output for operation with printers.

Further details from Hewlett-Packard Australia Pty. Ltd., 22-26 Weir Street, Glen Iris, Vic, 3146.

VERSATILE DOCUMENT SCANNER

Claimed to be the most versatile page and document reading systems available, the Scan-Data range can make the difference between what your computer does and what it can do.

They can read typed, printed, and even hand printed data, from pages and documents of varying sizes, without retyping – without keyboarding – without verifying. They convert to computer input, edit, and record on magnetic tape.

Typically, a paper feed of 12 inches per second combines with a scan rate of 800 characters per second. The characters are dissected into 1200 separate elements and analysed for more than 400 specific features in the recognition process. Error rate is stated to be less than one in 50 000 characters.

Further details from DC Datagraphix, 32 Smith Street, Collingwood, Vic. 3066.

NOVEL NON-CONTACT MEASUREMENT

An electronic measuring system, developed in the UKAEA's Reactor Development Laboratories, Windscale, has solved many of the problems of making measurements remotely or at high temperature.

The system is based on the accurate measurement of the variation in electrical charge movement between two sets of plates. The refined electronic circuit incorporates compensatory devices which permit changes of 10^{-6} picofarads to be measured at the ends of cables up to 50 metres in length. This technique has been applied to displacement (the basic parameter in most engineering measurement), pressure, differential pressure, fluid flow and transient detection, level determination, intruder detection and other 'quantities'.

The measuring system was developed initially for use in the fluid flow and vibration rigs because of a total lack of non-contacting displacement measuring equipment suitable for remote (long lead) applications at temperatures up to 350°C.

Extension of the useful temperature range

Now it's the turn of the silent runner.

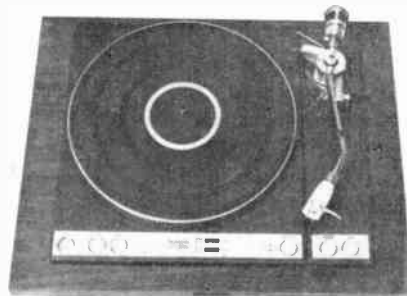

Now it's time for Pioneer's new turntable. The PL61. A piece of 'machinery' good enough for the professional studio, operated by a servo-controlled slow running "Hall-effect" motor and special polyurethane belt. A turntable that runs steady and without noise, and can be adjusted $\pm 2\%$. See it. Now it's time for the silent runner... if you're ready.

Motor: Brushless DC servo "Hall-effect" motor. Wow and Flutter: Less than 0.05% (WRMS). Signal to Noise Ratio: Better than 55dB. Cartridge: Induced magnet PC-50. Frequency Response: 10 to 25,000 Hz.

PIONEER

High Fidelity stereo
That's how perfection sounds.

AS-189-V

THE OLD MIXER



NOW THE NEW E.T.I.
414 MASTER MIXER

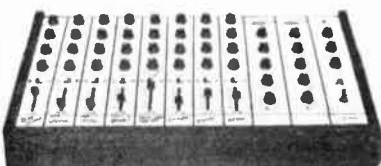

AVAILABLE NOW
IN A JAYCAR KIT

Complete kit of parts \$188.00 p&p \$2;
Kit of parts less national semis \$153.00
p&p \$2
Kit of parts for onemixer/equalizer
\$19.10 20c p&p (including semis)
Parts for pre amp and to ne controls for
two channels \$21.00 p&p 20c
including semis
Parts for power supply board including
semis \$26.25 p&p 20c
Metal work \$9.90 p&p \$1
Front panels \$3.40 p&p 20c
Timber case \$6.75 p&p \$1
All coils prewound
Kit wired and tested \$30 extra.

jaycar

PTY. LTD.

Telephone 211-5077
P.O. BOX K39, HAYMARKET
N.S.W. AUSTRALIA 2000

of the system to about 800°C is readily attained using mineral insulated cables. The high temperature use has been demonstrated particularly with a small differential pressure transducer about 30 mm square by 80 mm long. A wide spread of pressure ranges may be obtained dependent upon transducer design.

In measuring the relative displacement of two bodies, two sensing heads are normally used, giving a very sensitive linear output; for example, a pair of heads about 25 mm square can resolve changes of position of 0.0025 mm for an initial clearance of 25 mm.

The detection of transient flow changes is a very promising application, where the sensor, although in effect a drag-producing device, offers only a very low resistance to flow. In a typical case, the resistance will be only 25% of the local dynamic head.

Further details from Mr. J. A. Robson, U.K.A.E.A., Reactor Development Laboratory, Windscale Works, Sellafield, Seascale, Cumberland, CA20 1PF.

INSTRUMENT MONITORS DUST EMISSION FROM INDUSTRIAL PLANT

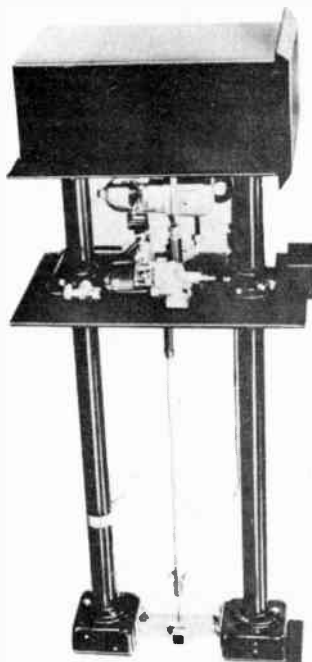

The Foster-Cambridge Dust monitor provides an accurate factual record of the emission of all sizes of grit and smuts from an industrial plant and makes possible effective monitoring and control of this type of pollution.

The flue gases from all coal burning furnaces, and to a lesser extent, all oil burning furnaces, carry considerable quantities of ash or soot and it is now mandatory to install dust collection plants on many installations. It is therefore necessary to have an effective means of monitoring the ash omitted from the dust collection plant in order to maintain and to avoid complaints from the neighbourhood of the plant.

Dust has a wide range of particle sizes ranging from at least 1µm to 100µm. The fine dust in the range below 10µm is largely responsible for the visibility of the plume and can be monitored by existing instruments which record the optical density of the flue gases. Coarse dust in the range from 10µm upwards is not monitored by these instruments and has no very marked effect on plume visibility, but is entirely responsible for the settlement of dust on objects at ground level and is the main cause of complaints of dust pollution.

The Foster Cambridge dust monitor was developed by the Central Electricity Research Laboratories to monitor the omission of coarse dust and is now in service in many power stations and industrial plants. It consists of a sampling unit, the nozzle of which is pointed into the flue gases to take a representative sample of the coarser particles. These particles are allowed to build up in the sampling unit for a period which is normally 15 minutes duration and the amount of build-up is measured photo-electrically. After the pre-set time the accumulated particles are blown away by a short blast of compressed air, after which the output returns to zero for another operating cycle to commence. Since the unit may not always be completely cleaned by the compressed air it is automatically wiped mechanically every 24 hours.

The Foster Cambridge dust monitor has been found to be more useful for checking the performance of electro-static precipitators than conventional smoke density meters because it responds better to the larger particles emitted. The manufacturer claims the instrument is the only one of its type offering this advantage.

Further details from Kent Instruments (Australia) Pty. Limited, P.O. Box 333, Caringbah, NSW, 2229.

UNIVERSAL BRIDGE FOR RESISTANCE, CAPACITANCE AND INDUCTANCE MEASUREMENTS

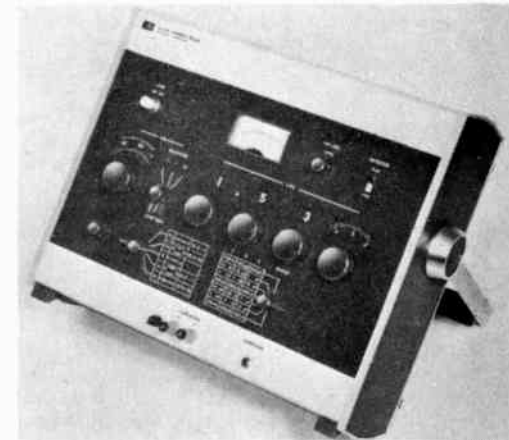

Using an ac bridge technique, this new Hewlett-Packard Model 4265A Universal Bridge measures L, C and R at 1 kHz to an accuracy of 0.2% of reading. Dissipation factor (D) and Quality factor (Q) are also measured. Results are read on a four-digit, easy-to-read, in-line display.

Large knobs appropriately spaced make the bridge easy to operate. A rugged handle doubles as a tilt stand so that the front

panel can be set to an angle of either 40 or 60 degrees.

Inductance is measured from 0.1 μ H to 1111H and capacitance is measured from 0.1 pF to 1111 μ F, both in seven ranges. Seven ranges of resistance measurements cover from 0.1 milliohms to 1.111 megohms. Q, measured at 1 kHz for series L or parallel C, is from 1 to 10. D, for parallel L or series C, is from 1 to 10. D, for parallel L or series C, is from 0.001 to 1. Both are measured to an accuracy of 5%.

With an external oscillator, the measurement frequency range can be extended from 50 Hz to 10 kHz. An external dc power supply and a null detector can be used for dc resistance measurements of inductors and capacitors.

Further details from Hewlett-Packard Australia Pty. Ltd. 22-26 Weir Street, Glen Iris, Vic. 3146.

LOW-COST FUNCTION GENERATOR



A new low priced function generator has sine, square, triangle and positive pulse outputs as well as a number of other features not generally found in low-cost instruments. The new Hewlett-Packard Model 3311A Function Generator has a separate TTL compatible pulse output that provides current sinking for up to 20 TTL loads. With a better than 25 nanosecond rise time, the pulses are useful for clocking logic breadboards, or as synchronisation signals.

In addition, an external voltage-controlled oscillator (VCO) input is provided for phase-locked loop and swept-frequency applications. With the frequency dial set at 1, a linear ramp of 0.0 to -10 volts will linearly increase frequency greater than 10 to 1. An ac voltage can be used to frequency modulate the function generator.

Output of the Model 3311A is 10 volts peak-to-peak into 600 ohms for sine, square and triangle waveforms. A continuously variable attenuator adjusts output over a greater than 30 dB range.

Complete dc isolation between the instrument case and earth reduces earthing problems and loops. Outputs may be floated to \pm 500 volts relative to earth.

Seven decades of frequency from 0.1 Hz to 1 MHz are selected by pushbuttons. Functions are also pushbutton selectable.

Dial accuracy is \pm 5% of full scale. Sine wave amplitude flatness is within \pm 3% of 10 kHz reference (maximum output amplitude) to 100 kHz, \pm 6% at MHz. Sine wave total

Most popular Kits from KITSETS

ELECTRONICS TODAY

Sound operated flash	\$9.35
Audio Signal Generator	\$30.50
Vari-Wiper	\$8.00
Car Theft Alarm	\$21.00
One Transistor Radio	\$7.50
Decade Resistance Box	\$19.00
Photo Enlarger Timer	\$19.00
Digital Frequency Meter	\$74.50

All Kits complete with metal work.
Postage for each above item — \$1.00.
Registered Postage for each above item — \$1.50

PLAYMASTER 132 KIT SET

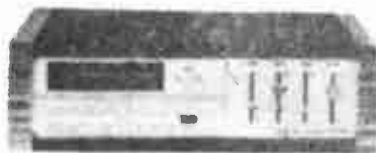

45W. RMS per channel. Complete kit as per parts list includes Tuner, Push-Button switching, 4 inputs, Reg. Power Supply with overload protection. Oiled Teak cabinet ready made. All parts new and guaranteed. See June/July 71 EA for all details.

KIT PRICE: \$146.00 Reg. Post \$2.00

PLESSEY

Ducon



STEREO AMP KIT

Also ideal for rear channel quadrasonic sound.

Beautifully presented, this simple "do-it-yourself" project for a 3 W. R.M.S. Stereo Amp. Module comes complete with all parts and instructions. As distributors for this line, we offer a special price.

special price as described February '73 e.a.

PRICE \$27.50 Post 75c

DOOR MONITOR ET1518

We now have this useful unit available as published in E.T. April. Ideal for the small shopkeeper etc., can be useful for level control and detection of moving objects on production lines. Kit includes lenses and box etc. COMPLETE KIT — \$18.55. Postage \$1.50.

Special Sansui AU-101

Few Amps. regardless of price give O/A test results as good as the AU-101. Superbly engineered with sparkling performance. 30 watts RMS. 20-60,000Hz \pm 2dB. Special Price \$129.00 reg. post \$2.00



HI FI SPEAKER SYSTEM

Especially selected compact book shelf, 2 speaker two-way system featuring large magnet 6" base speaker together with high efficiency tweeter. Incorporates C60 Plessey woofer and C3 GX Plessey tweeter with cross-over in peak enclosure 17" x 10 1/2" x 8 1/4" deep. Frequency response 50Hz-20kHz, Handling power 10 watts. Ideal for rear channel quadrasonic sound, this system blends beautifully with the 3+3 stereo amplifier. Budget priced without compromise in performance. Extra special price assembled \$39.00 per box. In kit form \$31.00 per box, registered post \$2.00.

ET414A MASTER MIXER

ETI Feb/March/April '72.

A high performance 8 input mixer with inbuilt equalizers, echo facilities, monitor output available, as well as mono or stereo outputs from mixer. We can supply all as a complete kit or in sections as follows:—

Kit 1 Pre-amp and tone control section. \$16.75. (As per list March less Semiconductors).

Kit 2 Mixer Equalizer Section \$16.10. (As per list March less Semiconductors).

Kit 3 All parts required for Power supply and output Amplifiers complete with meters. (As per list April less Semiconductors). Price \$28.50.

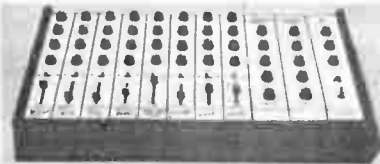

Kit 4 complete pack of semiconductors \$35.00 Labels 11 required \$2.40 ea. Backing Plate/chassis with brackets — \$13.00. Wooden Cabinet (Ready Built) \$10.50 Complete kit only \$205.00 reg. post \$5.00.

kitsets aust. pty. ltd.

NATIONAL MAIL ORDER DEPT.

P.O. BOX 176, DEE WHY, N.S.W. 2099.

SYDNEY SALES DEPT:

400 Kent Street, Sydney. Phone 29-1005

NORTHSIDE SALES DEPT:

2/21 Oaks Avenue, Dee Why. PHONE: 982-7500.

BRISBANE SALES DEPT:

293 St. Paul's Terrace, Fortitude Valley.

PHONE: 52-8391.

MELBOURNE SALES DEPT:

271 Bridge Rd., Richmond. Phone 42-4651.

CANBERRA DISTRIBUTOR:

Electro Pak, 5 Gareema Arcade.

NEWCASTLE DISTRIBUTOR:

Varcoe Bennett, 2 Third Avenue, Lambton North.

24 HOUR PHONE SERVICE: Sydney 982-7500 (Area Code 02)

Phone the above number ANY time, ANY day to receive prompt P.M.G./C.O.D. mail service. Your requirements are as close as your phone.

ALKALINE BATTERIES AUSTRALIA PTY. LTD.

Head Office: 165 Penshurst Street, Beverly Hills, N.S.W. 2209
 Telegraphic Address: ALKABAT/Sydney.
 Telephone: 579-6944

SUPPLIERS OF BATTERIES FOR THE ELECTRONICS INDUSTRY



Fully Sealed Lead Acid Batteries

The NOYPER battery is light in weight, compact in size and is maintenance free (except for recharging). Has a long service life, is leak proof, explosion proof and can be operated in any position, but must be recharged in the vertical position with a specially designed Clyde

Noyer Battery Charger. The batteries are suitable for a wide variety of electronic equipment such as two-way radios — transmitters and receivers, emergency lighting, security and fire alarm systems, portable TV video recorders and measuring equipment. They are available in 6 or 12 volt with capacities ranging from 1 ampere hour to 8 ampere hour at the 10 hour rate.

Alkaline Batteries Aust. Pty. Ltd.,
 21 Stewart Avenue,
 NORTHFIELD S.A. 5085.
 PHONE: 082 62-3552

Alkaline Batteries Aust. Pty. Ltd.,
 2 Dora Street,
 HENDRA QLD. 4001.
 PHONE: 072 62-1536

Alkaline Batteries Aust. Pty. Ltd.,
 Suite 9 Eton Square,
 476 St. Kilda Road,
 MELBOURNE VIC. 3000.
 PHONE: 03 26-1705

Alkaline Batteries Aust. Pty. Ltd.,
 294A Hay Street,
 SUBIACO W.A. 6008.
 PHONE: 81-1561



Nickel Cadmium rechargeable batteries

The ULTNICA range of batteries are all hermetically sealed, which guards against leakage. They can be used in temperatures as low as -20 C. and are completely shockproof. Suitable for usage in electronic equipment and communication equipment and electrical tools.

For More Information, Contact:—

ALKALINE BATTERIES AUST. PTY. LTD. TELEPHONE 579-6944

ZEPHYR RECOMMENDS THESE ELECTRET CONDENSOR MICROPHONES

- * ATTRACTIVE APPEARANCE * OUTSTANDING PERFORMANCE
- * EXCELLENT SIGNAL-TO-NOISE RATIO



EM-507
NON-DIRECTIONAL

Impedance : 600 OHMS
 Sensitivity : -70db (0.315MV)
 : ± 2.5db
 Freq. response : 50-15000 HZ
 Battery : 1.5.V (UM-3)

CMU-506
UNI-DIRECTIONAL

Impedance : 600 OHMS balanced
 Sensitivity : -72db ± 2db 1K HZ
 (0db = 1V/U BAR)
 Freq. response : 50-15000 HZ ± 3db
 Battery : H-7D/A9.1V

EM-4000
LAVALIER

Impedance : 1K
 Freq response : 100-10K HZ
 Battery : 1.5 VOLTS

MARKETED IN AUSTRALIA BY

ZEPHYR PRODUCTS PTY LTD

70 BATESFORD ROAD, CHADSTONE 3148, VICTORIA — PHONE: 56-7231

harmonic distortion at maximum output amplitude is less than 3%.

For triangle waveforms, deviation from the best straight line at 100Hz and maximum output is less than 1%. Square wave rise and fall times are less than 100 nanoseconds.

Pulse output amplitude is greater than 3 volts positive (open circuit) and is TTL compatible. Transition time is less than 25 nanoseconds.

The HP Model 3311A will operate on 100/120/220/240 volts, -10%, +5% and is switchable on the rear panel. Mains frequency range is from 48 to 440 Hz and power consumption is less than 12 VA.

Dimensions of the Model 3311A are: height, 3½ inches (89mm), width, 6¼ inches (160mm), depth, 9¼ inches (248mm). The instrument weighs 3½ lbs (1.5kg).

Further details from Hewlett-Packard, Australia Pty. Ltd., 22-26 Weir Street, Glen Iris, Vic. 3146.

NEW PROGRAMMABLE 520 MHz SYNTHESIZER

Schlumberger has unveiled its latest development in the field of synthesizers with the introduction of a new series of programmable instruments covering the spectrum of frequencies up to 520 MHz.

The 4000 series features a modular design allowing a wide choice of instruments ranging from the simple high precision remote controlled oscillator to the manual and programmable radio-telephone test set.

Resolution can be chosen by crystal controlled steps from 1 MHz to 0.1 Hz. Quartz stability is 5.10^{-9} /day and a thermal drift of 5.10^{-10} /°C is optional.

Four types of modulation can be built in:

- amplitude from 0 to 95%
- frequency from 0 to 19.9 kHz
- phase from 0.01 to 9.99 radians
- excursion from 100 Hz to 99.9 kHz

All these functions can be operated manually and programmed independently or simultaneously. An attenuator from 0 to 139.9 dB by 0.1 dB steps and an LF oscillator from 10 Hz to 20 kHz sine wave (0.01 Hz to 10 Hz triangular) can also be included.

Output levels are adjustable by steps of 0.1 dB from 1 V to 100 nV and the level remains constant within 0.1 dB from 300 Hz to 520 Hz. Phase noise is less than 120 dB/Hz at 10 kHz from carrier. Frequency switching time is less than 100 ms (1 ms optional) over the whole spectrum.

The 4000 is packaged in a 19" cabinet. All functions are controlled either from the front panel by push buttons or from the rear. The instrument is also available with a blank front panel for integration in automatic systems. As an option, a remote control box for all functions can be supplied. Mobile operation of the 4000 has been provided for and the instrument can operate from a 24 V power source such as a battery.

Specially designed for telecommunication measurements, the 4000 application fields include: frequency standard, control of filters and test of transceivers.

Further details from Schlumberger Instrumentation Pty. Ltd., P.O. Box 138, Kew, Vic. 3101.

ILLUMINATED FIBRE PRODUCTS

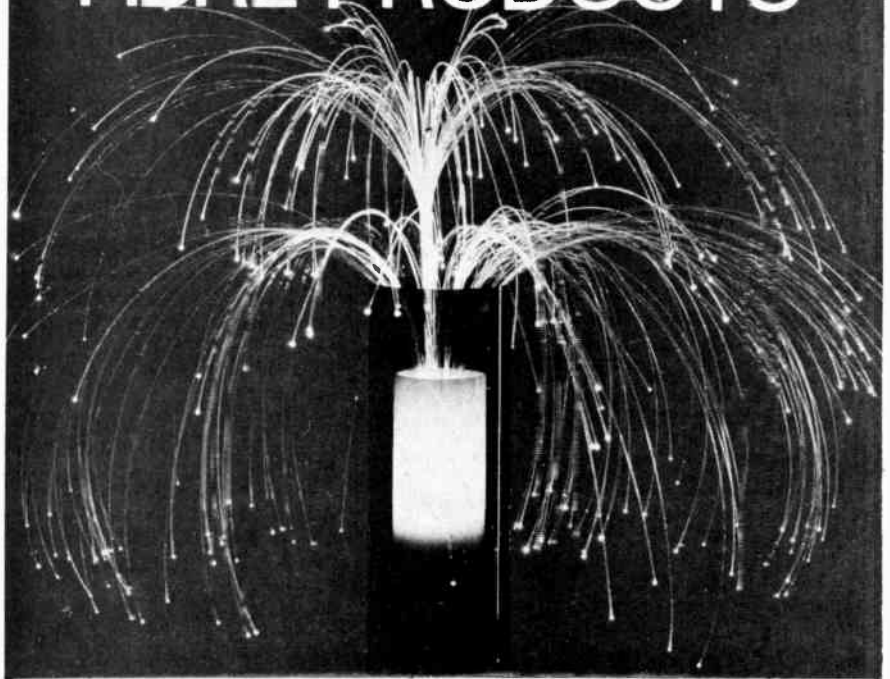

The amazingly sensational FIBRE OPTICAL LIGHTS that are sweeping the world with its beautiful soft lighting effects from hundreds of illuminated fibres, is now manufactured by ILLUMINATED FIBRE PRODUCTS a division of KIMBERLEY PLASTICS PTY. LTD. MELBOURNE.

Used as a table centre or T.V. lamp, you will be the envy of all your friends, as they gaze in amazement as you explain the Space Age Discovery of transmitting light by fibre optics. The colour of illumination of your OPTICAL FIBRE LAMP may be changed in SECONDS to suit the mood of your room decor, simply by placing a small piece of coloured transparent wrapping plastic film over the fibre socket. MODEL K.I.F.P. SERIES has been approved by the Electrical Approvals Board. \$27.95 Suggested Retail Price includes Sales Tax and freight within Australia. S.E.C. Approval No: V/C5JKIFP/1

NEW RELEASE

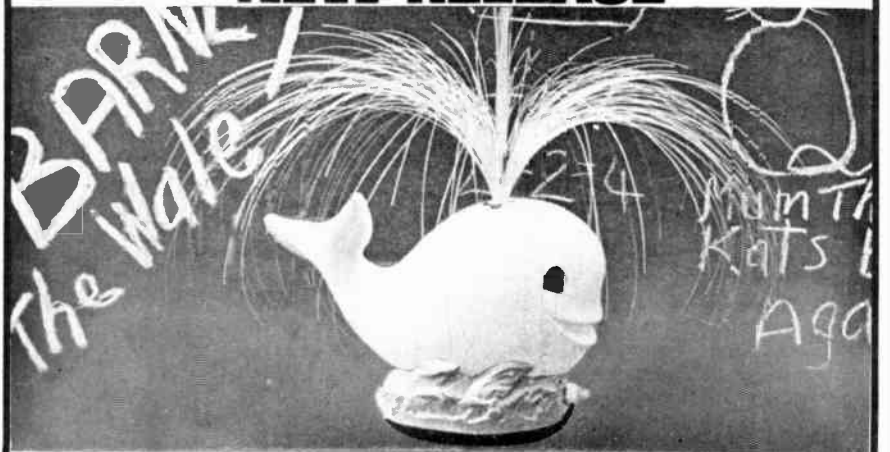

"BARNEY" THE WHALE

He spurts fibre optic light and his eyes light up. A fascinating children's night light. Available at all major retail stores, electrical and gift shops. Interstate trade enquiries invited.

DISTRIBUTORS

RADIO PARTS GROUP
562 Spencer Street, West Melbourne,
Victoria. 3003 Phone 30-1251, 239-7888

ACE PLASTICS (AUST.) PTY. LTD.
29 Hayward Street, Stafford, Brisbane
Phone 56-3041, 56-8044

KIMBERLEY SALES PTY. LTD.

58 ALEX AVENUE, MOORABBIN, VICTORIA. 3189
PHONE 95-6733 CABLES: KIMPLAS-MELB

The AR-6 speaker system from Acoustic Research.

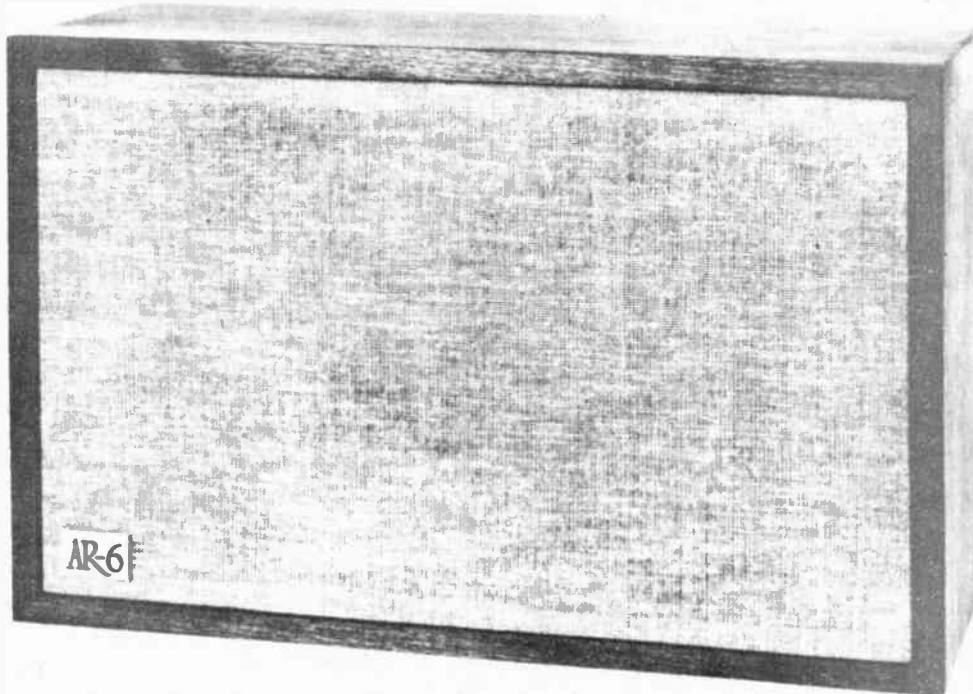

The least expensive speaker sold by AR (the AR-4x at \$132) is also the most widely sold of all high-fidelity speakers, because it has provided maximum performance per dollar of cost. The new AR-6 offers significantly better performance for \$180. It adds one-third octave of low distortion bass, and also provides superior dispersion and more uniform energy output at high frequencies. The seven inch depth of the AR-6 adapts it ideally to shelf placement, or it may be mounted directly on a wall with the fittings supplied with each speaker system.

Stereo Review says . . .

"All in all, the AR-6 acquitted itself very well in our tests. It was not quite the equal of the much more expensive AR models, whose sound it nevertheless resembles to an amazing degree, but on the other hand it out-performed a number of considerably larger and far more expensive systems we have tested in the same way. Incidentally, the AR-6 shares the AR characteristic of not delivering any bass output unless the programme material calls for it. If at first hearing it seems to sound "thin" (because it lacks false bass resonances), play something with real bass content and convince yourself otherwise. We don't know of many speakers with as good a balance in overall response, and nothing in its size or price class has as good a bass end."

High Fidelity says . . .

"Another great bookshelf speaker from AR . . . a really terrific performer. The AR-6 has a clean, uncoloured, well-balanced response that delivers some of the most natural musical sound yet heard from anything in its size/price class, and which indeed rivals that heard from speakers costing significantly more . . .

The response curves taken at CBS Labs tell a good part of the story. Note that across the largest portion of the audio spectrum and especially through the midrange the AR-6 responds almost like an amplifier . . .

Directional effects through the treble region, as evidenced by the average of 2dB that separates the three response curves, are actually less pronounced than we've seen in some costlier systems. Tests made of the effect of the tweeter level control show that it can vary the response from completely minus the tweeter to a steady increase in tweeter output of about 2 dB across its range. The design in this particular area is just about perfect . . . Pulse tests indicate virtually no ringing; in fact the AR-6 seems better than average in this regard too.

. . . a pair of AR-6s would be an excellent choice."

The workmanship and performance in normal use of AR products are guaranteed from the date of purchase; 5 years for speaker systems, 3 years for turntables, 2 years for electronics. These guarantees cover parts, repair labour and freight costs to and from the factory or nearest authorised service station. New packaging, if needed, is also free.

The AR catalogue and complete technical data on any AR product are available free upon request.



Acoustic Research Inc.
Massachusetts, U.S.A.

All AR audio equipment is on demonstration at the AR Music Room in the Sydney showrooms of the Australian Distributors.

Australian Distributors

W. C. Wedderspoon Pty. Ltd.

193 Clarence Street, Sydney. 29-6681

AR sound equipment may be purchased from the following Australian Dealers:

N.S.W.: Magnetic Sound, Sydney. 29-3371. Sydney Hi-Fi, Sydney. 29-1082. VIC.: Brasch's, Melbourne; Douglas Trading, Melbourne. 63-9321. S.A.: Sound Spectrum, Adelaide. 23-2181. A.C.T.: Homecrafts, Canberra. 47-9624. W.A.: Leslie Leonard, Perth. 21-5067. Alberts T.V. & Hi-Fi Centre, Perth. 21-5004. QLD.: Brisbane Agencies, Brisbane. 2-6931.

AUDIO NEWS

SPEAKER CONTEST PRESENTATION



John Brown (left) of Leroya Industries presents a pair of Rectilinear Mk XII speakers to Mrs M. Anstey, who received them on behalf of her son. On the right is Aubrey Barker, Electronic Today's West Australian representative.

NEW SPEAKER CONCEPT

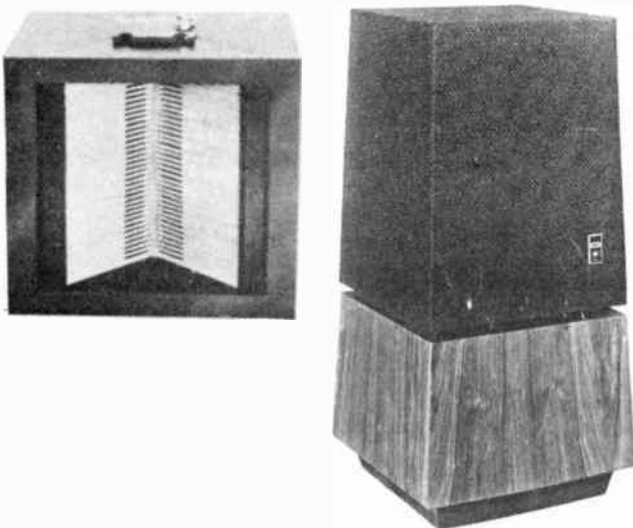

Claimed to be a totally new concept in loudspeaker design, an 'air motion transformer' system has been produced by the USA's ESS Inc.

The new speaker has no 'piston' surface as such, no voice coil, no elastic suspension device – nor in fact any significant mass.

Driving element is a light plastic assembly incorporating an array of multiple interfacing cavities. The volume of these cavities changes in response to the electrical energy from the program source, and a pneumatic lever causes the cavity volume changes to cause air movements over a large surface area.

ESS claim that their new system produces 25 times as much air movement compared with a conventional flat surface. They also claim that there "is almost perfect transfer of kinetic energy – with instantaneous acceleration and exceptionally low distortion.

At present the new driver, named the Heil unit after Dr. Oscar Heil – its inventor – is used as a mid-range unit – from 400Hz upwards.

However we understand that ESS plan to make bass units using the Heil principle also.

AUDIO CATALOGUE



Instrol's new audio systems catalogue must – at 50 cents (including postage) – be one of the best buys in audio today.

It shows, in four colour reproduction, a number of matched hi-fi systems priced from \$229 to over a thousand dollars.

Also included with the catalogue is a folder containing a large number of brochures describing a wide range of hi-fi equipment.

If you are thinking of buying hi-fi equipment, 50 cents spent on this catalogue would be a very good investment indeed – especially as Instrol refund the 50c if one subsequently purchases goods from them.

Obtainable from Instrol Hi-Fi 91a York St., Sydney, 2000.

BOSE AMPLIFIER



As forecast a few months back, Bose are now manufacturing a high-power amplifier to complement their two models of reflective loudspeaker enclosures.

Full details are still not available – but the picture above illustrates its impressive appearance.

SONY 4-CHANNEL IC'S

Sony Corporation are planning to market four-channel SQ decoder integrated circuits in October.

Three IC's are planned: a CX-049 SQ logic circuit, CX-050 demodulator and CX-718 gain control. All three IC's will be sold as a kit for about \$7.00 to licencees in Japan and overseas.

PIONEER IMPORT INTO JAPAN

Taking advantage of the revalued yen the Pioneer Electronics has established an organisation in Tokyo to import audio equipment from Europe and the USA.

At present Pioneer import Memorex cassette and open-reel tapes but will soon import a number of stereo component assemblies.

HIS HEARING IS BETTER THAN YOURS



*Champion Afghan
by courtesy of
Kafiris Kennels*

THAT'S WHY HE CHOSE KOSS

THE STEREPHONE FOR THE PROFESSIONAL
AVAILABLE AT YOUR HI-FI DEALER

N.S.W.
Autel Systems
20 Pittwater Road, Gladesville. 89-0663.

Audio Engineers
342 Kent Street, Sydney. 29-6731

Magnetic Sound
387 George St., Sydney. 29-3371.

VIC
Douglas Trading
185-191 Bourke St., Melbourne. 63-9321

WA
Alberts TV & Hi Fi Centre
282 Hay St., Perth. 21-5004

QLD
Brisbane Agencies Audio Centre,
72 Wickham St., Valley 2-6931

Distributed exclusively by DYNASOUND PTY LTD
329 Princes Highway, St. Peters 519-5284

Hi-Liner Stereo Sales

Present the finest selection of loudspeakers,
turntable bases and cabinets.



For a quote on all types of cabinet work,
ring Ian Alsop at:—

Hi-Liner Stereo Sales

7 Shaw Street, Bexley North
Telephone: 50-6220

DIGITAL VOLT/OHMETER



- * 0.1% DC ACCURACY
- * AUTO-POLARITY
- * 3½ DIGITS WITH 100% OVER-RANGE
- * 10 MEG INPUT RESISTANCE
- * DUAL SCOPE INTEGRATION
- * LOW COST

SCIENTIFIC ELECTRONICS PTY. LIMITED
42 Barry Street, Bayswater, Vic. 3153.
Telephone — Melbourne 729-3170 Sydney 25-3955
Brisbane 47-4311

BOOK REVIEWS

REVIEWERS: Shaun Kannon; Brian Chapman

RELIABILITY ENGINEERING by D. J. Smith. Published by Pitman, 1972. Hard covers, 136 pages, 8½" x 6". Review copy supplied by Pitman Publishing UK. Price \$4.90.

This is one of the first monographs in the Electronic Engineering Series planned by Pitman Publishing. As stated in the foreword by the Series Editor, Prof Gambling, the aim of the series is to provide a number of concise treatments, each covering a specific aspect of electronics. Particularly apt for the needs of today is Prof. Gambling's definition of electronics – as any function concerned with "transmission, storage, control and processing of information in all its different aspects" – in preference to the now out-of-date concept of electron-activated device engineering.

Subjects for future monographs are intended to cover almost every aspect of information processing, be it electrical, acoustical, optical or other forms – and should prove very interesting and useful to electronic engineers who today feel "equally at home using photons, phonons, valence . . . electron spin and other quantum states, etc".

This particular monograph aims to provide an introduction to reliability engineering for students and newly qualified engineers entering industry. An unusual and interesting feature is the inclusion of some of the pitfalls in achieving and measuring reliability which an inexperienced engineer is so often prone to.

This book does not attempt to examine causes of failure in specific components or systems – this is outside the stated scope of the monograph. It does however cover the theory and principles which form the basis for a study of system reliability. The reviewer found it particularly interesting that, going one step further than the IEC definition, reliability is defined by the author as the probability of satisfactory operation for a given period of time *without failure*.

Following a brief but very informative and readable introduction, the first chapter defines some fundamental terms associated with reliability activities and makes (what this reviewer regarded as) a passing reference to the need for effective organisation and management backing for the success of a reliability programme.

Chapter 2 defines reliability parameters using failure rates and makes the necessary (but oft ignored) distinction between MTBF and MTTF.

Chapters 3 to 7 discuss system reliability as a function of the reliabilities of its component items, the effects of operational and failure modes and stress aspects on system reliability, the suitability of Weibull parameters for variable failure rate (wear-out) components, and reliability testing to acquire and demonstrate failure data.

Chapter 8 discusses the use of Baye's Probability Theorem and the general Binomial theorem in reliability assessment for active redundant systems, and compares standby redundancy with active redundancy.

Chapter 9 deals with the effects of preventive and corrective maintenance on reliability data and has a useful section on how repair times affect the reliability (in all cases) of a system.

Chapter 10 is a brief exposition of the methods and organisation necessary to achieve reliability objectives – probably too brief considering that, for the price, this chapter could well have included specific case-history examples or a set of typical ground-rules for organising and operating a reliability program or for decision-making in trade-offs between cost and reliability.

There is a summary at the end of every chapter and certain chapters (dealing with theoretical and mathematical derivations) also conclude with problems for which fully and partially worked-out solutions are given at the end of the book. There is also a Glossary of terms and a set of Appendices on random failure rates of some electronic components, failure probability calculations for

redundant systems, and tables and formulae. A bibliography and index complete the book; the former could probably have been more extensive and included some key paper as well.

Though a concise and logically developed book which provides a good introduction to engineers wishing to specialise in reliability engineering and 'a complete coverage' for City & Guilds or National Certificate students in the subject, the book is perhaps a trifle over-priced for the amount or the extent of coverage of the subject. – S.K.

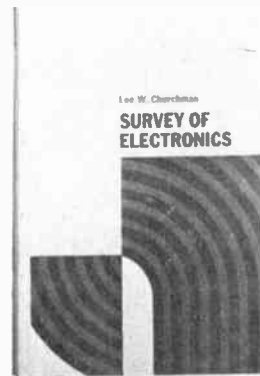

SURVEY OF ELECTRONICS
by Lee W. Churchman.
Published by Rinehart Press
San Francisco 1971. Hard
covers 500 pages 9¼" x 6¼".
Review copy supplied by
Holt Rinehart and Winston
(Aust) Pty. Ltd. Australian
price \$13.10.

This book is definitely unique, its purpose being to provide a survey of the entire field of electronics, the material is presented in a manner suitable for students of other disciplines, or engineers, doctors etc. who require background knowledge in electronics.

To quote from the preface – 'The justification for a survey course in electronics is easily stated. The student will live in a world in which the primary forces impelling social and cultural changes are largely the result of technological innovation. Electronics has become the nervous system of the body of technology. Knowledge of electronics has, therefore, now become an important part of the knowledge of the environment without which no education can be considered a general education'.

When you think about it, the above statement is largely true, electronics has pervaded every aspect of technology and will do so even more in the future. Most engineers or technicians these days will find their equipment has some electronic sub assemblies or is interfaced with electronic equipment in some way. Take for example electronics in the modern car – alternators, IC regulators, radios, servo systems plus a whole host of future aids such as "miles per gallon" metering, braking computers etc. A mechanical engineer would be very unwise to treat electronic devices as black boxes – he may find himself redundant when the next generation of engineers comes along.

This illustrates the need for a book such as this, and, greater general education in electronics in all technologies. Obviously a surgeon is the better for a rudimentary knowledge of the principles of the monitoring equipment (largely electronic) in the operating theatre.

Unfortunately the subject is so vast, that interest is in danger if the student is pounded with too much unnecessary data, and hence, the course must be kept interesting and must only include the essentials.

The book under review has been written with these factors in mind. It commences by discussing the input and output formats of various pieces of electronic equipment with which the student is most likely familiar – such as cathode ray oscilloscopes, TV, computers and audio amplifiers etc. It then progresses to the study of functional units of the above systems, from which the student sees that many of these functional units are common to many systems. From here we go to the consideration of common components and then discuss future developments. Whilst the subject order may seem to be, and is, the reverse of that usual, it is obviously best in terms of the aim of the book – to maintain interest.

The book cannot be read like an encyclopedia as most of the latter material depends on having assimilated the earlier material. One must start from the beginning and plow steadily on until the end. However, I feel that judged on its avowed aim – the book is excellent, and is therefore recommended as a source of electronic knowledge for engineers of other disciplines. – B.C.

- CAR - BURGLAR ALARM*

* Aust Patent 34882/71

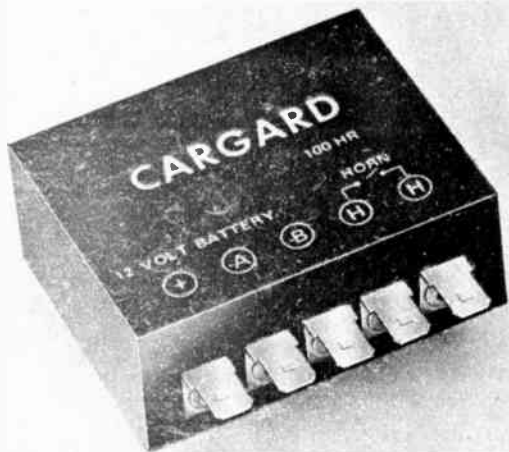

CARGARD 100 HR*

A fully automatic car burglar alarm which can be installed in minutes in any 12 volt vehicle. (It detects any disturbance in the electrical system of the car e.g. when a door courtesy light operates — so it eliminates all special wiring, door switches and other installation problems). An electronic exit/entry delay is included in the module so the unit can be switched on from inside the car before the driver leaves. The output is a pulsating horn relay which automatically resets after three minutes.

A full set of parts, assembled and tested with detailed instructions for the do-it-yourself man to install in any 12 volt car is available for \$29.50 including post and packaging.

CARGARD is fully guaranteed by the manufacturers for 12 months from date of purchase.

\$29.50
COMPLETE

TRADE ENQUIRIES WELCOME



**APPLIED
TECHNOLOGY
PTY. LTD.**

SUITE 101,
25 SPRING ST.,
CHATSWOOD,
N.S.W. 2067
PHONE: 412 1328
(48 5561 A.H.)

MAIL ORDER DIVISION
P.O. BOX 591, CHATSWOOD. 2067

NAME

ADDRESS

Postcode

A. YES, I would like to take advantage of your special offer. Enclosed is my cheque*/postal note for \$29.50. Please send my CARGARD by return post. (* Allow 7 days for clearance of personal cheques).

OR
B. I am interested in more information on CARGARD. Please send me your free brochure; I have enclosed a stamped self addressed envelope.

BOOK REVIEWS



104 EASY PROJECTS FOR THE ELECTRONICS GADGETEER. By Robert M. Brown. Published by TAB Books. Soft covers, 160 pages 8½ x 5½. Review copy supplied by Publisher. Australian price \$4.95.

There are indeed 104 projects in this book, most of them using only half a dozen components, or less. Whilst some are mere gimmickry, many quite useful little projects are included. The treatment consists in presenting the circuit diagram together with a very short light-hearted description of the operation and use of the device. Obviously the philosophy is — “have a fiddle and see for yourself.”

We have no real complaint about the subject treatment and in many ways the book is good value for money. Especially since it would seem that the book is sold together with a kit for one of the projects at the price of the book alone.

Apparently, a real bargain — but wait a minute — lets look at this kitset further. It is described as “An electronic decision maker” and consists of two neon indicators connected in a circuit such that either one or the other will light at random when a push button is pressed. Incredibly, this project is designed for direct connection to the mains via a two-pin American-type plug designed for 110 volt operation. No mention is made on the accompanying leaflet, or in the book, of 110 volt operation, or any warning given, anywhere, of the dangers attending devices attached to live mains. Thus the project could be lethal in the hands of a youngster connecting the device to our 240 volt mains. And further, we consider it could be dangerous, if not lethal, in the United States.

We submitted the book and kit to the Electricity Authority of New South Wales who confirmed our opinion of the kit — see their letter reproduced on this page. There are many such projects described in the book and parents are strongly urged not to let this book fall in the hands of youngsters.

In all fairness we must conclude by saying that those who know what they are doing will find many interesting and useful little circuits in this book. — B.C.

THE ELECTRICITY AUTHORITY OF NEW SOUTH WALES
KE

Address all Post to
Box 454, P.O. North Sydney 1580
Telephone Code Address
“AUTHORELIC” North Sydney

A.M.P. BUILDING,
50 MILLER STREET,
NORTH SYDNEY
EA-12674

Mr. C. Rivers,
Editorial Director,
Electronics Today International,
21-23 Bathurst Street,
S Y D N E Y. N.S.W.

Dear Sir,

TAB Books/No. 524 - "Easy Projects for the Electronics Gadgeteer"

I refer to the above publication and project material which you have brought to the attention of the Authority.

Following examination of the components supplied in kit form and a perusal of the circuits and project details in the publication by Authority officers, I wish to confirm that the construction of a large proportion of the devices described therein would result in the creation of a definite electrical hazard if connected to Australian electrical supply systems.

It is understood that the book has been submitted to you for review and in this event I would appreciate it if you would warn your readers that a number of the projects dealt with are unsuitable and unsafe for use in Australian power supply systems.

Yours faithfully,
S. J. Adeworth
(S. J. Adeworth)
Secretary

Deitron

DEITRON INTERNATIONAL PTY. LTD.
51 KYLE PARADE, KYLE BAY 2221
PHONE 546 7000 (3 LINES)
CABLES "DEITRONICS" SYDNEY

AS FROM 1ST APRIL 1973 THE UNDERMENTIONED GROUP OF COMPANIES WILL OCCUPY THE FOLLOWING ADDRESS:-
HOLYHEAD COMPLEX, 61-63 PLANTHURST ROAD, CARLTON, SYDNEY. CABLES "DEITRONICS" SYDNEY, PHONE 546-7000 (3 LINES)
DEITRON INTERNATIONAL PTY LTD • DEITRON CABINET INDUSTRIES PTY LTD • DEITRON ELECTRONICS SERVICE DIVISION PTY LTD

FOR SOUND PERFECTION FOR THE ENTHUSIAST WITH MORE TASTE THAN MONEY

For The Most Complete Range Of Loudspeakers Contact Your Local Dealer

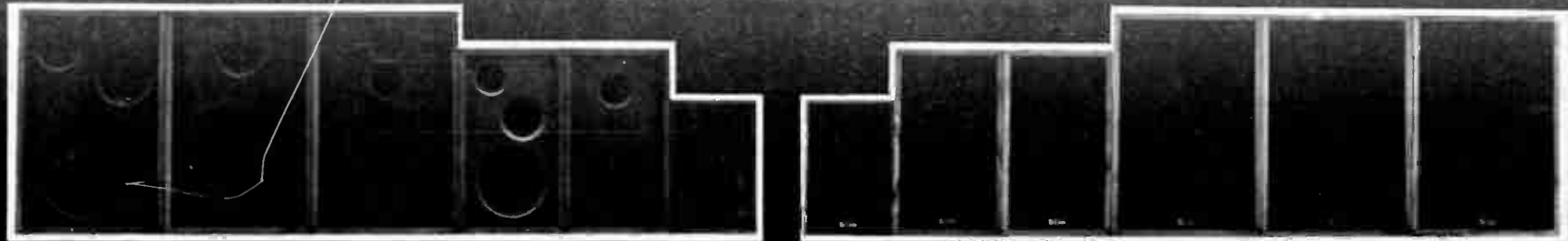

- 1... FULLY SEALED CABINETS
- 2... ACOUSTICALLY DESIGNED
- 3... LIFT OFF FRONTS
- 4... ATTRACTIVE FINISH IN
... AUSTRALIAN NATURAL TIMBERS
- 5... CUSTOM BUILT CABINETS

Manufacturer	Model	Handling Max. Power Watts rms.	Frequency Response Hz	Speaker			Impedance ohms			Dimension Inches H x W x D	Weight lbs.	Price \$A
				Woofer	Mid	Tweeter	4	8	16			
Deitron	DSS-63	8	55-18,000	6	-	3		x		-	30.00	
	DSS-83	10	55-18,000	8	-	3		x		-	45.00	
	DSS-853	15	35-20,000	8	5	3		x		-	55.00	
	DSS-833	30	25-20,000	8	-	3x2		x		-	70.00	
	DSS-125	20	25-20,000	12	-	5		x		-	85.00	
	DSS-1265	25	25-20,000	12	6	5		x		-	95.00	



MAHLER – DAS LIED VON DER ERDE
Rene Kollo (tenor), Yvonne Minton (contralto), Georg Solti (cond.), Chicago Symphony Orchestra. DECCA SET 555.

My initial impression of this *Lied* was one of studied coolness and a curiously hard to pinpoint lack of involvement with what I feel this music is about. Subsequent playings have hardly made me revise this opinion of the performance as a whole. It must surely be possible to strike a balance between distance and the very real regret for youth, beauty and zest, thus reinforcing the utter loneliness of this work. There is little doubt the first five movements can often be overstated in performance and must be interpreted with the cooling shadows of the final *Abschied* very much in mind. When Mahler's meticulous directions for the final movement are observed and this is almost never the case, the singing must have an almost nerveless quality to it. This Solti achieves beautifully, and rightly sees in this sixth movement the key to the overriding tenor of the work. He also justifiably treats the *Lied* as an essentially bi-partite work, the first five sections forming in reality one large movement that looks forward to and balances with the final sixth. Now while the atmosphere in this last section does contain the key to the work as a whole, I do feel that this need not detract from the intensity of the first five movements. For the contrast between this long sixth movement and those preceding to be clear, what one may call the memory of the experiences entailed by those five movements must be vivid enough, as Mahler's music and directions clearly imply, so that in that final farewell, everything does seem to gradually recede. The third and last Bruno Walter recording did, I feel, come close to conveying this balance. Solti obviously underscores the wealth and importance of the orchestral textures, while the voices always seem to possess the character of being orchestral parts. His very symphonic treatment and his concern for the sixth movement being of central importance in this work, does, however, unduly understate, so it seems to me, the very strong feeling behind the first movements. In this respect his approach is rather reminiscent of the late Fritz Reiner's

recording with the same orchestra. Yet even more than the Reiner or for that matter any other previous recording, it is possible to hear numerous details one usually reads in score (viz. especially pp. 21-28 in the Philharmonia edition, and the whole of the second movement). Others will no doubt disagree with my ultimate views about this recording but I do feel there should be more to the *Lied* than clarity or detachment. Solti's choice of singers serve to underline this overall impression, as they obviously take their cues from him. Neither Rene Kollo nor Yvonne Minton are always sensitive to the expressive demands of the text. Kollo quite misses the ironic playfulness of the third movement, nor does he have the weight of voice of Haefliger, nor the bitterness of Patzak for the first movement. One hastens to add, however, that the timbre of his voice and his delivery seems often echoed by Solti's treatment of the orchestra. Minton is similarly cool; she does sing beautifully but also seems inadequately sensitive to that descent of weariness in *Mein Herz ist mude* in the second movement, nor is that sudden *Andante* in the fourth movement (p. 77) sung with much feeling for sensuousness. But once again all this seems to be in keeping with Solti's ideas: he evidently underplays the various restless changes of tempo in the fourth movement, as for instance in the aforementioned *Andante*, which is, to my mind, hardly played as marked (*subito*). Minton is at her finest in the final song and is always sensible to Mahler's directions when the singing must be expressionless in contradistinction to the orchestra. But it is precisely in this last movement that Solti's ideas are justified. In sum then, a very different *Lied* this is from any other, one certainly very unified in conception, often incredibly played, and generally well sung. There is certainly much to admire here, even if I personally cannot bring myself to accept the ultimate results. Recording is, of course, also responsible for the great clarity to be had in this recording but once again surfaces are not that impeccable and there is a curious end-of-side noise between each band on the first side.

J.A.A.

BACH: THE MUSICAL OFFERING. Lionel Rogg (harpsichord), Jean Claude Hermenjat (flute), Quatuor de Geneve. HMV OCS-D-3704.

When Bach was in attendance on one occasion at the Palace at Potsdam, shortly before his death, the king played a theme of his own on the fortepiano (1) and invited Bach to improvise a three-part fugue on it. Bach did so and the king was so delighted that he requested a six-part fugue on the same theme. Bach hesitated, went to the instrument and performed a six-part fugue – on a theme of his own, considering the king's theme worthy of more attention than could be given to it by improvising. Shortly after that he presented to the king a set of canons, fugues and two ricercari written on it, calling it his Musical Offering.

Since then there has been constant debate over the order of movements and the instrumentation, due to the confused state of the Urtexts and Bach's almost total lack

of instrumentation – none of which has prevented the still-differing editions which continue to appear. This particular edition is performed with harpsichord, flute, two violins, viola and cello; the Harnoncourt edition (Das Alte Werk) for example is minus a violin and the viola; and oboes have also been used. Recent research has suggested that no more than two violins, or violin and flute, or even just one flute OR violin, in addition to the harpsichord is necessary in the canons, the extra parts belonging to the harpsichord which in no cases is otherwise occupied with continuo work.

In this Rogg edition the order followed is that in the Schneider (BWV) catalogue, a symmetrical arrangement with the great six-part fugue in the centre, unlike other editions which put it closer to the end. Many claim that the order of movements is irrelevant anyway, and that means the BWV edition is as good as any. If this is supposed to be Rogg's edition, it sounds uncommonly like the Bach Gesellschaft's. Surely a correction could have been made, as it has by at least one other, to the spurious expansion of the *Canon a 2, per augmentationem, contrario motu* (two different lines, one of which is simultaneously with themselves halved in time and turned upside down, the other line is a variant form of the king's theme) which, due to obscurity in the original text, has been written out by the BG to produce the most appalling dissonances.

But abandoning such musicological picket-lines, this performance can be recommended highly. Lionel Rogg is outstanding as usual at the keyboard; his clarity and separation of the parts is a model for all fugue-players (a further note for purists: it is now suggested that at least the three-part Ricercare was intended for the fortepiano). It is however a pity that the group indulges in very unBachian slowing up at the end of many of the pieces, but counter to that is the very Bachian dryness, an almost ascerbic outlook; this is particularly difficult to attain on modern and more lush instruments. I suspect this was unintentional but there it is, despite the quite lavish use of tremolo – an entirely post-Bach invention. One does not need any souping-up of such music because its merits are solely in its form. Any further embellishment constitutes musical drivel. And while on form, witness the old boy's cunning: the first canon is the king's theme somewhat elaborated, played simultaneously forwards and backwards; *canon a 2* in which the king's theme is played as a round, but the second voice is of course played upside-down – and there are four different ways the second voice can enter; and the *canon perpetuus* in which the king's theme is accompanied by a two-part canon, but which one cannot stop playing once one has started because it runs into itself – perpetual motion! (or a musician's nightmare). Such is the elegance of Bach's thought in his last years – in fact some have claimed that, partly because of Bach's unconcern over ordering and instrumentation and the music's form-dependence it was not really written to be performed but represented pure *ars musica*, or metamusic. Still, the music will be performed, but we must take it only as the audible signpost of Bach's genius. – T.B.

X30

a new high in Hi Fi...



The Plessey X30 dome tweeter

This is not just another high frequency speaker. It is a true high fidelity tweeter that can lift the performance of your present speaker system to a new high level. In fact, the Plessey X30 dome tweeter can add new brilliance to any speaker system—old, new or yet-to-be-built.

Here's why:

Superb frequency response. The X30 tweeter has a smooth response to beyond 30 kHz.

Ultra-wide dispersion. The X30 dome configuration provides up to 180° dispersion of the high frequencies.

Optimum clarity and extra brilliance.

The excellent transient response of the X30 is due to the very low mass of the moving system—an epoxy impregnated voice-coil on a multilayer polycarbonate former brings its total weight down to the all-time-low of only 0.3 grammes!

PLESSEY
Rola



High power handling. The X30 has excellent performance in systems over a wide variety of power handling capacities.

Non-metallic loading plate—eliminates flux leakage, improves efficiency.

Plessey X30 dome tweeters are available in pairs from all leading Hi Fi stores and come with full instructions, including details of a self contained tweeter array which can be used in conjunction with existing enclosures.



Plessey Rola Pty. Limited The Boulevard, Richmond, Victoria, 3181. Telephone 42 3821. Telex 30383. N.S.W. P.O. Box 2, Villawood, 2163. Telephone: 72 0183

Distributors: N.S.W.: General Accessories, Lawrence & Hanson Pty. Ltd., Martin De Launay Pty. Ltd.
Vic.: Lawrence & Hanson Pty. Ltd., General Accessories, Radio Parts Pty. Ltd. Qld.: General Accessories, The Lawrence & Hanson Electrical Co. (Qld.) Ltd.
S.A.: General Accessories, Gerard & Goodman Pty. Ltd. W.A.: Atkins Carlyle Ltd., General Accessories, Tee, W. & G. Genders Pty. Ltd., Homecrafts Tasmania.

AR48

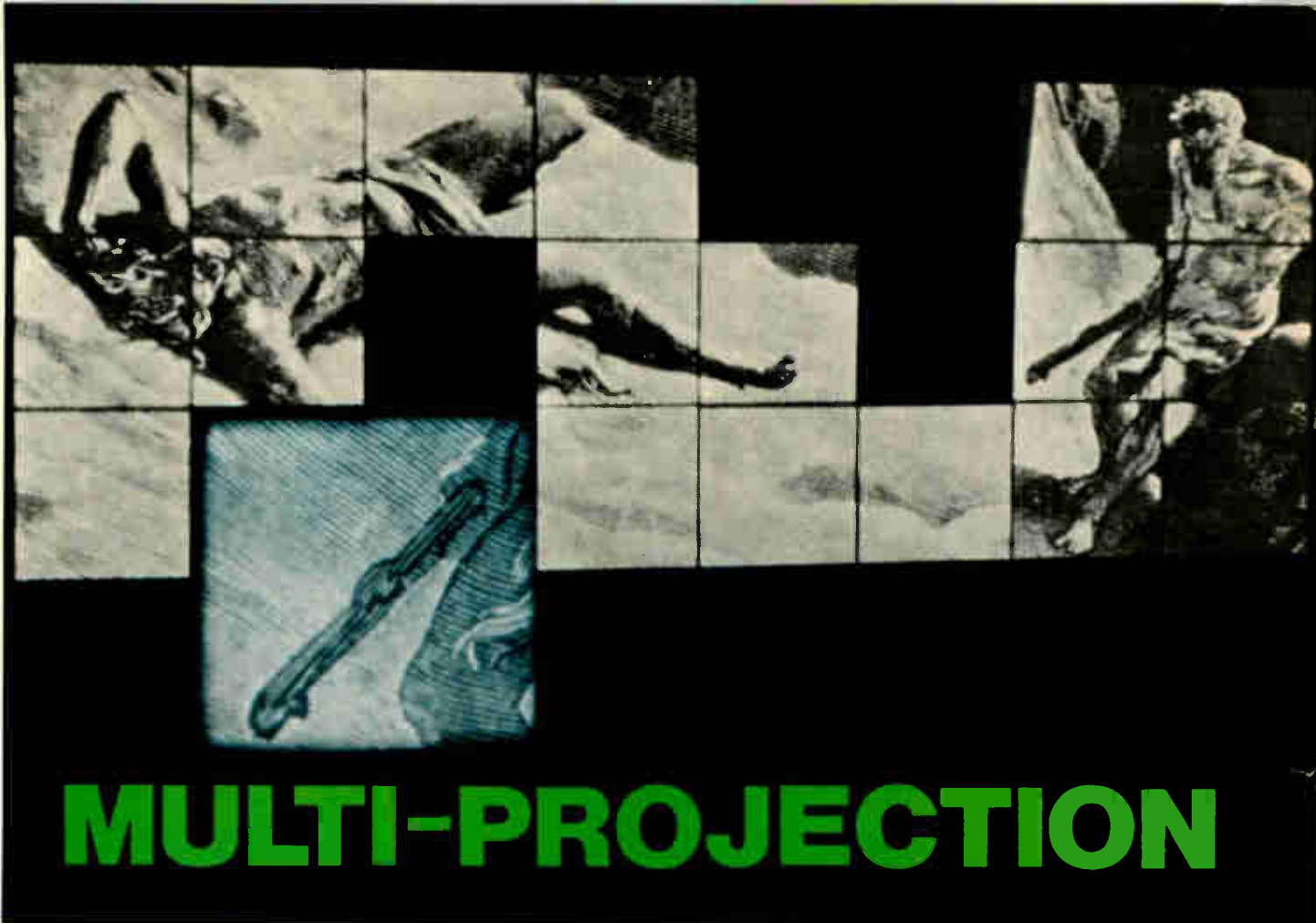

How to impart a lot of information in a short space of time.

MULTI-PROJECTION — or multivision, as it is sometimes called, is a technique of presenting information in an art-form using synchronized sight and sound.

The two most common examples are multi-projection shows involving varying numbers of projectors, each projecting on one of a series of screens that are related to one another in such a way that each picture appears

individually, but in a planned sequence and combination.

This visual presentation is usually accompanied by synchronized sound — derived from a single monophonic source — or from as many as 20 or 30 different sound sources.

In this format, multiprojection can impart a lot of information in a short space of time, for people are able to absorb considerable amounts of

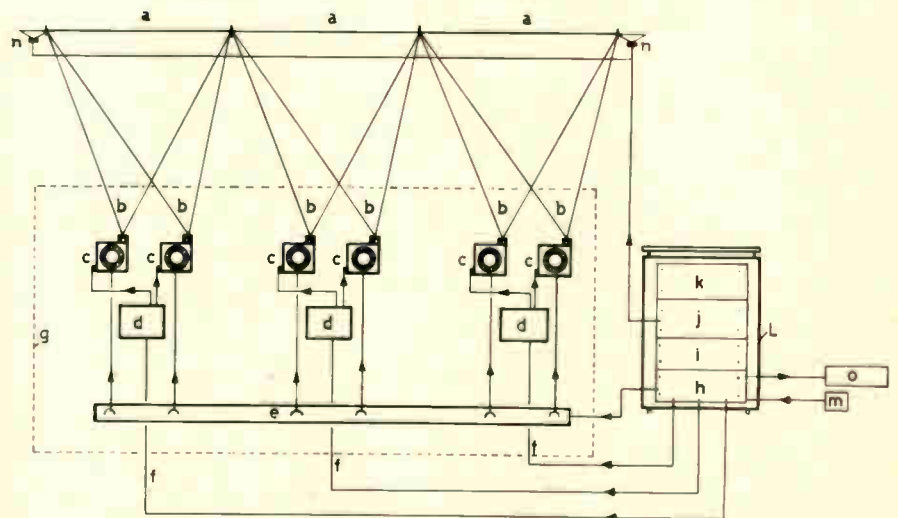

THREE SCREEN MULTIPROJECTION SYSTEM

ABOVE: Three-screen multi-projection system.
LEFT: Sound and light display at London's Madame Tussaud's shows astronauts Armstrong and Aldrin. Images are projected onto helmet mounted mirrors from projectors at floor level.

different visual information at the same time. Hence its growing usage at prestige exhibitions and presentations.

SON-ET-LUMIERE

The other well known multi-vision form is known as "Son-et-Lumiere" (meaning literally 'Sound and Light Show'). It refers to a complex synchronization between light sources and a sound track in which sound and light shows enhance, at night, the atmosphere of old structures such as castles, abbeys and ruins. Instead of projectors, the usual medium of vision is in the form of lights which are controlled by dimmer systems so that they rise and fall in cadence with music and voice. At the same time colour filters and wheels can be controlled in unison with these changes. Smoke, whistles, explosions, flag hoistings and many other effects are frequently linked in with these shows.

At Madam Tussaud's Waxworks Exhibition in London, there are two very good examples of sound and light shows. In one, the death of Nelson is recreated with sound, light and smoke effects, while in another section, the Battle of Britain is re-enacted in a three-screen multi-projection show with screaming Stukas and rattling Spitfire cannons. Each of these shows is controlled by a simple but reliable time division multiplex system (manufactured by Electrosonic Limited, London).

CAROUSEL VISION

In recent times some very sophisticated techniques have been developed in which a large number of projectors are controlled automatically. One of the first of these was introduced in the mid-1960's when Kodak (Stuttgart) created the now well-known 'Carousel Vision'.

This was an ever-changing pattern of still pictures, a pastiche of movement, colour and sound.

At the 1968 Photokina exhibition, KODAK joined forces with graphic designer Horst A. Rischka and Zurich photographer Rene Groebli to show just how effective the technique could be. In a circular structure made up of twenty 6ft-square screens, 40 electronically controlled CAROUSEL projectors and 2000 transparencies were used to create "impressions of the world we live in". The projectors worked in pairs, one pair to each screen, and were fitted with rotary-magnet shutters to give smooth changes and instantaneous cuts from one image to the next (the rotary-magnet shutter provides a slide-change lasting only 1/10th of a second, and ensures that one of the paired projectors is always ready for the next changeover). The show was

continuous and a central electronic control unit stored the complete program as well as playing the specially composed music. The score for the combined music and slide presentation looked like a pattern of graphs and was written in a specially developed notation that was then used to program the sequences and orchestrate the visual chords for "Carousel Vision".

The control signals were stored on tape, with appropriately spaced 10kHz pulses to separate the slide-changing pulses to each of the twenty pairs of projectors, producing either bursts of pictures that followed each other in quick succession or all-round panoramas that built up and disintegrated, all in a constantly changing and uninterrupted sequence.

The complete show lasted eight minutes, with the visual and aural elements skilfully balanced to give a fascinating impression of the world we live in.



This show toured Europe for a number of years until, through continual exposure of the slides, the original colours were lost and the show was retired.

DIGITAL TECHNIQUES

Tone pulse control systems were in use in Europe long before the development of the time division multiplex technique used to control the Carousel Vision show. But these systems were often beset with problems arising from changes in recorder speed and from electro-magnetic hash — such as that generated by phase control systems, fluorescent tube starters, contactors etc. All can introduce spurious signals into a simple tone pulse system and wreak havoc with the slide changing program.

Hence a system that responds only to predetermined code sequences — and

applies a 'degree of absurdity' test — becomes a virtual necessity if complex multi-projector presentations are to function reliably.

The time division multiplex system developed by Electrosonic uses digital techniques to signal on/off commands for each of the channels being controlled over a single audio link, which is normally one track of a multi-track magnetic tape or film system. The remaining tracks are normally used for music or commentary. Because the control track and the audio tracks are on the same tape or film, perfect synchronisation can be assured.

The system is based on digital techniques to achieve maximum reliability and it is extremely tolerant of factors which could be expected to limit the effectiveness of a tone pulse system. In fact, the performance is such, that assuming the program has been correctly recorded, the decoder will still function correctly even if

the signal level varies by ± 35 dB from nominal level and tape sound and other spurious signals may be within 10dB of the lowest signal to be received, also the tape speed may vary by $\pm 25\%$ from nominal.

In order to allow conventional audio tape recorders to be used for the recording, copying and replaying of programs, each digital bit is actually recorded on the tape as a sine wave burst. The carrier frequency used is about 5kHz. This choice of a low carrier frequency allows inexpensive tape replay systems to be used.

ENCODING — DECODING

Two pieces of equipment are required, in addition to a conventional audio tape recorder. The first is an 'Encoder' which generates the required multiplex signal for recording the program sequence on to magnetic tape. The second is a 'Decoder'; this

unit receives the signals from the tape and converts them into specific instructions to carry out particular functions. Although the system can be operated manually through a single line, programs are normally stored on standard audio tape recording systems. In principle, the encoder will work with any professional or semi-professional tape recorder equipped with a solenoid operated pinch wheel.

Programs have been encoded satisfactorily on standard compact cassettes, or stereo 8-track cartridges. Endless tape systems may be used to enable programs to be repeated automatically from a single switch or button.

Apart from the checking procedure described above, a second checking system ensures that no instruction is acted on until two successive instructions have been checked as identical. This is performed on a channel by channel basis and only when a change to a particular channel's program has been detected on two successive phrases will it be passed to the output.

The encoder generates the necessary sequence of coded instructions and each set of instructions is repeated four times.

Decoders are individually set to operate a predetermined number of functions (i.e. projectors etc.). A counter, built into each decoder, checks the number of information bits contained in each separate pulse train as it is received, and unless exactly the right number of bits are present, the information contained in that pulse train is rejected. In this event the decoder awaits the second repetition of the coded pulse train — and again checks for the correct number of bits.

Thus a program recorded for a 24 function decoder will only play back through a decoder set for this number of functions. This means that two or more separate multiplex programs may be encoded on a single tape without the danger of actuating the wrong decoder! As an example, the 56 function program may be recorded together with a 24 function program without the signals overlapping. On replay the 56 function decoder is only actuated by the 56 function pulse train and the 24 function by the 24 function signals.

This complex double checking procedure ensures that moderately dirty tape-heads or tape drop-outs, or spurious signals from lightning circuit breaker pulses or other electro-magnetic hash do not block out vital commands or create false ones.

CUEING

The minimum time between successive sets of instructions is determined both by the amount of information contained in the multiplexed signal — and assuming incremental recording — by the performance of the tape recorder being used in the encoding process. Theoretically, the minimum cue spacing for systems with up to 56 functions is 0.1 second. For 120 functions this increases to 0.2 second. In practice the spacing is about 30 percent greater than this.

Cues may be recorded accurately because the recording process is carried out incrementally — if even greater cueing accuracy is required, encoding can be carried out at a fraction of the tape master speed. Using this technique it is a simple matter to synchronize cues with a

particular musical beat, or key words within a speech.

The choice of projector and lens for use with multiprojector systems depends largely upon the requirements of each individual installation.

It is however essential to use projectors built to professional or industrial standards as domestic units — according to Electrosonic — invariably fail within 48 hours of installation!

Projectors are usually arranged in sets of pairs to ensure that there is no black interval during slide changes (Fig. 2). It is also possible to program the projector lamp and/or shutter to enable special optical effects to be developed.

PROGRAM PRODUCTION

Program production is a specialised business and the most successful multiprojection displays have always been those that have been properly produced.

The procedure follows a number of logical steps:

- 1/ Decide on format — whether to use a modular or single screen, speed of presentation, number of projectors required etc.
- 2/ Fix firm equipment and production budgets.
- 3/ Prepare storyboard, script, select music, prepare artwork, arrange location photography, engage actors etc.
- 4/ Depending on the format, the final sound track may be required at this stage.
- 5/ Prepare master audio and pulse tracks. This may be done using the client's own encoder — or by specialised companies equipped for this task.
- 6/ Preliminary showing and editing.

(Continued on page 118)

Block schematic of Electrosonic multiplex encoder/decoder

Multivision control rack

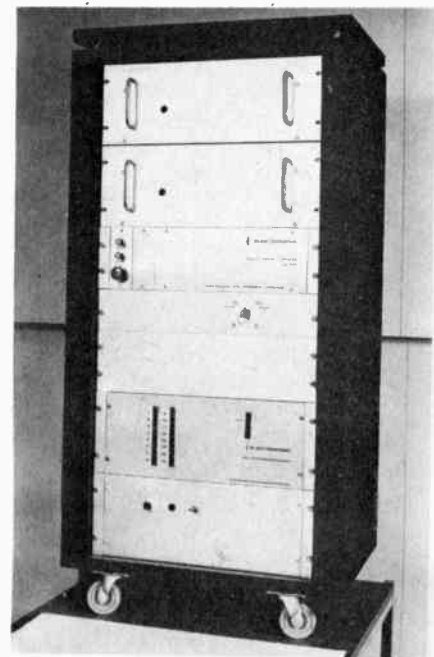
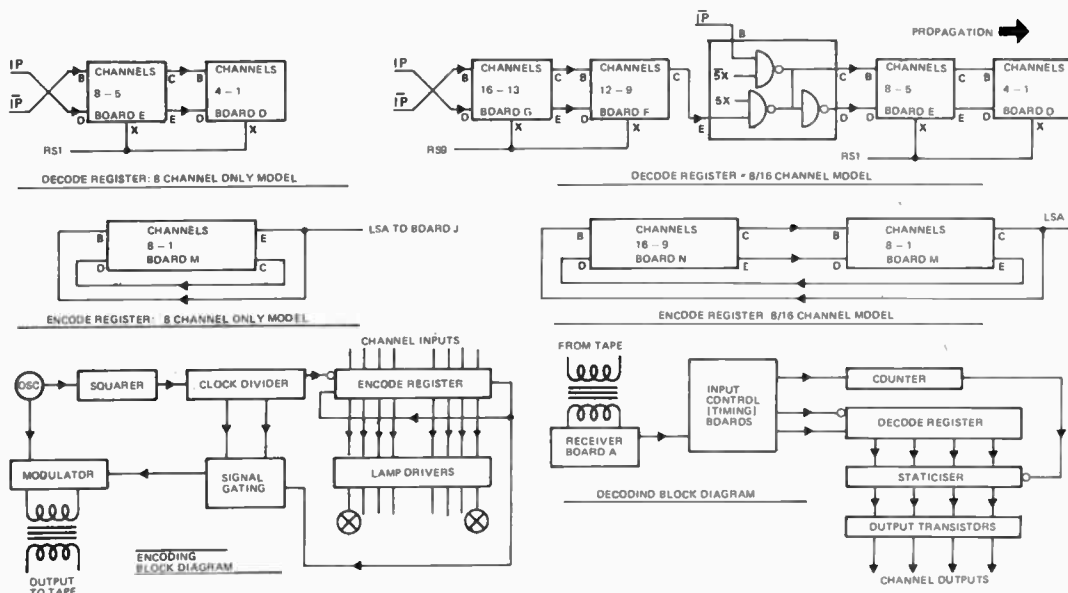

Convoy International Presents

ELECTROSONIC MULTIVISION

You can now obtain a completely integrated and automatic Audio-Visual system, starting from a single screen single projector show, or up to a 28 screen extravaganza of sound and vision using 56 projectors, all linked to the Convoy Electrosonic Multiplex control system which operates from a simple tape recorder system. It can be cassette, cartridge or reel-to-reel. All systems are now available in Australia from Convoy International. No operator is necessary. A push button will operate and reset the whole show once it is set up.

ELECTROSONIC is the world's International standard for MULTIVISION

The Convoy Electrosonic Multi-Vision system is world-wide and the standard adopted by the world's biggest international companies because a programme made anywhere in the world can be shown on other Electrosonic systems in U.K., Europe, U.S.A., Canada, South Africa, Australia, New Zealand and soon throughout most of Asia. No other system offers this international facility. Only Electrosonic gives you instant "SNAP" changes in MULTIVISION.

PHONE OR WRITE, CONVOY WILL...

ADVISE you on all aspects of the use of multi projection.

DEMONSTRATE the equipment and show you examples of multi projection.

SELL you a fully engineered multi projection system tailored to your specific needs.

RENT you a multi projection system for that important trade show, charity fund raising event, product launch etc.

PROVIDE you with full facilities including the use of a viewing studio for encoding, dubbing etc.

ORGANISE and supervise multi projection presentations throughout Australia and New Zealand.

ARRANGE the sale of Electrosonic equipment in all principal overseas countries through Electrosonic agents.

Convoy International Pty Ltd

Sole Australian agents for Electrosonic multi-vision equipment in Australia.

Corner Plunkett & Maclean Streets,
Woolloomooloo 2011, Sydney, N.S.W.
Telephone No. 357-2444

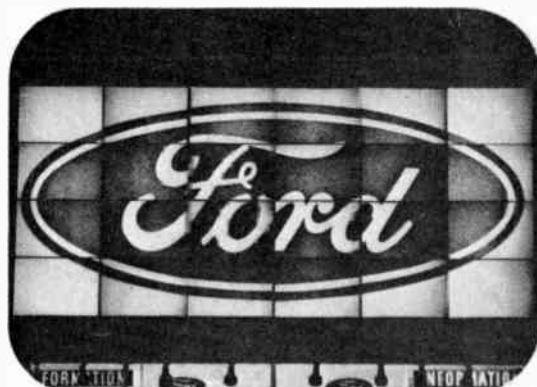

EXHIBITION IMPACT
A 24-screen 48-projector presentation for Ford of Denmark at the Danish Motor Show.



THEATRE: THE SCENE
Multivision as scenery, 19 projectors, some with dissolve control units, produced scenery like this for "You should have been here yesterday", a dramatized history of Sunderland presented at the Empire Theatre.



FASHION SHOW
A 15-screen touring show featuring ICI fabrics, the Multivision presentation forming an effective and changing backdrop to the fashion parade.

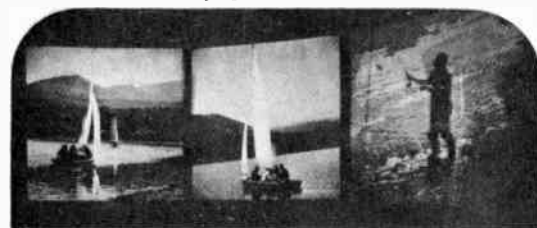

TOURIST ATTRACTION
The Landmark Highlands Visitor Centre in Scotland features a 3-screen presentation introducing the tourist to the highlands, its history and its amenities in an entertaining and informative way. A permanent all-the-year-round installation.

BRIGHT ◆ STAR ◆ CRYSTALS

ESTABLISHED FOR THE PAST 35
YEARS FOR ALL YOUR
REQUIREMENTS

Bright Star Crystals are preferred
by leading Manufacturers
throughout the country for

**ACCURACY – STABILITY
ACTIVITY – OUTPUT**

Consult us for Crystals for any
Mobile Radio. All types available.

DISCOUNT FOR QUANTITY ORDERS

**AMATEUR AIRCRAFT and
ULTRASONIC also available.**

Our modern factory equipment allows
us to offer you PROMPT DELIVERY
for all CRYSTAL requirements.

**DEVOTED EXCLUSIVELY TO
THE MANUFACTURE OF**

**PIEZO ELECTRIC
CRYSTALS**

Contractors to Federal & State
Government Departments.

REPRESENTATIVES –

Australia and New Zealand:

Messrs. Carrel & Carrel,
Box 2102, Auckland.

Rogers Electronics
P.O. Box 3,
Modbury North S.A.
Phone: 64-3296

Paris Radio Electronics,
7A Burton Street,
Darlinghurst, N.S.W.
Phone: 31-3273.

Fred Hoe & Sons Pty. Ltd.,
246 Evans Road,
Salisbury North, Brisbane.
Phone: 474311.

W.J. Moncrieff Pty. Ltd.,
176 Wittenoom Street,
East Perth, 6000.
Phone: 255722.

*Write for a free comprehensive
price list or quote for your
requirements.*

BRIGHT STAR CRYSTALS P/L.
LOT 6, EILEEN ROAD, CLAYTON,
VICTORIA, 546-5076

NEW HOT LINE MOSCOW - WASHINGTON

A CONTRACT for approximately 1
million US dollars, for earth station
equipment to provide a new hot line
communications link via satellite
between the Kremlin and the White
House, has been awarded by the Soviet
Union to ITT Space Communications,
a unit of International Telephone and
Telegraph Corporation (ITT).

The existing hot line, installed on 30
August 1963, is a direct, Washington -
Moscow teleprinter link for
transmission of top-priority
government messages.

The equipment now purchased
includes high-power amplifiers,
low-noise receivers, other radio and
control equipment, as well as Spade, a
specialized digital communication
system. Orientation and training of
Soviet personnel by ITT also will be
provided. The Soviet Union will
provide its own antenna structure.

For their part the United States are
constructing at Fort Detrich, near
Washington DC, a *Molnya-2* type earth
station which will provide a parallel
link to that ensured by the *Intelsat*
satellite. ●

MULTI-PROJECTION

At first sight multiprojection would
appear to have little to offer compared
with movie film. But this is not so -
say its protagonists. To achieve
comparable results on movie film
would, they claim, be at least ten
times as expensive.

It would seem however that there
must be a number of applications
where a combination of movie film
plus multiprojection would provide
dramatic impact. A striking example
of this was in the climax of the film
'Sundance Kid'. Here the producer
showed that there was much more
dramatic impact during the action
shots of the 'shoot out', using still
pictures, than could ever be achieved
by motion pictures. The stills engraved
themselves on the minds of the
audience in a manner that few of them
would ever forget. ●

*Electrosonic equipment is available
in Australia from Convoy Inter-
national Pty Ltd, Maclean St.,
Woolloomooloo, NSW.*

Integrated Circuits

SN7490	\$1.80 ea.
SN7441AN	\$2.50 ea.
SN7475N	\$1.80 ea.
SN7400N	75c ea.
SN7410N	75c ea.
SN7430N	75c ea.
SN7440N	75c ea.
SN7472N	\$1.75 ea.
SN7473N	\$2.00 ea.
SN7447N	\$2.60 ea.
LM709 OP AMP	\$2.60 ea.
LM709 OP AMP	\$2.60 ea.
LM305 Pos Reg	\$3.80 ea.
LM304 Neg Reg	\$4.90 ea.
TIL 209 L.E.D.	80c ea.

Postage on i/c's 10c ea.

Transistors

AD140	\$1.00 ea.
2N3055	\$1.60 ea.
BC109	60c ea.
BC108	50c ea.
BC107	50c ea.
2N3568	75c ea.
2N706	45c ea.
2N3866	\$1.50 ea.
2N3819 Fet	85c ea.
MPF 121	\$1.50 ea.
T.I.S. 88	\$1.20 ea.
LM380 2 Watt Audio IC. 8 volt to 22 volt Rall. 50K ohm input impedance, short circuit & overload protection. \$2.85 ea. p/p 10c.	

Computer Boards. Five for \$2.50.
Average of 50 Transistors. Numerous
diodes. Capacitors, Resistors. Post 30c.
New Cracked Carbon Resistors, 1/4W &
1/2W 5%. Full range. 5c each.

2 METRE CONVERTOR KIT

A kit that really works; no neutralisation
necessary; Frequency range 144-146
MHz or 146-148 MHz. IF Frequency 28
to 30 MHz. Sensitivity .1 UV for 8 db
S/N. Noise Figure 2 db Typ. Power
requirements 10-16 VDC 25 Ma. Double
sided P.C. Board. Mil. spec. components.
2RF stages (T1S88) Mixer MPF121 Osc.
(2N3819). Kit comes complete with all
components, drilled. Glass Epoxy P.C.
Board and Instructions. Price less XTAL
\$17.75 Crystal \$5.50.

YUNKER ELECTRONICS PTY. LTD.
757 Glenferrie Rd.,
Hawthorn 3122. PH: 81-2818

LAFAYETTE "Guardian 6600"

Direction Finder 6 Band Radio
AM - MARINE - FM -
AIRCRAFT - VHF



\$179.50 including Sales Tax
BATTERY OR 240V AC OPERATION

- Rotatable Antenna for LW, AM and MB reception & Direction Finding.
- Signal Strength Tuning/Battery Meter.
- Adjustable Squelch Control.
- 6 Bands (1) 180-380 kHz (2) 540-1600 kHz Broadcast (3) 1.6-4.6 MHz Marine (4) 88-108 MHz FM (5) 108-136 MHz Aircraft (6) 147-174 MHz VHF.

The "Guardian 6600" is the latest deluxe version of Lafayette's most advanced Portable Battery/Electric Radio for top reception plus Direction Finding.

LAFAYETTE ELECTRONICS
94 HIGH ST., ST. KILDA, VIC., 3182.
Phone 94-6036

a fine combination

MSP HI-FLUX SPEAKERS — 20 WATTS

MSP's advanced technology and craftsmanship has produced an exciting new combination of high performance speakers for Hi-Fi applications.

6½" Woofer LF-6WAC-16

A totally new concept in speaker design featuring a unique moulded housing manufactured from the latest high impact glass filled nylon materials, for the ultimate in appearance, rigidity, stability and reliability.

Part Nos. 56328-001/8 ohms.
56328-002/15 ohms.

Resonance: 45 ±7 Hz.

Frequency Response: 35 to 6000 Hz.
(With tweeter HF-4MBC 35 to 18000 Hz.)

Voice Coil Impedances: 8 or 15 ohms at 400 Hz.

Compliance (Equivalent Volume): 2000 cubic inches.

Total Q: 0.33.

Sensitivity: 100.5 dB.

Nominal Power Handling: 20 watts RMS in recommended enclosure.

4" Tweeter 4MBC/8-15HF

Part No. 56254-001.

Frequency Response: 2000 to 18000 Hz.

Recommended Crossover: 4000 Hz with 3.3 µF capacitor for 8 ohm system. 2 µF capacitor for 15 ohm system.

Voice Coil Impedances: 8-15 ohms.

Power Handling: Compatible with bass speaker power handling when used with suitable crossover network.

An economical alternative can be achieved with a single 6½" wide

range twin cone speaker.

6½" Wide Range Twin Cone 6WACX

Part Nos. 56327-001/8 ohms.

56327-002/15 ohms.

Ideal as an extension speaker for stereograms or tape recorders, etc.

Resonance: 45 ±7 Hz.

Frequency Response: 35 to 16000 Hz.

Voice Coil Impedances: 8 or 15 ohms at 400 Hz.

Compliance (Equivalent Volume): 2000 cubic inches.

Total Q: 0.33.

Sensitivity: 102.5 dB.

Nominal Power Handling: 16 watts RMS in recommended enclosure.

Recommended enclosure designs including the application of mid-range speakers and tweeters are available.



4MBC/8-15HF

LF-6WAC-16

mSP

MANUFACTURERS SPECIAL PRODUCTS PTY. LTD.
554 Parramatta Road, Ashfield, N.S.W. 2131. Phone 797 5757.

N.S.W. George Brown & Co. Pty. Ltd., 5195855. VIC. AWA Ltd., 679161. QLD. Chandler Pty. Ltd., 310341. S.A. Newton McLaren Ltd., 510111. AWA Ltd., 722366.
Gerard & Goodman Pty. Ltd., 232222. W.A. AWA Ltd., 286400. TAS. AWA Ltd., 343836. AWA Ltd., 315466.

A.D.29

INPUT GATE

LETTERS
FROM
OUR READERS

4-CHANNEL COMPATIBILITY

I read, with interest, your article in the December Issue "Hi-Fi — an Initiates Guide". Of special interest to me at the moment is 4-channel equipment. I was sad to read your opening sentence (in this section of your article). You stated the "there are several, *currently non-compatible*, systems for reproducing 4-channel sound". Could you tell me if this is still so (i.e. non-compatibility). I have obtained literature describing two "Onkyo" 4-channel systems model X-1 and Y-2. In this brochure, the manufacturers claim "perfect compatibility", enabling you to play music from any type of source (mono, stereo or quad — tape or record). Is this an extravagant claim or are these units really compatible.

Also, what's happening with 4-channel records? How many are there around, will all records eventually be produced in this way (as has happened with stereo — they are playable on mono equipment). Can a "Quad" record be played on an ordinary stereo unit?

Finally are there 4-channel tape decks (matrix type) in the cassette type, or are the reel-to-reel decks the only type that are being made at present for quadrasonic music?

A.L. Thirroul NSW

** There are a few commercially available four-channel amplifiers and/or decoders that can handle inputs from both matrix and discrete sources.*

They are 'compatible' in that respect. However, the great majority of four-channel equipment currently on sale can handle either matrixed or discrete signals but not both.

But it should be borne in mind that whilst the SQ matrix system and the JVC Nivico/RCA discrete record are the two systems most likely to be accepted as standard there are also many competitive systems jockeying for position.

A new and perhaps non-compatible system could quite well be adopted.

A number of SQ matrixed records are available in Europe and the USA and at least one company will be producing these in Australia fairly soon. All matrixed records may be played on normal stereo equipment if desired — and if so used they sound just like conventional stereo records.

In the USA, RCA are now producing all their records in discrete four-channel form — they no longer make them any other way.

These new records can be played on conventional stereo equipment without destroying the four-channel data. Of course a special stylus and decoder will be required if the

four-channel data on the record is to be exploited. These records are now on general sale in the USA and will shortly be available in Australia.

It is possible to record a matrixed four-channel signal onto a standard tape cassette, but we do not know of any company actually selling pre-recorded matrixed cassettes. The matrixed signal from the cassette recorder could be decoded using the same decoder as is used for matrixed records.

SCIENTIFIC RESPONSIBILITY

Your editorial director's reply to the Canberra reader, who said that it is not for scientists to control the uses of their discoveries, (ETI, April 1973) was absolutely right. As a scientist myself it appals me to know what some of my colleagues have done — and are doing.

Their action though is amoral rather than immoral and it needs strong comments — such as yours — to make them realize what they are doing.

J.S.

Sydney University
Sydney, N.S.W.

Congratulations on your reply to the reader suggesting that scientists should

ELAC PUZZLE COMPETITION NO.2

PRIZE — AN ELAC STS.244-17 CARTRIDGE

When it comes to choosing a pick-up cartridge, the choice should always be an ELAC.

ELAC have been designing and manufacturing the most advanced cartridges of the day, for over 20 years.

In the current range of magnetic models, STS.244 — STS.344 and STS.444. Each will outperform any others within the same price bracket.

ELAC cartridges are the choice of the world's biggest record manufacturer, E.M.I. to evaluate quality and check production control. You can't fool the experts, they have all the answers.

First correct entry opened one week after the publishing date of the next month's ELECTRONICS TODAY INTERNATIONAL will be awarded the prize. The name of each winner will appear in this column in the month after.

- With a pair of scissors, can a clock face be cut into 4 pieces, each piece containing numbers, which when added together, will total exactly 15. Draw a diagram showing how this can be done.*
- Which record manufacturer uses ELAC cartridges to check and evaluate record quality.*
- ELAC have designed and manufactured cartridges for: (How long)?*

Post entries to ELAC PUZZLE COMPETITION NO. 2
P.O. Box 150
CROWS NEST, N.S.W. 2065

CHOOSE AN ELAC—THE CHOICE OF THE EXPERTS

Permit No. T/C 4108

bear responsibility for their actions. Was it necessary though to use a sledgehammer to make your point!
 WL. Chatswood NSW.

It's about time that someone started querying the tunnel vision of a minority of scientists.
 JS. Collingwood Vic.

I thought this page was supposed to be letters to the editor — not letters from the editor.
 FB. Canberra ACT.

Hysterical nonsense — are you some sort of do-gooder?
 GH. Darwin NT.

I submit that it is not up to the scientist to bear responsibility for his actions — the problem quite clearly is with the general mass of the people who pervert his discoveries.
 TD. Woollahra NSW.

UPDATING MEDIA

The letter "Updating Media" by A.D.D. Plymouth U.K. has my total support. (ETI March 73).

Having attempted to file various articles from your and other magazines, I find the "magazine" format totally inflexible. Having been completely unimpressed by editors' answers to similar suggestions put in the past, I can only hope that the simple philosophy of his will help to jolt editors out of their journalistic rut and make them start to reassess their role as communicators, using modes of media more appropriate to today's flexibility. This must apply particularly to the technical magazines where the ability to file and easily find articles is the only real justification of the expenditure.

B.B. Goolwa, S.A.

I have just been reading a letter from A.D.D. of Plymouth U.K., published in your magazine of March 1973, in which the writer suggests improvements in the layout of technical articles etc to facilitate their removal for filing.

I have been collecting articles of interest to me for a number of years, and have had great difficulty in filing them, owing to the fact that seldom does an article appear on successive pages, but is scattered through the magazine. Quite frequently part of one will be on the same page as another, in which case a difficult decision has to be made as to which article to keep.

I strongly support his views and would appreciate your consideration of this problem.

J.E.W.
 Lower Mitcham
 S.A.

DICK SMITH & STAFF SUPER VALUES

CIRCUIT BOARDS

pre-tinned

The "Rolls Royce" of circuit boards are now available from Dick Smith — give your equipment that professional look—all boards are heavy duty and most are fully pre-tinned to prevent oxidation marks and to make soldering easier.

72/G7	Guitar Amp.	1.50
72/SA9	Amplifier	1.50
72/S10	Scaler	1.60
72/10	IC Probe	.95
72/S11	4 Channel Converter	1.50
72/SA10	Playmaster 136	1.90
ET025	Super Stereo	1.90
ET026	Tape Slide Sync.	1.50
ET029	Tuner	1.45
ET033	IC Power Supply	2.50
ET034	Int. audio system	2.60
ET111	Power Supply	1.50
ET143	100W AMP	2.20

60 SOLID STATE



VHF POWER TRANSISTORS 30 watts at 12.6 volts — FANTASTIC OFFER TO AMATEURS — \$9.85.

These transistors manufactured by "Solid State Scientific" are exactly as currently being used by Australia's largest VHF mobile radio manufacturers. They are virtually indestructible (they withstand severe V.S.W.R.) and are guaranteed to give in excess of 30 watts at 144 mcs on 12.6 volts (more at 13.8 volts!) Supplied complete with data sheet, test, circuit and layout diagram.

FEATURES:
 • Withstand severe V.S.W.R.
 • Low inductance stripline package.
 • All leads electrically isolated from stud.
 • Greater than 4.4 db power gain.

TYPE 2N 5591—\$9.85 plus 50c p. & p.

DRIVER TRANSISTORS AVAILABLE

Complete with data sheet and suggested circuit and layout diagram.
 2N 5590 (15 watts) \$7.75
 2N 5589 (7 watts) \$6.50 p. & p. 50c.

The complete set of three transistors are available as a special package offer for \$22.50 plus p. & p. 50c.

Data sheets available separately, 10c plus 20c p. & p.

144 MC'S P.C. BOARD

SPECIAL Now available—tinned fibre glass boards with full layout details and instructions to make each output stage (7, 15 or 30 watts). Prices for each board are \$1.50 each or supplied as complete 300 MW (IN) to 30 watt (OUT) board for \$4.20. P. & P. 20c.

PARTS FOR RECENT PROJECTS

Sigmatix 555 TIMER I.C. \$2.35
 SIGNETICS NE 561B Phase lock Loop I.C. \$9.56



P. & P. 20c.

MOLEX I.C. SOCKET PINS

With these you can build economical I.C. sockets (approx 1/3rd price) by simply cutting off the number of connections required (i.e., two strips of seven for 14 pin socket) and soldering on to P.C. Board. 50 Pins \$1.00



GET YOUR 1973 CATALOGUE NOW!



Many thousands of our 1973 catalogues have been sold—get yours now before they become collector's items. Yes—our catalogue is fully covered by our "satisfaction guarantee". If for any reason you are not satisfied with it, return it and your money (including P.&P. amount) will be refunded in full.
 Note: Any purchase to the value of \$10.00 will entitle you to a free catalogue—please mention if required in your order.
 Dick Smith Electronics Pty. Ltd.
 162 Pacific Highway, Gore Hill 2065 (near Channel 2) 439-5311 (5 lines).

SUPER KITS

Dick Smith "Super Kits" are very special as they have been selected by him for "V.I.P." treatment. At least one of each Kit has been built by Dick Smith or his staff and is on display at the electronics centre. Other features are:
 1. Expensive pre-tinned "silver" boards.
 2. Full copies of constructional articles included.
 3. Any changes in circuits, addendums, etc., are included—saves checking following issues.
 4. Most kits contain "extras" at no cost. These extras have been added where Dick Smith thinks they may be more reliable or where he feels the constructor may have difficulty in purchasing them.

100 WATT AMP. (E.T. OEC. '72)



We have just built our second model of this super-power amplifier and the results are breathtaking—when fed into two Rola 12U50 speakers the amplifier can be heard over a mile away! Remember this amp. has a true power output of 100 watts R.M.S. (not peak).

At the time of going to press we have a stock of the hard-to-get S.T.C. die-cast boxes. However, if supplies run out again we have a special Hammer-toned metal box which we will supply with the kit at no extra charge. The kit, as supplied, comes with special "tinned" boards, pre-punched heatsinks and special notes written by us to make building easier. Also included is a can of heat absorbing spray paint and a quantity of silicon grease for transistor mounting.
 New Low Price: \$65.00. P. & P. \$1.00.

SEPARATE PARTS FOR ABOVE KIT

Metalwork including predrilled heatsinks \$14.50. P. & P. 50c.
 PF 3577 Transformer \$10.60 P. & P. \$1.00.
 ET 1413 Board \$2.20. P. & P. 30c.

PRE-AMP KIT FOR 100W AMP.

We now have available an economical pre-amp kit for the 100W amplifier supplied complete with volume, treble and bass controls the unit allows for guitars or microphones of two sensitivities. The kit includes a pre-tinned circuit board, wiring diagram and all necessary parts other than a case.
 100W Pre-amp. \$9.50 P. & P. 50c.

E.T.I. MASTER MIXER

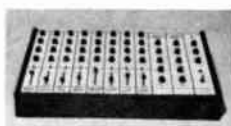

Good enough for studio use this 8 channel mixer has proved extremely popular among band enthusiasts, etc.
 Complete kit of parts: \$189.00 P. & P. \$1.50

JAYEM MODEL 50K MULTIMETER Fantastic Buy



- High Current Scale (0 to 12 amp)
- Compact and Rugged.
- Fully Protected.
- 43 Ranges.

DC Voltage 0-0.3, 0.6, 1.5, 3, 6, 12, 30, 60, 150, 300, 600, 1200.

AC Voltage 0-3, 6, 15, 30, 60, 120, 300, 600, 1200.

DC Current 0-30, 60ua, 1.5, 3, 15, 30, 150, 300 ma, 6, 12 amp.

Resistance 0-3K, 300K, 3 meg., 30 meg. (centre scale 15)

Decibels —10 to +17 db.

Output 0-3, 6, 15, 30, 60, 120, 300 volts.

Accuracy ± 3%.

Sensitivity 50,000 ohms/volt DC
 5,000 ohms/volt AC

DC/Circuit sensitivity = 30 uamp, 120 mv.

Meter Movement 4" meter, 20 uamp full scale.

Size 2 1/2" x 4" x 6"
 \$27.50 (\$24.00) P. & P. \$1.00

DEAR DICK,

Please send me your catalogue. I enclose 50c towards the cost plus 25c to cover p. & p. knowing that it contains special 50c discount vouchers.

NAME _____

ADDRESS _____

POST CODE _____

CATALOGUE AVAILABLE AT NO CHARGE TO ORGANISATIONS, RADIO CLUBS, SCHOOLS, ETC., APPLYING ON OFFICIAL LETTER-HEAD.

DICK SMITH ELECTRONICS PTY. LTD.
 162 Pacific Highway, Gore Hill 2065.

Enjoy top class stereo reproduction with this simple amplifier kit

Here at last is the "do-it-yourself" stereo amplifier kit from Plessey Ducon. This is a simple and easy to assemble kit, capable of producing truly first class reproduction from a 3-3 watt RMS integrated circuit amplifier at a cost far below that of equivalent powered units.

This kit comes complete with clearly defined assembly and testing instructions together with construction details for speaker housings, alternative input wiring for tape and radio and advice on how to choose your turntable, speakers and power transformer.

This kit has been thoroughly tested and proved and contains only the best of local and imported professional quality components.

Assemble and create your own means of music pleasure from a quality sound system that you alone have built.

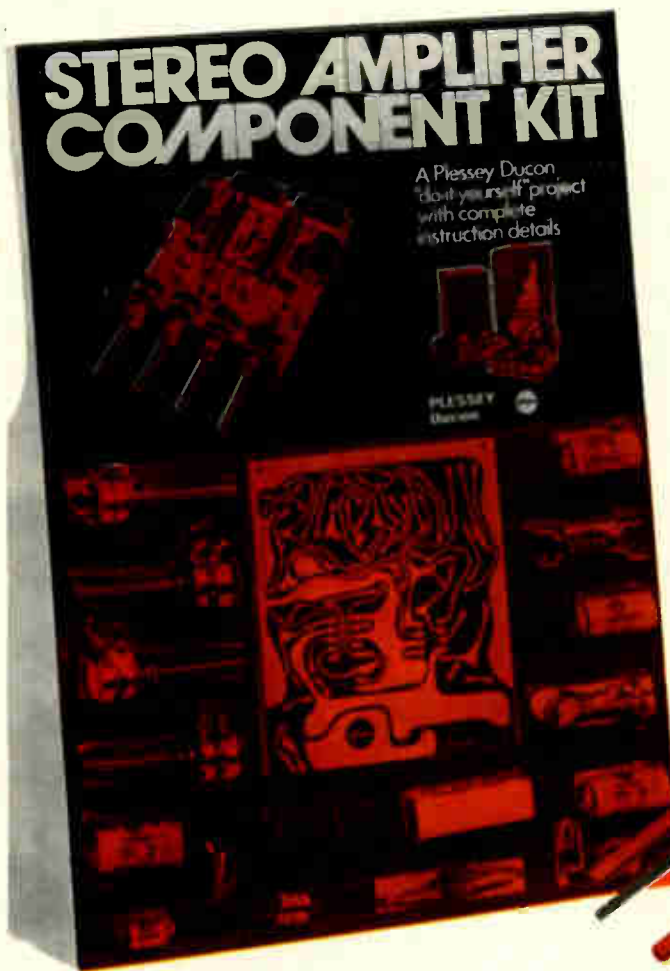

**PLESSEY
Ducon**



Plessey Ducon Pty. Limited, Box 2, P.O. Villawood, N.S.W. 2163
Telephone: 72 0133. Telex: 20384

Melbourne: Zephyr Products Pty. Ltd. 56 7231. **Adelaide:** General Equipments Pty. Ltd. 63 4844. **Brisbane:** Douglas Electronics Pty. Ltd. 97 8222. **Perth:** H. J. McQuillan Pty. Ltd. 68 7111. Everett Agency Pty. Ltd. 8 4137. **N.Z.:** Henderson (N.Z.) 64 189.

AC70

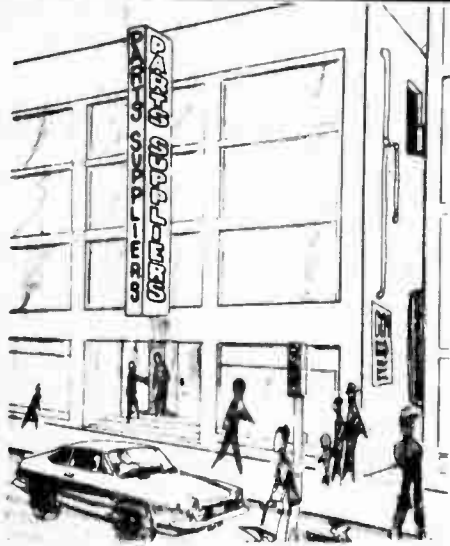

THE COMPANIES LISTED ON THIS PAGE STOCK KITS AND/OR PARTS FOR ETI PROJECTS. THEY DO THEIR BEST TO HAVE ALL PARTS AVAILABLE AS SOON AS POSSIBLE AFTER PUBLICATION. HOWEVER IT MUST BE APPRECIATED THAT DUE TO THE VAGARIES IN SUPPLY AND DEMAND THERE MAY BE OCCASIONS WHEN A PARTICULAR PART OR KIT CANNOT BE SUPPLIED DIRECTLY FROM STOCK. WE WILL EXTEND THIS SERVICE TO COVER ALL STATES AND NEW ZEALAND AS SOON AS POSSIBLE.

NEW SOUTH WALES

A.C.E. RADIO: 136 Victoria Road, Marrickville, 2204. Telephone 51-7008.

JAYCAR PTY. LTD.: 405 Sussex Street, Sydney, 2000. Telephone 211-5077.

EDGE ELECTRIX: 25a Burwood Road, Burwood, 2134. Telephone 747-2931.

DICK SMITH (WHOLESALE) PTY. LTD.: 160 Pacific Highway, Gore Hill, NSW, 2065. Telephone 439-5344.

KITSETS AUSTRALIA: Suite 2, 21 Oakes Avenue, Dee Why, 2099. Telephone 982-5571. 400 Kent St., Sydney. Telephone 29-1005.

NATIONAL RADIO SUPPLIES: 332 Parramatta Road, Stanmore, 2048. Telephone 56-7398.

RADIO DESPATCH SERVICE: 869 George

Street, Sydney, 2000. Telephone 211-0191.

VICTORIA

E.D. & E: 232 Flinders Lane, Melbourne, 3000. Telephone 63-3596.

J.H. MAGRATH & CO: 208 Little Lonsdale Street, Melbourne, 3000. Telephone 663-3731.

KITSETS AUSTRALIA: 271 Bridge Road, Richmond. Telephone 42-4651.

QUEENSLAND

KITSETS AUSTRALIA: 293 St. Paul's Terrace, Fortitude Valley, 4006. 52-8391.

SOUTH AUSTRALIA

GERARD & GOODMAN: 192-196 Rundle Street, Adelaide, 5000. Telephone 23-2222.

TRUSCOTT ELECTRONICS: 62-64 Hindmarsh Square, Adelaide, 5000. Telephone 23-3024.

PRINTED CIRCUIT BOARDS FOR ALL ETI PROJECTS CAN BE OBTAINED FROM R.C.S. RADIO PTY. LTD., 651 FOREST RD. BEXLEY, NSW. 2207. TELEPHONE: 587-3491.

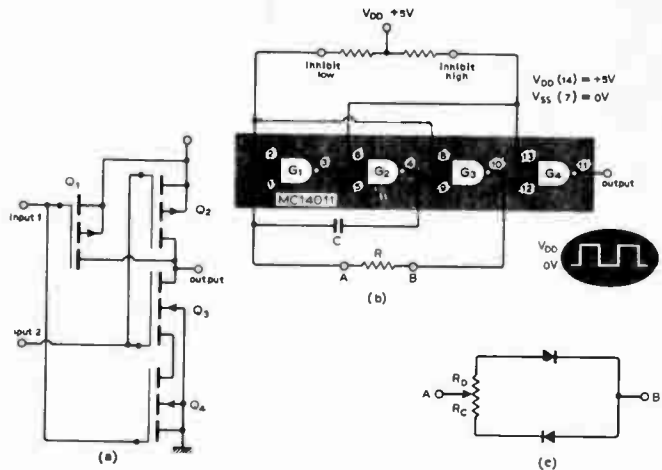
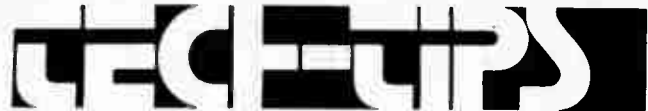

Fig. 1a. The basic circuit of the CMOS NAND gate on which the Astable is based. Fig. 1b. The ultra low frequency astable. Fig. 1c. Insert this network at points AB in place of R to obtain variable mark/space ratio up to 5000 : 1.

5000 SECOND ASTABLE

An astable multivibrator with RC network values as high as 200 M Ω and 25 μ F may be constructed using CMOS logic gates. A simple modification makes it possible to vary the mark-space ratio between wide limits. Mark-space ratios higher than 5000:1 can be achieved.

Such high values of RC frequency determining components are made possible by the almost infinite input impedance of the basic CMOS gate. This high impedance places negligible loading on the RC network, a factor that normally limits the lowest frequency attainable.

As the time constant of 200 M Ω and 25 μ F is 5000 seconds, it can be seen that the circuit can be used to provide long time delays or an ultra low frequency pulse generator.

The gates in the astable multivibrator, shown in Fig. 1b are used as simple inverters with the second inputs being employed to provide an inhibit function. Normally these inputs, pins 2, 6, 8 and 13, are connected to the positive supply line through two resistors and are at logical 1.

Three gates form the astable G₁, G₂ and G₃, and the fourth gate, G₄, performs the function of output buffer.

Gate G₁ monitors the potential at the junction of the timing capacitor (c) and resistor (R). When this potential is below the threshold of G₁, gate 2 connects one end of C to ground and G₃ connects one end of R to V_{DD}.

The capacitor charges through R until the potential at the input of G₁ exceeds the gate's threshold. When this occurs, the output of gate 1 falls to 0, G₂ rises to 1 and G₃ falls to 0. The gates have now connected the resistor to ground and the capacitor to V_{DD}. The capacitor discharges through the resistor until G₁ again switches off. The circuit therefore oscillates at a frequency determined by C and R with a mark-space ratio close to unity.

If the circuit shown in Fig. 1c is connected between A and B in place of R, the two diodes isolate the capacitor charge and discharge paths. Variable resistors in the two paths, or the potentiometer shown, allow the mark-space ratio to be varied over a very wide range.

Grounding the inhibit inputs stops the astable from oscillating and puts the output at either 1 or 0 depending upon which inhibit input is used.

READER INFORMATION SERVICE AND ADVERTISERS' INDEX

For further information on Advertisers listed below complete the coupon/s stating information required including company and position held (if relevant). Cut out the coupon and post to:—

**ELECTRONICS TODAY INTERNATIONAL, RYRIE HOUSE, 15 BOUNDARY STREET,
RUSHCUTTERS BAY, SYDNEY, 2011.**

ADVERTISERS' INDEX

	Page No.
Adcola Products P/L	.53
Alkaline Batteries Aust P/L	.104
Applied Technology P/L	.110
Astronics (A'asia) P/L	.101
Auriema (A'asia) P/L	.42
Australian General Electric Ltd	.68
Australian Musical Industries P/L	2,127
Australian Radio & TV College	.128
Autel Systems	10-11
Babylon Electronics Inc	.66
Bleakley Gray Corp P/L	.9,58,63
Bright Star Crystals P/L	.118
BSR (Aust) P/L	.52
Carr, John & Co P/L	.102
Control Data Aust P/L	.84
Convoy International	.97,99,117
Cunningham, R.H. P/L	.55
Deitron International P/L	.111
Dick Smith P/L	.121
Douglas Trading	.7
Dynasound P/L	.108
Eric Anderson's	.85
Expo International P/L	.88
Ferguson Transformers	.90
Ham Radio Suppliers	69,91
Hewlett Packard Aust P/L	.12
Hi-Liner Stereo Sales	.100
Hi-Tec Electronics	.94
Instrol Hi-Fi & Electronics Centre	56-57
Integral Design	.82
International Correspondence Schools	.79
International Dynamics (Agencies) P/L	70-71
IRH Components P/L	.49
Jacoby Mitchell P/L	82,126
Jervis Australia P/L	6,87
Ka-Zap Records P/L	.41
Kimberley Sales P/L	.105
Kit-Sets Australia	.103
Klarion Enterprises P/L	.99
Lafayette Electronics	95,118
Leroya Industries P/L	30,100
Magna Techtronics P/L	.120
Manufacturers Special Products	.119
Maurice Chapman & Co P/L	.77
McMurdo (Aust) P/L	.47
Melody School of Music	.95
Miranda Stereo & Hi-Fi Centre	.20
Modern Books & Plans	.94
MS Components	.39
Pacific Stereo	.27
Parameters P/L	.90
Philips Industries	.4
Plessey Ducon P/L	8,122
Plessey Rola P/L	.113
Pre Pak Electronics	92-93
Radio Parts Group	.35
Ralmar Agencies P/L	.50
Rose Music P/L	.40
Scientific Electronics P/L	.108
Sonab of Sweden	14,15
Tecnico Electronics	.97
Teknis P/L	.90
TV Tuner Service P/L	.97
Union Carbide	.60
United Trade Sales P/L	.95
WC Wedderspoon P/L	.75,80,106
Weston Electronics Co	.82
World Record Club	.89
Wright Audio Developments	.28
Yunker Electronics P/L	.118
Zephyr Products P/L	.104

Four reply coupons are provided here for your convenience. Please list only ONE advertiser and ONE product on each coupon. If you require information on more than four individual products, make as many copies of the coupons as you like (preferably typed)—again using one coupon form for each product.

	Send to: ELECTRONICS TODAY INTERNATIONAL, Ryrie House, 15 Boundary Street, Rushcutters Bay, Sydney, 2011.
ADVERTISER	_____
PRODUCT	_____
NAME	_____
ADDRESS	_____
	POSTCODE
COMPANY	_____
POSITION	_____
	5:73
<hr/>	
	Send to: ELECTRONICS TODAY INTERNATIONAL, Ryrie House, 15 Boundary Street, Rushcutters Bay, Sydney, 2011.
ADVERTISER	_____
PRODUCT	_____
NAME	_____
ADDRESS	_____
	POSTCODE
COMPANY	_____
POSITION	_____
	5:73
<hr/>	
	Send to: ELECTRONICS TODAY INTERNATIONAL, Ryrie House, 15 Boundary Street, Rushcutters Bay, Sydney, 2011.
ADVERTISER	_____
PRODUCT	_____
NAME	_____
ADDRESS	_____
	POSTCODE
COMPANY	_____
POSITION	_____
	5:73
<hr/>	
	Send to: ELECTRONICS TODAY INTERNATIONAL, Ryrie House, 15 Boundary Street, Rushcutters Bay, Sydney, 2011.
ADVERTISER	_____
PRODUCT	_____
NAME	_____
ADDRESS	_____
	POSTCODE
COMPANY	_____
POSITION	_____
	5:73

(Continued from Page 14)

NEW COMMUNICATIONS SYSTEM

A GEC-Marconi electronics engineer assembles a part of a revolutionary communications system, now in operation at the company's research laboratories in southern England, that will transmit 300,000 telephone conversations and 200 colour television signals simultaneously through a 50mm diameter circular waveguide.

This new "pipe", developed under a contract for the British Post Office, offers the basis of a practical solution to the problem of high capacity communications of the future. It is capable of supporting signals throughout the frequency band from about 32 to 110 GHz and, with this available bandwidth, the number of telephone, television and data channels which can be

accommodated is greater than could be envisaged by any other single means.

A second Post Office contract was awarded to Marconi in 1972 to develop and produce terminal and

repeater equipment for an experimental system by Spring of this year. This will employ the latest high-speed digital transmission techniques and will be used in conjunction with the waveguide "pipe".



EUROPE'S COSMIC RAY SATELLITE

The engineering model of COS-B, the European Space Research Organisation's (ESRO) eighth scientific satellite, is seen here in the British Aircraft Corporation's spacecraft assembly building in the west of England.

Unlike previous ESRO satellites, where the payload is built into the

satellite's structure, the size and complexity of COS-B's scientific payload (a gamma ray telescope) forms a major part of the satellite around which the structure and supporting systems will be built. COS-B will study cosmic rays from the galaxy, measuring their intensity, direction and distribution. Launch is planned for September 1974.

MAGNETIC TAPE RECORDER FOR AERONAUTICAL ENGINE TESTING

An accurate, 42-track, magnetic tape recording system introduced recently by a British firm is being used by the National Gas Turbine Establishment, in southern England, for the simultaneous measurement and recording of 40 separate engine intake pressures.

The National Gas Turbine Establishment is concerned principally with simulated altitude testing of aeronautical gas turbine engines, and is currently involved in the Concorde, RB 211 and MRCA RE 199 projects.

The new tape recorder — known as the Series SE 5000 — meets the stringent requirements essential to this



(Continued on Page 126)

news digest

sophisticated industry, simultaneously monitoring both selected channel input and output signals on a dual beam oscilloscope by the operation of a single push button. The push button 'interlock' is said to eliminate the possibility of data corruption while improving the calibration of the data.

The unit was made by SE Laboratories (Engineering) Ltd., North Feltham Trading Estate, Feltham, Middlesex, England.

MOTORWAY COMMUNICATION SYSTEM USES CMOS

An advanced data transmission system, designed and manufactured in Britain by AP Electronics of Chiswick, has been ordered by the Northern Ireland Ministry of Development to control the roadside telephones on the M2 motorway.

The system, which can replace a 185-core cable with just two wires, is interesting in that it is one of the first commercial examples of a complex logic network constructed from CMOS (Motorola's CMOS family).

The system comprises a central control station which is connected to a remote station by two wires for control and two wires for speech. The remote station, in turn, feeds the roadside telephones. Expansion is possible to 24 x 184 channels using the same pair of wires.

The most important advantage offered by AP Electronics' system in the motorway application is that the operator can 'dial' any of the roadside telephones (not possible with current installations) so that emergency situations involving risk to life can be handled before mechanical breakdowns, punctures and the like.

There were three main reasons why the CMOS logic family was chosen for the system. First, because the remote and control stations might be separated by as much as 20 miles of unscreened cable, noise immunity was of paramount importance. AP Electronics run the CMOS logic with a V_{DD} of 12 V so that, with the noise immunity of 45% of V_{DD} specified for CMOS, noise spikes of 5 V and more are ignored by the system.

The choice of a 12-V V_{DD} leads to the second reason why CMOS was employed. Data transmission between the remote and control stations is handled by two modems which require a stabilised 12-V supply. The wide

supply voltage tolerance of CMOS, from 3 to 18 V, meant that the logic could share the modems' power supply. In other words, it was not necessary to design and build a special power supply for the logic.

The third reason for using CMOS was power consumption. The data transmission system can be expanded in blocks of 8, 16 or 24 channels to a maximum of 184 channels. Due to the use of CMOS, a combined transmitter receiver unit for 184 channels consumes only 150 μ A per channel from the 12-V supply. In the Northern Ireland installation, a small 1.5 AH battery is all that is required to run the system continuously for 24 hours should the mains power supply fail.

The AP Electronics data transmission system, made possible by CMOS, has numerous applications apart from motorway telephone systems, including road and rail signals, remote unmanned out-stations or anywhere where a two-wire multichannel remote control and monitoring system is required.

The equipment was designed and is manufactured in Australia. It is suitable for use as a mobile unit in sedan or bulldozer, locomotive or truck.

Further details from:— Philips Telecommunications Manufacturing Company Limited, Clarinda Road, Clayton, Victoria 3168.

Built for ACCURACY with rugged design to RETAIN it— JAYEM M/METERS

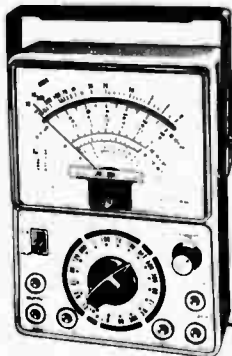

- with
- MAGNETICALLY SHIELDED METER
 - BUILT-IN DIODE METER PROTECTION
 - 'OFF' POSITION TO PROVIDE METER DAMPING DURING TRANSIT

These compact rugged meters give excellent accuracy and easy to read scales.

Highly sensitive ranges for measurements in transistor circuits • single-knob range/function control • for simple operation.

JAYEM Model 100K

51 Ranges: DC Voltage - 0-1,200; AC Voltage - 0-1,200; DC Current - 0-12A • Resistance - 0-20 M Ω (centre scale 20); Decibels - -20 to +63 in 6 ranges; Output - 0-300V • Accuracy: \pm 3% full scale, DC voltage and current; \pm 4% full scale, AC voltage • Sensitivity: 100,000 ohms/volt DC (50,000 in VA/2 position); 10,000 ohms/volt AC (5,000 in VA/2 position); DC circuit sensitivity = 15 μ A, 300 mV • Meter Movement: 5" meter, 9 μ A full scale • Batteries: Requires 2 type C cells for ohms function • Size: 2 1/4" x 7 1/2" **\$30.00** PLUS SALES TAX

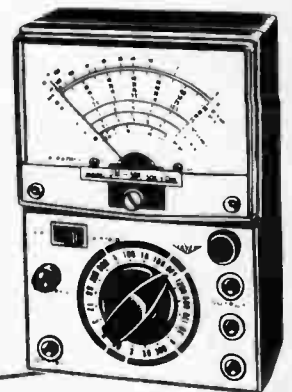

JAYEM Model 50K

43 Ranges: DC Voltage - 0-1,200; AC Voltage - 0-1,200; DC Current - 0-12A • Resistance: 0-30M Ω (centre scale 15); Decibels - -10 to +17 dB; Output - 0-300V • Accuracy: \pm 3% full scale, DC voltage and current; \pm 4% full scale, AC voltage • Sensitivity: 50,000 ohms/volt DC (25,000 in VA/2 position); 5,000 ohms/volt AC (2,500 in VA/2 position); DC/circuit sensitivity = 30 μ A, 120 mV • Meter Movement: 4" meter. 20 μ A, full scale • Batteries: Requires 3 type AA penlight cells for ohms function • Size: 2 1/4" x 6" **\$22.50** PLUS SALES TAX

Distributed by:

**JACOBY
MITCHELL**
and SELECTED DISTRIBUTORS

SYDNEY: 630 7400
MELBOURNE: 41 7551
BRISBANE: 44 4674
ADELAIDE: 93 6117
PERTH: 28 5725
CANNBERRA: 95 9138

JM/117-73



Bi-directional record and playback tape deck Model A-4070

- 4 Ferrite heads (6 head function) ● Reel size 7"
- Tape speed 3¾ ips and 7½ ips ● Triple motor mechanism ● Wow and flutter .06% at 7½ ips ● F/R 25 to 24,000 Hz at 7½ ips
- S/N ratio 58dB

**Make music-
not noise**

You may not realise it, but until now, even the best tape decks allowed a degree of noise during recording and playback. This may have been all right for conventional tapes, since they were far from perfect.

But with the recent introduction of the low noise/high output tapes, it's no longer permissible.

Which brings us to a new generation of decks by TEAC. And TEAC calls them Superior Sound/Low Noise decks: decks designed to get the most out of the low noise tapes as well as the conventional types.

Five of these new generation decks are described here. If you'd like to know more, write to us and we'll send you further information (catalogue, dealer list and price list) on the unit(s) that interests you.

TEAC

A Sound Idea.



Stereo Tape Deck Model A-3300

- Reel size 7" ● Tape speed 3¾ ips and 7½ ips ● Triple motor mechanism ● Wow and flutter .06% at 7½ ips
- F/R 25 to 24,000 Hz
- S/N Ratio 55dB



Stereo Tape Deck Model A-1230

- 3 heads-4-head function
- Reel size 7" ● Tape speed 3¾ ips and 7½ ips ● Triple motor mechanism ● Wow and flutter .08% at 7½ ips
- F/R 30 to 22,000 Hz at 7½ ips ● S/N Ratio 55dB



Automatic Reverse Stereo Tape Deck Model A-1250

- 3 heads-4-head function
- Reel size 7" ● Tape speed 3¾ ips and 7½ ips
- Triple motor mechanism ● Wow and flutter .08% at 7½ ips ● F/R 30 to 22,000 Hz at 7½ ips ● S/N Ratio 55dB



Combination Head Stereo Tape Deck Model A-1030

- Reel size 7" ● Tape speed 3¾ ips and 7½ ips ● One motor mechanism ● Wow and flutter .08% at 7½ ips
- F/R 30 to 22,000 Hz at 7½ ips ● S/N Ratio 55dB
- Auto. Shut-off

40,000 technicians can't be wrong.

- More than 40,000 ambitious men have benefited from A.R.T.C. training.
- Join this large number of successful men.
- Attain job security and financial reward.
- These can only be yours from:
THE AUSTRALIAN RADIO & TELEVISION COLLEGE
- Established over 40 years.
- Over 15 full-time staff to assist you.
- Full night-class practical lessons,
or
- Extensive correspondence training with special practical home-training kits.

AUSTRALIAN RADIO AND TELEVISION COLLEGE PTY. LTD.

E.S.&A. BANK BUILDING, CNR. BROADWAY
AND CITY ROAD, SYDNEY, (OPP. GRACE
BROS), PHONE 211-4244 (3LINES).

T305

AUSTRALIAN RADIO & TELEVISION COLLEGE PTY. LTD.
206 BROADWAY, SYDNEY, N.S.W.

Dear Sir,
Please send me without obligation, your free booklet,
"Careers in Radio, TV and Electronics".

NAME:

ADDRESS:

.....POSTCODE

MAIL COUPON NOW

You are invited to mail the coupon which can be your first step towards securing a job or business of your own with good prospects, security and big money. A.R.T.C. will mail to you by return, at no obligation to you the big free booklet: "Careers in Radio and Television". This booklet will show you definite steps you can take for a better job, how you can succeed in life. Post the coupon, phone or call NOW.

