

AUSTRALIA'S DYNAMIC MONTHLY

FEBRUARY 1972 50c

# electronics

*Steven Palmer*

## TODAY

HOW  
SPACE  
FLIGHTS  
ARE  
TRACKED

### SCOOP TEST: FERROGRAPH DOLBY RECORDER

CHOOSING A RECORD PLAYER 3 PRACTICAL PROJECTS DAMPING FACTOR CONTROVERSY  
SOLVING SIGNAL/NOISE PROBLEMS AR-6 TEST HOW TO DESIGN CROSSOVER NETWORKS

# electronics TODAY

FEBRUARY

Vol. 1 No. 11

## main features

- SPACE TRACKING STATIONS** .....16  
*The role of a tracking station in space exploration — exclusive story*
- A CONSUMER'S GUIDE TO RECORD PLAYERS** .....27  
*What to look and listen for when choosing your record player.*
- SIGNAL/NOISE RATIO** .....30  
*Its optimization in precision measuring systems.*
- DAMPING FACTOR — JUST A SALES GIMMICK?** .....42  
*Controversial article discusses effect of amplifier output impedance*
- RADIO ASTRONOMY FOR AMATEURS — PART III** .....46  
*This article describes the principle of the radio interferometer.*
- CROSSOVER NETWORKS — HOW TO DESIGN THEM** .....56  
*Complete design data for two and three-way crossover networks.*
- ELECTRONIC TORQUE-MEASURING SYSTEM** .....62  
*New torque measuring system uses inductive signal transmission.*
- HOW NOISE REDUCTION SYSTEMS WORK** .....64  
*The Dolby and the Philips noise reduction systems — full details*
- FINE MEASUREMENT IN GEOPHYSICS** .....76  
*Instrumentation problems involve many engineering disciplines*
- OPTICAL LEVITATION** .....116  
*New scientific discovery has many engineering applications.*

## projects

- OSCILLOSCOPE CALIBRATOR** .....41  
*Build this simple voltage calibrator into your oscilloscope*
- WIDE-RANGE VOLTMETER** .....50  
*This solid-state meter has 22 ranges — from 10mV to 1000V ac/dc*
- TWO BATTERY-SAVERS** .....68  
*Run your battery operated appliances from the mains or car supply.*

## product tests

- AR-6 BOOKSHELF SPEAKERS** .....22  
*The best true 'bookshelf' system that we have yet heard*
- A FIRST FOR FERROGRAPH** .....72  
*We test the first reel-to-reel Dolby recorder — World Scoop Report.*

## reviews

RECORDINGS — CLASSICAL, 103; RECORDINGS — JAZZ, 107;  
POP TRENDS — 111; BOOK REVIEWS, 117.

## news & information

NEWS DIGEST, 6; EQUIPMENT NEWS, 89; COMPONENT NEWS, 98;  
AUDIO NEWS, 100; MICRO-ADS, 118; SUPPLIER'S GUIDE, 119;  
INPUT GATE (READERS' LETTERS) 120; TECH TIPS 123.

COVER: The main antenna at Australia's Honeysuckle Creek space tracking station. Full story on space tracking station — page 16.

ELECTRONICS TODAY — FEBRUARY 1972

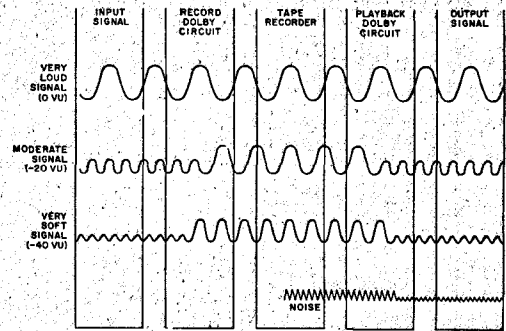
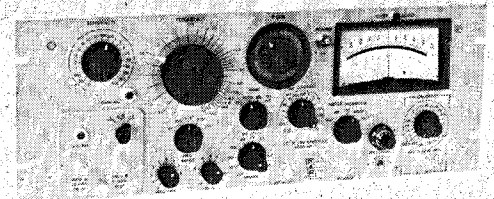
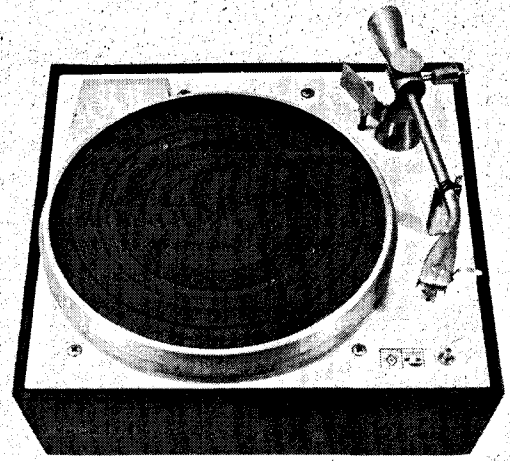

Published by MODERN MAGAZINES (HOLDINGS) LIMITED, 21-23 Bathurst Street, Sydney 2000. Phones: 26-2296, 26-6129. Cables: MODMAGS SYDNEY. Managing director: Colin Ryrie. Editor-in-chief: Jules Feldman. General advertising manager: Max Press. INTERSTATE advertising — Melbourne: Clarrie Levy, Suite 23, 553 St. Kilda Rd. (51-9776). Adelaide: W.J. Parkinson, A.C.P., 24 Halifax St. (8-4121). Brisbane: David Wood, Anday Agency, 329 Adelaide St. (2-2735). OVERSEAS — United Kingdom: A.C.P., 107 Fleet St., London EC4. U.S.A.: A.C.P., Room 401, 1501 Broadway, New York. Printed by Conpress Printing Ltd., O'Riordan St., Alexandria. Distributors: Australian Consolidated Press. (\*Recommended and maximum price only.) COPYRIGHT.

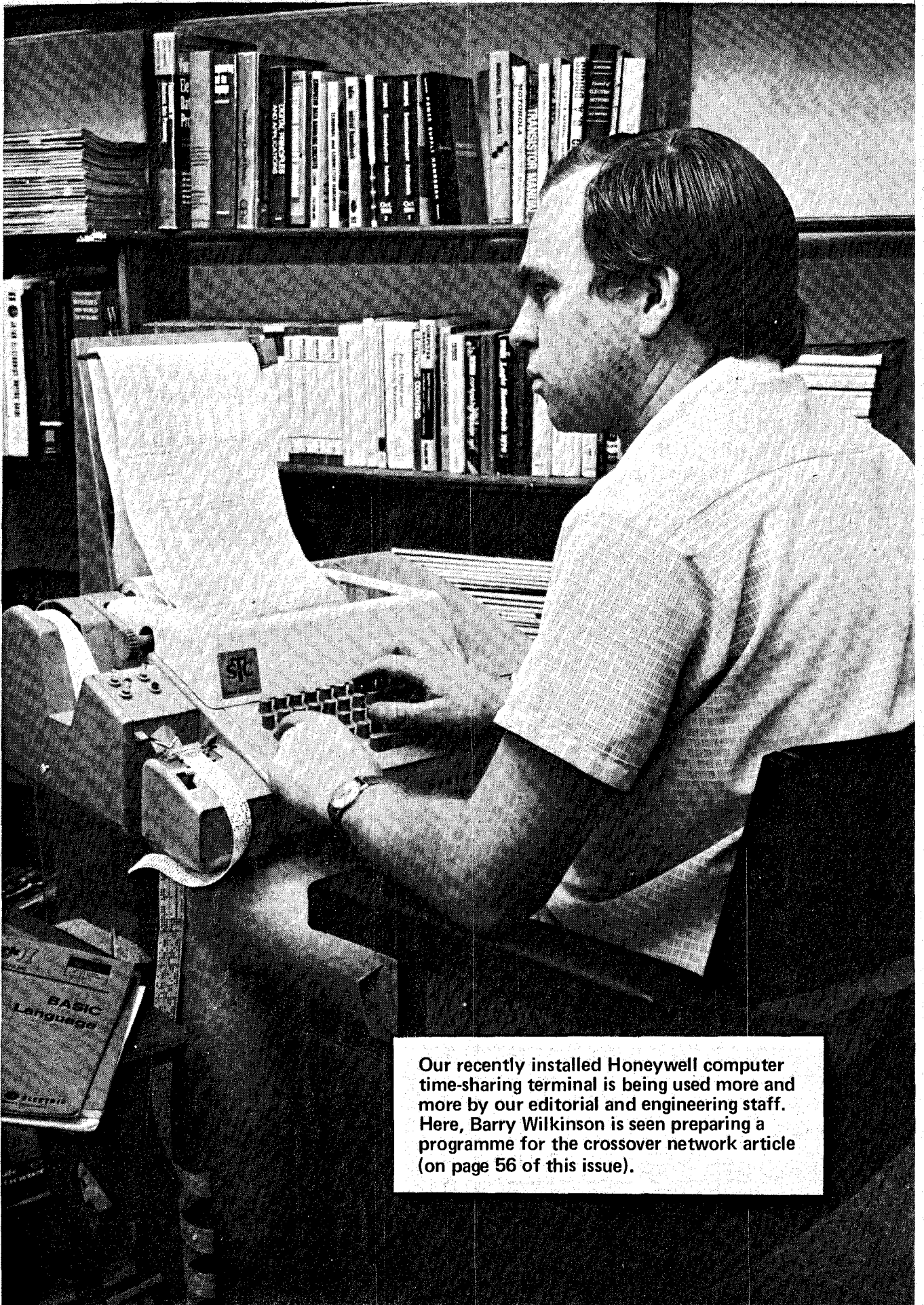

Our recently installed Honeywell computer time-sharing terminal is being used more and more by our editorial and engineering staff. Here, Barry Wilkinson is seen preparing a programme for the crossover network article (on page 56 of this issue).



*Collyn Rivers, Editor*

*Engineering Manager:  
Barry Wilkinson*

*Projects Adviser:  
Kim Ryrie*

*Laboratory Technician:  
Rob Giumelli*

*Review Editor:  
John Clare*

*Art Director:  
Clive Davis*

*Howard Jenkins  
Advertising Manager*

*Melbourne Manager:  
Clarrie Levy*

*Representative (Sydney):  
Terry Marsden*

*Advt. Production Manager:  
John Oxenford*

*Acoustical consultants  
Louis A. Challis & Associates*



*Bob Izzard  
Production Manager*

# true hi-fi or musical furniture?

**A** number of readers have taken us to task for not running product tests of low-priced modular stereo systems. Not everyone, they say, can afford first-class hi-fi equipment.

But a test based on any normal testing parameters would be irrelevant, for low-priced modular units are not hi-fi equipment — they are musical furniture,

It would be like asking a motoring magazine to test bicycles.

A number of good hi-fi systems can be purchased for as little as \$350, and in today's economy this is not a large amount to pay for something that will last practically a lifetime.

## beyond reason, too

**B**eyond Freedom and Dignity' is probably the most significant book, in the field of behavioural science, ever to be published. It is a book of immense importance to us all.

The implications of this book are so wide that Time magazine published a seven-page review and featured the author — Professor Skinner — on the cover.

Practically every scientific publication and national newspaper in the world has reviewed this remarkable book. Our own review was published last December.

Yet, incredibly, this book cannot be bought in Australia!

Why? — Simply because the American publishers have sold the rights for other English-speaking countries to a publisher in Britain, and the agreement precludes the American publisher selling his edition in Australia.

So we must wait until the English publisher exports his edition to us.

By what right do two foreign nations decide what Australians may read — and when?

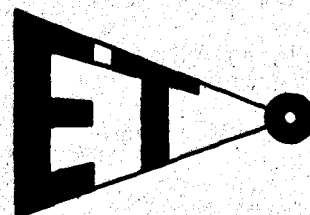

# AWA EXPORTS

## AWA WINS EXPORT AWARD



Winner of an Export Award, Amalgamated Wireless (Australasia) Ltd. has a background of 58 years in the wireless and electronics industries and a history of exporting dating back to shortly after its formation in 1913.

The Award for "outstanding export achievement", was presented to A.W.A. Managing Director, Mr. J.A.L. Hooke, by the Federal Treasurer, Mr. B.M. Snedden, at a function in Canberra.

It is in recognition of tangible success in export markets, aggressiveness in developing export sales and provision of services which contribute to the growth of Australia's export earnings.

AWA's first serious impact on the export field was in 1936 when the potential of a six-valve broadcast receiver was recognised and sample models were sent overseas. When World War II broke out, the Company held orders for many thousands but the programme had to be deferred until civil production was permitted. The Company appointed a network of overseas distributors to supplement those functioning prewar and the equipment was shipped to Africa, Asia, South East Asia and the Pacific areas.

Concentration had so far been on consumer products but in 1949 a wide range of engineering products were made available for export.

A.W.A. supplied and supervised the installation of an overseas telecommunications service, internal radio

communications network and coastal radio service for the Pakistan Posts and Telegraphs Department valued at more than \$1 million. Although initial shipments were made under an Aid Programme, these were followed by substantial commercial orders.

Police radio communication equipment has been exported to Kenya, Tanzania, Uganda, Syria, Lebanon, Thailand, Hong Kong and New Guinea. Transmitters and studio equipment were supplied to broadcasting services in New Zealand, Malaysia, Singapore, Hong Kong, Malta, Fiji and other areas.

Against strong competition from British, continental and U.S.A. manufacturers, A.W.A. gained a contract from the South African Civil Aviation Department for an H.F. radio communications network covering all major airports in the Union and a subsequent order for control equipment.

Up to 1965, a high percentage of the Company's exports consisted of capital equipment such as high-power communications and broadcast transmitting equipment.

In recent years, there has been a change in the Company's approach, greater emphasis being placed on exports such as low-power communication equipment, test instruments and broadcast studio equipment. The success of this is shown by the marked growth in the export market over the past four years.

## TAPE CARTRIDGE SYSTEM

A new tape cartridge system called the HIPAC system, combining the features of conventional 8-track tape cartridges and cassette tapes, has been developed in Japan.

The Pioneer Electronic Corporation fulfilled a leading role in the development of the cartridge and accompanying recording/playback equipment, and also took the initiative in the formation of a consortium that is marketing the HIPAC system.

The need for the new cartridge was dictated by a number of factors. First and foremost, it was recognized by one and all that there was a tremendous growth potential in the packaged tape market in the seventies, a potential which predicted that packaged tapes could very easily assume a position superior to disc records.

However, it was also recognized that existing 8-track tape cartridges and cassette tapes had a number of inherent problems.

Eight-track tape cartridges are bulky and cumbersome to handle and, because of their design, there is the risk of fluctuations arising in pinch-roller pressure, which often leads to undesirable "wow" and "flutter" in tape motion.

On the other hand, cassettes, while compact and handy in size, require a complex tape drive mechanism; and also require automatic reversing devices for continuous uninterrupted recording and playback.

These problems indicated that a new tape cartridge, solving these inherent shortcomings, would serve as an impetus to the popularization and widespread use of packaged tapes in the future.

The new HIPAC tape cartridge embodies the following features:

- small in size (70 x 85 x 12 mm; weight 50 g);
- unlike cassette tapes, the HIPAC uses an "endless" tape for continuous, uninterrupted operation. This also facilitates operation on a relatively simple drive mechanism; provides trouble-free operation; and also lowers production costs;
- handling is simplified; there is no need to stop the machine and then turn the tape over;
- because of the small size of the cartridges, the size of the drive mechanism can also be reduced, a

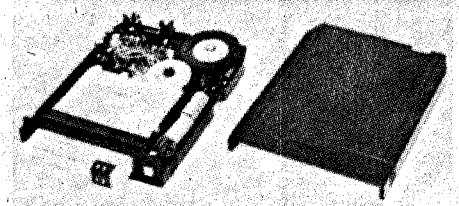

(Turn to page 11)

# The World's 1st Multi-range Volt-Ohm-Ammeter with 17 AC, DC measuring ranges

SNAP SERIES

# KEW SNAP

The KEWSNAP 7 is different from conventional models on the market today because it has far more. This one handy instrument is all that is needed for easy, accurate measurement of current and voltage, AC or DC and also resistance.

Both AC and DC current up to 600 amperes can be measured without breaking the circuit. Current detection is accomplished by means of a unique detector circuit. A rotating scale, pointer lock, 1.85, high jaw opening, ABS case, 3% accuracy are features of the instrument.

The KEWSNAP 7 is an invaluable aid for servicing in electric power authorities, electric railways, air conditioning equipment manufacturers and other heavy duty industries. Its wide range DC current measuring capability makes it a "must", not only for electrical contractors, but also for the automotive industry, the electroplating industry, telephone exchanges, computer installations, the electro-chemical industry and many others.

Send now for informative literature and technical details.

ALAN SHAW ELECTRO-TECHNICALS  
**JACOBY & MITCHELL**

SYDNEY  
MELBOURNE  
ADELWAIDE

300 7400  
30 2491  
98 6111

BRISBANE  
PERTH  
WALNUTS

44 4377  
28 6725  
25 222

# Already discerning enthusiasts have set two recently released And it's not

Both Sansui products . . . the Model 210A stereo tuner/amplifier and the Model AU-101 stereo control amplifier . . . offer extraordinary value for money. In terms of sheer performance no other similarly priced amplifier available in Australia today can match or surpass the 210A or the AU-101, including some products *twice the Sansui price.*

#### SANSUI MODEL AU-101 STEREO AMPLIFIER

Two leading Australian electronics magazines have reviewed the all low-noise silicon transistor Sansui Model AU-101. "*Electronics Australia*" (August, 1971) says . . . "*the best comment we can make about the AU-101 is that few amplifiers, regardless of price, give an overall test result as good as this. This makes it a real bargain at the very reasonable price of \$138*". "*Electronics Today*" (May, 1971) says . . . "*Surprise Packet*" . . . "*Performance of the Sansui AU-101 belies its low price*" . . . "*The hum and noise performance are both very good and better than most other amplifiers at twice the price*" . . . "*The Sansui AU-101 is a very good buy, particularly at the price*".

There you are . . . unbiased comments from two leading publications. What precisely does the Sansui AU-101 offer? Look at these specifications!

**AU-101 Specifications:**— ● Music power: 50 watts at 4 ohms, 44 watts at 8 ohms. ● R.M.S. power: 36 watts at 4 ohms, 30 watts at 8 ohms. ● Total harmonic distortion: Less than 0.8% at rated output. ● Frequency response: 20-60,000 Hz.  $\pm 2$  dB. ● Channel separation: Better than 45 dB. ● Input sensitivity: 3 mV. (Magnetic cartridge), 4 mV. (Microphone), 200 mV. (Auxiliary and Tape Recorder). ● Dimensions: 16" x 11" x 4 1/2". ● Price: \$138\* (Suggested list price inc. sales tax).

#### SANSUI MODEL 210A STEREO TUNER/AMPLIFIER

The recommended list price of the Model 210A stereo tuner/amplifier is only \$185\*. Power output is 34 watts music power into 4 ohm speaker systems or 22 watts R.M.S. Frequency response is 25-30,000 Hz.  $\pm 2$  dB. and extends well beyond this figure. Sensitivity of the power amplifier suits magnetic cartridges at 3 mV. and 180 mV. sensitivity caters for auxiliary inputs and tape recorders.

An easily read panoramic tuning dial simplifies selection of radio stations on AM/MW or AM/SW bands; a signal strength meter operates on the AM band. Selectivity is an almost unbelievable 40 dB. making the 210A the *most selective receiver Sansui has ever made*. This radically improved selectivity is directly attributable to Sansui's use of two ceramic filters each with two filter elements in the 210A's I.F. amplifier section. A whistle filter eliminates unpleasant interference and noise on weak AM stations. Every desirable control is provided in the Sansui 210A . . . a DIN socket for tape recorders, headphone jack, flexible bass and treble controls, a direct tape monitor switch, loudness control and clearly marked selector switch.

When you call at your franchised Simon Gray dealer to hear the Sansui 210A, *listen critically*. You'll be agreeably surprised with the audible difference Sansui quality makes. Only Sansui — Japan's leading audio only manufacturer — could design and manufacture an outstanding stereo tuner/amplifier expressly for Australian conditions and keep the price down to only \$185\*! **Call and see your Simon Gray dealer!**

**\*IMPORTANT:** Prices quoted in this advertisement are suggested consumer prices only.



*Simon Gray Pty. Ltd.*

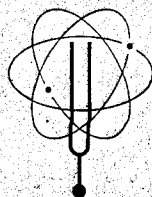

**Sansui Distributors: Australia, excluding W.A.:** Simon Gray Pty. Ltd. **Head Office:** 28 Elizabeth Street, Melbourne. 3000. Tel. 63 8101\*. Telex: 31904. **Sydney Office:** 53 Victoria Avenue, Chatswood. N.S.W. 2067. Tel. 40 4522\*. **Canberra Office:** 25 Molonglo Mail, Fyshwick, A.C.T. 2609. Tel. 95 6526. **Adelaide Office:** 301 South Terrace, Adelaide, S.A. 5000. Tel. 23 6219. **N.T.:** Pfitzner's Music House, Smith Street, Darwin. 5790. Tel. 3801. **Qld.:** Sydney G. Hughes, 154-158 Arthur Street, New Farm, Brisbane. 4005. Tel. 58 1422. **Tas.:** K. W. McCulloch Pty. Ltd., 57 George Street, Launceston. 7250. Tel. 2 5322. **W.A. Distributors:** Carlyle & Co. Pty. Ltd., 1-9 Milligan Street, Perth. 6000. Tel. 22 0191. **Sansui equipment is manufactured by:** Sansui Electric Co. Ltd., 14-1, 2-chome, Izumi, Suginami-ku, Tokyo, Japan.

# Australian stereo new sales records for **SANSUI AMPLIFIERS.** surprising.



**Ask for full details.  
Send the coupon  
right away and  
we'll send you all  
the facts!**

Simon Gray Pty. Ltd.,  
28 Elizabeth Street,  
Melbourne, 3000.

Please send me complete technical details on the Sansui Model 210A/AU-101 and the name of my nearest Simon Gray franchised dealer.

NAME.....

ADDRESS.....

POSTCODE.....



**DECORATIVE/FUNCTIONAL/RELIABLE/**This extensive range of Rodan indicator lamps, in both incandescent and neon styles, is designed for compatibility with and to enhance the presentation of electronic, electrical and industrial equipment . . . equipment in which space saving, long life indicators are essential. Features of the range include/long life (up to 100,000 hours)/Coloured lens in either red, yellow, green, blue or white./One hole mounting./Styles providing front-of-panel replacement./Styles with insertable lens— Suitable for symbol adaption and ideal for digital readouts./Clip-in bezel mounting styles./Chrome plated bronze or moulded plastic housings. The range is available from the Professional Components Department, Villawood, N.S.W. or Plessey Ducon Interstate Offices. Descriptive literature is available on request.

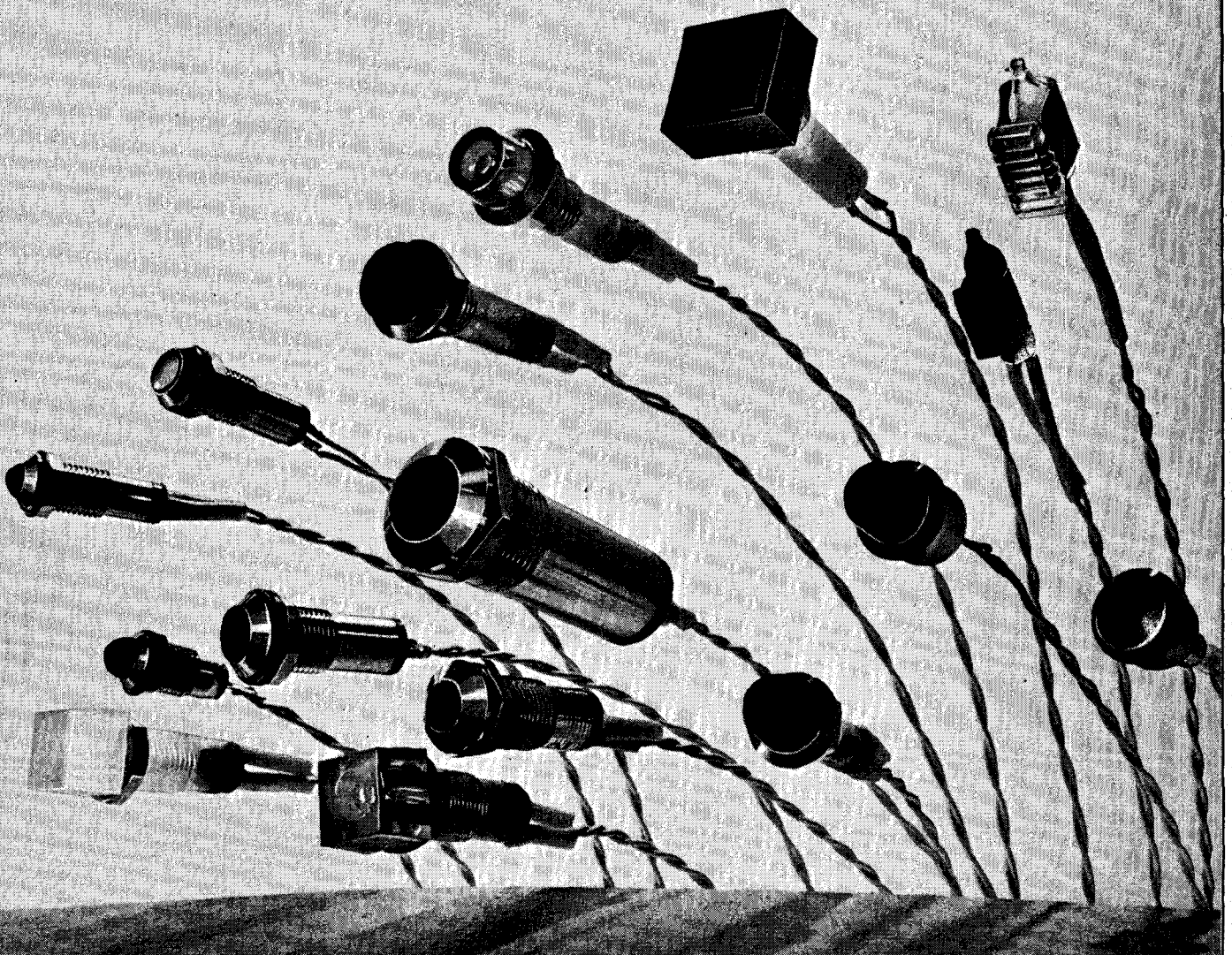

**PLESSEY**  
**Ducon**



PO Box 2 Villawood NSW 2163. 72 0133 /Perth 21 4821/Henderson (NZ) 64 189

AD34

# news digest

great advantage in designing stereo systems for motor cars;

- outstanding tonal quality;
- 2-speed operation is possible (can be operated at either 4.8 cm/s or 9.5 cm/s on the same tape drive mechanism);
- 4 tracks;
- maximum playing time: 60 min (at 4.8 cm/s).

Pioneer predicts that the new cartridge and accompanying hardware will, in due course, come to occupy a position equal to, if not surpassing, that presently held by 8-track tape cartridges or cassettes.

## VOICE DIALLER



Development engineers at Bell Telephone Laboratories in Holmdel, New Jersey are working on a device that can dial telephone numbers when given spoken commands.

The system consists of a clockface with ten lights labelled with the numbers nought to nine. The lights are illuminated in numerical sequence.

To 'dial' a number the user makes a sound - any sound at all will do - as the required digit is illuminated. As each number is spoken, the associated lamp remains lit for an extended period, to indicate that the digit has been registered.

Each digit is stored - in the correct sequence - in a memory bank. The stored digits are then used to initiate the telephone dialling circuit upon command.

The stored number remains in the memory bank even after the dialling sequence and can be reused if the number is not immediately available. The number is automatically erased when a new series of digits is generated by the user.

# Sydneys' LEADING HIFI Specialist Centre

has all leading brands at Sydney's leading prices

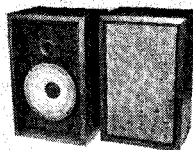

LS 150  
Speaker

## TEAC

SYDNEY'S LARGEST  
RANGE OF TEAC  
SPECIALIST EQUIPMENT  
ON DISPLAY



Teac A - 350  
Dolby



## AUTEL SYSTEMS Pty. Ltd.

20 Pittwater Rd., Gladesville, N.S.W. , 2111  
Telephone 89 0663

Open All day Saturday -  
JVC NIVICO and TEAC Authorised warranty repair centre.

## \$80 CALCULATOR



This pocket-sized electronic calculator has been developed by Ragan Precision Industries in the USA. It will be marketed by Alexanders — a large New York department store — at less than \$80!

The new calculator will add, subtract, multiply and divide, and provide an eight digit result with floating decimal point. The unit is 2 3/8" wide (roughly the width of this column) 3 1/2" high by less than 1" thick and weighs less than eight ounces.

The arithmetic operations are performed by complementary metal oxide logic chips. A liquid crystal display is used for the readout.

By using these techniques the maker's claim that the unit will operate for at least 2000 hours on its inbuilt 12 volt battery — compared to the three to four hours typical of many present calculators.

## IONOSPHERIC PREDICTION

The Ionospheric Prediction Service is currently carrying out research into unusual VHF propagation, with particular interest in trans-equatorial propagation and VHF propagation from Antarctica to Australia.

Reports from amateurs who have made VHF contacts via sporadic E, trans-equatorial, tropospheric or ionospheric modes in the past two years would greatly assist us in our research.

Log extracts and beacon observations giving times, dates, frequencies, call-signs, signal strength, fading characteristics, and such notes as when signal first appeared and when it disappeared or whether it was on when first observed and still on when observations ceased.

Two types of propagation are of particular interest at present, viz: VHF trans-equatorial propagation and VHF propagation between Antarctica and Australia. VHF propagation via Sporadic-E on the Australian mainland will also be investigated for its own sake in relation to the other two types of propagation in the near future. There

are a number of beacons that can assist in observations and indicate openings, these being JA11GY in Japan (51.995 MHz), HL9WI in Korea (50.100 MHz), KH6EQI (50.101 MHz) and KH6ERU (50.015 MHz) in Hawaii. These beacons will indicate trans-equatorial opening to the north and north-east.

Two beacons are located on the Antarctic mainland, VKOMX (52.525 MHz) at Mawsen and VKOGR (53.544 MHz) at Casey. A beacon is also located at the sub-Antarctic base at Macquarie Island, this is UKOTM (53.032 MHz).

We have received a number of confirmed reports of the beacons JA11GY, HL9WI, WB6KAP being heard in the last twelve months. It would greatly assist our research if reports of these beacons being heard over the past year and in the future could be submitted to the address below, along with reports of any contacts to the areas of interest.

*Roger Harrison, Ionospheric Prediction Service, 162-166 Goulburn Street, Darlinghurst, N.S.W. 2010.*

## HOVERTRAIN LATEST



The world's first all-electric hovertrain being pioneered in Britain successfully made its first demonstration run at the Tracked Hovercraft test site in Earith, Hunts on December 10th.

The vehicle — code name RTV 31 — designed to be capable of 300 mph, is the forerunner of commercial passenger carrying vehicles that could provide super fast yet quiet and smooth inter-city services at economic fare levels.

## FERROGRAPH RTS1 Professional push button test set

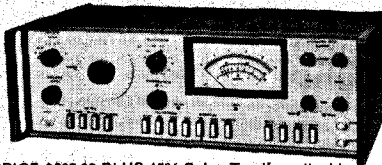

PRICE \$695.00 PLUS 15% Sales Tax if applicable

- MEASURES
- FREQUENCY RESPONSE
  - SIGNAL/NOISE RATIO
  - DISTORTION
  - CROSSTALK
  - WOW & FLUTTER
  - ERASURE
  - INPUT SENSITIVITY
  - OUTPUT POWER

SOLE AUSTRALIAN DISTRIBUTORS

**Leroy Industries Pty. Ltd.** 266 Hay St., Subiaco. W.A. 6008



"BARAC"

### CARBON FILM RESISTORS

All values and tolerances now available ex stock. Manufacturers and Distributors invited to send for samples and specifications.

**SOUND HOUSE PTY. LTD.**

AUDIO CONSULTANTS  
14 BEATTY AVE., ARMADALE,  
VIC. 3143 — PHONE: 205089

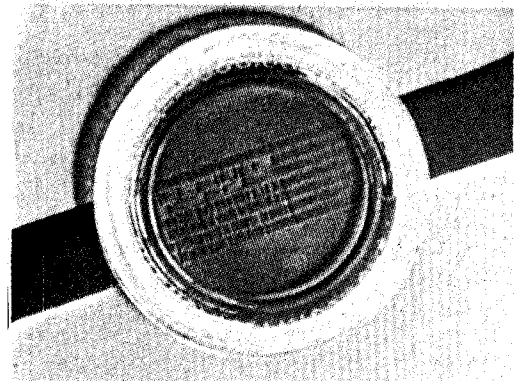

### TAPE CHECKING

The 3M company in the UK have developed a tape viewer to provide a fast, clean, method of making visible the signals recorded on magnetic tape. A circular plastic moulding contains iron oxide particles held in suspension. The recorded magnetic pattern is immediately visible when the viewer is positioned over the tape.

### ELECTRONICS IN THE A.C.T.

The Canberra Division of the IREE will hold a four-day Conference at the end of August and in early September, 1972.

Theme of the Conference will be — "Electronics in the A.C.T." An attractive venue close to the city has been selected.

Lectures and discussion groups will deal with a wide range of subjects involving electronics projects being undertaken in the A.C.T. These range from the control of one of the most powerful magnets in the Southern Hemisphere to a description of the 210-ft. dish antenna at Tidbinbilla.

Visits to most of the equipments discussed will support the lecture program.

Displays of equipment and components will be provided in an exhibition area adjoining the lecture rooms.

The Conference has been timed for the school holiday period in N.S.W. and

## SCOPE SOLDERING IRONS

Buy a SCOPE and join the club of satisfied USERS — you need not keep it a secret, others don't. That's why SCOPE IS KNOWN AT ALL THE BEST PLACES — in the tool kit, on the bench, in the boot, on the kitchen table, in the garage, on the service truck, in the engine room, even on the roof. . . . Wherever SCOPE goes it gives you the best service — and a host of satisfied users will agree it is the QUICKEST, the EASIEST, the SAFEST . . . THE BEST OF ALL SOLDERING IRONS.

### ECONOMY

Consumes current only whilst in use. Scope performs all the functions of other irons from 40 to 150 Watts. MINISCOPE — Up to 75 Watts.

### LABOUR SAVING

Fast warm-up — always ready, cuts wiping, retinning and filing of tips to a MINIMUM.

### VERSATILITY

Copes with all soldering jobs — from miniature components to large solder lugs. Can even be operated from a 6 volt car battery.

### CONTROL

Temperature control at your finger tips. Heat only when, where and as much as needed.

### CONVENIENCE

Ideal for those almost inaccessible spots. No burning of adjacent insulation.

### SAFETY

Low voltage operation.

### LESS MAINTENANCE

Longer tip life. NO expensive heating elements to replace. Maintenance without special tools. Spare tips and elements readily available from your Scope Distributor.

### SPEED

ONLY 5 to 6 seconds' initial heating up time from cold, then practically instantaneous.

### MINI WEIGHT

Scope De Luxe weighs only 3½ ozs. complete. Miniscope 1¾.



All irons are supplied complete with a spare tip and two elements and suitably packed for presentation as a gift.

### POWER SOURCE

Scope irons will operate from 2.5V to 6V. For convenience, Safety and complete satisfaction use only the \*Approved Scope Transformer — look for the name Scope.

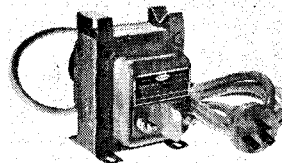

\*Approved by electricity authorities APP. No. N/360/6894 — 5

Fully guaranteed when used with the approved "Scope" Transformer — Scope Products are available from all major Electrical Wholesalers and Hardware Stores.



SCOPE DELUXE

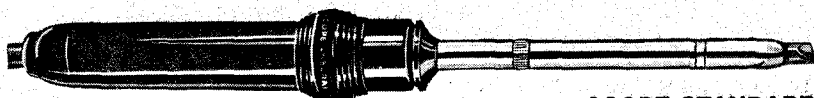

SCOPE STANDARD



MINISCOPE

## SCOPE MEANS A LIFETIME OF SATISFACTION

Please post free SCOPE literature.

NAME .....

ADDRESS .....

CITY ..... Postcode .....

**B & W D.M.1.**  
**LOUD SPEAKERS**  
**\$95.00 each**  
**"Jet Audio"**  
G.P.O. Box F336, Perth,  
Western Australia 6001.

**IRH Components Pty. Limited**  
The Crescent, Kingsgrove,  
N.S.W. 2208. Phone: 50-0111  
74 Raglan St. Preston,  
Vic. 3072. Phone: 44-5021

INTERSTATE	TELEPHONES
HOB. TAS.	54 2811
LAUN. TAS.	22 848
PERTH. W.A.	8 2271
ADEL. S.A.	23 1971
BRIS. QLD.	21 933



**IRH** THE COMPONENT DIVISION  
OF IRH INDUSTRIES LIMITED



## MSP FLUORESCENT BALLASTS for all lighting applications

New Atlantean buses are illuminated by MSP inverter ballasts.

MSP also make a complete range of 50Hz ballasts for general fluorescent lighting.

Available in three basic ranges: "CODE"—Low height—Twin code C322/168AP.

"PREMIUM CODE"—Reduced watts loss and temperature rise.

"LOW LOSS"—Very low watts

loss and temperature rise.

The complete range includes lagging and leading, dimming switch and rapid start types which can be used with all fluorescent lamps rating from 4 to 65 watts.

All MSP ballasts meet or exceed the requirements of Australian Standard Specification No. C322, where applicable, and comply with Test and Approval Specification C168AP.

For further information contact:

**MANUFACTURERS SPECIAL PRODUCTS PTY. LTD.**

47 York Street, Sydney 2000. Telephone 2 0233.

ADI9

Victoria to enable delegates to plan a family visit to Canberra.

Tours of the city and surrounding areas at reasonable prices are being planned and these may include a trip to the Thredbo snowfields on Saturday. On Sunday, following a visit to a tracking station there will be a barbecue lunch at Tidbinbilla Fauna Reserve.

An advance program and accommodation reservation form is in course of preparation. Requests for further information should be directed to the Secretary, Canberra Division, The Institution of Radio and Electronics Engineers Australia, P.O. Box 1246, Canberra City, A.C.T. 2601.

### LUNAR SAMPLES

Samples of lunar surface material collected on Apollo missions 12 to 17 are to be made available by NASA for study by a small research group led by Dr. Brian Fitton, Head of the Surface Physics Division of ESTEC's Space Science Department. Also collaborating in the study will be a high-energy optics team led by Dr. R. Haensel of the German Electron Synchrotron in Hamburg.

The aim of the studies will be to investigate the nature of the sheath of photoelectrons and secondary emitted electrons that is formed above the sunlit side of the moon as a result of bombardment of the lunar surface by the intense ultraviolet light and particle fluxes from the sun.

The formation of this negatively-charged sheath causes the surface of the moon to be positively charged and sets up local electric fields which could interfere with certain experiments placed on the moon's surface. The electrostatic repulsion between the small positively-charged surface grains may result in erosion of sharp surface features on a microscopic scale. In addition, the electron sheath will refract long-wavelength radio waves. It is therefore desirable to know the extent and magnitude of the sheath and the resulting electric fields. This will be determined by measuring the photoelectron and secondary electron emission of the samples, which will be from several landing sites.

The project has arisen through the group's current work on photoelectron emission from satellite surfaces, where a similar process of photoelectron sheath formation occurs. It is expected that some 12 to 18 months of part-time study will be involved.

# TANDBERG

**simply  
offers you  
sound  
reproduction  
indistinguishable  
from the  
original**

No *more* and no *less*. Just an accurate encore performance. Of course TANDBERG quality means greater long term reliability, more long term performance and greater long term satisfaction; these attributes go hand in hand with the TANDBERG name.

You may choose a TANDBERG stereo deck or a TANDBERG self contained stereo system. The Model 3000X stereo tape deck is worthy of the finest stereo amplifiers and the most sophisticated speaker systems; the all new Model 4000X stereo sound centre incorporates twin 10 watts R.M.S. stereo amplifiers, built-in wide range speakers and an input sensitivity of 1.5 mV. for magnetic cartridges as well as a host of other highly desirable and effective features. This versatile recorder can be the "heart" of your new stereo system!

Both TANDBERG models employ the proven TANDBERG Crossfield Head which, in lay terms, provides

*wider frequency response, a far better signal-to-noise specification and more natural sound reproduction.*

See and hear both TANDBERG models at all franchised Simon Gray dealers. **Listen and compare.** TANDBERG superiority is clearly evident when you hear a demonstration, when you install your own TANDBERG . . . and years later, after hundreds of hours of musical pleasure.

**Move up to TANDBERG!**

Telex — 31904.  
Simon Gray Pty. Ltd.,  
28 Elizabeth Street,  
Melbourne 3000.  
Please send me full technical information about the TANDBERG 3000X/4000X (strike out model not required) and the name of my nearest Simon Gray franchised dealer.

NAME.....  
ADDRESS.....  
POSTCODE.....

ET TB 571

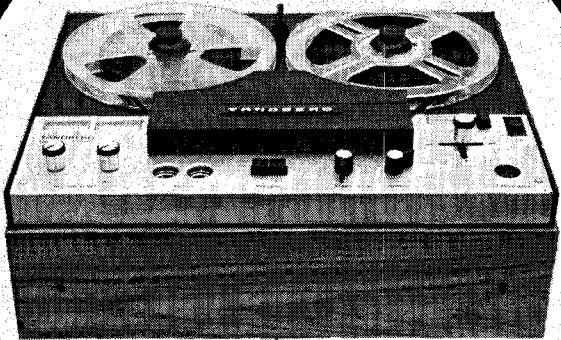

TANDBERG MODEL 3000X.

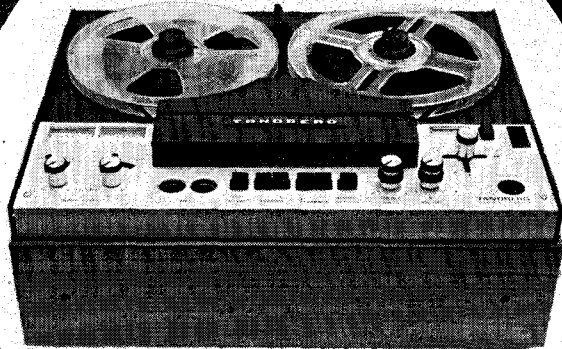

TANDBERG MODEL 4000X.

• 15 T.P.R. • 40-20,000 Hz. • Signal-to-noise ratio • VU meters • Inputs for tuners • pickups • Wow and flutter: 0.07% • 4 sound heads • All solid state • All desirable controls

Australian National Distributors:  
**Simon Gray Pty. Ltd.**  
28 Elizabeth St., Melbourne, Vic. Tel. 31111 • Telex: 31904  
111/111, 53 Victoria Ave., Chatswood, N.S.W. Tel. 40 4822  
Office: 29 Malunga Mall, Fremantle, A.S. Tel. 95 6526  
Office: 301 South Terrace, Adelaide, S.A. Tel. 23 0215

• 15 T.P.R. • 40-20,000 Hz. • Signal-to-noise ratio • VU meters • Inputs for tuners • pickups • Wow and flutter: 0.07% • 4 sound heads • All solid state • Twin 10 watts R.M.S. amplifiers

INTERSTATE REPRESENTATIVES:  
N.T.: Mulvany's Music House, Smith Street, Darwin, Tel. 3801  
Qld.: Sydney G. Hughes, 154-156 Arthur St., New Farm, Brisbane, 60 1421  
Tas.: K. W. McDonald Pty. Ltd., 52 George Street, Launceston, Tel. 520  
W.A.: Athol W. Hill Pty. Ltd., 613-615 Wellington Street, Perth, Tel. 71 7901

# SPACE TRACKING

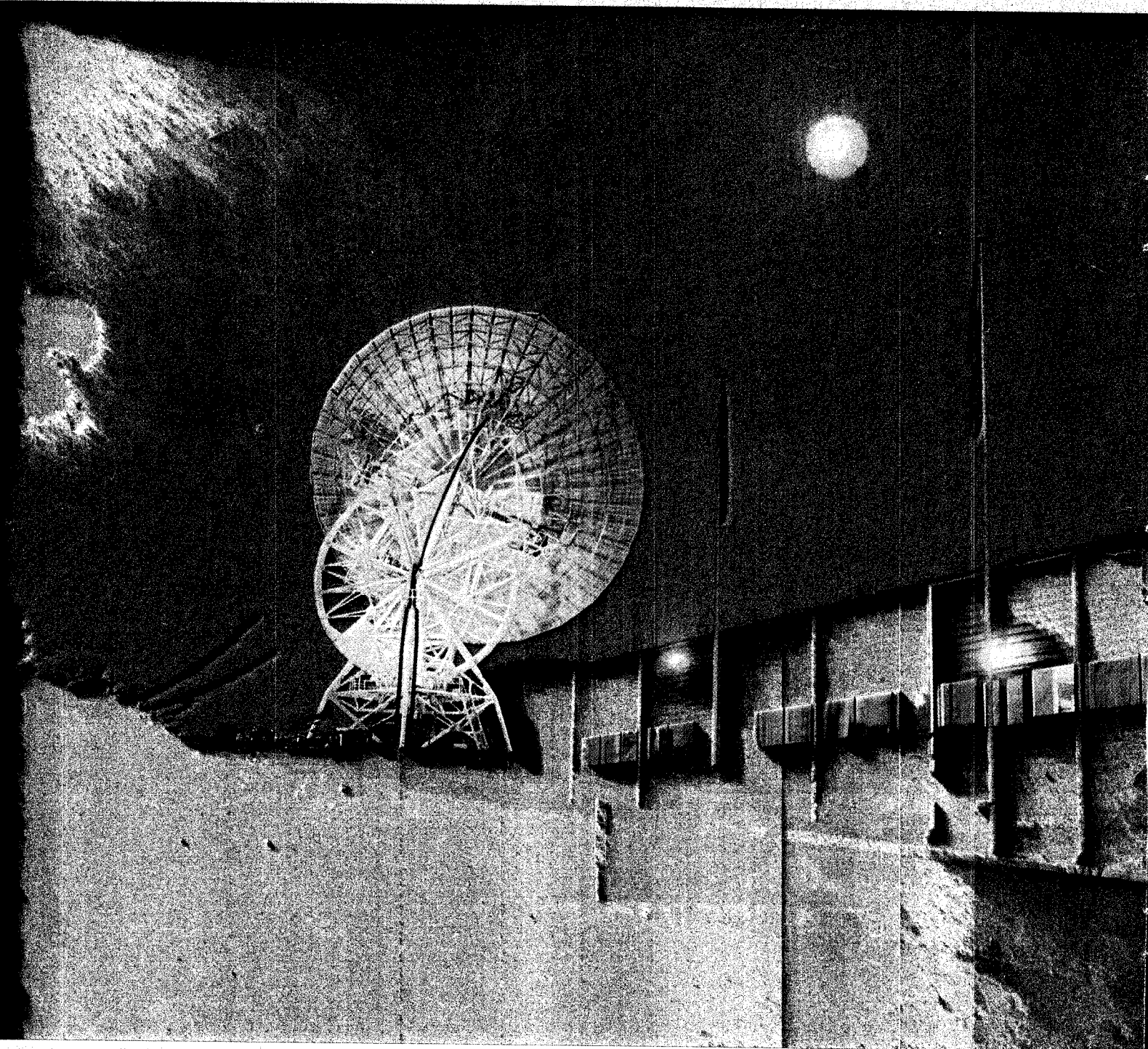

This dramatic picture, taken during the recent Apollo 15 mission, shows the main antenna of the Honeysuckle Creek Tracking Station pointing directly at the lunar surface.

The Honeysuckle Creek Tracking Station plays a major role in NASA's Apollo missions. Here is a detailed description of the equipment and techniques used.

# STATIONS

*Electronics Today acknowledges the assistance of the Dept. of Supply in the preparation of this article.*

NASA's tracking network for Apollo missions has three prime sites about 120° longitude apart. They are at Madrid (Spain), Goldstone (California) and Honeysuckle Creek (ACT). Other stations, located at various sites throughout the world, support the earth-orbit phase of the missions. Once the spacecraft is about 16,000 kilometres (10,000 miles) from earth, the prime stations assume the responsibility.

Two areas in Australia are concerned with the operational aspects of Apollo missions. These are near Canberra and at Carnarvon (WA).

The Canberra complex consists of two stations, Honeysuckle Creek and Tidbinbilla, each with a 26-metre (85ft) diameter antenna.

For operational purposes the CSIRO's radio-astronomy telescope at Parkes (NSW) is also considered to be part of the Canberra Complex when it is made available for lunar-phase tracking of Apollo missions.

Honeysuckle Creek is the co-ordinating and data processing centre for the complex. Tidbinbilla and Parkes are linked to Honeysuckle Creek via microwave links.

Carnarvon, 1,000 kilometres (600 miles) north of Perth, has two 9-metre (30ft) — diameter antennas and is concerned with the earth-orbit phase of the missions, but also acts in a back-up role during the lunar phase.

## TRACKING REQUIREMENTS

A glance at Fig. 1 shows the multiplicity of signals that had to be tracked at various stages of the Apollo 15 mission and Fig. 2 shows how the downlink signals were shared. In the Canberra complex, for instance, Honeysuckle Creek and Parkes tracked the lunar module and lunar rover on the lunar surface, while Tidbinbilla tracked the command module which

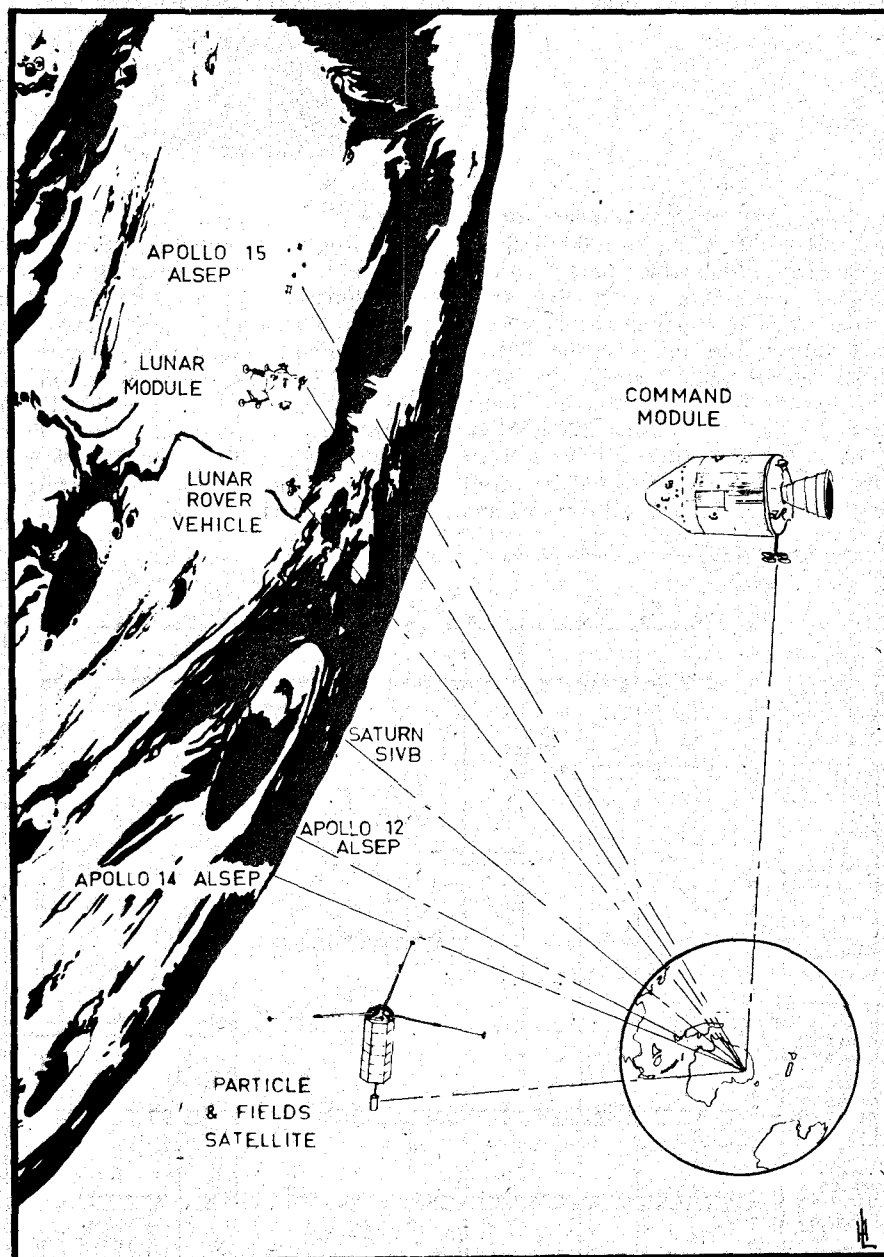
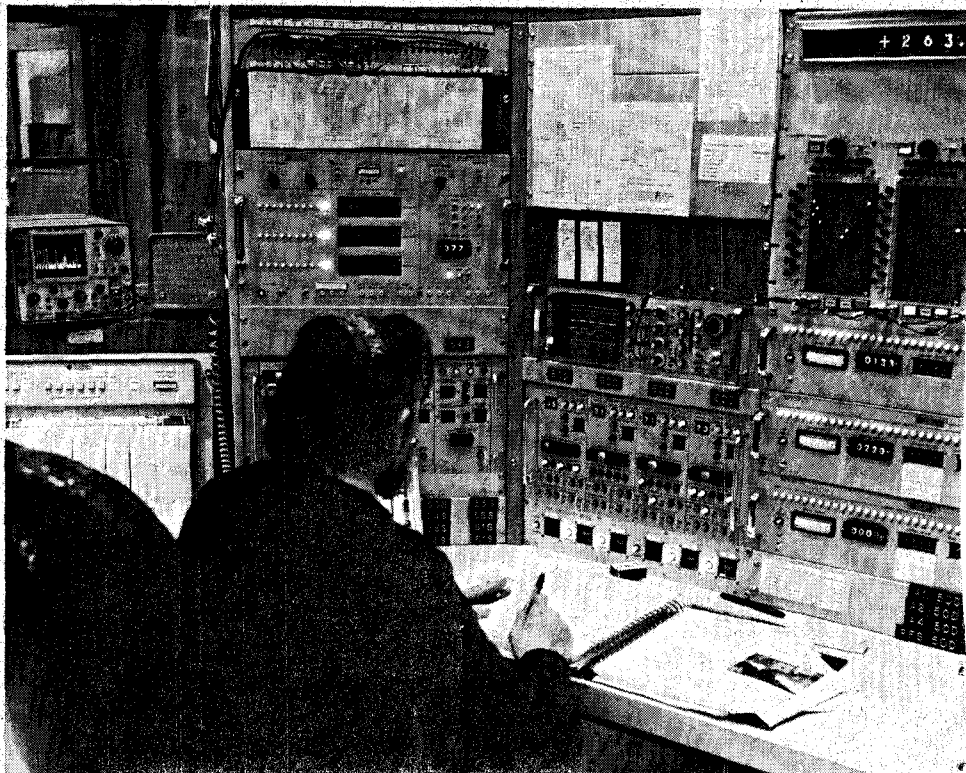

FIGURE 1. The various signal sources tracked during the Apollo 15 Mission. (ALSEP 12 and 14 operate continuously).



# SPACE TRACKING STATIONS

Bill Perrin monitoring the spacecraft signals at the Telemetry Console. The oscilloscope above the chart recorder on the left shows the RF down link spectrum from the Command Module. The display in the centre shows the PCM Telemetry bit streams from the Demodulators. Upper right are the switching matrices used to select data streams to the telemetry processing equipment. Directly below this are monitoring devices for selecting an individual word out of the bit stream. Finally on the upper left level with the oscilloscope, is a monitor for the telemetry bit stream leaving the site. The operator therefore has a complete picture of the telemetry data from the RF input to the final signal to line.



was orbiting the moon at an altitude of about 100 kilometres (60 miles).

Sharing is used when more than one signal source is using the same frequency. An example of this was the instrumentation unit of the Saturn IVB launch vehicle stage, the lunar module and the particles and fields sub-satellite — all using 2282.5MHz. The instrumentation unit and lunar module transponders would be offset by 85kHz in opposite directions and

tracked in this offset frequency.

During the outward journey, the lunar module was powered down on the lunar surface. This frequency was then available for the lunar module for use during its selenographic excursion.

Finally, it too was crashed on the lunar surface and the 2282.5MHz was available for the particles and fields sub-satellite which was ejected from the command module just before its return to earth.

## CANBERRA COMPLEX

A brief description of the operational centre of the complex (located at Honeysuckle Creek) will provide an insight into what is involved when a manned mission is in progress.

Located 3,600ft above mean sea level, and 50 kilometres (30 miles) south of Canberra, the Honeysuckle Creek operations centre can be regarded as an extension of the Mission Control Center at Houston, Texas. At the end of a link stretching across the Pacific, the station acts as a relay point between the spacecraft and the Mission Control Center. All communications and data are passed through the Canberra Switching Centre which is part of NASA's world-wide communications network.

## FUNCTIONS

The station — a block diagram of it is shown in Fig. 3 — is known as a Unified S-Band site, using frequencies in the 'S' Band. All uplink and downlink signals are modulated on to single carriers. In the earlier Mercury and Gemini programs each function used a separate frequency and antenna.

Bearing in mind the station is merely a relay point, the drawing is basically a flow diagram of information (data) between Houston on the right and the spacecraft on the left.

## UPLINK OR TRANSMIT PATH

Taking the simpler of the two, the link from Houston to the spacecraft is called the uplink or transmit path.

FIGURE 2. Frequencies used during the Apollo 15 Mission.

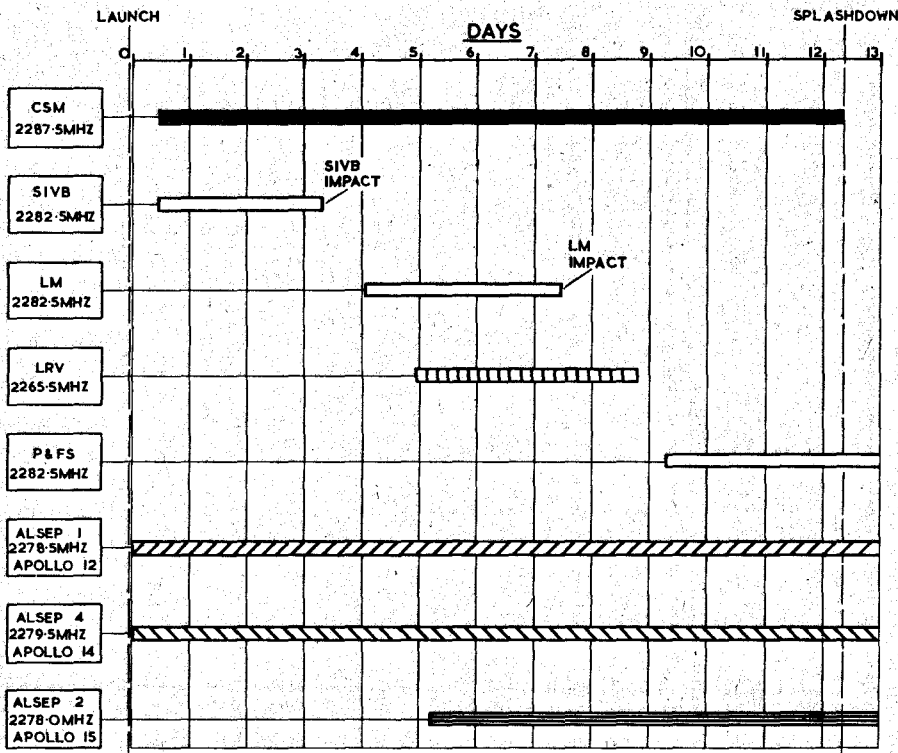

## VOICE

Speech is perhaps the prime requirement of the uplink path and in simplified terms provides a telephone link between the capsule communicator at Houston and the astronauts. A communication technician at the station monitors all traffic and ensures the best channel is used. The baseband voice signal is an analogue waveform, of frequency range 300-2500 Hz, modulated on to a 30kHz subcarrier, summed with the other uplink information, and phase-modulated on the carrier.

## COMMAND

Commands consist of instructions to spacecraft equipment, primarily to relieve the astronauts of regular chores. Examples are spacecraft antenna switching for optimum signal strength at the ground station, recorder control for transferring information stored on magnetic tape from the spacecraft to the ground, and the more important navigational data to update the command module/lunar module computer.

Commands are loaded into the station's Univac 642B command computer by high-speed data lines from Houston. These are transmitted, using a digital code of 57 bits at a rate of 4.8 kilobits/sec.

Commands can be called up for transmission to the spacecraft at a designated time or be sent in real time. Instructions to transmit a command are initiated in Houston and the 642B computer recalls the required command from memory and transmits it to the spacecraft, where a digital word is returned with the telemetry stream back to the computer. If no return word is received by the computer, it re-transmits the command a predetermined number of times before raising the alarm.

The command leaves the computer in

a digital 30-bit parallel code, which is converted to a serial phase-shift keyed (PSK) waveform consisting of a 2-kHz data signal combined with a 1-kHz reference. This baseband command signal is first frequency-modulated on a 70-kHz carrier before being summed with the other uplink signals and phase-modulated on the carrier.

During the Apollo 15 mission, a total of 3,540 commands were uplinked to the spacecraft from the Australian stations: Honeysuckle and Tidbinbilla uplinked 3,533. Of these 2,000 were commands to the camera unit mounted on the lunar rover.

## RANGING

Ranging is a code transmitted to the spacecraft and returned for time comparison with the original code. The pseudo random-noise range code, generated by the ranging system, is a combination of five codes to form a 5.4-second period code of 5,456,682 bits, which gives a maximum unambiguous range of 800,000 kilometres (500,000 miles) or twice the distance to the moon.

The range code is summed with the other uplink information and phase-modulated on to the carrier.

Resolution within the ranging system is  $\pm 1$  metre (3ft), but system inaccuracies due to jitter and ground instabilities give an overall accuracy of  $\pm 15$  metres (50 ft).

Ranging is manually initiated by the station and once acquired is updated by doppler only. The range code is only used to measure the initial distance.

## UPLINK

Both Honeysuckle Creek and Tidbinbilla can transmit two uplinks simultaneously. Both have dual equipment capable of handling two independent RF links. This provides both a backup in case of failure of one

link, or the capability of tracking two spacecraft within the antenna beamwidth.

The final modulation process on the uplink carrier is phase modulation using relatively narrow deviation to ensure that a phase stable carrier component arrives at the spacecraft, as the spacecraft transmission carrier is derived from the received carrier. The total rms phase deviation on the uplink carrier is kept at about 1 radian.

The command subcarrier of 70 kHz and voice subcarrier of 30 kHz are combined in a subcarrier oscillator system, and delivered to the exciter as normal modulation, phase-modulated on to the S-Band carrier.

The power amplifier uses a klystron and delivers a continuously variable output of 1 to 20 kW, CW. The bandwidth of 10 kHz is wide enough to accommodate both uplink frequencies. Five hundred milliwatts drive is required to produce the full 20 kW.

## ANTENNAS

The 26-metre-diameter parabolic dish at Honeysuckle Creek is a steerable antenna using an XY mount, which means the antenna can tilt in two directions, in this case N to S, and E to W. With combined operation, almost the whole sky can be covered. Both axes of the XY mount are horizontal at zenith.

## SOME ANTENNA FACTS

Beamwidth

7.5m rad  $\pm$  1.0m rad ( $0.43^\circ \pm 0.05^\circ$ )

Pointing accuracy

0.2m rad - (40 secs of arc)

Max tracking rate

50m rad/sec - ( $3^\circ$ /sec)

Polarisation

Right-hand circular/or left-hand circular switchable

Gain

51 dB up 53 dB down

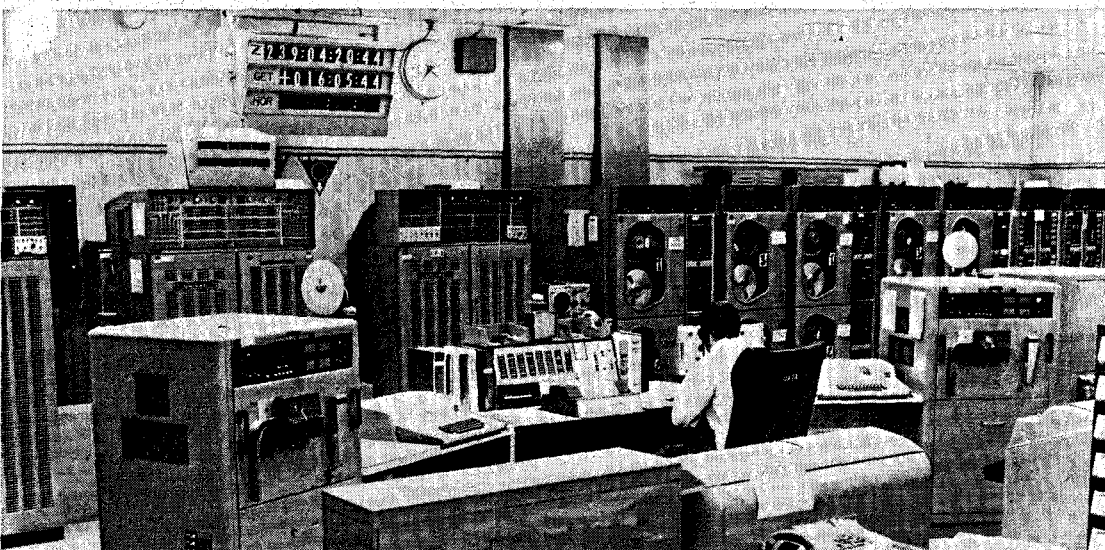

From left two Univac 642B computers with an expanded memory unit between. In the centre right are eight tape transports fully duplexed with the 642B computers. To the right are two Univac 1218 computers and associated magnetic tape unit with two tape transports. In the foreground are the I/O consoles and the operator's monitoring position.

## SPACE TRACKING STATIONS

*In the foreground is the servo console which controls the antenna's position. On the left are the main receivers with the Ranging System at the back. On the right is the Antenna Positioning and the tracking data (range antenna angles etc.) processing equipment.*

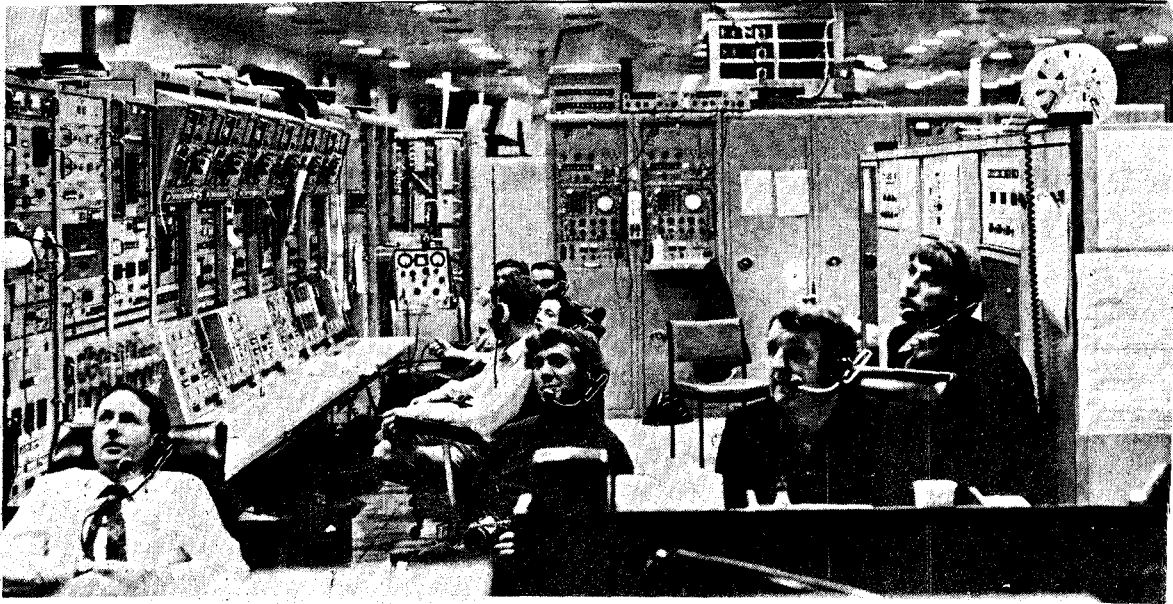

Acceleration  
 $90\text{m rad/sec}^2$  ( $5^0/\text{sec}^2$ )

There is a 2-metre (6ft) — diameter acquisition antenna and tracking system, but this is only useful on earth-orbit tracking, where the spacecraft is a relatively rapidly moving target. This system is not included in this discussion.

The Tidbinbilla 26-metre-diameter parabolic dish is a steerable hour angle-declination antenna and the Parkes 64-metre-diameter parabolic dish is a steerable AZ-EL antenna.

Due to the narrow beam width of the antenna it has to be extremely accurately directed. To achieve this, computers in Goddard Space Flight Center calculate the spacecraft trajectory from previous tracking and the information is then fed into a 1218 computer which can be switched to control the antenna directly.

Combined with the antenna position programmer (APP), the antenna can be directed to follow the spacecraft's path, even through a signal loss. Normally, once the spacecraft's signal has been acquired, the antenna follows the signal.

The range (determined by the ranging system) and speed of the spacecraft relative to the station, and the antenna angles relative to the station's geographical location are coded in the tracking data processor (TDP), transmitted to line and recorded. This data is coded both in high-speed data at 2400 bits per second and in teletype code.

### DOWNLINK OR RECEIVE PATH

The spacecraft downlink 'S'-Band frequency can be received from the spacecraft at levels of about -150 to -90 dbm. The signals are bounced to the hyperbolic focus where the feed system is split into four parts, giving a

common monopulse tracking system. This can be left or right circular polarisation, selected remotely.

The sum output of the monopulse comparator is fed into a cryogenic parametric amplifier (paramp) having a low system temperature. This paramp output is split five ways, four to independent phase-locked receivers, with tracking bandwidths switchable between 1 kHz to 12 Hz. (These receivers are capable of tracking down to -160 dbm).

The X and Y outputs of the monopulse comparator are fed to a triple-channel warm paramp and then to tracking receivers whose reference is derived from the original sum channel. The remaining channel of the warm paramp is used as a backup for the main cryogenic paramp.

The function of the diplexer (together with the band pass and reject filters) is to combine the uplink and downlink frequencies, giving a rejection of 180 db in the receive spectrum.

### RECEIVERS

The S-Band frequency from the paramp is converted down to an IF of 50 MHz and reconverted to a 10-MHz reference frequency. Phase detection at this frequency drives programmable local oscillators and multiplier chains for the phase-locked operation. The outputs from the receivers, that of 50 MHz and 10 MHz, are composite signals which are fed into the demodulators where the various channels of information are stripped off and patched to the appropriate areas.

### DEMOS

The demodulators accept these composite signals from the Honeysuckle Creek, Tidbinbilla and

Parkes receivers. They contain the voice, telemetry, biomedical and television information and break them down into a pulse code modulated (PCM) bit stream, voice and biomedical data. These are patched in both PM or FM modes as dictated by operational requirements.

The television information, which was frequency-modulated directly on the carrier in the spacecraft, enters via the 50-MHz FM channel and is completely demodulated and fed to the TV processing equipment.

Now let us take each data stream in turn and see how it is transmitted to Mission Control Center at Houston.

### VOICE

The recovered voice from the demodulators is fed to the communications technician who monitors and switches for best signal sources. The audio is then recorded on magnetic tape and sent to line to the Mission Control Center either by undersea cable or satellite.

### BIOMEDICAL

The biomedical data are in two distinct paths. One is used while the astronauts are in the command module when the biomed data comes via the pulse code modulated (PCM) telemetry. The other is used while they are in the lunar module or in their suits for external activities. Then the biomedical data, containing information on the condition of the astronauts as they are walking around the moon's surface (such as oxygen remaining, suit cooling, suit temperature, physical condition) are routed down separate analogue FM telemetry channels to special processing equipment which converts the analogue information to digital for the computer. Both sets of information, together with the other PCM data, are presented to the 642B computer.

## TELEMETRY

The PCM bit stream is routed to four decommutators in the telemetry area. The rates are variable, normally high at 51.2 kilo bits and low at 1.6 kilo bits a second.

The prime function of the PCM decommutators is to present all decoded data to the telemetry 642B computer in 30-bit parallel form, but they also allow station personnel to monitor selected data on indicators or chart recorders.

The PCM telemetry can be broken down into 6400 words of information on the spacecraft antenna direction, physical condition of the astronauts in the CSM, the quantities of consumables, engineering data, etc.

## COMPUTERS

As the data lines between the station and Mission Control Center have limited capability for data transmission, all the telemetry is presented to the 642B computers, where only data selected by the flight controllers in Houston are transmitted to line. The output from the computer of 30-bit parallel words is converted to a serial bit stream at 4.8 kilo bits a second and transmitted to line on similar circuits to the voice circuits.

Both command and telemetry computers are identical and interchangeable and have 20 input and 20 output channels, 64k memory and duplex magnetic tape units, each with four tape transports.

Programmes used during the mission are sent from Goddard on magnetic and paper tape and loaded into the computer at predetermined times.

The magnetic tape units are used for

fault analysis and storing information. They also hold the operational programme.

## TELEVISION

The television signal from the spacecraft is 525 lines/60 field frame sequential colour TV and also contains information on the TV camera temperature, battery voltage, etc. This TV signal from the demodulators is presented to a switch matrix which selects the best signal source available from the Honeysuckle, Tidbinbilla and Parkes receivers. The voice and telemetry subcarrier is filtered out with a subcarrier cancellation device which eliminates the subcarriers by a locally generated subcarrier locked to the incoming signal and 180° out of phase with it.

The signal is cleaned up and processed in a standard TV processing amplifier before vertical interval test (VIT) signals, multiburst and grey scale, are inserted on line 16 and 17 of the vertical blanking period.

The composite processed TV signal from Honeysuckle Creek/Tidbinbilla is monitored on a modified Conrac colour monitor and transmitted to a video centre in Sydney for selective distribution to the local networks and to Houston via the Overseas Telecommunications Commission's Intelsat satellite link over the Pacific. The TV signal from Parkes is sent direct to the video centre at Sydney.

The TV is also recorded on Ampex VR 660 video tape recorders.

## TIME

All activities in the station revolve around a dual time standard which

provides multiple readouts, pulses and various coded times for time tagging all data produced by the station.

Needless to say accuracy is essential, and various means are used to keep the station time within 10 microseconds of universal time. The well-known WWV and WWVH time signals are used for a coarse adjustment, but for a vernier adjustment down to  $\pm 10$  microseconds, the 100-kHz Loran C signals, now synchronised to universal time, are used.

The North-West Pacific Chain with the master station at Iwo Jima is presently used to monitor the station's drift. Prime frequency source is a Hewlett Packard Caesium beam frequency standard, giving a stability of around  $1 \times 10^{-12}$  with a Varian rubidium as back-up.

## OPERATIONS CONSOLE

A central co-ordinating console controls and interfaces the station with external organisations. The console is supplied with numerous lamp displays giving station configuration and equipment status. The console also has facilities for communication with the spacecraft and the initiation of commands.

## STAFFING

The responsibility of Honeysuckle Creek Station's activities is vested in a Station Director who is a senior officer of the Department of Supply. Standard Telephones & Cables Pty Ltd have contracted to provide the operations and maintenance services and employ about 100 professional, technical, and administrative personnel at the station for this task.

Fig. 3. Block diagram of the functions of Honeysuckle Creek during the Apollo 15 Mission.

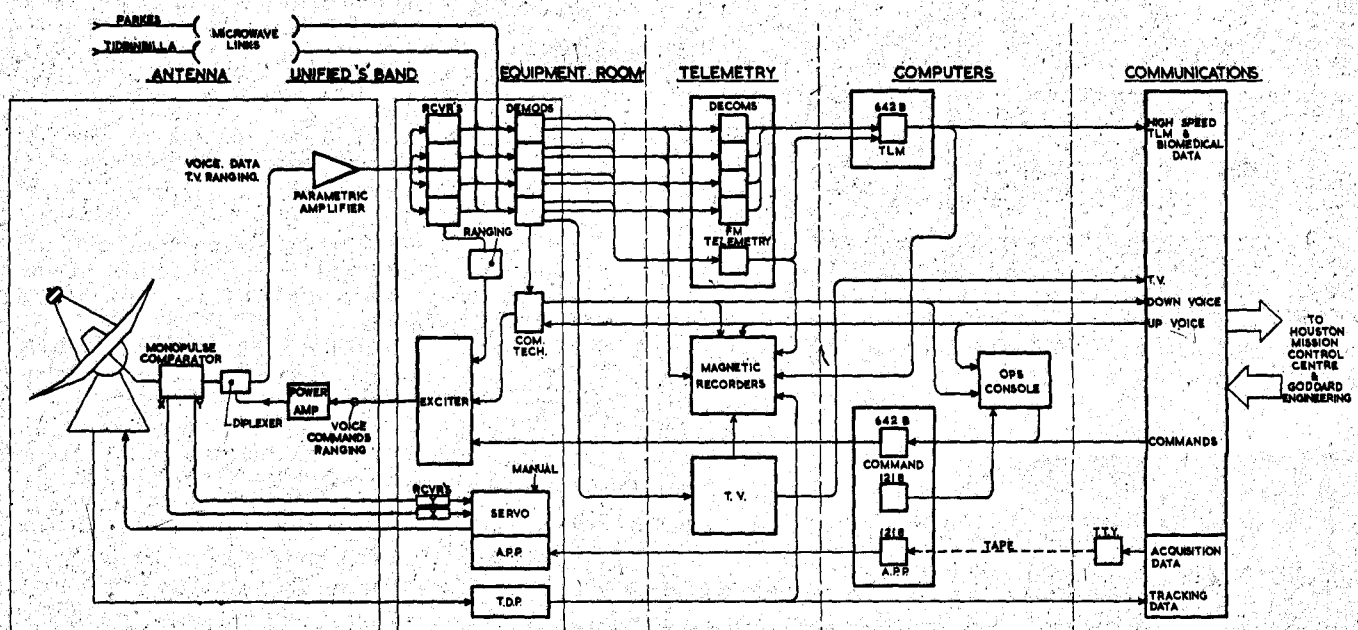

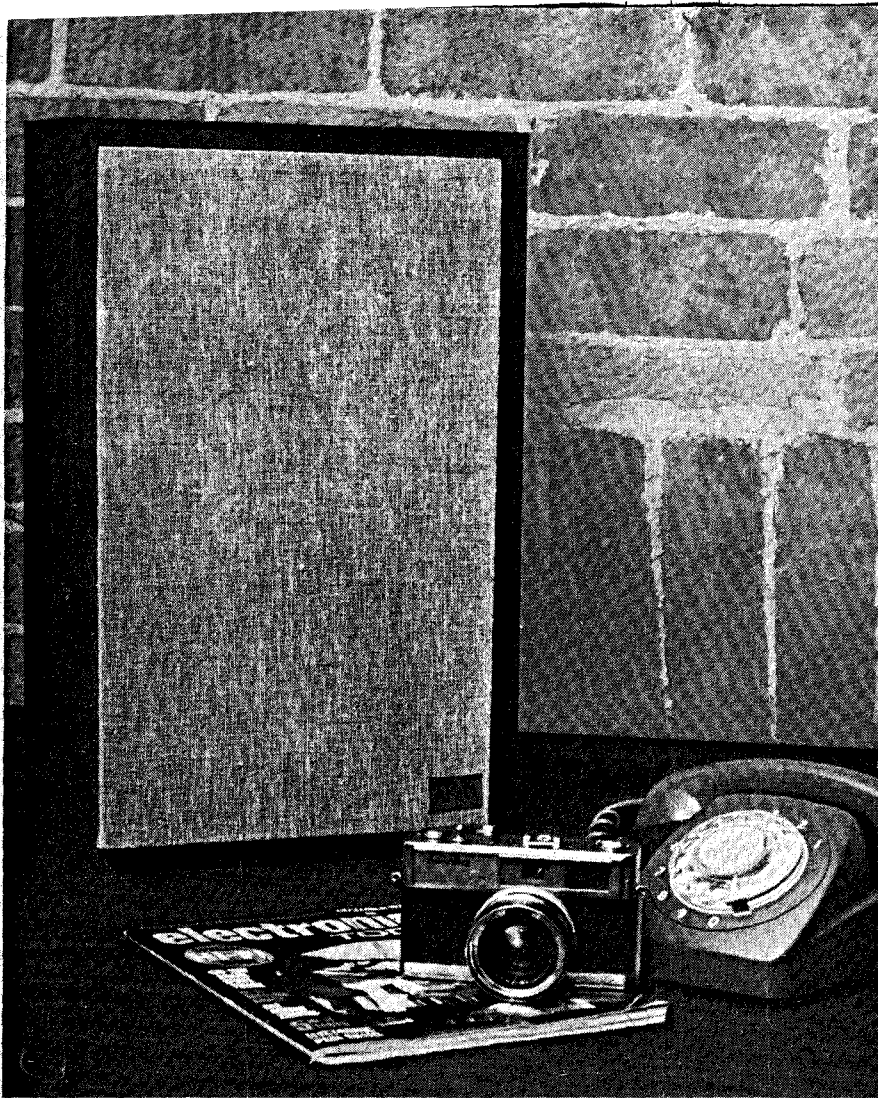

# THE AR-6 BOOKSHELF SPEAKER SYSTEM

**electronics**  
TODAY  
**product test**

The AR-6 speakers are the best true 'bookshelf speaker system' that we have yet heard.

**A**FTER producing in excess of a million high quality speaker systems over two decades it is not surprising that the USA's Acoustic Research Corporation should decide to develop the AR6 system, for whilst AR, have produced other small systems, including the AR-4X, that provide excellent performance, few of these will sit properly on a bookshelf.

For a speaker system to deserve the title "bookshelf" it should not be more than 8" deep and should have sufficient height or width so that its other smallest dimension is 12" or less. The AR-6 has dimensions of 12" x 19½" x 7" deep so it complies with the basic physical constraints to allow it to fit in a bookshelf. (Many speakers will fit *on* a bookshelf, but only a few actually fit *in* a bookshelf.)

All AR speakers are characterised by their unpretentious appearance and the AR-6 is no exception.

The result is an enclosure which, although devoid of any fancy trim and finish, reflects the quality and attention to detail put into the construction of all AR units.

The enclosure has a volume of only 0.65 cubic feet and is constructed from ¾" veneered particle board which is crafted into a solid resonance-free enclosure. The drive units used in the enclosure are a new 8" diameter woofer, with a flexible urethane edge suspension and a stiff cone, and a 1½" diameter wide-dispersion domed tweeter.

The drive units are conventional, at least by AR standards, but intriguing none the less. To obtain a linear travel in a long throw speaker you either need a long linear magnetic field for the air gap and a short voice coil, or, conversely, a short magnetic field air gap and a long voice coil.

Of these two basic approaches the first type, whilst technically refined, is, none the less, expensive. This type results in high efficiency, high linearity speakers of the type which J.B.L., Goodmans, and other top of the line manufacturers produce so well. But most hi-fi enthusiasts care little about speaker efficiency, providing the system has good linearity; and speaker linearity is synonymous with low distortion when the other physical characteristics of the speaker are also good.

Linearity is still maintained with the second design approach, but the electro-acoustic efficiency is generally way down. This, of course, is one reason why AR speaker systems are generally lower in efficiency than some other systems on the market.

The magnet assembly in the woofer uses an open yoke structure, that is sealed on the two sides with tape to keep out dust and dirt. (We did not really expect to find this type of

Measuring Obj.:  
FREQUENCY  
RESPONSE OF  
ACOUSTIC  
RESEARCH  
MODEL AR-6  
SPEAKER

1 decibel  
per  
division

Rec. No.:  
Date: 2/12/71  
Sign.:

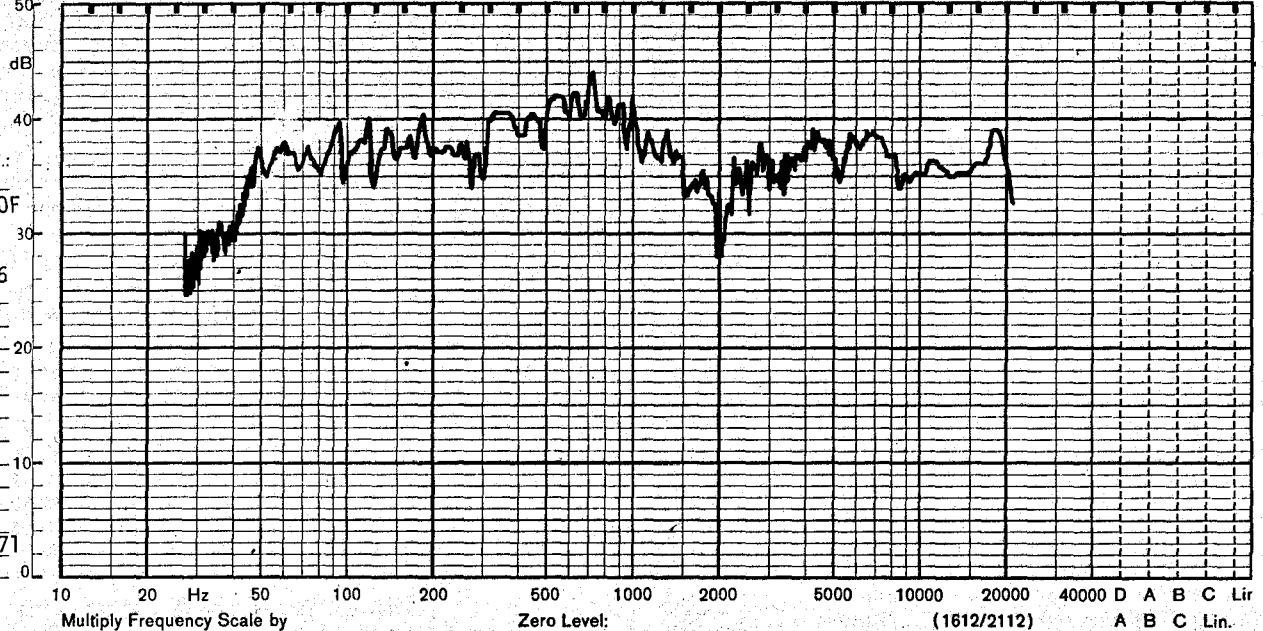

construction, having read the extracted blurb that one well known American reviewer had written on the back of the technical data sheet supplied with the speakers, but we assume that the system he tested was different — or something.) The linear travel of the speaker voice coil exceeds 0.7 inch (or 2 centimetres) which is a good starting point for a low distortion speaker. The visual impressions created by this voice coil and magnet structure belie the quality of the performance which they produce.

The tweeter is also conventional, but is as good as any tweeter that we have ever seen, with a performance which has to be admired particularly because of its exceptional dispersion. The tweeter is smooth to beyond 20 Kilohertz, for those whose ears have an ultrasonic response. The wiring of

the tweeter into the system is unusual, as the wires are taped onto the front panel (with electrical insulation tape), from a pair of feed-through terminals. This is simple, but adequate, as it facilitates easy replacement and insertion of the speaker from the front of the fully sealed enclosure.

Subjective A-B tests were conducted in our laboratory, against our control monitors, and domestically with a number of similar sized bookshelf speakers. When compared against the control monitors the major difference was the lower efficiency of the AR-6. The manufacturers recommend an amplifier rating of 20 watts per channel because of this low efficiency.

Frequency-wise the difference was much less perceptible, with the only real difference being the loss of very low frequency due to the roll off around 40Hz. The only other

difference was a slight loss of presence, which had a mellowing effect on the music reproduction. Actually, this lack of presence is synonymous with good frequency linearity, as later evidenced in our laboratory testing.

The manufacturers claim a maximum power handling capability under "normal home use on conventional music" of 200 watts short-term. We took them at their word and drove the speakers with a Pioneer SA1000 amplifier which delivers a nominal 170 watts peak power per channel at full volume. The results with a CBS Jerry Lee Lewis record, although ear shattering, were astounding, with the only noticeable distortion occurring at very high level low-frequency signals. Otherwise the speakers appeared to handle the power with ease, and without intermodulation distortion, particularly on the J.B.L.

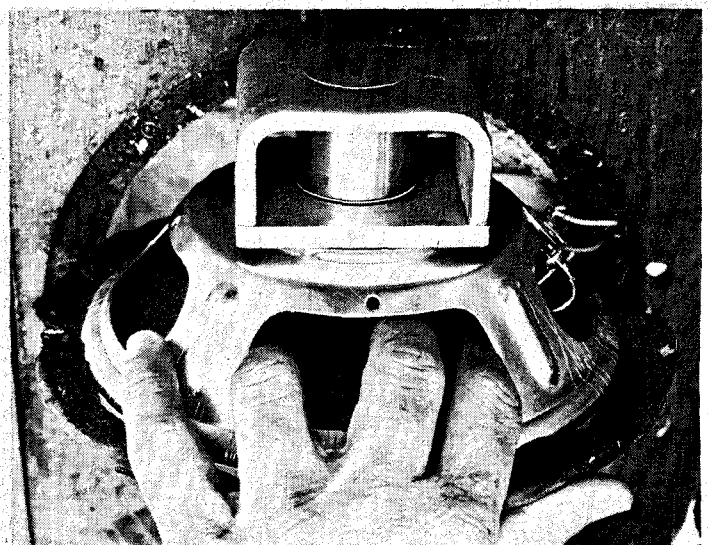

These two photographs dramatically illustrate the long voice coil of the AR-6 bass driver. (Note the open yoke construction of the magnet assembly).

## THE AR-6 BOOKSHELF SPEAKER SYSTEM

'Contemporary' Test Record PRO 496. We tried a number of other records, including the J.B.L. Classical Record SL672, and found that, in common with the other new AR speakers, this unit provides particularly clean reproduction of classical music. The ability to handle tympany and high frequencies can only be described as bright and effortless.

The measured performance confirmed our subjective appraisal with an effective response of 40Hz to beyond 20kHz. With 6 decibels of amplifier bass boost applied the lower cut-off frequency was reduced to 30 Hertz. With such a small enclosure volume it would be reasonable to expect the bass performance to be mediocre with a low frequency roll-over below 80 Hertz. But, the AR-6 does no such thing and, rather to our surprise, has a performance only slightly inferior to the other considerably larger speaker systems in the AR range. The linearity of the AR-6 is more than adequate for the purist, and only the crossover dip at 2kHz stopped the AR-6 from achieving the smoothest frequency response that we have ever measured between 40Hertz and 20 Kilohertz.

The distortion was particularly hard to determine, because of the recommended upper limit of five Watts continuous power for sine waves and the very low distortion levels generated by the speakers above 100 Hz.

### MEASURED PERFORMANCE OF ACOUSTIC RESEARCH SPEAKER MODEL AR-6 SERIAL NO. HG00 4925

#### Frequency Response

40Hz to 20kHz  $\pm$  6dB

Woofer Resonance in Free Air = 27Hz

in Enclosure = 60Hz

Cross Over Frequency

2kHz

Harmonic Distortion

at a frequency of 100Hz

$\frac{1}{2}$  watt .8%

5 watts 1%

Electro-Acoustic Efficiency

0.2%

Dimensions: 19 $\frac{1}{2}$ " x 12" x 7"

Weight: 20 lbs.

Price: recommended retail price —  
\$180 each.



Rear-mounted potentiometer provides 6dB cut or boost.

The cross over network is a simple LC circuit with a wire wound potentiometer in series with the tweeter. The capacitor used is a large block, solid dielectric capacitor mounted on the rear panel whilst the air-wound inductors provide good linearity.

As with all AR speaker systems, three terminals are mounted on a recessed panel in the back of the speaker enclosure. This panel also contains the tweeter level control potentiometer. This rather coarse wire-wound potentiometer provides approximately 6 dB boost or cut centred on the recommended 'normal' position. This control will seldom be used and provides adequate adjustment.

The terminals on the control panel are marker 1, 2 and T. Terminals 2 and T are bridged by the manufacturer. Normally, connections are made to terminals 1 and 2. Removing the link between terminals 2 and T isolates the tweeter, so that the woofer alone may be driven if required.

The enclosures are very effectively

sealed and, to maintain the sealing around the speaker openings, a very dense and tacky fibrous putty has been used. The filling in the enclosure is a long-fibre glass wool of above average quality, separated from the woofer by a tissue barrier.

The speakers are supplied with the usual AR performance data; brief wiring details which stress the recommended fusing requirements, and with each unit comes the 5 year international guarantee given on all AR speakers.

We found the AR data to be accurate and could not fault either the technical content or format

A set of hooks is supplied for mounting the speakers on a wall, for those who neither own or want a bookcase. An ideal wall mounting position is between 4' and 7' above floor level, but, unless properly sound-insulated, this could be annoying for anyone seeking peace and quiet on the other side of the wall, particularly in a home unit. Normally, some form of structural isolation is desirable to minimise low frequency vibrations being transferred to the building structure.

Acoustic Research have other fine speakers, but when we equate cost and size against performance it is clear to us that the AR-6 is most probably the best value for money that AR have ever produced, and the best true "bookshelf speaker system" that we have yet heard.

(We share our consultant's enthusiasm for these very beautiful speakers. Over a period of several days we listened to a wide selection of our favourite music; Carl Orff's Carmina Burani, Prokofiev's Second Violin Concerto, many of the Beethoven String Quartets, the Shostakovich Piano Quintet, a lot of modern Jazz — it was a truly pleasurable experience — ED).

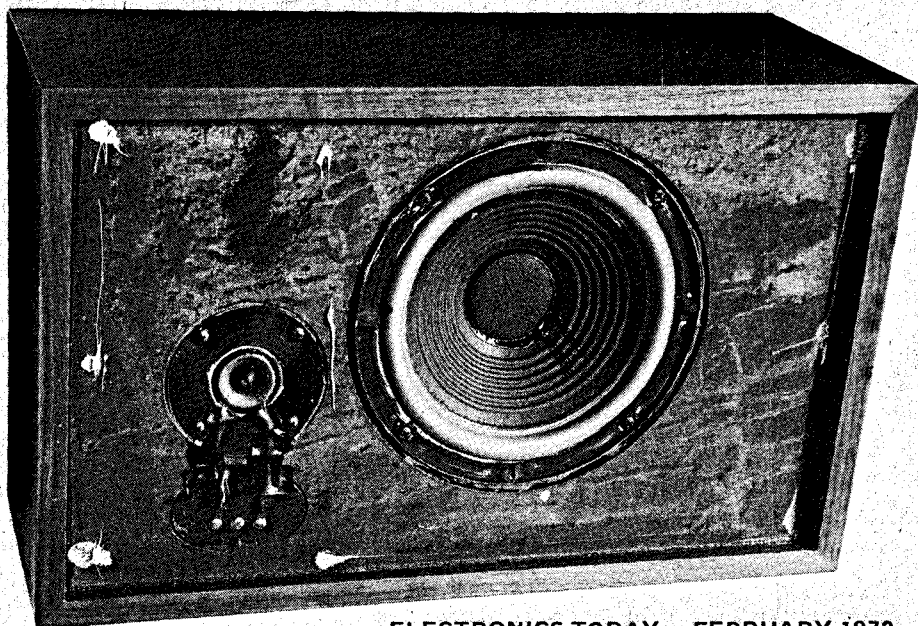

# BSR McDONALD

# total turntable packages...



MP60 four speed heavy balanced die cast turntable with viscous cue (single play) \$120.00 + cartridge.

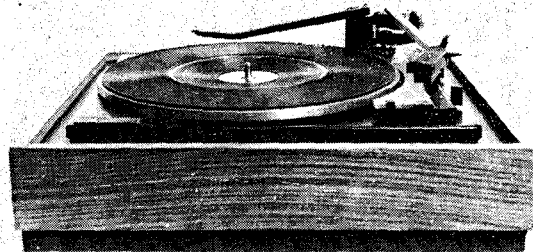

610 heavy balanced diecast turntable auto/manual turntable viscous cue \$125.00 + cartridge.

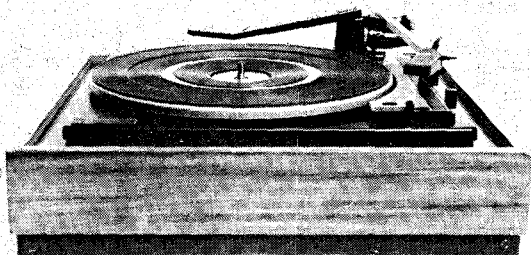

510 deep rim turntable auto/manual viscous cue \$115.00 + cartridge.

- 7", 10" or 12" diameter records.
- 78, 45, 33 and 16 r.p.m.
- Synchronous 4 pole motor to suit either 100-125 or 200-250 volt 50 cycles mains supply.
- Fitted with a high compliance magnetic cartridge the unit will track down to a minimum of 1 gram.
- Rumble — better than -35dB.
- Wow — better than 0.2% (Gaumont Kalee meter).
- Flutter — better than 0.06% (Gaumont Kalee meter).
- Satin black mainplate finish with black turntable mat inlaid with brushed aluminium trim. Pickup arm and controls in black and brushed aluminium.

• Prices apply in Australia only.

## and our total turntable concept...

Now you can buy any one of these three fine turntables professionally mounted on an attractive plinth with the latest smoke-tinted styrene dust cover. The unit is ready for mains operation complete with pickup leads and phono plugs. No wiring, no soldering, no waiting. Just plug in for BSR perfection.



**BSR (A'Asia) Pty. Ltd. Southern Section**  
**Industrial Estate St. Marys New South Wales 2760**  
**Telephone 623.0375 and 623.0376**

Wholesale Distributors **Goldring Engineering (A'asia) Pty Ltd**

- New South Wales** 26 Ricketty Street Mascot 2020 Telephone 67.6088
- Victoria** 162 Pelham Street Carlton 3053 Telephone 34 5105
- Queensland** 415 Adelaide Street Brisbane 4000 Telephone 2 3247
- Western Australia** 32 Northwood Street Leederville 6007 Telephone 84 988
- South Australia** 77 Wright Street Adelaide 5000 Telephone 23 3488
- New Zealand** C.P.O. Box 2630 Auckland



# CHOOSE YOUR MODEL, PARDNER!!!

**Douglas Trading is firing Big Discounts your way.**

Our opposition would probably like to shoot us if they could find out just how much you'll save. Think in terms of saving a quarter to one-third of going list price and you'll be right on the mark!



## **AKAI X-5000** 4-TRACK, 3-SPEED STEREO RECORDERS — in leather or wood!

Just listen to these features — 4-track stereo monaural recording and playback, 3-speeds, Cross Field Head, Hysteresis synchronous 2-speed motor, automatic shut-off, pause control, equaliser for each tape speed, DIN

and stereo headphone jacks . . . the list goes on and on but our heavily discounted stocks must run out soon. Hurry. Reach for the savings!

**\$299**

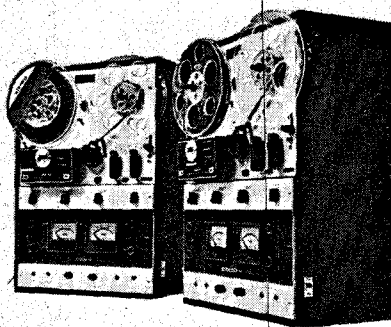

## **AKAI M-10** 4-TRACK, 3 MOTORS, STEREO.

Here's a model to give you a truly professional touch — with true Concert Hall Sound! Features 4-track stereo monaural recording and playback, Cross Field Head System with 3-heads, 3-speeds, 3-motors, auto. stop, auto. pinch wheel release, track selector and tape lifter. 40 W Music Power solid state amplifier with two integrated circuits.

**\$399**

# BREAKTHROUGH

**AKAI AND DOUGLAS TRADING EXCLUSIVE,**

AKAI 4-track, 2-channel Stereo Cassette Recorder. Breakthrough! Fantastic response . . . 30-18,000 Hz (+/- 3 dB) from cassette with 150,000 hours guaranteed head life. Integrated circuit . . . Hysteresis synchronous outer-rotor motor . . . recommended retail price was \$460 . . .

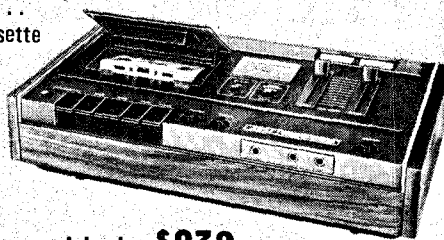

Douglas Trading special price **\$232**

# SPECIAL DELIVERY

The Biggest Discounts are at



191 BOURKE ST., MELBOURNE.  
Telephone 63 9321.

# A CONSUMER'S GUIDE TO RECORD PLAYERS



This authoritative article, by Edgar Villchur, tells what to look and listen for when choosing a record player.

**A** SURVEY of turntables may go into detail about such matters as the different types of drive between motor and platter (single-belt drive, double-belt drive, puck drive, puck-and-belt drive, etc.), as a method of distinguishing between different makes.

Drive systems are of legitimate academic interest to the consumer, but information about them does not provide a means for the comparative evaluation of turntables.

No drive system in itself can guarantee either good results or bad results, but, preconceived ideas about the superiority of one or another design approach sometimes prevent the dispassionate examination of performance.

I will here outline the important performance characteristics of a record player, and how they can be checked without equipment. I will also

describe some of the favorite old wives' tales about turntables, tales that are not to be confused with engineering knowledge.

Rumble is noise which is mechanical in origin, but is transmitted as an electrical signal and ends up in the speakers. It usually sounds like its name, a random low-frequency disturbance like that of a subway train heard from the street above.

All record players have rumble that is audible if the volume and bass controls are turned up high enough. There are large differences between units, however, so that in some cases the rumble is entirely inaudible at operating volume and in other cases it is definitely a distracting element.

Rumble becomes more obvious during quiet passages, and is much more likely to be present in a stereo system. Turntables or changers that have served silently in a monaural system are sometimes unusably noisy in stereo. The change takes place because rumble caused by vertical vibration is reproduced in a stereo system and suppressed in a monaural system.

The way to check for rumble is to set volume and bass controls at the maximum position at which they are ever used in the particular installation being tested, to turn the treble controls all the way down in order to cut surface noise, and then to play either a very quiet recorded passage or a "quiet-groove" test record.

(A test record is preferable because there is no distracting music, and because the grooves themselves are sure to be rumble-free). Under these conditions a first-quality record player will introduce little or no audible rumble. You should try different listening positions in the room to make sure you are not standing in a dead spot for the rumble bass frequencies.

It is also useful to make comparison tests by setting up two or more record players side by side. Using the same type of cartridge, the same record, and

## A CONSUMER'S GUIDE TO RECORD PLAYERS

the same control settings for each, relative ratings for each player can be established without too much difficulty. This test should be conducted at volume and bass levels much higher than those used above, since differences are more obvious at high volume.

Low rumble in a record player has real value to the music lover, and is not a fringe benefit of interest only to dyed-in-the-wool enthusiasts. Rumble detracts from the purity of sound, giving even well reproduced music something of an artificial, canned character.

Wow and flutter are the terms used to describe a wavering of pitch caused by tiny changes in the instantaneous speed of the platter. A bad case of wow sounds like a pitch vibrato. More subtle wow injects an overall sour quality into the music, particularly with piano music and even more particularly with sustained, single tones of the piano.

It is often difficult to detect small amounts of wow. This is not to say that it is not important unless immediately identifiable. The distortions created by wow are not always easy to isolate offhand, even when they detract from the quality of reproduction. One may feel that the piano doesn't sound right without knowing just why, until the same record is played on a turntable without wow. The tones will then take on a firmness and clarity that they previously lacked.

Acoustic feedback is quite different in origin from rumble, but it may increase the audible rumble markedly. Sound from the speakers transmitted through the floor and walls may cause the pickup to vibrate mechanically, setting up a self-sustaining chain of events. At worst a low-frequency howl or roar builds up, making listening impossible. In less extreme cases there is an emphasis of whatever rumble is present, a tendency to boominess, and a lessening of over-all clarity.

As in the case of rumble, all record players will exhibit acoustic feedback if the amplifier has enough gain and the volume and bass controls are turned high enough. The test for acceptable amounts of this feedback is similar to the test for rumble. Again setting the volume and bass controls at the maximum position at which they are ever used, but this time leaving the treble controls in their normal



A 'Dust Bug' can be easily fitted to any turntable — this simple attachment continually cleans the record during playing.

position, place the needle gently on a record at rest. Then stamp on the floor lightly or tap the table. If the turntable is on the edge of feedback a low-frequency ring will be set up. The longer it takes to die away the worse is the condition.

Acoustic feedback can always be cured by sufficiently compliant mounting of the turntable-arm system. When foam rubber doesn't work, springs will have to be used. Many turntables come supplied with such spring suspensions.

Compliant spring mounting also makes the record player much less sensitive to outside jarring and shock. But in order to take full advantage of this stability, the record player should be placed on a sturdy piece of furniture, and on a flat surface, so that the turntable base doesn't rock.

In a turntable installation sensitive to acoustic feedback, keeping the record player as far away as possible from the speaker will help. Mounting the two in the same cabinet can be disastrous.

The National Association of Broadcasters (NAB) specifies that turntables used for broadcast work be accurate within  $\pm 0.3\%$ . In terms of musical pitch this represents an accuracy of approximately one-tenth

of a quarter tone. If you have very good pitch discrimination, or intend to accompany the records with a live instrument, you should demand this professional accuracy; otherwise  $\pm 0.5\%$  is acceptable for high fidelity use. If the turntable is fast the music will be sharp, and if it is slow the music will be flat.

Speed accuracy is checked with a stroboscope card viewed under an ac light, preferably fluorescent.

It is not enough to glance at the strobe card. You must hold a pencil up to the card and count the drift of lines or dots per minute while someone calls time. Twenty-one lines per minute drift means an inaccuracy of 0.3% and thirty-five lines indicates 0.5%. The pickup should be playing the outside grooves of a record during the test.

The accuracy of speed may be affected by changes in line voltage or by changes in mechanical load. The first of these need be considered only if the turntable does not have a synchronous motor, and if the line voltage in your particular home varies significantly. If periodic speed checks show that your turntable speed is different at different times, you need either a voltage regulator between the

turntable and the wall socket, or a synchronous turntable.

Changes in mechanical load are created by the difference in needle drag between the outside and inside of a record, by heavily recorded passages, and by record cleaners that bear on the rotating record. The first two of these effects may be simulated by placing an extra three grams (a one-cent coin) on the pickup the last by placing five grams (a two-cent coin) on the pickup. All turntables, including those with synchronous motors, will slow down a bit from the added weight, but the drift of strobe card lines should remain within the limits you have set. Although this test does not seem to be a stringent one, many turntables do not pass it.

The difference in turntable speed associated with the difference in needle drag between the outside and inside of a record should be no greater than twenty-one lines drift, or the orchestra may sound as though it has gone flat when you change abruptly from the end of side one to the beginning of side two.

Hum from a record player may result from a simple error in connecting the cartridge leads. A reversal of left and right earth leads, for example, will create gross hum. Another potential source of hum is failure to connect a separate earth lead between the motor, turntable, arm, and preamplifier. If the hum increases when you touch the tone arm, earth lead trouble is indicated. A pre-assembled record player should already have this extra lead, terminated by an alligator clip or by a permanent connection to one of the phono tip shields.

Hum may also be induced in the cartridge from the magnetic field of a nearby amplifier transformer or from the field of the turntable motor itself. This can be checked at the same time as rumble. Move the arm over the playing surface of the record, keeping the needle just off the record, with the motor on and the amplifier controls set as in the rumble test.

Some cartridges are much more sensitive to hum pickup than others, and so you must see to it that the combination of cartridge, turntable, and mounting position are humless.

If you are about to buy a turntable you can learn a lot by carrying along a strobe-card and a test record when you visit friends with hi-fi systems. In testing different turntables you can get a frame of reference for your own choice (making enemies along the way). It will also be helpful to ignore the following old wives' tales:

*Old Wives' Tale No. 1:* A good turntable must have a heavy platter and motor, or alternately, there is an

inherent advantage to using a light turntable.

The flywheel effect of a heavy platter is one element that the designer makes use of to reduce flutter in the context of the complete design. It is not one of the major elements. Flutter and wow can neither be talked away nor introduced by pointing to the weight of the platter. A turntable designed by the writer has a medium-weight platter, so I speak from neutral ground.

The quality of the motor used is not gauged by its weight or size. A heavy motor does not necessarily mean more vibration, nor does a small motor mean inadequate power. The most significant tests of motor performance are for rumble and for speed drift with changes of mechanical load. If the turntable passes the rumble and coin tests, all the talk in the world about the light vs. heavy design "controversy" is irrelevant.

*Old Wives' Tale No. 2:* You can check a turntable for adequate "torque" by seeing how hard it is to stop by hand, or by noting how quickly it comes up to speed after starting.

Stopping the platter by hand may be a good test of the turntable's suitability for operating a small drill press, but it is no test of the table's suitability for playing records. It is possible for a turntable to show unacceptable slowdown on the coin test, yet to continue to turn, at an unusably slow speed, in the face of a large extra mechanical load. It is also possible for a turntable to hold its speed in the coin test and under the kind of mechanical strain it meets in actual operation, yet stall out with comparatively light pressure on the rim of the platter.

The starting torque of a motor is not

an index of its running torque. Some motors have a running torque many times higher than their starting torque, while others have higher torque during start-up than when running on speed.

*Old Wives' Tale No. 3:* An arm must be "dynamically balanced" for optimum performance.

Dynamic balance is a misnomer that has somehow found its way into tone arm jargon. It is taken by different people to mean different things, none of which relates to its meaning as a standard term in physics. The hi-fi reference seems to have settled on a tone arm whose counterweight balances the cartridge completely (instead of leaving a gram or two for stylus force), and whose stylus force is then created by a spring.

This design can produce excellent tone arms, and is used in arms of various price brackets. The unbalanced arm design (unbalanced by the amount of required stylus force) also can be used to excellent effect, and is similarly found in arms of different price categories. It goes without saying that all types are usually advertised as "perfectly balanced". The consumer's concern must be how the arm performs under the conditions assigned to it.

Arm balance affects sensitivity to off-level mounting and the ability to play warped records. If a record player does well in these characteristics the problem of tone arm balance has been well handled.

*Old Wives' Tale No. 4:* A synchronous motor guarantees accurate, constant turntable speed.

A synchronous motor does guarantee that the turntable speed will not be affected by changes in line voltage or by warm-up from a cold start. Correct

(Continued on page 114)

Stylus tracking weight can be set to a high degree of accuracy by using the BIB stylus balance.

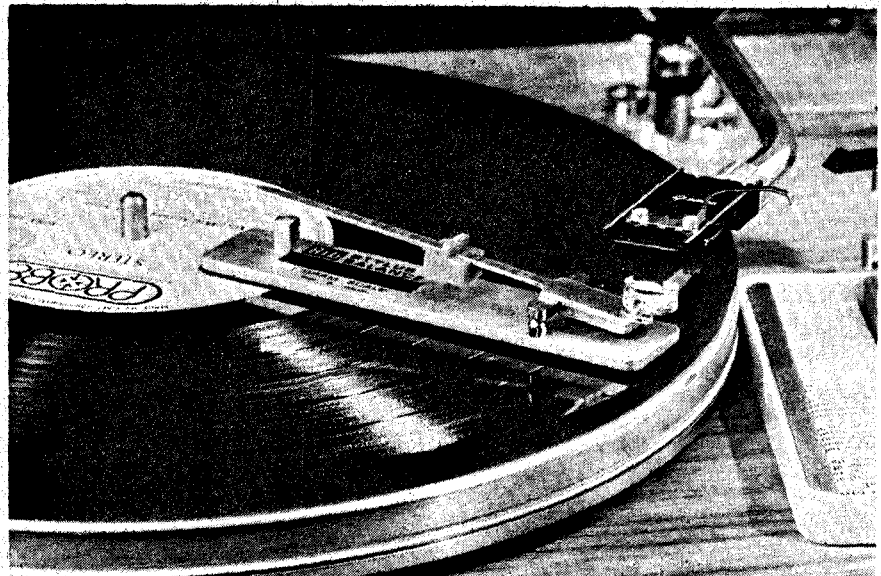

# SIGNAL TO NOISE RATIO

— its optimization in precision measurement systems

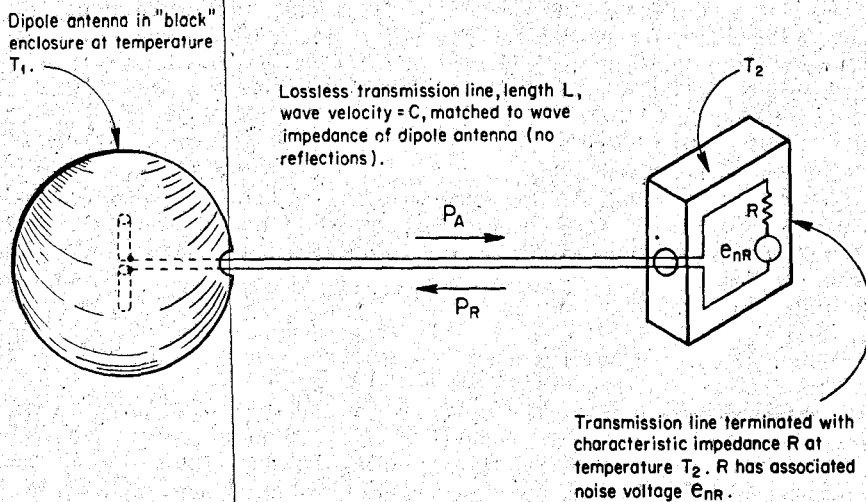

by Thomas Coor, BA., Ph.D.  
Vice President, Research  
Princeton Applied Research  
Corp.

Figure 1. Gedanken experiment used to derive the relations for Johnson noise in resistance  $R$  at temperature  $T$ . Thermodynamic and statistical arguments lead immediately to the results.

## SOURCES OF NOISE AND THEIR PROPERTIES

It was realized by Schottky very soon after the advent of the vacuum tube amplifier that unlimited gain is not useful and that after a certain gain is achieved, random fluctuations or noise show up.

These random fluctuations have been shown to arise from two basic causes: one is thermal in origin and its properties can be derived from thermodynamic and statistical mechanical arguments — the other arises from the fact that light and electrical charges are quantized and current in transistors, vacuum tubes, and photocells flows by virtue of the uncorrelated transfer of single electrons across some void, hence is statistical in nature.

## JOHNSON OR RESISTANCE NOISE

Although intimately related to Brownian motion, the existence of thermal noise in resistors was realized comparatively late. This noise is usually called "Johnson noise" after J. B. Johnson, its discoverer. Nyquist, a colleague of Johnson, first derived its properties.

It is instructive to derive the magnitude of Johnson noise in a resistor. The method here is related to, but not identical with, that of Nyquist, and will be given in outline form. Consider the idealized experiment pictured in Figure 1.

(1) Because of black-body radiation from the enclosure at temperature  $T_1$ , the dipole will be a source of average power,  $\overline{P_A}$ , which flows down the transmission line and is completely dissipated in  $R$ .

(2) The Second Law of Thermodynamics requires that resistor  $R$  must be a source of average power,  $\overline{P_R}$ , such that  $\overline{P_R} = \overline{P_A}$  if  $T_1 = T_2 = T$ .

(3) Statistical Mechanics states that every mode of a system at equilibrium with temperature  $T$  will have average

total energy  $= kT$ , where  $k$  is the Boltzmann constant, but that the total energy of a given mode will fluctuate.

(4) Assume an instantaneous short at each end of the transmission line. Energy trapped on the transmission line results from both  $\overline{P_R}$  and  $\overline{P_A}$ . Total energy trapped is:

$$(\overline{P_R} + \overline{P_A}) \times \left( \text{time for signal to traverse line} \right) = 2\overline{P_R} \frac{L}{C}$$

(5) Wave theory states that the number of standing waves,  $\Delta m$ , on the transmission line between frequency  $f$  and  $f + \Delta f$ , where  $\Delta f$  is the bandwidth, is

$$\Delta m = \frac{2L}{C} \Delta f$$

(6) The average total energy trapped on the transmission line having frequencies between  $f$  and  $f + \Delta f$  will then be,

$$\Delta m k T = \frac{2L}{C} k T \Delta f = 2\overline{P_R} \frac{L}{C}$$

(7) Solving for  $\overline{P_R}$  we find

$$\overline{P_R} = k T \Delta f$$

(8)  $\overline{P_R}$  results from an internal noise voltage source,  $e_{NR}^2$ , associated with  $R$ . Since the transmission line represents a matched (equal in resistance) load to the

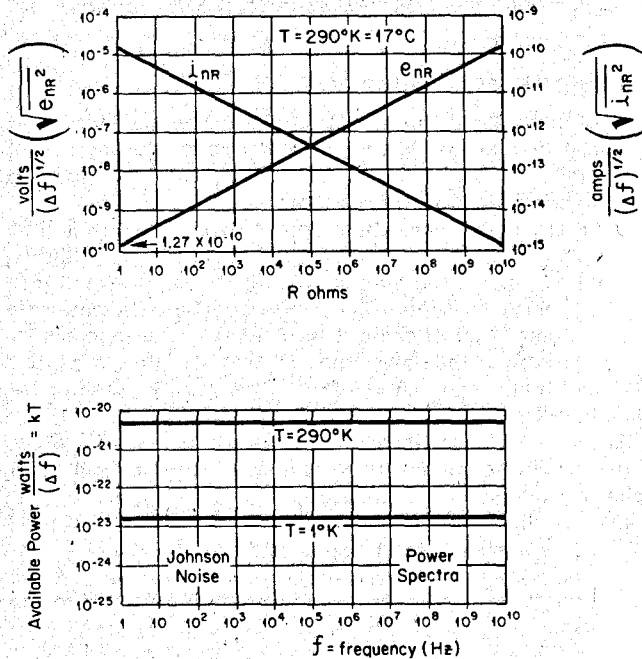
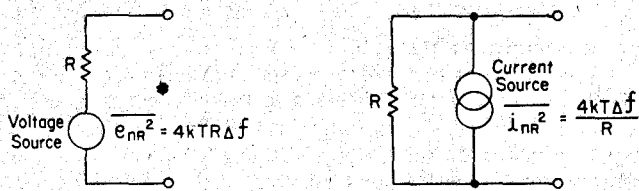

Figure 2. The two equivalent circuit representations of the thermal noise in resistor  $R$  are shown together with the magnitude of the rms voltage and current per cycle as a function of  $R$ . Also illustrated in the flat or "white" power spectra of the noise at two different temperatures.

voltage source,  $e_{nr}^2$ , of internal resistance  $R$ ,

$$\overline{P_R} = kT\Delta f = \frac{e_{nr}^2}{4R}$$

$$\text{Hence, } \overline{e_{nr}^2} = 4kT\Delta f \quad (1)$$

Similarly one can show that

$$\overline{i_{nr}^2} = \frac{4kT\Delta f}{R} \quad (2)$$

where  $i_{nr}^2$  represents the noise current that will flow across the shorted terminals of a resistor  $R$ . The two equally valid ways of representing the noise of a resistor are shown in Figure 2.

Note that the eqns. (1) and (2) are functions only of the frequency bandwidth,  $\Delta f$ , and not the frequency, hence the magnitude of the average noise voltage or current depends only on the effective frequency bandwidth of the measuring instruments. This type of frequency spectrum, plotted on a power-per-unit-bandwidth basis, is known as a white spectrum, hence resistor or Johnson noise is called white noise.

We thus see that any dissipative element, whether it be the membrane resistance of a glass electrode or the load resistance of a photocell, gives rise to a real noise voltage or current and this noise will add to any signal that appears across the resistor. Purely reactive elements, capacitances and inductance, have no noise voltages associated with them *per se*. However, real inductors have winding resistance and real capacitors have dielectric loss, both of which give rise to the expected noise.

Apart from Johnson noise, which appears across any resistor whether or not it is carrying current, there are additional sources of noise in resistors that are carrying

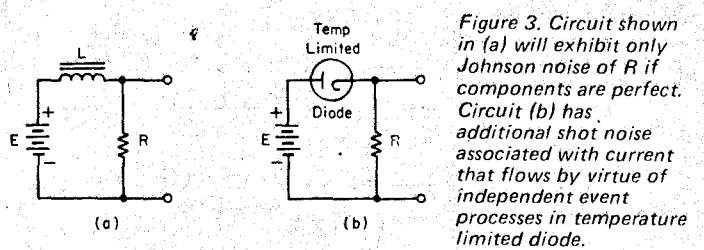

Figure 3. Circuit shown in (a) will exhibit only Johnson noise of  $R$  if components are perfect. Circuit (b) has additional shot noise associated with current that flows by virtue of independent event processes in temperature limited diode.

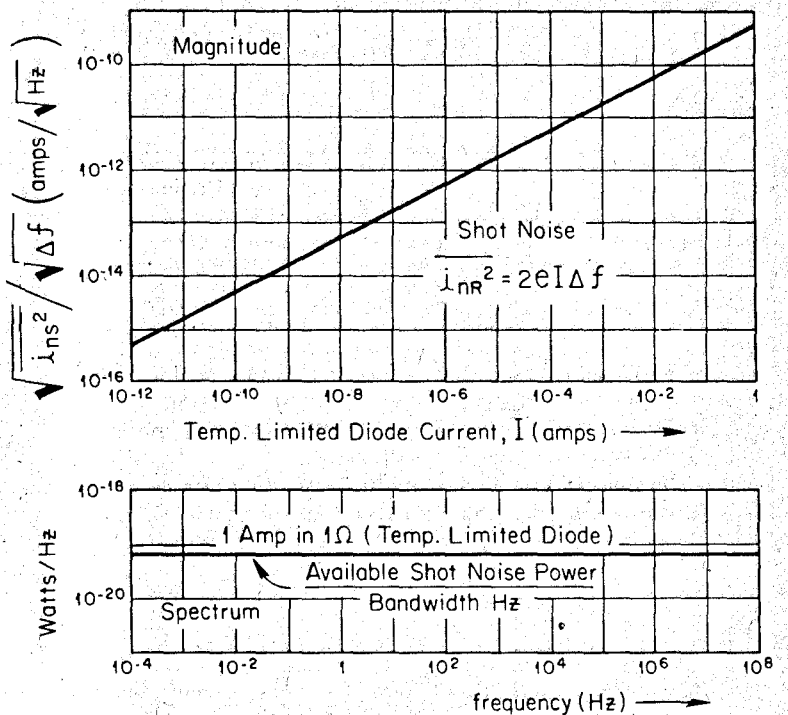

Figure 4. The magnitude and spectral characteristics of shot noise as a function to total diode current,  $I$ .

current. Wire wound resistors are in general quite good in this respect; microphonics being about the only source of additional detectable noise. On the other hand, composition, deposited carbon, and metal film resistors show voltage dependent noise, descending in that order. Good metal film resistors are almost — but not quite — as good as wirewound resistors. This voltage dependent noise is not too well understood but seems to be due to the granular nature of the resistance elements. The spectral characteristics of this excess resistor noise is quite interesting, having a peculiar  $1/f$  power spectrum, and has a flicker-like appearance on an oscilloscope or meter. This "1/f" or "flicker" noise is disastrous for low-frequency or dc measurements, because averaging for longer periods of time can result in no net increase in S/N!

## SHOT NOISE

In the last section the statement was made that good resistors carrying current had little noise in excess of the Johnson noise. How can this statement be reconciled with the known fact that electrical conduction occurs via electrons and that charge is quantized? This is an important point that is often missed. Consider the circuit in Figure 3a. For frequencies where  $R \gg 2\pi fL$ , the noise at the output terminals is just the Johnson noise. However if a diode is introduced in the circuit, as shown in Figure 3b, the situation is vastly different, even though the current through the resistor, is the same. In the diode (or photocell, transistor, triode, etc.) the passage of current is governed by a random single-event, electron emission process, while metallic conduction is a large scale correlated drift phenomenon with many discrete changes taking part at once. Hence the current through the single-event devices are subject to large statistical fluctuations while metallic

# SIGNAL TO NOISE RATIO

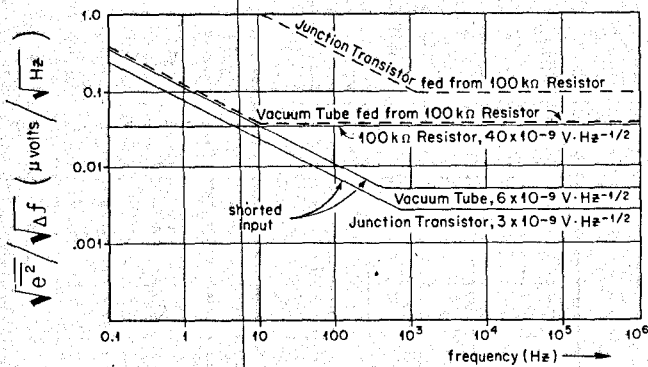

Figure 5. The noise voltage as a function of frequency of representative vacuum tubes and junction transistors under conditions of shorted input and with 100kΩ source impedance (noise referred to input). Also shown is noise of 100kΩ resistor at 290° K. The effect of base current noise is immediately apparent.

conduction is not. The "shot noise" due to the random emission of electrons from cathodes or semiconductor junctions was predicted by Schottky early in the era of electronics.

The derivation of the magnitude of this noise is straightforward but only the result will be indicated here. The mean square shot noise current,  $i_{ns}^2$ , is given by:

$$\overline{i_{ns}^2} = 2Ie\Delta f \quad (3)$$

where  $e$  is the electron charge,  $1.59 \times 10^{-19}$  coulomb,  $I$  is the current that flows due to some single electron random emission process (e.g., temperature limited diode), and  $\Delta f$  is again the bandwidth at the measuring apparatus with which  $i_{ns}^2$  is measured. We see that this noise is "white", i.e., has a flat spectrum. The magnitude of shot noise current is given in Figure 4.

All active amplifying devices used in electronics — the transistor, photocell, vacuum tube — exhibit shot noise. This noise is an important factor in determining the overall performance of an amplifying and measuring system. However, the shot noise in a vacuum tube is much less than given by eqn. (3). Space charge effects which introduce a smoothing action on the random conduction process are responsible for this reduction.

## FLICKER NOISE

The third source of noise which is important to our considerations is called *flicker-effect* noise and has been mentioned in conjunction with resistors. Flicker-effect noise is characterized by its unusual spectral characteristics and, for most electronic devices, dominates thermal or shot noise only for frequencies less than about 100 Hz. Flicker noise is especially troublesome for those trying to make small dc measurements, as we shall see.

Flicker noise is not completely understood but is found generally where electron conduction occurs in granular semiconducting material, or where cathode emission is governed by the diffusion of clusters of barium atoms to the cathode surface. Phenomenologically, flickering conduction can be pictured as resulting from a very large assemblage of series connected switch-resistor combinations randomly arranged in all possible ways between two terminals. The switches are then assumed to randomly open and close according to some statistical distribution. The particular distribution determines the power spectrum characteristics of the resulting noise. Almost all electronic elements exhibit flicker noise to some degree and their noise power spectra differ widely. Tubes and transistors typically show a power spectrum of the form  $1/f^n$  where  $n$

is a constant near 1. The noise of several typical amplifying devices is shown in Figure 5.

The particularly disturbing factor about flicker noise is that the  $1/f^n$  characteristic seems to hold down to as low a frequency as one cares to determine it. The long term drift in dc transistor or tube amplifiers would seem to be the manifestation of very low frequency flicker noise! Hence, dc electrical measurements are fraught with great difficulties. Even galvanometers exhibit flicker-noise-like effects. *Moral: avoid dc measurements if S/N is a problem.*

## ENVIRONMENTAL NOISE

Environmental disturbances which make their way into physical measurements can, in principle, be reduced to an arbitrarily small value, but in practice, can be very annoying and difficult to eliminate entirely.

Fifty Hz (and higher harmonics) from the power line, radio stations, motor and switch sparks, corona, building vibrations, and room temperature fluctuations all fall into this category. One interesting and important characteristic of the sum of all of these disturbances is the apparent  $1/f$  characteristic of the power spectra. Why this should be so is not entirely clear. Apparently the power spectra of temperature fluctuations, earth vibrations, and all the man-made fluctuations are determined by event disturbances not unlike those found in cathodes and other granular semiconductor processes. While not quantitative, Figure 6 illustrates the spectral characteristics of typical laboratory environmental noise. Apart from the power line frequencies, which are very sharp lines, the region between 10 and  $10^6$  Hz is comparatively quiet and is a good region to have information appear, as will be discussed later.

## THE SIGNAL MEASURING SYSTEM BLOCK DIAGRAM AND NOISE SOURCES

Before considering the S/N properties of instrumentation systems, let us make reference to Figure 7 in which a hypothetical system is shown in block diagram form, together with sources of noise. The quantity under study,  $Q(t)$  together with its inherent noise, is probed with a linear transducer of some type yielding an electrical signal  $E(t)$ . Generally, some provision is made to switch or move the transducer input from the object of study to some blank or standard. This allows a zero point to be established or a system calibration to be made. The signal  $E(t)$  from the transducer is amplified, processed for noise reduction, and finally recorded in some fashion.

In designing such a system the characteristics of each element must be specified in such a way as to pass the information of interest, act on it in the way desired, and optimize the S/N performance of the entire system. The most important considerations in system specifications are discussed in the following paragraphs.

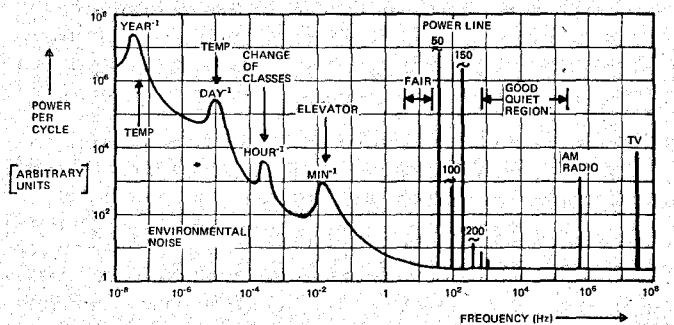

Figure 6. Pictorial representation of environmental noise in a typical location as function of frequency. Note the  $1/f$  character at low frequencies.

# ELMASET SYSTEM

## CARD FRAMES AND CABINETS

Most ranges of card frames and cabinets currently available are designed for the use of only one standard size of printed circuit card and edge connector. The ELMASET system has been carefully designed to allow the use of printed circuit card and modular units of many different types and sizes. All structural parts of the ELMASET system are provided with slots or tapped holes which allow rapid and simple subdivision of units into almost any required sizes.

The ELMASET range is both versatile and comprehensive. It extends from printed circuit cards and edge connectors to card frames; modules; instrument cases and cabinets right up to multi-section floor mounted 19" cabinets.

*A standard range available from Sydney stock.*

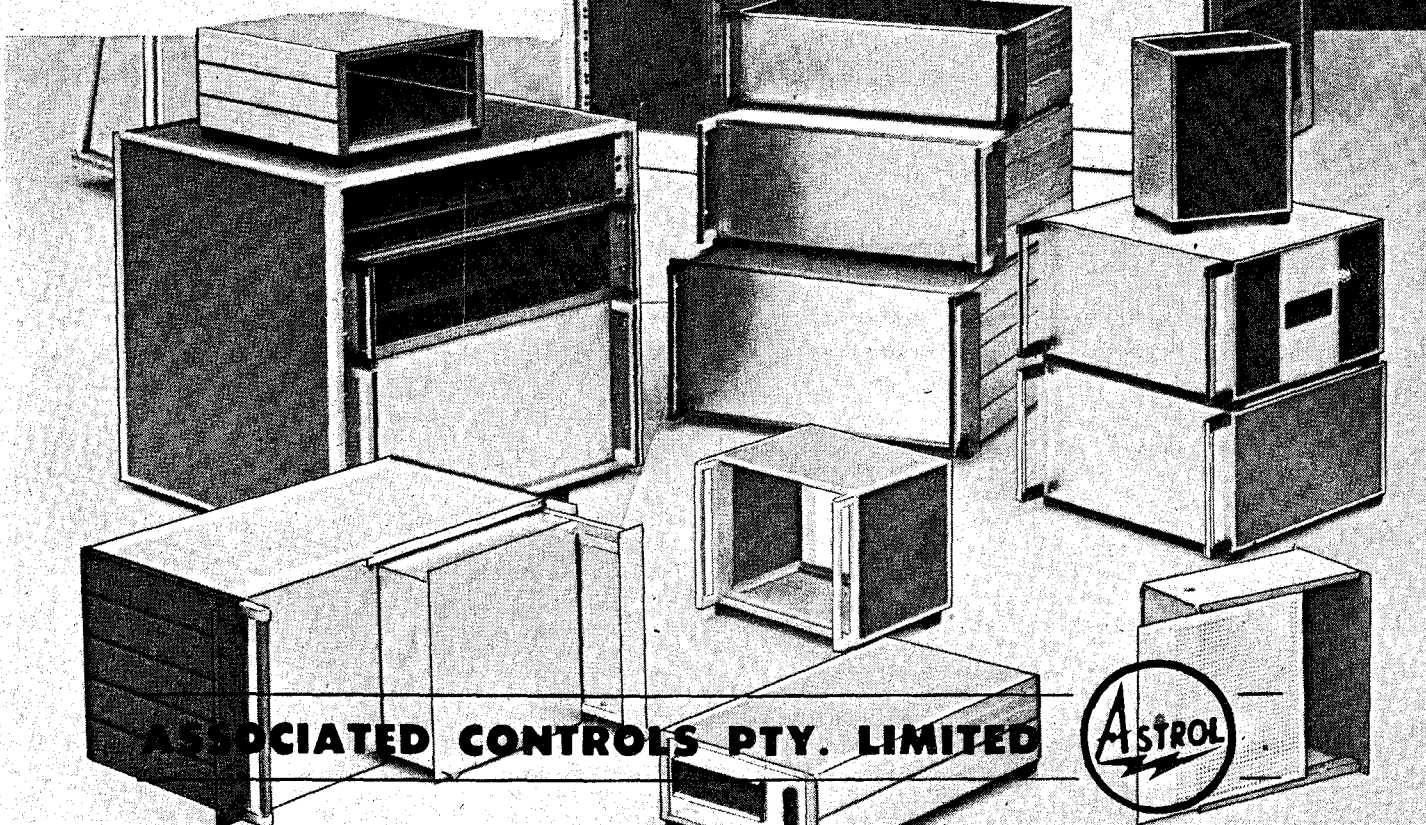
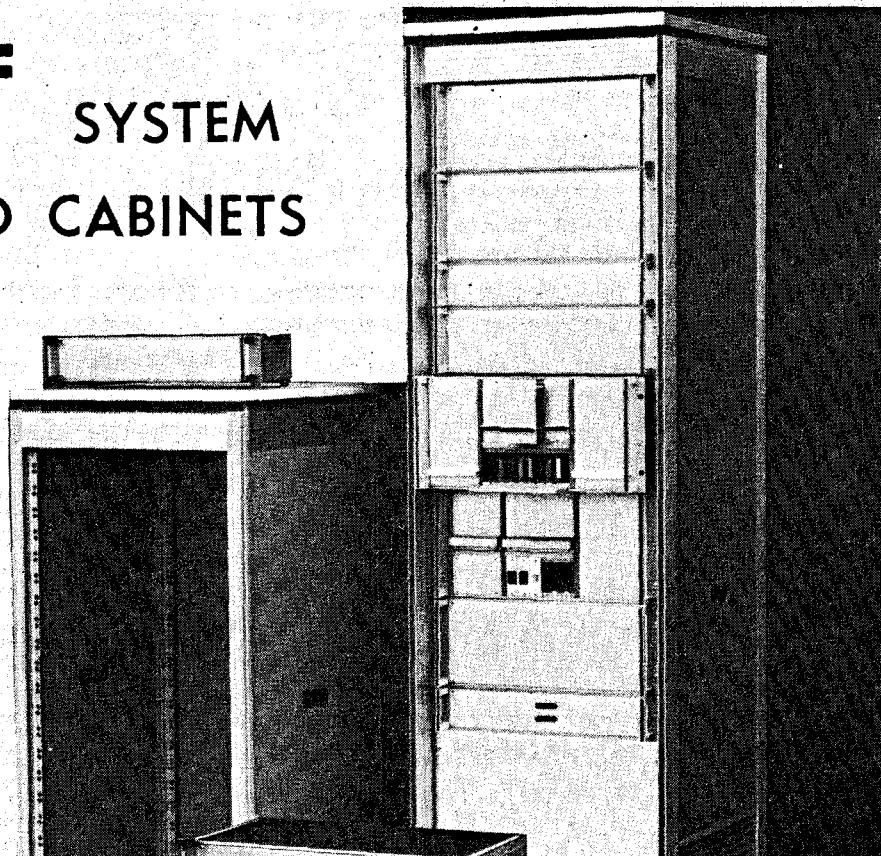

**ASSOCIATED CONTROLS PTY. LIMITED**



NSW  
55 Fairford Road, Padstow, 2211  
Telephone: 709 5700

VIC  
Suite 20, 73 Mahoneys Rd., Forest Hill, 3131  
Telephone: 878 6555



# SANWA MULTIMETERS

## PROVEN IN OVER 90 COUNTRIES

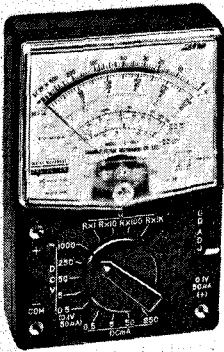

### U-50<sub>DX</sub> — Quality-wide range VOM

DC Voltage: 0.1V, 0.5V, 5V, 50V, 250V, 1000V.  
 AC Voltage: 2.5V, 10V, 50V, 250V, 1000V  
 DC Current: 50 $\mu$ A, 0.5mA, 5mA, 50mA, 250mA.  
 Resistance: Rx1, Rx10, Rx100, Rx1k  
 dB: -20dB ~ +62dB  
 M $\Omega$ : 1M $\Omega$  ~ 500M $\Omega$  with external power.  
 $\mu$ F: 0.0001 $\mu$ F ~ 0.2 $\mu$ F

**\*\$16.95**

### 460-ED — Ultrahigh Sensitivity VOM

DC Voltage: ( $\pm$ ) 0.3V, 3V, 12V, 30V, 120V, 300V.  
 DC Current: ( $\pm$ ) 12 $\mu$ A, 0.3mA, 3mA, 30mA, 300mA, 1.2A, 12A  
 AC Voltage: 3V, 12V, 30V, 120V, 300V, 1.2kV.  
 AC Current: 1.2A, 12A.  
 Resistance: Rx1, Rx10, Rx100, Rx10k (Max 50M $\Omega$ )  
 dB: -20dB ~ +63dB

**\*\$45.00**

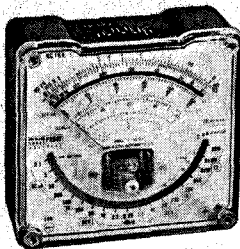
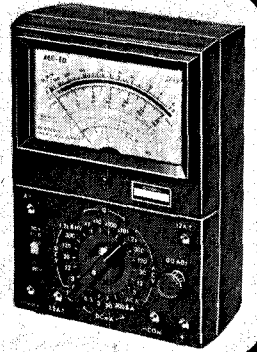

### F-80TRD — Unique Taut Band VOM

DC Voltage: 0.25V, 2.5V, 10V, 50V, 250V, 500V, 1000V.  
 AC Voltage: 2.5V, 10V, 50V, 250V, 500V, 1000V.  
 DC Current: 40 $\mu$ A, 0.5mA, 5mA, 50mA, 500mA.  
 Resistance: Rx1, Rx10, Rx100, (Max. 50M $\Omega$ )  
 dB: -10dB ~ +36dB  
 LI: 15mA, 1.5mA, 150 $\mu$ A  
 LV: 1.5V

**\*\$32.25**

### A-303TRD — Medium Size, High Sensitivity VOM

DC Voltage: 0.3V, 1.2V, 3V, 12V, 30V, 120V, 300V, 1200V.  
 AC Voltage: 6V, 30V, 120V, 300V, 1200V  
 DC Current: 60 $\mu$ A, 3mA, 30mA, 300mA, 1.2A, 12A.  
 Resistance: Rx1, Rx100, Rx1k, Rx10k, (Max 50M $\Omega$ )  
 dB: -10dB ~ +63dB  
 LI: 60mA, 600 $\mu$ A, 60 $\mu$ A  
 LV: 1.5V

**\*\$25.50**

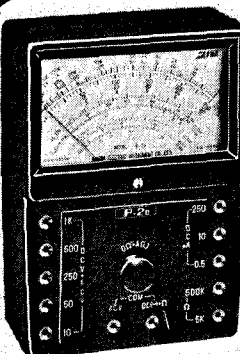
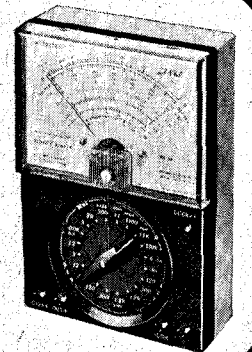

### P-2<sub>B</sub> — A versatile pocket multimeter

DC Voltage: 10V, 50V, 250V, 500V, 1000V.  
 AC Voltage: 10V, 50V, 250V, 500V, 1000V.  
 DC Current: 0.5mA, 10mA, 250mA.  
 Resistance: 0 ~ 5k $\Omega$ , 0 ~ 500k $\Omega$   
 Volume Level: -20 ~ +22dB, +20 ~ +36dB  
 Megohm: 0.1 ~ 50M $\Omega$   
 Capacity: .00002 ~ 0.3 $\mu$ F & use external power  
 0.01 ~ 0.6 $\mu$ F

**\*\$10.95**

### N-301 — Sensitive VOM with overload circuit breaker

DC Voltage: ( $\pm$ ) 0.25V, 1K, 2.5V, 10V, 50V, 250V, 1000V.  
 DC Current: ( $\pm$ ) 50 $\mu$ A, 1mA, 10mA, 100mA, 1A, 10A.  
 AC Voltage: 2.5V, 10V, 50V, 250V, 1000V  
 Resistance: Rx1, Rx10, Rx100, Rx1k, Rx10k. (Max 20M $\Omega$ )  
 Frequency Response: 50Hz ~ 100kHz for 10V & below.  
 50Hz ~ 20kHz for 50V & 250V.

**\*\$49.95**

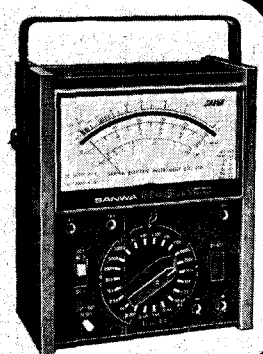

Distributed by:



**WARBURTON FRANKL**

WF 18111

\* Prices shown are suggested trade prices which may vary slightly from location to location.

**AVAILABLE FROM ALL LEADING ELECTRICAL TRADE HOUSES**

# SIGNAL TO NOISE RATIO

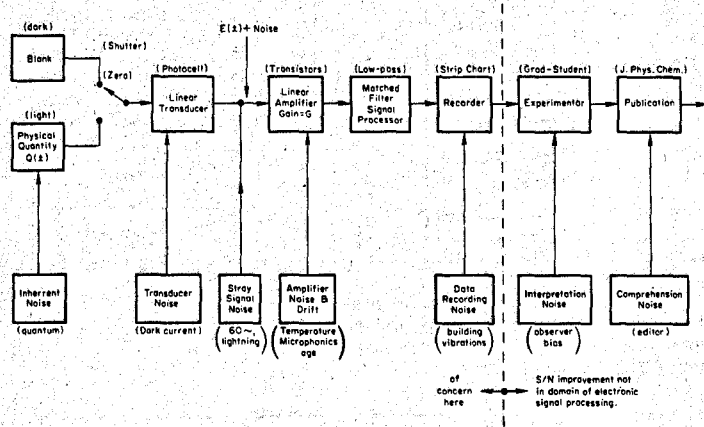

Figure 7. Block diagram of system required to record the changes with time of some quantity  $Q(t)$  (assumed to be light). Also shown are possible sources of noise.

## SYSTEM CONSIDERATIONS: NATURE OF SIGNAL

The first consideration in system specification is the nature of the information that is going to be handled by the system. The simplest and most common type of instruments are dc systems where the quantity of interest is steady or slowly varying with time, and the information "containing" the magnitude of the quantity is handled as a dc signal.

The other systems carry this information as the amplitude of sinusoidal or square wave signals with fundamental frequency  $f_c$ . These ac signals can result from the modulation of the phenomena under study by some means, or can result from the nature of the transducer used. In the latter case a steady or dc input to the transducer is converted by some chopping or modulating action into an ac signal as, for example, is done in a vibrating capacitor electrometer.

In still other systems, the information may be in the form of recurring waveforms, or in the amplitude of power spectra of signals from the material under study.

## SIGNAL FREQUENCY

In designing an instrumentation system, one often has the choice as to where the band of information of interest is made to lie. For example, in atomic absorption spectroscopy the changes in transmission of resonance radiation through the flame of a burner can be determined by a dc measurement. Alternatively, the resonance radiation can be chopped, or alternated between the flame path and a reference path at some frequency, say 400 Hz.

By chopping, the band of information is removed from very low frequencies (dc) and placed around the chopping frequency. This allows the use of ac amplifiers and thus avoids the inherent drift and flicker noise of dc equipment. In addition, it permits the use of some very powerful techniques for improving S/N. These techniques will be discussed later.

## SYSTEM BANDWIDTH

Having chosen the frequency at which the information is to appear, there is a further related question that must be considered — that of system bandwidth. If the quantity being chopped or modulated at frequency  $f_c$  has a steady or dc value, then the bandwidth of the information "channel" at  $f_c$  is very narrow. However, if the quantity is changing with time, the bandwidth  $\Delta f_c$  required to carry the information will be greater. For faithful reproduction of the original time-varying quantity, every element of the

system through which the information passes must have sufficient bandwidth to pass all components of the signal. However, as most noise sources have the property that the wider bandwidth  $\Delta f$  of the system the greater will be the resultant noise, this should not be overdone. From the standpoint of S/N, the system bandwidth should be only wide enough to faithfully reproduce the wanted time dependence of the original information. These considerations are equally true if the signals being processed are dc. Apart from  $1/f$  effects, narrower bandwidths will in general yield less noise.

## DYNAMIC RANGE

Dynamic range is a very important concept in information processing which is often neglected in system design. Any measuring system will have its own irreducible noise level and drift, which impose a lower limit on the level of signals that may be handled by the system. Likewise, the system will always overload and become non-linear for sufficiently large inputs. Often this overload point is dependent on whether the input is a signal at the chopping frequency  $f_c$  or is wide-band noise.

Dynamic range can be defined in two ways: (1) the ratio of the signal producing full scale output, to the signal corresponding to the inherent system noise and drift, (2) the ratio of the noise level producing overload to the signal that corresponds to full scale output. Both of these definitions are valid and useful and will be referred to again. In general, definition (1) is more useful in quieter situations. Definition (2) serves better where the input S/N is less than unity. It is obvious that the dynamic range of a measuring system has great bearing on the precision with which measurements can be made and on the ability of a system to function properly in the presence of large quantities of noise.

## DRIFT

Drift also is defined in two valid and useful ways: (1) *zero drift* — the variations with time of the output of a measuring system with zero input; (2) *gain drift* — the drift in the indicated value of a steady input with time. Zero drifts usually impose limitations on sensitivity or ultimate detectability, while gain drifts set limits on accuracy and precision.

## NOISE FIGURE

We have seen that any physical system providing some quantity to be measured will have a certain irreducible noise associated with it. What we wish to do, given this  $S_s/N_s$  from the source, is to transduce, amplify and then measure the characteristics of  $S_s$  with the least possible

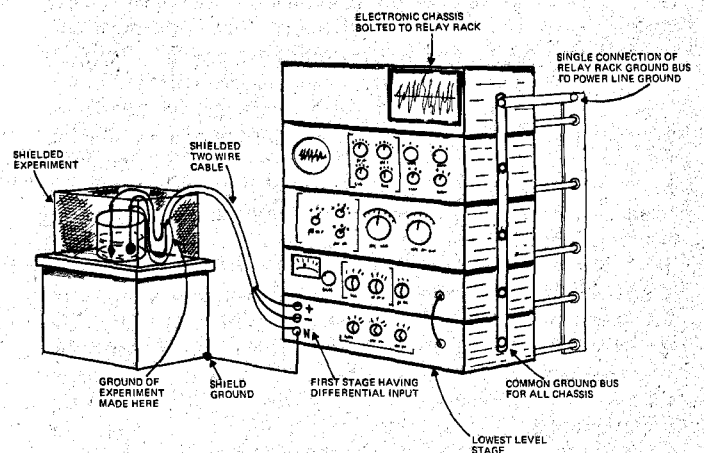

Figure 8. Experimental set-up shown to minimize the effects of line-frequency pick-up.

effect of  $N_s$  on the measurement. To do this, we should see that the transducer, amplifier, and other equipment through which the signals are processed, degrade the initial  $S_o/N_o$  at the output. Hence they should be "low noise." One sees that a quantitative measure of the degradation of S/N in passing information through some sub-system is important. One possible measure is called the *Noise Figure* (NF) of the unit. It is defined as:

$$NF = 10 \log \frac{S_i/N_i}{S_o/N_o}$$

where  $S_i/N_i$  is the ratio of the available input-signal and noise powers, the  $S_o/N_o$  the ratio of the available output powers. It is expressed in dB. The NF of any network is a function of the nature of the source (the source temperature and impedance), the frequency of operation, and its gain. In specifying the NF of any element, it is assumed that the signal source has an internal resistance at 20°C and that the available noise power  $N_2$  is just the thermal noise of this impedance.

We have seen in Figure 5 that the noise of tubes and transistors is dependent on the source impedance to which they are connected. The excess noise with high source resistance is in addition to the Johnson noise generated by the source resistance, and results from a noise current (grid or base current) flowing from the device giving rise to increasing noise as the source resistance is raised. Hence the NF of a signal processor or transducer is a complicated function of source impedance, frequency, input device characteristics, etc. A perfect signal processing system will have a NF of 0 dB, while one that degrades the S/N of the signal source by a factor of two has a 3 dB NF. We shall be concerned with NF when we discuss amplifiers and other signal processing equipment.

### SYSTEM GROUNDING

System grounding can be a most annoying and frustrating problem in S/N improvement. In almost every laboratory there are several electrical grounds available; the water or gas pipes, the third (neutral) conductor in the 50Hz power distribution system, or a building ground bus.

As far as small signals are concerned, none of these grounds is any good whatsoever. If one looks between two different points in a ground system, one usually sees hundreds of millivolts — if not volts — at 50Hz. One should in general, ground the chassis of electronic equipment being used to only one point of distribution system ground, and refer all shields to this same point. But this is not going to be good enough for the most sensitive measurements. The various chassis grounded to the one common point are still going to have millivolts of 50Hz between them — even if mounted in the same relay rack! Ac magnetic fields from transformers, etc., will induce potential differences even if the chassis' have zero resistance. Avoiding these ground-loop voltages is often difficult. Although more will be said on this subject when amplifiers are discussed, in general, measurements where ground-loop voltages are a problem are best handled with differential measuring equipment: amplifiers, oscilloscopes, meters, etc., having two inputs, responding to only the difference between the two inputs and rejecting the common mode signals. A ground-loop avoiding system for a hypothetical set-up is shown in Figure 8.

An additional point about 50Hz problems should be made here. Even though a given system relies entirely on dc or high frequencies for carrying the signal information, 50Hz problems can still be encountered. The magnitude of the power line pickup can easily be so large as to drive dc or even high frequency equipment beyond its linear or dynamic range.

### DC VERSUS AC SYSTEMS

From the standpoint of S/N the most important decision to be made in instrument or experiment design is that of

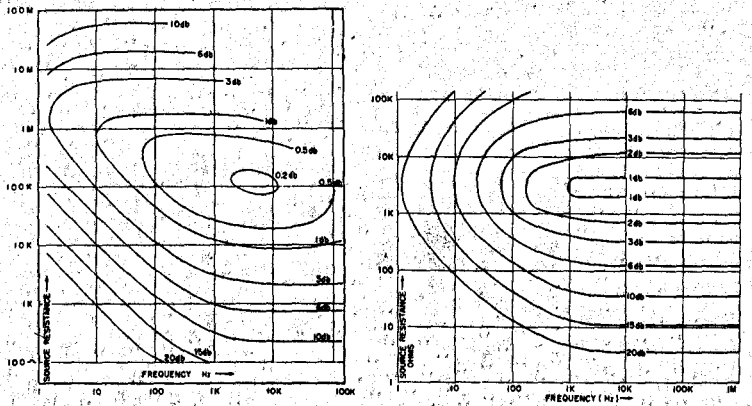

Figure 9. Noise figure contours for typical good low-noise amplifiers shown as function of frequency and source resistance (at 290°K). One at left uses vacuum tubes, on right junction transistors.

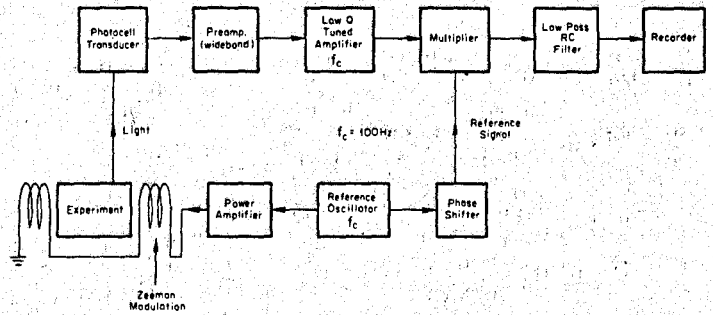

Figure 10. Hypothetical experiment in which light from experimental source, modulated by external magnetic field is measured. Lock-in technique are used to improve the S/N.

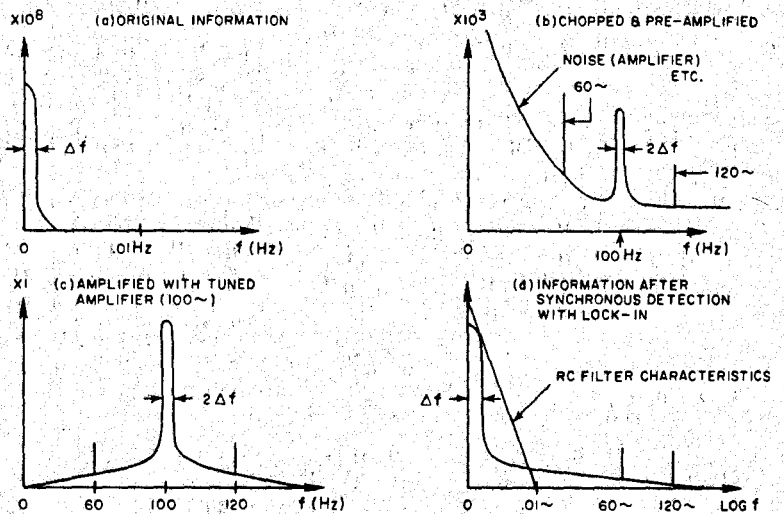

Figure 11. Diagrammatical representation of frequency spectra of information as it is carried through experiment shown in Figure 10.

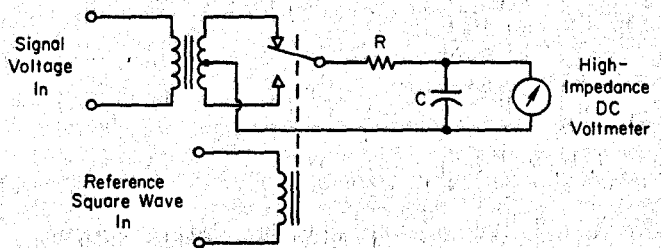

Figure 12. Synchronous detector in conceptual form to illustrate action of lock-in amplifier.

determining whether the electrical signals to be measured will be ac or dc. Returning to Figure 7, the signal  $Q(t)$  from the system under observation will in general not be ac, but will have some steady or slowly varying value. A necessary part of the apparatus is the provision for some means of "zeroing" the system: This should be done in such a way as to leave as much of the system unchanged as possible, including sources of noise. The ideal way would be to reduce only the phenomena of interest to zero, leaving the transducer or probe and all following equipment unchanged. To avoid noise, drifts, etc., the zero should be taken frequently. If the quantity of interest and the output of the transducer are dc, the simplest way to make the measurement is to amplify and record the signals as dc information. If the signals are small, the system is likely to be subject to drift and to all the other unpleasant properties of  $1/f$  flicker and environmental noise.

If it can be arranged to zero the system not once an hour or once a minute, but say 100 times a second, many important advantages can be realized. First, the repetitive zeros will easily keep up with the system drift. Second, ac amplifiers and ac signal processing techniques can be used, avoiding  $1/f$  noise. Third, it may be possible to have only the quantity of interest turned on and off (chopped) while interfering elements are not. This gives the wanted quantity a "signature" which can be identified by some signal processing scheme after amplification.

In designing a system in which it is possible to repetitively zero (or chop or modulate) the quantity of interest at some relatively high rate, it is extremely valuable to have a second signal available, one that tells when the system is on zero and when it is on the unknown. If this signal is available, correlation techniques can be used greatly to improve the S/N.

## TRANSDUCERS

In making a measurement of the desired small-effect phenomena, one must select a probe or transducer in order to derive a signal that can be processed and measured. If he has a choice, he will naturally choose one which gives the largest signal with the smallest amount of interference. The linearity, accuracy, and stability of the transducer, of course, are also important considerations. If the signal is modulated or chopped or is inherently non-dc, the frequency response of the transducer is also of importance. From the standpoint of S/N it is important that the transducer have a good NF and a high signal level output. Let us consider two examples of transducers that are often used by chemists.

The photomultiplier (6) is an example of an excellent transducer often used in photochemistry and spectroscopy. It is efficient in converting weak lights into electrical signals, has very high frequency response and has high inherent gain with large dynamic range. The noise properties are also very good, giving it a NF very near zero dB. When measuring very weak light signals the photomultiplier's NF can be improved by cooling it to dry-ice temperatures. Unfortunately, the gain of the photomultiplier is both strongly temperature and voltage dependent. Also, the device exhibits hysteresis effects. Exposure to strong light will cause a shift in operating characteristics which recover only over periods of hours. The amplification characteristics of photomultiplier tubes show a weak  $1/f$  effect, hence they are best used for non-dc applications.

The bolometer is another transducer often used by the physicist, generally to detect radiation in spectrographic equipment. The bolometer is usually a small blackened semiconductor element used as a resistance thermometer. There are many problems associated with bolometer radiation detectors. First, they have an appreciable amount of Johnson noise as they are generally high resistance. Second, they are used with a standing current, and thus exhibit flicker noise to a rather large degree. Since they are

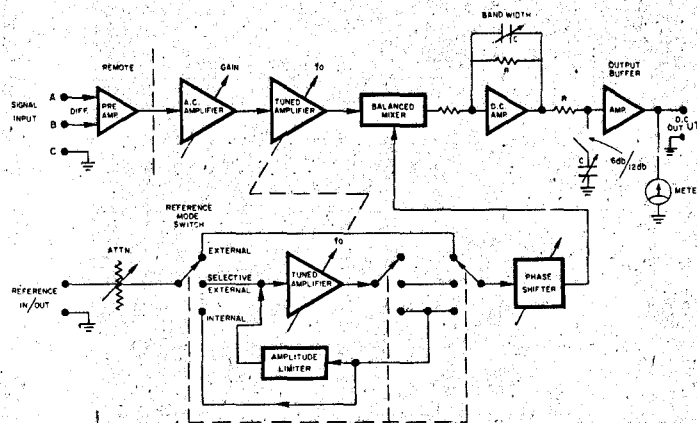

Figure 13. Block diagram of typical lock-in amplifier. With the exception of the preamplifier all the elements of the unit are usually contained in a relay rack chassis.

semiconductors, they are particularly prone to this type of noise. Third, they are rather slow to respond and so are not suitable for use where the radiation is to be chopped at a high frequency to avoid  $1/f$  noise. In using bolometers great care is required to achieve good S/N. Chopping at some low frequency, frequency around 10 Hz, is generally used. Within the range of wavelengths where they are sensitive, the new semiconducting diodes usually give much better noise figures than bolometers.

## AMPLIFIERS

It is often necessary in instrumentation systems to use amplifiers to raise the signal level of the information. Because they are usually used to process the lowest signal levels, they are very important in determining the S/N. In specifying amplifiers, one should be sure they have sufficient dynamic range and bandwidth. However, their bandwidth should be no more than necessary to carry the required information. The narrower the bandwidth the lower will be the noise at the output.

We have seen in Figure 5 that the noise of tubes and transistors is dependent on the source impedance to which they are connected. The excess noise with high source resistors is in addition to the Johnson noise generated by the source resistance, and results from a noise current (grid or base current) flowing from the device giving rise to increasing noise as the source resistance is raised. Hence the NF of an amplifier is a complicated function of source impedance, frequency, input device characteristics, etc. Figure 9 shows the NF curves for two good-quality audio frequency amplifiers one of which has junction transistors in the front-end, the other a Nuvistor triode. Recall that a perfect amplifier has a NF of 0 dB while one that just doubles the noise power has a NF of 3 dB. The effect of flicker noise at low frequencies, and of the input resistances of the two amplifiers is readily observable. It is obvious that there is an optimum source impedance for obtaining the best NF. Transformers can be used to match source impedances to the input of given amplifiers to obtain better NF, but at the risk of magnetic pickup and some NF degradation due to the winding resistance Johnson noise.

Summarizing, in choosing an amplifier or transducer for processing weak signals, care must be taken not to degrade

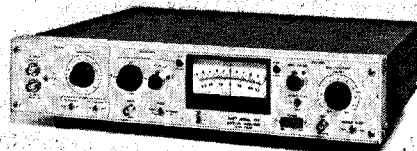

Figure 14. Model 128 Lock-In Amplifier manufactured by Princeton Applied Research Corporation.

# SIGNAL TO NOISE RATIO

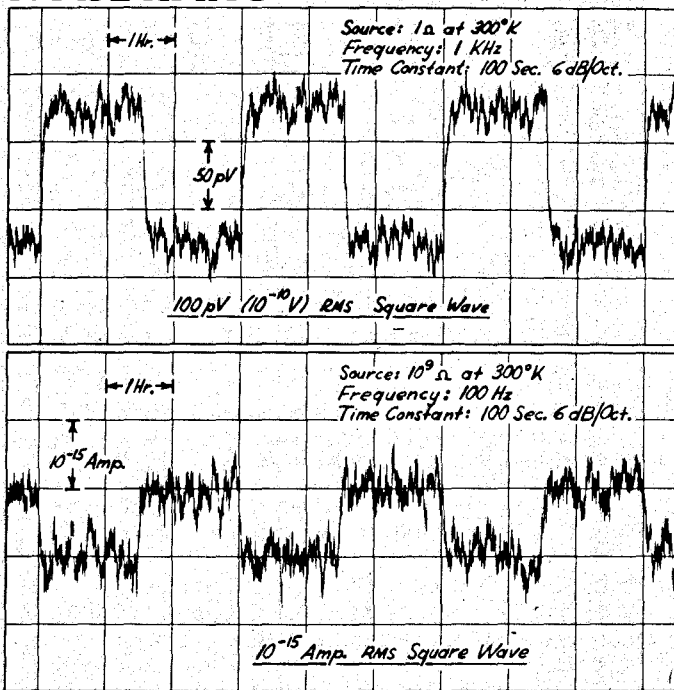

Figure 15. Recordings of the measurement of a very small ac current and voltage using lock-in techniques. The magnitude of the signals are well below the 1 Hz bandwidth Johnson noise of the associated source resistors.

the available S/N at the source. NF curves showing characteristic noise figure versus frequency and source impedance helps in choosing operating parameters. This is true regardless of the frequency or bandwidth of the information to be processed.

A pitfall often encountered should be pointed out. If the signal source is a constant current generator (like a photocell or photomultiplier), and one has a choice as to the load resistance  $R_L$  into which to develop the signal voltage, the optimum load resistance is *not* that which gives the best NF on the curves of Figure 9. It is instead the largest resistor which can be used without saturating the source or phase-shifting the signal (due to stray capacitances). In this case, it is clear that the source noise voltage goes up as  $\sqrt{R_L}$  while the signal of interest increases as  $R_L$ . This is particularly important in choosing load resistors for photomultipliers. By using large load resistors, one not only obtains better S/N across the load, but also lower PM gain due to the larger signal available. PM tubes themselves have NF considerations, and at high gains (high PM voltages), appreciable NF deterioration occurs.

An additional consideration in using small-signal amplifiers is to avoid power line frequency pick-up. The difficulty of doing this was mentioned in the system grounding discussion. An extremely useful technique for avoiding pickup problems is simply to use differential amplifiers in the lowest level stage of the instrument. Good ac amplifiers exhibit a common mode rejection greater than  $10^6$  for frequencies below 500 Hz. Hence the proper use of differential amplifiers can greatly reduce problems of spurious environmental pickup of all kinds and so merits serious consideration.

## SIGNAL PROCESSING

After the signals of interest have been amplified to a level where there is no longer danger that noise will degrade them, consideration should be given to processing the information in some way to enhance the signal and reject the noise. Also, if the signals are ac they could be converted into dc to drive one of the many available recording devices.

In the case of dc measurements, only a simple low pass

filter is needed to smooth the amplified signal. Averaging over longer periods of time (observing with narrower bandwidth at zero frequency) can hopefully improve S/N. However dc drift, flicker-noise, etc., often completely negate any theoretical S/N achieved.

If the signals of interest are inherently at, or can be made to lie at, a single frequency  $f_c$ , the situation is much better. First, tuned amplifiers which only respond to a small band of frequencies around  $f_c$  can be used to exclude broad-band and discrete noise not at the signal frequencies. If the frequency is high enough, flicker noise will not be a problem. The narrow band of frequencies which pass through the tuned amplifiers can now be detected (changed from ac to dc) and averaged in a low pass filter. Techniques of this type can be made to work quite well, but are limited in the achievable narrowness of bandwidth because of frequency drift problems. Drift of  $f_c$  relative to the response frequency of the narrow filters would make these filters difficult to use.

If one can arrange to have a clean "reference" signal at  $f_c$ , derived in some way from the modulation or chopping process such that this "reference" is phase-locked to the small signal to be measured, one can achieve dramatic improvement in S/N by a simple application of communication theory. The technique is a type of correlation analysis and allows one to employ arbitrarily narrow bandwidths for random noise rejection without frequency drift problems. The basic principle that is exploited here is the fact that the cross-correlation of random noise with a periodic signal tends to zero with increasing averaging time, while the cross-correlation of a signal with a replica of itself yields a constant independent of integrating time.

## THE LOCK-IN AMPLIFIER

Complete signal processing instruments embodying the techniques of cross-correlation described in the preceding paragraphs are finding increasing use in laboratories in all fields. They are generally called "Lock-In Amplifiers" or synchronous detectors. By their correct use the physicist can achieve essentially optimum S/N in his measurements. To understand how they may be applied consider the hypothetical experiment shown in Figure 10. Here the signal of interest is light which can be turned on and off by the application of a magnetic field externally applied to the system under study. The light, flashing at the modulation frequency  $f_c$ , is converted into an ac electrical signal by a photomultiplier transducer. The signal at  $f_c$  must now be brought to a level sufficiently high to drive the detector that will convert the information to dc for recording.

This level should be such that the inherent drift in the detector and following dc amplifier are of negligible magnitude compared to the dc signal. In general this amplification is best done in a tuned amplifier of moderate Q. While not contributing to the overall system S/N, the tuned amplifier helps prevent overloading of the detector by random noise (through reducing the bandwidth of the noise at the detector input) or by spurious signals such as 50Hz and 100Hz pick-up.

The detection of the signal is the most critical part of the system from the standpoint of S/N. The detector should have as narrow a bandwidth as possible consistent with the fact that bandwidth sets limits on the rapidity with which the amplitude of the initial unknown signal can be allowed to change, and also set limits on the observation time required to make the measurement.

In going to a very narrow bandwidth detector, provisions must be made to prevent the centre frequency of the detector from drifting off  $f_c$ . Fortunately the lock-in detector, or synchronous detector as it is sometimes called, is available for this application. In essence, the lock-in detector is a cross-correlator that provides an output dc

(Continued on Page 115)

# OTARI

## SERIES MX 7000

### The Professional Tape Deck

OTARI series MX7000 Professional Tape Decks are ruggedly designed for hard and continuous operation. The Transport Base is made of heavy aluminium die casting, which is precisely machined to accommodate all fixed and movable guides, rollers, levers, as well as head assembly. Electronically the MX7000 series has all solid state circuits, and utilizes an all push button control system. The heads are designed for quick interchangeability from 1 to 4 channels. The capstan is operated by a 3 speed hysteresis synchronous motor. The speeds are automatically equalized. Features such as sound with sound and reversible components to produce a vertical or horizontal cabinet configuration are standard equipment. The MX7000 series is as practical as it is beautiful, and will satisfy the most exacting user.



# OTARI

## SERIES MX 5500

### Compact Professional Tape Deck

The Otari MX-5500 comes from a long line of industry-accepted high-speed tape duplicating systems and is designed for the fastidious audiophile. Three motor system mounted on heavy Aluminium Die Cast Frame. The capstan is operated by a 2 speed Hysteresis Synchronous Motor. Amplifier has a three-stage directly connected IC, in addition, extra circuits such as Sound on Sound, Echo and Auto-Reverse as well as Bias change-over are provided. The MX-5500 compact professional tape deck will satisfy the most exacting user.

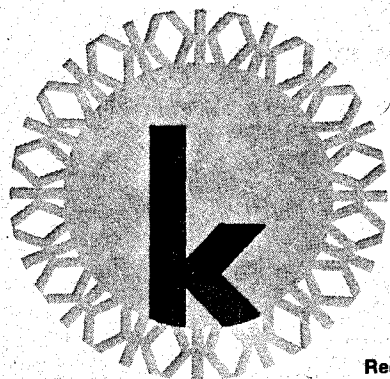

Please phone or write for brochures giving full specifications.

W.A. AGENT: Severin Distributors, G.P.O. Box E 3002, Perth. 6001.

## **KLARION ENTERPRISES PROPRIETARY LIMITED**

Regent House, 63 Kingsway, South Melbourne, 3205, Australia. Phone 61 3801 Cables Klaronmelb

# The AR-6 speaker system from Acoustic Research.

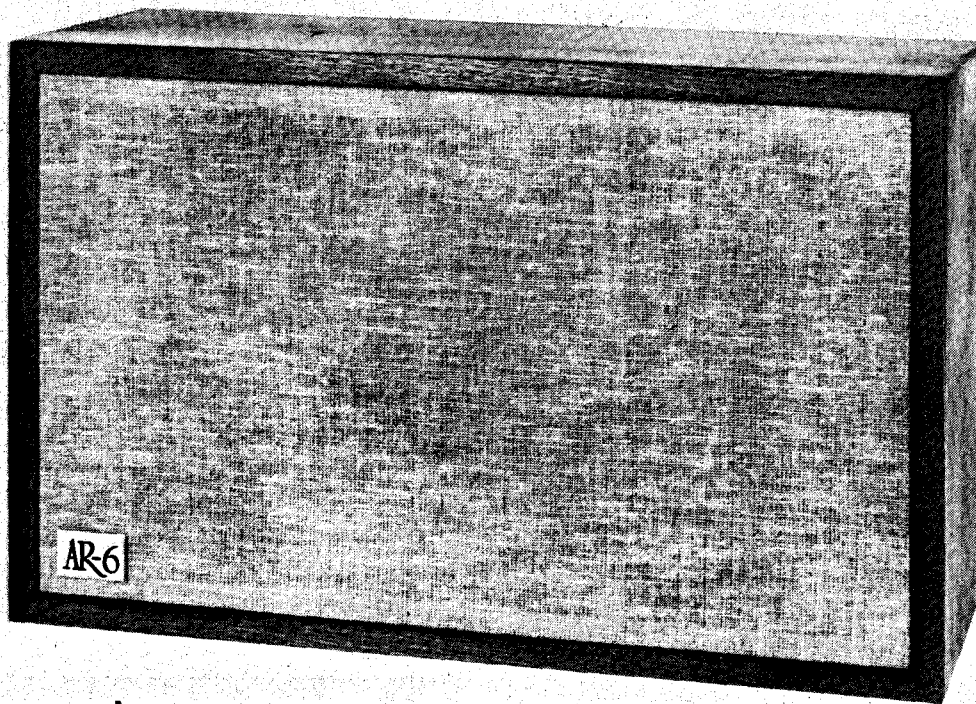

The least expensive speaker sold by AR (the AR-4x at \$132) is also the most widely sold of all high-fidelity speakers, because it has provided maximum performance per dollar of cost. The new AR-6 offers significantly better performance for \$180. It adds one-third octave of low distortion bass, and also provides superior dispersion and more uniform energy output at high frequencies. The seven inch depth of the AR-6 adapts it ideally to shelf placement, or it may be mounted directly on a wall with the fittings supplied with each speaker system.

#### **Stereo Review says . . .**

"All in all, the AR-6 acquitted itself very well in our tests. It was not quite the equal of the much more expensive AR models, whose sound it nevertheless resembles to an amazing degree, but on the other hand it out-performed a number of considerably larger and far more expensive systems we have tested in the same way. Incidentally, the AR-6 shares the AR characteristic of not delivering any bass output unless the programme material calls for it. If at first hearing it seems to sound "thin" (because it lacks false bass resonances), play something with real bass content and convince yourself otherwise. We don't know of many speakers with as good a balance in overall response, and nothing in its size or price class has as good a bass end."

#### **High Fidelity says . . .**

"Another great bookshelf speaker from AR . . . a really terrific performer. The AR-6 has a clean, uncoloured, well-balanced response that delivers some of the most natural musical sound yet heard from anything in its size/price class, and which indeed rivals that heard from speakers costing significantly more . . .

The response curves taken at CBS Labs tell a good part of the story. Note that across the largest portion of the audio spectrum and especially through the midrange the AR-6 responds almost like an amplifier . . .

Directional effects through the treble region, as evidenced by the average of 2dB that separates the three response curves, are actually less pronounced than we've seen in some costlier systems. Tests made of the effect of the tweeter level control show that it can vary the response from completely minus the tweeter to a steady increase in tweeter output of about 2 dB across its range. The design in this particular area is just about perfect . . . Pulse tests indicate virtually no ringing; in fact the AR-6 seems better than average in this regard too.

. . . a pair of AR-6s would be an excellent choice."

The workmanship and performance in normal use of AR products are guaranteed from the date of purchase; 5 years for speaker systems, 3 years for turntables, 2 years for electronics. These guarantees cover parts, repair labour and freight costs to and from the factory or nearest authorised service station. New packaging, if needed, is also free.

The AR catalogue and complete technical data on any AR product are available free upon request.



**Acoustic Research Inc.**  
Massachusetts, U.S.A.

All AR audio equipment is on demonstration at the AR Music Room in the Sydney showrooms of the Australian Distributors.

Australian Distributors

## **W. C. Wedderspoon Pty. Ltd.**

Showroom: 193 Clarence Street, Sydney. 29-6681

AR sound equipment may be purchased from the following Australian Dealers:

N.S.W.: Magnetic Sound, Sydney. Photo Hi-Fi, Sydney. Sydney Hi-Fi, Sydney. Paxton Photographics, Sydney. Milversons Hi-Fi, Chatswood. DynaStereO, St. Peters. Newcastle Hi-Fi, Hamilton. VIC.: Douglas Trading, Melbourne. S.A.: Sound Spectrum, Adelaide. A.C.T.: Home crafts, Canberra. W.A.: Alberts Hi-Fi, Perth. Leslie Leonard, Perth. QLD.: Brisbane Agencies, Fortitude Valley.

WD 21/FP

# OSCILLOSCOPE CALIBRATOR

## ET PROJECT 106

*This simply-constructed voltage calibrator can be built into practically any existing oscilloscope.*

**T**HIS simple calibrator enables 50 Hz square waves of exact amplitude to be displayed on an oscilloscope.

The calibrator can be added to existing oscilloscopes, or built as an external accessory. It eliminates measuring errors due to gain controls, or probe dividers, as a calibration signal is obtainable by inserting the probe tip directly into the calibration output socket and checking the displayed calibration signal against the calibration control switch setting.

The oscilloscope time-base accuracy can also be checked with this calibrator — the 50 Hz square-wave signal is derived from the mains thus providing a stable 20 millisecond period.

The calibration voltage is derived from a 22 volt zener diode; this voltage is chopped at 50 Hz by the BC 108 transistor, trimmed to exactly 20 volts by the calibration potentiometer and applied across a chain of precision resistors.

The consumption of the unit is negligible and is energized by the power supplies of the oscilloscope to which the unit is fitted.

It is obviously impossible to give installation instructions for each individual make and type of oscilloscope — however all that is required is to locate an HT rail carrying between 250 and 350 volts for the main divider supply, and the

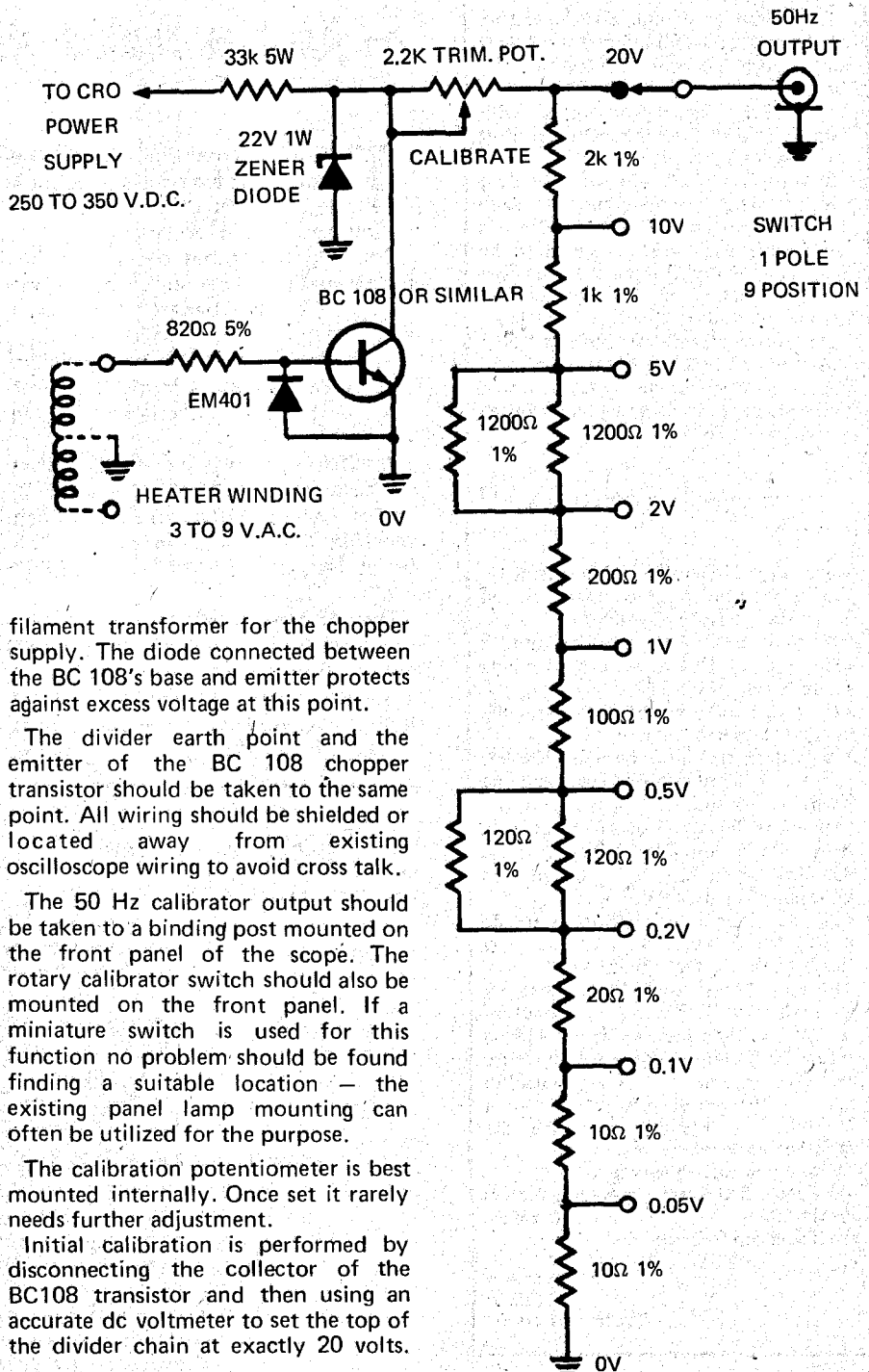

filament transformer for the chopper supply. The diode connected between the BC 108's base and emitter protects against excess voltage at this point.

The divider earth point and the emitter of the BC 108 chopper transistor should be taken to the same point. All wiring should be shielded or located away from existing oscilloscope wiring to avoid cross talk.

The 50 Hz calibrator output should be taken to a binding post mounted on the front panel of the scope. The rotary calibrator switch should also be mounted on the front panel. If a miniature switch is used for this function no problem should be found finding a suitable location — the existing panel lamp mounting can often be utilized for the purpose.

The calibration potentiometer is best mounted internally. Once set it rarely needs further adjustment.

Initial calibration is performed by disconnecting the collector of the BC108 transistor and then using an accurate dc voltmeter to set the top of the divider chain at exactly 20 volts.

*Circuit of complete oscilloscope calibrator — note that some resistor values in the divider chain are obtained by parallel resistors of higher value.*



16th November, 1971

Mr. Louis A. Challis,  
Louis A. Challis & Associates,  
158 Queen Street,  
WOOLLAHRA. 2025.

Dear Louis,

I think that a whole lot of nonsense is being written about the effect of amplifier damping on loudspeakers.

Conventionally this term is taken to be the ratio of the nominal load impedance to the internal impedance of the associated amplifier.

Thus, with an 8 ohm speaker and an amplifier with 1 ohm internal impedance (due to negative feedback) the damping factor is said to be 8 (although as the loudspeaker impedance varies with frequency, then the damping factor must do likewise).

Recently, one has seen amplifiers for which their manufacturers claim damping factors of 100 or more. But this is a whole heap of b . . . . because the argument totally ignores the fact that the dc resistance of the voice coil and the speaker leads is in series.

Thus, if the output impedance is 1 ohm and the speaker has a dc resistance of 6 ohms and ignoring the dc resistance of the leads then the damping factor for an 8 ohm speaker is not 8 but:—

$$\frac{Z_{vc}}{Z_{op} + R_{vc}} = \frac{B}{1 + 6} = 1.14$$

where  $Z_{vc}$  is the voice coil impedance —  $Z_{op}$  is amplifier output impedance and  $R_{vc}$  is dc resistance of voice coil.

If you half the amplifier output impedance to ½ ohm, then the damping factor is still only 1.23.

Even with zero output impedance, the damping factor is still only 1.33.

Admittedly the impedance of a speaker varies quite a bit with frequency and one might have a speaker impedance of say, four times the nominal value but even then, with 1 ohm output impedance the damping factor is 4.555 and with zero impedance it only rises to 5.333.

If you allow a realistic 0.2 ohm dc resistance for connecting leads etc. then the difference is very small.

Possibly I am overlooking something vital but I would like to see the result of stuffing a rheostat in series with a speaker and running a series of subjective experiments and then some objective ones using square wave inputs — or something — and photographing the resultant scope waveforms.

Would you care to have a go?

If you find that damping factors greater than '20' are significant, please see if you can find out why.

Collyn Rivers  
Editor  
Electronics Today

This controversial article suggests that the effect of amplifier damping on loudspeakers is of far less importance than generally claimed.

# DAMPING FACTOR

## — just a sales gimmick?

THE Editor has asked, in positive terms, that we have a good look at the effect of *damping factor* on loudspeaker performance.

Damping factor has become an 'in' phrase, with quite unsupported claims that it is the panacea for good amplifier/loudspeaker performance.

Amplifiers are currently available with damping factors from 10 to over 1000 — it is one of the last of the big numbers.

Possibly the only specification that we have ever seen quoted for damping factor is in DIN 45,500, which specifies that "Damping Factor shall be at least 3 from 40 Hz to 12,500 Hz."

This, of course, falls far short of the specifications of even the poorest high-fidelity amplifiers currently available, and most probably below the limits of valve amplifiers which were available a decade ago.

### WHAT IS DAMPING FACTOR?

Damping factor is specified as the ratio of the load impedance of an amplifier to the output impedance of

the amplifier. This simple definition has already introduced the first uncertainty — what is the load impedance when the load is a loudspeaker? For the time being we will insert the word "nominal" to enable us to quantify damping factor.

The damping factor of an amplifier — so far as the amplifier properties are concerned — is determined by the output impedance of the amplifier. In general, this is a result of an actual physical resistance of the output circuit, which may be about 10 ohms, together with the amount of negative feedback around the circuit. Twenty decibels of negative feedback will produce a reduction of 10. Our 10 ohm output impedance would, therefore, be reduced to one ohm, and if we had a *nominal* load impedance of 8 ohms, our damping factor would be 8. By providing 40 decibels of negative feedback the damping factor would be increased to 80 and so on.

The effects of negative feedback are extremely beneficial so far as the output amplifier characteristics are concerned. It improves the distortion

JBL Control Monitor driven by amplifier with output impedance 0.01 ohms. Top Trace Diaphragm Acceleration. Bottom Trace Sound Pressure Levels 6" from Diaphragm.

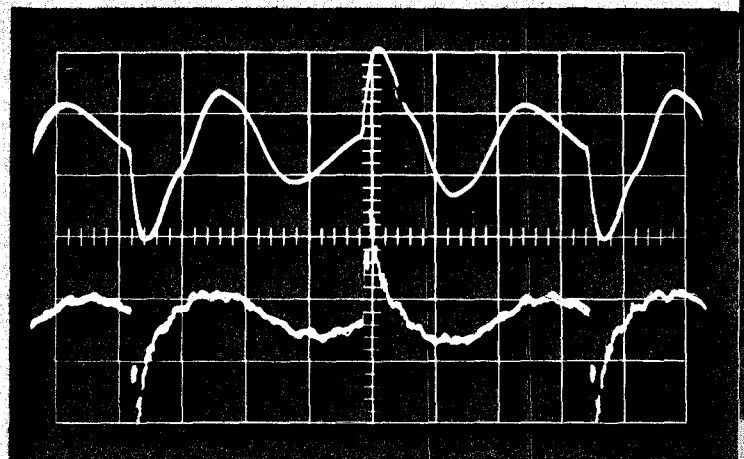

characteristics, the signal to noise ratio, and the frequency response. An amplifier design, without negative feedback would be totally unacceptable, but with it would have excellent characteristics. With careful design a very high level of negative feedback can be applied (at the expense of gain.)

As the feedback is increased the damping factor increases. The purpose of this article is to investigate whether, in fact, a high value of damping factor is of any use in itself, or whether it is only a by-product of the improvement of other amplifier characteristics.

One of the problems in dealing with loudspeakers is that they are not particularly amenable to mathematical computation, or even to simple physical measurement. Most papers dealing with loudspeakers limit their discussion to the piston range. This is the range of frequencies from the resonant frequency of the speaker to a frequency of the order of 400 Hz in the case of a 12" diameter loudspeaker. Outside this region the problems of analysis become extremely complex. In this article, for the purpose of simplicity, we are also considering only the piston range for a brief description of the parameters involved in a loudspeaker.

A practical loudspeaker in a vented enclosure has an equivalent electrical circuit, which may be approximated by the circuit shown in Figure 1. The two main components in this circuit that adversely affect the performance are the characteristics of the winding, its resistance and its self inductance. Because of these parameters the speaker cannot be completely externally controlled.

The winding resistance is a useful and necessary component to obtain the optimum low frequency response. If this resistance is too low, then the transient response of the system is

*JBL Control Monitor driven by amplifier with output impedance 4 ohms . Top Trace Diaphragm Acceleration, Bottom Trace Sound Pressure Levels 6" from Diaphragm.*

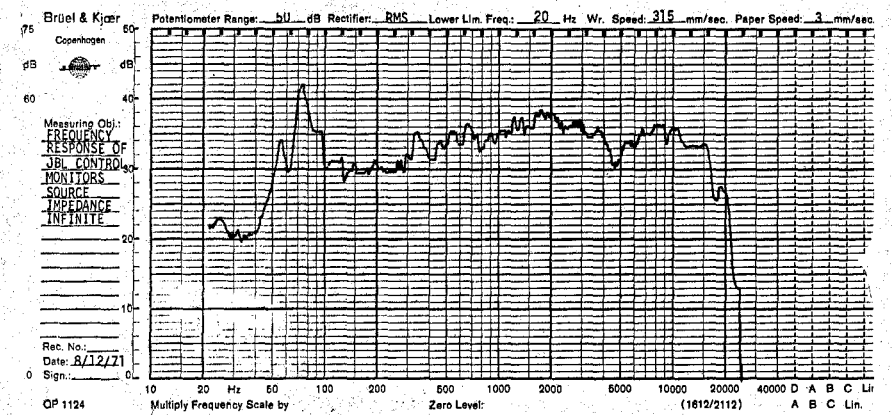
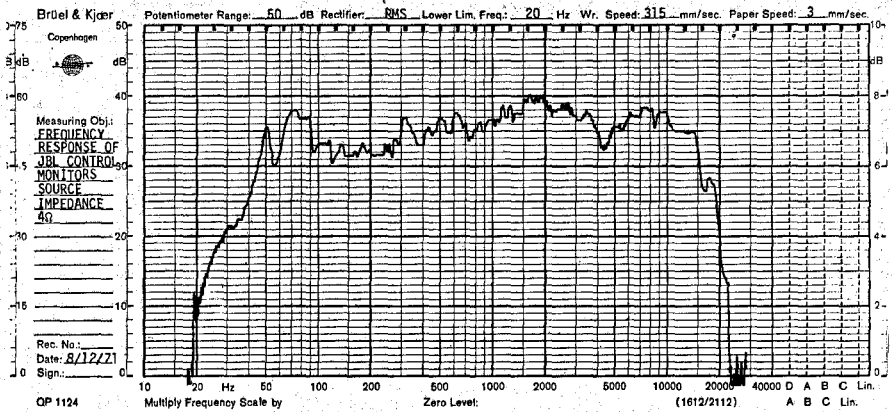
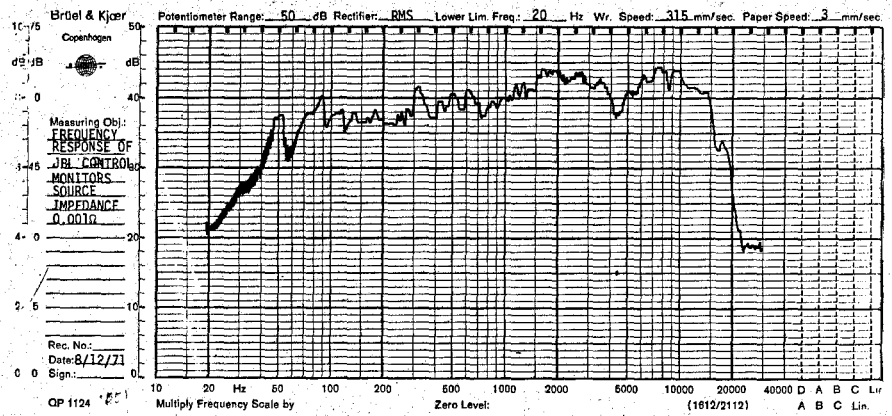

*JBL Control Monitor driven by amplifier with output impedance of 100 ohms. Top Trace Diaphragm Acceleration, Bottom Trace Sound Pressure Levels 6" from Diaphragm.*

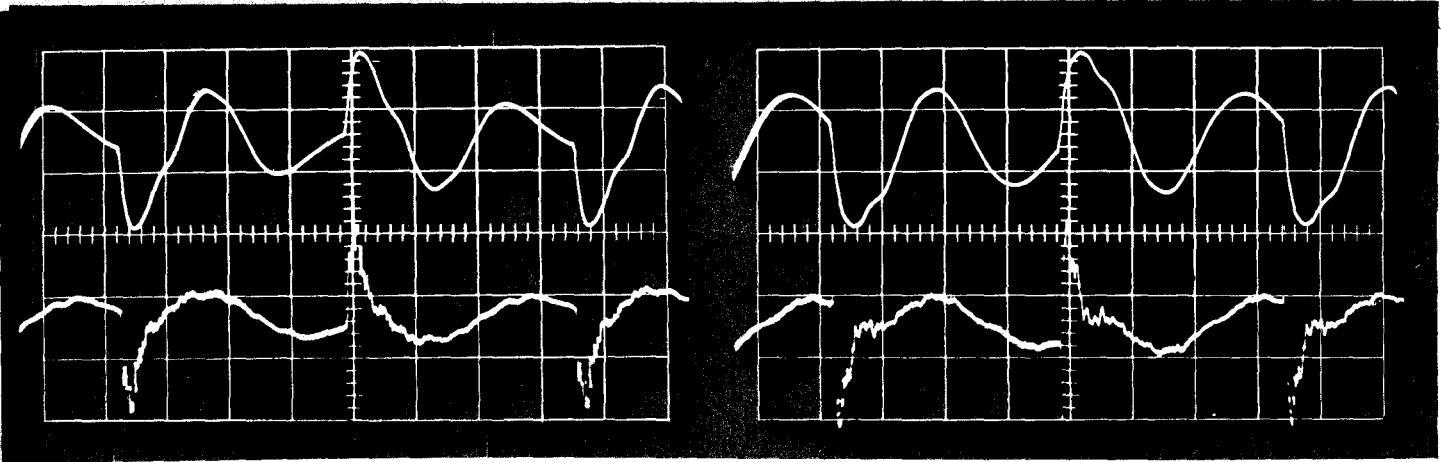

# DAMPING FACTOR

overdamped. If it is too high, the transient response is underdamped. The correct value provides critical damping. If the speaker is overdamped its frequency response will be poorer at the low frequency end of the spectrum. If the speaker is underdamped its response will tend to be 'boomy.'

We will now take a look at a typical loudspeaker system with a nominal 8 ohm impedance. The dc resistance as measured with a bridge is about 7 ohms. Let the damping factor of the amplifier be a fairly modest '20', the amplifier output impedance therefore 0.4 ohms; (based upon a nominal 8 ohm load), the total equivalent series resistance is therefore 7.4 ohms. Even if the amplifier has zero internal resistance, the series resistance would only be about 5% lower.

If the speaker system is such that a 5% change in the series resistance will result in a dramatic change in its performance, then the design would be unacceptable for normal use. And the normal method of connect speakers, using fairly fine figure "8" flex, could introduce a further 0.2 to 0.4 ohms of resistance.

## OUR TESTING METHOD

We decided to have a look at four different types of loudspeaker. We used the Bower and Wilkins DM1, an Acoustic Research Inc. AR-6, a special speaker system provided for the purpose by Magnavox Australia, (designed to give a distinct resonance at the bass end of the spectrum) and our J.B.L. control monitors which we use purely for comparison with other speakers in the laboratory. The B & W DM1 and the AR-6 were similar in that they are both small, fully sealed enclosures with two-way speaker systems. The special Magnavox enclosure was a simple two-way vented-enclosure system which consisted of two 8 inch low frequency speakers and one tweeter. We should emphasise that this speaker was not intended for high fidelity use, but was fabricated by Magnavox purely for this experiment. The measured impedance curves of the speakers showed that the impedance can vary between about 8 ohms and 30 ohms, depending on frequency for a nominal 8 ohm speaker.

Having determined that speaker impedance varies between such wide limits it is obvious that the term "damping factor" has little relevance. Output impedance is, therefore, a more relevant quantity.

We tested the frequency response of

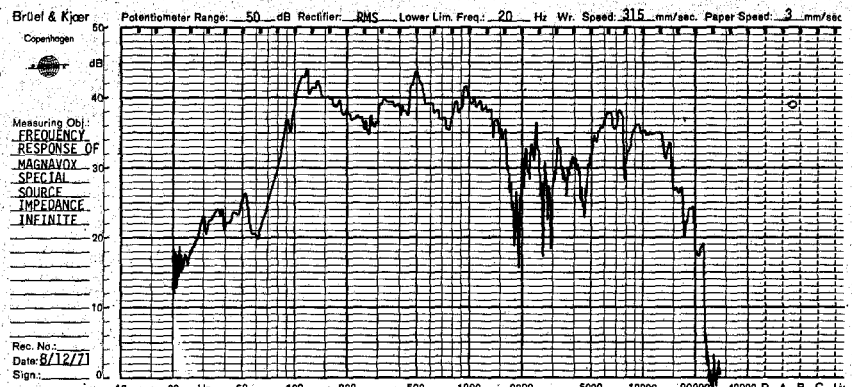
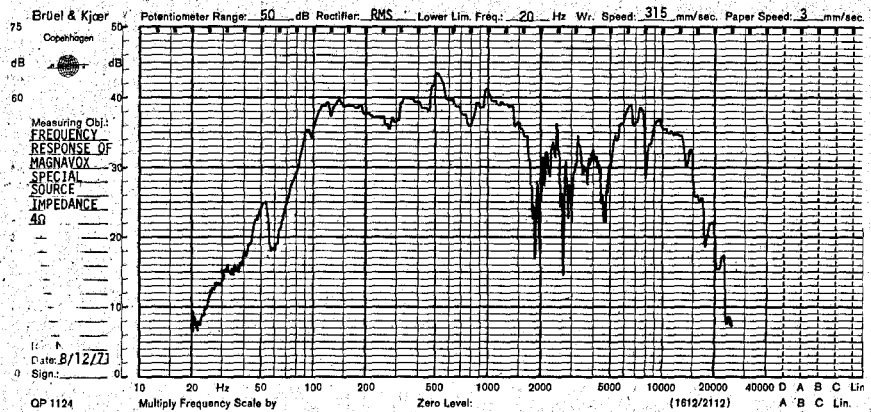
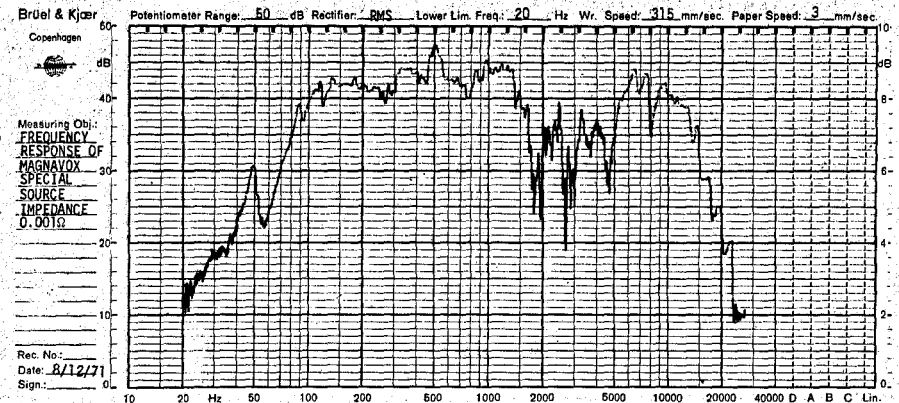

the J.B.L. and Magnavox speakers under the same conditions, but using different amplifier output impedances. We first used essentially constant voltage drive. This provided an output impedance of approximately 0.001 ohms (obtained using feedback from the speaker terminals to eliminate the effect of wire resistance to the speaker). The second series of measurements was with an output impedance of 4 ohms, and the third was with 'infinite output' impedance; that is, constant current drive. As can be seen from the level recordings, the difference is not as marked as one might expect, except in the region of the resonant frequency of the speakers. Absolute levels were not recorded as accurately as our normal speaker tests, since we were not so interested in the actual frequency response but rather in the relative

effects of the changes in the system parameters.

The conclusion to be drawn from this series of measurements is that, even with an effective output impedance of the order of 4 ohms, ie. a nominal damping factor of 2, the change in high frequency performance is not measurable, whilst the change in low frequency performance is just becoming significant.

These results tend to confirm the validity of the statement in DIN 45,500.

In order to examine the effectiveness of driving impedance on the resonant characteristics of the speaker we should, ideally, drive the speaker with either an impulse or a step response in order to evaluate the results. We chose to use a 20Hz square wave, to provide better characteristics for photography.

A number of different techniques

were utilised to measure the mechanical and acoustical characteristics of the speaker systems. For these tests we used amplifier output impedances of zero, 0.01 ohm and 100 ohms.

The first involved measuring the acoustical output from the speaker at a distance of one foot from the speaker diaphragm. The second method involved an examination of the mechanical motion of the speaker diaphragm using a miniature accelerometer suitably integrated to obtain the velocity, and later the displacement of the diaphragm.

The third method involved an examination of the sound pressure level inside the enclosures. Irrespective of which method of testing we used, the results were consistent. The effect of the 4 ohm amplifier impedance resulted in very little degradation of the speaker performance, compared with 0.01 ohms impedance. When we tried the 100 ohm impedance drive the result was a ringing, that was so pronounced that the original wave was hardly discernible. The main effect that showed up in this latter test was the generation of a fundamental component at the resonant frequency of the speaker system, and very little evidence of the original driving signal. Similar effects were observed on the other speakers tested.

We tried subjective listening tests using the Simon and Garfunkel "Bridge Over Troubled Water" and the J.B.L. Warner Brothers Contemporary demonstration record. The first record has good clean bass while the second contains selections from the Warner Bros. catalogue specifically designed to show up weaknesses in loudspeakers particularly in the low frequency region.

Changing the amplifier output impedance from 0.01 ohms to 4 ohms did not result in a very significant difference in performance; a slight boominess was apparent on all of the loudspeakers with the exception of the J.B.L. control monitors and the AR-6. When the amplifier circuit was

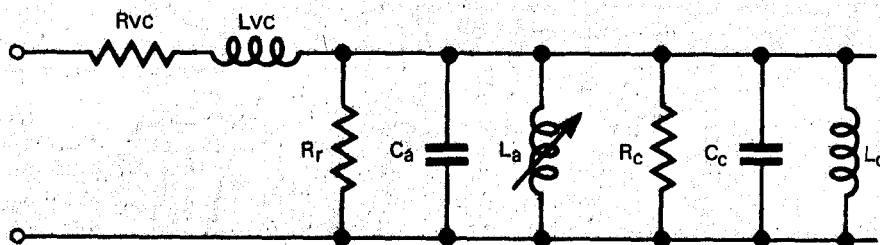

- RVC ~ Voice Coil Resistance
- LVC ~ Voice Coil Self Inductance
- R<sub>r</sub> ~ Radiation Resistance
- C<sub>a</sub> ~ Acoustical Capacitance
- L<sub>a</sub> ~ Acoustical Inductance
- R<sub>c</sub> ~ Resistance of Suspension
- C<sub>c</sub> ~ Compliance of Suspension
- L<sub>c</sub> ~ Mass of Cone and Suspension

Fig. 1. Approximate equivalent circuit of speaker in an enclosure.

modified to the high impedance drive the boominess became marked.

The principal difference between the speakers was the difference in the resonant frequency of each of the individual speaker systems. In the case of the J.B.L. control monitors, this was roughly 50Hz and consequently, even with an effective amplifier output impedance of 4 ohms, the effects could not be readily detected.

The Magnavox 'Special' had a resonant frequency of about 110 Hz which resulted in an audible boominess with the 4 ohm amplifier output impedance. The AR-6s and the DM1s, being heavily damped by their enclosures, did not show nearly as much deterioration even though the resonant frequencies were higher.

The conclusion that must be drawn from this is that even the 'worst' loudspeaker has a fairly high tolerance to amplifier output impedance and that acoustical resistance type enclosures have an even greater tolerance. In our tests a damping factor of 2 did not result in a severe degradation of performance.

If the speaker system has a low resonant frequency the subjective effect is even less noticeable. It would, therefore, appear that there is only a very slight subjective improvement to be gained from a low output impedance with the more expensive

speakers which have low resonant frequencies and a smooth frequency response.

There will be a more significant improvement in speakers which have marked resonances at higher frequencies.

Subjective A-B testing using an amplifier with a damping factor of 1000 and then with a fairly modest amplifier with a damping factor of 20 did not reveal any significant difference as a result of subjective tests. In fact, this is what would be expected from our measurements with due consideration of the actual change in the equivalent series resistance of the loudspeakers.

When the speaker lead resistance is taken into account, even an amplifier with a nominal damping factor of 1000 will probably only have an effective damping factor of, about 80 unless short copper bus-bars are used to connect the speakers to the amplifier!

We have only touched very briefly on some of the complex and difficult aspects of loudspeaker theory, but the results of the calculations, practical measurements, and subjective testing all come up with the same answer. That is, that an amplifier output impedance which corresponds to a nominal damping factor of 20 to 30 will result in a speaker performance which is not discernible from the performance of a speaker driven from the same amplifier with a nominal damping factor of, say, 1000, with lossless speaker leads.

It is apparent to us that a high fidelity audio amplifier with a "nominal" damping factor of between 10 and 30 (and all other things being equal) is adequate for most speaker systems, both good and bad, and that most of the statements made concerning the value of high damping factors are motivated by either lack of comprehension of the subject, or by manufacturers who are looking for a new sales pitch.

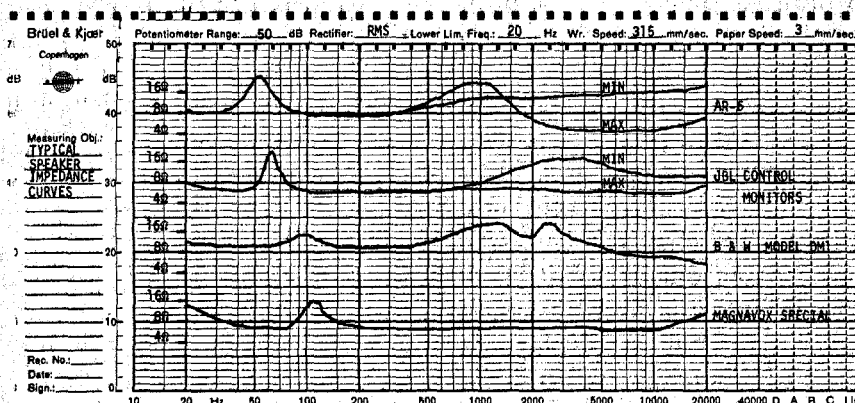

# RADIO ASTRONOMY FOR AMATEURS

*a series - by Roger Harrison VK3ZRY*

THE 'Lloyds Mirror' interferometer or 'cliff-top' interferometer has been very successfully used in Australia. It is a drift type interferometer and consists of an antenna mounted on a cliff overlooking the sea. As a source rises above the horizon, the emissions will reach the antenna via two paths. One is a direct path, and the other is reflected from the sea. Thus the paths are of two different lengths and when the path difference is a half wavelength, destructive interference occurs, forming fringes and the characteristic 'peaks and nulls' pattern. An illustration is given in Fig. 20.

The 'Michelson' interferometer, in its simplest form, consists of two antennae spaced ten wavelengths or more apart. The resultant antenna radiation pattern is shown in Fig. 21.

The Jodrell Bank (UK) radio telescope has a secondary disc used for interferometry as does the Parkes Radio Telescope in Australia. The two 90 ft. dishes at the Owens Valley observatory in California form an interferometer in themselves.

The "grating" interferometer consists of a number of antennae in line and connected to a receiver as shown in Fig. 22. The radiation pattern is similar to that produced by "grating" in optical work. Extremely narrow fringes result from this technique and it is a powerful tool.

The best example of this type of interferometer is the arrangement set up by Christiansen at the Radio Physics laboratory of the CSIRO. It consists of two lines of 19 ft. dishes set up in a cross pattern oriented north-south, east-west. There are 16 antennae in each arm. (This arrangement has become known as a Chriss-cross).

The *phase-switched interferometer* works on the principle of correlating the voltages from two antennae when the phase of one is changed with respect to the other. This is best done electrically by inserting a half wavelength of transmission line into the transmission line of one antenna. Thus, the output of each antenna is either in-phase or out of phase and detection is accomplished in synchronism with this action. It is most useful for detecting small sources. A block diagram is shown in Fig. 23 (a) and a reception pattern variations in Fig. 23 (b).

The *rotating lobe* interferometer is a variation of the phase-switched type in which the fringes can be rotated while the antenna structure remains fixed.

The North-South arm of the Mills Cross uses this technique.

A block diagram of how this can be accomplished is shown in Fig. 24.

## RECEIVER SYSTEMS

In the following discussion we assume that the reader knows the basic principles of the T.R.F. and superhet receivers.

We have already described the simple total power system and will be giving complete constructional details shortly.

One of the disadvantages of the simple total power method is that the receiver sensitivity is limited by the noise generated internally. Most of this is generated in the first stage.

Also the gain must be very stable for

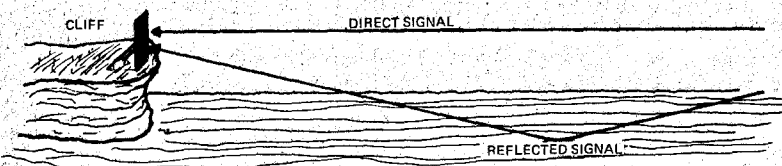

Fig. 20. This drawing shows the Lloyds mirror - or cliff top interferometer.

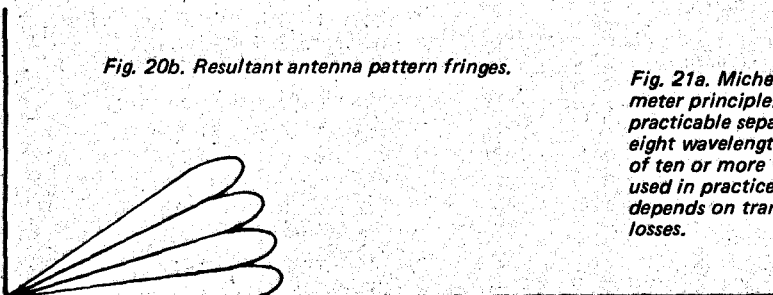

Fig. 20b. Resultant antenna pattern fringes.

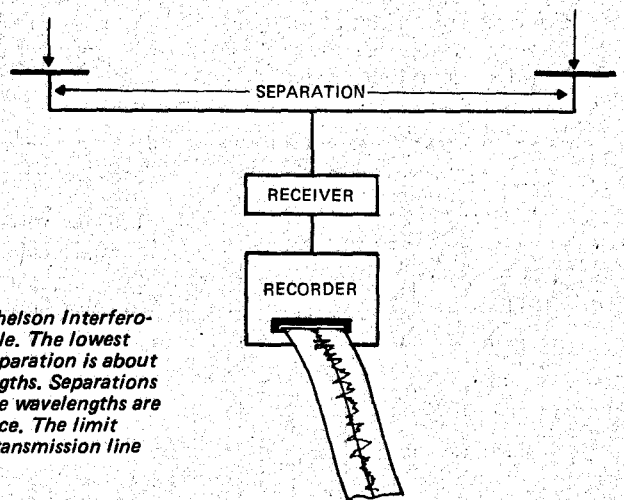

Fig. 21a. Michelson Interferometer principle. The lowest practicable separation is about eight wavelengths. Separations of ten or more wavelengths are used in practice. The limit depends on transmission line losses.

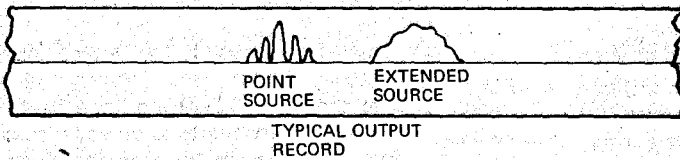

Fig. 21b. Typical output record from Michelson Interferometer.

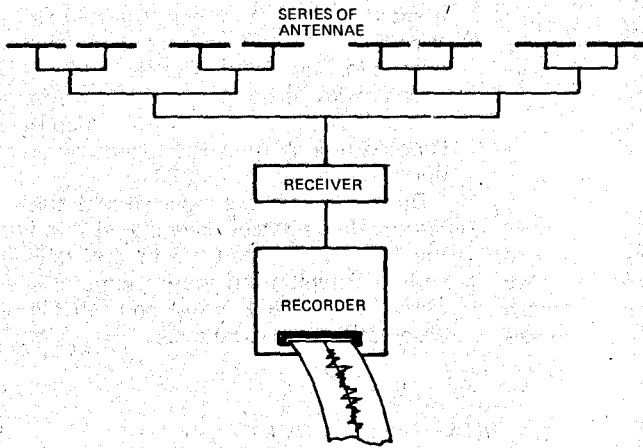

Fig. 22a. Arrangement of grating type interferometer.

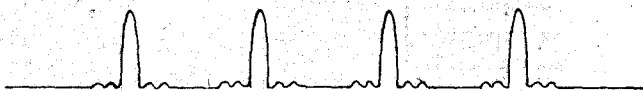

Fig. 22b. Reception pattern of grating interferometer.

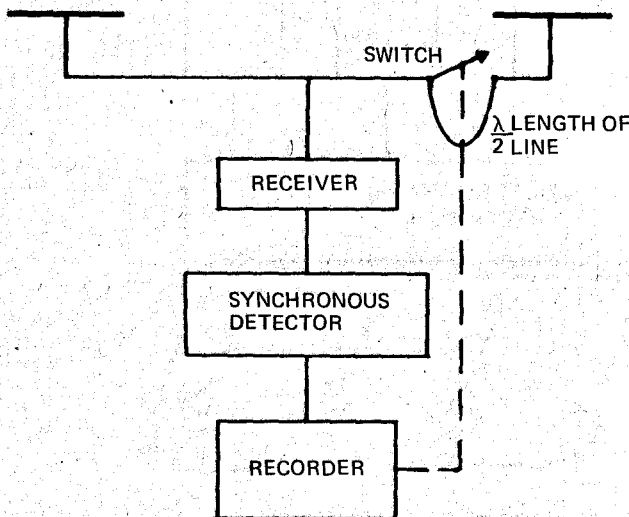

Fig. 23a. Phase-switched interferometer.

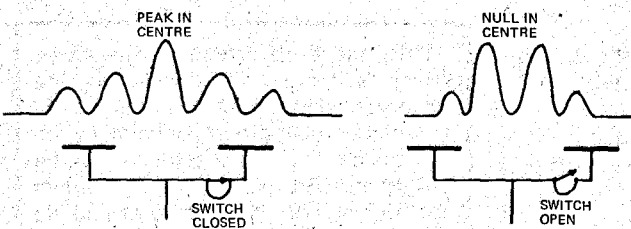

Fig. 23b. Reception patterns of phase-switched interferometers.

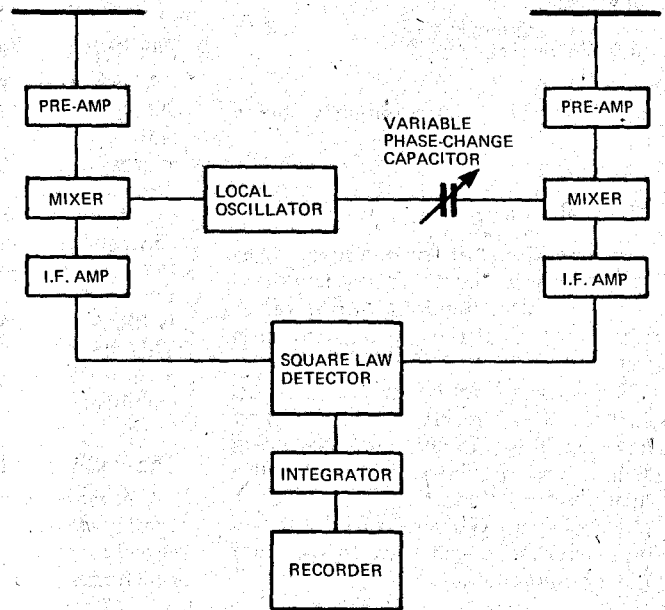

Fig. 24. Block diagram of a rotating lobe interferometer.

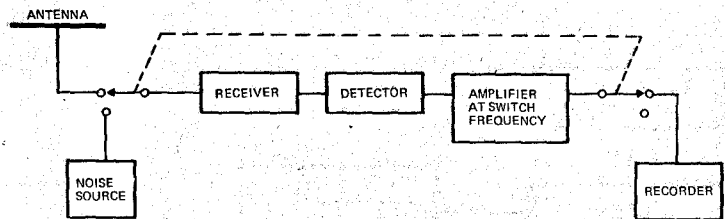

Fig. 25. The Dicke system used for comparing incoming noise and a noise reference source.

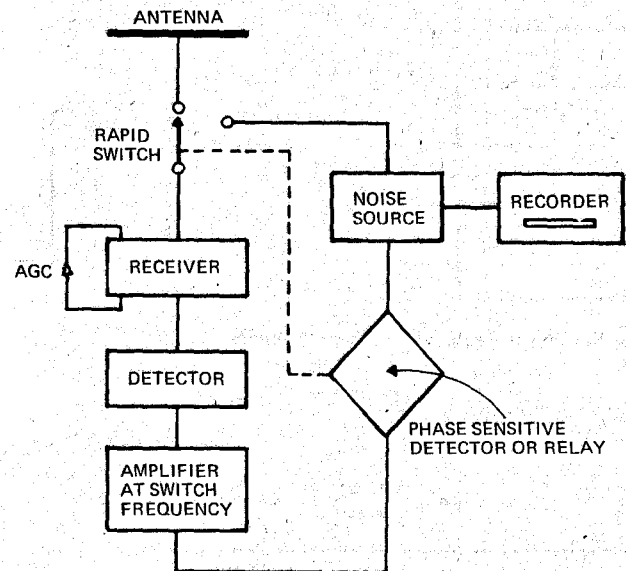

Fig. 26. The Ryle and Vonberg comparison system.

In the third part of this continuing series, Roger Harrison describes and illustrates the principle of interferometry.

# RADIO ASTRONOMY FOR AMATEURS

any accurate measurements being taken.

## The Dicke Comparison System

One method of overcoming these problems is to compare the incoming signal with a standard noise source (produced electronically) which puts out a constant level of noise.

The earliest form is that produced by Dicke. The receiver is switched between the antenna and the noise source at a fixed rate and the difference recorded after processing. A block diagram is given in Fig. 25. The noise source is also used to calibrate the instrument.

The disadvantage of this system is that the receiver is connected to the antenna for only half the time with a consequent loss of sensitivity.

## The Ryle and Vonberg System

A very useful modification of the Dicke system was investigated by Ryle and Vonberg. They used the noise source and receiver as a servo-loop. The difference between the incoming signal and the noise source is used to control the level of the noise source so that the difference is zero. The noise source control signal is then recorded. A block diagram is shown in Fig. 26. This system is very accurate and stable and independent of the receiver stability.

## The Radio Spectrometer

A number of sources emit or absorb energy at specific frequencies. We have already mentioned neutral hydrogen which can be detected by emission and

absorption around 1420 MHz (21 cm). Some of the latest discoveries include the OH line (a hydroxyl radical), the ammonia line and the formaldehyde line.

Instruments used to detect these spectral lines are called radio spectrometers. There are basically two types of instruments to detect spectral lines of radio emission or absorption. The first employs a superhet receiver with the local oscillator either swept or stepped continuously across a narrow range. A block diagram is shown in Fig. 27 (a) and a typical output in Fig. 27 (b). The second type uses a series of narrow band filters, in a broadband receiver, each of which is coupled to a multi-channel recorder. A diagram is shown in Fig. 28.

These systems are not beyond the resourceful amateur keeping in mind the frequencies used are in the VHF and UHF region but accuracy must be fairly good if any useful and reliable observations are to be made. ■

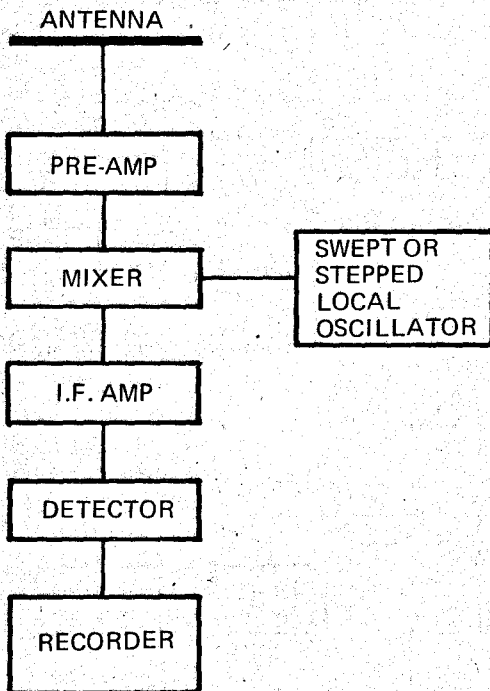

Fig. 27a. Swept frequency radio spectrometer.

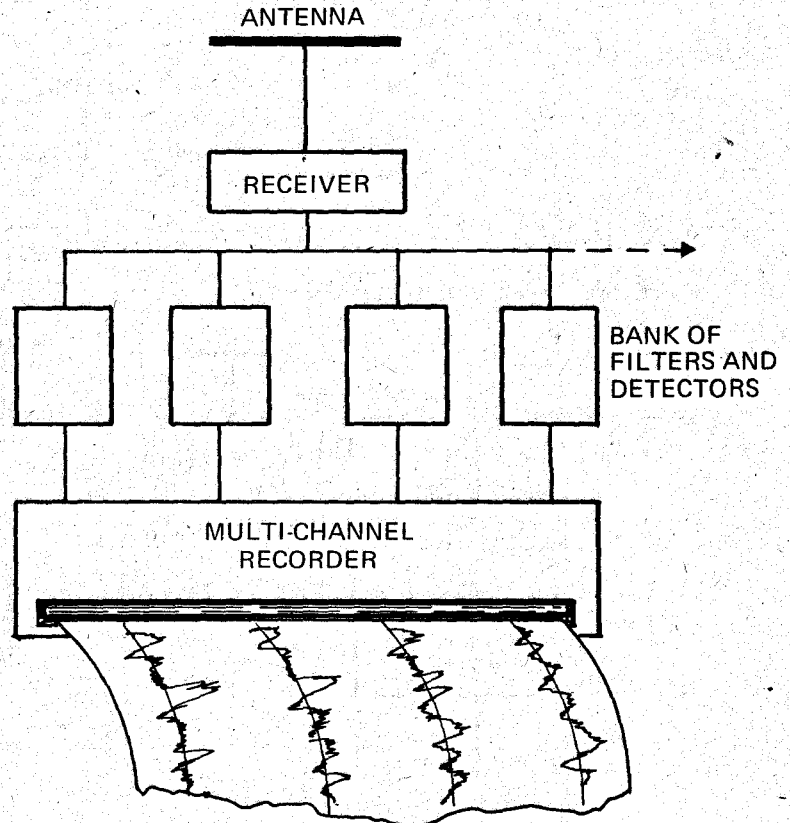

Fig. 28. Multichannel radio spectrometer.

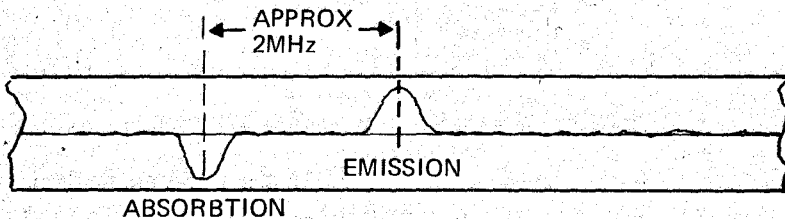

Fig. 27b. Typical record from swept frequency radiospectrometer.

This, the third article in this series, concludes our discussion of the history, development and basic techniques of radio-astronomy. In the fourth part of this series — to be published next month — we get down to the real nitty gritty side of making things.



**GOLDRING ACCESSORIES FOR EVERY SOUND NEED**

# GOLDRING

## Engineering (A'asia) Pty. Ltd.

**New South Wales:** 26 Ricketty Street, Mascot 2020. Telephone 67 6088.  
**Canberra:** 19 Molonglo Mall, Fyshwick, A.C.T. 2604. Telephone 95 8248.  
**Victoria:** 162 Pelham Street, Carlton 3053. Telephone 347 5177. **Queensland:** 32 Balaclava Street, Woolloongabba 4102. Telephone 91 4972.  
**South Australia:** 207 Flinders Street, Adelaide 5000. Telephone 23 3488. **Western Australia:** 32 Northwood Street, Leederville 6007 Telephone 8 4988.

For further obligation free information and technical literature clip coupon and post to your nearest Goldring office. I require further information

Name \_\_\_\_\_  
 Address \_\_\_\_\_



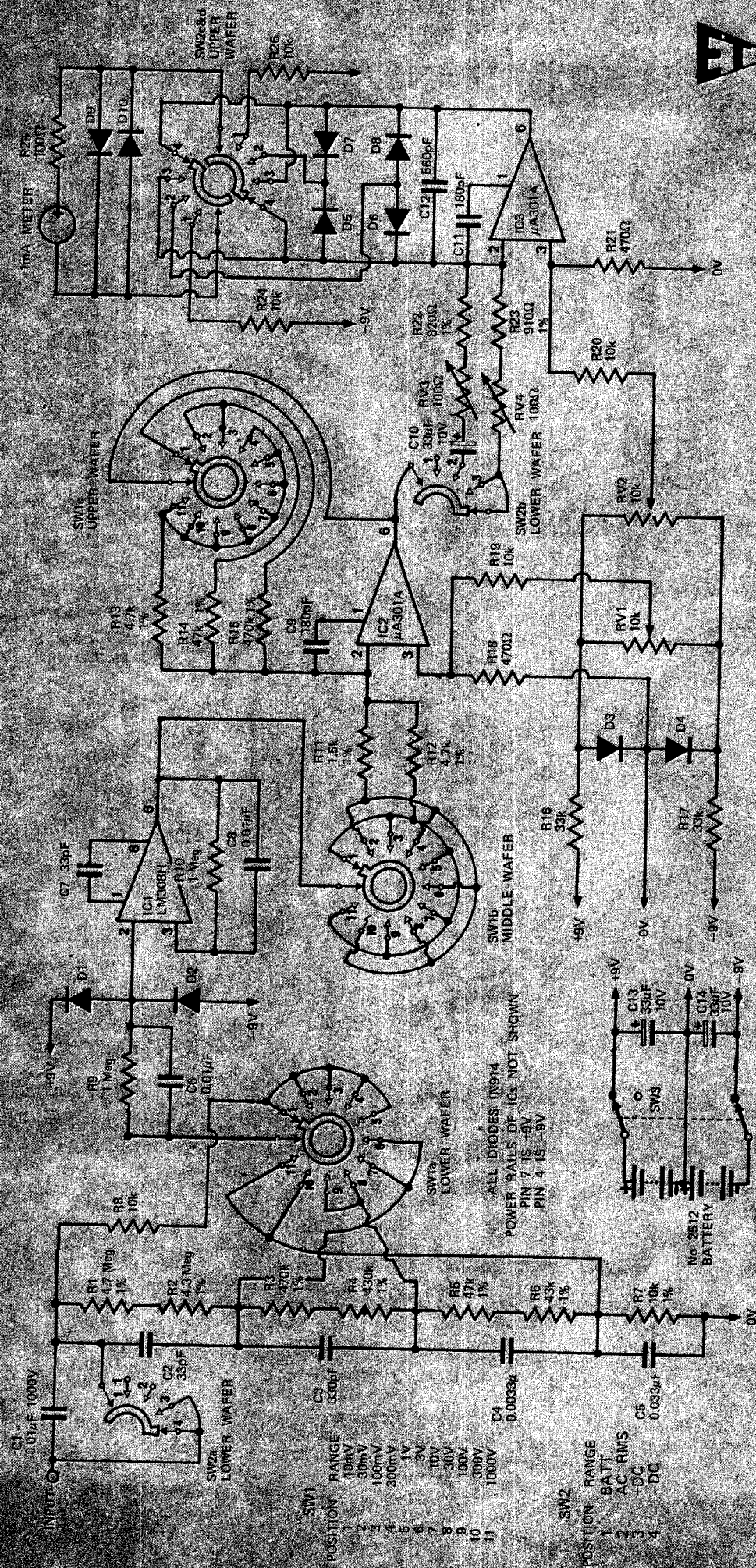

Circuit diagram of complete unit.

# WIDE-RANGE VOLTMETER

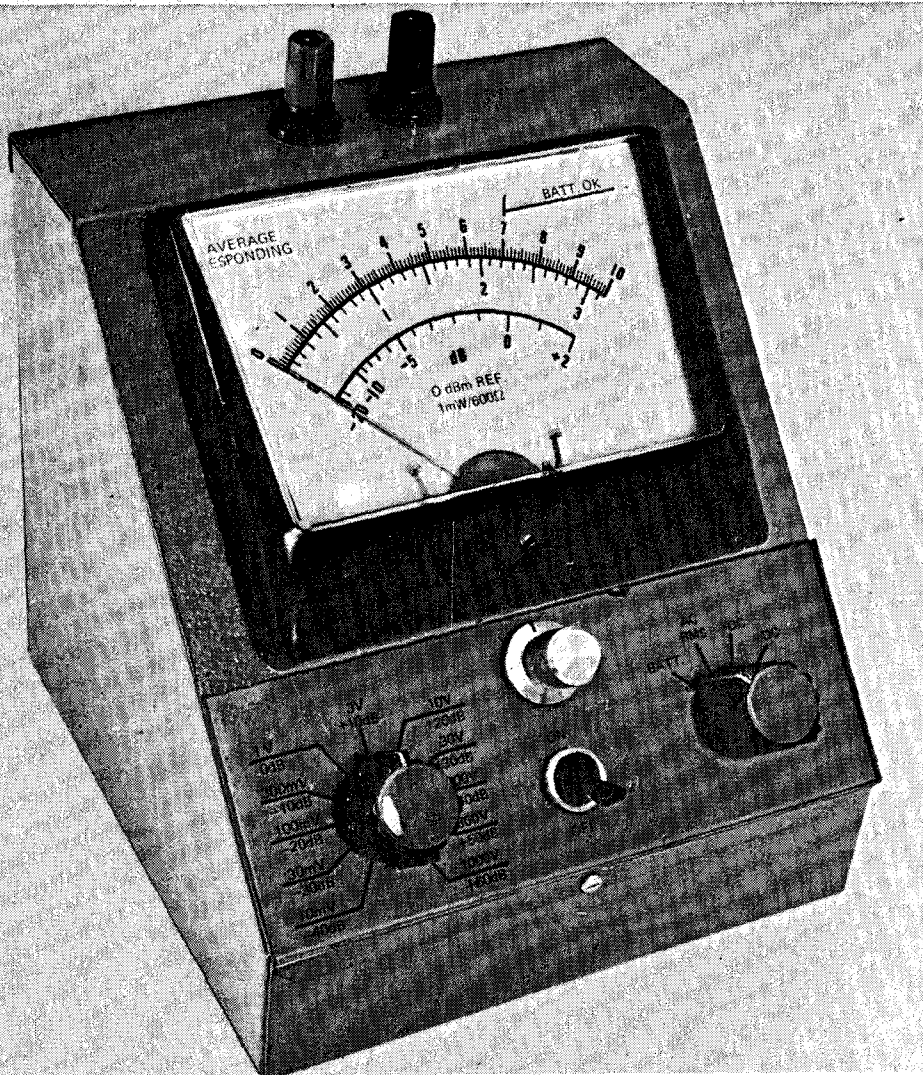

**S**URPRISINGLY good multimeters can now be purchased for less than \$30 and these instruments will perform many of the functions of an ac/dc voltmeter. But none of these instruments is capable of measuring low level ac or dc signals, and few have input impedances in excess of 50,000 or 100,000 ohms/volt.

The meter described in this project is necessarily more complex than a basic multimeter. The smallest measuring range is 10 mV full-scale deflection (both ac and dc) and levels as low as 0.5 mV can be measured. The input impedance of 10 Megohms on all ranges ensures that measuring errors due to meter loading are kept to a minimum.

Unlike most ac measuring instruments, the ac scale of the Electronics Today meter is linear. The same scale is used for both ac and dc measurements, thus avoiding errors due to reading the 'wrong' scale.

The meter is protected against application of excess voltage — 1000 volts can be applied to the input terminals on all ranges without damage.

The instrument uses three integrated circuits, together with 12 diodes plus capacitors and resistors, to provide voltage measuring ranges from 10mV to 1000 volts full scale deflection. If only the millivolt ranges are required, the cost of the meter can be reduced substantially by eliminating the input divider (R1 — R9), (C2 — C5), the

This solid-state ac/dc voltmeter has 22 ranges — from 10 mV fsd to 1000V fsd.

## SPECIFICATION

Ranges —	DC	AC	dB
	0- 10mV	0- 10mV	-40
	0- 30mV	0- 30mV	-30
	0- 100mV	0- 100mV	-20
	0- 300mV	0- 300mV	-10
	0- 1V	0- 1V	0
	0- 3V	0- 3V	+10
	0- 10V	0- 10V	+20
	0- 30V	0- 30V	+30
	0- 100V	0- 100V	+40
	0-1000V	0-1000V	+60
	0- 300V	0- 300V	+50
Input Impedance	10M (all ranges)	10M paralleled by 33 pF. (all ranges)	
Accuracy	±3%	±3% 10Hz — 20kHz.	
Reverse polarity Protection.	meter switch.	Over voltage protected up to 1000V on all ranges.	

# WIDE-RANGE VOLTMETER

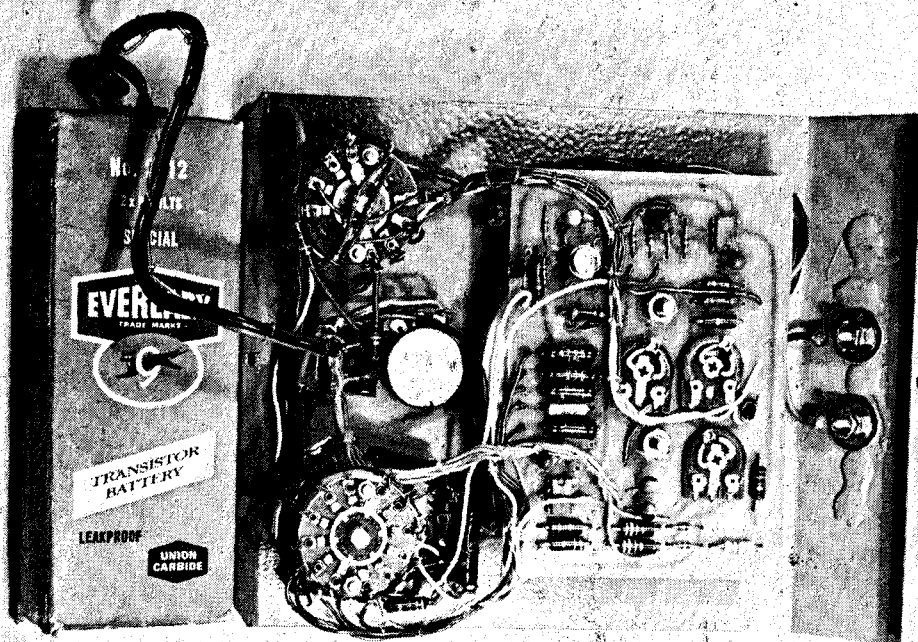

wafer of SW1a, and by changing SW1 to a 2 pole, 5 position switch.

Power is supplied by a dual 9 volt battery (Eveready type 2512), and since the current drain of the meter is about 4 mA, the battery will have a life of approximately 500 hours. A battery check position is provided.

## CONSTRUCTION

Although it is possible to construct this unit using tag strip or matrix board construction we strongly recommend using a printed circuit board. The foil pattern of the board is reproduced full size in Fig. 1.

Figure 2 shows how components are assembled on the board. Ensure that all components are orientated correctly as shown. Note that the 'tag' on the metal can type ICs indicate pin 8 and that the pins are numbered anticlockwise when viewed from above. For 8 pin plastic cased ICs — the 'notch' is between pins 1 and 8. Wiring connections to and from components mounted external to the board are shown in Fig. 3, all as seen from the rear of the components.

The metal case used in the prototype is a standard OXFORD box type SF6 — with a drilled front panel. Full details of this case are shown in Fig. 4.

Mount the meter, switches, potentiometer RV1 and terminals on the front panel. The switch interconnections — shown in Fig. 3 — should now be completed, and the switch

## HOW IT WORKS

The circuit may be studied in four separate sections.

### 1. INPUT DIVIDER

This is a string of resistors in series, having a total resistance of 10 Megohms. Four switch-selected tappings, provide division ratios of 1, 10, 100 and 1000.

Switch SW1a selects the division ratio required — SW2a shorts out the input series capacitor when the instrument is used in the dc modes.

All resistors in the division network should be 1% tolerance; the capacitors should be 5% tolerance (or at least selected within 5% tolerance).

### 2. INPUT BUFFER

This consists of an operational amplifier, IC1, connected as a unity gain voltage follower, i.e. the output voltage is the same as the input voltage but at a lower impedance. The input current to this amplifier (LM308) is extremely low, typically 1.5 nanoamps. To compensate for this current, 1 Megohm resistors are used in both inputs to the amplifier. Capacitors are paralleled across these resistors to eliminate noise. Capacitor

C7 provides frequency compensation for the IC.

Diodes D1 and D2 protect the input of this IC against over-voltage.

### 3. AMPLIFIER

This stage is again an op amp (IC2 — LM301A or uA301A). The gain of this amplifier may be changed by switching resistors in the input circuit (by SW1b) and resistors in the feedback loop (by SW1c). Using the values specified, the selected gains are 1,  $\sqrt{10}$ , 10,  $10\sqrt{10}$ , and 100.

A zero control (RV1) is provided on this stage to compensate for the initial offset of the IC, and to correct for any drift when measuring very low dc levels.

Diodes D3 and D4 stabilize the voltage across RV1. Capacitor C9 frequency compensates the IC.

### 4. METER CIRCUIT

A third operational amplifier is used in this stage. This is to enable the output of IC2 to be rectified and to compensate voltage drops across the rectifying diodes. This enables the meter scale to be linear on all ac ranges.

Contacts on SW2 enable the meter to be connected across the IC in either polarity, in all dc modes.

In the ac mode a capacitor is switched in series with the input to IC3 to eliminate any dc level that may be present on the output of IC2.

Two separate potentiometers (RV3 and RV4) are provided on the input to IC3. These enable the ac and dc meter scales to be calibrated independently. A 100 ohm resistor is in series with the meter resulting in a total 'meter resistance' of about 200 ohms, and at 1 mA (which is full scale deflection) the voltage across the meter plus resistance will be 200mV on dc, and 340mV peak on the ac range.

The diodes D9 and D10 connected across the meter network conduct once the voltage across the meter exceeds approx 500 mV. This limits the maximum meter current to approximately 2.5 mA on any overload condition.

In the 'battery check' position the meter is connected across the battery with 20 K $\Omega$  in series. An associated marking is provided on the meter scale.

Fig. 1. Here is the foil pattern of the printed circuit board — reproduced full size.

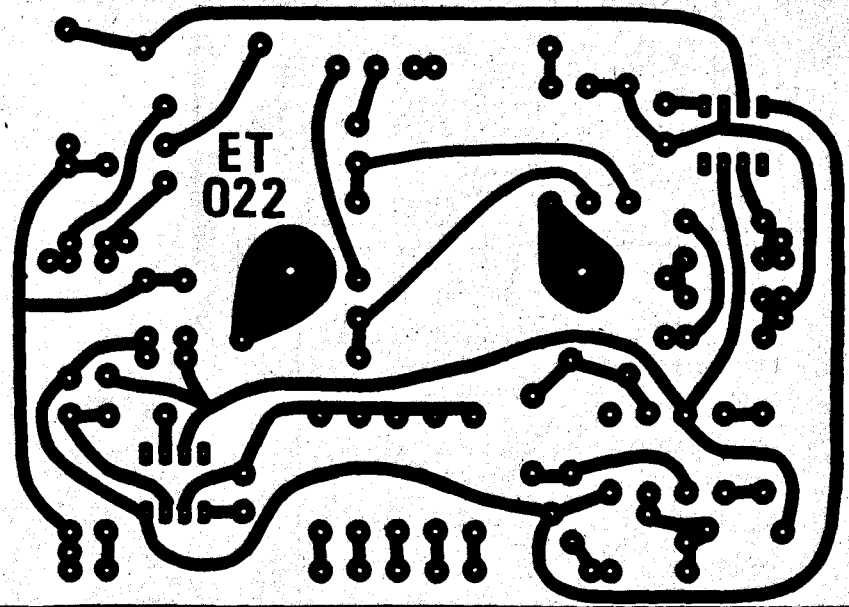

mounted components — shown in Fig. 3 — wired in place.

The completed printed circuit board is located by the terminals at the back of the Ferrier meter. This area of the printed circuit board should be tinned before final assembly.

The board can now be located in position and the remaining wiring completed. All external wires should be held together in a loom where practicable.

Before switching on recheck all wiring and component values. The unit is now ready for calibration.

**CALIBRATION**

**Zero setting** — short circuit the input terminals.

Select the + dc and 10 mV range. Adjust the zero set potentiometer on the front panel to give 'zero' on the meter. Select the 1000V range and set the meter to zero by using preset potentiometer RV2. Recheck zero on the 10 mV range and adjust RV1 if required.

**Voltage calibration** — the dc range is calibrated by connecting the input to a known dc voltage and adjusting RV4 to give the correct meter reading. The ac range is adjusted by connecting the input to a known ac voltage and adjusting RV3 to give the correct meter reading.

Check that all ranges work correctly, if any are faulty recheck the wiring of the switches and the components on the printed circuit board.

Once set, the calibration and zero setting of the instrument will remain constant for measurements across impedances not exceeding 1 Megohm.

(Continued overleaf)

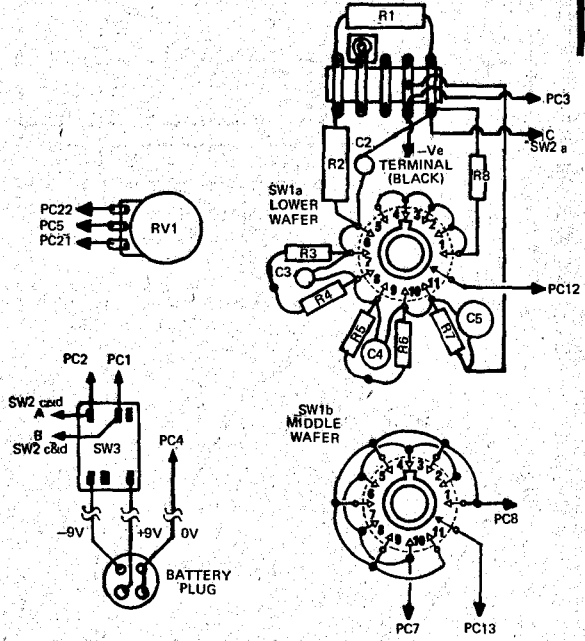
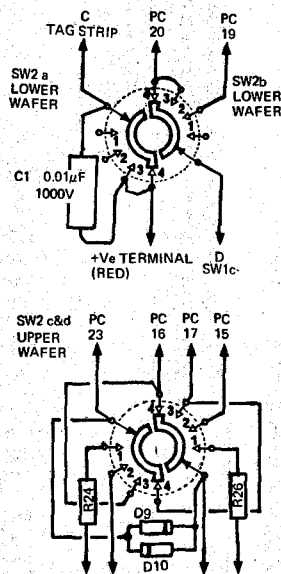
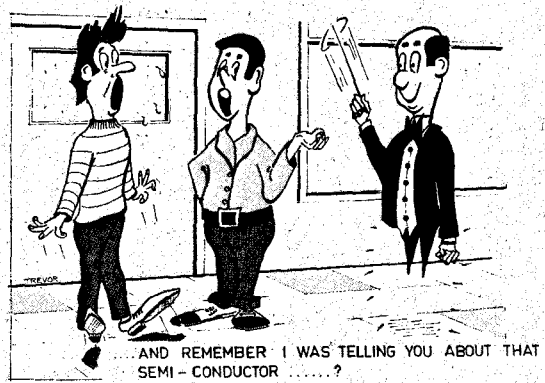
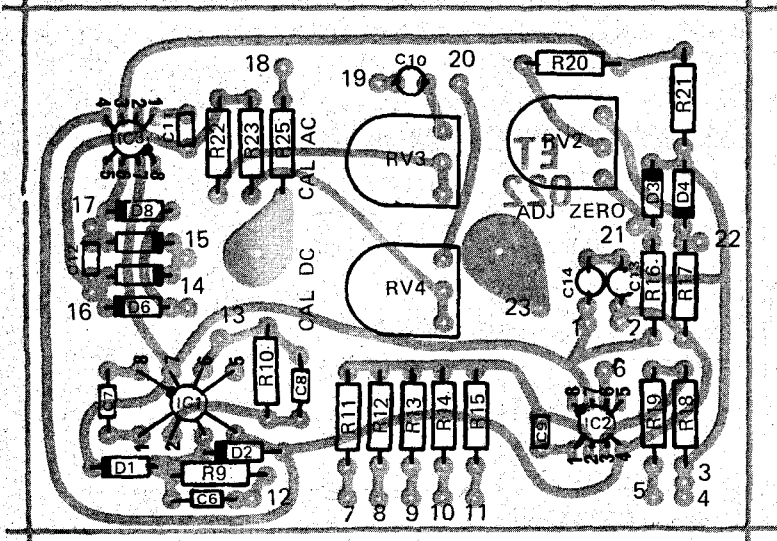

Fig. 2. How the components are assembled on the printed circuit board.

Fig. 3. Components and interconnections associated with the front panel.



# WIDE-RANGE VOLTMETER

FRONT PANEL CUTOUT  
SHOWN BEFORE FOLDING

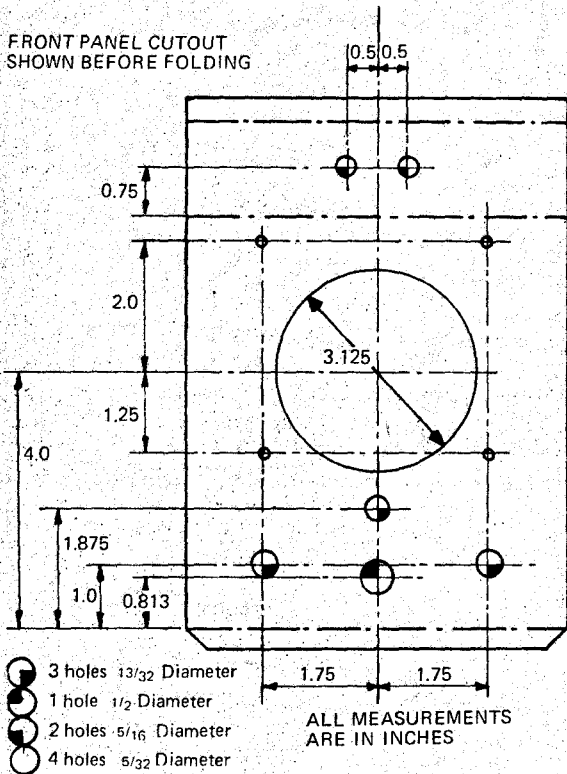
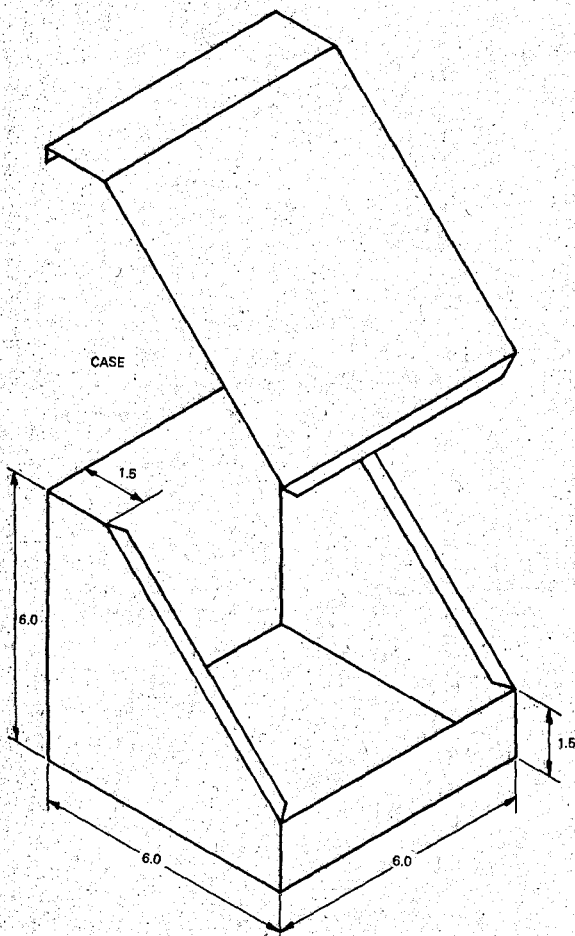

Fig. 4. Constructional details of the meter case.



### PARTS LIST ET107

R1	Resistor	4.7 Megohm,	1/2 Watt,	1%
R2	"	4.3	" "	"
R3	"	470k	" "	"
R4	"	430k	" "	"
R5	"	47k	" "	"
R6	"	43k	" "	"
R7	"	10k	" "	"
R8	"	10k	" "	5%
R9	"	1 Megohm	" "	"
R10	"	1 Megohm	" "	"
R11	"	1.5k	" "	1%
R12	"	4.7k	" "	"
R13	"	4.7k	" "	"
R14	"	47k	" "	"
R15	"	470k	" "	"
R16	"	33k	" "	5%
R17	"	33k	" "	"
R18	"	470 ohms	" "	"
R19	"	10k	" "	"
R20	"	10k	" "	"
R21	"	470 ohms	" "	"
R22	"	820 ohms	" "	1%
R23	"	910 ohms	" "	"
R24	"	10k	" "	5%
R25	"	100 ohms	" "	"
R26	"	10k	" "	"
C1	capacitor	0.01 uF, 1000V		
C2	"	33pF, 1000V,	5%	
C3	"	330pF, 100V,	5%	
C4	"	3300pF, 100V,	5%	
C5	"	0.033uF, 100V,	5%	
C6	"	0.01uF, 100V		
C7	"	33pF, 25V		
C8	"	0.01uF, 100V		
C9	"	180pF, 25V		
C10	"	33uF, 10V, TAG electrolytic		
C11	"	180pF, 25V		
C12	"	560pF, 25V		
C13	"	33uF, 10V, TAG electrolytic		
C14	"	33uF, 10V, TAG electrolytic		
RV1	potentiometer,	10k linear CTS45 or		
		equivalent.		
RV2	trimming potentiometer	10k, (large type)		
RV3	"	" " " " 100 ohms, (Large type)		
RV4	"	" " " " " " " "		
IC1	integrated circuit	National Semiconductor	LM308	
IC2	"	"	LM301A	
		(or Fairchild uA301A)		
IC3	As above			
	(note - ICs must be metal can type, or 8 pin plastic type)			
D1-D10	diodes	1N914		
SW1	rotary switch,	3 pole, 11 position		
SW2	"	4 pole, 4 position		
SW3	toggle switch,	2 pole on-off, MSP 625 or si		
		similar.		
Meter	1 mA movement, scaled	0-10 (0r 0-1) and		
		0-3.16, plus a dB scale. Ferrier type A135		
		or similar.		
Metal case	Oxford type	SF6		
Battery	type	2512		
	Plug for above			
	Metal clamp for battery			
	Terminals	2, one black, one red		
	Knobs	3		
	Anodized front panel (optional)			

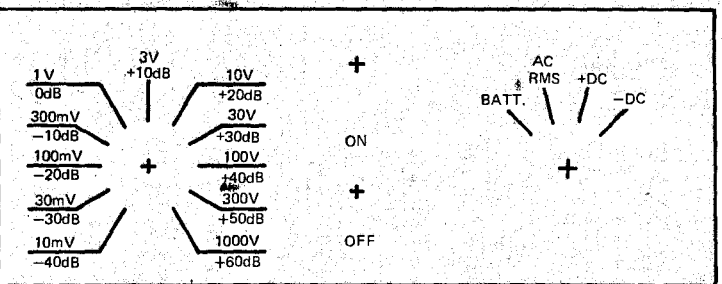

Fig. 5. Details of lettering on front panel.

# “it sounds really real”



## with **BASF LH-hifi** recording tape

Initially, the objective of all recording equipment is to translate the transient vibration patterns which are “sound,” into a permanent form.

The ultimate objective is to reproduce them in an audible form once again so that they are “really real” compared with the original. This ultimate objective is one step closer with **BASF LH-hifi recording tape**. L stands for low noise . . . H is short for high output. By eliminating the background noise, and increasing sensitivity, BASF engineers have achieved a dramatic improvement in signal-to-noise ratio of as much as 8dB over other quality tapes.

Now your recordings will take on magnificent studio quality—with greater clarity, more realism and less distortion—whether they be Beethoven symphonies or recorded birthday messages.

BASF LH-hifi tapes also available in Compact Cassettes.

Playing times:

C30 = 2 x 15 minutes = 30 minutes.

C60 = 2 x 30 minutes = 60 minutes.

C90 = 2 x 45 minutes = 90 minutes.

C120 = 2 x 60 minutes = 120 minutes.

BASF Compact Cassettes available everywhere in your choice of either “Trans,” “Snap” or “Plastic Pack.”

**BASF HAS THE QUALITY—YOU MAKE THE MUSIC—BASF FOR ENDLESS PLEASURE**

# BASF

Australian Distributors:  
**Maurice Chapman & Company Pty. Ltd.**,  
276 Castlereagh St., Sydney. Phone: 61 9881.  
146 Burwood Rd., Hawthorn, Vic. Phone: 81 0574.

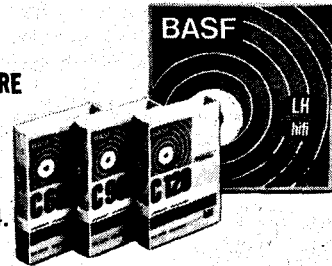

BA1371B

# SPEAKER CROSSOVER NETWORKS

## -and how to design them

Speaker crossover networks are quite simple to design — if you have a computer to calculate the component values. So we presented our Honeywell computer time-sharing terminal with the task. Here are the results — crossover design made easy.

**I**N MODERN high-fidelity systems the loudspeaker must cover a range of frequencies from 30 Hz to at least 15 kHz.

Generally this requires the use of two or more speakers in each enclosure, each speaker operating within a controlled frequency range.

The extent of that part of the sound frequency spectrum handled by each speaker is controlled by 'crossover' or 'frequency dividing' networks consisting of two or more filters.

A two speaker system usually has a two-way network consisting of a high-pass filter and a low-pass filter. The high-pass filter limits the low frequency response of the high frequency speaker, and the low pass filter limits the high frequency response of the low frequency speaker.

A three speaker system will usually have a three-way network. This will consist of a high-pass filter, a band-pass filter, and a low pass filter. The high and low-pass filters act in a similar manner as those in a two-way system. The band-pass filter controls the frequency range of the mid-range speaker.

The effect, in theory at least, is a smooth transition from one speaker to another over the total frequency range of the system.

For a multi-speaker system to have a substantially flat response, it is essential that each speaker in the

system has a usable frequency range overlapping the next. For example the bass speaker in a two speaker system may have a response that is substantially flat from say, 70 Hz to 3 kHz. The high frequency speaker chosen for this system would probably have a usable frequency range from 500 Hz to 15 kHz. Thus the overlap is 2.5 kHz.

### DETERMINING THE CROSS-OVER POINT

A crossover network for the system outlined above would be designed to operate somewhere between 800 Hz and 1 kHz.

A three-way system would probably be designed to crossover at 400 to 500 Hz and again at 5 kHz.

GRAPH 1

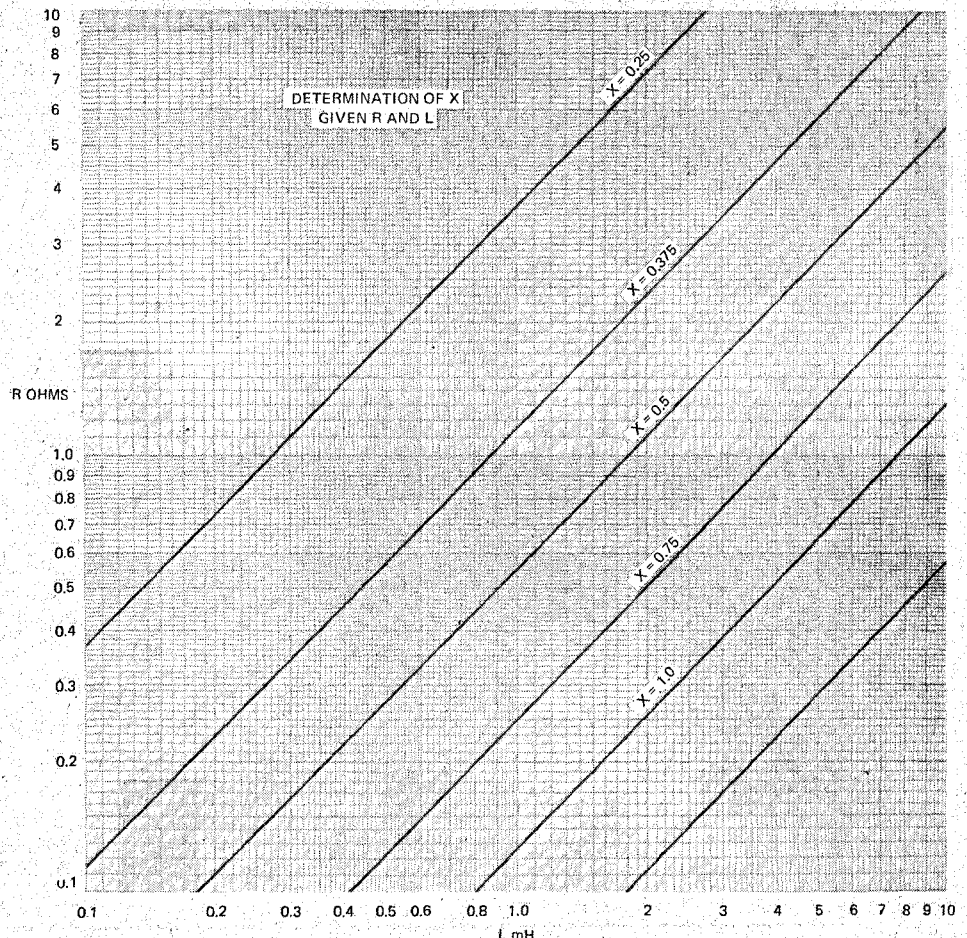

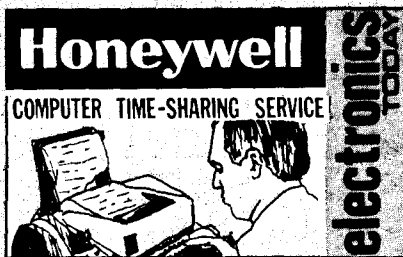

The optimum crossover frequency may be easily determined by studying the frequency response curves of the speakers to be used and arranging for the crossover to take place before the response of a given speaker unit falls off, or the movement of the diaphragm becomes non-linear. Few bass speakers, for example, have any really usable response beyond 2 to 3 kHz. The range of the frequency spectrum covered by the mid-range unit must be restricted to those frequencies at which the displacement of the diaphragm does not exceed the manufacturer's rating.

It should of course be quite clearly understood that the sole purpose of a crossover network is to control the operating range of each speaker. It is to prevent a tweeter with a cone travel of a few thousands of an inch from being driven by a 50 Watt amplifier at 35 Hz — and to ensure that a bass speaker does not have hysterics trying to emulate Victoria de los Angeles.

A crossover network cannot be used to correct for deficiencies in the record player, amplifier, speaker drive units or enclosure design.

### DIFFERENT TYPES OF FILTER

Figure 1 shows a typical frequency response for a crossover network (operating point 1 kHz) consisting of a low-pass filter and a high-pass filter. The graph does in fact show three different pairs of filters, each having a different rate of attenuation.

In practise an attenuation of 6 dB per octave is generally inadequate. The rate of cut-off is not always sufficient to protect the mid-range and high frequency drive units from being overdriven.

An attenuation rate of 12 dB per octave is commonly used, although 18 dB per octave filters are sometimes chosen. For amateur design it is advisable to stick to the 12 dB per octave filter.

Both series and parallel filters are used. Series filters are used only in two-speaker systems. Most commercially built networks use the parallel configuration because component values are the same for each filter and this reduces inventory costs. Apart from cost the parallel

SYD 0134

HONEYWELL G265 TIME-SHARING SYD.

ON TTY 41 AT 18:52 MONDAY 6/12/71

USER NUMBER---S85004  
MODERN MAGAZINE H.

PROJECT ID---BARRY  
SYSTEM---BAS  
NEW OR OLD--NEW  
NEW FILE NAME--FILTERS  
READY.

TAPE  
READY

```

15 PRINT USING 18
18:FREQ.      C1      C2      C3      C4      C5      L1      L2      L3      L4      L5
20 PRINT
35 READ R
37 READ M
40 DIM F(25)
50 FOR I=1 TO 22
60 READ F(I)
70 LET W=2*3.14159*F(I)
80 LET Z=R*W
90 LET X=2E6/Z
110 GOSUB 500
120 LET C1=X
130 LET X=1E6/(Z+Z*M)
150 GOSUB 500
160 LET C2=X
170 LET X=1E6/Z
190 GOSUB 500
195 LET C3=X
200 LET X=1E6/(2*Z)
220 GOSUB 500
230 LET C4=X
240 LET X=1E6*(1+M)/Z
255 GOSUB 500
260 LET C5=X
270 LET X=1000*(1+M)*R/W
280 GOSUB 500
285 LET L1=X
290 LET X=1000*R/W
295 GOSUB 500
300 LET L2=X
310 LET X=1000*R/(2*W)
320 GOSUB 500
330 LET L3=X
340 LET X=2*1000*R/W
350 GOSUB 500
360 LET L4=X
370 LET X=1000*R/(W+W*M)
380 GOSUB 500
390 LET L5=X
450 PRINT F(1);TAB(10);C1;TAB(16);C2;TAB(22);C3;TAB(28);C4;TAB(34);C5;
460 PRINT TAB(40);L1;TAB(46);L2;TAB(52);L3;TAB(58);L4;TAB(64);L5
480 NEXT I
500 IF X<100 THEN 520
505 LET X=INT(X+.5)
510 GOTO 600
520 IF X<10 THEN 540
525 LET X=INT(X*10+.1)/10
530 GOTO 600
540 IF X<1 THEN 560
545 LET X=INT(X*100+.5)/100
550 GOTO 600
560 LET X=INT(X*1000+.5)/1000
600 RETURN
700 DATA 8
710 DATA 0.6
720 DATA 100,150,200,250,300,350,400,500,600,750,1000,1250,1500
730 DATA 2000,2500,3000,3500,4000,5000,6000,7500,10000
999 END

```

RUN

USED 33 UNITS  
BYE

TOTAL TTY MINUTES = 35

TOTAL CRU'S USED = 33

\*\*\*OFF AT 19:27 MONDAY 6/12/71

*This is the computer programme used to calculate the circuit component values in the crossover networks. Copyright — Electronics Today.*



# SPEAKER CROSSOVER NETWORKS

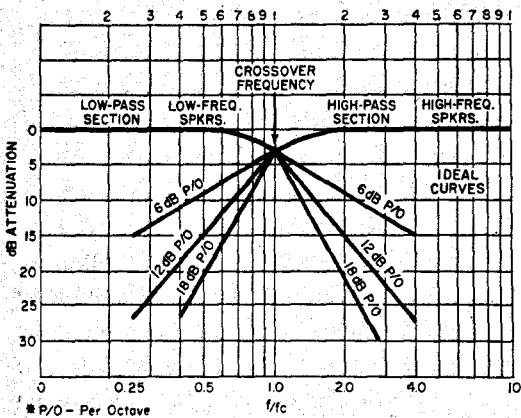

Fig. 1. Typical frequency response curves of a two-way crossover network. The graph shows three different pairs of filters, each having a different rate of attenuation.

FREQ.	C1	C2	C3	L1	L2	L3
100	199	281	141	12.7	9	18
150	133	188	93.8	8.49	6	12
200	99.5	141	70.3	6.37	4.5	9
250	79.6	113	56.3	5.09	3.6	7.2
300	66.3	93.8	46.9	4.24	3	6
350	56.8	80.4	40.2	3.64	2.57	5.14
400	49.7	70.3	35.2	3.18	2.25	4.5
500	39.8	56.3	28.1	2.55	1.8	3.6
600	33.2	46.9	23.4	2.12	1.5	3
750	26.5	37.5	18.8	1.7	1.2	2.4
1000	19.9	28.1	14.1	1.27	.9	1.8
1250	15.9	22.5	11.3	1.02	.72	1.44
1500	13.3	18.8	9.38	.849	.6	1.2
2000	9.95	14.1	7.03	.637	.45	.9
2500	7.96	11.3	5.63	.509	.36	.72
3000	6.63	9.38	4.69	.424	.3	.6
3500	5.68	8.04	4.02	.364	.257	.514
4000	4.97	7.03	3.52	.318	.225	.45
5000	3.98	5.63	2.81	.255	.18	.36
6000	3.32	4.69	2.34	.212	.15	.3
7500	2.65	3.75	1.88	.17	.12	.24
10000	1.99	2.81	1.41	.127	.09	.18

COMPONENT VALUES FOR CONSTANT-K LOUDSPEAKER CROSSOVER NETWORKS  
 INDUCTANCE IN MILLIHENRIES  
 CAPACITANCE IN MICROFARADS  
 SPEAKER IMPEDANCE = 8 OHMS

network has slightly better electrical characteristics in the transmission and attenuation bands. Nevertheless the design data given later in this article covers both series and parallel networks.

Apart from the series and parallel configurations, filters used for crossover networks are known as 'constant k' or 'm derived'. It is not essential for the amateur to understand the difference between the two types. Basically the 'constant k' networks are limited to a cut off rate of 12 dB per octave, whilst the 'm derived' networks can operate at cut off rates of 18 dB per octave. The 'm derived network' is often used by designers of top quality speaker

systems as the design approach permits closer control of impedance and attenuation characteristics.

## INSERTION LOSS

One of the most important design considerations is that the filter does not introduce any appreciable loss (this is called 'insertion loss') between the amplifier and the speaker drive units. The insertion loss — which is usually quoted in dBs — is caused by the dc resistance of the coils, together with the shunt and series reactance of the circuit elements. The insertion loss of a well designed filter should not exceed 0.5 dB (preferably less than this for high power systems).

For speaker systems driven by

Fig. 2

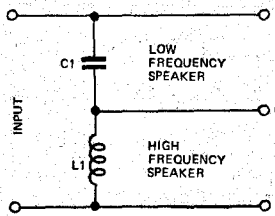
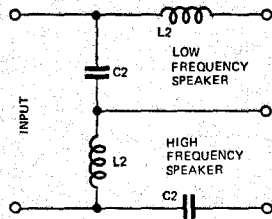

Fig. 4



Constant k crossover networks. Fig. 2 — series type, 6dB/octave. Fig. 3 — parallel type, 6dB/octave. Fig. 4 — series type, 12dB/octave. Fig. 5 — parallel type, 12dB/octave.

Fig. 3

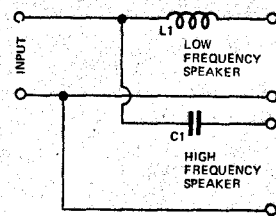
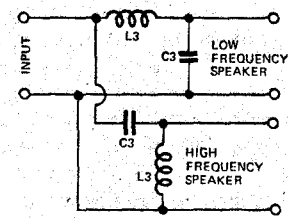

Fig. 5



amplifiers of less than 30 Watts or so, an insertion loss of 0.5 dB is quite acceptable. But a manufacturer of high power systems will usually try to reduce the insertion loss below 0.5 dB if economically feasible — for the power absorbed by a 0.5 dB filter at 100 Watts input will exceed 10 Watts.

Insertion losses are minimized by using coils of low dc resistance, and capacitors of low power factor.

(Apart from the insertion loss, a further loss of approx 3 dB will occur at the crossover frequency. This is because the amplifier power is divided more or less equally between the two speakers at this frequency. This loss is inevitable whenever a crossover network is used — but in practise it is hardly ever apparent to the ear.)

Speaker drive units used in multiple speaker systems should all have similar nominal impedances. Thus, if the bass driver is an eight ohm unit so also should be the mid-range (if used) and high frequency units. If twin units are used for any part of the spectrum — such as twin tweeters — then each speaker should be twice the nominal impedance of each of the remaining speakers, the twin speakers should then be connected in parallel. (Two 16 ohm speakers connected in parallel will reflect an 8 ohm load impedance to the crossover network.)

## CALCULATING COMPONENT VALUES

Calculation of the component values for crossover networks is a long tedious business. Unless you have a computer that is!

But as readers will be aware, we have just that — a time-sharing terminal connected to the Honeywell system —

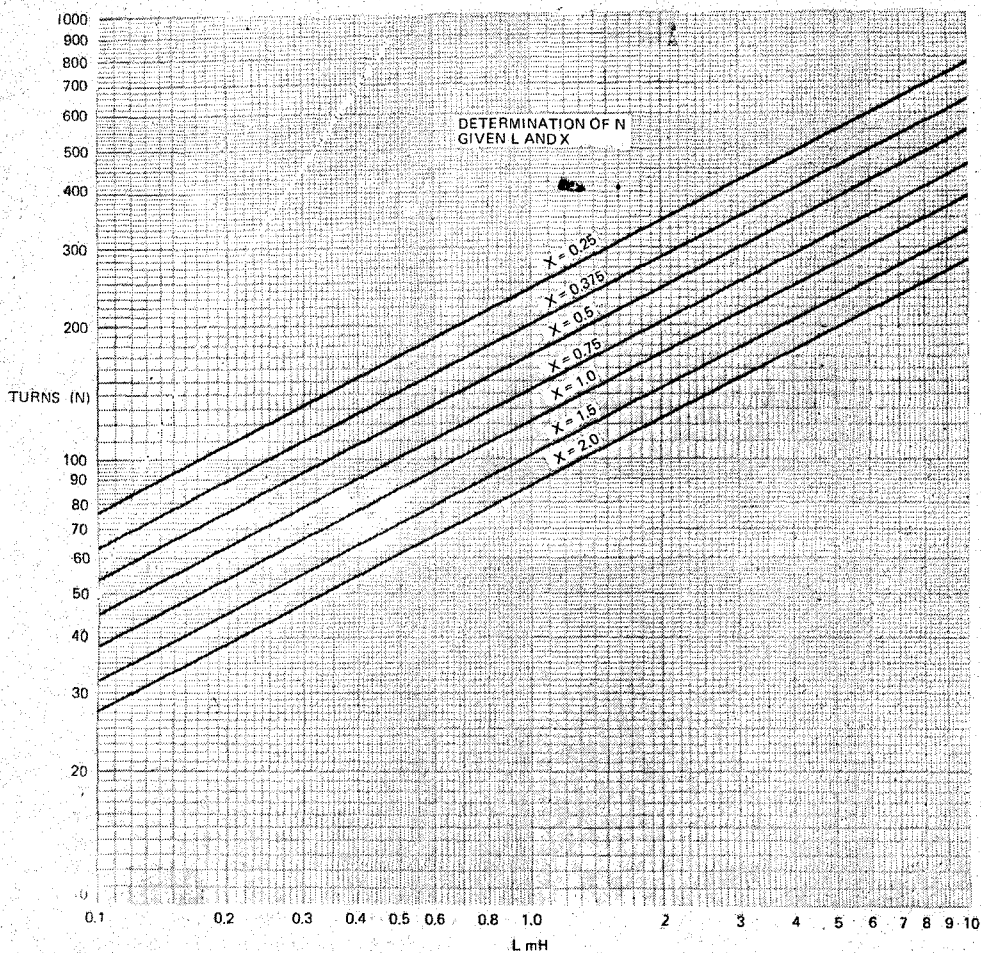

GRAPH II

and this was used to calculate the values of all components required.

The programme — specially written by our Engineering Manager, Barry Wilkinson — is reproduced elsewhere in this article. Component values have been calculated for both 'constant k' and 'm derived' filters and for speakers of both 8 ohm and 15 ohm nominal impedance; complete design data is given for all crossover frequencies from 100 Hz through 10 kHz.

### CONSTRUCTION

The actual construction of filter networks is quite simple. Air-cored coils are normally used (iron-cored coils can introduce distortion) and these are very simple to wind. (Design data for winding these coils is included in this article.)

Standard (non-polarized) electrolytic capacitors are not suitable for crossover networks, as even low leakage types have an unacceptable power factor for this application. Special non-polarized electrolytics are made by some firms specifically for crossover networks — but it is significant that many of the top speaker manufacturers will only use paper capacitors for this purpose..

When choosing capacitors for crossover networks ensure that the capacitors' rated dc working voltage is never exceeded by the peak voltage of the signal.

### DESIGN PROCEDURE

1. Determine crossover frequencies

FREQ.	C1	C2	C3	L1	L2	L3
100	106	150	75	23.9	16.9	33.8
150	70.7	100	50	15.9	11.3	22.5
200	53.1	75	37.5	11.9	8.44	16.9
250	42.4	60	30	9.55	6.75	13.5
300	35.4	50	25	7.96	5.63	11.3
350	30.3	42.9	21.4	6.82	4.82	9.65
400	26.5	37.5	18.6	5.97	4.22	8.44
500	21.2	30	15	4.77	3.38	6.75
600	17.7	25	12.5	3.98	2.81	5.63
750	14.1	20	10	3.18	2.25	4.5
1000	10.6	15	7.5	2.39	1.69	3.38
1250	8.49	12	6	1.91	1.35	2.7
1500	7.07	10	5	1.59	1.13	2.25
2000	5.31	7.5	3.75	1.19	.844	1.69
2500	4.24	6	3	.955	.675	1.35
3000	3.54	5	2.5	.796	.563	1.13
3500	3.03	4.29	2.14	.682	.482	.965
4000	2.65	3.75	1.88	.597	.422	.844
5000	2.12	3	1.5	.477	.338	.675
6000	1.77	2.5	1.25	.398	.281	.563
7500	1.41	2				

COMPONENT VALUES FOR CONSTANT-K LOUDSPEAKER CROSSOVER NETWORKS  
 INDUCTANCE IN MILLIHENRIES  
 CAPACITANCE IN MICROFARADS  
 SPEAKER IMPEDANCE = 15 OHMS

- and attenuation required (i.e. 6dB, 12dB or 18dB per octave).
- Decide whether filter is to be series or parallel — as explained earlier the parallel type has some advantages over its series counterpart.
- Select the appropriate circuit from Fig. 2 — 9.
- Establish component values for required speaker impedance (and either 'constant k' or 'm derived' design) from computer print-out.
- Design coils using data provided.

### COIL DESIGN

Any coil used in a crossover network has a certain amount of dc resistance — and this resistance will dissipate a proportion of amplifier power. Thus, the dc resistance of the coils should be as low as economically possible. A reasonable compromise — where the amplifier power does not exceed 30 Watts continuous power output per channel — is to keep the dc resistance below one ohm.

The coil design that will provide the highest inductance in proportion to the dc resistance is that shown in Fig. 10. In this drawing the radius of the circular winding bobbin is shown as 'x' and all other dimensions are related to this.

Construction of the bobbin is not critical and it can be made from cardboard, or a combination of a wooden core and cardboard cheeks. Metal must not be used.

The design procedure is as follows:—

- Determine the bobbin size required. This is done by using Graph I. This graph indicates bobbin size ('x' measurement) required to accommodate coils of different sizes and dc resistances. For example a 5.5mH coil wound on a 0.75" former (remember that this refers to the measurement shown as

# SPEAKER CROSSOVER NETWORKS

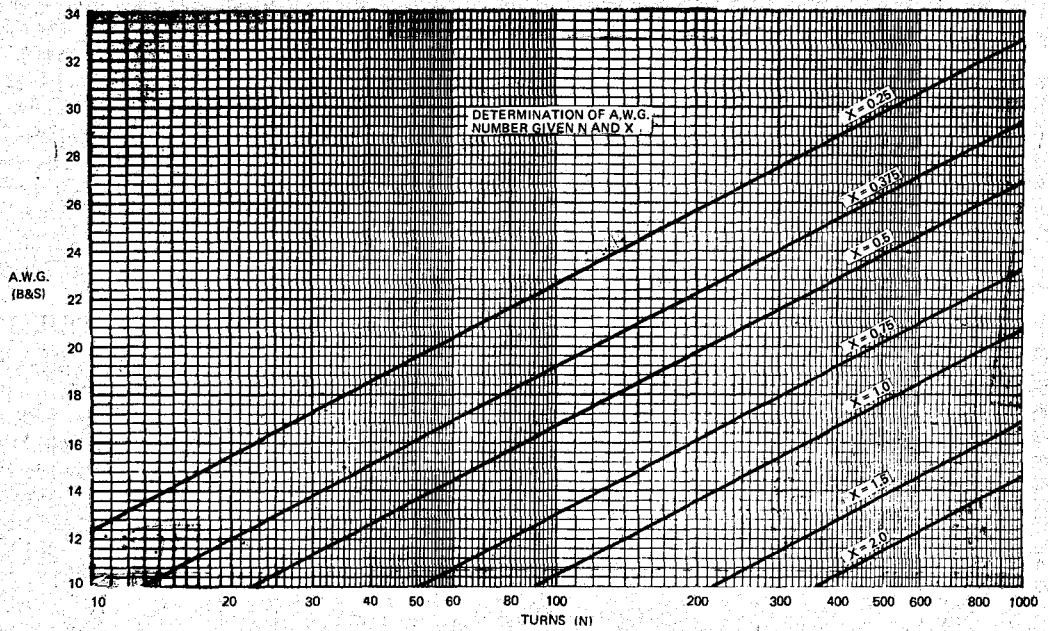

GRAPH III

Fig. 6

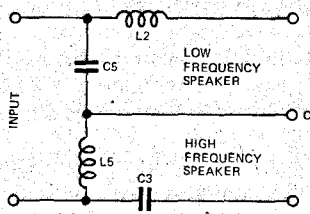

Fig. 7

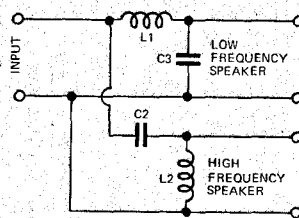

Fig. 8

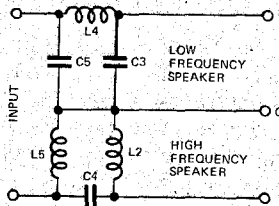
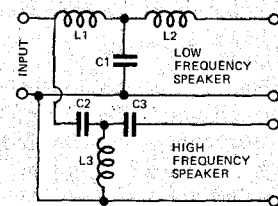

Fig. 9



M-derived crossover networks. Fig. 6 — series type, 12 dB/octave. Fig. 7 — parallel type, 12 dB/octave. Fig. 8 — series type, 18 dB/octave. Fig. 9 — parallel type, 18 dB/octave.

FREQ.	C1	C2	C3	C4	C5	L1	L2	L3	L4	L5
100	398	124	199	99.4	318	20.3	12.7	6.37	25.4	7.96
150	265	82.9	133	66.3	212	13.5	8.49	4.24	16.9	5.31
200	199	62.1	99.4	49.7	159	10.1	6.37	3.18	12.7	3.98
250	159	49.7	79.5	39.7	127	8.15	5.09	2.55	10.1	3.18
300	133	41.4	66.3	33.1	106	6.79	4.24	2.12	8.49	2.65
350	114	35.5	56.8	28.4	90.9	5.82	3.64	1.82	7.28	2.27
400	99.4	31	49.7	24.8	79.5	5.09	3.18	1.59	6.37	1.99
500	79.5	24.8	39.7	19.9	63.6	4.07	2.55	1.27	5.09	1.59
600	66.3	20.7	33.1	16.5	53	3.4	2.12	1.06	4.24	1.33
750	53	16.5	26.5	13.2	42.4	2.72	1.7	.849	3.4	1.06
1000	39.7	12.4	19.9	9.95	31.8	2.04	1.27	.637	2.55	.796
1250	31.8	9.95	15.9	7.96	25.4	1.63	1.02	.509	2.04	.637
1500	26.5	8.29	13.2	6.63	21.2	1.36	.849	.424	1.7	.531
2000	19.9	6.22	9.95	4.97	15.9	1.02	.637	.318	1.27	.398
2500	15.9	4.97	7.96	3.98	12.7	.815	.509	.255	1.02	.318
3000	13.2	4.14	6.63	3.32	10.6	.679	.424	.212	.849	.265
3500	11.3	3.55	5.68	2.84	9.09	.582	.364	.182	.728	.227
4000	9.95	3.11	4.97	2.49	7.96	.509	.318	.159	.637	.199
5000	7.96	2.49	3.98	1.99	6.37	.407	.255	.127	.509	.159
6000	6.63	2.07	3.32	1.66	5.31	.34	.212	.106	.424	.133
7500	5.31	1.66	2.65	1.33	4.24	.272	.17	.085	.34	.106
10000	3.98	1.24	1.99	.995	3.18	.204	.127	.064	.255	.08

COMPONENT VALUES FOR M-DERIVED LOUDSPEAKER CROSSOVER NETWORKS  
 INDUCTANCE IN MILLIHENRIES  
 CAPACITANCE IN MICROFARADS  
 M=0.6  
 SPEAKER IMPEDANCE = 8 OHMS

'x') will have a dc resistance of 1.4 ohms — if wound on a 1" former the resistance would be 0.7 ohms. As the dc resistance should be preferably less than 1.0 ohm, the 1" former should be used.

- Graph II shows the number of turns required to provide the required inductance for various bobbin sizes. In our example 290 turns are required.
- Graph III shows the wire gauge required. In our example 290 turns on a 1" bobbin would require 15.3 B&S. The nearest standard size is 16G so this is the wire size used.
- The coil should be layer wound using enameled copper wire. As the operating voltage is quite low, no interlayer insulation is required. Graph IV shows the dc resistance of the coil given the wire gauge and former size, providing the former is filled completely. In our case the resistance shown is 1.0 ohm — but as we have only 290 turns whereas the filled bobbin accommodates about 350 turns the resistance would be about 0.8 ohm. This is sufficiently close to our design requirement and

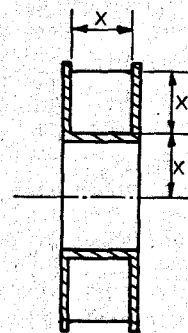

Fig. 10. Recommended dimensions of bobbin design. All dimensions are related to 'x' — thus if the measurement specified for 'x' is 1" then the winding width and depth are both 1", and the bobbin internal diameter is 2".

would be acceptable for a low power amplifier.

Figure 11 provides the approximate weight of wire used for fully wound coils of each size.

### THREE-WAY CROSSOVER NETWORKS

These differ from two-way networks only in that they include a mid-range filter.

A three-way 12 dB per octave parallel crossover is shown in Fig. 12. The midrange section is a bandpass filter consisting of a low pass filter (L3B and C3B) and a high pass filter (L3A and C3A).

The design procedure is firstly to establish the values of the low pass section L3 and C3.

Circuit elements L3A and C3A, in the mid-range filter, must also cross over at the same frequency as the low pass filter, and thus have the same values as L3 and C3.

The values of L3B is the same as L3C as also are C3B and C3C. The values of these components are determined for the changeover frequency of the mid-range and tweeter speakers.

Four and five way networks are designed in a similar fashion.

'x' inches	Weight (ozs.)
0.25	0.5
0.375	1.75
0.5	4.25
0.75	14
1.00	33
1.50	110

Fig. 11 - This table shows the weight of wire used for fully wound coils of each size of 'x'.

FREQ.	C1	C2	C3	C4	C5	L1	L2	L3	L4	L5
100	212	66.3	106	53	170	38.2	23.8	11.9	47.7	14.9
150	141	44.2	70.7	35.3	113	25.4	15.9	7.96	31.8	9.95
200	106	33.1	53	26.5	84.8	19.1	11.9	5.97	23.8	7.46
250	84.8	26.5	42.4	21.2	67.9	15.2	9.55	4.77	19.1	5.97
300	70.7	22.1	35.3	17.6	56.5	12.7	7.96	3.98	15.9	4.97
350	60.6	18.9	30.3	15.1	48.5	10.9	6.82	3.41	13.6	4.26
400	53	16.5	26.5	13.2	42.4	9.55	5.97	2.98	11.9	3.73
500	42.4	13.2	21.2	10.6	33.9	7.64	4.77	2.39	9.55	2.98
600	35.3	11	17.6	8.84	28.3	6.37	3.98	1.99	7.96	2.49
750	28.3	8.84	14.1	7.07	22.6	5.09	3.18	1.59	6.37	1.99
1000	21.2	6.63	10.6	5.31	16.9	3.82	2.39	1.19	4.77	1.49
1250	16.9	5.31	8.49	4.24	13.5	3.06	1.91	.955	3.82	1.19
1500	14.1	4.42	7.07	3.54	11.3	2.55	1.59	.796	3.18	.995
2000	10.6	3.32	5.31	2.65	8.49	1.91	1.19	.597	2.39	.746
2500	8.49	2.65	4.24	2.12	6.79	1.53	.955	.477	1.91	.597
3000	7.07	2.21	3.54	1.77	5.66	1.27	.796	.398	1.59	.497
3500	6.06	1.89	3.03	1.52	4.85	1.09	.682	.341	1.36	.426
4000	5.31	1.66	2.65	1.33	4.24	.955	.597	.298	1.19	.373
5000	4.24	1.33	2.12	1.06	3.4	.764	.477	.239	.955	.298
6000	3.54	1.11	1.77	.884	2.83	.637	.398	.199	.796	.249
7500	2.83	.884	1.41	.707	2.26	.509	.318	.159	.637	.199
10000	2.12	.663	1.06	.531	1.7	.382	.239	.119	.477	.149

COMPONENT VALUES FOR M-DERIVED LOUDSPEAKER CROSSOVER NETWORKS  
 INDUCTANCE IN MILLIHENRIES  
 CAPACITANCE IN MICROFARADS  
 M=0.6  
 SPEAKER IMPEDANCE = 15 OHMS

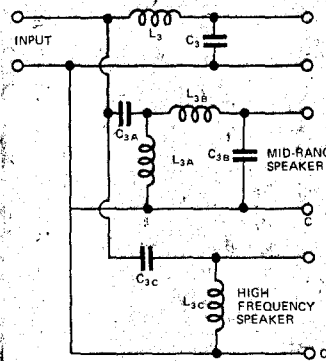

Fig. 12. Three-way 12 dB per octave parallel crossover.

The component values quoted for the three way 'constant k' network described above can be converted to an 'm derived network' by the following equations.

$$L3, L3B = (1 + m) \frac{R_0}{\omega C} \text{ Henry}$$

$$L3A, L3C = \left( \frac{R}{\omega C} \right) \text{ Henry}$$

$$C3A, C3C = \left( \frac{1}{1+m} \right) \left( \frac{1}{\omega C R_c} \right) \times 10^6 \mu F$$

$$C3B = \left( \frac{10^6}{\omega C R_c} \right) \mu F$$

Electronics Today would like to thank Mr. I.C. Hansen for his very valuable assistance in providing design data for the coils described in this article.

GRAPH IV

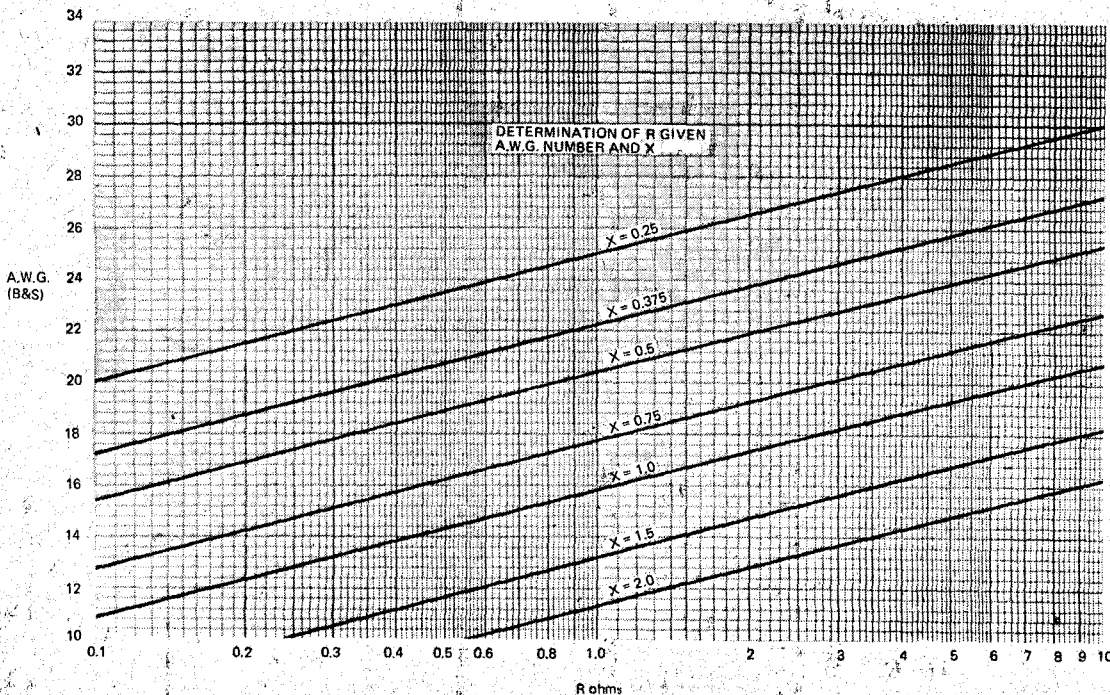

# ELECTRONIC TORQUE-MEASURING SYSTEM

*New torque measuring system uses inductive signal transmission to avoid slip-ring problems.*

**A** NEW torque measuring system that permits continuous monitoring of both static and dynamic torque values up to 500 mkg without any physical contact between rotating and static components of its transmission section, has just been introduced by Philips.

The system, (type PR 9372), can be used at shaft speeds up to 10,000 rev/min and eliminates problems of brush wear and tear and continual cleaning experienced with the commonly used slip-ring measurement system. Variations in contact resistance are thus avoided and the transducer system gives a consistently high measuring accuracy of better than 1%. A further advantage over the slip-ring system is that there is no difficulty in changing the direction of shaft rotation during measurements.

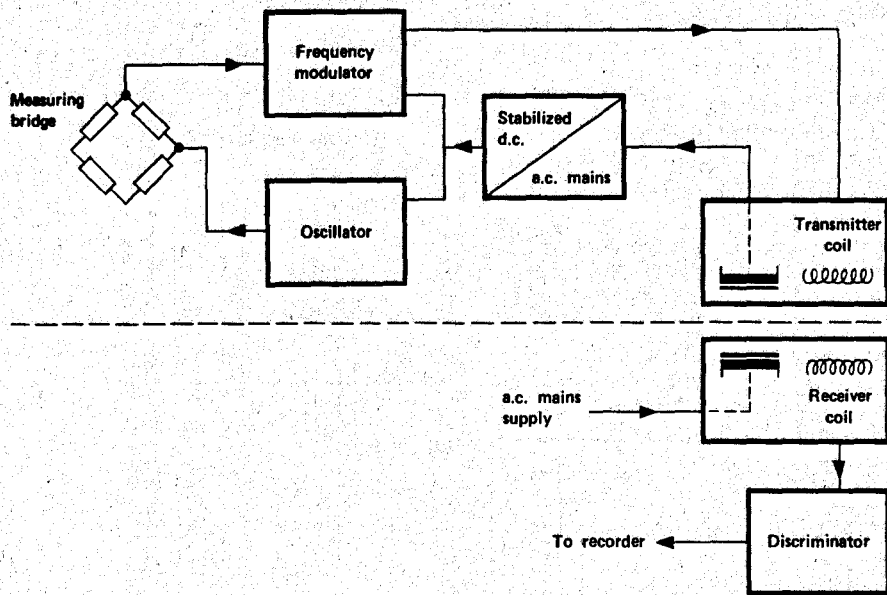

## STATIC AND ROTATING SECTIONS

The PR 9372 system consists of two parts — a rotating section which is mounted within the shaft whose torque is being measured, and a static section mounted in close proximity to the rotating section.

The rotor's measuring shaft contains strain gauges cemented to it in a Wheatstone-bridge configuration, and the body of the rotor contains two LF-FM units and a rectifying unit which constitute the information transmission system. The surface of the rotor is fitted with two coil systems, the outer one constituting a power induction coil and the centre one being the information-signal transmission coil.

The static section consists of two parts: a unit mounted adjacent to the rotating section and a discriminator. The former contains both the primary power-induction coil (from which power for the rotor unit is obtained) the information receiving coil, and the latter signal-conditioning circuits.

## FREQUENCY-MODULATED SIGNALS INDICATE TORQUE CHANGES

Variations in the bridge's resistance (proportional to changes in torque) are translated into frequency deviations of a fixed-frequency signal by the LF-FM units, the resulting frequency modulated signals being fed to the transmitting coil on the rotor surface. The discriminator within the static section demodulates signals from the receiving coil, its output being fed to the recording or indicating unit used.

A wide range of recording/indicating instruments can be used with the PR 9372 which provides the following outputs:

1. A carrier-frequency signal for use with magnetic-tape recorders.
2. A demodulated signal for use with high-speed chart recorders or oscilloscopes.
3. A demodulated signal for use with ultra-violet recorders or moving-coil instruments.

## IMPROVED EFFICIENCY AND VERSATILITY

The PR 9372 system, which is available in six versions to suit different measuring ranges and shaft diameters, can be used with any type of recorder, moving-coil instrument or oscilloscope for the testing of all types of motors, car engines and gearboxes. They can also be used to deduce the power output of machines by measuring their speed, for measuring torque variations up to 1.5 kHz, for checks on car-engine piston balancing, for measurements during blending of chemicals, and for accurate measurements where high rotational speeds are involved (up to 10,000 rev/min compared to the slip-ring system maximum of 6,000 rev/min).

Linearity and hysteresis deviations are both less than 0.2% with PR 9372 units, and zero-point variation less than 0.05% per 10°C in the range 10 – 70°C. ●

# **NEW SA-600**

**HIGH QUALITY, HIGHER POWER,  
LOW PRICE.**

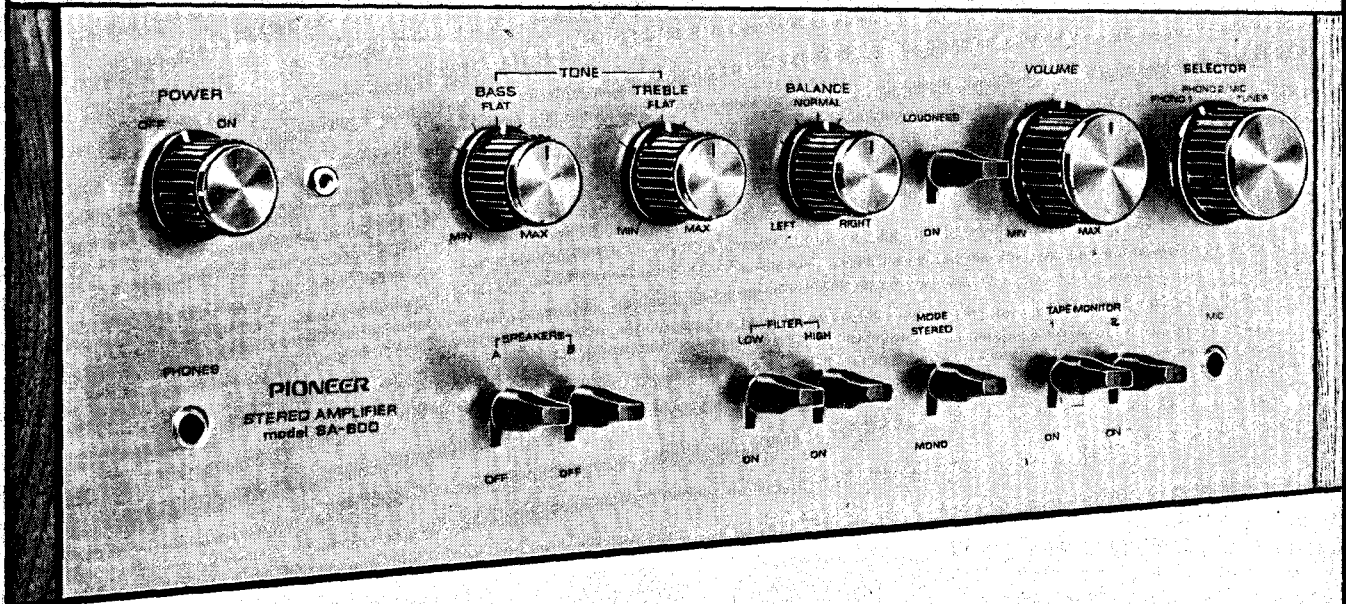

## **SPECIFICATIONS:**

Continuous Power Output: (both channels driven) RMS	19 watts + 19 watts (8 ohms)
Harmonic Distortion:	Less than 0.5%
Inter Modulation Distortion:	Less than 0.5%
Power Bandwidth (1 HF):	10 to 50,000 Hz (8 ohms, harmonic distortion less than 0.5%)
Frequency Response:	15 to 70,000 $\pm$ 1dB
Damping Factor:	30 (8 ohms, 1 KHz)
Input Sensitivity/Impedance: (1 KHz, rated output)	PHONO: 1, 2: 2.3 mV/50 k ohms MIC: 3.3 mV/20 k ohms TUNER: 200 mV/95 k ohms AUX: 1, 2: 200 mV/95 k ohms
Recording Output:	TAPE MONITOR: 1, 2: 200 mV/95 k ohms TAPE REC: 1, 2 (pin jack): 200 mV TAPE REC: (DIN connector): 30 mV
Bass Control:	- 15 dB, + 13 dB/50 Hz
Treble Control:	- 10 dB, + 9.5 dB/ 10 KHz
Low Filter:	- 6.5 dB/50 Hz
High Filter:	- 8 dB/10 KHz
Loudness Contour:	+ 13 dB/50 Hz, + 7 dB/ 10 KHz, with volume control set at - 40 dB position
Hum and Noise (1HF):	PHONO: better than - 80 dB TUNER, AUX: better than - 95 dB
Channel Separation (1 KHz):	PHONO: more than 50 dB TUNER, AUX: more than 55 dB

This handsomely styled unit from **PIONEER** is perfect for the stereo enthusiast who is building his system within a stipulated budget. The **SA 600** provides professional performance at a very practical price. It uses only long-life, low-noise silicon transistors, thus the frequency response and signal-to-noise ratio are superb. Two tape decks or two speaker systems may be used with the **SA 600** and the unit may also be adapted for multi-amp use. Equipped with two pairs of PHONO, TAPE and AUX input terminals it may be used for tape-to-tape duplications or two sets of speakers may be used simultaneously to compare the qualities of each system.

'Sound proof that the best can cost less at your nearest authorised **PIONEER** dealer.'

 **PIONEER**

V4279

# NOISE REDUCTION

This article describes the operating principles of the Dolby and Philips noise reduction systems.

**P**ERHAPS the two most dramatic developments in high fidelity sound reproduction during the past few years have been firstly, the development of magnetic recording tapes with a wide dynamic range, and secondly, the noise reduction systems introduced by Dolby, Philips et al.

These two developments have been exploited by manufacturers of cassette tape recorders, several of whom have recently introduced advanced machines, that perform practically as well as top quality record systems.

Product reviews of these latest tapes and tape recorders have been published in recent issues of *Electronics Today* — but until now, little has been published about the actual circuit operation of noise reduction systems.

These noise reduction systems are an inherent part of the new generation of recorders — in fact without them it is unlikely that such recorders could have *been* developed, for their slow tape speed and narrow track made it practically impossible to achieve wide range recordings without accompanying background hiss.

There have been many attempts in the past to reduce this noise electronically, but few of these systems were satisfactory, and practically all added a noise of their own — best described as a 'pumping' sound.

Then in 1966 a young physicist named Ray Dolby introduced a revolutionary tape-noise reduction system.

## THE DOLBY SYSTEM

Ray Dolby's system is unique for a number of reasons: it is used both during recording and playback, it does not process the entire frequency range as a whole, it does not process the louder parts of the signal, and its action is so fast that it is inaudible.

The original Dolby system was developed for professional users. It processes the signal being recorded and reprocesses it on playback over four frequency bands. This achieves noise reduction over the entire audio spectrum.

A less complex system (known as

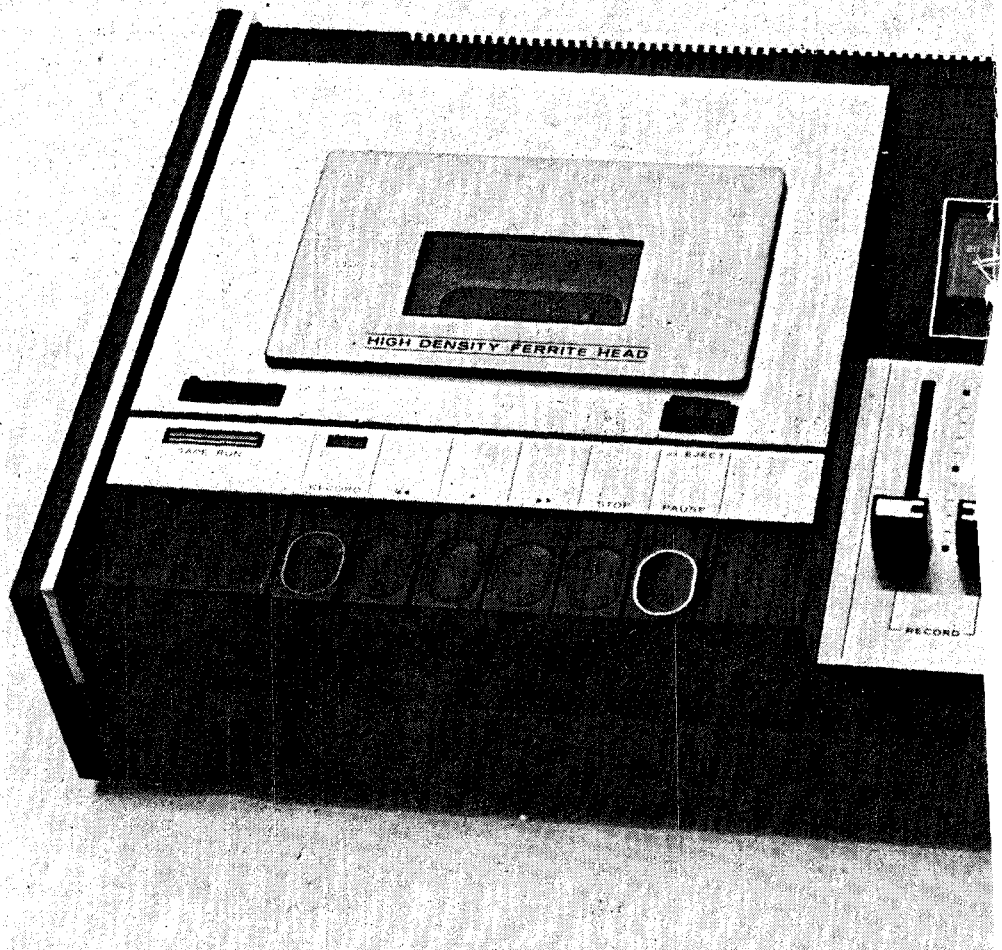

Dolby B) was subsequently developed by Dr. Dolby and this operates on the middle to high frequency part of the audio spectrum, thus removing the tape hiss inherent in the recording process. This system reduces noise by 3 dB at 600 Hz, by 6 dB at 1200 Hz and by 10 dB at 4000 Hz and above — where the ear is most sensitive to hiss.

Figure 1 shows the basic principle. In the recording mode, high level parts of the music being recorded are passed through the record Dolby circuits unchanged. By means of a level-sensitive 'threshold' circuit, low-level high-frequency signals are

boosted in level, to a degree dependent upon how low in level they are. The quietest high frequency signals are boosted the most, by as much as 10 dB. As the level of the high frequencies approaches OVU (that is — loud), the degree of boost becomes less and less. At OVU, there is no boost at all.

The resultant recording is now processed — or as it's often called 'Dolbyized'.

A similar principle is used for playback — but in the reverse direction. Now, the high level signals pass through the playback Dolby

# ION SYSTEMS

## -HOW THEY WORK

This 'new generation' TEAC cassette recorder has the Dolby system built-in (TEAC A-350)

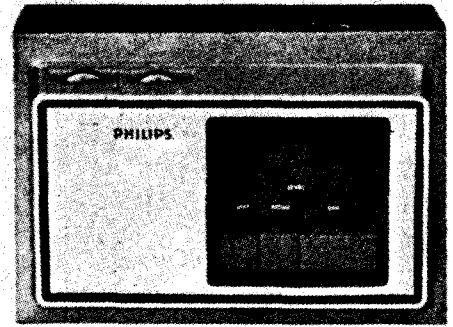

This is one version of the Philips dynamic noise limiting system — but most of these systems will be built-in. Philips are granting free licences to companies intending to use the system.

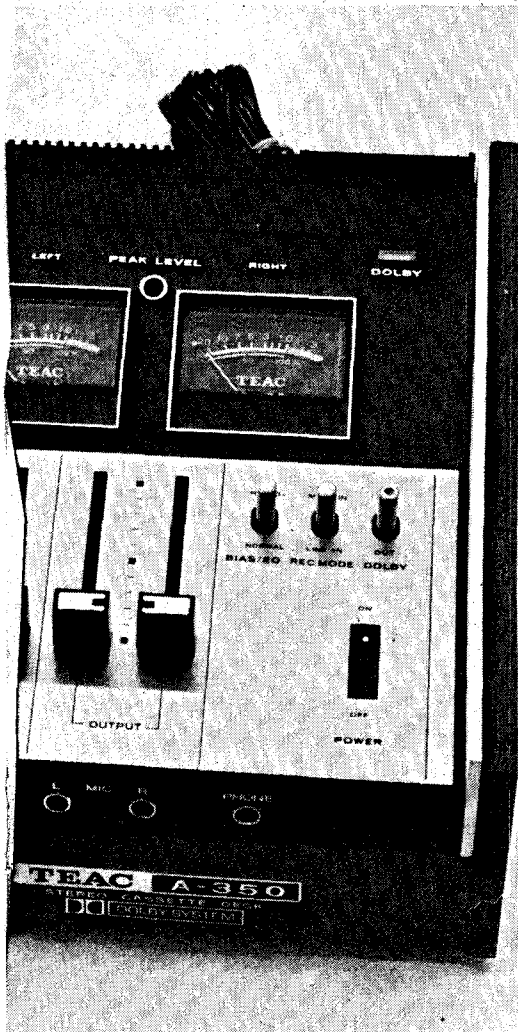

### HOW THE DOLBY SYSTEM WORKS

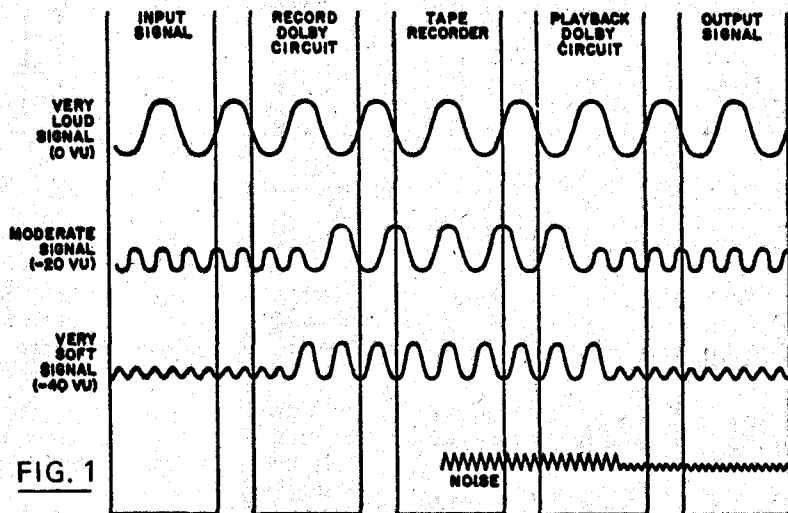

FIG. 1

circuit unchanged. The previously boosted low-level high-frequency signals are now lowered by precisely the same amount by which they had been boosted.

The tape hiss — which made its appearance between the record and playback halves of the Dolby system — is automatically lowered by a very substantial amount, effectively 10 dB (approx 90%). At the same time, because of the precise 'mirror image' playback action, the Dolby system causes no other change in the signal level relative to the original source that was recorded. It does not, as many

1. The signal being recorded passes through the record Dolby circuit *first*. The Dolby circuit operates on the higher ("hiss") frequencies in a predetermined manner, depending on their loudness level. The loudest signals (0vu) pass unaffected through the circuit. Signals of moderate intensity (-20vu) are boosted moderately, while the very soft signals (-40vu) receive maximum boost.

2. After being thus "Dolbyized," the signal is recorded onto the tape. It is at this point that tape hiss makes its appearance. You can see on the diagram how the record Dolby circuit's action has made the low-level signal louder than usual, relative to the tape hiss.

3. On playback, the signal from the tape is passed through the playback Dolby circuit, which is an exact "mirror-image" of the record Dolby circuit. The playback Dolby *lowers* the previously boosted parts of the signal, by precisely the same amount they had been boosted. The tape hiss — which made its appearance between the record and playback halves of the Dolby System — is automatically lowered at the same time by a very substantial amount, effectively 10 db or 90%. At the same time, because of the precise "mirror-image" playback action, the Dolby System causes no other change in the signal relative to the original source that was recorded.



# NOISE REDUCTION SYSTEMS

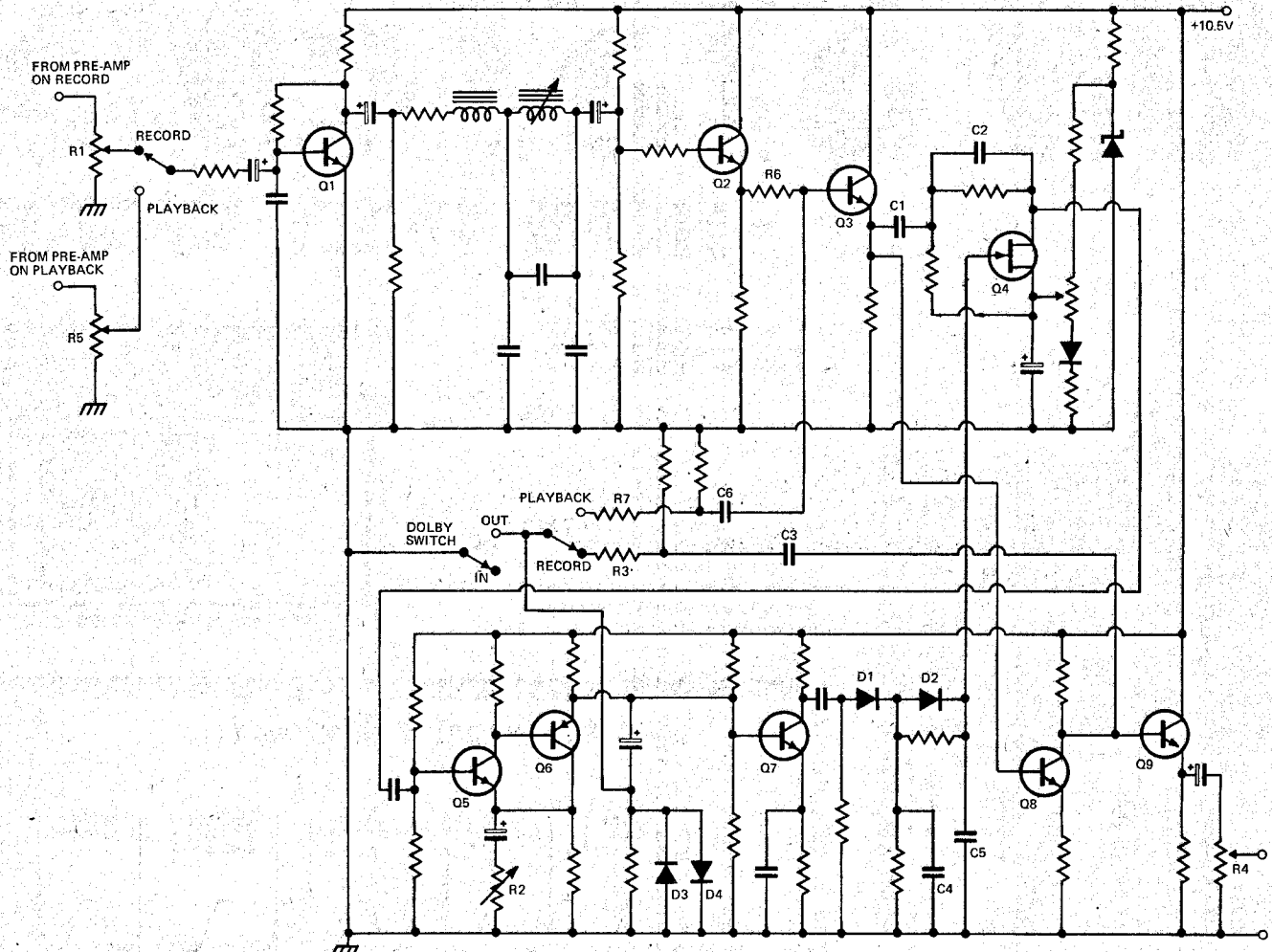

Fig. 2. This is the full circuit drawing of the Dolby system — shown in block schematic form in Fig. 3.

people think, reduce noise by cutting high frequencies.

## THE CIRCUIT DETAILS — DOLBY SYSTEM

A circuit diagram of the Dolby 'B' system — as installed in a current model cassette recorder — is shown in Fig. 2. A simplified block diagram of the system is shown in Fig. 3.

In the recording mode the incoming audio signal passes through the input attenuator R1 to the base of emitter-follower Q2 via a filter which removes any supersonic signals. This is necessary in countries that use FM stereo broadcasting as a very high frequency pilot tone is transmitted along with the audio signals. (Pilot tones or other supersonic signals or noise affect the Dolby noise reduction circuits).

Emitter-follower Q3 provides low impedance drive to the filter from which the noise reduced signal is derived. The filter consists of two high pass sections, the first consisting of C1 and a fixed resistor and the other being C2 and the field effect transistor

Q4. As the resistance of the field effect transistor depends on the dc level at its gate, the output will likewise depend on this voltage which is derived as follows: The output from the filter is amplified by Q5 and Q6 the gain of which is adjusted by R2 to limit the maximum amount of noise reduction signal available.

This signal is further amplified by Q7, whose collector is shunted by an RC network — this network provides approximately 30 dB of droop to prevent tape overload.

The signal from Q7 is integrated by D1 and C4, and then, on slowly varying signal levels, by a resistor and C5. On transients, the voltage across the resistor forward-biases D2 and this conducts, reducing C5's charging time constant. (The fast transient attack time is masked by the transient itself and is not noticed by the ear). The integrated signal is then used to control the effective impedance of Q4.

A second, unprocessed part of the input signal is taken from emitter-follower Q3 to the base of unity gain amplifier Z8. The output of

Q8 and the noise reduced signal from Q6 are in phase and these two signals are now summed by Q9, an emitter follower feeding the head drive amplifier via the record calibration preset.

The maximum level of the noise reduced signal component is limited on transients by diodes D3 and D4. This effect is again masked by the transient itself and is unnoticeable.

In the playback mode, exactly the same circuitry is utilized, but with some rearrangement of signal paths.

The signal from the playback pre-amplifier is filtered as for the record mode, and again appears at the emitter of Q2. Here it is summed with the signal component from the active filter via amplifier Q5 and Q6, resistor R7 and capacitor C6. This component is in antiphase to the input signal and hence reduces its amplitude. As the same filter and amplifier are used for record and playback, the result is an output signal identical in dynamic range to the original, but with reduced noise. The action of the filter and integrator stages is exactly the same in both modes.

To summarise, the difference between the two modes is that the two signals are summed (in phase) at the base of Q9 in record mode, and out of phase at the base of Q3, in the playback mode.

### THE PHILIPS SYSTEM

The Philips noise reduction system is somewhat less ambitious than the Dolby principle, and Philips openly admit that theirs will not enable true high fidelity sound to be obtained from cassette recorders.

It operates as a dynamic treble cut filter operating solely on playback. Unlike the Dolby system, no prior processing of the recording signal takes place and so the Philips unit can be used with most existing equipment simply by connecting it between the playback unit and the amplifier.

Whilst at first this progressive attenuation of all low level high-frequency material seems to be musically disastrous, Philips say that musical instruments played softly have a low harmonic content — most fundamentals being below the 4.5 kHz frequency at which the attenuation commences.

The circuit of the Philips system is shown in Fig. 4.

In this circuit transistor Q1 is a phase splitter which receives the replay signal. The phase-inverted signal from the collector of Q1 is passed, via a preset potentiometer, directly to the output of the unit. The in-phase signal from the emitter of Q1 is passed through a two-stage high-pass filter to the base of Q2 where the high frequencies *only* are amplified. Further amplification is provided by Q3 and Q4.

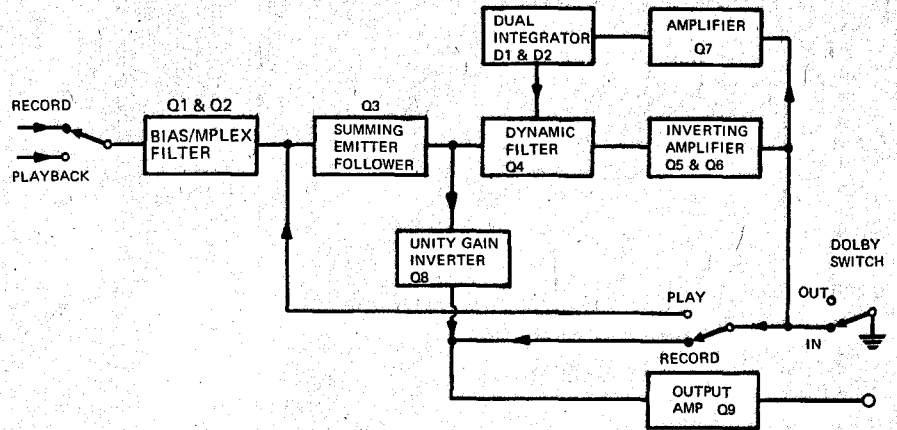

Fig. 3. Block schematic shows the operating principle of the Dolby (B) system.

Back-to-back diodes are connected, via a capacitor, between the base of Q3 and the emitter of Q4 to provide signal limiting, and to ensure fast decay of the compression performed by D3 and D4.

Transistor Q4 is also a phase splitter, and the signal from its collector feeds diodes D1 and D2 which respectively charge C4 (positively), and C5 (negatively). A potential therefore exists across diodes D4 and D3 that will cause them to conduct when the signal level reaches a specific value. When this happens, the junction of D3 and D4 will be effectively grounded by C4 and C5 in parallel. This prevents the high frequency component from the emitter of Q4 passing, via the 22k and 120k resistors, to the output. As this component is in antiphase with the output signal its presence would reduce the level of the high frequency signal component and hence noise.

The circuit does not operate on high level signals, which are passed through with a substantially flat frequency response, but only on those high

frequency signals below a certain threshold level.

Essentially, the circuit provides heavy attenuation of signal and noise for frequencies above 4.5 kHz that also fall below the threshold level. Philips claim that an effective signal-to-noise ratio improvement of 10 dB at 6 kHz and 20 dB at 10 kHz is obtained.

Overall gain of the circuit is unity, and this allows the unit to be inserted between playback devices (such as tape decks, record players etc.) and amplifiers of existing equipment with a minimum of change.

We have assembled this circuit in our laboratory and, subjectively at least, a substantial reduction of tape hiss could be immediately noticed. The input level to the Philips circuit must be at least 300 mV for satisfactory results. (The transistors specified in the circuit are not readily obtainable in Australia — however the following substitutes will almost certainly be satisfactory — Q1, BC 108B; Q2, BC 108B; Q3, BC 108C; Q4, BC 108B. ●

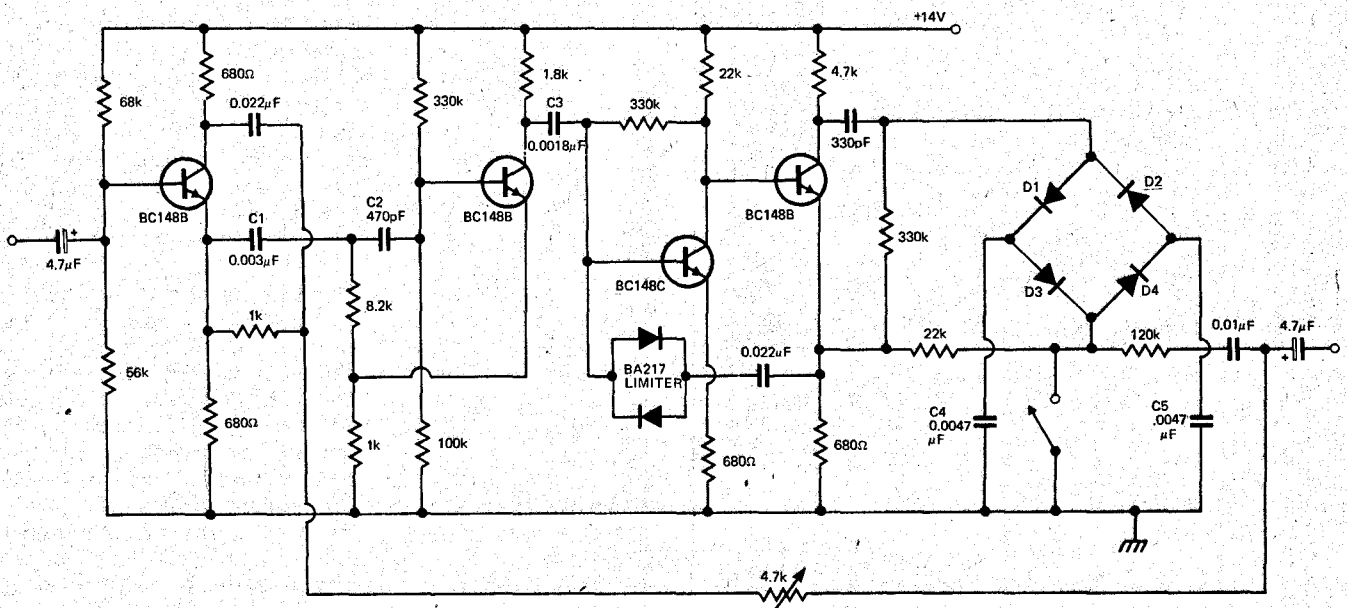

Fig. 4. This is the circuit diagram of the Philips' dynamic noise limiting system.

# TWO BATTERY

## ET PROJECT 511

These simple 'battery savers' will provide 9 volts at up to 250 mA.

*The 12 volt unit — before encapsulation.*

*Fig. 1. This shows a simple way of constructing the 12 volt version.*

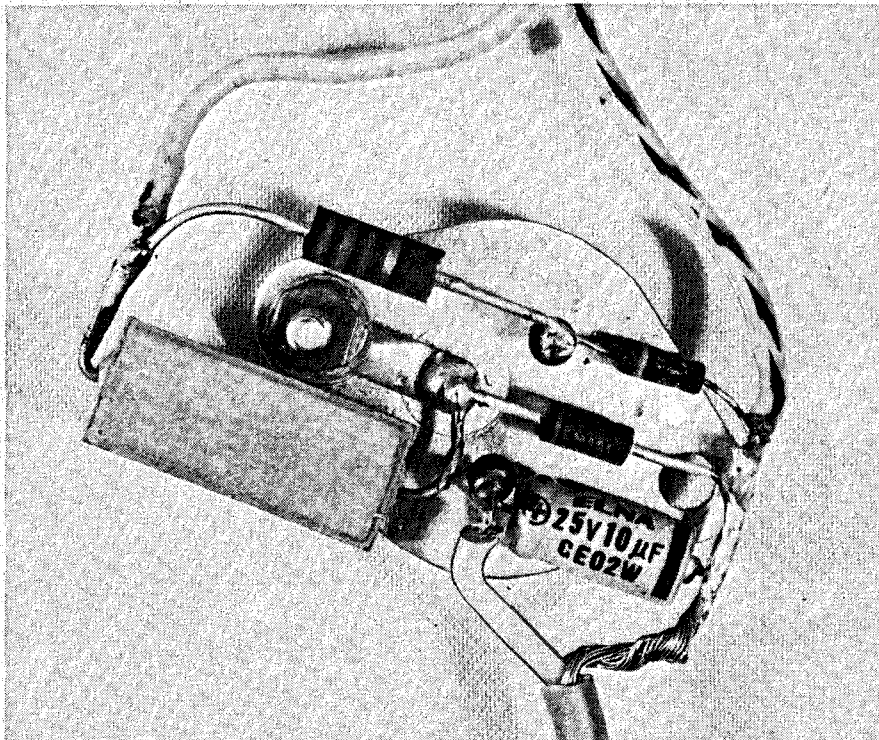

**M**ANY battery operated portable appliances are provided with a socket to enable them to be connected to a suitable external dc power supply.

This article describes the construction of two external power supplies, or 'battery savers', that may be used to energize many different types of tape recorders, record players, transistor radios, etc.

One unit is mains operated and is intended for use in the home — the second unit is intended for use in cars or trucks and operates from the vehicle's electrical system.

Both units are very simple to construct, provide adequate regulation and have sufficient power handling capacity to operate practically any small domestic (normally battery operated) appliance.

As the majority of battery operated appliances use a nine volt supply, both units described here have been designed for a nominal nine volt output. However for some purposes a six volt or a four and a half volt

# SAVERS

## POWER UNITS FOR BATTERY OPERATED APPLIANCES

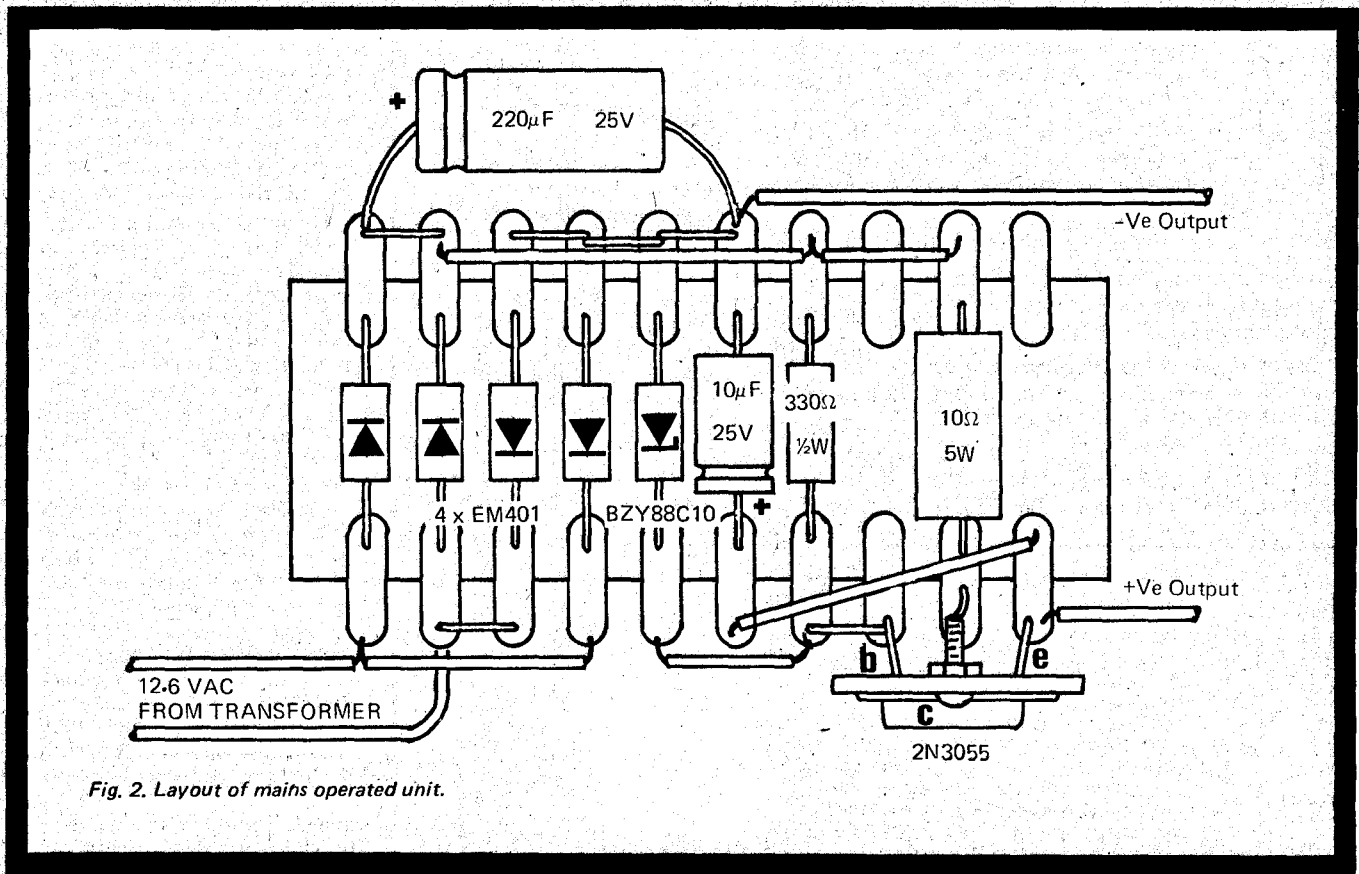

**PARTS LIST ET 511A**

**Twelve volt version**

- 1 - transistor, 2N 3055
- 1 - zener diode, BZY88C10
- 1 - diode, EM 401
- 1 - resistor, 10 ohm, 5 Watt, 10%
- 1 - resistor, 220 ohm, 1/2 Watt, 10%
- 1 - capacitor, 10µF, 25 volt electrolytic
- 1 - plastic box

Sundries, epoxy resin, cable, solder lug, plug.  
(Note, components quoted above are for nine volt output. See Table 1 for alternative output voltages)

TABLE 1

Output Volts	ZD1	R1 (12V) ohms	R1 (240V) ohms
9	BZY88C10	220	330
6	BZY88C6V8	470	680
4.5	BZY88C5V1	470	680

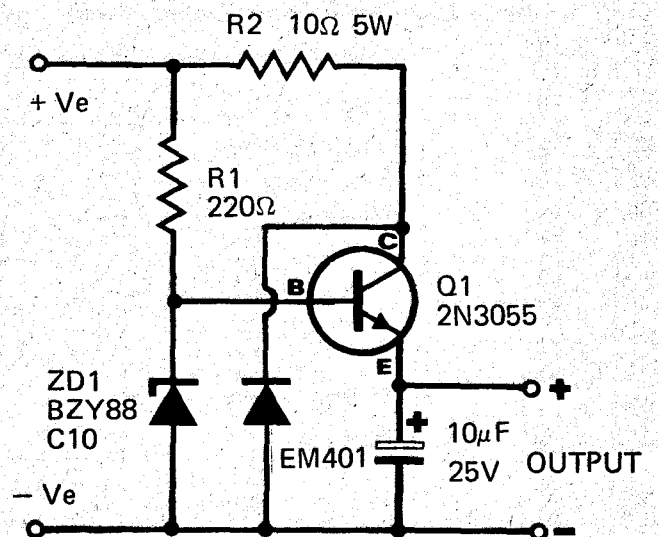

## TWO BATTERY-SAVERS

output may be required. This may be readily achieved by replacing the components ZD1 and R1 by those shown in Table 1.

### CONSTRUCTION

The 12 volt version has few components and the simplest method of construction is that shown in Fig. 1. As can be clearly seen, all components are soldered directly onto the power transistor.

After checking that it operates satisfactorily and that all joints are properly soldered, the complete unit may then be placed in a small plastic box and encapsulated in epoxy resin.

A cigarette lighter adaptor is fitted to the input lead and an appropriate power plug to the output.

The mains-operated version is larger than the simple 12 volt operated unit. This unit should be constructed using tag strips or matrix board.

A layout showing tag strip construction is shown in Fig 2. The

completed unit when finished, should be mounted in a suitable box.

### THE UNITS IN USE

Both units have been designed so that they will not be damaged if the output is accidentally short circuited. Nevertheless a continual short circuit must not be applied as this will cause excessive heat to be generated within the 10 ohm resistor.

If the appliance already has a socket for an external power supply this will almost certainly be of a type in which the plug cannot be accidentally shorted. If no socket is fitted then an external power supply socket should be installed. Standard plug/sockets for this purpose are readily available from most parts suppliers, but note that plugs/sockets intended for nine volt use are not interchangeable with those intended for six volt use — the centre pins are of different diameters.

The socket should be of the type which has a contact for disconnecting the internal battery when the power supply is plugged in. ●

### HOW THEY WORK

#### Twelve volt unit

Q1 is a 'series pass' transistor and drops the supply voltage to the required regulated output voltage.

The output of the transistor is controlled by the Zener diode ZD1. Resistor R1 supplies current for the correct operation of ZD1 and also provides base current for Q1.

The 10 ohm series resistor prevents damage to the transistor if the output of the unit is accidentally short circuited.

The EM 401 diode prevents reverse polarity of the supply voltage. If a polarized plug is fitted to your vehicle, this diode may be omitted. Again if there is no possibility at all of accidentally shorting the output — the 10 ohm resistor may be replaced by a link.

The 2N 3055 'series pass' transistor is much larger than required. We have specified this device as it provides very good overload capability and is readily available at low cost (under \$1.50 from many suppliers).

#### MAINS OPERATED UNIT

The mains operated version is complicated only by the addition of a power transformer, diode bridge, and a smoothing capacitor. The EM 401 diode used to protect against reverse polarity is obviously not required. Operation is otherwise as described above.

### PARTS LIST ET 511B

#### Mains operated version

- 1 — transformer, 240 volt to 12.6 volts (100 mA minimum)
  - 1 — transistor, 2N 3055
  - 1 — zener diode, BZY88C10
  - 4 — diodes, EM 401
  - 1 — resistor, 10 ohm, 5 Watt, 10%
  - 1 — resistor, 330 ohm ½ Watt, 10%
  - 1 — capacitor, 10 $\mu$ F, 25 volt electrolytic
  - 1 — capacitor, 220 $\mu$ F, 25 volt, electrolytic
- Sundries, plug, tag strips, cable, solder lug etc.  
(Note, components quoted above are for nine volt output. See Table 1 for alternative output voltages)

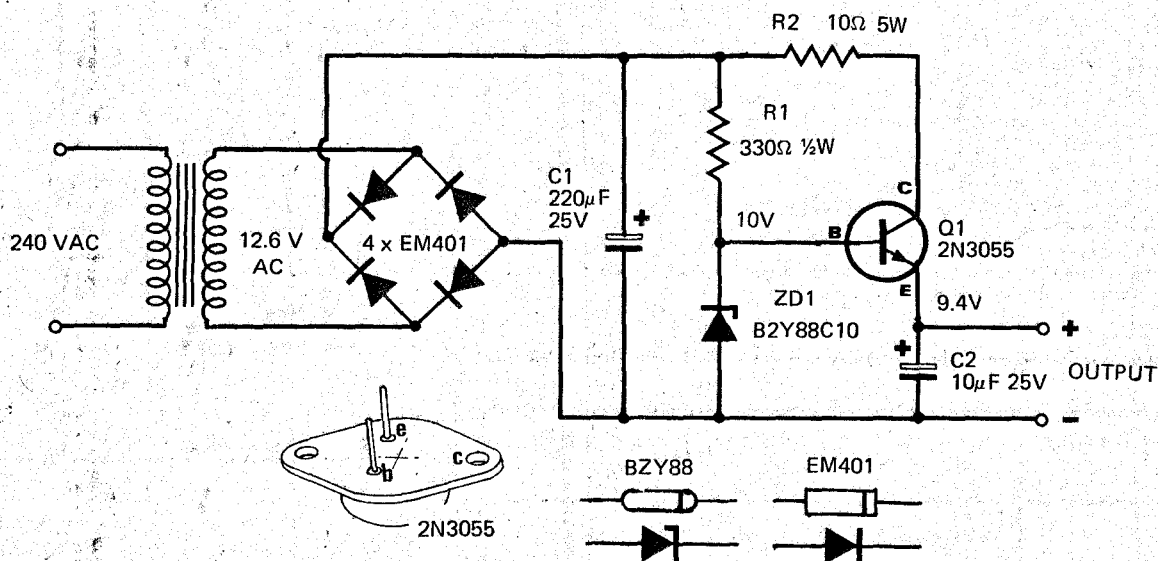

Fig. 4. Circuit diagram of mains operated unit.



### SONATA

#### All silicone solid-state Hi Fi Stereo Amplifier Model NS-1600D

10 watts R.M.S. per channel. Each channel has separate bass/Treble controls.

Inputs for magnetic or ceramic cartridge, crystal mic., radio, tape — tapeout stereo headphones. 8-16 ohms. Instruction booklet, circuit supplied. Timber cabinet. Dimensions: 14½" x 8" x 4". Price \$67.50. Pack & Post \$1.50. Interstate \$2.50.

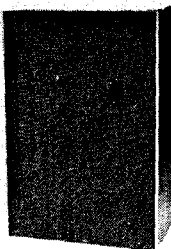

### NEW MAGNAVOX 8-30 SPEAKER SYSTEM

1.6 c. ft. 8 ohms and 15 ohms. Oiled Teak Formica Veneer.

Complete, ready for use ..... \$60.00  
8-30 speaker only ..... \$18.50  
3TC Tweeter Only ..... \$3.65.  
Fully built Cabinet only ..... \$35.00

### STEREO RECORD PLAYER

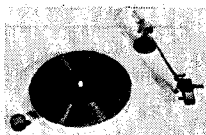

240V AC operation. Chromed tubular metal 9" tone arm with adjustable counter balance and rest — ceramic cartridge, sapphire stylus. 4-speed motor and 6½" metal turntable with mat. \$7.90 — post 50c. Mounting platform 15" x 11" x 2½" with cut-out to suit above record player. \$5.50 — post 50c.

### STEREO RECORD CHANGER

C116 — C117 — C117A3

Current models, 4 speeds, automatic or manual operation. Deluxe model with 12in turntable. Cueing device, Ceramic cartridge, Diamond Stylus ..... \$40.00  
Deluxe model as above with — adjustable counter balance, 2 spindles, calibrated stylus pressure control added ..... \$46.50  
Deluxe model as above with 12in. Diecast Heavyweight Turntable, 4-pole Shielded motor. Suitable for magnetic cartridge ..... \$56.50



Model C117 and C117A3 can be supplied with Magnetic Cartridge and Diamond Stylus at \$10.00 extra.

Pre-cut Mounting Platforms are available to suit Changers ..... Price \$9.00  
Also Fully Moulded Smoke Tinted Perspec Covers ..... Price \$9.00



### P.A. AMPLIFIERS



Two Hi-Imp inputs with independent volume controls. For mixing either microphones or P.U. bass/treble tone control.

Available with multi-tapped voice coil matchings (2,3,7,8,15 ohms) OR multi-tapped line matchings (66, 125, 250, 500 ohms). On ordering please indicate impedance matching required. 15 watts R.M.S. V-C matchings — \$49.50

15 watts R.M.S. Line matchings — \$53.50

30 watts R.M.S. Line — VC — \$59.50

240 VAC operation. From stock we have a full range of P.A. accessories available.

Low loss shielded mic., cable — \$10.00 per 100 yds.

Twin speaker flex — \$4.50 per 100 yds.

Floor model mic., stand — \$11.75

Table model mic., stand — \$3.50

Goose Necks — \$4.00

8" Spk., ceiling mounts \$6.75

8" P.A. speaker and projection flare — \$16.25

600/15 line transformers — \$3.00

Top quality Hi-Imp mic., — \$12.95

### ROTATING DISTRESS EMERGENCY BEAM

Red, Blue, Amber — Visibility ½ mile.

12V D.C. operation, Waterproof. Complete with heavy duty suction Cap. Size 3½in. dia. x 5½in. \$5.75.

Pack and Post. 35c.



### BATTERY SAVERS

240 vac operator approved. Suitable for operating battery operated transistor radios, cassette and tape recorders, etc.

6-9 V dc .1 amp ..... \$9.35

6-9 V dc .3 amp ..... \$14.35

4½-6-7½-9-12V ½ amp Regulated and protected ..... \$26.50.

Pack & Post 75c.

### THE NEW BSR RECORD PLAYER

Automatic or manual operation. Latest modern style square section brushed aluminium tone arm — fully counter-balanced with calibrated stylus pressure control — anti-skate bias compensator — silicone damped cueing device — lightweight head shell takes any type magnetic cartridge. 11" diecast turntable — dynamically balanced 4 pole motor fitted with click & noise suppressor. Finish — Satin black with brushed aluminium trim. Available with ceramic cartridge and diamond stylus \$54.75. Or Magnetic cartridge and diamond stylus \$62.50.

Pack & Post \$1.50.

### MAGNAVOX WIDE RANGE FREQUENCY RESPONSE TWIN CONE SPEAKERS, 8 or 16 ohms.

30 — 16000 Hz.

6WR Mk.V 12 watts RMS \$ 9.90

8WR Mk.V 16 " " \$10.75

10WR Mk.1V 16 " " \$11.50

12WR Mk.1V 16 " " \$12.50

Pack & Post 65c. Send S.A.E. for Data Sheet.

### PANEL METERS



Clear Plastic, Flush Mounting. Full range available. From 50uA 10A — DC, 15 VDC, 500 VDC, 300 VAC, VU and 5.

### ALSO EDMETERS

VU — Stereo Balance. Send for price list, S.A.E.



### SOLDERING IRON

Lightweight — 2½ ozs. 240V A.C. Operation. No transformer required. Heating time 1.8 secs. 30 watts. \$7.50 — pp 35c.

# WORLD SCOOP TEST REPORT



**electronics**  
TODAY  
**product test**

Ferrograph's Model 7 HD is the first reel-to-reel tape recorder to incorporate the Dolby Noise Reduction System. Here is the first test report — to be published anywhere in the world — on this superb new machine.

**F**ERROGRAPH have gained a 'first' with the recent introduction of their Series 7 recorders incorporating the Dolby B Noise Reduction System.

This unit is, to the best of our knowledge, the *only* reel-to-reel recorder that has the Dolby B system built-in.

Except for the Dolby trade mark on the hinge-down flap at the bottom of the unit, and a black anodized aluminium cover over the tape-heads, the external appearance is similar to the Ferrograph Series 7 D tape recorder (reviewed in our December issue).

But other differences became apparent when we checked out the control facilities to perform our subjective evaluation and laboratory measurements. For the 7HD has been improved in a number of areas compared with the standard Series 7 and not just by the inclusion of the Dolby system. Two of the more important of these improvements are described later in this review.

The recorder is housed in a timber cabinet covered in dark grey vinyl. The top half of the deck is finished in a dark grey vinyl-coated steel and the unit has a detachable lid cunningly held on by two slide catches next to

# FIRST FOR FERROGRAPH

# FERROGRAPH

## FERROGRAPH MODEL 7HD DOLBY TAPE RECORDER

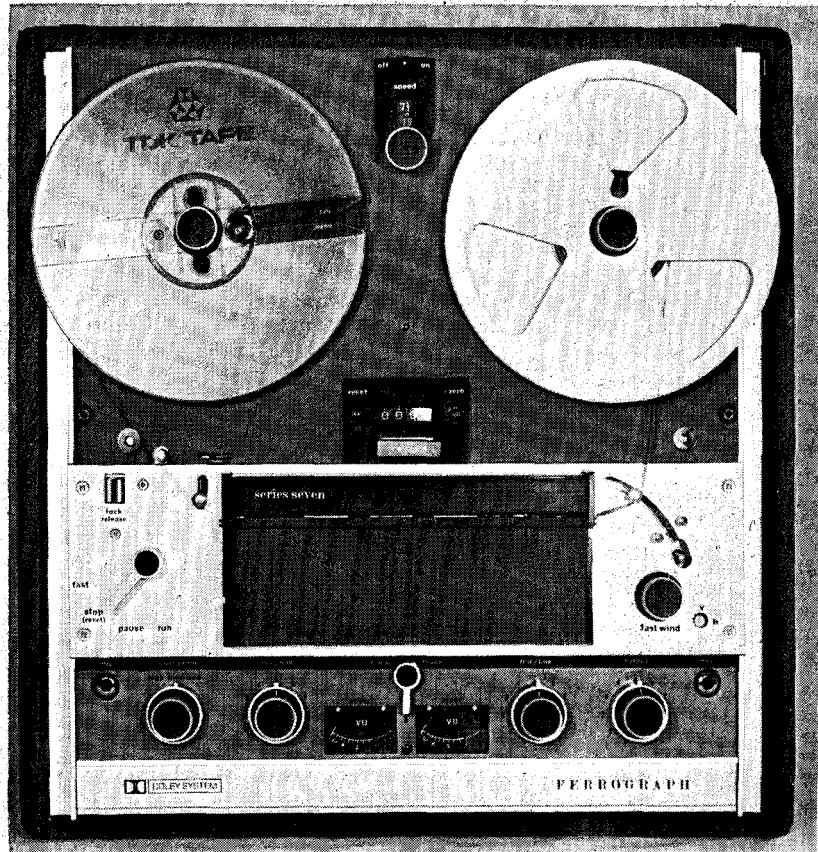
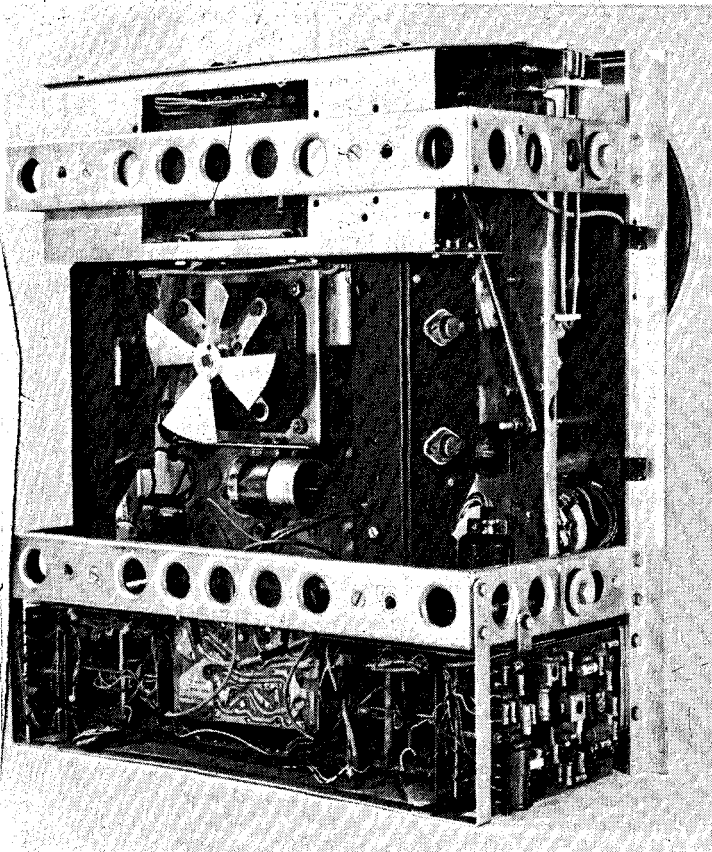

the carrying handle. But as this recorder weighs 49 lbs few would want to carry it very far.

### CONTROL FUNCTIONS

The power on/off rotary switch and speed selector switch are centrally located at the top of the front panel between the two tape spools. The record button and turn counter are centrally located at the bottom of this panel. On the previous Series 7 the record button could be depressed at any time during playback; not so with this unit. A small inconspicuous interlock is located to the left of the record button and this must be

operated before the record button can be depressed.

A further three, horizontally separated, panels contain the mixing and operating controls.

The centre panel contains the heads (located under a large black anodized aluminium cover), a function switch with fast forward lock at the left hand end, and the fast forward or reverse control knob at the right hand end.

The function switch has four positions, these are, fast, off, pause, and run. Once the fast position has been selected it is not possible to switch through stop to the pause or

run mode without operating the interlock.

In the fast position the forward or reverse speed is steplessly variable — by turning the control knob clockwise or anticlockwise. This knob controls the power fed to each reel motor by varying the voltage to each, and thereby determining the direction of travel and speed of the tape. This arrangement provides extremely accurate cueing by making it possible to 'inch' up to any point on the tape from either direction.

The next panel, below the heads, contains two extremely accurate VU meters, centrally located, with a three



Copenhagen



Measuring Obj.:  
FREQUENCY  
RESPONSE OF  
FERROGRAPH  
MODEL No.  
722 HD tape  
RECORDER  
1 Decibel  
per Division  
recordings  
displaced  
for clarity

Rec. No.:  
Date: 24-12-71  
Sign.:

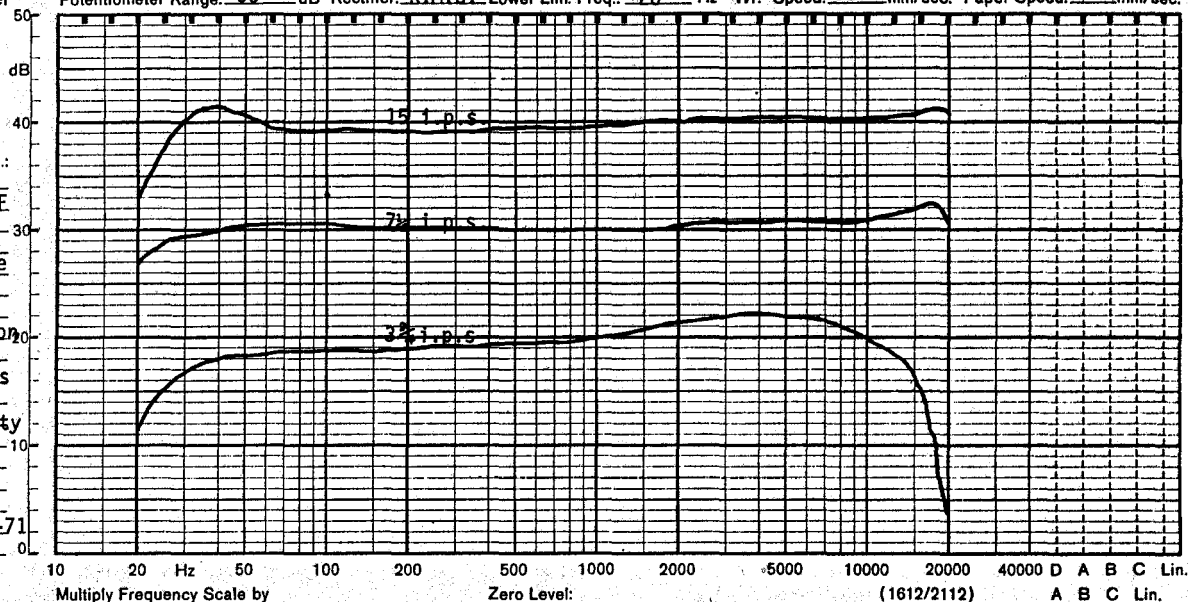

QP 1124

Multiply Frequency Scale by

Zero Level:

(1612/2112)

A B C Lin.

## FIRST FOR FERROGRAPH

position switch mounted above them for selection of upper or lower channel record mode, or stereo record mode. The left hand end contains the upper channel 'tip and sleeve' type microphone input, the equalization selector switch and the upper channel concentric line and microphone input level controls.

The separate equalization control appears to be an unnecessary complication, as the inclusion of a fault relay makes it impossible to select the wrong equalization for a given speed anyway. Surely this function could have been incorporated as part of the speed selector knob?

The right hand end of this panel contains the lower channel 'tip and sleeve' microphone input, the concentric line and microphone input level controls, and the concentric output level controls. The output level controls are associated with the monitor amplifiers and only affect the level of signal fed to the monitor speakers or remote speakers.

A large array of switches and control knobs are located behind a hinge-down flap at the bottom of the deck. These controls are, from left to right:—

- a) Upper channel output select switch with two positions, namely, tape or source.
- b) M.P.X. switch which switches in a filter to tune out the carrier frequency when recording F.M. broadcasts with the Dolby noise reduction 'on'.
- c) Upper channel bass control with calibrated boost and cut positions.
- d) Upper channel tape level adjusting

- e) Upper channel treble control with calibrated boost and cut positions.
- f) Upper channel bias potentiometer — located behind a screwdriver access hole.
- g) Three position meter mode switch which switches both meters to output source, or bias level indicating modes.
- h) Transfer switch with three positions for upper to lower channel transfer, off, or lower to upper channel transfer.
- i) Lower channel bias potentiometer — located behind a screwdriver access hole.
- j) Lower channel treble control with calibrated boost and cut position.
- k) Lower channel tape level adjusting potentiometer — located behind a screwdriver access hole.
- l) Lower channel bass control with calibrated boost and cut position.

- m) Three position noise reduction switch. In the first position the Dolby 'B' record and playback circuits are switched in so that the tape being 'Dolbyized' can be monitored in the fully processed form. In the middle position, only the playback Dolby circuit is used so the previously 'Dolbyized' source material may be recorded and monitored with correct equalisation. In the third position the Dolby noise reduction circuits are switched out and the recorder functions as a standard tape recorder.
- n) Lower channel output select switch with two positions, namely tape or source.

The adjusting potentiometers described in (d) and (k) above, make it possible to adjust the monitored signal of a tape to the same level as the source signal level. This is to correct for different tape sensitivities.

### FERROGRAPH MODEL 722HD SERIAL No. 81658

	3 3/4 ips	7 1/2 ips	15 ips
Record to replay frequency response (with Scotch 203 tape at OVU)	30Hz - 15kHz ±3dB	20Hz - 20kHz ±3dB	25Hz - 20kHz ±2dB
Total harmonic distortion at 1kHz (OVU)	2%	2%	2%
Intermodulation distortion (1kHz & 960Hz at OVU)	2%	2%	2%
Signal/noise ratio at OVU & 1kHz	55dB	56dB	57dB
Erase ratio for 1kHz signal (pre-recorded at OVU)	— better than 74dB		
Cross talk at OVU			
100Hz	47dB	47dB	47dB
1kHz	46dB	46dB	46dB
Wow & flutter	0.06% rms	0.12% rms	0.15% rms
Line input sensitivity (for OVU)	—	50mV	—
Microphone input sensitivity (for OVU)	—	300µV	—
Line input sensitivity (for OVU signal level)	—	300mV	—
Main amplifier power output	—	10 Watts continuous power/channel into 8 ohm load	
Frequency response (of main amplifier)	—	20Hz - 20kHz ±0.5dB	
Suggested retail price	—	\$1122 (model 722HD)	
	—	\$1173 (model 724HD)	

All input and output sockets are located on a recessed panel located under a hinged flap adjacent to the carrying handle in the top of the timber housing. These sockets include line inputs, low level outputs, 600 ohm outputs, and 8-16 ohm speaker outputs for the upper and lower channels — all utilizing tip and sleeve jacks.

The versatility of the recorder has been increased by the inclusion of a seven-pin DIN socket providing the following facilities:—

- a) Remote stop/start, with the recorder in the pause position.
- b) Fifty volt dc supply for driving auxiliary equipment.
- c) Low level outputs.
- d) Six hundred ohm outputs.

Three fuses are also located on this panel. One fuse is in the main supply and the other two fuses protect each amplifier output stage. A miniature three-pin power socket (of English design) is also located on this panel.

### INBUILT AMPLIFIERS

The Series 7 HD recorders are obtainable with full-track, half-track or quarter-track, mono or stereo channels and with or without power amplifiers. All versions are fitted with separate record, playback and erase heads with independent record and playback amplifiers.

The version that we tested was the half-track high speed model with 3 3/4 ips, 7 1/2 ips, and 15 ips tape speeds.

We believe that *all* tape recorders (as opposed to tape decks) should have internal amplifiers with at least six watts continuous power rating.

Ferrograph's incorporation of two 10 Watt amplifiers (when specified) is sensible, and the addition of good quality external speakers converts this recorder into a high quality tape recording system suitable for high quality sound reproduction in the home or even a small hall.

### HOW IT PERFORMED

Two important improvements are apparent when the new Series 7 HD unit is compared with the standard Series 7 recorder that we reviewed in our December issue — the first of these is a dramatic reduction in the level of operational (mechanical) noise. The Series 7 HD unit is at least 12 dB ('A' scale) quieter than the standard Series 7 recorder.

A second worthwhile improvement is the provision of rubber inserts in the tape hubs.

During subjective tests we were once again impressed by the quality of reproduction of Ferrograph recorders. In fact only at the lower speeds or at very low signal levels was the improvement from the Dolby unit

really noticeable. But we suspect that on old or cheap tapes, the improvement in signal to noise ratio offered by the Dolby system would be a very worthwhile feature.

The provision of simultaneously useable Dolby Noise Reduction circuits on both record and playback modes is an unusual feature. All the Dolby units we have seen previously have been intended to be used firstly in the record mode, and then subsequently in the playback mode. This is done to save money, but the Ferrograph is in no way a cut-price unit. By providing four Dolby units, permanently wired in either the record or playback mode, off-tape monitoring can still be performed on the Dolbyized Ferrograph without the loss of high frequency low level components.

The specification laid down by Dolby Laboratories to its licencees appears to be a tolerance of better than 1 dB between two Dolby units. The record and playback units in the Ferrograph recorder are sufficiently matched to give a record to replay performance which is within 0.1dB of the non-Dolbyized response at all frequencies and levels. Ferrograph have made this significant technical achievement by using precision components.

We have previously commented on the ease of using 'built-in' Dolby units over 'add-on' Dolby units. As the Ferrograph has been designed to perform all its functions with the Dolby system incorporated... we suspect that the average user will probably switch the recorder to 'Dolby in' and forget the switch for ever more, unless playing non-Dolbyized tapes.

### FM BROADCAST RECORDING

Recent experiments in the USA have

shown that the signal-noise ratio and effective coverage of FM broadcasting systems can be considerably enhanced by the inclusion of the Dolby noise reduction system. For those younger purchasers who may yet live to see the day when Dolbyized FM stereo multiplex broadcasting is used in Australia, this machine has a switch position to enable such a signal to be recorded directly on the tape, and then be monitored directly off the tape with the correct Dolby processing. In the meantime this facility has its uses for transcribing 'Dolbyized' tapes without reprocessing.

Our only real criticism of the recorder — concerns the automatic shut-off system. On the unit tested the automatic braking at the end of a 7" reel was so violent that it resulted in the end of the tape slipping down into the space between the wound tape and its supporting reel. Whilst this may be an isolated example of this phenomena we feel that Ferrograph's quality control should not allow a machine with a fault of this type to leave the factory.

Nevertheless — the Ferrograph Series 7 HD is the finest Ferrograph recorder that we have yet seen and one of the finest AM recorders available in the world today.

The performance of the unit that we tested was impeccable. Material recorded from other sources was indistinguishable in every way from the original.

The price of over \$1100 may deter many intending purchasers, but for those who can afford it, this must be one of the best, possibly even *the* best professional-quality tape recorder yet made. ●

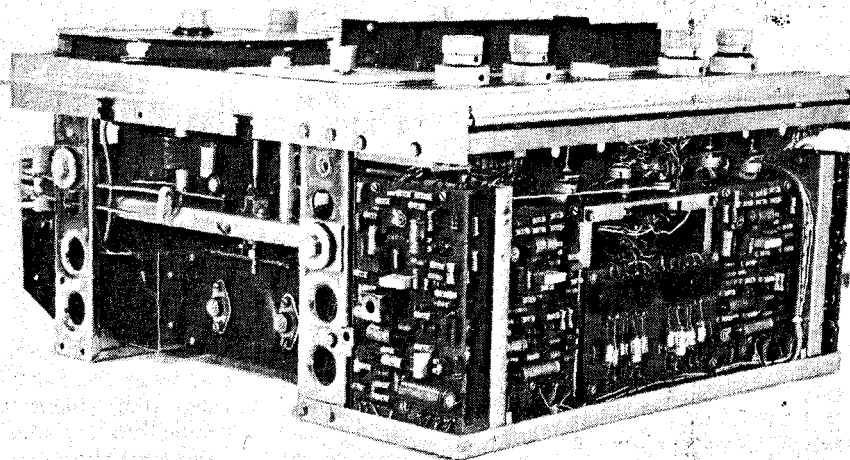

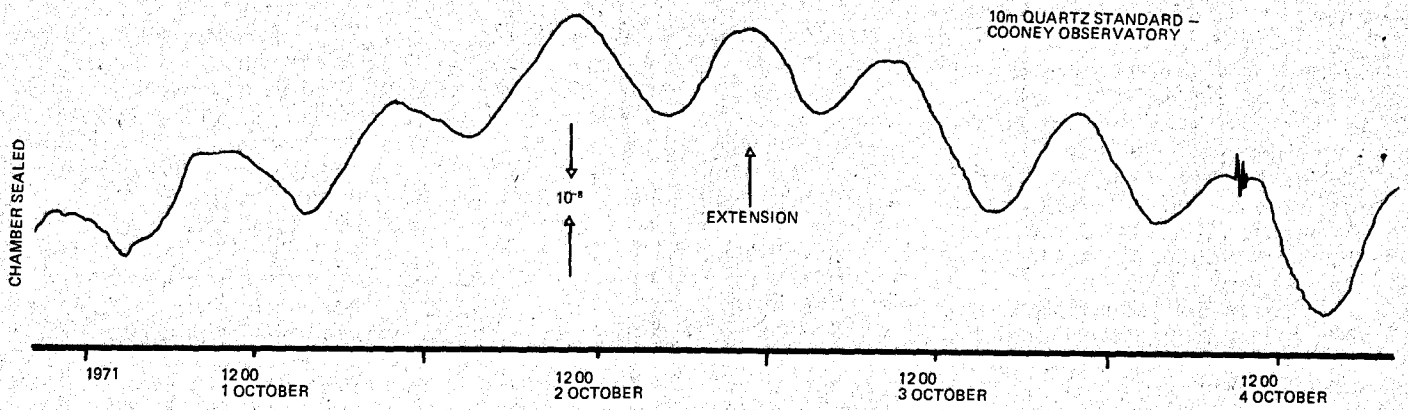

Fig. 1. Tidal strain curve as produced by quartz-tube extensometer located in the Cooney Observatory in the New England area of NSW.

by  
Associate Professor  
Ronald Green and Dr. Peter  
Sydenham, Department  
of Geophysics, University  
of New England,  
Armidale, N.S.W.

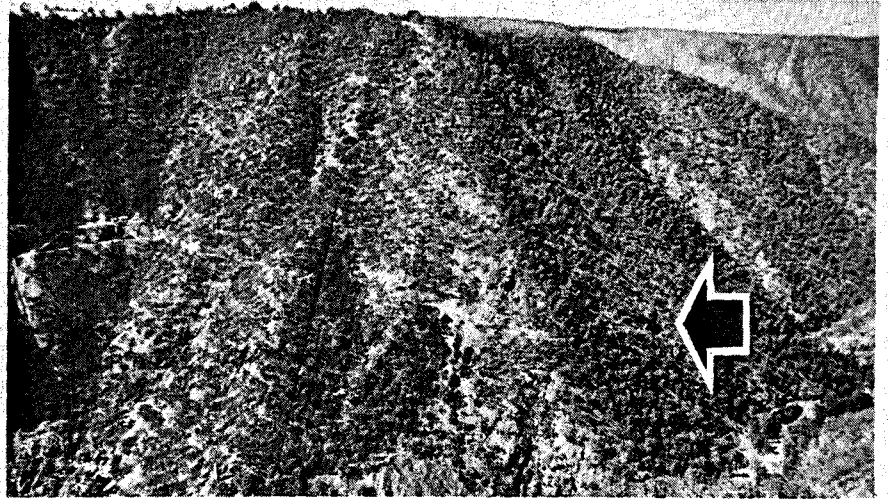

Fig. 2. Looking across the Hillgrove Gorge toward the Observatory entrance which is arrowed near the bottom on the right.

# FINE MEASUREMENT IN GEOPHYSICS

**N**OT only the atmosphere and the oceans but the entire globe itself is continually changing shape due to the varying gravitational pull exerted by the Moon and Sun on the Earth.

Earthquakes and large explosions also set the Earth in vibrational motion as the released energy is slowly dissipated over a period of several days. The amplitude of the movements is usually too small to see visually but with extremely sensitive instruments the changes in the shape of the Earth are clearly demonstrated. It is geophysicists who are concerned with this phenomena.

## THE ROLE OF INSTRUMENTATION

Common to all aspects of geophysics (and indeed to all human activity) is the need to measure in order to provide quantitative facts for theories, for forming new theories to explain observed facts and for monitoring or improving a known process.

In particular, the task of gaining fundamental knowledge of the Earth continually requires the highest possible levels of detection and the greatest stability from instruments.

But instrumentation is more than the intercoupling of standard electronic

black-boxes — it is a scientifically based creative art in which, in the main, electronic, mechanical optical and chemical processes are intermixed to change the original form of the one or more variables of interest into a converted (transduced is the technical term) equivalent form that is more appropriate for recording or control purposes. The best solution comes from careful selection of all available techniques — not merely from the tools of one discipline.

In geophysics, especially, consideration must be given to the noise present in a measurement (the

term is used here in its most general sense to mean any unwanted and unpredictable disturbance and is not restricted to electrical signal disturbances). For example, a stray magnetic field would perturb the motion of a pendulum of a precision clock. The effect may be reduced to a satisfactory level by using non-magnetic construction. That is a simple remedy but as precision increases, unwanted effects appear at an alarming rate. A very good example of this occurred in an experiment to measure the force of gravity with extreme precision.

In this experiment a precisely calibrated ruler with distance marks at each end was released to fall past a photo-electric sensor, the whole operating in vacuum. The time taken for the two marks to pass enables the gravitational constant to be determined in relation to the time and length standards. It was found that precision was limited by length oscillations of the scale as it fell. The ruler altered length once it was released for it no longer had to support its own weight. The effect was minute but so was the precision required — parts in 100/million.

It is the relative magnitude of signal resolution and noise disturbance levels that matters, not the absolute level.

### CRUSTAL MOVEMENTS

No material known to man is perfectly rigid; the Earth is certainly no exception. As it rotates around the Sun, and the Moon around it, the gravitational attraction between the three bodies varies due to changing orbital separations. This continually changing attraction produces sea tides which are familiar to all. It also produces the less obvious, minute changes in the shape of the elastic

*The optimum solution to many problems of instrumentation involve the combined efforts of many engineering disciplines.*

Earth — the surface bulges out at the point of maximum attraction. Earthquakes and large explosions also cause the Earth's crust to change shape in an oscillatory manner.

Three main effects can be measured in the surface. Firstly, the crust is strained as it bulges in and out. This effect has a maximum amplitude of a few parts in 100 million. In tangible terms, a 10 metre length of rock slowly increases in length by up to 300 nanometres ( $300 \times 10^{-9} \text{m}$ ) (12 millionths of an inch in a 33 foot distance) and then returns to zero. This cycle has a period of approximately 12 hours as seen from a recent record shown in Fig. 1. The maximum velocity of this movement is such that it would take a million days (2740 years) to cover a metre if the maximum rate of movement continued in one direction.

A second effect is that as the Earth's shape changes, the relative movements of mass causes changes in both the direction and magnitude of the local gravity field. A freely hanging plumb-bob on the surface will, therefore, change its inclination by a small amount. This tilt variation also follows the strain curves in its general form. It is a very small effect. A deflection of six inches over the distance from Sydney to Melbourne is the angle involved.

The point of measurement on the surface is raised and lowered with respect to the position of the centre of mass of the Earth. This effect added to changing gravitational pull exerted directly by the Moon and Sun

produces variations in gravitational pull which can be measured with a continuously recording, highly sensitive, tidal gravity meter. (Readers will remember an article in the September issue of *ELECTRONICS TODAY* by Professor Jones, where he described the work on fine geophysical measurement at Aberdeen in Scotland). The change in weight due to tidal causes is like adding a one-cent piece to a 21 ton block (a steel block would be five feet cube).

### THE COONEY UNDERGROUND TIDAL OBSERVATORY

Solid-tidal strain and tilt effects cannot be satisfactorily measured on top of the ground as the surface undergoes dimensional changes caused by exposure to the weather elements. For example, a submerged wall in the basement of our Geology building changes length by several parts per million as a court-yard above is cyclically exposed to the sun. This swamps tidal strain. Best measurements are made at depths of 100 metres or more where ground cover acts as an insulator to average-out surface effects to virtually zero. (Tidal gravity can be measured on the surface but underground operation eases the instrument construction considerably.) For large-scale observatory operations in this field of measurements it is essential to move underground. It is, however, not an easy matter to locate a suitable underground tunnel complex. It must be deep in the

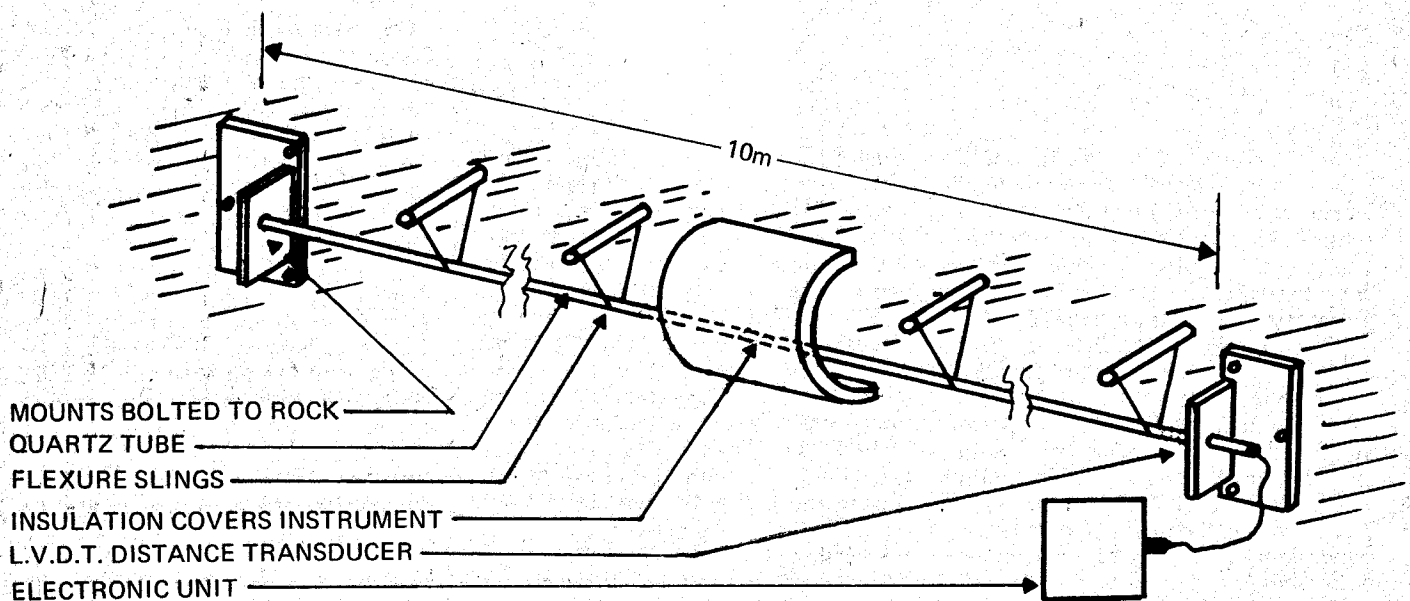

Fig. 3 (a). Schematic view of the Cooney quartz strainmeter.

# FINE MEASUREMENT IN GEOPHYSICS

Figure 3 (b). Layout of a laser interferometer extensometer.

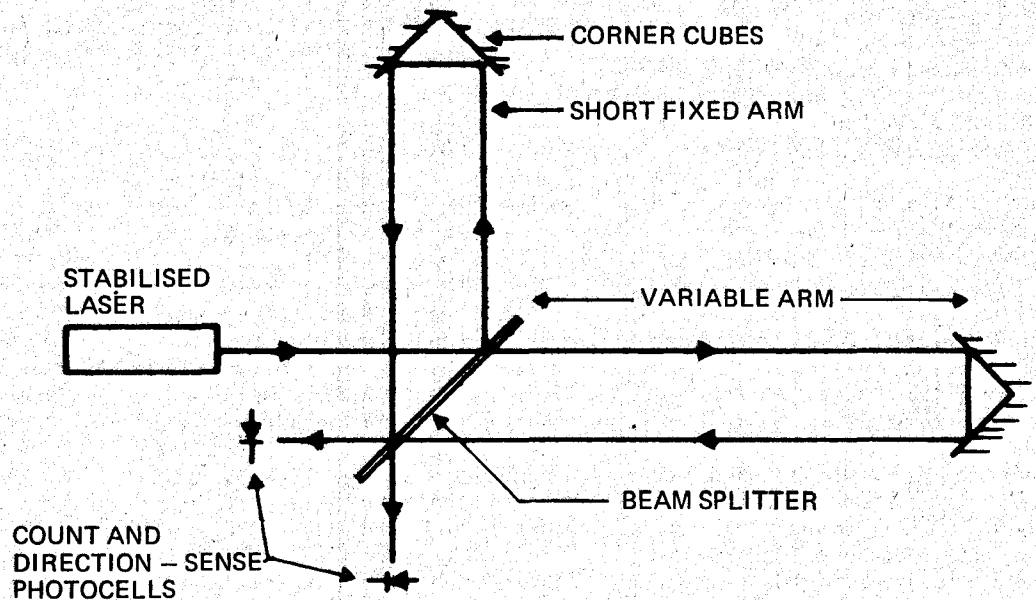
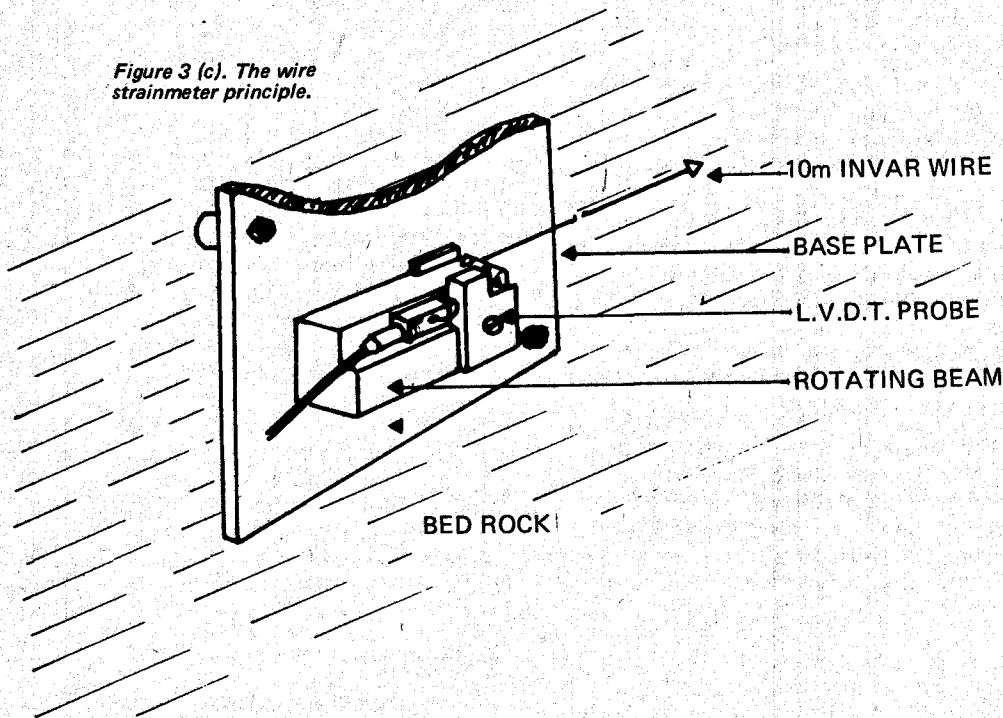

Figure 3 (c). The wire strainmeter principle.



ground, yet easy to get to; it should have mains electricity with good voltage stability; it must not be close to the sea as sea-loading effects modify the strains and tilts; it should not be close to a city as cultural noise can be a problem yet it should be near to the institution operating it. Dryness, or at least, absence of freely running water, is also highly desirable. In order to measure the three components of strain, two perpendicular tunnels in the horizontal plane are needed with one in the vertical direction. Finally, a newly made tunnel will not be as dimensionally stable as one made naturally.

Hillgrove is a small community some 25 miles from Armidale in the New

England area some 350 miles northwest of Sydney. In the late 19th century, Hillgrove was booming: it was larger than (the then) Armidale, had several hotels and 3000 inhabitants who were there to seek gold and antimony. After a feverish 17 years it declined as rapidly as it had grown. Our heritage from this period is numerous shafts, drives and chambers that were driven into the sides of the Bakers Creek Gorge.

In 1969 two tunnels, known as the Upper and Lower Cooney drives were selected by this Department for conversion into the first Southern Hemisphere earth-tide observatory. The upper tunnel (see Figure 2) is 180 metres long and has passages and

niches leading off it. The first 30 m of tunnel has been fitted out as an observers' chamber. Chart recorders, recording instrument-outputs can be placed here as the environment is less humid than deeper in. Benches are provided for on-site repair and servicing of equipment. This area also houses the terminal used to send signals from instruments to the gorge top for transmission by VHF radio back to the Department.

The tunnels are divided into chambers with brick walls to provide areas isolated from each other. Chambers are set-up to measure strain in one, tilt in another and one is devoted to the development of means to check the long-term stability of strainmeters. Walls are painted white and lit by fluorescent lights to provide attractive working conditions. Signal and power cables run through all chambers. The signal cable is used to take outputs to the observers' chamber.

We have called it the Cooney Observatory in memory of the mining syndicate who drove the tunnels in the 1890s. Although they did have explosives and crude air drills in those days, there was no electricity — they worked by lamplight using hand tools and hand-pushed trolleys. The rock in the Cooney is so hard it burns tungsten-tipped drills away. We are thankful for their efforts for today such a tunnel would cost \$20,000 to drive and there would be no guarantee that it would be suitable until finished. Using their methods of mining, today's cost would be \$1,000,000.

Down the side of the gorge runs large overhead power lines and a multi-pair signal cable which takes signals to the transmitter. It also provides a circuit for a P.M.G. telephone. Once an instrument is deemed satisfactory its output can be fed back via the data-link.

# SHARP 12-CHANNEL MOBILE/BASE STATION TRANSCEIVER

MODEL CBT-72

The compact CBT-72 ensures superior performance and reliability for every occasion. The latest solid state IC superheterodyne circuit, 12-channel crystal control system, all 23 channel manual tuning, tuned RF stage squelch control, AC/DC operation, dual conversion, mechanical filter and call signal system; incorporates Sharp's unsurpassed engineering superiority. Perfect for base station or mobile use such as commercial or personal communications.

## ■ ADVANCED SOLID STATE IC CIRCUIT

Sensitive, IC (Integrated Circuitry) and all transistorized circuit, crystal-controlled superheterodyne receiver; assure professional performance. Tuned RF stage amplifier provides 12 channel versatility. Provides instant play without warm-up. IC reduces weight and size of unit, yet improves performance.

## ■ SENSITIVE RECEPTION AND TRANSMISSION

Full variable squelch control provides maximum pulling power for picking up the weakest signals. Wide, pin-point selectivity with mechanical filter and dual conversion system. Modulation boost circuit for superior modulation sensitivity and boosting communication range. Automatic noise limiting and squelch control eliminate undesirable disturbances such as highline interference, static, etc.

## ■ SOPHISTICATED STYLING

Sophisticated, compact styling; ideally suited for any occasion.

## ■ EASY-TO-READ SIGNAL RF POWER OUTPUT METER

Illuminated signal RF power output level meter indicates the input level or output level and assures perfect reception and transmission.

## ■ TRANSMIT/RECEIVE COLOR INDICATOR

Easy-to-see illuminated dial provides rapid selection easily and assures accurate reception and transmission.

## ■ CALL SIGNAL SYSTEM

Exclusive pushbutton call signal affords selective and private communication.

## ■ PUBLIC ADDRESS SYSTEM

Convenient PA (Public Address) button provides public address operation (with the EXT. PA SPEAKER connected to the EXT. SPEAKER JACK).

## ■ WIDE TEMPERATURE RANGE OPERATION

Maximum stability in temperatures ranging from  $-20^{\circ}\text{C}$  to  $+60^{\circ}\text{C}$ .

## ■ CONVENIENT AC/DC OPERATION

Operates on car batteries or regular household current; no adaptor required. Uses DC 12V plus or minus ground mobile battery.

## ■ 23-CHANNEL MANUAL TUNING RECEIVER SYSTEM

Provides maximum communication flexibility and variety.

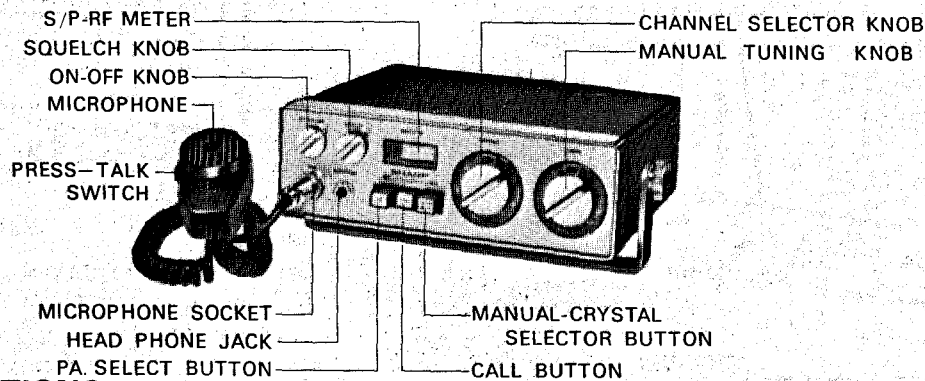

## SPECIFICATIONS

### RECEIVER

**Circuit:** Dual conversion with tuned RF amplifier, crystal controlled, mechanical filter, Integrated Circuit, series gate noise limiter, adjustable squelch and AGC.

**Frequency:** Tuning Coverage 26.965 to 27.900 MHz  
Crystal frequency incoming signal frequency  
+4.225 MHz

Crystal tolerance  $\pm 0.005\%$   
1st IF 4.225 MHz  
2nd IF 455 kHz  
Channels 12 channels

**Sensitivity:**  $0.5\mu\text{V}$  @ 10 dB S+N/N, 1000Hz 30% mod

**Selectivity:** 6dB down @  $\pm 2.5\text{kHz}$  50dB down @  $\pm 10\text{kHz}$

**AF output:** 3 watts

### TRANSMITTER

**Circuit:** Crystal controlled, 2-stage RF amplifier with modulation booster circuit, 4-transistor modulator.

**Final stage DC input:** 5 watts

**Range booster:** Yields high average modulation at average voice levels.

**Frequency:** Crystal frequency, any 12 channels of 26.965 to 27.255 MHz  
Crystal frequency tolerance:  $\pm 0.005\%$  at  $-20^{\circ}\text{C}$  to  $+60^{\circ}\text{C}$

**Power supply:** AC 110V or 120V (CBT-72)  
220V (CBT-72F) } 50/60Hz  
240V (CBT-72G)  
DC 13.2V (nominal) + or - ground mobile battery

### GENERAL

**Dimensions:** 70mm (2-3/4") high  $\times$  220mm (8-3/4") wide  $\times$  177mm (7") deep. **Weight:** 2.74kg (6.03 lbs.)



Available from

## OLIMS TRADING CO. & DISTRIBUTORS

NEW SOUTH WALES: 559-1011

VICTORIA: 42-4236

QUEENSLAND: 51-5548

SOUTH AUSTRALIA: 514025

WESTERN AUSTRALIA: 23-4683

TASMANIA: 34-6711

# PRE-PAK ELECTRONICS



## DISPOSALS DIVISION

95-97 REGENT ST., REDFERN, N.S.W., 2016. PH: 69 5922—  
BRISBANE & QLD.—RADIO COMPONENTS, 67 SANDGATE RD., ALBION, 4010

HOURS OF BUSINESS:  
MON., WED., FRI.—8.20 a.m. to 5.30 p.m.  
THURS. 8.30 a.m.—8 p.m. SAT 8.30-1 p.m.

### MISCELLANEOUS

Transistor type Miniature Jack Sockets. 3.5mm. 10 for \$1.00 Post 15c. 'Tuchel' 8 pole Plug and Socket with top entry cover, non-revers. \$1.00 Post 15c. Miniature Flashing Lamps, 2.5 volt. 12 for 50c Post 10c. 3 pin Din Plugs 3 for \$1.00 Post free. Philips Z505S Counting Display Tubes, \$1.00 ea. Post 15c. IBM Computer Boards, size 4" x 2 1/2". 4 Boards with a minimum of 16 Transistors. \$1.75 plus 20c Post. Hamlin Reed Switches, Type DRG2. Rating 240V 1 amp. 80c ea. or 10 for \$7.00. Post free. 12AT7 Valves by Toshiba, new and individually packed. 4 for \$1.50 Post 15c. Extruded Aluminium Channels. Suitable for Heat-sinks. 2 sizes, 6"x1 1/2" and 3"x1 1/2". The 2 for 50c plus 15c post.



### S.T.C. RSB Series HIGH POWER SILICON RECTIFIERS

Suitable for outputs of 100 amperes (Direct forward current) at crest-working voltages of between 50 & 700v. These rectifiers incorporate an alloyed silicon junction in a stud ended hermetically sealed case. Type RS801 80 PIV 120 amps. \$5.00 plus 75c post. RS812 120 PIV 120 amps. \$6.50 plus 75c post.

### HONEYWELL COMPUTER PANEL



(Exclusive to Pre-Pak.) Size 12" x 4 1/4". Packed with approx. 90 to 100 high-grade components, transistors, rectifiers, diodes, caps and resistors. Qty. 1 to 4 \$2.25 ea. plus 50c post. Qty. 5 to 9 \$1.75 ea. plus 1.00 post. Qty. 10 to 25 \$1.50 ea. plus \$2.00 post.

BRAND NEW 1/4 H.P. MOTORS. Made for IBM. Although for 240V 3 ph. use, we supply full conversion details for operation on 240V AC 1 phase. Complete with Instructions and Start Capacitor. Guaranteed New and Unused. Ideal for Small Lathes, Grinders, Saws and Drills, etc. \$12.00 each plus \$2.00 freight. Only applicable in N.S.W., VIC. and QLD.

PAY US A VISIT . . . Although we attempt to list a variety of Electronic components every month, list the many thousands of lines we have available in a sensible sequence mainly owing to the rapid sales we have over the counter and consequently run out of many lines before we can advertise them. We can assure you that you can advertise a most interesting morning or afternoon in our Regent Street Shop, browsing around in our leisure and you can be quite surprised at what you can find. Many of our customers can testify at some of the "difficult" items they have found and at the most reasonable prices. It is with some pride that we state . . . "OUR CLAIM, WE ARE THE CHEAPEST" . . . "OUR AIM, TO KEEP IT THAT WAY." . . . "OUR AIM, TO BE READY SOON . . . Our Bumper 1972 Components, Hi-Fi & Stereo Catalogue, \$1.00 refundable after your first purchase of \$10.00.

FANTASTIPAK . . . For One Month only. A Fantastic 5lb. Bargain Parcel of guaranteed NEW Electronic components. Included are Transistors, Electrolytic Capacitors, Resistors, Potentiometers, Rotary switches, Magnetic counter, Computer Boards, P.C. Boards, Transformers, Tag strips, Lamp Holders, etc. We guarantee the value of this parcel to exceed \$30.00. FIRST COME, FIRST SERVED, AS WE HAVE ONLY LIMITED QUANTITIES AVAILABLE. Don't be astonished but we are only asking \$18.00. Post Free.

HIGH GRADE METAL TUBULAR PAPER CAPACITORS. 2md + .1mfd. 200 volt working. Ideal for cross-over networks and time delays. Size 3" x 1" dia. New and packed. 10 for \$1.00 plus 50c post. 50 for \$4.00 plus \$1.25 post. 100 for \$7.50 plus \$2.00 post. SELENIUM RECTIFIERS. By Westinghouse & S.T.C. Types: LT91 Full wave 20V 2A—FSL1733A Full wave 18V 2A—'Sentercel' Contact Cooled 250V 60m/a. The 3 for \$1.50 plus 20c post.



## PRICES

## PRE-PAK

### SUPER PAKS

- Pak 1. 10 assorted BC177 & BC178 PNP Transistors. New but unmarked. 10 for \$1.50 plus 15c post. Guaranteed quality.
- Pak 2. 10 Fairchild PNP transistors. Silicon Planar. New, guaranteed but unmarked. 10 for \$1.50 plus 15c post.
- Pak 3. New top quality German made resistors. 1/2 watt 5%. 30 different values. 100 for only \$1.50 plus 20c post.
- Pak 4. New, high-grade wire-wound resistors. 3 watt to 20 watt. 50 for \$2.00 plus 20c post.
- Pak 5. EM404 Diodes. 400V. 1 amp. 8 for \$2.00 Post free.

MERCURY WETTED CONTACT RELAY. Made by Clare, U.S.A. Operating Voltage 12V. Coil resistance 500 ohms Current 50 m/a. High speed type. Single pole Change-over. Complete with 8 pin Base. Part No. HGS 1059. \$1.50 ea. plus 15c post.



'PEE-PEE' TIME DELAY SWITCH CONTROL. Complete Kit of parts with full building instructions. The unit may be used to either switch a circuit on for a pre-set period of time for up to 30 seconds or switch a circuit on after a delay of up to 30 seconds. For 12V. DC supply only. Only \$6.00 complete plus 50c post.

### SUPER-PAKS

- Pak 6. Texas Power Transistors —1 of each type: TIP29A. NPN Transistor 60V 1A TIP30A. PNP Transistor 60V 1A TIP31A. NPN Transistor 60V 3A \$4.25 post free.
- Pak 7. Sub-miniature Electrolytic Capacitors, top quality Printed Circuitry of the following types. 5 each 2mfd 3V, 5mfd 6V, 5mfd 10V, 10mfd 10V, 35 for \$3.50 post free.
- TEXAS Integrated Circuit Operational Amplifier SN7209. \$1.20 plus 10c post.
- IS94 RECTIFIER 500V .35A IS103 RECTIFIER 400V 1A. 75c the pair, Post free.

### HIGH GRADE FIBRE GLASS Copper Laminate Printed Circuit Board

2 1/2 lbs. of various and useful sizes, single sided. \$2.00 plus 40c post.

### TWIN TRANSFORMER UNITS

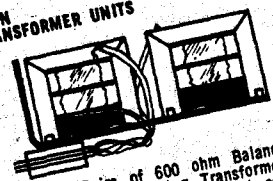

Matched Pairs of 600 ohm Balanced Line 1 to 1 Isolating Transformers. both mounted in sturdy metal case. \$1.00. Complete as specified plus 30c post.

FEDERAL Electric Underdome Bell. Cat. No. BL2. Operates on 3V. DC or 5V. AC. Coil resistance 6 ohms. Gong 3". New & Packed. \$2.00 ea. plus 25c post

DO YOU NEED LOTS OF MICROFARADS? Then take your pick from these precision made Computer grade electrolytics. Made by very famous manufacturers. All plus 25c post.



200mfd	200V	\$2.00	8000mfd	13V	\$2.25
250mfd	110V	\$2.25	8000mfd	55V	\$4.00
2500mfd	.45V	\$2.00	10000mfd	25V	\$4.00
3500mfd	.75V	\$2.50	10000mfd	33V	\$4.50
4000mfd	.50V	\$2.50	11000mfd	19V	\$3.50
4000mfd	60V	\$2.75	14000mfd	13V	\$3.00
4000mfd	75V	\$3.00	15000mfd	10V	\$3.25
5500mfd	45V	\$2.00	16000mfd	12V	\$3.50
6600mfd	45V	\$2.50	25000mfd	6V	\$3.00
7000mfd	13V	\$2.00	74000mfd	10V	\$5.00

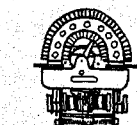

### UNISELECTORS

Made to stringent P.O. specifications. Suitable for Digit counting and Storage, Numicator selection, Batch counting and controlling, Switching and Phasing and many other uses. Type A (Illustrated), 4 Level 25 wiper with Forward and Reverse Coils each of 120 ohms. Can operate on 18 volts. \$5.50 each, post 50c. Type B. As Type A but single coil and only forward switching. 75 Ohms Coil. 24 volt operation. \$3.50 each plus 50c post. Type C. 8 Level 25 Full Double wiper 75 ohms Coil. 48 volt operation. \$8.00 each, plus \$1.00 post.

## FINE MEASUREMENT IN GEOPHYSICS

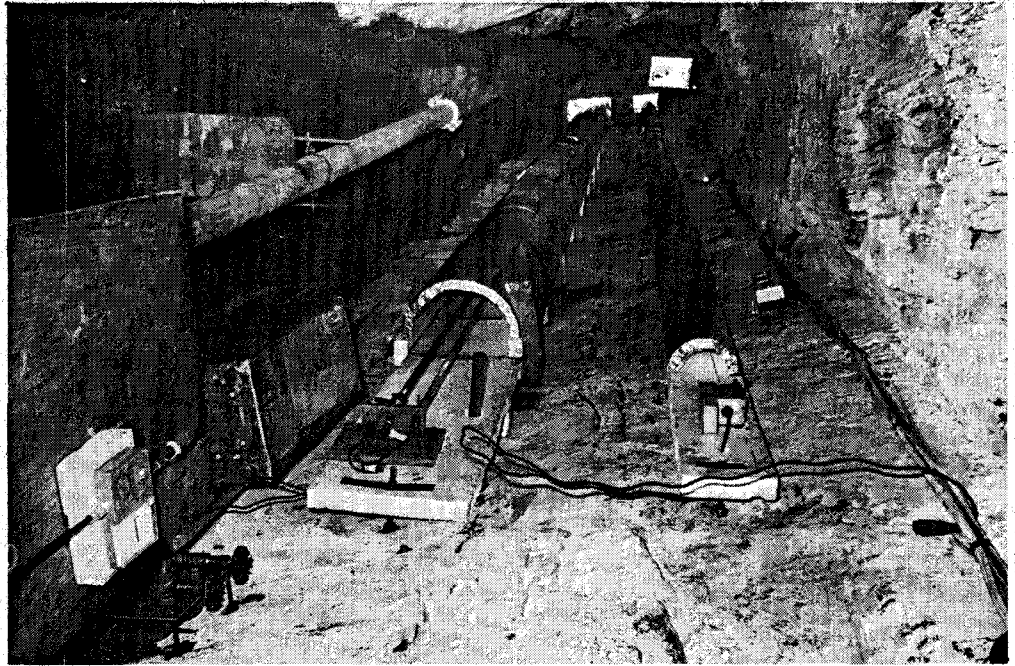

Fig. 4. The strain chamber. The top insulated cover encloses the wire strainmeter, the lower cover the quartz tube strainmeter and the pipe near the floor encloses the laser beam of the interferometer.

### THE INSTRUMENTS IN THE COONEY OBSERVATORY

To date we have built several strainmeters and have installed two tilt-meters in co-operation with the Bureau of Mineral Resources. Gravity instruments will be added soon.

There are three types of tidal strainmeters. The first, and oldest, style uses a long fused-quartz tube as an invariant length standard. A ten-metre length is hung along the wall on flexible pivots. One end is fixed to the wall, the other hangs free. At the free end is a transducer that monitors the gap between the end and a wall bracket. Strain appears as gap variations. The set up is shown schematically in Figure 3(a) and is the middle instrument seen in Figure 4.

At present we use inductive measurement techniques in which an iron-core moves inside a centre-tapped solenoid. When the core is central, each half of the coil has equal inductance and the ac bridge to which it is connected is balanced giving no output. As the core moves away from the centre, an output appears which is linearly related to displacement. These are called linear variable differential transformers, LVDTs for short. Although the commercial units we use are not as sensitive as the capacitance micrometers of Professor Jones' group, they can reliably detect  $10^{-10}$ m (1 angstrom) which is adequate for our purposes. They do, however, have some advantages over the capacitance method for they are little affected by moisture in the air, are easier to adjust, have greater dynamic range and are commercially available at low cost. There are a number of quartz rod instruments operating over the globe

but few are in the Southern Hemisphere.

The second type of strain instrument to be adopted widely was the laser interferometer. A stable wavelength laser radiates a beam through a beam splitter, (as shown in Figure 3b) that provides two coherent beams. One beam travels to the far end of the wall and is returned by a corner-cube reflector. The other beam is returned as a reference-phase signal and it interferes with the other to form fringes. Changes in length between the beam splitter and the corner cube show up as movements in the fringes. Electronic methods monitor this movement by counting fringes or by keeping the fringe stationary with a servo in which case the servo position is a measure of movement. As the wavelength of the light is varied by air pressure, humidity and temperature, the interferometer is operated in a vacuum using pipes to enclose the beams (see Figure 4). There are about six units operating in the Northern Hemisphere but as yet, none in our half. They range in length from 40 to 1000 metres and are the most expensive strainmeter to build.

A few years ago one of us devised a very simple method which uses an invar wire as a length standard. The wire is tensioned by a robust, yet sensitive, beam balance which is bolted to the rock with expanding bolts. Figure 3(c) shows this method. The gap between the wire end and the mount is measured with the LVDT transducer. Following limited success with an initial crude design, Cambridge University have now developed an improved version and several units are being placed at intervals over Britain

and the Continent. Three units of another improved design are operating in New Zealand. Our unit is at the top in Figure 4.

The Cooney Observatory is but a year old and to date we have been concentrating on development of one of each type of strainmeter, measuring in the same direction and on the same rock face. This greatly assists the eradication of defects as each should give the same results. Once a satisfactory design has been settled on (it is not possible to buy tidal-strainmeters ready made) we will place more instruments over the local region and then across Australia using two-wheel trailers to operate them in remote areas. The first trailer-station, an advanced student project, nears completion in readiness for field work in 1972.

Although overseas groups have been working on strainmeters for over thirty years, no special effort has been expended on research to investigate the stability of each standard in use. Mechanical rods and wires may change length even though the temperature is controlled. Laser wavelength also is a function of the laser cavity length stability. In one chamber is a 10m long, massive, steel frame which hangs from the wall on flexure strips. This base, shown in Figure 5, is temperature controlled to a few millidegrees by a sensitive mercury contact thermometer. In this thermometer, the mercury rising up the small indicator tube contacts a fine tungsten wire. This closes a circuit switching off the heating. This degree of control holds the length stable to within a part in 100 million per day. On to this framework we can mount



The neutral amp you've waited for!

# ROTEL®

CONTROLS sound, but exerts no influence on it!

With Rotel, the best value for money equipment available, the quality of sound is not determined by the amplifier at all, but by the ancillary equipment. Which should be the case with all good quality amplifiers.

Rotel RA 310 offers 60 watt power output (IHF) 17/17 watts RMS 8 OHM, at 0.3% THD, all silicon transistors, signal source indicator lamps, tape monitor and mode push-button switches, loudness contour push-button switch, 2 pairs of back panel speaker terminals, 2 front panel speaker selector switches, 1 magnetic phono and 1 ceramic phono inputs, front panel, headphone jack. Also in the wonderful Rotel

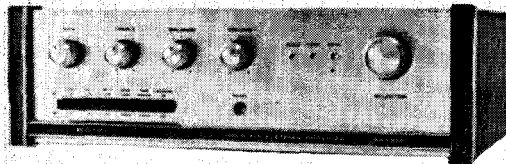

range: RA 610 amplifier, 120 watts (Ask for copies of the Electronics Australia and 'The Gramophone' Reviews) Rotel Tuner Amplifiers RX150, RX200, and RX400, Rotel Stereo Headsets RH 630, RH 711.

and with 4-channel sound in mind,

# MICRO introduces

## NEW! MA 101 ARM

Leader of the new generation of cartridges! A highly sophisticated new concept. Super precision radial bearings enable the playing of 4 channel records because of negligible bearing friction. New spring type anti-skating. The force being evenly distributed over the entire record surface enables superb tracking, stereo imaging, and quadrasonic channel balance. Arm lowering control damped in both directions, and special arm rest eliminates accidental damage to stylus, and records.

## NEW! VF 3200E CARTRIDGE

Elliptical stylus and alloy cantilever are the only moving parts, reducing the moving mass to half that of other cartridges. Cantilever tube only 25 microns thick. With low tip mass and correctly shaped and polished diamond stylus, the VF3200E fully reproduces all complex wave forms present on modern records. Magnifying lens stylus guard protects stylus, also enables dust on stylus to be easily seen. WRITE FOR TECHNICAL INFORMATION.

## OTHER STARS OF THE MICRO RANGE!

**TURNTABLES:** You'll find a turntable that gives good performance at a reasonable price, or ultimate performance regardless of price in the Micro range of turntables MR 111, MR 211, MR 311, MR 611. Also MB 300, MB 600 turntable only, for those who wish to use their own tonearm.

**CARTRIDGES:** Micro 2100/5, VF 3100/E (approved for use in Australian Broadcasting Stations that meet Control Board Standards) Micro 3100/5 (conical diamond stylus) and the 'rave notice' MC 4100, moving coil.

**SHOCK ABSORBER:** MSBI, specially designed to minimise acoustic feedback and external shock vibration.

### STATE AGENTS

VIC: Encel Electronics Pty. Ltd., 431 Bridge Rd, Richmond. Tel: 42-3762.  
N.S.W.: Encel Electronics Pty. Ltd., 257 Clarence St, Sydney, 2000. Tel: 29-4563.  
QLD: Stereo Supplies, 100 Turbot Street, Brisbane. 4000.

Distributors for Australia



International Dynamics (Agencies) Pty. Ltd.  
P.O. Box 205, Cheltenham. Vic. 3192.

S.A: Challenge Recording Co., 6 Gays Arcade, Adelaide. 5000.

TAS: Audio Services, 72 Wilson Street, Burnie. 7320.

Send coupon for technical information.

To: International Dynamics (Agencies) Pty. Ltd.,  
P.O. Box 205, Cheltenham. Vic. 3192.

Please send information re .....

NAME .....

ADDRESS .....

8484 ET

## FINE MEASUREMENT IN GEOPHYSICS

the various types of strainmeter for intercomparison of their drift and calibration. If the wall were used as a measuring base we would not be certain if it were instrument or earth drift that was observed. The base is under continual development and the next stage should realise ten times better stability. A project to start in 1972 will use coaxial tubes and water jackets in an attempt to reach microdegree instead of millidegree control.

The tilt-meters came ready made, for the Bureau of Mineral Resources chose the Cooney as a suitable place to instal two horizontal-pendulum tilt meters which were purchased from Professor Melchior of the Royal Belgium Observatory. These are the same as tens of other pendulums working elsewhere and now we are able to supply Australian data to the International Centre for Earth Tides which is situated in Brussels.

These tilt-meters are based on a different principle to those Professor Jones described. Imagine a gate. Even

with minimal friction, if the hinge-line of the gate is vertical the gate will remain at rest in what ever direction it is swung round to. If now the hinge line is tilted slightly out of vertical, the gate will swing and come to rest fronting in the direction of the tilt. Melchior's pendulums consist basically of a quartz tube pyramid frame, suspended horizontally is a quartz arm with a quartz bob (the weight) on the end. This is the pendulum. Quartz fibres, 6  $\mu\text{m}$  in diameter support the pendulum in what is known as a Zollner suspension arrangement. They are fused directly to the pendulum and to the frame. Hanging from the pendulum arm is a small mirror which supplies the readout using the optical lever principle. Five metres away is a light source that projects a fine slit of light onto the mirror and back to the recorder. This equipment uses photographic recording and no sophisticated electrics are needed. Tide inclination changes show up as 150 mm amplitude signals having a similar form as tidal-strain. Two pendulums

are needed to measure the two components of deflection of the vertical. To ensure stability the units are placed on the floor of a niche drilled into the end of the tunnel (shown in Fig. 6).

With all types of tide record, it is necessary to have a common time system to synchronise the data. At present Observatory timing is derived as hour pulses provided by a Bulova Accutron clock. Soon an IBM observatory clock will also be installed. This clock is synchronised with the international radio timing system.

Other instruments are used to monitor the environment for few instruments are entirely free from the effects of pressure, humidity and temperature. For instance, in the

*Fig. 5. The stabilised base. Water is pumped around the steel pipework, the temperature being controlled by a sensitive mercury thermometer.*

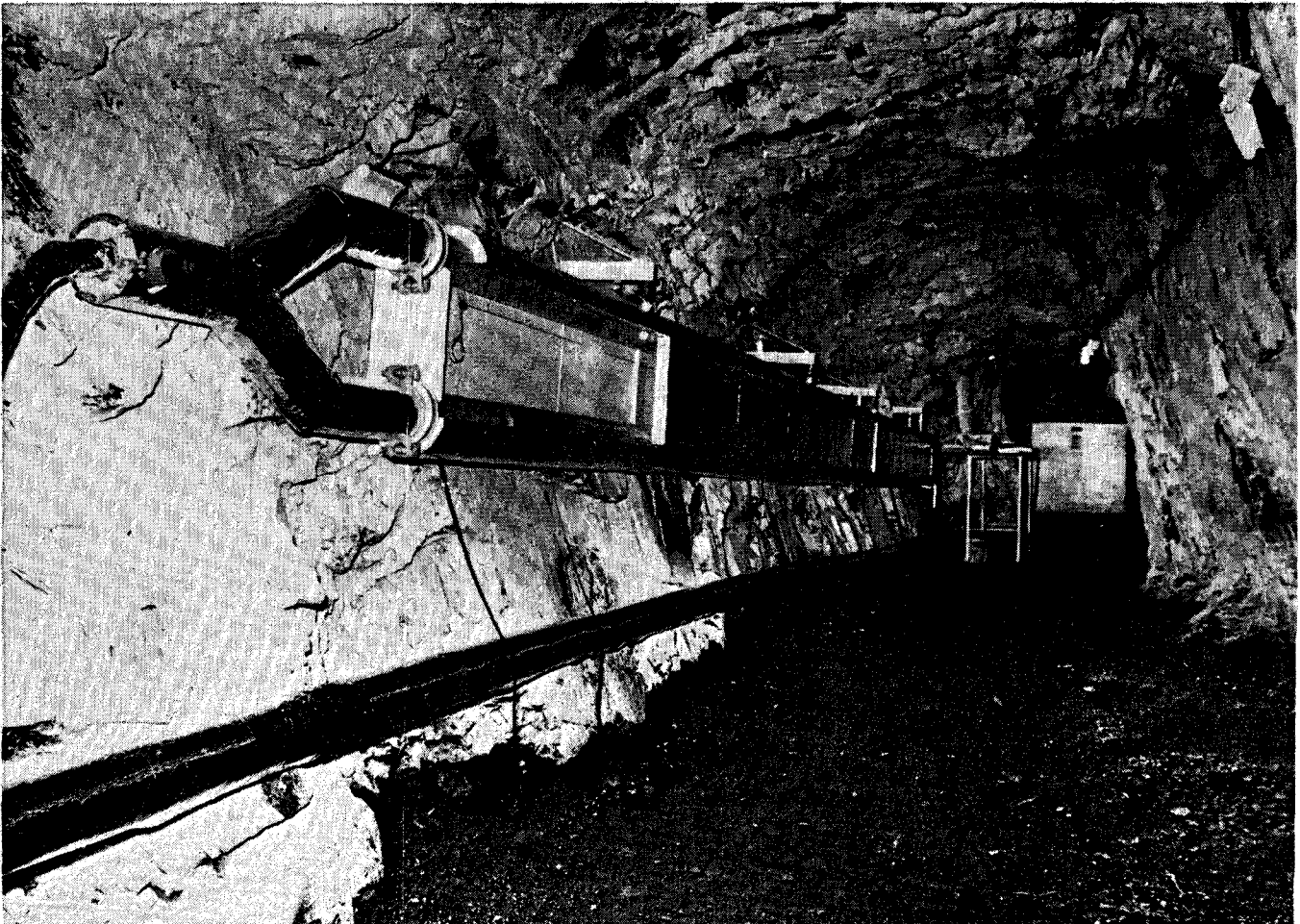

# University

## Diode Protected, General Purpose Multimeters

All backed by "UNIVERSITY" sales, spare parts & service.



**MODEL MVA-100 Multimeter.**  
 D.C.V.: 0.5-2.5-10-50-250-500-1000 (100K $\Omega$ /V).  
 A.C.V.: 2.5-10-50-250-1000.  
 D.C.A.: 10 $\mu$ A-250 $\mu$ A-2.5mA-25mA-250mA-10A.  
 A.C.A.: 0-10A.  
 Ohms: 20K-200K-2M-200M.  
 db: -20/0/+62.  
 Price each: \$35.00 + 15% S.T.  
 Features: 100K $\Omega$ /V - 10 A.A.C. - 200M $\Omega$  Res.

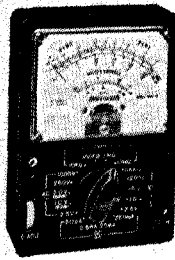

**MODEL MVA-4 Multimeter.**  
 D.C.V.: 2.5-10-50-250-1000 (20K $\Omega$ /V).  
 A.C.V.: 2.5-10-50-250-1000 (8K $\Omega$ /V).  
 D.C.A.: 50 $\mu$ A-2.5mA-25mA-250mA.  
 Ohms: 10K-100K-1M-10M.  
 db: -20/0/+22 +22/+36  
 Price each: \$16.00 + 15% S.T.  
 Features: Metal Case back - Low Price.

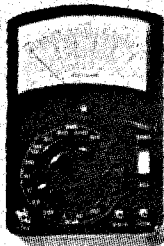

**MODEL CT-500 Multimeter.**  
 D.C.V.: 2.5-10-50-250-500-5K (20K $\Omega$ /V).  
 A.C.V.: 10-50-250-500-1K (10K $\Omega$ /V).  
 D.C.A.: 50 $\mu$ A-5mA-50mA-500mA.  
 Ohms: 12K-120K-1.2M-12M.  
 db: -20/0/+62.  
 Price each: \$14.00 + S.T.  
 Features: 500mA D.C. - Mirror Scale - Low price.



**MODEL MVA-5 Multimeter.**  
 D.C.V.: 5-25-50-250-500-2.5K (20K $\Omega$ /V).  
 A.C.V.: 10-50-100-500-1000 (10K $\Omega$ /V).  
 D.C.A.: 50 $\mu$ A-2.5mA-250mA.  
 Ohms: 0.6K-6M.  
 db: -20/0/+22.  
 Price each: \$12.00 plus 15% S.T.  
 Features: Colour Scale - Small Size

## University TEST EQUIPMENT

Also backed by "UNIVERSITY" sales, spare parts & service.

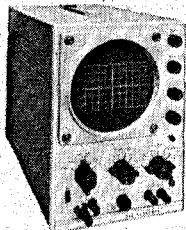

**MODEL UC5 5" Oscilloscope.**  
 Vertical: 10mV P.P./cm.  
 Freq. Range: D.C. to 10 MHz.  
 Horizontal: 300mV P.P./cm.  
 Wide Sweep 1Hz to 200 KHz.  
 Continuously variable.  
 Price each: \$250.00 + 15% S.T.  
 Features: D.C. to 10 MHz - 5" Screen.

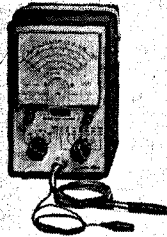

**MODEL MVA-6 vacuum tube Voltmeter.**  
 AC-DC Volts, 7 ranges to 1.5KV;  
 P.P. volts, 7 ranges to 4KV.  
 db (1mW-600) - 10db to +65db;  
 Ohms .2 to 1000M.  
 Price each: \$48.00 + 15% S.T.  
 Features: Colour Scale - Single output socket.



**MODEL 6803 - Generator**

Frequency Coverage: 10Hz - 100kHz in 4 bands continuously variable.  
 Waveform: Sine and Square waves  
 Frequency Accuracy:  $\pm$  (2% + 1 Hz)  
 Max. Output (600 $\Omega$  load): +9dBm or more, continuously variable with variable resistor  
 Output Impedance: 600 $\Omega$   $\pm$  100 $\Omega$  unbalanced  
 Output Frequency Response:  $\pm$  1 dB at 1 kHz  
 Distortion Factor: Less than 0.3% 200Hz-100kHz  
 Less than 0.8% 10Hz-100kHz  
 Square Wave Risetime: 0.2 $\mu$ S  
 Power Source: 240VAC, 50Hz (approx. 3VA)  
 Dimensions: 190(L)x95(W)x100(H)mm

Features: Solid State - small size

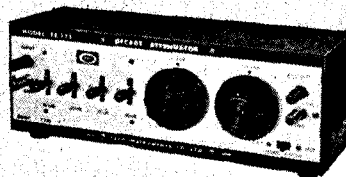

**MODEL RA-111 Decade Attenuator**

Range: 0.1db-111db. (DC to 150KHz)  
 Connection Systems: Unbalanced T & Bridge T.  
 Impedance: 600 $\Omega$   
 Range: (0.1db x 10) + (1db x 10) + 10 + 20 + 30 + 40db.  
 Measuring Frequency: D.C. - 200KHz (-3db)  
 Accuracy: 0.05db + indication db x 0.01  
 Maximum Input: Less than 4W (around 50V)  
 Additional device: 600 $\Omega$  load resistance with internal, external change over switch built-in.  
 Dimensions: 12" x 4 1/2" x 4"

Features: Ease of operation

## University Graham Instruments Pty. Ltd.

106 Belmore Road, Riverwood, N.S.W., 2210.  
 Telephone: 53 0644 (5 lines).

Telegrams and Cables: Raquip, Sydney.

City Office: Instrol Electronics Centre, 91A York Street, Sydney - 29 4258.

Victorian Office: 180 York Street, Sth. Melbourne.  
 Phone: 699 1126.

## REPRESENTATIVES

W.A.: Sandovers Ltd.  
 28 Belmont Ave. Belmont,  
 PERTH, 6104. Ph: 65 0111  
 T.A.S.: W.P. Martin and Co.  
 202 Argyle Street,  
 HOBART, Tas., 7000  
 And 32 Canning Street,  
 LAUNCESTON, Tas., 7250,  
 22 844.  
 S.A.: Compar Distributors P/L.  
 33 Market Street,  
 ADELAIDE, S.A., 5000 51 6264 Phone: 36 0344

NEWCASTLE DISTRICT  
 Hunter Engineering Sales P/L.  
 64 Broadmeadow Rd.,  
 Broadmeadow, NEWCASTLE,  
 NSW, 2303. Phone: 61 4321.  
 PORT KEMBLA DISTRICT,  
 Hurdell Engineering Sales P/L.  
 1 Fitzwilliam Street,  
 PORT KEMBLA, 2505 43 397  
 Qld.: Gee & Co., 35 Railway Terrace,  
 Milton, Bris. Qld. 4064.

Also available from all leading wholesalers

## FINE MEASUREMENT IN GEOPHYSICS

mechanical strainmeters, atmospheric pressure will vary the length of the standard. The daily variation causes length changes equivalent to about 10% of the tidal strain amplitude. Temperature changes also vary the length of standard. Whilst quartz has the low coefficient of thermal expansion of roughly 1 part per million per degree, Kelvin, (the new name to be used for Centigrade in the S.I. unit system) a temperature change of  $0.01^{\circ}\text{K}$  gives tidal amplitude changes in signal. To combat this we are developing a novel instrument. Hanging under the quartz tube is a brass tube (as can be seen in Fig. 4). The two outputs of each gauge are mixed electronically to produce a temperature compensated signal, for the brass expands some thirty-times greater than the quartz, enabling length changes due to temperature to be differentiated from those due to true strains. This technique was used in 1890 by Colby to survey the British Isles but he had to use a mechanical link to couple brass and steel bars, electronics being unknown in his day.

At present these measurements are taken by manual means but soon the Observatory will record the variables continuously so that the conditions at any time can be recalled. One of the small niches has been built into a small room. At first sight it looks like any other room but, in fact, the construction has been performed without the use of magnetic materials. This is the laboratory area for testing magnetometers to their limit of resolution. There appears to be no strong relationship between the magnetic phenomena and earth tides but the Observatory offers excellent thermal conditions for testing instruments as the daily variation is only several thousands of a degree.

The development of alkali-vapour magnetometers is another Departmental project which involves optics, mechanics and electronics. In this a discharge lamp radiates visible light through a glass cell fitted with an alkali-metal vapour, to shine on a photcell. Around the cell is a magnetic solenoid coil which is energised by

control from the output of the photcell. As the magnetic field strength is adjusted the system breaks into oscillation at a high frequency, the frequency depending on the total magnetic field around the cell. This method is the most sensitive magnetometer device available.

Another project underway is a possible new form of gravity meter which uses no springs. Molecules in a gas flowing along a horizontal heated tube deflect downwards proportional to the gravitational attraction. A laser beam is radiated along the tube centre and its vertical displacement is measured with a position-sensitive photcell. Electronics control the heating of the tube.

Electronics and geophysics are inseparable. Electronics, however, must be combined with mechanical and optical techniques if measurement is to be employed to the fullest. ●

*Fig. 6. Horizontal-pendulums — the niche was made without explosives, by drilling and chiselling. It is lined to prevent water droplets falling on the instruments.*

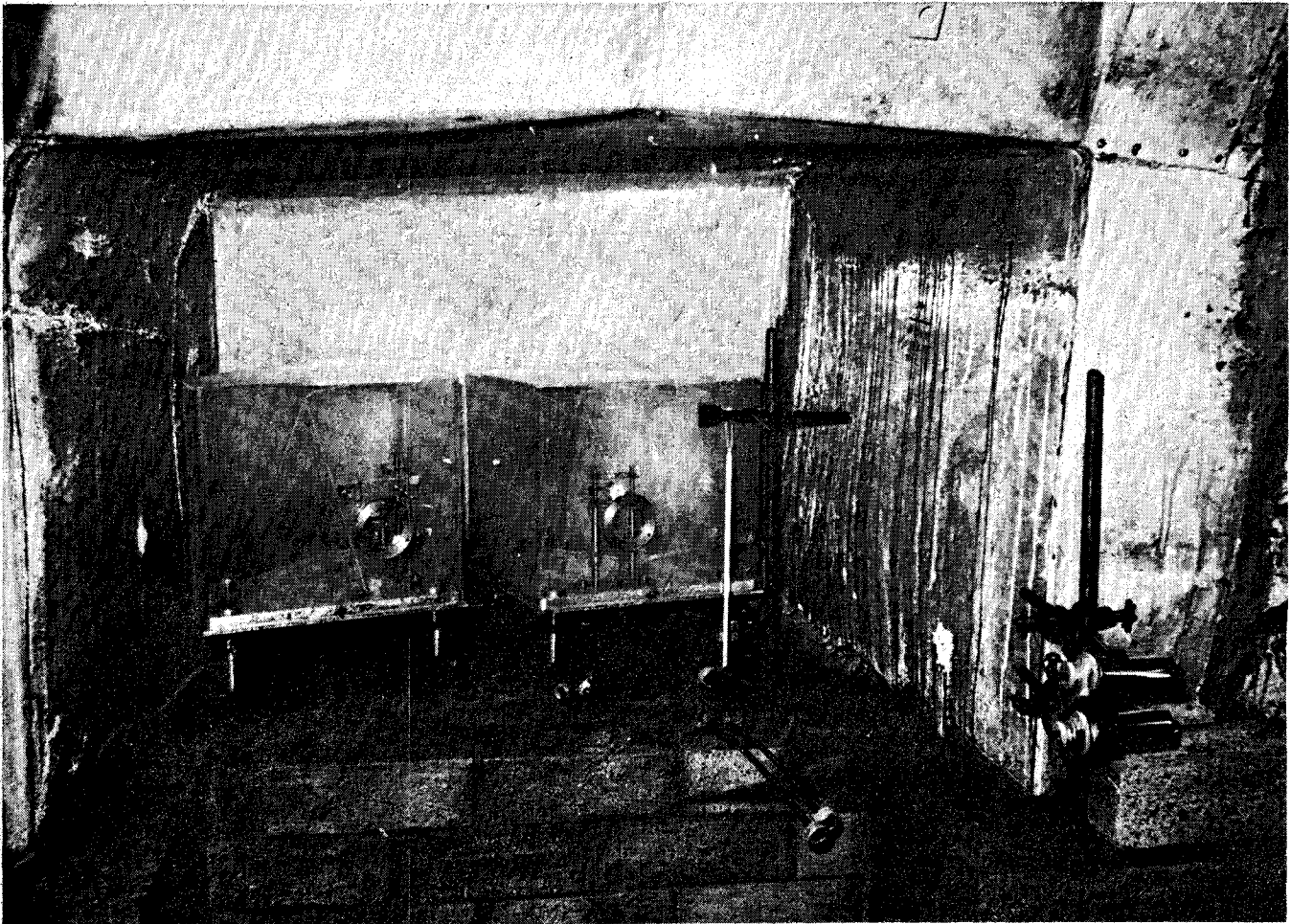

# How to see w

Before you say it's not possible — try this.  
Seat yourself somewhere near a pair of  
Sonab omni-directional stereo speakers.  
Playing the Stravinsky Firebird.

Close your eyes.  
Then listen.

And there, right behind your closed  
eyelids, you'll be able to see.

The entire orchestra. Every instrument  
just where it should be. Spread in front of you  
in an arc.

Then try the same experiment with a  
pair of front facing speakers.

What you see will be rather different.  
Instead of an orchestra you'll see two  
front speakers aiming solid wedges of sound at  
you.

And that's all.

Why the difference?

The Sonab omni-directional system  
reproduces sound exactly as it was originally  
produced.



# with your ears

Using the acoustics of the room. Using the walls, ceiling, floor as reflecting surfaces.

It seems so simple. But it took twelve years of university research and several world patents to get the Sonab system right.

Don't take our word for it.

Try the experiment.

And see with your ears for yourself.

Write or phone us — and we'll send you the Sonab literature — and the name of your nearest stockist.

Please send me details of your equipment.

Name: \_\_\_\_\_

Address: \_\_\_\_\_

Post Code: \_\_\_\_\_

## Sonab

Sonab of Sweden Pty. Ltd., 114 Walker Street,  
North Sydney, NSW 2060. Phone: 929 4288/4554



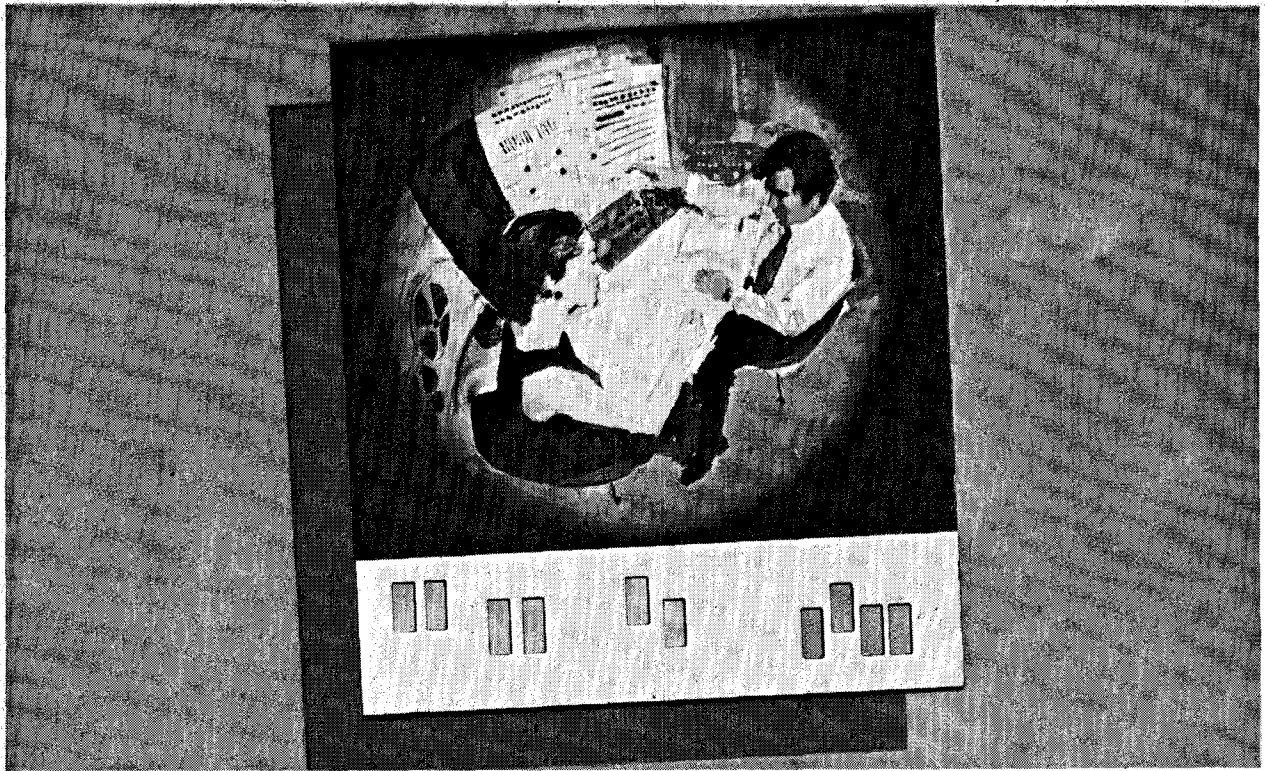

# Programme yourself for success in the computer age

Take advantage of new trends in commerce and industry. Step up to a more interesting career, with higher pay and increased status. Opportunities abound for those with the right specialist skills, and you can acquire them through easy-to-follow I.C.S. home study courses attuned to modern needs. Post coupon below for details without obligation.

## Select the career that suits you best

### TV, Radio Electronics

Basic Electronics  
Colour TV Servicing  
Commercial Operator's Certificate  
Computer Technician  
Electronic Engineering  
Electronic Instrumentation and Control Systems  
Electronics Technology  
Electronics Technician

Fundamentals of Electronic Computers  
Hi-Fi and Sound Systems  
Industrial Electronics  
Maintenance of Electronics Equipment  
Radio-Television Engineering  
Radio and Television Servicing  
Radio Electronic Telemetry  
Transistor Radio and Printed Circuit Servicing

### Computer Programming

Business Data Processing  
Cobol Programming  
Computer Systems Analysis  
Fortran Programming  
General Computer Programming  
I.B.M. 360 Computer  
Office Automation  
Operational Research  
Systems and Procedures Analysis



**CUT OUT AND POST THIS COUPON  
TO INTERNATIONAL CORRESPONDENCE  
SCHOOLS, DEPT. 549—TODAY.**

Please send me, without cost or obligation, the I.C.S. book on

Name (Mr., Mrs., Miss) \_\_\_\_\_ Age \_\_\_\_\_  
please print

Address \_\_\_\_\_

Postcode \_\_\_\_\_

Occupation \_\_\_\_\_ Phone \_\_\_\_\_ Dept. 549

POST TO: International Correspondence Schools, 400 Pacific Highway, Crows Nest, N.S.W. 2065.  
Telephone 43 2121. Also in all States throughout Australia and in N.Z.  
If the career you want is not listed please nominate the course you want.

JW309512

# EQUIPMENT NEWS

## OPTICAL CARD READER

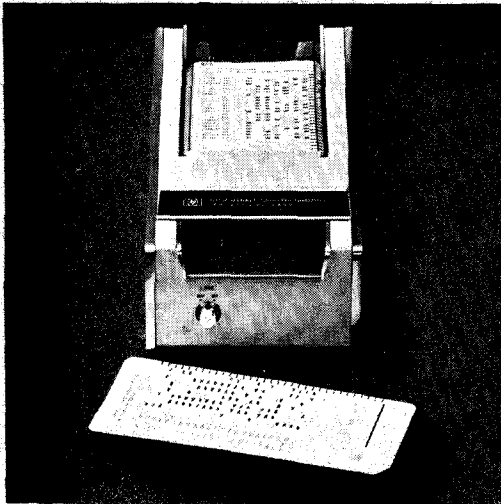

An inexpensive way to input data to computers, time share terminals, numerically-controlled machines and other devices that accept eight-bit parallel words in serial fashion has been developed by Hewlett-Packard.

A new eight-channel optical mark sense card reader is a low-cost and convenient way to input 8-bit data to computers and other devices. Called the Hewlett-Packard Model 3260A Marked Card Programmer, the new reader detects pencil marks or punched holes on hand fed cards. It gives a digital output corresponding to the presence of marks or holes in the eight columns. The TTL logic level output is "1" state low. A mark or punched hole = "1".

The Model 3260A has its own internal power supply. Inserting a card starts the motor which pulls the card through the reader. Cards are stacked in the output tray so that the original card order is maintained.

Each card has a maximum of 32 words. Reading time for a complete 32 word card is typically 1.5 seconds.

Data may be fed into a computer or time share terminal by means of the cards. This system may be used for calibration and setup of numerically-controlled machines. The reader and cards may also be used for programming of some programmable instruments. Operator errors during repetitive production testing are reduced using the Model 3260A. The cards are also a hard copy record of the programme and data.

The Model 3260A weighs 6 lb. (13.5kg) and operates from 120 V or 240 V  $\pm 10\%$ , 48 Hz to 440 Hz. Power consumption when reading a card is less than 9 watts.

Full details from Hewlett-Packard Australia Pty. Ltd., 22-26 Weir St., Glen Iris, Victoria. 3147.

## DIGITAL FREQUENCY METER TO 300 MHz

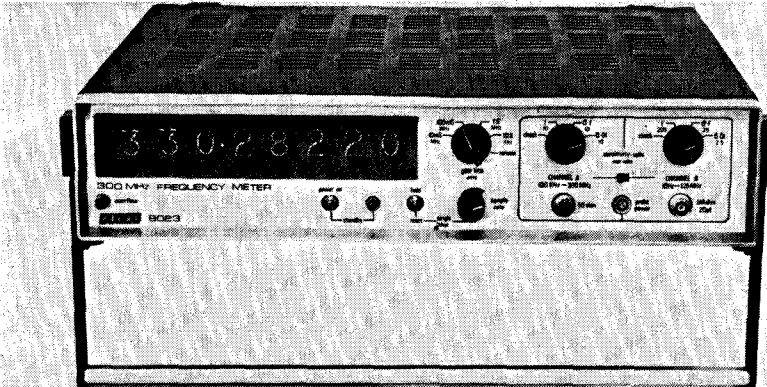

Racal Instruments Limited have announced the introduction of the 9023, a directly gated 300 MHz Digital Frequency Meter. Use of MECL (Motorola Emitter Coupled Logic) integrated circuits and thick film techniques enables this instrument to provide a directly gated frequency coverage from 10 Hz to 300 MHz with a sensitivity of 10 mV. Provision is made for the use of an Active Probe which enables accurate measurement to be made down to 1 mV.

The thick film circuits incorporated in this advanced digital instrument were designed and manufactured in-house using the Redac computer - aided design and thick film manufacturing facilities. A latched eight digit display with overspill and automatically positioned decimal point provides a resolution of 1 Hz up to 300 MHz using a one second gate time.

Two input channels are provided; Channel "A" having a 50 ohm input impedance and

frequency range of 100 kHz to 300 MHz, and Channel "B" with a 1 megohm input impedance and a 10Hz to 150MHz frequency coverage. Both channels are fitted with three range attenuators to eliminate errors due to superimposed noise on the input signal.

The frequency standard is a Racal designed precision oscillator Model 842 with a stability of better than 1 part in  $10^9$  per day which enables the full resolving power of the eight digit display to be utilized up to the maximum input frequency.

Programmability includes time base, channel selection and operation of the "A" channel attenuator which incorporates a number of thick film elements making the 9023 Digital Frequency Meter ideally suited for Automatic Test Equipment applications.

Full details from RACAL ELECTRONICS PTY. LTD., 47 Talavera Road, North Ryde, NSW 2113.

## NEW CURVE TRACER

Tektronix Australia Pty. Limited announces the new CT71 Curve Tracer designed and manufactured by Telequipment.

The Telequipment CT71 Curve Tracer is a dynamic tester designed for displaying the characteristic curves of a wide range of

transistor, FET and diode semiconductor devices on its 10 x 10 cm (5 1/2 in.) CRT.

The basic specifications are:

### COLLECTOR SUPPLY

Voltage -0 -1 kV

Positive and negative polarity

Twice line frequency or dc

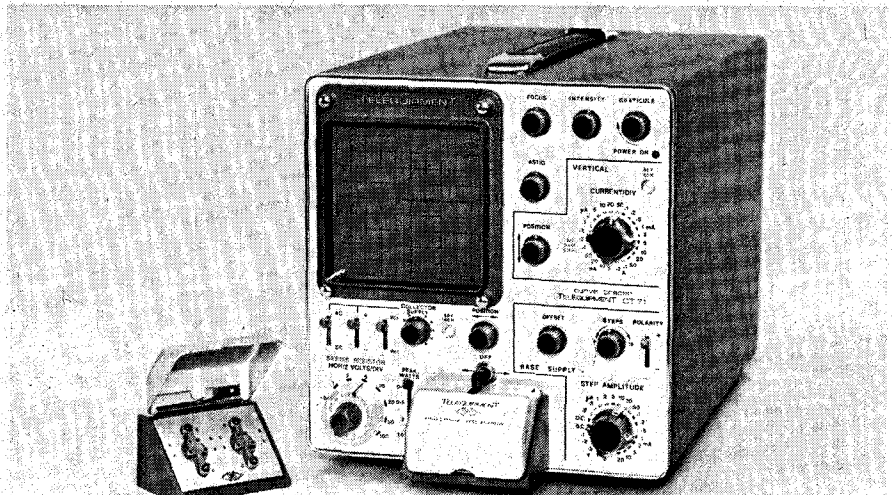



# LEADER TEST INSTRUMENTS

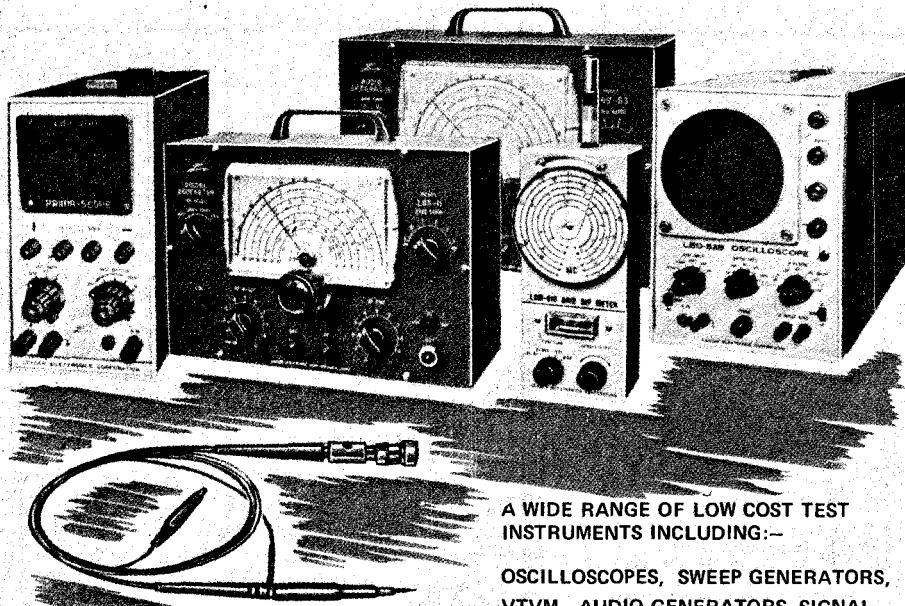

A WIDE RANGE OF LOW COST TEST INSTRUMENTS INCLUDING:-

OSCILLOSCOPES, SWEEP GENERATORS, VTVM, AUDIO GENERATORS, SIGNAL GENERATORS, TRANSISTOR CHECKERS, ATTENUATORS, PROBES.

## LSG-11 WIDE BAND SIGNAL GENERATOR

Probably the most popular low cost Signal Generator in the world. This signal generator has a useful frequency range from 120 kHz to 130 MHz and using an optional crystal, can be crystal controlled. Adjustable output modulation frequencies of 400 and 1000 kHz can also be used for testing audio amplifiers.

\* \$45.00

+ S. TAX

## LAG-55 AUDIO GENERATOR

The LAG-55 is an indispensable instrument for audio work. Three different waveforms, (sine, square and complex) are available for a variety of tests. The wide frequency range from 20Hz to 2MHz and constant output levels are most desirable features of the LAG-55. Sine waves are generated with a Wien-bridge configuration and square waves by a Schmitt trigger circuit.

\* \$85.00

+ S. TAX

## LDM-810 GRID DIP METER

The well known Leader LDM-810 Grid Dip Meter is one of the more useful instruments for checking receivers, oscillators, transmitters and circuit components.

A frequency range from 2 to 250 MHz (in 6 bands) is available with an internal modulation frequency of 1 kHz.

\* \$45.00

+ S. TAX

## LBO-52B 5" OSCILLOSCOPE

The LBO-52B Oscilloscope has been designed for high performance operation wideband, DC to 10 MHz with a high sensitivity of 10 mV p to p makes it an invaluable tool in the development and testing of electronic circuits. It is especially useful in the examination of low level equipment such as tuners, IF amplifiers etc.

\* \$295.00

+ S. TAX

## LBO-31M 3" OSCILLOSCOPE

The LBO-31M is a compact oscilloscope designed for all round service. Its small and handy size will appeal to experimentors, servicemen and plant technicians who demand maximum performance with minimum space requirements. Responses from 3 Hz to 1 MHz and sensitivity is 80 mV/cm.

\* \$137.50

+ S. TAX

## LPB-10Z LOW CAPACITANCE PROBES

The LPB-10Z is a high impedance probe specially designed for Leader LBO-52B, LBO-55B, LBO-32B, LBO-33B Oscilloscopes. Its use prevents any disturbance to the circuit under test. Input impedance is 10 MΩ shunted by 18 pF and attenuation is 20 dB.

\* \$16.50

+ S. TAX

CATALOGUES AVAILABLE ON REQUEST.

Distributed by:



**WARBURTON FRANKI**

\* NOTE THAT THESE ARE SUGGESTED LIST PRICES ONLY AND MAY VARY SLIGHTLY IN SOME AREAS.

AVAILABLE FROM LEADING ELECTRICAL SUPPLY HOUSES.

WF5101

# EQUIPMENT NEWS

Current - Peak - 2 Amps  
(max 15 Watts)  
Series Resistances -  $0\Omega$  to  
 $1.7M\Omega$  in 11 steps

## BASE STEP GENERATOR

Current -  $0.2\mu A$  to 20mA in 16 steps  
Voltage - 0.1V to 2V in 5 steps  
Steps/Offset - Adjustable from  
0 to 10 steps in positive or negative  
direction.

## VERTICAL AMPLIFIER

Collector Current Range - 5 nA/div to 0.2  
A/div in 24 steps

## HORIZONTAL AMPLIFIER

Collector Voltage Range - 0.1 V/div to  
100 V/div in 10 steps

## OTHER CHARACTERISTICS

Plug-in test fixtures with safety interlock  
Power Requirements - The CT71 has  
voltage settings for 100 V to 125 V in 5-V  
steps, 200 V to 250 V in 10-V steps. 48-Hz  
to 63-Hz line frequency, 37VA.

Tequipment is a division of Tektronix  
U.K. Ltd., a wholly owned subsidiary of  
Tektronix Inc.

Full details from Tektronix Australia Pty.  
Ltd., 80 Waterloo Road, North Ryde, NSW.

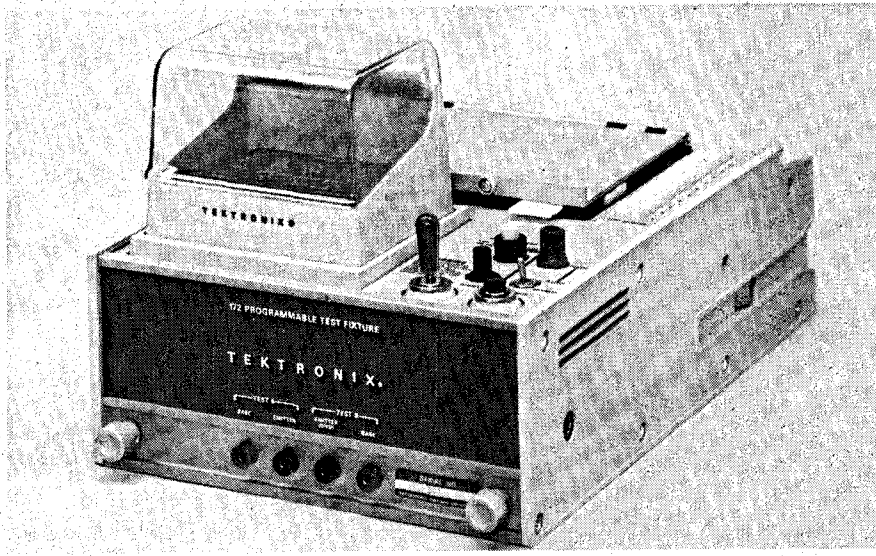

## PROGRAMMABLE TEST FIXTURE FOR SEMICONDUCTOR CURVE TRACERS

Tektronix Australia Pty. Limited announces the 172 Programmable Test Fixture, which when used with the TEKTRONIX 576 Curve Tracer, permits the operator to programme up to eleven sequential tests on FETs, transistors and diodes. This fixture saves measurement time in applications where a series of tests are to be made on a number of devices. To make the same tests without this fixture requires manual setting of the 576 controls for each particular test. This process is repeated for each test. The programmable fixture sequences through as many as eleven different tests on each device without readjusting panel controls and while the device remains in the test socket.

The 172 sequences through the various tests either automatically or manually. A variable RATE control is provided for the operator to set the test sequence at a rate which is best for him. A new operator requires more time per test, but with experience he will want to test at a faster rate. A front-panel switch or an optional foot switch advances the test in the manual mode.

Programming is straightforward. Inserting plastic pins in holes in the programming

card sets individual test conditions. Omit the pin from a particular test hole and the 172 skips that test. After installing the programme pins in the card, the card is put into the card reader portion of the 172 and the operator starts the test sequence.

Full details from Tektronix Australia Pty. Ltd., 80 Waterloo Road, North Ryde, NSW.

## ULTRASONIC CLEANER

Royston Electronics Pty. Ltd. announce a new and larger unit in the American Beauty line of industrial Ultrasonic Cleaners.

The new cleaner, Model S-90, has a foot-long, two-gallon tank and 200 watts of cleaning power for on-site cleaning of large

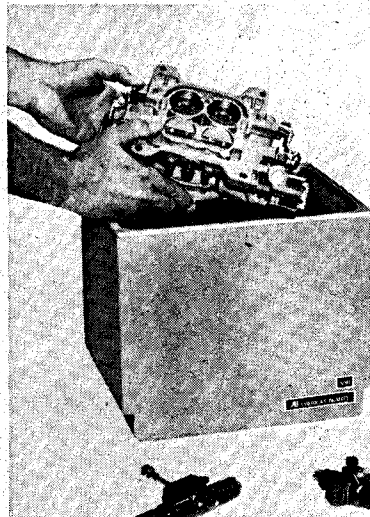

Peter Clark says I guarantee that these are

## Sydney's Five Best Hi-Fi's

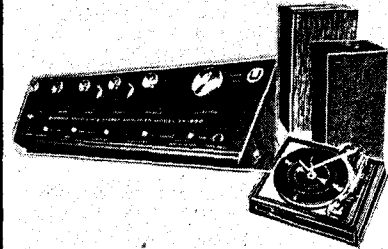

### 1. Junior Executive \$185

"Magnetic Sound's" specially made solid-state Stereo Amplifier with scratch filter and separate bass and treble. 20 watts of music with complete purity through matched "AKAI JET-STREAM" Speakers. Deposit \$19. Up to 2 years to pay.

### 2. Philips "MONACO" \$259

Completely new! CONTINENTAL AND VERY "CHIC". The amplifier! OH "LA!! LA!!" 20 watts of music power! Press-button controls. Stereo balance for tapes, records. 3-speed, dynamically balanced. Record player with independent suspension. Loudspeakers in acoustic enclosures with frequency response 20 Hz - 20,000 Hz. Deposit \$26.

### 3. "Indi-500" \$329

"Pioneer's" 44 watt solid-state integrated amplifier. Built to very high specifications. Matches Pioneer PL12 record player. Magnetic cartridge. Turntable belt driven. Two CS30 loudspeakers, separate base and treble. Deposit \$33.

### 4. Philips "ST. TROPEZ" \$460

Tastefully discreet outward design. The SOUND of the RH 590 amplifier is well known in Europe and is coupled with the GA 308 Hi-Fi. Stereo transcription record-player fitted with Philips Super M cartridge! Listening fully enjoyable at low volume. Loudspeakers 15 LITRES: bass and tweeter in each. Deposit \$46.

### 5. Tape Deck Special \$149

Nivuo 3-speed, 4-track stereo tape-deck. Handcrafted teak cabinet, dual recording controls, headphone socket, powerful drive motor, solid-state pre-amplifier. Plays and records through any radio. Deposit \$15.

Listen to Peter Clark's Tape and Hi-Fi Information Service on 2GB every Tuesday evening at 5.30 p.m., Wednesday 5 p.m.

**Magnetic Sound**  
INDUSTRIES

387 GEORGE STREET, CITY 29-3371  
One door from Kodak  
20 MACQUARIE ST, PARRAMATTA  
(Next to O.P.S.M.) 635-0830

MG3178

# NEW ALL-TRANSISTOR STEREO AMPLIFIERS WITH IN-BUILT A.M. TUNER ULTIMATE IN DESIGN— LONG DEPENDABILITY

using all silicon transistors 40 WATTS — RMS

## SPECIFICATIONS:

20 watts per channel R.M.S. Total output 40 watts R.M.S.

## FREQUENCY RESPONSE:

From 20 cycles to 20,000±1db.

## HARMONIC DISTORTION:

Less than 1 per cent at rated output.

## HUM AND NOISE:

Aux. 70db. Mag. 50db.

## INPUT SENSITIVITY:

Mag. 3mv. Aux. 200mv.

SPEAKER IMPEDANCE: 8 ohms.

EQUALISED: Mag. RIAA.

## TONE CONTROLS:

Bass, 50 c/s ± 12db. Treble 10

kc/s 12db.

## LOUDNESS CONTROL:

50 c/s 10db.

## SCRATCH FILTER:

(High filter) at 10 kc/s 9db.

## RUMBLE FILTER:

(Low filter) at 50 c/s 5db.

## PROVISION FOR TAPE RECORDER:

Record or play-back with din plug connection.

## PROVISION FOR HEAD PHONES:

With headphone/speaker switch on front panel.

## DIMENSIONS:

16 1/2 in. x 5 1/2 in. x 11 in. deep.

## TUNER:

This unit can be supplied with either valve or transistor tuner with a coverage of 530 to 1,600 K.C. Calibrated dial available for all States.

## THE CIRCUIT INCORPORATES

regulated power supply with transistor switching protection for output transistors. 26 silicon transistors plus 5 diodes are used.

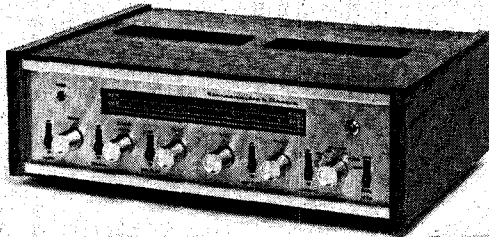

**\$134.00** Plus Freight  
(cabinet extra)

Model C300/20/T (with Tuner)



Model C400/20

**\$108.00**

Plus Freight (cabinet extra)

AMPLIFIER ONLY. Specifications as above but with the added feature of front panel switch which allows selection of two speaker systems.

Cabinets for above in teak or walnut with metal trim, \$10 extra.

### THE NEW MAGNAVOX 8-30 SPEAKER SYSTEM

COMPLETE SYSTEM: (1.6 cubic ft.) IN WALNUT OR TEAK VENEER, OILED FINISH. (Regret no mail orders for complete system.) — \$60.00.

SPEAKER KIT: (Less cabinet.) COMPRISING 1 8/30 SPEAKER, 2 3TC TWEETERS, 1 3" TUBE, 1.4 or 2 mfd. CONDENSER, INNERBOND AND SPEAKER SILK. AVAILABLE IN 8 OR 15 OHMS. \$29.50 Postage \$1.50 extra.

**CLASSIC RADIO**

245 PARRAMATTA ROAD,  
HABERFIELD, N.S.W. PHONE 798 7145

## The World's Most Versatile Circuit Building System!



Remove paper backing and place adhesive side downwards in the selected position. Press down firmly. When used with plain board drill from the 'Cir-Kit' side. Pass through component lead, bend over and cut to length. Solder in usual way.

When used with 'punched' board lay strip between rows of holes, pass component leads through holes adjacent to strip, bend the leads over the strip, cut to length and solder in the usual way. Alternatively lay strip over the holes and using a drawing pin or scribe prick a hole in the 'Cir-Kit' in the required position.

'Cir-Kit' strip can be bent or curved to whatever form you require and used on either or both sides of the board. When joining two pieces of 'Cir-Kit' bend over the end of the overlapping strip so that a metal to metal contact is made and solder in the usual way.

Made in the U.K.

SIZES: 1/8" and 1/16" WIDTHS

Length: 100 ft. roll, 5 ft. card

IDEAL FOR PROTOTYPE AND PRODUCTION CONSTRUCTION.

USEFUL FOR WIRING REPAIRS

\* NO DRILLING \* FAST \* NO MESS

Available from all leading Radio Houses

Marketed by:—

**ZEPHYR PRODUCTS PTY. LTD.**

70 BATESFORD RD., CHADSTONE, VIC. 3148

Telephone 56-7231.

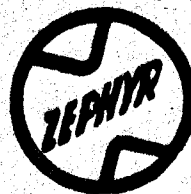

MANUFACTURERS OF  
RADIO AND  
ELECTRICAL  
EQUIPMENT AND  
COMPONENTS

# EQUIPMENT NEWS

printed circuit boards, small motors, die sets, carburetors, diesel mechanisms, etc.

The single unit design, with generator in its base, features solid-state circuitry of new technology that is claimed to eliminate radio frequency interference and hold component loading and internal temperatures at low levels.

The new cleaner carries a one year guarantee and is available with a complete line of accessories, including automatic timer.

Full details from Royston Electronics Pty. Ltd., P.O. Box 101, Doncaster, Victoria.

## OPERATIONAL AMPLIFIER TESTER

## NEW TAPE SERVICE

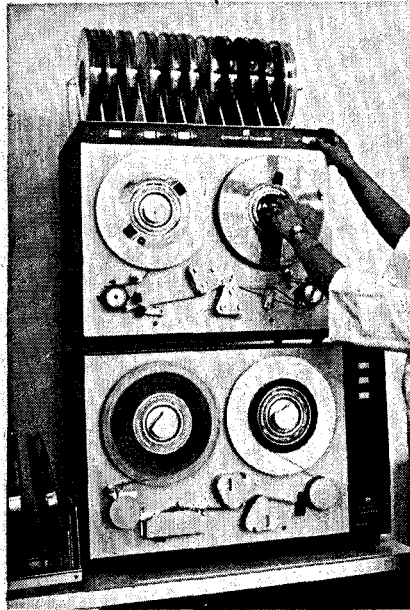

A new service offering tape cleaning, tape evaluation and reporting, tape library management and spooling is now available to computer users in Australia.

The service, operated by Total Computer Services, has been evolved in association with Memorex and Computer-Link from exhaustive studies of the needs of their clients around the world.

The company has established a 'clean room' in which the magnetic computer tape is passed through electronic cleaning equipment to remove all superficial contamination. Spools and canisters are also cleaned.

Also offered by the company is an evaluation service. This service covers edge damage, dropouts and length of tape, thus enabling the user to know the condition of the tape before putting it into service. Evaluation is undertaken at a higher threshold level to that used by the computer. This reduces fault incidences caused by dirty tapes, and ensures that all tapes are maintained to high standard.

The company states that all tapes are subsequently rewound to Industry Standard Specification and returned to the user at the correct tension.

Full details from Total Computer Services, 67 Alexander Street, Crows Nest, N.S.W. 2065.

## MULTIPLEX RECORDING MODULES

Two channels of analogue data may be recorded on a single tape track using a set of MT465 Multiplex modules developed by Electrodata Associates Pty. Ltd. Bandwidth of each channel is DC-200Hz at 7.5 ips, DC-100 Hz at 3.75 ips, and DC-50 Hz at 1.85 ips. The input level for each channel is adjustable between 0.1V and 10V peak, crosstalk is less than 1%, and signal-to-noise ratio is better than 40dB.

The modules may be used with any high



# STA

## ELECTRONICS P/L

Manufacture - Sales - Service

392 Centre Road, Bentleigh, Vic.,  
3204. Tel.: 97 4832 A.H. 97 5539

### NOW AVAILABLE - TRANSISTORISED ULTRA-VIOLET

BATTERY PORTABLE LIGHT.  
Can be used for Prospecting,  
Mineral Identification, Fluorescent  
Research, Secret Messages, Plans,  
Party Fun, etc.

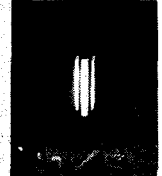
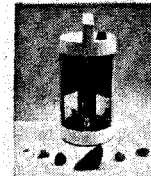

COMPLETE WITH BATTERIES  
\$49.00 inc P.P.

- Handy, compact cassette-corder with "Swing-balance" mechanism ... perfect for people on-the-go.
- Small and light ... weighs only 1lb 11oz and measures only 1-15/16" x 7x4-3/8".
- Sensitive built-in Electret Condenser Microphone.
- "Swing-balance" mechanism for keeping tape speed constant and assuring stable performance even while the unit's in motion.



You can plug this microphone into most portable tape recorders and have your voice operate the on-off switch. As long as you talk the machine will record. \$19.00.

If you have a legitimate use for a miniature microphone like reporters or businessmen, this nicely finished tie bar unit is just the thing at \$3.75.

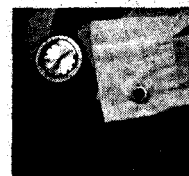

This is the jewel of them all. Gold plated cased micro miniature dynamic microphone, 50 ohm imp. with shielded 3ft. cable & 3.5mm plug. \$16.00.

Models 5104 & 5107

## Operational Amplifier Testers

Automatic & Semi-Automatic Operation  
Slow Rate Testing (5-17)  
Input-Output Flexibility for Interface with Automatic Machines  
Data Logging and Printouts  
Comparator Testing  
Test Time 3.2 Seconds (up to 16 Tests)  
Incoming Inspection  
Production Testing  
Evaluation Selection

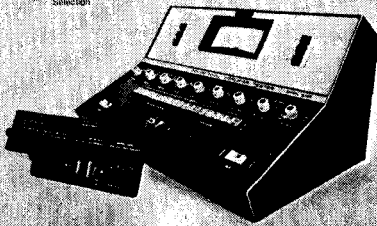

TELEDYNE PHILBRICK

The new Philbrick 8-page, 2-colour Guide to Automatic/Semi-automatic operational-amplifier testers provides circuit descriptions and diagrams for testing such parameters as quiescent current, input offset voltage, input bias current, input offset current, open loop gain, output voltage swing, common mode rejection, common mode voltage, power supply rejection and slew rate.

Discussed in terms of two new Philbrick Testers (Models 5104 and 5107), this brochure describes how testing of up to 16 op. amp. or comparator parameters can be performed in less than 3.2 seconds - automatically or semi-automatically, using precise synchronous-demodulation techniques.

Additionally, numerous types of programme cards are described that allow virtually any type of testing - incoming inspection, production, evaluation, selection and categorizing - to be accomplished in a minimum of time.

Full details from Elmeasco Instruments Pty. Ltd., P.O. Box 334, Brookvale, N.S.W.

# Adcola solves printed circuit soldering problems

Printed circuit soldering — a recognised problem area. Adcola soldering tools and tips, designed and calibrated for the job — a known answer to the problems. Adcola tools obviate delamination, track separation from substrate, dry joints, component damage and destruction, intermittent joints, poor appearance.

Adcola has a special range of tips for printed circuit work — and the precision made soldering tools to run them at the correct temperature.

Selection is simple — from our brochure. Yours for the asking.



## ADCOLA

Selection is simple; from our brochure. Yours for the asking.

**ADCOLA PRODUCTS PTY. LIMITED**

VIC.: 22 Firth St., Doncaster, 3108 (Tel. 848 3777)  
 NSW: 17 Burwood Rd., Burwood, 2134 (Tel. 747 1606)  
 S.A.: F. R. Mayfield Pty. Ltd., Adelaide (Tel. 8 4131)  
 QLD.: T. H. Martin Pty. Ltd., Brisbane (Tel. 21 5644)  
 W.A.: Everett Agency Pty. Ltd., Perth (Tel. 8 4137)

RA.7

## LANTHUR ELECTRONICS

(ARTHUR ROSENTHAL)  
 69 BUCHANAN AVENUE  
 NORTH BALWYN, VIC. 3104.  
 TELEPHONE 85-4061

### SPEED CONTROLLER —

For electric drills & other hand tools. Will vary speed from top to stop without loss of torque. Suitable for all ac/dc or brush type motors. Supplied ready to use complete with flex & plug. 2 amp. (500 watt) size. \$12.95  
 10 amp. (2500 watt) size. \$20.50 Plus postage. Vic. 0.40c Other 0.70c

### LAMP DIMMER —

Basic kit consisting of — 6 amp. triac, diac, 4 resistors, 2 capacitors, ferrite rod inductor, switch pot & knob. Complete with circuit. \$5.95 Including postage.

### AMPLIFIER —

Solid state. Complete kit of parts consisting of printed circuit board 3¼" x 2½", 4 Fairchild transistors, 5 capacitors, 6 resistors, circuit & wiring diagram. Suitable for Record Players, Intercomms., etc. Output 1.5 watts with 12 volt supply & 3.5 watts with 20 volt supply. \$6.50 Including Postage.

## TELSTAR ELECTRONICS

133 Parramatta Road, Concord (Strathfield). 2137. N.S.W.  
 Telephone. 747-2730

**All Electronic Components at Wholesale Prices.**

Sensible buying enables us to pass on the savings to you, the customer.

*Look At This Months Specials.*

Log or Lin Std Pots ..... 40c ea  
 Log Switch Pots ..... 75c ea  
 Log or Lin Gang Pots ..... \$1.45 ea  
 8 Track Cart Tapes ..... \$3.25 ea  
 C60 Cassette Tapes ..... \$1.00 ea  
 Lock Down Aerials ..... \$3.25 ea  
 2N3055 ..... \$1.66 ea  
 Stereo Speaker Boxes ..... \$10.00 pr

*Special quotes on quantity lots of all components.*

**Complete mail order service**

**OPEN SATURDAY MORNING.**

# EQUIPMENT NEWS

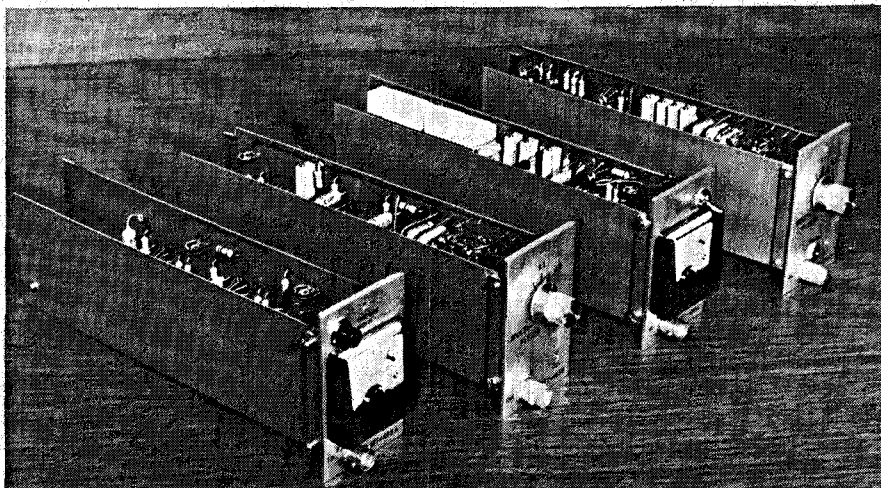

quality stereo tape deck when up to 4 data channels are desired, or with a 4 track/4 channel deck when 8 data channels are required. The modules are seen as being of particular value in the recording of physiological and other types of low frequency information. This follows since the filter characteristic of the modules has been designed so as accurately to preserve transient phenomena during the reproduction.

Using four sets of these modules coupled to an Electrodata-Sony 4 track deck, an 8 channel recording system may be built at a fraction of the cost of an equivalent 1/2 inch tape system. The modules, which are fully Australian designed and manufactured, feature the use of F.M. recording for channel A and PWM for channel B.

Full details from Electrodata Associates Pty. Ltd., 8 Barry Avenue, Mortdale, N.S.W. 2223.

## SCANNING ELECTRON MICROSCOPE

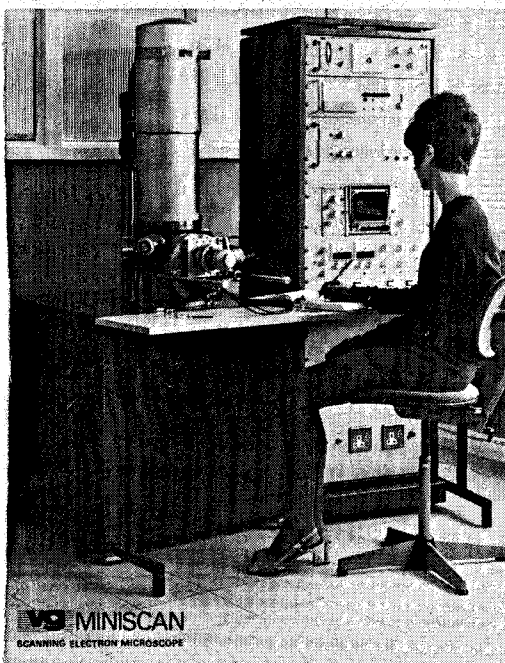

Scanning electron microscopy is a very useful technique with widespread applications in many areas of research and quality control.

To date its application has been limited by the high capital and operating costs of available instruments, often resulting in 'shared' equipment. Because SEM investigations are so rewarding, 'shared' machines are frequently overloaded, often with work where maximum magnification

and resolution is unnecessary.

A new scanning electronic microscope manufactured by Vacuum Generators Ltd, in the UK, has a resolution of 1000 Angstroms with optimum magnifications from X10 to X5000 and a minimum 2mm depth of field. It operates in the emissive, reflective and conductive modes and is claimed to be the cheapest scanning microscope currently available, providing SEM techniques to laboratories who could not previously afford them, and as a support equipment to free more costly instruments for highly specialised work.

Full details from Astronics Australasia Pty. Ltd. 161-173 Sturt Street, South Melbourne, Victoria.

## NEW PLUG-INS

Tektronix Australia Pty. Limited announces the 5A13N Differential Comparator which is a plug-in amplifier for all 5100-Series Oscilloscope systems. It incorporates a number of performance features which make it particularly versatile, especially for measurements in difficult low-amplitude, low-frequency areas. The following three operational areas describe the functions of the 5A13N.

As a conventional amplifier the 5A13N has dc-to-2 MHz or 10 kHz bandwidth over the 1 mV/div to 5 V/div deflection factor range.

As a differential amplifier it maintains its conventional features and provides a balanced input for applications requiring rejection of a common-mode signal. The CMRR is 10,000:1 from dc to 20 kHz, decreasing to 100:1 at 2MHz.

The 5A13N may be used to apply a signal

# power source

## For Every Need

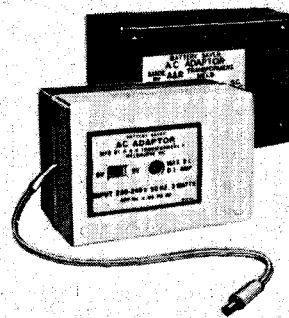

**A & R model PS64**  
for tape recorders  
and model PS82 for  
transistor radios.



**A & R model PS104**  
for larger battery-  
operated tape  
recorders.

**A & R ELECTRONIC  
EQUIPMENT CO.  
PTY. LTD.**



### SALES OFFICES

VIC: 30-32 Lexton Rd., Box Hill.  
89 0238.

NSW: 82 Carlton Cr., Summer Hill.  
798 6999.

SA: 470 Morphett St., Adelaide.  
51 6981.

### INTERSTATE AGENTS

QLD: R. A. Venn Pty. Ltd., Valley.  
51 5421.

WA: Everett Agency Pty. Ltd., West  
Leederville. 8 4137.

# IMPORTED COMPONENTS PTY LTD

BOX 1683 P — MELBOURNE, 3001.

AC125	.96	BC186	.79
AC126	.96	BC207	.72
AC187/188	2.36	BC208	.63
AC128	1.05	2N2160	2.40
AC132	1.01	2N2188	2.79
AC172	1.20	2N2270	2.40
AC187/188	2.36	2N2646	2.19
AD149	2.45	2N2647	3.15
AD161/162	4.32	2N2669	6.53
AN1102	.68	2N2926	2.25
AN1103	.60	2N3005	5.32
AN1104	.60	2N3054	1.80
AN1105	.60	2N3525	3.70
AN2001	.45	2N3563	.90
AN7102	.90	2N3564	1.08
AN7105	.68	2N3565	.86
AS147	.80	2N3566	1.01
AS148	.76	2N3567	1.08
AS208	1.46	2N3691	.86
AS301	.81	2N3692	.90
AS306	.84	2N3694	.90
AS307	.84	2N3702	1.01
AS308	.84	2N3703	.96
AS310	.99	2N3704	1.77
AS311	.96	2N3705	1.73
AS312	.93	2N3706	1.65
AS313	.92	2N3707	1.14
ASY73	2.12	2N3708	.80
ASY76	2.10	2N3716	5.30
ASY77	1.68	2N3731	3.17
AS216	3.03	2N3790	11.25
AS217	2.59	2N3819	1.77
AS218	2.91	2N3826	1.68
AS220	.98	2N4121	1.04
AS221	2.16	2N4250	1.17
AT316	.68	2N4354	1.28
AT318	.68	2N4355	1.65
AT319	.69	2N4356	1.65
AT321	.69	2N4360	1.58
AT322	.63	2SB186	1.50
AT323	.68	2SB407	3.30
AT324	.68	2SB474	3.30
AT325	.83	2SD150	1.50
AT331	.92	2SF28	5.60
AT337	.69	3N140	2.55
AT338	.70	3N141	2.34
AT341	.70	AA119	.36
AT350	1.14	AB1101	1.20
AT1138	2.66	AB1102	.87
AX1101	1.53	AC107	2.28
AX1103	1.70		
AX1104	1.86		
AX1108	1.86		
AX1127	1.50	AY1101	.31 ea.
AX1130	1.50	AY1103	.51
AX1131	1.77	AY1104	.70
AX1132	1.50	AY1110	1.03
AX1142	1.20	AY1112	.57
AX1143	1.58	AY1115	.45
AX1144	1.44	AY1116	.45
AX1166	1.37	AY1117	.45
AX6168	1.98	AY1120	.63
AY1102	1.04	AY1121	.63
AY1108	1.65	AY8110	2.55
AY1113	.69	AY8111	2.55
AY1119	.60	SE1001	.31
AY6108	1.66	SE1002	.52
AY6109	1.65	SE1010	.57
AY8108(8103)	3.75	SE4001	.44
AY8109(8104)	3.00	SE4002	.51
AY8112	6.75	SE4010	.58
AY8135	5.40	SE7001	2.76
BA100	.44	2N3053	1.53
BA102	1.46	2N3055	1.26
BA114	.39	2N3568	.63
BC107	.83	2N3569	.67
BC108	.76	2N3638	.56
BC109	.91	2N3638A	.71
BC147	.76	2N3640	.93
BC148	.68	2N3641	.57
BC149	.79	2N3642	.77
BC157	.89	2N3643	.71
BC158	.76	2N3644	.77
BC159	.89	2N3645	.96
BC177	.91	2N3646	.69
BC178	.84	2N3693	.31
BC179	.92	EM404	.22

### SPECIALS

PLEASE ENQUIRE FOR ANY TYPES  
NOT LISTED  
SPECIAL QUOTES FOR 100 LOTS.

IMPORTED COMPONENTS  
PTY LTD  
BOX 1683 P — MELBOURNE, 3001.

# THE rustrak PRIVATE EYE

Rustrak Miniature Recorders chart voltage, current, power, temperature, pressure, strain, events; or virtually any parameter that can be converted into an electrical signal. Inkless, drywriting, rectilinear recording with wide range of sensitivities, writing and chart speeds. Quick, easy chart review and re-wind. Sliding access window. Rugged die-cast aluminium case in epoxy suede-like charcoal gray finish.

63" chart roll — one month's supply at 1" per hour. Portable or for panel mounting as a system component. Accuracy  $\pm 2\%$  of full scale. Only  $5\frac{3}{8}$ " high,  $3\frac{3}{8}$ " wide,  $4\frac{1}{8}$ " deep. Weighs  $3\frac{1}{2}$  lbs. Combine any two functions on one chart in our new Dual 300 Series.

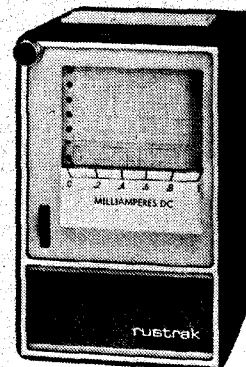

Model 288

TECNICO ELECTRONICS



53 Carrington Road, Marrickville, N.S.W. 2204. Tel. 55 0411  
2 High Street, Northcote, Vic. 3070. Tel. 489 9322  
211 Flinders Street, S.A. 5000. Tel. 23 3979  
97 Merivale Street, South Brisbane, Qld. 4101. Tel. 4 1571

TE5932

## VARIABLE POWER SUPPLIES

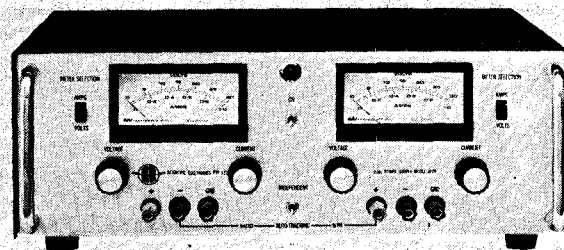

- Single and Dual Outputs
- Output Voltages to 60 Volts
- Output Current to 2 Amps
- Excellent Line and Load Regulation
- 0° to 60°C Operating Temperature
- Ten Turn Controls
- Constant Voltage/Current Limit
- Constant Voltage/Constant Current

SCIENTIFIC ELECTRONICS PTY. LIMITED

42 Barry Street, Bayswater,  
Vic. 3153. Phone:  
Melbourne 729-3170; Brisbane 47-4311;  
Adelaide 77-1325; Perth 21-6146

# EQUIPMENT NEWS

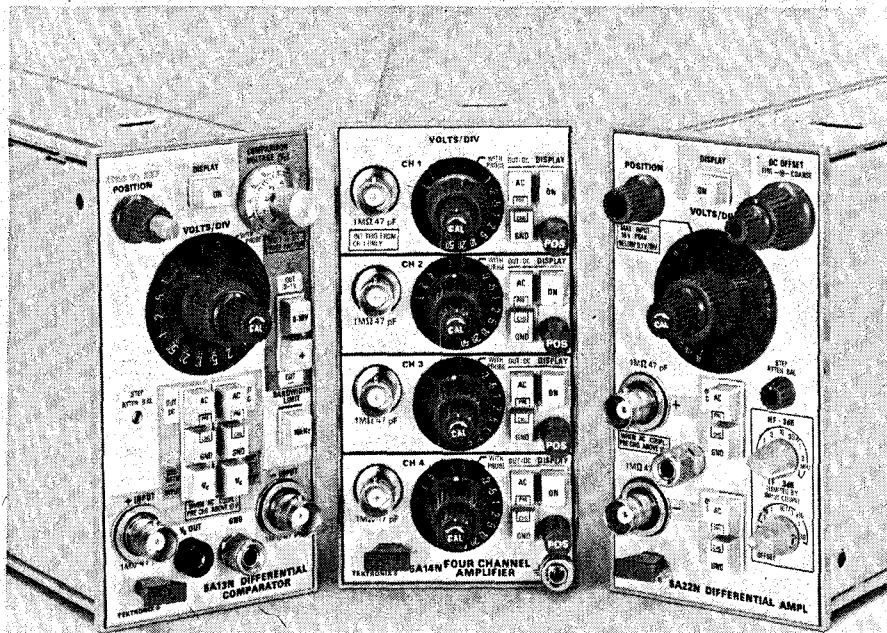

of up to  $\pm 10$  volts to either input with the deflection factor set at 1 mV/div. The signal may then be viewed in 10,000 1-mV increments by offsetting the signal with the opposing comparison voltage.

The 5A14N Four Trace Amplifier is a solid-state amplifier for use in the 5103N Oscilloscope. Four identical channels with simplified controls have deflection factors from 1 mV/div to 5 V/div, with bandwidth at least 2 MHz at all deflection factors. The 5A14N may be used in any combination with any other 5100-Series Plug-in. For instance, two 5A14N Amplifiers provide eight traces; one each 5A14N and 5A15N Amplifiers provide five traces. Each amplifier may be used in the 5103N horizontal plug-in compartment for X-Y operation.

5A14N operating modes are each channel separately, and alternate or chop between any combination of channels. Internal trigger is available from channel one only or from each displayed trace.

The 5A22N Differential Comparator is a differential amplifier for use with all 5100-Series Oscilloscope systems. Significant performance features are 10  $\mu$ V/div to 5 V/div deflection factors, dc-to-1 MHz bandwidth, selectable HF and LF -3 dB points, common-mode rejection ratio of 100,00:1 at  $\mu$ V/div dc coupled, and a dc offset feature with  $\pm 0.5$  V range from 10  $\mu$ V/div to 50 mV/div and  $\pm 50$  V range from 100 mV/div to 5 V/div.

Full details from Tektronix Aust. Pty. Ltd., 80 Waterloo Road, North Ryde, NSW 2113.

## AC FLUXMETER

A new British fluxmeter is for research, development, and design work involving the measurement of alternating magnetic flux in closed magnetic circuits such as toroidal cores and laminated transformers.

The standard unit, which is complementary to most probe-type gauss meters used for magnetic circuits, enables a variety of measurements to be made at frequencies in the 50-1600 Hz range and is suitable for a core-size range of .0015 in. <sup>2</sup> to 0.4 in. <sup>2</sup> cross-sectional area.

The signal is derived from the pick-up or turns on the circuit being measured and the six measurement ranges (one pick-up turn) are from 3 to 10<sup>3</sup> u-Webers (300 to 10<sup>5</sup> Maxwells or 0.3 to 100 kilolines).

The measuring range can be extended by using more pick-up turns on smaller cores, or by an external attenuator on larger cores.

A terminal for oscilloscope connection is provided for the qualitative examination of the flux waveform.

Power supply is from 30V internal batteries, input impedance is 10 kilohms, and accuracy is plus/minus 2 per cent full scale deflection. Unit dimensions are: width 11 $\frac{1}{4}$  in. depth 10 $\frac{1}{2}$  in., height 7 in. Weight 13 lb.

Full details from Control Technology Ltd., 44 Meeching Road, Newhaven, Sussex, England, U.K.

## "OXFORD"

radio chassis . . .  
instrument cases . . .  
engraved & printed panels

## "MINI BOXES" (Aluminium)

Any kind of metalwork  
such as

switchboards

rack & panels

F.E.T. Four Input  
Mixer Sept. '71.

light or  
heavy work

Laboratory Power  
Supply Nov. '71.

send us  
your plans &  
let us quote

manufacturer of  
'CONTINENTAL'  
electric ranges

HEATING SYSTEMS  
PTY. LTD.

19-21 The Boulevard  
Caringbah. 2229  
Phone 525-5222

(4 lines)



# COMPONENT NEWS

## NEW PATCH CORDS

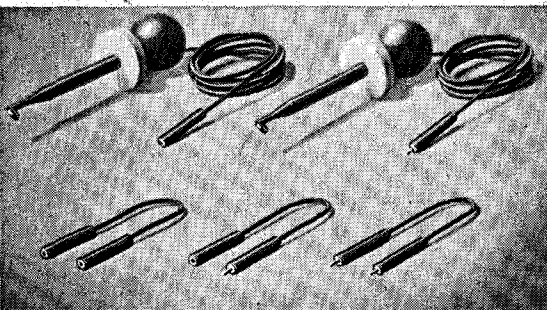

AP Incorporated, announces the addition of a complete line of patch cords ideally suited for breadboarding and trouble shooting. These patch cords are available with any combination of pin-plugs, sockets, and E-Z Hook terminations.

Pins are made in two sizes — .019" dia. and .030" dia. Mating sockets accommodate pins and square wrap posts in sizes .019/.028 and .028/.035. E-Z Hooks will clip onto posts or wires up to .050".

All cords are No. 26 AWG stranded wire with PVC insulation and incorporate rugged, integral, strain reliefs. Metal parts are gold plated.

Various lengths from 2 to 15 inches are available. Colour choices are red, yellow, blue, and black.

These patch cords are compatible with AP Breadboards, Terminal Strips, Super-strips, Distribution Strips, Test Clips, and Miniature 8-Pin Connectors as well as standard .025" square wrap posts.

Full details from Aureima Pty. Ltd., 549 Pittwater Rd., Brookvale, NSW 2100.

## DUAL POWER DRIVER SUPPLIES SIX AMPS TO LOAD

High current loads can now be driven by logic circuitry, using the Motorola MCH 2890, dual power driver rather than using more complex discrete circuitry. This new device translates logic voltage levels to high power outputs. Either DTL or TTL logic levels may be used to control the device and loads can be either resistive or inductive.

Many applications such as hammer-drivers, paper tape punches, relay drivers, stepping motors, and lamp drivers require high current pulses that are digitally controlled. The new device provides this interface in a single package replacing an IC and two Darlington transistor packages.

The MCH2890 combines a dual 2 input M TTL AND gate similar to the MC3101 and a pair of Darlington power transistors in a hybrid design to provide up to 6 amps at 10% cycle and 25 ms pulse width. Continuous output current is 1 A maximum.

The output Darlington transistors have 120 V minimum  $BV_{CEX}$  ratings, which is

desirable for driving inductive loads at high current. The maximum rating  $V_{CE(Sat)}$  at  $I_C = 6 A$  is 2.5 V.

A factor which has hampered IC drivers in the past was package power dissipation. A new 10-pin aluminium package similar to the popular TO-3 was designed for the MCH2890. Besides the power handling capabilities of the TO-3 package, it was also chosen because of its longtime popularity as the standard industrial power package. The package thermal resistance is  $6.0^{\circ}C/W$ .

Full details from Motorola Semiconductor Products, Suite 204, Regent House, 37-43 Alexander Street, Crows Nest, NSW 2065.

## SINGLE-CHIP SERVO

The Electronics Department of Ferranti Ltd. is now offering as a standard item a pulse proportional integrated servo system on a single chip. Although the device was developed originally as a specific custom design for use in the radio control of models, Ferranti have made this move in order to take advantage of the great potential in industrial control systems which has been created by designing a more sophisticated version of the original system.

This new standard servo amplifier is based on a Digilin device embracing linear and digital functions on a single chip. The circuit operates on input pulses and provides output pulses directly related to the input pulse width, allowing accurate proportional control of the system, with a total error factor of better than  $1^{\circ}$  of rotation.

The servo system has a low duty cycle capability allowing time division multiplexing of several channels. The voltage supply of  $\pm 2\frac{1}{2}$  volts, combined with low current consumption, makes adequate allowance for battery operation.

Full details from Ferranti Ltd., Electronics Department, Gem Mill, Fields New Road, Chadderton, Oldham, Lancs. England.

## NEW SCHOTTKY DIODE

A new Schottky diode from Hewlett-Packard has a lower turn-on voltage than any other silicon diode. At a forward current of 1 mA, the junction voltage is only 340 mV. This compares with 700 mV for conventional silicon PN junction diodes and 410 mV for earlier Hewlett-Packard Schottky-barrier diodes, and is comparable to germanium diodes. The new diode however, has much better temperature characteristics (operating range:  $-55^{\circ}C$  to  $+125^{\circ}C$ ) than germanium diodes.

Turn-on voltage is important to circuit designers because of its effect on mixer and switching circuit performance. The low turn-on voltage of the new diode is advantageous in UHF mixer service because it reduces cross-modulation, and hence improves signal-to-noise ratios. It is

important for clamping circuits and low-level switches since offsets introduced by the diodes are lower. Turn-on remains low at current levels above 1 mA, increasing to only 450 mV at 10 mA.

The new diode (Hewlett-Packard type 5082-2835) also has the fast recovery time ( $<100$  ps) characteristic of Schottky-barrier diodes. This too is important for UHF mixers and for fast-switching circuits. Junction capacitance is only 1 pF at 1 MHz and zero bias.

The diodes, epitaxially grown and passivated, are manufactured in a planar batch process that achieves excellent uniformity from diode to diode, as well as low cost. Because of the high uniformity, diode performance can be predicted more accurately, simplifying circuit design. Where diodes must be matched, as in balanced mixers, the uniformity eliminates the need and expense of selecting diodes.

The low turn-on voltage was achieved with a proprietary formulation of the metal used to form the Schottky barrier with the semiconductor. The trade-off is in the breakdown voltage, which is 5 volts, adequate for low-level mixers and most logic circuits. This compares to 10 – 70 V for other Hewlett-Packard Schottky diodes.

The new Hewlett-Packard type 5082-2835 Schottky diode is in a miniature glass package.

Full details from Hewlett-Packard Australia Pty. Ltd., 22-26 Weir St., Glen Iris, Victoria.

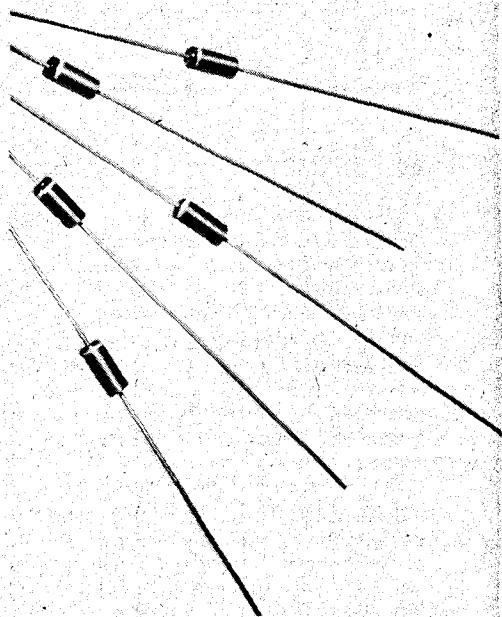

# ATTENTION ALARM INSTALLERS

## SIMPLIFY YOUR INTRUDER ALARM PROJECTS

Allow us to supply professional equipment at reasonable prices.

Due to mass production we can offer quality equipment freeing you to devote your time to the heart of your intruder system i.e. the application and installation.

Contact us for information on Pressure Mats, Bells, Magnetic Reed Switches, Control Systems, Timers, Photo-Electric Beams, etc.

## SECURITY ENGINEERING PTY. LTD.

SUPPLIERS TO THE SECURITY INDUSTRY

182 GEORGE ST., PARRAMATTA, NSW.  
2150. PH: 635 6550 -- 635 6468.

# We train radio enthusiasts who want to become experts

## Stotts

ET272

TECHNICAL CORRESPONDENCE COLLEGE

159 Flinders Lane, Melbourne, 3000. 383 George St., Sydney, 2000.  
290 Adelaide St., Brisbane, 4000. 45 Gilles St., Adelaide, 5000.  
89 St. George's Terrace, Perth, 6000. P.O. Box 3396 Singapore 1.  
Please send me, free and without obligation, full details of your  
courses in Radio For Amateurs.

Mr., Mrs., Miss.....

Address.....

Age.....

No sales counsellor will call

We can make you the person to whom people will look to when they have a radio problem. We can help you become an expert in the theory and practice of modern radio, or we can give you the know-how to get an Amateur Operator's Certificate.

Either way, you're making the most of your interest in radio by taking a Stott's correspondence course.

**Radio for Amateurs Course:**  
From radio basics, to intricate principles. Receiver design and construction. Latest techniques in electronics. Everything you'll ever need to know, made easy to understand by top radio engineers.  
**Amateur Operator's Certificate:**  
Gives you the background knowledge and the skills you need to pass the PMG exams and get your Certificate of Proficiency.

## UNITED TRADE SALES P/L

280 LONSDALE STREET, MELBOURNE, 3000  
PHONE 663-3815 (Opposite Myers)

**COMPUTER RACKS** — 28½" x 28½" x 71". Square Tube 1½" Cad. Steel. All members are bolted together and can be made to various size racks. Double B/Bearing slide rails. Price \$30 ea. Racks are dis-assembled for transport. Freight Forward.

**POWER TRANSFORMERS** — BRAND NEW, Primary 230 Volt AC-Sec. 26-0-26 volts 280 ma-Sec No.2 90 volts. Size 2½" x 2" x 7/8". Only 1-50 ea. P/P 50 cents.

**SPECIAL** — CURLY CORDS, 25 cents ea. P/P 15 cents.

### MULTIMETERS —

	Sensitivity DC	Sensitivity AC	PRICE
C-1000	1,000 o/v	1,000 o/v	\$6.75
CT500/P	20,000 o/v	10,000 o/v	\$17.75
AS 100D/P	100,000 o/v	10,000 o/v	\$34.50

Add 60 cents for pack/post.

**POWER SUPPLIES**, 35 volt, 5 amp, C Core Transformer and Filter Choke 5-10,000 uF 50 volt electrolytics Transistor Regulator voltage adjustable. Size 21" x 7½" x 7½". Weight approx. 25 lbs. Price \$35.00. Freight forward.

**POWER SUPPLIES**, 12 volt, 5 amp, same specifications as 35 volt model. Weight approx. 18 lbs. Price \$25.00. Freight forward.

**SPECIAL: ERIE** 1 watt 5% High Stab. Resistors and 2 watt 1% and 2% Mixed 1 and 2 watt, \$1.50 per 100. P/P 40 cents.

**3,000 TYPE RELAYS**. No specific coil resistance supplied. 50 cents ea. P/P 30 cents.

**PIANO KEY SWITCHES**. 6 keys, 4 sections with 6 changeovers. \$1.00 ea. P/P 40 cents.

**SILICON DIODES**. 100 P.I.V.-145 amps. \$4.50 ea. P/P 40 cents.

**CAPACITORS**. Mixed values Mica and Ceramic. Poly bags, \$2 per 100 P/P 30 cents.

**SPECIAL. HIGH IMPEDANCE HEADPHONES**, 2600 ohms. Hurry, limited number only at this price, just \$2.50. P/P 50 cents.

**VALVES** — 6J6, 30 cents ea. ATS 25-807, 50 cents ea. 6J7, 60 cents ea. 6SL7GT, 60 cents ea.

**SPECIAL ELECTROLYTICS**. 75 uF 10 volt working, upright printed circuit type. 10 cents ea. P/P 6 cents.

**CAPACITORS**. 33 uF 400 volt DC working, printed circuit type. 10 cents each. P/P 6 cents.

**VHF Converters**, Aircraft Band 108 Mhz-136 Mhz. Just place alongside your Broadcast Radio and set dial in a clear spot between 600 Khz and 1000 Khz, then do tuning on converter dial. No connecting wires are needed. Converter operates from 9 volt transistor battery. Price \$14.65. P/P 45 cents.

**RELAYS** — 6 volt miniature 280.ohm coil \$1.20. P/P 25 cents.

**COMPUTER MODULES**. Contain 2.12AU7 and 1% Resistors. 40 cents ea. P/P 20 cents.

**DENSHI CONSTRUCTION KITS**, no soldering required. There are 16 Projects, including Transistor Radio, Morse Code Oscillator, Continuity Tester, Signal Injector, Transistor Wireless Microphone, Transistor Reflex Radio and numerous others. These kits are priced at only \$11.50. P/P 80 cents.

**ELECO ELECTRONIC KIT No. 9**. 20 Projects, no soldering or tools required. This kit includes a Solar Cell. Projects include Transistor Radio, Transformer coupled with 2 Transistor Radio, Shortwave Radio, 2 Transistor Intercom, 2 Transistor Audio AMP, Signal Tracer, Wireless Microphone, Audio Oscillator, Microphone, included in kit. **SPECIAL PRICE** only \$16.50. P/P \$1.00.

ALL PRICES SUBJECT TO ALTERATION WITHOUT NOTICE

Wanted to buy — Test Equipment  
Transmitters, Receivers, etc.

# AUDIO NEWS

## SOUND DUNE

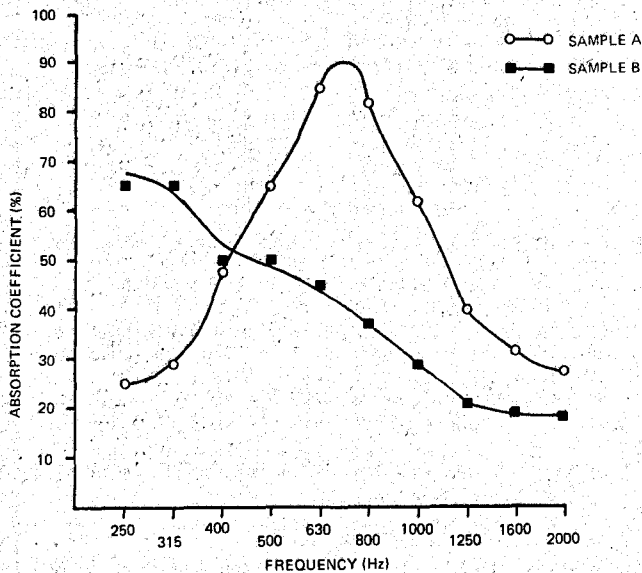

**SAMPLES:** A. Composite absorber consisting of foam plastic front layer (thickness 1/8 in.), an intermediate layer and foam plastic backing (thickness 1/2 in.).  
B. Composite absorber consisting of foam plastic front layer (thickness 1/8 in.), an intermediate layer and a mineral wool back layer (thickness 1 in.).

A new soundproofing material called 'Sound Dune' has been introduced by the Acoustics Projects Division of Angus and Coote. The material consists of thin flexible sheet lead, sandwiched between two layers of foam plastic.

The material has a number of uses including the sound proofing of walls, ducts, machinery etc. It is also extremely effective in reducing feedback between loudspeakers and turntables.

## SHARP ELECTRONICS IN AUSTRALIA

The Sharp Corporation of Osaka, one of the oldest names in Japanese electronics, has set up its own wholly-owned company here to market electronic products throughout Australia and neighbouring countries.

The Australian head office is at 22 Burrows Road, St. Peters, N.S.W. Phone: 519-5522.

Resident director of the parent company and General Manager in Australia is Mr. Jiro Nakata, Mr. Warren Pegg (formerly with Olms Consolidated Ltd. in charge of Sharp products distribution) is Assistant General Manager and spokesman. Mr. Peter Thorpe is Marketing Manager.

The company, which employs 20,000 people in its several factories in Japan, has a staff of over 70 people to commence its operations in Australia.

Mr. Nakata says that the Australian organisation will also be Sharp's regional headquarters in the South Pacific covering Fiji, New Zealand, Tahiti, New Guinea and other major South Pacific areas.

Sharp Electronics has set up its own offices in capital cities and appointed agents in Canberra, Newcastle, North Queensland, Tasmania and western N.S.W.

It will also offer full service facilities in all States.

## FERROGRAPH MAKE SPEAKER

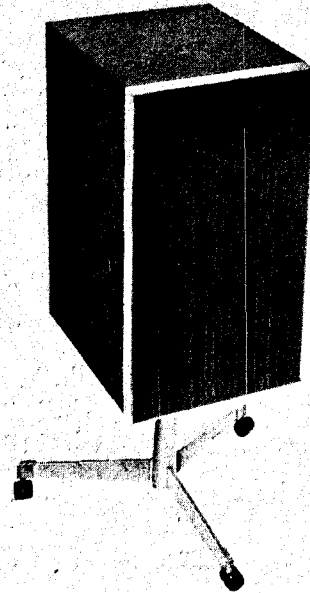

The UK's Ferrograph organisation, best known for their range of professional and domestic tape recorders, have entered the field of loudspeaker manufacture.

The first loudspeaker to be manufactured by the company is a bass reflex unit, designed by Bradford University's A. R. Bailey, and based on a KEF B139 bass, and Goodmans mid-range and treble drive units.

A smooth extended bass response is claimed for the new enclosure, due, according to the manufacturers, to a reflex port lined with a special long-fibre wool. (We have a recollection of a similar system - called the resistive reflex method - some years ago - Ed).

## NEW AM TUNER

Few people realise that AM broadcasting both in Australia and New Zealand is of a very high technical standard, with a flat frequency response to 10 kHz and a very low level of distortion.

Surprisingly good reproduction can be obtained provided one lives in an area where reception is reasonable - and uses a tuner of above average quality.

An AM tuner specifically intended for high quality sound reproduction has been produced by Wright Audio Developments of Cammeray in NSW.

The company's new tuner - the LDT3A is claimed by the manufacturer to be the first tuner that is capable of taking full advantage of our excellent AM sound quality. A precise ac/dc converter replaces the more normal diode detector and this together with operational amplifiers has resulted in distortion figures that are claimed to be very considerably lower than those normally obtained from conventional tuners.

Noise and static, usually a major limitation to AM reception has, it is claimed, been reduced by a balanced, shielded antenna.

Bandwidth of the tuner is 20 kHz and an active filter has been incorporated to remove the otherwise annoying 10 kHz interstation beat notes.

ELECTRONICS TODAY is currently arranging to publish a full product review on this interesting new unit. In the meantime full details may be obtained from Wright Audio Developments, 3 Rowlinson Parade, Cammeray, NSW.

# JOIN THE TAPE REVOLUTION 'TDK-SD' IS HERE!

(\*SUPER DYNAMIC)

Professional quality recording tape praised the world over.  
Tape recorders are . . . "dramatically improved"  
says Consumer Guide, U.S.A.

"Significantly different performance from other tapes that  
we have tested" says Electronics Today, Sydney.

**THE TDK STORY** In 1932, TDK's founders invented a new class of materials, ferrites, that became the basis of the entire magnetic recording industry. Today TDK is an International Company with more than 5,000 employees in Japan, U.S.A., West Germany and Taiwan, maintaining TDK's leadership in audio, video and computer grade tapes.

**'SD' SUPER DYNAMIC CASSETTE TAPE** The tape that turned the Cassette into a High Fidelity Medium.

Gamma Ferric Oxide, an exclusive TDK high resolution, high efficiency magnetic formulation, has made it possible to achieve fidelity in the cassette medium that could previously be obtained only with reel to reel decks.

The surface of SD tapes is almost mirror smooth, which combined with special binders and lubricants has all but eliminated head wear. The tape offers the following features:

Frequency response from 20-30,000 HZ • Increased output level • Minimum distortion • Expanded dynamic range • Lowest noise, best signal-to-noise ratio • High reliability jam proof cassette construction • Polyester Base.

**'SD' SUPER DYNAMIC REEL TAPE** Engineered for the next generation of tape recorders, TDK Super Dynamic tape on open reels is capable of dramatically improving the performance of old recorders of modest quality. With reasonably good home equipment, it can produce professional, studio quality results 20-30,000 HZ.

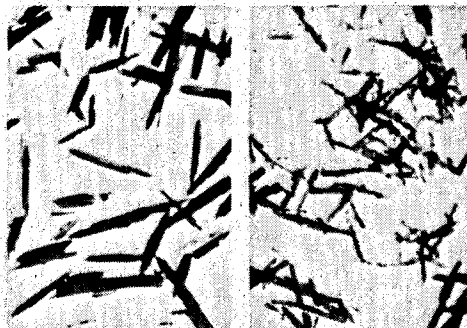

(left) Ordinary magnetic particles, magnified (right) SD-tape microfine particles of Gamma Ferric Oxide exclusive to TDK, also magnified.

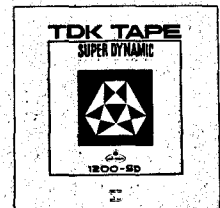

Size available:  
7" 1200' & 1800'  
10" NAB 3600'  
C60, C90, C120,  
C180.

## OTHER TDK TAPES AVAILABLE

DIGI-Pack Computer Cassettes • Endless tape cassettes (3 mins, 6 mins, 30 sec. and 90 sec.) • Video and Computer tapes • Bulk packs. All tapes are Polyester based.

## SOLE AUSTRALIAN AGENTS

CONVOY IMPORTS, 1 Maclean St., Woolloomooloo, Sydney, 2011.  
Phone 357-2444.

## AUDIO LEADS

A comprehensive range of audio leads and adaptors is now being marketed in an attractive transparent package.

The range includes mini, RCA, PMG and DIN speaker plugs and sockets; these are now available through leading wholesalers, hi-fi, stereo and music shops.

Approximately eighty different types are available ex-stock but the manufacturers, Swe-check Instruments, East Bentleigh, Victoria, will quote for bulk supplies or make up special leads to specifications.

Special introductory kits including display boards are also available on request.

## SONAB IN AUSTRALIA

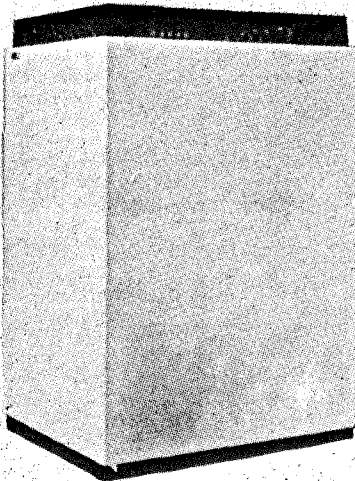

Sonab of Sweden Pty. Ltd., 114 Walker Street, North Sydney, a subsidiary of Sonab AB of Stockholm, will be releasing its range of Carlsson omni-directional loudspeakers on January 1, 1972.

This range of loudspeakers, designed by a Professor of Acoustics from the University of Stockholm, and covered by four world patents, is available in a choice of eight finishes.

To compliment the loudspeaker is a Sonab designed transcription turntable together with the American Clark headphones.

During the past 2½ years Sonab AB has established companies throughout Europe and the United Kingdom and the formation of the Australian company makes yet another step forward in their world-wide expansion programme.

## NEW BRUEL AND KJERR ANALYSER

During a recent lecture given to the British section of the Audio Engineering Society, John Kuehn of Bruel and Kjerr described a real time analyser recently developed by his company.

Signals under observation are amplified via a bank of separate 1/3rd octave filters and rms detectors, whose outputs are scanned sequentially and then displayed digitally. Variable scaling rates enable the measured frequency response to be displayed at various decay time rates, thus allowing the study of transient phenomena.

The new instrument may also be used, in conjunction with a digital computer, for impulse analysis. Other applications include reverberation time curve display, tape recorder wow and flutter indication, and many other specialised functions.

Please send me further information on "TDK-SD" Super Dynamic tape.

Name . . . . .

Occupation . . . . .

Address . . . . .

Postcode . . . . .

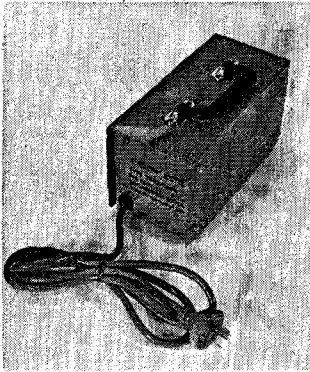

Step-down transformer

# FERGUSON Transformers Pty Ltd

MANUFACTURERS OF:— \*TRANSFORMERS \*FLUORESCENT LIGHTING BALLASTS \*MERCURY VAPOUR CONTROL EQUIPMENT \*SODIUM VAPOUR CONTROL EQUIPMENT \*NEON TRANSFORMERS \*OUTPUT TRANSFORMERS \*TRANSISTOR OUTPUT \*TRANSISTOR DRIVER \*MATCHING TRANSFORMERS \*GENERAL PURPOSE \*FILAMENT TRANSFORMERS \*LOW VOLTAGE TRANSFORMERS \*SPECIAL PURPOSE \*FILTER CHOKES \*STEP-DOWN TRANSFORMERS

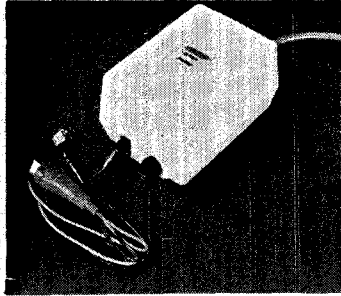

12V, 1½ AMP battery charger

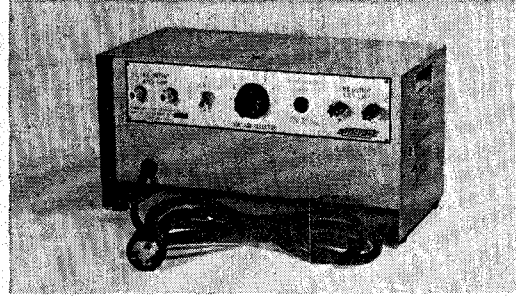

A.C./D.C. variable power supply used by N.S.W. Dept of Education in school science laboratories

Ferguson products are available from electrical and radio wholesalers and  
**HEAD OFFICE — 331 High St., Chatswood. Phone: 40 0261**

## AGENTS

**TAS.**  
 Associated Agencies Pty Ltd  
 25 Barrack St.  
 Hobart, 7000.  
 Phone: 2 1843

**A.C.T.**  
 Errol Nazer Pty Ltd  
 84 Barrier St.  
 Fyshwick, 2600.  
 Phone: 9 0325

**QLD.**  
 Keith Perty & Co Pty Ltd  
 Waterloo St.  
 Newstead, 4006.  
 Phone: 51 5461

**W.A.**  
 H.J. McQuillan Pty Ltd  
 107 Wellington St.  
 West Perth, 6005.  
 Phone: 21 4821

**S.A.**  
 K. Farmer Sales Pty Ltd  
 49a Whitmore Sq.  
 Adelaide, 5000.  
 Phone 51 4488-9

**VIC.**  
 Ferguson Transformers Pty Ltd  
 181-183 Hawke St.  
 West Melbourne

# KEEP INFORMED



with Australia's most-read motoring magazine

**modern MOTOR**

**OUT NOW! All newsagents**

# RECORDINGS... CLASSICAL

REVIEWERS: John Clare,  
Christopher Wagstaff, John Araneta.



**J. S. BACH — CONCERTO TRANSCRIPTIONS — Triple Concerto in D Major (from BWV 1064)** Helmut Winschermann (oboe) Hans Jurgen Mohring (flute), Georg Frederick Hendel (Violin) German Bach Soloists conducted by Helmut Winschermann **Oboe d'amore Concerto in A major (from BWV 1055)** Violin Concerto in G minor (from BWV 1056) Saschko Gawriloff (violin), Frankfurt Bach Orchestra conducted by Theo Egel. Three Centuries of Musik (Barenreiter/Oryx) 3C 307.

One is often wary of transcriptions from keen musicologists — more often than not they sound *just* experiments, fun though they might be. True, there have been fine achievements — one might recall Ravel's incredibly brilliant arrangement of Mussorgsky's "Pictures at an Exhibition" or J. S. Bach's beautiful arrangements for organ of a few Vivaldi concertos, but both Ravel and Bach were composing musicians, not musicologists.

Well, here we have transcriptions of three of Bach's harpsichord concertos. Fascinating-listening: one acquires a new (or clearer) awareness of the different lines of the three harpsichords in BWV 1064 and also of the melodic qualities of the solo lines (if this is necessary) in BWV 1055 and 1056. But there are bound to be problems — for instance, what is going to happen to the left hand harpsichord configurations or those difficult quasi-bravura passages so suited to the harpsichord? Well, the left hand configurations are either omitted (especially if the instrument is playing on its own) or else the 'cello doubles (which often means playing its own part and the harpsichord part simultaneously). Also, the solo instruments often rest during orchestral interludes (especially if the first violin doubles as against the continuous use of harpsichord, although surprisingly, I think a harpsichord *is* used in these interludes (rather distant sound though).

Pitch is another problem when transcribing — one is bound to run out of notes

especially with the oboe or flute. In this case some of the passages are transposed (this is indeed questionable) or the violin plays them (these include the bravura passages in BWV 1064) so that one really "loses track" of what "harpsichord" is playing in the Triple Concerto. Certainly it is true that Bach himself reconstructed (not arranged) works for different instruments — the harpsichord concerto (BWV 1056) is a reconstruction (and a development?) of an earlier flute concerto but does one think of both works as BWV 1056? Perhaps, but I have always thought of them as "concerto for harpsichord" and "concerto for flute". Nonetheless as far as *these* transcriptions are concerned the Oboe d'amore Concerto and the Violin Concerto "come off" with more promise than the rather eclectic rendering of the Triple Concerto.

The playing on the other hand is simply first class. The soloists are all admirable performers, especially oboist Helmut Winschermann who in the Triple Concerto also conducts. The two orchestras (of which the Frankfurt Bach Orchestra is the slightly smaller) consist of a fine body of eminent musicians and make a splendid sound, both in balance and timbre, for Bach. The harpsichord is, however, as I have suggested, a little too indistinct — perhaps it would have been better omitted. Ornamentation is abundant and always quite apt.

A disc certainly worth acquiring even if it is just for the quality of performance. C.M.W.

**LISZT — SONATA IN B MINOR — Benediction De Dieu Dans La Solitude; Waldesrauschen; Gnomenreigen.** Claudio Arrau (piano) PHILLIPS 6500 043.

One wonders whether even Liszt could have acquitted himself on this Sonata in such a way that the work would seem neither prolonged boredom nor and a mere vehicle for unbelievable pyrotechnics.

Like the man, this Sonata seems only too often sham and pretention.

The 1933 Horowitz recording? If not sham (though remarkable) it certainly is irritatingly mannered. Brendel (TURNABOUT) certainly delivers an unassuming reading but grand it certainly is not: one wants more.

Difficult to accept even today that Liszt the man was also genuine, but then it is not perhaps surprising if once in a while one encounters a performance of this Sonata that is also an experience of rare nobility. Such a performance the deleted Fleisher recording was, but we must always be watching for another such.

A great-pupil of Liszt, Arrau has at last come to record the Sonata. The pianism on

this record is breath-taking. Arrau is certainly grand in the way Romantic pianists were grand. This is large-scale playing such as one seldom hears today. Arrau elicits remarkable gradations of tone from his instrument and his rubatos are unquestionably of the highest order. But it seems to me precisely those marvellous rubatos that keep this performance from being noble. One senses affectation, mannerism in those pauses, ever so slight an urge for show. Others may disagree and in lieu of the Fleisher I certainly would not be without this recording because it does come close to what a B minor Sonata can be. And what playing!

Performances of the other Liszt pieces on this record are fine indeed. One gets less of the feeling of affectation here or else mannerism may suit these pieces of far less depth than the Sonata.

PHILIPS' recording is in every way superb and I have seldom heard a more powerful and lifelike piano sound on disc. — J.A.A.

**BERLIOZ — LELIO (THE RETURN TO LIFE) OP. 14B — Jean-Louis Barrault (Lelio), John Mitchinson (tenor), John Shirley-Quirk (baritone), London Symphony Orchestra & Chorus, John Aldiss (chorus master), Pierre Boulez (conductor) CBS SBR-235444.**

Berlioz's sequel to his *Symphonie Fantastique* is not quite an unknown quantity to record collectors. Still at times available, is an early LP recording made by Leibowitz for VOX. Nor is this Boulez recording exactly new. Long available as part of a two record set with the *Symphonie* this recording did at least serve to draw attention to one of Berlioz's least known works and also illustrated well (granting the validity of Boulez' thesis) the composer's need for gestures, for drama.

But I doubt if even a more intense, less analytical performance can convince me that Lelio is anything more than puerile self-indulgence. And it is just as well we do not play this embarrassing sop after the *Fantastique* or we may find ourselves wondering whether Berlioz, despite current popularity is not, in fact, just brilliant bathos. Boulez, at any rate, delivers a cool and correct reading, an obviously inappropriate interpretation. Either this piece is played for all it is worth, or it better not be done at all. Mitchinson and Shirley-Quirk take their cues from Boulez and are also otherwise rather in uncomfortable voice for Berlioz's admittedly difficult writing. Barrault delivers his lines in very civilized fashion, hardly evoking the romantic Lelio/Berlioz. A very curious reading indeed. The recording is good enough. — J.A.A.

# you only have to take one a year



**RECORDS**

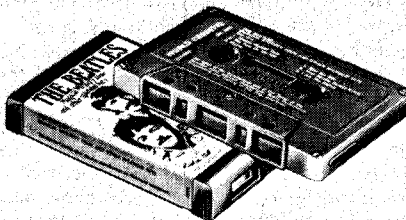

**CASSETTES**

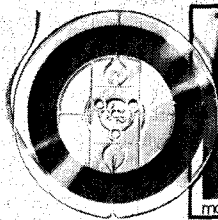

**REEL-TO-REEL TAPES**



**CARTRIDGES**

Whether it's records, cassettes, 8-track cartridges or reel-to-reel 7½ or 3¾ stereo tapes, World Record Club has much to offer you in all kinds of music — classical, light and pop! And you only have to take one a year — one record or cassette or cartridge or tape. Records are \$3.39, cassettes are \$4.00, cartridges \$4.75, tapes \$4.25 and \$5.25 . . . you enjoy massive savings, whatever your choice. Send for details without obligation via the coupon below. There's no entrance fee, no catch, no hidden conditions. You order only what you want — and are sent only what you order.

**TO: WORLD RECORD CLUB,**  
177 Elizabeth Street, Sydney, 2000  
299 Flinders Lane, Melbourne, 3000

Please send me without obligation details of:

- RECORDS       REEL-TO-REEL TAPES  
 CASSETTES     8-TRACK CARTRIDGES

NAME Mr. Mrs. Miss .....

ADDRESS .....

POSTCODE .....

## REVOLUTIONARY BULK BUY AT CUSTOM ELECTRONICS

304 NEW SOUTH HEAD ROAD,  
DOUBLE BAY, N.S.W. PH: 36 2560

### 36 watt PACKAGE — \$160 —

CUSTOM Amp. w/Mag. Cart. Garrard w/lowering dev. Two-8" 2-way spkrs.



### 50 watt PACKAGE — \$221 —

CUSTOM Amp. w/filters Garrard w/hyd. low. mag. cart. Two-8" 3-way spkrs. ("MIDI").

New "Upright" Base

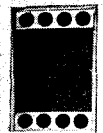

### 75 watt PACKAGE — \$377 —

AWA Orthofidelity Amp. Garrard w/hyd. low. mag. cart. Two-12" 3-way spkrs. ("2001").

"2002" 12" 3-way 25W RMS

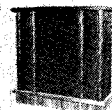

### 80 watt PACKAGE — \$431 —

PIONEER SA600 Amp. Garrard New SL72B syncrolab Giro arm & Pickering Cart. Two-12" 3-way spkrs. ("2001").

15" Ultimate 5 element 50W RMS

**MUSIC MAKER** — the magazine for all with an active interest in music. From newsagents or by post, 30c, from Music Industry (Magazines), Box 4526, GPO, Sydney 2001.

## EDGE ELECTRIX

SPECIALISTS IN ELECTRONIC PARTS AND EQUIPMENT

OPEN 8.30 AM TO 5.30 PM  
MONDAY TO FRIDAY —  
8.00 AM TO 12 PM  
SATURDAY & SUNDAY

25A BURWOOD ROAD  
BURWOOD, 2134 N.S.W.  
PHONE: 747-2931

### FULL RANGE OF:

Capacitors — Resistors — Potentiometers  
— Semiconductors — Tuning Condensers  
— Transformers — Speakers — Valves —  
Switches (Rotary, Slider, Toggle, etc.) —  
Bezels — Batteries — Stylus — Tape  
(B.A.S.F.) — Cassettes — Flex — Soldering  
Irons — Relays — Plugs — Sockets  
— Terminals — Tag Strips — Tagboard —  
Matrix Board — Copper Clad Board —  
Etching Material — Rectifiers — Cases —  
Chassis — T.V. Aerials — Cable — Fuses  
— Jacks and Jack Plugs and Kits.

### COMPLETE MAIL ORDER SERVICE

All goods available at competitive prices. Please write or ring for a quote . . .

# CLASSICAL



**VIVALDI. "L'AMOROSO" DGG Stereo 2530 094 Berlin Philharmonic conducted by Herbert von Karajan. Concerto for Violin, Strings and Continuo in E major, PV 246; Sinfonia in B minor; Concerto for Violin, Strings and Continuo in D major, PV 208; Concerto for Strings and Continuo in G major, PV 143; Concerto for Strings and Continuo in D minor, PV 86; Concerto for 2 Violins, Strings and Continuo in A minor, PV 28.**

It is hard to predict whether it will prove to be an unfortunate decision for the sales of this recording to have led off with the Concerto in E major (subtitled L'Amoroso) of whether it will indeed have the popular appeal for which the cover — a photo of lovers, in a lush green field, blurring romantically beyond them, and stamped in one corner with the following: "contains theme featured in Elvira Madigan" — would appear to be designed.

The performance of this first piece (I presume it was the one featured in Elvira Madigan) conspired with the marketing approach to lead me to believe quite wrongly that this recording would not be for me.

L'Amoroso is played by a string orchestra somewhat larger than that for which Vivaldi would have written it. The playing in the first movement is slightly uncoordinated, particularly at the beginning, adding to the rather amorphous effect. The solo violin plays behind the beat, to no great expressive effect, and the lower strings are definitely out of tune in their playing of the ritornello towards the end. You cannot blame me for thinking that the recording showed promise of being a disaster.

But this was not to be. Henceforth Karajan pulls his players together and gets a series of performances which illustrate Vivaldi's virtues quite strikingly.

The larger orchestra enhances the grandeur and strength of many of Vivaldi's ideas, and increases interest in the plangent chromaticism which Vivaldi often employed on the cadences. One can see clearly why Bach based some of his works for three or more harpsichords and orchestra on themes from Vivaldi. They were precisely what was needed to provide stepping stones for the listener through the profound milky way of Bach's complex developments. Vivaldi's

development is, of course, often somewhat stodgy in its predictable formality, following inevitably the movement of the harmony to its all too logical conclusion. Similarly, Vivaldi's soli often seem like exercises in taking a single idea through as many routine transpositions on a chord as time will allow.

If one is inclined to laugh and say, 'Here he goes again' during some of the solo passages, one is soon silenced by the power of an orchestral motif. The Sinfonia evokes the burial of Jesus with a minor lament which is both tearing in its confrontation with the reality of death and ethereal in its contemplation of the attendant mysteries. The Concerto in D major, subtitled "Disquiet", displays a certain eccentricity, crankiness even, of musical thought: the ominous heavy gallop of the first movement, the slow motion dervishing in the Largo; but this is almost the crankiness of a William Blake, and the disquiet expressed here is a profound unrest of the spirit.

Above all, this recording is full, or nearly full of glorious sound. The very grand and full string tone is well reproduced, with perhaps a shade less edge than some would have preferred. The cembalo could have been more prominent without being obtrusive. — J.C.

**WEBER-OBERON — Grobe, Nilsson, Domingo, Prey, Hamari, Schiml, Auger Kubelik (cond.), Chorus & Orch. of the Bavarian Radio. 3-DGG 2720 035.**

In his notes on the recording, Wilfred Daenicke leaves us wondering what DGG's Oberon actually consists of. This recording, of course, does not present the opera in any versions with newly composed recitatives, but as this recording is sung in German we do not naturally get Planche's "Old English" dialogue but we do get a "version" of the dialogue by Friedrich Schreyvogel and Oscar Fritz Schuh in the arrangement published by Bohme & Co. (Vienna). Whether this means merely or mainly a translation of Planche, mostly new dialogue, Daenicke does not say. As to what music was used, he is just as uninformative. We are told the "music" is taken from Weber's original score (Robert Lienau edition) with No. 20 "Rondo" omitted and "Preghiera" from Appendix I included. But the "sung words (chorus and soloists)" (sic) are based on the Reclam vocal score. Does this mean merely the German translation in this vocal score is used or are the amendments to the music in this score also utilized? To top it all, Daenicke is convinced from the start about the impossible dramatic structure of the libretto, saying that even stereo-effects would not have made the action intelligible, hence DGG's brilliant decision to have the fairy Droll also act as narrator. Whether or not this retouching of the dialogue helps the action, it seems strange to have Franz Willnauer also claiming elsewhere that "in this age of comic strips and action films" (yuck!) "audiences would surely be more

prepared than in the past to accept stage action full of improbabilities" and that "this recording will . . . etc." and may promote stage production.

Many admire Weber's score and more will always have mixed feelings about Planche's libretto but inasmuch as these records preserve after all these years a very well played and sung performance of Oberon, surely a more consistent and sympathetic introduction would have been more useful. And surely both Daenicke and Willnauer do not seem to have the imagination to wonder whether the gramophone record would not be more suitable a medium than the opera hall for precisely such a libretto as Oberon. Oberon is after all not nearly as "fantastic" as certain Baroque operas. DGG was, unfortunately, of the same mind as Daenicke and Willnauer and stereo effects are very rigidly eschewed. Surely, it would not have been amiss to include some sound effects, or at least a horn call in-say, Act II scene I when Huon paralyzes his assailants by blowing on Oberon's magic horn. All in this scene is narrated by Droll and because precisely there is no sense of stage excitement Sherasmin's awakening of Fatima directly after seems quite uneventful and the action disjointed. Whether the scene is a storm at sea or one with pirates one can hardly tell but for narration. But mere narration cannot achieve continuity nor help suspend our disbelief. Oberon may be a string of episodes but not of tableaux. If anything this recording proves that a straight concert reading such as this one hardly suits Oberon and cannot convince us of its viability as stage nor excite us much whatever beauty we may find in the score.

Never mind. As least we have finally received a more than listeneable Oberon. Kubelik's performance is to my mind one of his finer achievements. The delicate transparency of Weber's score is obviously to his taste and he does convey its magic. All his singers are usually more than competent. Birgit Nilsson (Rezia) may at her first appearance be quite vocally inaccurate but she warms up to her part while "Ozean, du Ungeheuer!" is brilliant. Perhaps the only exceptionable member of the cast is Placido Domingo (Huon). There are times when he seems uncomfortable not I think because his part is difficult (it is) but rather it seems unfamiliar to him. On the other hand, Hermann Prey (Sherasmin), Julia Hamari (Fatima), Marga Schiml (Puck), and Arleen Auger (mermaid) all suit their roles and sing well with Donald Grobe (Oberon) giving the finest performance of the set. Ensembles are especially a joy to hear. A pity, however, that DGG has chosen a somewhat disinterested cast of speakers and worse still, their voices have little resemblance to their singing counterparts. For a more exciting Oberon we will have to wait, one with sound effects and real sense of drama. Perhaps we should have it in English this time? And let us hope that the producer of that set will remember that Oberon is not just a descendant of Mozart's Abduction but more of the spectacular English masque and King Arthur.

Fine if somewhat smooth and distant sound. — j.A.A.



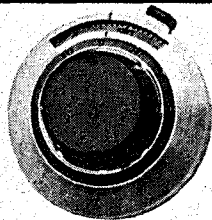

## MULTI-TURN DIALS

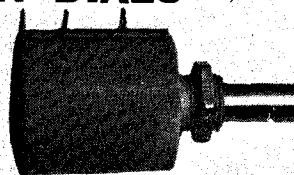
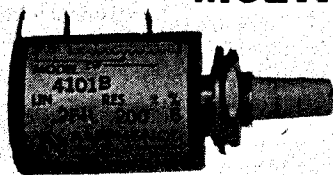

## SINGLE AND MULTI-TURN POTENTIOMETERS

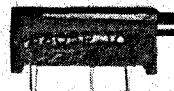
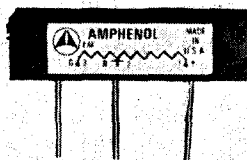

## SINGLE AND MULTI-TURN TRIMPOTS

A FULL RANGE OF CERMET AND WIRE WOUND POTENTIOMETERS WITH ASSOCIATED DIALS AND HARDWARE ARE AVAILABLE EX STOCK FROM:

# ELMEASCO INSTRUMENTS PTY. LTD.

P.O. Box 334, Brookvale, NSW and P.O. Box 14, St. Kilda South, Victoria

Tel.: Sydney 93 7944 — Melbourne 26 1552

ADELAIDE — Phone 64 3296 BRISBANE — Phone 71 3366

### NEW IMPORTED STEREO TURNTABLE AND PICK-UP



240V. AC Operation

3 speed turntable with ceramic stereo pickup counter-balanced tubular arm, \$7.90. Base in teak or walnut, \$5.50 extra. De Luxe Base... \$8.50. Post 50c, or \$1.00 with Base. Turntable and motor separate... \$4.50 Pick up arm and cartridge... \$3.50

At last a breakthrough in the cost for high quality portable radio transceivers of the walkie-talkie hand-held type. We are introducing and offering for sale a fully PMG approved

### MIDLAND 1 WATT TRANSCEIVER

for 27,240 kHz operation with switch provision for two additional channels, tone call signal, background noise squelch control, battery voltage indicator, steel case with separate cover, good for five miles distance communication under average field conditions, with penlite cell-batteries for



ONLY \$39.95 PER UNIT, FULLY GUARANTEED  
Postage extra.

### FET FOUR INPUT MIXER

AS FEATURED IN SEPTEMBER "ELECTRONICS TODAY"

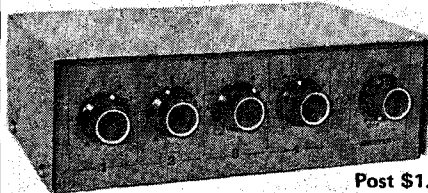

COMPLETE KIT OF PARTS AS SPECIFIED CASE & COVER IN BAKED ENAMEL FINISH

Post \$1.00 \$24.75

### NEW RANGE OF RESISTORS CONDENSERS & POTENTIOMETERS

The resistors are mainly I.R.C. and Morganite and are in a wide range of values from 100 ohms to 3 meg. in 1/2, 1 and 2 watt and include wire wound. LIST PRICE \$9.00 per 100. OUR PRICE \$2.00 per 100. Post and packing 35c extra. The condensers are in most popular brands and include Polyester, Paper, Mica, Ceramic and Electrolytic in values up to 8mfd. LIST PRICE \$11.00 per 100. OUR PRICE \$2.00 per 100. Post and packing 65c. The pots, are all current types and include switch pots, and dual concentric, tandem, tab pots, etc. LIST PRICE \$12.00 per dozen. OUR PRICE \$2.50 per dozen. Post and page 60c extra.

### NEW GARRARD RECORD PLAYER

Three speed turntable with "Sonatone" ceramic pickup mounted on grey metal base plate with automatic stop. \$15.50. Post and packing NSW — \$1.00; Interstate — \$1.50.

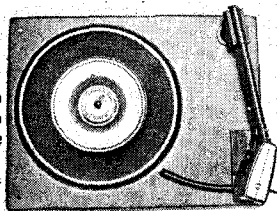

### MAGNAVOX WIDE RANGE TWIN CONE SPEAKERS

8 or 16 ohms V.C. Post & Packing 65c.

6 WR MK V 12 Watts rms \$9.90  
8 WR MK V 16 Watts rms \$10.75  
10 WR MK V 16 Watts rms \$11.50  
12 WR MK V 16 Watts rms \$12.50

**SPEAKER SPECIAL**  
Imported Tesla 8" Speakers. 8 ohm imp. \$4.75. Post & Packing 65c.

# NATIONAL RADIO SUPPLIES

332 PARRAMATTA ROAD, STANMORE, N.S.W. PHONE 56-7398

# RECORDINGS... JAZZ

REVIEWER: John Clare.



**Stan Getz. The Very Best Of Stan Getz.** Verve Stereo 2304 024. *Manha De Carnival, So Dance Samba, Menina Flor, O Pato, Trains And Boats and Planes, What The World Needs Now, Desafinado, O Grande Amor, etc.* With Gary Burton, Luiz Bonfá, Maria Toleda, Charlie Byrd, Jobim, Laurinda Almeida, Chick Corea.

Stan Getz first made his mark in the Woody Herman band of 1947 as part of that famous sax section known as the four brothers. He had always been impressed by the light singing quality of Lester Young's tenor playing, and in turn impressed many tenor players — and alto players too, such as Paul Desmond, I shouldn't wonder — with the rather remote and lovely solo he played on a Herman recording of *Early Autumn*. Lester Young was to say to him, shortly before Lester died, "You are my singer", a tribute which moved the younger man very deeply.

Later, Getz was to play more aggressively, in a conscious attempt to move away from the cool sound, almost without vibrato or reedy overtones, which had brought him to prominence. On ballads he even showed some tonal similarities to John Coltrane.

It would be extremely interesting to have a recording which traced the development of Getz's style, one which included his *Early Autumn* solo as well as tracks from recordings he made with Chet Baker, JJ Johnson and Dizzy Gillespie. Such a recording might more accurately be called the 'Very Best Of' than the one under review. This recording is confined to Stan's Bossa Nova period.

Getz plays here with a lean, and often quite edgy sound, and even manages to strike out with stinging effect over the simultaneous shuffle and lilt of the Bossa Nova. However, he rarely takes a very long or a very adventurous solo, and is usually content to paraphrase the melody.

This is very pleasant and occasionally exciting music. Just forget the 'very best of' tag.

Gary Burton, whose name is quite prominent on the cover, can be heard only on *Manha De Carnival*, and he is rather badly recorded. The recording balance is often less than brilliant. — J. C.

**CHARLIE MINGUS — Pithycantropus Erectus.** America, Stereo, 30 AM 6109 *Erectus, Peggy's Blues Skylight, Love Is A Dangerous Necessity.* Mingus, bass; Charles McPherson, alto sax; Bobby Jones, tenor sax; Jacki Byard, piano; Dannie Richmond, drums, Eddie Preston trumpet.

It is almost a relief to review a Mingus recording without having to drag out all the superlatives. This is not an earth shaking record, but it is quite a satisfying one. Superb musicians not trying terribly hard, producing the kind of relaxed jazz you might hear on Arch McKirdie.

*Pithycantropus Erectus* takes up all of side one, but do not be put off if you are averse to long 'raves'. This is all very disciplined, and sections of doubled tempo smooth harmonised theme statements alternating with brief somewhat wilder collective improvisations, plus solos by all except Richmond and Mingus sustain interest throughout without ever stirring up much excitement. The theme is a very simple bluesy one, in fact little more than a series of chords held for two bars at a time by the wind instruments while the rhythm section walks buoyantly, carrying as it were a long pole of wind sound, mounting with it to a level a semitone above and carrying it again, and so on.

Mingus, Byard and Richmond play beautifully together, and it sounds as though the soloists, rather than using the rhythmic foundation as a springboard, decided to just relax on it for a change. McPherson's performance is far removed from his long howling solo on *Mingus At Monterey*. One of the few altoists who have been able to capture the spirit of Charlie Parker in their playing, he doesn't sound at all like Parker here, even when playing a Parker phrase. He plays quite nicely at a low, for him, level of intensity and invention.

Preston has a nice clear brassy sound and he plays mostly simple declamatory blues phrases with a few more fluid passages. Byard plays the best solo on the record, full of humour and strength. Jones is interesting. A white man, he would have to be pretty good to be hired by the rather angry Chaz

Mingus. He gets a big, slightly hollow sound, reminiscent at times of Roland Kirk's river barge sound on tenor, and he has obviously been influenced by contemporary players such as Shepp, perhaps Joseph Jarman, but like the others he is taking it easy here.

*Peggy's Blues Skylight*, contrary to the name is a melodic theme over a ballad chord sequence, with rather a West Coast feeling. Everyone plays the changes with sensitivity, particularly Byard who is overflowing with invention within a fairly restrained context. I've always felt that it was a mistake to dismiss the so-called West Coast school as an aberration having little to do with jazz. Mingus himself played with West Coast musicians for quite a while, and the influence is obvious here, but then so is that of Thelonius Monk.

*Love Is A Dangerous Necessity* is a showcase for trumpeter Preston. His sound is very brilliant here. I like the way he makes his notes break out as though they are too big to be contained by the instrument, the same feeling that Lee Morgan gets. However, his concept seems a little old fashioned for a Mingus sideman. McPherson's solo has hardly begun before it is arbitrarily cut off. Seems they just ran out of record. Sound is good and clear, bearing in mind that this is a low priced recording. — J.C.

**BENNY GOODMAN — 'Benny Goodman Today'** Decca DDS 3, Stereo. *Let's Dance, Sweet Georgia Brown, Stealin' Apples, Sing Sing Sing, Don't Be That Way, Willow Weep For Me, Big John's Special, Body And Soul, A String of Pearls, Poor Butterfly, Blue Skies, One O'Clock Jump etc.* (Double Album).

If your copies of the Carnegie Hall concerts are wearing out, do not despair — replace them with this double album and you'll hardly notice the difference, because Benny Goodman Today sounds exactly like Benny Goodman circa 1938.

This album records a performance in Stockholm by a band which Benny recruited, so I understand, in England. The charts are generally very similar to the originals — indeed, I haven't checked them but I imagine that many are not altered at all — and the band, with the exception of the rhythm section, play them EXACTLY as they would have done in the thirties.

*Willow Weep For Me* is an exception. Never a Goodman tune so far as I know, the lovely ballad is here debased by a weird attempt on the part of arranger and the

# SPECIAL: RF POWER TRANSISTORS

BLY 89 25 Watts output at 175 Mhz with 13.6v Supply. Only \$9.00 each.  
 2N 3927 15 Watts output at 175 Mhz with 13.6v Supply. \$4.00 each.

**SOLID STATE** 2 metre A.M. Receiver Kit 9 FETs, 5 Diodes, Double Conversion, Noise Limiter, Audio Amplifier, Electronic Tuning, Fibre Glass Printed Circuit Board.

**SPECIFICATIONS:** Frequency 144 MHz to 145 MHz. Sensitivity .3uV for 6dB S/N at 50 ohm. Audio Output 1 Watt into 8 ohm. Price \$48.00.

## INTEGRATED CIRCUITS AND TRANSISTORS

SN7490N	\$2.60	BC107/108	\$0.70
SN7441AN	\$2.85	BC109	\$0.75
SN7475N	\$2.45	2N3645	\$1.20
SN7400N	\$0.85	2N3642	\$1.20
SN7410N	\$0.85	2N3568	\$1.20
SN7472N	\$1.45	2N3055	\$1.50
SN7473N	\$2.20	2N3819	\$0.80
T1S88	\$1.00	AD140	\$1.00

Light Emitting Diodes \$1.20 each.

100 UF 500 Volt	\$1.50
1000 UF 100 Volt	\$1.00
25,000 UF 25 Volt	\$3.00
40,000 UF 10 Volt	\$2.00
35,000 UF 15 Volt	\$2.00

## VALVES

6E58 \$1.00 - 12DQ7	\$1.50
2E24 (12 Volt 2E26)	\$2.00

## SPECIAL

2 Watt Carbon Resistors Mixed Values - \$1.50 per bag of 250

## CERAMIC TRIMMERS. SCREWDRIVER ADJUST

15 pf. 50c each  
 50 pf. 50c each.

# WAYNE COMMUNICATION ELECTRONICS

757 GLENFERRIE RD. HAWTHORN. 3122

TELEPHONE: 81-2818

## ACOS

## REPLACEMENT LONG LIFE CARTRIDGES

Acos 90 Series - a family of pick-up cartridges covering all the main types needed today, each fitted with Diamond Stylus at no extra cost.

GP91-1 MONO CRYSTAL Stereo Compatible	\$6.95
GP91-2 HIGH OUTPUT MONO CRYSTAL Stereo Compatible	\$6.95
GP92 MONO CERAMIC Stereo Compatible	\$7.55
GP93 STEREO CRYSTAL	\$8.55
GP94-1 STEREO CERAMIC	\$8.95
GP94-5 STEREO CERAMIC FOR TRANSISTOR AMPLIFIERS	\$9.95

TECHNICAL DATA SHEETS SENT FREE ON REQUEST

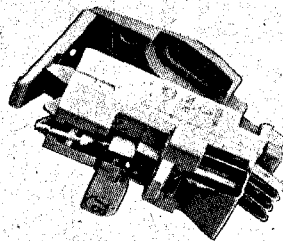

fitted with  
**DIAMOND**  
 Stylus at no extra cost

Sole Australian Agents:

**AMPLION (A'SIA) PTY. LTD.**

29 Majors Bay Rd., Concord,  
 Sydney, N.S.W. Phone: 73 1227

## CLEARANCE SALE

### ELECTRONIC EQUIPMENT AND COMPONENTS

Receivers, transceivers ex-Army & Citizens Band transmitters, test equipment, oscilloscopes, sig. generators, multimeters, chassis racks, panels, computer parts & boards, power transformers up to 6.6KV, valves, transistors, potentiometers, etc., speakers, amplifiers, cables - hook/up & coaxial 50 & 70 ohm, multicore up to 50 core. Panel meters, AVO meters, valve testers and all types of electronic components.

7,000 sq. ft. of electronic gear, plenty of parking come and inspect. Open 10-5 p.m. weekdays, 9.30-12 Saturday. Wanted to buy receivers, transceivers, electronic equipment & components. Top prices paid.

#### SPECIAL THIS MONTH

No. 62 transceivers Army type 1.6 to 10M/C 12 Volt operation price \$39.50. 50 ohm coaxial cable 1/2" diam. new price 45c yd.

#### HAM RADIO (DISPOSAL BRANCH)

104 Hightett Street, Richmond, Vic. 3121. PHONE: 42-8136.

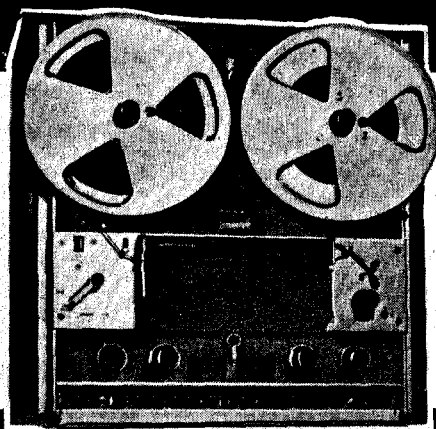

THE ULTIMATE...

# FERROGRAPH

SERIES SEVEN D

with  
**DOLBY B NOISE REDUCTION SYSTEM**



Sole Australian Distributors

**Leroya Industries PTY. LTD.**

266 Hay Street, Subiaco. 6008. W.A.

# JAZZ

exhibitionist trumpet soloist to turn it into a declamatory blues. Most of the other performances are less offensive than funny. Big John's Special is a priceless period piece. You can just see them dancing to it with a stiff jerky strut as though pumped along by their rigid arms clamped down at their sides, hands clasping suddenly switching direction with a violent action befitting store window dummies galvanised by some diabolic occurrence as the brass suddenly increases volume with that 'I'm gonna GRAB you!' feeling of comic opera menace. Oh, boy! Goodman fans will love this.

Benny himself is as ever the Frankie Laine of the clarinet. He tries so hard to break everything up, and he is certainly not without feeling but nothing happens, because he has no ideas; he swings in his fashion, but it is just not enough: without ideas it is all bluster and undirected energy. I love his sound whether pure or gritty, and he is a superb technician, but I have no idea how anyone could have mistaken this for good jazz.

None of the soloists is particularly distinguished, but the trumpeters are positively bad. One keeps throwing in Harry James' corniest devices, in an attempt I suppose to get into the spirit of things.

Benny Goodman's version of the Mozart clarinet concerto is still the highest selling performance in England. In my opinion that is where Mr. Goodman's talents lie. This album is beautifully packaged and recorded. Goodman fans will love it. — J.C.

**DUKE ELLINGTON.** New Orleans Suite. Atlantic SD 1580, stereo. Blues For New Orleans, Bourbon Street Jingling Jollies, Portrait Of Louis Armstrong, Thanks For The Beautiful Land On The Delta, Portrait Of Wellman Braud, Second Line, Portrait Of Sydney Bechet, Aristocracy A La Jean Lafitte, Portrait Of Mahalia Jackson.

This recording qualifies as a collector's item without the benefit of antiquity and before one has even heard the music. I hope it turns out not to be the case but this could be the last suite Ellington will write. It contains what was unfortunately the last solo of the late Johnny Hodges, and it represents a looking back by Ellington at the very roots of his music.

What a fascinating and rewarding view of New Orleans it is! There are no traditional jazz reconstructions — which is a bit of a shame: a contingent from the Ellington band played beautiful 'mouldie' jazz at Newport in the Fifties — but the spirit and the atmosphere of old New Orleans as one feels it through the reminiscences of Louis Armstrong and Jelly Roll Morton — the unique blend of subtropical languor, rich raucous passion, French elegance syncopation, musical rivalry and miraculous empathy — are expressed in solo and orchestral terms.

Bourbon Street features Norris Turney on flute — an instrument hardly typical of New

Orleans jazz — over a gliding sonorous flow of trombones, flugelhorn and bass clarinet, in a slow fluid rhythm something like a samba. Yet this exotic, languid mysterious piece achieves exactly Ellington's aim, which was to write "a rhythmic tone parallel to the excruciating ecstasies one finds oneself suspended in, when one is in the throes of the jingling rhythmic jollies of Bourbon Street."

Turney is again featured on Portrait Of Mahalia Jackson, through which run, not inappropriately, rock and roll triplets. Thanks for the Beautiful Land On The Delta, also has a Latin feeling in the rhythm, and Stanley Dance does not mention in his excellent cover notes the similarity of this to the sort of rock beat he holds in such contempt! Ellington, unlike his more fanatical devotees, has never been above absorbing elements of current musical trends, though it is true that the seeds of everything that has happened in popular music and jazz have always existed in Ellington's work. Harold Ashby's hoarse fervent cries on tenor over the ensemble in the abovementioned piece are most stirring.

Again, we have Wild Bill Davies on electric organ, an instrument that did not even exist in the earliest days of jazz, on Blues For New Orleans. I must admit, though, that this track seems to me the least relevant to the New Orleans theme. Sure, it's a fine rocking blues, and the blues were essential to the development of New Orleans jazz, but there is nothing about it which makes it more suitable than a lot of other fine blues performances. However, it's great stuff and it does have Johnny Hodges' last solo, which is a good strong one, though not a great one — let us not pretend.

The closest approaches to reconstruction are in the tracks Second Line and Portrait of Louis Armstrong. The first has some beautiful clarinet descant in traditional style by Russell Procope, over romping, charging ensembles. Portrait catches exactly the spirit of Louis, both in the playing of Cootie Williams, and in the ebullient theme. Cootie has the most massive trumpet sound of anyone, including Harry Edison. The feeling of ponderous weight is increased by his penchant for playing his notes very broadly (giving an impression at first of ineptitude) but with maximum attack. Whitney Baillieaut, an American writer who generally irritates more than somewhat, wrote that Williams expresses a percheron emotion, and I must admit that he hit it on the head that time. It is also very much an old man's grand passion. One is pulling with him as he labours in the trough between beats; one feels rewarded as he emerges magnificently on the crest like a galleon in full sail. Take note of his elephantine but inexorably swinging coda over Joe Benjamin's ostinato bass. That is really Louis.

My copy has a lot of surface noise, and I think that in many cases the soloists could have been recorded more prominently but this should not deter Ellington collectors. This is not the greatest of Ellington's suites, but there is a great deal of lovely and exciting music here. J.C.

## Alex Encel's column

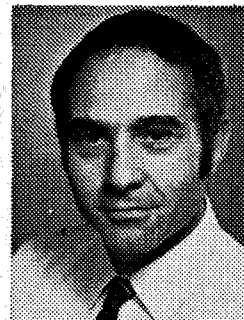

### 'HARTLEY CONCERTMASTER' EXCLUSIVE TO ENCEL!

"We at Encel are privileged to be the only audio centre in Australia to be chosen to demonstrate the Hartley range of speakers, acclaimed by critical listeners everywhere as the world's finest loudspeakers. The Hartley "Concertmaster" uses the 24" bass speaker to achieve a 16 Hz natural organ note. The authoritative magazine "Stereophile" which gives Concertmaster a top Class A rating, said in review, "Highs seemed even smoother and better defined — so sweet and airy as electrostatic highs should be but rarely are. The extreme bottom was floor-shaking and the bass range had a degree of detail that we have not often heard from anything that went this deep". Hear Concertmaster at Encel, or write for the full review.

### SPECIALLY PRICED SYSTEMS FROM STOCK!

*Unquestionably Australia's best value!*

Jason. Comprises a high performance Interdyn X50 amplifier, belt-driven turntable, 3 piece modular unit and Interdyn Varby speaker system.

**\$238**

Heart of this system is the Rotel RA 310 amplifier, Dual 1215 turntable with base and cover, Micro VF 3100 magnetic cartridge and famous Celestion Ditton 10 speakers.

**\$368**

Powered by a J.E. Sugden A21 amplifier, JBL Trimline speakers (limited quantity only) a Connoisseur BD2 turntable, and featuring a Grace F8L or Shure cartridge.

**\$594**

This system has a Lux SQ503X fully complementary amplifier, Micro MR 311 deluxe turntable, choice of Grace, Micro moving coil, Shure or Ortofon cartridge, and Interdyn 225 speakers.

**\$787**

In our superbly equipped sound studios, you can hear the world's finest components under ideal comparative conditions.

*Come see — and hear!  
or write for information on  
the equipment of your choice!*

**AUSTRALIA'S FOREMOST HI-FI AUTHORITIES**



431 Bridge Road, Richmond, Vic. 3121.  
Tel: 42-3762  
257 Clarence St, Sydney. 2000  
Tel: 29-4563

# HAM RADIO SUPPLIERS

MAIL ORDER SPECIALISTS

323 Elizabeth St. (2 doors from Little Lonsdale St.)  
Melbourne, Vic. 3000. 'Phones: 67 7329, 67 4286

## SPEAKERS - HI-FI TYPES WELL KNOWN MAKES

5" twin cone 10 watt tweeter 8/ohms only 4000/16000 C/S — \$3.50, P.P. 30c; 6" twin cone 5 watt 55/15000 C/S 8/16/ohm V.C. — \$5.75, P.P. 30c; 8" twin cone 8 watt 50/15000 C/S 8/16/ohm V.C. — \$7.75, P.P. 40c; 10" twin cone coaxial 30/20,000 C/S 20W (horn tweeter) — \$28.50, P.P. 40c; 8" twin cone coaxial 40/20,000 C/S 25 Watt (horn tweeter) — \$23.50, P.P. 40c; 12" guitar type E.G. 35-5.5 K/C 15 watts rms 15/ohm K.C. — \$17.50, P.P. 50c; 12" guitar type imported 20 watts rms 8/ohm V.C. — \$22.50, P.P. 50c; 15" guitar type imported 30 watts rms 8/ohm V.C. — \$30.00, P.P. 70c; 2½" horn type tweeter 5000/20,000 C/S 20 watt — \$5.50.

## ELECTRONIC KITS

ABSOLUTELY SAFE, BATTERY OPERATED, NO SOLDERING

28.207 Crystal radio kit, easy 1 hour construction — \$4.50, P.P. 40c; 28.214 2 transistor radio kit, tunes AM band, inc. solar battery — \$7.95, P.P. 40c; 28.241 AM tuner/amplifier kit, 2 separate chassis, easy to assemble — \$12.50, P.P. 40c; 28.242 2 set telephone telegraph kit, build your own 2-way communication system — \$12.50, P.P. 50c; 10/1 Electronic project kit, 10 easy to assemble projects — \$9.50, P.P. 40c; 20/1 I/C integrated circuit, builds radio's oscillators etc., amplifiers — \$11.95, P.P. 40c; 50/1 Project kit, 50 projects inc. 15 solar energy projects — \$19.95, P.P. 50c; 150/1 150 project kit in wooden case, inc. meters, radio's loudspeakers, ideal gift — \$32.50, P.P. 50c.

## SINCLAIR

Sinclair IC10 Integrated amplifier, \$14.90; Sinclair 230 20 watt amplifier module, \$14.90; Sinclair 250 40 watt amplifier module, \$18.75; Sinclair active filter unit, \$26.50; Sinclair PZ5 power supply unit 30V 1.5 amps, \$17.75; Sinclair PZ8 power supply unit, \$27.00; Sinclair PZ8 power supply unit, \$23.75; Stereo 60 control unit and pre-amplifier, \$34.00.

## REPLACEMENT RADIO SPEAKERS

2½" 8/ohm Voice Coil, \$1.50; 2½" 8/ohm V.C., \$1.75; 2½" 8/ohm V.C., \$1.90; 3" 8/ohm V.C., \$2.00; 4" 8/ohm V.C., \$2.75; 7x5 8/ohm V.C., \$4.75; 6x9 8/ohm V.C., \$5.75.

MODEL C-1000 POCKET MULTIMETER, 1000 ohms/per Volt. AC Volts: 0-10/50/250/1000 (1000 opv). DC Volts: 0-10/50/250/1000 (1000 dpv). DC Current: 0-100mA. Resistance: 0-150K ohms (3K centre), 2 colour scale. Range Selector Switch. Dimens.: 3½ x 2¼ x 1 in. — \$6.75 post free.

MODEL 200H MULTIMETER, 20,000 opv. DC Volts: 0-5/25/50/250/500/2500V (20,000 opv) AC Volts: 0-15/50/100/500/1000V (10,000 opv) DC/Amps: 50uA/2.5mA/250mA. Resistance: 0-60K/6M ohm scale centre 300 ohm — 30K ohm. Capacitance: 10uuf to .001uF — .1uF, D3 scale 20 db to plus 22 db. Size 4½ x 3¼ x 1 1/8. — \$11.75, P.P. 40.

MODEL CT330 MULTIMETER, 20,000/OPV, DC Volts: 0-6/6/30/120/600/1.2K/3K/6K Volts. AC Volts: 0/6/30/120/600/1.2K Volts (10K/OPV). DC/Amps: (0.06 mA / 60 mA / 600 mA). RESISTANCE: 0-6K/600K/6M/60M/600 Megohm. (30/3K/30K/300K ohms) centre scale. Capacitance: 50 uf to .01 uf .001 to 0.2 uf. Decibels: —20 to plus 63 db size approx. 5½ x 3 5/8 x 1¾. — \$18.75, P.P. 40.

MODEL OL-64D MULTIMETER, 20,000/OPV, DC Volts: 0-0.25/1/10/50/250/500/1000V at 20K/OPV, 5000 volts at 10K/OPV, AC Volts: 0-10/50/250/1000V at 8K/OPV. DC/A: 50uA/1mA/50mA/500mA/10 amps. RESISTANCE: 0-4K/400K/4M/40 Megohm. DB Scale: —20 to plus 36 db; Capacitance: 250pF to .02uF. Induct. 0-5000H, size 5¾ x 4 1/8 x 1¾ in. — \$19.75, P.P. 40.

NEW MODEL US-100. Overload protection. Shockproof Movement, polarity switch. DC volts: 0.25/1/25/10/50/250/1000V (20K/OPV), AC Volts: 0-2.5/10/50/250/1000V (5K/OPV), DC/Amps: 1mA/25mA/500mA and 10A. AC/Amps 10A. RESISTANCE: 0-50M/ohms (centre scale 50) R X 1/10/100/1K/10K, db scale —20 to plus 10 plus 22/plus 35/plus 50 db. — \$29.90, P.P. 40.

US-106 As above but 50,000/OPV. — \$34.00, P.P. 40.

MODEL AS100/DP HIGH SENSITIVITY, 100,000/ohms/volt DC. Mirror Scale, PROTECTED MOVEMENT, SPECIFICATIONS: 6/20/120/300/600/1200 Volts A.C. (10K/OPV), Volts D.C.: 3/12/60/120/300/600/1200 (100K/OPV), D.C. Amps: 12uA/6mA/60mA/300mA/12 Amps. RESISTANCE: 2K/200K/20Mg/200Meg. Decibels: —20 to plus 63 db. AUDIO OUTPUT: 6 Volts/30/120/300/600/1200V A.C. Size: 7½ in x 5½ in x 2½ in. — \$34.50, P.P. 40.



1 WATT TRANSCEIVER, 13 TRANSISTOR, 3 CHANNEL and Call System. Specifications: Circuit: 13 Transistors, 1 Diode, 1 Thermistor. Range: Up to 10 miles (depending on terrain, etc.). Frequency: 27.240 MHz (PMG approved) Freq. Stability: Plus or minus 0.005%. Transmitter: Crystal controlled, 1 watt. Receiver: Superheterodyne, Crystal controlled. Antenna: 13 Section Telescopic. Power Source: 8 UM3 1.5 volt pen batts. Size 8½ in. x 3¼ in. x 1¾ in. Weight: 25 ozs. Other features: Leather carrying case, battery level meter, squelch control, earphone jack, A.C. adaptor jack, etc. Price - Single units \$39.95. Be early!

# CAR ALARMS\*

\*AUST PATENT 34 882/71

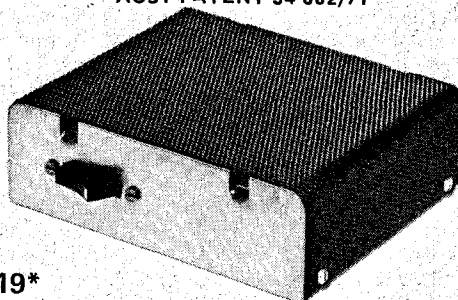

## ET019\*

As described in E.T. Jan '72. Complete kit includes all components, pre-punched box, etched and drilled P.C. board, hardware and full instructions. \$25.50 plus \$1.00 post. (Wired and tested \$3.50 extra) Specify positive or negative earth versions.

## SE500\*

Fully automatic version of ET019. Adjustable re-entry delay enables the alarm to operate from the ignition only. Simple to install, easy to operate, fully guaranteed. Complete with full instructions. \$32.50 plus \$1.00 post (available only in wired version). Specify positive or negative earth version.

## SINCLAIR ELECTRONICS

P.O. BOX A306, SYDNEY SOUTH, 2000.

# TRIO

## 9R-59DS



## COMMUNICATIONS RECEIVER

Suggested retail price: FOR/FOA Sydney: \$178.50

- 4 BANDS COVERING 540 Kcs. TO 30 Mcs.
- TWO MECHANICAL FILTERS ENSURE MAXIMUM SELECTIVITY.
- PRODUCT DETECTOR FOR S.S.B. RECEPTION.
- AUTOMATIC NOISE LIMITER.
- LARGE TUNING AND BANDSPREAD DIALS FOR ACCURATE TUNING.
- CALIBRATED ELECTRICAL BANDSPREAD.
- "S" METER AND B.F.O.
- 2 MICROVOLTS SENSITIVITY FOR 10 db S/N RATIO.

Weston electronics  
PTY LTD

(A unit of Jeffrey Mitchell Holdings Ltd)  
376 EASTERN VALLEY WAY, ROSEVILLE, 2069.  
Cables and Telegraphic Address: "WESTELEC",  
Sydney, Phone: 40 1212

Please forward free illustrated literature and specifications on Trio equipment.

Name: \_\_\_\_\_  
Address: \_\_\_\_\_

# RECORDINGS... POP TRENDS

REVIEWER:  
Michael Delaney.



"Rock On" - Humble Pie. Stereo. SAML 934172.

It's taken Humble Pie just over three years to produce an album that has fully realized the collective potential. Their music is crude, raucous and down-right lusty. They play some of the most exciting rock'n'roll this side of The Rolling Stones and "Get Your Ya's Ya's Out".

Headed by Steve Marriot and Peter Frampton - this English quartet has recaptured much of the dynamic gut-appeal that has been absent since Cream decided to take themselves seriously. Humble Pie are not out to prove anything that hasn't been heard before. They're not all that concerned with developing a sense of originality beyond the expected group approach. However, this is exactly where the strength of the band can be found. They throw themselves right into the thick of some good old hard-core rock. Humble Pie are just about as subtle and thought-provoking as Grand Funk Railroad.

However, there is a marked difference. Marriot & Co. pull no pretext whatsoever. They are concerned wholly and solely with getting right off. Each song is a physical assault - a four pronged gang bang loaded with punch and vigour. Watch 'em and I'll guarantee that they will make the little girls wet their pants. Humble Pie hurtle along with limitless vitality. You don't have to think twice about anything that they've put down. Marriot has his way in "79th & Sunset": "Underneath her red sweater/She's a big deal go-getter. There'll be some dramas inside your pyjamas tonight..." Apart from this, Humble Pie appear to be in the throes of picking up where Free left off. Their music is simple and compact. The band has a definite direction to follow. Frampton and Marriot really do have a nice double guitar thing going throughout the entire album. They egg each other on taking greater liberties with the basic rhythms.

Humble Pie never fail to hold your complete attention. They are one of the most versatile rock'n'roll groups to have emerged from England for over four years. Simply this: Humble Pie do not deal in

half-measures. It's rock and it's rock all the way. "Shine On", "Stone Cold Fever" and "The Light" are three of the meanest. Doris Troy, Alexis Korner, P.P. Arnold, Claudia Linnear, Bobby Keys and B. J. Cole are some of the friends who have helped Humble Pie bring it on even keel. The production is crisp and clear. It complements their thick-stringed sound without detracting the bass. Humble Pie are everything a good rock'n'roll band should be - overbearing, slightly repetitious and loud. They are one of the last out-posts in riff-rhythms. "Rock On" is a fine album. - M.D.

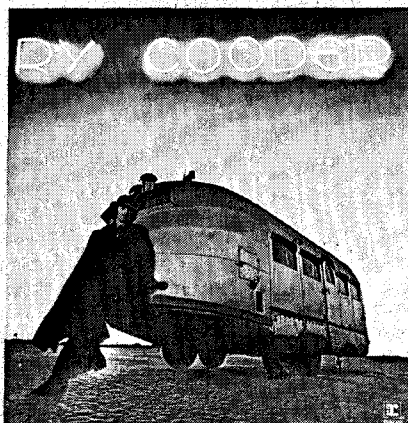

"Ry Cooder" - Ry Cooder. Stereo. RS.6402.

Ry Cooder has paid his dues. He's not all that worried about commercial success as an artist in his own right. His reputation as one of America's top session-men has already been assured due to dealings with Leon Russell and Marc Benno. He seems to be quite content as things stand. This album was prepared with a great deal of thought behind it. He obviously had time to spare. The least affected of the "Mad Dogs" studio crew, Ry Cooder seems to hold a marked preference for traditionals. He strips them bare and starts all over again - right from scratch. His smokey, low-keyed phrasing and lethargic vocals combine to present a character well-suited to the somewhat weatherbeaten atmosphere.

Cooder was raised on Mississippi Delta Blues. He has this slightly bedraggled charm that makes him sound sinister - tame but never tedious. The essential thing about this recording is it's next to total authenticity. Despite the elaborate production, there's the rough edge of an artist who don't hold much truck with four walls and a console. Cooder cuts loose with restraint. He makes everything revolve around this feeling of complete relaxation. Each song settles about his guitar with a boozy impatience too zonked to spring. "Alimony" and "One Meat Ball" provide the answer to his gruff delivery. Cooder's handsome, dark brown

tones hold much in comparison with a subdued Tony Joe White, i.e., "Pig Mast". Perhaps the most adventurous cut would be the instrumental "Dark Is The Night". Cooder lays down a smouldering bottleneck/slide that'll keep the blues freaks well and truly satisfied.

"Ry Cooder" - the title of his first Kinney album - has a great deal going for it all the way along. However, there is a tendency toward repetition. The tempo and the rhythms - the continuous back-beat all build a sameness that could become a little annoying. The orchestral arrangements supplied by Van Dyke Parks help to partially remove the threat of boredom. Nevertheless, things do get a bit hairy near the end. Produced by Parks and Lenny Waronker, this album probably won't go and break many records. However, it should be able to put a pretty good fight. Listen to "Old Kentucky Home", "Brownsville" and "Do Re Mi" for the separation and balance. - M.D.

"If You Saw Thro' My Eyes" - Ian Matthews. - Stereo. 6360.034 Vertigo.

Ian Matthews would be one of the major figures in the British folk/country movement. His early dealings with Fairport Convention and, at a later stage, the original Matthews' Southern Comfort had left him with quite a sizeable reputation. However, he was still very much regarded as an unknown quantity. Fairport was geared toward Sandy Denny, whilst Southern Comfort seemed to progress further into the hands of Carl Barnwell with each new album. This left Matthews with a great deal of experience and a somewhat chronic lack of individualism. It was pretty obvious that he'd eventually turn solo - almost as a last resort. "If You Saw Thro' My Eyes" is the result of this recent venture and, as such, says more for the man than all previous recordings.

In many instances, he compares admirably with the likes of Cat Stevens. They are both considerate performers - gentle, slightly reserved verging on the serene. Matthews is much more the balladeer and, conversely, is all that less an extrovert. His appeal is centred on that discernibly aloof interpretation at once vivid and distant. He has a peculiar warmth spawned more through the melodic character than the lyrical atmospheres. His songs are far from what you'd call 'immediate'. They've been closely etched and brooded upon. Matthews' music is under-stated to the point of labour. Apart from anything else, he just happens to be one of the most subtle producer/arrangers around at the moment. Everything has been modulated - counter balanced with the utmost in simplicity as the order. "Hearts", "Little Known", "It Came Without Warning" and the lilting namesake "Thro' My Eyes" stand as the most interesting cuts. With the assistance of

# \*AEGIS

\* registered trade mark

Transistor and Valve Type  
Aerial R.F. and Oscillator  
TUNING COILS . . .

Transistor and Valve Type  
I.F. TRANSFORMERS . . .

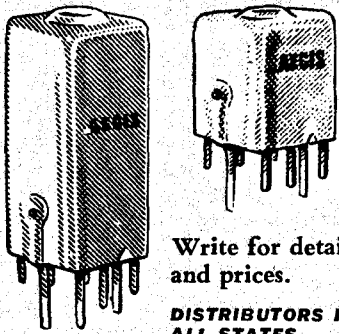

Write for details  
and prices.

DISTRIBUTORS IN  
ALL STATES.

## AEGIS PTY. LTD.

347 Darebin Rd., Thornbury, Vic. 3071  
Phone 49 1017, 49 6792. P.O. Box 49  
Thornbury, Vic. 3071

## "INNERBOND"<sup>®</sup> BONDED ACETATE FIBRES

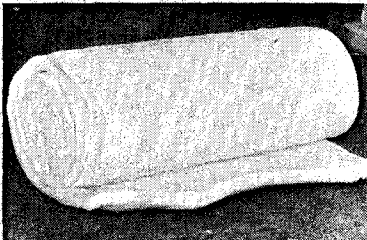

FOR PACKING IN  
SPEAKER ENCLOSURES

AVAILABLE AT ALL  
LEADING ELECTRONIC  
DEALERS

## WONDER WOOL PTY. LTD.

87 James Street, Leichhardt  
N.S.W., 2040.

Box 548 G.P.O., Sydney 2001.  
Phone: 56 2780.

## POP

some of England's top musicians (including Keith Tippett, Sandy Denny and Andy Roberts) — Matthews has finally done himself justice. He maintains a fluidity and sense of invention that will see the album played over and over. Catch up with it soon. — M.D.

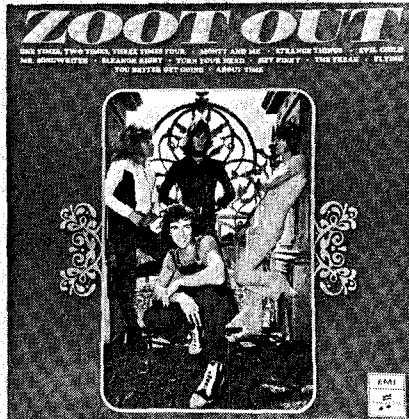

"Zoot Out" — Zoot. Stereo SOEX.9842.

Whether you liked them or not, you must remember Zoot. They are strictly hams — olde worlde showbiz with all the triss, priss, plumage and puffery. Zoot pulled out the sequins and glitter — high camp commercials with all the cliches. They had everything and flaunted the hell out of it in return. They were simply devastating. Zoot managed to partially shatter the great delusion. They revived the magic of pop with all the sham, glamour and gimmickry. Their magnetism could not be ignored. Zoot was the band with style. Cotton and Spring field would mince-wince across the stage like two demented mannequins all sweat, tassles, matted hair and pained expression. They'd fling themselves about and thrash the air — very stimulating; v-e-r-y sexual. Zoot was pure energy — a noise machine with fists, feet, elbows, knees and hands every which way at once. It was beautiful. Their music was flashy and fierce — snarling guitars and furious beat. It was total pandemonium — highly synchronized and expert pandemonium. You couldn't fault them. They were so good. "Hey Pinky", "Evil Child" and "Strange Things" were the kind of organized chaos that made them into one of the best bands this country will ever produce. "Eleanor Rigby" is the one most complete piece of rock'n' roll music I've ever heard. It's pungent and brutal. Springfield was a nifty guitarist. Let's leave it at that. "Mr. Songwriter", "Monty & Me", "Flying" and "The Freak" round the programme. Production is mediocre — little balance sustained between the separation and the levels. Yecch. Zoot was a remarkable band. I haven't been caught up in anything quite so extraordinary. I really miss them. Buy this album. — M.D.

"THE FLYING BURRITO BROTHERS" — The Flying Burrito Brothers. Stereo: SAML. 934262.

Seldom have I heard an outfit in anyways

comparable to The Flying Burrito Brothers. They would have to be one of the finest bands currently involved with American music. Spliced somewhere t'wixt trad bluegrass and finger-lickin' Nashville — this Californian quintet has developed a truly invigorating approach to an otherwise staid convention. The Burritos stand as the most consistent example of mainstream country & western minus the nagging plagiarism, stylistic repetition and associated lyrical bathos. They have reached a standard of instrumental agility and invention that has placed them on a par with their foster-parents — The Byrds. Together with Poco and New Riders Of The Purple Sage — The Burritos represent the one major saving grace of a musical style hopelessly bogged within outmoded traditions. Their sound is potent. It possesses a haunting resonances — a subtlety and conviction that lingers long. Billy James describes this on the sleeve-liners: "I have always gone to the Burritos for to make me feel good and innocent; not the innocence of Poco, but more like the hurt child-sweet country bands not pre-occupied with 'technique'. Their music is wonderfully astute; their lyrics alert and perceptive. They produce these strangely wistful images. You've probably heard the like once or twice before but couldn't remember exactly where — a few road songs, several hard pickin' knee-slappers, and a hotshot lover's lament. The Burritos are the only 'white soul' band outside the Byrds who retain any fair sense of originality. Their unusual rhythms and weeping steel overdubs; the lazy vocal control and colour — it's all there just exactly the way it should be. They have captured that fine down-home earthiness and splendour that still rises to the occasion i.e. "Hand To Mouth", "Why Are You Crying" and "Tried So Hard". Listen to the Burritos next time passed the A-Wop-Bop shop. Their version of Merle Haggard's "White Line Fever" is outstanding whilst "Colorado" — a song penned by newcomer Rick Roberts — is a classic. You won't find better value anywhere. Despite Festival's determination to destroy the last traces of the brilliant production, drag out the earphones if you get the opportunity. You'll hear one of those "Abbey Road" mixes all over again. Jim Dickson is to be congratulated. Wow. — M.D.



# ZERO 100...the last word in sound reproduction

Garrard proudly presents the incomparable Zero 100 . . . a dramatic new concept in automatic turntables . . . a classic in record playing perfection.

The Zero 100 features a unique new pick up arm design that virtually eliminates tracking error; provides manual control or automatic play of up to six records, two speeds (33-1/3 and 45 rpm), freedom from distortion and new life for your records.

Among the twelve new major advances included, are magnetic bias compensation, viscous damped cueing device, variable speed ( $\pm 3\%$ ) patented Synchro-Lab

motor, illuminated stroboscope and magnetic anti-skating control.

This then is part of the Zero 100 story. But while the appearance of a product does not improve performance, it is indicative of the craftsmanship and quality that went into it. The Zero 100, utilising materials such as acrylics, brass, satin finish aluminium, all set off on a sparkling white base plate, is the very personification of quality.

Garrard has pioneered and introduced virtually every significant new feature in record playing units for over 50 years . . . this is the cue for '72.

## National Distributors Audioson International Pty. Ltd.

W.A: 196 Adelaide Terrace, Perth.  
Qld: 78 Wickham Street Valley, Brisbane.  
S.A: 7 Osmond Terrace Norwood, Adelaide.  
Vic: Westbank Terrace Richmond, Melbourne.

N.S.W: British Merchandising Pty. Ltd.  
49 York Street Sydney

Available at all leading Hi Fi Stores  
and Sound Centres

# Garrard

Plessey Ducon Pty. Limited  
Villawood N.S.W. 2163 Phone 72 0133

\*International Award (1971) "Maker of the Microphone" (U.S.A.) · European Award (1971) "Mercurio d'Oro" (Italy)



AD27



Only Convoy Technocentre has all the NEW B & W MONITOR Speakers with McIntosh Amplifiers.

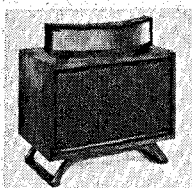

Continental Model 70 B & W Electrostatic Monitor speakers are shown above in black and white decor, also available in walnut. Left, Mayfair Model in teak and walnut. (Speaker kits available.)

#### What the Critics say about B & W MONITOR Speakers

**MODEL 70 ELECTROSTATIC** "approaching the ideal everyone is seeking - perfection." Mr. John Gilbert in the Gramophone London. - "I was astounded . . . they sound like the real thing!" John Freestone, distinguished music critic England. **MODEL DM3 Monitor Speakers** 2 cu. Ft., "The DM3 is a loudspeaker design worthy of the name MONITOR. We heartily commend it," Audio Record Review. **MODEL DM1-72, New Monitor Speakers,** 0.65 cu.Ft., ". . . the very best we have heard within its size and price range," Tape Recording Magazine . . . with my colleague audio consultant David Phillips we like them sonically better than any other system."

#### B & W Speakers start at \$139.00

**J.B.L., U.S.A.** Hear the L.100 Century speakers. See the Aquarius range of omni-directional speakers - surround yourself with superlative sound.

**PEERLESS OF DENMARK.** A superb 12" 3 way in Teak or Walnut only \$220. pr. astounding value. Cameo 2 way \$100. pr. best value. **McINTOSH OF U.S.A.** America's most famous, 210 watts RMS Amplifier complete with Super Control Unit \$2012. Other models from \$760.

**PIONEER, Japan.** Best value for money in Amplifiers, Turntables, Speakers, 15 months Guranatee.

**SONY, Japan.** Full range of Cassette Recorders, Amps, Turntables, Speakers.

**PHILIPS INTERNATIONAL HI-FI, HOLLAND.** Europe's top Hi-Fi Equipment manufactured to din standards. A full range of this equipment on demonstration.

**TEAC CENTRE FOR AUSTRALIA.** A complete range of new TEAC semi-professional equipment on demonstration, fabulous AS100 Amplifier, reminiscent of valves. The Model 1230 Deck and the fully professional 7010 and 3300. Also professional quality TEAC Hi-Fi Cassette Deck from \$183. The superb model A350 with Dolby and bias switch only \$318.

**TECHNOCENTRE SERVICE DIVISION.** We Set up your tape recorder or deck for the correct bias to give you optimum from the tape you use. It will be like a new machine when set up for TDK-SD Tape. All repairs and service for Hi-Fi equipment.

Where you hear and buy the world's top equipment!

Free Customer Parking!

# Convoy Technocentre

For Sound Satisfaction A Division of Convoy International Pty. Ltd.

Now at corner of Plunkett & Maclean Sts., Woolloomooloo, Sydney, 357-2444 (past Astor Model).

## A CONSUMER'S GUIDE

(Continued from page 29)

speed to begin with, wow, and speed drift with increased mechanical load depend more on the drive mechanism than on the motor. Further, some synchronous motors slow down with increased mechanical load.

The confusion about motor types is so involved that it cannot be described in a simple sentence. When people ask me if a particular brand of turntable motor is hysteresis synchronous for four-pole I am stopped. This question is based on the incorrect assumptions that (a) the only kind of synchronous motors are the hysteresis type, and (b) hysteresis motors do not have poles, or if they do it is some number other than four. When I answer that the drive motor is an 18-pole permanent magnet synchronous motor I sometimes get a suspicious look, as though I were dodging a clearly asked question.

Almost all hysteresis motors in current use are four-pole units (when an induction motor, a non-synchronous type, is used in the better players four-pole rather than two-pole design is also employed). The consumer will want to know whether or not his turntable is synchronous if he expects power line variations in voltage; otherwise his investigation of the turntable motor should be in terms of turntable performance. The motor can affect rumble, speed drift, wow, and hum.

Assuming that you have ignored these old wives' tales, and carefully selected your record player so that you have ended up with a rumbleless, wowless, humless wonder that turns at exact speed, a good part of your effort will be wasted if you don't take care of your records. Surface noise and distortion resulting from record wear are as annoying as any of the other defects described.

To begin with, set your stylus force with a gauge. The lower limit of stylus force is indicated by the entrance of distortion in loud passages, especially those with heavy treble. To set the stylus force too low is bad both for records and for the sound; to set it too high will increase record wear. Don't check for distortion on loud, brassy passages at the inner grooves of a record - these often have their distortion built in.

Records must be kept clean. Dirt, in addition to causing surface noise, may collect in a ball around the needle and introduce increasingly severe distortion. This can happen several times during the playing of a single record, and is responsible for a lot of bad sound. The ball of dirt can be cleaned off with a soft brush.

Cleaning devices that I have had good experience with are the "Dust Bug" and the "Disc Preener". The former is a brush that continually cleans the record during play. It comes equipped with its own suction-cup stand. If you are going to use a Dust Bug make sure that your turntable passes the coin test; the drag of the Dust Bug is about the same as an extra six grams on the pickup.

The Disc Preener is used to treat the record with an anti-static (non-radio-active) agent beforehand, and its effect in preventing the record from attracting dust appears to last quite a while.

Dirty records should be washed with a mild detergent, rinsed, and blotted dry with a towel. When you handle a record, hold it by the other edge and centre area or you will probably get grease spots on the surface. Records should be stored vertically in their jackets and inner protective covers.

Some small amount of preventive maintenance for record players is required, such as oiling, checking the freedom of the tone arm pivot, checking the belt or puck for dirt or wear, and fairly frequent checking of the stylus force. The proper guide for this maintenance is the equipment manufacturer's instruction manual.



# OPTICAL LEVITATION

Scientists suspend matter in space with laser light

USING a beam of laser light, scientists have raised small transparent glass spheres off a glass surface and held them aloft for hours in a stable position.

The experiments, which demonstrated optical levitation for the first time, were conducted by Arthur Ashkin and Joseph Dziedzic of Bell Laboratories, Holmdel, NJ.

In the experiment a laser beam is focused upward on a glass sphere about 20 microns in diameter (about one-thousandth of an inch). Radiation pressure from the light not only

counteracts gravity and raises the particle, but also traps the sphere in the beam and prevents it from slipping sideways out of the beam.

In the experiment, which has been successfully demonstrated in air and in a partial vacuum, they generate a stable optical trap for holding particles which they term as an "optical bottle."

"Light photons have momentum as well as energy," Dr. Ashkin, head of Bell Labs physical optics and research department, says. "When we focus a quarter-watt laser on a small transparent particle, the extremely

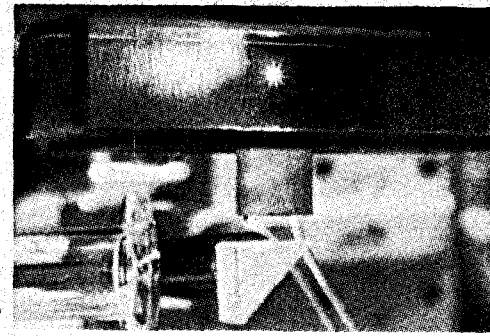

small force exerted by light is then sufficient to lift the sphere off the surface and suspend it."

The sphere is launched by lifting it off a transparent glass plate with the light beam. Initially, radiation pressure is not sufficient to overcome molecular attraction between the sphere and the glass plate.

This attraction, known as Van der Waals force, is about ten-thousand times gravity for a 20-micron sphere. For this experiment, the Van der Waals attraction is broken acoustically by vibrating a ceramic cylinder attached to the plate.

When the attraction is broken the sphere rises in the light beam and comes to rest where the upward pressure of the laser is balanced by the earth's gravity.

In this position, it can be held aloft as long as the light is focused on it. By changing the position of the focus, the trapped sphere can be moved up and down or sideways very precisely.

In the experiment, these trapping forces were also studied, using a second laser focused on the particle from the side. As the power of the second laser is increased, the particle is displaced within the first beam until it is finally driven out and falls.

"Any laser will produce the levitation effect," Dr. Ashkin says. "However, the particle is preferably transparent. If the beam were focused on objects that absorb light, most would melt. By remaining cool, the transparent sphere allows radiation pressure to be studied without any disturbing thermal effects."

The new technique is expected to provide simple, precise methods for manipulating small particles without mechanical support. It could be useful in communications research to measure scattering loss caused by particles, either in the atmosphere or in other transmission media. Such measurements may help in developing optical communications systems for the future.

When used in an evacuated environment, where damping effects on the particle are negligible, the techniques may also have applications in inertial devices such as gyroscopes and accelerometers.

We put a little more feature into each feature.



• A Papst hysteresis-synchronous motor with outer rotor for unvarying speed accuracy. • Precise stylus overhang adjustment with built-in gauge — no shifting, no guesswork, no templates. • Silicone-damped cueing in both automatic and manual play. • And, those exclusive light touch pushbuttons to make it easy to enjoy all those other wonderful 50H features. • Three other models to choose from — 770H — 630 — 610. Ask to see them at your hi-fi dealer.

**ELAC MIRACORD 50H**

Cut out and post for a FREE BROCHURE

**MAGNA TECHNICS AUST. P/L**

P.O. BOX 314, CROWS NEST, 2065. N.S.W.

Please send information on

ELAC TURNTABLES & CARTRIDGES

NAME .....

ADDRESS .....

# BOOK REVIEWS

REVIEWER: Brian Chapman.



**Electrical Installation Work (S.I. Units Edition)** by R. A. Mee. Published in 1971 by Macdonald & Co., London. 268 pages 8½" x 5½". Hard covers. Australian price \$7.75. Our review copy was supplied by Novalit Pty. Ltd., Richmond, Victoria.

The City and Guilds of London Institute provide set examinations in a wide selection of technical subjects. Qualification at the highest level course examination provides a technical standing roughly equivalent to the Australian Trades Certificate (or better), and is of high standard and well regarded.

Electrical Installation Work is covered in three courses A, B and C, and this book covers course "C"; the most advanced course, which is designed for the qualified U.K. technician who wishes to be promoted to foreman or engineer. (It must be remembered however that the term engineer is much more loosely applied in the U.K. than it is in Australia and qualification in this course would not be sufficient to gain entry to an Australian professional institute).

Layout of the book is in the form of questions as set in previous City and Guilds examinations and model answers to same. The standard is high and the book would be valuable as a means of increasing and consolidating knowledge of electrical installations.

The Australian reader should always bear in mind, however, that the questions are framed around the British IEE regulations and wiring rules which are not all valid here. In fact, some of the practices used in U.K. are illegal here and vice versa. This in itself, whilst bearing watching, is not necessarily a tremendous disadvantage. By watching for these differences, knowledge of our own rules will be consolidated and the example of a different code can broaden the outlook and provide a deeper understanding of the reasons for the use of various rules. There is nothing better than picking holes in someone else's system, to increase understanding of the merits and failings of one's own.

Subject coverage is wide, from ac theory through ac and dc machines to distribution systems, cables and cable jointing, illumination, space and water heating. Good value for money. — B.C.

"Electrical Craft Studies" by Henry A. Miller. Published 1971 in two volumes by Macdonald and Co, London. Each volume 142 pages 8½" x 6", soft covers. Australian price \$4.75 each. Our review copy was supplied by Novalit Pty. Ltd., Richmond, Victoria.

These two volumes are the standard texts for City and Guilds of London Institute Course No. 500 and have been specially written

## ONLY for the DISCRIMINATING B & W 'MONITOR' SPEAKERS

There's a MONITOR Speaker by B. & W. for every purpose and pocket.

Clement Brown writing in "Hi-Fi Sound" says, "What is MONITOR class? Use of this term implies all sorts of things — smooth extended frequency response, superior power handling capacity, low distortion... a truthful loudspeaker... which will gain the approval of professional users, B. & W. present professional quality in a format that will meet domestic requirements."

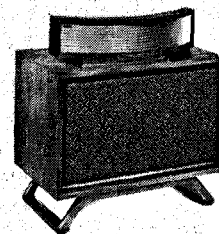
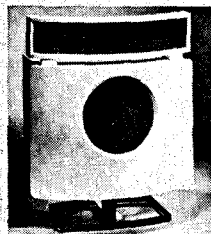

### B. & W. Model 70 MONITOR Electrostatic Speaker.

For the ultimate Perfectionist, \$536. each "... approaching the ideal everyone is seeking — perfection", writes Mr. John Gilbert in the Gramophone, London.

"I was really astounded... a major breakthrough in Speaker design... the new models don't sound like loudspeakers at all." "They sound like the real thing," says distinguished English Music critic John Freestone.

The B. & W. 70's are also available in kit form, and cabinet can be made to special designs or built in. Convoy experts advise on technical requirements.

For Amplifiers over 30 watts RMS 8 ohms, up to 100 watts.

### B. & W. Model DM3-72 MONITOR 3-way

For the Compact Perfectionist (2 cu.ft.) \$285. each. "The DM3 is a loudspeaker design worthy of the name monitor, we heartily commend it. Many words could be written in an attempt to convey an idea of the speaker's merits as a musical instrument," says Clement Brown in "Hi-Fi Sound", "... Monitoring quality is truthful quality". David Philips and Donald Aldous in "Audio Record Review" say "... the response is clean and smooth, indeed amongst the smoothest we have heard from a loudspeaker."

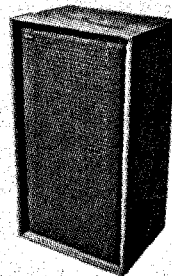

### B. & W. Model DM1-72 MONITOR 3-way.

For the mini-space Perfectionist (0.65 cu.ft.) \$139. each. An improved, new version of the famous DM1 superseding previous models. Mr. H. W. Hellyer says in "Popular Hi-Fi", "Why should the DM1, despite its volume... give such a superior performance? Firstly, because this is a three-unit loudspeaker with elliptical bass 'woofer', round mid and high unit and a super 'tweeter' for the topmost frequencies. Secondly, because the crossover units have been engineered to no-compromise standards making them more complicated and costly and finally because of the most stringent test procedures are undertaken at B. & W.'s Worthing headquarters." This is the perfect 'second' speaker for offices, dens, patios, boats, cars or bookshelves (16½" H. x 9" W. x 8" D.)

Limited shipments now available. Write to sole Australian Agents for further information about your nearest B. & W. Monitor Speaker supplier.

## Convoy Imports

A Division of Convoy International Pty Ltd.

CONVOY IMPORTS A Division of Convoy International Pty. Ltd. Cnr. Plunkett & Maclean Sts., Woolloomooloo. 2011. Sydney. Australia. 'Phone (02) 357-2444. Cables & Telegrams 'Convoy Sydney'.

ELECTRONICS TODAY MICRO ADS RATE IS ONLY \$7.50 PER SINGLE COLUMN INCH OR 76c PER LINE. TO PLACE YOUR MICRO AD, MERELY FILL IN THE FORM BELOW AND SEND TO ELECTRONICS TODAY, MICRO ADS, 21-23 BATHURST STREET, SYDNEY, 2000.

**HOBIPAK** - Box 224, Carlton South, 3053. Resistors Carbon film 5%, 1/8, 1/4, 1W, 5c. 1N914 - 51c, 2N3643, 2N3638 \$1.20. Despatch 10c order Catalogues S.A.E. please.

**MICRONICS SUPER BARGAIN SPECIAL** for this month only!!! EM401 (1N4001) only 15c ea. RESISTORS, 5%, 1/2 watt carbon film - 5c ea. Post Pack 20c. I.C.s, Semiconductors, Electrolytic, Ceramic, Polyester, Tanatalum Capacitors, etc. send 9" x 4" S.A.E. for catalogue. MICRONICS, P.O. Box 175A Randwick, N.S.W. 2031.

**STATE** and Commonwealth distributors wanted for radio telecommunications and associated electronic equipment. Paris Radio Electronics, 7a Burton Street, Darlinghurst.

**HEATHKIT** B/W bar and dot

generator good condition \$90.00 Sydney 31-3273

**CRYSTALS** ... for CB 27, 240 and 26, 785 MHz, 1/4in. pin, miniature, \$6 pr. Post Free, Shalley, 127 York Street, Sydney.

**AUSTRALIAN** Tape Record Society offers tape library, "The Microphone" Journal, audio visuals, round robins, tapes on demand, sales. Inquiries, P.O. Box 130, Hornsby, NSW, 2077. Please enclose large, stamped envelope.

**REPAIRS** to receivers, transmitters construction testing: TV alignment, Xal conv., specialised electronics equip. Eccleston Electronics, 146a Cotham Road, Kew, Vic. 80-3777

**ELECTRONIC** Organ. Do not build yourself an organ without first finding out about the superb Schober (USA) Assemble-It-Yourself Kits. Inquiries to Schober

Organ (Australia), 124 Livingstone Av., Pymble, NSW. 2073. (Mail only, please.)

**TAPE** to disc service. Take advantage of W. and G. Records professional experience when next needing a tape to disc service. W. and G. Record Processing Co., 185 A'Beckett St., Melbourne. Tel 329-7255.

**HOBBYISTS** build yourself a small spray unit for less than 50c. Takes less than half an hour to make. Ideal for most spraying jobs. Uses an everyday household item. Full details send \$2.00 to:- Spray Unit, P.O. Box 1104, Wollongong, NSW, 2500.

**STOCKLIST** of Semiconductors, including SCRs, Triacs, and Integrated Circuits. Send S.A.E. TDK Super Dynamic Tapes Size C90 only \$3 ea. Custom Electronics, Box 1452, G.P.O. Adelaide, S.A. 5001.

## INTRUDER ALARMS

FOR HOMES, OFFICE, WEEKENDERS, CARS ETC.

If you can install a doorbell then you can install these.

- Home Alarms (6-12 Volt Trans.) \$10.50-\$35.00
- Sirens 12 Volt. 1/2 to 2 mile range) \$9.50-\$29.00
- Pressure Mats \$6.50-\$10.00
- Car Alarms (Protects car & contents) \$25.00
- Reed contacts & Magnet \$1.25
- Reed contacts (Screw-on type) \$2.50
- Key switch \$5.25
- Aluminium circuit tape \$2.00
- Adhesive contacts for tape \$0.20
- Mini shock recorders \$2.50
- Heat sensors (N.O. - Close at 135°F) \$4.00
- Light sensitive relay (switches on at sunset, off at dawn) \$7.50

**MANY MORE** - Send S.A.E. FOR Catalogue

R. C. Protector Alarm Systems Box 226, Brookvale, N.S.W. 2100 or call at ...

10 Crinan St., Hurlstone Park, N.S.W. Phone 55 7151

9 Chard Rd., Brookvale, N.S.W. Phone 93 7292

**OPEN SATURDAY MORNINGS**

Electronics Today Micro Ads Name .....

Please Print Clearly Address .....

Electronics Today, 21-23 Bathurst St., Sydney, 2000 State ..... Post Code .....

Electronics Today Micro Ads Name .....

Please Print Clearly Address .....

Electronics Today, 21-23 Bathurst St., Sydney, 2000 State ..... Post Code .....

# READ

ALL THE LATEST POWER AND SAILING NEWS, BOTH LOCAL AND OVER-SEAS. PLUS BOAT TESTS OF ALL THE NEW BOATS. COMPREHENSIVE ACROSS-THE-MARKET PRODUCT COMPARISONS.

IT'S ALL IN AUSTRALIA'S TOP-SELLING BOATING MAGAZINE

MODERN

boating

• AUSTRALIA • NZ • THE WORLD

OUT NOW!

## BOOK REVIEWS

for students working towards the English equivalent of our electrical trades certificate.

The subject matter is mainly concerned with the practical aspects of electrical trades rather than the theoretical, as the following list of contents illustrate.

Volume 1: Safety; Movement of materials; Use of hand tools; Electrical precautions; Fire fighting; Marking, Measuring and checking; Limits and fits; Engineering materials; Temperature and heat; Changes in materials.

Volume 2: Effects of force; Restraint and location; Bolts and screws; Adhesives; Benchwork; Fastening methods; Electricity supply and distribution; Electric wiring.

The text is well written in simple language and is profusely illustrated by line drawings in two colours where necessary to obtain extra emphasis. Each chapter is followed by a selection of self-test type questions designed to validate the knowledge gained from the preceding chapter.

An ideal text for the school trades course or for the practical side of electrical trades courses. The student should bear in mind that any wiring methods or regulations mentioned in the text are not necessarily legal in this country. When in doubt consult the SAA wiring rules. A good elementary text on workshop practice. — B.C.

'Materials in Electronics' By C. E. Jowett. Published 1971 by Business Books Limited, London. 321 pages 6" x 9" hard covers. Australian price \$22.55, our review copy was supplied by Hicks Smith & Sons Pty. Ltd., 301 Kent Street, Sydney.

Charles E. Jowett is currently a consultant to eight electronic companies. He is a member of several Technical Institutes and British Editor of an international microelectronic journal. His work in research, development and production in the guided weapon and space satellite industries since 1957 as a senior reliability engineer has endowed him with considerable background experience in the application of materials in electronics.

ELECTRONICS TODAY reviewed a previous work of Mr. Jowett's in the December issue, namely 'Reliable Electronic Assembly Production' with which we were quite impressed. This work defined the best candidate materials, processes and fabrication methods for electronic assembly production and in our opinion was a very valuable text, filling as it did, a need for information on a subject which is assuming increasing importance due to the present accent on reliability which has occurred due to the solid state revolution.

Too often these days, equipment from even large and well known companies although sophisticated and well-designed electronically, may sometimes be unreliable because of poor utilisation of materials. The approach "A piece of that will do" or "stick it with araldite" is just not good enough. The characteristics of the materials, adhesives, etc., which are used for electronic equipment production must be thoroughly understood in order to select the most reliable product for the environmental conditions under which the equipment must operate.

'Materials in Electronics' is similar in many respects to the previous volume, but is much more extensive in its coverage of the properties of materials used in the manufacture of integrated circuits and of other discrete components. Basically this text is more concerned with component production rather than with electronic equipment.

The text opens with a resume of the essential concepts of the nature and behaviour of materials. Next are presented a description and comparison of materials used in electronics and microelectronics in sufficient detail to allow design or production engineers to choose the most suitable material for the purpose. Subsequently the optimum practices in the application of materials to major components is treated.

The final chapter provides a brief description of the common tests applied to electronic materials and outlines the reason for their use. This is followed by an annotated bibliography for those who wish to pursue the individual topics further.

An excellent book for electronic design engineers who are concerned with the reliability of their equipment, and a must for production engineers. — B.C.

# electronics TODAY

**APPROVED  
KIT  
AND  
PARTS  
SUPPLIERS**

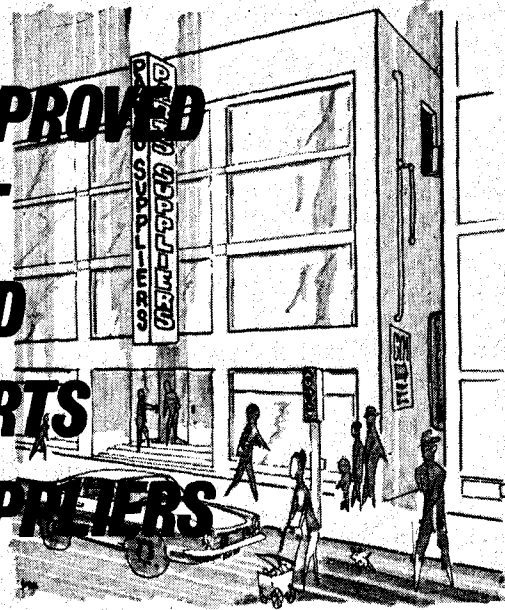

THE COMPANIES LISTED ON THIS PAGE STOCK KITS AND/OR PARTS FOR "ELECTRONICS TODAY" PROJECTS. THEY DO THEIR BEST TO HAVE ALL PARTS AVAILABLE AS SOON AS POSSIBLE AFTER PUBLICATION.

HOWEVER IT MUST BE APPRECIATED THAT DUE TO THE VAGARIES IN SUPPLY AND DEMAND THERE MAY BE OCCASIONS WHEN A PARTICULAR PART OR KIT CANNOT BE SUPPLIED DIRECTLY FROM STOCK.

WE WILL EXTEND THIS SERVICE TO COVER ALL STATES AND NEW ZEALAND AS SOON AS POSSIBLE.

### NEW SOUTH WALES

**A.C.E. RADIO:** 136  
Victoria Road,  
Marrickville, 2204.  
Telephone 51-7008

**EDGE ELECTRIX:** 25a  
Burwood Road,  
Burwood, 2134.  
Telephone 747-2931

**INSTROL:** 91a York  
Street, Sydney 2000.  
Telephone 29-4285

**KITSETS AUSTRALIA:**  
Suite 2, 21 Oakes  
Avenue, Dee Why, 2099.  
Telephone 982-5571

**NATIONAL RADIO  
SUPPLIES:** 332  
Parramatta Road,  
Stanmore, 2048.  
Telephone 56-7398

**RADIO DESPATCH  
SERVICE:** 869 George  
Street, Sydney, 2000.  
Telephone 211-0191

### VICTORIA

**E.D. & E:** 232 Flinders  
Lane, Melbourne, 3000.  
Telephone 63-3596

**J.H. MAGRATH & CO:**  
208 Little Lonsdale  
Street, Melbourne, 3000.  
Telephone 663-3731

**S.T.A. ELECTRONICS:**  
392 Centre Road,  
Bentleigh, 3204.  
Telephone 97-4832

### QUEENSLAND

**KITSETS AUSTRALIA:**  
2/673 Ann Street,  
Fortitude Valley, 4006.  
52-8391

### SOUTH AUSTRALIA

**GERARD & GOODMAN:**  
192-196 Rundle Street,  
Adelaide, 5000.  
Telephone 23-2222

## SATURATING CORE TRANSFORMERS

Congratulations on a well-presented magazine. However, I disagree with the statement published on page 28 of the October issue, which, referring to transformers states: "as the current increases so does the flux". As I understand it, a flux is set up according to the input voltage following the relation  $v = \frac{v d\phi}{dt}$

This demands a certain magnetizing current depending on the B-H characteristic of the core, this current is a loss, and is constant for all loads if the supply voltage is constant (I am neglecting the resistance of the windings). As current is drawn from the secondary winding the number of amp-turns tends to reduce the flux, and reflect a lower back emf to the primary. The primary current increases to restore the flux to its original level, and achieves this when the primary amp-turns (over and above the magnetizing amp-turns) are equal and opposite to the secondary amp-turns. The flux level stays constant and transformers can be loaded infinitely without saturation occurring.

I suggest that the statement published applies only to the magnetizing current, and does not explain the action of the self-regulating transformer.

A.K.W., Tranmere, S.A.

● A similar letter has also been received from J.R.H. of Caulfield Institute of Technology.

The author of the article replies.

"Your correspondent is, of course, quite correct in what he says. He has caught me at the one point where I chose to grossly over-simplify the explanation rather than present the full explanation which has in my experience usually produced more confusion than enlightenment unless presented very carefully over many, many paragraphs.

The full explanation of the self regulating action of the saturating core transformer is that, as Mr. Wallace says, the flux is set up by the magnetizing current, and if this magnetizing current is sufficient to saturate the core then loading will have no effect on the input current while the core is saturated.

The secondary current produced by loading the secondary generates a magneto-motive force (mmf) which opposes the flux in the core. In a linear magnetic circuit this will tend to cause a reduction in the flux and the back-emf at the primary will tend to fall below the supply voltage, allowing more primary current to flow and so increasing the primary mmf until the flux level is restored. Thus the primary mmf will always exceed the secondary mmf by an amount equal to the mmf required to produce the same flux as is produced by the magnetizing current.

However, with a saturated core the presence of a secondary current still produces a mmf which will tend to reduce the net mmf around the circuit, but because the core is saturated this reduction in mmf will not reduce the flux, so there will be no change in the back emf of the primary ( $n_1 d\phi/dt$ ) and therefore no change in primary current. There is then no tendency to reduce the flux level of the transformer, no matter what the secondary load, so the output voltage ( $N_2 d\phi/dt$ ) will be unchanged regardless of the load.

While this explanation will be intelligible to readers with Mr. Wallace's background it may prove a little confusing to your general readership".

B. Doherty

## HI-FI BUYERS GUIDE

In reference to your article "Hi-Fi — a buyers guide" (E.T. December 71), I would like to compliment you and your staff on compiling a well-balanced, unbiased coverage of the products available on the market today. Contrary to the comments of "F.S." Sydney (Letters to the Editor January 72), I found the article to include a good cross-section of the better quality products, more synonymous with the title — High Fidelity. There is a practice among retailers to call ANY reproducing equipment hi-fi, but in some cases, that title could not be further from the truth.

I congratulate you on your reply to "F.S.", and I admire the manner in which you assert your knowledge and appreciation of matters dealing with high fidelity equipment.

I consider "F.S.'s" letter to be purely destructive in its criticism and therefore totally unwarranted. Your article could do nothing but good for the industry, as it promoted the idea of real high fidelity as it is viewed by professionals and enthusiasts alike.

I think "F.S." would be accusing a large number of people of being insane ("nobody in their right mind would pay over \$250 for a complete hi-fi system") just because they have paid more than \$250 for a true high fidelity reproducing system. I, and I suppose many more like myself, have learned from bitter experience that high fidelity is much more than "modular units selling at competitive prices."

May I also compliment you and your staff on the format and text of Electronics Today. I find the format appealing, and the text to be interesting, informative and wide in its scope of subjects, all of which make a fine magazine. I look forward to your next publication, and many more to come. — G.R.F., Inala, Qld.

## LOWERING THE BOOM

Some time ago I built a bass reflex cabinet — based on a speaker manufacturer's design — as the cabinet had to fit into a certain sized area I reduced the width of the cabinet by 10%. The resultant speaker has a very 'boomy' sound. Is there any way I can improve the quality of reproduction — or must I start again from scratch?

T.H. Birchgrove NSW.

● Excessive boominess at low frequencies is generally caused by incorrect port dimensions. The present port area is probably too large. Connect an audio oscillator to the amplifier input and an ac-indicating voltmeter (or oscilloscope) across the speaker leads.

Sweep the oscillator through the range from 30 Hz to 150 Hz and note the voltage across the speaker. You will probably find that there will be a large peak around 70 — 120 Hz. Then progressively block off the port area until the voltage across the speaker is fairly constant over the swept range.

You will never eliminate all the peaks but you will almost certainly improve the response of your system very considerably.

You can tell the quality  
by the **SOUND** ...  
with fine crystal or with

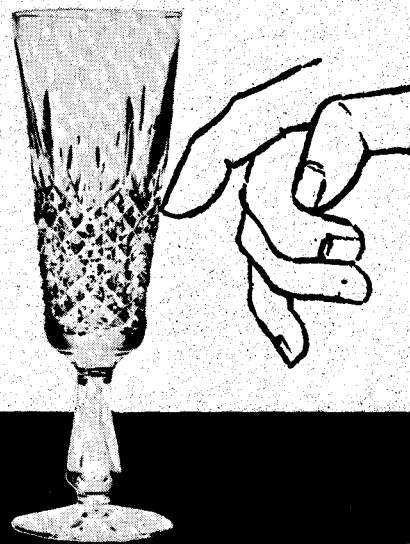

 **KENWOOD**  
Stereo turntables

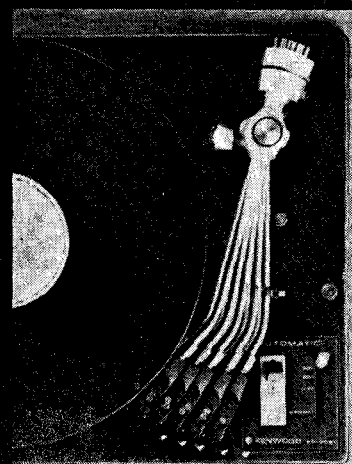

**ALL AUTOMATIC OPERATION**

— all you do with KP-3021 is switch on and press a button ... your records stay scratch-free and play better longer.

**KP-3021 Automatic Stereo Turntable.** All you do is switch on, with this 24-pole synchronous motor turntable. Everything is automatic! **AUTO-PLAY** ... the arm leaves the rest and goes gently onto the disc. **AUTO-RETURN** ... arm returns to rest and turntable stops. **AUTO-REPEAT** ... arm returns to start and plays disc again. **AUTO-CUT** ... if you want to stop playing arm rises and returns to rest. Two speeds — 33.1/3 and 45 r.p.m. wow and flutter less than 0.08%. Super sound in the Kenwood manner.

Also available — **KP-4021** belt-idler double drive stereo turntable with 16-pole synchronous motor. High quality MM type cartridge with wide 20-20,000 Hz. **KP-2021** belt drive stereo turntable with durable outer-rotor synchronous motor for vibration-free operations. Lateral balancer for best tone arm balance.

*the sound approach to quality*

 **KENWOOD**

SYDNEY: 630 7400  
ADELAIDE: 93 6117  
PERTH: 28 5725  
CANNBERRA: 47 9010

**JACOBY  
MITCHELL**

MELBOURNE: 30 2491  
BRISBANE: 44 4674  
LAUNCESTON: 2-5322  
NEWCASTLE: 61 4991

PORT KEMBLA: 4 2071

To: Jacoby, Mitchell & Co. Pty. Ltd.  
P.O. Box 2009, North Parramatta, N.S.W. 2151  
Please send me full details on Kenwood Stereo Turntables  
 KP-3021  KP-4021  KP-2021  
(tick models required) and location of nearest Kenwood Sound Centre.

Name .....  
Address .....  
..... Postcode  
JM/K-7ET272



# MAIL ORDER BOOKS

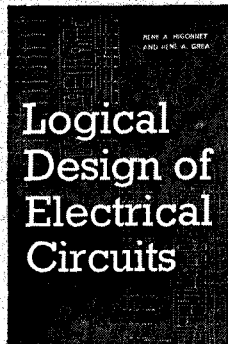

**E48. LOGICAL DESIGN OF ELECTRICAL CIRCUITS** — R.A. HIGONNET & R.A. GREA — 8 3/4" x 5 1/2" 220 pp. \$8.30. Virtually all the fields used by the present day circuit designs are covered in the book including combinational circuits (steady state), sequential circuits, which are treated by a modern, simpler method; and shunt-down circuits (inhibitors) described by Boolean algebra. Many worked examples plus more than 300 illustrations are provided.

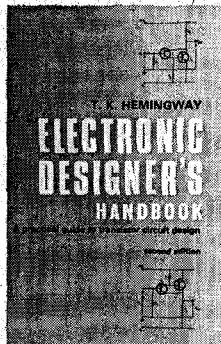

**E16. ELECTRONIC DESIGNER'S HANDBOOK** — 2nd EDITION — T.K. HEMINGWAY — 296 pp. 8 1/2" x 5 1/2" \$10.85. This book provides an up-to-date introduction to transistor circuit design. The basic techniques of design are emphasised and the circuits analysed are done so in such detail that the underlying techniques can be applied to any circuit of a known mode of operation. Contents (in brief) basic circuits; special circuits; useful techniques and troubleshooting.

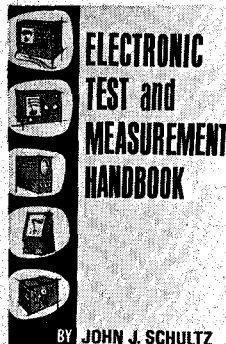

**E50. ELECTRONIC TEST AND MEASUREMENT HANDBOOK** — J.J. SCHULTZ — 8 1/2" x 5 1/2" 220 pp. P/B \$6.15. Whether electronic equipment is commercially built or "home constructed" or a combination of the two, eventually there is a need to test it. It may be concerned with verifying or establishing proper operation, checking performance or repairing a defective circuit. This manual is designed to facilitate such testing regardless of its purpose.

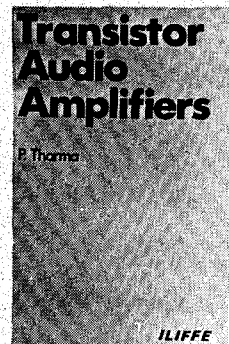

**E45. TRANSISTOR AUDIO AMPLIFIERS** — P. THARNA — 8 1/4" x 5 1/2" 352 pp. \$19.00 pub 1971. This book presents the various aspects of design of transistor audio amplifiers and is based on the work done by the audio application group of the Mullard Central Application Laboratory. The contents (in brief) cover transistor characteristics, circuit design and measurements, considers various applications and describes circuits.

**E10 BREAKTHROUGH** — DR. KONSTANTIN RAUDIVE. BOOK & L.P. RECORD. 391 pp. 8 1/2" x 5 1/2" \$13.90. Dr. Raudive's research points to the fact that seemingly there is life after death and with the aid of tape recorder, radio and microphone a "breakthrough" has been achieved. This book and the recording of the voices from the dead has been the subject of world wide discussion.

**E12 PULSE DIGITAL & SWITCHING WAVEFORMS** — JACOB MILLMAN Ph.D. 958 pp. 8 1/2" x 6" Soft Cover \$18.40. There are many ways of implementing a pulse or digital system designed to perform a particular function. It is hoped that through a study of this text and the experience gained for solving problems the reader will develop facility with these circuits and sharpen his creativity and ingenuity.

**E14 DIGITAL PRINCIPLES & APPLICATIONS** — A. P. MALVINO — D. P. LEACH. 433 pp. 9 1/4" x 6 1/4" \$10.45. This book introduces the exciting field of digital electronics. It covers all the necessary fundamental concepts offered in a first course in digital systems. Glossaries, review questions and problems with solutions appear at the end of each chapter as study aids.

**E15 DESIGNING WITH LINEAR INTEGRATED CIRCUITS**. ED. BY JERRY EIMBINDER. 300 pp. 9 1/2" x 6" \$11.50. In the past few years integrated circuits have rapidly come into use and have also undergone many changes and found new applications. The authors of these articles, application engineers at integrated circuit manufacturers, provide the latest information on the subject.

**E21 THE WORLD OF TOMORROW** — K. GOLDSTEIN. 10" x 7 1/4", 128 pp. Well illustrated in colour \$3.95. Board a Time Machine and travel a century into the future. Explore the oceans and outer space, imagine creating and living in tomorrow's world! An excellent gift book for budding young scientists and engineers.

**E28 TAPE RECORDING FOR THE HOBBYIST** — A. ZÜCKERMANN. 9" x 5 1/4" \$4.40. This book suggests not only WHAT you can do with a recorder, but HOW. Apart from the hobbyist there are many ideas on what a recorder can do for anybody's home and business life.

**E34 BEGINNERS GUIDE TO TRANSISTORS** — J. A. REDDHOUGH. 7 1/4" x 5" 160 pp. \$3.55. Describes what transistors are, how they work, the many types available and their many applications. This will be useful to the layman wishing to understand the fundamentals or the apprentice technician.

**E35 DICTIONARY OF ELECTRONICS** — H. CARTER. 7 1/4" x 5" 416 pp. \$5.95. The concise but explanatory definitions from many branches of electronics, including radio, television, communications, radar, electronic instrumentation and industrial electronics should prove useful to all those interested in modern electronic terminology.

**E36 DICTIONARY OF TELECOMMUNICATIONS** — R.A. BONES. 7 1/4" x 5" 208 pp. \$7.50. The wide range of definitions, including many reproduced from, or based on, British Standards recommendations, is supplemented by appendices including units and abbreviations, wavelengths and frequency bands and signal reporting codes.

**E38 ELECTRONIC'S DATA HANDBOOK** — M. CLIFFORD. 8 3/4" x 5 1/2", 158 pp. \$3.55. This is an incredible reference work for both students and technicians as it provides in one volume the formulae and tables most frequently required.

**E39 ELEMENTS OF TRANSISTOR PULSE CIRCUITS** — T. D. TOWERS. 8 3/4" x 5 1/2" 168 pp. \$6.30. Provides the busy engineers with a review of the transistor version of the building bricks commonly used in pulsed circuits; descriptive and practical detailed analyses and maths have been kept to a minimum.

**E44 20 SOLID STATE PROJECTS FOR THE CAR & GARAGE** — R. M. MARSTON. 8 1/4" x 5 1/4", 116 pp. Hard Back \$6.10. P/B \$4.25. Eighteen projects for the car range from those that warn of danger to easing the driver's task — Two for the garage — a self-regulating battery charger and a speed controller for an electric drill.

**E45 TRANSISTOR AUDIO AMPLIFIERS** — P. THARNA. 8 1/4" x 5 1/2", 352 pp. \$19.00. The background information which has helped in the design of several original circuits is presented. The classical method of design and evaluation are adopted and simplified to suit transistor audio amplifier circuits.

**E46 SIX-LANGUAGE DICTIONARY OF AUTOMATION, ELECTRONICS & SCIENTIFIC INSTRUMENTS** — A. F. DORIAN. 10" x 8" 732 pp. \$12.60. Orders taken, delivery 12 weeks. This book enables the engineer and physicist to understand the technical publications of another language. Contains over 5,500 terms in English, French, German, Italian, Spanish and Russian.

**E47 PRINCIPLES OF ELECTRONICS IN MEDICAL RESEARCH** — D. W. HILL. 8 1/4" x 5 1/2", 302 pp. \$12.00. Orders taken, delivery 12 weeks. Written specifically for doctors and others responsible for electronics staff and apparatus it describes the more commonly used terms, components and circuit techniques with references to further reading.

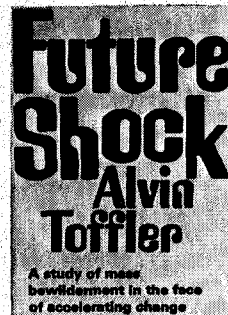

**E11. FUTURE SHOCK** — ALVIN TOFFLER — 8 1/2" x 5 1/2" \$6.90. Future Shock is the most startling survey on the present weakness of our society and its future yet written. It is about change and how we adapt to it. It is about the future and the shocks that its arrival brings.



**E29. LEARN ELECTRONICS THROUGH TROUBLESHOOTING** — WAYNE LEMONS — 3 1/2" x 5 1/2" 576 pp. \$12.75. In this excellent book, illustrated by many photographs and drawings, the subject matter is presented in terms of practical troubleshooting situations and simple, reproducible examples. These facts will be indispensable to the technician entering the electronics field.

Prices are current at time of publishing but are subject to change.

**MODERN BOOKS & PLANS,**  
21-23 Bathurst Street, Sydney 2000.

Please state code number when ordering

Please send me the following book(s) .....

.....

Add postage—N.S.W. 60c, other States 80c.

I enclose \$ .....

Name .....

.....

..... State ..... P. Code .....

# TECH-TIPS

## PULSE COUNT TO SPEED CONVERTER

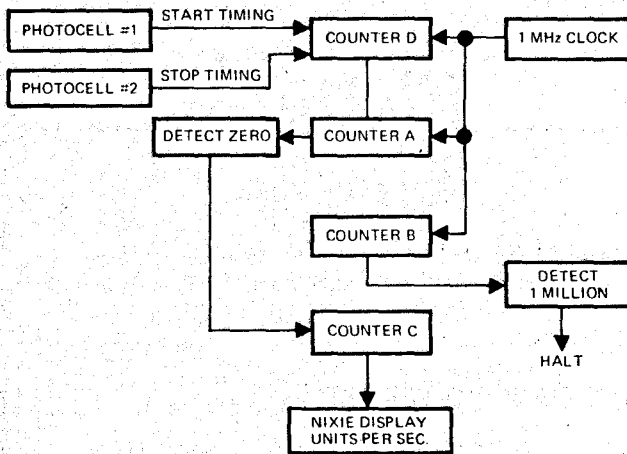

A customary way to find the speed of an object is to measure the time it takes to go between two points. In applications from traffic intersection control to laserbeam projectile tracking, this kind of measurement is made by a pair of spaced photocells that start and stop counting of a known timebase.

A disadvantage of this method is that the counter measures elapsed time, not speed. To obtain a speed measurement, the reciprocal of the pulse count must be determined. This involves division, and when BCD quantities are involved, arithmetic dividers can require a lot of hardware.

A system has been designed using logic modules to employ a simple serial counting technique that forms a four-BCD digit conversion of a 16-bit binary count in about one second. Using a one MHz clock, the circuit provides speed readout in "units per second" where the unit is the distance between the photocell sensors. Thus, if the photocells are one yard apart, the readout is in yards per second. A negative pulse from the first photocell enables counter D to accumulate 1MHz clock pulses. Counting continues until a negative pulse from the second photocell disables the counter. The information in counter D is then jammed into counter A, which is counted down on each clock pulse, while counter B is counted up. When counter A reaches 0, counter C is incremented and counter D is again jammed into counter A. Counter A again counts down, while counter B continues to count up with counter C incrementing each time counter A reaches 0. The process continues until counter B reaches one million. At this time counter C and the Nixies hold the final answer. The logic in effect determines the number of times the accumulated count can be divided into one million. Since counter C counts in BCD, a decimal answer is displayed on the Nixie indicators.

Many duration-to-speed applications are obvious, and the same conversion system can be employed whenever reciprocal relationships must be determined: photometrics; automatic photo processing equipment, etc.

*From Hewlett-Packard News Sheet*

# CAREER OPPORTUNITIES

**EMPLOYERS — Seeking Staff? Electronics Today is read by the very people you seek! (and our copy deadline is only 10 days). Managers, Engineers, Technicians, Draughtsmen, Salesmen, etc. • You already have a good job but seek a better one. Here they are.**

## TECHNICAL MANAGER

Hyco Products Pty. Ltd.

Applications are invited for the position of Technical Manager of one of the subsidiary companies of DAVIS CONSOLIDATED INDUSTRIES LIMITED.

**QUALIFICATIONS:** A University Degree (or its equivalent) in a field related to Polymer Chemistry together with at least 5 years' industrial experience, preferably in P.V.C. Chemistry and its application are essential. Experience in the field of Technical Service to customers is desirable.

**AGE:** 30 to 40 years preferred.

**DUTIES:** The appointee will be responsible for the Technical Management of a rapidly developing industry providing raw materials for a plastics applications.

**SALARY AND CONDITIONS:** This is a senior executive position and salary is subject to negotiation by \$9000 may be taken as a minimum.

A company car will be provided.

An attractive Superannuation Scheme is available after a qualifying period.

Applications will be treated in strictest confidence and should be addressed to:—

The Technical Director  
DAVIS CONSOLIDATED INDUSTRIES LTD.,  
P.O. Box 169, BOTANY, 2019.

## CONSTRUCTIONAL ENGINEER

The Commonwealth Department of Works invites applications for a position of Engineer Class 2 in its Construction Section, located in the Tower Building, Australia Square.

**Duties —** Under general technical direction, responsible for the professional and technical control of electrical work performed by Metropolitan Day Labour organizations, including the installation and maintenance of underground and aerial reticulation and associated buildings, and the maintenance of air conditioning plants, automatic oil fired boilers and emergency generating equipment throughout the Sydney area.

**Qualifications —** Educational qualifications admitting to Grad. I.E. Aust.

**Salary —** Within the range of \$7650-8750 according to qualifications and experience.

**How to Apply —** Standard application forms are obtainable from the Department of Works, Sydney (phone 2709.228). Complete forms should be forwarded to:

Director of Works,  
Department of Works,  
P.O. Box H27,  
Australia Square, SYDNEY, N.S.W. 2001  
By: 29 Oct. 1971.

## TELEVISION SERVICEMAN

A leading Service Company requires additional Servicemen for FIELD AND WORKSHOP to cope with its expanding commitments.

Only experienced men seeking permanent employment should apply.

Wages and conditions are good. Superannuation available after qualifying period.

For appointment phone Mr. J. Hicks, at 73-0211, Extension 305.  
E.I.L. SERVICE PTY. LTD.  
443 Concord Rd., RHODES.

(A Division of Electronic Industries Ltd.)

# CAREER OPPORTUNITIES

## DRAUGHTSMAN

A vacancy exists in the Engineering Drawing Office of our Port Kembla Works for an EXPERIENCED DRAUGHTSMAN to assist in the mechanical work in developing and maintaining plant associated with the smelting, refining and casting of copper. Qualifications should include the mechanical certificate and practical experience in heavy industry. Conditions include a subsidised superannuation scheme and, at the discretion of the company, overtime and annual bonus. Salary by negotiation. Apply in the first instance, in writing to

The Manager,  
**THE ELECTROLYTIC REFINING AND SMELTING  
 COMPANY OF AUSTRALIA LIMITED,**  
 BOX 42, POST OFFICE,  
 Port Kembla, N.S.W. 2505.

## TECHNICIAN

(Data Electronics)

Our Field Engineering Department requires a Technician who will ideally have certificate level qualifications in electronics and who has had considerable practical experience in data techniques. Excellent conditions

Apply Staff Office,  
**AMALGAMATED WIRELESS (Australasia) LIMITED**  
 422 Lane Cove Road, NORTH RYDE.

## SOUND ENGINEERS

ELECTRONIC TECHNICIANS, PROJECTOR TECHNICIANS AND RADIO & TELEVISION TECHNICIANS required for vacancies for Sound Engineers, Radio and Motion Picture Branch, Sydney.

Salary: \$4278 range \$5073 depending on qualifications, experience and subsequent service.

Duties: Checking and servicing of Radio and Television Equipment, Sound Equipment, Tape Recorders, 16mm and 35mm Sound-on-Film Projection Equipment and other forms of projectors.

Qualifications: Intermediate Certificate and completion of some recognised technical training in electronics. Experience in fitting and/or turning and TV/Radio servicing an advantage. Driver's licence essential.

Applications: Staff Officer, Government Stores Department, 144 Gloucester Street, Sydney, closing 12th November, 1971. Enquiries - Mr. Kroehnert, telephone 67-0331.

## TECHNICAL OFFICER

An interesting position is available for a man with electrical engineering certificate or an electrical tradesman currently engaged in the above course.

Duties include routine and type testing of high voltage power capacitors, current transformers.

**ENDURANCE ELECTRIC PTY. LTD.**  
 P.O. Box 64, Villawood, 2163  
 Attention: Mr. P. Ackerman, Phone 727-8088.

**For more information on the Careers Opportunity Columns of Electronics Today (Advertising rate 76c per line) contact:—Sydney, Howard Jenkins or Terry Marsden, 26 2296; Melbourne, Clarrie Levy, 51 9776.**

### COPYRIGHT — ALL RIGHTS RESERVED

Devices or circuits illustrated or described in **ELECTRONICS TODAY** may be the subject of patent protection. Information is given without prejudice to patent rights and without responsibility for any circumstances arising from its application.

**ELECTRONICS TODAY'S** product tests are—unless otherwise stated—performed by our independent testing consultants, whose name will be supplied on request. No product test, or part thereof, may be reproduced for any purpose without the written authorisation of the Editor.

# TECH-TIPS

## BOOST YOUR MAINS

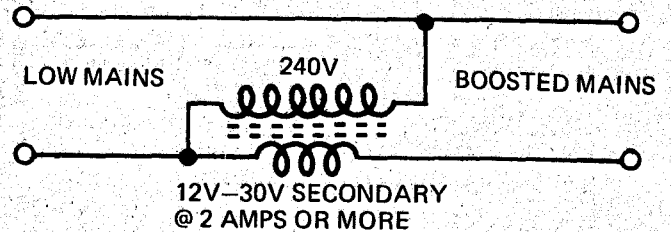

Mains voltage may be boosted by up to 10% by using a standard filament transformer connected as shown above.

## IMPROVING UJT LINEARITY

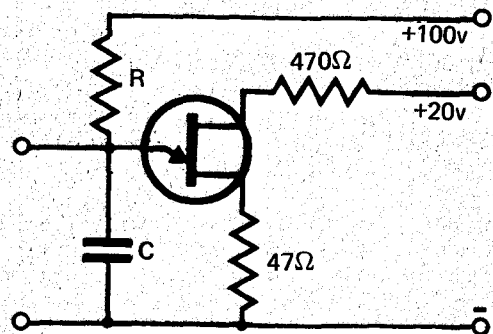

The linearity of a UJT relaxation oscillator may be improved by returning the 'timing' resistor R to a high voltage supply.

## LOUDSPEAKER MICROPHONE

We regret that a drawing error occurred in the "Loudspeaker Microphone" Tech-Tip published on page 107 of our January 1972 issue.

The correct circuit is reproduced below.

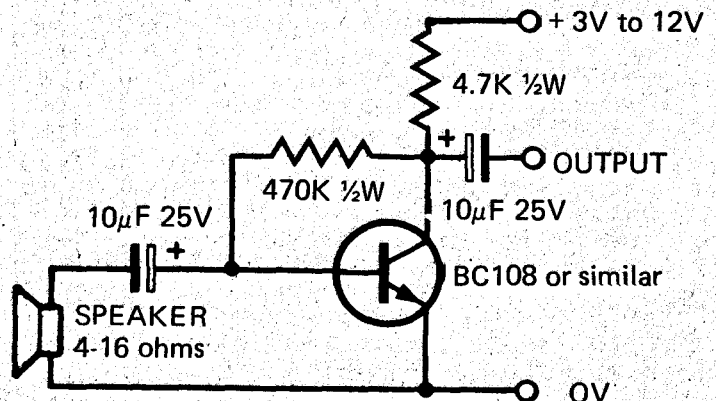

# READER INFORMATION SERVICE

For further information on Advertisers listed below complete the coupon/s stating information required including company and position held (if relevant). Cut out the coupon and post to:—

**ELECTRONICS TODAY, 21-23 Bathurst St., Sydney. 2000.**

## ADVERTISERS

	Page No.
A & R Electronic Equipment Co P/L	.95
Ace Radio	.94
Adcola Products P/L	.94
Aegis P/L	.112
Amplion (A'asia) P/L	.108
Associated Control P/L	.33
Astronics Australasia P/L	.63
Australian Musical Industries	.127
Australian Radio & TV College P/L	.128
Autel Systems P/L	.11
B.S.R. (A'asia) P/L	.25
Classic Radio Service	.92
Convoy International	.101
Custom Electronics	.104
Douglas Trading P/L	.26
Edge Electrix	.104
Elmeasco Instruments P/L	.106
Encel Electronics P/L	82,109
Ferguson Transformers P/L	.102
Goldring Engineering P/L	.108,110
Ham Radio Suppliers	.97
Heating Systems	.96
Imported Components P/L	.88
International Correspondence Schools	.13
Intruder Alarms	.7,121
IRH Components P/L	.39
Jacoby Mitchell & Co P/L	.126
Klarion Enterprises	.94
Lafayette Electronics	.12,13,108
Lanthur Electronics	.116
Leroya Industries	.91
Magna-Techtronics (Aust) P/L	.14
Magnetic Sound Industries	.104
Manufacturers' Special Products P/L	.106
Maurice Chapman & Co P/L	.113
Music Maker	.96
National Radio Suppliers	.99
Olims Trading Co	.8-9,15
Plessey Ducon	.110
Pre-Pak Electronics	.86-87
Scientific Electronics	.2
Security Engineering P/L	.12
Simon Gray P/L	.93
Sinclair Electronics	.99
Sonab of Sweden	.96
Sony (Jacoby Kempthorne & Co P/L)	.94
Sound House	.99
STA Electronics	.96
Stotts College	.94
Tecnico Electronics	.99
Telstar Electronics	.84
United Trade Sales P/L	.34,90
University Graham Instruments P/L	.108
Warburton Franki Ltd	.110
Wayne Communication & Electronics	.112
Weston Electronics P/L	.104
Wonder Wool P/L	.92
World Record Club	.92
Zephyr Products	.92

Four reply coupons are provided here for your convenience. Please list only ONE advertiser and ONE product on each coupon. If you require information on more than four individual products, make as many copies of the coupons as you like (preferably typed)—again using one coupon form for each product.

**Send to ELECTRONICS TODAY, 21-23 Bathurst St., Sydney. 2000.**

ADVERTISER.....

PRODUCT.....

NAME.....

ADDRESS.....

POSTCODE.....

COMPANY.....

POSITION.....

2:72

**Send to ELECTRONICS TODAY, 21-23 Bathurst St., Sydney. 2000.**

ADVERTISER.....

PRODUCT.....

NAME.....

ADDRESS.....

POSTCODE.....

COMPANY.....

POSITION.....

2:72

**Send to ELECTRONICS TODAY, 21-23 Bathurst St., Sydney. 2000.**

ADVERTISER.....

PRODUCT.....

NAME.....

ADDRESS.....

POSTCODE.....

COMPANY.....

POSITION.....

2:72

**Send to ELECTRONICS TODAY, 21-23 Bathurst St., Sydney. 2000.**

ADVERTISER.....

PRODUCT.....

NAME.....

ADDRESS.....

POSTCODE.....

COMPANY.....

POSITION.....

2:72

NEWSAGENT: .....

Please deliver **ELECTRONICS TODAY** for the next 12 months, starting with the..... issue, to:

NAME.....

ADDRESS.....

GIVE THIS COUPON, AND \$6, TO YOUR LOCAL NEWSAGENT. (If he already delivers your papers — as he probably does — there will be nothing more to pay; if not, he may make a small charge for the service.)

**USE THIS COUPON**

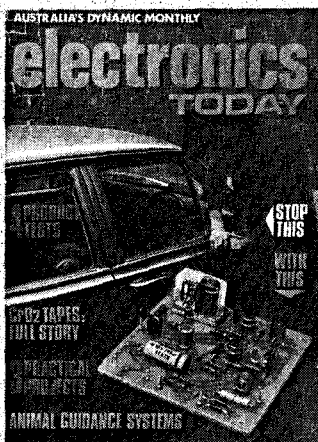

**costs no more delivered to your door ...**

**...by your local newsagent**

For only \$6 a year (12 issues at 50 cents each) you ensure that every copy of **ELECTRONICS TODAY** will arrive on your doorstep as soon as it is published --- and that you'll never miss out on it if an issue happens to sell out.

**electronics TODAY**

# ADVERTISERS' INDEX

	Page No.
A & R Electronic Equipment Co P/L	.95
Ace Radio	.94
Adcola Products P/L	.94
Aegis P/L	.112
Amplion (A'asia) P/L	.108
Associated Control P/L	.33
Astronics Australasia P/L	.63
Australian Musical Industries	.127
Australian Radio & TV College P/L	.128
Autel Systems P/L	.11
B.S.R. (A'asia) P/L	.25
Classic Radio Service	.92
Convoy International	.101
Custom Electronics	.104
Douglas Trading P/L	.26
Edge Electrix	.104
Elmeasco Instruments P/L	.106
Encel Electronics P/L	82,109
Ferguson Transformers P/L	.102
Goldring Engineering P/L	.108,110
Ham Radio Suppliers	.97
Heating Systems	.96
Imported Components P/L	.88
International Correspondence Schools	.88
Intruder Alarms	.13
IRH Components P/L	.13
Jacoby Mitchell & Co P/L	7,121
Klarion Enterprises	.39
Lafayette Electronics	.126
Lanthur Electronics	.94
Leroya Industries	.12,13,108
Magna-Techtronics (Aust) P/L	.116
Magnetic Sound Industries	.91
Manufacturers' Special Products P/L	.14
Maurice Chapman & Co P/L	.104
Music Maker	.106
National Radio Suppliers	.113
Olims Trading Co	.96
Plessey Ducon	.99
Pre-Pak Electronics	8-9,15
Scientific Electronics	.110
Security Engineering P/L	.86-87
Simon Gray P/L	.2
Sinclair Electronics	.12
Sonab of Sweden	.93
Sony (Jacoby Kempthorne & Co P/L)	.99
Sound House	.96
STA Electronics	.94
Stotts College	.99
Technico Electronics	.99
Telstar Electronics	.84
United Trade Sales P/L	.108
University Graham Instruments P/L	.110
Warburton Franki Ltd	.112
Wayne Communication & Electronics	.104
Weston Electronics P/L	.92
Wonder Wool P/L	.92
World Record Club	.92
Zephyr Products	.92

## LAFAYETTE GUARDIAN "6000" 6-Band

AM — Marine — FM — Aircraft — VHF — Portable Radio

With Radio Direction Finder

Rotatable Antenna for LW, AM and MB reception & Direction Finding

**\$169.50**

Including Sales Tax

Signal Strength Tuning/Battery Meter

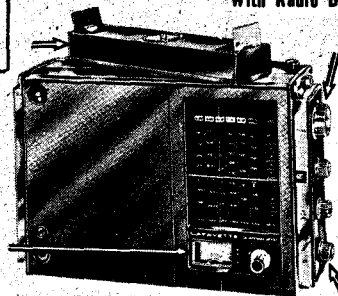

Tunes 6 Bands

Squelch Control

**BATTERY OR 240V AC OPERATION**

(1) 80-380 KHz (2) 540-1600 KHz Broadcast (3) 1.6-4.0 MHz Marine (4) 88-108 MHz FM (5) 108-136 MHz Aircraft (6) 147-174 MHz FM VHF.

The Guardian "6000" is Lafayette's most advanced deluxe Portable Battery/Electric Radio for top reception plus Direction Finding.

**LAFAYETTE ELECTRONICS** 94 HIGH ST., ST. KILDA, VIC., 3182. Phone: 94 6036

The new TEAC A-350 reaches a new low in background noise. Because the Dolby Noise Reduction System\*\* is incorporated into it. Signal-to-noise ratio is improved by as much as 5dB at 1kHz, 10dB at 4kHz and above. Eliminating coloration and audible noise and hiss inherent in the tape or induced by the recorder.

Even mike pre-amp noise is eliminated by means of the Input Selector Switch.

The TEAC A-350 reproduces low frequencies never heard on a cassette before. As well as high. Multiple functions tape selector switch sets the exact bias and equalization for maximum frequency range from

any tape—regular or high energy and the new chromium dioxide tapes.

There's a new low in distortion. Peak Level Indicator warns you of overload *before* VU meters peak out. Especially critical with the new low-noise tapes which require a higher recording level. Expanded VU meters, too, for further accuracy. Up to +6dB vs. +3dB.

There's a new low in tape head wear and maintenance. High density ferrite heads are standard on the A-350, the same ones used on expensive open-reel machines. So durable and precisely milled, TEAC guarantees them for the life of the machine.

Not an improved model, the TEAC A-350 is an all-new tape deck designed especially for the expanded frequency range and low-noise characteristics of new chromium dioxide and high energy tapes.

Which is why it delivers a new high in cassette stereo sound reproduction.

\*\*Dolby is a trademark of Dolby Laboratories, Inc.



**Cassette  
tape decks  
have reached  
a new low.**

**TEAC**

A Sound Idea

Australian Distributors:

**Australian Musical Industries Pty. Ltd.,**  
155 Gladstone St., Sth. Melbourne, Vic., 3205.  
Phone 69 7281

NSW: Convoy International Pty. Ltd., 357 2444; Magnetic Sound, 29 3371; W. C. Wedderspoon, 29 6681; Autel Systems Pty. Ltd., 89 0663. TAS: Willis & Co., Launceston 2 4641; Audio Services, Burnie 31 1960. NT: P. J. Leunig Pty. Ltd., Alice Springs. SA: Truscott Electronics, 23 3024. QLD: Brisbane Agencies Audio Centre, 26 931; Stereo Supplies, 21 3623. WA: Arena Distributors Pty. Ltd., 21 9993. ACT: Homecrafts Hi-Fi Centre, 47 9624. VIC: Douglas Trading, 63 9321; Brashes Pty. Ltd., 63 6701; Suttons Pty Ltd., 60 1201.



# 40,000 TECHNICIANS CAN'T BE WRONG!

- More than 40,000 ambitious men have benefited from A.R.T.C. training.
- Join this large number of successful men!
- Attain job security and financial reward.
- These can only be yours from:

AUSTRALIA'S

## ESTABLISHED ELECTRONICS COLLEGE

**THE AUSTRALIAN RADIO & TELEVISION COLLEGE PTY. LTD.**

- ESTABLISHED OVER 40 YEARS
  - OVER 15 FULL TIME STAFF TO ASSIST YOU
  - FULL NIGHT-CLASS PRACTICAL LESSONS
- OR
- EXTENSIVE CORRESPONDENCE TRAINING WITH SPECIAL PRACTICAL HOME-TRAINING KITS

**Mail Coupon NOW**

• You are invited to mail the coupon below which can be your first step towards securing a job or business of your own with good prospects, security and big money. A.R.T.C. will mail to you by return, at no obligation to you the big free booklet: "Careers in Radio and Television". This booklet will show you definite steps you can take for a better job, how you can succeed in life. Post the coupon, phone or call NOW.

**AUSTRALIAN RADIO  
AND TELEVISION  
COLLEGE**

**PTY. LTD.  
E.S.&A. BANK BUILDING,**

**Cnr. Broadway and City Road, Sydney.  
(Opp. Grace Bros). Phone 211-4244 (3 lines)**

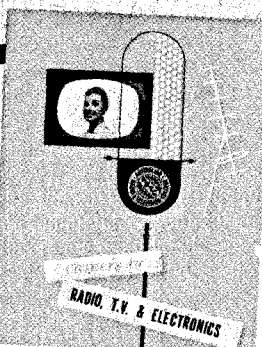

**AUSTRALIAN RADIO & TELEVISION  
COLLEGE PTY. LTD.  
206 Broadway, Sydney, N.S.W.**

Dear Sir,  
Please send me, without obligation, your free booklet, "Careers in Radio, TV and Electronics".

NAME.....

ADDRESS.....

**T202**