

SPECIAL OFFER: TDK NECKLACE

electronics today

FEBRUARY 1978

INTERNATIONAL

\$1.25*
NZ \$1.50

SOUND LEVEL METER

SPECIAL PROJECT:

**Real Time
Audio Analyzer**

**TV/FM ANTENNA TO BUILD
OVER THE HORIZON RADAR
PLUS**

News, Hi-Fi, Microprocessors...

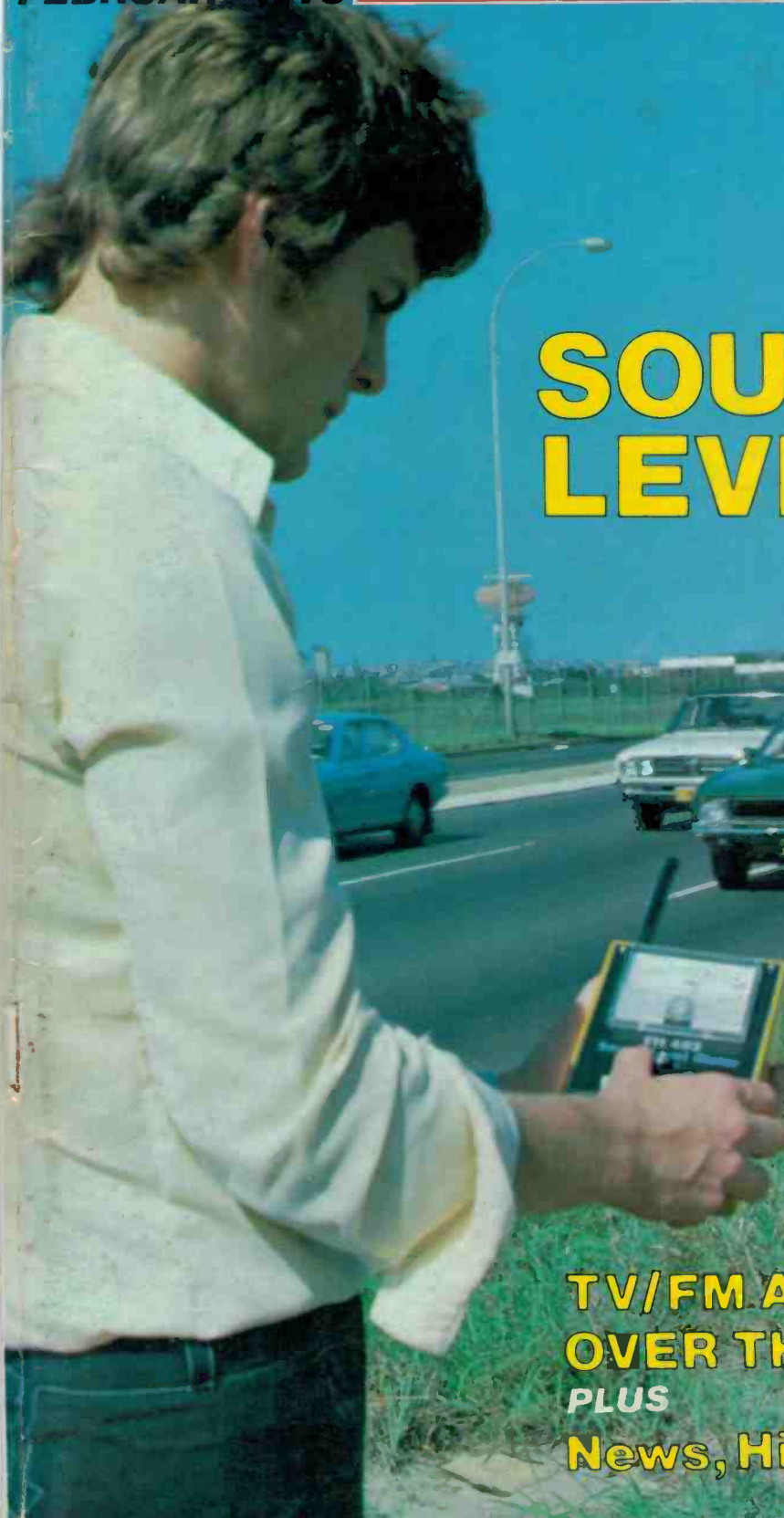

The Precision Decision. We made it. Now it's your turn.



QL-7

We believe that precision is the most important factor in turntable design and performance. Which is why we've built such a high degree of precision into our advanced new line of JVC turntables.

So you'll need a whole new set of reasons to choose the one that's right for you. And when it comes to value, all will play second to none.

Take our new QL-7 Quartz-Locked and JL-F50 Fully Automatic direct drive, shown above. They're both unusually close when it comes to some important specs, but what will surprise you most is that they're also both in the same price range.

For instance, the JL-F50 checks in with less than 0.03% wow and flutter (WRMS); 70dB signal-to-noise ratio (DIN B). And it offers a host of convenience features as well, with most controls up front so you can operate them without lifting the dust cover. Its fully automatic operation gentles your favourite records, and lets you repeat them from one to six times, or infinitely. A built-in strobe makes speed adjustments easy and accurate. And the JL-F50's looks are in keeping with its precision design.



JL-F50

The QL-7's looks are equally great. And in its electronic heart, it's a tiger. All business, with the incredible accuracy only a Quartz-Locked machine can boast. Truly for a perfectionist, the QL-7's wow and flutter measures only 0.025% (WRMS); S/N is more than 74dB (DIN B). Figures that most other QL turntables we've seen in its category cannot match. It's totally manual, with strobe speed indicator.

The way we see it, you're left with a superb decision: our JL-F50 at less than \$350* . . . with all the convenience and performance most people could ever want, or our QL-7, the finest under \$450* turntable available today for the discriminating audiophile.

Whatever JVC you choose, you'll know you've made the right choice.

For details on JVC Hi Fi Equipment, write to: JVC Advisory Service, P.O. Box 49, Kensington, N.S.W. 2033 *Approximate retail value.



the right choice

electronics today

INTERNATIONAL

Editorial: Les Bell
 Publisher: Collyn Rivers

We regret that, due to space restrictions, we have had to postpone the final description of the 588 Theatrical Lighting Controller rack until the March issue. All specialised components used in this project should be available by that time.

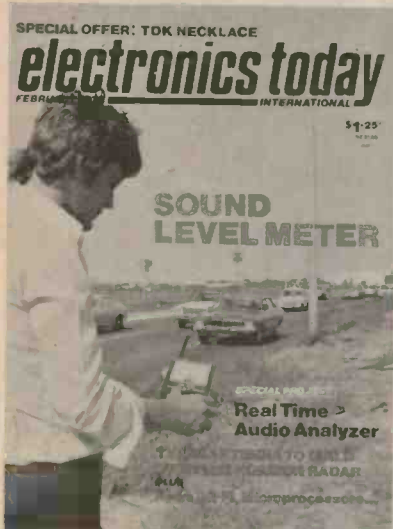

Cover: We took the 483 Sound Level Meter out for various trials, including measuring traffic noise.

PROJECTS

487: Real Time Audio Analyzer	12
<i>Do my ears deceive me?</i>	
483: Sound Level Meter	28
<i>Or is it just too loud?</i>	
714: VHF Log-Periodic Antenna	45
<i>One antenna for FM and TV.</i>	
715: VHF Power Amps	66
<i>140 W on 2 m.</i>	

FEATURES

Sound	20
<i>Looks at SME III.</i>	
OTH-B Radar – In Defence of Australia	35
<i>Radar 'sees round corners'.</i>	
VFETs for Everyone, Pt II	53
<i>Practical applications.</i>	
UHF CB Antennas	62
<i>The coming system.</i>	
The One-armed MPU	81
<i>Using an MPU.</i>	
Special Offer: TDK Necklace	94
<i>Stiff neck?</i>	

NEWS & INFORMATION

News Digest	5	Print Out News	77
Unitrex Calculator Contest	9	Mini Mart	92
Sound Briefs	24	Ideas for Experimenters	99
Data Sheet	72	Reader Services	106
		Index to Advertisers	106



A Modern Magazines Publication
 * Recommended retail price only.

Registered for posting as a publication – Category B

TO JUDGE THE QUALITY OF OUR NEW MAGNETIC CARTRIDGES WE MADE USE OF THE MOST SOPHISTICATED MEASURING EQUIPMENT AVAILABLE.

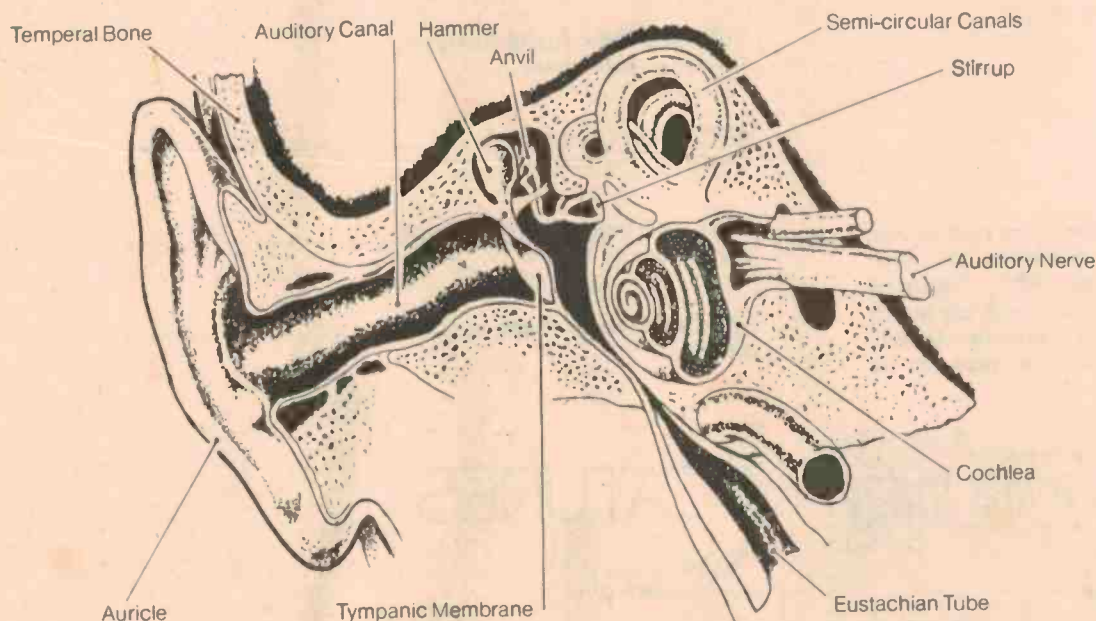

WE WANT YOU TO DO LIKEWISE.

No matter how often we are praised by reviewers in curves and data, we know that for you it's not worth the paper it's printed on unless your ears agree.

For that reason each and every step on the way to our new line of magnetic cartridges was carefully monitored by the Ortofon "Golden Ear Panel". We believe that a good cartridge should produce perfect sound rather than convincing diagrams. And we trust you feel the same.

So, when choosing your new cartridge, trust your ear. You will inevitably end up with an Ortofon.

We're easy to find. Just listen.

ortofon
accuracy in sound

Distributed by—
HARMAN AUSTRALIA PTY. LTD.,
P.O. Box 6, BROOKVALE, N.S.W. 2100.
Telephone: (02) 939 2922

Distributed in New Zealand by—
AWA NEW ZEALAND Ltd, P.O. Box 1363, AUCKLAND, Telephone: 76 0129;
WELLINGTON, Telephone: 85 1279; CHRISTCHURCH, Telephone: 89 0449.

MA104/78

News Digest

New BASIC Compiler

December 31, 1977, Los Angeles, California — Futuredata Computer Corporation has announced the availability of a Universal BASIC Compiler to run on 8080, 8085, 6800 and Z-80 microprocessors. In addition to being the first truly universal compiler, the Futuredata BASIC Compiler includes a high level debugger that allows program debugging without dealing directly with assembly language.

All standard BASIC statements are included plus string variables, array variables, bit functions, PEEK, POKE, INP and OUT functions. The user is also permitted to intermix assembly language instructions directly in the BASIC program. The Debugger allows the user to set and clear breakpoints with BASIC statement numbers and to display variables in memory using the BASIC variable name.

Futuredata BASIC has the option of outputting an assembly language source code of the compiled program to an editor file. Each BASIC statement becomes a comment in the assembly listing. The compiled assembly instructions follow the BASIC statement.

This allows the user to optimize sections of the program by directly editing the assembly language after compilation.

The Futuredata Universal Compiler is especially well suited for developing programs for real-time process control and test equipment. The Compilers run in systems with at least 32K bytes of memory and are available for any of Futuredata's disk-based MICROSYSTEMS — the MICROSYSTEM/20 with dual 5" minifloppy disks, the MICROSYSTEM/30 with dual 8" floppy disks, or the MICROSYSTEM/32 with dual 8" double-sided, double-density floppy disk. Each MICROSYSTEM comes complete with an 8080, 8085, 6800 or Z-80 processor, a 960 character CRT-display, a 53-key ASCII keyboard, memory peripherals, full operating software and a full set of manuals.

Price: Universal BASIC Compilers — \$300 each. Availability: stock to 30 days. Manufacturer: *Futuredata Computer Corporation, 11205 So. La Cienga Blvd., Los Angeles, CA 90045. Telephone: (213) 641-7700. Sales contact: R. Schaaf, Director of Marketing.*

Tektronix Digital Latch

As an extension of its logic analyzer the 16 channel DL 502 Digital Latch enhances the user's ability to make asynchronous measurements by latching pulses as narrow as 5 ns and amplitudes as small as 500 mV centered on a threshold set by the user.

The DL 502 plugs into any TM 500 Mainframe/Power Module. The digital latch is conveniently interfaced to the TEKTRONIX LA 501W Logic Analyzer with both housed in a TM 500 Mainframe. The DL 502 can also be used in a TM 500 Mainframe for convenient connection to the TEKTRONIX 7D01 Logic Analyzer in a configuration such as the popular TEKTRONIX 7603 Oscilloscope/7D01F Logic Analyzer/Display Formatter combination. The TEKTRONIX P6451 low capacitance data acquisition probes connect to the DL 502 which then interfaces to either the 7D01 or LA 501W Logic Analyzers. Further information from Tektronix Australia Pty. Ltd., 80 Waterloo Road, North Ryde, NSW 2113 (or local offices).

FUTUREDATA DOS ASSEMBLER - VER 1.2

PAGE 2

* FOR I=1 TO 71 READ (I): NEXT I

```

0096 210000 LXI M,0
0099 220004 SHLD VI
009C 21F9FF LXI M,-7
009F 220204 SHLD FT1
00A2      LOA   EQU *
00A2 2A0004 LHLD VI
00A5 110404 LXI D,VU
00A8 29      DAD  H
00A9 19      DAD  D
00AA E5      PUSH H
00AB E1      POP  H
00AC CDE2D8 CALL READ
00AF 02      DC   2
00B0 2A0004 LHLD VI
00B3 23      INX  H
00B4 220004 SHLD VI
00B7 EB      XCHG
00B8 2A0204 LHLD FT1
00BB 19      DAD  D
00BC 7C      MOV  A,M
00BD B7      ORA  A
00BE FAA200 JM   LOA
00C1 85      ORA  L
00C2 C2A200 JNZ  LOA
00C5      * 10 IX=1: IY=0: AN=
00C5      * 10 CP
00C8 C0C000 JMP  #+7
00CB 31      SC   '10
00CC      LXI  M,1
00CD      SHLD VI
00CE      LXI  M,0
00CF      SHLD VI
00D0      SHLD V
00D1 21E000 LXI  H,0
00D2 21E000 LXI  H,0
00D3 21E000 DAD  H
00D4 21FFFF LXI  H,0
00E7 211027 * H=1
00EA 221004 SHLD V
00ED 210A00 LXI  H,0
00F0 221204 SHLD VDL
00F3 21F23C * C=15602+16163
00F6 114F40 LXI  M,15602
00F9 19      DAD  D
00FA 221404 SHLD VC
00FD 21FFFF * EX=-1: EY=1: D=RND(36)+31864
0100 221804 LXI  M,-1
0103 210100 SHLD VEX
0104 221A04 LXI  M,1
0109 212600 SHLD VEY
010C C00000 LXI  M,36
010F 11787C CALL RAND
0110      LXI  D,31864
    
```



Due for a Fall

Amidst widespread concern following the re-entry of a Russian satellite over Canada, H.H. Sargent, chief forecaster for the US National Oceanographic and Atmospheric Administration (NOAA) has predicted that the days of the Skylab space station are also numbered — and are fewer than hitherto believed. Increased solar activity, as the sunspots increase, will cause ionisation and consequent expansion of the atmosphere thus increasing orbital drag at Skylab's altitude. Although many authorities are predicting sunspot numbers of 110 or less, H.H. Sargent's prediction is of a sunspot maximum number of 154, with peak activity during the first half of 1980.

432 MHz World Record Broken!

On the evening of 11th January, Les Jenkins VK3ZBJ and Wally VK6KZ (ex - VK6ZAA) shattered the existing world distance record for the 432 MHz amateur band.

Les, located at Frankston, near Melbourne, worked Wally who operated portable from a hill 26 miles to the west of Albany. Both stations used SSB, Les running 80W PEP to a 44 element set of yagis (19.5 dB measured gain) and Wally ran 8W PEP to an 8 element yagi.

The distance covered is close to 1800 miles.

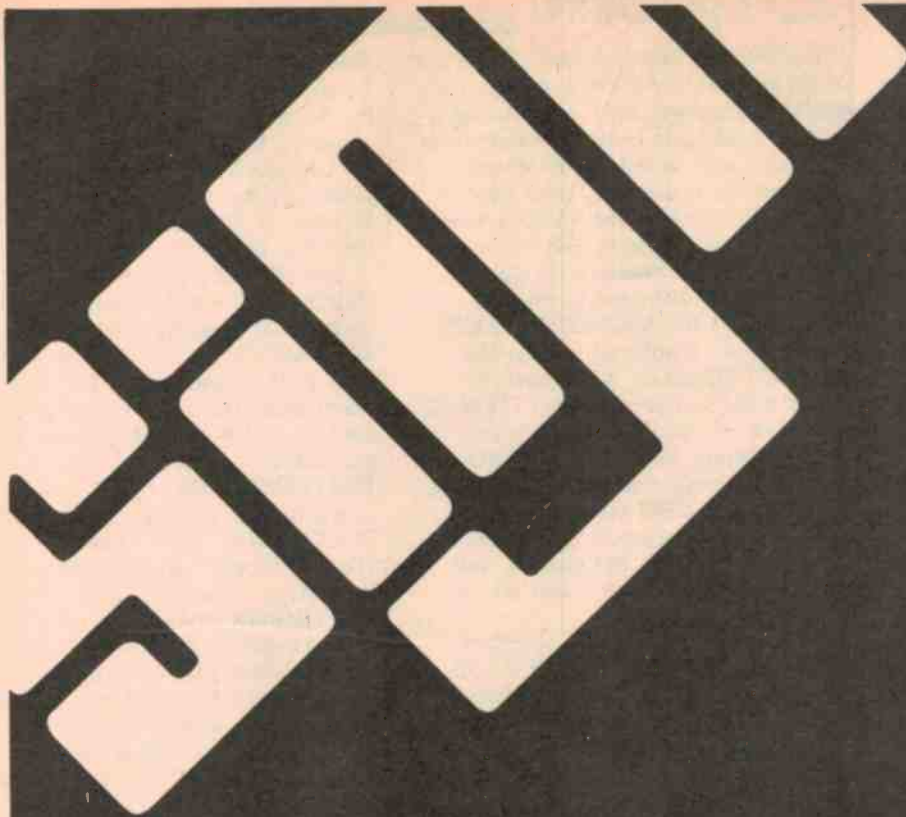

WHICH IC FIRM IS CAUSING A NATIONAL UPSET?

A new team is jostling the biggest names in ICs. When you see who it is you'll appreciate why. Signetics - known worldwide for reliability and high technology has become part of Philips with massive R & D, manufacturing, and servicing resources. That's important news for

you. Signetics offers a natural alternative for all your IC requirements. Signetics ICs are supported by a strong sales and technical team and are available nationwide through an expanded distribution network. We'll supply all types of industrial and consumer

ICs. And we'll ensure the continuity of that supply short or long term. Let us prove our IC capability. Ask us for a quote. Write today to Signetics IC Marketing Group at Philips Electronic Components and Materials, P.O. Box 50, Lane Cove, N.S.W. 2066

signetics

LOGIC - MEMORIES - INTERFACE - MICROPROCESSORS - LINEAR - MILITARY



Electronic
Components
and Materials

PHILIPS

Reflective Object Sensors

Two new low cost reflective object sensors providing solid state reliability for non-contact sensing applications were announced by Optron, Inc., recently.

Both the new OPB 706 and OPB 707 reflective object sensors are ideally suited for such non-contact sensing applications as paper edge detection, tachometers, motor speed controls, eot/bot sensors, and proximity detection. The devices combine a high efficiency solution grown gallium arsenide infrared LED with a silicon n-p-n phototransistor (OPB 706) or maximum sensitivity photodarlington (OPB 707) in a plastic package. The photosensor senses radiation from the LED only when a reflective object is within its field of view.

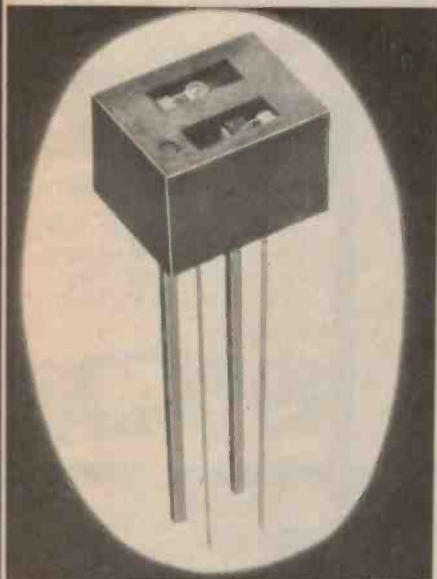

With LED current of 20 mA, the output of the OPB 706 is typically 750 μ A when the device is positioned 0.050 inch from a 90% reflective surface. Under similar operating conditions, the output of the OPB 707 is typically 35 mA.

A built-in light barrier in both devices prevents response to radiation from the LED when there is not a reflective surface within the field of view of the sensor. With no reflective surface, the maximum sensor output due to crosstalk between the sensor and LED is 0.200 μ A and 10 μ A for the OPB 706 and OPB 707, respectively.

Technical data on the new OPB 706 and OPB 707 reflective object sensors is available on request to:

*Namco Electronics,
239 Bay Street,
Brighton North 3186*

Magnetic necklaces from TDK

Everyone even remotely involved with audio knows of TDK. They're the General Motors of the recording industry and respected worldwide for the integrity of their engineering.

Imagine our surprise then when we were told that TDK are marketing a magnetic necklace specifically intended to alleviate 'stiff shoulders and necks' — but when a company like TDK produce such a product they must be taken seriously.

TDK state that whilst it is generally believed that the cause of 'stiff shoulders' is mental and bodily stress, the exact reasons for the symptoms are not totally known. Nor is it understood how or why an applied constant magnetic field alleviates the symptoms.

There is nevertheless a great deal of evidence that the devices do work. They have for example been approved by the Japanese Ministry of Health and Welfare (approval number 51B-614). Prof. T. Yamamoto (Juntendo University, Tokyo) reports . . . with patients whose main complaint was stiffness in the shoulder, the necklaces were found to be significantly effective by 65-70 per cent (P 0.05).

Kyoichi Nakagawa (Director, Isuzu Hospital, Tokyo) states, 'Effectiveness of the magnetic necklace was found at the rate of 82.1 percent — 96.3 per cent on the probability level one percent to subjective symptoms. No disadvantageous side effect has been found . . .'

Akio Hirose (Medical Faculty, University of Tokyo) states . . . no detailed explanation of how it works is available . . . but as proved from our experiment magnetic necklaces are effective against 'stiffness' and we believe no side effects are caused (the experiment referred to involved blind sampling with 198 participants using TDK necklaces and 'dummy' necklaces having some minor magnetic field — Ed).

TDK's magnetic necklaces look just like normal jewellery. Nevertheless, the necklaces contain rare earth cobalt magnets originally developed for the NASA space project and having permanent life. They are about five times more powerful than ferrite magnets used in previous magnetotherapeutic devices. Field strength is a massive 1300 gauss but when worn the necklaces feel no different from a conventional piece of jewellery.

TDK magnetic necklaces are handled in Australia by the Caldor Corporation and that company has arranged to make the necklaces available to our readers at

\$49.95 including postage and packing. The offer is spelt out in greater detail on page 94 of this issue.

Thousands of people have used these necklaces and claimed they have experienced relief of 'stiffness' — however we must make it absolutely clear that there is no totally tangible scientific evidence to support or refute any claims or statements made although research is continuing worldwide. Therefore as no claims can currently be substantiated (and of course no claims are made by us or Caldor) — the ultimate decision and experience must be yours.

Nevertheless, the necklaces are made by TDK and that must mean something.

Hitachi Pull Out

Hitachi Ltd. is no longer selling CB radios in the US under its own name, but is continuing to supply to some US companies such as Radio Shack (Tandy) Sears and J.C. Penney. A spokesman for Hitachi said that their CB radio plant was being kept open not just to supply the US firms, but because the company was looking to Australia as a new market.

Meanwhile, RCA is 'carefully pruning' its CB product line while it studies the CB market to 'make our determination as to what our long-range posture in this business should be'.

Addendum

Somehow, the parts list of the 40W Stripline Broadband Amp got missed out last month. We reproduce it here, with apologies to frustrated readers.

Parts List — 40W Stripline Amp

Cin	680-1000p ceramic
C1, C4	47p metal-clad mica cap
C2, C3	100p metal-clad mica cap
C5, C8	two each 200p metal-clad mica caps
C6	200p metal-clad mica cap
C7	82p metal-clad mica cap
C9	150p metal-clad mica cap
C10	68p metal-clad mica cap
C11	33p metal-clad mica cap
C12	680-1000p button standoff cap
C13, 15,	
17	1500p ceramic
C14, 16,	
18	1 μ 25 or 35 V DC tantalum
R1, R2,	
R3	15 ohm, 1/4W resistor
RFC1, 2,	
3, 7, 10	printed inductors, on PC board
RFC4, 5,	
6	4.7 μ H moulded RF choke
RFC8, 9	5 turns, 18 or 20 gauge tinned copper or enamel wire, 6mm i.d., 15mm long
SL1-9	50 ohm stripline
Q1	CTC B3-12
Q2	CTC B12-12
Q3	CTC B40-12

MIDLAND IS BACK

yes! Midland, the world's number one selling CB radio, is now available in Australia once again. And it's in the new 18 channel Australian standard. Out of the multitude of brands of CB on the market comes a famous name that you can trust — from Australia's leading supplier of CB. Trust Midland, Trust Dick Smith — the CB experts!

MIDLAND Economy

77A-857 18 CH AM
Here's a CB that'll leave change in your pocket without sacrificing performance. Can be mounted in confined space (mic screws into front) Complete with inst, mic & hardware.
Cat D-1429



\$139⁵⁰

MIDLAND Versatility

77A-861 18CH AM: 3-way op. Portable — with own antenna & battery pack; mobile (ext 12V & external ant) base (mains adaptor & ext. antenna.) Full power unit, comp. with leather-look case, straps, mic, instructions.
Cat D1432



\$159⁵⁰

FREE Free with any CB on this page, Dick's own book on CB! Big 128 pages, incredible value at normal price of \$3.95, now FREE! Also available as a separate item, from our stores or your local newsagent.



(Cat B-2325... \$3.95)

MIDLAND Elegance

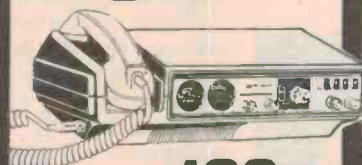

\$199⁵⁰

4A (Peak) SUPPLY

Ideal for AM or SSB rigs.

Famous Southern Star supply is 13.8V output at 1.5A cont. (4A peak). Terminals on back so leads are kept out of sight. Switch on front panel. Regulated voltage.

39⁵⁰
Cat M-9545



SWR AND POWER METER

Special feature: needs no jumper lead. Easy connections, checks SWR so you don't do damage. Also measures power. Large, easy-to-read scale, front controls.

Cat Q-1350

19⁵⁰



MIDLAND Performer

Magnificent Midland 882: ask an old pirate! One of the world's most-used sets.

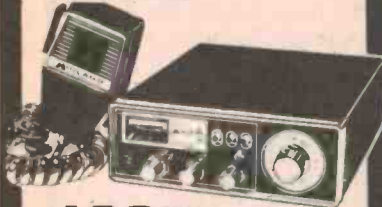

\$149⁵⁰

77A-882
18CH AM

Has delta tune, antenna warning light, external CB & PA facility, all in an up-to-the-minute set. Complete with mic, hardware, etc.
Cat D-1436

MIDLAND the Poser



\$179⁵⁰

77A-963 18CH AM
Shades of James Bond! Imagine driving down the road with one of these — telephone handset, yet! PLUS has LED readout, SWR as well as power metering, delta tune, — and can be mounted under dash or on transmission tunnel. Smart!
Cat D-1437

MIDLAND SSB magic

SSB performance for the real CBER — who wants the best. Full features, maximum range.

79A-892 18 CH SSB.



Cat D-1700

\$239⁵⁰

Has clarifier control on mic, easy-to-use. Tone switch, too. RF gain control for better copy. A superb set.

Solve your neighbour's TVI problem. Just hooks into feed-line on set. Helps in almost all cases.
Cat D-7084



Stop your own rig causing interference
Lo-pass filter goes on CB to cut out TVI causing harmonics.
Value! Cat D-7082



\$950

HORN SPEAKERS

Turn any rig into a loud hailer: 99.9% of CB's have a PA socket to plug a horn speaker into. CB then doubles as a PA speaker — ideal for club days, advtg. promotions, etc etc. Can be mounted anywhere!



\$8⁹⁰
Cat. C-2705

EXCLUSIVE

THE DSNO SYSTEM: Dick's CB theft & re-sale protection: When you register your warranty, the un-removeable CB serial no. is entered into our IBM computer along with your name and address in our special D.S.N.O. memory bank. If your set is stolen, the police or any prospective purchaser can ring us and have the rightful owner's details in minutes! Exclusive to Dick Smith!

DICK SMITH ELECTRONICS



SHOP HOURS
Mon-Fri 9AM — 5.30PM
Sat. 9AM — 12 noon
(Brisbane ½ hour earlier)

bankcard
welcome here

Order value	P&P charge
\$5 — \$9.99	\$1.00
10 — \$24.99	\$2.00
25 — \$49.99	\$3.00
50 — \$99.99	\$4.00
\$100 or more	\$5.50

SYDNEY:
125 York St.
City. Ph 29-1126
Open 'til 8PM Thursday

SYDNEY:
361 Hume Hwy.
Bankstown. Ph 709-6600
Open 'til 8PM Thursday

SYDNEY:
162 Pacific Hwy.
Gore Hill. Ph 439-5311
Ample parking at door.

SYDNEY:
30 Grose St.
Parramatta. Ph 683-1133
1st floor — friendly store!

MELBOURNE:
399 Lonsdale St.
City. Ph 67-9834
New: right in town!

MELBOURNE:
656 Bridge Rd.
Richmond. Ph 42-1614.
Easy access: huge stock.

BRISBANE:
166 Logan Rd.
Burranda. Ph 391-6233
Opens 8.30AM

ADELAIDE:
203 Wright St.
City. Ph 212-1962
Now Open. See us!

MAIL ORDER DEPARTMENT: PO Box 747, Crows Nest, NSW 2065. Phone 439-5311. Post & Pack extra.

WE HAVE DEALERS RIGHT ACROSS AUSTRALIA — THERE'S ONE NEAR YOU!



Low-light TV Camera

A new television camera which sees in the dark could well revolutionise security surveillance techniques and bring new opportunities to engineers, scientists and naturalists. It is the RCA Type TC 1040H closed circuit ISIT (intensified silicon intensified target) camera. AWA Rediffusion, jointly owned by Amalgamated Wireless (Australasia) Limited and Rediffusion of Great Britain, are exclusive agents in Australia for RCA closed circuit TV products.

The camera "turns night into day" in conditions where artificial light is not permitted or does not exist. The RCA ISIT camera tube ensures that bright highlights on the scene will not cause excessive blooming which results in useful picture information being obscured.

With the four billion to one

automatic light range when using an f1.4 auto-iris lens, full 24-hour operation is possible from starlight to full sunlight, scene illuminations being $2.7 \text{ by } 10^{-5}$ foot candles for a usable picture. A single C/mos chip generates CCIR sync with phased locked loop synchronising the camera to power line zero crossing. Crystal control is optional. Mechanically, the camera is designed about sturdy die-cast and extruded metal structures making the entire case a heatsink, resulting in cooler operation and full shielding. Printed circuit boards are modular and plug in for convenience. The camera can be supplied in a weather-proof housing if required.

The camera has great possibilities for security work at night. It will also enable naturalists, zoologists and others to study wildlife in natural surroundings during darkness.

Fluke 8020A Update

In our review of the Fluke 8020A digital multimeter (ETI Dec. '77, p.81), we stated that the device was designed to reject 60Hz mains ripple. Elmeasco have informed us that all instruments they supply are designed for 50Hz rejection (they use a different crystal).

ETI/Unitrex Calculator Contest

Congratulations (and a Unitrex calculator) go to Mr. & Mrs. C. Mesnage of Elizabeth South, South Australia, who managed to get the two mobs of sheep in the December contest past each other in only 23 moves (and draw some delightful sketches on the envelope as well). The complete solution is too long to reproduce here; besides, the fun lies in working it out for yourself.

And now, with thanks to I. Rossow, of Bundamba, Qld., here is the February problem:

A rope is hanging over a pulley with a weight at one end and on the other end is a monkey the same weight as the weight.

The weight of the rope is 4 oz per foot; the age of the monkey and that of the monkey's mother combined is four years and the weight of the monkey is as many pounds as the monkey's mother is years old.

The monkey's mother is twice as old as the monkey was when the monkey's mother was half as old as the monkey will be when the monkey is three times as old as the monkey's mother was when the monkey's mother was three times as old as the monkey.

The weight of the weight and the weight of the rope is a half as much again as the difference between the weight of the weight and the weight of the monkey and the weight of the monkey.

What is the length of the rope?

Seal an empty envelope, write your answer on the back of it, with your name and address, and send it to: Unitrex Calculator Contest (February), ETI Magazine, 15 Boundary Street, Rushcutters Bay, NSW 2011. The closing date is the 17th March.

Erratum

In the December issue, the digital frequency meter prices in the advertisement for J.R. Components (p. 119) were given incorrectly. In kit form, the prices are: for 20MHz version, \$82.00; for 200MHz version, \$89.50. For assembled and tested units, the prices are: for 20MHz version, \$122.00; for 200MHz version, \$129.50. We apologise for any inconvenience this error may have caused.

GREEN
DISPLAY

Scientific Calculators

HORNET SR-46\$17.99

● 37 Function Keys ● 8 Digit Mantissa and 2 Digit Exponent ● Two levels of Parenthesis ● Polar — Rectangular co-ordinate conversion ● Trig & Log Functions



**LOGITECH
LC1233S\$17.99**

● 8 Digit Mantissa and 2 Digit Exponent ● Two levels of Parenthesis ● Degree & Radian conversion ● Trig & Log Functions



ZENY — 35SR . \$14.99

● 8 Digit Floating Point or 5 Digit Mantissa and 2 Digit Exponent ● Two levels of Parenthesis ● Trig & Log Functions

SUPER THIN

LCD Calculators

**LOGITECH
LC-52S**

\$29.99

● 8 Digit LCD Display Floating Point or 5 Digit Mantissa and 2 Digit Exponent ● Two levels of Parenthesis ● Trig & Log Functions ● Statistical Functions ● Battery Life 1000 Hours



**LOGITECH
LC-25T**

\$17.99

● 8 Digit LCD Floating Point ● Memory ● Percentage Calculation ● Square Root ● Battery Life 2000 Hours

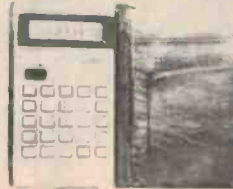

WELDS
SOLAR CELL
CHRONOGRAPH

LCD
DIGITAL
WATCH



\$65

● Stainless Steel ● Continuous 6 Digit Readout; Hour, Minute, Second or Month, Date, Day ● With 1/100 Second Accuracy Stop Watch ● Start, Stop, Reset, Lap Time Instant Time Freeze ● Four-year Calendar ● Back Light ● Solar Cell ● One-year Guarantee

Notes:

1. All Calculators are Tax Exempted Price, add 15% Sales Tax if Applicable
2. All Calculators are 3 Months Guarantee
3. Add \$2 for P & P

**CHAN MERCHANDISING
CO PTY LTD**

111 RESERVOIR ST. SURRY HILLS 2010
TEL (02) 211-4660

GET IT TOGETHER!



COMPATIBILITY is the name of the game. TECHNICS named it!

Whether you're starting a music system or upgrading one. If you want outstanding specifications, as well as the latest advances in component technology and design.

You want Technics components.

The concept is simple. The execution is precise. The performance is outstanding.

THE NAME IS TECHNICS

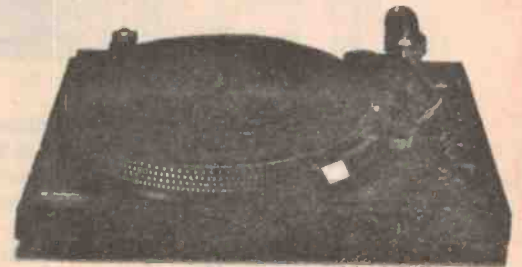

See the latest Technics range now!

Including, the astounding SB series speakers (left), the precise SL-2000 turntable (above), and the all new powerful 7300 and 7700 amplifiers.

Technics
from

RON CHAPMAN HI-FI

NEWCASTLES MAIL ORDER SPECIALIST — 880 HUNTER STREET, NEWCASTLE 2302. PHONE 69 2733.

TDK MAKE YET ANOTHER BREAKTHROUGH!

A.D. is here



**NEW TDK AD could do more
for your Hi-fi system
than \$1,000 worth
of better equipment.**

TDK's SA (Super Avilyn) made chrome dioxide tape obsolete. Now, in normal bias setting, or in all machines which are not equipped with a bias change switch, TDK AD (Acoustic Dynamic) will make your hi-fi gear sound like it's never sounded before. Wait till you hear what you've been missing! Because of AD's superior dynamic range at the critical high end, you'll hear any music that features exciting "highs" with amazing brilliance and clarity that you won't get with any other tape (except TDK's top of the line SA).

Read what Louis A. Challis & Associates Pty. Ltd. say:

"TDK AD tape generally provided the lowest harmonic distortion and indicates the tape's ability to provide higher quality sound at the same time as giving extended frequency range on medium or low quality machines."

"(Of the four premium tapes tested) TDK AD had by far the best drop-out characteristics, being equal to the best we have ever seen."

TDK AD is not only a breakthrough in tape technology — it features the jam-proof, friction-free precision cassette shell already released with TDK SA. Just as much attention has been paid to the cassette housing and mechanism as to the tape inside.

Truly the machine for your machine! At all good hi-fi stores and record bars.

 **TDK**® **AD** (Acoustic Dynamic)

SOLE AUSTRALIAN AGENTS:
CONVOY INTERNATIONAL PTY LTD
4 DOWLING ST WOOLLOOMOOLOO 2011
TEL 357 2444 TELEX AA23111

Audio Spectrum Analyser

Equalise systems for room acoustics accurately using this neat piece of 'test' gear.

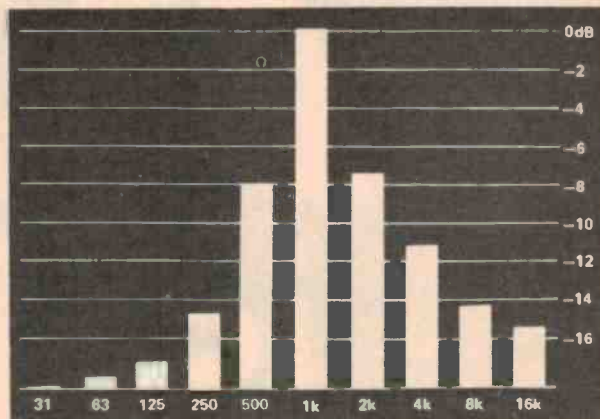

AUDIO SPECTRUM ANALYSERS can be a valuable tool used in the setting up of a room acoustically with a graphic equalizer such as the ETI 485; to monitor programme material or just as a gimmick to please yourself and friends.

When setting up rooms pink noise is pumped into the room using an amplifier. A microphone is then used to monitor the sound and its output is the input to the analyser. Now by adjusting the graphic equalizer a flat response can (hopefully) be obtained.

Design Features

Spectrum analysis can be done by two main methods. The first is to have a tuneable filter which is swept across the band of interest. The output of the filter, when displayed on an oscilloscope, will be a frequency/amplitude graph of the input. While this gives a well-formatted and accurate display it is not "real time" in that if an event occurs at one frequency while the filter is sweeping elsewhere it will not be recorded. For this reason this method is used normally where the spectral content is constant and the sweep is only over a small percentage of total frequency (such as the output of a radio transmitter).

For real time analysis the frequency spectrum is broken into bands using bandpass filters and the output of each rectified. The output from these rectifiers can be displayed on a CRO as in this project or by columns of LEDs or similar methods. The number of

SPECIFICATION – ETI 487	
No. of bands	10
Frequencies	31, 63, 125, 250, 500, 1k, 2k, 4k, 8k, 16k
Filter characteristics	-12dB, one octave from nominal centre frequency
Display	CRO in XY mode
Input level	50mV – 10V
Input impedance	200k
Pink noise output	200mV
X output	± 4V approx
Y output	0V to 10V

bands and the dynamic range required determine the filters used. In this project where only about 20dB is required a single LC network is sufficient. Another unit we have built (not for a project) uses a 6 pole high pass filter followed by a 6 pole low pass one. This gives a flat response (± 1 dB) over $\pm \frac{1}{2}$ octave and is 36dB down 1 octave away. However, it uses 6 op amps and 2% capacitors and resistors in each filter!

If there are sufficient requests for it we will publish a LED version of this unit.

Fig. 1. The frequency response of the 500Hz filter. All other filters follow a similar curve.

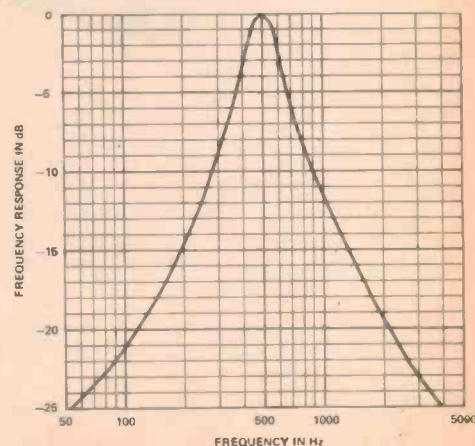



HOW IT WORKS – ETI 487

The unit can be broken into eight sections to help the explanation of how it works.

- (a) Input amplifier
- (b) Ten individual filters and rectifiers.
- (c) Ten way analogue switch with decade counter.
- (d) Staircase generator controlled by "c". (X output).
- (e) Log converter.
- (f) Ramp generator and comparator. (Y output)
- (g) A pink noise generator.
- (h) Power supply.

(a) The input amplifier has an input impedance of 220 k (set by R1) and a gain of 101 ((R3 + R2)/R2). The output of the amplifier drives all ten filters and Q1 and Q2 are used to buffer IC1 to give the drive capability required.

(b) The ten filter-rectifiers are identical except for component values and a bias resistor in the three lowest frequency filters, where tantalum capacitors are used in series. The filter is a parallel LC network which, with a series resistor, gives a band-pass filter.

As large valve inductors are expensive we have used an active one using an operational amplifier, two resistors and a capacitor. The value of such a network is as follows:

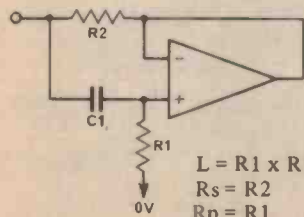

$$L = R1 \times R2 \times C1 \quad H$$

$$R_s = R2$$

$$R_p = R1$$

The frequency response of the networks is given in fig. 1.

The rectifier is a half wave type where the gain is variable from about 4 to 12. A diode from the output back to pin 2 keeps the op-amp in the linear region on the negative half cycle allowing operation up to the 16kHz of the top filter.

(c) The analogue switches IC23/1 – IC25/2 are controlled by IC22. This is a decade counter with 10 decoded outputs, each of which is high only for one clock period. As the analogue switches need a high to switch them on, only one will be selected at any one time.

(d) The output of the decade counter also controls the staircase generator IC28 with the weighting networks R58 – R72 giving equal steps of about 0.9 volts. Resistor R89 provides a bias current and the output of IC28 starts at about +4 volts and steps down in 0.9V steps to about -4.2 volts when the output switches back to +4 volts. This is used to drive the X input of the CRO. To add some width to the vertical lines, IC29/1 and IC29/2 form an oscillator of about 300 kHz and after filtering by R90 and C69 is coupled into the input of IC28 by R91.

(e) The output of the analogue switch is fed to the diode-resistor network (D21 - D26, R73 - R77) which gives a simple log conversion. This method is simple, needs no adjustments and is adequate for the purpose. As there is some loss in this network IC26 is used to provide a gain of three to recover this loss.

(f) The ramp generator is formed by the constant current (12μA) source and capacitor C71. The capacitor can be discharged by IC25/4 and the current source

is controlled by IC24/3. The voltage out of the log converter (IC26) can vary between zero and +10 volts and this is compared to the ramp voltage by IC30. The output of IC30 controls the oscillator formed by IC29/3 and IC29/4. When the ramp voltage exceeds the voltage from IC26 the output of IC30 goes high allowing the oscillator to start. This immediately discharges C71 and switches off the current source which causes the output of IC30 to go low again after only about 2μs. Diode D27 ensures however that the oscillator acts as a monostable giving an output of about 6μs to ensure the capacitor C71 is completely discharged. The output of IC29/4 also clocks IC22 which selects the next input. If the input from IC26 is ever negative and C71 cannot be discharged to less than this voltage, IC29/3 and IC29/4 will oscillate continuously at about 100kHz clocking IC22 until it finds an input higher. This prevents possibility of lockup if the offset voltages of the op-amps all go the wrong way.

(g) White noise is generated by the zener action of Q3 which is reversed biased. It is amplified by Q4 to give 200 mV of white noise on its collector. White noise however has equal energy per unit bandwidth and what we need is pink noise which has equal energy per percentage bandwidth (i.e., equal energy per octave). To convert white to pink we need a filter at 3 db/octave. This is performed by IC27 with the RC networks providing the necessary curve.

(h) The power supply is a simple rectifier type with IC regulators to give stable supply voltages.

Project 487

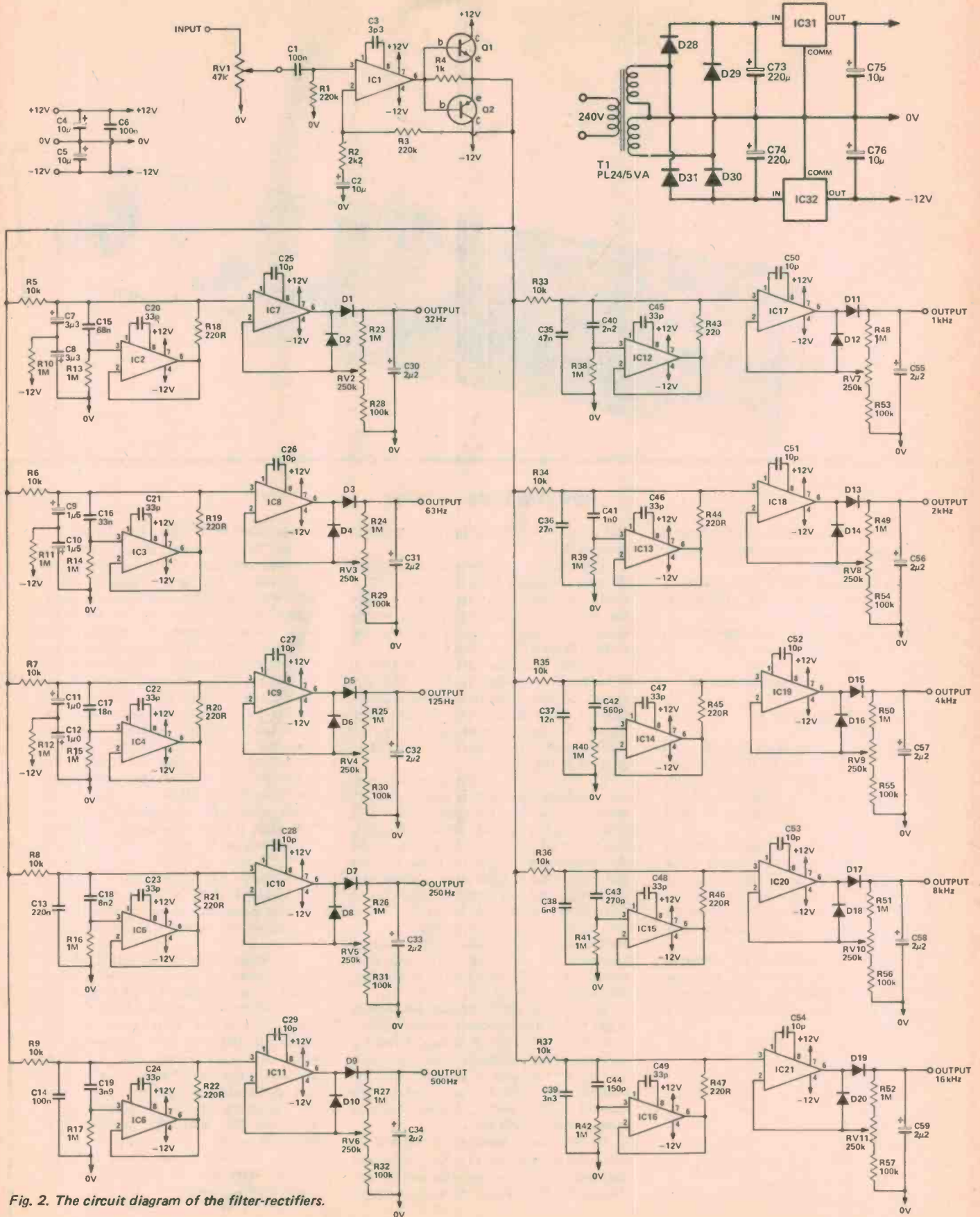

Fig. 2. The circuit diagram of the filter-rectifiers.

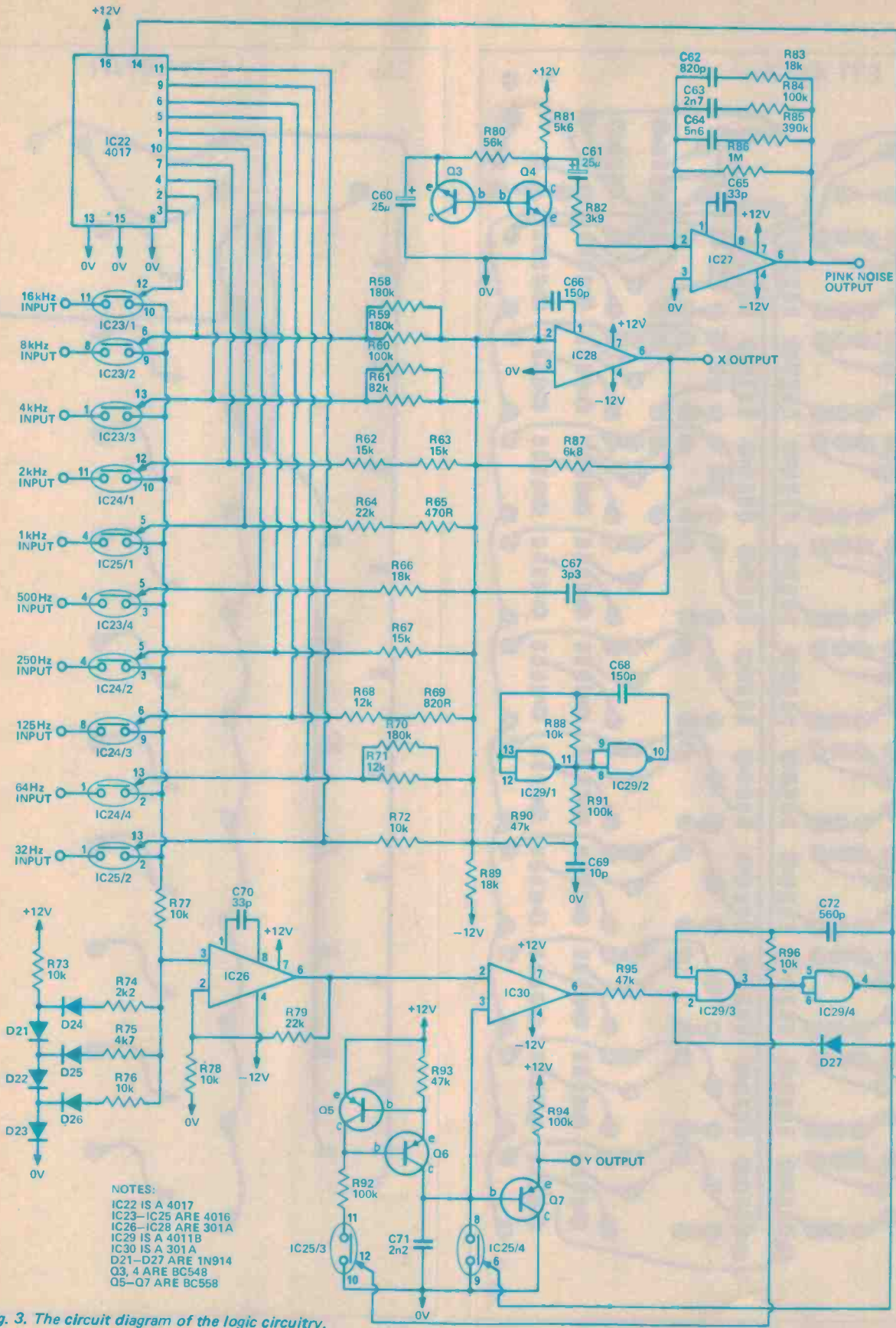

Fig. 3. The circuit diagram of the logic circuitry.

Description continued on page 88.

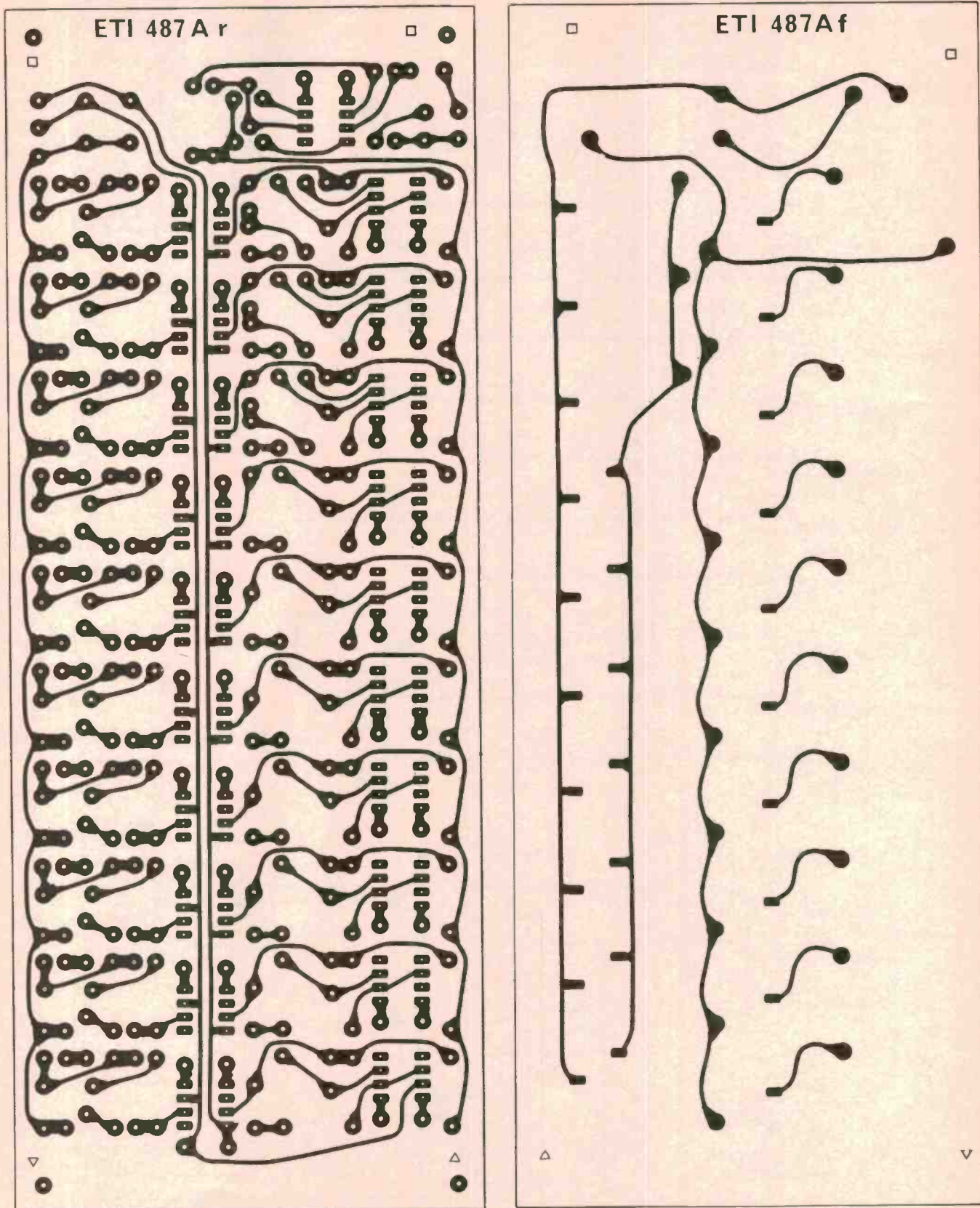

Fig. 4. Both sides of the ETI 487A board shown full size. See page 90 for details on making negatives from this page.

DENON

DIRECT DRIVE TURNTABLE SL-7D



providing a direct drive system with the following features:—

- HIGH ROTATIONAL ACCURACY
- LARGE DIAMETER TURNTABLE EQUIPPED WITH STROBOSCOPE
- RUBBER & FELT INSULATORS
- INDEPENDENT CUEING LEVER
- HIGH SENSITIVITY TONE ARM
- WOW AND FLUTTER OF LESS THAN 0.04 PER CENT (WRMS) at 33-1/3 rpm

SPECIFICATIONS

STARTING TIME:

2.1 seconds for 0 to 33-1/3 r.p.m.

WOW AND FLUTTER:

Less than 0.04% (WRMS) at 33-1/3 r.p.m.

SIGNAL TO NOISE RATIO:

Over 60 dB.

POWER CONSUMPTION:

12 watts

The Professional Audio Brand

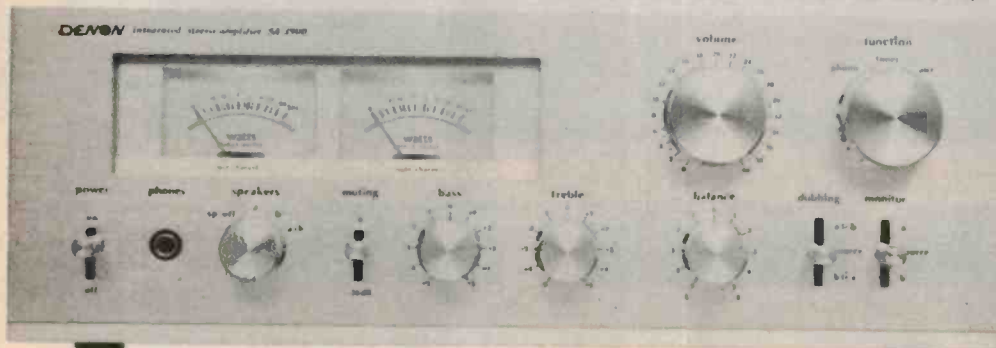

SA-3900 AMPLIFIER

This integrated stereo unit has a rated output of 40W + 40W both channels driven, and through the use of PNP-NPN transistors a pure complementary circuit has been provided, permitting improvement in driver efficiency and power bandwidth.

SPECIFICATIONS Residual Noise: Lower than 2 mV (0.5 μ W)

All silicon transistor stereo preamplifier. Damping Factor: More than 35

Power Bandwidth: 20 Hz - 45 kHz (-3 dB at rated output)

ST-3900 AM-FM Tuner

The design of this receiver has been co-ordinated with that of the above integrated amplifier, and features include silicon IC chip, diode limiter, and three ceramic filter elements. Also provided is a muting circuit to minimise interstation noise.

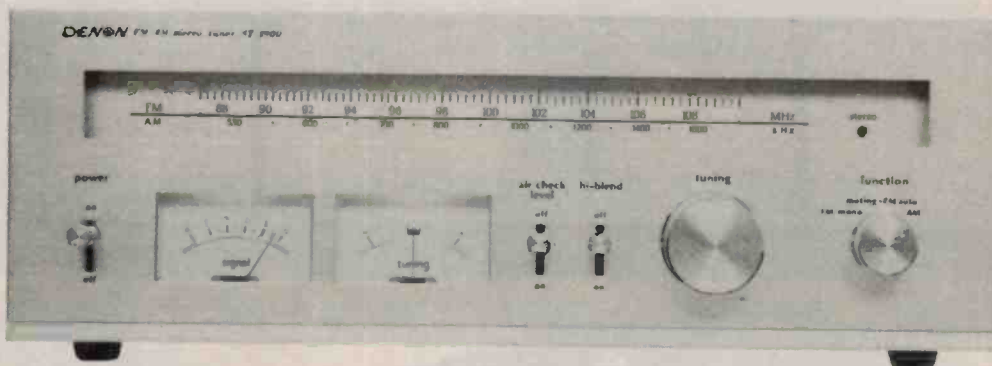

SPECIFICATIONS

Solid State AM-FM Stereo Tuner.

3-Integrated Circuit, 1-FET, 8-Transistor and 5-Diode.

Power Requirement:

AC 100, 120, 200, 220
230~240 volts changeable,
50/60 Hz

Hi-Fi Audio Equipment

AMALGAMATED WIRELESS (AUSTRALASIA) LIMITED

554 Parramatta Road, Ashfield, NSW 2131 Phone 797 5757

Melbourne 560 4533	Brisbane 44 1631	Adelaide 272 2366	Perth 71 0888	Hobart 34 5266	Townsville 79 6155	Canberra 95 3431
-----------------------	---------------------	----------------------	------------------	-------------------	-----------------------	---------------------

Newcastle 2 5166	Launceston 44 5155
---------------------	-----------------------



AD A18

AUTOMATIC CrO₂ TAPE SELECTOR

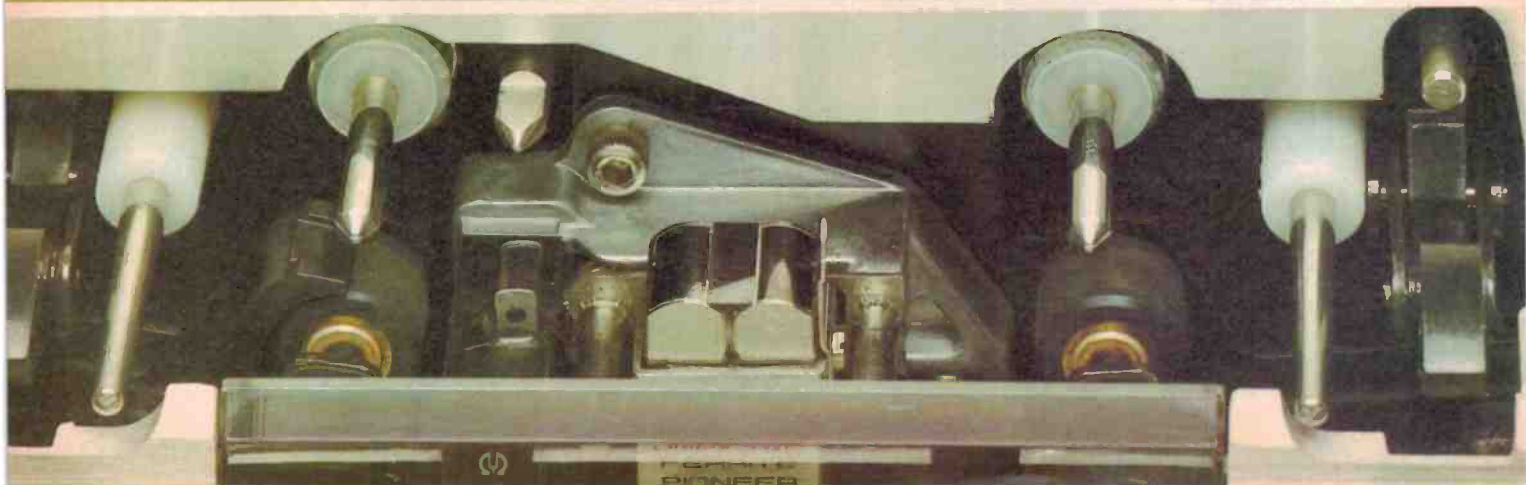
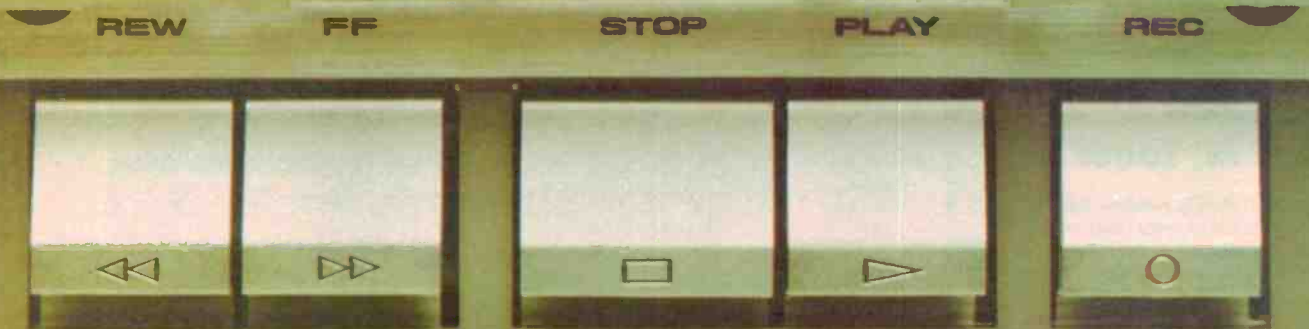

“Before the CT-F 1000 you could count the exceptional cassette decks on one finger.”

Pioneer's CT-F1000 is a unique new three-head machine which brings together every worthwhile technological advance. In the important areas of facilities, performance and price, it is the possible dream that most sound connoisseurs have been waiting for.

With separate record and playback heads, you naturally have the ability to monitor sound a split-second after recording, as well as the provision to lay additional tracks over those already recorded. And since the CT-F1000 is equipped with separate [®]Dolby circuitry for both recording and playback, you can actually monitor Dolby in operation. This in itself is a valuable aid to recording quality, but the big plus is the facility to calibrate the degree of Dolby required to eliminate hiss and high frequency noise.

Facilities are one thing. And you can go into raptures over external cosmetics. But the performance of any tape device relies heavily on the heads.

In the CT-F1000, ordinary crystal ferrite has been superseded by uni-crystal ferrite, leading to higher linearity gap construction potential, unity, and anti-abrasion characteristics.

In terms of absolute performance, the sophisticated tape transport system in the CT-F1000 plays a critical part. Fast forward/rewind is powered by one motor. While a stable DC servomotor takes charge of the record/play functions, driving a closed-loop dual capstan. With two separate sets of capstans and pinch rollers, stable head contact combined with reduced dropout and level variation is assured. The result of all of this is a wow and flutter reading of not more than 0.05% WRMS.

The front-loading CT-F1000 is a showcase of Pioneer advances. Memory stop/memory play. Auto chrome sensing/switching. Auto tape slack cancelling. And new integrated IC amplifier circuitry, to name but a few.



Other facilities provided include: pitch control with a $\pm 6\%$ adjustment. 2-position Bias, 3-position EQ curves. Direct logic controls. Switchable MPX filter. Wide-range Vu meters. Full auto-stop and tape-end indicator light. Separate mic input controls line/source. Optional rack mounting adapters.

In turntables and some other component areas, it's fair to say that

no longer is exceptional performance of purely academic interest. In the CT-F1000, Pioneer introduces 'the possible dream' for all those vitally interested in truth in sound. It represents a whole new benchmark in accessible cassette deck technology.

A short specification:

Frequency response	20 to 19,000 Hz.
Wow and flutter	No more than 0.05% (WRMS)
Signal-to noise ratio	
Dolby off:	More than 54dB
Dolby on:	More than 68.5dB (over 5kHz)
Harmonic Distortion	No more than 1.3% (0dB)
Reference tape	Chromium Dioxide (CrO ₂)

All Pioneer cassette decks are covered by warranty for one year. Excellent service facilities are available throughout Australia via a network of Pioneer approved outlets.

[®]Dolby is a registered trademark of Dolby Laboratories Ltd.

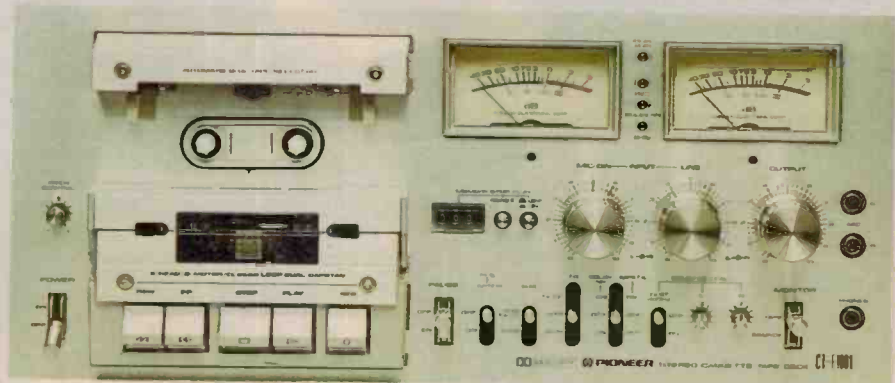

To Pioneer Electronics,
PO Box 295, Mordialloc,
Vic. 3195

- CT-F1000 Cassette Deck Folder.
- Folders on other components of equivalent compatibility.
- Other (Please indicate).....

Please mail me: (tick as required)

Name..... Address.....
..... State..... P'code.....

PIONEER
leads the world in sound



The professionals

Rehearsals have ended. This is the real thing. Early this year, Ampex professional quality cassettes and tapes will be available from selected retailers. Ampex — well worth waiting for.

Photographed at Alberts Studios — Sydney
Recording Engineer — Bruce Brown
ACT 01C

AMPEX AUSTRALIA PTY LIMITED
4 Carlotta Street,
Artarmon, N.S.W. 2064. Telephone: 439 4077

SOUND

SME Series III a close look...

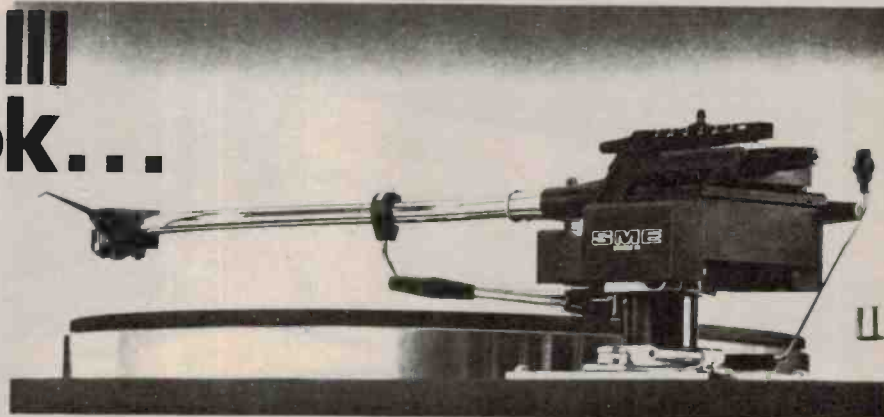

by John Gardner

IN WHAT TO SOME WAS the 'golden age' of audio, when valves glowed merrily in crude-looking amplifiers, and sound emanated from an enormous loudspeaker in the corner of the room, there was a perfectionist who loved high fidelity. His search for the ultimate in audio led him naturally to focus critically on the currently available pickup arms. Nothing he saw pleased him and, being something of an engineer, he decided that he could make one far better than any that had so far been made. Thus it was that in 1959 a Sussex firm, Scale Model Engineering, produced a limited number of pickup arms for the pleasure of the managing director and a select group of his friends. After that the inevitable happened and in 1960 the first series of SME pickup arms appeared on the market. The Series II followed in 1962 and the Series II (Improved) in 1972.

Following the Rolls Royce tradition, SME have long proclaimed, proudly and unrepentantly, that theirs is 'the best pickup arm in the world'. This type of arrogant claim makes some reviewers and countless competitors all too eager to stick a spanner in the works: not an easy task in the early days because there was no rival to the Series II. When the Series II (Improved) first appeared the opposition had hardened and the SME, although still predominant in the pickup field, was hotly pursued by several aspiring champions.

Narrow Margin

Recently there has been a tendency in some quarters to 'write down' the SME in favour of other arms. This is not because the SME is any less good than it was, but because the margin between the leading makes is so narrow now as to be non-existent. An ideal time, in fact, to launch the Series III SME pickup arm.

Any resemblance between the Series III and its predecessors is, as they say, purely coincidental, but those of a conservative taste will be glad to know that production of the Series II will continue indefinitely. Seven years of development work went in to the new arm, during the course of which one version was abandoned as the cost of manufacture would have made it prohibitively expensive. Not that the Series III is cheap; at \$318 in Australia, it is the tool of a perfectionist.

Gone is the J-shaped aluminium tube, gone is the elegant headshell and gone are the cylindrical counterweights. In their place, an S-shaped arm of titanium, a skeletal headshell of

carbon fibre and a clever system of weights concealed in mouldings of glass-reinforced nylon. Retained are the pulley-and-weight bias compensator, the bed plate and the lateral bearing with adjustable pillar. The knife-edge fulcrum bearing is similar to that of the Series II but it is now angled with respect to the arm so that the cartridge moves in the same vertical plane as the bearing. On the J-shaped arm of the Series II, movement of the headshell vertically, appeared as a twisting motion at the knife edges, which some critics claimed was unsatisfactory. It would perhaps be more accurate to say that it was not perfect.

The New Design

Mounting details are exactly as for the previous arms and the Series III will fit any existing mounting board ready-drilled to receive an SME arm. The titanium 'carrying arm', as it is designated by SME, is very much smaller in diameter than any of their previous arms. SME say that titanium was chosen because it has the strength-to-weight ratio required, the tube being both light and rigid, with a nitrogen hardened skin and a soft fibrous core. Lightness is, of course, important as it minimises the effective mass of the arm; whilst rigidity is essential as the arm must not transmit mechanical vibrations. Other materials were tried for the arm, including carbon fibre, but it was found that for this application it was less suitable than titanium. The S-shape was adopted because it was convenient geometrically and it was felt that a straight arm could act as a torsion spring. Presumably a manufacturer who uses straight carbon fibre arms would counter the above argument but we cannot comment at present as we have not had an example for review.

The previous SME arm had the option of either a detachable or a fixed headshell. The detachable one is convenient and allows cartridges to be interchanged quickly but the coupling adds to the effective mass. The fixed head version is extremely awkward for changing cartridges but does have the advantage of lower mass. In the new arm we have the best of both worlds; the headshell itself is fixed but the entire carrying arm is a push fit into a socket close to the fulcrum. A connector in this position adds insignificantly to the effective mass. The logic of this arrangement is impeccable; slightly less acceptable is the \$46 which a spare carrying arm costs. This should commend to us all the wisdom of selecting a cartridge that we like and sticking to it!

TECHNICS PRESENTS ITS CREDENTIALS.



RS 671 US

RS 630 US

RS 615 US

Technics offer superb sound recording and reproduction in a range of front-loading hi-fi cassette decks—all packed with practical, purposeful features.

The RS 615 US credentials include super permalloy head, timer recording/playback facilities and the Dolby* NR system to reduce tape hiss to imperceptible levels. There are two large, easy-to-read VU meters, three-position tape selection and an electronically controlled DC motor which assures a high degree of stability in tape transport.

Models RS 630 US and RS 671 US have separate bias and equalization selectors assuring optimum recording quality with any type of cassette. Auto-stop mechanism, lockable pause button and the exclusive Technics HPF head are incorporated.

With a choice of three models, there's one that's compatible with your system . . . and pocket.

RS 615 US:—Wow and flutter: 0.10% (WRMS) \pm 0.20% (DIN).
Frequency response: CrO2 tape 30-16,000 Hz; normal tape 30—14,000 Hz.
Signal-to-noise ratio: Dolby NR in 60dB (above 5 kHz); Dolby NR out 50dB (signal level 250 nWb/m). Motor: DC—electronic motor. Heads: 1—super permalloy head for rec./playback; 1—ferrite head for erasing.
Dimensions: 41.0 cm (W) x 14.0 cm (H) x 30.5 cm (D). Weight: 6.3 kg.

RS 630 US:—Wow and flutter: 0.09% (WRMS) \pm 0.20% (DIN).
Frequency response: CrO2 tape 20-16,000 Hz; normal tape 20—14,000 Hz.
Signal-to-noise ratio: Dolby NR in 60dB (above 5 kHz); Dolby NR out 50dB (signal level 250 nWb/m). Motor: Electronic speed control motor.
Heads: 1—HPF head for rec./playback; 1—ferrite head for erasing.
Dimensions: 41.0 cm (W) x 14.2 cm (H) x 32.1 cm (D). Weight: 7 kg.

RS 671 US:—Wow and flutter: 0.063% (WRMS) \pm 0.15% (DIN).
Frequency response: CrO2 tape 20—18,000 Hz; normal tape 20—16,000 Hz.
Signal-to-noise ratio: Dolby NR in 62dB (at 10 kHz); Dolby NR out 52dB (signal level 250 nWb/m). Motor: 2—motor system; 1—electronic speed control motor for capstan drive; 1—DC motor for reel table drive.
Heads: 1—HPF head for rec./playback; 1—ferrite head for erasing.
Dimensions: 41.0 cm (W) x 14.0 cm (H) x 33 cm (D). Weight: 9.4 kg.

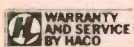

For a National Technics catalogue please write to:
National Technics Advisory Service, P.O. Box 49, Kensington, N.S.W. 2033

DOLBY SYSTEM * Under licence from Dolby Laboratories Inc.



Technics
hi-fi

SOUND SME Series III a close look...

The knife-edges, the arm socket and the counterweight framework are all of carbon fibre. The various adjustable weights are of metal encased in black glass-reinforced nylon. The few remaining links with previous designs, the bed plate, adjustable pillar, fulcrum, arm rest and lowering device are of solid metal and have the familiar camera finish.

Most of the counter-balancing is done by adjusting a number of fine-threaded screws with conical, milled heads forming a finger-and-thumb grip. Each screw draws a particular weight along a guide track to its required position. The main counter-balance comprises a weight box with a number of lead and plastic inserts of differing thicknesses. By choosing suitable combinations to pack the box all cartridge weights from 0.1 to 13 grams can be balanced. To achieve the lowest possible inertia, the weight box must always be packed with the heaviest weights close to the pivot. As supplied the box covers the range of cartridge weights from 6 to 10½ grams and so suits a high proportion of cartridges. An auxiliary pack of

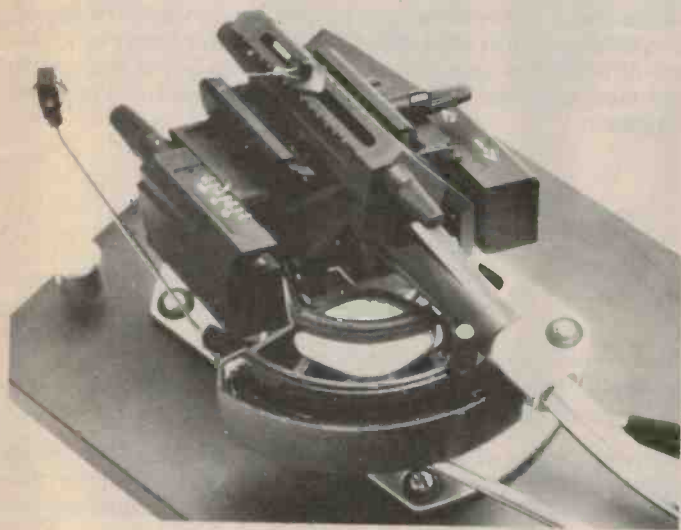

two lead and three plastic spacers is provided, and a very clear diagram in the instruction book shows how the box should be re-packed if heavier or lighter cartridges are to be used.

Once the arm is at balance, the required tracking force is set by screwing a rider weight along a channel in the main weight assembly. The rider is marked with a clear numerical scale in ¼ gram steps from 0 to 1.5 grams. On the opposite side of the weight box there is another rider but this one does not have an adjustment screw: instead it can be slid to and fro, and it carries two calibrations, '0' and '+1'. If it is pushed back to the '0' position the tracking force is as indicated by the scale referred to above. In the '+1' position the indicated tracking force is increased by 1 gram, giving a total range of adjustment of 0 to 2.5 grams.

The next adjustment is that of lateral balance, this being necessary because the pickup arm is not straight and the weight of the cartridge applies a twisting force to the arm, so unbalancing the knife edges. To offset this a further screw moves the entire weight box laterally to the left or to the right.

The lateral balance is not too critical and is carried out by using the thread of the bias weight to lift the arm slightly from its bearing, then any imbalance can be detected by eye and compensated appropriately.

Hitherto the fine positioning of the main pillar on the bed plate was done by loosening a pair of hexagonal clamp nuts and sliding the column to and fro until the headshell and cartridge align symmetrically. Then the assembly was slid to and fro until the headshell and cartridge aligned symmetrically with the grid on the protractor provided. The same principle is still employed but there are now no clamping nuts: instead there is a type of rack-and-pinion system. The outer slot on the bed-plate has a series of serrations along its length and what was the clamp bolt is sprocketed to engage with the serrations. The head of the bolt is round but with inset flats for a special thin spanner which is supplied. A small movement of the spanner then drives the pillar along the bed plate. This particular adjustment can be done more easily than it can be described, and the rack-and-pinion system is more elegant and more simple than the previous arrangement.

There is also the benefit that the inner clamp nut is no longer required and this has allowed a further worthwhile design improvement to be made. One problem with the Series II is that the outrigger arm for the bias pulley is secured by the nut. Whenever this is loosened to move the pillar along the bed-plate, the bias thread neatly tangles itself up or else must be unthreaded from the pulley: more of an irritating hindrance than a permanent annoyance. This small criticism is removed on the Series III by the simple expedient of fitting a small holder for the bias outrigger in the position previously occupied by the inner clamp nut. The holder can be moved by finger pressure to angle the outrigger as required, but there is sufficient friction to hold it in a given position.

On the top of the weight box there is a stud which may be moved, by an adjustment screw, along a slot in the moulding. The loop from the bias thread fits neatly over this stud and the slot along which the stud moves is graduated from 0 to 2.5 grams in ¼ gram divisions. Bias compensation is set, as expected by twiddling the screw until the stud lines up with the calibration corresponding to the playing weight.

Fluid Damping

Some months ago a fluid damping system (FD 200) was introduced as an accessory for Series II arms; this damper is supplied with the Series III arm. In a laboratory situation we have been using a pair of arms, one fitted with the FD 200 and one without it. The arms are fitted with matched cartridges and fed to a common replay system. From the tests we have done we have no doubt that the damping system gives an audible improvement in quality. This manifests itself as greater clarity and smoothness of bass response. Fitting of the FD200 to the Series III is optional but strongly recommended by the manufacturer. If a high compliance cartridge with good tracking properties is used, the benefit of fitting the damper may be less immediately obvious than if a medium to low compliance cartridge is used. However it will be found that in addition to improving the sound quality, the damper also gives considerable protection against external shock or mechanical vibration, and for this reason alone it is worth fitting. Our experience indicates that the damper will be essential for all moving coil cartridges.

For those not familiar with the FD 200, it is basically a crescent-shaped tank filled with a viscous silicone fluid and fitted close to the pickup lowering device. A small paddle is clamped to the pickup arm so that the blade is immersed in the fluid. The idea is that the fluid and paddle inhibit any sudden unwanted movement of the arm, either vertically or laterally, whilst not impeding its slow progress across the record. Thus neither warps nor heavy footed children prevent the stylus from following the groove to the best of its ability.

SOUND

Setting up the arm is not difficult but it does require a degree of common sense and some manual aptitude. There are now gold plated phono sockets on the base of the column instead of a multi-way socket. It is essential that the flying earth lead on the output cable is connected as instructed. The cable itself has gold plated phono plugs at each end, which gives improved electrical contact. Stereo or CD 4 cartridges may be used but for CD 4 operation a small capacitor must be removed from each phono plug, at the amplifier end of the cable.

The trickiest single part of the assembly is the fitting and filling of the damping device and the securing of the paddle to the arm. Balancing, bias compensation and tracking weight adjustments are more elaborate than any other arm we know but if the manual is followed for a time or two there should be no problem. Incidentally, the manual, as we have come to expect, is a model of clarity with twenty-three pages of text and over sixty diagrams and photographs.

During the evaluation period no difficulties were experienced in everyday usage. Once the cartridge was fitted to the headshell and the arm was plugged in and balanced, there was nothing else to do but sit down and enjoy the music. Several different cartridges were used, the main one being the Shure V.15/III. One disappointment was that the dimensions of the new headshell, having been cut to a minimum, made fitting of the AKG P8ES cartridge very tricky. The AKG has the mounting lugs set forward which means that the body of the cartridge and the terminal pins set well back in the headshell, leaving barely sufficient clearance for the connector tags. We did succeed in fitting the cartridge but not without some risk of damage to the fine connector leads or the terminal pins. No other cartridge we tried gave this problem and it seems a shame that such a superb cartridge cannot be fitted more easily.

Impressions

Only an inexperienced reviewer would endeavour to find any obvious difference in sound quality between the Series II and the Series III pickup arms. Any improvement on excellence

will inevitably be slight and therefore difficult to detect. In the end we decided to use the Series III alone for some time and then to re-fit the Series II and see whether we had any impressions worth reporting. A large number of familiar records was played during this experiment and many of them gave no distinct impression. A few we definitely preferred played with the Series III, but in no case did we find a preference in favour of the Series II with any of the records sampled. Obviously there is nothing conclusive about this test but it does give an indication of the kind of margin we are dealing with. Where there was an impression of improvement, it was of more detailed bass and a more overall transparency of sound.

The effective mass of the Series III is 5.05 grams which with a high compliance cartridge gives a theoretical low frequency resonance at 11 or 12Hz: this falls in the 'safe' area below the lowest wanted frequency and well above the highest warp frequency. A low frequency test record designed for locating resonances showed the low frequency resonance to be negligible. Lateral and horizontal bearing friction was so low as to defy measurement with the relatively crude gauges which are available for this purpose.

Whether the Series III at almost twice the price of the Series II is good value for money, is an impossible question. The fluid damper is included in the price of the new arm, which does reduce the differential a little. However, we suspect that this is one of the few reviews where price will not be the major influence on the potential purchaser. The law of diminishing returns says that the Series II is a better buy: the law of perfection says that the Series III is a better engineered and more universal arm. For many people that will settle the argument.

SME Series III Pickup Arm

Price \$318

Distributor: Audio Engineers, 342 Kent Street, Sydney 2000

SOUND BRIEFS

- | | |
|-----------------------------|--|
| Vereker In Australia | Julian Vereker, of Naim Audio, the British amplifier manufacturer, paid a short visit to Australia recently. Full report in the near future. |
| Technics Class A+ | We're still awaiting a review sample of this powerful new amplifier, although an explanation of the operation of its output stages leaves us in doubt as to whether the device tends toward Class A or Class B. But of course, what we're most interested in is its audible performance. |
| Laser record players | The big news at the recent Tokyo audio show was a laser record playing system developed by a consortium of major Japanese manufacturers. Similar to proposed designs already developed in Europe and elsewhere, the system apparently works well but poses the question of how long it will be before purely electronic sources will become available. |
| Entre enters | We announced recently the introduction of the Entre moving coil cartridge, and have now heard a sample playing via a Lentek head preamp. Results? Excellent, with first class tracking and a very smooth, clean sound. |
| New P77 | Garrott Brothers, the Weinz parabolic stylus people, have revised the damping of their excellent P77 cartridge. We're awaiting a sample and should be able to report on the effectiveness of the modification in the next issue. |
| New arm from ADC | A new arm, similar in appearance to the Infinity Black Widow, has been introduced by ADC/BSR. Performance with the new ZLM cartridge seemed excellent to us when we heard the arm on a Linn-Sondek turntable. |
| HK receiver | We've heard news of a new tuner amplifier from Harman-Kardon which is devoid of tone controls and other non-essential paraphernalia. Appearance is reported to be most attractive and claimed performance looks very interesting indeed. |

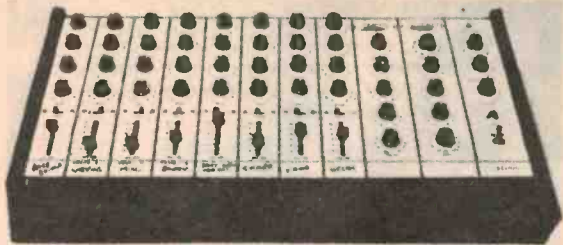

414 8 CHANNEL AUDIO MIXER

- 8 input channels each with linear fader, input attenuation switch, bass, treble, echo send and pan controls. High and low impedance PMG inputs.
 - 2 output channels with 5 stage equalisation on each channel, VU meters, overload led, master pan, echo and volume controls.
 - Black anodised front panel with yellow lettering. Vinyl covered cabinet.
- COMPLETE KIT \$254.00 plus \$5.00 Freight.**

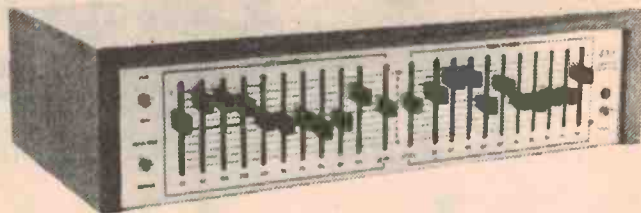

485 STEREO GRAPHIC EQUALISER

- This superb equaliser offers 10 octave-centred linear controls for each channel; level match control, in-out switch and tape monitor switch.

- The performance of this unit is equal to some of the best available.

COMPLETE KIT \$105.00 PLUS \$2.50 Freight.
 Send stamped addressed envelope for specification sheet or \$1.00 for complete construction manual.

jaycar PTY LTD. P.O. Box K39 Haymarket 2000,
 405 Sussex Street, SYDNEY.
 Tel: 2115077.

The all new JAVELIN 900 series 1/2"

PORTABLE RECORDING SYSTEM

are compact and 7 lbs., lighter than anyone else's.

FOUR MODELS to choose from. Javelin VTC systems are available to cover every operational range from bright sunlight down to starlight.

VERSATILE. Self contained rechargeable batteries provide a full hour of field use. Or plug into 240 VAC or your car's cigarette lighter for continuous operation. One long playing cassette will store a 30 minute program, and you can pop in a fresh one in two seconds flat.

EASY TO USE. An electronic viewfinder provides 'see what you get' operation, and can be used for instant, on the spot playback. Sound and light levels are set automatically, insuring smooth recording continually no matter how many times you stop and start. Or you can dub the sound later, if you prefer. Record directly from any monitor/receiver if you want. Or use them to play back your own program.

AFFORDABLE. Even with all these features, Javelin's portable recording system are as easy to own as they are to operate. For further details, specifications and availability contact:

Photo Scan

Distributors (NSW) Pty. Ltd., P.O. Box 588,
 Potts Point, NSW 2011 or telephone 31-0966.

TRADE ENQUIRIES WELCOME



HARKSOUND

a new name in turntables!

looks suspiciously like the celebrated CEC
doesn't it?



in fact it is!

CEC, Australia's top-selling range of imported turntables,* will now be known as HARKSOUND. But don't despair . . . nothing's changed but the name.

Still the same five year warranty, still the same proven performance, and when you consider that CEC are Japan's oldest and most experienced turntable manufacturer, you know you're buying the best.

The HARKSOUND range by CEC offers everything you want and need for noise-free, Hi-Fidelity performance, plus operational ease . . . and there's a turntable for everyone

*HIA Survey figures Sept. 1977.

in the HARKSOUND range—right from the BD2200 belt drive, up to the unique DD8200 direct drive.

The HARKSOUND features include:

- High quality, statically balanced S-shaped tone arm.
- Adjustable anti-skating.
- High quality magnetic cartridge.
- Fully decoupled motor to turntable/arm suspension.
- Low profile design with balanced acrylic dust cover.
- Excellent value and performance for the price.

HARKSOUND

by

CEC

CHUO ELECTRIC CO. LTD.

Sound Level Meter

This sound level meter gives accurate results to allow noise levels to be monitored and controlled. An 'A' weight response is provided as well as the 'flat' mode.

THE PUBLIC TODAY is increasingly critical of excessive noise levels. Aircraft like the Concorde, for example, face opposition on grounds of noise levels while jet aircraft of around 1958 were just as noisy but then they were a great advance in science! Public awareness of noise has caused laws to be passed limiting the sound levels which can be produced without prosecution.

However, while it may be good to have a law to say the acoustic output of your party should not exceed 85 dB, how can you tell precisely what the actual level is! If the local constable is called the chances are he will not have a meter and will only be able to give his subjective assessment.

For this reason we have designed this project. It is not a super-duper do-all sound level meter but one which is economical yet gives meaningful results. The microphone used is relatively cheap (about \$3.00), but is rugged and has a good frequency response. The microphone used in the B & K sound level meter is delicate and costs a small fortune!

There are many weighting networks used with sound level meters including ones which need a computer to calculate the results. We chose only the two most popular, the "A" weight and flat. The response of the "A" weight filter is given in Fig. 2.

SPECIFICATION – ETI 483

Sound level range	30dB to 120dB
Weighting networks	Flat or 'A' weight
Microphone	Electret
Power supply	9V dc @ 10mA

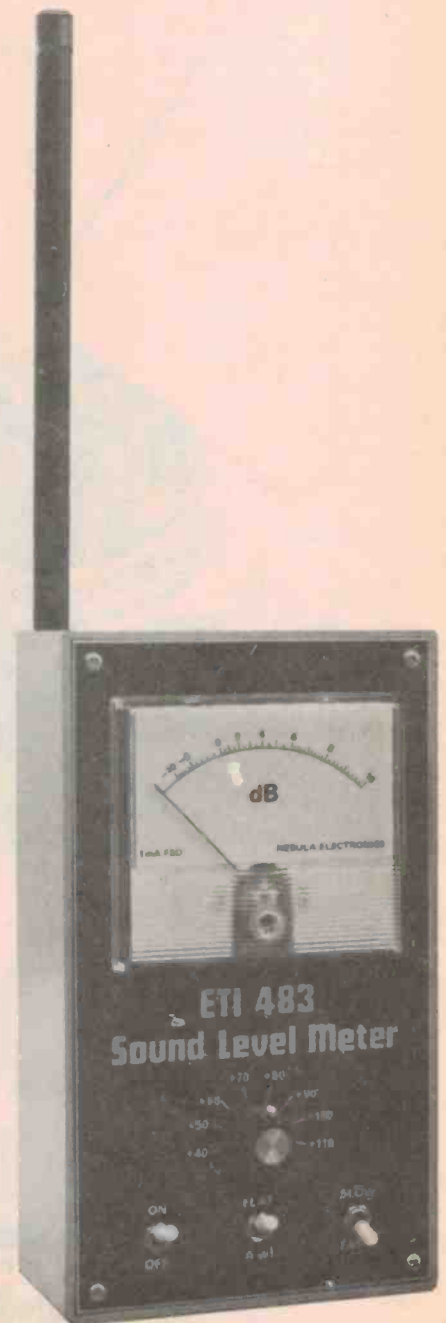

Calibration

This is a little difficult as a known reference is needed or another sound level meter to match it against. Initially however the "flat" attenuator potentiometer must be adjusted. To do this a 1kHz audio tone or sine wave signal across R1 is needed. Select "A" weight and an appropriate range and note the reading. Switch to "flat" and adjust RV1 to give the same reading.

Calibration is performed by RV2 and is adjusted with a known audio signal. If you cannot calibrate the meter Nebula Electronics Pty Ltd have offered to help. See page 30 for details.

Construction

Assemble the PC board according to the overlay in Fig. 4. The rotary switch can be either of the two popular sizes and can be mounted either with tinned copper wires or by drilling large (3mm) holes in the PC board, through which the leads of the switch can be passed and soldered directly to the tracks. Check when assembling that the wiper contact is in the correct position.

Assemble the front panel and leave the leads to the switches and meter long enough to be able to hinge it forward, as the PC board is mounted in the base of the box. The microphone insert is mounted on the end of a length of aluminium tube well away from the box. This is to help prevent reflections from the box affecting the readings. We attached the microphone using a length of heat shrink tubing over the aluminium tubing.

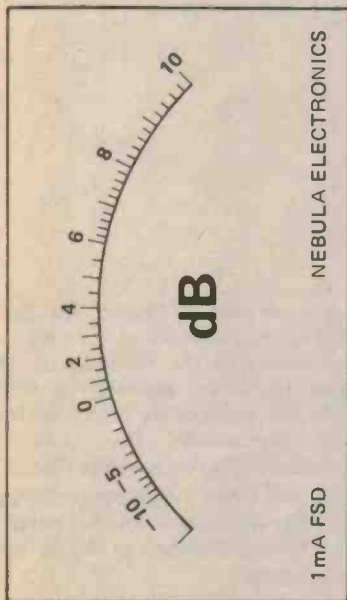

Fig. 1. The meter scale shown full size.

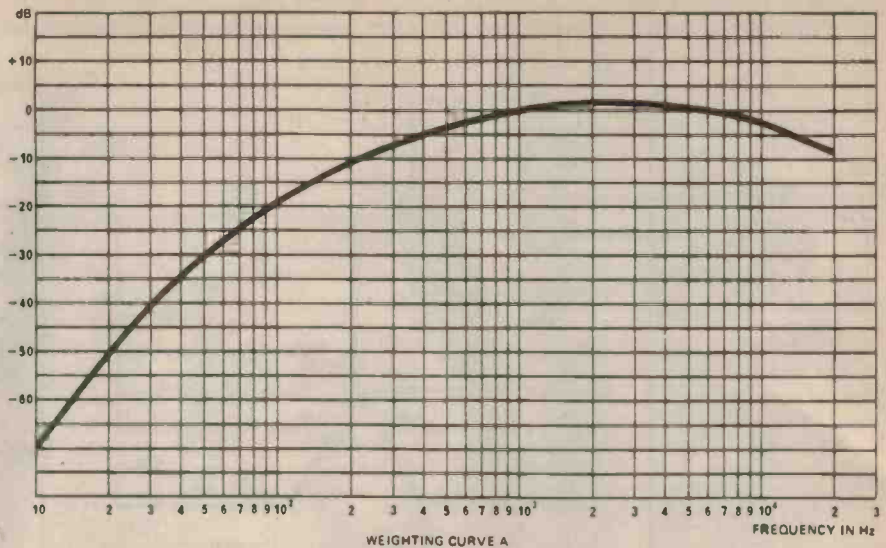
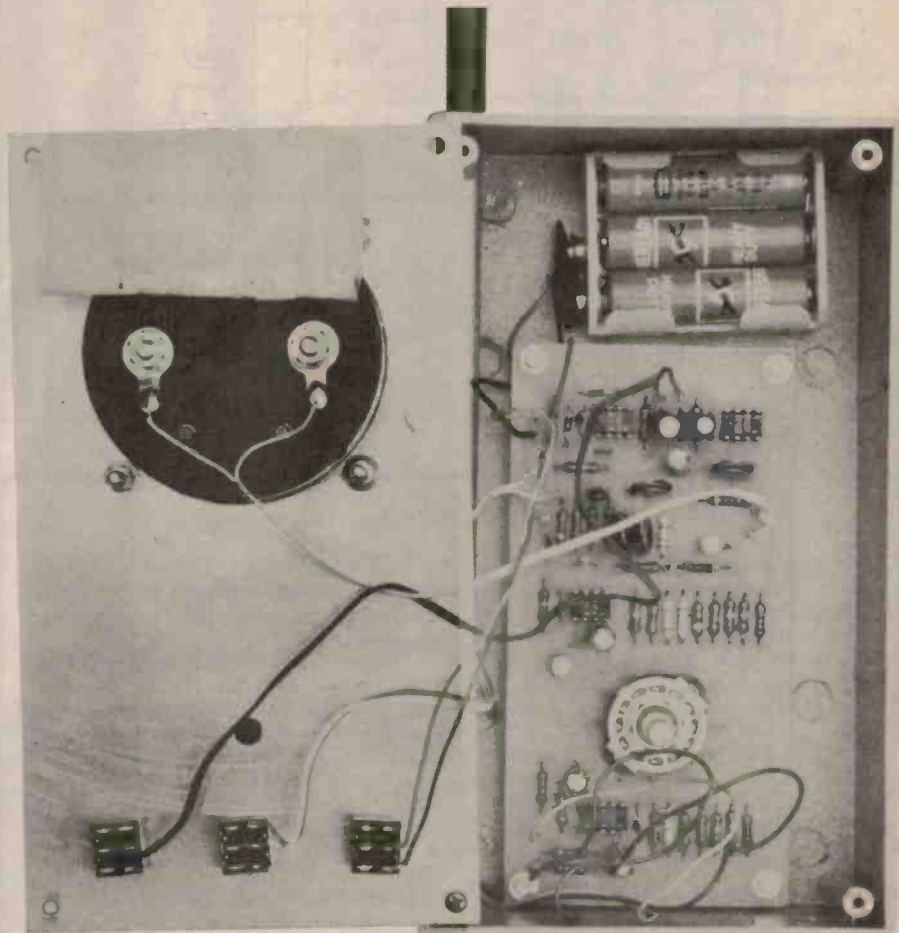
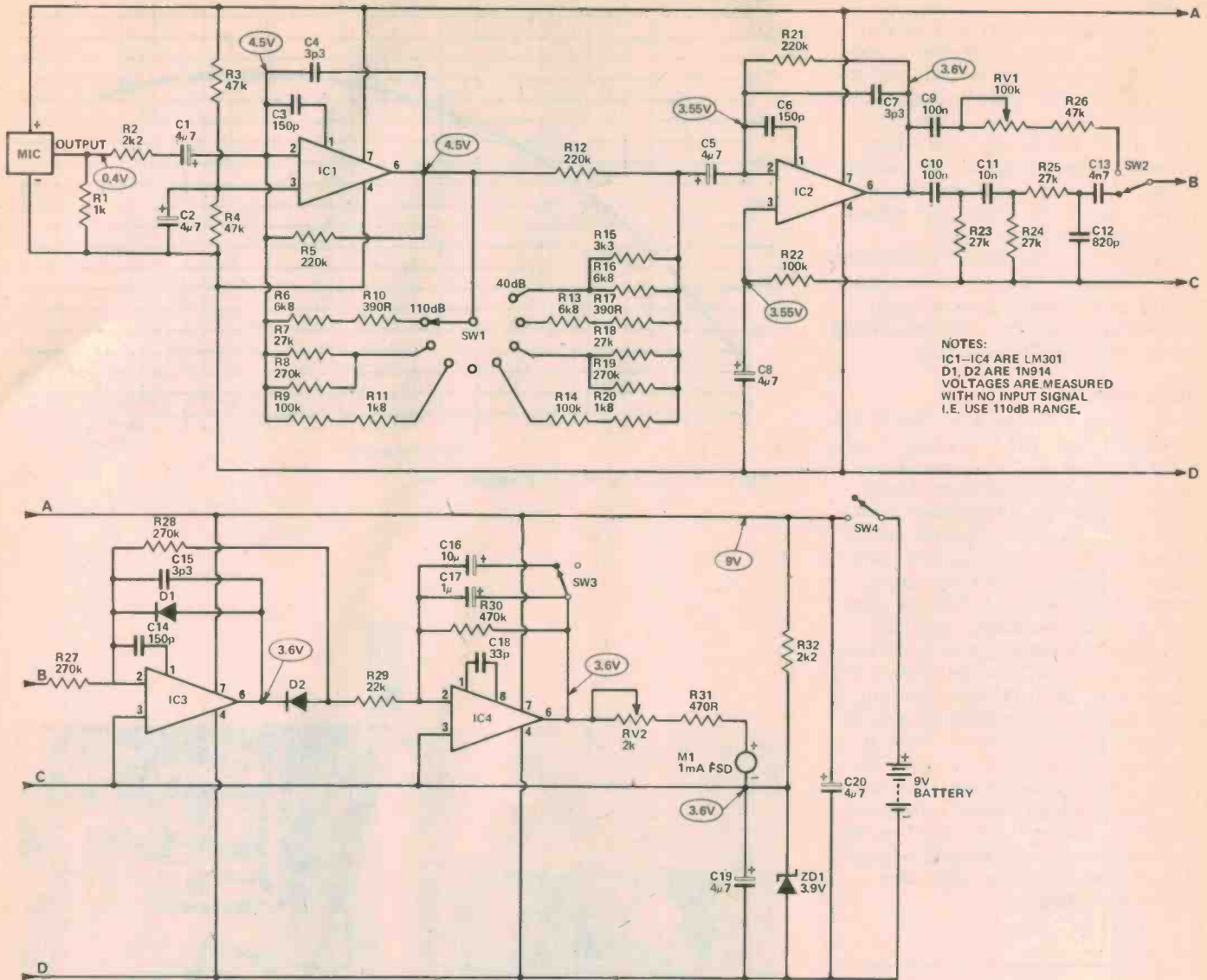

Fig. 2. The response of the 'A' weight filter.



An internal view of the unit.

Project 483



NOTES:
 IC1-IC4 ARE LM301
 D1, D2 ARE 1N914
 VOLTAGES ARE MEASURED
 WITH NO INPUT SIGNAL
 I.E. USE 110dB RANGE.

Fig. 3. The circuit diagram of the unit.

HOW IT WORKS - ETI 483

We have used an electret microphone insert which has the necessary FET preamp inside. As its output is a low level, especially in ambients around 40dB it is amplified by IC1 and IC2. The range switch SW1 is used to vary the gain of both ICs as shown below:

Range (dB)	Gain IC1 (dB)	Gain IC2 (dB)	Total Gain (dB)
+40	40	40	80
+50	40	30	70
+60	40	20	60
+70	40	10	50
+80	40	0	40
+90	30	0	30
+100	20	0	20
+110	10	0	10

The use of a switch as shown allows

a single pole switch to control the gain of the two ICs while reducing the possibility of instability where gains of 80dB are involved.

The output of IC2 is filtered by the "A" weight network C10-C13, R23-R25 and R27. Switch SW2 selects either this "A" weighted output or the "flat" output via RV1, R25. The potentiometer RV1 is necessary to compensate for the loss of the filter network. Both networks should have the same loss at 1kHz.

IC3 is used to halfwave rectify the signal and IC4 integrates the signal to give the average level. Two values of integration capacitor are used to give the two response speeds.

The bias for the first IC is provided by R3 and R4 while the other three are biased by the voltage across ZD1. The meter is also biased to the zener voltage.

The printed circuit layout for this project is on page 90 of this issue.

Scotchcals of the front panel and rescaled meters are available for \$3.00 and \$11.50 respectively post paid from Nebula Electronics Pty. Ltd. 15 Boundary St. Rushcutters Bay 2011. Nebula also offer a calibration service (for meters which are working correctly except for calibration) at \$5.00 plus \$1.00 postage.

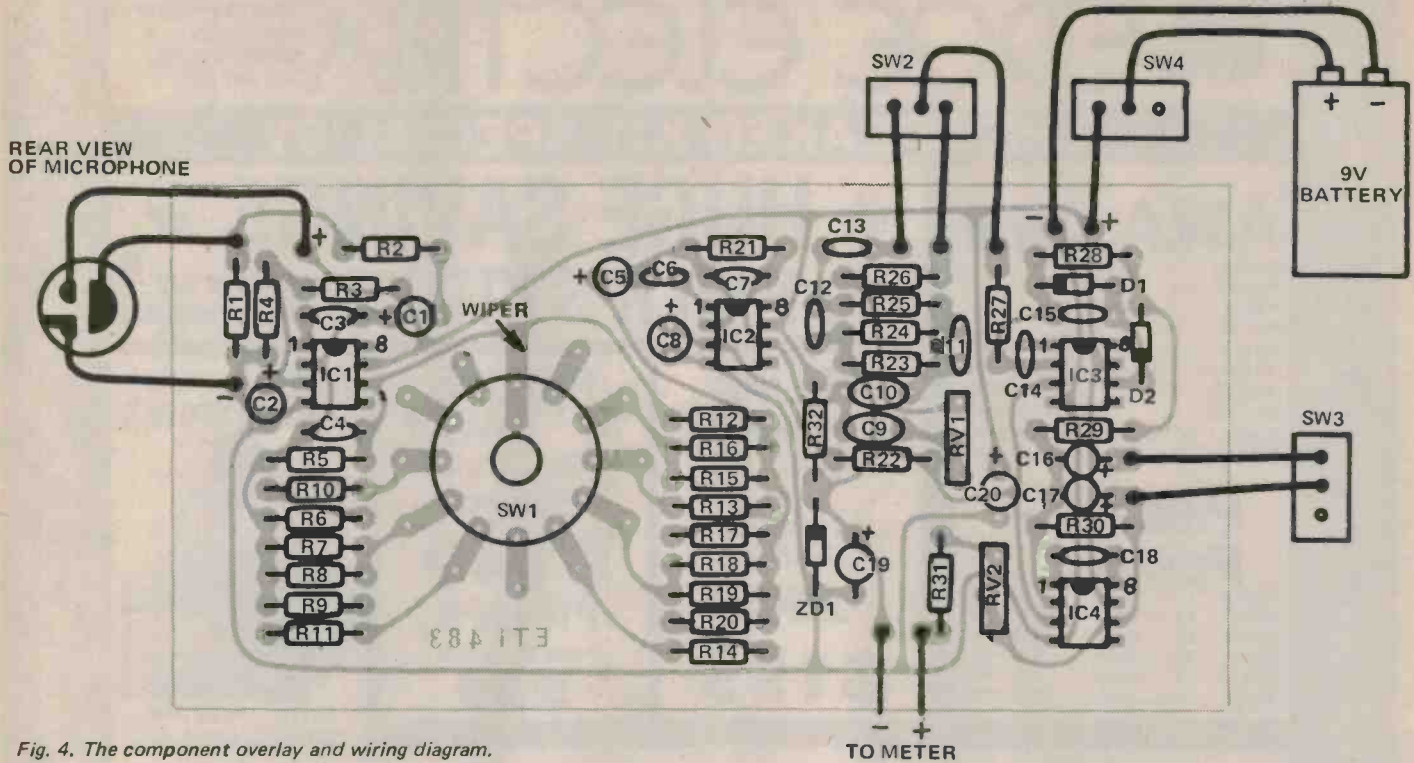

Fig. 4. The component overlay and wiring diagram.

PARTS LIST - ETI 483

Resistors	all 1/2W 5%	Capacitors	
R1	1k	C1,2	4μ 7 16V electro
R2	2k2	C3	150p ceramic
R3,4	47k	C4	3p3 "
R5	220k	C5	4μ 7 16V electro
R6	6k8	C6	150p ceramic
R7	27k	C7	3p3 "
R8	270k	C8	4μ 7 16V electro
R9	100k	C9,10	100n polyester
R10	390R	C11	10n "
R11	1k8	C12	820p ceramic
R12	220k	C13	4n7 polyester
R13	6k8	C14	150p ceramic
R14	100k	C15	3p3 "
R15	3k3	C16	10μ 16V electro
R16	6k8	C17	1μ0 16V "
R17	390R	C18	33p ceramic
R18	27k	C19,20	4μ 7 16V electro
R19	270k		
R20	1k8	Semiconductors	
R21	220k	IC1-IC4	LM301A
R22	100k	D1,2	1N914
R23-R25	27k	ZD1	3.9V 300mW
R26	47k		
R27,28	270k	Miscellaneous	
R29	22k	PC board	ETI 483
R30	470k	Microphone insert	for RAPAR
R31	470R	ECM1001	
R32	2k2	SW1	single pole 11 position rotary
		SW2-SW4	SPDT toggles
		RV1	1mA meter
		RV2	Plastic case
			6xAA size battery holder
Potentiometers			
RV1	100k trim		
RV2	2k "		

The Decibel (db)

The ear can hear a sound power as low as 10^{-13} watt - this is a pressure of 0002 dynes per cm^2 . The ear drum moves an amount approx. equal to the diameter of a molecule of nitrogen. When sound is uncomfortably loud, the hearer "feels" a tickle, then pain in the ear; a power level of 1 watt. approx.

Engineers take the logarithm of the power ratio and call it the DECIBEL (db).

$$\text{The db level is given by } -db = 10 \log_{10} \frac{\text{Watts}}{10^{-13}}$$

$$\text{The sound pressure level is } = 20 \log_{10} \frac{P(\text{dynes})}{0002}$$

Typical Decibel levels encountered

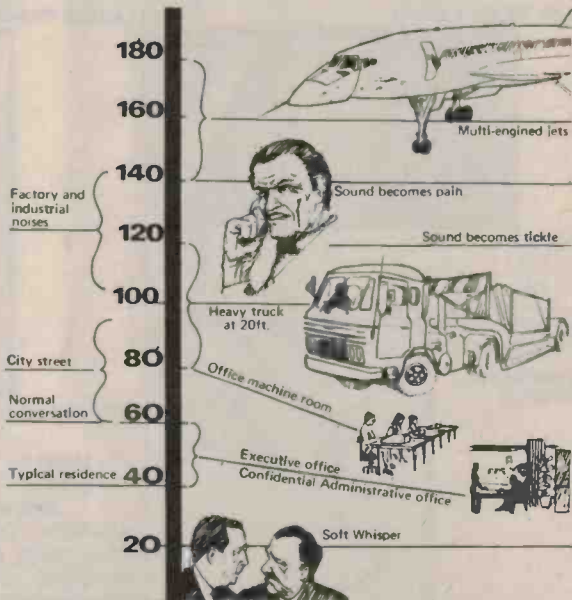

- For a sound to be perceptibly louder or softer, it must be changed by 3 decibels.
- A noise twice as loud or 1/2 as loud is a change of 10 decibels.
- A reduction in noise of a few decibels in the low noise region (administrative office) is not significant. The same change at high sound levels (office machine room) is significant.

EDGE ELECTRIX

31 BURWOOD RD,
BURWOOD,
SYDNEY, 2134.
Tel: 747 2931

THE SPEAKER KIT SPECIALIST

A.W.A. Coral

- 12SAI 30W RMS
- 10SAI 25W RMS
- 8SAI 18W RMS
- 6SAI 15W RMS
- 12SA5 30W RMS
- 10SA5 Improved 25W RMS
- 8 SA5 18W RMS
- 12SA7 40W RMS
- 10SA7 Dome Series 30W RMS
- 8 SA7 20W RMS

Plessey Foster

- 3016 12" 3way 40W RMS
- 3003 12" 3way 40W RMS
- 2503 10" 3way 40W RMS
- 2510 10" 3way 30W RMS
- 2010 8" 3way 20W RMS
- 2006 .8" 2way 12W RMS

★ HUGE SAVINGS ★ on PHILIPS KITS Check these terrific prices!

PHILIPS 12" 3-WAY

(similar to AD12K12)

OUR
NORMAL
PRICE

~~\$245~~

\$199

PHILIPS 10" 3-WAY

WOULD USUALLY BE
PRICED ABOUT

~~\$199~~

\$149

PHILIPS

2-way 8" system

\$99

HURRY — LIMITED STOCKS



NOTE: THESE ARE GENUINE SPECIALS

THERE ARE SOME SLIGHT MARKS ON SOME CABINETS BUT BE QUICK

- OVER 20 DIFFERENT SPEAKER KITS NOW STOCKED
- HUNDREDS OF DIFFERENT SPEAKERS
- CROSS-OVERS, CABINETS AND ACCESSORIES

DEL SOUND - PTY LTD

BRISBANE

229-6155

1 Wickham Terrace, Brisbane.
Also 35 Logan Road, Woollongabba
Queensland Distributors for Swann
Electronics (ex Murdo)

I.C. TEST CLIPS



- 14/16 PIN\$4.60
- 28 PIN\$9.50
- 40 PIN\$11.90

INSULATED TERMINALS TERMINAL PLUGS

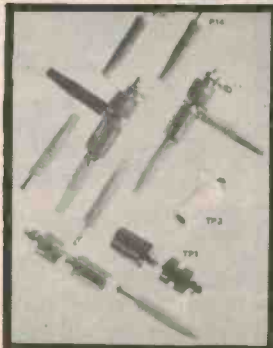

- TP1 & TP245c
- P12 (2mm) THROUGH PLUG15c
- P14 (4mm) TOP BANANA PLUG22c

JACK PLUGS

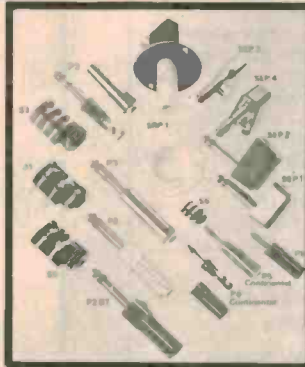

- P2, MONO 6.3mm TOUGH MOULDED COVER 50c
- ASSORTED COLOURS
- P5, MONO METAL 3.5mm40c
- SEP3 MONO METAL COVER95c
- JACK SOCKETS (Nylon)**
- S1—MONO, CHASSIS INSULATED35c
- S3—STEREO, CHASSIS INSULATED57c
- S5—MONO, CHASSIS METAL FACIA NUT60c

MAIL ORDERS & TRADE ENQUIRIES WELCOME

STOCKS AS OF 1/10/77

ALL PRICES PLUS 10% POST & PACK
CBs & ACCESSORIES

CONTROL KNOBS. SCREW FIX

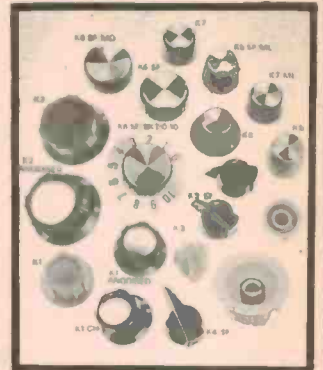

PRICE LIST FOR CLIFF KNOBS

- K1 Black/Grey28c
- K1 Black/Grey Chrome Top34c
- K1 Black/Grey Coloured Anodised Top34c
- K2 Black/Grey Chrome Top40c
- K2 Black/Grey Plain29c
- K2 Black/Grey Coloured Anodised Top48c
- K3 Black/Grey28c
- K4 Black/Grey29c
- K5 Black/Grey49c
- K5 Black/Grey Marker Line54c
- K6 Black/Grey54c
- K6 Black/Grey Marker Dot56c
- K6 Black/Grey Skirt 0-1076c
- K7 Black/Grey54c
- K7 Black/Grey Marker Line56c
- K8 Black/Grey48c

AUSTRALIAN DISTRIBUTORS

Electronics is where it's all happening

...if you're into it you've got it made!

It's the world's fastest growing industry... with new discoveries...new products every day. And, every day, there are more jobs...bigger salaries...better opportunities...for people who are trained.

You can be part of this boom now by training with International Correspondence Schools. Learn to design, build, install, test, control and maintain modern electronic equipment...from your own colour TV or hi-fi set to a digital computer.

Your career opportunities are limitless...in broadcasting, industry, the military, aerospace programs, medical science and communications. With your enthusiasm and ICS tuition, a well paid job and a secure future in electronics is well within your grasp.

How do I get into it? ICS have put together a FREE Electronics Career Folder. It tells you all about the many courses open to you including Communications and Broadcasting, Industrial Electronics, Computer Servicing and Audio/Radio Servicing...courses endorsed by the Television and Electronics Technicians Institute of Australia. Post the coupon and the career folder will be on its way to you without obligation. Don't wait another minute...progress won't. The big developments in electronics are happening now and the demand for skilled people is growing all the time.

Special Colour TV repair course. Colour TV is booming all over Australia, beyond the expectations of all the manufacturers, resulting in a shortage of qualified people to fill the service gap.

You could make a successful career in this growing field with the help of the ICS School of TV Servicing. You can benefit by this course - all you need is the enthusiasm to learn and enjoy rewarding work.

Your ICS course could be a start of an exciting new career or you can use your new-found knowledge to earn extra money in your spare time.

This special course is endorsed by the Television and Electronics Technicians Institute of Australia.

Send the coupon today. It could be the first step in an exciting new future for you.

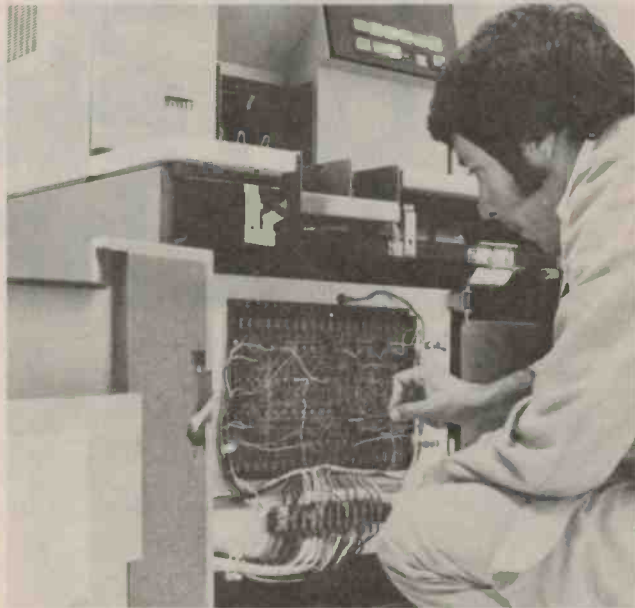

Find out how you can be where it's all happening - in Electronics. Fill in the coupon and post today!

ICS Home Study ...your passport to success in life!

Your invitation to join the thousands of successful ICS graduates.

To: International Correspondence Schools
400 Pacific Highway, Crows Nest, NSW. 2065
18-20 Collins Street, Melbourne VIC. 3000
182 Wakefield Street, Wellington. N.Z.

YES!

Please send me, entirely without obligation, a copy of the:

- ICS Electronics Career Guidance Kit
- ICS Colour TV Servicing Career Guidance Kit.

MR/MRS/MISS _____

ADDRESS _____

POST CODE _____

PRESENT OCCUPATION _____

AGE _____

Take the first step -
Fill in and mail this coupon today!

ICS

276620

How to crack a highly paid job as an electronics technician.



We'll give you excellent training - as good as you'll get anywhere in Australia.

We'll give you free medical, dental and hospital treatment.

We'll provide plenty of good tucker and a comfortable place to stay.

We'll give you substantial leave, and on top of all that, we'll pay you well while you're training.

On your side, you'll give us a period of hard, but interesting and rewarding work. And, when eventually you leave us, you'll find yourself a fully qualified and experienced Electronics Technician. Not a bad thing to be, these days.

So, if electronics is your idea of a great career and you are (at time of entry) approx. 15 to 17 for apprenticeship

and over 17 for an Adult Trainee, join the Navy, Army or Air Force.

Phone us at:

Adelaide 223 2891. Brisbane 226 2626.

Canberra (Navy) 66 4697.

Canberra (Army or Air Force) 47 6530.

Hobart 34 7077. Melbourne 61 3731.

Perth 322 4355. Sydney 212 1011.

Write to either the Navy, Army or Air Force Electronics Technician Counsellor, GPO Box XYZ in your

nearest State Capital City (please include your date of birth).

**Learn
Electronics
with us.**

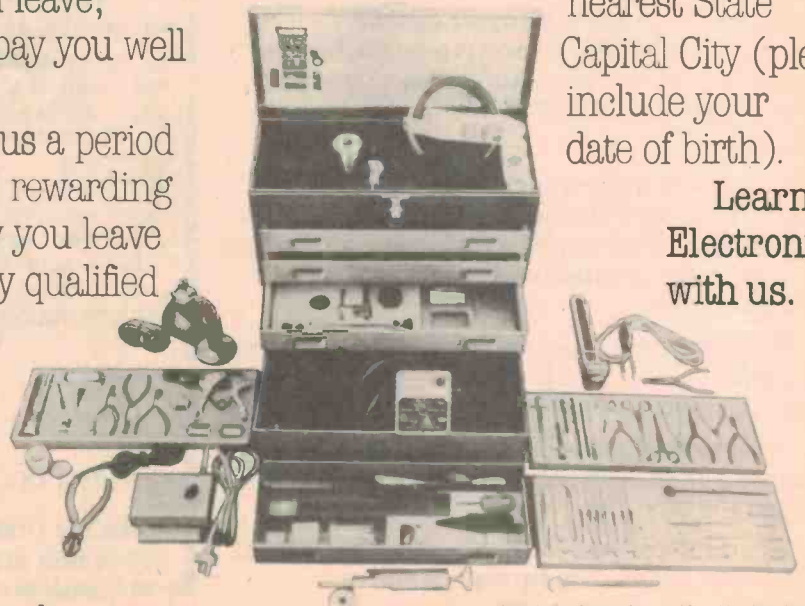

Authorised by Director-General of Recruiting, Dept. Defence.
TSAP3.FP.97

OTH-B Radar - In Defence of Australia...

'Only the United States and the Soviet Union have comparable systems.'

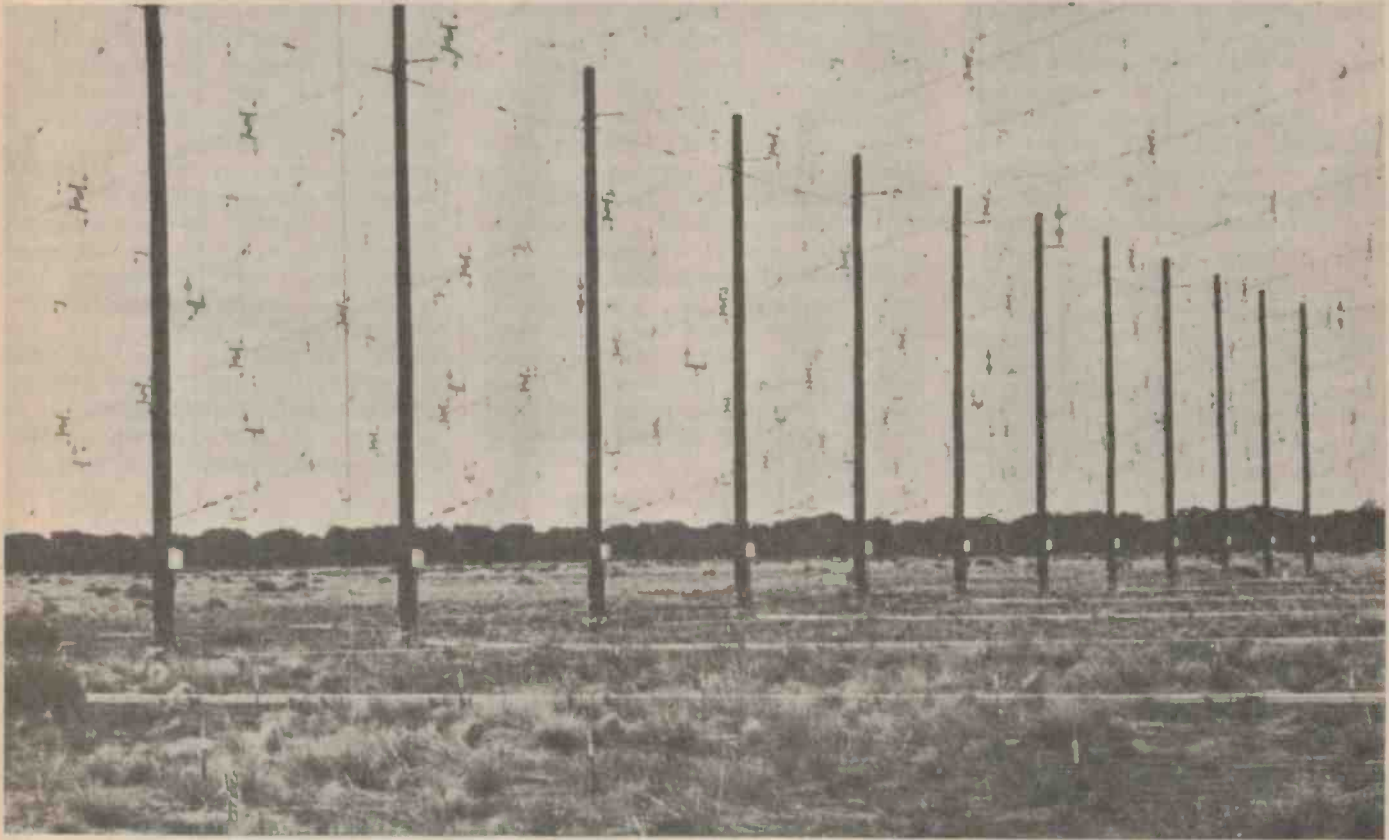

A paper by Dr. Desmond J. Ball, Strategic and Defence Studies Centre, Research School of Pacific Studies, Australian National University.

IN RECENT YEARS there has occurred a series of technological developments which appear to be making landbased national technical means of surveillance and early warning operating from one's own territory increasingly promising. One of the most significant of these is that of 'over-the-horizon' backscatter (OTH-B) radar. Australia is at the forefront in developing this technology - the Project Jindalee prototype system has been undergoing tests for over two years now, and has already achieved detection ranges against aircraft of more than 2,800 kilometres.¹ Only the United States and the Soviet Union have comparable systems.²

Jindalee is of enormous significance to the electronics community. For one thing, radio operators have recently been affected by the HF signals from the powerful transmitter - and, more especially, from overseas OTH transmitters, such as the new Soviet system. Second, private industrial organisations have benefitted from

Jindalee contracts - \$911,000 just from the exploratory stage of the project. Participation by Australian industry in the future is likely to amount to several millions of dollars. And, third, Jindalee is one of the most promising new developments from the point of view of the defence of Australia.

This paper briefly describes OTH-B and explains how it works, both in technical and operational terms; describes something of the history of OTH research in Australia; provides some cost-effectiveness comparisons with other surveillance and early warning systems; discusses some limitations of OTH-B systems; and, finally, discusses some of the more particular implications of the system for the defence of Australia.

High frequency radio waves (3 to 30 or even 40 MHz) have the interesting property of being able to propagate beyond the line of sight by reflection by the ionosphere - out to distances of several thousand kilometres. The

¹ At a National Press Club luncheon on 30 September 1976, Dr. John Farrands, then the chief defence scientist, said that Jindalee would enable surveillance of aircraft or missiles over a range of 1000 kilometres. And although Dr. Farrands did not mention it in his speech, defence sources in Canberra said that the system had successfully tracked Qantas aircraft from Alice Springs to Singapore. See Canberra Times, 1 October 1976, p. 1, and 4 April 1977, p. 13.

² The American OTH systems are regularly described in Congressional testimony and in the Secretary of Defense's Annual Defense Department Report to Congress.

Canada, Japan and the United Kingdom have participated in a number of co-operative OTH radar programmes with the United States.

A new Soviet OTH system began test transmissions in July 1977. Located near Kiev, the transmitters are extremely powerful - 20 or 40 MW or more. Radio operators from as far away as Australia have been affected by the transmissions. The signals have been affecting frequencies from 4 to about 27 MHz, or almost all of the HF band; they centre on 14.215 MHz. The signal bandwidth varies from 30 kHz to more than 300 kHz at some times. The pulsed signals have a repetition rate of 10 per second.

exploitation of this property has led to the development of three basic types of OTH radar systems. The first of these is a forward-scatter OTH system, designed to detect ICBM launches by the disturbance created in the ionosphere when it is penetrated by an ICBM with its engine plume. The United States operated an OTH-F system for this purpose until early 1975 — programme 440-L, with four transmitters in the Far East and five receiver sites and a correlation system in Europe. Programme 440-L was phased out because of the validation of the backscatter principle, which freed the US from dependence upon overseas bases.

Two different forms of OTH-B systems have been developed, one to detect missile launches (the American system of which is designated programme 441-L and known as Cobra Mist), and the other for the detection and tracking of aircraft (programme 414-L) by means of energy reflected off the targets themselves, back, via the ionosphere, to receivers located with or near the transmitter. The currently planned American programme involves two OTH-B radars, one near Cutler, Maine (the prototype) looking north-east, and one in the State of Washington or Oregon looking northwest; the need for a third, south-looking radar is to be considered later.

The concept of an OTH radar that would operate on the backscatter principle dates back to at least the late 1940s. It was not proceeded with then because too little was known about the basic physics of the ionosphere and the complex signal processing needed was beyond current capabilities. In Australia, an experimental high frequency (HF) array was erected at Rockbank, Victoria, in 1961, and used for backscatter experiments between September 1961 and February 1962. These proved successful, and a new array was constructed by the Australian Army for operational purposes. Extensive research was conducted during the 1960s, usually in conjunction with the US Air Force, 'involving the study of ionospheric propagation in relation to long range radio paths', much of which proved valuable from the point of view of the development of an OTH radar for operation in the southern hemisphere.³ Actual investigation of OTH radar technology was begun by the Weapons Research Establishment in 1969, and in 1974 Australia signed an agreement with the United States to co-operate in the Jindalee project.

On April 11, 1974, the then Defence Minister, Mr. Barnard, announced that approval had been given

to the Project Jindalee experimental OTH-B programme. The cost of the project between 1973-74 and 1977-78 was estimated at \$3.4m. The radar equipment for the Project was assembled at the Weapons Research Establishment, Salisbury, and installed near Alice Springs during 1975-76. The transmitter site, consisting of a phased array antenna 185 metres long, several other masts to support communication and radar calibration antennas, power house, etc., is located in the Hart's Range about 160 km northeast of Alice Springs. The main receiving site, in the Mt. Everard area about 15 km north of Alice Springs, features a 600 m long receiving array, calibration and communication aeriels, and large earth mats providing stable ground planes; some 300 km of wire was used to make these mats. About six or seven technicians from WRE reside in Alice Springs, and these provide a 24 hour a day manning of both the transmitter and receiver sites.

Under Stage One of the project, the transmitting station at Hart's Range operates on a power output of some 50 kW, provided by five 10 kW sub-transmitters — 40 kW is utilised in the actual radar transmission, and 10 kW feeds into the 'ionospheric sounder' dedicated to monitoring the behaviour of the ionosphere. Sixteen further sub-transmitters are being installed under Stage Two. (Much of the equipment for this installation is from one of the decommissioned American OTH radar stations in Japan). The Hart's Range station should eventually operate on at least 1 MW. The basic operating frequency spectrum of the installation is expected to be 5 — 29.5 MHz. It will of course be at the higher end of the range at dawn, and the lower in the early afternoon, with considerable other variation due to other ionospheric and operational factors. It could at times go up to 60 MHz. On overseas experience, the operating frequency will centre around 14 MHz. The bandwidth will be quite wide, probably varying from about 30 kHz to more than 300 kHz at some times. The basic pulse repetition rate will depend to some extent on how the system is eventually optimised for the detection and tracking of high-Mach aircraft and relatively slow-moving ships. It should be somewhere from about 3 pulses per second to about 10/sec.

For early warning, an actual operating system would require two or three such 'Jindalee' installations. Given an angle coverage of 120° and a 60° redundancy over the direct north, two installations would provide

surveillance and early warning over 180°; if no redundancy was required, two installations would cover 240°, and three the full 360°. ⁴ An actual working system could be operational within five years from today.

Costs

It is not possible to be definitive with regard to the costs of an OTH-B system. Dr. John Farrands, the chief defence scientist, has said that the Jindalee Project will cost about \$20m 'before we go to an actual working system'. This is much less than the \$50m which the Americans have spent on the testing and validation of their OTH-B concepts.⁵ Construction costs for the deployed operational system would add considerably to this. (The American OTH station at Orford Ness, UK, was reported to have cost £22m. The 1975 contract for the 414L station in Maine was for approximately \$40m). It is unlikely that Australia could deploy a full working system of at least two

³ The principal facilities here were those manned and operated by the US Air Force at Amberley, Qld, from 1965-1975, and Norfolk Is. in 1969-70.

Most of the relevant Defence research today is being undertaken at the RAAF Base at Pearce, W. A.

⁴ From the point of view of early warning of an air attack against Australia, duplicated coverage of the direct north is probably more important than full 360° coverage. It not only provides some redundancy, in the direction from which any threat is likely to come, of installations which are vulnerable to attack themselves as well as being subject to normal malfunctions; it also allows the application of the bistatic radar technique (which can be extended to the multistatic technique).

Bistatic radar systems, which involve the separation of the transmitter far away from the receiver(s), have come under intensive study in the US in the past year or so (the Sanctuary Project).

If some redundancy is accepted, a number of transmitters and receivers can be netted to provide look angles and precise tracking by triangulation, improving the target resolution of the system and hence increasing its utility for air defence.

Bistatic systems also have the advantage of allowing co-operative users to receive surveillance data without having to risk disclosure of their presence by radiating radar energy, an important advantage in some limited battlefield situations where the transmitter might be exempt (for technical or whatever reasons) from attack.

It is worthwhile recalling that the bistatic method was actually first considered in the 1950s in relation to OTH radar. See Joseph W. Chamberlain, *Physics of the Aurora and Airglow*, (Academic Press, New York, 1961), p. 220.

⁵ One reason why the Australian R & D cost should only be 40-50% of this is that, as Mr. Killen has said, 'costs have been kept down by borrowing special electronic equipment from the United States'. *Hansard, (H. of R.)*, 4 June 1976, p. 3115.

transmitter and receiver pairs for much less than \$100m.

This does not compare altogether unfavourably with the costs of alternative surveillance and early warning systems. The two Hubcap radars, installed at Williamstown and Amberley in late 1968, cost about \$6m each, while the five new aircraft surveillance radars recently installed at RAAF bases at Townsville, Amberley, Williamstown, Pearce and Darwin would have each cost only slightly less than this. These radars, however, are limited to line of sight detection — a few hundred kilometres for low flying aircraft or ships. Literally scores of these radars would be needed to provide the same radar coverage as one or two OTH-B radars.

Airborne early warning radars are even more costly. The unit flyaway cost of the cheapest of these aircraft, the Grumman E-2C Hawkeye, came out at \$17.5m in the 1976 Israeli purchase, while in March 1976 the unit flyaway cost of the Boeing E-3A AWACS was given as \$53.7m. The programme unit costs of these aircraft are about \$30m and \$104m respectively. Allowing for some down-time, some six to eight of these aircraft would be needed to provide full-time, all-weather coverage over a single battlefield area, and two or three such cohorts for a large-scale conflict. In any case, these aircraft are not really suited for strategic early warning, but really only for battlefield warning and control. Some longer-range early warning system is still necessary to allow these aircraft to get into the air in time to move out to meet the advancing threat.

Australia might also consider a satellite early warning system. The United States developed such a system for missile warning in the late 1960s, and recent testimony on the HALO and Teal Ruby programmes suggests that in five years or so spaceborne surveillance systems will also be able to detect tactical aircraft. These satellites would have to be in synchronous orbit to allow continuous coverage of the continent and the maritime and air approaches. The present American SLBM satellite early warning system relies on two satellites for such coverage, with at least one in reserve on the ground; these must be replaced approximately every five years. These satellites were estimated to cost \$61.5m each in 1970, and the Australian price would have to include some reimbursement for R & D, launch costs, and the necessary ground support equipment, including a ground read-out station and sophisticated data processing facilities.

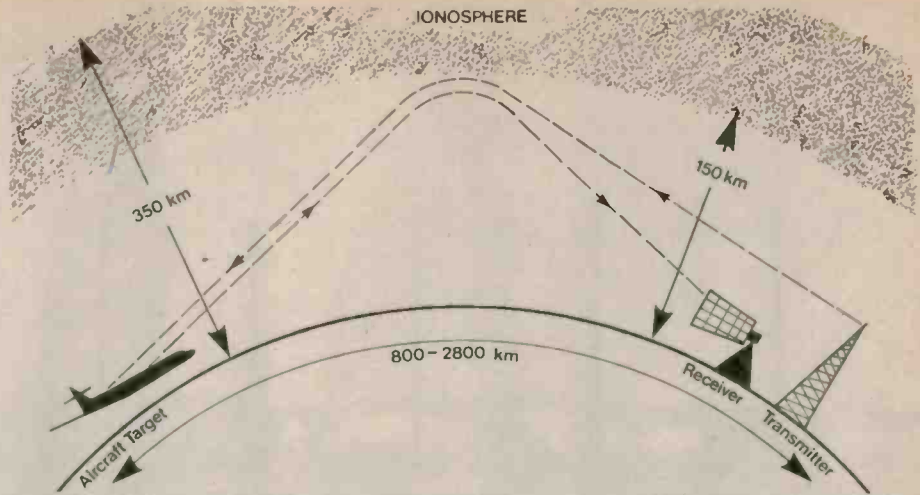

Over The Horizon — Backscatter radar relies upon the ability of the ionosphere to 'reflect' HF radio waves around the curve of the Earth's surface. Because the ionospheric layers vary in height and ability to reflect at different frequencies, complex processing by computer, in conjunction with continuous monitoring of the ionosphere, is required to derive meaningful information.

Limitations

OTH-B systems emerge quite favourably from these cost/coverage comparisons. This is not to say, however, that OTH radar does not have other limitations and inadequacies.

For one thing, although they can detect an incoming vehicle, OTH-B systems cannot identify its nationality or intent. Advances in signal processing techniques and powerful computers, together with inputs from some form of air traffic control data (such as electronic interception of air traffic communications) can alleviate this to a large extent. Indeed, as Mr. Barnard announced, one of the principal reasons for Jindalee's site location is 'the added attraction that Alice Springs was a check point on the routes of many international aircraft entering Australian airspace from the north, so that the radar had a ready source of aircraft of different characteristics for test purposes'. In any case, this is a problem for all long-range non-optical early warning systems, including all those alternative systems mentioned above.

Secondly, OTH systems could be vulnerable to enemy jamming of the receivers. However, although a relatively low-powered transmitter in the receiver's beam working at the right frequency would obliterate target returns, to do this operationally would be difficult. Because Jindalee is located so far inland, any jammer would have to be shipbased and relatively high-powered. The location of the receiver would also have to be known, which is not always the case, particularly with bistatic OTH-B systems. And the problems of tracking and imitating the radar frequency, shifting constantly over a quite wide frequency range, could be insoluble. Moreover, as General

Gordon T. Gould, USAF, has testified in a discussion of the possibility of jamming OTH radar:

'When you start jamming something . . . you produce a form of warning itself. This is a way of alerting someone.'

USAF OTH installations have electronic countermeasures (ECM) monitors to determine whether any interference is man-made, and no doubt these will be applied to the Australian system.

Third, the proper functioning of OTH radar depends upon good steady reflections from the ionosphere, which requires both good knowledge of the local ionosphere and an ability to rapidly tailor the frequency to the ionospheric weather. As Peter Laurie has written:

'Low frequencies are necessary at night to get reflection and high ones during the day to avoid excessive absorption. In practice, an OTH radar needs a secondary, vertical, sounding radar to test the ionospheric weather, together with an HF receiver to search the band for quiet channels. The best radar frequency is then calculated by a computer and the transmitters and receivers adjusted accordingly — which for installations as powerful and complicated as these are, is in itself quite a performance.'

Knowledge of the local ionosphere has improved immensely in Australia in the last few years, and techniques for monitoring solar activity now allow some prediction of ionospheric behaviour, and hence the adaption of frequencies to reduce the impact of solar induced phenomena.⁶

Fortunately, from Australia's point of view, auroral effects on the ionosphere are much more a concern in the northern hemisphere, with our *Aurora Australis* being comparatively less dramatic but also less serious; moreover, these effects are generally only significant at latitudes greater than 60°, which is a concern for northern

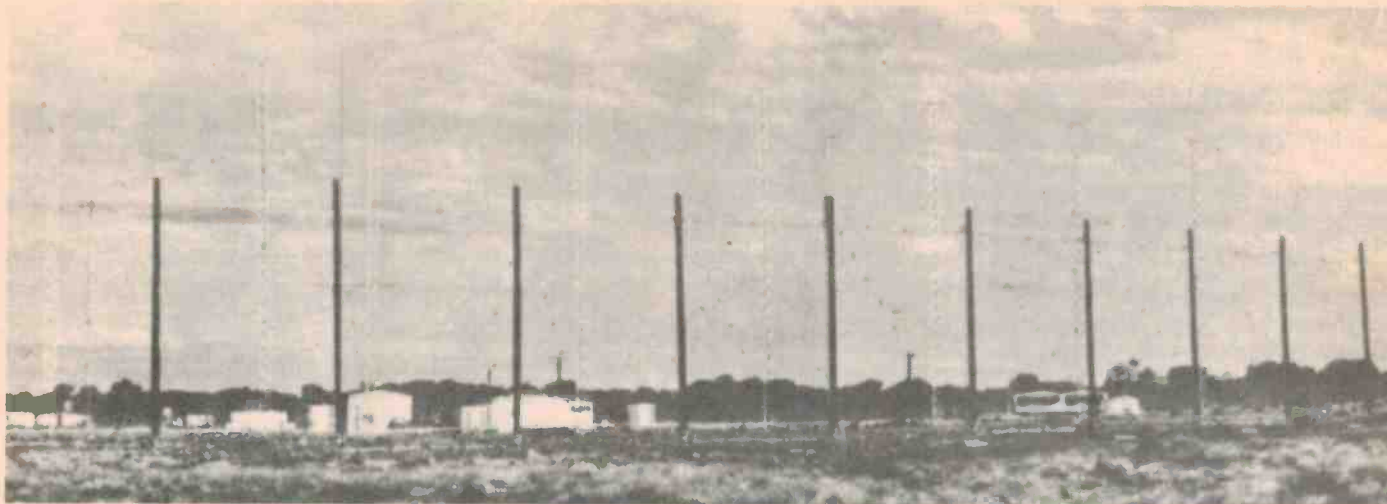

The Jindalee transmitting antenna.

hemisphere nations looking over the Arctic at each other, but not for a northward-facing Australian system.

In addition to the effects of natural phenomena on the ionosphere, attention must also be given to possible man-made disturbances — particularly by nuclear explosions in a possible general war. In 1962, the US conducted a number of high-altitude nuclear explosions to determine their effect on ionospheric propagation. The most spectacular of these was a 1-megaton bomb exploded more than 400 km above Johnston Is. In the Pacific on 9 July, which blacked out HF transmission between Australia and Hawaii and San Francisco for 20 minutes, and Japan and the US for 40 minutes.

Finally, the OTH radar installations, being large and fixed are vulnerable to destruction by direct physical attack, by both nuclear or conventional weapons. This is especially the case for the transmitters, which offer an extremely powerful signal (from 50-100 kw to 2 MW and even much higher) for radar-homing missiles (such as Shrike, Standard ARM, or long-range anti-radiation cruise missiles). This potential vulnerability is no greater than for many other early warning systems (such as the ground

surveillance radars, the satellite ground stations or even the satellites themselves, and the airborne early warning system), but it may be necessary to divert elements of the Tactical Fighter Force (TFF) to the protection of these; this may involve the deployment of some of the force to, for example, Alice Springs. Of course, an attack on any of these systems represents unequivocal early warning.

Other more passive means of protection could also be adopted. For example, the vulnerability of OTH systems can be dramatically reduced by making the transmitters and receivers mobile. If the bistatic or (even better) multistatic techniques are adopted, whereby the transmitter is separated far away from the receiver(s), then there is no problem for the (assumedly concealed) receivers.

ion of such a system to be held in reserve for any future emergency. And, in the longer term, consideration should be given to satellite-borne transmitters.

Other Contributions

This discussion suggests the enormous value to Australia of an OTH-B system for the early warning mission. Three other contributions which OTH-B might make to Australian defence will be briefly discussed here.

The first is the contribution to continental air defence. In parallel with the development of the Jindalee Project, studies have been conducted by the Central Studies Establishment with the co-operation of the Navy and RAAF on the implications of Jindalee for this defence mission. OTH-B systems have detected targets out to about 3200 km,

'It now seems that (OTH-B radars) also have a significant ability for tracking surface targets.'

The transmitters, however, are another matter. In the United States, both transmitting and receiving equipment was originally located on trailers, which were regularly moved about during the R & D phase of the development of the OTH-B system. Many of the roads in north and central Australia are capable of carrying the sorts of trailer which would be required to haul the OTH-B transmitter(s). The trucks used in 'beef trains' and ore haulage are capable of trailing 185-metre transmission antennae. Since the system may not be expected to operate while in transit, it can be constructed on a modular basis for rapid re-assembly at any one of a large number of pre-prepared sites.

The US Navy also has a shipborne OTH radar in advanced development; if this programme proves successful, Australia might consider the acquisit-

but the system has inadequacies from the point of view of air defence vectoring; although it can detect, the system has problems of location, especially at long ranges and when using relatively high frequencies, and its tracking capability is limited to distance and azimuth. The range resolution at this distance is about 1½–2 km for bandwidths of about 100 kHz, but is typically 20–40 km for the bandwidths at which OTH-B systems normally operate. The relative range accuracy is typically 2–4 km for a target location relative to a known location observed by the same radar, with absolute range accuracy 10–20 km assuming good real-time path assessments are made. The use of bistatic or multistatic techniques would improve these nominal performance characteristics.

Two means are available for using gross target data such as this for air

⁶ The United States has developed a worldwide network of solar optical telescopes and solar radio telescopes for continuous monitoring of the sun, enabling it to detect, identify and assess the impact of any solar activity which would affect radio or radar use. Because it takes from 8-20 minutes to 72 hours for electromagnetic particles associated with solar flares to reach the earth, it is possible to adapt frequencies and other procedures to ensure continuous effective radar performance. See Hearings before a subcommittee of the House Committee on Appropriations, *Department of Defence Appropriations for 1977*, (Part 5), pp. 1441-1443.

defence purposes, depending on the capabilities of the interceptor aircraft's own radar system. The first involves the use of an airborne warning and control system in conjunction with the OTH-B radar, the approach being adopted by the US in its 414-L programme. Australia now has a requirement for such an airborne warning and control system in its Five-Year Rolling Programme; the aircraft under some consideration for procurement, the E-2C, can detect and track cruise missiles at 100 nautical mile ranges and large aircraft at 250 nm, and can spot small boats in high sea states. OTH-B radars would give airborne warning and control aircraft time to take to the air and move out to meet the advancing threat; interceptor aircraft with a good radius of action and a 'look down/shoot down capability' could then be vectored into actual intercept.

Given the relatively high costs of such airborne warning and control aircraft, however, consideration should be given to the operation of fighter aircraft in direct contact with the OTH-B receivers. Several of the TFF contender aircraft have radars which have a capability of directing long-range interception on the basis of OTH-B radar data simply by enveloping the area of irresolution given by the OTH-B station; these would include the Hughes AN/APG-63, the Hughes AN/AWG-9, the Marconi-Elliott system for the Tornado, the L.M. Ericsson PS-37A, and the new Hughes AN/APG-65. Interception probabilities would be increased if the fighters flew out in tandem.

The Jindalee Project is an important reason why Australia's new tactical fighter should have a large radar. Advocates of contender fighters with smaller radars (e.g. the F-16 and its 25 nm system) argue that large radars are unnecessary because most air combat takes place at visual or at least infra-red ranges — ignoring not only the enormous advantages in air combat of early target acquisition, but also denying the possibility of realising most of the air defence potential of the Jindalee system.

For the future, there are two possible techniques which, if successfully developed and applied, could greatly enhance the air defence potential of the system. One is the use of 'differential' systems. Because conventional OTH-B systems have a typical range resolution of 20–40 km and an absolute range accuracy of only 10–20 km, they have only limited capability in target location and tracking roles. However, it should be possible to construct a chain of relatively inexpensive forward monitoring stations some 100 km from the

Australian coast which would enable this resolution to be reduced dramatically. The concept is essentially similar to that employed in the differential version of the Omega navigation system. Differential Omega involves the reception of Omega signals at fixed monitor receivers and the communication of lane resolution data to a central location where it is combined into an overall set of corrections and the 'differential fix' communicated to user systems. This technique improves the accuracy of the Omega system from that of about ± 1.2 nautical miles in the case of normal hyperbolic Omega to about 200 metres. Improvements of a

of the reflected signal gives each target a recognisable signature. During trials with models it has proved possible to differentiate the MiG-19, MiG-21, F-104 and F-4.⁷ Again, the continental air defence implications are quite profound.

Surface Target

The second set of contributions which OTH-B systems can make to the defence of Australia lies in the area of naval applications. Recent developments indicate that much more consideration should be given to these applications. While OTH systems were originally developed for detecting and tracking airborne objects, it now seems that they also have a significant capability for

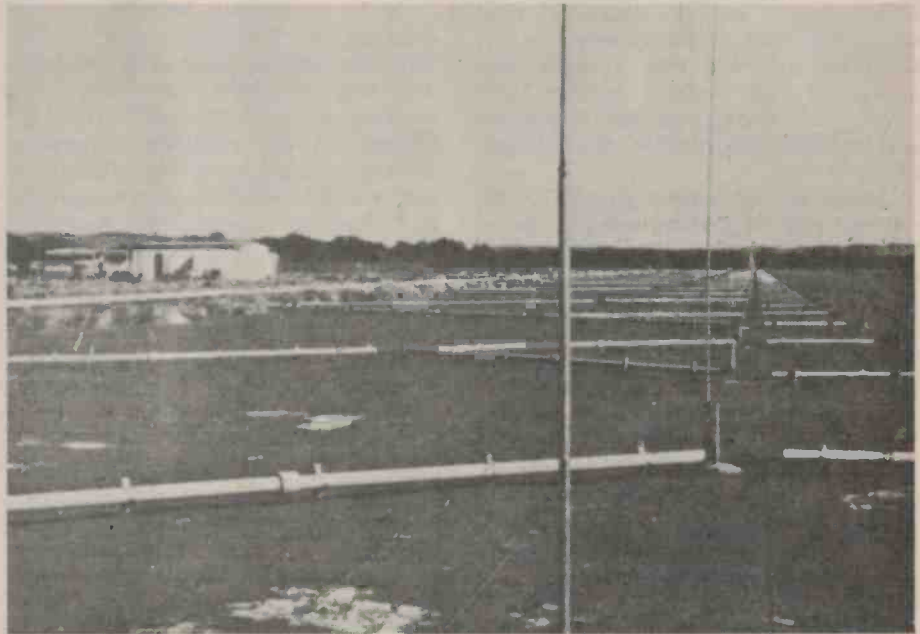

The Jindalee receiver antenna array.

similar order should be feasible for a differential OTH-B system. Such a system would require some 30 forward monitor receiver stations describing an arc of some 12,000 km from (say) Lord Howe Island around through Papua New Guinea to islands off the south-west coast of Western Australia. In this system, the relative range accuracy would typically be 2-4 km. The continental air defence implications of this are quite profound, with the OTH radar correlation centre being able to control the direct vectoring of interceptor or maritime strike aircraft.

Another possible technique has apparently enabled the United States to demonstrate a capacity not only to detect and track aircraft targets but also to identify them positively as well. According to *Flight International*:

'Tests have showed that — provided the frequencies used are such that the wavelength is longer than the largest dimension of the target, and that two or three different frequencies are used — examination of the amplitude, phase and polarisation

tracking surface targets. Recent experiments by US Navy engineers, using an experimental OTH-B system in Virginia, have involved the successful tracking of ships in the Gulf of Mexico — a distance of about 2000 km. Australian Defence officials have been regularly informed of American progress with the naval application of OTH-B systems for at least the past three years. US intelligence sources reportedly believe that the Soviet OTH-B transmitter near Kiev is trying similar techniques.

Depending to some extent on the eventual site(s) selected for the system operational ranges against surface targets of out to about 2000 kilometres should provide excellent surveillance coverage of Australia's maritime approaches. Detection of surface targets is limited to relatively large and/or fast-moving vessels, but this is no real

⁷ See 'USSR Develops Anti-B-1 Radar?', *Flight International*, 8 January 1977, p. 50.

disadvantage from the point of view of early warning since any significant attack on Australia would include vessels in this category. Resolution of targets whose Doppler frequencies differ by 0.1 Hz or less is generally possible; at a transmission frequency of 20 MHz, 0.1 Hz corresponds to a difference in relative velocity of about 1.5 knots.

The US Office of Naval Research has also been investigating another interesting application of OTH radars. In May 1974 it was disclosed by Dr. Stephen J. Lukasik, Director of the Defense Advanced Research Projects Agency, that DARPA had been pursuing the detection of submarines and other ASW research through the application of OTH systems, but no details of this work were given. More recently, the US ONR has revealed that at least one aspect of this research involves the mapping of mid-ocean surface conditions and studying the detailed morphology of the surface.

The other contribution which OTH-B can make to Australian defence lies in the intelligence area. It is clear that a strategic policy of defence of Australia (as opposed to 'forward defence') requires an upgrading of our indigenous intelligence capabilities. The Army Signals Corps discovered with its Rock-

with the new Soviet system; 'elint' can be gathered during the off-periods. It should be possible to develop programme for utilising the radar detection and electronic intercept capabilities of the system so that the early warning function is maximised. Alternatively, it may even be possible to modulate the frequencies so that the radar detection and the elint intercept capabilities can be operated simultaneously.

The operation of such a national technical system would reduce Australian dependence on US intelligence sources and make a genuine contribution to an independent Defence of Australia posture.

It is a common criticism of the Defence establishment that it has difficulty making positive or long-term decisions, and that, when made, its decisions often do not contribute to the defence of this continent. Australian defence science has come a long way with the Jindalee Project, in recognition of its enormous potential for Australia's defence posture. But Jindalee is still a research project, and to become fully operational would take perhaps five years following a decision to proceed. Giving the go-ahead for Jindalee to proceed to development as an operation-

Weapons Research Establishment, *Annual Report 1975-76*, pp. 21-23.

The Rockbank HF project is described in the series of articles by Dr. J.F. Ward, in *Nature*, 12 May 1962, pp. 518-521, 17 November 1962, pp. 636-639, and 13 March 1965, pp. 1062-1064.

The distribution of the Southern auroral zone is described in F. Jacka, 'The Southern Auroral Zone as Defined by the Position of Homogeneous Arcs', *Australian Journal of Physics*, Vol. 6, 1953, pp. 219-228; F.R. Bond and F. Jacka, 'Distribution of Auroras in the Southern Hemisphere', *Australian Journal of Physics*, Vol. 13, 1960, pp. 610-612; and E.H. Vestine, *Distribution of the Southern Auroral Zone*, (The RAND Corporation, P-3416, Santa Monica, August 1966).

For some discussion of the Jindalee project in the overall context of the new requirements of the defence of Australia, see Ross E. Babbage, *Australia's Security Planning in a Changing Strategic Environment*, (Doctoral dissertation, Australian National University, Canberra, 1978).

Naval applications of OTH radar are described in S.R. Curley, J. Headrick, and J. Ahearn, 'Measurements of Mid-Ocean Surface Conditions by Over-the-Horizon Radar', *Naval Research Reviews*, (Vol. XXVI, No. 11), November 1973, pp. 1-21; and Ronald T. Pretty, (ed.), *Jane's Weapon Systems, 1976*, (London, 1976), p. 621.

For a discussion of the use of OTH-B and AWACS in conjunction for continental air defence, see Albert Legault and George Lindsey, *The Dynamics of the Nuclear Balance*, (Cornell University Press, Ithaca, Revised edition, 1976), pp. 137-139.

General Gould's testimony on the vulnerability of OTH radars to jamming and on their electronic intelligence potential is described in Philip J. Klass, 'HF Radar Detects Soviet ICBMs', *Aviation Week and Space Technology*, 6 December 1971, pp. 38-40.

For more detailed references on all matters discussed in this article, see Desmond J. Ball, 'Over-the-Horizon Radar in the Defence of Australia', *Pacific Defence Reporter*, February 1977, and 'Some Further Thoughts on Project Jindalee', *Pacific Defence Reporter*, April, 1977.

⁸ The Mt. Everard receiver has already picked up signals from as far away as England on some occasions.

This eavesdropping function explains at least partly the presence of officers of the Defence Signals Division (DSD) in the Jindalee Project, although DSD expertise in long-range radio reception and knowledge of local ionospheric behaviour would undoubtedly merit its involvement in the project anyway.

'Airborne early warning radars are even more costly.'

bank experiments in the 1960s that any type of OTH radar is potentially a means for eavesdropping on HF radio communication that might otherwise be too weak for ordinary receivers.⁸

Because of the great sensitivity, wide bandwidths and ability to cover such bandwidths over a wide frequency range, OTH-B receivers are admirably suited for gathering electronic intelligence. OTH radars must have an inherent capability for covering a wide range of the radio spectrum and for rapidly shifting from one frequency to another, in order to adjust to solar activity, day/night transitions and other changes in the ionospheric weather. This is especially significant because of the amount of military signals and communications which are transmitted on the HF band. General Gould alluded to this when he discussed the capabilities of OTH-B systems in 1971:

'It is clear from what we know that this system will have intelligence value . . .'

he said.

For early warning, the OTH-B system can be used both as a radar and as an electronic intercept system. Since it is not necessary that the transmitter be continuously operating, transmission can be cut off every 30 minutes or so for a few minutes or even an hour, as

al system would be an excellent way for the Defence establishment to answer its critics.

Select Bibliography:

The best descriptions of OTH radar and its military potential are James M. Headrick and Merrill I. Skolnik, 'Over-the-Horizon Radar in the HF Band' *Proceedings of the IEEE* (Vol. 62, No. 6), June 1974; and Peter Laurie, 'An Eye on the Enemy Over the Horizon', *New Scientist*, 7 November 1974.

The nominal performance characteristics of OTH radar discussed in the present paper are derived from these two articles.

For some recent discussions of the new Soviet OTH system, see *Aviation Week & Space Technology*, 8 November 1976, p. 19, and 15 November 1976, p. 25; *Time*, 10 January 1977, p. 17; and *Wireless World*, February 1977, pp. 53, 68. For reference to Congressional testimony on an earlier Soviet OTH-B system, see *Aviation Week & Space Technology*, 6 December 1971, p. 40.

For details of the Jindalee project itself, see statement by Mr. Barnard, 'Project Jindalee', *Defence Press Release*, No. 252/74, 11 April 1974; and

NOW IN STOCK AT TANDY, THE 'PARTS PLACE'

Top quality devices, fully functional, carefully inspected. **Guaranteed** to meet all specifications, both electrically and mechanically. All are made by well known

American manufacturers, and all have to pass manufacturer's quality control procedures. Count on Tandy for the finest quality parts.



TTL Digital ICs

First Quality Devices Made by National Semiconductor and Motorola

Type	Cat. No.	Only
7400	276-1801	.99
7402	276-1811	.99
7404	276-1802	1.09
7406	276-1821	1.29
7410	276-1807	.99
7413	276-1815	1.99
7420	276-1809	.99
7427	276-1823	1.29
7432	276-1824	1.29
7441	276-1804	2.49
7447	276-1805	2.49
7448	276-1816	2.49
7451	276-1825	.99
7473	276-1803	1.29
7474	276-1818	1.29
7475	276-1806	1.99
7476	276-1813	1.39
7486	276-1826	2.69
7486	276-1827	1.29
7490	276-1808	1.99
7492	276-1819	1.89
74123	276-1817	2.49
74145	276-1828	2.69
74150	276-1829	2.89
74154	276-1834	2.79
74192	276-1831	2.69
74193	276-1820	2.69
74194	276-1832	2.69
74196	276-1833	2.79

74C and 4000 Series CMOS ICs

74C00	276-2301	1.09
74C02	276-2302	1.09
74C04	276-2303	1.09
74C08	276-2305	1.09
74C74	276-2310	1.99
74C76	276-2312	2.39
74C90	276-2315	3.39
74C192	276-2321	3.69
74C193	276-2322	3.69
4001	276-2401	1.09
4011	276-2411	1.09
4013	276-2413	1.99
4017	276-2417	3.69
4020	276-2420	3.69
4027	276-2427	1.99
4049	276-2449	1.59
4050	276-2450	1.59
4511	276-2447	3.99
4518	276-2490	3.69

Linear ICs



First Quality Devices by National Semiconductor and Motorola

Type	Cat. No.	Only
301AH	276-017	1.29
324N	276-1711	2.69
339N	276-1712	2.69
386CN	276-1731	1.99
555CN	276-1723	1.99
556CN	276-1728	3.29
566CN	276-1724	3.99
567CN	276-1721	3.99
723CN	276-1740	1.99
741CN	276-007	1.29
3900N	276-1713	1.99
3909N	276-1705	1.99
3911N	276-1706	3.99
4558CN	276-038	1.69
75491	276-1701	1.49
75492	276-1702	1.49
7805	276-1770	2.19
7812	276-1771	2.19
7815	276-1772	2.19

Microcomputer Chip

8080A Microprocessor. With 16-bit address bus capable of addressing up to 65k bytes of memory and up to 256 I/O ports. TRI-State data bus gives II DMA and multiprocessing capability. All buses TTL compatible. Up to 244 variable length instructions, with 6 general purpose registers plus an accumulator. 40-pin DIP. 100% Prime. 276-2510 24.95
RS2102 Static RAM. 1024-word by one bit random access read/write memory. Under 750 nS access. Single +5V power supply. 276-2501 6.95



LEDs/Optoelectronics



Item	Cat. No.	Only
A. Solar Cell	276-115	1.59
B. Photocell	276-116	1.19
C. FPT 100	276-130	.99
D. Lg Red LED	276-041	1.39
E. Lg Cir LED	276-047	1.39
F. Med Red LED	276-026	1.39
G. Med Cir LED	276-040	1.39
H. Sm Red LED	276-042	1.39

Digital Displays

Digits	Size	Drive	Cat.No.	Only
A.1	0.6"	Anod	276-056	4.99
A.1	0.6"	Cath.	276-066	4.99
B.1	0.3"	Anod.	276-053	3.59
B.1	0.3"	Cath.	276-062	3.59
B.1	0.3"	Anod.	276-1210	12.95
B.1	0.3"	Cath.	276-1211	12.95

Experimenter's PC Board



Simplifies IC Projects

Ideal for two-circuit projects. Fire-retardant copper-clad board is only 6.35x12.7x.158cm (2½x5x1/16"). Really simplifies integrated circuit projects by extending leads for easy soldering. 276-151 3.29

Project Accessories

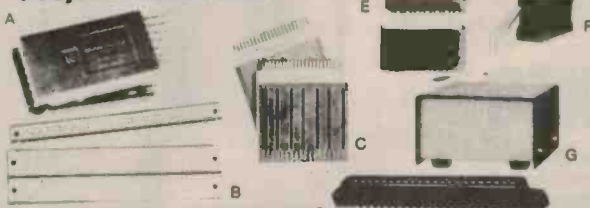

- A. IC Troubleshooting Test Clip. Test up to 16 pins with probes or clips. 276-1951 6.99
- B. Experimenter Socket. 2x47 rows of 5 connected tie points. 276-172 14.95
- B. Bus Strip. 2x40 connected tie points. Clips to socket above 276-173. 2.99
- C. Standard Edge-Card Board. 22-pin 129 mounting holes 276-152. 3.99
- C. 2-Voltage Source Edge-Card Board. 1368 mounting holes 276-154. 3.99
- C. 3-Voltage Source Edge-Card Board. 1368 mounting holes 276-153. 3.99
- D. 22-Pin Edge-Card Board Connector. 44 terminals 276-1551 3.99
- E. DIP Header. 16-pin spacing 276-1980 1.89
- F. Right Angle IC Socket. Mount LED's vertically. 16-pin spacing. 276-1985 1.99
- G. Metal Cabinet. 10 16x6.03x15.24cm (4x2 3/8 x 6) 270-252 3.79
- G. Metal Cabinet. 13 33x7.62x14.9cm (5¼x 3x5 7/8, 270-253 4.79

Selected Diodes

Type	Cat. No.	Only
1N4001	276-1101	2/ 69
1N4003	276-1102	2/ 79
1N4004	276-1103	2/ 89
1N4005	276-1104	2/ 99
1N4735	276-561	2/1 29
1N4739	276-562	2/1 29
1N4742	276-563	2/1 29
1N4744	276-564	2/1 29
1N5401	276-1141	2/1 29
1N5402	276-1142	2/1 49
1N5403	276-1143	2/1 59
1N5404	276-1144	2/1 69
1N5405	276-1145	2/1 79
1N5406	276-1146	2/1 89
1N5407	276-1147	2/1 99
1N5408	276-1148	2/2 09
1N5409	276-1149	2/2 19
1N5410	276-1150	2/2 29
1N5411	276-1151	2/2 39
1N5412	276-1152	2/2 49
1N5413	276-1153	2/2 59
1N5414	276-1154	2/2 69
1N5415	276-1155	2/2 79
1N5416	276-1156	2/2 89
1N5417	276-1157	2/2 99
1N5418	276-1158	2/3 09
1N5419	276-1159	2/3 19
1N5420	276-1160	2/3 29
1N5421	276-1161	2/3 39
1N5422	276-1162	2/3 49
1N5423	276-1163	2/3 59
1N5424	276-1164	2/3 69
1N5425	276-1165	2/3 79
1N5426	276-1166	2/3 89
1N5427	276-1167	2/3 99
1N5428	276-1168	2/4 09
1N5429	276-1169	2/4 19
1N5430	276-1170	2/4 29
1N5431	276-1171	2/4 39
1N5432	276-1172	2/4 49
1N5433	276-1173	2/4 59
1N5434	276-1174	2/4 69
1N5435	276-1175	2/4 79
1N5436	276-1176	2/4 89
1N5437	276-1177	2/4 99
1N5438	276-1178	2/5 09
1N5439	276-1179	2/5 19
1N5440	276-1180	2/5 29
1N5441	276-1181	2/5 39
1N5442	276-1182	2/5 49
1N5443	276-1183	2/5 59
1N5444	276-1184	2/5 69
1N5445	276-1185	2/5 79
1N5446	276-1186	2/5 89
1N5447	276-1187	2/5 99
1N5448	276-1188	2/6 09
1N5449	276-1189	2/6 19
1N5450	276-1190	2/6 29
1N5451	276-1191	2/6 39
1N5452	276-1192	2/6 49
1N5453	276-1193	2/6 59
1N5454	276-1194	2/6 69
1N5455	276-1195	2/6 79
1N5456	276-1196	2/6 89
1N5457	276-1197	2/6 99
1N5458	276-1198	2/7 09
1N5459	276-1199	2/7 19
1N5460	276-1200	2/7 29
1N5461	276-1201	2/7 39
1N5462	276-1202	2/7 49
1N5463	276-1203	2/7 59
1N5464	276-1204	2/7 69
1N5465	276-1205	2/7 79
1N5466	276-1206	2/7 89
1N5467	276-1207	2/7 99
1N5468	276-1208	2/8 09
1N5469	276-1209	2/8 19
1N5470	276-1210	2/8 29
1N5471	276-1211	2/8 39
1N5472	276-1212	2/8 49
1N5473	276-1213	2/8 59
1N5474	276-1214	2/8 69
1N5475	276-1215	2/8 79
1N5476	276-1216	2/8 89
1N5477	276-1217	2/8 99
1N5478	276-1218	2/9 09
1N5479	276-1219	2/9 19
1N5480	276-1220	2/9 29
1N5481	276-1221	2/9 39
1N5482	276-1222	2/9 49
1N5483	276-1223	2/9 59
1N5484	276-1224	2/9 69
1N5485	276-1225	2/9 79
1N5486	276-1226	2/9 89
1N5487	276-1227	2/9 99
1N5488	276-1228	2/10 09
1N5489	276-1229	2/10 19
1N5490	276-1230	2/10 29
1N5491	276-1231	2/10 39
1N5492	276-1232	2/10 49
1N5493	276-1233	2/10 59
1N5494	276-1234	2/10 69
1N5495	276-1235	2/10 79
1N5496	276-1236	2/10 89
1N5497	276-1237	2/10 99
1N5498	276-1238	2/11 09
1N5499	276-1239	2/11 19
1N5500	276-1240	2/11 29
1N5501	276-1241	2/11 39
1N5502	276-1242	2/11 49
1N5503	276-1243	2/11 59
1N5504	276-1244	2/11 69
1N5505	276-1245	2/11 79
1N5506	276-1246	2/11 89
1N5507	276-1247	2/11 99
1N5508	276-1248	2/12 09
1N5509	276-1249	2/12 19
1N5510	276-1250	2/12 29
1N5511	276-1251	2/12 39
1N5512	276-1252	2/12 49
1N5513	276-1253	2/12 59
1N5514	276-1254	2/12 69
1N5515	276-1255	2/12 79
1N5516	276-1256	2/12 89
1N5517	276-1257	2/12 99
1N5518	276-1258	2/13 09
1N5519	276-1259	2/13 19
1N5520	276-1260	2/13 29
1N5521	276-1261	2/13 39
1N5522	276-1262	2/13 49
1N5523	276-1263	2/13 59
1N5524	276-1264	2/13 69
1N5525	276-1265	2/13 79
1N5526	276-1266	2/13 89
1N5527	276-1267	2/13 99
1N5528	276-1268	2/14 09
1N5529	276-1269	2/14 19
1N5530	276-1270	2/14 29
1N5531	276-1271	2/14 39
1N5532	276-1272	2/14 49
1N5533	276-1273	2/14 59
1N5534	276-1274	2/14 69
1N5535	276-1275	2/14 79
1N5536	276-1276	2/14 89
1N5537	276-1277	2/14 99
1N5538	276-1278	2/15 09
1N5539	276-1279	2/15 19
1N5540	276-1280	2/15 29
1N5541	276-1281	2/15 39
1N5542	276-1282	2/15 49
1N5543	276-1283	2/15 59
1N5544	276-1284	2/15 69
1N5545	276-1285	2/15 79
1N5546	276-1286	2/15 89
1N5547	276-1287	2/15 99
1N5548	276-1288	2/16 09
1N5549	276-1289	2/16 19
1N5550	276-1290	2/16 29
1N5551	276-1291	2/16 39
1N5552	276-1292	2/16 49
1N5553	276-1293	2/16 59
1N5554	276-1294	2/16 69
1N5555	276-1295	2/16 79
1N5556	276-1296	2/16 89
1N5557	276-1297	2/16 99
1N5558	276-1298	2/17 09
1N5559	276-1299	2/17 19
1N5560	276-1300	2/17 29
1N5561	276-1301	2/17 39
1N5562	276-1302	2/17 49
1N5563	276-1303	2/17 59
1N5564	276-1304	2/17 69
1N5565	276-1305	2/17 79
1N5566	276-1306	2/17 89
1N5567	276-1307	2/17 99
1N5568	276-1308	2/18 09
1		

DISCO MIXER

DISCO MIXER MODEL DM-1000 is a sound studio control unit combining the qualities of a broadcast mixing console with the features and flexibility needed by a disc jockey.

Built-in low noise preamplifier for magnetic phonos and low impedance microphones.

Headphone circuit to monitor each input.

Talk switch to attenuate music volume 14 dB so mics can be used without re-adjusting music levels.

Input SensitivityMIC 0.5mV
 PHONO 3mV
 LINE 150mV

Input ImpedanceMIC 10K ohms
 PHONO 50K ohms
 LINE 50K ohms

Maximum Input LevelMIC 45mV
 PHONO 140mV
 LINE 35V

Rated OutputAMP. 1V
 REC. 1V

Output Impedance100 ohms
 Harmonic DistortionAt Rated Output 0.2%
 At 6V Output 0.3%

Hum and NoiseMIC -52 dB
 PHONO -62 dB
 LINE -65 dB

Frequency ResponseMIC 30 to 16000 Hz (-1 dB)
 PHONO 30 to 20000 Hz (RIAA ±2 dB)
 LINE 20 to 30000 Hz (-1 dB)

Headphone Output (CUE) . .50 mW at 75 ohms at 0.5% T.H.D.

Talk Switch-14 dB at Phono or Line at TALK Position

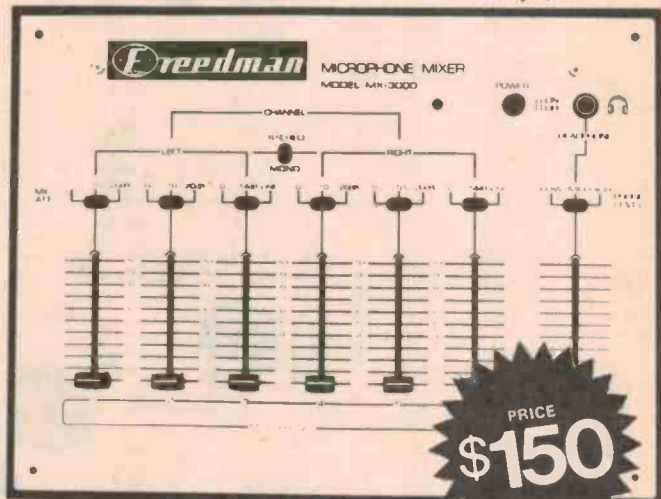
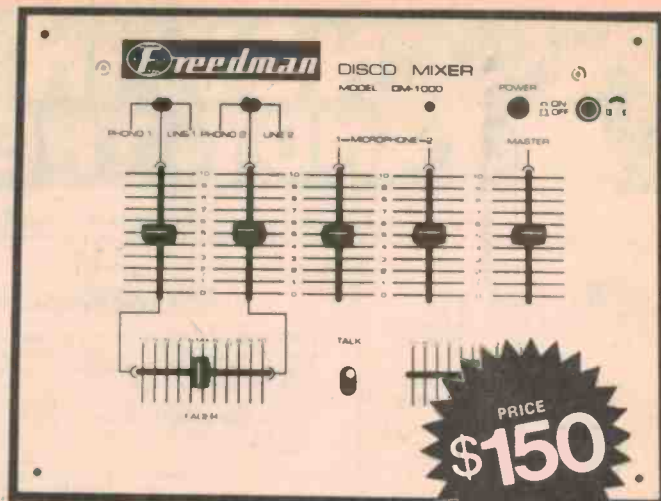

MICROPHONE MIXER

MICROPHONE MIXER MODEL MX-3000 is a sound studio control unit incorporating the most advanced integrated circuits and precision components in its design and is capable of handling any quality high power amplifier, without the use of an external pre-amplifier. It is flexible enough to be used with almost any auxiliary input in a pre-amplifier, integrated amplifier, or receiver.

Input SensitivityMIC 0.5mV
 LINE 65mV

Maximum Input LevelMIC 500 mV (Att. 20 dB)
250 mV (Att. 14 dB)
160 mV (Att. 10 dB)
50 mV (Att. 0 dB)
Line 30 Volt

FREQUENCY EQUALISER

FREQUENCY EQUALIZER MODEL EQ-2000 is a sound studio control unit incorporating the most advanced integrated circuits and precision components in its design.

ChannelsTwo (left and right with separate controls each channel)
 Frequency Response10 to 30,000Hz -1dB (flat setting)
 Tone Control Range50, 130, 350, 1000, 3000, 6000
 and 12000 Hz ± 12dB 7 Ranges

Inter Modulation DistortionAt 2 Volt output 0.05%

Harmonic DistortionAt 2 Volt output 0.05%

Hum & NoiseShorted input -80 dB below 2 Volt output.

Output LevelMaximum 10 Volts

FREEDMAN ELECTRONICS

89-91A Liverpool Road, SUMMER HILL, N.S.W. 2130. Tel. 797-9941 - 797-0986

PTY. LTD.

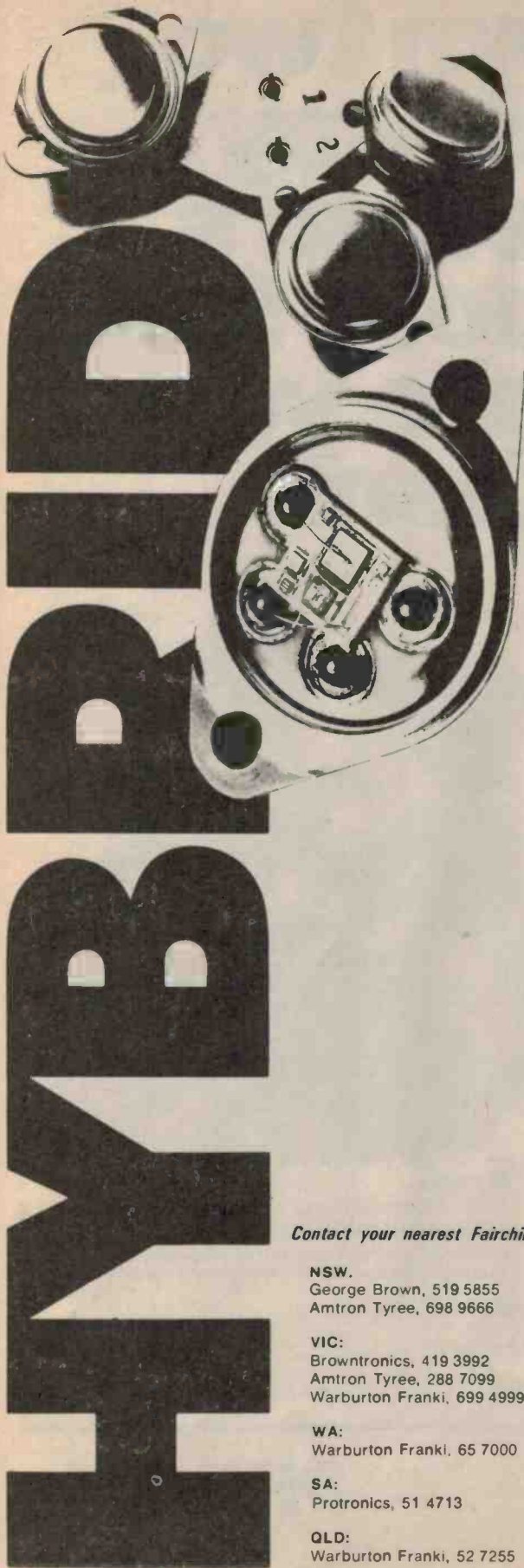

LOOK WHAT \$4.50 WILL BUY TODAY!!

**FAIRCHILD JUST CANNED A WHOLE
FAMILY OF 5-AMP REGULATORS.**

These new Fairchild hybrids include three fixed voltage devices at 5, 12 and 15 volts and one adjustable regulator with output selection from 5 to 20 volts. All pin-for-pin compatible with the industry standard 7800 Series monolithic Voltage Regulators in TO-3 packages. But with more power and better performance.

IT TAKES LESS TO DO MORE.

Our new 5-amp regulators save you a considerable amount of time. You won't have to fool around with extra components, trying to make 1-amp and 3-amp regulators add up to 5. And you'll be able to short-cut your approach to short-circuit current limiting and thermal shut-down requirements.

In brief, you'll have better specs than previous high-current regulators gave you (50-watt power dissipation, low drop-out voltages, etc.) with none of the design disadvantages.



COME AND GET THEM.

Your very favorite Fairchild distributor can fill your palm with 5-amp regulators whenever you're ready. At these prices, how can you **not** be ready?

Device	Volts	Price (100 Quantity)
uA78HO5KC	5	\$4.50
uA78H12KC	12	\$4.50
uA78H15KC	15	\$4.50
uA78HGKC	5-20	\$4.50

Contact your nearest Fairchild distributor

NSW.
George Brown, 519 5855
Amtron Tyree, 698 9666

VIC:
Browntronic, 419 3992
Amtron Tyree, 288 7099
Warburton Franki, 699 4999

WA:
Warburton Franki, 65 7000

SA:
Protronic, 51 4713

QLD:
Warburton Franki, 52 7255

FAIRCHILD

WHO ELSE?

How to own two superb 12" 3-way 40 watt speakers and save about \$50 per hour while you assemble them.

The Philips AD12 K12 MKII Speaker Kit. Full 40 watts RMS capacity. Modern, completely finished cabinet. Assembles in nine simple steps, taking most people about two hours. The finished job looks like it has been put together by a professional. And you save about \$100 per pair on a comparable assembled system!

A modern three-way Hi-Fi system with 1" domed tweeter, 5" mid-range and super 12" woofer, all fully imported, and rated full 40 watts RMS per channel. Power to deal with any reasonable living room. A particularly brilliant sound, with an excellent overall frequency response for the cost. It closely follows the ideal Bruel & Kjaer curve for Hi-fi equipment measured in an actual listening room, using the "Third Octave Pink Noise Method".

Also available: Other quality systems at similar impressive savings. Phone or send coupon now for full details of all kits.

PHILIPS ELECTRONIC COMPONENTS AND MATERIALS

Sydney 427 0888 • Melbourne 699 0300 • Brisbane 44 2471
• Adelaide 223 4022 • Perth 65 4199



ELCOMA

Philips Electronic Components and Materials
P.O. Box 50, Lane Cove, NSW 2066

Please send me full details and brochures on your loudspeaker kits and a list of retailers who stock them.

NAME _____

ADDRESS _____

STATE _____ P/CODE _____

ET



**Electronic
Components
and Materials**

PHILIPS

BA.EL. I.

VHF LOG-PERIODIC ANTENNA

by Roger Harrison, VK2ZTB, who swears the prototype is still in use!

WITH THE AVAILABILITY of many imported transistor receivers that cover a variety of VHF bands, many people have discovered the delights of 'VHF Listening'. There are many interesting communications services using channels in the VHF region including taxis, aircraft, courier services — even weather satellites can be heard! From the small transistor 'portable' with auxiliary VHF coverage, many enthusiasts graduate to a more expensive 'general coverage' VHF receiver like the Eddystone 990R for example.

To receive the various transmissions that are spread over a wide range of frequencies, in various bands between 60 and 250 MHz, a wideband antenna is necessary. Most enthusiasts put up a simple dipole or perhaps several. Some make do with a TV antenna. Either system is a compromise. A 'discone' antenna is installed by some enthusiasts and while it is wideband with omnidirectional coverage, it has no gain.

Apart from the general VHF listening aspects, there are many 'TV DX' enthusiasts who seek out long distance reception of TV stations. During the summer months sporadic-E propagation via the ionosphere 'skips' distant TV transmissions many thousands of kilometres and Brisbane channel-0 for example may be seen in Adelaide. Certain favourable weather conditions produce atmosphere 'ducts' which propagate VHF signals long distances. Radio amateurs often use TV DX as an indicator to amateur band DX 'openings'. A wideband antenna is worth its weight in QSL cards in these circumstances!

There are also many Hi-Fi enthusiasts using their TV antenna installation in a dual role: adding a splitter and connecting the TV and FM tuner. This situation is also very often a compromise. Many TV antennas, while having reasonable, if not adequate,

response on most TV channels, do not have the required sensitivity or directivity over the 88 to 108 MHz FM broadcast band. They have demonstrably poor performance on stereo FM transmissions in many cases, particularly if one lives a fair distance from the transmitters, but not necessarily in a fringe area.

The difficulty in using a readily available TV antenna arises in the fact that it is generally a compromise. Those marketed for use in metropolitan areas are a compromise in several parameters. Response from channel 2 to channel 10, or channel 0 to channel 9, is required in capital cities — a frequency range spanning 60 to 222 MHz in the first case, and 45 to 215 MHz in the second.

A number of antennas are manufactured to respond to channels 0 or 2 (to cover the low frequency channels) and channels 6 to 11 in the upper range. That leaves a big hole in the middle. Others are cut to have a broad response around channel 2 and a 'peaked' response at three times that frequency, for use in strong signal areas.

The bandwidth response of these antennas on the lower frequency TV channels is often poor, although the effect may go largely unnoticed. When colour TV is installed and perhaps a splitter is added to allow connection of an FM tuner, the existing limitations of the installation become embarrassingly apparent.

Well, here's an antenna to solve all the multifarious problems for the various enthusiasts outlined above.

Log-Periodic Antenna

The antenna described is of the log-periodic type, so called for its physical design and wide frequency response. It has virtually constant gain and directivity pattern across the design frequency range. It uses a number of elements, arranged in this design as a series of dipoles. Only a

small group (generally three or four) of these are 'working' on the chosen frequency or across a relatively narrow band within the design frequency range when the antenna is in use. A reflector element has been added to improve the front-to-back ratio, particularly on the lower frequencies.

Construction, although it appears complicated, is quite easy and inexpensive to boot! Most, if not all, the components can be purchased from hardware stores.

There are basically two models: one covering 60 to 250 MHz (TV channels 2 to 11 including the FM band), and the other covering 40 to 250 MHz (TV channels 0 to 11 including the FM band).

The overall construction of the 60 to 250 MHz model is illustrated in Figure 1. The 40 to 250 MHz model requires an additional three-elements of a larger size to accommodate the lower frequency range from 40 to 60 MHz. Construction of the additional elements is illustrated in Figure 6.

The model in Fig. 1 consists of ten dipole elements plus a parasitic reflector. A balun transformer with a 1:1 impedance ratio converts the approximately 70 to 80 ohms antenna feedpoint impedance from a balanced configuration to unbalanced, to suit a 75 ohm coaxial cable feedline.

Construction

Each of the dipole halves must be insulated so an insulated boom is required, along with some convenient method of mounting the dipole elements on it. There are two basic ways of achieving this — using a wooden boom and wooden element support brackets; or using a boom of ABS or PVC water pipe of a suitable diameter and conventional element to boom brackets.

VHF LOG-PERIODIC ANTENNA

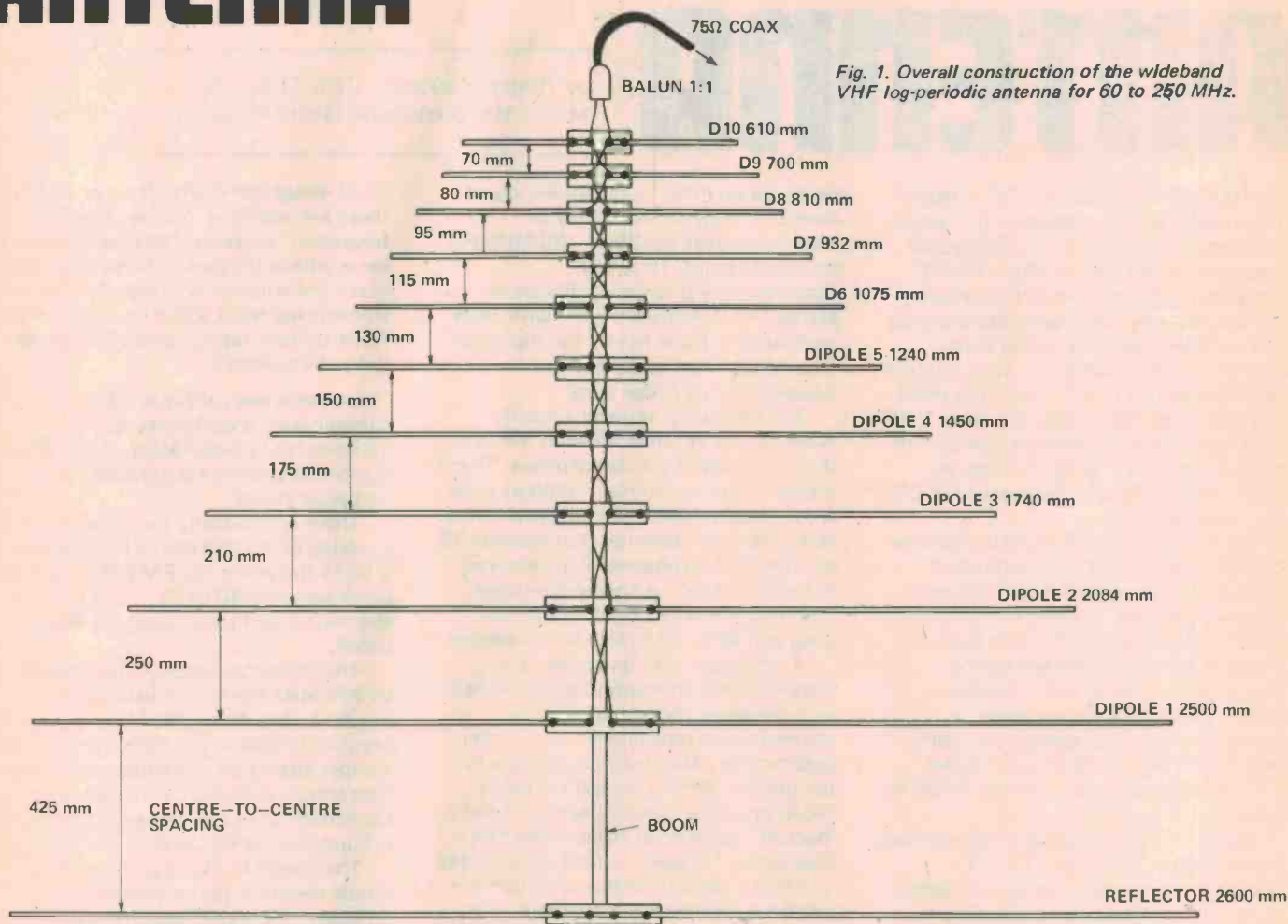

Fig. 1. Overall construction of the wideband VHF log-periodic antenna for 60 to 250 MHz.

Wooden Construction

The boom chosen for the model in Fig. 1 was ordinary rectangular-section 19 by 42 mm dressed size timber. Pine is cheapest, but is subject to warp. Western red cedar, or any close-grained, well-seasoned hardwood, free of warps and knots, would be a better choice. A length a little over 1.7 metres is necessary for the boom alone. A further 1.9 m length will be necessary to make the element to boom brackets.

The elements on the prototype were cut from nine, 1.83 m long (six foot) lengths of 10 mm (3/8") diameter aluminium tubing. This can be bought in many hardware stores, or from specialist aluminium suppliers (such as

Alcan, Parramatta Aluminium Supplies, etc) for around 75 cents per length. Alternatively, the tubing can be bought in any of the standard length sizes, sufficient to make the required number of elements. The total length required is about 15.75 m, although around 700 to 800 mm must be added to this figure to account for wastage in offcuts. Thus, about 16.5 m will be needed altogether.

Each of the dipole halves is cut 5 mm shorter than required. The element lengths indicated on Fig. 1 are tip-to-tip measurements, and a 10 mm gap is allowed in the centre of inter-element feedline connection on each dipole. This is illustrated in Fig. 2.

If you are purchasing the aluminium

TABLE

ELEMENTS	DIMENSION A
LOW REFLECTOR LOW DIPOLES 1, 2 & 3	400 mm
REFLECTOR (2600 mm) DIPOLES 1 & 2	250 mm
DIPOLES 3, 4, 5 & 6	200 mm
DIPOLES 7, 8, 9 & 10	140 mm

tubing in 1.83 m lengths, they should be cut in the following way:—

Firstly, the reflector will have to be made from two halves, necessitating a joint at the centre during final construction. All the elements should be

cut and then stacked according to size before going on with the next stage of construction.

(a) From one length, cut exactly half the reflector, and half of dipole 7 (5 mm less than 466 mm, or 461 mm as explained). Repeat this with another length. You should end up with two pieces 1.30 m long, and two pieces 461 mm long. You then have the reflector and dipole 7 (or D7).

Align each bracket and element at right angles to the boom. A pilot hole should be drilled in the boom, to suit the 35 or 40 mm long screws, to avoid splitting the timber.

The spacings between each dipole, given in Figure 1, are centre-to-centre spacings of the elements.

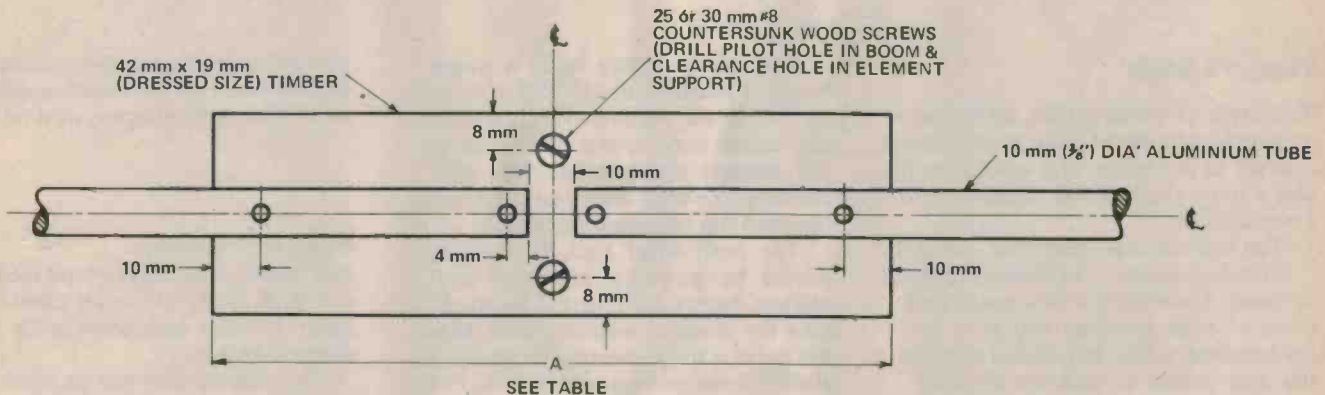

Fig. 2. Dipole boom bracket construction.

(b) From one length cut half D1 and half D6. Repeat this with another length.

(c) From one length cut half D2 and half D4. Repeat this with another length.

(d) Cut both halves of D3 from one length of tubing.

(e) Cut both halves of D5 and one half of D8 from one length.

(f) Last of all cut one half of D8 plus both halves of D9 and D10 from one length of tubing.

The wooden element to boom brackets should be cut next. Dimensions are given in the table in Figure 2. Three, 250 mm lengths will be needed for the reflector and dipoles, 1 and 2. Four each of 200 mm and 140 mm lengths will be needed for the other elements. The first line in the table in Fig. 2 refers to the low frequency portion, described later.

Once these are cut and drilled, the element halves should be individually drilled according to Fig. 2, and then screwed to the brackets using 20 or 25 mm screws as in Fig. 3. Solder lugs are placed under the screws holding the centre ends of the dipole halves, as illustrated in the diagram. These provide for the feedline connections.

When the elements and brackets are all assembled, they can be mounted on the boom. Commencing with either dipole 10 or the reflector, mark the position of each bracket on the narrow side of the boom, one by one, and mount them.

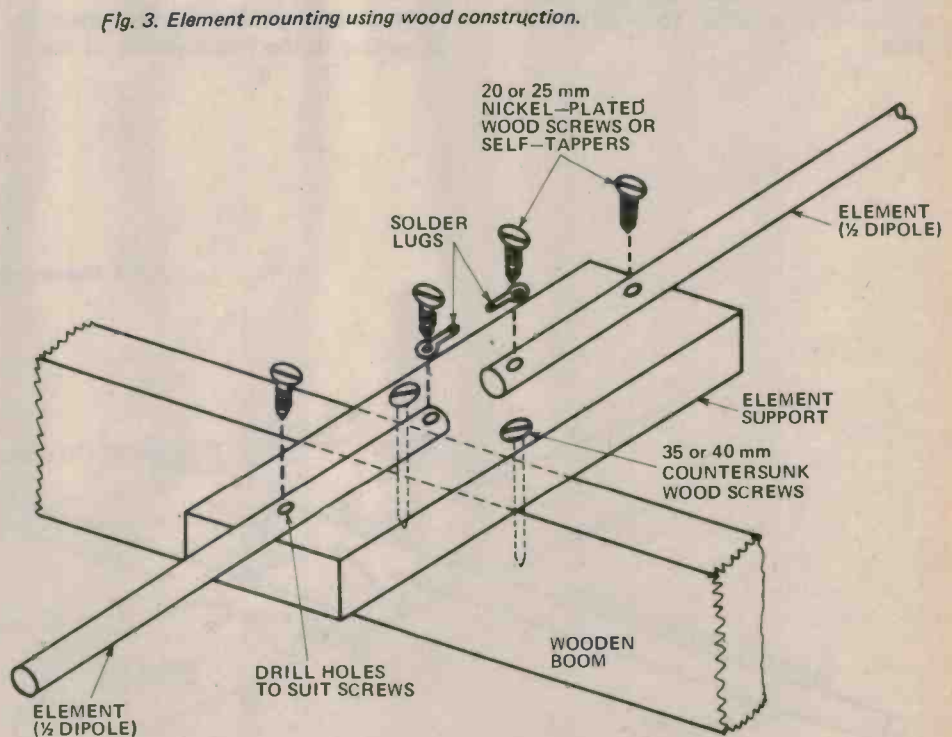

Fig. 3. Element mounting using wood construction.

VHF LOG-PERIODIC ANTENNA

'Plumber's delight'

This style of construction, while more expensive than the wooden construction, is likely to last longer and will certainly give a more professional appearance if done carefully.

The technique is illustrated in Fig. 4. Standard element to boom brackets are used. These consist of a cad-plated piece of steel punched and bent to the required shape, and drilled through the 'top' centre to take the securing bolt. They are made to accept 10 mm diameter elements and fit 25 to 30 mm diameter booms. Each half of the elements is attached to an insulated boom consisting of a 1.7 m (approximately) length of ABS or PVC plastic pipe, often used these days for domestic plumbing. An offset between the dipole halves of about 15 or 20 mm is used.

The reflector may be in a single length if possible (not if 1.83 m lengths of tubing are purchased). Otherwise, two halves may be placed as close as the element to boom brackets will permit and a solid electrical joint made between the two securing bolts.

The position of each dipole half should be carefully measured and marked before drilling the boom to take the element securing bolts. Make the holes a little oversize so that the elements can be rotated a little to line them up for the sake of appearance.

Cut all the elements to size, more or less in the order given previously. However, with this form of construction, each dipole half will need to be longer by an amount equal to half the length of the element to boom clamps — about 25 mm.

Next drill all the dipole halves according to the requirements of the

element to boom brackets, and assemble each element on the boom, commencing with either the reflector, or dipole 10.

Feedline Connections

The feedline connections are illustrated in Fig. 5. Each individual dipole feed-point is cross connected with the succeeding one.

The connections can be made with light-gauge hook-up wire, such as PVC covered 7/010, obtainable from most electronic component suppliers. Carefully solder each joint.

The balun transformer is mounted on the end of the boom, adjacent to, or beneath, dipole 10. Short connecting leads run from the balun input connections (balanced) to the feedline connection lugs of dipole 10.

Fig. 4. Element mounting for the 'plumber's delight' version.

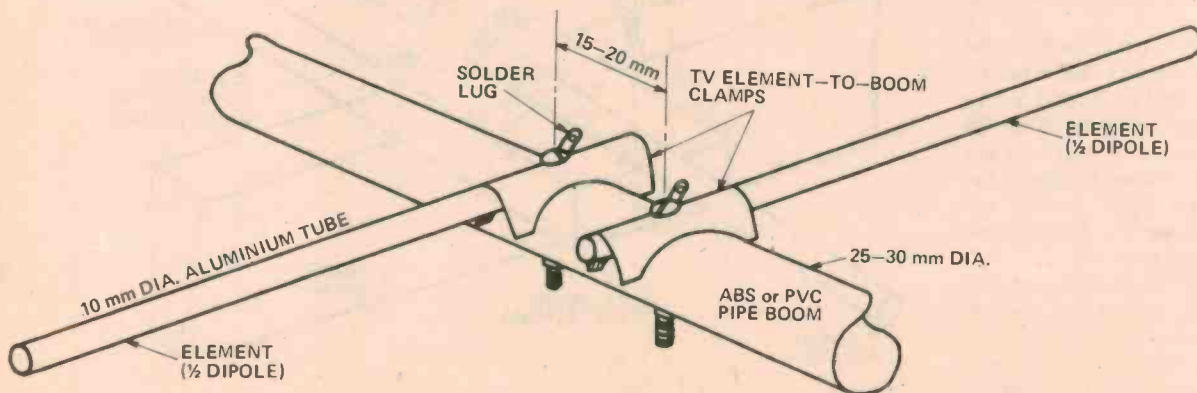

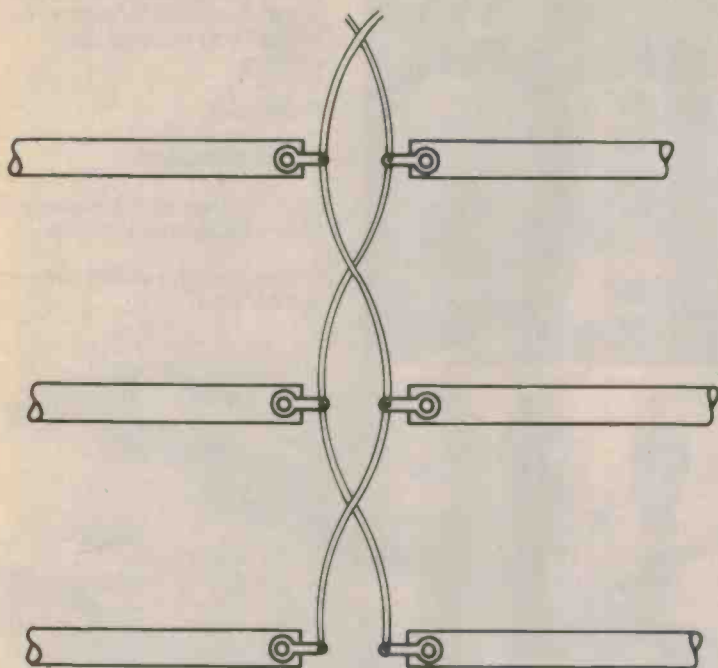

Fig. 5. Feedline connections between the elements.

Low Frequency Coverage

The 40 to 250 MHz model requires a longer boom, of larger cross-section, and has a total of fourteen elements. The dimensions of the extra three elements are given in Figure 6. They are mounted to the rear of dipole 1, and the original reflector is not used.

A boom 3.3 m long and about 25 mm by 50 mm dressed size cross-section is required to support the fourteen elements. The element to boom brackets can be made of 19 by 42 mm dressed size timber as before. A total length of 3.35 m (including cutting allowance) will be needed, as shown in the dimension in the table of Figure 2.

Plumbers delight construction can also be used for this model; construction is the same as described previously.

The longer low frequency elements in this model necessitate obtaining longer lengths of aluminium tubing, otherwise the shorter lengths will need pieces attached to the ends in order to make up the required lengths of the dipole halves. This can be done by slipping a 40 mm length of the next largest size tubing over the two pieces at the joint, and securing with small self-tapping screws. The feedline connections to the dipoles are as described previously.

Next month we shall continue with balun designs and further details on installation.

Fig. 6. Construction of the low frequency extensions to 35 MHz.

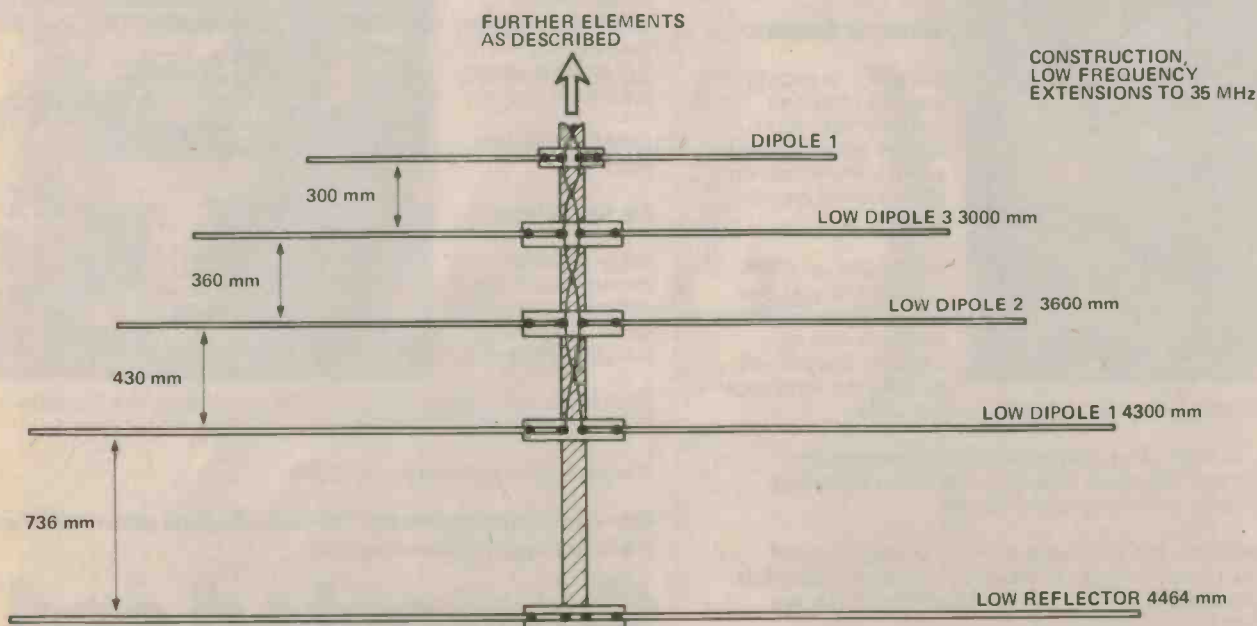

Rated G

The Best Game In Town.

Welcome to ComputerLand. An incredible adventure into the world of personal computers. A one-of-a-kind shopping experience.

Each ComputerLand store presents everything you ever wanted to know about computers. And then some.

Take our Game Room, for starters. You'll find excitement for the whole family in our endless variety of challenging computer games. You can battle the Klingons in an out-of-this-world game of Star Trek. Create an electronic work of art with a computer controlled TV. Test your skill in a game of computerized hangman.

You can even plot your biorhythm.

But we're more than just fun and games. Each ComputerLand store offers a knowledgeable and personable staff of professionals



And if your system breaks down, our in-store service department will get you back up and running.

Right now!

Great Selection.

Your first stop at ComputerLand may well be your last stop.

ComputerLand offers the finest quality and



to serve you. Plus the greatest available

selection of micro components. Whether it's a data processing system for your business or a computer controlled sprinkler system for your home, you'll find whatever you need at ComputerLand.

Plus a complete inventory of tools, books and accessories.

What's more, at ComputerLand, we deal in product. Not promises. Our inventory is on our own shelves. Rather than the manufacturer's. So you can take delivery on tomorrow's components today.



Read on.

Genuine Service.

We want to supply you with the one system that's right. Rather than a complete system that isn't. Or a limited system that is.

That's why, at ComputerLand, you deal with real professionals who are also real people. People who speak your language

... In addition to BASIC, COBOL or FORTRAN.

People, in short, who can offer both the novice and the old hand the same expert guidance in selecting the optimum system he or she needs.

Yet, assisting in the purchase is only the beginning of ComputerLand's service. If the kit you bought requires a little more do-it-yourself than you yourself can do, we provide assembly assistance.

If that complex program proves to be just that, we provide programming assistance.

Which means, simply put, that at ComputerLand, you get exactly what you want.

Exactly when you want it.

Be Our Guest.

Begin with the grand tour of our exhibit areas. "Test-drive" any of our individual systems.



Then tell us your needs. We'll sit down and talk about the system that's right for you. It's as easy as that at ComputerLand.

The great computer store. RATED G.

Call or write for the address of the ComputerLand store nearest you. Franchise opportunities available.

ComputerLand™

55 Clarence St, Sydney 2000. Tel. 29 3753.

SHOP AT MELBOURNE'S BRIGHTEST ELECTRONICS OUTLET...

ROD IRVING'S

discount COMPONENTS

499 HIGH ST., NORTHCOTE, VIC.
3070, PHONE (03) 489-8131
OR WRITE AND ORDER TO US AT
P.O. BOX 135, NORTHCOTE, 3070, VIC.

SUPER SPECIAL 10 555 TIMERS FOR \$4.00

TTL			
7400	.25	7432	.36
7401	.25	7437	.55
7402	.25	7438	.55
7403	.25	7440	.25
7404	.31	7441	1.30
7405	.31	7442	.75
7406	.77	7443	1.75
7407	.77	7444	1.75
7408	.28	7445	1.39
7409	.28	7447	1.15
7410	.25	7451	.25
7411	.31	7454	.25
7412	.25	7470	.59
7413	.47	7474	.55
7414	.86	7475	.66
7416	.78	7491	1.01
7417	.78	7492	.61
7420	.25	7493	.61
7421	.25	74107	.50
7423	.44	74121	.51
7425	.44	74123	1.25
7426	.38	74141	1.14
7427	.44	74175	1.60
7430	.25	74367	1.25

VOLTAGE REGS.			
7805	5v	1A.	1.30
7806	6v	1A.	1.30
7808	8v	1A.	1.30
7812	12v	1A.	1.30
7815	15v	1A.	1.30
7818	18v	1A.	1.30
7824	24v	1A.	1.30
7912	-12v	1A.	2.00
723	14 PIN DIL		.45

CANNON CONNECTORS	
XLP-3-11	\$2.05
XLP-3-12c	\$2.95
XLP-3-31	\$2.95
XLP-3-32	\$2.70

XLR-LNE-11c	\$2.75
XLR-LNE-32	\$3.90

TOGGLE SWITCHES	
NKK Ultraminiature	
U2012 SPST	.75
U2013 SPDT (Centre off)	1.00
U2022 DPDT	.90
U2023 DPDT (Centre off)	1.20

CMOS			
4001	.25	4021	1.40
4002	.25	4023	.25
4006	1.40	4024	.86
4007	.25	4027	.83
4008	1.32	4028	1.25
4011	.25	4040	1.30
4012	.25	4049	.60
4013	.55	4066	.85
4014	1.40	4069	.30
4015	1.20	4510	1.46
4016	.55	4511	1.46
4017	1.40		
4018	1.40		

LINEARS			
uA311	.80	uA339	.85
uA3401	.85	uA555	.45
uA556	1.10	uA741	.35
9368	1.75	LM380	1.25
RL4136	3.60		

DIODES			
OA91	.15	OA95	.16
1N4002	1A	200V	.07
1N4004	1A	400V	.08
1N5625	5A	400V	.45
1N 4148			.05
30 AMP 400V Bridge			4.75

PRICES CURRENT TILL 7/2/78

P.C. BOARD		
1oz. Copper F/glass Lam		
8" x 2"	0.85	0.35
6" x 3"	1.00	0.40
6" x 4"	1.20	0.50
8" x 4"	1.50	0.65

ZENERS	
400mW 5% E24 Values 3V to 33V	.20

RESISTORS	
I.R.H. Metal Glaze G.L.P. or G.L. 1/2Watt 2.20	
HM to 1MEG 3 cents each or 2.5 cents for 100 plus.	

CB REGULATOR	
UA78CB 13.8V at 2A	\$2.60

TRANSISTORS			
BC107	.18	PN3565	.20
BC108	.18	PN3566	.20
BC109	.18	PN3568	.20
BC547	.20	MJ2955	1.60
BC548	.20	2N3055	.85
BC549	.20	FT3055	.80
BD139	.60	TIP31B	.75
BD140	.60	TIP32B	.75
BF180	.60		

OPTOELECTRONICS			
FND 357	.375"	c.c.	1.30
FND 500	.5"	c.c.	1.40
RED LED			.22
GREEN LED			.35
YELLOW LED			.40

ELECTROLYTICS			
4.7uF	25V	PCB	.07
10uF	25V	PCB	.08
10uF	50V	PCB	.09
22uF	16V	PCB	.07
22uF	35V	PCB	.09
33uF	16V	PCB	.08
33uF	50V	PCB	.10
47uF	16V	PCB	.09
47uF	35V	PCB	.11
100uF	10V	PCB	.10
100uF	16V	PCB	.11
220uF	25V	PCB	.14
470uF	16V	PCB	.16
1000uF	25V	PCB	.36
2500uF	50V	Axial	1.85

TANTALUMS			
1uF 35V	.18	2.2uF 35V	.20
4.7uF 25V	.22	10uF 16V	.20
15uF 16V	.27	22uF 16V	.30

POTENTIOMETERS	
.25 watt rotary carbon single gang, Log or Lin.	
1K, 5K, 10K, 25K, 50K, 100K, 250K, 500K, 1M.	.45
5K Lin Slide Pot	.75

CERAMICS	
10pF to 680 pF	.05
820pF to .0015uF	.06
E12 Values.	

PACK AND POST MIN. .50

ROD IRVING ELECTRONICS

P.O. Box 135, NORTHCOTE, Vic. 3070.

499 HIGH STREET, NORTHCOTE, Vic. 3070 Phone (031) 489-8131.

ELECTRONIC DISPOSALS

297 Little Lonsdale St., Melbourne, 3000
Phone 663-1785

AWA Solid State TV Tuners \$7.50 ea.
AWA Thorn Valve TV Tuners \$5.00 ea.
EHT Stick Rectifiers 75c ea.
13KV, 18KV, 20KV
Plessey 8" 10W 8Ω or 15Ω \$6.50 ea;
4" 8Ω \$1.50 ea. Many other types in stock.
12V DC 5 Ω Solenoids \$2.00 ea.
12V AC Min. Relays 5 Amp. \$1.50 ea.
Slide Pots. 20K to 3meg. Singles 35c ea. Dual 60c ea.
Resistors. Most values ¼ to 1 Watt. 3c ea.
Carbon Pots. Most values 30c ea. Duals 60c ea.
resistors 100 mixed \$1.50.
Skeleton Preset Pots 100Ω to 3 meg. 8c ea.
Green Caps .001 to .022uF 5c ea.
.033 to .22uF 15c ea. .47 to .68uF 20c ea.
Polystyrene Capacitors. Many Types 5c ea.
Disc Ceramics. Large Range. 5c ea.
Disc Ceramic capacitors 100 mixed \$2.00.
Polyester Capacitors. Large Range. Up to 1.5uF 250V 10c to 25c ea.
New Desk Telephones — Grey. \$15.00 ea.
Polyester Capacitors 6.8uF and 3.3uF 60c ea. 2.2uF 40c ea. Tantalum Capacitors. Good range 15c ea.
BC. 107 Transistors 10c ea.
OA636 600V 2A Fast Recovery Silicon Diodes — TV Type 25c ea.
Dual 100 Ω 3W Wire Wound Pots. \$1.25 ea.
S.C.R. BT100A 300V 2AMP 60c ea.
Triacs. 2AMP 400V 60c ea.
2N3055, 90c ea. AD149, \$1.00 ea.
AY8110, 80c ea. OC912, \$1.00 ea.
AY8139 and 9139, 45c ea. IN914 diodes 10c ea. 5 amp AC panel meters \$3.50 ea.
2500 uF 35V P/T electrolytics, 60c ea.
2200 uF 25V P/T electrolytics, 40c ea.
Aluminium and plastic instrument boxes and ARLEC multimeters NOW IN STOCK.
Spkrs MAGNAVOX 5"x3" 8ohm \$1.50 ea.
Belt drive T/T kits 240V AC motor with speed change. 12" cast alloy platter, rubber mat, bearing, spindle and belt, \$25.00 ea.
CTS 10" woofers Mod10W14P 8 ohm 50W continuous power, 30-2000Hz. Air suspension foam cone surround, 15oz ALNICO V magnet. \$19.50 ea.
Silicon bridge rectifiers 400V, 1.5A, 85c ea.
Balance meters 35Mm x 15Mm, \$2.00 ea.
A&R 240V ac primary, 115V secondary at 95Vamps, \$7.50 ea.
Phone enquiries and personal shopping only.
Also in stock — large range of electrolytic capacitors — wire wound resistors — switches — panel meters — transistors — diodes — plugs — sockets — edge connectors — vero board — transformers — chokes. We could go on and on, so call in and browse around and check our low, low prices.

UNIQUE ELECTRONICS SECURITY CO. P/L.

682-3325

- A new shop catering for the hobbyist, CB'er and for the trade.
- We specialise in: Components Kits Technical Books Burglar alarm equip. CB Club needs.
- We have a range of data books for your use — or purchase your own copy.
- We stock a full range of security equipment Installation companies check our prices.
- If you are having technical problems with your equipment drop in and have a chat, perhaps we can help you.
- If you don't see what you want displayed, please ask us, we can probably obtain it for you.
- MAIL ORDERS WELCOME SEND YOUR ORDER TO P.O. BOX 402, PARRAMATTA, 2150
- TRADE SALES WELCOME

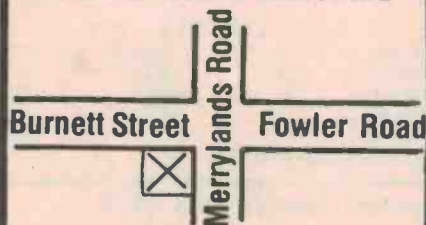

383 MERRYLANDS ROAD,
(CNR. BURNETT STREET)
MERRYLANDS, N.S.W. 2160
682-3325

• MIRRORBALLS • BEACONS
• ROPELIGHTS • CHASERS
• STROBES • SOUND TO LIGHT
• STAGE DIMMERS • BUBBLE BLOWERS • ULTRA VIOLET



• LARGEST RANGE OF 3" EFFECTS CASSETTES AND 6" WHEELS.

Australia's most helpful professional supplier of effects lighting equipment and discotheque consoles

Solar, Tutor and Aquarius effects projectors and accessories.

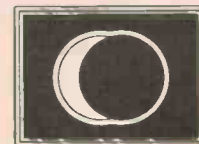

ECLIPSE LIGHTING & ELECTRONICS

100 Penhurst St.,
Willoughby, Phone 95-4212.

VFETS FOR EVERYONE

In the first part of this article we examined the structure and features of a new type of semi-conductor, the vertical channel power metal oxide semi-conductor field effect transistor, Vertical MOSFET, or V-MOS recently introduced by Siliconix. This month we shall examine the actual use of V-MOS.

V-MOS POWER FETS like signal MOSFETS, may be used to perform many different functions. However, no matter what the circuit, certain conditions, common to all applications, must be provided. These are supply power, loading, drive signal, and establishment of appropriate operating points.

The electrical characteristics of the VMP1, VMP11, and VMP12, are shown in Fig. 1, and Fig. 2 shows them in graphic form. Since these are uni-directional devices, the source and drain are not interchangeable, and as they are n-channel devices conduction can occur only if the drain is positive with respect to the source, and high enough to ensure operation in the linear region — as with a vacuum tube, bi-polar transistor, or signal FET.

Like the vacuum tube, the absence of secondary breakdown allows full dissipation at any voltage supply up to maximum voltage and current ratings.

Thus, where two different designs require the same dissipation but different voltage/load current, no derating is required. This is shown in the "safe operating area" curves. The only bi-polar transistor possessing this characteristic is the single-diffused type, which is also the least suitable for any application requiring wide bandwidth and/or high speed.

This characteristic also simplifies the establishment of suitable load-lines allowing greater safety margin in driving reactive loads where the load-line may be elliptical to the point of leaving the safe-operating area. Designers accustomed to using high voltage-high dissipation devices to assure adequate safety margins at relatively low power levels need not therefore be too disconcerted at the 25 watt rating of these devices.

A 10 watt class A amplifier suitable

for driving a tweeter in a bi-amped speaker system, for example, need not suffer excessive dissipation except perhaps with an electrostatic unit where such a power level would be inadequate anyway, unless it were operating at a very high cross-over frequency.

Output

These devices may use any of the types of output circuits in general use with tubes and bi-polars, including transformer coupled (Fig. 12) where the benefits of the absence of charge carrier storage become apparent in the absence of severe ringing at the cross-over point, conventional series output such as in Fig. 3, which is a straightforward transformation from a bi-polar

Fig. 1 Electrical characteristics of the VMP devices (Siliconix).

Characteristics	VMP 11			VMP 1			VMP 12			Unit	Test Conditions
	Min	Typ	Max	Min	Typ	Max	Min	Typ	Max		
1 BV _{DSS} Drain-Source Breakdown	35			60			90			V	V _{GS} = 0; I _D = 100 μA
2 V _{GS(th)} Gate Threshold Voltage	0.8	2.0		0.8	2.0		0.8	2.0		V	V _{GS} = V _{DS} ; I _D = 1 mA
3 I _{GS} Gate-Body Leakage		0.5			0.5			0.5		μA	V _{GS} = 15 V; V _{DS} = 0
4 I _{D(off)} Drain Cutoff Current		0.5			0.5			0.5		μA	V _{GS} = 0; V _{DS} = 24 V
5 I _{D(on)} Drain ON Current*	1	2.0		1	2.0		1	2.0		A	V _{DS} = 24 V; V _{GS} = 10 V
6 I _{D(on)} Drain Off Current*	0.5			0.5			0.3			A	V _{DS} = 24 V; V _{GS} = 5 V
7 R _{DS(on)} Drain-Source ON Resistance*		2.0	2.5		3.0	3.5		3.7	4.5	Ω	V _{GS} = 5 V; I _D = 0.1 A
		2.4	3.0		3.3	4.0		4.6	5.5	Ω	V _{GS} = 5 V; I _D = 0.3 A
		1.2	1.5		1.9	2.5		2.6	3.2	Ω	V _{GS} = 10 V; I _D = 0.5 A
		1.4	1.8		2.2	3.0		3.4	4.0	Ω	V _{GS} = 10 V; I _D = 1 A
11 β _{DM} Forward Transconductance*	200	270		200	270		170			mS	V _{DS} = 24 V; I _D = 0.5 A
12 C _{iss} Input Capacitance		48			48			48		pF	V _{GS} = 0; V _{DS} = 24 V
13 C _{rss} Reverse Transfer Capacitance		7			7			7		pF	f = 1 MHz
14 C _{oss} Common Source Output Capacitance		33			33			33		pF	
15 t _{ON} Turn ON Time**		4	10		4	10		4	10	ns	See Switching Time Test Circuit
16 t _{OFF} Turn OFF Time**		4	10		4	10		4	10	ns	

*Pulse Test **Sample Test
Pulse Test Pulse Width = 80 μsec, Duty Cycle = 1%

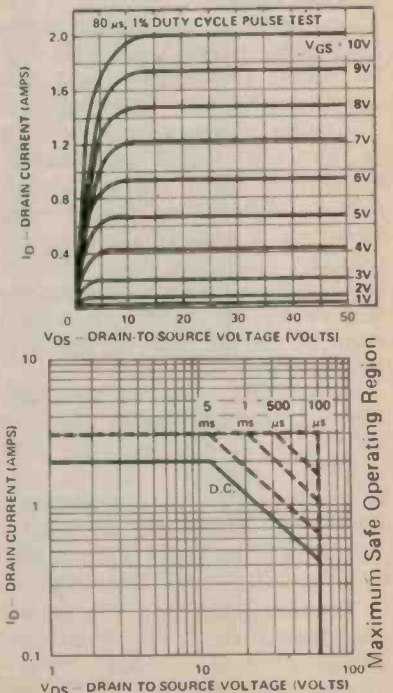

Fig. 2 Typical VMP1 performance curves (Siliconix).

VFETS FOR EVERYONE

circuit (1), and single-ended output with current source, also transposed from an excellent bi-polar circuit (2) (Fig. 4).

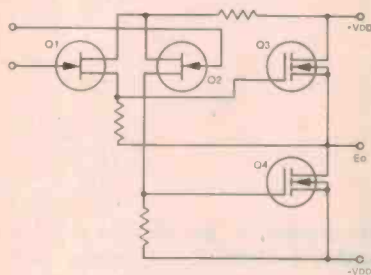

Fig. 3 Series output arrangement

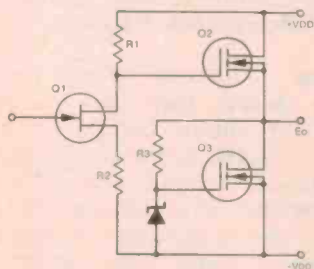

Fig. 4 Single ended output with current source.

Bias and Drive

These series of devices are n-channel, enhancement type MOSFETS, and may be biased and driven using methods appropriate to signal types and bi-polars. The drain is made positive with respect to the source and the gate enables conduction by being forward biased with respect to the source, that is to say it is biased in a positive direction. Unlike bi-polars, however, they are voltage, rather than current controlled, and circuit values are selected to provide the required voltage. Any current drawn is by the bias network itself.

Three bias methods are shown in Fig. 5. Figure 5a shows bias supplied from a fixed bias supply. It is the simplest possible method, allows extremely high input impedances since R_g may be almost any very high value desired, and its stability is limited only by the stability of the bias supply.

The design shown in Fig. 5b has the advantage of requiring no extra supply voltage since it is taken from V_{DD} . Disadvantages are low impedance and

stability. Input impedance consists of the parallel combination of R_1 and R_2 (disregarding input capacitance of the MOSFET and the very low input leakage.) There are practical limits as to how high this combination can become; if for example, we have a 60 volt supply and require 6 volts bias, we might have some difficulty obtaining higher values than 9 megohms and one megohm for R_1 and R_2 .

Higher values become more difficult to obtain, stability becomes less reliable, internal inductance and distributed capacitance become problems, and overcoming these difficulties usually costs money. In addition, if V_{DD} is subject to variation, then bias varies. In a class AB amplifier this could be quite serious, since V_{DD} varies considerably with output level; at high levels, V_{DD} can be expected to drop, causing a reduction in bias.

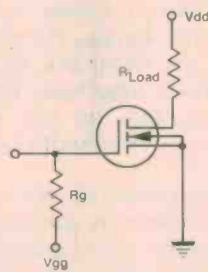

Fig. 5a. Hi-Z separate bias supply.

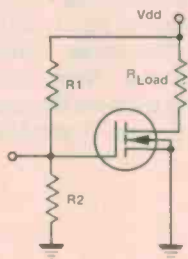

Fig. 5b. Moderate impedance supply.

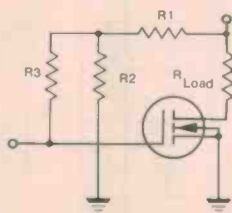

Fig. 5c. Hi-Z common supply.

While this may reduce the danger of over-driving the device, it will be forced to operate in its non-linear region which may result in unacceptable performance characteristics unless taken into consideration in the overall circuit design (e.g.

choice of feedback values). It does provide some degree of overload protection, and with correct choice of values can provide for class AB operation at low levels, shifting to class B at high levels. With these considerations in mind, and/or where moderate impedances are required, it offers a low cost, simple, and reasonably reliable method of establishing the operating point.

The method used in Fig. 5c is similar except that with the addition of R_3 higher input impedances are possible. Its configuration is similar to a noiseless biasing system frequently used in low-level bi-polar amplifiers and integrated circuits (e.g. National LM381A) but its function is somewhat different. Resistors R_1 and R_2 form a voltage divider as in Fig. 5b, but their junction now forms a fixed bias source as in Fig. 5a. Resistor R_3 can be quite high since no current flows. Meanwhile, since the parallel combination of R_1 and R_2 are effectively in series with R_3 they can be reduced to more manageable values. Alternatively R_2 can be replaced by Zener diode for stability comparable to Fig. 5a.

Input Protection

Unlike most signal MOSFETS, the gate of each of these devices, with the exception of the VMP4, is protected with an internal 15 volt, 10 mA zener diode. Most signal MOSFETS, as well as the VMP 4, are unprotected, or where extremely high impedances are not required, are protected by back to back zeners. I have no information as to why this different technique is used.

This different technique is used, but it is obvious that a negative signal swing on the gate will result in forward current through the zener. If the device is to be driven beyond cutoff, the driver must be capable of delivering current during its negative swing. Alternatively, a constant current source can be used, a series limiting resistor or a driver biased to the same class of operation as the V-MOS FET.

A constant current source (we'll examine an example of its use a little later) will limit current drive to the value of the constant current diode used; a series resistance will drop the drive voltage as the diode draws current. In both cases, diode current must be limited to 10 ma maximum. Higher currents will damage the protective zener diode.

In amplifier applications, a class A driver is commonly used. However, if a class B output is used, conduction only occurs during positive half-cycles. Therefore drive signal is not required during negative half-cycles. If a source or

emitter follower driver stage is biased so as to pass no negative drive, the problem does not occur. However, great care must be exercised in the design of such a stage to ensure that drive does not disappear before the output device is cut off.

This is not too difficult with a class B or near class B stage; If the output device is operated at zero bias, then a small amount of bias on the driver will ensure conduction during slightly more than 180 degrees. Class AB operation is a little more tricky. If conduction is to occur for 270 degrees, for example, the driver should conduct for slightly more than this period.

Two types of drive circuits familiar to designers of bi-polar circuits are the Darlington and super beta, commonly used together to provide a quasi-complementary circuit. Both circuits are current amplifiers designed to provide a compound device with very high hfe and provide base current to the output device. However, similar circuits can be used with these devices to provide phase inversion in a series output stage.

Thermal considerations

As described earlier (Part 1) these devices exhibit a negative temperature coefficient with respect to current, so that as temperature rises, current is reduced, thus providing a self-inhibiting action which provides some protection against overload. However, this is not an unconditional effect Fig. 6 shows the relationship between RDS(on) and temperature (3), based on a worst case temperature coefficient of 0.7 per cent per degree C.

Suppose that the device when 'on' passes a current of 1 amp which causes it to heat up. The 'on' resistance increases (which is why current drops), increasing the voltage drop across the device and the device dissipation. Now, if adequate heat sinking is used there is no real problem but if it isn't, the 'on' resistance and junction temperature will rise to the point where extra charge carriers are generated, thus stabilizing

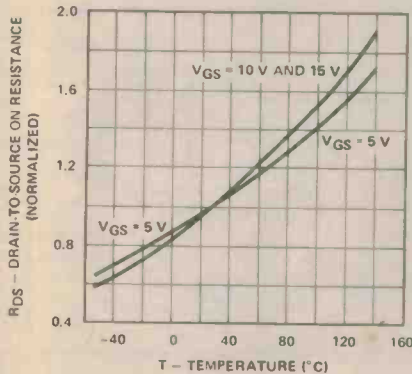

Fig. 6 Drain to source resistance against temperature (Siliconix).

RDS(on). That's great, except for the fact that this doesn't occur until the maximum safe junction temperature of 150 degrees has been exceeded.

You'll remember that we said earlier that the device was free of thermal runaway problems because of its negative temperature coefficient, but it isn't free of thermal destruction problems, and in any case, excessive temperatures will reduce output conductance. Heat-sinking requirements are, therefore, similar to those of bi-polars. The calculations of thermal operating conditions are beyond the scope of this article, but interested readers are referred to the Siliconix literature listed in the references, (4).

Extending the ratings

The current handling and therefore total dissipation capability may be increased by simply connecting several devices in parallel (Fig. 7). No ballast resistors are needed to ensure proper current sharing since if one device draws more current than another it simply gets a little warmer which causes it to draw less (assuming adequate heat sinking, of

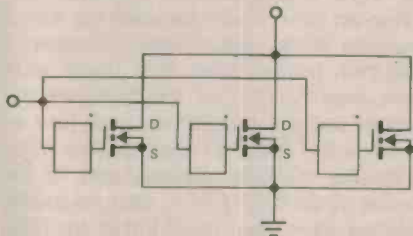

*TO PREVENT SPURIOUS OSCILLATIONS, A 500 Ω-1K Ω RESISTOR OR FERRITE BEAD (FOR HIGHER SPEED) SHOULD BE CONNECTED IN SERIES WITH EACH GATE.

Fig. 7 Basic circuit for parallel operation (Siliconix).

course). The only major precaution needed is to keep lead inductance in the gate and source connections to a minimum to prevent parasitic oscillations, unless the devices are driven from a low impedance source.

It may be advisable to insert what the British call "stoppers" — small resistors (100 to 1000 ohms) in series with each gate, wired directly to the socket, or ferrite beads mounted on the leads close to the socket terminals. An additional plus when paralleling several devices is that the gm is multiplied by the number of devices used. Mutual conductance gm is specified as the ratio of a large change in current to a small change in control voltage. If, for example, a change of 0.4 volts on the gate produces a change of 0.1 amp through one device, connecting two devices in parallel will give us an output swing of 0.2 amps, but it will still require only the original 0.4

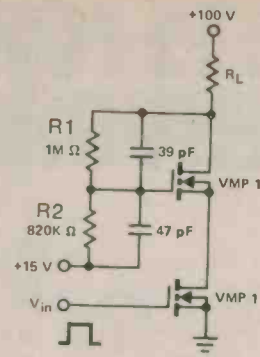

Fig. 8 Diagram for series operation (Siliconix).

volts gate swing. Since voltage gain $A = gm \times RL$, if gm is increased, A is increased.

In real use, of course, the internal resistance of two devices in parallel is less than of one, the optimum load is less, so in amplifier applications, the net amplification A is the same. But notice that the drive requirements have not changed. With bi-polars current would have to be supplied to each base, thus increasing the output requirements of the drivers. Indeed, with many high-power amplifiers using multiple output devices the drivers are also power devices.

We can also extend the voltage ratings by series operation of two or more devices Fig. 8 shows the technique. Resistors R1 and R2 bias Q2 'on', while C1 and C2 ensure fast switching. The input control signal is inserted between gate and source of Q1. Ordinarily the bottom of the divider chain is at ground potential for signal frequencies, so that circuit is really a cascade.

Maximum current and gm are the same for one device.

Some practical applications

An efficient light dimmer circuit as proposed by Siliconix is shown in Fig. 9. The 4011 acts as a pulse width modulated oscillator whose duty cycle is determined by the ratio of R1 to R2, with R2 adjusted to control the brightness of the W-90 bulb. Of special interest here is the fact that with its fast switching time, the VMP1 is especially suited to pulse width modulation at power levels and suggests it as being suitable for use in switching, or class D linear amplifiers.

A DC to DC converter is outlined in Fig. 10. The VMP1s form an oscillator with positive feedback provided by the additional coil in the gate circuits. In operation the upper V-MOSFET is biased 'on', and the lower V-MOSFET

VFETS FOR EVERYONE

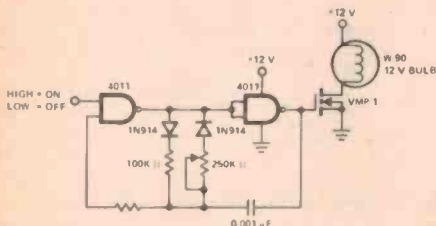

Fig. 9 Circuit of a high efficiency light dimmer (Siliconix).

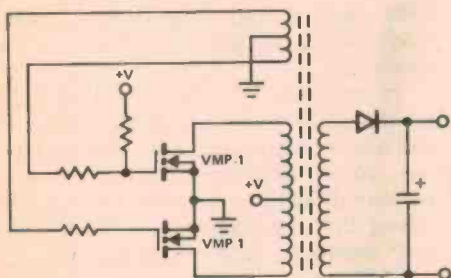

Fig. 10 A d.c. to d.c. converter (Siliconix).

is 'off'. When power is applied the upper device conducts causing current to flow from Vdd through the upper half of the transformer primary and the upper V-MOSFET to ground. The induced current flow through the feedback coil develops a voltage such as to shift the bias in the upper device 'off' (if the winding is connected with the correct polarity) and the lower device 'on'. This causes current flow from Vdd through the lower half of the transformer primary and the lower V-MOSFET to ground.

The secondary circuit consists of a single rectifier and filter. The resistor in the upper gate prevents shorting out gate bias, and the one in the lower gate keeps both sides balanced. In addition, each resistor limits current through the protective diodes. These are expen-

sive devices for such an application, but the high reliability, the reduced rf radiation (due to reduced switching transients) and the circuit simplicity easily make up for the cost. The very high circuit impedance enables running frequency to be set by the self-resonance of the transformer.

Single-ended push-pull transformer coupled audio amplifiers are shown in Figs. 11 and 12. Both utilize the biasing system described in Fig. 5b. A load-line drawn on the output characteristic will show the optimum load to be 24 ohms. In Fig. 11 gate drive is supplied by a single junction FET, and voltage feedback is taken from the output transformer secondary and series fed to the source of the input device. Distortion is under 2% at full output (try to get that with a single ended tube or bi-polar) and could probably be reduced even further by adopting a source follower output stage.

A push-pull version of Fig. 11 is shown in Fig. 12 using a differential input to provide phase splitting, drive, and a feedback point. Although the transformer winding ratio implies the use of a low impedance loudspeaker, a step-up ratio could be used for direct coupling to an electrostatic speaker, a balanced transmission line (both with some modification of the feedback circuit) an unbalanced transmission line, or a 70 volt speaker distribution line.

Notice in both circuits, and in the biasing circuits of Fig. 5, that no source resistors have been used, either for local feedback or for bias setting. In tube and bi-polar circuits it's a useful technique, and with bi-polars can be used to stabilize bias and control thermal runaway by using the increased current flow to increase the voltage drop, thus reducing base-emitter voltage. However, if used with these devices, it will actually impair the self-limiting action of its negative temperature co-efficient. If temperature rises due to high current, current flow is reduced. This would reduce the voltage drop across a source

resistor, lowering the source voltage and increasing the gate-to-source voltage, causing an increase in current flow. The circuit would work great while it lasted — which wouldn't be for long.

Record amp

Figure 13 shows a magnetic recording amplifier derived from a tube circuit. Its biggest advantage lies in its ability to provide equalization for head losses by incorporating the head within the feedback loop. Additional equalization is then required only for gap losses and tape self-demagnetization. Q1 acts as a driver for Q2, the output stage, which, with series resistor R9, provides a high impedance current source for the record head, as well as providing a mixing pad between audio and bias currents.

The record head's return path to ground is through R11. The inductance of the record head results in an impedance characteristic which rises with frequency. At frequencies at which the impedance of the head is low in comparison with R9 and R10 in series, load current is essentially constant. As frequency rises, however, head impedance becomes appreciable. With appropriate selection of R9 and R11, depending on head characteristics, the voltage across R11 decreases as the head impedance becomes significant. If feedback is taken across R11 it will decrease with rising frequency, causing an increase in gain, at a rate of 6dB/octave.

Feedback is applied across R3 via R10 and C8 (which supplies bass boost below 80 Hz) C5 and C6 provide additional high frequency boost for a total ultimate slope of 12 dB/octave. This circuit is so effective that no additional boost is needed at 15 ips, and only a small amount at 7.5 ips with high coercivity tape.

The biasing method used is that of Fig. 5c. The large amount of local current feedback provided by R2 and R3 results in a high output impedance

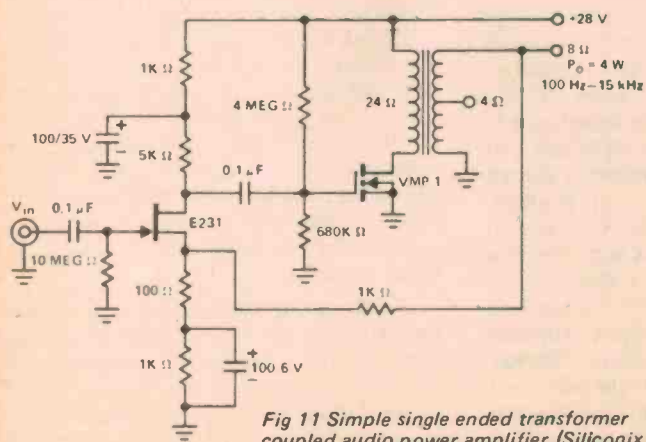

Fig. 11 Simple single ended transformer coupled audio power amplifier (Siliconix).

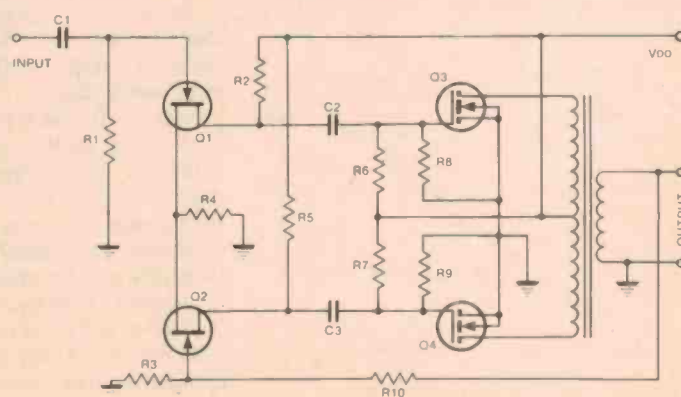

Fig. 12 Transformer coupled output.

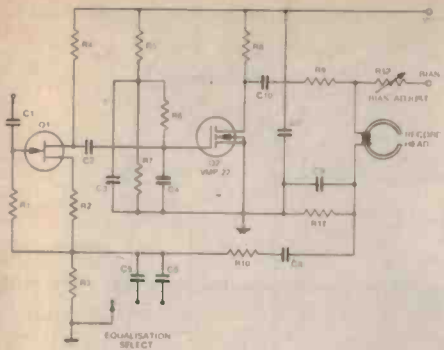

Fig. 13 Tape recording amplifier.

for Q1, so the biasing network is selected to provide high impedance with reasonable values. Capacitors C3, C4, C7 and C9 bypass bias signal to avoid overloading Q2, and to prevent attenuation of bias current.

Power amp

Figure 14 shows a high quality power amplifier designed by Siliconix Inc. (5) and described in their application notes. Output current capability is increased by using three VMP12's in parallel, providing for 6 amp current 75 watt dissipation and load optimized at 8 ohms. Q11-13 operate as a source follower, while Q8-10 form a quasi-source follower. This is accomplished by applying local feedback from drain to gate via R14, R15, and driving the gate by a modified current source. This consists of a cascade circuit with a constant current diode as the load.

For the benefit of those not familiar with these devices, a constant current diode is really a FET connected internally as shown in Fig. 15. Since current in a FET is controlled essentially by the gate-to-source voltage, changes in load

or in applied drain-to-source voltage have negligible effect since gate-to-source voltage is held constant. This is a current analogue to the zener diode and is described in detail in Siliconix literature (6).

The design is push-pull from input to output, thanks to differential circuitry throughout, prior to the drivers. Open loop distortion is low, bandwidth wide, allowing satisfactory performance with only 22 dB of feedback. Lead compensation only is used (via C4), along with the liberal use of local feedback (R4, R5, R11, R12,). The result is very low transient IM and a slew rate of over 100 V/microsecond. THD is quite respectable even though the numbers might not impress the average audiophile accustomed to amplifiers with great specs and poor sound.

Incidentally, D8 and D9 illustrate an excellent method of providing output current limiting. In this case, 9.1 volt zener diodes limit drain current to slightly less than 2 amps. At first one might be tempted to depend on the built-in protection diodes to accomplish this, but it should be remembered that these devices are for protection against static discharge. Their zener voltage of 15 volts at 10 mA cannot possibly be used since the absolute maximum permissible drain current occurs at a gate-to-source voltage of 10 volts.

Commercial amps

A simplified version of Yamaha's B1 amplifier is shown in Fig. 16, (8). In this circuit a cascade drive system is used, but in a differential form with the constant current source in the

Fig. 14 A high quality 40W amplifier (Siliconix).

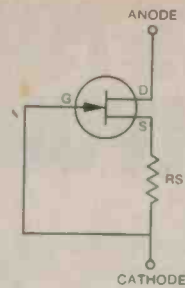
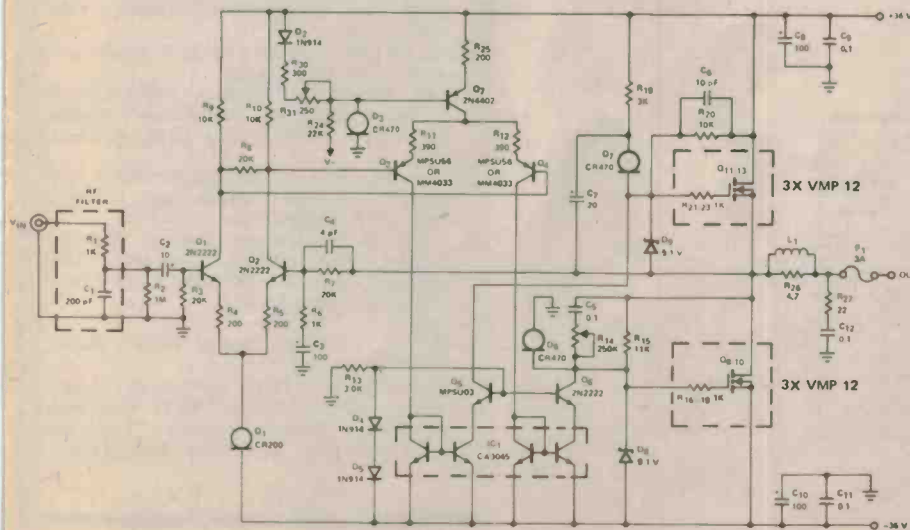

Fig. 15 A FET as a constant current diode.

common source circuit. This is an example of all FET design of excellent performance and received rave reviews in several publications including ETI. It's also inexpensive!

The VHF linear amplifier in Fig. 17 will deliver 5 watts peak envelope with second and third order intermodulation at -30 dB from 144-146 MHz. It will also prove useful as a receiver pre-amp with a noise figure of 2.4 dB. V-MOSFETS show considerable promise in rf applications because of their linear transfer characteristic, the high gain capabilities even with Ft somewhat above 600 MHz, low noise and (in receiver front ends) very wide dynamic range. Although this article has dwelt on the VMP 1 family, there is also the VMP 4, designed specifically for rf applications and which is now available.

Finally, how about something elegant for its simplicity, such as the tapered current voltage limiting battery charger shown in Fig. 18. This is especially useful with Ni-Cad batteries which are intended for stand-by use and are permanently on charge, such as electronic clocks. Overnight shut-downs of a few hours are occasionally but irregularly experienced. You know what this can do to clocks. Especially alarm clocks which are supposed to make noises, turn on radios, start the coffee at a pre-set time in the morning so you can go to work. Battery operation is not too satisfactory if the readout is on continuously, and Ni-Cads should not be on permanent floating charge.

With this little device current is supplied to the battery via the VMP-1. Gate voltage is set at a value equal to the desired end-of-charge voltage. As the battery charges, its voltage increases, reducing gate-to-source voltage, thus reducing charging current. When the battery reaches full charge its voltage, and that of the source, equals gate voltage, and charge is terminated. If a load is placed across the battery it will draw current, and as the battery voltage drops slightly below gate voltage, charging at a trickle rate occurs - automatically.

VFETS FOR EVERYONE

Experimentation

The various applications shown are intended as suggestions for further experimentation. They are mainly designed to illustrate various characteristics of the device under consideration, and are not necessarily representative of commercial practice or of finished designs. In some cases this may be just as well! But we would be delighted to hear of any readers' experience with any of these or other circuits.

The author's feeling is that V-MOS constitutes a genuine breakthrough in semi-conductor technology, as important as the silicon transistor and the FET itself. We'll be seeing more of these devices, with higher ratings (a 10 amp 200 volt unit is already under development) and specialized characteristics. They are said already to be in use commercially as magnetic core drivers.

Digital enthusiasts may be somewhat impatient with the strong emphasis on audio applications in this piece but other literature has placed great emphasis on digital applications, with little attention paid to linear techniques beyond the 40 watt amplifier described here. The serious reader in all areas is referred to the references at the end.

Further literature may be obtained from Siliconix Inc., 2201 Laurelwood Rd., Santa Clara, CA 95054. They have been most helpful in providing information for the preparation of this article. Have fun.

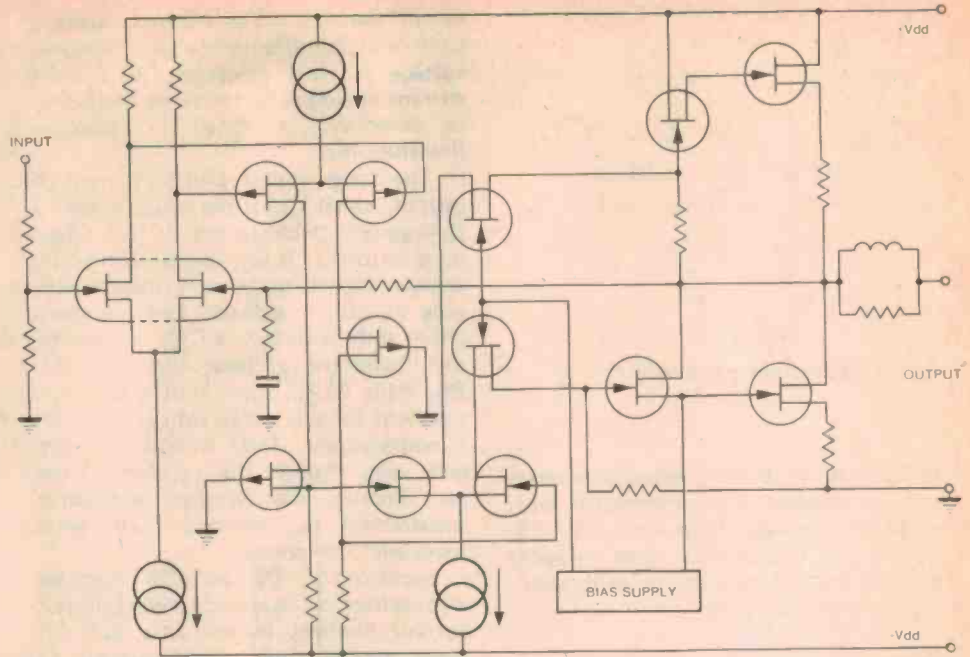

Fig. 16 Simplified Yamaha VFET amplifier diagram.

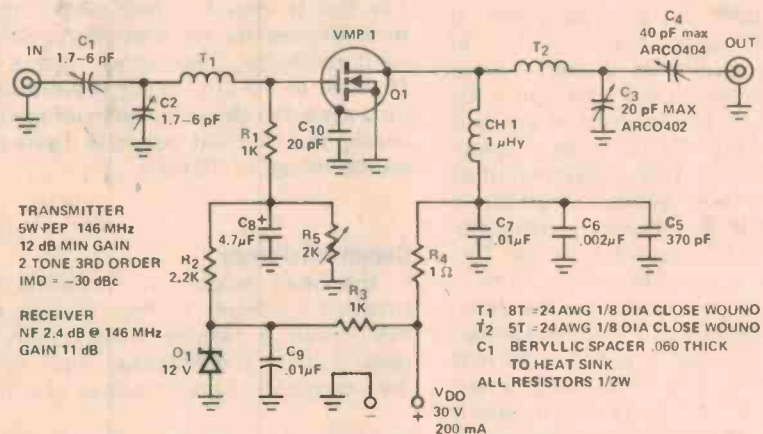

Fig. 17 144-146 MHz linear amplifier (Siliconix).

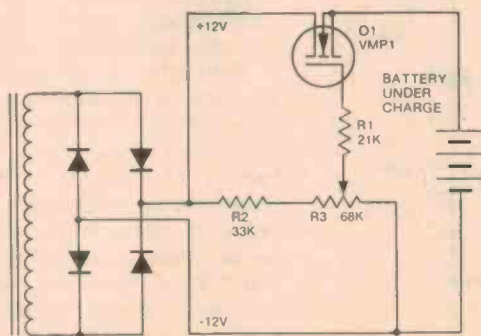

Fig. 18 Tapered current voltage limited battery charger.

REFERENCES

1. W. Marshall Leach: "Construct a Wide Bandwidth Preamplifier" Audio, Feb. 1977, p.39.
2. Nelson Pas: "Build a Class A Amplifier" Audio, Feb. 1977, p. 29.
- 3,4 Lee Shaeffer: "VMOS-A Breakthrough in Power MOSFET Technology" Application Note AN76-3, May 1976, Siliconix Inc.
5. Lee Shaeffer: "The MOSPOWER-FET Audio Amplifier" Design Aid DA76-1, May 1976, Siliconix Inc.
6. "The FET Constant Current Source" Design Idea D171-1, January 1976, Siliconix Inc. Also Siliconix Field Effect Transistors Data Book.
7. Ref. 5.
8. Bascom H. King: "Power FETs" Audio, Feb. 1975, p. 42.
10. Ed Oxner. "A New Technology: Application of MOSPOWER FETs For High Frequency Communications" Technical Article TA76-2, Nov. 1976, Siliconix Inc.

Williamsons the world's only 13.5 watts 6 band 7 speaker portable radio cassette with Enviro Stereo.

AIE ASIA INTERNATIONAL ELECTRONICS LTD.

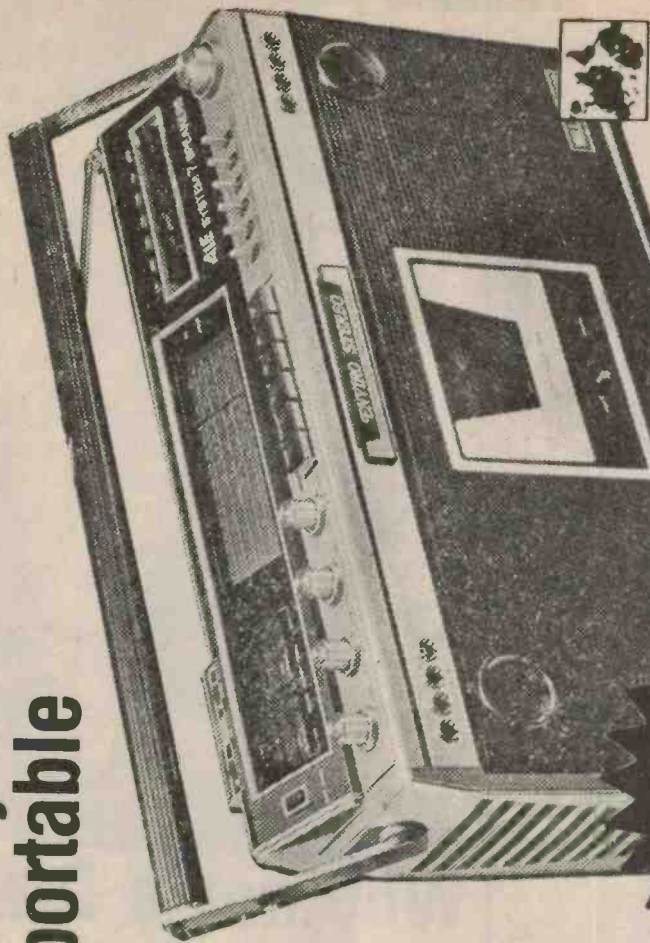

Has an exciting 3-way system can be used independently as:
A: 6-band, 7-speaker, high powered cassette, portable radio
B: 13.5 watts RMS Stereo Amplifier.
C: Quality Stereo Tape Deck

Williamsons Radio Cassette. The new Williamsons Enviro Stereo Radio Cassette has been designed to recreate the atmosphere of the concert in the living room or anywhere else. With the revolutionary AIE System (Patents pending), the Williamsons surrounds you with true, living sound, the rich, clear and compelling sound only this seven-speaker system can deliver.
 Enviro Stereo. A totally new concept created by AIE engineers and first introduced with the Williamsons Radio Cassette, designed to produce multi-dimensional sound quality. Sounds of different weight and pitch are separated and fed into 7 different speakers in the set. Balanced placement of woofers and squawkers reproduces the true colour and texture of any music faithfully.
 13.5 watts RMS power output. The Williamsons is designed for powerful output performance. With a continuous power output of 13.5 watts RMS, it is also ideal as a part of an audio set-up. Used either as a stereo cassette deck or as a stereo amplifier.

equipment report

SEVEN SPEAKERS GIVE ENVIRO STEREO

A new stereo radio cassette player, designed to recreate the quality of a concert hall wherever it is played, will soon be available in Adelaide for about \$345. It is the Williamsons portable radio cassette with Enviro stereo, seven speakers, six-band radio and 13.5 watts RMS power output. Enviro stereo is a new concept designed to produce multi-dimensional sound quality. Sounds of different weight and pitch are separated and fed into seven different speakers, while balanced woofers and squawkers reproduce the true color and texture of the music. Designed for powerful performance with a continuous power

output of 13.5 watts RMS, it is also ideal as part of an audio setup used either as a stereo cassette deck or a stereo amplifier. There are two easy-to-read VU meters for playback, record and battery levels as well as the tuning signal strength and a pause control for immediate stop or restart during record or playback. Single channel input is fed through speaker groups on each side of the set and where a stereo strength is received the main treble sounds can be switched from one side to the other with a flick of the control switch.

The variable sound monitor enables you to record and listen to the recording at a higher volume at the same time without affecting the recording level.

BIG PUNCH

The Williamsons Enviro Stereo is not a conventional portable radio cassette, as I found to my enjoyment during an exhausting six-hour test. Exhausting for me, that is. I didn't faze the unit at all. It is easy on the eye, the ear and, for what it can do, its \$345 price tag makes it surprisingly easy on the pocket.

A profusion of knobs, dials, push-buttons and switches at first makes the unit look a little confusing, but its soon apparent their number and positioning make for ease of operation. During the six-hour test there was no hint of vibration from any of the unit's seven speakers — even at its ear-shattering best. For its size (49 cm x 27 cm x 15 cm) it is light, easily carried about and built to take some hard knocks.

PRICE
\$345
 DELIVERED FREE

- SPECIFICATIONS**
- Radio LW, MW, SW 1.2-3, FM
 - Power 13.5 watts r.m.s.
 - Frequency 30 Hz, 16 kHz • 7 Speakers
 - Tape Selector CR02 and normal Twin Condenser Microphones • 4-Way VU Meters • Electronic Tape Governor • Auto Stop, Pause Control • A/C — Battery — 12v Car
 - Enviro Stereo, a totally new concept to produce a multi-dimensional sound • Variable Sound Monitor

Made in the Traditions of AEI's Hi-Fi Stereo Amplifiers & Sound Equipment

XENON WORLD IMPORTS

SHOP — 2 BYRON STREET,
 GLENELG S.A. 294-1648

TRADE OUTLETS WANTED ALL STATES
 PO Box 33, Warradale, S.A.

DRAKE COMMUNICATIONS RECEIVER **SSR-1**



- Synthesized ● General Coverage
- Low cost ● Selectable Sidebands ● All Solid State
- Built-in Ac Power Supply ● Excellent Performance

The SSR-1 Receiver provides precision tuning over the short wave spectrum of 0.5 to 30 MHz with capability of reception of a-m (amplitude modulated), cw (continuous wave) and ssb (upper and lower single side band) signals.

A synthesized/drift-cancelling 1st mixer Injection system giving thirty tunable ranges from 0.5 to 30 MHz is derived from a single 10 MHz crystal oscillator providing frequency stability necessary for ssb operation. A stable low frequency VFO tunes each of the 30 one-MHz ranges with a dial accuracy of better than 5 kHz which is sufficient to locate and identify a station whose frequency is known. Separate detectors (product and diode) are used to provide for best performance whether listening to ssb or a-m signals. Narrow band selectivity for ssb and wide band selectivity for a-m and wide band selectivity for a-m reception is provided. A manual tuned preselector provides for maximum sensitivity and maximum interference rejection. Solid state circuitry throughout allows efficient operation from built-in ac power supply, internal batteries or external 12 V-dc source.

ELMEASCO INSTRUMENTS PTY. LTD.

P.O. Box 30, Concord NSW 2137 - 13-15 McDonald St, Mortlake, NSW 2137. Phone (02) 736-2888, Telex: 25887
P.O. Box 107, Mt. Waverley, Vic. 3149 - 21-23 Anthony Drive, Mt. Waverley, Vic. 3149. Phone (03) 233-4044
Adelaide: 51-3521; Brisbane: 392-2884; Perth: 325-3144

You have your
own
calculator.

FLUKE

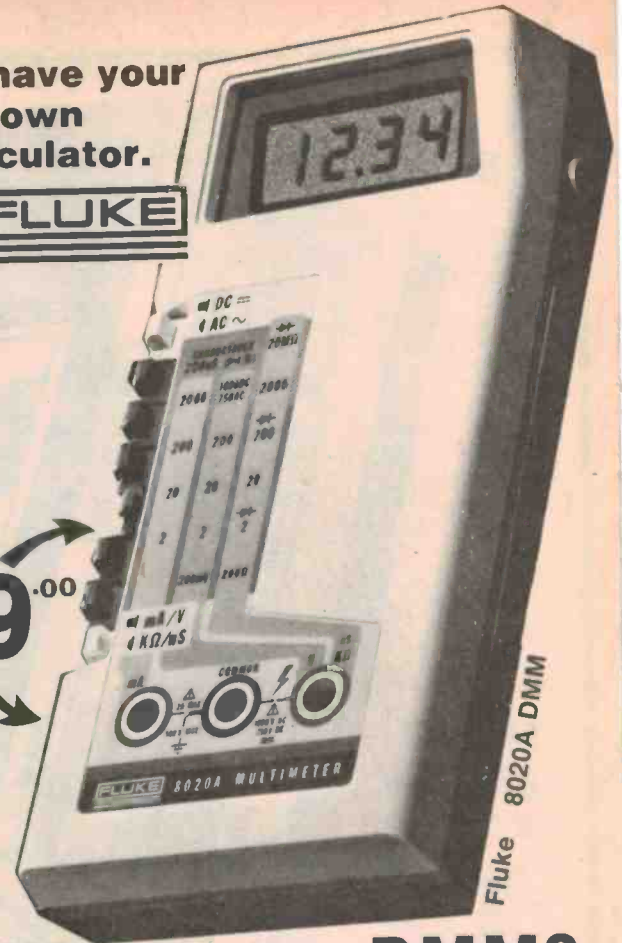

\$ **179** .00

Why not a DMM?

Finally, a digital multimeter that's yours, just like your pocket calculator and more useful.

Your pack only 13 ozs, in your pocket or service kit, but size is deceptive. The 8020A has more useful features than any other multimeter available at any price. Features liked 26 ranges and seven functions, including conductance. 2000-count resolution. Hi/Lo power ohms.

And it's rugged. The high-impact case protects a minimum number of component parts (47 in all), and they're all readily available from any of the worldwide Fluke service centres. Your 8020A is factory calibrated by NBS traceable equipment. And we guarantee it will live up to published specs for a full year.

The 8020A is a true field instrument. Designed with a highly readable LCD display, and inexpensive 9V transistor battery power for continuous use up to 200 hours. Reliability quality and value: that's Fluke tradition.

Please send me the DRAKE SSR1

PLEASE SEND ME THE FLUKE 8020A.

I enclose cheque
Money Order
for \$
OR Please charge my Bankcard
\$215 (exempt) or \$270 (Inc. S.Tax)
Includes FREE delivery.
Bank
Card No
Expiry Date
Card Holder's
Signature
Name
Address

Postcode



I enclose cheque Money Order
for \$
OR Please charge my Bankcard.
\$179 (exempt or \$205.85 (inc.S.Tax).
Includes FREE delivery.
Bank
Card No
Card Holder's
Signature
Name
Address

Postcode

ANNOUNCEMENT

CALLING ALL AMATEURS, NOVICES

SHORT-WAVE - LISTENERS

We've often been asked why our amateur radio section hasn't been one of our biggest departments. After all, Dick and many of his staff hold amateur licenses. The reason is simple: we, like everyone else, have had tremendous problems obtaining supplies from local distributors. We maintained it was pointless having a large showroom displaying a lot of lovely samples if we couldn't sell them because we had no stock. . . We understand many of the suppliers work this way: we would not. The problem is over. After many years, Dick Smith has managed to secure an agency for the world's leading amateur gear:

DICK SMITH IS PROUD TO ANNOUNCE HE HAS BEEN APPOINTED A DIRECT DISTRIBUTOR FOR

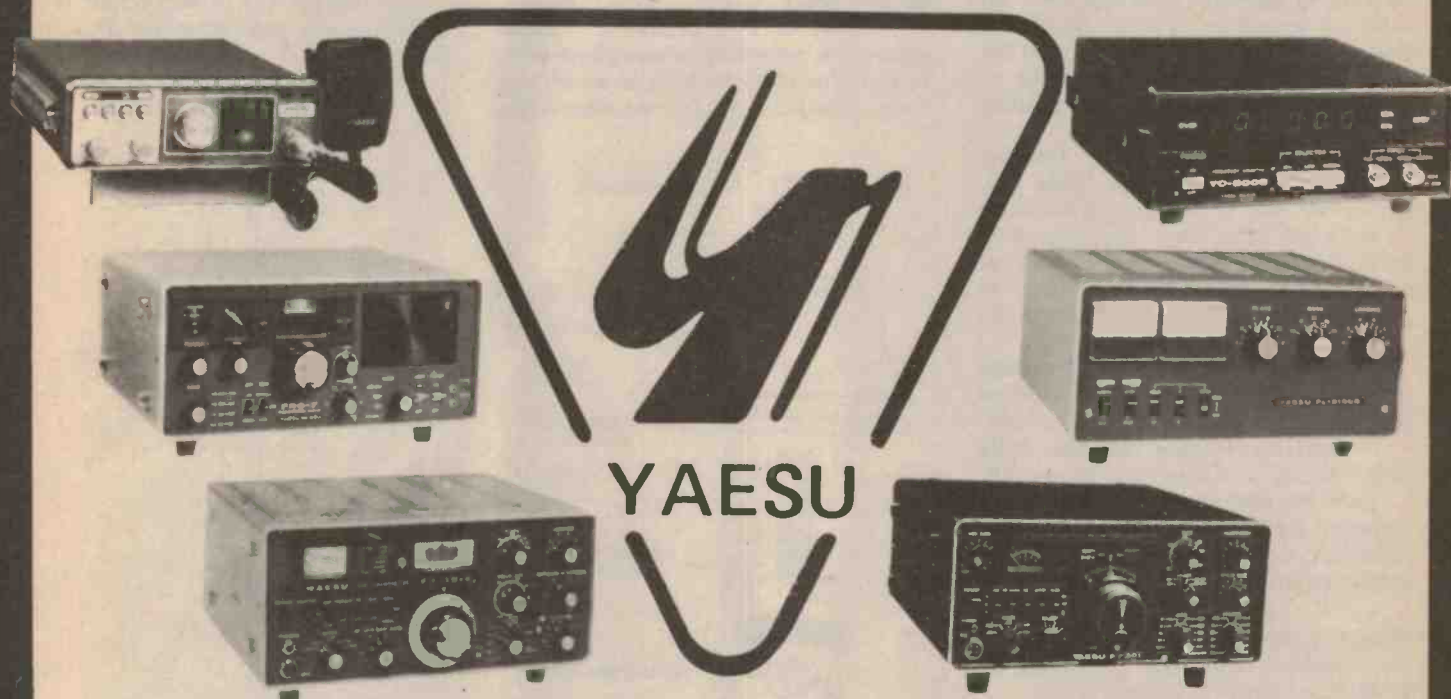

Check out this incredible YAESU equipment:
FT-101E — 10 to 160 metre amateur band transceiver, with inbuilt AC/DC power supply. Comes with microphone. 260W PEP input SSB, also has CW & AM. Solid state except for driver & final in tx. Cat D-2860 \$850.00

FT-301 — 10 to 160 metre transceiver, fully solid state for mobile or base use (12V DC). 200W PEP input. (SSB) AM, SSB, CW & FSK. Cat D-2870 \$949.00

FT301S — as above, but 20W PEP. Ideal for novice use. Cat D-2880 \$699.00

FL-110 — Linear amplifier, companion unit to FT-301S. 20 watts in, 200 watts PEP input. Turns your novice rig into a full license version. Cat D-2884 \$249.00

FT-227R — Fully synthesised 2 metre rig, with 'computer select' any channel of 800 available between 144 & 148. Features far above any other unit around at this price, has memorizer to instantly recall channel.
NEW UNIT! Cat D-2890 \$375.00

FL-2100B Linear amplifier with 1.2kW capacity. 10 to 80 metres, uses 2 572B triodes. Twin fans, similar style to FT101E. Cat D-2546 \$578.00

FP-301 POWER SUPPLY — 12 volts at 20 amps. To suit the 301 series transceivers. Cat D-2872 . . \$175.00 (price applies only if purchased with matching transceiver; otherwise duty applies to power supply).

YO-100 — Monitor 'scope. Designed for use with the FT101E, but also suits other Yaesu units.
 Cat D-2862 \$279.00

YO-301 — Monitor scope to suit 301 series.
 Cat D-2882 \$349.00

YC-500S — Digital frequency counter, to 500MHz. Ideal for VHF/UHF workers! Accuracy 1PPM.
 Cat D-2892 \$439.00

Clock — 24 hour type. Smarten up your QTH with the QTR-24: a deluxe ham clock which shows the time in any zone at a glance. Runs for a year on one battery. Cat X-1054 \$33.00

Yaesu Desk Microphone For really smart appearance. Suits all the Yaesu equipment (replaces hand-held unit supplied with rig). Cat C-1116 \$49.00

DICK SMITH ELECTRONICS



SHOP HOURS
 Mon-Fri 9AM - 5:30PM
 Sat 9AM - 12 noon
 (Brisbane - hour earlier)



Order value	P&P charge
\$5 - \$9.99	\$1.00
\$10 - \$24.99	\$2.00
\$25 - \$49.99	\$3.00
\$50 - \$99.99	\$4.00
\$100 or more	\$5.50

SYDNEY 125 York St. City Ph 29-1126 Open 'til 8PM Thursday
SYDNEY 361 Hume Hwy. Bankstown. Ph 709-6600 Open 'til 8PM Thursday
SYDNEY 162 Pacific Hwy. Gore Hill. Ph 439-5311 Ample parking at door.
SYDNEY 30 Grose St. Parramatta. Ph 683-1133 1st floor - friendly store!
MELBOURNE 399 Lonsdale St. City. Ph 67-9834 New right in town!
MELBOURNE 656 Bridge Rd. Richmond. Ph 42-1614. Easy access. huge stock.
BRISBANE 146 Logan Rd. Buranda. Ph 391-6233 Opens 8.30AM
ADELAIDE 203 Wright St. City. Ph 212-1962 Now Open See us!

MAIL ORDER DEPARTMENT PO Box 747, Crows Nest, NSW 2065. Phone 439-5311. Post & Pack extra. **WE HAVE DEALERS RIGHT ACROSS AUSTRALIA - THERE'S ONE NEAR YOU!**

UHF CB ANTENNAS

Roger Harrison explains what's what on 476 MHz mobile.

MANY CBERS HAVE been sitting on the sidelines waiting to see what happens with UHF, and as everything seems to be coming together now for UHF CB — here's an article on antennas for the UHF CB band. It was compiled with the assistance of Scalar Industries, one of Australia's foremost antenna manufacturers.

The introduction of the 476MHz CB band has opened up a whole new field in antenna technology to the CBer.

Although it is true that the same basic principles apply for 27MHz as well as UHF there are a number of critical differences when you get down to the practical situation.

That old phrase about "near enough is good enough" no longer applies when it comes to UHF antenna systems.

Physical construction and coax cable terminations become quite critical.

Even the mounting base becomes an intricate part of the whole antenna, contributing to, or detracting from, the overall efficiency of the system.

Mounting bases:

The antenna mounting bases used on 27 MHz are virtually unusable.

Their physical construction makes them become part of the antenna and the usual method of terminating the cable further compounds the problem.

Efficiency of these bases, while fine on 27MHz, is quite poor on 476 MHz because of these physical problems.

This can be best appreciated when you look at the length of antennas for the UHF band.

A full quarter-wave antenna is only 15cm long while the same type of antenna on 27 MHz is 277 cm long.

The amount of unshielded cable termination and the bolt to which the whip attaches, that passes through the antenna base, all become an appreciable part of the antenna itself.

The combined length of cable termination and whip bolt is typically between 4cm and 7cm on a 27 MHz antenna base!

If most or part of this is situated below the necessary groundplane area, or roof line of the vehicle to which it is fitted, then it can result in an appreciable

loss. You might do just as well sticking a screwdriver in the transceiver antenna socket.

The availability of above-roof terminating bases overcomes the problems just outlined.

In these special bases the whole of the coaxial cable is terminated above

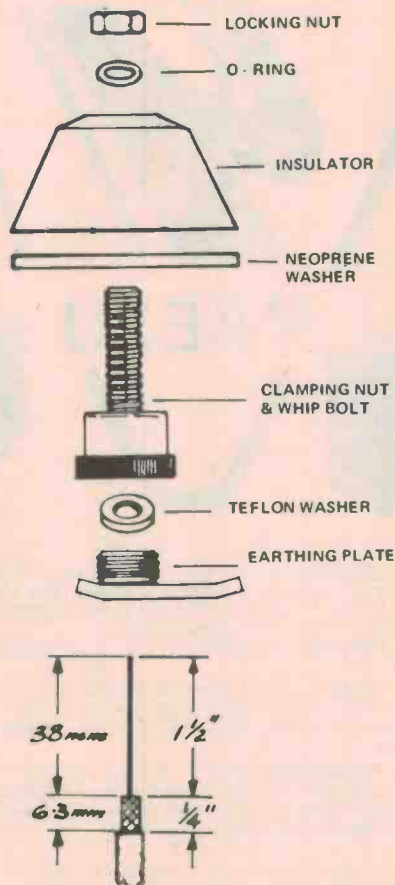

Figure 1. The Scalar antenna mounting base type OB, illustrated here in an exploded view, permits correct termination of the coax for proper operation of the UHF antenna.



Figure 2. This base antenna, model CB470 made by Scalar, has a genuine gain of 6dB over a half-wave dipole and provides an increase in the effective radiated power of four times omnidirectionally. Overall height is 2.44 metres.

the vehicle roof or groundplane line so that as much as possible of the available power from the transmitter is radiated by the antenna itself.

A typical UHF antenna mounting base is illustrated in Fig. 1.

These bases are used quite extensively in commercial grade mobile antennas for the 400 MHz to 500 MHz land mobile band, and are generally more easily assembled than conventional mounts.

And that's not to be sneezed at. As you can see, such an antenna would be very useful in a base station installation for 476 MHz.

With a height of 2.44 metres, a 6 dB gain antenna is an eminently manageable size — and there are no SWR adjustments to make! The Scalar model CB470 base station antenna is of this type and is illustrated in Fig. 2.

The same thing can be done for mobile antennas, as the same principles apply.



Figure 3. This mobile whip has a gain of 4.5dB and is only 534mm long. It is Scalar's model CB410 and mates with their type OB UHF base.

UHF base antennas:

BASE station antennas for the UHF band become quite sophisticated.

An antenna having a real gain of 6 dB over a half-wave antenna becomes a practical proposition.

It should be realised by most readers here that a 27 MHz base station antenna with a true gain of 6 dB would be 22 metres (72 ft) high!

Compare this to a 6 dB gain UHF antenna — it's only 2.44 metres (8 ft) high.

These types of 'gain' UHF antennas are comprised of 'collinear dipoles'.

They consist of a series of half-wave radiators stacked one on top of the other and all connected in phase.

This increases the effective radiated power.

A vertically polarized antenna of this type, having a gain of 6 dB, when used in conjunction with a 5 watt UHF CB transceiver would increase the effective radiated power to an equivalent of 20 watts omnidirectionally.

In other words, the set up would produce the same results as a 20 watt transceiver connected to a half-wave vertical antenna.



Figure 4. Scalar's dual band 27 MHz and 476 MHz mobile antenna, model CB420, allows operation on both the HF and UHF bands.

UHF mobile antennas:

'GAIN' mobile antennas are already available for the UHF band.

Two-element, vertical whip antennas are available that have considerable gain compared to a quarter-wave whip. One type has a gain of 3 dB which increases the effective radiated power by two, and another has a gain of 4.5 dB, increasing the effective radiated power by a factor of three. A 4.5 dB gain mobile antenna, the Scalar CB410, is illustrated in Figure 3.

The antenna 'gain' also works on reception so adding a gain antenna boosts performance both ways.

Dual-band antenna:

A RATHER unique antenna development, designed by Scalar Industries and peculiar to Australian CB requirements, is a dual-band-mobile antenna which can be used quite effectively for either 27 MHz or 476 MHz (it is illustrated in figure 4).

A diplexer, or combiner as it is more commonly referred to, will also be shortly available which will enable this antenna to be used simultaneously with a 27 MHz and 476 MHz transceiver, either in receive or transmit mode, without the need for switching.

You'll be able to hold dual-band duplex conversations while mobile!

Cable and connectors:

Coaxial cable for UHF CB transceiver installations will have to be carefully selected.

The old standard — RG58 can only be used in short runs, provided a good-quality brand is selected.

It is quite unusable in base station installations as the antenna coax run is usually around 15m to 30m.

A 30m length of even good quality RG58 coax will have a loss of about 10 dB! That is, only one tenth of your power will reach the end of the cable. The rest of it will be vainly trying to keep the coax warm!

As you need to deliver as much power to the antenna as you can get, a loss of this much is just no good.

However, manufacturers have been coming to the rescue for many years and some excellent quality coax cables are available that will do the job nicely.

They cost more than the RG58 you use on 27 MHz, but it's worth it.

Connectors too, can be a source of loss in a UHF installation.

That old PL259 is just too 'lossy' to use.

The problem is that, to the RF signal trying to get through a connector of that sort, it finds that it doesn't look like a connector! Even with 'good' connectors, a loss of around 0.2 dB is always allowed for each connector.

A commonly available connector that serves very well on UHF is the BNC connector.

These suit the smaller-diameter cables (5mm — 6.5mm) and are a push-on type of connector. They're relatively inexpensive these days.

For larger diameter cables, the type N connector is more commonly used.

These will handle cables up to 13mm in diameter used for long, low loss, runs in base station installations.

The Philips FM320 transceiver uses a Belling-Lee coax antenna socket, as used commonly with TV coax installations, and have proved adequate.

Shop around!

THE variety of UHF antennas available to the CBER will be quite broad, and careful consideration should be taken before jumping in and buying the first antenna you see.

Plenty of good advice will be available from Australian antenna manufacturers as to the most suitable type and proper installation of UHF antennas for the 476 MHz ultra high frequency CB band.

Take advantage of it.

"THE STOCKING EXPORTER"

FREE FREE FREE FREE FREE

WITH EVERY ORDER FOR OVER \$25.00 YOU WILL RECEIVE A GRABBAG OF "DO-IT-YOURSELF-TESTING" CALCULATOR CHIPS

TTL		
7400	\$.12	7486 .32
7401	.12	7490 .36
7402	.13	7492 .32
7403	.13	7493 .30
7404	.13	7495 .45
7406	.19	74107 .20
7410	.12	74121 .25
7413	.25	74123 .42
7420	.13	74141 .32
7430	.15	74151 .45
7438	.24	74153 .50
7440	.13	74154 .95
7442	.50	74157 .60
7445	.60	74161 .60
7447	.60	74163 .75
7448	.55	74164 .60
7450	.15	74174 .80
7454	.12	74175 .80
7474	.21	74192 .75
7475	.40	74193 .60
7485	.45	74367 .45

LOW POWER SCHOTTKY		
74LS138	\$.25	74LS00 .50
74LS139	.25	74LS02 .50
74LS151	.25	74LS04 .42
74LS157	.25	74LS08 .42
74LS160	.25	74LS20 .60
74LS161	.25	74LS30 .60
74LS162	.30	74LS32 .60
74LS163	.31	74LS38 .60
74LS174	.55	74LS42 .70
74LS175	.60	74LS47 .70
74LS192	.60	74LS48 .70
74LS221	.40	74LS74 .85
74LS257	.40	74LS75 .55
74LS266	.30	74LS86 .35
74LS283	.60	74LS90 .63
74LS365	.60	74LS94 .55
74LS366	.30	74LS109 .55
74LS368	.40	74LS126 .55
74LS386	.60	74LS132 .45

C-MOS		
4001	\$.22	4020 1.20
4002	.20	4021 .95
4006	.90	4022 .80
4007	.22	4023 .20
4008	.90	4024 .60
4009	.50	4025 .18
4010	.50	4028 .60
4011	.20	4030 .40
4012	.20	4035 .95
4013	.35	4040 1.00
4014	.80	4049 .50
4015	.80	4050 .50
4016	.40	4071 .22
4017	.80	4507 .28
4018	.85	4510 .50
4019	.35	

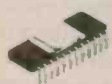

S-100 BUSS KITS		
8K	RAM	179.95
16K	RAM	449.00
2K/4K	1702A EPROM	
	less	
	PROMS	59.95
8K/16K	2708 EPROM	
	less	
	PROMS	75.95
2+2	I/O KH	139.95

Write for complete catalog of manufacturer and kits.

Memories and Micros		
1702A-2K PROM	\$	5.49
2708-8K PROM		15.00
21L02-1K RAM		1.39
Low Power		
8080A	CPU	15.99
MC6800L	CPU	13.50
7489	64BIT ROM	1.59

LINEAR		
LM1458CN	\$.35
LM3900N		.42
75451N		.30
75452N		.30
75454N		.30
N8T97N		1.30
N8225B		.65

CLOCK-CHIPS		
MM5314n	6-DIGIT CLOCK CHIP	\$3.99
MM5316N	4-DIGIT CLOCK CHIP	4.49

OPTO-SPECIAL			
FND503	.5	7 SEGMENT DISPLAY COMMON CATHODE	\$.85
FND510	.5	7 SEGMENT DISPLAY COMMON ANODE	\$.85

Payment conditions:
 Check, International Money order, or Bankdraft (in US Dollars)
 Prices are quoted in Australian Dollars.
 Please Incl. Air Parcel Post charges.
 Shipment will be made within 1 week.
 All merchandise guaranteed.

LINEAR		
LM301AH	\$.35
LM301AN		.28
LM304H		.75
LM307N		.25
LM308AH		2.00
LM308H		.75
LM308N		.75
LM309H		.75
7805KC		.95
LM311D		1.90
LM311N-8		.40
LM312H		1.00
LM317H		1.80
LM317K		3.00
LM318H		1.30
LM318N		1.25
LM320H		
5,6,8,12,15,18,24V		.75
LM320K		
5,6,12,15,18,24V		1.00
LM320T		
5,12V		1.00
LM323K		6.50
LM324N		.80
LM339N		.60
LM340K		
5,12,18,24V		1.30
LM340T		
5,6,12,15,18,24		.95
LM380N		.85
LM381N		1.20
LM387N		.40
LM555CN		.40
LM567CN		1.25
LM723CH		.55
LM741CH		.32
LM741CN		.30
LM747CH		.62
LM1458CH		.50

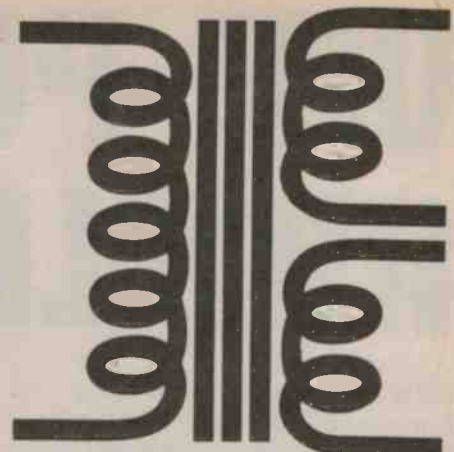

GENERAL PURPOSE TRANSFORMERS TO SUIT EVERY PROJECT WITH TWIN SECONDARIES FOR GREATER VERSATILITY...



5VA P.C.B. MOUNTING

SERIES	PARALLEL		TYPE	
	V	A		
6	.83	3	1.67	PL6/5VA
9	.56	4.5	1.11	PL9/5VA
12	.42	6	.83	PL12/5VA
15	.33	7.5	.67	PL15/5VA
18	.28	9	.56	PL18/5VA
24	.21	12	.42	PL24/5VA
30	.17	15	.33	PL30/5VA

20VA CHASSIS MOUNTING

12	1.67	6	3.33	PL12/20VA
15	1.33	7.5	2.67	PL15/20VA
18	1.11	9	2.22	PL18/20VA
24	.83	12	1.67	PL24/20VA
30	.67	15	1.33	PL30/20VA
40	.5	20	1.0	PL40/20VA
50	.4	25	.8	PL50/20VA

40VA CHASSIS MOUNTING WITH TAPS

Vs	15, 13.5, 12, 9, 3	2.67A	PL15/40VA
Vp	7.5, 6, 1.5	5.33A	
Vs	30, 27, 24, 18, 6	1.33A	PL30/40VA
Vp	15, 12, 3	2.67A	
Vs	50, 45, 40, 30, 10	0.8A	PL50/40VA
Vp	25, 20, 5	1.6A	
Vs	30V at 0.5A and 9V at 3A		PL30-9/40VA
Vp	15V at 1.A and 9V at 3A		

60VA CHASSIS MOUNTING WITH TAPS

Vs	30, 27, 24, 18, 6	2A	PL30/60VA
Vp	15, 12, 3	4A	
Vs	50, 45, 40, 30, 10	1.2A	PL50/60VA
Vp	25, 20, 5	2.4A	
Vs	80, 70, 60, 50, 20	.75A	PL80/60VA
Vp	40, 30, 10	1.5A	

Available from Electrical Wholesalers or contact:



FERGUSON TRANSFORMERS PTY. LTD.
 331 High Street, Chatswood, NSW. 2067
 Tel: 407-0261 Telex: AA25728

INTERNATIONAL COMPONENTS SALES

5220 West El Segundo Blvd. • Hawthorne, California 90250 U.S.A.
 Phone: (213) 679-8125 Telex: 673268

VHF POWER AMPLIFIERS

Final part of the VHF power amp saga by Roger Harrison VK2ZTB, and Phil Wait VK2ZZQ – and this is where the story really ends, that is the way it is, sometimes.

140 W Microstrip 2 Meter Amplifier

With the introduction of larger VHF transistors it is now possible to construct relatively simple high power amplifiers. The circuit of Fig. 17 shows a 140 W output amplifier using two CTC BM 70-12 transistors. The transistors are used in parallel with separate input and output circuits of 25Ω impedance, the two circuits combining to make a 12.5Ω impedance point at C13 and C14.

Stabilization is accomplished by using collector to base feedback networks which have a low impedance to low frequencies applying large negative feedback to prevent oscillations.

Current sharing between the devices is improved by tying the devices together at a high impedance point (relative to the transistor impedance) along the line (12.5 ohms) and tying the bases and collectors together with 15 ohm resistors, R3 and R4.

Underwood metal clad mica capacitors are used throughout because of their low series inductance and high current capacity. They cannot be substituted. Elmenco trimmers are used for C13 and C14. These were not variable in the original design but were found necessary to optimise the matching at two metres.

Bias can be applied for linear operation using one of the bias circuits described in November and 140 watts pep can be achieved before flat topping.

Construction

The pc board layout is shown on page 75. This layout will work for G-10 glass filled epoxy board with a thickness of $.062" = 1.6\text{mm}$. Other types of pc board can be used, however, microstrip line length and widths will have to be corrected! The pc board has copper foil on both sides. One side is etched to form the pattern and the other side is used as a ground plane.

The recommended assembly procedure follows:

1. Trim the board to size.
2. Punch or drill 10 tap holes for 6BA screws (no. 43 drill). Hole centres shown as small dots on the pc layout.

part 3

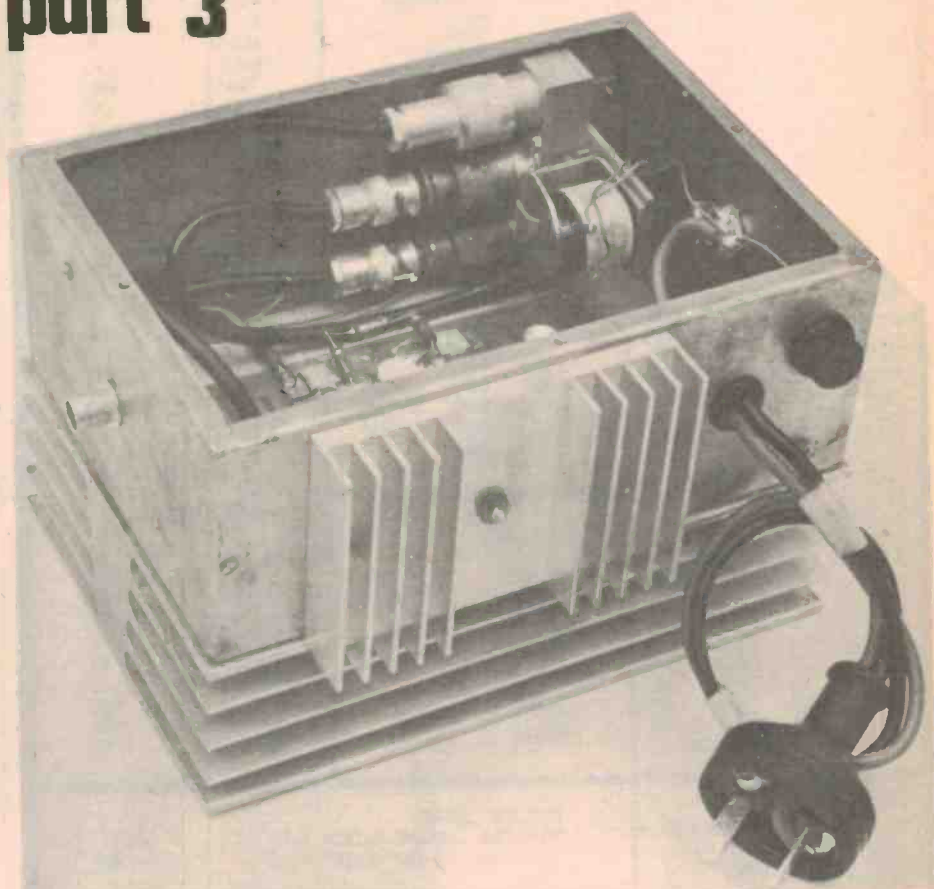

Overall view of the 10 W to 140 W amplifier used for 2 m mobile operation. Note size of the main heatsink – designed for continuous operation! Heatsink for the ET1 716 driver in the foreground. Mounted on the inside back panel is the changeover relay. The fuse holder proved inadequate for the job as around 25 amps is pulled from the car battery when you hit the button!

3. Use the pc board for a template and lay it on the heat sink. Drill 8 pilot holes into the heatsink using the previously drilled holes in pc board as guides. Drill one in each corner and one in each side of the device mounting hole. Drill out centre holes where the transistors mount.
4. Tap the 8 heatsink holes for 6BA screws.
5. Use a file to clear the mounting hole for the BM70-12 flange. Check transistor for flange dimension.
6. Use 10 mil copper shim stock to connect top side ground points to

the ground plane (bottom side). Make one ground plane connection under each emitter lead. Two additional ground plane connections are made by folding the shim stock over the edge of the board to ground the case of C15 and C18.

7. Study photograph very carefully. first, mount the BM70-12 into position. Locate the shunt capacitors as shown in the photograph and spot solder the case to ground. Remove the BM70-12 and mount copper straps L1 and L2. Notice that these straps mount on top of the capacitor

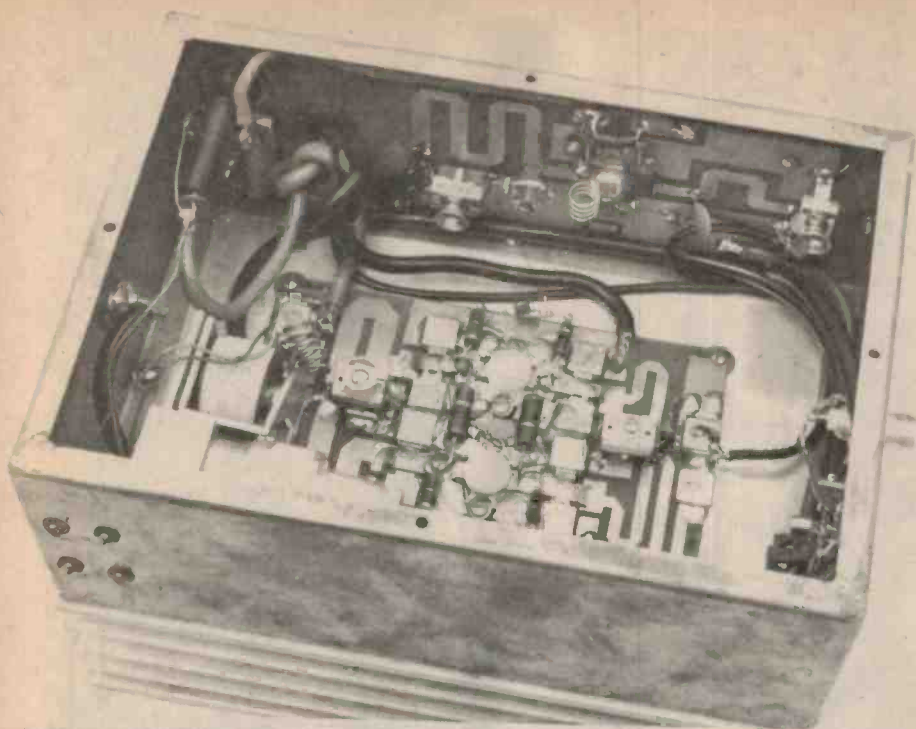

Inside view of 10 W to 140 W broadband power amplifier used on 2 m band. Input on the right, output on the left. The ETI 716 drives the 140 W output broadband amplifier utilising two BM70-12's. By a fortunate accident, the ETI 716 pc board was made laterally reversed! Simplified cabling arrangements. The carrier-operated switching and bias circuits are located on a small board on the lower right.

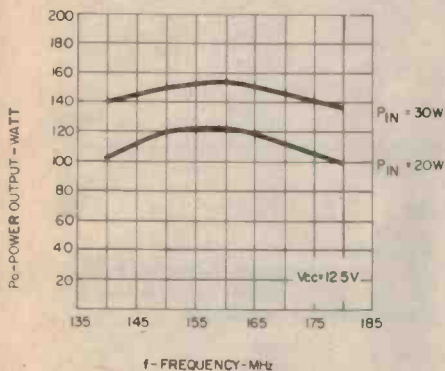

leads and the base and emitter leads will mount on top of the straps. Solder all capacitors and straps carefully to avoid shorts. Mount the BM70-12 and solder its leads near the cap. Repeat Step 7 for Q2.

- Mount remaining shunt capacitor and miscellaneous components as shown in photograph.

Performance

The power bandwidth is shown on the graph. The performance at 146 MHz was improved by making C13 and C14 variable.

Power output — 140 watts
 Power input — 30 watts
 Efficiency — 50%
 Supply voltage — 12.5V

Supply current — 23 amps
 Max supply voltage — 16.0V
 Spurious — better than 60dB down

This amplifier is fully protected against infinite VSWR. In fact a 10 mm spark can be drawn from the output terminal to a key ring with the antenna removed. We did it and the amp still worked!

Using the ETI 716 and the 140 W Amp
 How about 140 watts output mobile? The ETI 716 was mounted in the same case as the 140 W amp and used to drive it. See Fig. 18.

A coax relay was used on the output with diode switching on the input. The $\frac{1}{4}\lambda$ coax line was used with the delay which shorted the unused contacts to earth on transmit, therefore shorting the end of a $\frac{1}{4}\lambda$ line which reflects an open circuit at the amplifier input. The exact length of this line will have to be measured with an impedance meter or by cut and try method due to the effects of the coax fittings into the relay and the length of line inside the relay itself to the shorting contacts.

If a shorting type relay is not available, normally open contacts can be used with a $\frac{1}{2}\lambda$ line which again reflects an open circuit at the amplifier input. This line must also be measured in situ due to the effects of the relay.

Switching

A carrier operated relay circuit is included in Fig. 18. A small portion of the drive signal is tapped off via the 1pF capacitor, rectified and used to drive the BC109-179 pair which switches the coax relay. A delay is introduced if the 10 μ F capacitor is switched in giving fast-attack slow-delay switching for SSB use. This simple circuit is very effective and will operate on less than a watt input.

Heatsinks

Heatsink requirements for these amplifiers depend on the type of service. However maximum heatsink temperature should not be allowed to rise above 100°C from a 30°C ambient.

For the ETI 716 amplifier the recommended heatsink would be better than 2.3°C/watt rating — for the 140 watt amplifier better than 0.5°C/watt.

$$H.S. = \frac{\Delta T^{\circ}C}{\text{power dissipated (watts)}}$$

Always use heat conducting compound between the transistor and the heatsink and be sure that the heatsink is perfectly smooth and flat.

Parts List

C1, C3	two each 68p or 69p metal-clad mica caps.
C2, C4	two each 200p metal-clad mica caps.
C5, C7	two each 100p metal-clad mica caps.
C6, C8	two each 68p metal-clad mica caps.
C9, C11	1500p redcap or hi-k ceramic
C10, C12	1 μ 35V DC tantalum (metal-case type)
C13, C14	40p Elmenco mica compression trimmer in parallel with 25 to 47p metal clad mica cap. — or 115p Elmenco trimmer.
C15, C18	33p metal-clad mica caps.
C16, C17	300p metal-clad mica caps
R1, R2	15 ohm $\frac{1}{2}$ W resistors
R3, R4	15 ohm 1W resistors
RFC1	0.33 μ H moulded RFC.
RFC2, RFC3	0.15 μ H moulded RF chokes
RFC4	6 turns, 18g tinned or enamel wire, 6mm i.d., 15mm long.
L1, 2, 3, 4	copper strap, 5mm wide x 20mm long x 0.4mm thick (0.2 x 0.75 x 0.015 mil)
Q1, Q2	CTC BM70-12.

VHF POWER AMPLIFIERS

What Next?

The last 10 years or so have seen the introduction of commonly available RF power transistors to 150 W power output and others that operate to 3000 – 4000 MHz.

The next generation of devices are likely to be VMOS power FETS. Already available is a device which gives 20 watts output at 160 MHz, has a gain of 15dB, a drain impedance of around 60 ohms, is completely indestructible, can be used in a broadband circuit flat from 30 – 250 MHz and if that's not enough can be used for the front end transistor as well with a noise figure of 2.4dB!

Acknowledgements

The authors wish to thank Sydney University Department of Electrical Engineering for their help in providing much of the test equipment used. We would also like to thank Ian Little of Ampec Engineering for generously supplying us with the VHF power amp evaluation kits and copious amounts of data on the CTC range of transistors used in these projects.

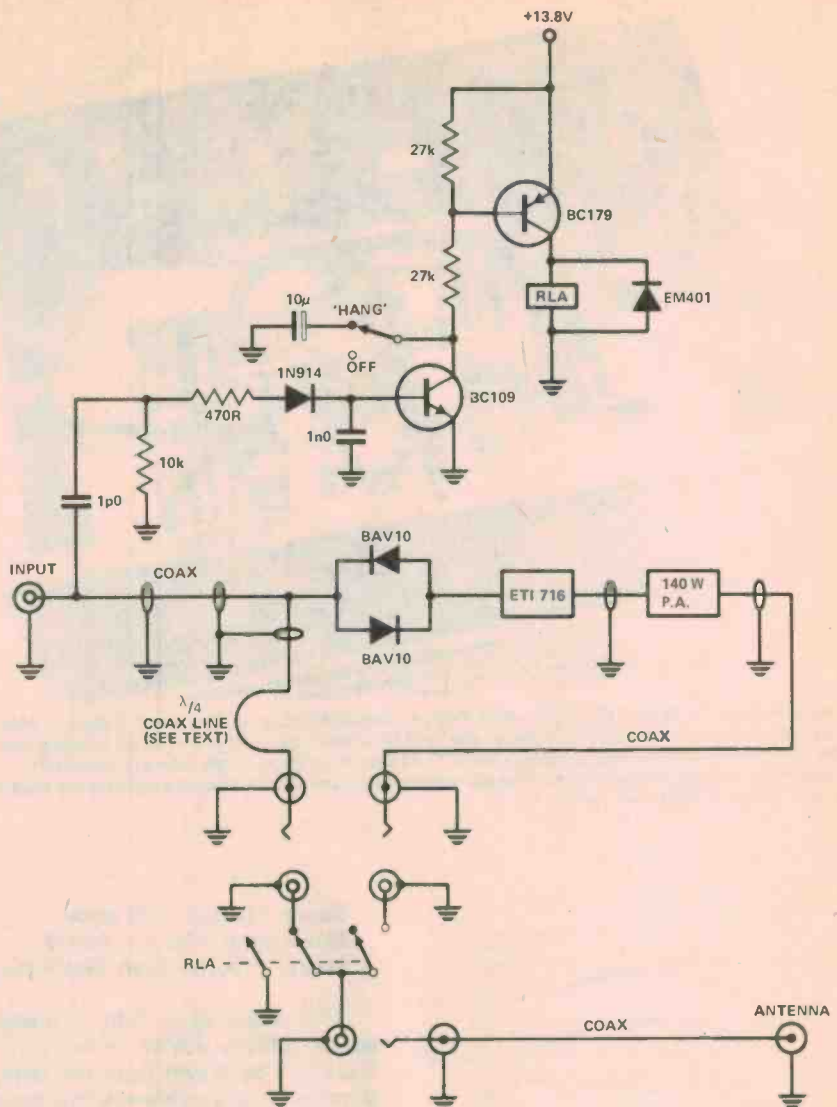
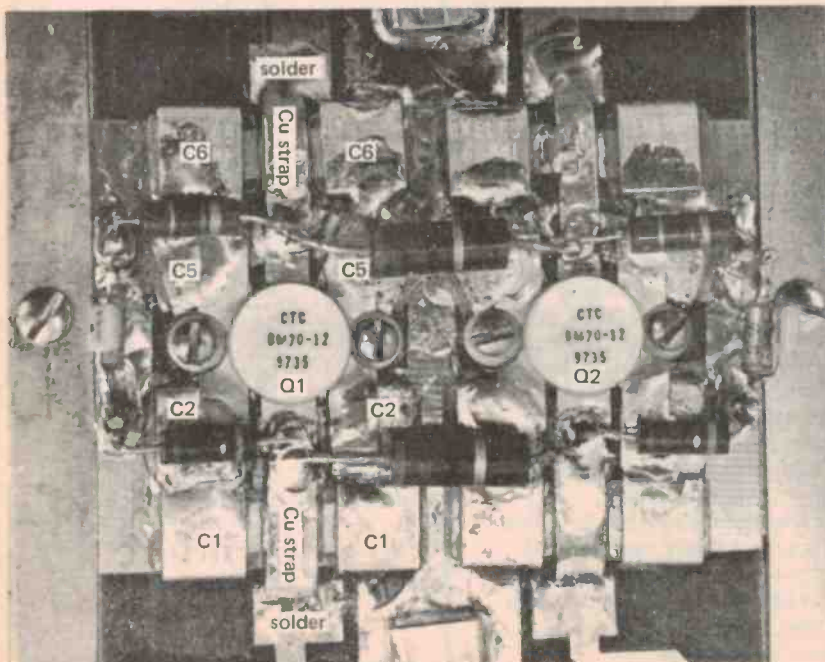

Figure 18.
The carrier-operated relay switching circuit for the 10W to 140W mobile power amplifier. Construction is non-critical.



Pix 6
Close view of portion of the 140W amplifier showing mounting of the transistors, metal-clad mica capacitors and small components.

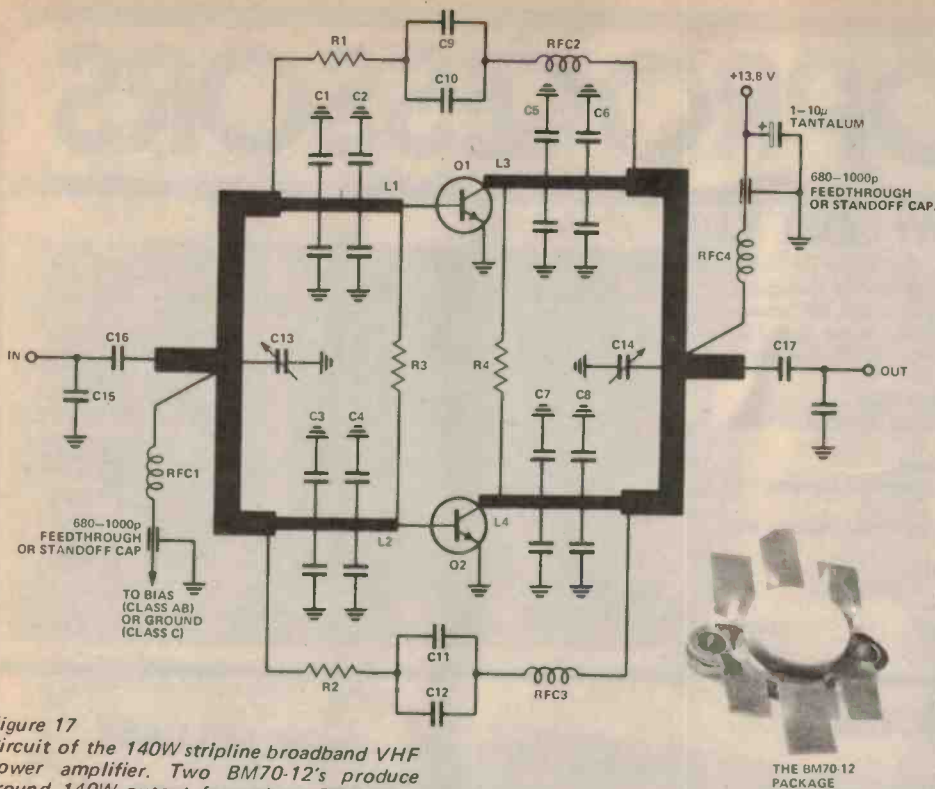

Figure 17
Circuit of the 140W stripline broadband VHF power amplifier. Two BM70-12's produce around 140W output from about 25W drive. Bandwidth extends from 140 to 180 MHz. Construction is illustrated in the photographs. The DC input power may be reduced by simply reducing drive power or the DC supply voltage.

References

Not a definitive list, but certainly 'required reading'.

1. "Matching Network Designs with Computer Solutions", by Frank Davis; Motorola Applications Note AN-267.
2. "Practical VHF and UHF Coil-Winding Data", by Donald Kochen, K35VC; 'Ham Radio', April 1971, pp. 6-14.
3. "Solid State Two-Metre FM RF Power Amplifiers", by Arthur R. Hall, W4CGC; 'Ham Radio', April 1973.
4. "Mounting Stripline-Opposed-Emitter (SOE) Transistors", by Lou Danley; Motorola Applications Note AN-555.
5. "Transmitter Power Amplifier Design", by W.P. O'Reilly; Wireless World, September-October-November 1975 - January 1976.
6. "40 Watt, 12 Volt VHF Broadband Power Amplifier", by Robert Artigo, CTC Applications Note 2.1.8.4D.
7. "140 Watt, 12 Volt VHF Broadband Power Amplifier", by Robert Artigo, CTC Applications Note 2.1.8.4E.
8. "Microstrip Transmission Line", by James R. Fisk, WIHR; 'Ham Radio', January 1978, pp. 28-37.

THE BM70-12 PACKAGE

C.B.

TRANSCEIVERS AND ACCESSORIES

S.S.B.
COBRA
JOHNSON VIKING
HY-GAIN
X-TAL
COURIER
PANTHER

A.M.
COBRA 21
COBRA 26
SIDEWINDER 111
PANASONIC
A.M.-F.M.-C.B.

ALSO AVAILABLE
FULL RANGE OF
ANTENNAS S.W.R.
METERS. PLUGS,
SOCKETS AND
CABLE.
FROM THE NORTHS
LARGEST SUPPLIER
OF C.B. EQUIPMENT

Ron Chapman Hi-Fi Centre pty Ltd.,

880 Hunter Street, Newcastle West. 2302. Phone 69-2733 - 69-2796

MICROPROCESSORS

NEW RELEASE

LOW COST V.D.U.

(E.A. FEB/MARCH 1978)

Based on a clever design by Michael O'Neill of Newcastle Uni., this compact module is an ideal terminal for micro-processor users. The heart of the terminal is the E.A. 100 V.D.U. as described in E.A. February, 1978. Exclusive features of our kit include —

- ☆ Top quality P.C.B. with plated through holes.
- ☆ Step by step Assembly Manual complete with waveforms and detailed circuit description.
- ☆ 4.43 MC. Xtal and trimmer cap supplied.
- ☆ Sockets for memories and character generator (to simplify setting up).
- ☆ Low power drain — uses low power Schottky devices, not standard TTL.
- ☆ Full service backup — details with kit.

E.A. 100 V.D.U. (Complete kit) **\$99.50**

OPTIONS	
KB04 PROFESSIONAL KEYBOARD	\$59.50
ENCODER/UART (See E.A. March)	\$32.00
MODULATOR/POWER SUPPLY	\$22.50

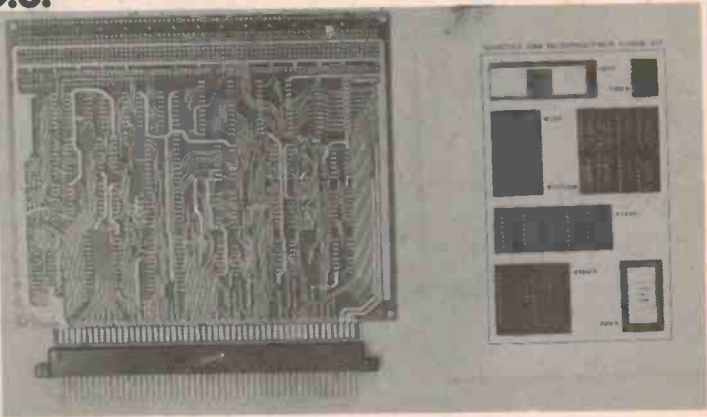

KB04 Professional Keyboard



KB04 UNIVERSAL KEYBOARD	\$59.50
KB05 NUMBER PAD	\$16.50
KB06 CURSOR CONTROL	\$7.50
KB10 MATCHING BLANK SWITCHES	\$2.00

NEW RELEASE

We have now available a superior quality keyboard with UNIVERSAL ENCODING. This exclusive feature makes the keyboard ideal for software scanning or use with any keyboard encoder. It is ideal for the E.A. 100 V.D.U. and eliminates the tedious switch to switch wiring associated with other unencoded keyboards.

The KB04 is laid out in ASR33 format and includes two user defined keys.

A matching number pad KB05 is also available, as well as cursor control set KB06 and spare key switches (KB10).

2650 Micro Computer

Now that you have the low cost terminal, you should consider the 2650 for your own microprocessor system. The 2650 is easy to learn to program, simple to use and features a powerful instruction set and a rapidly growing wealth of software support.

Using the kits detailed below you can readily expand your 2650 as your requirements and budget permit. The end result is probably the most cost effective home computer available in Australia to-day.

All systems are supplied with the incredibly effective PIPBUG operating system which handles all serial communication with the 2650, enables you to examine and modify address locations, set the registers, set breakpoints and also include a powerful routine that loads and dumps programs using a standard cassette tape.

BABY 2650 — STARTER KIT	\$75.00
B2650/KT9500 CONVERSION KIT	\$142.00
KT9500 FULLY BUFFERED KIT	\$199.00
KT9500 MOTHER BOARD with COMPONENT KIT (2650 RSMB)	\$35.00
RAM STICKS 1K x 8 MEMORY MODULES	\$25.50
2650 USERS GROUP	\$40.00

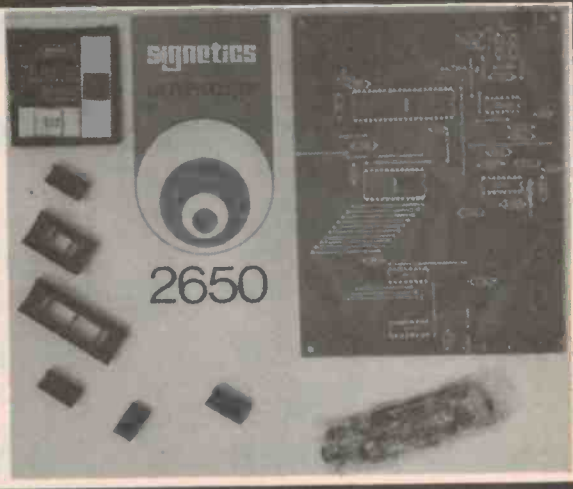

**APPLIED
TECHNOLOGY
PTY. LTD.**

POSTAGE \$2.50 CERTIFIED PER ORDER

POSTAL ADDRESS P.O. Box 355, Hornsby, 2077

SHOWROOM 109-111 Hunter St., Hornsby 2077
(9-5 Monday to Sat)

PHONE 476 4758 — 476 3759





**APPLIED
TECHNOLOGY
PTY. LTD.**

ELECTRONIC COMPONENTS BY POST

Linear

301	.75	4511	2.45	74121	.75
307	.90	4518	2.45	74123	1.05
308	2.00	4520	2.45	74150	2.50
311	2.20	4528	1.65	74151	1.70
324	1.75	4556	2.20	74153	1.55
339	1.40	14553	8.50	74154	2.50
349	2.25	74C00	.45	741157	1.70
379	7.50	74C02	.45	74160	2.20
380	2.60	74C04	.45	74164	2.30
381	2.60	74C08	.45	74165	2.30
382	2.60	74C10	.45	74173	2.75
386	1.95	74C14	2.45	74192	2.20
555	.60	74C48	3.00	74193	2.20
556	1.95	74C73	1.10	74221	2.20
565	2.00	74C75	1.15	74LS00	
566	2.20	74C76	1.40	74LS00	.45
567	2.50	74C89		74LS01	.45
709	.65	74C90	3.00	74LS02	.45
741	.50	74C93	3.00	74LS03	.45
3900	1.25	74C192	3.20	74LS04	.45
3089	2.80	74C193	3.20	74LS05	.45
1310	3.20	74C221	2.45	74LS08	.45
TCA 220	2.00			74LS09	.45
SAK 140	2.75			74LS10	.45
UAA 170	3.50	7400		74LS11	.45
UAA 180	2.50	7400	.35	74LS12	.45
50 242	15.00	7401	.35	74LS14	2.40
CA3130	1.85	7402	.35	74LS20	.45
		7403	.35	74LS21	.45
		7404	.35	74LS27	.49
		7405	.35	74LS28	.49
		7406	.70	74LS30	.45
		7407	.70	74LS32	.55
		7408	.35	74LS37	.70
		7409	.35	74LS38	.70
		7410	.35	74LS40	.70
		7411	.45	74LS42	1.80
		7413	.70	74LS73	.75
		7414	2.20	74LS74	.65
		7416	.68	74LS75	1.10
		7417	.65	74LS78	.65
		7420	.35	74LS85	2.50
		7426	.55	74LS86	.70
		7427	.45	74LS90	1.65
		7430	.35	74LS92	1.65
		7432	.45	74LS93	1.65
		7437	.65	74LS109	1.65
		7438	.65	74LS113	.75
		7440	.35	74LS114	.75
		7441	1.20	74LS138	2.50
		7442	1.20	74LS154	2.75
		7447	2.10	74LS151	2.20
		7448	2.10	74LS157	2.40
		7450	.35	74LS163	2.70
		7451	.35	74LS164	2.30
		7453	.35	74LS174	2.30
		7454	.35	74LS175	2.30
		7460	.35	74LS181	2.30
		7470	.70	74LS191	2.95
		7472	.65	74LS192	2.95
		7473	.70	74LS193	2.95
		7474	.65	74LS194	2.40
		7475	1.00	74LS195	2.40
		7476	.70	74LS196	2.40
		7480	1.20	74LS221	2.20
		7482	1.60	74LS253	2.20
		7483	1.75	74LS365	1.75
		7485	2.40	74LS367	1.75
		7486	.65	74LS368	1.75
		7489	4.20		
		7490	.90		
		7491	1.50		
		7492	.95		
		7493	.95		
		7494	1.80		
		7495	1.80		
		74100	2.90		
		74107	.69		

CMOS.

4000	.35	7405	.35	74LS28	.49
4001	.35	7406	.70	74LS30	.45
4002	.35	7407	.70	74LS32	.55
4006	2.35	7408	.35	74LS37	.70
4007	.39	7409	.35	74LS38	.70
4008	2.10	7410	.35	74LS40	.70
4009	1.00	7411	.45	74LS42	1.80
4010	1.00	7413	.70	74LS73	.75
4011	.35	7414	2.20	74LS74	.65
4012	.45	7416	.68	74LS75	1.10
4013	.85	7417	.65	74LS78	.65
4014	2.50	7420	.35	74LS85	2.50
4015	2.20	7426	.55	74LS86	.70
4016	1.00	7427	.45	74LS90	1.65
4017	2.20	7430	.35	74LS92	1.65
4018	2.50	7432	.45	74LS93	1.65
4019	1.35	7437	.65	74LS109	1.65
4020	2.60	7438	.65	74LS113	.75
4021	2.60	7440	.35	74LS114	.75
4022	2.40	7441	1.20	74LS138	2.50
4023	.45	7442	1.20	74LS154	2.75
4024	1.90	7447	2.10	74LS151	2.20
4025	.45	7448	2.10	74LS157	2.40
4026	2.40	7450	.35	74LS163	2.70
4027	1.20	7451	.35	74LS164	2.30
4028	2.00	7453	.35	74LS174	2.30
4029	2.40	7454	.35	74LS175	2.30
4030	1.10	7460	.35	74LS181	2.30
4035	2.50	7470	.70	74LS191	2.95
4040	2.65	7472	.65	74LS192	2.95
4043	1.65	7473	.70	74LS193	2.95
4044	1.65	7474	.65	74LS194	2.40
4046	2.75	7475	1.00	74LS195	2.40
4049	1.00	7476	.70	74LS196	2.40
4050	1.00	7480	1.20	74LS221	2.20
4051	2.50	7482	1.60	74LS253	2.20
4060	2.85	7483	1.75	74LS365	1.75
4066	1.20	7485	2.40	74LS367	1.75
4068	.45	7486	.65	74LS368	1.75
4069	.45	7489	4.20		
4070	.45	7490	.90		
4071	.45	7491	1.50		
4081	.45	7492	.95		
4082	.45	7493	.95		
4416	1.35	7494	1.80		
4426	3.56	7495	1.80		
4449	.35	74100	2.90		
4510	2.45	74107	.69		

ELECTROLYTIC CAPACITORS

		1	10 OFF		1	10 OFF
.47	63vw	.22	.20	220	25vw	.70 .62
1	63vw	.22	.20	220	35vw	.75 .70
2.2	63vw	.22	.20	220	63v	.85 .75
3.3	63vw	.26	.23	330	16v	.55 .50
4.7	63vw	.26	.23	330	25v	.80 .72
10	25vw	.26	.23	330	63v	.85 .75
10	63vw	.28	.25	470	16v	.65 .60
25	25vw	.28	.25	470	25v	.85 .75
25	63vw	.35	.30	470	35v	.90 .80
33	16vw	.26	.23	470	63v	.95 .85
33	25vw	.28	.25	1000	16v	.75 .66
47	16vw	.26	.23	1000	25v	.95 .85
47	25vw	.30	.27	1000	63v	1.80 1.60
47	63vw	.45	.40	2500	16v	1.00 .90
100	16vw	.28	.25	2500	25v	1.40 1.20
100	25vw	.33	.30	2500	35v	1.65 1.45
100	63vw	.55	.50	2500	50v	2.00 1.80
220	16vw	.45	.40	4700	35v	2.50 2.30

VOLTAGE REGULATORS

309K	+5v, 1A	\$2.00
317	+3-30v ADJ	3.50
323	+5v 3A	8.95
325	± 15v 100mA	3.75
7805	+5v 1A	1.95
7806	+6v 1A	1.95
7808	+8v 1A	1.95
7812	+12v 1A	1.95
7815	+15v 1A	1.95
7818	+18v 1A	1.95
7824	+24v 1A	1.95
78L05	+5v 100mA	.75
78L12	+12v 100mA	.75
78L15	+15v 100mA	.75
79L05	-5v 100mA	.90
79L12	-12v 100mA	.90
79L15	-15v 100mA	.90
723	Adjustable	1.20
7905	-5v 1A	2.70
7912	-12v 1A	2.70
7915	-15v 1A	2.70

POLYESTER GREENCAPS 100V VALUES IN mfd

.001, .0012, .0015, .0022, .0027, .0033	
.0041, .0056, .0068, .0082, .01, .012	.15
.022, .027, .033, .047, .056, .082	
.01, .012, .015, .018, .022, .027, .033	
.039, .047, .056, .068, .082	.20
0.1, 0.22	

TAG TANTALUM VALUES IN mfd 25U W

.1, .22, .33, .47, 1, 1.5, 2.2, 3.3	.40
4.7, 6.8, 10	
22, 33, 47	.45
100/25v	.50

DIODES

OA91	Germanium	.20
IN914	Silicon	.10
IN4004	1A/400v	.11
A15A	3A/100v	.75
MD3501	35A/100v Bridge	3.80
MD3504	35A/400v Bridge	4.80
400mW Zeners	3.3, 4.7, 5.1, 5.6, 6.2, 6.8, 8.2, 10, 12, 15, 18, 20	.30

POTENTIOMETERS

Available in values of:
1kΩ, 5kΩ, 10k, 25k, 50k, 100k, 500k, 1mΩ

SINGLE GANG	Linear	.70
	Logarithmic	.70
DUAL GANG	Linear	1.40
	Logarithmic	1.40
TRIMPOTS	Linear	.30

I.C. SOCKETS

LOW PROFILE SOLDER

8 pin	.35
14 "	.40
16 "	.45
18 "	.55
22 "	.85
24 "	.90
28 "	1.20
40 "	1.60

WIRE WRAP

14 pin	.60
16 pin	.65
Posts 19mm 10 for .40	

CAPACITORS

CERAMIC DISC 50V

1pF to 82pF	.10
100pF to .047μF	.10
0.1μF	.15

RESISTORS

1/4w	1Ω to 10MΩ	5c
1/2w	1Ω to 10MΩ	5c
1w	1Ω to 1MΩ	8c

SCR'S, TRIACS & DIACS

C106Y1	30v 4A SCR	1.00
C106D1	400v 4A SCR	1.50
C122D	400v 8A SCR	2.00
SC141	400v 6A Triac	2.00
ST4	Diac	.75

TRANSISTORS

BC107/547	.25	BC639	.80	BF160	1.20	2N6577	2.50
BC108/548	.25	BC640	.80	MU10	.65	2N3442	3.60
BC109/549	.25	BD137	.85	MJ2955	1.95	40A11	4.00
BC177/557	.25	BD138	.85	BD266	2.50	2N3638	50
BC178/558	.25	BD139	1.00	BD267	2.50	PN3643	55
BC179/559	.25	BD140	1.00	2N3055	1.00	2N3644	55
						2N2646	1.85
						MPSA12	.80
						MPSA14	.90
						MJE340	1.75
						BC327	.45
						MPF131	1.20

POSTAL ORDERS TO P.O. Box 311, Hornsby 2077
SHOWROOM 109-111 Hunter St., Hornsby
PHONE 476-4758 HOURS 9-5 Mon. to Sat.
476-3759

* MINIMUM ORDER \$5.00
* Please add \$1.00 towards post & packaging
Prices subject to change after 31/3/78
* WE ALSO STOCK

Micro Processor Components
Magazine Printed Circuit Boards
- details on request

</

THE SN76477 is a bipolar/1²L device that provides a noise source, VCO, low frequency oscillator, envelope generator, plus various mixing and control logic on a single 28 pin DIL package. By the connection of appropriate external components and application of logic level control signals a wide variety of complex sounds can be synthesized. The design of the SN76477 allows for maximum user flexibility and the device should prove useful in applications requiring audio feedback to an operator (home video games, toys, timers, alarms, etc.)

The block diagram in Fig. 1 shows the main circuit blocks, each of which is described in detail below.

SLF (Super Low Frequency Oscillator)

The SLF can be operated in the range 0.1-30 Hz, the specific frequency is determined by a control resistor connected to pin 20, and a capacitor connected to pin 21. The frequency being given by the following equation:

$$F_{SLF} = \frac{0.64}{R_{SLF} C_{SLF}} \text{ Hz}$$

VCO (Voltage Controlled Oscillator)

The VCO provides an output whose frequency is dependent upon a voltage fed to its input, the higher the voltage the lower the frequency. The control voltage may be either the SLF output, or an external voltage applied to pin 16, the SLF output being selected when the voltage applied to pin 22 is a logic '1', and the external source when pin 22 is at logic '0'.

The "range" of the VCO is internally set at a ratio of 10:1. The minimum VCO frequency is determined by a control resistor connected to pin 18 and a capacitor to pin 17. This minimum frequency is given by the equation:

$$F_{MIN VCO} = \frac{0.64}{R_{VCO} C_{VCO}} \text{ Hz}$$

The "pitch" of the VCO's output is changed by varying the duty cycle of the output. This is achieved by adjusting the ratio of the voltages at pins 16 and 19. The duty cycle is given by the following equation:

$$\text{VCO Duty Cycle} = 0.5 \left[\frac{V_{pin 16}}{V_{pin 19}} \right] \%$$

leaving pin 19 high produces an output with 50% duty cycle.

Noise Oscillator

The "noise oscillator" supplies random frequencies for the "noise generator". The noise oscillator requires a 43 k resistor to ground at pin 4. The "noise oscillator" controls the rate of the "noise generator". An external noise oscillator may be used to provide this control. The external source is applied to pin 3 and provides an automatic override of pin 4.

VOLTAGE FED TO VCO

RESULTING VCO OUTPUT WAVE FORM

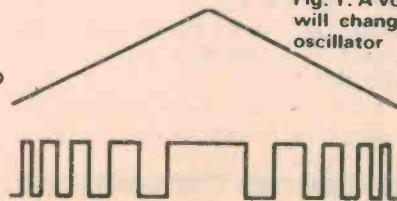

TABLE 1

MIXER SELECT C	MIXER SELECT B	MIXER SELECT A	MIXER OUTPUT
PIN 27	PIN 25	PIN 26	
0	0	0	VCO
0	0	1	SLF
0	1	0	NOISE
0	1	1	VCO/NOISE
1	0	0	SLF/NOISE
1	0	1	SLF/VCO/NOISE
1	1	0	SLF/VCO
1	1	1	INHIBIT

Noise Generator/Filter

The output of the "noise generator" feeds an internal noise filter. This "rounds off" the generator's output, reducing the HF content of the noise. The upper 3 dB point is given by

$$F_{UPPER} = \frac{1.28}{R_{NF} C_{NF}}$$

where R_{NF} and C_{NF} are external components connected to pins 5 and 6 respectively.

Mixer

The "mixer" logic selects one, or a combination, of the inputs from the SLF, VCO and noise generator. Selection is according to Table X.

System Enable Logic

The "system enable" input provides an enable/inhibit for the system output. The output is inhibited when the voltage at pin 9 is a logic '1', and enabled when logic '0'.

One Shot Logic

The "one shot" logic can be used to provide sounds of a short duration. The duration of the "one-shot" is given by the following equation.

Fig. 2. Showing the various envelopes that the SN 76477 circuitry can produce.

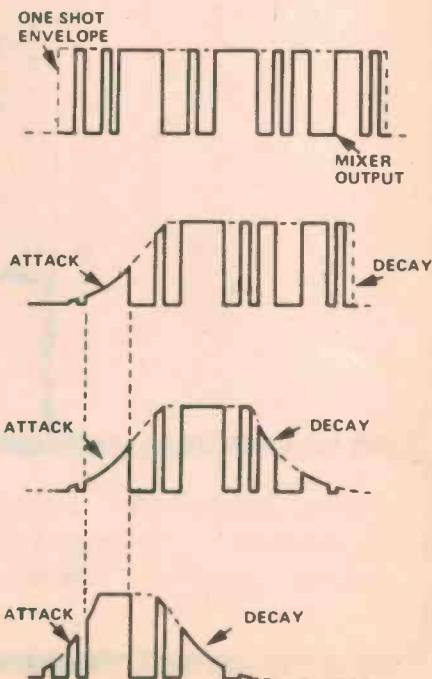

ABSOLUTE MAXIMUM RATINGS

AT TA = 25° C (Unless otherwise specified)

SUPPLY VOLTAGE, Vcc (1), PIN 15	6.0V
SUPPLY VOLTAGE, Vcc (2), PIN 14	12.0V
INPUT VOLTAGE APPLIED TO ANY DEVICE TERMINAL	6.0V
STORAGE TEMPERATURE	-65 C to +150 C
OPERATING TEMPERATURE RANGE	-55 C to +120 C
LEAD TEMPERATURE 1/16 INCH FROM CASE FOR 10 SECONDS	+260 C

RECOMMENDED OPERATING CONDITIONS

	MIN	TYP	MAX	UNITS
SUPPLY VOLTAGE, Vcc1, PIN 15	4.5	5.0	5.5	V
SUPPLY VOLTAGE, Vcc2, PIN 14	5.7	9.0		V
OPERATING FREE-AIR TEMPERATURE	0	25	70	C

OPERATING CHARACTERISTICS AT TA = 25° C AND Vcc1 = 5.0V

Fig. 1. A voltage fed to the input of the VCO will change the output frequency of this oscillator

SOUND EFFECTS GENERATOR

Fig. 3. Block diagram

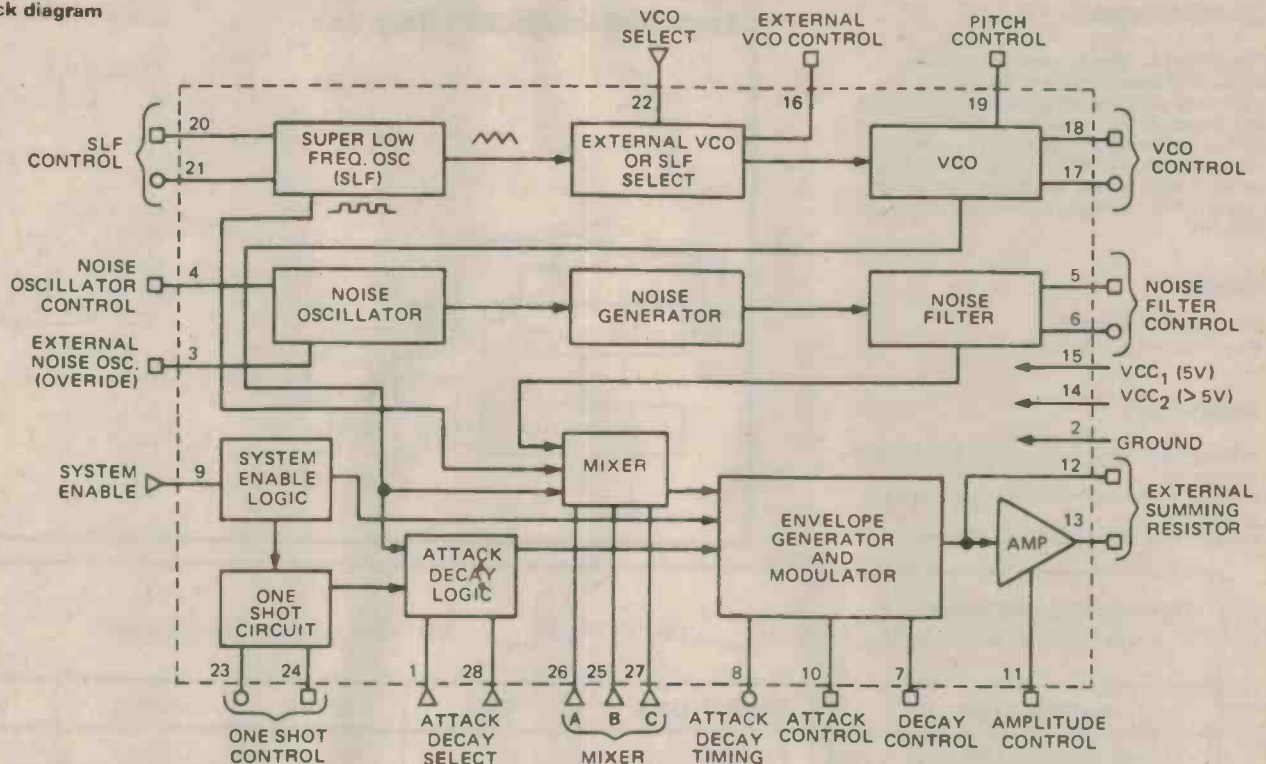

TABLE 2

AOL SELECT 1 PIN 1	AOL SELECT 2 PIN 28	OUTPUT
0	0	VCO
0	1	MIXER ONLY
1	0	ONE-SHOT
1	1	VCO WITH FLIP-FLOP

$$T_{OS} = 0.8 R_{OS} C_{OS}$$

where R_{OS} and C_{OS} are external components connected to pins 24 and 23 respectively. The maximum duration of the "one-shot" is about two seconds.

The "one-shot" logic is triggered by the trailing edge of the system enable logic control signal.

ADL (Attack/Decay Logic)

The ADL determines the envelope for the mixer's output. The envelope selected is

determined by the ADL control inputs to pins 1 and 28, the output selected being shown in Table 2.

Envelope Generator and Modulator

The attack/decay characteristics of the output are determined by the components connected to pins 7, 8 and 10.

The attack and delay times are given by the following:

$$T_{ATTACK} = R_A C_{A,D} \text{ secs}$$

$$T_{DELAY} = R_D C_{A,D} \text{ secs}$$

where $C_{A,D}$ is the attack delay capacitor connected to pin 8, and R_A and R_D are resistors connected to pins 7 and 10.

Output Amplifier

The output amplifier provides a low impedance output. The peak output voltage is determined by the following equation:

$$V_{OUT} = \frac{3.4 R_S}{R_G}$$

where R_S is a summing resistor connected to pins 12 and 13 (set equal to 10 k) and R_G is a gain resistor connected to pin 11.

Notes:

1. Supplies greater than 5V may be used, in which case they should be connected to pin 14 to allow the internal regulator to supply the internal circuit requirements.

2. For dedicated sound logic inputs (pins 1, 9, 22, 25, 26, 27 and 28) may be hard-wired to high or low logic levels.

ATTACK/DECAY SELECT 1 (INPUT)	1	28	ATTACK/DECAY SELECT 2 (INPUT)
GROUND	2	27	MIXER SELECT C (INPUT)
EXTERNAL NOISE OSCILLATOR (INPUT)	3	26	MIXER SELECT A (INPUT)
NOISE OSCILLATOR RESISTOR (INPUT)	4	25	MIXER SELECT B (INPUT)
NOISE FILTER CONTROL RESISTOR (INPUT)	5	24	ONE-SHOT CONTROL RESISTOR (INPUT)
NOISE FILTER CONTROL CAPACITOR (INPUT)	6	23	ONE-SHOT CONTROL CAPACITOR (INPUT)
DECAY CONTROL RESISTOR (INPUT)	7	22	VCOSELECT (INPUT)
ATTACK/DECAY TIMING CAPACITOR (INPUT)	8	21	SUPER LOW FREQUENCY OSC. CONTROL CAPACITOR (INPUT)
SYSTEM ENABLE INPUT	9	20	SUPER LOW FREQUENCY OSC. CONTROL RESISTOR (INPUT)
ATTACK CONTROL RESISTOR (INPUT)	10	19	PITCH CONTROL RESISTOR (INPUT)
AMPLITUDE CONTROL RESISTOR (INPUT)	11	18	VCOCONTROL RESISTOR (INPUT)
EXTERNAL SUMMING INPUT (RESISTOR)	12	17	VCOCONTROL CAPACITOR (INPUT)
EXTERNAL SUMMING OUTPUT (RESISTOR)/SYSTEM OUTPUT	13	16	EXTERNAL VCO CONTROL RESISTOR (INPUT)
VCC ₂ (GREATER THAN 5 V) (INPUT)	14	15	VCC ₁ (5 V) (INPUT)

ETI data sheet

MM5837 NOISE SOURCE

General description

The MM5837 digital noise source is an MOS/MSI pseudo-random sequence generator, designed to produce a broadband white noise signal for audio applications. Unlike traditional semiconductor junction noise sources, the MM5837 provides very uniform noise quality and output amplitude. The circuit is packaged in an 8-lead Epoxy-B mini-DIP.

Features

- Uniform noise quality
- Uniform noise amplitude

Applications

- Electronic music rhythm instrument sound generators
- Music synthesizer white and pink noise generators
- Room acoustics testing/equalisation

Logic And Connection Diagrams

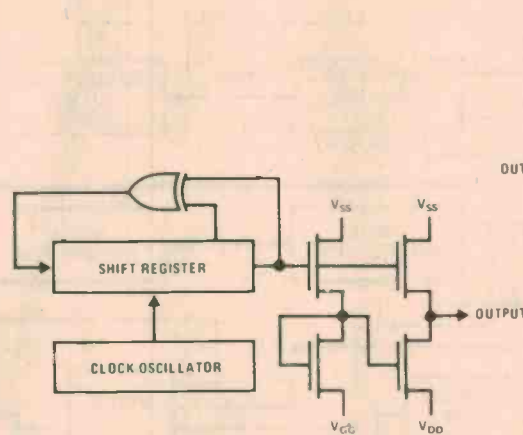

Dual-In-Line Package

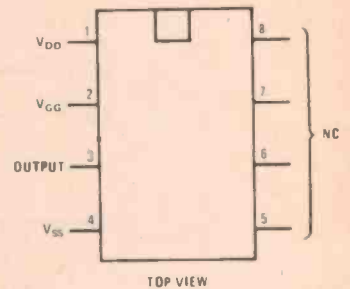

Electrical Characteristics

T_A within operating range, $V_{SS} = 0V$, $V_{DD} = 14V \pm 1.0V$, $V_{GG} = -27V \pm 2V$, unless otherwise noted.

PARAMETER	CONDITIONS	MIN	TYP	MAX	UNITS
Output (Loaded 20 k Ω to V_{SS} and 20 k Ω to V_{DD})	$T_A = 25^\circ C$				
Logical "1" Level		$V_{SS} - 1.5$		V_{SS}	V
Logical "D" Level		V_{DD}		$V_{DD} + 1.5$	V
Logical "0" Level	$V_{GG} - V_{DD}$	V_{DD}		$V_{DD} + 3.5$	V
Supply Currents	No Output Load				
I_{DD}		3		8	mA
I_{GG}				7	mA

Absolute Maximum Ratings At $T_a = 25^\circ C$ (Unless Otherwise Specified)

Supply voltage, V_{cc} (1), pin 15	6.0V
Supply voltage, V_{cc} (2), pin 14	12.0V
Input voltage applied to any device terminal	6.0V
Storage temperature	$-65^\circ C$ to $+150^\circ C$
Operating temperature range	$-55^\circ C$ to $+120^\circ C$
Lead temperature inch from case for 10 seconds	$+260^\circ C$

Recommended operating conditions	MIN	TYP	MAX	UNITS
Supply voltage, V_{cc1} , pin 15	4.5	5.0	5.5	V
Supply voltage, V_{cc2} , pin 14	5.7		9.0	V
Operating free-air temperature	0	25	70	$^\circ C$

Physical Dimensions

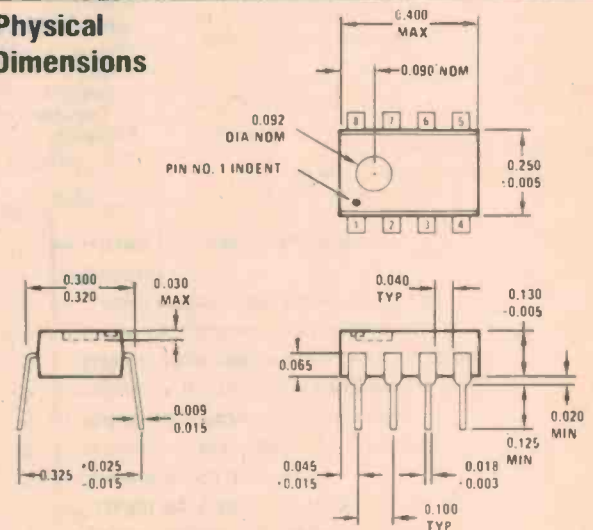

Moulded Dual-In-Line Package (N)
Order Number MM5837N

d.i.l. Reed Relays



GR108 SERIES DUAL IN LINE

GR108	A1	— 5 volt	1-9	\$2.60
GR108	A1	— 12 volt		\$2.60
GR108	A1	— 24 volt		\$2.60
GR108	C41	— 12 volt		\$4.95
GR108	C41	— 24 volt		\$4.95
GR208	AD24	— 24 volt		\$4.50



MZ SERIES RELAYS DUAL IN LINE

	Volts	Colour	Coil Resistance
MZ5H	5	Green	56 ohm
MZ9H	9	Red	180 ohm
MZ12H	12	Yellow	320 ohm
MZ24H	24	White	1230 ohm

MZ-Series **\$2.75 ea.**

DATA FOR ABOVE

Contact Ratings: 24V DC 1 amp max. or 100V AC .5 amp max.

Coil Rating: Nominal power consumption approx. 0.45 watts. Duty .1 watt at 20°C. DC continuous .048 watt at 50°C. Voltage range +10% and -30% of nominal voltage.

BLACK ANODIZED EXTRUDED TYPE

Ideal for mounting semiconductors required to dissipate large amounts of heat. Fluting provides greater heat dissipation. Flanges on base allow for mounting in any position, for natural or forced cooling. Supplied undrilled.

4"	\$2.50	\$2.25
6"	\$3.45	\$3.00
12"	\$4.75	\$4.00

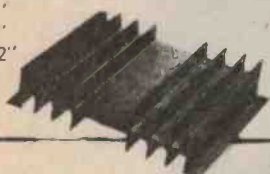

BH6 Square
Type 1015 6 cell
1-9 10 up
65c 60c



Ferrite Rod

This is the standard length aerial rod which is suitable for crossovers, tuners, etc.

FR1	8" x 3/8"	1-9	10 up
		75c	65c



Fuseholders

FH1 Panel Mounting
to hold 1/4" x 1/4"
3AG fuse. Mounting
hole 16 mm dia.
1-9 10 up
69c 65c

FH2 Panel Mounting
to take 20 x 5 mm
fuse. Mounting hole
13 mm dia.
1-9 10 up
69c 65c



Amplifier Cases

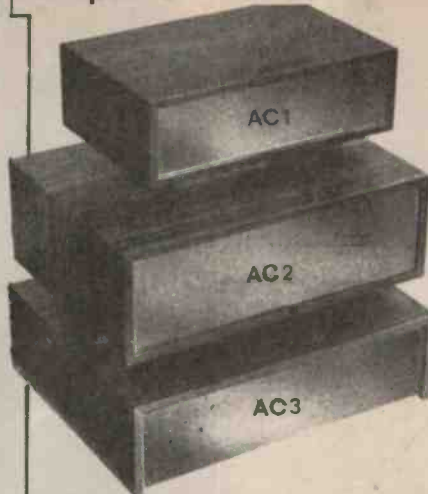

Length 300 mm
Width 195 mm
Depth 92 mm

Length 360 mm
Width 282 mm
Depth 110 mm

Length 380 mm
Width 295 mm
Depth 110 mm

Now comes complete with anodized aluminium front panel

Egg Insulator

For outdoor radio
aerials, stays, etc.

60c
ea.



MM52



MM51

Rubber Feet

Essential for fitting to base of chassis, amp. cabinets etc., and many other uses where protection is required.

MM51	12 mm dia.	8 per pkt	30c
MM52	15 mm dia	8 per pkt	34c
MM54	23 mm dia.	8 per pkt	44c

Stereo Dynamic Cartridge



Highest quality top brand. 5.5MW at 5.5 cms/sec, 20db channel separation, 47K ohms recommended load. 15Hz to 18kHz ± 4db, 2-3 grams tracking weight. Elsewhere \$24.95

Only \$14.95

Electrokit 10

3 watt Amplifier 4.5-15V supply. All parts including screened board.

\$5.25

Aluminium Chassis

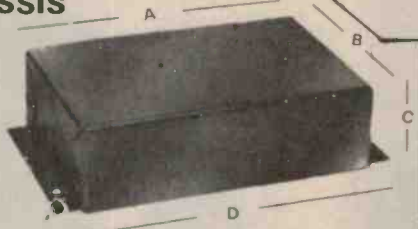

Type	A	B	C	D	
CH1	120	80	35	135	\$1.75
CH2	150	100	50	165	\$1.95
CH3	175	125	50	190	\$2.45
CH4	280	180	50	295	\$2.95

All dimensions in millimeters. Chassis come complete with base (D x B) already punched for rubber feet.

Mail Order Instructions

Minimum P + P \$1.00
Orders over \$9.99 must include additional postal charges (see right)

ADDITIONAL POSTAL CHARGES

Order value	Charge
\$5 — \$9.99	Nif
\$10 — \$24.99	\$0.50
\$25 — \$49.99	\$1.50
\$50 — \$99.99	\$2.50
\$100 or more	\$4.00

Copper Laminate

Paper Phenolic	Epoxy Glass
6" x 3"	45c 6" x 5" \$1.45
12" x 6"	\$1.35 12" x 5" \$2.50
(Callers only 25" x 25"	\$8.25) (Callers only 25" x 18" \$15.25)

Ferric Chloride Pellets

An etching solution. Prepared by adding the crystals to water. Supplied with all instructions for use. WHAT A PRICE!

ONLY \$3.45

20 oz jars

DAVRED ELECTRONICS PTY. LTD.

104-106 King Street Newtown Sydney Australia P.O. Box 317 Newtown, N.S.W. 2042.

THE NEW BREED IN ELECTRONICS SERVICE

Telephone 516-3544

A black and white photograph of a man in a dark suit, white shirt, and tie. He is looking down at a RAM chip he is holding in his right hand. The chip is held between his thumb and index finger, and is clearly visible. The background is a plain, light color.

Look who's delivering 2114 4K Static RAM's.

No chip enable pulsing.
No clocking required.
No refresh circuitry.
No waiting.
No kidding. We have them.

Synertek and Cema

your semi specialists

CEMA

CEMA ELECTRONICS PTY. LTD.
SYDNEY:

21 Chandos Street, Crows Nest,
N.S.W. 2065. Phone: 439-4655

MELBOURNE:

208 Whitehorse Road,
Blackburn, Victoria, 3130.

Phone: 877-5311

ADELAIDE:

170 Sturt Street, Adelaide, S.A.
5000

BRISBANE: Electronic Components (QLD) — 371-5677 • CANBERRA: Daicom — 82-3581 • PERTH: Reserve Electronics — 87-1026 • HOBART: Tasmanian
Electronic Supplies — 44-1337 • WOLLONGONG: Macelec — 29-1455

ARTICLE

ETI's COMPUTER SECTION

NEWS

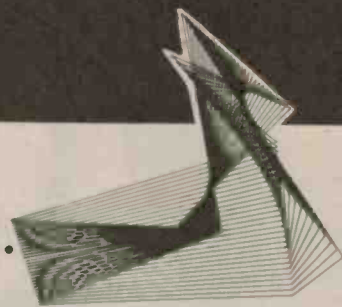

S100 Standardisation

In the attempt to standardise and define the S100 'standard', Steve Edelman of Ithaca Audio, P.O. Box 91, Ithaca, N.Y. 14850, USA, is organizing a group to undertake the job. Anyone interested can contact Steve, and if you are at the Second West Coast Computer Faire (San Jose, California, March 3-5) there will be a meeting on this topic, chaired by Steve.

New IBM Micro

Now that IBM's 5100 desk-top computer is over two years old, the General Systems Division has come up with an upgraded version. The 5110 uses floppy disk drives rather than the tape cartridge, and is reportedly much faster than the old machine. Other enhancements include an improved display and extended I/O capabilities. Pricing starts at US\$9,875.

Fairchild 9440

Fairchild has begun deliveries of a new 16-bit microprocessor, the 9440, which is the subject of a trade secret lawsuit filed by minicomputer maker Data General. The IIL 9440 is claimed to execute a minicomputer instruction set at TTL minicomputer speeds, and uses a 16-bit bus to carry both addresses and data. Although the 9440 executes the Data General Nova 1200 instruction set, Fairchild claim they are not out to replace 1200's, but instead go for applications like top-line smart terminals, telecommunications and personal computers. A basic kit, including software, will cost \$750.

Hard Disks

Rumour has it that both IBM and Shugart are working on a new type of non-floppy disk with a capacity in excess of 10 Mbytes, compared to less than 1 Mbyte for standard floppies. Although the same size as a standard floppy, the disk is non-removable, and consequently more reliable.

Price Cut Round

Following a recent price cut move by Intel, who reduced SBC boards by up to 25%, Motorola has slashed prices on its memory boards, and Mostek has reduced the prices on its OEM-80 Z-80-based boards by up to 28%. At the same time, Zilog's second-source in Carrollton, Texas, introduced a new 16K byte RAM board, using 16K dynamic RAMs. The RAM-80A sells for US\$364 in 100-up quantities.

IREECON '79

The Institution of Radio & Electronics Engineers, Australia, will be holding its next International Electronics Exhibition/Convention - IREECON - in Sydney between 27th and 31st August, 1979.

As has been the case in the past, it is anticipated that overseas and Australian engineers, scientists and technical personnel will be participating in discussions and lectures during the course of the Exhibition, which is to feature an extensive display of technical electronics equipment by leading worldwide and local manufacturers or distributors.

The Institution is pleased that enquiries regarding exhibition space at the 1979 Exhibition have already been received following the outstanding success of the 1977 Exhibition in Melbourne.

Next Month in ETI

We've got all kinds of good stuff lined up for your edification and delight - but one thing in particular stands out. Put together a microprocessor, some ROM, some logic and a loudspeaker and what have you got? Yes, you're on the right track . . . No, it's an electronic musical doorbell, actually! This little gizmo caused the biggest stir in the office since the talking calculator, and you can build it for around \$40 - full constructional details in next month's ETI!

COMPUTER CLUB DIRECTORY

Sydney: Microcomputer Enthusiasts Group, P.O. Box 3, St. Leonards, 2065. Meets at WIA Hall, 14 Atchison St., St. Leonards on the 1st and 3rd Mondays of the month.

Melbourne: Microcomputer Club of Melbourne, meets at the Model Railways Hall, opposite Glen Iris Railway Station on the third Saturday of the month at 2 p.m.

Canberra: MICSIG, P.O. Box 118, Mawson, ACT 2607 or contact Peter Harris on 72 2237. Meets at Building 9 of CCAE, 2nd Tuesday of month at 7.30 p.m.

Newcastle: contact Peter Moylan, Dept. of Electrical Engineering, University of Newcastle, NSW 2308. (049) 68-5256 (work), (049) 52-3267 (home).

Brisbane: contact Norman Wilson, VK4NP, P.O. Box 81, Albion, Queensland, 4010. Tel. 262 1351.

New England: New England Computer Club, c/- Union, University of New England, Armidale, NSW 2351. (New club; not restricted to students)

Auckland: Auckland Computer Club, P.O. Box 27206, Auckland, N.Z.

Computer clubs are an excellent way of meeting people with the same interests and discovering the kind of problems they've encountered in getting systems 'on the air'. In addition, some clubs run hardware and software courses, and may own some equipment for the use of members. Try one - you'll like it!

If your club is not listed here, please drop us a line, and we'll list you. The same applies if you are interested in starting a club in your area. Also, if established clubs know their programme of forthcoming events, we can publicise them.

SOME OF AUSTRALIA'S LOWEST COMPONENT PRICES

POLYESTER FILM CAPS

E12 10% 100V	All values .001 to .01 — 7c ea.	
.01	7c .1	13c
.012	8c .12	14c
.015	8c .15	14c
.018	8c .18	14c
.022	8c .22	16c
.027	8c .27	16c
.033	8c .33	18c
.039	9c .39	19c
.047	9c .47	22c
.056	9c	All values
.068	10c	in uF
.082	10c	in uF
10% off 100 same uF		

NOTE: REGULAR PRICES — NOT TEMPORARY SPECIALS — KEEP US IN MIND FOR THAT NEXT ORDER

ELECTROCAPS (UPRIGHT) (per 100 prices in brackets)

Cap.	16V	25V	50V
0.47 uF thru to all	all	all	all
10 uF	5c(\$3½)	6c(\$3½)	7c(\$4)
22 uF	6c(\$3½)	7c(\$4)	8c(\$5)
33 uF	8c(\$5)	9c(\$5)	10c(\$5)
47 uF	9c(\$5)	10c(\$6)	11c(\$7)
100 uF	10c(\$6)	12c(\$7)	14c(\$11)
220 uF	12c(\$8)	16c(\$10)	35c(\$17)
470 uF	16c(\$12)	22c(\$16)	45c(\$30)
1000 uF	22c(\$18)	30c(\$25)	75c(\$50)
1000 uF/16V axial	— 20c ea. \$8 per 50		
2200 uF/50V axial	— 95c ea. \$8 per 10		
Full axial price list — SAE			

TO3 MOUNTING KITS: 10 for \$1 or \$4 box of 50. Generous kit includes mica, screws, nuts, washers, tag, nylon brushes. LEDs: \$12 per 100, \$110 per 1000, or 17c each, 10 for \$1.50 clips 3c each all quantities. LEDs superb — 5mm red — well diffused. Wide viewing angle — sample 40c stamp.

Potentiometers: 50c ea. rotary carbon sing. gang) log or lin: 1K, 5K, 10K, 25K, 50K, 100K, 250K, 500K, 1M, 2M (metal shafts) Trim Pots: 17c ea. — 10mm 1W horiz. or vert: 100 Ohm to 2M

ZENER DIODES: 15c each 400mW 5% E24 values 3V to 33V

2c RESISTORS — our 2 year old price still current. Opposition hoped we would go broke but our price remains at 2c ea. 1 Ohm to 10 M ¼W 5% E12 carb. film \$1.80 per 100 same value (or ½W 3c, \$2.50 per 100 same value)

Keep electronics a hobby and not a luxury, compare our prices and buy from us. Same day turnaround service (unless swamped). All goods top quality and new. No minimum order. One P/P charge of 40c regardless of quantity. Advert current 3 months for late reorders.

DIGGERMAN ELECTRONICS

P.O. BOX 33, CORAMBA NSW. 2466.

5CRs:	TRIACS:	DIODES:
0.8A 30V C103V — 35	2A 400V ESP240 — 65	1N4001 — 7c(1A 50V)
0.8A 200V C103B — 60	6A 400V SC141D — \$1.30	1N4002 — 8c(1A 100V)
4A 30V C106V1 — 40	10A 400V SC146D — \$1.50	1N4004 — 9c(1A 400V)
4A 400V C106D1 — 75	25A 400V SC260D — \$2.50	1N4007 — 12c(1A 1000V)
8A 500V C122D — \$1.05	DIAC S12 — 35	1N4148 — 6c \$4.50/100
8A 500V C122E — \$1.20	Chart to identify leads 15	
26A 400V C37D — \$2.50	Plus trigger info.	

End noise and cross-talk with our exclusive Noiseguard™ system

The WunderBuss™
A product of Morrow's Micro-Stuff for

Capacity	20 positions for edge connectors
Edge Connectors	S-100 type, 25 spacing Available from Thinker Toys or Masterite
Shielding	Every signal fully shielded by both interconnected ground lines
Termination	Active termination of each line Termination network includes 1M201 op amp, 2N3904, 2N3906 TIP29 and TIP30 transistors 2.4 volts, 180 ohms

COMPUTER BITS A DIVISION OF AUTOMATION STATHAM PTY. LTD.
47 Birch Street, BANKSTOWN N.S.W. 2200 Phone (02) 709-4144 Telex AA26770

TRANSFORMERS

12 or 24 Volt Range: Primaries 220-240 volts

Ref. No.	Amps	24v	Wt. Gms.	Secondary Windings	\$
242	300MA	150MA	198	0-12V at 150 MA x 2	2.50
111	0.5	0.25	283	0-12V at 0.25A x 2	3.25
213	1.0	0.5	425	0-12V at 0.5A x 2	4.00
71	2	1	793	0-12V at 1A x 2	6.00
18	4	2	1020	0-12V at 2A x 2	7.50
70	6	3	1538	0-12V at 3A x 2	9.50
108	8	4	2268	0-12V at 4A x 2	12.50
116	12	6	2722	0-12V at 6A x 2	14.00
115	20	10	5300	0-12V at 10A x 2	20.75

15/30 Volt Range: Primary 220-240 volts: Secondary Windings 0-12-15v at 5 amps, 0-5-9-15v at 5 amps. Voltages obtainable: 3, 4, 5, 6, 8, 9, 10, 12, 15, 18, 20, 24, 30, or 12-0-12 or 15-0-15.

Ref. No.	Amps	30v	Wt. gms.	Secondary Taps	\$
51	10	5	3120	0-12-15, 0-5-9-15	15.00

30 Volt Range: Primaries 220-240 volts Voltages obtainable 3, 4, 5, 6, 8, 9, 10, 12, 15, 18, 20, 24, 30, or 12-0-12 or 15-0-15.

Ref. No.	Amps	Wt.	Secondary Taps	\$
124	0.5	737	0-12-15-20-24-30	5.00
79	1	737	0-12-15-20-24-30	6.25
3	2	1361	0-12-15-20-24-30	8.50
21	4	2600	0-12-15-20-24-30	10.50
89	10	5670	0-12-15-20-24-30	21.75

50 Volt Range: Primaries 220-240 volts Voltage obtainable: 6, 7, 8, 10, 14, 15, 17, 19, 21, 25, 31, 33, 40, 50, or 25-0-25

Ref. No.	Amps	Wt.	Secondary Taps	\$
102	0.5	737	0-19-25-33-40-50 V	7.00
103	1	1304	0-19-25-33-40-50 V	8.00
104	2	2495	0-19-25-33-40-50 V	10.50
105	3	3176	0-19-25-33-40-50 V	12.50
106	4	4100	0-19-25-33-40-50 V	15.00
107	6	5444	0-19-25-33-40-50 V	22.00

60 Volt Range: Primaries 220-240 volts Voltages obtainable: 6, 8, 10, 12, 16, 18, 20, 24, 30, 36, 40, 48, 60 or 24-0-24 or 30-0-30.

Ref. No.	Amps	Wt.	Secondary Taps	\$
124	0.5	737	0-24-30-40-48-60 V	6.50
126	1	1361	0-24-30-40-48-60 V	8.00
127	2	2495	0-24-30-40-48-60 V	10.50
125	3	4083	0-24-30-40-48-60 V	15.50
40	5	5670	0-24-30-40-48-60 V	21.00

Miniature transformers with screens: Primaries 220-240 volts

Ref. No.	MA	Wt. Gms	Volts	\$
238	200	85	3.03	2.50
212	1A 1A	596	0.6 0.6	5.50
13	100	113	9.0 9	2.50
236	330, 330	198	0-9, 0-9	2.50
207	500, 500	566	0-8-9, 0-8-9	5.25
205	500, 600	1077	0-15-20, 0-15-20	6.00
214	300, 300	623	0-20, 0-20	4.00
221	700 (DC)	737	20-12-0012-20	6.50
206	1A 1A	1304	0-15-27, 0-15-27	9.00
203	500, 500	822	0-15-27, 0-15-27	8.50
204	1A 1A	1417	0-15-27, 0-15-27	12.00

All transformers continuously rated, vacuum varnish impregnated, and guaranteed. Prices do not include postage or packing. Assess postage to your address using your weights given and add 10% of postage rate for packing. Unless quoting sales tax number add 15% to order cost.

DOUGLAS TRANSFORMERS, DEPT. MO, BOX 23, COORANBONG, N.S.W. 2265.

DIODES/ZENERS

1N914	100v	10mA	.05
1N4005	600v	1A	.08
1N4007	1000v	1A	.15
1N4148	75v	10mA	.05
1N753A	6.2v	z	.25
1N758A	10v	z	.25
1N759A	12v	z	.25
1N4733	5.1v	z	.25
1N5243	13v	z	.25
1N5244B	14v	z	.25
1N5245B	15v	z	.25

SOCKETS/BRIDGES

8-pin	pcb	.25	ww	.45
14-pin	pcb	.25	ww	.40
16-pin	pcb	.25	ww	.40
18-pin	pcb	.25	ww	.75
22-pin	pcb	.45	ww	1.25
24-pin	pcb	.35	ww	1.10
28-pin	pcb	.35	ww	1.45
40-pin	pcb	.50	ww	1.25
Molex pins	.01	To-3 Sockets		.45
2 Amp Bridge		100-prv		1.20
25 Amp Bridge		200-prv		1.95

TRANSISTORS, LEDS, etc.

2N2222	NPN	(Plastic .10)	.15
2N2907	PNP		.15
2N3906	PNP		.10
2N3054	NPN		.35
2N3055	NPN	15A 60v	.50
T1P125	PNP	Darlington	.35
LED Green, Red, Clear			.15
D.L.747	7 seg	5/8" high com-anode	1.95
XAN72	7 seg	com-anode	1.50
FND 359	Red	7 seg com-cathode	1.25

C MOS

4000	.15
4001	.20
4002	.20
4004	3.95
4006	1.20
4007	.35
4008	.95
4009	.30
4010	.45
4011	.20
4012	.20
4013	.40
4014	1.10
4015	.95
4016	.35
4017	1.10
4018	1.10
4019	.60
4020	.85
4021	1.35
4022	.95
4023	.25
4024	.75
4025	.35
4026	1.95
4027	.50
4028	.95
4030	.35
4033	1.50
4034	2.45
4035	1.25
4040	1.35
4041	.69
4042	.95
4043	.95
4044	.95
4046	1.75
4049	.70
4050	.50
4066	.95
4069	.40
4071	.35
4081	.70
4082	.45

7400	.15
7401	.15
7402	.20
7403	.20
7404	.15
7405	.25
7406	.35
7407	.55
7408	.25
7409	.15
7410	.10
7411	.25
7412	.30
7413	.45
7414	1.10
7416	.25
7417	.40
7420	.15
7426	.30
7427	.45
7430	.15
7432	.30
7437	.35
7438	.35
7440	.25
7441	1.15
7442	.45
7443	.85
7444	.45
7445	.65
7446	.95
7447	.95
7448	.70
7450	.25
7451	.25
7453	.20
7454	.25
7460	.40
7470	.45
7472	.40

- T T L -

7473	.25
7474	.35
7475	.35
7476	.30
7480	.55
7481	.75
7483	.95
7485	.95
7486	.30
7489	1.35
7490	.55
7491	.95
7492	.95
7493	.40
7494	1.25
7495	.60
7496	.80
74100	1.85
74107	.35
74121	.35
74122	.55
74123	.55
74125	.45
74126	.35
74132	1.35
74141	1.00
74150	.85
74151	.75
74153	.95
74154	1.05
74156	.95
74157	.65
74161	.85
74163	.95
74164	.60
74165	1.50
74166	1.35
74175	.80

74176	1.25
74180	.85
74181	2.25
74182	.95
74190	1.75
74191	1.35
74192	1.65
74193	.85
74194	1.25
74195	.95
74196	1.25
74197	1.25
74198	2.35
74221	1.00
74367	.85
75108A	.35
75110	.35
75491	.50
75492	.50
74H00	.25
74H01	.25
74H04	.25
74H05	.25
74H08	.35
74H10	.35
74H11	.25
74H15	.30
74H20	.30
74H21	.25
74H22	.40
74H30	.25
74H40	.25
74H50	.25
74H51	.25
74H52	.15
74H53J	.25
74H55	.25

74H72	.55
74H101	.75
74H103	.75
74H106	.95
74L00	.35
74L02	.35
74L03	.30
74L04	.35
74L10	.35
74L20	.35
74L30	.45
74L47	1.95
74L51	.45
74L55	.65
74L72	.45
74L73	.40
74L74	.45
74L75	.55
74L93	.55
74L123	.55
74S00	.55
74S02	.55
74S03	.30
74S04	.35
74S05	.35
74S08	.35
74S10	.35
74S11	.35
74S20	.35
74S40	.25
74S50	.25
74S51	.45
74S64	.25
74S74	.40
74S112	.90
74S114	1.30

74S133	.45
74S140	.75
74S151	.35
74S153	.35
74S157	.80
74S158	.35
74S194	1.05
74S257 (8123)	.25
74LS00	.35
74LS01	.35
74LS02	.35
74LS04	.35
74LS05	.45
74LS08	.35
74LS09	.35
74LS10	.35
74LS11	.35
74LS20	.35
74LS21	.25
74LS22	.25
74LS32	.40
74LS37	.35
74LS40	.45
74LS42	1.10
74LS51	.50
74LS74	.65
74LS86	.65
74LS90	.95
74LS93	.95
74LS107	.85
74LS123	1.00
74LS151	.95
74LS153	1.20
74LS157	.85
74LS164	1.90
74LS367	.85
74LS368	.85

LINEARS, REGULATORS, etc.

8266	.35
MCT2	.95
8038	3.95
LM201	.75
LM301	.25
LM308 (Mini)	.75
LM309H	.65
LM309K (340K-5)	.85
LM310	1.15
LM311D (Mini)	.75
LM318 (Mini)	.65

LM320K5 (7905)	1.65
LM320K12	1.65
LM320T5	1.65
LM320T12	1.65
LM320T15	1.65
LM339	.95
7805 (340T5)	.95
LM340T12	1.00
LM340T15	1.00
LM340T18	1.00

LM340T24	.95
LM340K12	2.15
LM340K15	1.25
LM340K18	1.25
LM340K24	.95
LM373	2.95
LM380	.95
LM709 (8,14 PIN)	.25
LM711	.45

LM723	.50
LM725	1.75
LM739	1.50
LM741 (8-14)	.25
LM747	1.10
LM1307	1.25
LM1458	.95
LM3900	.50
LM75451	.65
NE555	.50
NE556	.95
NE565	.95
NE566	1.75
NE567	1.35

9000 SERIES

9301	.85
9309	.35
9322	.85
95H03	.55
9601	.75
9602	.50

MEMORY CLOCKS

74S188 (8223)	3.00
1702A	6.95
MM5314	3.00
MM5316	3.50
2102-1	1.75
2102L-1	1.95
TR 1602B/ TMS 6011	6.95
8080AD	15.00
8T13	1.50
8T23	1.50
8T24	2.00
2107B-4	4.95

INTEGRATED CIRCUITS UNLIMITED

7889 Clairemont Mesa Blvd., San Diego, CA 92111 U.S.A.
No Minimum

All prices in U.S. dollars. Please add postage to cover method of shipping. Orders over \$100 (U.S.) will be shipped air no charge.

Payment should be submitted with order in U.S. dollars.

All IC's Prime/Guaranteed. All orders shipped same day received.

Phone (714) 278-4394

BARCLAYCARD/VISA/ACCESS/AMERICAN EXPRESS

SPECIAL DISCOUNTS

Total Order	Deduct
\$35 - \$99	5%
\$100 - \$300	10%
\$301 - \$1000	15%
\$1000 - Up	20%

THE POLYPURPOSE PERFORMER

SEE THE PROFICIENCY
FEEL THE POWER
PONDER THE POSSIBILITIES
DEPEND UPON THE QUALITY



See for yourself the features it has.
Think about what YOU could do with it.

THE TECHNICO 9900-SS 7" x 16" SINGLE-BOARD COMPUTER with virtually unlimited expansion capabilities

The Technico 9900-SS microcomputer is polypurpose — it will outperform any 8-bit microcomputer and will compare very favourably with any 16-bit minicomputer, having in fact many programming and performance advantages and superiorities over a number of minicomputers costing several times its price. It is the ideal choice for the hobbyist, and can be readily and economically expanded into a powerful small-business computer and wordprocessor.

The price? Fully assembled and tested, as illustrated above:
\$857 (Sales Tax included) or \$770 (if exempt)
(Basic kit prices range from only \$440)

Just hook up power supply and terminal, and
you're ready to go

Distributed in Australia by:-

**Innovative Micro Processor
And Computer Technology**
P.O. Box 177, Petersham 2049 (560-7603 AH)

Please send me more details about the TEC-9900-SS
Microcomputer.

NAME:

ADDRESS:

STATE: P/CODE:

NORTRONICS

AUDIO & DIGITAL TAPE HEADS
Long Life-Extended Response



Replacement heads for:

Domestic Recorders Cassette decks.
Cassette players.
Reel to reel.
Cartridge.

Professional Recorders Broadcast recorders in reel to reel & cartridge or
cassette.

Studio recorders 1/4" to 2" multi track.

Duplicators Reel to reel & cassette.
Aircraft Recorders, cockpit & background.

To fit: AMPEX, SCULLY, TEAC, ATC, GATES,
PENTAGON, INFONICS and many others.
ALIGNMENT TAPES — Reel to reel, Cartridge, Cassette.

EMAC INDUSTRIES PTY. LTD.
9 Meriton Place, Clayton South, Vic. 3169.
Ph: 544-5157

electronics today

INTERNATIONAL

BINDERS
HOLDS 12
COPIES OF

eti



Protect and file your back issues of Electronics Today with these
attractive binders. Price: \$4.50 plus postage and packing (80c NSW-
\$1.70 other states).

SUBSCRIPTION DEPARTMENT

ELECTRONICS TODAY INTERNATIONAL
MODERN MAGAZINES (HOLDINGS) LTD.,
15 BOUNDARY ST., RUSHCUTTERS BAY, 2011

ONE ARMED MPU!

The instructions which we feed into our decoder could be decoded as a transfer of data from a register to a latch which is in turn connected to the outside world. It is convenient to have only one set of information connections to the outside world and thus these connections have to serve as instruction input and as counter input/outputs, this set of lines to the outside is called a bi-directional data bus.

As we need to use this data bus for both instructions and data we need to store each separately internally, thus are born the expressions Instruction Register and Accumulator Register, really just a couple of 8 bit latches. SC/MP has an extension to the Accumulator and naturally enough this is called the Extension Register. It can swap its data with that in the Accumulator and has the additional function of being a shift-register with its serial input and output connected to the outside world. Thus our first instruction could cause the data on the data bus to be latched into the Accumulator, the second instruction swaps data with the Extension and the third and subsequent instructions clock the data in the Extension out to the MPU output pin at the same time as clocking the data on the serial input into the Extension. To build such a device with TTL would require about a dozen packages. With SC/MP it becomes a set of bit patterns input to the decoder.

The 8 bit wide instructions mentioned above have to be presented at the data bus in sequence as they are required. The address of the next data unit is supplied by the Address Bus which is normally 16 bits wide thus giving access to 65,536 sets of data. The address is held internally in a 16 bit parallel access counter which can exchange data with the Accumulator, Extension or Pointer Register. Thus, if we can change the value of the Address bus counter we can point the MPU back to a previous instruction address and thus cause it to enter a loop. The Address register is known as a Pointer register in SC/MP which has 4 such registers. PR-0 is used for the next instruction address and the other 3 are used to access other addresses for data I/O. By loading a Pointer Register in a manner similar to that of loading the Extension we can either access any of our 65,536 address-

able slots or we can cause the MPU to get its next instruction from any of the slots.

Accumulating data

The Accumulator is used for input/output, for the results of logical ANDs, OR, and EX-ORs and can also be used as the result and one of the operands in an ADD instruction.

Data input/output can be accomplished through the serial I/O pins connected to the Extension Register or via the main data bus. It is usual to have some area of RAM connected to the data bus for storage of intermediate results, a couple of 2112 chips gives 256 pigeon holes each with 8 bits of data storage. The RAM is accessed by a Pointer Register which selects a) the RAM physical devices and then b) one of the 256 locations within that RAM. The 16 bit pattern for location zero (the first) in a RAM based as hex location OFOO would be 0000 1111 0000 0000, and it is easy to see how this bit pattern could be decoded with AND and NAND gates to give a single enable line signal (one 7420 and two 7421s?). Similarly, if we had a couple of 7475 latches we could decode a particular address (eg OE00) and use the enable to clock the latches and thus store the data which had been output on the data bus at the same time. These 7475s are to be used for driving the LED lamps in our Bandit so that we need two sets of latches (OE00 and OE01) to give us a

maximum of 16 LED lamps (we need 12). We can use a similar latch but with WIRE-OR or TRI-STATE outputs (74173) to latch data into the MPU from a series of switches such as the start handle or possibly HOLD switches.

Simulation is the Answer

If you had lots of sheets of paper you could pretend to be an MPU pretending to be our bandit. Get someone else to operate you by pulling your left arm as the Start Handle and then start counting very fast until they release your arm. If you can manage it count three totals at a time and thus when your arm is released you can write down these three numbers on a scrap of paper. The MPU would do the same thing by sensing the changes in the data from our switch latch, adding to pseudo-counters in RAM locations (scraps of paper) and then stopping when the switch latch changes state again.

Now you look at your scraps of paper and decide whether the numbers correspond to any on a list of winning combinations which you have previously compiled. If the combination is a winning one then your list will have a 'Win amount' figure next to the winning combination, which is now credited to the players bank. If the player did not

Fig. 2 Block diagram showing 'Bandit' based on MPU chip.

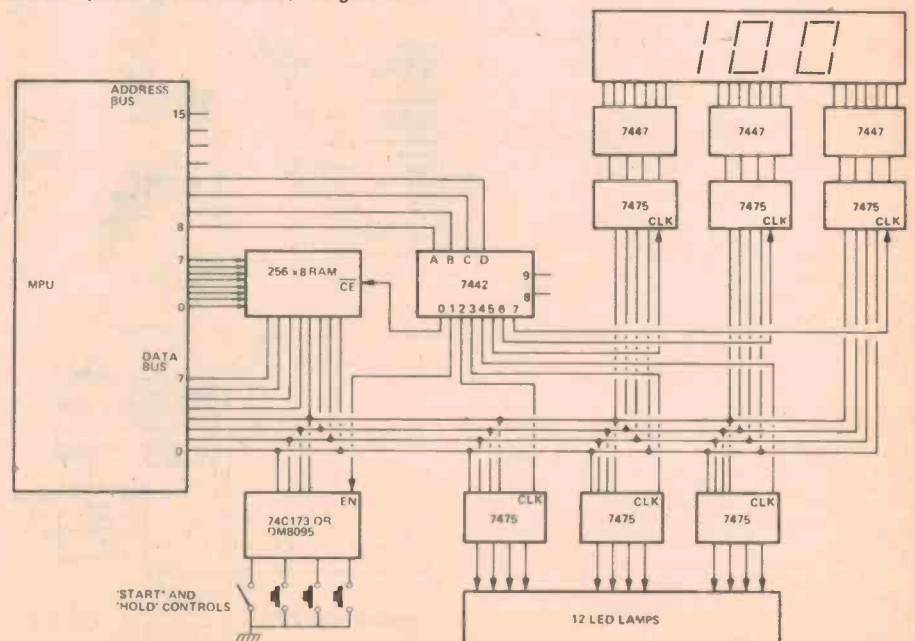

win then one unit is taken from his bank. You are now ready to have your arm pulled again.

If we use the existing display PCB we have to add or subtract from the bank by pulsing the bank counters on that PCB. We could keep these counters internally and latch out the BCD data in a similar way to that with the LED lamps, via a couple of latches. These latches would then feed into the BCD to seven segment decoders and on to the displays. There is no reason at all why the BCD to seven segment conversion could not be done within the MPU and seven segment data output to the latches and then directly to the displays.

Hardware and Software

A simple definition used to be that Hardware hurts your foot if you kick it and you cannot kick software. Now that computers are not the giant metal monsters that they used to be this definition is no longer true but hardware is still the physical devices and software the program.

For our application we obviously need an MPU chip and as our application is very simple let's use a SC/MP MPU. We need somewhere to store our program and our pseudo-counters. For this we could use a 256 x 8 bit RAM (2 MM2112s). For a more permanent unit we would have to additionally use a PROM but we can use RAM in this example. We have to enter our program as a sequence of bit patterns into the RAM starting at address location 0001 as this is where SC/MP goes to find its first instruction after the reset button is pressed. A simple development system will allow programming of the RAM with simple toggle switches and the program can be checked out at a very slow speed or as single steps.

We also need a four bit input latch (74173) connected to the handle and HOLD switches and 3 four bit latches (74173 or 7475) for the LED lamp drivers. If you intend to replace the BANK counters with software pseudo-counters then another 3 four bit latches will be needed to latch out the BCD data for each digit. To make accessing of these latches easy we can ignore the top four bits of the address bus and use the next four bits as inputs to a 7442 1 of 10 decoder. This will now break up the addresses into 256 byte lumps, any access to 0000-00FF will enable the

RAM, 0100-01FF the switch latch, 0200-02FF and LED latch, etc. A block diagram of this is shown as Fig. 2, and as you can see the outputs from the 7442 are used as follows:— Output 0 address locations 000-00FF used for main RAM (program & data).

Output 1 address location 0010 used for switch latch, Outputs 2, 3, 4 address locations 0200, 0300, 0400 used as LED lamp drivers. Outputs 5, 6, 7 address locations 0500, 0600, 0700 used as BCD output latches. With the exception of the RAM all of the other devices hung onto the data bus only use bits 0-3 of the data bus. the other bits being ignored.

Conclusions

The system we have started to design here is hopefully one of the simplest MPU circuits you have ever seen. Once you have grasped the idea of using one 8 bit data bus for most of your input/output you are well on the way to understanding MPUs. The very nice thing about MPUs is that for any given hardware configuration there are lots of software possibilities, for instance we have to have a four bit latch for the start switch so why not hang 3 HOLD buttons on it as well? By latching out seven segment data instead of BCD you could use any combination of the seven segments plus decimal point to display letters or patterns. By moving up to a 5 x 7 matrix display you could output even more patterns/letters. At an approximate guess the hardware shown in Fig 2 would cost about \$45 compared to the \$20 for the original (displays not included) but for the extra money you have a much more flexible system. MPU's are not cheap but for what they can do for you they are a bargain!

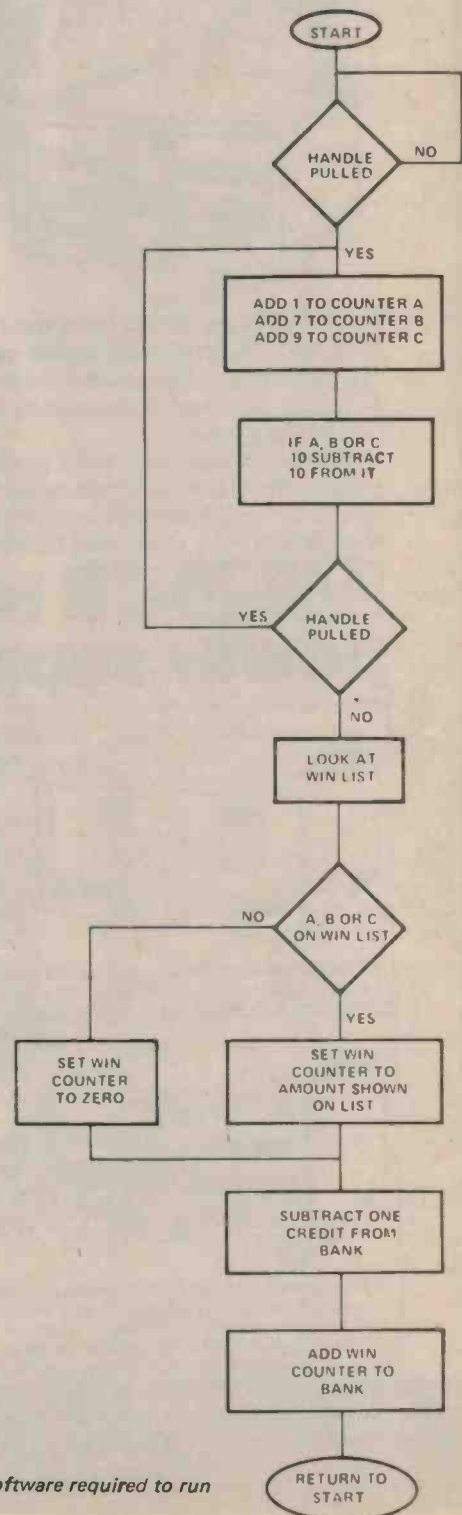

Fig. 3 Flow chart of software required to run the MPU 'Bandit'.

Convert your CB into a base station



Power your rig direct from mains electricity with an SEC approved power supply.

These small portable units provide a factory-set 13.8V DC regulated output for maximum transmitting power.

High performance integrated circuitry guarantees clean, hum-free reception.

Quick-connect terminals facilitate rapid changeover from static-mobile-static operation.

ARLEC CB radio power supplies

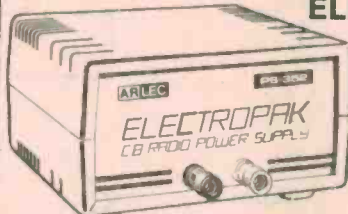

ELECTROPAK PS352

For CB Radios up to 5 Watts Rating

1.8 Amp peak capability. Automatic overload protection.
1.0 Amp continuous output. Size: 140 x 80 x 133mm



SIDE 4 BAND PS353

For CB Radios up to 15 Watts Rating

4 Amp peak capability. Automatic overload protection.
2 Amp continuous output. Size: 140 x 80 x 133mm

See them at your local CB Store or write to
A&R Electronic Equipment Co. Pty. Ltd. for further details

A+R ELECTRONIC EQUIPMENT CO. PTY. LTD.

A MEMBER OF THE A+R-SOANAR ELECTRONICS GROUP
SALES OFFICES: VICTORIA 89 0661
N.S.W. 78 0281
S. AUSTR. 51 6981
QUEENSLAND 52 5421
W. AUSTR. 81 5509

30 Lexton Road, Box Hill, Vic. 3128
Australia Telex 32286



SEMCON MICROCOMPUTERS PTY. LTD.

ATTENTION OWNERS!

MOTOROLA D2

If you want a functional, expandable system, you need:

8K BYTE, STATIC MEMORY CARD

Australian Designed and Built

- Fast Access 350 ns Chips (2102LF)
- Low Current — 1.3 Amps
- Motorola Bus Compatible
- Write Protect
- Parity Generation/Checking available
- Professional Finish
- Plated through Holes
- \$275 assembled board
- \$219 in kit form
- 298 Assembled with Parity

* \$110 for 8k kit without rams

• Built Boards Guaranteed 12 months



CARD CAGE/BACKPLANE:

- Designed for Motorola Cards
- Anodised Aluminium chassis
- Sturdy Construction
- Tin Plated Backplane
- Accomodates 8 cards

\$74.00



EDGE CONNECTORS —

43 x 2 x 0.156" \$8.50 each

Eight for \$59.00

\$100 Connectors \$8.50

THIS MONTHS SPECIALS

555 TIMER 35 cents

16 PIN DIL SOLDER IC SOCKET 28 cents

8 T26 \$2.30

2708 \$18.50 — 2102 LFPC \$1.90

1 Amp Positive Regulators T0220 \$1.20

LOW POWER SCHOTTKY

74LS00.....33	74LS38.....40	74LS109.....53
74LS02.....33	74LS40.....37	74LS138.....1.20
74LS04.....34	74LS42.....1.30	74LS160.....1.20
74LS05.....37	74LS47.....1.30	74LS161.....1.20
74LS08.....33	74LS74.....0.55	74LS174.....1.00
74LS09.....33	74LS75.....0.70	74LS175.....1.00
74LS10.....33	74LS85.....1.58	74LS190.....1.20
74LS11.....33	74LS86.....0.60	74LS191.....1.20
74LS13.....80	74LS90.....1.20	74LS192.....1.20
74LS14.....1.40	74LS91.....1.20	74LS193.....1.20
74LS20.....33	74LS92.....1.20	74LS367.....80
74LS30.....33	74LS93.....1.20	

I.C. SOCKETS — LOW PROFILE

SOLDER	DIL — TIN	WIRE WRAP GOLD
8.....25	22.....35	24.....1.40
14.....35	24.....45	14.....70
16.....28	28.....50	16.....70
18.....35	40.....90	

Sunspot cycle 21 coming up....

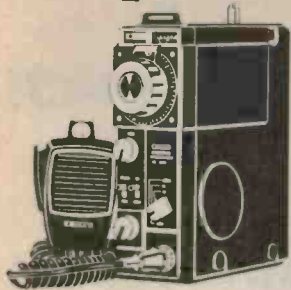

ICOM IC-215 2m FM transceiver \$219

- 2 meter FM • 3 W PEP • 15 channels, 12 by selector, 3 by function switch
- Dual power level, 3 W HI for long distance, 0.5 W LOW for local • Dial illumination for night use • Power pilot lamp • Frequency range: 146 to 148 MHz.

Sunspot cycle #21 is now on the up-and-up! Share in some of the fun on 6 metres DX with the ICOM IC502 ssb portable transceiver. The IC502 covers 52-53MHz with VFO control, RIT, effective noiser blanker, provision for external power and antenna and comes complete with carrystrap, mic and English handbook. Backed by VICOM 90 day warranty. Price \$219

HELLO 6M DX IDEAL FOR SATELLITE WORKING

The IC202 is the ideal 2m exciter for those long-haul DX contacts or to work oscar. 3watts ssb and cw, VXO control, quality manufacture and comes complete with manual, carry-strap, mic and VICOM 90 day warranty. Price \$219

ACCESSORIES FOR THE PORTABLES

- BC-20 nicad pack and reg. \$57
- Rubber Ducky 2m antennas \$13
- Mobile mounting bracket \$18
- IC3PS matching power supply \$115
- IC20L 2m linear, 10w out \$98
- IC50L 2m linear, 10w out \$90

quality
ICOM
portable

Hold it!

QUALITY HANDY PORTABLES

WRITE FOR THE ICOM CATALOG



ICOM IC-22S FM transceiver

Price \$279

The popular VC2 swr/pwr meter for ham and CB use covers 3-150MHz. Each unit is individually calibrated for the Australian ham bands plus CB, high accuracy with power measurements 12/120 watts with total capability 1000 watts. Comes complete with informative instructions. Price \$38

FOR THE PROFESSIONAL

The popular Oskerblock SWR200 handles power measurement 2/20/200/2000 watts with dual impedance and good accuracy. Price \$75

NOISE BRIDGES

- TE7-01 Omega, up to 100MHz \$40
- TE7-02 Omega, up to 300MHz \$55

BALUNS

- AS-BL (Asahi) for beams \$31
- BN86 (HyGain) for beams \$30
- BL50A (Rak) 50 ohm, 4Kw, dipole \$25
- BL70A (RAK) 70 ohm, 4Kw, dipole \$26

COUPLERS

- CL65 500w, 2.5 thru 20MHz \$134
- CL99 200w, 2 metres \$61
- CSW216 incl swr/pwr meter, 3.5-28MHz \$219



\$849 uniden

The fabulous Uniden 2020 phase-locked-loop transceiver offers separate usb/lsh/cw 8-pole crystal filters as standard and 6146B's in the final with screen voltage stabilisation for minimum distortion products. Features plug-in pcb's and even the front panel can be swung out for easy servicing. A full spares catalogue is available together with change-over pcb's. Compare the Uniden 2020 with other HF transceivers and you'll be quickly convinced that it offers the best value!

ROTATORS

- ART300C heavy duty with control box \$199
- ART800C super heavy duty \$478
- AR22XL light duty for small beams \$109

Direction: Russell J. Kelly
Peter D. Williams

swr bridges

MORSE KEYS

- HK702 deluxe, marble base \$35
- HK708 economy model \$19
- HK706 operator's model \$20
- MK701 manipulator \$38
- ED103W electronic keyer \$159

MICROPHONES

- VM-1 ptt lowZ, noise-cancelling \$8.90
- VM-2 base with preamp, low Z \$29.80

L.P. FILTERS

- FD30M 32MHz cut-off, 1KW pep max \$35
- FD30LS 32MHz cut-off, 200w max \$20

Antennas!

You know you can count on

hy-gain

- TH6DXK 6el 10/15/20m Thunderbird \$320
- TH3MK3 3el tribander 8dB gain \$248
- TH3Jr 3el tribander, 12' boom \$199

TRAP VERTICALS

- V5Jr 6.7m high, 80 thru 10m, no guys \$109
- V4Jr 4.25m high, 40 thru 10m, no guys \$89

TRAP DIPOLES

- MidyVN 80 thru 10m \$67
- AL48DXN 40 & 80 metres, 2Kw \$54

TWO METRES

- ARX-2 Ringo Ranger base antenna \$49
- Lindenow wave mobile whip \$26
- 425 1/4 wave mobile whip with cable \$14
- 82D mobile whip with cable \$26

Prices and specifications subject to change without notice.

Head Office and Mail Orders:

139 AUBURN ROAD, AUBURN, Vic.

Telephone: (03) 82.5398, (03) 813.2355

TLX 30566

Adelaide: 43.7981 Brisbane: 38 4480

Canberra: 82.3581 Gold Coast: 32.2644

Perth: 446.3232

COMING SOON!

The new ICOM IC701 HF solid state transceiver. Write for details!

WARNING: The law requires that a licence be held for all transmitting equipment. Purchasers may be asked to provide evidence that he/she is the holder of an appropriate certificate of proficiency.

YAESU



FT-101E

- FT101E HF transceiver 160m thru 10m \$859
- FL2100B HF linear amplifier \$578
- FRG-7 Receiver \$338
- FT301D HF solid-state transceiver \$1149

KENWOOD

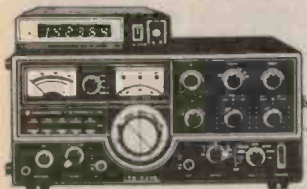

KENWOOD TS-520S transceiver

- TS820S HF digital transceiver \$1105
- TS520S HF 160-10m transceiver \$705
- VFO820 vfo for TS820S \$115
- TV502 2m transverter \$260
- TV502 2m transverter \$229
- TV506 6m transverter \$229
- TR7400 2m fm digital transceiver \$450
- MC50 desk mic, dynamic \$54

SPEECH PROCESSORS

- MC330 audio mic compressor, aL/dc \$71
- RF550 rf speech processor \$112
- RF440 rf speech processor \$149

VICOM



SPECIAL CB SERVICE FOR TRUCKERS!

Loan rigs available while your rig is being repaired. Full service facilities for all communications equipment, C.B. radios, stereo units etc.

OPEN 7 DAYS A WEEK

**7 DAY REPAIR AND
INSTALLATION ON CB,
CASSETTE, RADIOS ETC**

419 3342

**Road Runner
Communications**

39 Vere St, Collingwood 3066

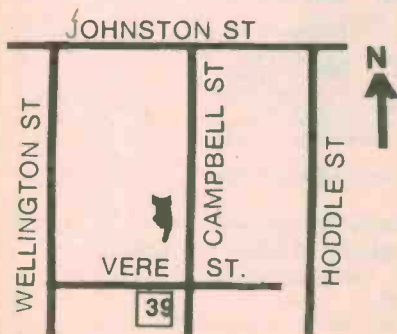

TELEX®

CUSTOM TAPE COMPONENTS

A wide variety of head and channel configurations with optional electronics to suit custom designers of broadcast, educational and entertainment systems.



**MODEL 36 ENDLESS LOOP
CARTRIDGE TRANSPORT**

- NAB format, solenoid operation, remote control, three head facility, single or dual speed.



MODEL 230 OPEN REEL TRANSPORT

- Three motors, two speed, solenoid controls, high efficiency braking, four head facility, tape lifters, photo cell tape stop.



**MODEL RP85 RECORD/PLAY
PREAMPLIFIER**

- Use with model 36 or 230 or most other transport systems. Direct head connections N.A.B. equalization for 3 speeds, -60DB bias rejection, optional rack mounting panel.

FOR FURTHER INFORMATION:

AUDIO TELEX COMMUNICATIONS PTY. LTD.

SYDNEY
54-56 Alfred Street,
Milsons Point 2061
Telephone: 929-9848

MELBOURNE
828 Glenferrie Road,
Hawthorne 3122
Telephone: 819-2363

ADELAIDE
Werner Industries,
28 Gray Street,
Kilkenny 5009
Telephone: 268-2801

PERTH
Electro Acoustics Pty. Ltd.
11 Frobisher Street,
Osborne Park,
W.A. 6017.

BRISBANE
Bruce Window Elect.
10 Buchanan Street,
West End 4101
Telephone: 44-6844

HOBART
Video & Sound Services,
141 Murray Street,
Hobart 7000
Telephone: 34-1180

Instant Component Service

DISTRIBUTORS:-

NORTH.
J. A. SEVERN
P.O. Box 47
Epping 2121
869-1058

SOUTH.
**BRYAN CATT
INDUSTRIES.**
105 Miranda Road South,
(Near Motor Registry)
Miranda.
Phone: 524-4425
Telex AA27266

EAST.
**RADIO DESPATCH
SERVICE.**
869 George Street,
Sydney, N.S.W. 2000
Phone: 211-0191

WEST.
**ELECTRONIC
(DISTRIBUTORS)**
(A Division of Electronic
Enthusiasts Emporium).
2-3 Post Office Arcade,
Joyce St., Pendle Hill,
N.S.W. 2145. Phone
636-5222

NEWCASTLE:
DIGITRONICS
186 Parry Street,
Newcastle West, 2302
Phone: (049) 614991

DISTRIBUTORS

for the Electronic Industry

ARE YOU AWARE??

THAT WE HAVE PROBABLY THE LARGEST RANGE IN AUSTRALIA OF TOP-BRAND, QUALITY PRODUCTS AT CURRENT MARKET PRICES WITH OFF-THE-SHELF AVAILABILITY.

Semi-Conductors

Delco
E.D.I.
General Electric
Intermetall
I.T.T.
National Semiconductor
N.E.C.
Philips
Sanyo
Signetics
Solitron
Texas Instruments
A.M.D.
Intersil
Monolithic Memories

Passive Components

Bournes
Elna
Erie
I.T.T. Capacitors
I.T.T. Thermistors
Philips (Elcoma)
R.C.A.
Soanar
Sprague

Electro-Mechanical and Hardware

Alco
Cannon
Delco Heatsinks
I.T.T. Diecast Boxes
I.T.T. Fans & Blowers
Dica I.C. Accessories
I.E.E.
I.T.T. Relays
Jean Renaud
J.A.E.
National Relays
Pomona Accessories
Rotron Fans
Switchcraft Connectors
Thermalloy Heatsinks
T.I. I.C. Accessories
Weller Soldering Erous
G.E. Rechargeable Batteries

**ANNOUNCEMENT
BRISBANE BRANCH
NOW OPEN
Phone 44 6667**

Trade enquiries to:

Instant Component Service

P.O. Box 2, Arncliffe. N.S.W. 2205. Ph (02) 597-1444
Adelaide 267-2393. Melbourne 95-9566. Sydney 597-1444

Audio Spectrum Analyser

Continued from page 15.

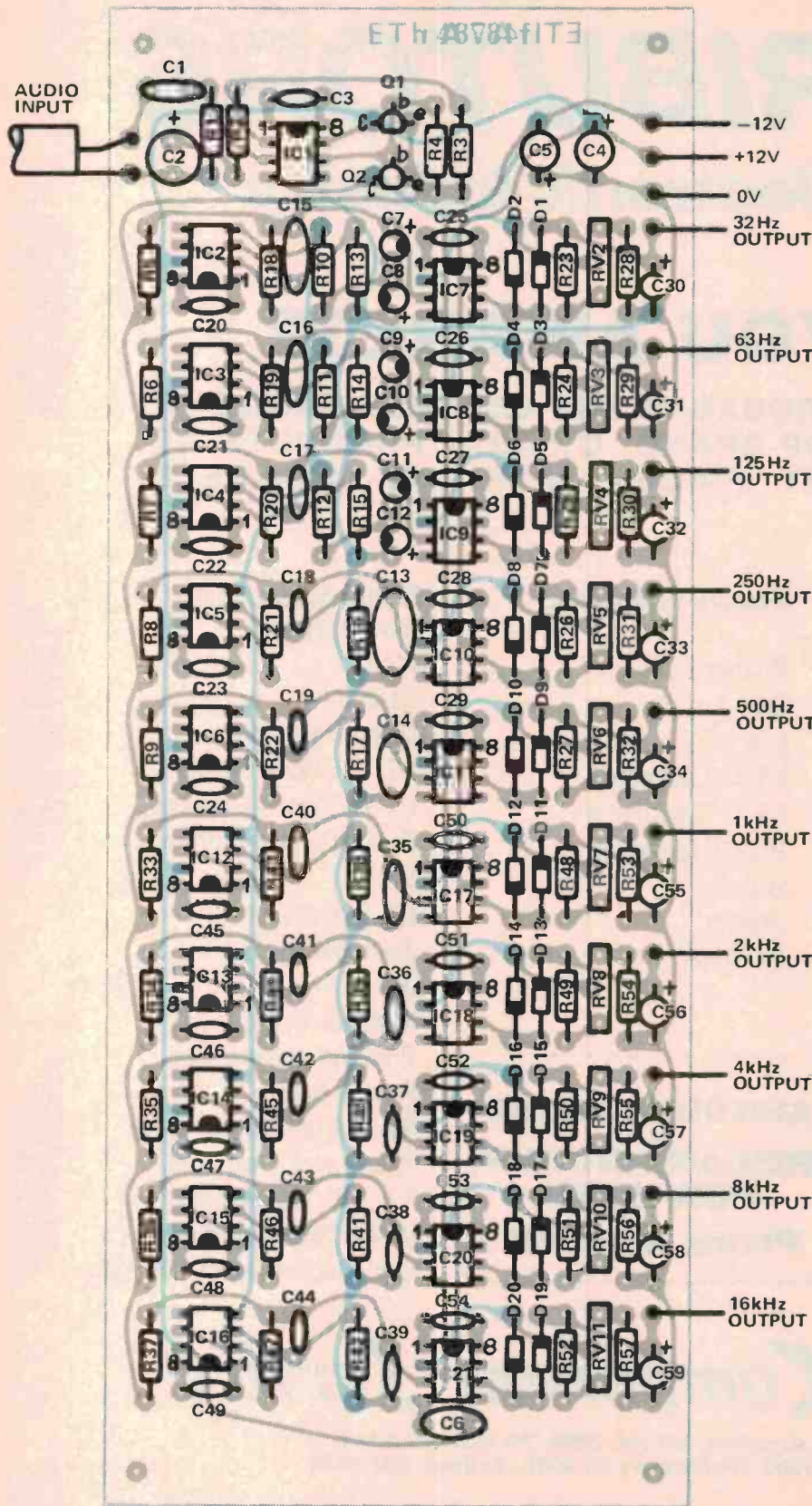

Fig. 5. The component overlay of the filter-rectifier board.

PARTS LIST - ETI 487

Resistors	all ½W 5%
R1	220k
R2	2k2
R3	220k
R4	1k
R5-R9	10k
R10-R17	1M
R18-R22	220R
R23-R27	1M
R28-R32	100k
R33-R37	10k
R38-R42	1M
R43-R47	220R
R48-R52	1M
R53-R57	100k
R58,59	180k
R60	100k
R61	82k
R62,63	15k
R64	22k
R65	470R
R66	18k
R67	15k
R68	12k
R69	820R
R70	180k
R71	12k
R72,73	10k
R74	2k2
R75	4k7
R76-R78	10k
R79	22k
R80	56k
R81	5k6
R82	3k9
R83	18k
R84	100k
R85	390k
R86	1M
R87	6k8
R88	10k
R89	18k
R90	47k
R91,92	100k
R93	47k
R94	100k
R95	47k
R96	10k

Potentiometers	
RV1	47k log rotary
RV2-RV11	250k trim

Capacitors	
C1	100n polyester
C2	10µ 25V electro
C3	3p3 ceramic
C4,5	10µ 25V electro
C6	100n polyester
C7,8	3µ3 16V tantalum
C9,10	1µ5 16V "
C11,12	1µ0 16V "

Construction

Due to the complexity of the unit it is recommended that PC boards are used. These boards are assembled as per the overlay diagrams. Watch the orientation of all the ICs, diodes, capacitors, etc., when installing them. Note that as the board is not a plated through type that the tracks on the top side of the board must also be soldered to the components. This prevents the use of sockets for the ICs but they are not really worth the cost for low priced ICs

Capacitors continued

C13	220n	polyester
C14	100n	"
C15	68n	"
C16	33n	"
C17	18n	"
C18	8n2	"
C19	3n9	"
C20-C24	33p	ceramic
C25-C29	10p	"
C30-C34	2μ2	25 V electro
C35	47n	polyester
C36	27n	"
C37	12n	"
C38	6n8	"
C39	3n3	"
C40	2n2	"
C41	1n0	"
C42	560p	ceramic
C43	270p	"
C44	150p	"
C45-C49	33p	"
C50-C54	10p	"
C55-C59	2μ2	16 V electro
C60,61	25μ	16 V "
C62	820p	ceramic
C63	2n7	polyester
C64	5n6	"
C65	33p	ceramic
C66	150p	"
C67	3p3	"
C68	150p	"
C69	10p	"
C70	33p	"
C71	2n2	polyester
C72	560p	ceramic
C73,74	220μ	25 V electro
C75,76	10μ	25 V "

Semiconductors

IC1-IC21	LM301A
IC22	4017 (CMOS)
IC23-IC25	4016 (CMOS)
IC26-IC28	LM301A
IC29	4011B (CMOS)
IC30	LM301A
IC31	7812
IC32	7912
Q1	BC548
Q2	BC558
Q3,4	8C548
Q5-Q7	BC558
D1-D27	1N914
D28-D31	1N4001

Miscellaneous

- PC boards ET1 487A, 487B
- Transformer PL24-5VA
- Case to suit
- 3 core flex and plug
- 240V power switch
- Input / output terminals to suit

as used.

With the board 487A be very careful as there is 240V on the board. It is recommended that the wires be terminated directly to the board, without PC board pins, and that the 240V tracks on the underside of the board be coated with epoxy to prevent contact.

We mounted the unit into a home-made box as we did not have a commercial one on hand to suit.

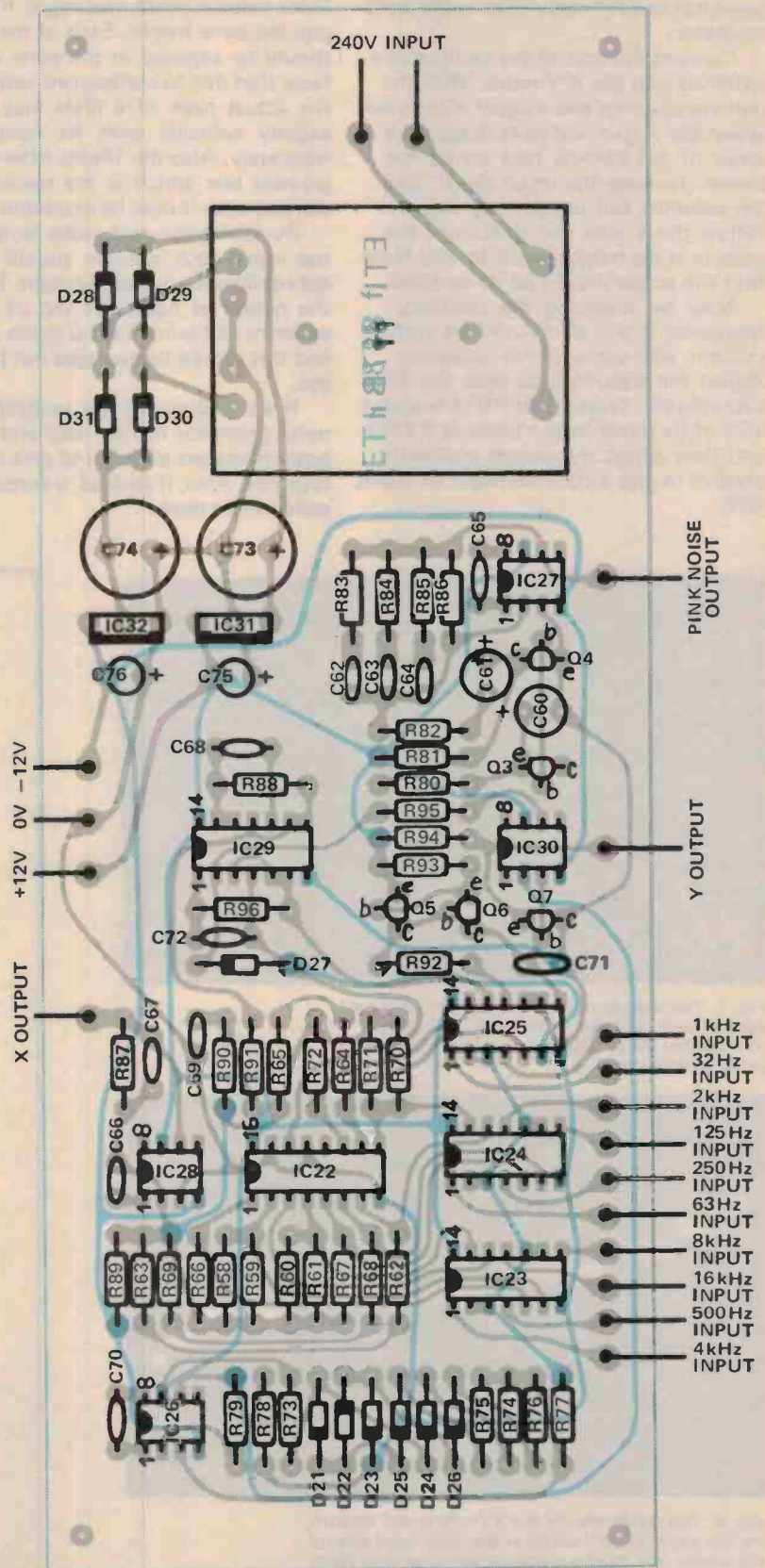

Fig. 6. The component overlay of the logic-power supply board.

Project 487

Alignment

This can be done using the pink noise generator or preferably with a sine wave oscillator.

Connect the unit to the oscilloscope switched into the X Y mode. With the unit switched on and a signal connected, adjust the X gain and shift to obtain a series of ten vertical bars across the screen. Increase the input signal until the columns will not get any higher. Adjust the Y gain and shift until the column is the height of the screen. Note that the scope should be dc coupled.

Now by sweeping the oscillator frequency it will be found that each column will come up in sequence. Adjust the frequency to peak the 16 kHz column. Now adjust RV11 to about 75% of its travel (wiper towards RV10) and then adjust the overall sensitivity control to give a column height of about 80%.

Now using the same amplitude adjust the signal generator frequency until the 8kHz column peaks and adjust RV10 to give the same height. Each of the filters should be adjusted in the same way. Note that due to component variations the actual peak of a filter may not exactly coincide with its nominal frequency. Also the 16kHz filter has the greatest loss which is the reason for starting with it near its maximum gain.

By taking the pink noise output to the input each column should be approximately the same height. Due to the nature of noise the top of the columns will jump up and down a little and this should be averaged out by the eye.

If an oscillator is not available the noise generator can be used and the potentiometers adjusted to give an even response. Also, if desired, a vertical dB scale can be made.

Making negatives

This method can be used to copy ETI artwork from October 1977 on only. The film used is Scotchal 8007 which is UV sensitive and can be used under normal subdued light.

Cut a piece of film a little larger than the pc board and expose it to UV light through the page of the magazine. The non emulsion side should be in contact with the page. This surface can be detected by picking it up by one corner and it will curl towards this surface. Exposures of about 20 minutes are normally necessary.

The film can now be developed by placing it emulsion side up on a table, pouring some Scotchal 8500 developer on the surface and rubbing it with a clean tissue.

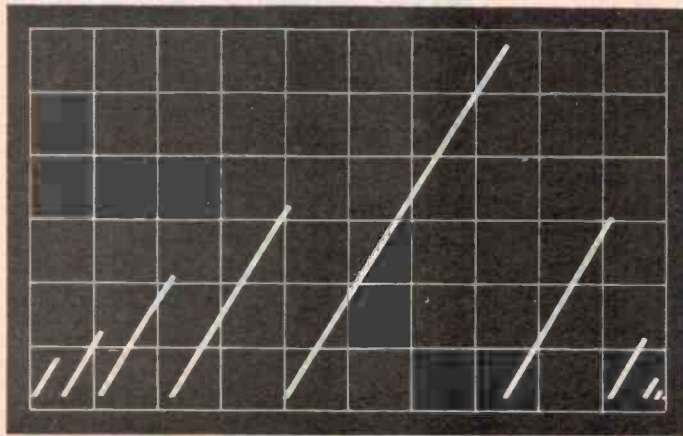

Fig. 7. The waveform on the Y output (vertical) with a 1 kHz tone input. See page 12 for the X-Y display. Note that the time between cycles varies with the height.

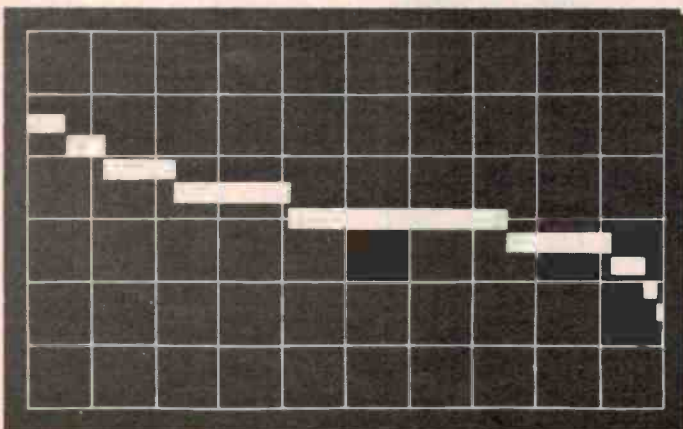
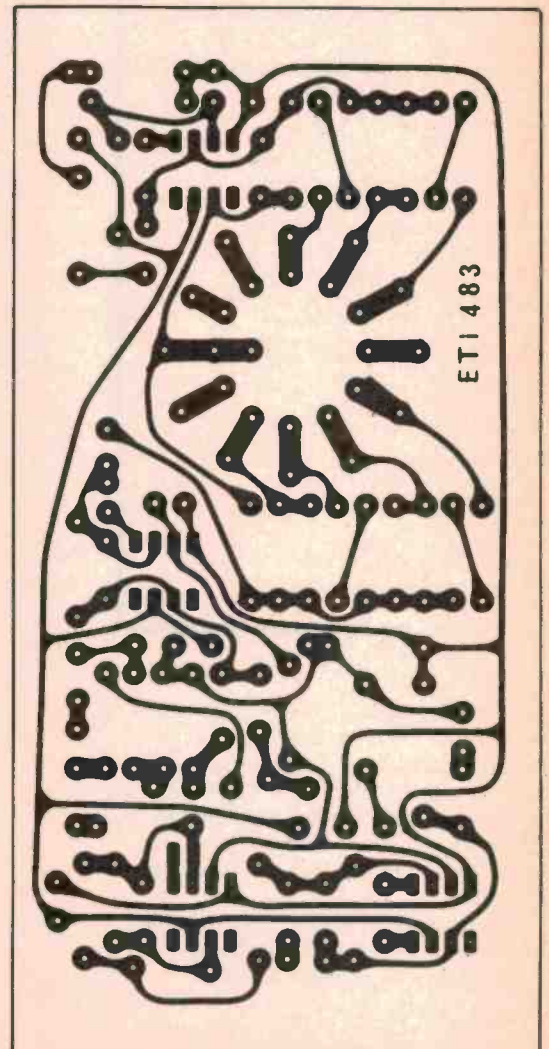

Fig. 8. The waveform on the X (horizontal) output. As this starts at +4 V which is the right hand side of the screen, the 16 kHz output is sampled first. Note that the time between steps corresponds to that in fig. 7.

The printed circuit layout of the sound level meter ETI 483 shown full size.



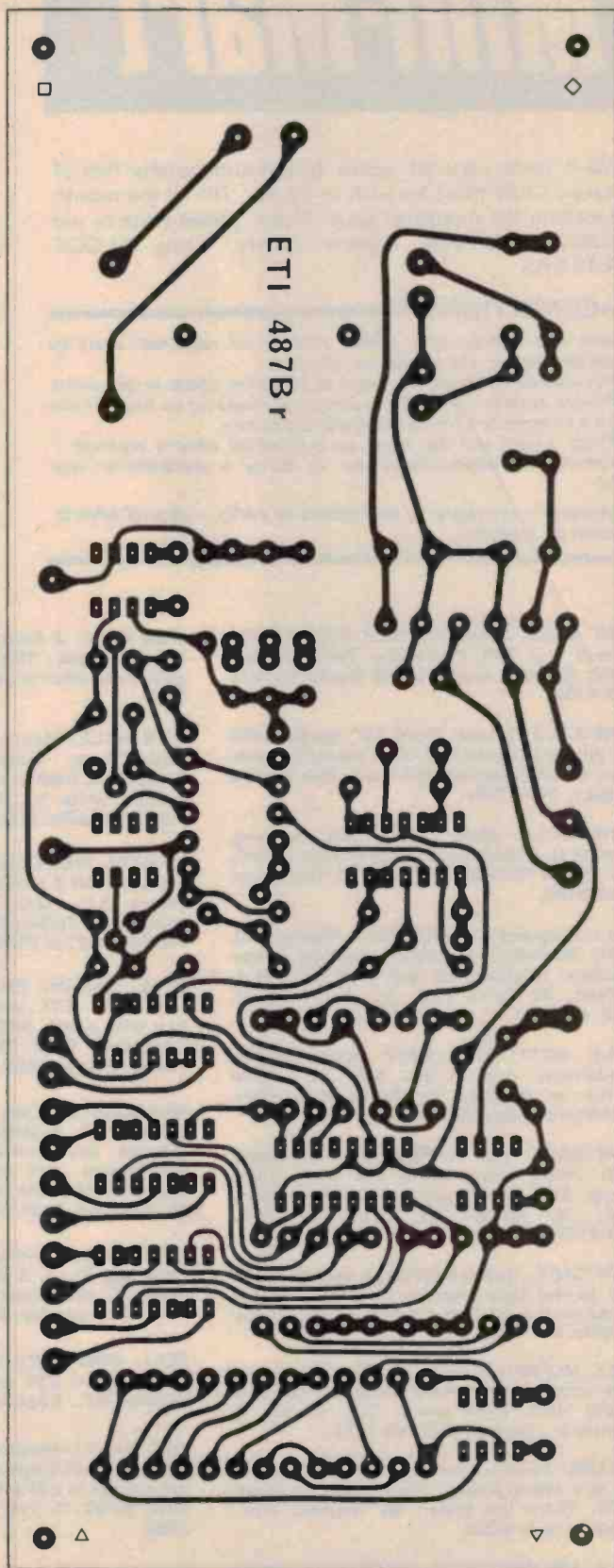
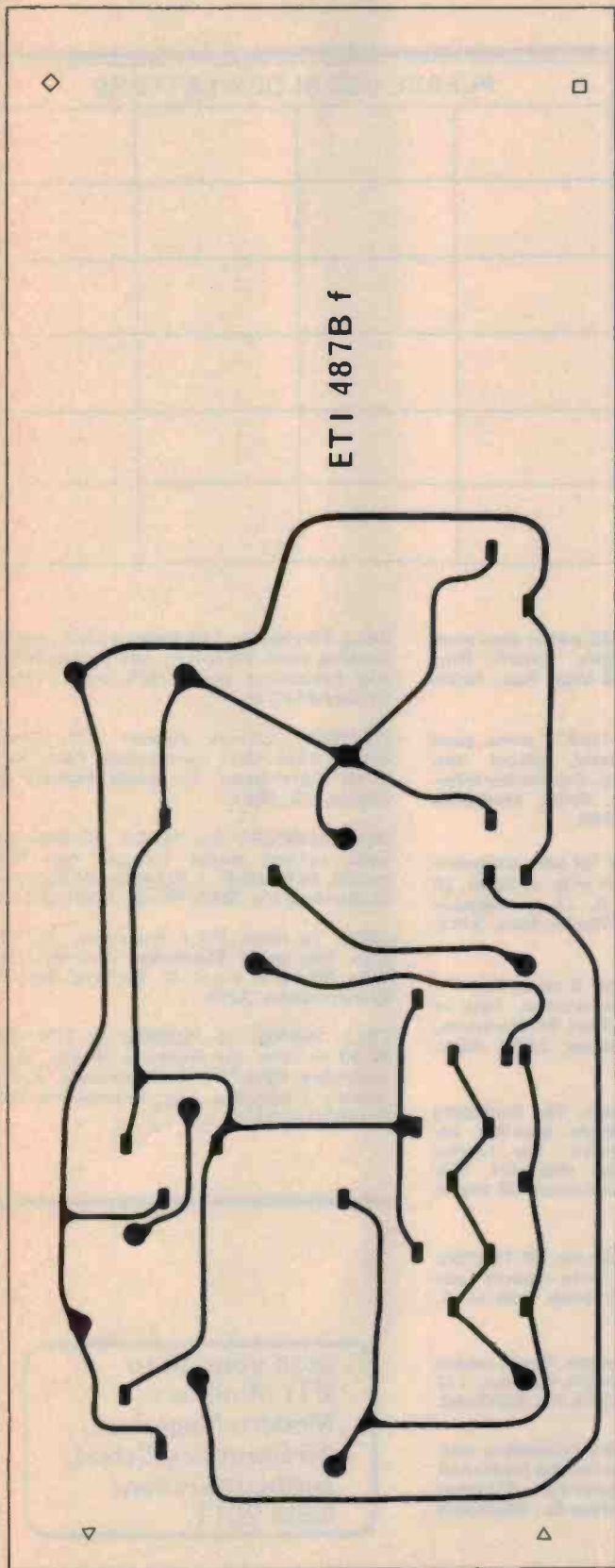

Fig. 9. Both sides of the ETI 487B board shown full size.

Mini-Mart

We'll print your 24 words (maximum) totally free of charge. Copy must be with us by the 7th of the month preceding the month of issue. Please, please write or preferably type your adverts clearly, using BLOCK LETTERS.

CONDITIONS

Name and address plus phone number (if required) must be included within the 24 words allowed.

Reasonable abbreviations, such as 25 Wrms, count as one word.

Private adverts only will be accepted. Please let us know if you find a commercial enterprise using this service.

Every effort will be made to publish all adverts received — however, no responsibility for so doing is accepted or implied.

Adverts must relate to electronics or audio — general adverts cannot be accepted.

PLEASE USE BLOCK LETTERS

FOR SALE, Musicolor MK3 \$55, ET1424 Reverb unit \$35, Playmaster Twin 25 Amp \$100, All built, working. Bob Gipslis, Sydney 449-4186.

FOR SALE, 1 Leak Duad 15" speaker with 6" elliptical tweeter in large capacity enclosure. Good condition \$40 o.n.o. Bob Gipslis, Sydney, 449-4186.

FOR SALE: Baby 2650, See Running, moving to a more basic system: \$50 — ONO. E.J. Pinder 750-0030 PO Box 101, Roselands, NSW 2195.

SELL programs for HP25/25C — Mastermind, Golf, Battleship, Blackjack, Cannon, Poker-machine, Roulette. \$3 each or 8 for \$15. I. Webber, 92 Royal Pde., St. John's Wood. Q'ld, 4060.

SELL BC221 with 240V power supply, headphone, manual etc. Still in original carton as supplied to Army. Best offer. P. Hartmann, Box 101, Epping, 2121.

FOR SALE: MK III Musicolor. Assembled with timber dress sleeve and triple 100w lamps. \$70. Owner getting married — needs cash. 24 Malouf St., Canley Heights. 604-4137.

FOR SALE: Toshiba GT601V vertical mono reel to reel tape recorder. \$43. 14 5" tapes \$1 ea or the lot \$50. 24 Malouf St., Canley Heights. 604-4137.

SELL MC/MP Introkkit plus SCMP10. Comes with comprehensive data manuals — switches hardly used. \$100 o.n.o. D.K. Brown, 8 Whittle St., Gatton. (075) 62-1814.

ET14600 Synthes. Set assembled and tested. P.C.B.'s. Wired Keybd, Reverb Unit, Patchbd. \$800. Write Ian Miller, 35 Guilford Ave., Prospect, S.A. 5082.

SELL 100 Watt Guitar amplifier with Etone 15" 160 Wrms speaker in vinyl covered cabinet. Has four inputs. Ph. 397-7193 Bris. Q'ld. \$400 ONO.

FOR SALE: 2 Auditec 033 power amp modules. Unused 100 WRMs. \$1020. Ring 547-7445 after 6 pm. 13 Mons Pde., Noble Park.

FOR SALE: House and land, 7 acres, good outbuildings. Town water, school bus. Telephone, freshly painted. For further information write to Mr. B. Paton, Macksville Rd., Bowraville. N.S.W. 2449.

DIGITAL MULTIMETER for sale. Kamoden HM-35 \$150 3 months use with no faults. 26 ranges A.C., D.C., V, A, Ω rechargeable charger. 68 Reillys Rd., Winston Hills. 2153. Ph. 639-8621 & 29-6227

SELL, Realistic Patrolman 9 band AM/FM VHF/UHF S.W. portable receiver. New in box with access. \$80 or offers. M. Stevenson, "Attunga" RMB 59, Harden, 2587, NSW. Phone A.H. 86-8201.

MELBOURNE Tape friends. The Recording Society of Australia meets monthly for lectures and demonstrations. For further information and syllabus ring AH (03) 459-1717 or wrote to Don Patrick, 36 Argyle St., Macleod. 3085. Vic.

SELL master mind program for HP 19C/29C (specify); \$2.28. 5 digits, auto random code generator etc. Need only press GSB O. S. Bliss, 7 Cooper Plc., 5110.

SELL. BWD model 300 scope. Needs repairs (transformer) \$20 with circuit. C. Coen, 117 Sladden Rd., Engadine, 2233, Ph. 520-6498.

FOR SALE: comprehensive conversion instructions (with diagrams) to include horizontal bat control in ETI's November color TV-game offer. \$2.50. D. Yee, 8 Bolton St., Beaumaris 3193.

DICK SMITH 10" woofers. Pair cost \$55. As new sell \$35. Pair 8" Wharfdale wide range speakers, \$40. Perfect. Lockerbie, Cameron St., Merimbula. 2548. Ph. 51565.

SELL Playmaster 144 Cassette deck, perfect working cond. VU meters, overload indicators and headphone socket \$65 o.n.o. Phone: Sydney 44-6449.

WANTED: Circuit diagram A.C. Cossar. Model 1035 Osc. Instructions. Palec Mod. ET4a Valve tester. R. Brazill, Howard St., Epsom, Vic, 3551.

OSCILLOSCOPE trio 1560A. 15 MHz dual trace current model includes two PC27 probes. \$495 ONO. J. Kingston, 24 Carpenter St. Bendigo, Vic, 3550. Phone: (054) 42-1104.

SELL 74 issues E.T.I. from Oct. '71, \$50. Also 105 issues Electronics Australia from June '68. \$70 o.n.o. G. Brooker, Box 41, Broadmeadow, 2292.

SELL 25000 μ f to 70,000 μ f to 70V Caps \$5.00 or swap for Resistors, diodes, 555's, transistors NPN/PNP small electro's. J. Winchester, 8 Allambie Ave., Koonawarra, 2530 Ph: (024) 613245.

send your ad to —
ETI MiniMart,
Modern Magazines,
15 Boundary Street,
Rushcutters Bay,
NSW 2011.



De-soldering problems?

The new Weller power vacuum desoldering station for printed circuit board repair. Famous Weller closed loop temperature control protects sensitive components while soldering or desoldering. See-through solder collector is easy to clean or replace. Non-burnable cord sets afford safety and longer life. Low voltage tool inputs give added safety margins. High impact resistant tool handles and stainless steel barrels mean longer tool usage.

Also there's now cordless soldering from Weller - (see right). Soldering was never easier than with the Weller cordless kit, consisting of iron charger, solder, 4 different tips and a handy screwdriver. Other products from The Cooper Group include Crescent, top quality electronic pliers; Lufkin, measuring equipment; Nicholson, precision files; Xcelite, professional hand tools and Wiss shears and scissors. Whatever your requirements, you can choose Cooper products with confidence.



The Cooper Group

CRESCENT · LUFKIN · NICHOLSON · WELLER · WISS · XCELITE

The Cooper Tool Group Limited,

P.O. Box 366, Nuringong Street, Albury NSW 2640, Australia. Telephone: 215511 Telex: 56995



TDK Magnetic

\$49.95



Send us your coupon NOW!

TDK NECKLACE OFFER

Please forward one TDK Magnetic Necklace. I enclose my cheque/postal note for \$49.95 accordingly. Please make cheques etc. payable to 'Necklace Offer' and post together with order form (or replica thereof) to 'Necklace Offer', Electronics Today International, 15 Boundary St, Rushcutters Bay, NSW, 2011.

Name

Address

Postcode

Please specify your choice

- Gold-plated, designed for women
- Rhodium-plated, designed for men



Necklace Offer!

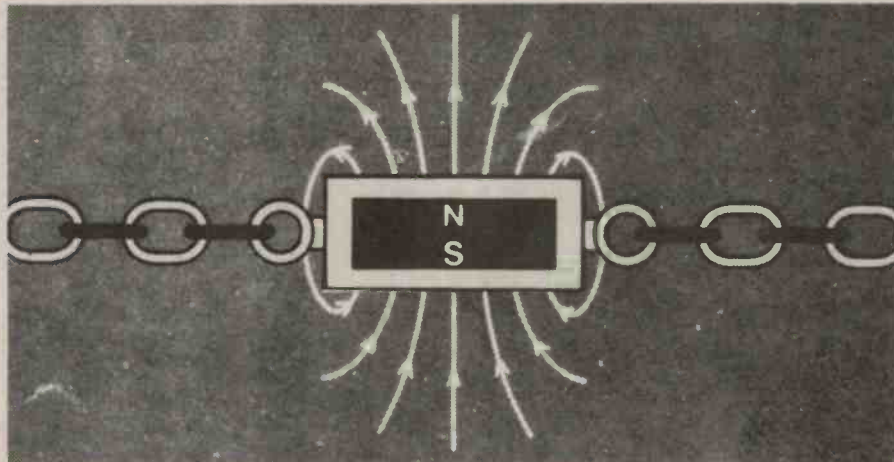

VERY many people suffer from so-called 'stiff shoulders' or 'stiff necks'. It is generally believed that these unpleasant symptoms are caused by mental or bodily stress but the exact cause is not apparently really known.

The TDK Electronics Corporation have produced a magnetic necklace which they state has proven effective in relieving such symptoms for a very high proportion of sufferers.

The Japanese Government's Ministry of Health and Welfare has given its approval (NO. 51B-614) to this necklace and we have read four fully documented reports from independent authorities (such as the University of Tokyo's Medical Faculty) to support TDK's statements.

The necklaces are made in two basic forms. Gold-plated 430mm long and rhodium-plated 560mm long — these, TDK suggest, would suit men or women respectively. Both are sold at the same price.

The necklaces contain extremely powerful rare earth cobalt magnets which were originally developed for the NASA space programme. The magnets are permanent. Necklaces are supplied complete with two connecting rings, one hook and one length of chain as spares.

TDK advise users to wear the necklace in direct contact with the skin. It should be worn continuously including whilst asleep, removing it only whilst taking a shower or bath.

Most people find it effective after two to three days.

The TDK magnetic necklace is handled in Australia by the Caldor Corporation and they have made arrangements for our readers to obtain either type at the same price — \$49.95 including postage and packing.

Necklaces should be ordered via this magazine using the form (or replica thereof) published on this page.

Please make cheques payable to 'Necklace offer' and send c/- Electronics Today, 15 Boundary St, Rushcutters Bay, NSW, 2011.

Please allow at least three to four weeks for delivery — there really are mail delays — particularly of parcels!

Thousands of people have used these necklaces and claimed they have experienced relieve of 'stiffness'. Nevertheless we would like to make it absolutely clear that all papers published so far show that the devices vary in their effect from one person to another and that in some cases they have no effect at all. There is no totally tangible scientific evidence to support or refute any claims or statements made although research is continuing worldwide. Therefore as no claims can currently be substantiated (and of course no claims are made by us or Caldor) the ultimate decision and experience must be yours.

Nevertheless, the necklaces are made by TDK and that must mean something.

Manufactured by,

 **TDK**
TDK ELECTRONICS CO., LTD.

Lafayette)) 27MHz two-way



**5 WATT 6 CHANNEL
'MICRO 66'**

The latest Lafayette 27 MHz transceivers whose versatility, reliability and performance are famous world wide with 100,000's in constant use. Lafayettes two-ways offer ruggedness and compact size making them ideal for use in industry, farm, sports and marine applications.



**5 WATT 12 CHANNEL
DYNA-COM 12A**

**1 WATT 3 CHANNEL
LAFAYETTE HA-310**

All units Telecom Type Approved (Licence Required)

Lafayette are 2-way specialists. Full range 27MHz crystals, antennas, auxiliary equipment available!

Dealer enquiries invited

Lafayette))

the Communicators
LAFAYETTE ELECTRONICS
Div. of Electron Tube Distributors P/L
94 ST. KILDA RD., ST. KILDA
Victoria 3182. Tel. 94 6036

ROMARTELEC ELECTROMART ELECTROMART

P.O. BOX 36, Highbury, SA 5089
Phone 264-2301

CASSETTES
PROFESSIONAL GRADE
C60 LN \$1.99
C90 LN 2.60
10% discount for 10 or more

C.B. ACCESSORIES
PL259 Antenna Plug \$1.00 (No adaptor required) Lightning Arrestor \$2.65 (connects in antenna line to C.B. Rig) Patch Cord 1 metre of \$3.00 50 ohm coax with PL 259 Plug at each end Cigarette Lighter Plugs \$1.00

★ SPECIAL OFFERS WHILE STOCKS LAST ★

TAG TANTALUM CAPS
4.7 μ F & 6.8 μ F 25V .20
or \$2.00 per dozen

ROTARY WAFER SWITCHES
Single Bank 1 pole 12 position \$1.00
2 pole 5 position \$1.00 3 pole 4 position \$1.00 4 pole 3 position \$1.00

SOLDERING IRONS
Lotring 240 V 30w \$10.96 Spare Tips .58

VOLTAGE REGULATORS
LM 340-T POSITIVE REGULATOR
AVAILABLE IN 6, 8, 12, 15, 18 or 24 volts \$1.70

INTEGRATED CIRCUITS
LM 555 CN .65 LM 741 CN .50

WE ALSO STOCK A COMPREHENSIVE RANGE OF LINEAR, T.T.L. & CMOS INTEGRATED CIRCUITS AT COMPETITIVE PRICES!

POST & PACKING .60c
SEND 20c STAMP FOR QUANTITY PRICES OR COMPLETE CATALOGUE

METERS
EDGEWISE 35 x 15 mm CENTRE ZERO UNSCALED. \$3.75
EDGEWISE 35 x 15 mm SCALED 0-10. \$3.75
SQUARE 40 mm CENTRE SCALED 5-0-5 \$3.50
SQUARE 25 mm SCALED 0-10. \$3.10

TAG TANTALUMCAPACITORS
.1, .22, .33, .47, .68, 1, 1.5, 2.2, 3.3, 4.7 ALL 35 Volt .30

6.8	35v	.33
10	25v	.30
15	16v	.30
22	10v	.33
33	10v	.39
47	6v	.69

LIGHT EMITTING DIODES
Red 24 mCD 2.15
Green 30 mCD 1.55
Red 6 mCD High Intensity .72
Yellow 7 mCD .75

CERAMICS PHILIPS 100V
1.8-39 pf NPO .10 47-120 pf NPO .13
150-330 pf N750 .14 390-1800 pf HiK .09
2200-4700 pf HiK .14 1000-10000 pf HiK 40v .09

ELECTROLYTIC SPECIALS

UPRIGHT TYPES		
220 μ F	16v	.13
220 μ F	25v	.17
470 μ F	16v	.17
470 μ F	25v	.22
1000 μ F	16v	.24

EMONA
enterprises
C.B.C. Bank Bldg, Haymarket,
Room 208, 661 George St.,
Sydney 2000 Ph: 212-4815
MAIL ORDERS: P.O. BOX 188
Coogee, N.S.W. 2034

NATIONAL SEMICONDUCTORS CALCULATORS



* NS4640 - Scientific/Engineering/Statistical calculator - 12 digit including 2 digit exponent. RPN logic. 3 separate addressable memories. Four level "rollable" stack. Fixed or floating decimal statistical functions. Metric conversions, percentage, square roots, etc. Rechargeable batteries. Supplied with charger. **PRICE: \$33.00**

● NS - 201R, Full scientific, rechargeable batteries, charger and desktop stand. Billfold style. **PRICE: \$26.85.**

● NS - 201R, Full scientific, rechargeable batteries, charger and desktop stand. Billfold style. **PRICE: \$26.85.** ● NS100 - Ultrasmall Pocket (7.5mm thin) Billfold style, **PRICE: \$21.74.** ● Other National Semiconductor models available. ● Elcon SC-44F, Scientific - \$32.50 (Recharg. battery & charger). ● Plus 15% Sales Tax, if applicable - all calculators. ● P & P. Int. \$3.00. N.S.W. \$2.00.

NEW! UNIK TIME BY EMONA - the world's thinnest digital timepiece

* 5 function, 4-digit quartz crystal accuracy
Hour minute, second, month, date. * Super thin styling (6mm) with 4 elegantly styled faces.
* Removable battery hatch for easy customer battery replacement.
* Gold or silver toned case with lizard or mesh band options. * High contrast, easy to read liquid crystal display with command backlight. * Full year warranty with worldwide service.

**** TRADE ENQUIRIES WELCOME!**

STOP PRESS!
Now available full range of TEXAS calculators at competitive prices.

ALSO AVAILABLE:
* Full range of National semiconductor watches (see E.T.I. Dec '77) * LED Electronic Digital Alarm clocks. * A range of Digital Clock Radios.

BULK Electronic Warehouse

NEW PRODUCTS FOR MICROPROCESSOR USERS NUMERIC KEYBOARD KITS



Ideal for keyless entry systems, burglar alarms, micro processors etc. Keys 0 to 9, blue with white lettering and CLR key, red with white lettering. Giant key-top 18 x 18mm, long life (10-6 guaranteed operations), made in Germany by Rafi, PC mounting, very low profile. \$5.90 Full Kit or 75c per key. 10 kits \$5 ea 25 kits \$4 ea.

DOLLAR STRETCHERS \$1 PACS

- 99 2 PVC Transistor Tuning Gangs 20mm x 20mm, 200pf as in most radios.
- 1 20 Yds Hookup wire. Multi-stranded in assorted colours.
- 3 9 Phillips Asst. VDR's. For servicemen, experimenters, c.w. data.
- 8 200 Asst. Screws, Nuts.
- 129 60 Asst. Self-Tapping Screws.
- 130 120 Asst. Steel Washers.
- 131 120 Asst. High Grade Nuts.
- 132 100 Asst. Screws.
- 124 12 Pot. Nuts, Washers.
- 11 20Ft. Plastic Spaghetti Tubing in various colours.
- 17 10 Volume Controls. Some with switch, ganged.
- 18 10 Preset pots. Tab mtg. TV types.
- 2 50Ft. Speaker Cable — colour coded.
- 170 4-14 Pin DIL Sockets — gold pins.
- 171 3-16 Pin DIL " " "
- 24 3-UM3X4 Battery Holders.
- 25 10 — No. 216 Battery clips.
- 27 3 Magnetic 8 ohm Earpieces — 3.5mm plugs.
- 29 15 Fuses 3AG 1 1/4" x 1/4" Choose 1/4A, 1A, 2A, 3A, 5A, 10A.
- 39 5 Core 16G Solder — 60-40 multicore, 10Ft.
- 5 15Ft Twin Core Shielded Fig. 8 cable.
- 96 5—5K ohm Volume Controls. Miniature for trans. radios — c.w. knobs.
- 76 Mono crystal cartridge, Gen. purpose
- 87 3 3/8" x 8" long round ferrite rods.
- 134 3 Suppressor Resistors — HT Lead.
- 110 3 Computer Boards, loaded with trans, diodes, res, caps, approx 150 asst. parts.
- 111 2 Car Cigarette Lighter Plugs Useful for all car accessories.
- 112 2 Neon Indicator Bezels — 250v. AC Red.
- 136 3 Asst. Neon Bezels 250VAC.
- 113 2-6V Indicator Bezels, Chromed, choose red, green, amber.
- 119 5-2 Pin Plug Sockets Sets. Polarised with covers.
- 120 8-3AG Plastic In-line Fuseholders.
- 123 10 ASST. Potentiometers. New, incl. preset, gang, switched etc.
- 14 25ft. Dial Cord — plus 5 springs.
- 26 Tuning Dial Kit. Incl. spindle, 3 pulleys, pointer, drum, cord, spring and instructions.
- 121 Handspan Radio Dial Kit, round dial, all states dial scale, bush etc. suit most PVC tuning gangs.
- 2 RCA to RCA audio leads.
- 95 15 Radio Knob Assortment.
- 151 2 Push button switch, 6P2T ea.
- 30 2 Panel Fuseholders — std 3AG.
- 152 6 Mini-Slide Switches, 3P2T, PCB mtg.

JUMBO BAGS \$3ea.

- 400 1/4W Asst. Resistors
- 500 1/2W " " "
- 300 1W " " "
- 100 Asst. Semiconductors
- 100 Asst. Poly Caps 160—630V
- 150 Asst. various caps
- 60 Asst. Electrolytics
- 160 ASST. BULK PARTS Inc. res, caps, semis etc. We don't have time to sort out!

BONANZA JACKPOTS

For experimenters and constructors, a large assortment of new, high quality parts — samples, specials, end-of-line components incl. semiconductors.

JACKPOT No. 1
A 500gm (approx) Lucky-dip offer, all useable parts. Up to \$25 worth for only \$5.

JACKPOT No. 2
A 2Kgm (approx) assortment in a 315 x 270 x 160mm box includes relays, edge connectors, pots, switches, semis and many others too numerous to mention ONLY \$10.

10W STEREO AMP

Sounds great, many features — bass/treble controls, 5 pin din rec/play & h'phone sockets, loudness, rumble and scratch switch ceramic cart, input, 35V 1.2A req, transformer, extra \$4.00.

Few only Available **\$19**



5" B & W SHARP TV TUBE

Brand new, sealed in manufacturers carton. Ideal for servicemen, amateurs, experimenters etc. Were selling at \$11.95, now only \$5.95; sorry no yokes avail.



DOLLAR STRETCHERS \$1 PACS

- 337 10 Asst. Mini Preset Pots.
- 338 2 Bourns 2K Cermet Trimpots
- 234 4 DPDT Medium Slide Switches
- 235 6 DPDT Mini Slide Switches
- 232 5 T05 Black Finned Heatsinks
- 220 100 Asst. 1/2W RESISTORS. 5/, 10/ mixed carbon composition.
- 169 5-16 PIN DIL PLUGS. Gold Pins, suit 16 Pin IC Sockets
- 170 5-14 PIN DIL PLUGS.
- 167 10-IN914 Silicon Diodes.
- 166 3-6V 1W Zener Diodes.
- 163 1 Valve Output Transformer G.P.
- 148 1-1 Watt Audio IC Amplifier-with circuit diagram
- 142 10-0.0022 Feedthrough Capacitors
- 87 3 FERRITE RODS 3/8" diam x 8" long
- 306 15-0.22uF 160V Polyester Capacitors.
- 307 15-0.0047uF 400V Polyester Capacitors.
- 308 10-0.1uF 400V Polyester Capacitors.
- 309 15-100uF 10V Pigtail Electros
- 310 12-22uF 63V Pigtail Electros
- 311 10-470uF 16V Pigtail Electros
- 312 5-1000uF 10V Pigtail Electros
- 3-3300uF 6.3V Pigtail Electros
- 313 15 Asst. Lamps-low voltage 6-50V.
- 314 3 Sub-min Painton Preset Pots 1K.
- 315 3 Sub-min Painton Preset Pots 2.2K
- 316 2-90mfd 300VW Can Electros
- 317 1-200mfd 1/2 100mfd 200VW Can Electros
- 138 2-12 Pin PCB Connectors.

DOLLAR STRETCHERS \$2 PACS

- 137 30 Asst. ELECTROLYTICS. All good quality low voltage.
- 180 5 WAFER SWITCHES MSP rotary, std. mtg. 1/4" diam. shaft, 1to4 bank, various positions, all new.
- 319 MSP. CAR SPEAKER 5"x4" — 150hms.
- 320 8 ohm TWEETER 75mm-8 ohms.
- 321 3 Edge Connectors, 46 way, double sided 0.156" pitch, Plessey.
- 300 1-12V MINI RELAY — PCB mtg, 2A c/o contacts, 200ohm coil.
- 217 10-TIC44 SCR's -40V 600mA rating, mini T092 plastic pkg.
- 181 1-SUPER SENSITIVE MICROPHONE. Hearing aid type by Shure, 1" diam. x 3/4" high, low imp. Ex. Govt. use.
- 318 15 Neons. 60-90V pigtail.
- 231 2-10 Amp Microswitches.
- 193 10 Asst. Switches: Toggle, slide, rotary, all new, useful.
- 266 2-2SB337 Germ. Power Transistors.
- 198 50 TO-18 Asst. TRANSISTORS PNP&NPN, tested OK, marked.
- 218 250 Mixed Bulk RESISTORS:- 1/8W, 1/4W, 1/2W, up to 10W.
- 156 10-200pf TRIMMER CAPS. Air-spaced, mini, cer. base.
- 154 4-100pf CERAMIC TRIMMERS. High Quality Air-Spaced, PC or chassis mtg., communications specs.

"SUPA" SPECIALS for DEC.

- 322 MOTOR SPEED CONTROL KIT. Suits most electric motors. 240V 750W max. \$4.50
- 323 TRANSISTOR RADIO REPAIR KIT. Gang. speaker. semis. caps. pots etc. \$4.50
- 324 5" B&W SHARP TV TUBE. New. ideal servicemen. experimenters. \$5.95
- 199 600V 25A SILICON RECTIFIERS. International Rectifier. 10 for \$6.50, 25 for \$15.00 ea. .75
- 205 VHF Trans. TV TUNER. Miniature Sharp. 12 channels. 9 with biscuits. new. 2 for \$11.00. \$6.00 ea.
- 219 100 ASST. 1W RESISTORS. 5. 10x mixed carbon composition. \$1.50.
- 331 30 A 400 PIV SILICON RECTIFIERS. Heavy duty STCRS640 stud mounted. \$1.50.
- 332 CATHODRAY COND. 0.5mfd 2KV. Stud mtg. hi qual. special purpose. \$1.00 ea.
- 249 HP 5082-7300 LED DISPLAY. 7 Segment 4x7 dot matrix, in built decoder-driver and memory, L.H. decimal pt. 0-9 Readout. buy 4 for \$26.00. \$7.00 ea.
- 9 BONANZA JACKPOT A 500 gm (approx) lucky-dip offer, all useable parts, samples, specials, end-of-line components incl. semis. \$5.00 ea.
- 333 3 PIN MINI PLUG & SOCKET .60pr.
- 334 7 PIN MINI PLUG & SOCKET 1.00pr.
- 335 14 PIN MINI PLUG & SOCKET 1.20pr.
- 336 37 PIN MINI PLUG & SOCKET 1.80pr.

Electronic Agencies

Trading Hours — 12.00 — 6 pm Mon-Fri. 8.30 — 1 pm Sat.
Mail Orders — P.O. Box 1005 Burwood North 2134.
Post & Pack — Add 15 per cent up to \$25 order value. 10 per cent over.
Minimum Order Value — \$5.00 C.O.D.'s Send \$3.00 pre-paid
Prices and availability — as at 25/10/77

115-117 Parramatta Road, CONCORD, N.S.W. Telephone (02) 747 6472

Write your Name, Address, P/Code here and send your order to P.O. Box 1005, Burwood Nth. 2134.

HAND TOOLS

The search for new products is never ending and tools are one of the important areas we are constantly checking. Just look through this great range and their incredible prices. It must all add up to good value. Especially when you realize how simple it is for you to get any of these great products, either send in to our mail order dept., or pop into any Dick Smith store or dealer!

.01 TRANSISTOR NIPPER for very small gauge wires. 3 1/2" (115mm) long. Spring opening insulated handles. Similar quality normally around \$7.00. **\$4.50**

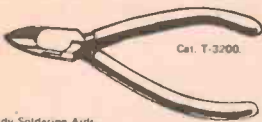

Cat. T-3700.

Handy Soldering Aids
PS6 TWEEZERS with very fine, sharp, straight points and non-slip jaws. 125mm long. A must at only 75c. (Ideal for medical cabinet tool!)
Cat. T-4630.

H3-C-R PULLER your extra hand for removing awkwardly located parts. Spring loaded to remove component as solder melts. Ideal for servicemen. \$2.25.



Cat. T-2600.

H9 SOLDER BULB. A simple rubber bulb type solder sucker for de-soldering. \$2.50.

Cat. T-2580



Cat. T-2620.

H72 HEAT SINK SET. Like alligator clips made of aluminium. A must for transistor work. \$1.20.



Cat. T-2560.

EL-1 SOLDER SUCKER. Full metal construction - better than plastic! With Teflon tip. Simple push/release thumb mechanism. Complete with nozzle/wiper. (H) Normal price was \$9.00. Now only \$8.75. spare Teflon tips avail.



Cat. T-4940.

K88 NIBBLING TOOL cuts any shape opening in sheet steel to 0.6mm thick or light alloy to 1.5mm. Easy to use, cuts plastics too without distortion. Follows scribe lines easily. Only \$8.50.



Cat. T-4940.

HIMICUND HK705 MORSE KEY. Unfortunately, the instructions are in Japanese, but we can tell from the diagrams that this key has real ball-bearing pivots which can be adjusted. It is beautifully made and a delight to handle. Heavy duty construction throughout. Not a toy but a professional key. Screws adjust spring tension and knob travel. Measures 160mm x 90mm x 65mm high. Highly recommended for you CW enthusiasts.



Cat. D-7104.
Only \$25.00!

CHARGEITE
 The neatest 12V, 1A trickle charger yet. Can be run continuously with special thermal overload protection switch. Looks like a big main plug with leads straight to battery. A handy unit for car, boat, caravan owners - keeps your battery in tip-top condition for just \$15.00.



Cat. M-8802.

look at this for value!

AM/FM MULTIPLEX TUNER YFX-801-1C.
 Here is the greatest tuner value you will ever see. Specially produced for Australia with 50uS FM de-emphasis (NOT the overseas 75uS). Has in-built ferrite rod for AM reception over broadcast band. 25dB stereo separation. Pro'n for stereo indicator (C Multiplex). Separate TUNED f.f. stage. Beautiful spaced AM/FM tuning gauge covers all Australian AM/FM band width. Fully assembled at less than the value of the parts. Highly recommended at only \$37.50.

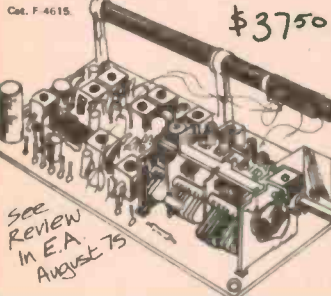

\$37.50

See Review in E.A. August 75

Cat. F-4615.



NEW!

RANGE OF HANDY MODULAR PLASTIC COMPONENT BOXES FOR THE HOBBYIST OR HANDYMAN

Frankly, we have seen a lot of component drawers come and go over the years. In our opinion, these are the best ones that we have come across. Check these features:
 Large handle on the front of each drawer. Special index card slot moulded into handle for labelling. Outside of boxes have precision dovetail ways so that boxes may be securely fitted together. Wall or bench mountable. Trays do not slide inside box as many inferior other types do. Two types available. One with 2 drawers per box (M-2585). The other has one drawer (M-2584) per box. All boxes in smart white high impact plastic with the drawers moulded in a smart red. Overall dimensions S: 1/8in. D: x 4.1/2in. W: x 2.1/4in. H. Price is only \$1.20. for either.

HUGE HI-WATT BATTERY SHIPMENT IN

Specialty imported, factory fresh, high capacity, long life batteries. Just look at these prices!
 Cat. S-3001 D size metal jacket. ONLY 75c.
 Cat. S-3002 C size metal jacket. ONLY 20c.
 Cat. S-3003 AA penlite. ONLY 15c.
 Cat. S-3006 9V Transistor metal case. ONLY 45c.



BURGLAR ALARM VIBRATION SWITCH L-5250.
 Flipped little switch goes open circuit when it is shaken. Ideal for plateglass windows and safes, etc. Adjustable sensitivity. Tamper proof case, rugged PVC case. 5W, 50V @ 0.1A. Only .75in x .85in x .225in. \$2.80. Normally closed contacts.

MINI REED ALARM SWITCH L-5210.
 Fully moulded in grey PVC with riveted case for extra security. Solder free screw terminals. Complete with PVC encapsulated magnet. Normally open contact closes by magnet. Same rating as above. Get a pair for only \$1.95.



Cat. L-5250.

Cat. L-5210.

AND NOW... Dickwick! DESOLDERING DRY WICK

De-solders all sizes of electronic and electrical connections in one second without flux. All sizes of electronic joints and electrical connections, from integrated circuits and printed circuit boards to telephone connections, can be quickly, safely, neatly and economically desoldered with Dickwick and a regular soldering iron. Cat. N-1682. \$2.00.



115V trannies for foreign gear
HANDS UP IF YOU WENT OS FOR THE HOLIDAYS. Have you got a red face like many overseas travellers have - buying an appliance in, say, Japan - only to find it's for 115 volts! We can help - our 115 volt transformer is rated at 30 watts, which suits many small cassettes, radios, etc. Has normal mains flex and plug, with 115V socket to plug appliance into. Fully approved by the electricity authority.
 Cat. M-1156. \$22.00
HEY! THAT'S A SAVING OF NEARLY \$8.00!!

MA 1002 Digital Clock



Cat K-3434

IDEAL FOR THE EXPERIMENTER!

Here's a neat little kit to play around with - this digital clock is four big LED digits, and is pre-assembled on its own PCB. All you do to finish it off is add the transformer and a couple of switches.

Complete kit - chip, trans, sw.

\$19.75

CHIP ONLY - MA1002 clock chip only.
Cat X-1052 \$13.50

Metal Detectors

Sensing Indicator Light

FANTASTIC VALUE

\$59.50

Light indicator shows presence of metal objects.

WHAT VALUE! This "Builders Mate" metal detector is ideal for finding pipes & wires in walls, or nails in wood before you saw through them and ruin the saw! **UNDER HALF PRICE**
 Cat X-1060. \$4.75
FIND A FORTUNE! The quality metal detector shown at right is just the thing for searching for coins on the beach. Several stories from overseas prove that serious searchers can make the cost of one of these units back again!
 Cat X-1064. \$59.50

Mini Cassette Recorder

NEW

What a bewtily! A little cassette recorder ideal for personal recording, business, meetings, etc. Has in-built cond. microphone, takes standard cassettes. You'll see elsewhere for over \$80.00. Our price near half!
 Cat. A-4050

\$49.50

SUPER GLUE!

What's faster than a speeding bullet, more powerful than a locomotive, able to stick tall buildings together?
 A must for all hobbyists!
 Cat. N-1220. \$2.25.

BOOKS BOOKS BOOKS

MICROPROCESSOR MICROPROGRAMMING HANDBOOK. 294 pages. Phew! The titles almost a book in itself. Tells you what they are, how they work, and how to work them.
 Cat. B-2346. \$9.50

DISPLAY ELECTRONICS 252 pages. Cat. B-1844. A learning as well as a doing book. Find out how all the devices used as displays work, plus build projects using them. Cat. B-1844

B-1248. CMOS COOKBOOK (woops - who forgot to take a picture?) Thousands of CMOS ideas, incredible value for the experimenter. Few only \$13.50

PROGRAMMING MICROPROCESSORS 280 pages. Yes, another book on uprocessors (you can tell which direction this scene is going, can't you!) All sorts of information for the person dealing with uprocessors - and that's YOU.
 Cat. B-2348. \$9.50

BUILD IT BOOK OF DIGITAL ELECTRONIC TIMEPIECES 294 pp (Clocks to the mob) This one's got the lot. All types of beaut clocks to build, with an introduction to digital timekeeping for the beginner. Real value.
 Cat. B-1850. \$8.95

DICK SMITH ELECTRONICS



SHOP HOURS:
 Mon-Fri 9AM - 5:30PM
 Sat 9AM - 12 noon
 (Brisbane 1/2 hour earlier)



Order value	P&P charge
\$5 - \$9.99	\$1.00
\$10 - \$29.99	\$1.50
\$30 - \$49.99	\$2.00
\$50 - \$99.99	\$2.50
\$100 or more	\$3.00

SYDNEY: 125 York St. City. Ph 29-1126. Open 'til 8PM Thursday
SYDNEY: 361 Hume Hwy. Bankstown. Ph 709-6600. Open 'til 8PM Thursday
SYDNEY: 162 Pacific Hwy. Gore Hill. Ph 439-5311. Ample parking at door
SYDNEY: 30 Grose St. Parramatta. Ph 683-1133. 1st floor - friendly store!
MELBOURNE: 399 Lonsdale St. City. Ph 67-9834. New: right in town!
MELBOURNE: 656 Bridge Rd. Richmond. Ph 42-1614. Easy access: huge stock.
BRISBANE: 166 Logan Rd. Buranda. Ph 391-6233. Opens 8.30AM
ADELAIDE: 203 Wright St. City. Ph 212-1962. Now Open. See us!

MAIL ORDER DEPARTMENT: PO Box 747, Crows Nest, NSW 2065. Phone 439-5311. Post & Pack extra.

WE HAVE DEALERS RIGHT ACROSS AUSTRALIA - THERE'S ONE NEAR YOU!

Ideas for experimenters

These pages are intended primarily as a source of ideas. As far as reasonably possible all material has been checked for feasibility, component availability etc, but the circuits have not necessarily been built and tested in our laboratory. Because of the nature of the information in this section we cannot enter into any correspondence about any of the circuits, nor can we produce constructional details.

Electronics Today is always seeking material for these pages. All published material is paid for — generally at a rate of \$5 to \$7 per item.

Solid State Switch

The circuit was designed for use as a solid-state calculator on-off switch, as the mechanical equivalent was found to be unreliable.

Layout is not critical and the switch will operate with a supply from +6V to +15V and current consumption in the 'OFF' state is a negligible 30 μ A.

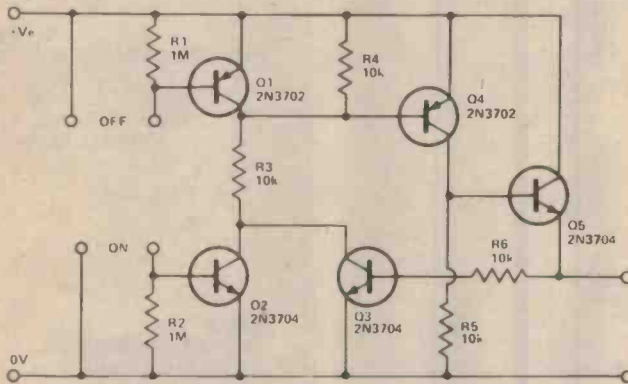

A finger across the 'OFF' contacts turns Q1 off and takes the base of Q4 to the +ve rail, turning Q4 off. This in turn stops Q5 conducting, and R6 and Q3 latch the circuit in this state.

Touching the 'ON' contacts takes R3 to ground turning Q4 on. Q5 now conducts and again R6 and Q3 latch the circuit.

Heartbeat Preamplifier

This simple circuit, when connected to an audio amplifier, allows one to listen to heartbeats. The low frequency gain is set by R1 and R3, in conjunction with VR1 and R4. VR1 permits the gain to be varied over the range 60-80 dB.

C1 and C2 introduce some low frequency cut, reducing 50 Hz pickup whilst C4 and C5 help prevent instability caused by the high gain of the circuit.

The output should be connected to the magnetic cartridge input of the audio amplifier, with the bass turned up high.

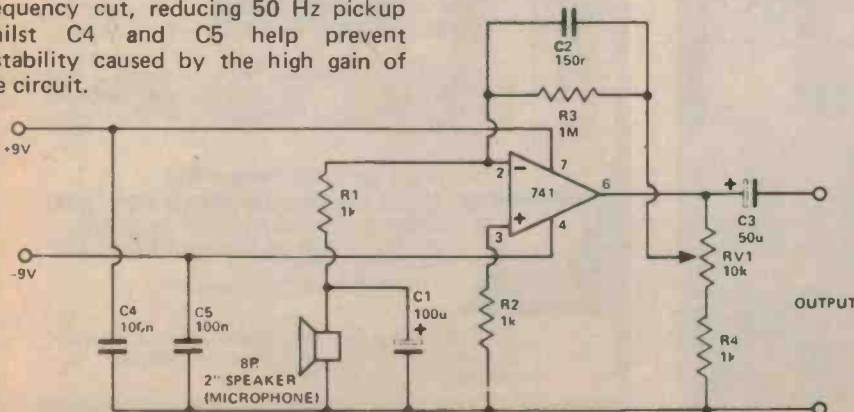

12" 3-WAY 75-litre 80 W
Handling TIMBER VENEERED
ENCLOSURE COMPLETE KIT

audio spectrum
HI FI SPEAKERS & KITS
DIRECT FROM MANUFACTURER

\$139

PAIR

10" 3-Way 75-litre 70 Watts
HANDLING

\$109

PAIR

75-litre cabinets..... \$48 pr

50-litre cabinets..... \$40 pr

30-litre cabinets..... \$35 pr

**DISCO LIGHTING SYSTEMS
& CONSOLES P.A. BINS
AMP ETC MADE TO ORDER
YOUR DESIGN OR OURS PLEASE
WRITE FOR QUOTE**

*All orders forwarded by road
transport payable on delivery*

ALL CHEQUES & MONEY ORDERS TO
AUDIO SPECTRUM

audio
spectrum

41 WHITEHORSE ROAD
DEEPDENE 3103
Ph (03) 80-1074 or
(03) 488. 821

STRIKE GOLD



SOVEREIGN CITY ELECTRONICS Ballarat

PHILIPS — LOCMOS

HEF 4000	.30	HEF 4021	1.28	HEF 4050	.50	HEF 4082	.32
HEF 4001	.30	HEF 4022	1.22	HEF 4051	1.24	HEF 4085	.94
HEF 4002	.30	HEF 4023	.30	HEF 4052	1.24	HEF 4086	.94
HEF 4006	1.28	HEF 4024	.99	HEF 4053	1.24	HEF 4093	.96
HEF 4007UB	.30	HEF 4025	.30	HEF 4066	.20	HEF 4510	1.34
HEF 4008	1.24	HEF 4027	.57	HEF 4068	.33	HEF 4511	1.76
HEF 4011	.30	HEF 4028	.99	HEF 4069UB	.35	HEF 4512	1.86
HEF 4012	.30	HEF 4029	1.50	HEF 4070	.32	HEF 4516	1.76
HEF 4013	.50	HEF 4030	.52	HEF 4071	.30	HEF 4518	1.56
HEF 4014	1.28	HEF 4035	1.28	HEF 4072	.32	HEF 4519	.74
HEF 4015	1.24	HEF 4040	1.37	HEF 4073	.32	HEF 4520	1.41
HEF 4016	.52	HEF 4041	.98	HEF 4075	.32	HEF 4528	1.02
HEF 4017	1.24	HEF 4042	1.96	HEF 4076	1.86	HEF 4531	2.74
HEF 4018	1.28	HEF 4043	1.24	HEF 4077	.39	HEF 4539	1.12
HEF 4019	.73	HEF 4044	1.24	HEF 4078	.32	HEF 4555	1.02
HEF 4020	1.41	HEF 4046AE	2.92	HEF 4081	.30	HEF 4556	1.02

GENERAL ELECTRIC

SCR's

C 1038 8A 200V	1.14
C 10601 4A 400V	1.19
C 1220 8A 400V	2.11
C 1226 8A 500V	2.54

TRIACS & DIACS

SC1410 10A 400V	1.95
SC1510 15A 400V	1.37
ST2	.33
ST4	.60

UJT's & PUT's

2N2646	1.24
2N2160	3.65
013T1 (2N602B)	1.88
013T2 (2N6027)	1.18

signetics TTL LOW SCHOTTKY

74LS00	.36	74LS30	.36	74LS74	.49	74LS93	1.23
74LS02	.36	74LS42	1.42	74LS78	.47	74LS95A	1.70
74LS04	.38	74LS51	.36	74LS85	1.99	74LS164	1.76
74LS10	.36	74LS55	.36	74LS86	.56	74LS196	1.70
74LS20	.36	74LS73	.47	74LS90	1.73	74LS367	1.19

signetics LINEAR

UA 741	.56
LM 301	.56
LM 308	1.43
LM 381	1.04
LM 382	2.69

TIMERS

NE 555	.64
NE 556	1.43

REGULATORS

LM 309K	2.56
LM 340T(V)	2.10
LM 723	.65
UA 78CU(V)	2.10

Transistors

AC127	65c
AC128	65c
AC187	65c
AC188	65c
BD137	60c
BD138	60c
BD139	65c
BD140	65c
BC547	22c
BC548	22c
BC549	22c
BC567	22c
BC568	22c
BC569	22c

Polyester Film 100V Caps

capacity ul	1 ea	10 ea
001 - 01	8c	6c
012 - 033	10c	7c
039 - 056	12c	9c
068 - 18	14c	10c
22 - 33	18c	15c
39 - 56	22c	18c
68 - 82	26c	24c

Crossover Caps.

Poly Film 100V

1mfd 42c	3.3mfd 1.10
1.5mfd 55c	4.7mfd 1.50
2.2mfd 75c	6.8mfd 2.10

2N3055

Including complete mounting kit and T03 transistor socket
\$1.10 set

0.5 ohm 5W wirewound resistor
20c ea.

IN4003
1A 200V diode
5c ea.

uA78CB
13.8V 2A CB reg.
\$2.45 ea.

Pin for Pin substitute may be supplied where original not available.
P & P semiconductors only 60c orders including cable etc. \$2.80

Gold Rush Specials



PHILIPS AD8080/M8 6W 8Ω \$6.65
8" Twin cone loudspeaker



12V Relay
Double Pole C/O PCB
\$2.50

P.O. Box 623
Ballarat Victoria 3350

SCALAR UHF/CB ANTENNAS

FOR CITIZENS BAND RADIO

DESIGNED AND MANUFACTURED IN AUSTRALIA

SCALAR'S UHF MOBILE MOUNT FOR CORRECT TERMINATION OF CO-AX AT UHF FREQUENCIES PAT. PENDING No. 20506/76

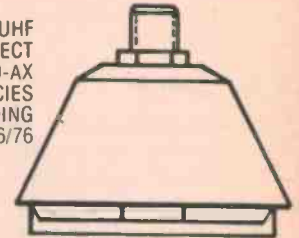

MODEL OB

CB420

HIGH PERFORMANCE DUAL BAND 476 AND 27 MHz MOBILE CO-LINEAR WHIP GAIN AT 476 MHz 4.5 dB OVERALL HEIGHT 42"



CB410
HIGH PERFORMANCE 4.5 dB GAIN MOBILE WHIP. REQUIRES NO TUNING. OVERALL HEIGHT 21"



CB420

CB470 GDB GAIN CO-LINEAR BASE ANTENNA. ENCLOSED IN FIBREGLASS RADOME. LENGTH. 8ft.

A WIDE RANGE OF SCALAR UHF/CB AND 27 MHz CB ANTENNAS (FROM 30" TO 108" LONG) AND ACCESSORIES ARE AVAILABLE FROM LEADING RETAILERS AND DISTRIBUTORS THROUGHOUT AUSTRALIA.

TRADE ENQUIRIES WELCOME.

SCALAR INDUSTRIES PTY LTD
COMMUNICATION ANTENNA ENGINEERS
18 SHELLEY AVENUE, KILSYTH, VICTORIA 3137
TELEPHONE 7259677.
CABLES WELKIN TELEX AA34341

NSW: 20 THE STRAND, PENSHURST 2222. TEL: 570-1392
QLD: 969 ANN ST, FORTITUDE VALLUE, QLD 4006
TEL: 52-2594. TELEX AA43007

Ideas for experimenters

CLASS A AMPLIFIER

The main advantage of class A amplifiers is the absence of crossover distortion. Against this major advantage must be weighed the disadvantage of permanently hot heatsinks and large capacity power supplies.

The circuit shown here contains several novel features and will deliver 5W of pure class A sound into an 8 Ω load.

Q1 and Q2 form, with the associated components, a high quality voltage amplifier with overall ac and dc feedback applied from the collector of Q2 via R6 to the emitter of Q1.

The output stage proper, consists of Q6 and Q7 connected as an emitter follower darlington pair. These transistors are driven by IC1, a 741 op amp,

and are included in the latter's feedback loop.

These three form a near perfect output stage with an input impedance of several megohms and a bandwidth extending from dc to over 100 kHz.

Quiescent current is provided by the constant current source Q3, Q4, Q5, R9 and R10. The use of a constant current source here effectively isolates the output from line variations and ripple.

With the components shown, the circuit has a bandwidth of 10Hz — 30kHz at -3dB, a distortion of less than 0.1% before the onset of clipping, an input impedance of 1.5MΩ and a sensitivity of 180mV for full output.

Transistors Q4 to Q7 must be mounted on an adequate heatsink, a 5" by 4" finned type is suitable, but must be mounted vertically and in such a position as to allow ample ventilation.

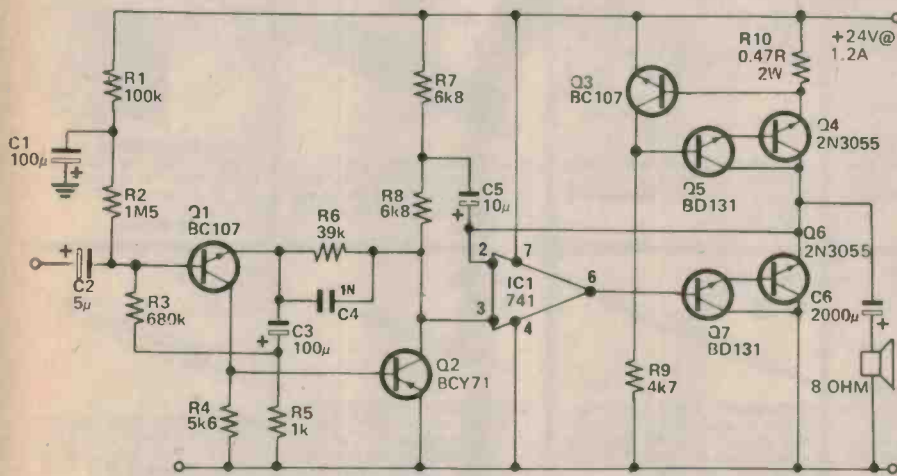

Low Cost Transducer Amplifier

Capacitive transducers are often used to measure displacement or pressure. The versatility of the low-cost 555 integrated circuit timer can be utilised with these types of transducer to provide a frequency modulated output. This output, fed into a frequency-to-voltage converter, will give an analog output voltage proportional to the capacitance of the transducer.

The 555 module is connected with the transducer C_t substituted for the external timing capacitor. Precise setting of the duty cycle is obtained with resistors R_a and R_b and with pins 2 and 6 connected together, the device will trigger itself and thus free-run as a multivibrator. As the output will source or sink current up to 200 mA or drive TTL circuitry, it can be fed directly into

most types of frequency-to-voltage converter.

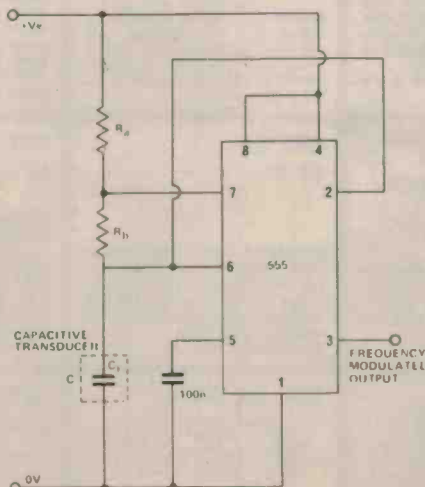

27102-12

\$1.00 each

P&P FREE

LOW POWER, 650 ns
ACCESS TIME

BRAND NEW,
FULLY GUARANTEED!

MAILMAN
ELECTRONICS
P.O. Box 536 Lane Cove
PH: (02) 498-3405 A.H.

SHERIDAN ELECTRONICS PTY. LTD.

THE GREAT NAME FOR ELECTRONIC COMPONENTS IN AUSTRALIA

164-166 REDFERN ST., REDFERN,
P.O. BOX 156 REDFERN, N.S.W. 2016 TEL: 69-5922 or 69-6912

FROM MARCH '78 699-5922 or 699-6912

PLEASE NOTE
NO ORDERS
UNDER \$5
ACCEPTED.
EXCL. OF P&P.

FIGHT INFLATION WITH

Our Cut PRICES

CAT No.
CP.36.



FERRITE POT CORE. Non-adjustable. Supplied complete with formers and clamps as shown. Overall dimensions: 40mm x 40mm x 25mm. Type H74-MB. Ready wound. No data available. \$1ea. or 5 for \$4.50. p & p 40c each.

CAT No.
CP.37.



As CP.36 but size is 30mm x 30mm x 16mm. Type A75-MB. 75c each or 5 for \$3.25. p & p 30c each.

CAT No.
CP.38.



POWER TRANSISTORS IN T026 'Flat-pak' package. The following NPN types are available: BD283, BD281, BD375 & BD377. Hfe between 30 & 200. Fantastic value at only 35c each or the 4 for \$1.30. p & p 30c

CAT No.
CP.39.



As CP.38 to 'The following' PNP types are available: BD284, BD376, BD378, BD282. Hfe between 65 to 200. Same prices as NPN types in CP.38.

CAT No.
CP.40.



4001 C.M.O.S. ONCE IN A LIFETIME OFFER . . . ONLY 18c each . . . YES . . . 18c each or 10 for \$1.50 . . . Where else can you get this kind of 'GIVEAWAY'? p & p 30c

CAT No.
CP.41.

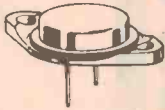

2N3055 Power Transistors. Un-marked but all guaranteed useable. Below spec's. 20 for \$3.00. We have now sold 1000's with very little returns. p & p 75c

CAT No.
CP.42.

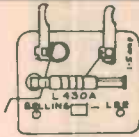

THERMAL DELAY 'MINITRIP' Switches by Belling Lee. Type L430. In the following values: 100/200/250 & 750mA, 1amp & 1.5amp. Only 40c each or any 6 for \$2.00. Sound value. p & p 40c

CAT No. CP.43.



THUMBWHEEL SWITCHES. 10 position BCD & Complementary BCD. Approx. size 46mm x 33mm x 10mm. Limited quantity. Our price only \$2.25 or 10 for \$21. p & p 30c & 75c.

CAT No.
CP.44.



NKK Miniature LAMP LIGHTED SWITCHES. 2 types available. 2002 Is DPDT On/Off and 2023 DPDT Centre Off. Precision in miniature switchcraft. Handles in the following colours:— RED, GREEN, WHITE & ORANGE. Each type 75c each or 5 assorted for \$3.50. p & p 30c each.

CAT No.
CP.45.



BNC In-Line Cable socket. A very popular precision conn- for that special piece of test equipment. Nom. Imp. 50 (UG69/U). ONLY FROM US at \$1.00 each or 5 for \$4.50. p & p 30c each piece.

CAT No.
CP.46.



BELLING-LEE UNSCREENED 3mm Plug & Square Faced Panel Socket. Low resistance high current contact. In white, yellow, Green & blue. 45c per pair or any mixed 10 pairs for \$4.00 p & p 60c

CAT No.
CP.47.

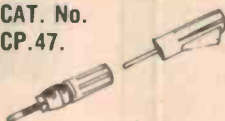

BELLING-LEE Miniature Terminal post with 2mm top socket and complete with stacking plug — In Blue, White, Green & Yellow. 50c per pair or 5 pairs for \$2.25. p & p 30c.

CAT No.
CP.48.

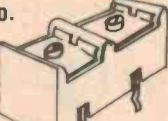

BELLING-LEE sub-miniature 2-way TERMINAL BLOCK. Size: 20mm x 10mm x 10mm. ONLY 30c each or 5 for \$1.35. p & p 20c ea.

CAT No.
CP.49.



EDGE CONNECTORS. Top quality brand. 2 types available in 0.15" pitch for 1/16" board. 18-way 75c 12-way 50c. Take 10 percent off for orders of 10 and over.

CAT No.
CP.50.



POWER TRANSFORMER by General Electric. Type MGE03050. Pri: 240VAC. Sec: 117V at 300mA and 20V & 5.7V at 3 amps. ONLY from us at \$7.00 each. p & p \$3.00 all States.

CAT No. CP.51.



FUSE HOLDERS . . . Panel sealed type miniature. Will accept size 00 fuse links to 2amp. Approx 30mm overall length. Panel cut-out 0.575" dia. 45c ea. or 5 for \$2.00. p & p 30c.

CAT No.
CP.52.



GEL RECHARGEABLE BATTERIES. Use these for your CB. 6 Volt 1.8 Amp Hour. Size: 'A' 75mm x 'B' 52mm x 'C' 50mm. Precision German made. S.E.'s. Price only \$8.75, worth double. p & p \$1.25

CAT No.
CP.53.

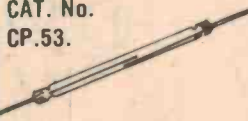

REED SWITCH. Hamlin type DRG-2. Normal closed. 250V 1A. 15W. Standard general duty. SPST. Special to clear at 50c ea. or 5 for \$2.25. Overall length: 3 3/4". L of Tube: 2". p & p 20c or 5 for 40c.

CAT No.
CP.54.

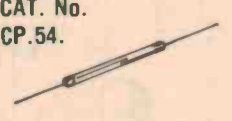

REED SWITCH, F & R type R06/0991/5. Normal closed. 150V 100mA. SPST. Overall length: 1" L of Tube: 3/4". VERY SPECIAL at 32c ea. or 6 for \$1.80. ONLY LIMITED QUANTITIES. p & p 20c or 6 for 40c.

CAT No.
CP.55.

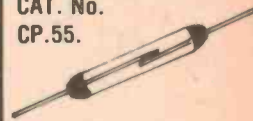

REED SWITCH. Hivac type XS4/2. 250V 400mA. Overall length: 1 3/4" L of Tube 1". On/Off switch. Real value here at 35c each or 10 for \$3.00. p & p 20c or 10 for 50c.

CAT No.
CP.56.



'C' CORE TRANSFORMER by General Electric. Type MSC225. Pri: 240 & 254VAC. Sec: 36V & 5.3V at 1amp. Worth treble. ONLY FROM US at \$6.00 each. p & p \$2.50 all States.

CAT No.
CP.57.



'RODAN' Digital Indicator Tube. Type GR-211. Reads 1 to 0. Supply volts 300. Cath. Current 5mA. Mt. of digits, 35mm. Full data supplied. Only at 'SHERIDANS' at \$2.00 each. p & p 50c. or 6 for \$11.00. p & p \$1.50.

CAT No.
CP.58.



MINIATURE MODEL MOTORS by LENCO. 6-12 VDC. Precision made with inbuilt speed regulation. Length: 70mm Dia: 35mm. Spindle length: 20mm. \$1.75 ea. or 2 for \$3.25 p & p 40c each.

CAT No.
CP.59.

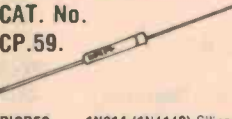

DIODES . . . 1N914 (1N4148) Silicon small signal switching. Everyone should know this one as being a very popular diode. We've gone 'NUTS' again. Only 6c each or 10 for 50c. . . HOWZAT FOR VALUE please add approp. post.

CAT No.
CP.60.



MINIATURE PRECISION POTENTIOMETERS by COPAL. Screwdriver adjust. on graduated scale. In 1K vertical mounting or 500Ω horizontal mounting. Dia: 1/2". 75c each or 2 for \$1.35. p & p 30c.

CAT No.
CP.61.



SPRING REVERB. UNITS. Specs: Input current — 350mA, Driving Coil Impedance — 16 . . . Pickup coil Impedance — 10k . . . Frequency response — 100 to 3000 Hz, Attenuation — 30 dB, reverberation time — 25 to 30 msec. Dimensions — 253 x 36 x 26mm. Only \$6.95. SAVE — SAVE — SAVE. Only from us at this price. p & p \$1.25.

CAT No.
CP.62.



MULON MICRO-SWITCH Miniature type. Size: 28mm x 16mm x 10mm. Normally closed on/off switch. 250VAC 5 amps. Only 95c each or 5 for \$4.50. p & p 30c ea or 5 for 60c.

CAT No.
CP.63.



INTEGRATED 3 WATT AUDIO POWER AMPLIFIERS in Modified JEDEC 10 pin TO3 case. Operate on Vcc plus 13.8V — Max 18V. Data supplied. LAST FEW AT ONLY \$2.00 each to CLEAR. P.C. Board to suit \$1.50 ea. p & p 40c ea. item.

CAT No.
CP.64.



SINCLAIR Power Supply Units. Type PZ.6 Stabilised mains supply unit delivers 35 volts at 1.5 amps with ripple less than 20mV at any output up to max. current. Size: 3.9" x 2.8" x 1.6". ONLY A FEW LEFT SO RUSH YOUR ORDERS . . . Only \$10 ea. Wera \$29. p & p \$2.00.

CAT No.
CP.65.



CRYSTAL MIKES. Very neat about the size of a large egg. Complete with shielded lead and stand. High impedance. Great value at only \$2.50 each. p & p 60c.

CAT No.
CP.66.



AMPHENOL 57 Series Micro ribbon Miniature connectors. 14 way Plug & Socket. Spring type latch on panel receptacle. SUPERB QUALITY for that extra special piece of equipment. Only \$6.00 per pair. Less than half price. p & p 60c.

CAT No.
CP.67.



A & R POWER TRANSFORMER. Type 6413. Pri: 240VAC. Sec: 32V 2A D.C. Bridge rectifier condenser output. Wt: 4lbs. Ht: 3 1/2". Overall base: 3" x 3 1/4". A KNOCKOUT SPECIAL AT ONLY \$6.00 each. p & p \$2.50.

CAT No. CP.68.

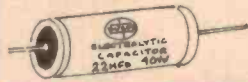

DUCON BI-polar Electrolytic capacitors. 22mfd 40VW. Very handy for that cross-over at a 5th of the price. Size: 57mm x 25mm. Axial leads. ONLY 25c each or 10 for \$2.25. p & p singles 20c or 10 for \$1.00.

CAT No.
CP.69.

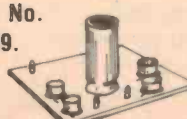

FULL-WAVE BRIDGE RECTIFIER ASSEMBLIES. Fully filtered 3amp 200W. DIRTY CHEAP at only \$2.00 ea. p & p 50c.

CAT No. CP.70.

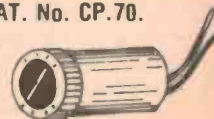

BATTERY INDICATOR LEVEL METER . . . Made by SONY. Size: 15mm x 10mm. ONLY 75c each p & p 30c.

Ideas for experimenters

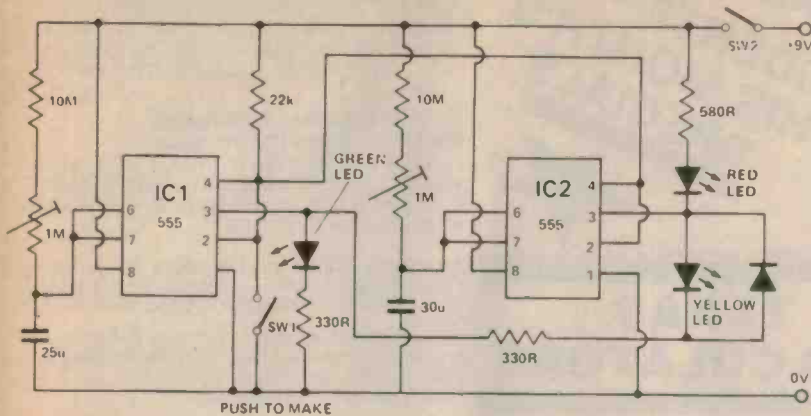

Talk Timer

This circuit was designed for use as a timer for educational talks, providing a timing period of 5 minutes. During the talk, a green LED is turned on, but half a minute before the end, the green LED is extinguished and the yellow LED lit, giving a warning that only half a minute remains. At the end of the 5 minutes, the yellow LED turns off and the red LED turns on.

The circuit is simply two one-shot

monostables connected together, the first with a timing period of 4½ minutes, and the second ½ minute.

Timing is started by momentarily closing S1, pin 3 of both ICs go high turning on the green LED and off the red and yellow LEDs.

At the end of the first timing period, pin 3 of IC1 goes low turning the green LED off and the yellow LED on. When at the end of the second timing period, pin 3 of IC2 goes low, the yellow LED is turned off and the red LED lit.

Tape Recorder Controller

The circuit shown enables a solenoid operated tape recorder to be left to record a programme unattended. It was originally designed to be used on a Revox A77, in conjunction with a digital clock based on the Caltex CT7001, but could be adapted for other recorders, clocks, or mechanical time switches. The clock is set to switch on one minute before the programme starts, and switch off as it finishes.

When the clock contacts close, RLA is operated via Q2 and Q3, applying power to the receiver and recorder. At the same time C1 is discharged, and C2 applies a negative pulse to pin 2 of the timer, which triggers, discharging C4. The output of the timer goes high for one minute, allowing time for the recorder and receiver to warm up. As the timer output goes low, C4 charges

through Q4 momentarily, operating RLC which starts the recorder.

At the end of the preset time the clock contacts open, discharging C2 through Q2 and Q3 which delays RLA from dropping out by approximately 5 seconds. As the clock contacts reopen C1 charges through Q1, operating RLB opening the normally closed stop contacts for a short period, stopping the recorder. After the 5 second delay has elapsed, RLA opens, removing power from the equipment.

RLB and RLC may have light contacts, but RLA must be a heavy duty mains rated type. Ideally the digital clock should be crystal controlled, to eliminate short term mains frequency fluctuations. The numbers shown in brackets are the appropriate pin connections on the 10 way remote control plug of a Revox A77.

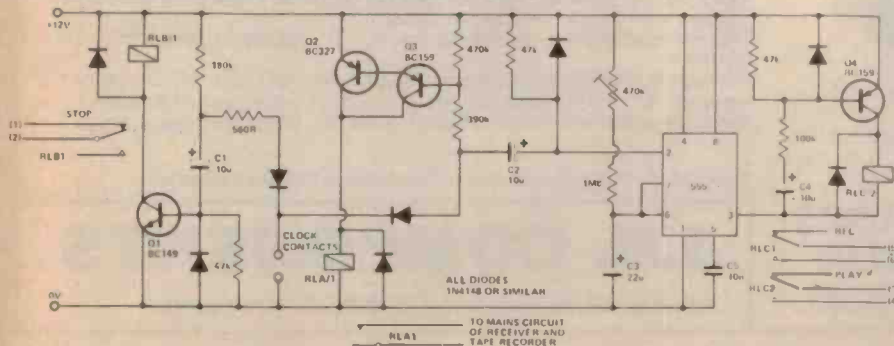

NESSEL AUDIO

NEW NESSEL PROFESSIONAL SERIES 15 LOUDSPEAKER

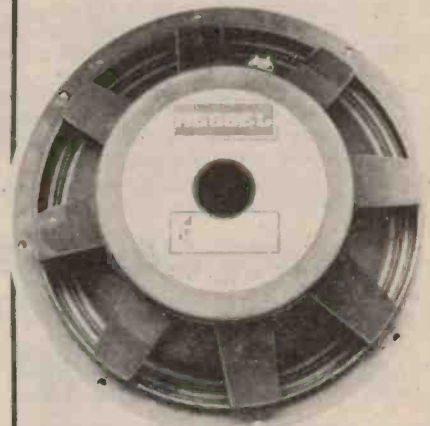

MODEL SL1502

Voice coil diameter 4"
Magnet structure weight 9 kilos
Cone resonance 55 Hz
Power handling 150 Watts
This speaker is suitable for musical amplifying systems, PA, sound reinforcement, discos etc. . .

TRADE ENQUIRIES WELCOME

Available from

NESSEL AUDIO

9 Nellbern Rd,
Moorabbin East, Vic. 3189
Ph (03) 95 9510

SR51 II \$55 (SAVE \$6)

THE ULTIMATE NON-PROGRAMMABLE CALCULATOR, 3 FULLY ADDRESSABLE MEMORIES, MORE KEY-BOARD FUNCTIONS THAN ANY OTHER MODEL.

Ti57 \$75 (SAVE \$9)

COMPUTER LIKE PROGRAMMING, 50 MERGED STEPS — UP TO 150 KEY STROKES, 8 MULTI-USE MEMORIES, SUBROUTINES, LOOPS AND CONDITIONAL BRANCHING.

Ti58 \$115 (SAVE \$14)

UP TO 480 STEPS, OR UP TO 60 MEMORIES, PLUS PLUG-IN MODULE WHICH RETAINS 5000 PROGRAMME STEPS (1 MODULE WITH CALCULATOR — 5 OTHERS AVAILABLE).

Ti59 \$265 (SAVE \$34)

UP TO 960 STEPS, OR UP TO 100 MEMORIES, PLUS PLUG-IN MODULES, PLUS CARD PROGRAMMABLE. (THE MOST POWERFUL POCKET CALCULATOR AVAILABLE).



TEXAS CALCULATORS

NATIONAL SEMICONDUCTOR CALCULATORS

4650 \$33 (SAVE \$14), 4640 and 4660 EACH \$43 (SAVE \$17). PERFECT POCKET MODEL — LIQUID CRYSTAL NS100 (MEMORY, %) \$22. NS100 BATTERY LIFE — 2000 HOURS, BILLFOLD-STYLE CARRYING CASE.

PC-100A ALPHA-NUMERIC PRINTER \$225 (SAVE \$30)

FOR TI58 AND 59, OVER 60 CHARACTERS, WRITES WORDS, LISTS PROGRAMMES, PLOTS GRAPHS, ETC. (N.B. ALL CALCULATORS EXCEPT NS100 HAVE RECTANGULAR TO POLAR).

ALL PRICES QUOTED EXCLUDE SALES TAX — AND 15 PERCENT IF NOT EXEMPT — SALES TAX FORMS MUST BE DULY SIGNED AND STAMPED BY COLLEGE, UNIVERSITY OR SCHOOL.
PACKAGING AND POSTING — EXTRA \$1.50 FOR N.S.W., ELSEWHERE \$2.50 PER ORDER. SAVE BY ORDERING WITH YOUR FRIENDS. (S/T FORMS AVAILABLE — WRITE FOR FULL PRICE LIST OF ALL MODELS).



ELECTRONIC CALCULATOR DISCOUNTS



P.O. Box 106, BAULKHAM HILLS, N.S.W. 2153. Phone: (02) 6248849 (8am till 3pm)

NEW MODEL, 3-30 MHz BI-LINEAR AMPLIFIER

HF-3-100L2

Frequency Range 3-30 MHz

Input Power: 10W Nom, 5-20 W PEP range

Output Power: 100W Nom \pm 1/2 dB across band 200-250W PEP output

Input Impedance: 50 Ω nom, adjustable to match exciter range under 2:1 across band

Output Impedance: 50 Ω nom, up to 3:1 VSWR acceptable with little degradation

Current Drain: 16A nom. 20 A supply recommended at 13.6 VDC

Power Supply: 13.6 VDC recommended for best results, 11.14 VDC acceptable positive or negative ground

Pre-amp: 18 dB nom. gain across entire HF band, 15 dB typ. at 50 MHz, 3-4 dB NF

Size: 19.1 x 16.5 x 8.9 cm wt 1 1/2 Kg

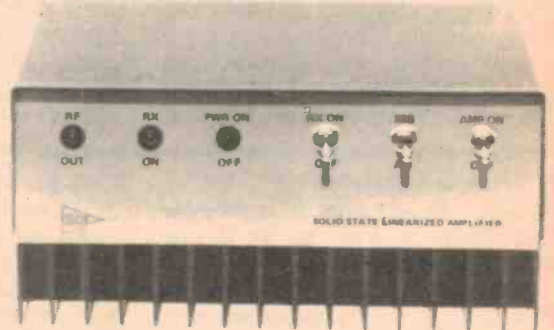

DEALERS ENQUIRIES WELCOME

SOLE AUSTRALIAN DISTRIBUTORS FOR SCS LINE OF LINEAR AMPLIFIERS



EMONA electronics

PHONE 2124815

P.O. BOX K21,

HAYMARKET, N.S.W. 2000

7 DIGIT FREQUENCY METER KIT



'Electronics Australia' March 1977 design High Stability Crystal (30 P.P.M. -10°C to +60°C) in cold-welded HC18/U holder.

ALL high quality components (National, Fairchild, etc.) Fibreglass P.C. Boards with component overlay 'Polaroid' front panel, L.E.D. readouts, 'BNC' socket standard — 'UHF' socket optional. Pre-drilled aluminium chassis with black 'Marviplate' cover.

240 volt operation — provision for 12 Volt operation. Instructions included.

Postage N.S.W. \$2. Interstate \$4. Registration \$2, "Comet" — Sydney \$2

insured. 'T.N.T.' Air-road courier, insured \$6 anywhere in Australia.

Separate components (post free) Crystal \$8, 95H90 prescaler \$9.50.

Please Note: The prices shown in December ETI were a misprint.

COMPLETE KITS

20 MHz \$82.00

200 MHz \$89.50

ASSEMBLED UNITS

20 MHz \$122.00

200 MHz \$129.50

J.R. COMPONENTS

P.O. Box 128, Eastwood, N.S.W. 2122 Ph: (02) 853976.

INTERNATIONAL ELECTRONICS UNLIMITED

DISCOUNT ON ALL IC'S AND LED'S
10% OFF ON \$25.00
15% OFF ON \$50.00

TTL

7400	.11	7451	.20	74155	.75
7401	.18	7453	.20	74156	.75
7402	.14	7454	.20	74157	.85
7403	.14	7460	.20	74158	1.39
7404	.16	7464	.35	74160	1.23
7405	.19	7465	.35	74161	.95
7406	.29	7470	.38	74162	1.39
7407	.28	7472	.35	74163	.95
7408	.22	7473	.35	74164	.95
7409	.17	7474	.31	74165	.95
7410	.16	7475	.49	74166	1.19
7411	.25	7476	.34	74170	1.90
7413	.43	7483	.68	74173	1.49
7414	.65	7485	.88	74174	1.19
7415	.25	7486	.38	74175	.95
7416	.35	7489	2.25	74176	.84
7417	.35	7490	.43	74177	.84
7420	.16	7491	.75	74180	.95
7423	.37	7492	.48	74181	2.30
7425	.35	7493	.48	74182	.85
7426	.22	7494	.75	74188	2.20
7427	.35	7495	.75	74190	1.25
7430	.20	7496	.75	74191	1.15
7432	.23	74100	1.15	74192	.89
7437	.25	74107	.37	74193	.85
7438	.25	74121	.37	74194	1.15
7439	.50	74122	.38	74195	.74
7440	.15	74123	.45	74196	.98
7441	.85	74125	.54	74197	.95
7442	.59	74126	.58	74198	1.69
7443	.65	74132	.75	74199	1.69
7444	.73	74141	.85	745200	3.95
7445	.65	74145	.90	74279	.79
7446	.81	74150	.88		
7447	.59	74151	.68		
7448	.79	74153	.60		
7450	.17	74154	1.20		

SPECIAL SALE

ZENER DIODE — 400MW
 3.6V 5.1V 6.8V 15V
 4.7V 5.5V 10V **\$.15 EA.**
8/\$1.00 ANY MIX

TTL BARGAINS

7416	\$.19
7420	.13
7432	.19
7437	.19
7440	.13
7442	.29
7460	.07
7495	.59
74141	.68
74145	.59
74151	.59
74165	.79

SIGNAL DIODES — 400 MW
20/\$1.00

SHIFT REGISTERS

2510	\$1.75
2511	1.95
2518	2.50
2522	1.95
2532	2.29
5016	

LED'S
 MAN 72 .99
 NSN 74R .99
 DL702 .99
 FND 359 .59
 MVI0B

6/\$1.00

KEYBOARD

20 KEYS
 2 SLIDE SW
 3" x 3"

\$.99

MM 5330
 4 1/2 DIGIT DVM LOGIC **\$ 4.95**

LINEAR SPECIALS

LM301	mini dip	\$.20
LM308	TO-5	.65
LM311	mini dip	.65
LM340T	6V	.89
LM565	dip	.89
LM567	mini dip	1.09
LM747	dip	.50
LM1458	mini dip	.50
CA3046	dip	.75

8038 FUNCTION GENERATOR
 Voltage controlled oscillator — sine square, triangular output. **\$3.95**

5738 CALL CHIP'S FLIP-NET WITH MEMORY **\$2.95**

6 Digit Clock Kit

MM5314 with 6 NS71 .27" displays 2 P.C. boards — Display board may be remote. Internal or wall transformer can be used. 50-60 Hz, 12-24 hour. Includes all necessary transistors, resistors, capacitors, diodes, 3 switches and complete assembly instructions.

CK6-3 \$12.95

CALCULATOR DISPLAY

9 MAN 3 M ON PC BOARD **99¢**

CALCULATOR KIT
 LITRONIX 1502 MEMORY
 CALC. KIT ONLY **\$7.95**
 ADAPTER -60Hz **\$3.95**



CERAMIC DISC CAPACITOR PACKAGE

10 EA. OF FOLLOWING VALUES — 50 VOLT

1pf	33pf	82pf	220pf	820pf	.022uf
5pf	47pf	100pf	270pf	.001uf	.030uf
10pf	56pf	150pf	470pf	.0047uf	.050uf
22pf	68pf	180pf	600pf	.01uf	

24U CAPACITORS **\$10.95**

PRECISION RESISTOR PACKAGE

METAL FILM ±1% 1/4 WATT
 4 EA. OF FOLLOWING VALUES 240 RESISTORS **\$21.95**

10.5	100	499	1.65K	4.53K	7.50K	13.0K	22.1K	44.2K	80.6K
20.0	130	604	2.00K	5.11K	8.45K	14.0K	24.9K	48.7K	90.9K
30.1	162	750	2.49K	5.49K	9.09K	15.0K	27.4K	52.3K	100K
49.9	200	1.0K	3.01K	6.04K	10.0K	16.2K	30.1K	57.6K	147K
60.4	301	1.21K	3.48K	6.49K	11.0K	17.8K	34.0K	63.4K	210K
76.8	402	1.40K	4.02K	6.98K	12.1K	20.0K	40.2K	69.8K	464K

2708 FULL SPEED ROM

\$10.95

170 2A

\$ 4.75

8080A, 8008

\$16.95

LD110, LD111

3 1/2 DIGIT A/D CONVERTER **\$24.75**

82S23

256 BIT PROM **\$2.95**

MM5369 Divider mDIP

Crystal 3.58 MHZ color TV **2.49**
 Crystal 2.010 MHZ **1.75**
 Crystal 2.010 MHZ **3.95**

RESISTOR PACKAGE

CARBON FILM ±5% 1/8 OR 1/4 W
 USAGE EVALUATED ASSORTMENT
 455 RESISTORS, 44 VALUES **\$12.95**

METAL FILM RESISTORS 1%

STANDARD DECADE VALUES FROM 10.5 OHM TO 464K OHM

EACH		MINIMUM 100 PER VALUE		PER VALUE	
0 - 10	\$.20				
10 - 100	.20	\$.15			
100 -		.10	\$.09		

SHIFT REGISTERS

2502	1024 bit MULT DYN	16 pin	\$2.95
2504	1024 bit MULT DYN	8 pin	2.95
2511	Tri-State Dual 50-100-200 bit		
2518	Hex 32-bit STATIC	16 pin	2.95
2519	Hex 40-bit STATIC	16 pin	2.95
2527	Dual 256 bit STATIC	8 pin	2.95
2532	Quad 80 bit STATIC	16 pin	3.95
5013	1024 bit accum. Dynamic	8 pin	1.75
5016	500/512 bit Dynamic	8 pin	1.59

MINIATURE SOLID STATE ELECTRONIC BUZZER

LONG LIFE — HIGH RELIABILITY
 LOW CURRENT DRAIN
 NO MOVING CONTACTS
 NO ARCING — NO RF NOISE
 RICH & CLEAR SOUND
 78 dB min AT 1 FT. — 450 Hz 1A
 EB-106 6V 15mA 4-9 VDC \$1.99
 EB-112 12V 15mA 8-20 VDC 1.99

ELECTRONIC DOOR CHIME KIT

WITH TI TMS 1000 MICROPROCESSOR CHIP PROGRAMMED TO PLAY 24 DIFFERENT TUNES

INTERLATIONAL FLAVOR — PLAYS NATIONAL ANTHEMS OF U.S., BRITAIN, FRANCE AND WEST GERMANY PLUS OTHER POPA TUNES, CLASSICAL AND TRADITIONAL MELODIES.

- SUPPLIED WITH ALL PARTS INCLUDING PC BOARD, SPEAKER, CASE AND COMPLETE INSTRUCTION MANUAL WITH FULL CIRCUIT DETAILS
- 1500 1/4W TRANSISTOR BATTERIES (NOT SUPPLIED)
- LOW POWER CONSUMPTION
- INTERNAL SELECTION OF TONE, VOLUME, TEMPO AND TUNING FUNCTIONS
- PROGRAMMED MATHEMATICALLY TO PLAY IN PERFECT PITCH
- PERMANENT
- ATTRACTIVE CASE, CONVENIENT WALL MOUNT.

\$39.50 SHIPPING \$1.00

TANTALUM CAPACITORS

Solid dipped +20%

.1 mid	35V	\$.25	10 mid	16V	\$.40
.33 mid	35V	.25	10 mid	25V	.45
1 mid	35V	.25	15 mid	10V	.40
2.2 mid	20V	.25	15 mid	20V	.45
2.2 mid	35V	.30	22 mid	16V	.45
3.3 mid	35V	.30	33 mid	10V	.40
4.7 mid	16V	.30	47 mid	6V	.40
6.8 mid	6V	.30	56 mid	5V	.45
6.8 mid	50V	.40	150 mid	15V	1.50

CALCULATOR CHIPS

CT5002	12 digit, 4 function fixed decimal battery operation — 40 pin	1.95
CT5005	12 digit, 4 function plus memory, fixed decimal — 20 pin	2.49
MM5725	8 digit, 4 function, floating decimal 18 pin	1.90
MM5736	6 digit, 4 function, 9V battery operation — 18 pin	2.95
MM5738	8 digit, 5 function plus memory and constant floating decimal, 9V battery operation — 24 pin	3.95
MM5739	9 digit, 4 function, 9V battery operation — 22 pin	3.95

CLOCK CHIPS

MM5314	6 digit multiplexed 12-24 Hr, 50-60 Hz	24 pin	4.45
MM5316	4 digit, 12-24 Hr, 50-60 Hz, alarm	40 pin	4.95
5375AA	4-6 digit, 12 hour, 60 Hz snooze alarm brightness control capability, alarm tone output — 24 pin		4.95
CT7001	6 digit, 12-24 Hr, 50-60 Hz, alarm, timer and date circuits — 28 pin		6.95

Satisfaction guaranteed. Shipment will be made within 3 days from receipt of order.
 Prices are in Australian \$. Payment may be made with personal check, international money order (include receipt), charge card (include no. & expiration date) or bank cheque made payable in U.S. \$
 All items are shipped via air-prepaid unless otherwise indicated.
 Add \$1.00 service charge for orders less than \$10.00

INTERNATIONAL ELECTRONICS UNLIMITED
 VILLAGE SQUARE, P.O. BOX 449
 CARMEL VALLEY, CA 93924 USA
 PHONE (408) 659-3171

LINEAR CIRCUITS

LM300H	1.71	LM372N	2.93	LM733H	79
LM301CN	29	LM376CN	59	LM739H	99
LM302H	85	LM380CN	1.28	LM741CN(1)	32
LM304H	80	LM380 BCN	.95	LM741CN(1)	32
LM307CN	26	LM381N	1.75	LM741CH	35
LM307H	30	LM382N	1.75	LM747H	79
LM309H	89	LM385K	.45	LM747H	71
LM309H	1.05	NE531V	2.90	LM748CN	35
LM309K	.99	NE540L	2.90	LM1310N	2.60
LM310CN	1.07	NE548A	1.09	LM1414N	1.59
LM311CN	89	NE550A	.75	LM1458CN	1.29
LM311H	89	LM555CN	39	LM1458CN	59
LM311H	89	NE555A	.95	LM1490N	89
LM319H	1.13	MM5300	2.95	LM1800N	2.49
LM320K		LM561N	2.95	LM2202B	89
5, 5, 2, 12, 15, 1 29		LM565N	1.19	LM2209	89
LM320T		LM565H	1.39	CA3046	1.19
5, 12, 15	1.19	LM568H	1.39	CA3081	1.49
LM322H	1.59	LM568CN	1.19	LM3900N	79
LM324H		LM567H	1.20	LM7821	79
LM(2002N)	1.52	LM567H	1.49	LM7825	79
LM339N	1.58	LM703H	59	80380	4.59
LM340K		LM703CN	39	75451CN	35
5, 6, 8, 12		LM709N	.25	75453CN	35
15, 18, 24	1.29	LM709H	29	75453CN	35
LM340T		LM710N	.59	75454CN	35
5, 6, 8, 12		LM711N	39	78491N	71
15, 18, 24		LM723H	.55	75492N	.85
[78 — Equip] 1 19		LM723N	.52		

CMOS

4000A	.26	4018A	1.39	4068A	.89
4001A	.25	4020A	1.72	4068A	.44
4002A	.25	4021A	1.18	4069A	.44
4006A	1.35	4022A	.94	4071A	.26
4007A	.26	4023A	.25	4072A	.35
4008A	1.52	4024A	.89	4073A	.39
4009A	.57	4025A	.25	4075A	.39
4010A	.54	4027A	.59	4078A	.39
4011A	.29	4028A	.98	4082A	.35
4012A	.25	4030A	.44	4518A	1.56
4013A	.45	4035A	1.27	4528A	1.56
4014A	1.27	4040A	1.39	4585A	2.10
4015A	1.27	4042A	1.47		
4016A	.48	4049A	.59		
4017A	1.01	4050A	.59		

IC SOCKETS

Solder Tail — low profile

8 pin	\$.17	24 pin	.42
14 pin	.20	28 pin	.59
16 pin	.22	40 pin	.69
18 pin	.29		

CERAMIC DISC CAPACITORS

1pf 50V	56pf 50V	270pf 50V	.01uf 1000V
5pf 50V	68pf 50V	390pf 50V	.022uf 50V
7pf 50V	82pf 50V	470pf 50V	.030uf 50V
10pf 50V	100pf 50V	600pf 50V	.050uf 50V
22pf 50V	120pf 50V	820pf 50V	.1uf 50
27pf 50V	150pf 50V	.001uf	
33pf 50V	180pf 50V	.0047uf 50V	
47pf 50V	220pf 50V	.01uf 50V	

(each) (Minimum 10 per value)

READERS' LETTERS

No charge for replies but a foolscap-size stamped addressed envelope must be enclosed. Project queries can only be answered if related to item as published. We cannot assist if project is modified nor if components are otherwise than specified. We regret we cannot answer readers' enquiries by telephone.

SUBSCRIPTIONS AND BACK ISSUES

ETI subscriptions cost \$17.00 per year (inc. postage) within Australia. Cost elsewhere is \$17.65 (inc. postage — surface mail). Airmail rates on application.

Back issues cost \$1.25 (Sept. onwards) each plus post and packing.

We can supply only the following issues.

1976: Nov., Dec.

1977: All issues except Jan, Feb, March.

Photostats are available of any article ever published in ETI. We charge a flat \$1.00 regardless of page quantity from any one issue of ETI. Thus if the article is in three issues the cost is \$3.00. Send orders to address below.

Binders \$4.50 plus 80c post NSW, \$1.70 other States.

COPYRIGHT

The contents of Electronics Today International and associated publications is fully protected by the Commonwealth Copyright Act (1968).

Copyright extends to all written material, photographs, drawings, circuit diagrams and printed circuit boards. Although any form of reproduction is a breach of copyright, we are not concerned about individuals constructing projects for their own private use, nor by pop groups (for example) constructing one or more items for use in connection with their performances.

Commercial organisations should note that no project or part project described in Electronics Today International or associated publications may be offered for sale, or sold, in substantially or fully assembled form, unless a licence has been specifically obtained so to do from the publishers, Modern Magazines (Holdings) Ltd or from the copyright holders.

LIABILITY

Whilst every effort has been made to ensure that all constructional projects referred to in this edition will operate as indicated efficiently and properly and that all necessary components to manufacture the same will be available, no responsibility whatsoever is accepted in respect of the failure for any reason at all of the project to operate effectively or at all whether due to any fault in design or otherwise and no responsibility is accepted for the failure to obtain any component parts in respect of any such project. Further, no responsibility is accepted in respect of any injury or damage caused by any fault in the design of any such project as aforesaid.

A MODERN MAGAZINES PUBLICATION

Managing Director:

Arnold Quick

Secretary:

Charles O'Leary

Publisher:

Collyn Rivers

PRODUCTION

Art Director:

Jim Hattersley

Assembly:

Eric Osojnik

Production Manager:

Roy Leight

Subscriptions & Circulation:

John Oxenford

Project Design:

Nebula Electronics

Acoustical Consultants:

Louis A Challis & Assoc.

ADVERTISING

Sydney:

Bob Taylor (Manager), Geoff Petschler (NSW Manager), 15 Boundary St, Rushcutters Bay 2011. Tel: 33-4282.

Melbourne:

Tom Bray (Manager), Poppe Davis, Suite 24, 553 St. Kilda Rd, Melbourne. Tel: 51-9836.

Brisbane:

Geoff Home, 199 Jesmond Rd, Indooroopilly, Brisbane, 4068. Tel: 378-3273.

Adelaide:

Ad Media Group of SA, 37 Fullarton Rd, Kent Town 5067. Tel: 42-4858.

Perth:

Aubrey Barker, 38 Mounts Bay Rd, Perth. Tel: 322-3184.

Hobart:

H.W. Lincolne Advance Publicity, 281 Elizabeth St, North Hobart, 7000.

Tokyo:

Genzo Uchida, Bancho Media Service, 15 Sanyocho, Shintoku-Ku. Tokyo 160.

London:

Electronics Today International, 25-27 Oxford St, London, W1R 1RF. Tel: 01 434-1781/2.

Advertisers: Index:

Ampex	20
Applied Technology	70, 71
Arena	25
A & R Sonar	84
Auto Stratham	78
Audio Telex	86
AWA	17
Chan Merchandising	10
Cema	76
Computerland	50
Convoy	11
Cooper Tool Co.	93
Davred	75
Delsound	32
Dick Smith	8, 61, 97
Diggerman	104
Director of Recruiting	34
Douglas Transformers	78
Eclipse Lighting	52
Edge Electrix	32
Electronic Agencies	98
Electronic Disposals	52
Electromart	96
Elect. Calculator Discounts	78
Emac	69
Emona	86, 104
Fairchild	43
Ferguson	65
Freedman	42
Haco	O.B.C, 22
Hagemeyer	I.F.C, I.B.C.
Harman	4, 27
IC's Unlimited	79
Impact	80
International Components	65
Inter. Correspondence School	33
Inst. Computer Service	86, 87
Int. Elec. Unlimited	105
Jaycar	26
J.R. Components	104
Lafayette	96
Mailman Electronics	101
Nessel Audio	103
PDK	99
Philips	6, 44
Photo Scan	26
Pioneer	18, 19
Roadrunner	86
Ron Chapman	10, 80
Rod Irving	51
Scalar	100
Semcon	84
Sheridan	102
Sovereign City Electronics	100
Tandy	41, 64
Unique Elec. Securities	52
Vicom	85
Xenon World Imports	59

Electronics Today International is published by Modern Magazines (Holdings) Ltd, 15 Boundary St., Rushcutters Bay NSW 2011. It is printed (in 1978) by Wilke & Co., Browns Rd, Clayton, Victoria and distributed by Australian Consolidated Press.

The competition don't like the sound of this at all.

For quite some time, other manufacturers have been trying to produce tape with the qualities of the Maxell UD-XL. At the same time, Maxell have been quietly perfecting an even better series.

The UD-XL I and UD-XL II tapes are designed to attain maximum performance at the ferric and chrome position on your tape deck. Whichever tape position you choose, Maxell can give you a better performance.

UD-XL I TAPE, FOR FERRIC (norm.) POSITION (120us)

UD-XL I offers an excellent sensitivity of 1 dB higher than even UD-XL. MOL performance is also 1 dB higher over the entire audio frequency spectrum. The result is a new standard in ferric tape, with wider dynamic range and less distortion than ever before.

How does the UD-XL I compare then, with ordinary low-noise tapes?

Sensitivity is higher by 2.5 dB, and MOL performance by as much as 6 dB.

Yet, for all this UD-XL I requires no special bias or equalization. Simply set your tape selector as you normally would at the ferric position – but there the comparison ends.

UD-XL II TAPE, FOR THE CHROME POSITION (70us)

UD-XL II tape is such a dramatic improvement on most other tape that can be used in this position, that comparison is really unfair.

For example, if you're familiar with conventional chromium-dioxide tape, you'll know of the associated problems of head wear, poor output uniformity and relatively high price – plus low maximum output level and rather high distortion.

UD-XL II tape offers you excellent MOL, sensitivity, and an output improvement of more than 2 dB over the entire frequency range.

Maxell's unique 'Epitaxial' process gives you absolute sensitivity and stability, and no drop-out problems. What's more, the shells are moulded in diamond cut dies, and made to tolerances 5 times greater than the Philips standard. And, like all Maxell tapes, UD-XL II has the unique 5-second cleaning leader.

In short, if you're recording in the chrome position, you can now achieve all the advantages – with none of the drawbacks.

A prospect we think you'll find very exciting – even if the competition don't.



maxell[®]
simply excellent

TECHNICS PRESENTS ITS CREDENTIALS.



Technics Model SL-2000

Technics invented the world's first direct-drive turntable. The concept was elegantly simple, because the platter was an extension of the DC servo motor which revolved at precisely record-playing speed. This eliminated the need for belts, gears and idlers – the sources of vibrations, wow and flutter.

Our first sensational direct-drive turntable has since been succeeded by a whole family of them, including a thoroughly professional model with quartz-crystal speed control, so accurate that 'drift' over a 30-minute LP side is less than 0.036 of a second. Its great speed accuracy, plus enormous torque and super fast

start/stop action makes it the choice of top broadcasting stations and discos both in Australia and throughout the world. Naturally we are proud of this, but the real sense of 'mission accomplished' comes from the fact that creative use of automation has brought direct-drive turntables within the reach of millions of discerning music-lovers.

The Technics range includes more models than anyone else – in manual, semi-automatic or fully automatic. But there's a lot more to Technics direct-drive than just more models of turntables. There's more precision, better performance and greater reliability.



For a National Technics catalogue please write to:
National Technics Advisory Service, P.O. Box 49, Kensington, N.S.W. 2033



Technics

hi-fi