

THE BEST OF AUSTRALIA'S

AUSTRALIA \$3.95  
NZ \$4.50

# Wireless Weekly

IN 1927



**A FASCINATING & NOSTALGIC  
TRIP BACK INTO  
AUSTRALIA'S RADIO PAST!**

**SEE THE RADIO SETS THAT  
GRANDPA BOUGHT (OR BUILT)  
TO TUNE IN THE NEWFANGLED  
WIRELESS PROGRAMS!**

**TYPICAL PROGRAMS ★ LISTENERS' LETTERS  
PICTURES OF STARS ★ ORIGINAL ADVERTS**

# INTRODUCTION

Welcome to our time machine. It may look like a book, but don't let its innocent appearance fool you. There are no whirling dials and control levers; but once you turn over the next page, it'll take you on an incredible journey backwards in time. You'll find yourself back in the 1920's, when Australia's first few radio stations were just getting established.

We make no apologies — it's a nostalgia trip. In this modern world of colour TV, video cassette recorders, digital CD records, and personal computers, it's easy to forget that only 60 years ago none of these things existed. Radio or "wireless" had only just begun, and people were still adjusting to the wonder of this new and exciting technology.

The department stores were selling radio sets in big cabinets, with fanciful flared horn loudspeakers and staggering price tags. A typical set cost around 50 pounds, for example — as you'll see. When you consider that the average male weekly wage in Australia at the time was almost exactly five pounds, this was obviously a small fortune: around ten week's wages, or the equivalent of about \$4000 in today's money!

Small wonder that the only way for many people to get a radio was to build their own. In order to do so, they needed the special parts. So a new type of retail/wholesale store sprang up: the "radio dealer".

They also needed information — where to get the parts, how to build your own set, which stations to tune in for, and details of the programmes being broadcast. To meet this need, a new weekly magazine sprang into being late in 1922. It was called "Wireless Weekly", and it was one of the first radio magazines in the world.

This book is a collection of the highlights from early issues of Wireless Weekly. We've chosen them carefully, to try to give you the best possible insight into Australian radio in the twenties.

We've taken the material from issues in 1927, because this year was a particularly interesting one. The first few stations — all privately owned — had just been established in the capital cities, with regular broadcasts each day (well, most days!), and already quite a few radio dealers were advertising parts. There were even a few firms starting to offer locally-made sets.

At the same time, it was in 1927 that Australian radio broadcasting was already coming to the end of its pioneering era. The early days when an amateur entrepreneur could set up his own station were drawing to a close. Shortly after this, the industry would be taken over and formalised, first by big business and then by the Federal Government.

In 1927, issues of Wireless Weekly sold for three pence and consisted of 64 pages with a cover. Each issue contained an editorial or "leader", some news stories, background on what was happening at the stations, and a programme listing for the next week. There was also some technical information, to help those who wanted to build or instal their own set.

What we've done here is pick out the most interesting bits from quite a few issues. You'll find some front covers, a few editorials, some of the best news items, a collection of typical do-it-yourself radio set designs, and some selected pages from the programme listings. Plus a generous sprinkling of the original advertisements, of course. These are particularly fascinating, because they show prices and put everything into a proper context.

Here are a few things to note as you take this journey back in time. As you can see from the program listings, by mid-1927 there were only three stations in Sydney broadcasting regularly most days. Similarly there were only two in Melbourne, and one each in Brisbane, Adelaide and Perth. Later in the year a fourth station appeared in Sydney, 2UW.

Remember that all of the stations operating in 1927 were still privately owned. 2FC was owned by the retailer Farmer and Company, 2BL by Broadcasters Ltd, 2GB by the Theosophical Society and 2UW by Otto Sandell. In Melbourne, 3LO was owned by the Broadcasting Co. of Australia, and 3AR by the Associated Radio Company. The Australian Broadcasting Commission didn't come into being until 1932.

You can see from the data panels in the program listings that the short-wave bands weren't too crowded, either. There were a few stations in the USA for the short-wave fan to tune for, plus the Dutch station PCJJ run by the Philips company. That was about it!

Already in 1927 quite a lot of early work on television had been done by inventors in a variety of countries. A picture of one of these appears on one of the Wireless Weekly covers we've reproduced: the Scot John Logie Baird. However, very little of this work had been seen in Australia, and this probably explains the rather skeptical comments in the editorial on the subject.

To give you an insight into reader attitudes, we've squeezed in a few pages from Wireless Weekly's "Safety Valve" column. This was a forum for reader letters, and you can see one of the controversies which raged in the column during the year: whether or not there was too much religious programming.

Whatever happened to Wireless Weekly? In 1939 it changed into a monthly, called "Radio & Hobbies". Sixteen years later, just before television broadcasting began in Australia, the name was changed to "Radio, TV & Hobbies". Then in 1965, the name was changed again to "Electronics Australia", to indicate the way its subject area was becoming ever broader. It's still going strongly today, after sixty-three years of continuous publishing — one of the longest established electronics magazines in the world.

So Wireless Weekly lives on, in today's Electronics Australia — the leading electronics magazine in the country.

One person has been associated with and responsible for the magazine far longer than anyone else: Neville Williams. Neville started with it in the early 1940s, and retired as Editor-in-Chief in 1983. He still writes for it regularly as a consultant. We thought it would be appropriate for him to write a foreword to this commemorative book, and we're delighted that he was able to accept our invitation to do so. You'll find it overleaf.

OK now, settle into a comfortable chair and read on. If you find half as much fascination and enjoyment in reading it as we have in preparing it, you're in for many hours of fun!

**Jim Rowe**



**MANAGING EDITOR** Jamieson Rowe  
**LAYOUT & ASSEMBLY** Brian Jones  
**PUBLISHER** Michael Hannan

An Electronics Australia Publication

Published by The Federal Publishing Company Pty Ltd,  
140 Joynton Avenue, Waterloo 2017 Australia.

National Library of Australia card number and  
ISBN 0 86405 086 0  
Copyright © The Federal Publishing Company  
Pty Ltd, 1985

All rights reserved. No part of this work may be  
reproduced in any form, or by any means without  
the written permission of the publisher.

Printed by ESN — The Litho Centre, Waterloo 2017

# FOREWORD

Without any great feat of memory, I can recall the days when there was not a single radio set in the NSW country town or indeed in the district where I spent my boyhood. There was no friendly voice in the corner, to be switched on or off at will; no news and no weather forecasts other than in the morning papers, which arrived belatedly each day by train; no way to check the time, except by the clock in the stationmaster's office!

As for music, you had to provide your own, unless you were one of the fortunate few who owned a wind-up phonograph and a handful of records to go with it.

It is of little wonder that, when radio finally appeared on the scene, it had such an enormous social impact. With it came music, talks, religious services, news, market and weather reports, time signals — in short, information, diversion and companionship at the turn of a switch.

As Jim Rowe has pointed out in his introduction, domestic radio did not come cheaply at first, as measured either by the cost of receivers or the batteries to power them. Even when you owned a receiver, you certainly didn't leave it run all day. You searched the week's programs for items that you most wanted to hear and hoped fervently that the signal would not be blotted out on the day by atmospheric static.

If the wanted program was being broadcast from the capital in another state, you hoped even more fervently that you would still be able to pick it up. There was no networking in those days; no economical way to relay programs over long distances; no really practical means of recording them for re-broadcast elsewhere.

That's the way it was back in the middle '20s — sixty years ago. By 1927, any lingering doubts about the future of radio (or "wireless") had largely disappeared. The pressure was on for families to buy (or build) a radio set, to string up a large outdoor aerial and proclaim to the world that they had joined the ranks of regular listeners.

Living with radio was a totally new experience, with implications probably more profound, in their day, than anything that was to follow. For the first time, radio brought the outside world right into the home instantly and intimately. Think of this as you sample the articles, the letters, the programs and the attitudes of 1927 — itself a significant year in the history of domestic radio.

1927 saw the start of a boom which peaked in the early '30s, with a whole new generation of new-look receivers and an industry target of a radio in every home; this, with a proliferation of stations to serve them. Three generations, born since then, have never known a world without instant music, instant news and, indeed instant communication.

As a writer and editor, it has been of absorbing interest to share in, and report on, technical progress from the pioneering days of "wireless" to the fascinating world of "electronics", which grew out of it. But I wonder, in all that time, whether there has ever been a broadcast more memorable than a voice from the Moon announcing: "We have lift-off!"

**Neville Williams**



# WIRELESS WEEKLY

Broadcast Programmes a Week in advance

VOLUME 10

Registered at the G.P.O., Sydney, for  
transmission by post as a Newspaper.

NUMBER 17

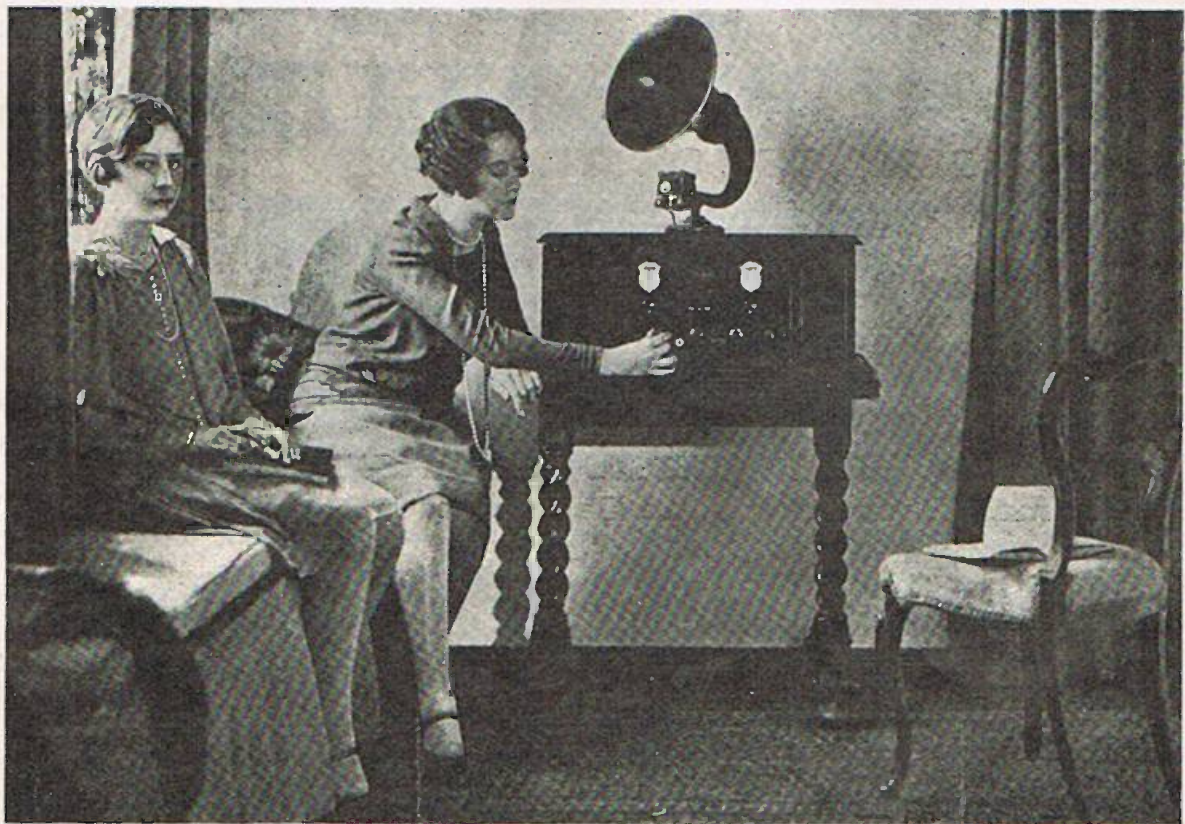

Friday, August 19, 1927.

Price Threepence

# EVERYONE IS TALKING ABOUT

The UDISCO  
Man will  
Demonstrate



in Your  
Home FREE  
of Cost.

MANILLA! LOS ANGELES! on Five Valves!—even Japan under favourable conditions

**SIMPLICITY ITSELF.**

The Udisco One-Dial Super Neut. surpasses even the wonder of Aladdin's lamp. The Udisco owner has twentieth century magic at his command—in his own home. Aladdin had to "fish" for the Genie of the Lamp, and was never quite sure of results, but the Udisco One-Dial Super Neut. owner is certain of getting just what he wants. By a gentle half-turn of the One-Dial, Space vanishes and the Genie of the Super Neut. brings all the Music of the Spheres at your command.

The Udisco One-Dial Super Neut. is the Open Sesame to the limitless Realms of Pleasure.

The  
Ideal Set  
for the  
Country

Free Demonstrations in your Own Home 'Phone B 7921 or your local dealer, and appoint the hour for a free demonstration in your own home. Within a few minutes he will show you how easily you can get any one of a score of Stations from any part of the Commonwealth. No litter or fuss. No outside aerials nor gadgets of any kind. The Udisco One-Dial Super-Neut. is simplified perfection, and has rendered tens of thousands of sets obsolete.

DANCES! SONGS! SPORT! OPERA! MARKET REPORTS! LECTURES! STORIES!

## "UDISCO" SUPER-NEUT ONE-DIAL

Australian Patents 20,643/24.  
U.S.A. Patents 1010918.  
British and Canadian Patents  
Pending.

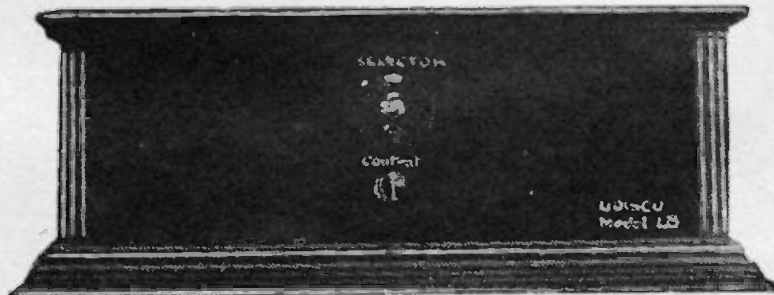

The Australian Invention  
that astounded the  
Wireless World.

Daylight  
Reception

Interstate  
Stations

Attractive Terms Arranged. Small Deposit—Balance over Twelve Months

<b>PRICES :</b>	4 Valve Set with Philips A609 Valves	£20	Complete Sets of Accessories, including Loud Speaker, from £12 upwards extra
	5 " " " "	£30	
	6 " " " "	£40	
	8 " " " "	£55	
Cancelling all Previous Prices			

FULL PARTICULARS AND DEMONSTRATIONS AT

# United Distributors Limited

72 Clarence Street, and 28a Martin Place, SYDNEY  
Sole Australian Distributors of "RAY-O-VAC" BATTERIES

343 Queen St., BRISBANE    27 Chesser St., ADELAIDE    26 Queen St., PERTH    Cr. Jervois Quay & Harris St., WELLINGTON, N.Z.    66 Charles St., LAUNCESTON, Tas.    664 Bourke Street, MELBOURNE    109 Collins Street, HOBART

# WIRELESS WEEKLY

Broadcast Programmes a Week in advance

VOLUME 10

Registered at the G.P.O., Sydney, for  
transmission by post as a Newspaper.

NUMBER 19

## *Radioing the Race Results*

TOM FERRY  
AT THE  
2FC. MIKE

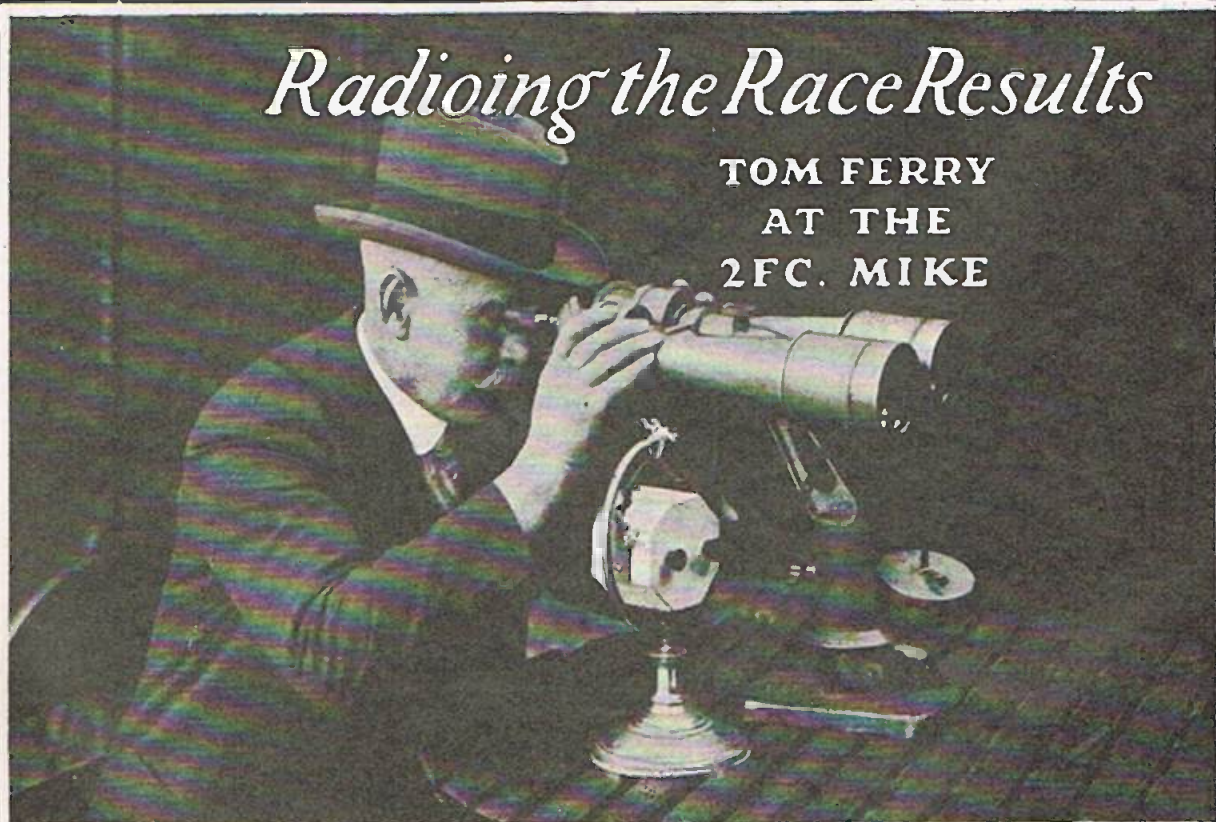

Friday, September 2, 1927.

Price Threepence

# Radio's Latest Broadcast RECEIVER COLMOVVOX 1928 Super Eight

Standard Battery Model

£62/10/-

All Electric Model

£75

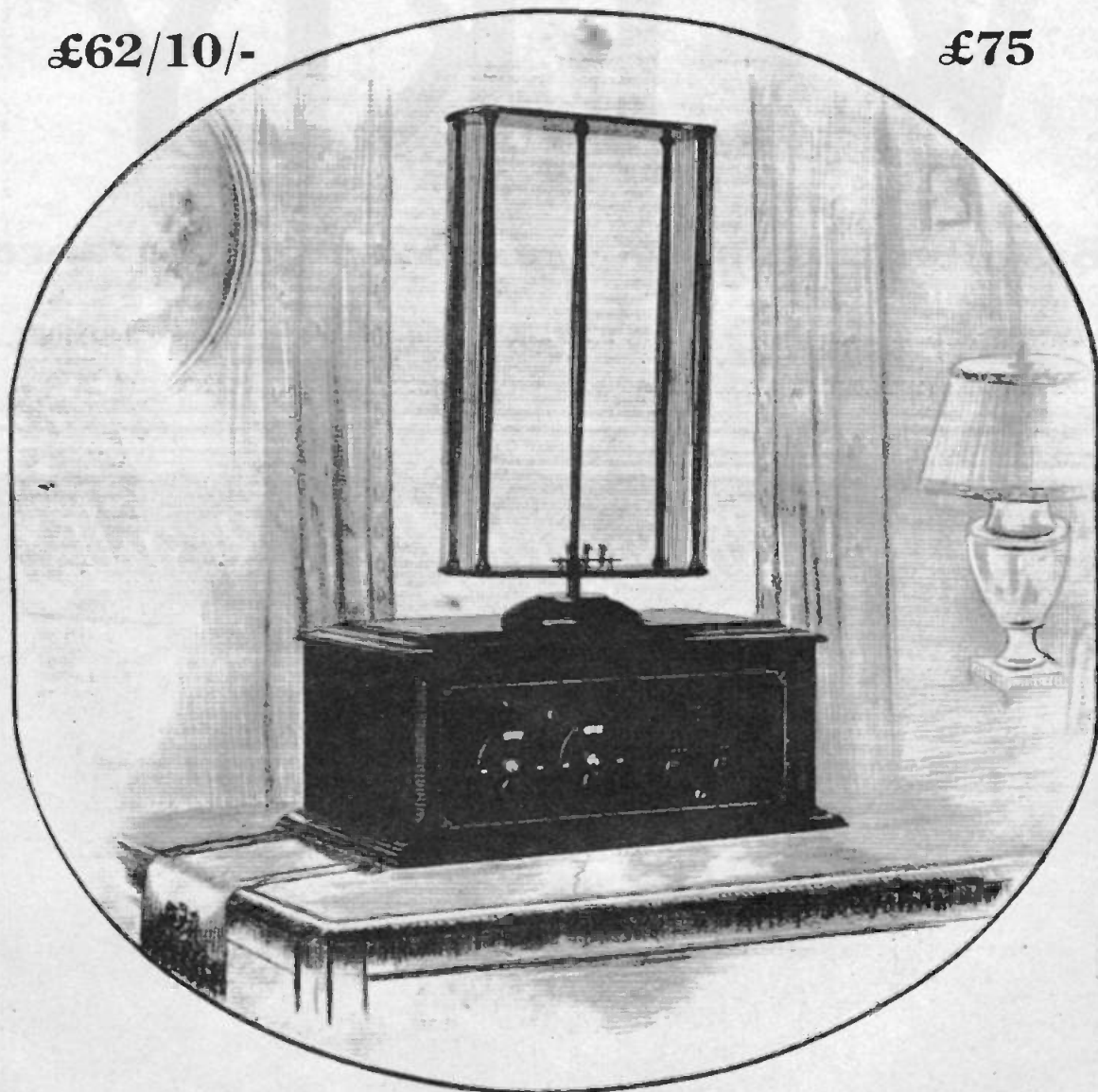

Tunes in all Australian and New Zealand Stations on Loop Aerial

**ALWAYS READY      ALWAYS RIGHT      GUARANTEED**

## Colville Moore Wireless Supplies Ltd.

'PHONE, B2261

10 Rowe Street (Near Hotel Australia) SYDNEY



# WIRELESS WEEKLY

Broadcast Programmes a Week in Advance

VOLUME 11

Registered at the G.P.O., Sydney, for  
transmission by post as a Newspaper.

NUMBER 10



Friday, December 30, 1927.

Price Threepence



Dr. J. A. Fleming, F.R.S., original inventor of the Thermionic Valve, writes, "You may be glad to know that with one of your AMPLION Loud Speakers I receive broadcast most splendidly."

*The*  
**SENIOR  
 DRAGON**  
 with Oak Flare, Type AR.65.0

"British and Best"

The popular "Dragon" shape—at once graceful and efficient—with wooden flare of Jacobean oak finish. Improved appearance—pleasing mellow tone. A full size, well designed, well balanced and exceedingly efficient Loud Speaker, with the Amplion Hall-mark, for five pounds, ten shillings.

**£5.10.0** **AMPLION**

Other Models from 25/- to £9.10.0

*The World's Standard Wireless Loud Speaker*

Advt. of Amplion (Australasia) Limited, Melbourne and Sydney

# WIRELESS WEEKLY

VOL. 10, No. 14

FRIDAY, 29th JULY, 1927.

## *Home Made Sets—are they Decreasing ?*

IT would be interesting if we could find out the number of receivers in use that are home made. By home made one means, of course, the assembling together of component parts of the set obtained from radio traders.

We are apt to class all sets not made completely in the factory as home made. Actually there are very few sets that can properly be called home made. Home assembled is a better description. There may be, and probably are, still a few crystal sets that are made up by the enthusiastic and energetic owners from details supplied by the various wireless traders. The preparation of the former, winding of the coil or coils and making of the connections and even the cat whisker—all the work of making a crystal receiver, except the actual crystal itself—that constitutes a home-made set really. In some cases, indeed, the actual piece of crystal is obtained other than from a wireless shop.

In the construction of "home-made" valve sets one comes across energetic workers, who make up the inductances, resistances and the condensers—all, in fact, but the valves. Thus we can say that there are some sets that cannot unreasonably be called home-made sets. But the number of home-assembled sets is probably greater. So many traders are selling component parts with very complete instructions for assembly. And there are many "kits" that are really complete sets disassembled or disconnected and all ready for assembling. The purchasers of these kits must constitute a large proportion of the listeners. Not only in the metropolitan districts but in the country centres are these sets found. Undoubtedly, the greater number is in the suburban areas. Crystal sets and what might be termed low-powered valve sets are plentiful in those parts. The owners of the sets are near to the traders, and any difficulties met with in finally assembling

the set or in testing it can be remedied, as advice is thus easily obtained.

We must admire the amateur set builder in the back country who constructs his set. He has few of the advantages and facilities of his city friends, and his difficulties after he has once started to tune in are greater. The important factor of selectivity does not play such a part in a country operated set. One can easily operate a 4-valve set for inter-state reception in the country with comfortable selectivity; whereas the same set operated within, say, twenty miles of a station like 3LO, Melbourne, would prove very unsatisfactory from the selectivity point of view.

The more one ponders the subject, the more evident it becomes that we are a long way from the phonograph state. That is, from the stage when all the sets in use will be factory made. And it is probably just as well. There is a charm in the assembling of your own set—or the tinkering with its assembly. Provided that that is done with knowledge there is no great risk.

The radio traders will continue to offer various types of components. The concentration on design in all countries will result in improvements and changes that will surely be tried out. And it will be good for the development of the industry.

The wireless papers show no abatement of the quantity of instructions for the assembly of sets, and the tests of new components. The instructions are generally very complete and the data, including diagrams, are of sufficient clearness and detail for anyone of average ability to follow. So long as the use of interfering circuits is not encouraged this procedure cannot be condemned.

Thus we see there is not much likelihood of the home assembled set disappearing, or being reduced in any quantity.

WIRELESS WEEKLY

# The Elec-Tru-Tone

gives you *music!*

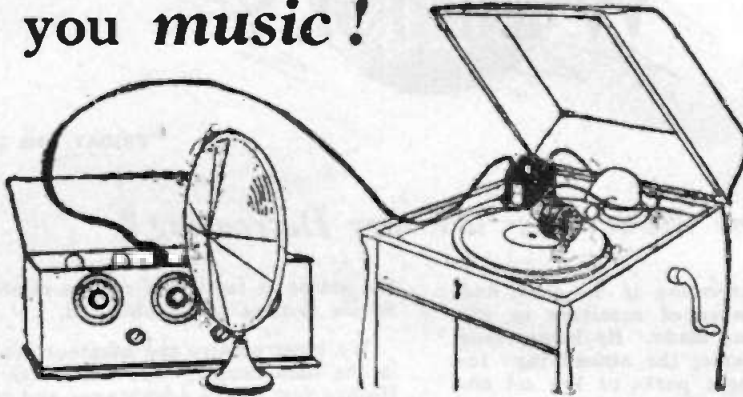

Any old phonograph can now be easily and cheaply converted into a powerful instrument..

Improved reproduction of phonograph records by the use of the Elec-Tru-Tone will amaze you. No matter what kind of instrument you have you can change it instantly into one of the new electric reproducing machines. The Elec-Tru-Tone is simply placed over the tone arm and the plug inserted in the detector socket of your radio: the speaker is plugged in as usual. You will find this appliance a great hit at your next dance party or musical evening. Obtainable from leading Phonograph or Radio Stores, or from Harringtons.

PRICE **£8:10:0**

The

## Planifier

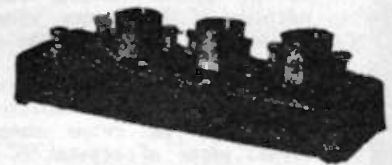

If you do not have a Radio Set, you can use the Elec-Tru-Tone with the "Planifier"—a 3-stage resistance, coupled amplifier, using the ordinary valves and power valve, with Batteries, as used in a Radio Set.

PRICE  
**£2:10:0**

# Harringtons LTD

Goodwill Built on  
Public Confidence, Since 1882.

386 GEORGE STREET, SYDNEY.

Also at Newcastle, Katoomba, Melbourne, Brisbane, Adelaide,  
Wellington (N.Z.), Auckland (N.Z.).

# WIRELESS WEEKLY

VOL. 14, No. 19.

FRIDAY, 24th SEPTEMBER, 1927.

## *Some Notes on Television.*

SOME prominence has been given lately in the non-technical press to the subject of Television. Cabled reports from London refer to "Televisor" sets that are being produced or likely to be produced in the near future, and to be sold at very low prices. Sets developed by a radio engineer from Hungary are to be sold at twenty pounds.

Such statements demand careful analysis by people concerned with the proper development of wireless, and of broadcasting in particular. The public generally are prone to accept attractive statements like that without question, and look forward confidently to having televisions or "looking-in" attachments wired to their receivers. They expect that such desirable new facilities will be available in a month or so. If they are not obtainable, and are not up to expectations, some harm is done to wireless generally.

It is that type of statement, unqualified, and only in part explained, that has done considerable harm to wireless. Well meaning enthusiasts have spoken a few guarded words about new devices or methods which they were developing, and before they can have any properly completed or tested samples available the public are told of revolutionary departures and improvements that are available to broadcast listeners or to other wireless users. The listeners find on enquiry that the new device is either not available, or is only partly completed. A state of mind bordering on

suspicion or scepticism develops, and caution gives way to enthusiasm.

This has been noticed in the history of broadcasting in Australia as in all other countries. A new circuit is announced. It is the last word in simplicity of adoption and the receiver in which it is embodied is one hundred per cent. efficient in selectivity, volume and tonal quality. Upon careful examination it is subsequently found to be an old friend in a new garb; some well known circuit with a few additions or alterations that introduce very few, if any, advantages, and the *new* receiver is no better than the old one.

Thus, with television or radio vision, as it is more correctly termed in its application to radio transmission. We have had several intriguing stories during the past two years of the early advent of "looking-in." And we have not yet been shown any demonstration of it, nor has any practical application of it to the ordinary user been given in any part of the world.

True there have been demonstrations of the new art in America, and Europe, of more or less promising success, but all of these exhibitions have been on an experimental scale, and not one of them has shown how the system could be applied with reasonable simplicity, and economy to the general public now known as Listeners. The truth is, of course, that no such system has so far been developed, or at all events, no detailed description of it has appeared in the reliable technical publications.

WIRELESS WEEKLY

# Radiola

## Broadcast Receivers

*Products of Australia's Greatest  
Wireless Organisation*

**W**HENEVER Broadcast Receivers are mentioned you will hear nothing but enthusiasm for the A. W. A. Radiola Superheterodyne Receiver.

¶ The Superheterodyne principle is recognised as being the highest development in the art of receiver design. The Radiola incorporates in a superlative degree all the essentials of a perfect radio reproduction — ultra selectivity — simplicity of tuning — beautiful appearance and superb tonal qualities.

¶ Every Radiola is guaranteed for a period of twelve months.

DEFERRED PAYMENTS TO SUIT YOUR CONVENIENCE

*Demonstrations at all Authorised Radiola Dealers  
throughout Australia.*

or at

**Amalgamated Wireless**  
*(Australasia) Ltd.*

47 YORK STREET,  
SYDNEY

*Cut this out and Post Now!*

Amalgamated Wireless  
(Asia Ltd)  
47 York St Sydney  
*Please forward me illustrated Radiola Booklet with particulars of deferred payment system*

Name \_\_\_\_\_  
Address \_\_\_\_\_

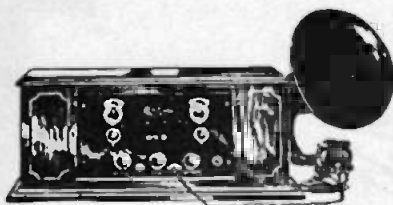

THE RADIOLA STANDARD 6

A 6 Valve Superheterodyne Receiver housed in a handsome Laminated Maple Cabinet. Complete with all accessories, including Amplion Loud Speaker, £45.

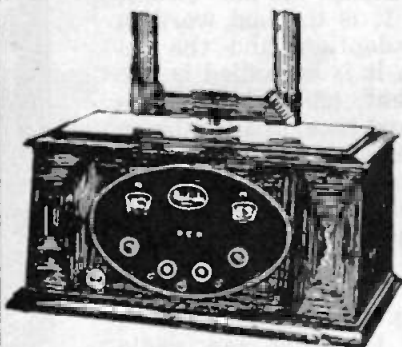

THE RADIOLA SENIOR 6

A 6 Valve Superheterodyne Receiver complete with all accessories, including Amplion Loud Speaker, £65.



THE RADIO SUPER 8

A magnificent 8 Valve Superheterodyne Receiver with concealed loop and enclosed Amplion Loud Speaker.

# WIRELESS WEEKLY

VOL. 11 No. 2.

FRIDAY, 4th NOVEMBER, 1927.

## *The Saturation Point in Broadcasting Services.*

THE continued increase in listeners' licences, especially in Victoria, to a degree that exceeds the ratio to population of England has caused people to talk of the "saturation point." It is argued by some that the number of listeners has reached pretty near the limit, that the maximum number of listeners that can be expected is within sight.

This saturation point or maximum density has frequently been applied to discussions concerning other industries. The motor industry, the phonograph industry, have similarly been examined and wiseacres shook their heads and said in effect—we cannot expect to sell many more. But despite these calculations, the sales continued. Even with the sewing machines, the saturation point has often been threatened.

With broadcasting the problem of discovering just when the maximum number of sets or licences is to be reached is more difficult, particularly so with listening equipments.

The types of sets are so variable and various, and the development in new "hook-ups" and methods so rapid, that it is well nigh impossible to say when the demand will fall down to the supply. Sets in use will deteriorate or go out of fashion, better or simpler methods of control will be evolved, and consequently people will change their sets. Thus the replacements of existing receiving equipments or the use of auxiliary sets will be almost as great as the

new sets representing additions to the great body of the listening public.

The cheapening of sets and of component parts will also be a factor of no inconsiderable importance in supplementing and adding to the number of sets in use.

Thus, one might argue that the radio trade will be in no danger of declining into slackness, but signs of a flattening out of the curve of licence development will not be unexpected. The extraordinary result of the concentration on service by 3LO Melbourne, whereby over 130,000 licensed listeners have paid for their services, is an indication that people in large numbers can be induced to listen without any serious flagging of interest. But the point is coming in the curve, when it will tend to flatten out, new listeners will not be so easily found.

The responsibility of the station then will be as great or greater than before, no slackening up can be allowed. It will be just as necessary then to concentrate on every aspect of the service as at present, so that the subscribers and patrons may be retained. It behoves all broadcast enthusiasts to remember the element of co-operation, and to help the broadcasting company, by assisting neighbors in the operation of sets, and by making helpful and useful criticisms of the service. Thus may we expect to find broadcasting in all States developing safely.

WIRELESS WEEKLY

# The Safety Valve

Readers are urged to express their opinion on matters pertaining to broadcasting. If you have some grievance, if you have some constructive criticism to offer, here is your chance for expression—your safety valve. The editor assumes no responsibility for statements made by readers and published on this page, as opinions of correspondents do not represent our editorial policies or beliefs. Anonymous letters are not considered.

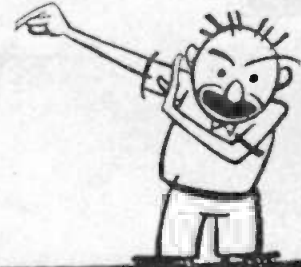

## LESS RELIGION.

Dear Sir,—For some two years I have held my peace. I have realised that not everybody shares my views, and that when I criticise I should bear this in mind.

That was what I thought until a little time ago. I believed that there was a great body of listeners—in both outback and in the cities who wanted broadcast church services, and although I myself believed this feature was overdone I said nothing.

But in my travels I realised slowly that there was no great body of listeners who appreciated religion by radio; that city folk preferred to spend their Sundays out of doors and that they wanted cheerful joyous music—instead of monotonous monologues and dreary organ recitals, or wailing choirs. Country folk, I found, wanted a rest—a day off from duties around the station or farm, and also wanted lighter fare.

The religious programme at the broadcasting stations is tiresomely overdone. In the other fields of broadcasting experience shows that talks must be short and snappy, and that music must be bright and changeable. These lessons have been carried into effect in every programme except the church services, to which it applies just as much as to any other. Instead of broadcasting direct from the pulpit, why not have a radio minister who could deliver a short talk or sermon, and there let it end?

Are the broadcasting managers afraid of offending an imaginary public? Have they been bluffed into making the Sunday programme bore-some in the extreme by the fear of the howl that would be set up by the clerical profession if any change were to be made? Do they fail to realise that nothing is doing more to make church unpopular than broadcast services?

After all the duty of the broadcasting stations is to the public who pay the fees and not to the parsons who get the publicity.

And although the public has been silent on this subject for the same reason that I have held my peace, let us hear something now that I have broken the ice.

Yours, etc., JACK BLAIR.  
Drummoyno.

## NO COMPLAINTS.

Dear Sir,—I feel it my duty to express my feeling towards our broadcasting stations. As regards 2BL, I really don't know how this station could be criticised as regards their transmission. I can tune in to 2BL day or night, and find this station just the same from when I tuned in until I tuned off, no fading whatever. I have had all the relays PCJJ from 1 o'clock till 6 in the morning, and have written to Broadcasters and had what I received verified by a letter I still have.

With 2FC I find no fault. I have had some very fine programmes from that station and have heard them just as loud as 2BL and 3LO, or any of our A class stations. 3LO has no doubt a wonderful variety as regards programmes, but the transmission fades a little, as does 4QG, although I have no cause to complain about these stations. We do not pay them one penny of our license fees, so what right has one?

I also get 1YA very nicely, 2GB are O.K., while 7ZL are the same. I have heard some good programmes from 7ZL lately.

I may state that my receiver has been working for 4 years and I have not had one day's trouble with it. It was made by my brother and myself, and for clarity, and volume—well, it will be hard to beat.

My own opinion is that a lot blame these stations fading and not getting good reception, as they have a dry "B" Battery, and if they were to get a wet "B" Battery, I think that would overcome a lot of their trouble. There is one thing I would like to have rectified, and that is howling valves. I think some people when handling their receivers think they have hold of a mangle handle, instead of a condenser.

Yours, etc., P. J. SCULLY.  
Maryville.

Under no circumstances can we consider personal callers whose mission is technical information. Queries of this nature are dealt with only through the columns of "Wireless Weekly." Send your letter addressed, "Wireless Weekly," 51 Castlereagh-street, Sydney. Enclose no stamps, but confine the number of your queries to four.

## CALLOUS?

Dear Sir,—As one reared on 3LO I have not yet become reconciled to 2FC'S callous disregard of their advertised programme, nor yet to their irresponsible way of starting and finishing relayed tunes more or less in the middle. However, if ever they should need a testimonial I shall be pleased to state that I once had much pleasure in setting my clocks by their time signal tuned in on a crystal receiver at Launching Place not far from Melbourne.

Yours, etc.,  
BOXER.

Balmain.

## FROM THE SOUTH.

Dear Sir,—With reference to different letters in your magazine, dated 15th July, on "Day and Night Reception in the Country," I notice that all letters have come from the north and western districts, so I don't suppose one from the south will be out of place. We are just on halfway between Sydney and Melbourne, so one should be able to compare both very favorably.

Having had two years' experience with wireless, I can give you the following information using a 3-valve set (Detector and 2 Audios):

2FC.—Day reception poor—much better when on 1100 metres—night reception better, but a lot of fading.

2BL.—Day reception poor—night reception very little better, too much fading.

3LO.—Good daylight reception—night reception best of all stations, excellent—a little fading.

4QG.—No day reception—night reception very good with a little fading of late. It might be as well to note that 4QG up till last month had practically no fading.

3AR.—Good night reception.

5CL.—Good night reception. Trusting that this will be a little information for your magazine.

Yours, etc.,  
H. V. MUTCH.

Junee.

Burgess Went with U.S. Mail Flyers.



# Melbourne University Symphony Orchestra at 3LO

Notes by our 3LO Correspondent

MELBOURNE is torn at present by rival factions quarrelling about the proposed fund for establishing a permanent orchestra. One faction wishes the University Symphony Orchestra to be the foundation of the endowed body; another favors the symphony orchestra carried on by the late Alberto Zelman and now conducted by Fritz Hart, of the Albert Street Conservatorium.

The whole idea is, of course, designed to give good orchestral music to the great mass of the people. If the latter have to wait till disharmonies are changed into harmonics, the first official programme will probably contain works of the matters of 1947.

It is fortunate, under the circumstances, that wireless has opened the way to giving the people fine orchestral concerts under circumstances that make for true harmony. Professor Heinze, of the University, has arranged with 3LO to give a series of such concerts, providing orchestra and singers. The first will be given on August 3rd. Unquestionably there are, among people who do not go habitually to concerts, a great number who will appreciate good music in their own homes. That this is so is proved by the fact that the music sold for gramophones and other mechanical music reproducers is to a great extent of very fine quality. Wireless has educated the public ear to this discrimination, and the work of 3LO has been consistently directed to giving, apart from what the public wants, a modicum of what it should want, in the hope that the unusual may appeal and create a demand for more. That this has been so is now certain, and the engagement of Professor Heinze is an indication of the agreement of the listening community with the policy of 3LO.

## SHAKESPEARE ON THE AIR.

Shakespeare, of course, that giant intellect who seemed to anticipate most things, and even prefigured wireless in the picture of his Ariel, who could "put a girdle round the earth in 40 minutes," and only erred on the side of slowness in his guess, would not be surprised at knowing that one of his most beautiful love-scenes was going to be shot at far greater than Ariel's speed round the world.

3LO has arranged with Stephanic Deste, that lithe temptress in "Rose Marie," who is an extraordinarily good reciter, to play the balcony scene in "Romeo and Juliet" with



The Melbourne University Symphony Orchestra, which has been engaged by 3LO for a series of Classical Recitals.

Howard Edie. It will be interesting to see how Shakespeare fares on the air. There will be no need of setting a stage for listeners, for the Balcony Scene carries its own implication, and the most sluggish imagination will be equal to visioning that gallant doubled figure looking up to the white-gowned Juliet on her balcony, while the Nurse waits within, ready to call a warning. I have always thought that Shakespeare is spoiled by the muck that scenery producers think it necessary to hamper him with, just as by the music that is so superfluous. Shakespeare is scenery, words and music in himself, and without the distraction that stage settings provide, the mind can concentrate far more easily and happily on the immortal words that make the drama. If this succeeds, as it should, there is no reason why Shakespearian scenes should not become a regular part of a programme on certain nights. They may give back to the people that appreciation of Shakespeare of which teachers and actors have robbed them.

SO SUCCESSFULLY WERE the excerpts from "Madame Pompadour" broadcast from 2FC that a relay by 3LO has been arranged for Monday, August 8.

A FASCINATING little competition has been arranged for the little ones by 3LO, and shortly will be heard over the air.

A short story will be read to the children, and this includes the names of ten popular songs. Blanks will be left in the narration where the kiddies will be expected to fill in the name of a song.

Thus the story might read: "One day 'Rose Marie' met 'Cecilia' who was 'Sitting on Top of the World,'" and so on.

This little tale has been written with great care, and the fact that the competition is for children has been borne in mind both with regard to the story and selection of songs.

3LO IS LEAVING NO STONE unturned in procuring absolutely the best of adventure tale tellers.

The latest to be engaged is the well-known exponent of wrestling, Al Karasick, who shortly will give a series of tales about the True Siberia—but he will also recount his own thrilling experiences in Siberia for the benefit of interested listeners.

The last to relate adventure tales was another well-known wrestler named Mike Yokel, who gave adventurous stories of life in the valley of the Yukon.

Ask for the New 83X Philco Battery.

# Detonators — 4QG Averts a Calamity

THE value of wireless was very clearly demonstrated recently when a series of announcements broadcast from 4QG assisted the police and parents to take action in recovering a quantity of dangerous explosives of which a number of children in one of the suburbs of Brisbane had gained possession. It is quite probable that through the agency of the station a number of children were saved from serious, if not fatal, injuries. The facts make very interesting reading.

Listeners to Station 4QG on the night of Wednesday, August 17th, were quite startled to hear the following announcement made:—

"About 4.30 p.m. to-day, after the children had been dismissed from the Musgrave Park State School, several of them found a cement bag containing a box of 100 detonators. Not knowing what they were, the children distributed them amongst themselves.

"All parents of children attending that School are asked to question their children and ascertain if they are in possession of any detonators, as they are highly explosive. Any compression or heat, or picking on the inside would cause an explosion, and result in serious or perhaps fatal injuries. Any parents recovering any detonators from their children kindly advise C.I. Branch or nearest police station immediately."

The announcer at 4QG then stated that the matter was quite serious and in order to enable parents to identify any detonators which might have been in the possession of children he gave a description of a detonator. Parents of children attending the school and owning wireless sets were then asked to make the matter known to any other parents not possessing receivers.

The story of the manner in which the message came to be broadcast by 4QG is as follows:—At tea-time on Wednesday night a resident of South Brisbane was surprised when his young son, who attends the school, put a detonator on the tea table. The father recognised it and asked where the boy had picked it up. He was advised that the youngster had found it near a neighbour's gate, and the father, thinking that more may be about, searched and mentioned it to the neighbour.

The neighbour's son overheard the conversation and quite gleefully remarked that one of his schoolmates was lucky, "he has a lot of them," he said. Alarmed, the two parents went to the third house where a very pleased youngster had more than twenty detonators spread on the floor.

When it was discovered that the school children had found a box of them and shared them amongst them-

selves, the parents were quite alarmed and informed the police. Realising the danger to so many children, the police inaugurated a search and advised 4QG of the happening. The officials of 4QG were quick to realise that serious injuries might be received by the children if prompt action were not taken, and accordingly the message set out above was broadcast at regular intervals throughout the evening.

Due to the wireless announcement quite a large number of detonators were recovered. The circumstances under which they were found make one realise that there must be some truth in the old time worn expression that a merciful providence safeguards children and intoxicated persons.

Some of the children had used the detonators in such a manner that it is impossible to understand just why serious accidents did not happen. One small boy had thought that the de-

tonator looked something like a cracker and had wanted to throw it in the fire at home to hear the noise. His mother refused to allow him to do so on the grounds that it might put out the fire.

Three or four children had rammed pencils into the detonators and were using them as holders. Another small boy had found a plug piece of gelignite in the park near the detonators and was carrying it in his pocket.

On the Thursday morning a vigilant police officer discovered a young Australian wandering along to school with a detonator in his mouth. These and other cases show just how remarkable it is that no serious accident happened. The whole incident served to show just exactly how useful wireless may prove in case of emergency, and there are many parents in Brisbane to-day who are thankful that they own radio receivers.

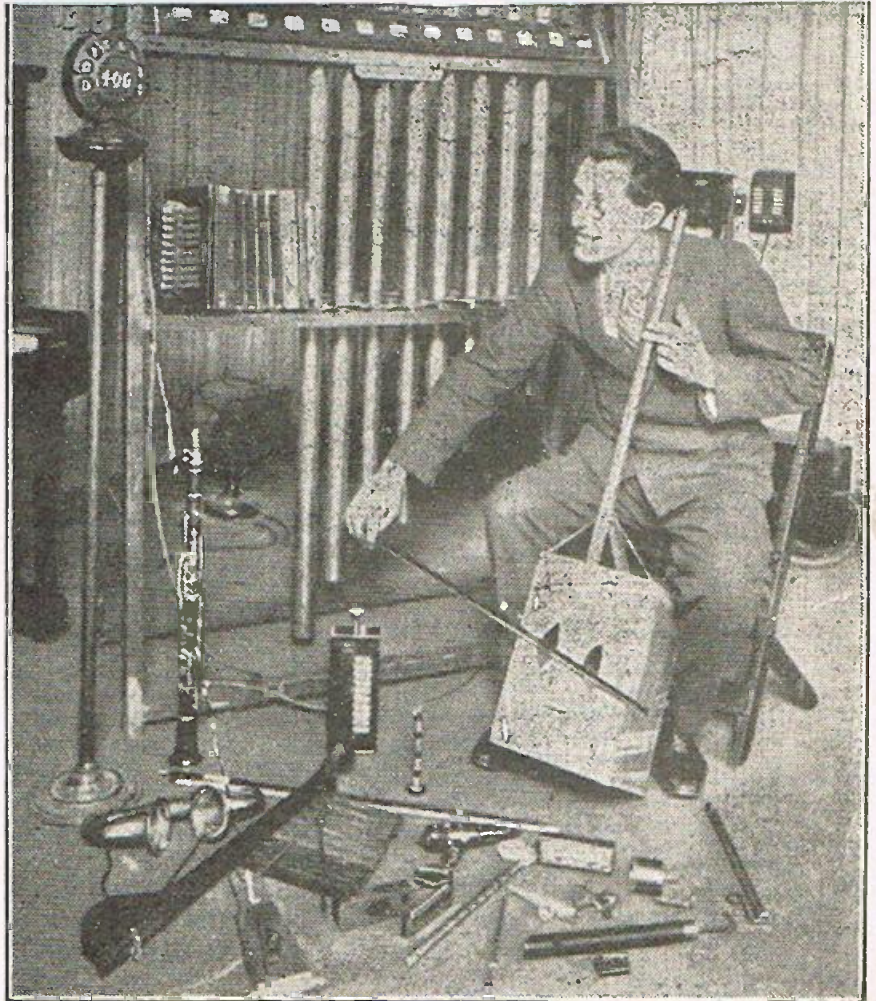

The Sandman at 4QG. tries out a variety of instruments. *Queenlander Print.*

Ask any Radio Engineer about Burgess.

# 2FC Broadcasts to the World

*World-Wide Short Wave Broadcast carried out by 2FC last Monday—Heard in India, South Africa, Canada, England and the United States*

**S**TATION 2FC, First Empire Broadcaster.

It will go down in history. The first Australian station to be rebroadcast in England, Canada, India, South Africa, and in the United States of America.

Between 2 a.m. and 4 a.m. on Monday last the most famous musicians, singers and statesmen in Australia gathered together in the studio of 2FC to transmit the finest programme ever compiled in Australia. The transmission took place on a special low wavelength through the short wave transmitting station attached to 2FC, and was picked up by the short wave stations of the Marconi Company in India, South Africa, and England, and by the stations of the Radio Corporation of America in Canada and the United States.

The programme was heard by listeners of 2LO, London, between the hours of 5 and 7 p.m. on Sunday, September 4.

Those taking part in the programme did so without payment. They included, The Governor General of the Commonwealth (Lord Stonehaven), The Governor of New South Wales (Sir Dudley de Chair), The Prime Minister of Australia (Mr. S. M. Bruce), The Premier of New South Wales (Mr. J. T. Lang), Mr. W. M. Hughes, Mr. E. T. Fisk, Dame Nellie Melba, Mr. John Hislop, Miss Strella Wilson, Mr. Andrew McCunn, Mr. T. H. Mostyn, Sir James Fairfax, Mr. Alfred Cunningham, Miss Rene Maxwell, Mr. Raymond Ellis, Mr. Albert Cazabon, Mr. Alexander Sverjensky, Mr. Jules Van der Klei, and many others.

To gather together such talent in the ordinary course of events would have cost many hundreds of pounds.

The programme was as follows:—

2 a.m.—  
The Chimes of Sydney's General Post Office  
Call Sign.  
"God Save the King."  
Chorus and Orchestra.

Announcement covering full details of the transmission.

A message from the Governor-General of the Commonwealth of Australia, His Excellency, Lord Stonehaven, to other parts of the Empire.

Call Sign.

2 FC Instrumental Trio:

Mr. Lionel Lawson, violin.

Mr. Gladstone Bell, 'cello.

Mr. Lindley Evans, piano.

will play the first movement of the Trio in D Minor (Mendelssohn).

Call Sign.

From GOVERNMENT HOUSE, SYDNEY, the Governor of N.S.W., His Excellency Sir Dudley de Chair will deliver a short message to other parts of the Empire.

Call Sign.

Mr. John Hislop, eminent English tenor, will sing.

Mr. Albert Sciarretti at the piano.

Call Sign.

From his home at Frankston, Victoria, the Prime Minister of the Commonwealth of Australia, the Rt. Hon. Stanley M. Bruce, M.P., P.C., M.C. will deliver an Empire message, over a land line of 600 miles, to the Studios of 2FC.

Call Sign.

From the Studio, arrangement for two pianofortes:

"Whirlwind" (Gerault).

Mr. Frank Hutchens and Mr. Lindley Evans.

Call Sign.

An Empire message from the Premier of N.S.W., Hon. J. T. Lang, M.L.A.

Call Sign.

Miss Strella Wilson, principal of the Gilbert and Sullivan Opera Company.

Mr. Andrew McCunn, Musical Director of J. C. Williamson, Ltd., at the piano.

Call Sign.

A message from the Lord Mayor of Sydney, the Right Hon. T. H. Mostyn, J.P., to the Lord Mayor of London.

Call Sign.

Miss Rene Maxwell (Australian soprano) and Mr. Raymond Ellis (operatic baritone) from the British National Opera Company):

Duet from "Lilac Domino."

Call Sign.

A message from Dame Nellie Melba.

Call Sign.

'Cello solo:

"Andante from Concerto in A Minor (Gottmann).

Mr. Gladstone Bell.

Call Sign.

Sir James Fairfax, President of the Australian Section of the Empire Press Union, will deliver a message to the Press in other parts of the Empire.

Call Sign.

Mr. Alfred Cunningham, English operatic baritone:

"Simon the Cellarer" (Old English).

Call Sign.

"The Four Waifs," vocal quartette:  
"Sally Horner."

Call Sign.

A message from Rt. Hon. W. M. Hughes, P.C., Director of Amalgamated Wireless.

Call Sign.

Mr. Raymond Ellis, baritone:  
"It is enough" ("Elijah") (Mendelssohn).  
Piano, organ and 'cello accompaniment.

Call Sign.

Mr. Albert Cazabon, Conductor of the Prince Edward Theatre Orchestra:  
Violin solo.

Call Sign.

A message to Mr. C. R. Marcuse, of England, read by Mr. A. McDonald, Chief Engineer, Amalgamated Wireless.

Call Sign.

Miss Mabel Batchelor, soprano:  
"Absence" (Sir Frederick Cowan).

Call Sign.

Mr. Alexander Sverjensky, pianoforte solos  
"The Stream" (Arensky).

Call Sign.

Announcing result of reception overseas.

Call Sign.

Mr. Jules Van der Klei, 'cello solo:  
"Arlequin" (Popper).

Call Sign.

Madame Emily Marks, soprano:  
"Prayer" ("La Tosca") (Puccini).

Call Sign.

Mr. Lionel Lawson, violin solo:  
"Wings of Song" (Mendelssohn).

Call Sign.

Miss Rene Maxwell, soprano:  
"A Prayer" (Haydn Wood).

Call Sign.

Greetings, World Wide.

Call Sign.

"The Four Waifs," vocal quartette:  
"Cornfield Melodica."

Call Sign.

Final Announcement.

4 a.m.—"God Save the King."

At the piano:

Mr. Andrew McCunn.

Mr. Lindley Evans.

Mr. Ewart Chapple.

The various announcements and call signs will be given by:

Mr. George Carney, well-known English comedian.

Mr. Scott Alexander, English actor.

Mr. Jack Win, English entertainer.

And the following officials associated with Station 2FC:

Mr. A. S. Cochrane.

Mr. L. Halbert.

Mr. H. P. Williams.

Mr. R. Garling.

Mr. F. Chapple.

Mr. O. A. Anderson.

Mr. E. A. Burbury, Engineer, 2FC.

Call Sign.

A message from Mr. E. T. Fisk, Managing Director of Amalgamated Wireless (A/asia), Ltd., to wireless interests overseas. (To be read by Mr. L. A. Hoek, Assistant Managing Director of Amalgamated Wireless).

The whole of the arrangements were carried out by Farmers' Broadcasting Service, in conjunction with Amalgamated Wireless (Aust.), Ltd., and "The Sydney Morning Herald."

## 3LO, Too

As we go to press 3LO, Melbourne, announce that on Tuesday night, from 11.45 p.m. to 2 a.m., a short wave broadcasting test on high power will be carried out from their Braybrook Station.

The programme will be given in the studio in the ordinary way and passed on to Braybrook by land line.

Continued on Page Eight

The World's Flyers carried Burgess.

## Broadcasts to the World

Continued from Page Seven

It is anticipated the wave length will be 29.8 metres and the power drawn from the mains will be 15,000 watts. At Braybrook the output from the studio is applied through a line amplifier and sub-modulator unit to the grids of the modulator proper, which in turn is coupled to the plate of the special short wave oscillating valves. These valves are of unique design and are enclosed in metal screens in order to distribute the high frequency losses over the whole of the glass envelope and thus reduce the risk of puncture at the high potentials used. The oscillator is worked on the amplifying drive system through the stages of magnification—modulation taking place on the last stage. The output from this is then fed through a specially designed coupling circuit through a lecher feed to the distant aerial. The lecher lines consist of two highly insulated, tightly stretched wires supported on miniature telegraph poles. The energy from the transmitter is fed into the base of the aerial system by means of a special coupling. Steps are taken to prevent radiation from the lecher system and to eliminate reflection so as to ensure the maximum transfer of energy from the oscillating apparatus to the aerial. The advantages of this system are that the aerial may be kept free from interference likely to be caused by conflicting electric fields in and around the actual generating apparatus, building, and other factors likely to cause absorption due to the enormous intensity of the electromagnetic fields set up at frequencies of the magnitude of those to be used for these tests.

The various units of the transmitting equipment are electrically screened from each other, and the frames and panels made of brass. The circuits are so balanced that all fields induced in the frames are neutralised. All high frequency portions of the equipment are supported on plate glass strips to eliminate dielectric losses.

The potential on the plates of the main transmitting valves will be 8,000 volts, supplied by a specially constructed 3 phase double wave rectifier and associated smoothing unit. With this equipment 3LO, Melbourne, will have the most modern and most powerful short wave broadcasting station in the Southern Hemisphere, which should be capable of being heard in any part of the world.



**ROY GALLOWAY:** A famous English baritone with a long string of important stage and platform triumphs to his credit, Roy Galloway comes to 3LO, Melbourne, as afresh and pleasing addition to the programmes.

**BERYL HAYDEN:** A new comedienne at 3LO, who has an extensive repertoire, and is broadcasting many excellent comedy numbers. Coupled with Roy Galloway in comedy duets, she is delighting listeners with her quaint and clever patter and singing.

### Dempsey v. Tunney

A full ring-side description of the fight between Dempsey and Tunney for the world's heavyweight title on September 22, will be broadcast by the Crosley Radio Corporation's super-power station, WLW, Cincinnati, Ohio, U.S.A.

The transmission will be on 52 metres—a short wavelength specially chosen by arrangement with the International Radio Co. (local agents for the Crosley Corporation) to ensure reception here.

Although the broadcast will take place at 10 p.m. Eastern Standard Time, America, on September 22, the corresponding time here will be 1 p.m. the following day (September 23).

### AUTHORS' WEEK.

During "Authors' Week" every effort will be put forth to try and stimulate the interest of that very important person, "the man in the street," with regard to Australian authors—not to speak of authoresses. Papers on the subject will be read from Studio 3LO—readings from our favorite native poets will be given, and no stone will be left unturned in our effort to "tell the World" that our home-grown products can more than favourably compare with the majority of the imported stuff we see lining our bookshelves and book stalls.

### AUSTRALIAN AUTHORS' WEEK:

Commencing Monday, September 12, an Australian Authors' Week has been organised throughout Australia. 5CL has arranged to co-operate with the organizers by arranging special programmes.

A SPECIAL ORGAN recital, to be given in the Adelaide Town Hall by the City Organist (Mr. W. R. Knox), will be broadcast by 5CL on Sunday evening, September 11, at 8 p.m. In addition to organ selections, items by well-known artists will also be broadcast.

### KATHLEEN SIMMS.

This charming soprano comes to Studio 3LO, Melbourne, from the University Conservatorium of Music. She made a name for herself recently by being selected for second place in the Table Talk Musical Comedy Actress Competition—an honor, indeed, considering the large number of charming and talented competitors.

**5CL CHARITY BALL:** The 5CL Charity Ball has been booked to take place in the Maison de Dance at Glenelg on the evening of August 31, and is causing widespread interest. Tickets are in great demand, and there is every evidence that the function will be very successful. Among the features which will be presented is the arrival of Professor Bravotti from Mars. Other novelties have been arranged, and a number of special musical items are to be given.

### ANITA SHAW.

As leading lady with the original "No, No, Nanette" Company, Miss Anita Shaw is no stranger to Australian audiences. She is to appear before the "Mike" at 3LO, Melbourne, shortly, and having an extensive repertoire will be sure to delight listeners-in. Miss Shaw's versatility should suit broadcasting, especially as she has had a series of successes in revue, musical comedy, pantomime and variety the world over.

Philcos are Aristocrats among Batteries.

# The Safety Valve

Readers are urged to express their opinion on matters pertaining to broadcasting. If you have some grievance, if you have some constructive criticism to offer, here is your chance for expression—your safety valve. The editor assumes no responsibility for statements made by readers and published on this page, as opinions of correspondents do not represent our editorial policies or beliefs. Anonymous letters are not considered.

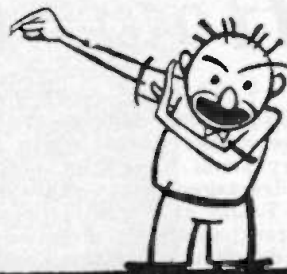

## HEARD NEW YORK ON "WIRELESS WEEKLY" SET.

Dear Sir,—On Saturday, 23rd July, I built the 3 valve receiver as described in your issue of the 15th July, 1927, and have had very good results.

On Sunday, 24th July, I picked up 2XAF, New York, at good loud speaker strength, and during the 24 hour test from PCJJ I had no difficulty in receiving that station at any hour. Then yesterday (Sunday, 31/7/27) I picked up station 2XAF at 5.50 p.m. and heard President Coolidge, of U.S.A., make a speech in presenting Colonel Lindberg with a decoration, and Lindberg's reply. The announcer at 2XAF stated there were 150,000 people present. After this a special programme for Hawaii was transmitted, and the whole received until 2XAF announced the station was closing down at 6.43 p.m.—The whole of this transmission was received at good loud speaker strength, using 3 Radiotron UX20IA Valves.

This may be of interest to readers of "Wireless Weekly," to which I have subscribed since its inception and submitted accordingly.

Yours, etc.,

H. H. BURRASTON.

Murrurindi.

## MOR(S)E TROUBLE.

Dear Sir,—I wish to draw your attention to the fact that country listeners have been considerably interrupted by the Morse code from various stations. Now I know you will say straight away that it is through the set not being selective. I have been working a Magnavox 5, which for selectivity is as good as the next, and one night during last week the programme of each station was interrupted by the Morse code. It appears the Morse comes from several stations. One night 3AR and 5CL were continually interrupted by a dull buzz, and 3LO was subject to a continuous whistling and a far-away speech which was unintelligible. Farmer's 2FC are subject to interruption from Morse code, and it considerably hampers country listeners, as you must admit that while listening to a programme of music, it is

very annoying to have to hear Morse, Morse, Morse.

I write this in good faith and not as a sarcastic complaint, and for the betterment of radio. The country people I find are just beginning to become enthusiastic in wireless matters, and it seems a pity that something cannot be done to rectify this annoyance.

I might state that the transmission from the two Sydney "A" stations is not all that could be desired. This, of course, is subject to discussion, but my own personal experience is that of the two stations, 2FC is somewhat superior, but even then is not very good.

In conclusion, I might add that the Morse at times is so loud that it is almost impossible to hear any other items at all, and it seems to be on occasions on all wave lengths from 350 to 450 metres.

Yours, etc.,

SYDNEY BROOKS LLOYD.

Mosman.

## DREAMY DRIVEL.

Dear Sir,—I heartily endorse Jack Blair's views and also think it is time the local broadcasting companies woke up to the fact that the great majority of listeners in are sick of the Sunday services, not only Sunday but also Saturday. If the broadcasting stations are going to cater for religious bodies, punters, indifferent cooks, people who can't read, weather prophets, and other uninteresting subjects, they will soon be better than a sleeping draught.

Cut out churches, football matches, weather reports, cookery lectures, race meetings, tips to punters, lectures of all kinds, announcers' opinions, clock and chimes every half-hour, kids' stories and lies also pious hymn singing, and let us have something worth listening to; not the dreadful, dreamy drivel we have suffered so long.

Yours, etc.,

THOMAS STILLEY.

Clovelly Rd.

## NO ALTERATION NECESSARY.

Dear Sir,—I have been reading with considerable interest the controversy between listeners regarding the nature of the Sunday broadcasting programmes. It makes one wonder just what some people really want for the trifling cost of less than one penny per day to constitute a listener's license. License holders should, when they consider the variety they get for their small contribution, be more than satisfied.

As for the popularity of the broadcast Church services, to my idea this is not to be disputed. A studio service to be conducted for the benefit of listeners alone, which has also been suggested, would not fall into public favour, because a service direct from the Cathedral itself would certainly be more interesting.

How any person could listen to jazz, etc., six nights from every week, and then actually desire the same form of entertainment on the seventh amazes me to the extreme. I think it is a pleasant departure from the usual programmes to be able to listen to a church service on the Sabbath and enjoy the music of organ and choir.

I live in a town where Sunday sport is well entrenched, but I think I am voicing the sentiments of fellow listeners in this small centre by requesting that the Sunday broadcasting programmes remain unaltered.

Yours, etc.,

JACK WILLIAMS.

Curlewis.

## THE MERRY WIDOW.

Owing to the great success of the recent production of "The Merry Widow" from studio 3LO, Melbourne, under the direction of Mr. William G. James, a second performance is to be given on September 12th. The principals will be the same as on the first occasion—Madame Saïfo Arnov will give a good account of the soprano role, which she played throughout England and the Continent with great success—and the two popular announcers, Mr. Alfred Andrew and Mr. Maurice Dudley, are each lending the production able support.

You can Recharge a Philco for a few pence.

# How To Tune In PCJJ

**D**URING these last years the opinion has existed that the very small wave-lengths offer many advantages for radio-telegraphy. To-day this opinion has become a conviction, and attention is specially drawn to these small wave-lengths by the results obtained by PCJJ at Eindhoven, Holland, on a wave-length of 30.2 metres.

In principle, telephonic transmission on a wave-length of about 30 metres has been applied for some years, particularly by various American broadcasting stations. But it has remained for the Philips station to prove their efficiency.

PCJJ has been heard with a wonderfully great signal strength in nearly all parts of the world.

In the letters and reports on the reception of this station sent in from the most distant places of our globe, again and again the question is asked: How is it possible to reach us with such a wonderful pureness and signal strength?

From U.S.A. many reports have been received stating that the transmission is better than that of the local broadcasting stations, others, in Japan, Hindustan, and Java, communicate that the reception surpasses that of all other foreign broadcasting stations.

In many cases the reception of short waves is subjected to fading—by which is understood the fast or slow decreasing of the signal strength. Various amateurs, however, emphatically state that there was little or no fading at all on PCJJ.

When radio waves of a short wave-length are transmitted, it often occurs that the reception is very good in distant places, whereas in countries nearer to the transmitter those transmissions cannot be heard. As may be considered well known already, this fading is explained by supposing that the ionised layer of air in the atmosphere—the Heaviside layer—casts the rays directed upwards back to the earth by refraction at a larger or smaller distance from the transmitter.

The fact, however, that the Philips shortwave transmitter is also heard in all European countries without any exception and that moreover reports

*An article, translated from the Dutch, by the engineer in charge of the Philips Short Wave Station in which the type of receiver circuit best suited for reception of PCJJ is discussed at length and constructional hints are given for building.*

are received from many places in Holland stating a strong reception, may be considered as a particularly interesting and justifies the question: "How can the Philips' shortwave transmitter be received?"

The wave-length of 30.2 metres differs very much from the smallest wave-lengths, normally in use for broadcasting generally between 200 and 600 metres. Hence an alteration of the receiving sets is necessary in order to enable the tuning for the reception on a wave-length which is about seven times as small.

First it may be mentioned that it cannot be expected from a normal receiving set for wavelengths between 200 and 2000 metres, that it can be brought up to the point of oscillation when receiving on 30 metres. In this case the losses are too high with this extraordinarily high frequency (about 10 million cycles per sec.).

However, good reception can be obtained with apparatus in which the tuning coils are arranged at the outside of the panel, and, can be interchanged, or if the diagram of connections is a diagram with a H.F. Valve and a tuned plate circuit. In this case first the H.F. Valves is to be taken from the valve socket, as the use of this valve for the reception of a wave-length of 30 metres is rather a drawback—it very much hinders the exact tuning.

By an alteration of the circuits in which the aerial coil, the coil in the tuned plate-circuit of the H.F. Valve and the reaction-coil in the plate-circuit of the detector are connected, the change resolves itself into a simple circuit for inductive reception.

The aerial condenser has no further use on the very short wavelengths, hence, if possible, it is to be connected in series with the aerial coil and otherwise to be kept out of circuit.

Further on honeycomb coils, of which 25 turns are the smallest type,

cannot be used to tune wavelengths below about 100 metres, and for the reception of the Philips shortwave transmitter the coils must be replaced by smaller ones, which can be constructed from a piece of insulated wire three windings of about 10 cm. (4 inches) diameter and putting same in the coil-holders.

When it is realised that the coils formed in this way make good contact in the coil-holders the three coils can be brought very near together and after the apparatus is set to work the exact tuning can be found with the second condenser, very near to zero of the scale and which as a rule asks for a very sharp tuning.

In relation with the fact that the dimensions and the construction of the various aeriels are very different, it is to be recommended to try a coil of two turns, or even of one turn, as an aerial coil, if the tuning experiment should give negative results.

If the receiving set does not show too great losses, in many cases the Philips transmitter can be heard well, but, of course, the maximum volume of sound of a specially constructed short-wave receiving set cannot be expected.

The construction of a small short-wave receiver for this purpose is not difficult. As a circuit that consisting of a simple reactance deflector with inductive aerial coupling is to be used, where the aerial is not tuned.

If short connections are provided for and if a tuning condenser of .00025 mfd. is used for the tuning of the grid-circuit of the detector, the point of oscillation can be reached, or at least nearly reached, when using coils as described above.

As a matter of course, a L.F. amplifier with resistance coupling or transformers can be connected to this apparatus in order to obtain loudspeaker reception.

Normal valves, e.g., A409, A425 or A141 can be used. It is not necessary to remove the caps.

Those who might be induced by the above to follow the transmissions of the Philips short-wave transmitter can assist to obtain general information re the strength of reception and the occurrence of fading at certain dates. Such information is of general interest as well for distant as for points situated nearer to the transmitter.

Perfect Reception Every Day Possible with Philco.

# It's All in the Air

## Coming Features in the Broadcasting Programs

### N.S.W. STATE CONSERVATORIUM ORCHESTRA.

**N**EGOTIATIONS have been completed for 2FC to present the N.S.W. State Conservatorium Orchestra in a programme of popular music. This will be given in the Sydney Town Hall, on Saturday evening, September 24, at 8 o'clock. The orchestra will be under the baton of the Director of the Conservatorium, Mr. Arundel Orchard, and they will present an essentially popular programme, including such items as the overture, "William Tell," "Nutsacker Suite," prelude and overture to "Lohengrin" selection from "Carmen" and others.

Alfred O'Shea, Australia's foremost tenor, will sing with the orchestra, the "Prize Song from Meistersingers" and "Questa o' quella" from "Rigoletto." He will also be heard in "Bird Songs at Eventide" by Eric Coates.

Arrangements have also been made with J. C. Williamson, Ltd., for Miss Strella Wilson, who is at present appearing with the Gilbert and Sullivan Opera Company, to appear at this concert. She will be heard in items accompanied by the orchestra, as well as a group of popular songs.

A considerable time has elapsed since the Conservatorium Orchestra was heard at the Sydney Town Hall, and the opportunity of hearing items of a popular nature, associated with the appearance of two such famous artists, will we feel sure be welcomed by everybody.

"LAUGH AND GROW FAT" has evidently been the motto of Mr. Syd. Fayne, the versatile humorist, who is getting in training with an object of compelling listeners to studio 3LO, Melbourne, to split their sides with mirth. They say that people who are ample of girth have a distinct sense of humor, and, this being the case, Mr. Fayne must surely be the Prince of Fun Makers, and, in no sense of the word, is he content to fill a small corner. His songs cover the type of humor that was so much in vogue



**RADIO REVELLERS** who, led by Laurence Halbert, give one of the brightest and most interesting programmes at 2FC. From left to right: Charles Lawrence, Laurence Halbert, Jack Win, Wally Baynes, Peggy Peat, Gladys Finister, and Nora Windle.

On our front cover we reproduce the Sparklers, a company of entertainers who appear regularly at 2FC. From left to right they are: Jerry Dunbar, Wilfred Thomas, Brunton Gibb, Maida Jones, Ernest Archer, Rus. Garling and Jerry are in the centre.

twenty years or more ago (when a joke was a joke, and everybody recognised it and laughed at it immediately) to the present-day kind of subtle humor, where the audience has to be very "quick on the up-take"—so all classes of mirth seeking listeners will be catered for. Mr. Fayne has been a successful member of the Melbourne concert world for some years past, and is all agog to get before the microphone to tell us one or two of his "specials."

**A ROUMANIAN SINGER:** The other night, while waiting for her turn at 3LO's world-broadcast programme, Saffo Arnav talked to me in her delightful broken English. Though married to one of our finest pianists, Mr. William James, the singer has not yet learnt to speak her husband's language without all sorts of pretty inflections that don't really belong to it. She told me that soon she hopes to sing at 3LO, Melbourne, in six different languages in the one night. This is somewhat of a feat. Mdme. Arnav is a Roumanian herself, and she speaks English, Russian, German, Italian, French, besides her own Slavonic tongue. Pretty, appealing, gay, she is in real life the merry widow whose songs she has made so attractive over the wireless that the opera is to be repeated yet again at the beginning of October. These opera studio productions rank among the most popular items of the 3LO, Melbourne, programmes.

**AH! THE TELEPHONE:** Stories of behind the scenes are always interesting to theatre-goers. Likewise listeners are usually anxious to know how things are done at 3LO, Melbourne. Not many of the 500,000 people who listen-in daily to that station realise the most important part played by the telephone in the service of broadcasting. Not only is it indispensable in relaying outside programmes and ceremonies, procuring sporting results and keeping in contact with the hundreds of artists always engaged in programmes, but it is used most extensively by listeners who continually ring up seeking information about a thousand and one things—many not in any way connected with broadcasting. So frequent are the calls that the telephone attendants at 3LO, Melbourne, who have been specially trained at the Central Exchange, usually have one or two rings waiting to be answered. Many of the enquiries are trivial and annoying, yet, withal, the attendants give a patient and attentive hearing and reply courteously to all enquiries, whether they be connected with a lost dog or cat, the title of a song broadcast perhaps a month previously, the correct time, or the winner of the last race at Woop Woop. Verily their task is unenviable, and they must often desperately shriek in their dreams—"Yes, we are doing the wrestling to-night."

From Icy Pole to Tropic Jungle: Burgess.

# Recent Radio Apparatus

## PRIESS DE LUXE SET.

Manufacturers Products Pty., Ltd., have demonstrated to us a Standard One Dial Control Priess De Luxe 8-Valve Set. The set itself operates direct from a loop, and has all the characteristics of ultra selectivity with tremendous volume. The main feature is, of course, the single control, which makes tuning easy and cuts out complications. The circuit of the Eight Valve Set comprises five stages of Radio Amplification, Detector and two stages of Audio Amplification. Tuned Radio Frequency has been successfully and efficiently linked with untuned Radio Frequency amplification with complete stability. The control settings are visible through a window in the panel, in wavelengths. There are two supplementary controls, both independent of

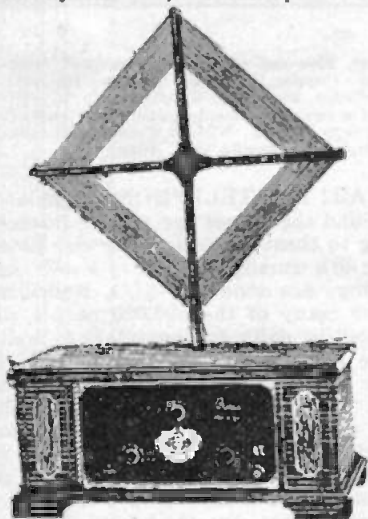

the tuning control, one for sensitivity and one for volume. A Toggle switch controls the filaments and cuts in one or two audio stages. Great precautions have been taken to eliminate or reduce energy losses to a minimum. In the loop contact system, instead of using the ordinary telephone plug and jack system of control, air insulation over the major path of the opposite polarity contact areas with hard rubber insulation is employed, thus ensuring the least possible energy losses. The switch is equipped with coin silver contact points, and the high Radio Frequency potential leads are shielded. The magnetic fields in the inter-stage coupling devices are balanced so as to be separately independent and to avoid inter-stage reactions.

The cabinet is finished in two-tone inlaid mahogany with battery compartments on each side, and a Baldwin Switch Loud Speaker or Tower Cone

Speaker is supplied with each set. An interesting departure from the customary practice is seen in the panel, which is of etched malloy metal finished in duo tone. This gives a refined appearance, and at the same time shields the set against hand and body capacity effects while tuning.

## THE HEATH CONDENSER.

Maling and Company have forwarded to us a sample of the latest type of Heath Condenser, which has markedly improved characteristics. The new Heath Condenser displaces the usual end plates with sturdy aluminium end plates, into which small solid pieces of hard rubber are forced, thus forming the insulation of the Rotor from the Stator plates. Riveting these end plates cuts out leakage and the necessity for shielding. The metal end plates prevent warping and disalignment of the condenser plates, this point being added to by the fact that the Stator and Rotor plates,

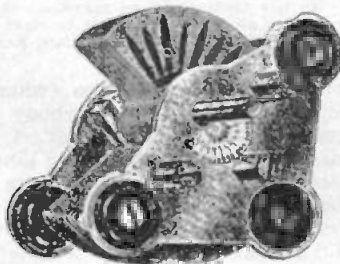

spacing supports, and end plates are made practically all in one piece—thus forming a rigid non-warping piece of metal.

The New York laboratories in conducting exhaustive tests upon the model illustrated here, found an equivalent series resistance of only 0.1 ohm. and a phase difference of less than one minute.

The Heath Condenser has a geared micrometer vernier control which gives it an easy gradual movement free from backlash. Of attractive appearance, it unquestionably represents one of the best types on the market.

## EMMCO DE LUXE DIAL.

Electricity Meter Company have now placed on the market an entirely new type of Dial, known as The Emmco de Luxe Dial, as illustrated here. The sample submitted to us proves that the manufacturers in producing this Dial have more than maintained the high quality standard so long associated with their well-known brand of radio parts. Finished in black or mahogany, or with clock-

wise or anti-clockwise movement, the De Luxe Vernier Dial is, at the same time of solid construction, being manufactured throughout of high-grade Bakelite. Adapted to a set, it proved to possess an easy yet firm vernier

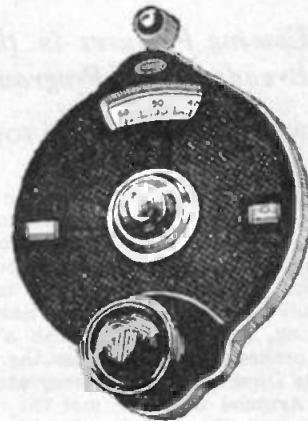

movement without jerkiness and giving a steady, firm, tuning control over the whole scale.

A feature of the Dial is that its special construction eliminates hand capacity whilst the logging windows at either side and the hair line adjustment are features which will be appreciated by all who use it. The small knob at the top is attached to an Emmco, which may be obtained with the Dial if desired.

Our sample from Manufacturers Products Pty., Ltd., sole selling agents,

## FERRANTI OUTPUT TRANSFORMER.

The use of an Output Transformer is desirable for use with all types of loud speakers, and in many cases



essential. The Ferranti 1-1 Ratio Transformer has for its main objects

"Half the Cost because Double the Life": Burgess.



## Recent Radio Apparatus

(Continued.)

the elimination of the D.C. plate current of the last valve from the windings of the loud speaker. It also completely isolates the loud speaker from the high tension voltage. This results in the following advantages:—

(1) The heavy plate current taken by large power valves cannot damage the loud speaker windings.

(2) The magnets of the loud speaker cannot be impaired by reversing the connections.

(3) The signals will not be distorted through magnetic saturation of the loud speaker pole pieces.

(4) The gap of the loud speaker can be more finely adjusted because no D.C. current passes around the windings.

(5) It removes the possibility of shock from the loud speaker terminals when using an H.T. battery eliminator, either pole of which may be at a high voltage relative to earth.

(6) It enables greater volume to be obtained without overloading by allowing almost the full H.T. voltage to be applied to the plate of the power valve, which avoids the excessive volt drop normally occurring in loud speaker windings.

The use of a Ferranti Output Transformer is preferable to a choke filter unit because (a) the majority of chokes are inefficient with a large plate current passing through them, and (b) the blocking condenser has to be large if the lower notes are to be reproduced properly. The result is that the lag caused by charging and discharging the condenser as the signal varies, spoils music, involving sharp changes, such as given by drums, plucked strings, the harp and even the piano.

### Construction.

In construction and appearance, Ferranti Output Transformers are similar to the well-known Ferranti Audio Frequency Transformers, the same care being taken in winding and testing to render them reliable and free from the possibility of breakdown.

The windings are arranged on the well-known Ferranti patent sectionalised system by which the potential between turns is reduced to a minimum, and the self capacity kept low and in suitable proportion to the other properties. The transformer is available in two ratios:—

Type OP 1-1 to 1 for use with ordinary loud speakers of the diaphragm

and cone type, and Type OP 2-25 to 1 for operating loud speakers of the coil driven cone type. Distributors, A. Beal Pritchett (Aust.), Ltd.

## The Clyde Radio "A" Power Unit.

The Clyde "A" Power Unit is the latest development in the radio battery world. It is a combination radio "A" Battery and trickle charger power unit, housed in a one-piece container with a special compartment for the charger itself. The unit incorporates either a 6-volt or a 4-volt Clyde battery with a current rectifier and transformer. Left permanently attached to the power supply, the unit will deliver strong unwavering life for many years after installation, with only the addition of a little distilled water to the cells of the battery and trickle charger every three months. This unit will prove a boon to many thousands of valve set users in areas supplied by alternating current, as the total cost very little exceeds that of the ordinary battery only. The unit ensures a fully charged battery at all times.

The outfit delivers current at .6 to .75 of an ampere, which, under normal operation of, say, a five-valve radio set, requires to be run three



hours for every hour of operation of the set, using bright valves taking ½ ampere. Furnished complete with a liberal length of cord and plug, the outfit is supplied all ready for immediate and permanent service. The charger itself is fool-proof, and can neither overcharge, short-circuit, nor undercharge the battery in any way. In emergencies it may be used while the set is in operation without interfering with the receipt and the battery will be unaffected by variations in line voltage.

A specially designed transformer of the automatic self-regulating type, made specially for Clyde, gives the proper charge rate, and prevents overloading of the rectifier. No protecting fuses are required, and the charger meets all the requirements of the Fire Underwriters' Regula-

tions. The efficiency of this Clyde "A" Power Unit has been conclusively demonstrated by a series of very exhaustive tests and comparisons with other chargers on the market.

It was found that there was an absolute minimum of hum or ripple in the Clyde Unit, due to stoutness of construction of the transformer, efficiency of operation of the rectifier, combined with the ruggedness and constant voltage of the Standard Clyde Battery used. Our sample from The Clyde Engineering Co., Ltd., Battery Service Dept., 106 Goulburn Street, Sydney.

## RADIO DRY BATTERIES DROP 25,000 FEET FROM ARMY BALLOON AND ARE STILL IN USE.

Just how durable is a radio dry battery? Captain Hawthorne C. Gray, of the U.S. Army Air Corps, satisfied himself on this point recently when he broke all previous world altitude records for free balloon flights in reaching a height of 42,470 feet at Scott Field Air Depot, Belleville, Ill.

At a height of approximately 25,000 feet the radio "B" batteries and dry cells, with which his balloon was equipped, were hurled overboard in a specially made parachute; were recovered uninjured and returned by parcel post to Captain Gray without packing, in the condition shown in these photographs.

Captain Gray, in a letter to National Carbon Company, makers of the Columbia Batteries, so ignominiously treated, writes:

"The same set of batteries was used in my altitude flight of March 9th and is still in condition to be used again. The 'B' Batteries (originally 22½ volts) tested 21 volts each, and 'A' batteries tested 23 amps."

THE ANNUAL MEETING OF THE LISTENERS' LEAGUE OF N.S.W. will be held in the Real Estate Hall, Martin Place, on Tuesday, September 20, at 8 p.m.

The president, Mr. A. N. Brain, states that during the year excellent work has been done by the League, and as a result of the energies of the Committee the case of the listener was placed in no unmistakable manner before the Wireless Commission. However, in spite of all efforts to stimulate the interest of listeners in matters that vitally concern them, in spite of instructive lectures, the majority of listeners remain apathetic, he states.

Why Blame Static? Buy a Philcol

# 4QG's One Act Plays

*4QG's Experiments in the Radio Drama Field.  
How a Young Brisbane Writer is Developing  
the Art.*



Miss Thelma  
Champion.

4 QG has taken some interesting steps to provide for the broadcasting of a series of one act plays during the coming few weeks.

Plays of various descriptions have made a strong appeal to public imagination for countless years, but the growth of the broadcasting movement and the consequent adaptation of plays for radio purposes has necessitated some rather sweeping changes being made by authors.

The producer of a play in the theatre has both the ears and eyes of his audience to which to make an appeal. In consequence he pays attention to the spoken word and also to scenic effects.

The writer of a play for broadcasting purposes has to realise from the outset the fact that only the spoken word or a mechanical sound effect can appeal. The scenic effect is quite absent, and the writer cannot, therefore, take scenery into any consideration at all.

Not realising these facts to be of paramount importance, many writers of plays for radio purposes have failed to hold the interest of their large audiences.

Another important fact must be borne in mind by the writer of a radio play. The vast unseen audience does not "arrive" at the same time. Quite a number may switch in their sets at the starting time, but many others may not perhaps tune in until half-way through the evening. In view of this fact, the successful radio play must, therefore, not be written with a plot which necessitates the strict attention of the listener from the very first moment it is announced until it is finished, but rather must each scene in it be self contained.

There exists to-day quite a number of plays suitable for broadcast-

ing, but in giving consideration to radio plays, 4QG has decided not to use any which have been broadcast in other countries or in other parts of Australia, or have been produced in book form. It has been decided to have written in Queensland a series of exclusive one act plays, which will be broadcast during the next two or three months.

Miss Thelma Champion, a young Brisbane writer, who is remembered by many listeners in connection with the one act play, "The Love Charm," which she successfully produced some time ago, and who more recently produced "Off Duty," a Digger play, is now hard at work preparing several other plays, which will be produced from 4QG.

The first of these new plays will be "Homeward Bound," a sequel to "Off Duty," and will depict the adventures of four Diggers during their trip back to Australia on a transport.

Later, "Husbands, Know Your Wives" and "Samuel Goes Swimming," two comedies, will be produced by Miss Champion at 4QG.

In all of these plays there is an abundance of music, which adds color to the spoken word, and some very clever effects are being arranged.

The writing of radio plays is quite a new avenue in journalism, and 4QG has determined to give first preference to local authors.

## Next Month's Features at 3LO.

**A**MONG interesting items listed for the early part of October, a Sunday night recital by Madame Ella Kingston is arranged for the 9th. Madame Kingston is a singer, besides being the conductor of the Baptist Church Choir. Concerted Church music has proved one of the most popular features of Sunday programmes, and this church takes deservedly high rank among trained choirs. Every voice is that of a skilled singer.

Speaking of choral singing reminds me that even where such is not skilled, but merely hearty, the heartiness seems to come over the air and please listeners. Few things are more enjoyed, to judge from letters of the unseen audience, than community singing.

A few weeks ago 3LO Melbourne broadcast community singing from Ballarat, and the item proved so much to the taste of the public that a repetition has been demanded, and Ballarat, which has become known as Australia's Art Capital, will again have the honor of having its community choir broadcast. This will take place on the 14th October.

It is in diversity of interest that the best aerial programme reveals itself. Something must be devised

to suit every conceivable taste, if perfection is ever to be approached. Mr. W. H. Butcher, the expert stamp-collector, has been giving talks on his fascinating subject about once a week. Boys are supposed to be the most interested listeners to these talks, but letters show that a great number of men follow them too. Stamps are still collected, apparently. Whatever stimulates interest in such a hobby is doing good work, and Mr. Butcher's talks are to be continued, while the interest in them lasts.

In the same category, as creating interest and stimulating competition is the Children's Voice Trials, which have for the last two years been held in October.

It is undecided yet whether 3LO Melbourne means to continue this competition this year. It is to be hoped that they will, because many people get a decided "kick" out of hearing the childish trebles raised in more or less tuneless quavering. There is this much of good about it, that it has resulted in the past in the discovery of one or two excellent little voices, the owners of which have been strictly enjoined not to misuse them by public singing or the other stupidities of which the parents of clever children are sometimes guilty.

Let Your Battery Save our Purse: Philco.



The Huzham Serenaders broadcasting at 3LO Melbourne.

These artists have made a remarkable hit with Melbourne listeners.

## 3LO Has Popularised Wrestling

THE stalwart band of world champion wrestlers which 3LO has managed to coax before the microphone, has been added to recently in the personage of Billy Edwards, "the cave man," and Kilonis, whose philosophy is "the rougher the better."

Outstanding contrasts mark the characters of these talking wrestlers. Mike Yokel, who is the proud father of 11 hefty Yokels, and whose home ranch is away up in the snows of the Rockies, tells stories to children in a very nice quiet style, which does not seem to fit in altogether with his picturesque ruggedness.

Sam Clapham preaches health and hygiene in a way that unmistakably betrays his medico student days.

Head-lock Karasick, who is known at 3LO Melbourne as "Classical Karasick," talks on a wide range of literary subjects, but chiefly upon the Russian Classics

The Modern Apollo, Clarence Weber, will give some cultured talks on physical fitness, but is is problematical what the impulsive Mr. Kilonis and "the cave man," Billy Edwards, will talk about. It would not be surprising, even in these days of wrestling surprises, if one of them should choose Tennyson's poems.

Ted Thye and Billy Meeske seem to be too busy training to face the

"mike," but no doubt Walter Miller, who was mainly responsible for the introduction of big wrestling in Australia, will have something interesting to say about his experiences.

These talks by wrestlers at 3LO Melbourne are indeed fascinating listeners, who are kept in a state of tip-toe expectancy all the time as to what subjects the rugged stalwarts will select.

### New Comedy Opera

A LITTLE wireless bird has whispered to me that Alf Andrew has in preparation for early production at 3LO the delightful romantic comedy opera, "Ma Mie Rosette." Listeners have had a feast of heavy and light operas lately from 3LO, with "Faust," "Trovatore," "Fidelio," "The Merry Widow," "Floradora," and now comes "Ma Mie Rosette." The average listener is not aware of the great expense and endless care involved in these productions. Apart from the principals performing, there are bands, orchestras and choruses to be trained and mustered before the microphone—or microphones, for 3LO Melbourne uses several of them in these big feature transmissions.

IT is now generally acknowledged that Norman McCance, by broadcasting descriptions of wrestling matches through 3LO Melbourne, has done more perhaps than anyone else to popularise that branch of athletics and place it on the map in Australasia. It is estimated that over half a million people in every part of the Commonwealth and New Zealand listen-in to 3LO Melbourne to Mr. McCance's descriptions. Many thousands of people who previously knew nothing of "headlocks," "body presses" and "toeholds," now follow Norman with breathless attention, and atmosphere is added, of course, by the microphone picking up the demonstrations of enthusiasm of those witnessing the match, whose barracking is heard as a background to Mr. McCance's description. This naturally lends color and makes them all the more exciting to listeners.

Mr. McCance, however, does not manage to keep every listener keyed up to a pitch of tiptoe excitement all the time. 3LO Melbourne has actually discovered one lady who evidently found the description of a recent match rather slow, but perhaps this was more the fault of the unspectacular wrestling. This lady rang up after the match was over, and wanted to know who won, as she said she had "fallen asleep whilst listening to the description."

Square Glass Cells with each Philco.

# The History of Radio for the Beginner

IN theory radio is old, in practice, it is still very young. Over eighty years ago Joseph Henry demonstrated at Princeton that under certain conditions electrical effects are oscillatory, or vibratory, and that these oscillatory effects can be transmitted over considerable distances. Others studied these effects. Numerous experiments were conducted. Decades later, Professor Heinrich Hertz, of Germany, demonstrated in a striking manner how the discharge of an electrical condenser sets up invisible waves, and how these waves can be detected several feet distant. That was in 1887. Several years later, Professor Righi, of Italy, undertook the study of Hertzian waves.

In Righi's laboratory there chanced to be a young student named Marconi, who became intensely interested in the work. He saw a possibility of applying these invisible or Hertzian waves to telegraphy without wires. Soon Marconi was conducting extensive experiments on his father's estate. From a few feet he soon advanced his wireless jumps to miles, using an upright wire and ground connection at the transmitting and receiving ends. From a laboratory experiment, Marconi's efforts passed over to the commercial stage mainly in England. Year by year Marconi spanned greater distances, while numerous steamships were equipped with wireless apparatus to work in conjunction with land stations. By 1907 Marconi succeeded in spanning the vast Atlantic, transmitting signals from England to Newfoundland and laying the foundation for world-wide wireless.

By this time many scientists and technicians had been attracted to the virgin field of wireless communication.

Originally the invention of Marconi, wireless communication now began to represent the combined efforts of many pioneers. Thus an Englishman, Sir Oliver Lodge, Dr. M. I. Pupin, an American, and several others contributed the principle of tuning without which wireless communication would be impracticable. Another Englishman, Professor Fleming, contributed the basic vacuum tube which was later developed by the American, De Forest, and ingeniously applied by the young American student Armstrong. Vacuum tube improvements owe their conception to many American technicians led by Dr. Irving Langmuir, of the General Electric Research Laboratory.

## From a Talk delivered from 5CL

of transmission. In due course, the Westinghouse tests included the Alexanderson, another American, developed a remarkable generator known as the Alexanderson alternator, which made possible reliable and economical radio communication over great distances. A variation of wireless telegraphy first tried out two decades ago by the Danish Poulsen made it possible to transmit the spoken word instead of the dots and dashes of the telegraph code. Up to the world war, however, wireless telephony was crude and impracticable, but the remarkable technical advances made during the trying days of conflict soon placed wireless telephony on a practical basis. Indeed, the Atlantic was experimentally spanned by wireless telephony in 1915 by American telephone engineers, and by the end of the war wireless telephony was available for reliable communication over considerable distances and even on aircraft.

In 1920 the Westinghouse engineers conducted a series of experiments with wireless telephony from a laboratory in East Pittsburgh. Wireless amateurs then possessing receivers for the purpose of listening

to dot-dash messages were asked to listen in on the wireless telephone experiments and report on the quality transmission of phonograph records and the novelty of talks and music coming over the air soon caused many laymen to buy and instal inexpensive radio receivers. And having created a large audience for its experimental transmission, the Westinghouse organisation soon felt duty bound to place its experiments on a schedule basis. Singers and speakers were now introduced in place of phonograph music. And radio broadcasting came into existence with a rapidity of growth that stands without parallel. From a single experimental station, radio broadcasting grew to hundreds of stations dotting the entire country and from the crude phonographic concerts of the early days, radio broadcasting has grown into a national auditorium wherein the talents of the world's greatest artists are presented to an audience running into the tens of millions. In England very similar happenings took place and a single experimental station, under the control of the army, which sent out programmes about three times a week, gradually grew into the vast organisation called the B.B.C., or British Broadcasting Company, which has lately been placed under Government control, and has become an important public service. Practically every large centre has its station, and there, in addition to broadcasting, radio is used as a means of communication between far distant parts by means of the morse code, and an outstanding example of this is seen in our beam wireless system between Australia and the Old Country.

This service will enable messages to be sent without the aid of cable under the ocean and should prove a valuable means of communication in time of war.

In Australia, broadcasting is not very old, and as yet is not so popular as in other countries, but the time will soon arrive when it will be as common to see a wireless aerial on a house as the telephone wires. At a not so far distant date television will pass from its experimental stages, and seeing as well as hearing by wireless will become an accomplished fact. All the wonderful advances in radio have taken place in a comparatively short period of approximately 30 years, and it is a brave man who will attempt to tell us what another 30 years will bring forth.

### Queensland Readers Note.

Copies of the issues of "Wireless Weekly" prevented from circulating in Queensland during the recent Railway Strike are now available.

They are —

SEPTEMBER 9th—Containing Short Wave Adapter.

SEPTEMBER 16th—Containing Harkness Reflex Receiver. How to tune in PCJJ.

SEPTEMBER 23rd—Containing Universal Four Valve Receiver. Adding a stage of Radio to the Reinartz.

Hurley used Burgess in New Guinea.



# The Safety Valve

Readers are urged to express their opinion on matters pertaining to broadcasting. If you have some grievance, if you have some constructive criticism to offer, here is your chance for expression—your safety valve. The editor assumes no responsibility for statements made by readers and published on this page, as opinions of correspondents do not represent our editorial policies or beliefs. Anonymous letters are not considered.

Dear Sir,—I have been a licensed radio dealer for nearly two years, and I would like to point out a few facts to safety valve grumblers, which the majority of wireless fans probably do not know and which, to my mind, have a lot to do with the slow "taking on" of wireless in the country.

It costs me £5 per annum for my dealer's license, and this is quite in order, but, if we wish to have a little music in our own home, I must pay another £1/7/6; then, if I wish to take my set out into the country and demonstrate to a few "likelysts" at a concert or house party, I must pay a special fee of £1; or, if there is a smoko in town and I am invited to bring my set along, another fee of £1. A radio dance night, even in aid of charity, costs yet another £1.

Now, Mr. Editor, I am sure you will agree with me that if many of these unreasonable charges were rescinded, wireless could be more freely demonstrated, and, as a natural consequence, the sale of sets would increase which, in turn, means more revenue for the broadcasting companies. Under present conditions, radio demonstration would cost me considerably over £5 a year, unless I cared to take a risk and do it "on the quiet," chancing a fine. Few men like underhand work such as this.

Other dealers' views on this subject would be much appreciated.

In conclusion, may I again stress the fact that this letter is not penned in a spirit of grumbling, but purely with a desire to better wireless conditions generally.

Yours faithfully,  
Coolamon. "DEALER."

## ON 'PHONE, TOO.

Dear Sir,—With reference to Mr. Burden's letter ("W.W.," 30/9/27), it would possibly be of much use to a lot of people thus afflicted if they knew that (in nearly every case of a person being deaf or partially so) the use of headphones would probably bring to them the joys of wireless. I have noticed this repeatedly in my own job (telephone mechanic), that a person who is deaf to all ordinary conversation can hear well on a 'phone fitted with two receivers.

Yours, etc.,  
"ONE LUNGER."

## Sunday Programmes

THAT the Sunday programmes are preferred as they are at present broadcast by an overwhelming majority of listeners-in was proved by the voting in the 287 coupons received (560 from listeners-in to whom the ordinary services are not available).

There were 54 votes only in favour of eliminating all religious matter from the broadcasting programmes, as against 541 in favour of the programmes as at present, and 302 in favour of increasing the number of religious items.

105, however, were for decreasing, though not eliminating, religious matter.

The votes were as follows:—

- (1) Are you in favour of eliminating all religious matter from the broadcasting programmes? 54
- (2) Are you in favour of the Sunday broadcasting programmes as given at present? 541
- (3) Are you in favour of increasing the number of religious items in the Sunday broadcasting programmes? 302
- (4) Are you in favour of decreasing the number of religious items in the Sunday broadcasting programmes? 105
- (5) Are you in favour of any of the following changes in the present Sunday broadcasting programmes?

- (a) Religious addresses instead of church services. 21
- (b) More sacred music ..... 135

IMPORTANT: Indicate by means of a cross, if regular weekly religious services which you might attend are through any reason such as distance, home duties, etc., not available to you. 550

This closes the controversy.

## MORE LECTURES.

Dear Sir,—The criticisms of the wireless stations and their programmes are interesting. With regard to the former, I would like to say that the remarks regarding transmission are often unjust, as I find two different sets give a great variation between 2FC and 2BL using the same aerial.

I have also noted that barometric pressure and the direction of the isobars have a decided influence on transmission—especially from 4QG.

Few have time to write and say so, but I am sure that many country people would appreciate more lectures on such subjects as would make wireless sets more of an asset to those who have to wrest a living from the soil. For these, we have to turn to 3LO or 4QG and they are too infrequent.

Before closing, allow me to express appreciation (most heartily endorsed by friends who also listen in) of the good music—classical, and especially sacred—that a wireless set brings to us of the outback places.

Yours, etc.,  
DUDLEY JONES.  
Nymboida, North Coast.

## USSR.

Dear Sir,—I picked up a foreign station on 60 metres on Sunday, 25th; Monday, 26th; Tuesday, 27th, from 8 p.m. to 10 p.m. (Sunday) 8 p.m. to 9.15 p.m. (Monday and Tuesday).

He came in at very good loud speaker strength on two valves. His clarity of transmission left nothing to be desired. The music on Sunday and Tuesday was worth listening to. His announcements were all in foreign, the only thing I got was USSR.

The Russian Station RFN also used the letters USSR when I got him a few months back, but he spoke in English also.

Could any listeners enlighten me on this subject?

Yours, etc.,  
H. KELSICK,  
Aberdare Colliery, Cessnock.

Canada chose Burgess for her outposts.



*Joe Aronson's famous symphonists at 3LO busy working out effects for new dance numbers.*

## Running Description of Cup by 3LO and 2FC

### RACING IN THE AIR.

THE Cup—a signal for enjoyment for so many thousands (including bookmakers)—is a season of woe and lamentation to broadcasting companies. There is so much to see to, so many chances of slipping, so many extra thousands listening in and judging the pleasures of a wireless set on the way the descriptions of the classic races come over the air, that a station sees the end of a Spring Meeting with relief. This year, 2FC is going to re-broadcast 3LO's description of the Melbourne Cup, with some more of the most important races. This re-broadcasting by an inter-State station is an excellent thing. Some few weeks ago, I urged greater co-operation in this respect. It is pleasant to see that it is being done, and in a reciprocal way. Three nights recently 2FC picked up the band of the 3LO studio, and Sydney people danced to music over 500 air miles distant.

Co-operation along these lines will save a good deal of money, for many ways of utilising items in common will suggest themselves as time goes on. Broadcasting need not be made a cut-throat business.

### RADIO PLAYS.

NOW that the competition for radio plays has been decided, there should be at least a score of clever, interesting plays available for transmission in the near future.

The competition was widely taken up and among the three prize-winners, and those whose plays were very highly commended were a New South Wales woman, Tasmanian and West Australians, proving how widely spread was the interest in the contest.

The prizes have been awarded to the following:—

First: Mrs. May Murphy, David-street, Northcote (Victoria).

Second: Miss Helen Armstrong, Clear Hills, Dunning (N.S.W.).

Third: Mr. Jack Curlett, Railway Avenue, East Caulfield (Victoria).

Over a dozen received warm commendation from the judges, a proof that the winning trio should be worth listening to. It will be interesting to hear how far the winners have developed a new technique, or if they have followed the old stage conventions.

### ARMISTICE DAY FIXTURES.

WE are approaching one of the most solemn ceremonials of the year. No day is quite like Armistice Day, not even Anzac Day itself, for the greater includes the less, and the Armistice Day exercises are Empire-wide in their significance. Broadcasting has come to widen the scope of the ceremonies, so that hundreds of thousands may take part in them by listening to the metropolitan ceremonies. This year, in addition to the usual services on Parliament House steps, Melbourne, is to have two ceremonials of great importance. One of these is the laying of the foundation stone of the great projected War Memorial in the Domain. This great building destined to become our most significant temple has been long in materialising. The stone to be laid on Armistice Day will signalise its commencement.

The other service is that to mark the laying of the Foundation Stone of the War Memorial of the Melbourne Grammar School. This will be done in the afternoon, after the bigger event.

There are no rivals to the Philco.



2FC Artists who sang the National Anthem for the benefit of London listeners on October 11 on the occasion of the Second Empire broadcast.. Mr. Ewart Chapple at the piano.

## King May Shortly Address Australians

THE British Broadcasting Corporation, which controls all broadcasting in Great Britain, has informed the Radio Broadcast Bureau, Sydney, that it is of opinion that the time is close when it will be able to invite the King to address his 450 million subjects throughout the world by word of mouth.

This communication was made in view of the recent progress in broadcasting from one part of the Empire to another. Within the past few days 2FC radiated a programme on two wave lengths simultaneously—28.5 metres for oversea reception and 442 metres for reception in Australia and New Zealand. This was heard in England and part of the programme was re-broadcast by the British Broadcasting Corporation so that listeners throughout the United Kingdom could hear.

It would be useless to suggest that the reception was entirely satisfactory. Listeners in England were certainly thrilled to hear the great broadcasting station in Australia, but there was considerable distortion, showing the need for further experience before world-wide radio is completely reliable.

### Empire Broadcasting Chain Nears Completion

The British Broadcasting Corporation informs the Radio Broadcast Bureau that at the present rate of progress the inauguration of an Empire broadcasting service from Britain will depend upon the results of a new series of experiments which are being carried out this month.

**EMPIRE BROADCAST:** It is one of the remarkable facts in life that "it's the little things that count." When mighty Germany attempted to brush modest Belgium from her path, that gallant little country proved she was a power to be reckoned with, despite her meagre population. When 2FC sent the Australian radio call throughout the length and breadth of England, in co-operation with the all powerful British Broadcasting Company, history was made, and even the most blase listener thrilled at the wonder of it all. But the giant London broadcasting machine casually accepted this feat, and went its way, ". . . You have just heard the Savoy Orchestra play . . ."

But 2FC, tiny unit in the radio world, proved that it too was a power

to be reckoned with. A second programme was arranged for overseas broadcast, on dual wavelength for the benefit of local listeners, and London's teeming listening millions once more stood tip toe on expectation. It is a curious contradiction that after twenty-three minutes, BBC discontinued the relay, "owing to atmospheric." Yet amateurs from near and far poured indignant letters of protest into the papers, together with indubitable proof that Australia's programme had been heard, by a concise logging, not only of musical items, but of announcements and messages.

The pen of one cartoonist offered a caustic solution. BBC's engineer, with one hand on the control, and the other desperately straining a telephone receiver to his ear. "Yes, darling, I'll come along right away . . . important programme? No, it's only Australia!"

The Press, wholehearted in its condemnation, aroused the Corporation to unusual activity, with the result Station 2FC received a cable asking for a special programme for relay, on Monday morning, 31st October, between 3.45 and 5.30. Of a surety, "great oaks from little acorns grow."

Burgess Went Over the Pole with Byrd.

# The Third Empire Broadcast

*How the Third Empire Broadcast was received in London, Extracts from the letters of British listeners who tuned in 2FC. The return programme from 2LO London, was relayed by 2FC during Christmas*

**T**HOUGH the third Empire Broadcast took place over a month ago, letters of appreciation from England have only just arrived owing to the fact that it takes over a month for mail to reach us from the British Isles.

In response to the request made by 2FC, over 1000 letters were received, and it is interesting to note that in most cases each writer refers to a sudden bad period of reception and fading which should not have occurred at the hour in question, according to the general supposition that reception improves with night, but fades with approaching daylight.

In a nutshell, those who give a detailed notification of the reception, state that the reception was almost perfect at the commencement, which took place whilst it was still daylight in England—viz., 7 o'clock. It was 5 a.m. in Australia, and was still dark. As dawn was breaking in Australia, reception began to fade—thought it was becoming dark in England, and upon daylight breaking out in Australia, and a corresponding night in England, reception improved to such an extent, that it even improved on that received at the first part of the programme.

It is interesting to note that most correspondents agree that these fadings occurred exactly at the same times both on the high and the low waves. Atmospheric were not very troubling, though now and again they marred some musical item. High pitched voices and instruments came through better than those of lower key, which seemed to be slightly distorted.

All were evidently highly delighted with the programme, and many young Englishwomen have fallen in love with Mr. Cochrane's cheery voice, which they say is most musical, easy, and charming.

The kookooburra which 2FC broadcast through the concert, was remarked on in nearly every letter, though in various ways. Quite a number of listeners missed the name of our national bird, and their reports are most amusing.

One lady says:—"I heard some sea gulls making a funny noise during the broadcast. I suppose they were picked up as the waves crossed the ocean."

Another:—"Reception was perfect, even to the clucking of the hens." Several others worthy of note read as follows:—"There was a slight hissing sound, like some wounded animal." "And was it a cockatoo we heard singing—" "It seemed as if you had a kangaroo or something else giving the station's call as we have from Germany—bells, clock, buzzer, and siren, etc."

"I heard a peculiar noise. What was it? It sounded like an Australian wild cat." "We heard a most extraordinary noise during the transmission, it seemed to be like a lot of birds jabbering—or was it the artists talking in the studio?" "The chickens were very noisy, but sounded nice—I suppose they'll be eaten at Christmas." "All items came through very clearly, especially that bird (I don't know how you spell it)."

The word "kookooburra" was spelt in many different ways, among them being cookcookbourough, kookooburgh, kookooburri, and many others.

One gentleman who writes from London claims as a brother Mr. John Howard Payne, the well-known author of "Home, Sweet Home"—that piece of music that stirs the mystic instinct of the wanderer.

When 2FC announced "Dawn is just breaking on a typical warm Summer's morning," many listeners wished they were here, for as they wrote, precisely at that moment, rain and sleet were pouring down, and the wind was bitterly cold. One lady so taken up with the programme, forgot that it was warm in Australia at the time, said "And I hope you didn't forget to give the dear artists a nice hot drink as soon as they had finished."

## THE GOVERNOR'S NEW YEAR GREETINGS.

Immediately after the G.P.O. clock chimes the hours of midnight on New Year's Eve, his Excellency, from his private residence at Sutton Forest, will broadcast a New Year's message to the people of New South Wales. His Excellency will be the first person to speak from 2BL during the New Year.

The artists had to be in the 2FC Studio by five a.m., and that there effort was appreciated is shown in many letters.

A writer from Chelsea says: "I am sure I could not laugh like some of you fellows at five o'clock in the morning. Seven-thirty is my time, and then I don't laugh—I growl."

Many photographs were enclosed, some depicting beautiful countryside cottages, happy smiling families, and so on.

A misunderstanding must have been caused somehow regarding the words "2FC." Quite a number of the enthusiastic writers addressed their letters to 2SC, 2XC, 2SE, and other various unknown stations whose call signs are phonetic with that of 2FC.

The London "Daily Sketch" in an article states: "Coo-ee! came a man's high pitched voice last night, calling across the world from Sydney, Australia, to the British Isles. Sydney (2FC) was calling 2LO at 4 a.m. this morning (Aust. time), the early dawn of a late Spring morning in Australia, and Sunday tea time in Britain. This third Empire Broadcast was the most successful yet. It lasted for nearly two hours."

The Australian programme opened with the National Anthem, and consisted of pianoforte solos, cello solos, and popular airs from Gilbert and Sullivan and "Rose Marie." A correspondent writing from Wales, says the National Anthem seemed more inspiring to him than it has ever appeared before, and the whole company under his roof, joined heartily in the Anthem with the 2FC artists so far away.

To all those who have written to 2FC from abroad, cards will be sent. As there are well over 1000 letters to be attended to, 2FC are now working their very hardest in order that even the little children (whose scrawly remarks on the programme were welcomed) shall not be disappointed.

Australians are now looking forward eagerly to the return programme from 2LO, London, which is being relayed by 2FC during Christmas. On Boxing morning, which will be Christmas Day evening in England, a further Empire Broadcast is to be arranged by 2FC, which will again be picked up by 5SW, and rebroadcast throughout the British Isles.

From Icy Pole to Tropic Jungle: Burgess.



# Telling the World About Australia.

ONE of the most interesting developments associated with broadcasting in Australia during recent months has been the recognition of the part played by the broadcasting companies in making Australia known to the world. Prior to the advent of our big stations, Australia and Australians were little more than names to tens of thousands of people in every corner of the outside world. They saw our coastline on the map; they knew, possibly, that we grew wool and that we had some gold mines; but of our national life and our national resources they knew little. But to-day they feel they know us. They have listened to our musical programmes, they have followed the descriptions of national events such as the opening of Canberra, and they have learned, too, something of our national hopes and aspirations.

The efficiency of stations such as 3LO, Melbourne, has made such a result possible, and the benefit to Australia as a whole should be unbounded. New evidence of the growing interest in our country is contained in almost every overseas mail received by 3LO, Melbourne. From Alaska, from the Continent, from America, from Canada, from England, from China, and from almost every other corner of the world, come letters of appreciation of the programmes received. In such letters, too, it is not infrequently mentioned that 3LO, Melbourne, has interested the writer in Australia, and in Australians.

In an outpost on the edge of the civilisation, for instance, on the furthest border of Alaska, one lonely listener frequently tunes in to 3LO, Melbourne, and his letters to the station are illustrative of the great majority of messages:—"I have never seen Australia," he once wrote, "but I think I know something about you. 3LO, Melbourne, has shown me that you must have a great country, and some day, when the opportunity offers, I am coming 'down under' to see for myself. I feel that I will not be disappointed."

Broadcasting, under such circumstances, carries with it a large measure of national responsibility, and for that reason alone, no effort should be spared to maintain the high level of efficiency reached by 3LO, 2FC, and the other big stations.

## WORLD-WIDE TESTS.

The world-wide short wave tests now being conducted every Monday morning by 3LO, Melbourne, have brought in a new range of appreciative listeners, and the tests also have served to further emphasise the national aspect of the whole realm of broadcasting in Australia. Dutchmen in Holland and in Java, tea planters in Ceylon and India, Japanese radio operators and experimenters, Englishmen and Australians in the Strait Settlements and in Malaya, missionaries in the Pacific outposts, listeners in almost every State in America and Canada, all have joined with Englishmen in England, and radio men in almost every other corner of the world, in wishing 3LO well, and in showing a new-born interest in Australia.

Slowly, but surely, Australia and Australians are being made known to the world. This is an age of publicity and national advertisement, and if we have been lacking in that direction in the past, the broadcasting companies now are filling the much-felt need.

**UNCLE NORMAN:** Listeners are more familiar perhaps with Norman McCance's Stadium descriptions than with any of his other varied efforts before the microphone. Perhaps it is because he made his name with the former. However, his broadcasting versatility is remarkable, and it is surprising even to those who know him best with what speed his mind works as he visualises passing events.

Recently at the Laverton Air Force Depot he assayed the task of describing the arrival of Father Xmas by aeroplane, and his effort is regarded as one of the very best broadcast descriptions ever given.

He quoted certain scriptural facts for the purpose of lending color to his description, and even the Padre at the Air Force Depot acknowledged that he did not know that one very important event happened at Nazareth, whilst Wing Commander McBain stood in astonishment at Norman's flights of imagination.

Realising that he was speaking mostly to children, Mr. McCance said that it was the first time he had



Arthur Stigant, the popular comedian of the Student Prince Company in Melbourne, who is broadcasting from 3LO.

spoken to them, and no doubt he would be known as "Uncle Norman"—a title which somehow seems to suit him very nicely. Let us hope that the children will hear more of "Uncle Norman" in the near future from 3LO, Melbourne.

## DELIGHTFUL ENTERTAINER:

Rita Hilton, the well-known soprano entertainer, who, with delightfully witty songs at the piano, has sung herself into the favour of all listeners to 3LO, Melbourne. A hospital concert held during the war, and a dearth of artists was the main "urge" for Miss Hilton adopting the role of comedienne, but so successful was her first attempt in this direction, that she has carried on with the good work ever since. At this particular concert, all the humorists had failed to turn up, and though the Diggers were "perfect dears" and behaved like little gentlemen as ballad after ballad was sung—one felt a restiveness in the air, as though a bomb would explode at any minute. It was at this time that it was thought a good comedy song had better be introduced—Miss Hilton was prevailed upon to sing a "rag," and in the language of "the" profession, simply "brought down the house." It is interesting to note that Miss Hilton's repertoire included some excellent numbers by the Australian composer, Sonia Hardy.

Buy a Burgess and Cut Battery Cost.

# Receive Interstate Stations

ON A LOOP AERIAL with the

## 8-VALVE SUPERHETERODYNE SET

Featured in this Issue of Wireless Weekly.

£21/5/4

—HERE ARE THE PARTS—

£21/5/4

	£	s.	d.
1 Genuine Radion Panel, highly polished and cut true, 20 x 7 x 3-16 in.	0	14	6
1 Bakelite Sub-panel, cut true, 19 x 9 x 3-16 in.	0	14	3
1 Genuine Radion Terminal Panel, 19 x 1½ x 3-16 in.	0	2	6
2 Philmore Wire Wound 30 ohm. Rheostats	0	1	10
1 Philmore Wire Wound 400 ohm. Potentiometer	0	2	6
1 B.M.S. Double Circuit Jack, with fantail lugs	0	2	2
1 B.M.S. Single Circuit Filament Control Jack, with fantail lugs	0	2	6
1 B.M.S. Push-Pull Battery Switch	0	1	6
1 Pilot Midget Condenser, .000045 M.F.	0	5	9
3 Dubilier Mansbridge 1 M.F.D. Bypass Condensers, at 6/-	0	18	0
1 Pair Volton Nickel-plated Sub-panel Brackets	0	3	6
8 Valve Sockets, with black base standard, American, at 1/9	0	14	0
2 Sangamo (highest grade) .00025 Grid Condensers and Clips, at 3/6	0	7	0
2 Philmore 2 Megohm Gridleaks, at 1/-	0	2	0
2 Rauland Lyric Audio Transformers, at 45/-	4	10	0
10 Engraved Binding Post Terminals, at 4d.	0	3	4
2 Emmco Bakelite Slow-motion Vernier Dials, at 7/6	0	15	0
1 Sangamo (highest grade) Fixed Mica Condenser, .001	0	2	9
1 "All American" Superheterodyne Kit, comprising 3 I.F. Transformers, 1 10,000 metre T.R.F. Transformer, and 1 R.F. Coupler	9	5	0
1 Grodan (Tapped) Loop Aerial	1	12	6
1 25ft. Carton Celatsite Insulated Flex Wiring	0	4	9

### FURTHER WONDERFUL VALUES

- Metal Shell 201A Sockets .. 1/6
- Lightning Arrestors ..... 1/4
- Puramax Giant Loudspeakers.  
Price ..... £2/14/-
- Trumusic Jr. Speakers .. 19/9
- F.M.C. Transformers, with pig-tail connection ..... 7/6
- Aircraft T.R.F. Kits, including 3 L.L. Condensers ..... 38/-
- De Jur Buffalo 30 ohm. Rheos.  
Price ..... 2/11
- Vernier Adjusters ..... 9d.
- Loudspeaker Units ..... 13/6
- Precision Vernier Dials .. 4/6
- Panel Mounting Switches,  
Double Pole, D.T. .... 10d.
- R.C.A. Audio Transformers, 11/6
- Advance .00025 S.L.F. Condensers ..... 9/6
- Titan Bulb Type Battery  
Chargers ..... £5/10/-

### COUNTRY CUSTOMERS!

Please note that all our goods carry a MONEY BACK Guarantee. If you are not satisfied return goods in good order within 7 days and we will Refund in full.

WE PAY CARRIAGE on orders of 10s. and over, except on Cabinets, Batteries, Loud Speakers and C. O. D. Parcels.

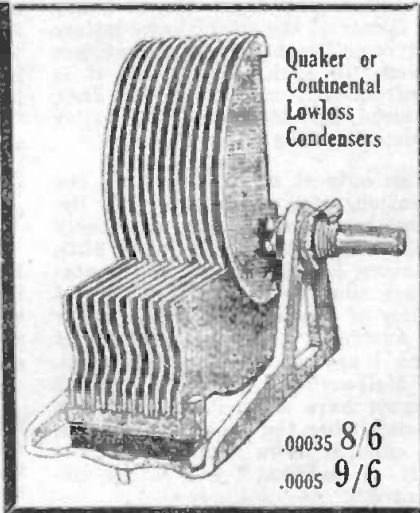

Quaker or Continental Lowloss Condensers

.00035 8/6  
.0005 9/6

"YOURS FOR LOWER PRICES,"

## THE ECONOMIC RADIO STORES

PARRAMATTA:  
Cor. Macquarie and Church Sts.  
Phone: UW 9601.

25 NEW ROYAL ARCADE,  
near Palace Theatre, Sydney.  
Phone: M 3049.

NEWCASTLE:  
569 Hunter St. West.  
Phone: New. 1622.

# How to Make an 8 VALVE SUPERHETERODYNE RECEIVER

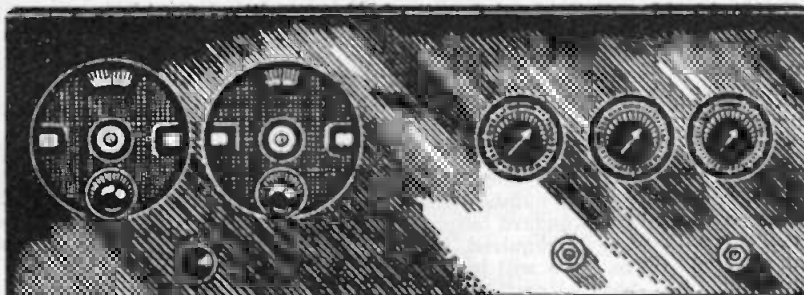

*By carefully following the instructions laid down in this article any home constructor possessed of sufficient patience can build this super-het—the world's best receiver.*

**S**UPERHETERODYNE is a word which conveys something of the magical to many people. Often is it used by people who don't really know what it means. Most understand that it is some type of radio receiver which employs usually between seven and eight valves, which of course, is quite correct. Quite a number of listeners seem frightened when the seven or eight valves are mentioned, but there is a reason or, we should say, several reasons. There are those who claim that the Superheterodyne is "le dernier cri"—the last word—in radio receivers, and it is in many respects true, provided always that it has been built correctly. There lies the rub. We venture to say that there have been more headaches created by building a superheterodyne than by any other receiver. It is hoped that this article is clear enough to permit the average constructor to build his own superhet.—as it is more familiarly called—with a minimum of trouble.

Now what does a superhet. do? That it will receive radio signals, it is true, but also that those radio signals from great distances which, by many another set are not collected, will be brought right inside your own home by a superhet. The surprising factor is that from the point of view of volume all local and interstate stations are on a par. A simple loop or frame aerial replaces the outdoor aerial. This loop may be stood on the top of the cabinet, and is all that is required to collect the energy to actuate the receiver. The Superhet.

will, therefore, be extremely sensitive and, incidentally, selective—the two most important factors in any wireless receiver. Combined with this there is simplicity of control, and with a good audio portion purity should be present.

The loop aerial will receive as many stations on a Superhet. as can be received by, say, a good neutrodyne on

an outdoor aerial. In addition, it is more selective, the directional qualities of the frame aerial assisting greatly in this matter, and also reduces interference from static. When static is bad the reception of interstate stations is rendered difficult on the average receiver, but the Superhet., while still liable to static, is not nearly so upset because of the use of a loop receiver.

Round about 1923 to 1925 great research was executed on Superheterodyne receivers, and as a result to-day we have a simply controlled, extremely efficient receiver from the complicated systems of earlier years. Many well-known radio men condemned the Superhet., doubting its possibilities as a commercial product, but to-day, owing to vast development, the Superhet. has come into its own.

In this Superhet. there are eight valves, first detector, oscillator, coupler, three intermediate valves, second detector and two audio valves. Sounds quite impressive, doesn't it? But not so terrible after all. You know what a detector valve does, and also the functioning of an audio valve. The three intermediate valves are really radio frequency amplifiers. It is known that with some exceptions three stages of radio frequency is difficult to control, but with the Superheterodyne receiver such is not the case as will be seen later.

This brings us to the oscillator. This oscillator is adjusted by means of the oscillator condenser so that it generates a radio frequency current of

## LIST OF PARTS.

- 1-Dilecto Front Panel 20 x 7 x 3-16.
- 1-Dilecto Subpanel 19 x 9 x 3-16.
- 1-Dilecto Terminal Panel 19 x 1 1/2 x 3-16.
- 2-Type L.0005 Bremer Pully Variable Condensers.
- 2-30 ohms Rheostat.
- 1-400 ohms Potentiometer.
- 1-D.C. Jack B.M.S.
- 1-S.C. Jack B.M.S.
- 1-Battery Switch.
- 1-.00045 Pilot Midget Condenser.
- 3-1 mfd. Fixed Condensers.
- 2-Benjamin or Bolton Brackets.
- 8-All-American Valve Sockets.
- 2-.00025 Grid Condensers and Clips.
- 2-2 mfd. Grid Leaks.
- 2-Rauland Lyric Transformers.
- 10-Terminals (3 for loop).
- 2-Emmco Dials.
- 1-.001 Fixed Condenser.
- 1-All-American Super Het. Kit comprising.
- 3-L.F. Transformers.
- 1-10,000 meter T.R.F. Transformer.
- 1-R.F. Coupler.
- Fort wiring, screws, etc.
- 1-Tapped Loop.

Buy a Burgess and Cut Battery Cost.

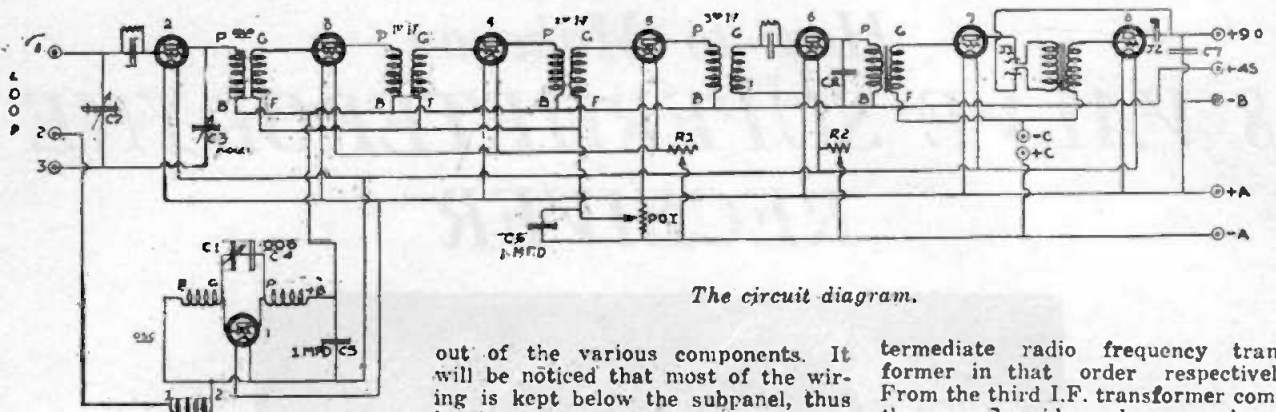

The circuit diagram.

a slightly different frequency to the received oscillations. These two currents interfere with each other and produce a heterodyne or beat note, of a frequency equal to the difference between the oscillator frequency and the incoming signal frequency. This beat note is inaudible. As the two radio frequency currents are added to each other, the beat current is much stronger than the incoming signal current. This beat current, by the way, actuates the first detector valve.

The three intermediate stages of radio frequency further amplify this beat note or intermediate frequency at a much longer wavelength and corresponding lower frequency than that of the broadcast wave band because at the broadcast wavelength the amplification per stage is not very great using the fixed or untuned type of transformer common in the Superhet. Thus we have a simple system of radio frequency amplification which gives great amplification per stage and only requires two condensers for tuning purposes. The foregoing is not a dissertation of the theory underlying Superheterodyne reception, being merely a few words explaining simply, it is hoped, just what takes place "inside," and the reason for the number of valves used.

The front view of the receiver shows the two dials, for tuning the variable condensers. On the left is the oscillator condenser dial, while its neighbor on the right is the loop condenser dial. Below and in between the two is a knob for a small midget condenser, which provides a variable reaction from a portion of the loop. To the right are seen the two rheostats and the potentiometer, which is also known as a stabilizer. This is in the centre of the two rheostats. The jacks are easily picked out. Not shown, but actually incorporated in the receiver is a battery switch, the position of which is found by consulting the back of panel wiring diagram.

The back panel view and the plan view gives an indication of the lay-

out of the various components. It will be noticed that most of the wiring is kept below the subpanel, thus leaving a very neat looking arrangement. This subpanel method of assembly and wiring will appeal to quite a number of constructors, but if the standard baseboard method of wiring is required, this may be resorted to. We will leave you to make whatever alterations you may need to convert from the subpanel method to the baseboard method. The wiring diagram will suit both types.

The whole scheme is compact: just sufficient space to accept all the parts comfortably without cramming. All the illustrations are drawn to scale, but to determine the correct positions and distances between parts an indication will be gathered from the panel dimensions. Take the positions of the variable condensers and the rheostats and potentiometer, and gauge from these the distances of the other subpanel components. Study the plan view carefully. Compare with the back of panel wiring diagram and the circuit diagram. Notice the three loop terminals on the plan view. Immediately in front of these is the oscillator coil; recognised by the four terminals on the one side and the two on the opposite side. In front of this unit is the oscillator valve, to the left of which is the first detector valve. The first grid condenser and leak is situate between these two valves, which occupy the space behind the two variable condensers. Again, behind the first detector valve is the coupler, to the immediate left of which will be found the first, second, and third in-

termediate radio frequency transformer in that order respectively. From the third I.F. transformer comes the second grid condenser and grid leak, which joins the grid terminal of the sixth valve socket governing the second detector valve. The three I.F. valve sockets are between the first and second detector valves, and are valves 3, 4 and 5 respectively, as shown on the back of panel, and also the circuit diagrams. The first audio transformer is that one nearest the loop variable condenser with valve 7, the first audio valve, immediately following it to the left. The second audio transformer is to the left of this valve, with the second audio or last valve immediately to the left of this again, and behind the second detector valve, but close to the panel.

The construction begins with the marking out and drilling the panel. Lay this on a flat surface and, using a centre punch, mark out from the panel drilling diagram. Only the centre holes for the two main tuning condensers are shown, the template, supplied with each condenser, giving the remaining dimensions. The parts should be mounted securely, and this portion layed aside while the subpanel is attended to.

Before proceeding with the subpanel layout, turn to the All-American valve sockets. Carefully remove the two F terminals of each valve socket and reverse them, that is to say, turn them upside down so that the connecting terminals come underneath the socket. Don't put back the terminal nut as these are not required now, the projecting screw having to go through

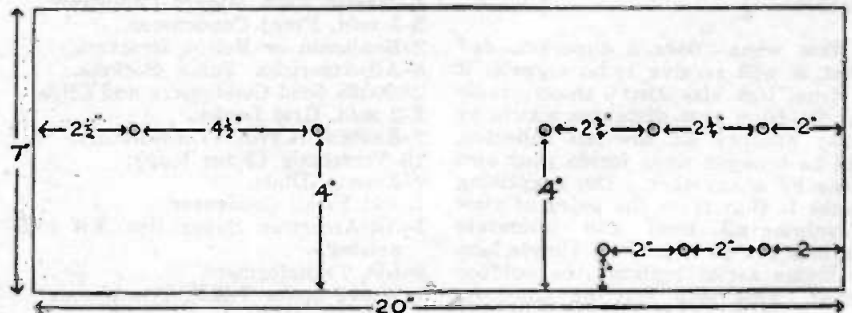

The panel drilling template.

Perfect Reception Every Day Possible with Philco.

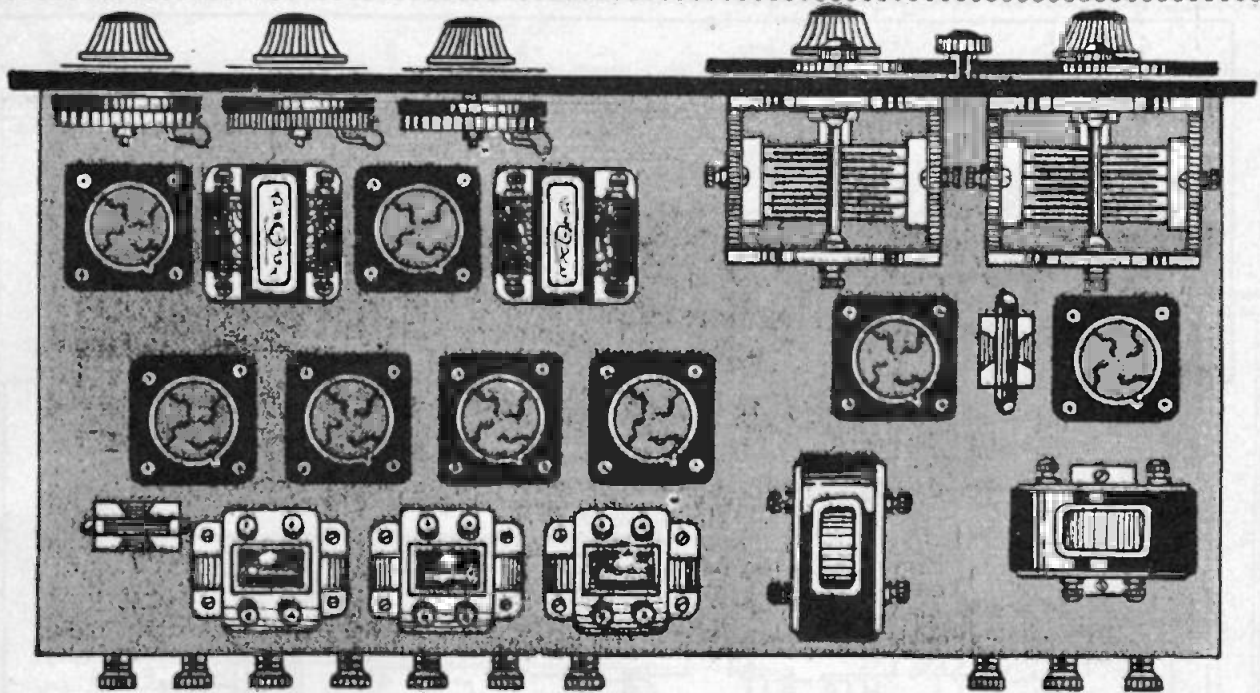

The baseboard layout of the component parts—follow carefully. This is important.

the subpanel to the underside. Only the F terminals of each valve socket should be treated this way, the G and P terminals remaining in proper position.

It is advisable when the terminals are out, to lay out all the apparatus on the top of the subpanel, all excepting the fixed condensers. Place everything in its correct position. Start off with the valve sockets. Then the two audio transformers, noting the position of the G terminal in relation to the G terminal of the succeeding valve. The oscillator and the coupler are placed at right angles to one another, the relative directions for wiring being seen on the wiring diagram.

The intermediate transformers should be so placed that the P terminal should be opposite or above the P terminal of the valve it governs, and the G terminal above the G of the next valve. The B positive and F terminals are at the back. Reconcile the panel wiring diagram with the other diagrams. When all have been allotted their respective positions, mark out with a centre punch the required fixing holes, and also provide for small holes to allow the wiring wire to come through to the bottom of the subpanel. All the grid and plate leads may remain on top, but all filament wiring is run underneath the subpanel. Even the leads from the rheostats and the potentiometer remain below, as do the connections from the variable condensers. Two small holes should be drilled at a convenient place underneath each condenser to allow these leads to pass through. Perhaps it would be wise to fit contact studs in these holes as

soldering points, and when wiring solder the leads from the condensers to these studs, and continue the rest of the wiring underneath.

However, it will not require much imagination to realise that some short brass or nicked bolts and nuts are necessary to bolt the transformers, etc., to the subpanel. Do this making certain that all parts are securely held in position. Place this subpanel on the brackets and fit it in position against the front panel. Note that the room left for the variable condensers. The midget condenser fits below the subpanel and is, therefore, like both jacks and battery switch, concealed. If everything is in order there should be ample room for everything without any cramming.

Before commencing the wiring, prepare the terminal panel. This is mounted by means of two small brackets, and the panel may be seen in the back view of the receiver. On the extreme left is the B positive Amplifier, then B positive for the detector, intermediates and oscillator, then B negative next A positive, A negative, C positive, C negative, and at the right-hand end the three terminals for the loop connections. Mark out and drill the holes for these terminals, and mount the terminals on the strip.

The wiring may now be commenced. Here is where the wiring diagram becomes more valuable. Wire up the filament circuits first. This is done beneath the subpanel. Notice that the three intermediate valves are taken to one rheostat, all other valves being connected to the remaining rheostat.

The potentiometer is connected right across the A battery with the centre point or moving arm joined to the grid return of valves 3, 4 and 5 as shown. Then continued with grid and plate wiring. Where wires cross beneath the subpanel keep them apart, even although Fort wiring wire is insulated. When it is necessary to "duck" from the top of the subpanel through to the bottom, it will be wise to measure off just that length of wire which, when connected to the top component, just fits through the small hole drilled. The remaining connection is soldered to this projecting piece beneath the subpanel. By following out the layout suggested in this article a neatly wired job will result. The 1 mfd., in fact all by-pass condensers, may be added, or wired in last, even after the terminal board wiring has been completed. Take the wiring in easy stages, checking carefully as you proceed. There is no need to fully describe these wiring instructions, as the person who builds a Superhet. will be able to read, if not the circuit diagram, the back of panel wiring diagram.

When everything has been completed satisfactorily, get ready to test out. Insert the valves in their sockets. On actual test at Marrickville the following valves were used successfully:—1st valve, oscillator, A609; 2nd valve, detector, A609; 3rd, 4th and 5th valves, intermediates, A630; 6th valve, 2nd detector, A609; 7th valve, 1st audio, A609, and last valve, 2nd audio, A608. All these are of the 6-volt series and when used with a

Philco Batteries Save Pounds in a Year.

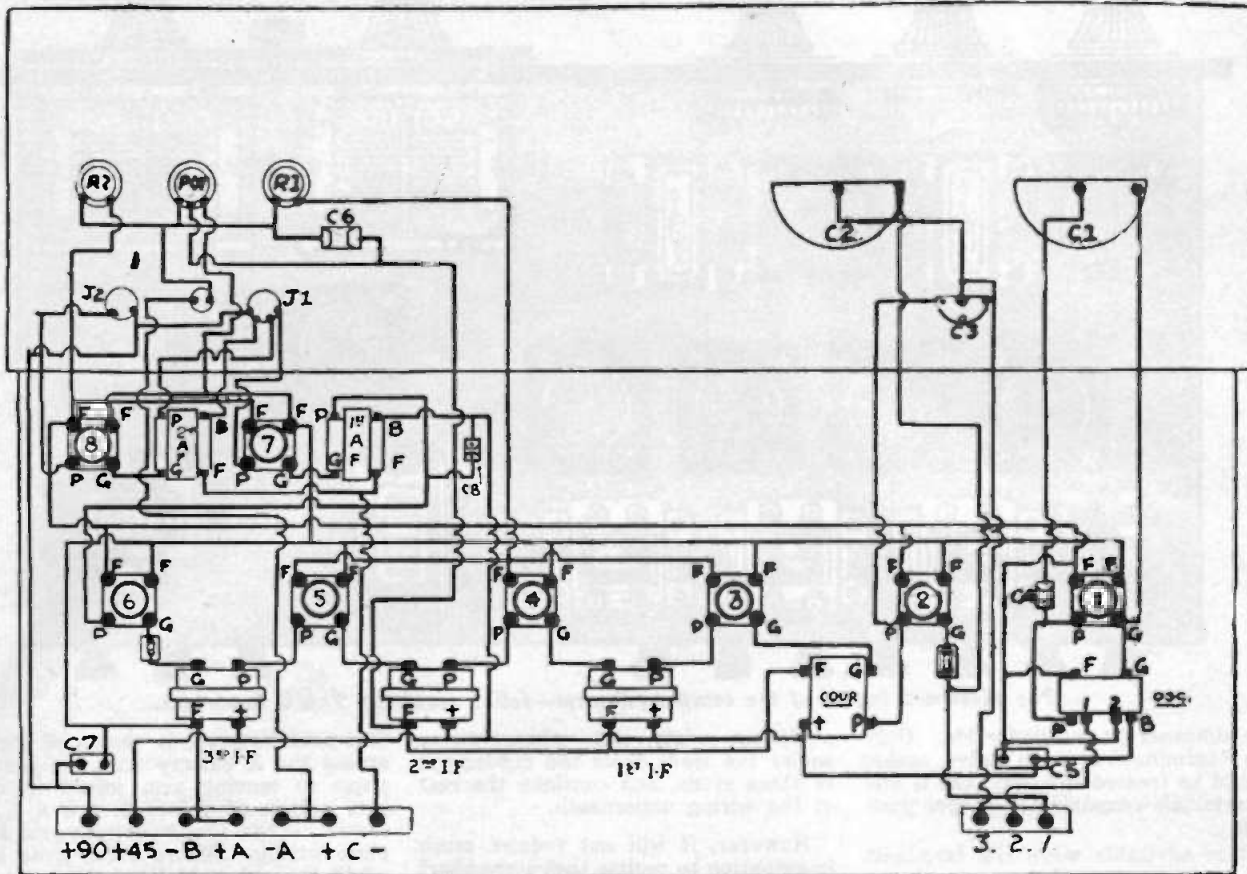

How to wire the component parts.

Philips B Eliminator the plate draw was 30 milliamps.

On the 4-volt series of Philips valves the following valves were found to do justice to the good receiver:—1st, A409; 2nd, A409; 3rd, 4th and 5th, A425; 6th and 7th, A409, and 8th, B406 or B403. Later in the evening the A630 was taken from the 3rd intermediate stage and transferred to the 1st detector position, the A609 valve from which proved useful in the 3rd intermediate stage.

Again all B406 valves were used, but the plate draw or plate consumption was too great. They are not to be recommended accordingly for this receiver right throughout, only where specified. Other makes of valves may do, but the writer hasn't had any experience of them. But bear in mind that in a receiver of this type the valves must be matched. Your dealer will assist you in this.

However, using the correct valves, connect up the A and B batteries, say 90 volts for the B audio and 45 volts for the other stages, and the A battery according to the valves in use, link up the loop and the speaker. An Airzone loop was used to advantage, the tap for regeneration being.

The midget condenser proved its value. This condenser controls the amount of regeneration. The Airzone loop is tapped at 1-3rd of its length, that is the 4th turn, and this midget condenser brings the otherwise weak station into utmost prominence. The C battery was 4½ volts.

Here is the actual readings of the Emmco dials on the B.D. condensers for the different stations of Australia. New Zealand has been omitted, although all three stations were very much present, but as the ultimate new wavelengths of these stations are, up to the moment of writing, not definitely decided, they are being left out.

LOG OF STATIONS.

Station.	Oscillator Dial.	Loop Dial.
2BL	51½/57½	79
3LO	47/54½	76½
4QG	40/48½	72
5CL	35/46	71
1YA	32	69
2FC	27/37	63
3AR	13	55
7ZL	10½	40

It will be seen that the oscillator dial has two readings. This is quite correct. Prove for yourself. All Superhets. with one or two exceptions; have two readings on the oscillator dial. Find both and decide on which one suits best. Quite a number of whistles will be heard as each dial is turned, but forget these whistles for a start until the whole receiver is properly mastered. Remember that when receiving Melbourne the loop should be pointed edgewise to Melbourne, or to the desired station. Try it and note how strong an otherwise weak station will become. The potentiometer is critical, in fact, so is the first rheostat, that one controlling the intermediate stages. Smooth, undistorted music will result, thanks, of course, to the Rauland Lyric Transformers. If trouble is met with, write in. We will assist you to our utmost, but still this Superhet lives up to its good name, and very little trouble should be found anywhere. Remember the whole secret of success of this or any Superhet. depends on its bypassing. Think it out for yourself.

The World Flyers carried Burgess Batteries.

# Build Your Own 8 Valve Superheterodyne Receiver

With the famous Remler Super Kit, and enjoy real Radio reception, using Remler Kit, the music or speech is filtered before being amplified, therefore ensuring true reproduction, Wonderful Selectivity, Simple to Operate. Local, Interstate and New Zealand stations on full loud speaker strength on Loop Aerial, and absolutely free from interference.

Price £7:10:0

With Blue Print  
of Working Plan  
and Circuit  
Diagram.



Price £7:10:0

With Blue Print  
of Working Plan  
and Circuit  
Diagram.

The Remler Kit consists of 1 oscillator, 3 intermediates, and 1 filter transformer. Price of complete parts, using the Remler Kit, with best quality selected and tested parts, only

£15/5/6

New Shipment T.C.C. Condensers, guaranteed accurate; all sizes, .0001 to 2 m.f. Yaxley aerial and battery cord (7 wires), with plug and jack, 21/-. All Sizes, D.C.C. and enamel wire.

Your Unsatisfactory Set Rewired by Experts and Satisfaction Guaranteed.

## WILES' WONDERFUL WIRELESS

.....and ELECTRICAL STORES.....

BRANCH:  
23 PITT ST.  
Near Circular Quay.

PITT & GOULBURN STS.,  
SYDNEY.

BRANCH:  
384 PITT ST.  
Opposite A. Horderns'

MAIL ORDER BRANCH, 60 GOULBURN STREET.

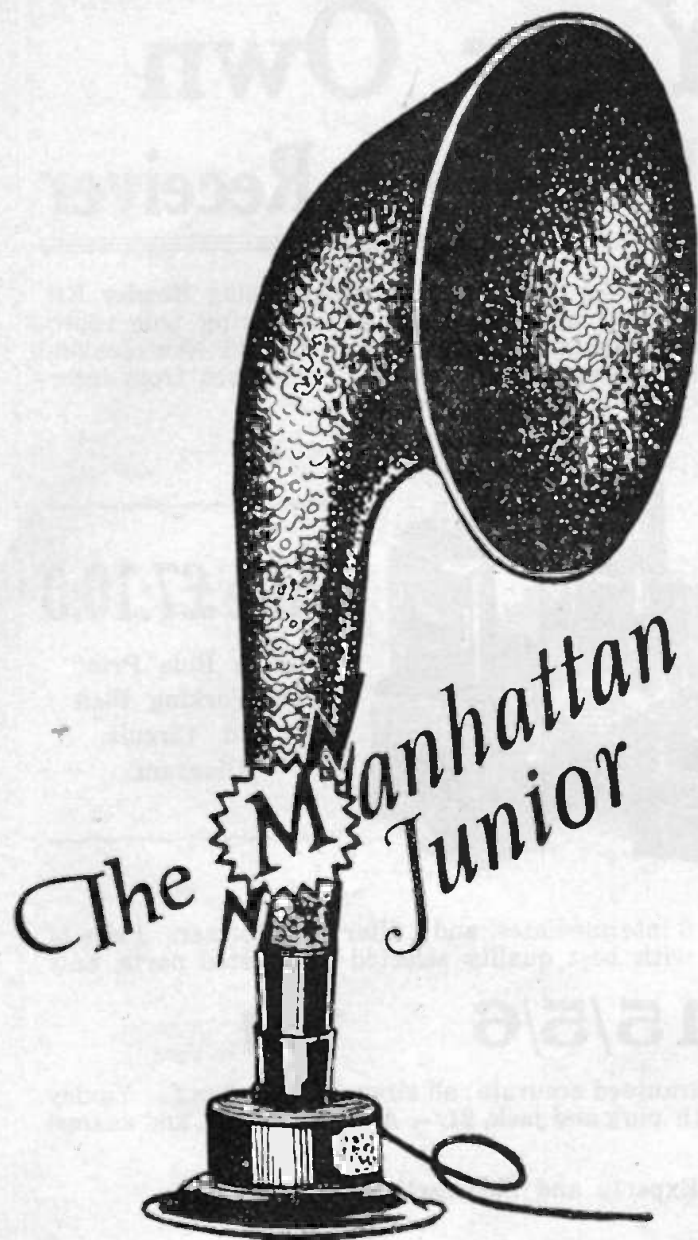

Height, 22 inches.

**The  
World's Most  
Widely Sold  
Loud Speaker!**

**WHAT greater  
reputation could  
it possess?**

Scientifically designed to meet the insistent demand for a Loud Speaker embodying all the factors essential to perfect radio reproduction, it efficiently serves the needs of thousands.

---

Write or Call and Hear this  
Wonder Little Speaker—TO-DAY!

---

Sold at the Remarkable Price of

**23/6**

(Post Free anywhere in Australia)

**Mick Simmons Ltd.**

Headquarters: HAYMARKET, SYDNEY

"The Premier House for All Radio Supplies."



The parts used are as follows:—

- 1 Polymet 3 Stage R.C. Kit.
- 3 Radion Valve Sockets.
- 1 30 Ohms, Rheostat.
- 1 Dilecto or Radion, Panel 12 x 7 x 1-8.
- 1 Standard Terminal Board.
- 1 Base Board, 11 x 6 x 1/2.

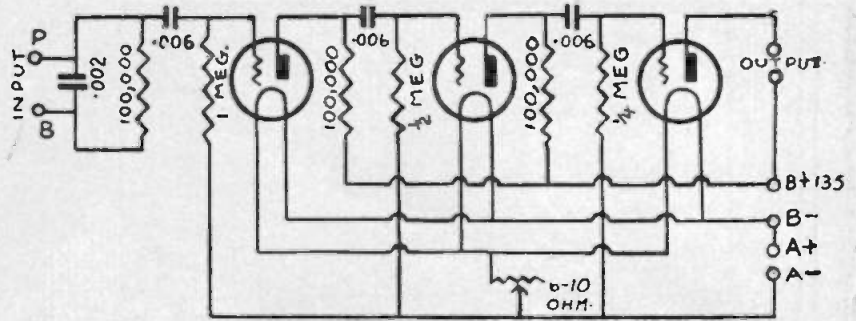

## A Three Stage Resistance Coupled Amplifier

OVER and over again in these pages have we discussed the many different types of audio frequency amplification; the Englishman calls it note magnification and thus conveys more meaning than ourselves. For audio frequency amplification is used to build up the signal strength after it is detected or rectified.

You see, radio frequency amplification is of such a high frequency that it is inaudible to the human ear without some form of rectification to convert it into audible or audio frequency.

For the benefit of the uninitiated, let us consult the Wireless Dictionary. We will turn up audio frequency for a start. What does it say:—

“Audio Frequency. A frequency of alternating current which can produce audible sounds in a telephone receiver, i.e., within a range of from about 25 cycles per second to about 10,000 cycles per second. However, the

range of frequencies used in ordinary telephony is only from about 100 to 3,000 cycles per second.”

That's that! Now let's turn up frequency.

Frequency:—The number of complete cycles an alternating quantity passes through in one second. Sometimes called the periodicity.

Now let us tackle alternating current:

Alternating Current (A.C.).—An alternating current is one which flows first in one direction and then in the opposite direction round a circuit alternately. One way round the circuit is taken as positive and the other as negative. The sequence of valves attained by the current in passing through one complete set of positive and negative valves is called one Cycle. The time of one complete cycle is called the Period, and the number of cycles passed through in one second is called the Frequency, or Periodicity. Now one more:

Radio Frequency:—A frequency within the band of frequencies used for wireless telegraphy and telephony, i.e., within a range from about 12,000 up to 100,000,000 cycles per second, representing a range of wavelengths from 25,000 metres down to about 3 metres.

Read that over again! It will be seen that the difference between radio frequency and audio frequency is explained. To sum up, simply radio frequency amplification is inaudible, because the frequency is so high that the human ear cannot respond to it, whereas audio frequency is brought low enough to be impressed on the human ear and therefore becomes audible.

Some form of rectification or detection is stepped between radio frequency and audio frequency, and that form may be a crystal detector or a valve detector. Still suffice it to say that the average audio frequency stages may be appertainable to any

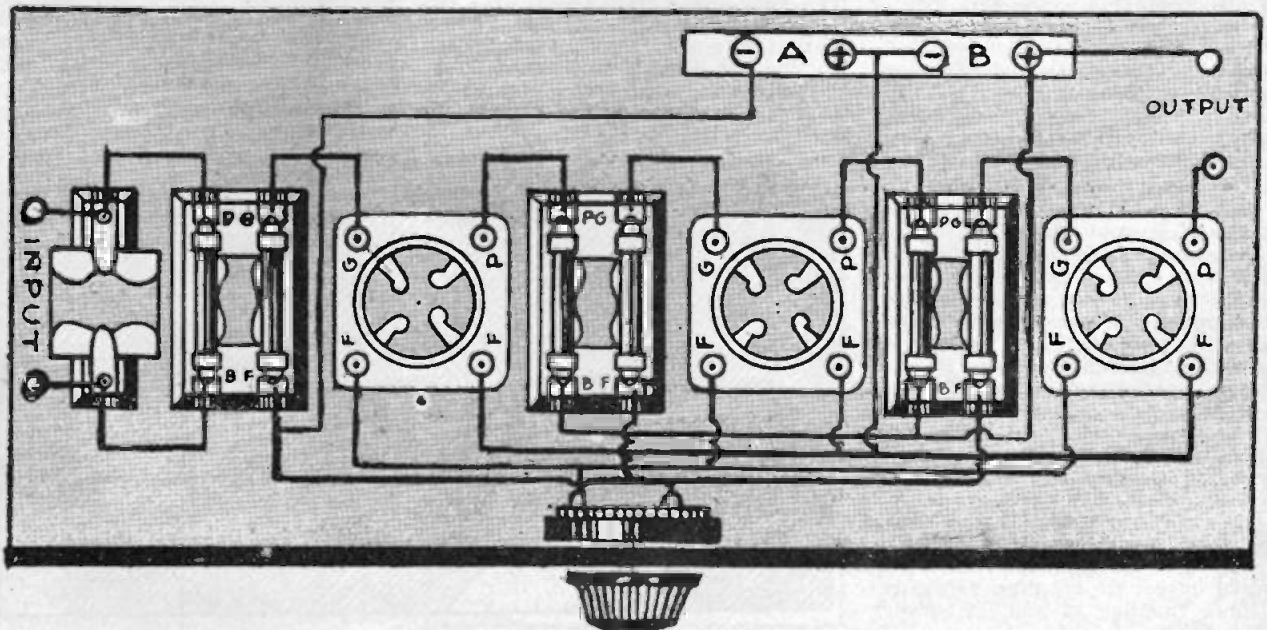

You can Recharge a Philco for a few pence.

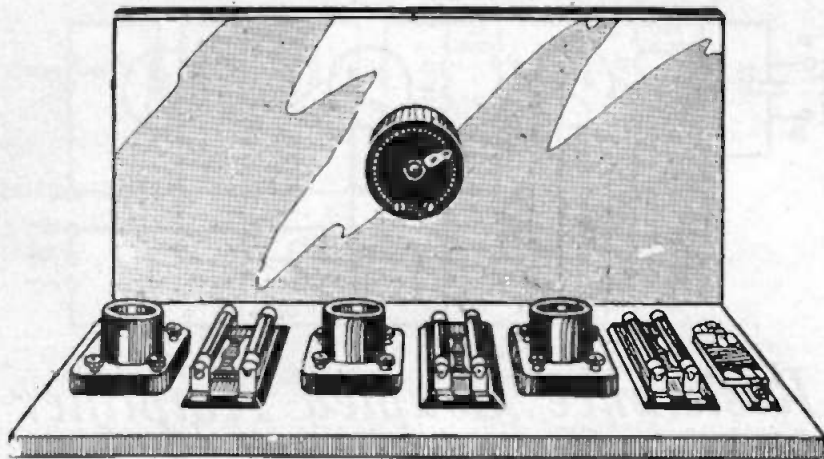

system of detection, whether crystal or valve. This is by the way, however, as it is our purpose to interest all our readers in every technical article appearing in our pages. Some there are who will read this article, but who will not build the unit, being satisfied with their own system, and again there are some who will build this unit and want to know why. We endeavour to cater for all.

Now, coming back to audio frequency, it must be understood that this is useful for building up the note magnification or the signal strength after it is detected, and it may be added to any set, whether valve or crystal detection, it even may be preceded by one or two stages of radio frequency amplification. For example, the person who owns a single valve receiver and who enjoys good earphone strength on the local or even the inter-State stations, and who again desires loud speaker strength on all stations, will find this unit of particular interest. It is, of course, realised that there are many who have a receiver employing radio frequency and a detector only, who would like the detected or audio frequency energy built up so as to permit all the sounds to be heard in any part of the home. Well, build this unit.

Realise at the very outset that to ensure maximum satisfaction on the interstate stations, some form of radio frequency amplification is desirable, so don't expect to hear these distant stations at remarkable punch unless they can be heard reasonably well after the detector valve. If the distance station can be heard at all after the detector, then this unit will help you to hear on the speaker comfortably but if this distant station is not heard, then don't expect too much from this unit.

Over and over again has there been discussions on the relative merits of transformer coupling, impedance, and double impedance coupling versus-resistance coupling of audio frequency

stages. It is claimed that resistance coupling is far more natural and far purer than the standard transformer coupling method of audio frequency amplification. This may be true, but there are exceptions.

As a matter of fact, the writer was very much impressed with good qual-

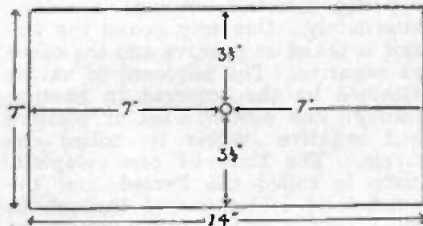

ity reception of a receiver using only two very cheap transformers for the audio coupling stages, and also found that the much vaunted resistance coupling was the most raucous. On investigation, it was found that the fault lay in the resistances used and not the valves or the circuit. So it

behaves the constructor who desires this system to adhere faithfully to the list of parts given in the panel having this information.

Poor quality resistances are useless after the first week or two. The application of the B. battery breaks down poor resistances and renders them useless. The Polymet resistances chosen have been functioning well for weeks, and look like doing so for many more weeks. Please understand that it is absolutely essential to have a B. battery of from 100 to 150 volts to get the maximum output and that this maximum output of three stages of resistance coupled amplification equals only in volume two stages of transformer coupled amplification. But the purity is outstanding; it is wonderful.

The constructional details are simple. Only one hole is required on the panel. If it is desired to have a jack and plug for the output, fix the jack on the right hand bottom corner, and if a switch is wanted to cut off all valves, this may be inserted on the left hand corner to match the jack. The baseboard beyond is simple.

Don't forget to shellac the baseboard and trim up the corners. Then lay out your Poly 3 stage Kit A., as shown on the diagrams. Screw everything securely to the baseboard and get ready for wiring.

Choose whichever socket suits you. The average socket to-day is the standard UX type, and this is easily wired. This is the socket which we used in our unit, in fact, we used the UX Radion socket because of good contact with the springs. This plays an important part in all receivers. The layout is simply followed, but watch the three different stages. The Poly units come to you as four separate parts; one with a .002 condenser in clips and base the rest with two resistances, and a .006 condenser contacting with the two. These units have a valve socket between them, as is shown on the diagrams. Lay out accordingly.



The Mighty 83X Philco is Supreme.



# It's the FILAMENT YOU PAY FOR

## BUY BRITISH

Glass tubes and bases are much of a muchness; rigidity of construction is also in itself an easy achievement. But remember that there is but one Filament which will do full justice to your set and to your sense of hearing —

### The Wonderful P.M. Filament in MULLARD P.M. VALVES.

Longer, stronger and tougher, it carries the published test report of the British National Physical Laboratory, the test that protects you.

Demand the wonderful P.M. Filament. Obtainable only in Mullard P.M. Valves. A British Filament in a British Valve.

Note the generous and robust construction of the Wonderful Mullard P.M. Filament shown in the above sectional view of the P.M.5. This is the construction that brings improved results from any radio receiver.

Obtainable from every radio dealer in Australia.

MULLARD P.M. VALVES ARE BRITISH MADE. BUY BRITISH.

For 2-volt accumulator			
P.M.1 H.F.	...	...	0'1 amp 13/6
P.M.1 L.F.	...	...	0'1 amp. 13/6
P.M.1 A (Resist Cap.)	...	...	0'1 amp. 13/6
P.M.2 (Power)	...	...	0'15 amp 13/6
For 4-volt accumulator or 3 dry cells			
P.M.3 (General Purpose)	...	...	0'1 amp. 13/6
P.M.3 A (Resist Cap.)	...	...	0'1 amp. 13/6
P.M.4 (Power)	...	...	0'1 amp. 13/6
For 6-volt accumulator or 4 dry cells			
P.M.5 (General Purpose)	...	...	0'1 amp. 13/6
P.M.5 B (Resist Cap.)	...	...	0'1 amp. 13/6
P.M. 6 (Power)	...	...	0'1 amp. 13/6
Super power valves for last L.F. stage			
P.M.254	...	(4 volts) 0.25 amp.	15/-
P.M.256	...	(6 volts) 0.25 amp.	15/-

All Mullard Valves are made at the Mullard Works, Balham, London, Eng.

# Mullard

## THE MASTER VALVE

Advt. The Mullard Wireless Service Co., Ltd., ARKS 16A  
Mullard House, Denmark Street, London, W.C.2.

Then commence the wiring. The wiring diagram shows this in detail. Follow out carefully. Take one step at a time. Check over as you proceed. See that the contacting springs of each unit are securely resting on the coupling condenser. One rheostat controls all three valves. If three valves of the .1 variety are used, a 30 ohms. rheostat is all that is required. If again, three .25 amp. valves are used, then a .6 ohms. rheostat is necessary to carry the filament current to these valves. On the wiring diagram a 6 ohms rheostat is specified, but this is subject to alteration, as suggested.

The A. battery, of course, depends on the valves used. If 6 volt valves are required, then a 6 volt accumulator or A. battery is necessary, but if 4 volt valves are used, then by all means use a 4 volt battery as an A. battery.

Wire up carefully, using good bus-bar or some good wiring wire. Solder neatly when it is called for, and finish off. The B. battery must be more than 100 volts; 135 volts being better still. Connect up the A. and B. batteries, loudspeaker, etc. Then connect the unit to the set. Join the input terminals of this unit to the telephone terminals of the set and things will go O.K.

Try out the set on the phones first, then join the resistance coupled unit to the set and plug in the speaker. Note the remarkable volume and purity on the speaker. Really good—so it will be always. And if Poly resistances are used, it will always remain good, provided your B. battery is always up to the mark. This unit doesn't alter the tuning of the detector side in any way, but will increase the strength of received signal immensely.

Valves should be of the high amplification type found in Osram, De Forest and Cossar Range. Ask your dealer.

## Everyman's Four

*We regret that owing to the illustrations not being available, at the last moment we were compelled to withdraw the above Technical article.*

*It will appear next issue.*

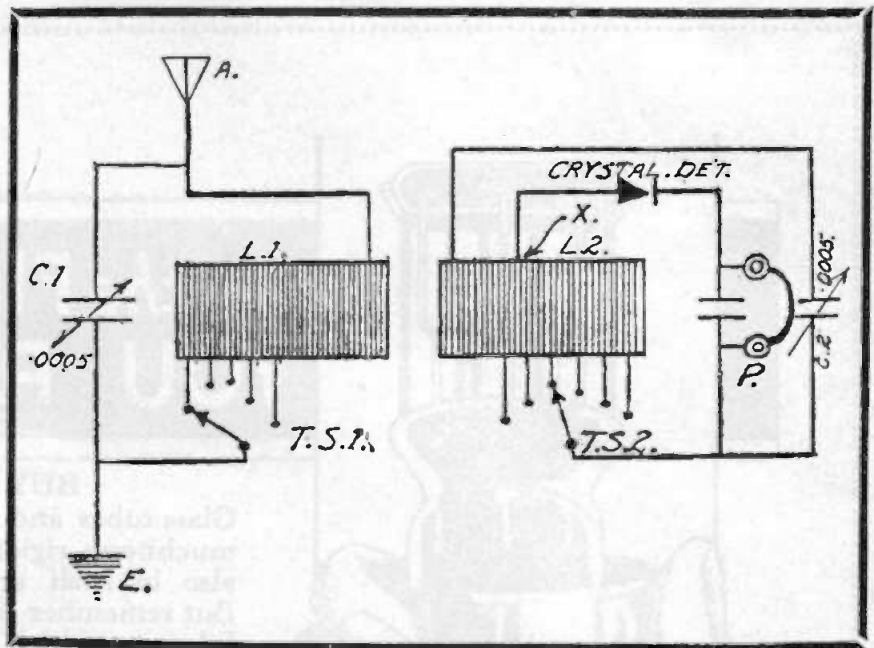

## The Best Crystal Receiver

BY H. K. LOVE

(President of the Victorian Section of the Wireless Institute)

From a Talk Broadcast by 3LO

Before much time is spent in consideration of any type of crystal receiver I advise listeners to first examine their aerial system. When satisfied that the best aerial possible in the circumstance is provided, it is time to look at the earth lead. This should not be more than about 10ft. long before it is grounded, by burying it in the earth or soldering it to a water pipe or other earth point. When these details have been attended to satisfactorily attention may be turned to the design of construction of the crystal receiver itself.

In order that the circuit shown in the above diagram may be extremely selective a certain amount of experiment has been carried out for the benefit of listeners to 3LO. It was found by practical experiment that the point at which the tap at point X was connected to L.2. varied slightly, and it is, therefore, impossible to state definitely that it should be fixed at any point on L.2. Its approximate relative position is clearly indicated in the diagram, and the builder of this circuit will need to conduct a few practical experiments as to the best point of fixing this tap.

The principle involved in this circuit is very simple. By using only a portion of the inductance L.2. the resistance of the crystal circuit is slightly reduced while the tuning of the whole of L.2. is accomplished by the condenser C.2, which has a voltage of .0005. With the reduction of re-

sistance in the crystal circuit maximum energy is made available to the crystal detector, and through it to the telephone P. The condenser C.3, which has a value of .001, acts as a radio frequency by-pass which allows the radio frequency in the circuit to pass to T.S.2 without having to traverse the windings of the telephone. This condenser will in most cases effect a considerable increase in the strength of signals received in telephones. The coils L.1 and L.2 are wound on 2½ or 3in. cardboard formers and consist of L.1 90 turns, tapped at 50, 60, 70, 80, 90. These taps are connected to the studs of a rotary selector switch, and by its use the number of turns may be adjusted to receive any particular band of wave lengths. L.2 is also wound on a 2½in or 3in. former with 90 turns, and is tapped at 40, 50, 60, 70, 80, 90. These taps are in turn connected to the studs of the rotary switch T.S.2. The two coils should be clamped to the baseboard of the receiver by means of screws and hard rubber strips in such a manner that the distance between them can be varied at will. This receiver should be carefully constructed of good parts and will undoubtedly produce good results if a little care and experiment is undertaken in its construction. It is essential that a good high aerial be used in conjunction with this receiver if maximum results from a crystal set are desired.

Square Glass Cells with each Philco.

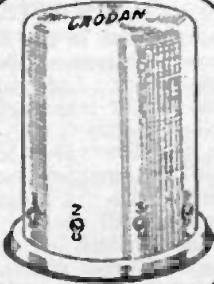

Grodan Solodyne Kits. Three tested units, blue print circuit, lay out, etc., etc., £3/7/6 per kit.

*The Grodan Folding*  
**LOOP AERIAL**

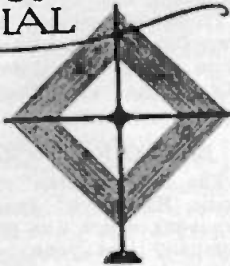

Loop Aerial ..... £1/12/6 each  
No. 2 Loop ..... £3/10/- each  
No. 3 Loop ..... £3/5/- each

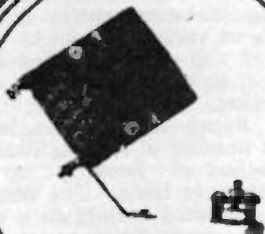

Neutrodyne Kits.  
£1/17/6 each.

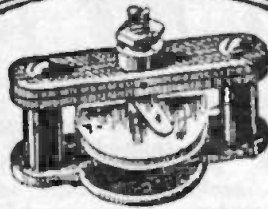

**NEUTRALISING CONDENSER 3/9**

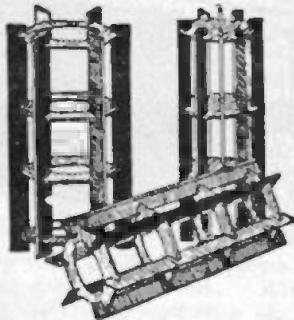

**ANTI-LOSS COIL FORMERS**  
MADE IN 3 SIZES. VIZ.  
3 1/4" x 3" x 2 1/2" 2/6  
7 INCHES LONG

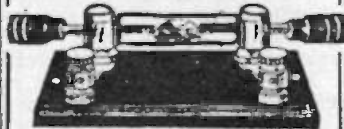

**PERICON DETECTOR 3/9**  
**PERICON REFILS 1/6**

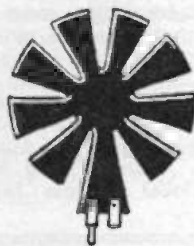

**SPIDER WEB COIL FORMERS**  
**PLUG IN FORMER 1/3**  
**PLAIN FORMER 6<sup>D</sup>**  
Easy to wind any size wire

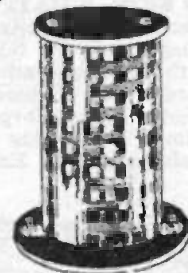

The New 3 in 1 Choke Coil, 200, 300, or 500 turns may be used. Best on the market, 8/9 each.

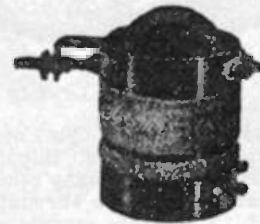

Single Rotor Tuners .... 12/6  
Double Rotor Tuners ... 18/6  
Kindly write for illustrated pamphlet.

GROSE & DANIELL,  
Holden Street, Redfern,  
Sydney.

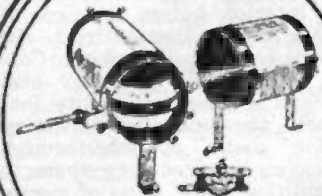

New Browning-Drake Kits,  
£2/2/-.

**GRODAN RADIO COMPONENTS**

**REDFERN SYDNEY**

# A Section for the Trade

## 5,000 SETS A DAY.

Five thousand Radio Receivers complete every day is a very tall order, but this is the average number of sets which are being produced daily by the Crosley Radio Corporation, which is claimed to be the world's largest manufacturer of Radio re-

the Crosley Corporation of the "Die Casting" process for the mass production of the variable condensers incorporated in their receivers is an example. For this purpose a battery of ten machines has been installed in the modern six-storey addition to the Crosley plant. A novel machine

## NEW SETS.

A new entrant in the field of radio set manufacturers, is New System Telephones Pty., Ltd., who are now engaged in the manufacture of De Luxe New System 5, 6, 7, and 8 Valve Models, the five valve model selling for £49/10/, complete with Burgess "B" and Philco "A" batteries, loud speaker and all other accessories. There are no dials on the receivers, and the dual drum control makes the tuning infinitely simple. To one side of the drum control are the dial markings, together with the call signs of the various stations, and on the other appear the wavelengths in their natural order.

The set is constructed on a cast aluminium chassis, having absolute rigidity, and eliminating the possibility of the displacement of parts. We demonstrated a five valve model on local broadcasting, to our entire satisfaction, and have no hesitation in endorsing this new receiver.

There are certain territories still open for agents, who are advised to write to New System Telephones Pty., Ltd., for further particulars.

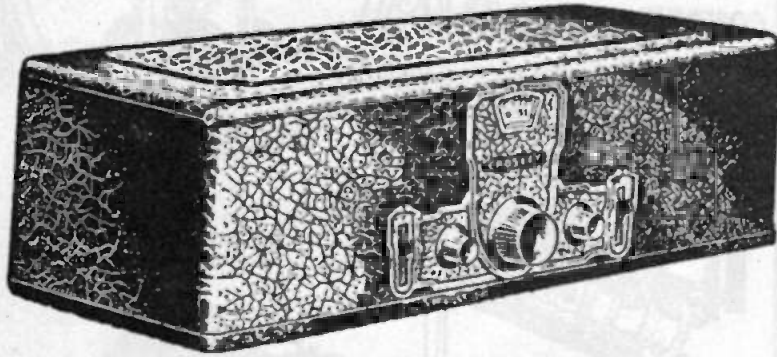

The Crosley Bondbox Receiver.

ceivers. In addition to sets, this Company manufactures Power Supply Units, Loud Speakers, and many other parts which are well-known throughout the world. The whole process of manufacture is based upon mass production methods, and the man responsible for the growth of this colossal organisation is Powell Crosley, Junr., founder and president of the Crosley Radio Corporation.

The Crosley Corporation has specialised for years in the perfecting of suitable machinery and the training of skilled personnel to reach their ideal of turning out receivers which are at once highly efficient, extremely attractive, yet with rugged strength and extremely reasonable price. Many people are under the impression that because an article sells for a reasonable price it is necessarily cheap or inferior, but in the case of the Crosley Radios, Power Units, and Speakers, it is the policy of the Corporation to put only the very best material and engineering ability into its products, the moderate marketing price being made possible through high efficiency in producing them in large quantities. Vast sums of money have had to be expended to install the special equipment required, not to mention personnel, for the proper functioning of such a detailed mass production system calls for an extremely skilled group of executives and intermediate subordinates to properly direct the activities of the several thousands of workers engaged. Many of the machines in use for the production of the various parts are the result of study and solution of intricate problems. The utilisation by

employed is an automatic tempering or hardening furnace heated by electricity and used for hardening the steel magnet segments in the Crosley Musicone Loud Speaker. There are many other novel machines for speeding production of the parts required to make up complete radio receivers, etc. After all of the required parts are complete they enter the conveyor belt assembly and wiring line where they are in continuous process until the finished product in the shape of a Radio receiver or other article, emerges from the final inspection and test booths for packing and shipping to the distributor.

Cincinnati, the pioneer centre of Radio Broadcasting, may well be proud to number such a modern plant among her numerous industries. The Crosley Corporation also operates Station WLW, which recently broadcast the Dempsey-Tunney fight, and is frequently heard in Australia on 50 metres. International Radio Co., Ltd., are local agents for Crosley products.

ONE NIGHT recently, a well-known local listener to 4QG wished to know if all were well with the transmitter. He complained of a certain amount of distortion which he called "fuzziness." As everything was quite normal at the station, this distortion was explained to him as being no doubt occasioned by the discharges of static electricity (which was collecting in his aerial due to the heavy thunderstorm then prevailing) through his receiver to earth, thereby spoiling his usually clear reception.

## EMMCO RADIO HANDBOOK.

The 1927 edition of the "Emmco Radio Handbook" far surpasses the handbook which was produced by that Company last year. It contains 32 pages, together with an art cover printed in two colors, and with most attractive designs, front and back. There is a full detailed list of Australian and New Zealand Radio call signs, including Broadcasting Stations A and B class, Amateur Transmitters, special call signs, etc. There also appears a world list of short wave stations in addition to a chart showing the comparative differences in time of various points in different parts of the world. There are circuits of Reinartz Receivers, Brown-Drakes, Short Waves, Neutrodyne, Super Heterodynes, etc., besides a number of circuits illustrating the method of hooking up A.B.C. eliminators to them. The rest of the book is devoted mainly to a description of the many Emmco parts, including several new lines which are just now appearing on the market. There is also an illustration of the new Emmco factory, which is just nearing completion, and which will have a total plant and equipment to the value of over £200,000. The book throughout is excellently printed, and distinctly informative, so much so, that we recommend all Radio enthusiasts to procure a copy. It is supplied free to users of Emmco products.

Four or more Valve Sets demand Philcos.

## NEW A. AND B. CHARGER.

The Rectigon, a new type of A. and B. Charger, has now made its appearance on the market. The Radio enthusiast will certainly be strongly impressed with the simplicity of this latest type of charger, which, besides having no moving parts, comprises a considerably reduced number of parts. It is a charger of the bulb type, which means that there are no moving or vibrating contacts, no acids or other chemicals. There is no danger in case of a failure of the power supply, the batteries cannot discharge, and, as soon as the line voltage is restored, the charger will automatically resume

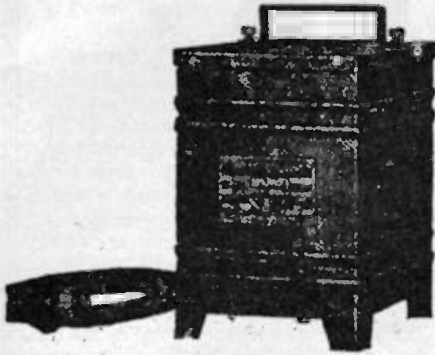

operation. It is essentially an economical job, because of its low first cost and practical elimination of upkeep expense. The bulb is the only part requiring renewal, and its life is exceptionally long and uniform. The charger is started by simply turning on a snap switch and adjusting the dial switch to obtain the proper current for the number of batteries being charged. It is contained in a case of sheet steel finished in glossy maroon—an attractive and hard wearing apparatus. Manufactured by the Westinghouse Electric International Company and every phase of its performance is therefore guaranteed by Westinghouse experience. Weighs approximately 15½ pounds. Measures 6½ in. x 5½ in. x 8 inches high. Distributors, Amalgamated Wireless A'sia, Ltd.

## EMMCO, CLYDE.

Mr. H. J. Hapgood, managing director of Manufacturers' Products Pty., Ltd., left for Melbourne last week, and is at present busily engaged in furthering the interests of Emmco, Clyde, and other lines that his company represents. He reports very good business in the southern State, and many new licenses. On returning to Sydney he is leaving almost immediately for New Zealand, in which country he will make an extensive tour for the purpose of pushing sales.

## More DX With Proper Grid Bias.

It is not too much to say that ease and smoothness of regeneration control in a receiver consisting of a valve detector, especially when followed by audio amplification, may account for the difference between being able to receive a distant station at good strength and not being able to hear its signals at all. Such devices as geared dials, or even the use of capacity controlled regenerative circuits, may help a great deal in this respect, but unless the operating characteristics of the valve itself are such as to permit a gradual approach to the oscillation point the full sensitivity possible cannot be obtained. This condition may best be brought about by careful adjustment of the values of the applied B battery voltages, and particularly by choosing a suitable leak and working potential for the grid, as well as by using a regenerative coil of correct inductance.

It is usual to connect the lower end of the grid leak to the positive side of the A battery, in order that a positive voltage equal to that of the battery may be applied with respect to the negative end of the filament. It is quite possible that this may be excessive, and, in the case of a tube where the grid current starts early (i.e., before the grid becomes appreciably positive), it may be preferable, from the point of view of smoothness of regeneration control, to keep its potential at zero, or, at any rate, only slightly positive, without seriously impairing its rectifying properties.

The effect of connecting the lower end of the leak to various points of the filament circuit should be tried. Provided that the controlling rheostat is in the positive filament, we have the choice of negative filament, positive filament and positive battery.

If a finer control of grid potential is desired, a separate biasing battery of dry cells may be used, or, better, a potentiometer connected across the filament or A battery leads. The latter arrangement is to be preferred, and the general idea should be to work with the least amount of positive voltage consistent with good detection and smooth regeneration control, remembering also that an excessively positive grid will cause an unnecessary drain on the plate battery.

A NEW WIRELESS set that dispenses with batteries and accumulators has been perfected.

How about one that dispenses with bad programmes?

## 3LO Melbourne and Research.

I HAVE just been reading an interesting pamphlet by Mr. Cherry, the Research Physicist at the Melbourne University, on "Signal Strength Measurements of 3LO."

Few people who put on their headphones, or turn on the loud speaker, realise that to give them the pleasure of a programme, a tremendous deal of research and experiment are necessary.

3LO Melbourne maintains a staff of radio experts, whose care are problems of "fading" and the like, which must be solved to make broadcasting 100 per cent. efficient.

## Special Grant.

To obtain the best advice on the matter, 3LO Melbourne gives the sum of £500 to the University for Radio Research annually. In the University are two renowned physicists, Professor Laby and Mr. Cherry, and these two men have been doing important work on measuring the signal strength of 3LO Melbourne. The practical value of the work lay in getting knowledge through which "fading" could be located and attacked.

For their work they used a measuring set so constructed that it could be dismantled and transported from place to place on the carrier of a motor-cycle, to be set up afresh at different places in the field. The scientists point out that it will soon become necessary to give signals of a specified intensity. A very high signal strength has two disadvantages. The first is high cost; the second is its interference with signals from other, and particularly remote stations.

On the other hand, a weak signal will not be audible above the "noise level." This phrase is used to indicate the mean field intensity of natural and artificial electrical disturbances which interfere with reception. The audibility of a signal depends on the ratio of its intensity to that of the noise. No measurements of this "noise level" in Melbourne have been made. Day and night measurements of this were made for a year in England and America before the establishment of trans-Atlantic telephony, in order to determine the signal intensity.

There is a ratio between high frequencies and "noise level," and the study of this will have important bearing on broadcasting. It appears, so far, that in Australia, a short wave will have a higher ratio of signal to noise than a long wave, assuming signal strength in each is equal.

The experiments in signal measurement by these two scientists will continue at greater distances.

Hurley used Burgess in New Guinea.

# Announcing REDUCED PRICES!

	OLD PRICE	REDUCED PRICE
R 5 V ... ..	6/-	5/- each
DE 2 H.F. ... ..	13/-	} <b>10/6</b> each
DE 2 L.F. ... ..	13/-	
DE 3 ... ..	13/-	
DE 3 B ... ..	13/-	
DE 8 H.F. ... ..	13/-	
DE 8 L.F. ... ..	13/-	
DE 4 ... ..	15/6	} <b>12/6</b> each
DE 6 ... ..	15/6	
DE 5 A ... ..	22/6	<b>20/-</b> each

# Osram Valves

for **TONE & POWER**

At All Licensed Radio Dealers.

**British General Electric Co. Ltd.**

Magnet House, 154-6 Clarence Street, SYDNEY

Scott and Bolton Streets, NEWCASTLE

And in all States and New Zealand..

*The Boon Companions of Osram Valves.*



'TONE'



'POWER'



# EVERYMAN'S FOUR

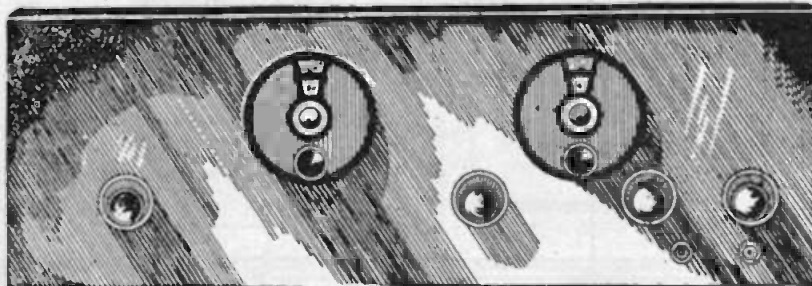

FOR some reason or other four valve receivers are not so common amongst listeners, the exceptions being the Browning-Drake and the Marco Four, and the Bayer Four. Three and five valve receivers seem to enjoy more popularity than the four, but a good four valve receiver is an acquisition.

Four valves may be of different combinations. A set of this number of valves may comprise a detector, followed by three stages of resistance coupling or double impedance amplification. This combination is good for local stations. Also it can be of two radio stages detector and one audio. This arrangement will bring in the distant stations very nicely. But the most popular arrangement is the one stage of radio, a detector, then two stages of audio frequency amplification. This is the combination used in the three receivers mentioned above, and is the same used in this week's receiver.

Now radio frequency amplification is indeed useful for bringing in the inter-State stations, but some good form of stabilised radio frequency is necessary before it is worth bothering with. This time we will make it of the transformer coupled variety and neutralised. When transformer coupled is mentioned, some folk accept an impression of the old UV1714 type of encased transformer, which was very broad in tuning. This impression is wrong, as any two coils of wire coupled together with energy induced from one to the other, becomes a transformer. The ordinary three coil tuner is a radio frequency transformer, and it is two three coil tuners we press into service for this week's receiver.

These three coil tuners used are quite new to the Sydney enthusiast, although they have been made in Sydney for some time now. Our Victorian readers will recognise the neat, compact Aladdin tuner. It is efficient

and is adaptable to many different circuits. Like the average three coil tuner, the Aladdin boasts of a primary, a secondary, and a reaction coil. The primary coil is wound on the outside of the secondary, which is fixed as a stator, and the tickler is the rotor, which turns inside the secondary. Very little space is taken up with this little tuner, and as all the wiring points come out on a small panel the connections are greatly simplified.

One of these tuners is used as a radio frequency transformer, and the other as the usual aerial-grid coupling device. To this end, the first, a few alterations in the connections. There are eight soldering points in the couplers, and they are marked R, R, G, T1, F, E, T. and A, meaning

R.R. reaction coil connections, G, grid of secondary coil; T1, tapping for neutralising where necessary; F, the grid return, which joins the filament; E, the earth connection; T, a tap for connecting a long aerial, a tapping in the primary coil, and A, the standard aerial connection.

For our purpose, here in the first unit neither tapping is used, but in the second unit, the radio frequency transformer, T1, is used for neutralising purposes. It is really necessary to control oscillations in some manner, and the method adopted is the well known system of neutralising the inter-electrode capacities of the valves and associated wiring. This is a modern method which is extremely efficient.

Looking at the circuit diagram, it will be seen that in the first unit the reaction winding, R.R., is used for the aperiodic primary. Actually, it is not really aperiodic, as its relation to the secondary being variable, a certain amount of inductive tuning is effected. The F and E lugs are joined together, thus extending the secondary or grid coil from G to A, therefore joining the primary proper to the secondary coil, making the grid return come from A instead of F, as is the case in the second unit.

The second unit, the radio frequency transformer, uses the primary proper A to E, as the primary of the R.F. transformer, the secondary being from G to F, and the reaction from R to R. The radio frequency valve grid coil is tuned with a .0005 or an .00035 variable condenser, and the detector grid coil is tuned with a similar sized condenser. An Emmcostad is used as filament control for the radio valve, and one also for the detector valve. The two audio valves are controlled by one Amperite. When purchasing this Amperite, specify the

## List of Parts.

- 1 Dilecto or Radion Panel, 24 x 8 x 3-16.
- 2 Aladdin 3 Coil Tuners.
- 2 .0005 Pilot Capacigrads, or
- 2 .00035 Pilot Capacigrads.
- 2 Pilot Vernier Dials.
- 2 Emmcostads, No. 1.
- 1 B.M.S. S.C. Jack.
- 1 B.M.S. Battery Switch.
- 1 .001 mfd. Pilot Isograd.
- 4 Benjamin Sockets.
- 2 F.M.C. A.F. Transformers.
- 1 .00025 Grid Condenser and Clips.
- 1 2 meg. Leak.
- 1 Renrade Neutralising Condenser.
- 1 Amperite for 2 Valves.
- 2 1½-inch Knobs for Tuners.
- 1 Terminal Board.
- 1 Baseboard, 23 x 9 x 1.
- Busbar Screws, etc.

Burgess Went over the Pole with Byrd.

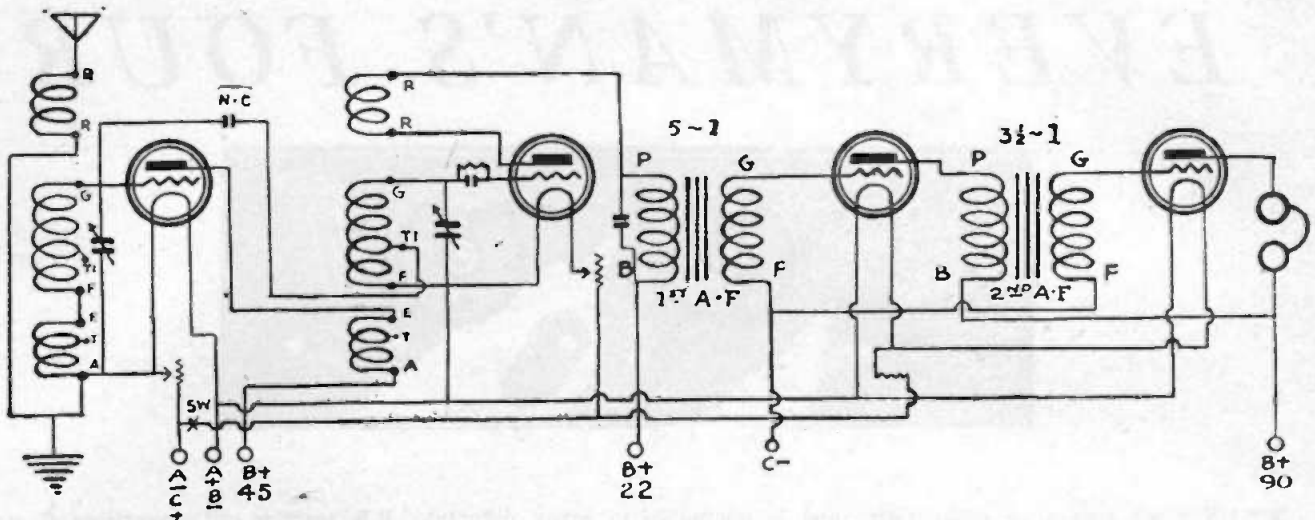

valves you intend using and also the size of the A. battery in voltage, as differently sized Amperites are available for different valves. The usual two stages of audio are added to this receiver, the standard practice being followed of using a larger ratio in the first stage and a lower ratio in the second stage.

Notice that the A. negative and C. positive are connected to the same terminal, and also that the B. negative and A. positive are on the one terminal.

It is suggested that 45 volts B. battery is sufficient for the radio frequency valve and 22 volts for the detector valve, while 90 volts as plate current for the audio valves will be ample. A grid bias battery of from 4 1/2 to 7 1/2 volts will be found suitable. Only by trial can the correct biasing be found.

The construction will not present many difficulties. The front panel view shows the relation of the different parts. The two dials for the condensers will be recognised. The Aladdin tuners are represented by the two small knobs on the left, the Emmcostads by the other two small knobs. A battery switch and single circuit jack completes the panel.

The baseboard components are clearly seen. The Aladdin tuners may be viewed snuggling into the panel, one to the left of the first variable condenser, and one to the right, and close to the second variable condenser. The Amperite is plainly shown, as are the valve sockets, transformers, etc.

Treat the baseboard to a coat of shellac after trimming the edges, and lay out the parts. Follow out the layout given. Remember that the audio transformers should be placed at right angles to one another. Fix the panel to the baseboard, then commence the wiring.

Join the aerial terminal to R2 of the first tuner. Join the earth terminal to A of this tuner, and to the moving plates of the first condenser. Link together one filament terminal of each valve socket, then run a wire to the A positive of the terminal board, which is joined to B negative. Link together the two remaining F terminals of the audio valves, and join to one side of the Amperite. The other side of the Amperite join to a common wire between one side of each Emmcostad. The remaining side of that Emmcostad, which is near the variable condenser, is joined to

the remaining F. terminal of the radio frequency valve socket. The remaining P. terminal of the detector valve socket is connected to the remaining side of the second Emmcostad. Make a connection from the common Emmcostad-Amperite wire to one side of the battery switch, the other side of which joins the A. negative wire terminal to A. negative and C. positive.

On the first tuner join B to F, then take G to G of the radio frequency of the terminal board. Join earth valve, and to the fixed plates of the first tuning condenser. From the G of the first valve take a connection to one side of the neutralising condenser, the other side of which is taken to T1 of the second tuner. Join P of the first valve to E of the second tuner. Join F of this second tuner to the common positive A wire, and to the moving plates of the second variable condenser. Join the fixed plates of this condenser to G of the second tuner base, and to one side of the grid condenser, the other side of which joins G of the detector valve. P of this detector valve is joined to R1 of the second tuner, R2 making contact with the P of the first A.F. transformer. To this wire, solder one side of a .001 fixed condenser, and take the other side to the B. of this transformer and to the B. positive 22 volts on the terminal board. Connect the B. 45 terminal to A of the second tuner.

G of the first audio transformer goes to G of the third valve. F of this transformer joins P of the next transformer, and from here a connection is made to the C. negative terminal. Join P of the third valve to P of the second A.F. transformer and take a lead from G of this transformer to G of the fourth valve socket. Link B. positive 90 volt terminal with B. positive of the second

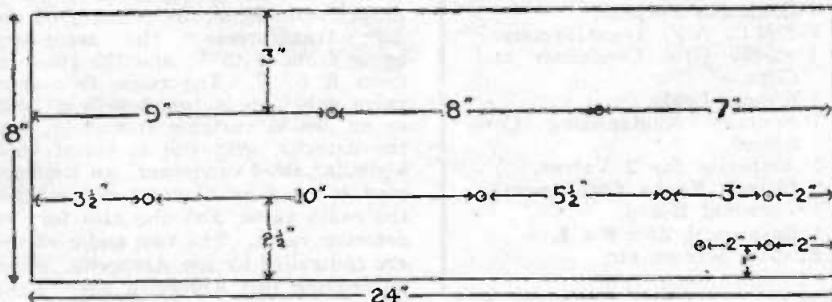

"Burgess" spells "Quality; Life; Service."

# Delighted Users



## The G. & R. "V"

The cabinet, as shown above, is a masterpiece, size 26 x 16 x 11 inches, with a walnut finish. It has two compartments, one on each side, for the A and B batteries. The set is guaranteed to bring in all interstate stations; the illuminated drum control is particularly advantageous for indicating stations at night. A log is furnished with the set, giving the exact location on the drum that will bring in each particular station on a standard aerial.

Price, with 5 G. & R. Valves, no other Accessories ..... £30/-  
 Price, with Accessories complete, £39/10/-

# THE G & R RECEIVER

The G. & R. One Control Five Valve Receiver is a masterpiece in modern Radio Receivers.

*A Single Turn of the Dial Brings in Everything on the Air.*

The new circuit combines in one Receiver ALL the desirable features you would look for in the IDEAL set. Extreme selectivity, great sensitivity for distance-getting. A tonal quality that is a revelation and of exceptional importance for Perfect Reproduction. One illuminated drum tunes in Interstate Stations. Volume controllable.

Get Everything on the Air with the G. & R. Five.

Manufactured by  
**The G. & R. Electrical Co.,**  
 4 HILL STREET, DARLINGHURST

Sales Agents to the Trade:—  
**Manufacturers' Products Pty.,**  
 LIMITED  
 CHALLIS HOUSE, SYDNEY

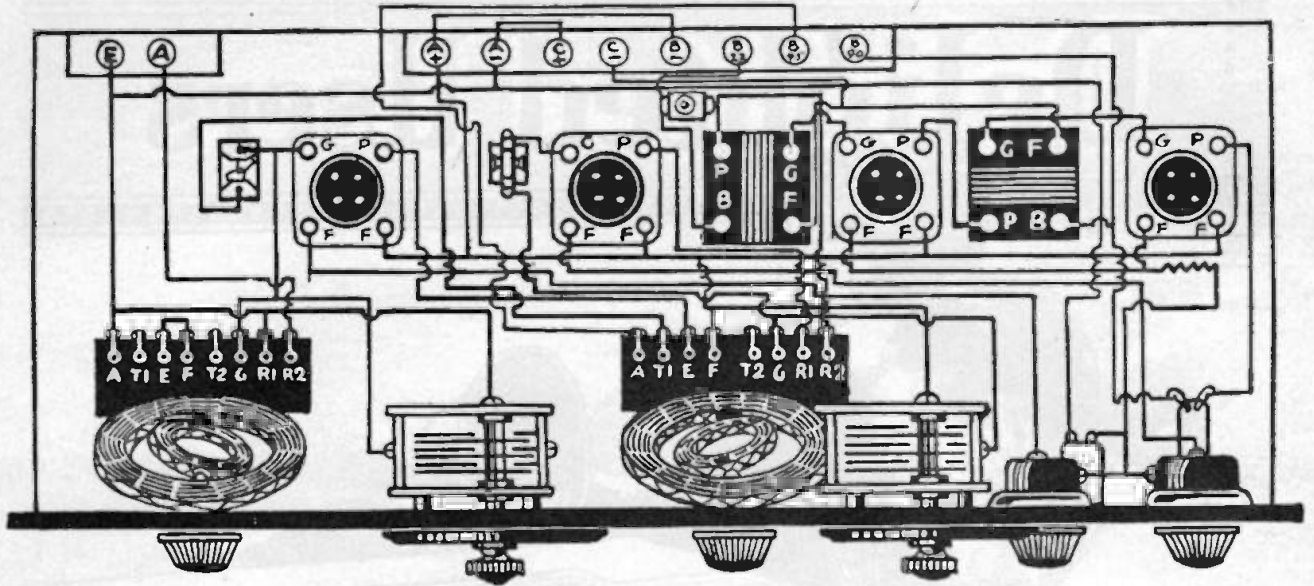

A.F. transformer, and to one side of the jack. The other side of the jack join to P of the last valve. This completes the wiring.

Compare your connections with the plan view, and the circuit diagram. Carefully check over every wire, then test out. Connect the aerial and earth and insert the valves in their sockets. Join up the A. and B. batteries. If 6 volt valves are being used, then a 6 volt accumulator is necessary. Don't expect the best results from 6 volt valves with a 4 volt accumulator, and be judicious when you use a 6 volt accumulator in conjunction with 4 volt valves. The B. battery must be connected in accordance with the valves used. The set illustrated was tested on Cossar valves of the Point One variety, and 22 volts were applied to the detector valve with 60 volts for the radio side. The whole of the battery, 90 volts, was applied to the audio valves with a grid bias battery of 4½ volts.

Try these valves for a start, and plug in the speaker. If the speaker emits a high pitched whistle when first plugged in, turn the knob governing the reaction coil in the second tuner. As this is rotated, the whistle will drop in cadence to a low growl, and finally disappear. If it doesn't entirely vanish, this effect can be produced by lowering the Emmicostad governing the radio frequency valve and also that one which controls the detector. Now tune with the variable condensers. A station will soon be heard. Gradually turn the reaction knob and the volume will increase up to the point of oscillation. Now watch your primary coil control on the first tuner. As it is turned one way or

the other, the volume is altered, and the receiver may oscillate slightly. Adjust the first condenser again to overcome this whistle. Try different adjustments. The local stations will be easily brought in. Seek the interstate now. Careful tuning is required. Find 4QG, Brisbane. Bring it up to the maximum volume. Get a long sharp pointed stick and neutralise. As you adjust this small neutralising condenser, the volume will increase, or decrease, according to the side to which it is tuned. You will find the best adjustment to be near the point where the moving plate begins to be enmeshed within the fixed plates. Tune again, noting that no violent oscillation takes place. A few hours with this wonderful set will be spent in getting to know it properly. No one can learn all about a receiver the first night. It takes a certain amount of understanding. Time alone will yield this.

On actual test at Marrickville the results were good. Melbourne, Bris-

bane and Adelaide were quite good in volume. 2YA of New Zealand on 420 metres, took a little bit of handling to separate from 2FC, but it can be done.

**RADIO AND THE AURORA BOREALIS:** The influence exerted on wireless reception by the aurora borealis has formed the subject of researches by the director of the Goodhaon wireless station in Greenland. He states that tests over a prolonged period have not revealed any increase of diminution in signal strength which could be attributed to the "Northern Lights."

**HAVE YOU FILLED** in your income tax form? Worried looks, labored calculations and fears of sins of omission are plentiful just now. The income tax month provides many problems. SLO, Melbourne, is endeavoring to simplify matters by broadcasting a talk on "Income Tax," by Mr. C. J. Williams, on Monday, August 22nd. Mr. Williams literally wrestles with such problems. Occasionally he talks from the studio on wrestling.

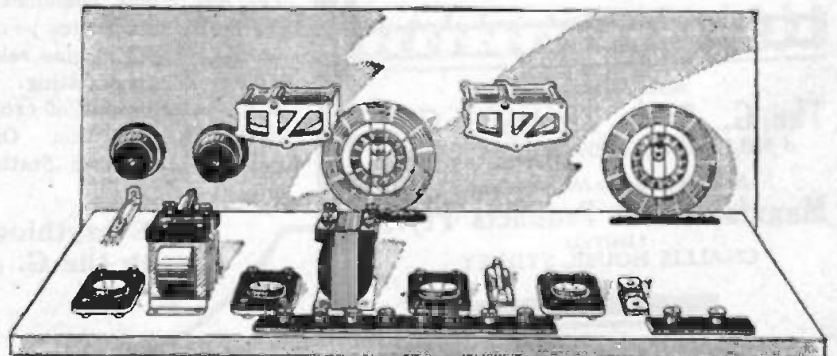

Square Glass Cells with each Philco.

# NEW PRINCIPLES \_\_\_\_\_!

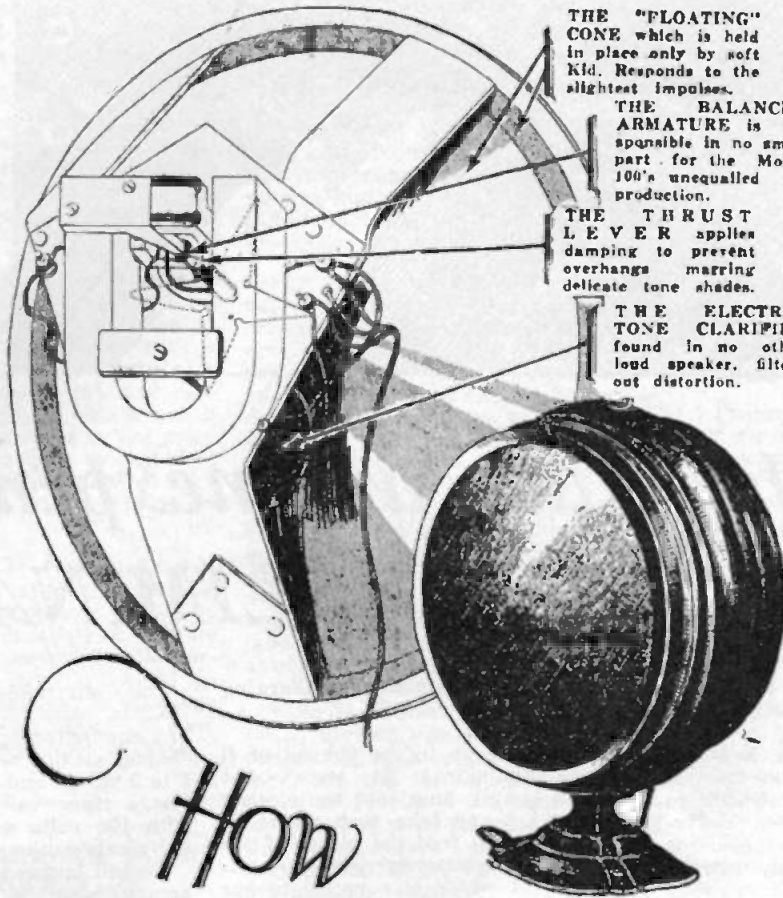

THE "FLOATING" CONE which is held in place only by soft Kid. Responds to the slightest impulses.

THE BALANCED ARMATURE is responsible in no small part for the Model 100's unequalled reproduction.

THE THRUST LEVER applies damping to prevent overhangs marring delicate tone shades.

THE ELECTRIC TONE CLARIFIER found in no other loud speaker, filters out distortion.

## RCA Loud Speaker Model 100

brings headphone clearness to loud speaker reproduction.

FOR months the great research laboratories of the Radio Corporation of America had pored over the problem of clearer, sweeter, loud speaker reproduction. Then—Eureka! New principles were discovered. The "floating" cone and balanced armature ideas were born. An electric tone clarifier to filter out distortion was evolved. And the Model 100 made its bow to the radio world.

YOU need a Model 100. It will bring your set in line with the most recent advances in radio to-day. It will vastly improve your reception. The Model 100 reproduces the complete tonal range. Subtle shades of tone ordinarily missed are reproduced in all their true delicate value. Hear the Model 100 to-day at any City, Suburban or Country Radio Dealer's, or at our Showrooms.

### AUSTRALIAN

53 KING STREET.  
Newcastle

CIVIC CENTRE.  
Canberra

**GENERAL ELECTRIC**  

  
 Australian General Electric Company, Ltd.  
 93-95 CLARENCE STREET, SYDNEY

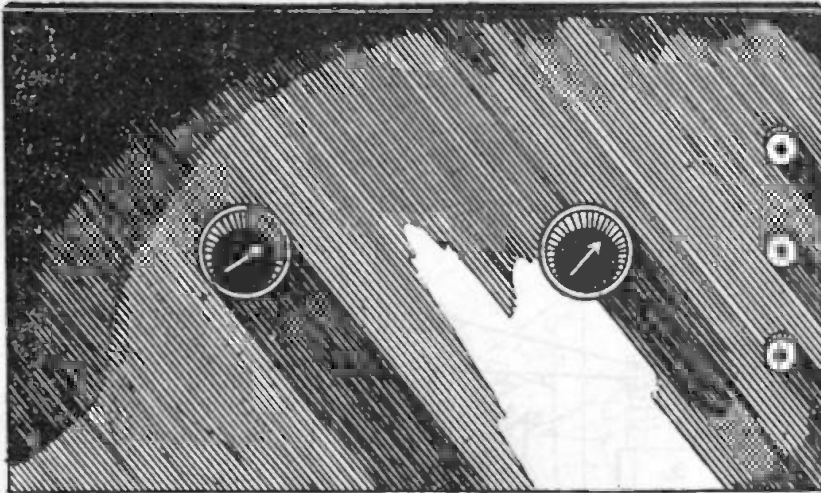

## How to Make an Inexpensive "B" BATTERY ELIMINATOR

THE wireless journals the world over are to-day featuring B battery eliminators; in fact, some are concerned with A, B and C battery eliminators. Most people agree that the biggest drawback to wireless is in the B batteries. Unfortunately the B battery is blamed for more troubles than really can be traced to its door.

That old and worn out B batteries are a source of continual trouble is true, but, frankly speaking, the cost of renewals is that which most people balk at. This is hardly fair, for when one comes to consider that £2/10/ is the cost of 90 volts of a good B battery, which lasts on the average of 6 months. Say, used on the average of 3 hours per day, we have approximately 540 hours' life for 50 shillings, or, roughly, 10 hours for one shilling.

The drawback is that the batteries need renewing always at the time the gas bill, the electric light bill and the rates fall due. How true this is, the reader himself knows.

Wet B batteries have been popular with a number of people, and as these may be recharged they are one solution of the problem. But there are those who claim that the recharging is a nuisance, and again they are faced with the alternative of having to purchase a suitable charger, or

send or take it to a battery charging station.

This brings us to the subject of B battery eliminators. It seems the ideal to simply plug into the electric light socket and take such power as is necessary to feed the plates of the valves. Unfortunately the alternating current which is supplied to our homes is not suitable for this purpose without some modification. Direct and not alternating current is required, therefore the A.C. has to be rectified to D.C. There are several different methods of rectifying A.C., but the most popular at the moment is the valve type. You know how the valve rectifies, and you also know how the Tungar bulb rectifies for charging accumulators. A special valve is used for the average B battery eliminator, this valve being known as a Raytheon rectifying valve.

For our purpose an ordinary UX201a valve is all that is required. The eliminator depicted here is only a simple, small one, suitable for from 1 to 3 valves and no more. On actual test a three valve set was delivered with 100 volts maximum and operated nicely without any trace of hum.

To suit larger sets a more elaborate arrangement is necessary. Being more elaborate it necessarily follows that it will be more expensive. Some other time we will give details for this bigger eliminator, but for the present let us be happy with this little fellow.

The greatest difficulty to overcome with any eliminator is the presence of the 50 cycle A.C. hum. This must be filtered out. To do this large capacity condensers are needed. In this little model two 4 mfd. proved adequate, although perhaps in some instances two 2 mfd. will suffice. In the larger types as much as from 16 to 22 mfd. are used, and this makes an eliminator very expensive. The writer has in front of him now the parts for a larger type of B battery eliminator, and the fixed condensers alone cost £3/7/6. The whole unit for this small job cost less than this. Let us consider the parts and the cost.

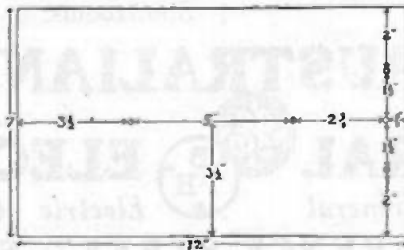

The Mighty 83X Philco is Supreme

1-Bayonet Base Batten Holder . . . . .	£0 1 3
1-Jefferson Bell Ringing Transformer . . . . .	0 11 0
4-2 mfd. Imperia Condensers . . . . .	1 2 0
1-Valve Socket . . . . .	0 2 6
1-.002 Isograd Fixed Condenser . . . . .	0 2 0
1-30 ohms Rheostat . . . . .	0 3 0
1-Bradleyohm No. 10 . . . . .	0 15 0
1-Dilecto or Radion Panel 12 x 7 x 1/4 . . . . .	0 7 0
<b>Total . . . . .</b>	<b>£3 5 9</b>

No consideration has been taken of the valve or the audio frequency transformer. Most of us have a spare valve at home, and also an audio frequency transformer with a broken-down primary winding—burnt out primary most people call this sad state. The secondary of an average 5 to 1 ratio transformer is a suitable substitute for the usual expensive 30 heavy choke. Although the parts listed have to be purchased, this applies only if the constructor hasn't a "junk" heap large enough to supply these parts.

It is admitted that the Bradleyohm No. 10 is somewhat expensive, but if this is not available one of the many types of Emmcostads will suit, and they are only half the price. The Emmcostad, which has a range of from 10,000 to 100,000 ohms, is the correct unit. The idea of using the Bradleyohm or Emmcostad is to make a separate provision for the detector valve. If the receiver employs a stage of radio, detector and one stage of audio then connect the radio and detector valve to the detector B positive terminal for a start. It may sometimes be wise to join the radio tapping to the B positive audio tap, but this can be learned only by trial.

Still the construction presents little if any difficulty. The front

view shows the appearance of the completed panel, which is 12 inches long by 7 inches deep. On the left is a standard rheostat, and on the right is the Bradleyohm 10, which gives the separate tapping for the detector voltage.

The detector voltage is varied by means of the adjustment of the Bradleyohm. As low as 22½ volts is obtainable, and up to 80 volts, this range being sufficient for most purposes. The rheostat included is not absolutely necessary, being a refinement only, the eliminator functioning quite well without it.

The front panel view shows the rheostat on the left and the Bradleyohm on the right. Three terminals on the extreme right are for the output, the top end being convenient for the B negative, the middle one for the B positive detector, and the bottom one for the B positive audio valves.

Looking at the two circuit diagrams it will be seen that both are similar. Across the secondary of the bell ringing transformer in one diagram is a potentiometer. This is another refinement and is only necessary if A.C. hum is pronounced. For our purpose the circuit without the potentiometer is being used. Compare both circuits for a few moments.

Having all your components at hand, begin the construction. Examine the bell ringing transformer. On one end will be seen two heavy electric light wires, one white and one black. On the other end will be seen three terminals, and on looking closely you will find that the first two on the left, that is, the left hand and the middle terminal, are marked 6 volts. These are the two which interest us.

The panel layout is simple in the extreme, but still a diagram is provided as a template. Drill the panel, not forgetting the necessary holes to

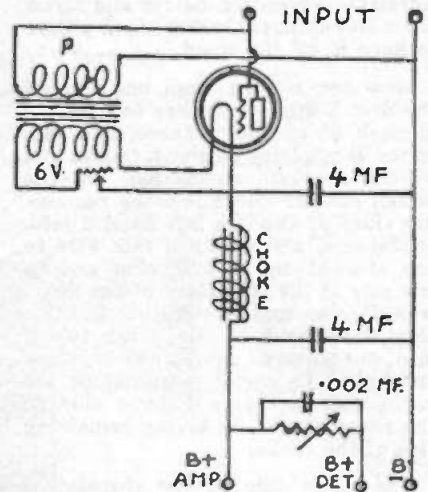

allow the screws to pass through to hold the panel to the baseboard. Mount the rheostat and the Bradleyohm and the three terminals. Fix the panel to the baseboard and lay out the baseboard parts.

The plan view will show this. Note the bell ringing transformer on the left near the rheostat. Behind again is the bayonet base batten holder, an ordinary electric light socket for baseboard mounting—you know the type of thing used at home to hold the red or pilot lamp for the iron point—that is what is wanted. As no 4 mfd. condensers were available, the writer had recourse to four 2 mfd. condensers, and they are seen at the back of the baseboard.

The valve socket is between the bell ringing transformer and the audio transformer. That little fixed condenser between the valve socket and the panel is the .002 mfd. Pilot condenser, which is connected across the Bradleyohm. Lay out the parts as suggested in this view and begin wiring.

Spaghetti covered wire is advised here. Begin by connecting the two heavy electric light wires to the batten holder. Unscrew the shade ring, then the clamping ring from the brass portion of the batten holder. The porcelain insulating material will then be on view. Look closely and you will see the two small holes which go through from the bottom of this porcelain portion to the brass plunger base on the top. Bore the heavy wire and fitting the base of the batten holder over the two heavy wires, insert one connection into one hole until it comes opposite the screw in the brasswork of the porcelain and grip it with the screw. Repeat the process with the other side, paying strict attention to the fact that neither of these wires should touch one another.

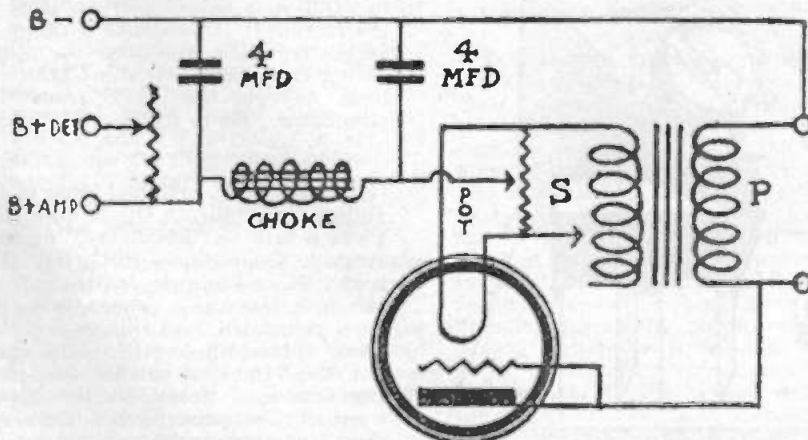

You can Recharge a Philco for a few pence.

Assemble the batten holder and screw down on baseboard, using small pillars to keep it off the wood.

Now run a wire from one side of the first 2 mfd. condenser to one side of each of the other three, and join to the B negative output terminal and to the nearest connection on the batten holder. Next join the remaining sides of the two left hand 2 mfd. condensers, and continue this wire to one side of the Bradleyohm and to one side of the secondary of the audio transformer and to the B positive amplifier terminal. The other two 2 mfd. condensers are joined together and taken to one F terminal of the valve socket, thence to one side of the rheostat and on to the remaining side of the choke.

The other side of the rheostat is joined to one of the terminals of the bell ringing transformer. The other 6 volt terminal of this bell ringing transformer is joined to the remaining filament terminal of the valve socket. Join the G and the P of the valve socket together, and continue it to the nearest side of the batten holder. Connect the .002 mfd. Pilot condenser across the Bradleyohm, thus completing the wiring.

Bear in mind that only the secondary portion of the audio transformer is used—it doesn't matter if the primary is "burnt out." Check the wiring with the combined plan view and wiring diagram, as well as the circuit diagram. Now connect a length of flexible wire, say 23/36 gauge electrical flex, to a bayonet adaptor in the usual manner, and to a 2 pin plug, or whatever is desired to make connection with the electric light.

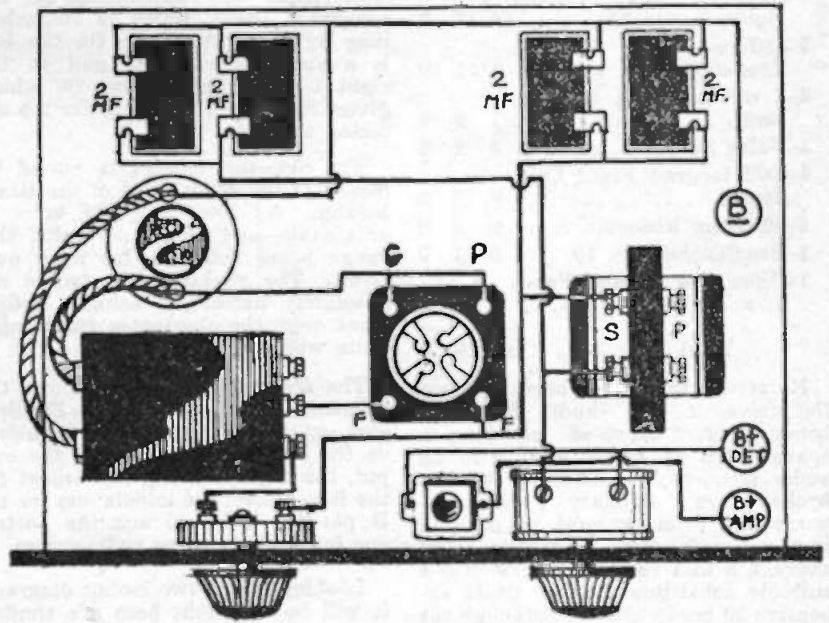

Plug the adaptor into the batten holder and the other end into the electric light or power point, and insert a 201a valve in the valve socket. Connect up the output terminals to the set. Switch on the electric light and turn up the rheostat. Tune in on the set, keeping the eliminator at least three feet from the receiver. No A.C. hum should be discerned; if any, it should be very slight. If this hum is pronounced, move the eliminator a little further away from the set and reverse the connection from the light point to the batten holder. Simply take the bayonet adaptor out of the

batten holder and reverse it—turn it round and reinsert. This invariably helps matters.

Another system to overcome pronounced hum is to earth all the metal cases of the components. Try it. The Bradleyohm regulates the detector voltage. Turn it and notice the difference. One of the best selling is found; leave it at that.

Remember this eliminator is not suitable for a five valve set, only from one to three valves should be connected to it. When the night's reception is over, turn off the electric light switch and remove the batten holder if desired. Perhaps it may be found necessary to use two "burnt out" transformers as chokes. If so, connect them in series. There is no harm in trying, because this little fellow is worth while getting to work properly. A little patience may be required, so don't be afraid to exercise it. Different valves may be tried in the rectifier. If you have a range of valves try them one after the other, noting the results. It won't take you long to get the best from the eliminator. Go to it!

**JAMES HAY**, principal tenor of the Gilbert and Sullivan Opera Company, gives a talk on "Ruddigore," on 25th August, from Studio 2FC. On that night, Miss Vivia de Loitte, wife of the late Howard Vernon, who has been associated with Gilbert and Sullivan operas all her life, will carry out No. 7 musical competition, playing excerpts from these popular operas. The prize is a Gilbert and Sullivan score, to be selected by the winner.

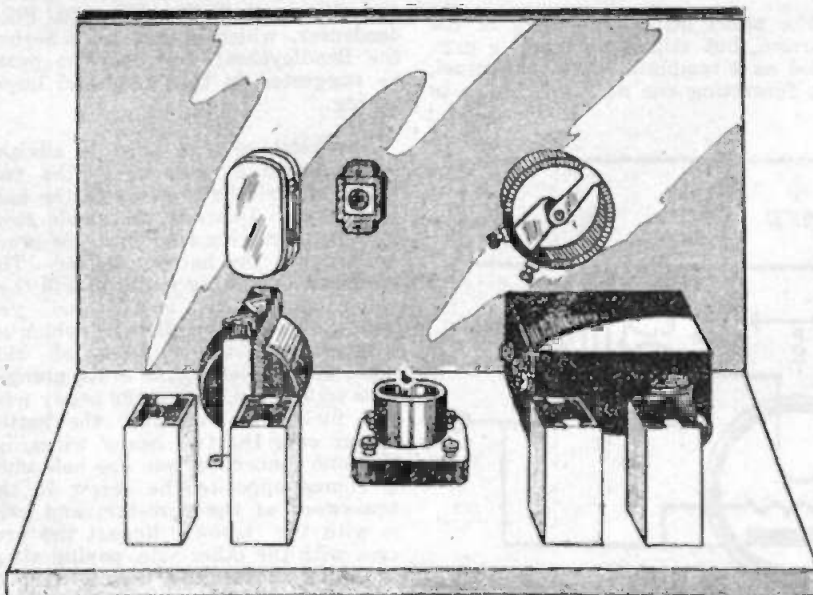

Over-size Burgess for Heavy Current Drains.



# BRIGHT STAR

A, B and C BATTERIES

*“They Last Twice as Long”*

A big statement, but one which is quite common among the users of Bright Star A, B and C Batteries. They are made to last, that's why you pay a reasonable price for them, but, strangely enough, no higher than myriads of other types.

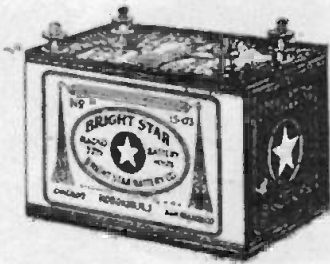

22½ Volt.  
C or B Battery, 11/9

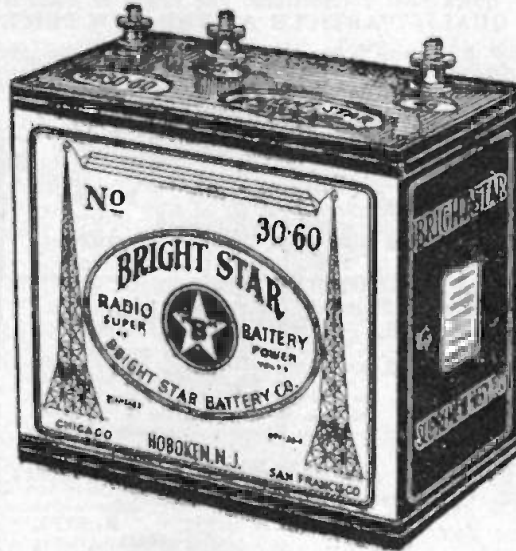

45 Volt, Triple Duty B, 33/-

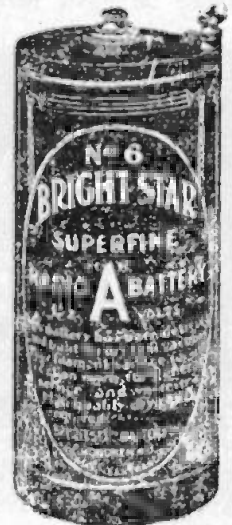

No. 6  
1½ Volt.  
A Battery

## BRIGHT STAR

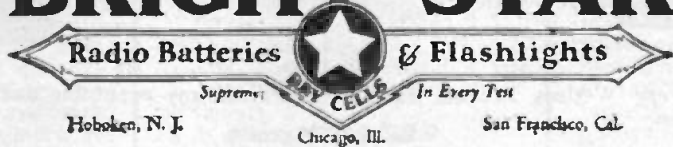

Hoboken, N. J.

Chicago, Ill.

San Francisco, Cal.

SEND FOR OUR NEW FREE CATALOGUE

**International Radio Co. Ltd.**

200 CASTLEREAGH ST. :: :: SYDNEY

W. & G. GENDERS LTD., Hobart and Launceston

RADIO IMPORTS LTD., Adelaide

# WETLESS PRODUCTS

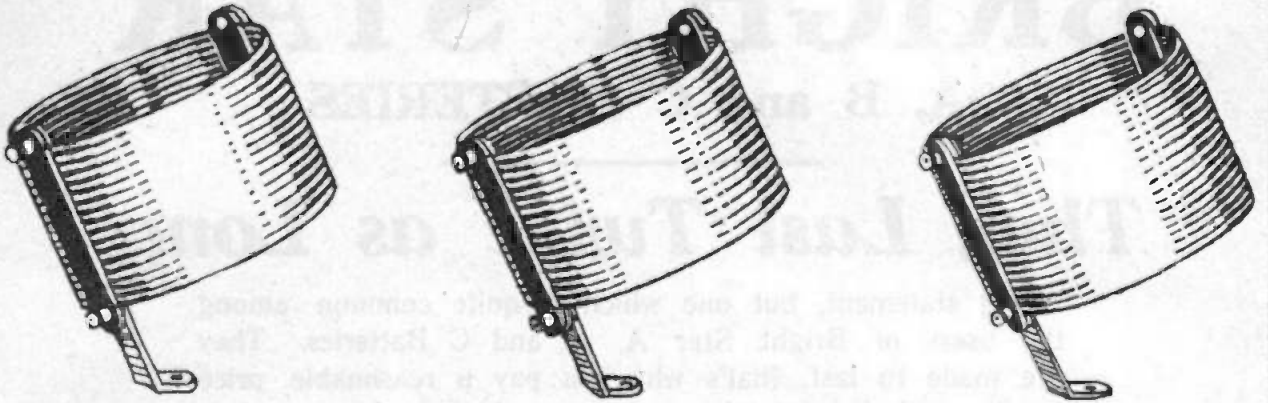

The secret of success in a Neutrodyne lies in the coils used. Ensure your success by using **THE WETLESS NEUTRODYNE KIT.**

There is a minimum of di-electric in the field making for maximum amplification and selectivity. Neat branded terminals permit quick neat connections. The angle of each Neutrodyne is correct to a degree. **A QUALITY ARTICLE AT THE LOW PRICE OF £1/7/6.**

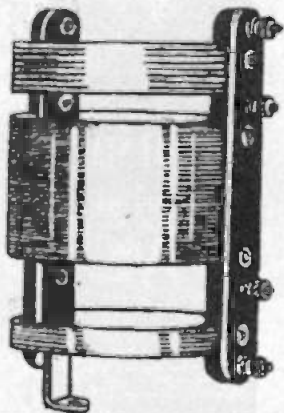

The Wetless Reinartz Tuner meets the demand of the Reinartz receiver man.

Built along similar lines to the Neutroformers; neat and efficient. Guaranteed.

Price, 12/6.

The Well-Known Single Roter Three-Coil Tuner is one of the latest Wetless products. Sturdily built, positive connections throughout. Correctly designed, primary, secondary and reaction.

Price, 13/-

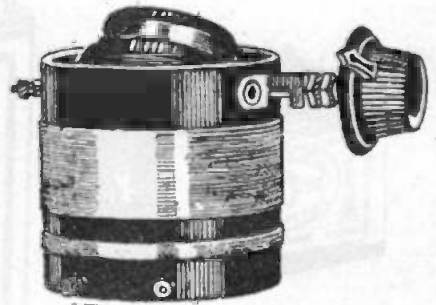

The Wetless Mica Fixed Condensers need no introduction. For years they have stood the test of time. Made in two types and all capacities. Look at the prices.



A TYPE.	
.0001	} 1/6
.00015	
.0002	
.00025	
.0003	
.0004	
.0005	
.001	
.002	
.00025 Clips	
B TYPE.	
.0001	} 2/-
.00015	
.0002	

B TYPE.		
.00025	} 2/-	
.0003		
.0004		
.0005		
.001		
.002		
.00025 Clips		2/6
.003		2/6
.004		2/6
.005		3/-
.006	3/6	
.0075	3/9	
.01	5/-	
.02	5/6	

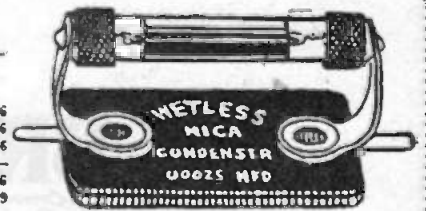

Every Wetless Product may be had from any reputable dealer.

Wholesale Agents:

AUSTRALIAN GENERAL ELECTRIC CO., LTD., 93 Clarence Street.  
 HARRINGTONS LTD., 386 George Street. HOPKINS AND WITTS.  
 WELDON ELECTRIC SUPPLY CO., LTD., 352 Kent Street.

Manufactured by—

**J. WETLESS, 28 KING STREET, ROCKDALE**

LW 1155.

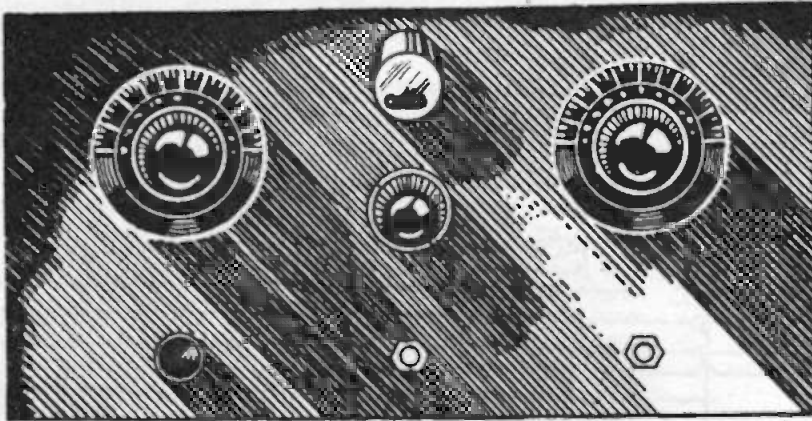

# The Harkness Reflex Receiver

*The demand for the back number of "Wireless Weekly" containing this circuit has so far exceeded the supply that we are constrained to publish it again. Hundreds and hundreds of reports have been received from constructors showing that it is undoubtedly the most popular circuit of its kind.*

**R**EFLEX receivers are not in any way a new idea. Shortly after the inception of the three-electrode valve, reflex or dual amplification receivers were produced. Many are their advantages, the main one being economy in cost of construction and upkeep. This economy is produced by the fact that one valve does the work of two, thereby saving the cost of a valve and the cost of keeping up battery power.

There are many reflexed receivers, the more popular being the ST.100, the Grimes Inverse Duplex and the Harkness Reflex. The latter is the loudest and sweetest two valve receiver I had heard. A most remarkable volume, combined with clarity of tone, places the Harkness Reflex in a category of its own. While being tested at Dulwich Hill, those present were pleasantly surprised to hear the comparisons between this two-valver and a four-valve receiver. The volume was comparable and the purity was superior. Now, who is going to build a receiver of this type? Look at the illustrations and assure yourself that you are looking at a remarkable set. The front view is quite pleasing—no coils sticking out in front—just two condensers with a rheostat between these two, above which is the crystal detector. The battery switch, and the two jacks are seen at the bottom of the panel. Simplicity of tuning is thereby gained—no coil coupling to consider; simply turn

## Parts for the Harkness Reflex

- 1-Dilecto or Radion Panel 14 x 7 x 3-16.
- 2-.0003 Gecophone Variable Condensers.
- 1-30 Ohms Pilot Rheostat.
- 1-B.M.S. D.C. Jack.
- 1-B.M.S. S.C. Jack.
- 1-Battery Switch.
- 1-Harlie Crystal Detector, or
- 2-Lion Crystal Detector.
- 2-Gecophone or Ferranti Audio Frequency Transformers.
- 2-H.T. Transformers (as described).
- 1-Terminal Board.
- 2-3in. x 3in. Dilecto or Radion tubing.
- 8-ozs. No. 24 D.C.C. Wire.
- 1-Baseboard 12 x 9 x 1/2.
- Busbar, Screws, etc.

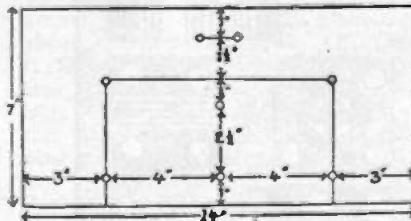

the condenser dials. The back of panel view shows the coils, transformers, valve sockets, and terminal board. The aerial and earth terminals are on the same board as the battery terminals, thus keeping ugly stray wires from the front of the receiver.

Although this layout is neat, maximum efficiency is not sacrificed to gain good looks, rather does it yield itself to efficiency, as may be seen from the back of panel wiring diagram.

The ready-wound coils for this receiver were once available on the local market, but with the exception of a spider-web type, the solenoid coils are all sold. But don't let this worry you, as they are easy to make, half an hour being all the time required.

An analysis of the circuit shows that the greatest drawback of most reflex receivers is absent in the Harkness. Usually in reflex receivers the crystal is in the plate circuit of one of the valves, and means that the plate current flows right through to the plate. This is a disadvantage, inasmuch as it is a constant wear on the crystal, which, sooner or later, gives trouble. In the Harkness, the crystal is entirely free from the plate potential, being included in the secondary circuit of radio frequency transformer (R.F.T.2).

With one valve, good speaker

World's Best Rechargeable Battery; Philco.

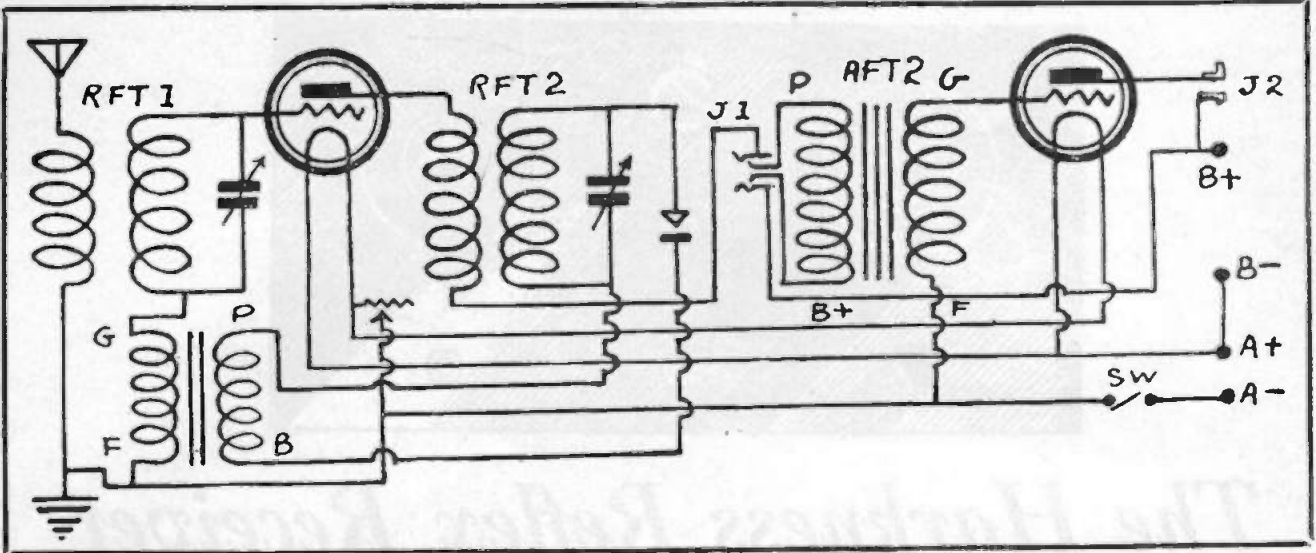

strength is obtainable, but the addition of a second valve means much greater volume without sacrificing purity.

**Construction.**

The coils or radio frequency transformers, as they are known, are the first consideration in the construction of this two-valver. The two pieces of bakelite or composition tubing are required for this purpose. Half an inch from one end of the tubing drill two holes with a small drill, about one-sixteenth of an inch in diameter. Through these two holes, doubling back from one to the other, thread the beginning of your No. 24 D.C.C. wire, leaving about 6in. free from connections. Then wind on this tube, one turn close to the other, sixty turns of your wire, and hold the wire securely and prevent any slipping which may

take place. Procure a strip of good, strong paper, 12in. long and 1in. wide, and wrap this around this winding just completed, keeping it in the middle. Apply a little gum to hold this firm, and wind on your primary, which consists of 15 turns of the same gauge wire wound in the same direction. It may be a bit difficult to hold the beginning of this wire securely, but here's how to do it.

A piece of tape, 3/4in. wide by 2 1/2in. long, is pressed into service. Fold the tape in two, now giving a double piece, 3/4in. wide and 1 1/2in. long. Into the top of the fold, slip one turn of your wire, leaving about 6in. hanging free, and lay this tape longways across the present winding and on top of the paper, and proceed to wind your primary turns over this tape until you have fifteen wound on. Cut

your wire, holding your primary turns over this tape until you have fifteen wound on. Cut your wire, holding your primary turns in place with your

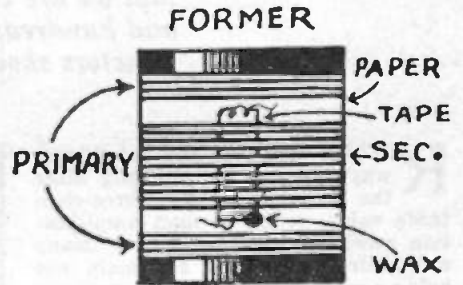

finger, and make secure by applying a small portion of sealing-wax at that particular place where the last turn crosses the protruding tape at the bottom.

The second radio frequency transformer (R.F.T.2) is wound in a similar manner to the first, only instead of having a 15-turn primary this coil boasts of a 35-turn primary, which should be wound in a manner similar to the primary of the first transformer. Carefully place these transformers out of harm's way until you drill your panel.

**Panel Layout.**

The panel layout is indeed simple, as may be seen from the plan. Again I must advise that provision only is made for the centre spindle of the condensers, on account of the many different makes of condensers with different templates. As previously mentioned, the crystal detector is above the rheostat, but the position of this depends upon the type of detector used. I, myself, used the Harlie detector for this receiver and found it to be satisfactory, but the Carborundum detector, frequently employed in our different circuits, would, no doubt, be quite satisfactory. Quite a lot de-

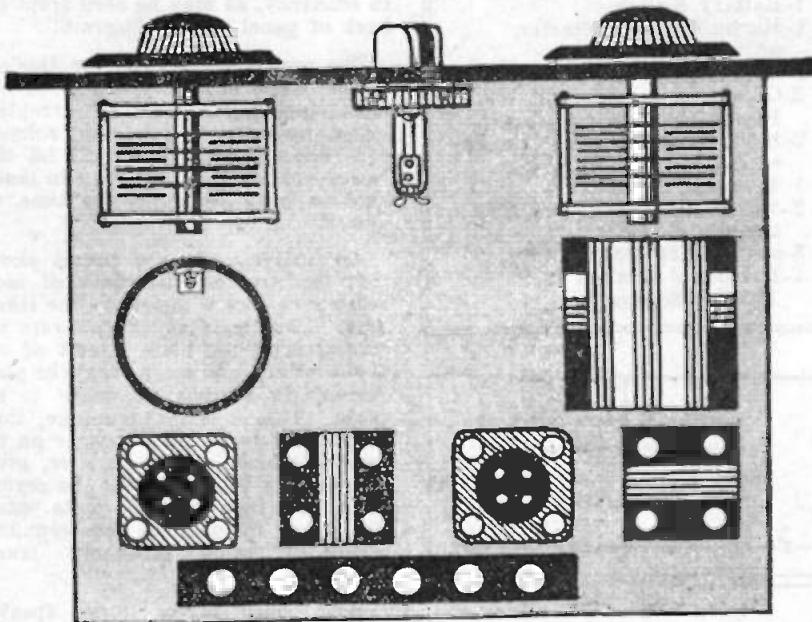

Burgess Went with U.S. Mail Flyers.

depends upon the crystal, so, whatever type you use, be sure that it is a good brand, and of stable qualities. Again, you will find that one rheostat only controls the two valves, this being quite in order, as both valves are amplifying valves.

Beneath the rheostat is found the double circuit jack, the single circuit being to the right and the battery switch situated to the left. Take care in drilling this panel, for, after all, it is the show window. When the drilling has been completed, mount your panel apparatus, screwing everything up tightly and securely, as there is nothing more annoying than a rattle in your receiver, which is caused by imperfect contact or loose screw.

**Baseboard.**

On the baseboard are mounted the coils, valve sockets, transformers, and terminal board. The layout adopted will be easily seen from the back view of the panel. I don't think you could do better than follow this out. The coils or radio frequency transformers are secured to the baseboard by means of two brackets in each case. Strips of thin brass will be found efficacious here, and the height of the coils should be 1in. above the baseboard. The fashioning of these brackets calls for

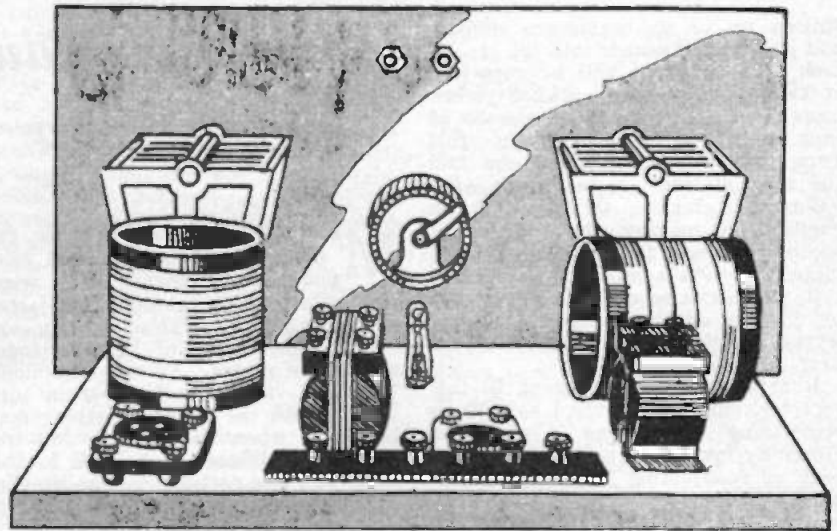

practically no engineering skill, a pair of pliers and a drill sufficing to make the bends and fill the holes. Attention must be paid to these coils, inasmuch as one must be mounted at right angles to the other. Perhaps, I should have advised you in the winding of these coils to begin and finish your primary windings on the opposite

sides of the formers to the side on which you started and finished your secondary winding. Don't forget, of course, that your secondary winding is wound first, and your primary winding is wound on the top of this coil. Don't confuse these terms.

**Wiring.**

Carefully proceed with your wiring, consulting the back of panel wiring diagram and the circuit diagram to attain success in this. Before permanently attaching your panel, connect one side of your battery switch to the nearest side of your rheostat, this wire being somewhat awkward to insert after the panel is permanently secured to the baseboard. Take this wiring in easy stages, making neat right angled bends in your busbar and check off carefully with back of panel diagram and the circuit diagram. A consultation with the back of panel view will assist you greatly, as quite a number of these connecting wires may be seen in the illustration. Properly solder every joint, where soldering is called for. A small piece of mica placed underneath two joints to be soldered, and held close to the bottom of these joints, will ensure the soldering running in properly, and not dropping on the baseboard or on any instruments which may be underneath. Always wipe off the residue of flux, or soldering fluid, after you have soldered the joints, as this will prevent any corrosion at a later date.

When everything is wired and checked off carefully the receiver is in a condition to be tested on the air. Connect up your "A" and "B" batteries, insert your valves in their sockets, hook on the aerial and earth, and plug in your 'phones on the first jack (J1). Being assured that your crystal is properly inserted, turn up your rheostat and slowly move your condensers and you will hear the station at most astounding volume, considering that only one valve and a crystal is in the circuit. Bring this

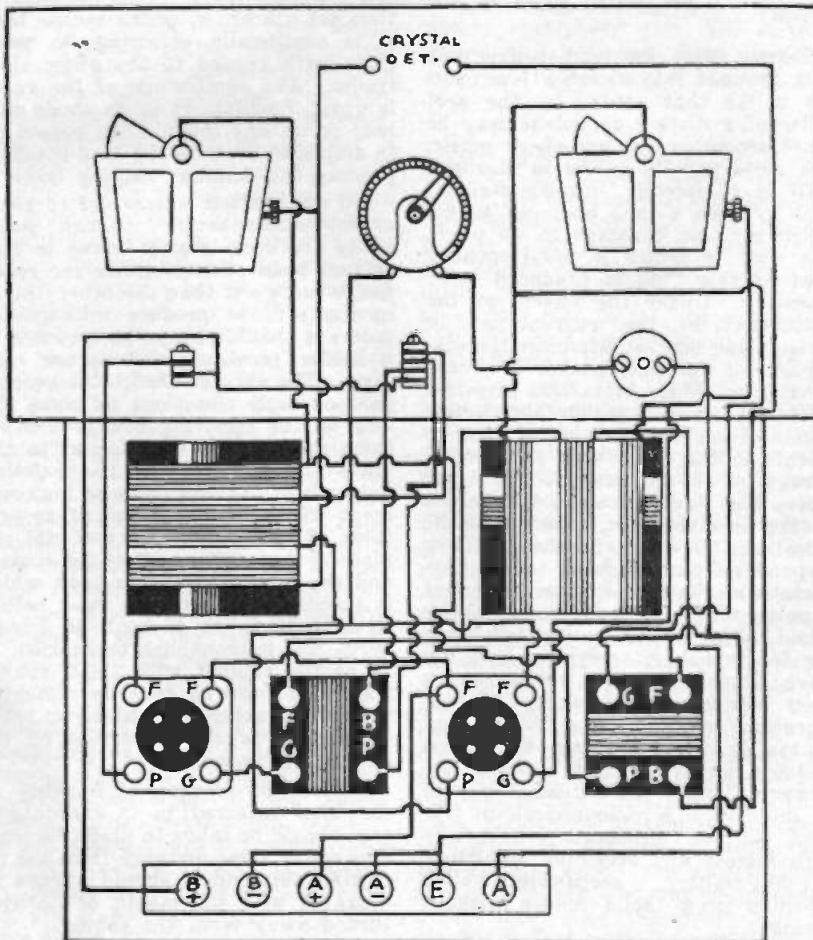

Philco Batteries Save Pounds in a Year.

## Vibration Causes Microphonic Noises in a Radio Receiver

station up to its maximum volume, and plug your speaker into the second jack (J2), and you will be surprised at the volume your speaker yields. Listen carefully to the excellence of tone quality. It is really wonderful! Turn your condensers until you find the next station; note again the volume and clarity. Of course, if you enmesh the moving plates of your second condenser too far into the fixed plates, a certain mushiness may result, which can be overcome generally by finding another setting on your crystal detector or re-tuning with your first condenser.

Buzzing is seldom present in this receiver, only the slightest sometimes registering itself, and is overcome either by lowering your rheostat current or readjusting your crystal detector.

Any standard make of valve will suit this receiver, which functions best with a "B" battery voltage of between 60 and 90 volts, the latter being preferable if maximum volume is desired. As before mentioned quite good music may be obtained on the speaker with one valve only, and there is no particular care required in balancing or adjusting the Harkness. There are no howls or squeals to worry you nor your neighbours, so that this receiver comes under the class of non-radiating receivers, which will be the most popular of all very shortly.

### BRITISH POST OFFICE EXPERIMENTS IN SHORT WAVE TRANSMISSION.

A very interesting announcement was made from 2FC on Friday last in regard to experiments to be carried out by the British Postal Authorities in short wave transmission. The information was received by 2FC by radio from Rugby and reads as follows:—

"In a week's time an interesting wireless experiment will be undertaken by the General Post Office. There are certain areas in different parts of the world where wireless signals transmitted on long wave lengths can only be received with difficulty at all, while in other places such signals can only be received at certain hours of the day. With the object of ascertaining to what extent short wave transmission may be capable of reaching such areas, the British official press will be transmitted for two months beginning on September 8th on long and short wave simultaneously. The same call sign will be used and the long wave will remain as it is at present. The short wave will be twenty-two metres at noon, Greenwich meantime transmissions, and thirty-seven metres at eight p.m. and midnight. Reports on reception by stations will be welcomed by the General Post Office."

**M**ICROPHONIC noises are the sounds produced in the telephones or loudspeaker of a wireless set when the cabinet is subjected to jarring or vibration. They are due to movements of the electrodes within the valves. As an experiment, tap each valve in the set in turn lightly with the finger. Nothing may be heard when the high or low-frequency amplifiers are treated in this way, but the rectifier is almost sure to respond, a "pong," which may or may not be very loud, being heard. Similar "pongs" will be produced by any valve in the set that is oscillating or close to the point of oscillation. Where microphonic effects are particularly marked the lightest touch upon the cabinet or even walking across the floor may be sufficient to cause the ringing noise to occur. Microphonic tendencies are likely to give rise to a fault that may be very puzzling if the cause of it is not known.

Shortly after the loud-speaker has been brought into action a low noise not unlike that made by the propeller of a distant aeroplane may be heard accompanying speech or music. The noise rapidly grows in strength until it completely drowns signals; it is by then a loud booming sound, which remains constant in its pitch. The way in which a low-frequency howl of this kind is produced is of interest. Under the effects of the fluctuations in the current passing through the magnet windings the diaphragm of the loud-speaker is caused to vibrate. These vibrations give rise to sound waves which strike the drums of our ears and cause them to vibrate in the same way as the diaphragm of the instrument. The sound waves also impinge upon the valves of the receiving set, causing slight vibrations to occur in them. They respond by passing back to the diaphragm of the loud-speaker electrical impulses which give rise to a ringing sound. The sound is emitted from the loud-speaker, corresponding air waves travelling to the valves, where they increase the strength of the vibrations already occurring. And so the process continues, the sound building up in strength until it becomes at times almost deafening in its intensity. A vicious circle of this kind can be produced deliberately with almost any receiving set using a dull-emitter rectifying valve, mounted in a solid holder without springs.

Within the bulb of the valve are three electrodes, the grid, the filament, and the plate, which are attached to the glass pinch by means of metal supports. All of these, the electrodes and their supports, have natural frequencies of their own at which they vibrate when jarred. Experiments have shown that microphonic effects are due mainly to vibrations of the filament, of which the natural frequency is often such as to produce an audible note. In the old, bright valves, the filaments were, comparatively speaking, stout, and there was for this reason little tendency on the part of the valves to ring. Many of the modern dull emitters have filaments considerably finer than a human hair. When the bulb of the valve is tapped, or when vibrations caused in any other way reach it, they are conveyed to the pinch and thence, by way of the filament supports, to the filament itself. The filament is thus set vibrating, which means that it is continually changing its positions with regard to the other electrodes. The equilibrium of the valve is upset, fluctuations in its anode current occur, and these, when passed on in amplified form to the loud-speaker, produce the familiar ringing noise.

All dull-emitter valves are to some extent microphonic, though some kinds are considerably worse in this respect than others. Since the rectifier is more apt than the other valves in the set to produce microphonic noises it should always be mounted in a holder provided with spring contacts. The springs absorb the greater part of such vibrations as come the way of the receiving set, preventing them from being transferred to the valve itself. Where the existing holder is of the solid type an improvement will generally result if several folds of some soft thick material are placed between the base of the cabinet and the top of the table upon which it stands. Another very good palliative—there is at present no known cure—for microphonic tendencies, is to fit the cabinet with small rubber feet, which can be done by attaching revolving rubber boot heels or small door-stops to the underside of the base at the corners.

Where low-frequency howling of the kind referred to is encountered care should be taken to place the loud-speaker at some distance from the receiving set, and it should always be operated with the mouth of its horn turned away from the cabinet.

Burgess Went over the Pole with Byrd.

# CROSLEY RADIO

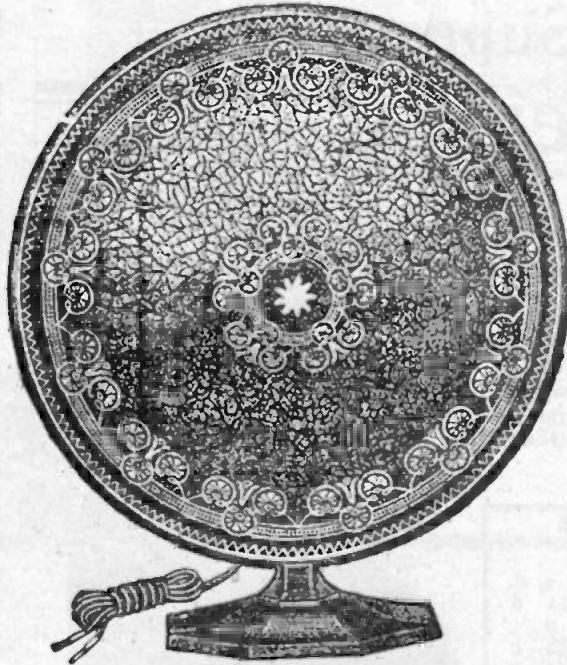

CROSLEY MUSICONE £3/5/-

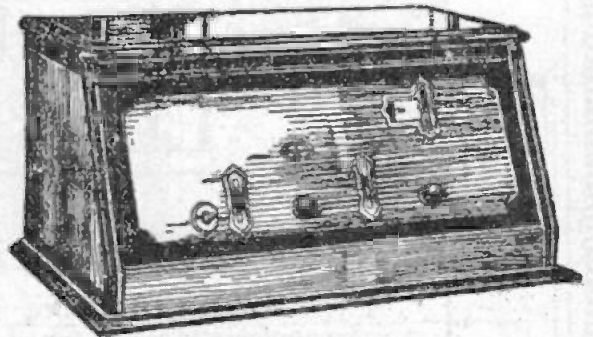

CROSLEY 6.60. 6-VALVE SET £25/10/-



CROSLEY MUSICONSOLE £10/10/-

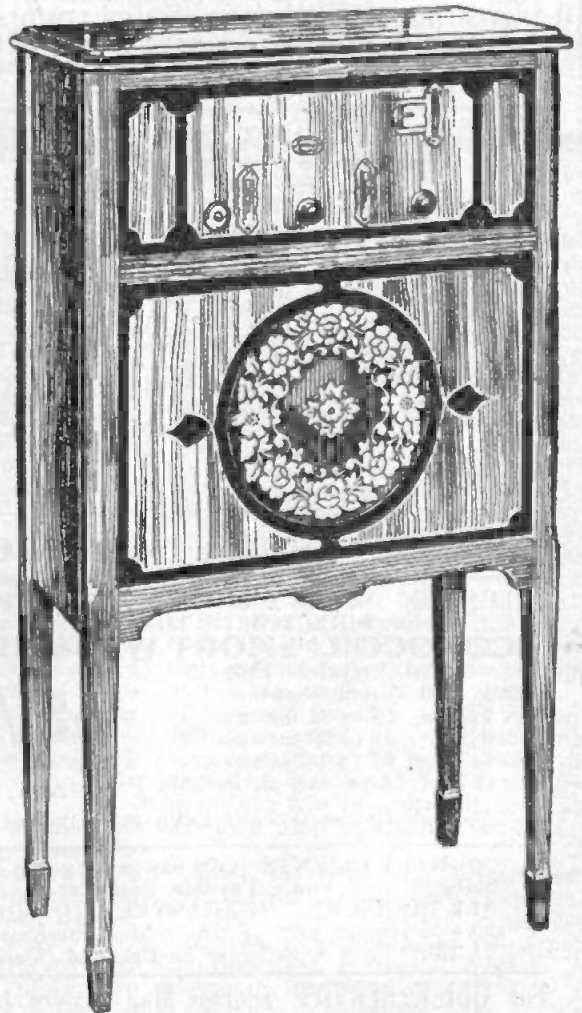

CROSLEY 6.85. 6-VALVE SET £36/10/-

Factory Representatives:

**International Radio Co., Ltd.**  
200 CASTLEREAGH STREET, SYDNEY, N.S.W.  
Send For Our New Free Catalogue

ANOTHER SHIPMENT HAS JUST ARRIVED

The "Wheelan Supercone"

Loud Speaker

15/-

15/-

The amazing Values we are offering in Loud Speakers have created a demand unprecedented.

SEND AT ONCE before it is too late for one of these wonderfully clear-toned, adjustable, 4000 ohm. Speakers

IF YOU PREFER THE HORN TYPE LOUD SPEAKER, there is no better value to be obtained anywhere than the PUREMAX GIANT, 27in. high, 14in. bell, 4000 ohms adjustable.

AT

54/-

The KLOTZ 2-Valve RECEIVER

Described in This Issue.

	£	s.	d.
1 Radion Panel, 14 x 8 x 3-16	0	11	8
2 Eco Centreline Condensers, .0005, 10/-	1	0	0
2 Emmco Bakelite Vernier Dials, 7/6	0	15	0
2 Certified 30 ohm. (One-hole fixing) Rheostats	0	4	0
3 Radiokes R.F. Chokes, at 8/6	1	5	6
1 Wetless Reinartz Coil	0	12	6
2 Kelford Anti-vibration Sockets, U.X., at 3/-	0	6	0
1 Single Circuit Jack (Pilot)	0	2	0
1 Wetless Mica Condenser, .0003	0	1	6
1 Wetless Mica Condenser, .001	0	1	6
2 Wetless Mica Condensers, .0001, 1/6	0	3	0
1 Crescent Audio Transformer	0	13	6
1 Doz. Square Buswire	0	0	10
2 Lengths Spaghetli, 3d.	0	0	6
1 Standard Terminal Board	0	2	9

This Set of Quality Parts costs £6/0/3



Pure Tone, Volume Surprising, Adjustable Unit.

The Puremax Loud Speaker

27in. High, Adjustable

£2/14/-

TUNE IN TO THE EMPIRE BROADCASTS DIRECT WITH THE

'ECONOCOIL' SHORT WAVE KIT

This Outfit Comprises Plug in Coils and Circuit Diagram.

No. 1 Tunes 15 to 34 metres.

No. 2 Tunes 31 to 68 metres.

No. 3 Tunes 57 to 133 metres.

And Stand and Adjustable Primary.

55/-

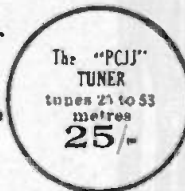

The "PCJJ" TUNER tunes 25 to 53 metres 25/-

THE "ECONOCOIL" BROADCAST BAND PLUG IN COIL (For Above) 11/-

THE "ADVANCE" SHORT-WAVE TUNING CONDENSER, .00014

COUNTRY CLIENTS:—We pay carriage on all orders of 10/- and over, except on Speakers, Cabinets, Batteries and Value Payable Post Parcels.

ALL GOODS ARE GUARANTEED TO YOU. If not satisfied, return same in good order within 10 days of receipt, and we will refund purchase price in full.

TERMS: Cash with order or Cash on Delivery. NO DISCOUNTS TO ANYONE.

For QUICK SERVICE address Mail Orders to ECONOMIC RADIO STORES, 492 George St., Sydney

"YOURS FOR LOWER PRICES."

THE ECONOMIC RADIO STORES

PARRAMATTA:  
Cor. Macquarie and Church Sts.  
Phone: UW 9601.

SYDNEY:  
25 NEW ROYAL ARCADE,  
Phone: M 3049.

NEWCASTLE:  
569 Hunter St. West.  
Phone: New. 1622.



# The KLOTZ Two Valve Receiver

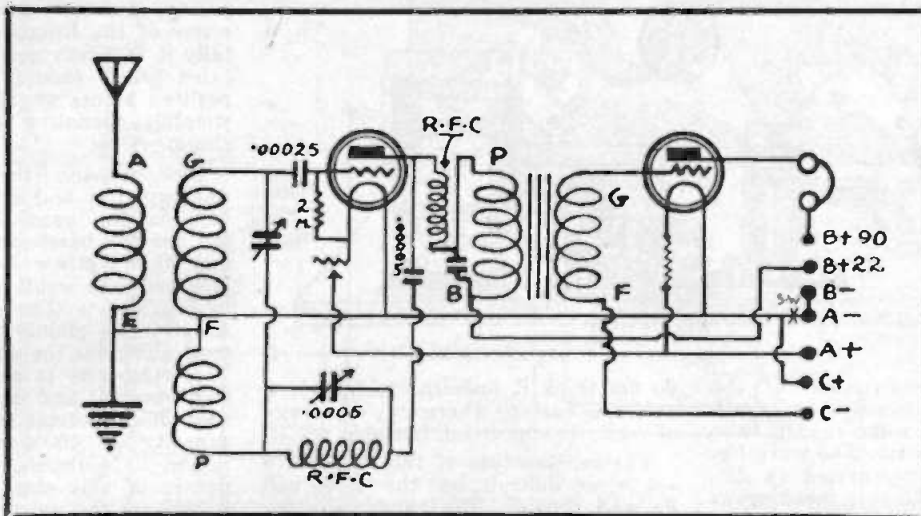

## The most Popular Receiving Circuit of European Radio Enthusiasts

**T**O-DAY, amongst many members of the community, there is a demand for a real good two valve set. Now, as has been explained, frequently in these pages, a set employing two valves, may take many different forms. For bringing in distant stations on the earphones, a two valve set may be built in such a way that the first valve can be used for building up the weak oscillations arriving here from a distant station. For loud speaker work on the local stations, these types of receivers would be very disappointing, it being necessary to increase the volume of the local station to use one stage of low or audio frequency amplification.

There are quite a number of two valve reflex sets, and several have been published in "Wireless Weekly" in days gone by. But for our purpose this week we are giving the details necessary to construct a two valve receiver for loud speaker work on the local stations. Thus, one stage of audio is being used. The circuit diagram shows this Klotz circuit to be very similar to the standard Reinartz.

Similar as it is, it is nevertheless different. The whole secret of the receiver lies in the chokes. Reference to the circuit diagram shows the circuit in which are the R.F. chokes. The choke in the plate-transformer

circuit tends to deflect the radio frequency energy through the .00005 mfd. condenser back through the other choke to the bottom of the tuned circuit.

Read what the designer says: "The action of the circuit is not hard to understand. The presence of the R.F. choke in the plate circuit of the valve tends to deflect a large amount of R.F. energy through the circuit represented by the .00005 mfd. fixed condenser, the second R.F. choke, and its shunting variable condenser, and the bottom end of the tuned circuit.

"Now, when the variable .0005 mfd. condenser shunting the bottom R.F. choke is set to its maximum, this R.F. choke will, to all intents and purposes, be short circuited so far as R.F. energy is concerned. The impedance of the plate circuit choke is much higher than the impedance of the .0005 mfd. fixed condenser, and, therefore, most of the R.F. energy will travel round to the bottom end of the tuned circuit, and oscillation will occur.

"When the condenser shunting the bottom choke is, however, tuned to its minimum position, we then have the impedance of this choke in series with the small fixed condenser, and even if the two chokes are of equal impedance, it is obvious that the impedance of the circuit through the small fixed condenser and bottom choke will be higher than the impedance through the plate circuit choke, and less R.F. energy will get through the former circuit than the latter."

### Parts Required

Although the parts listed below and mentioned throughout the article were those actually used by us in the receiver described, it must be pointed out that it is not absolutely essential that they be rigidly adhered to.

Other parts of similar quality and technical values should function quite satisfactorily.

- 1 Dilecto, Radion or other hard rubber panel, 14 x 8 x 3-16.
- 2 .0005 Mfd. Advance Little Centralign Condensers.
- 2 Emmco Vernier Dials.
- 2 30 ohms. Rheostats.
- 3 Radiokes R.F. Chokes
- 1 Wetless Reinartz Coil.
- 2 U.X. Sockets.
- 1 B.M.S. S.C. Jack.
- 1 Wetless .0003 Condenser.
- 2 Wetless .0001 Condensers.
- 1 Wetless .001 Condenser.
- 1 F.M.C. A.F. Transformer, Usual Spaghettil, Terminal Board, etc.

Leading Broadcasting Stations use Burgess Batteries

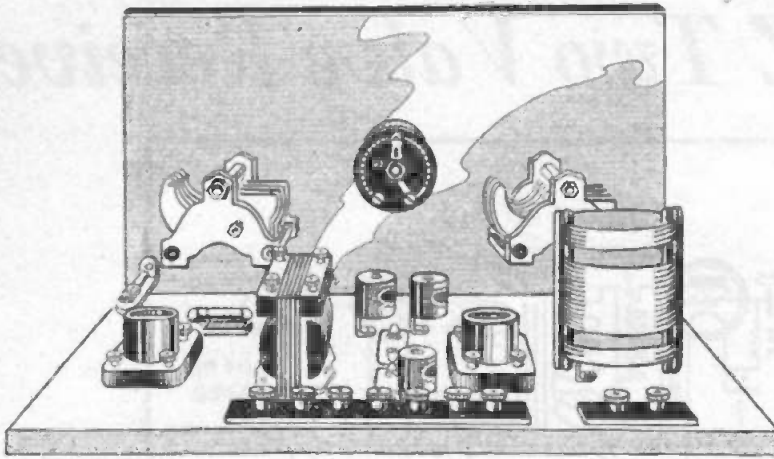

This author's explanation of the theory of the circuit will interest all. Perhaps there are some readers who cannot quite follow it. The word impedance may be interpreted in different forms. Take this meaning as simple. The impedance is the total opposition offered by a circuit to the passage of an alternating current, and given by the ratio of voltage to current, being measured in ohms. The impedance of a circuit is due to the combined effects of resistance, inductance and capacity. These three latter terms are well known to most, so there is little need to enlarge upon them.

Read over the last three paragraphs carefully if the theory of the circuit is to be understood. Refer to the circuit diagram, picking out the individual chokes mentioned. Look at the back panel wiring diagram to see the chokes. It will be seen that there are three chokes altogether used, one in the plate lead and two in series with the bottom end of the tuned circuit, these two being shunted by a variable condenser. The reason for this has been explained above. So much so.

Standard practice has been departed from as far as the grid leak is concerned. Instead of the grid leak being shunted across the grid condenser it has been taken direct from the grid to the A. battery positive wire. Again the audio transformer has a .001 mfd. fixed shunted across the primary winding--from the P. to the B. plus. This is necessary to create constant oscillations, and its exclusion is far from being wise.

Another feature of this receiver is the inclusion of a C. battery. A C. battery or grid bias battery is always advisable, for not only does it provide a saving of B battery current, it also provides a means of creating a purer and often a louder value of volume. There are some people who

do not think it judicious to include a grid bias battery where only one stage of audio is concerned, but still try it.

The construction of this two valve set is not difficult, but the effort will be well repaid. The panel calls for attention first of all. It should be laid on a flat surface and marked out as shown in panel drilling diagram. Centre punch each position, then drill all the holes with a small one-eighth inch drill, making a pilot hole. It often happens that the constructor is a bit careless in drilling by not holding the drill straight. Always be careful in this matter, as much trouble will be saved later on.

After drilling with the pilot drill, make the proper sized holes afterwards. If you are short of the correct sized drill, the next smallest drill may be used, and the tang of a file can be pressed into service to enlarge the hole. Remove all burrs on the edges with a sharp penknife. One or two holes need countersinking, so

if a rosebit is not included in your kit of tools, use a much larger drill, but be careful not to bite too deeply.

Mount the condensers and rheostat switch ar.d jack. Remember to provide a small hole for the catch screw of the Emmco dials. Incidentally it is worth mentioning that this catch screw should be mounted in position before anything else. This simplifies mounting the dial at a later stage.

Now prepare the baseboard by sandpapering and shellacing. When dry, fix the panel in position, and lay out the baseboard parts. Notice how the Wetless Reinartz tuner is mounted. The small mounting bracket is provided. The position for the Amperite is plainly seen in the plan view alongside the audio valve socket. This Amperite is an automatic filament control and dispenses with the need of a rheostat for this valve. A capacity of .00005 mfd. is required in the plate circuit. As a fixed condenser of this size is not available, it behoves the constructor to use two .0001 mfd. fixed condensers and join them in series, as is seen in the plan view. The two R.F. chokes in series will find a nice position near the rheostat. The other R.F. choke is conveniently located near the P terminal of the audio transformer. The rest of the apparatus may be laid out accordingly. It is always wise to adhere to the layout of any receiver unless a knowledge of the theory of radio is known. Magnetic fields are likely to spring up here and there, and as these have to be avoided, it is policy to follow the suggested layout given by the author if best results are desired.

Again while it is not always necessary to purchase the exact brands of parts specified, the valves, sizes,

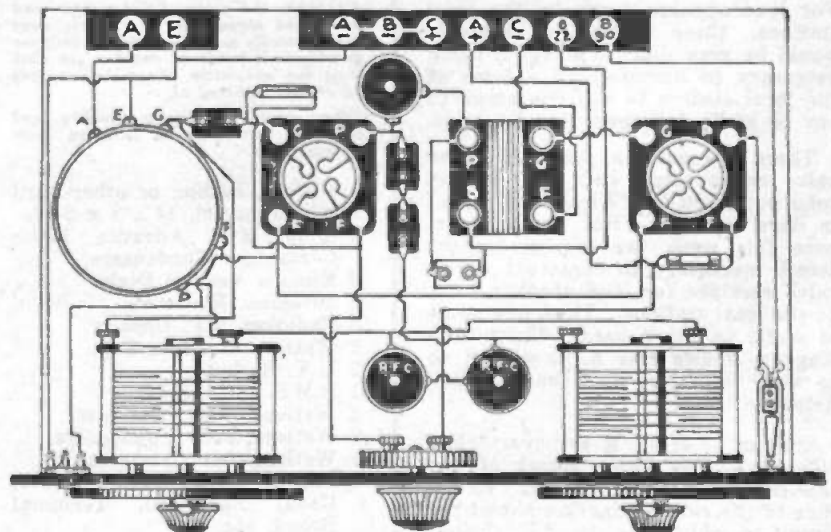

There are no rivals to the Philco.

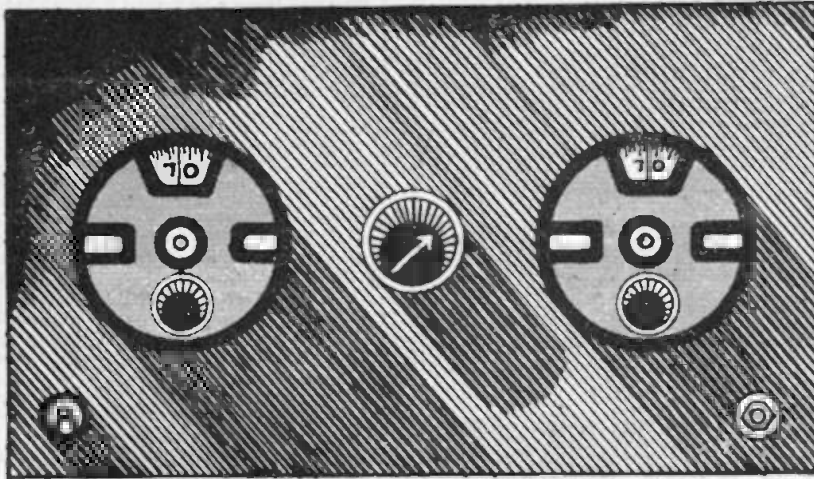

which is often difficult to locate later on. Always use a clean, nicely tinned, soldering iron, and before soldering, wipe on an old rag. A little practice will let you know just when the iron is hot enough.

Now valves are a consideration. The original receiver built by the writer, functioned splendidly on Cossor valves. A H.F. red label valve was used as a detector, followed by a black label L.F. valve for the audio stages. Both valves only consume .1 of an amp. each, so a great saving in A battery current results, without any loss of signal strength.

The detector valve was fed with 45 volts, and 90 volts were supplied to the amplifier. A grid bias of 4½ volts proved ideal. The aerial used is 70 feet long, with an average height of 30 feet, the earth being the usual waterpipe.

On tuning in, a surprise was in store. At first nothing at all could be heard, but by gradually varying the tuning condensers, 2FC made its presence known. The second variable condenser provides a very smooth reaction control, its function being to vary the impedance of the choke. The first condenser tunes in the stations, and the aperiodic aerial makes for selectivity. With the headphones besides the local stations, 3LO and 4QG, and 3AR were found at a nice strength. The local stations agreed nicely with the Amplion speaker, real, good strength filling the room.

This receiver is very sharp in its tuning; the vernier dial on the first condenser is indispensable. At Mar-rickville, four miles from 2BL and 17 miles from 2FC, no interference was met with from 3LO. The Wellington station 2YA could be heard faintly, but pleasantly. The reaction control is interesting, the smoothness is astounding. The circuit was devised by Heinrich von der Klotz, and on the Continent of Europe it enjoys a great popularity. It will do so here.

etc., should be adhered to throughout, and remember always that shoddy parts yield poorer results than quality parts. In radio to-day the old Biblical quotation is true, which states, "As you sow, so shall you reap," or words to that effect. The output is commensurate with the input, and this applies in particular to the quality of apparatus used.

The wiring requires a little thought. The constructor himself may choose busbar or point to point wiring at will. The wiring diagram shows the system of connections. Begin by linking together one F terminal of each valve socket, continuing this, wire to F of the Wetless tuner, and also to one side of the battery switch. The other side of this switch take to E of the Wetless coil, and to the Earth terminal, also to the A negative terminal, B negative, and C positive terminals. Connect one side of the rheostat to one side of the Amperite, and then to the A positive terminal.

The other side of the rheostat take to the remaining F terminal of the first or detector valve socket, and also connect the remaining connection of the Amperite to the remaining F terminal of the second socket.

Link the Aerial terminal to the A of the Wetless coil, then join G of this coil to the fixed plates of the first variable condenser, and to the one side of the grid condenser, the other side of which is joined to the G terminal of the detector valve socket. To this G join one side of the grid leak, connecting the other side of this leak to the A positive wire.

The moving plates of the first condenser joins P of the Wetless tuner, and also the nearest side of the two R.F. chokes in series, and to the moving plates of the second variable condenser. Make the short connection joining these chokes in series, then join the remaining side of the chokes to the fixed plates of the second condenser, and to one side of

the two .0001 condensers in series. The other side of these condensers join to P of the detector valve socket, and to one side of the single R.F. choke. The other side of this choke connect to the P of the audio transformer. The B of this transformer link up with the B positive 22 volt terminal on the terminal board. Join a .001 fixed condenser across the P and B of this transformer.

Connect G of the audio transformer to G of the second valve socket. Now run a wire from P of this second valve socket to one lug of the jack, the other lug join to B plus 90 volts terminal of the terminal board. This completes the wiring. If bare wire is used, then unless otherwise specified, don't allow one wire to touch another. Keep the grid leads very short, and don't allow a plate lead to run parallel to a grid lead. Spaghetti covered wire is good for connections. Acme Celatsite being also splendid.

Check over all your work. Be sure that your soldered joints are secure. A poorly soldered joint creates trouble

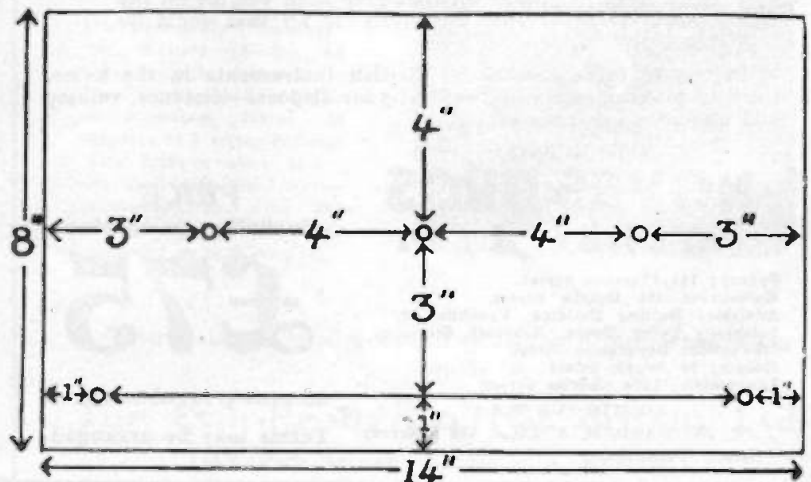

Philco Batteries Save Pounds in a Year.

# DISTANCE

## VOLUME AND CLEARNESS TOO

with

# The IGRANIC SUPER HETERODYNE

**B**ECAUSE of its formidable list of high-quality features the Igranic Supersonic-Heterodyne has been hailed in many directions as the finest set yet produced. And such claims are not without adequate foundation, for, since hundreds of these sets have been sold to enthusiasts in all parts of the country, letters of testimony giving accounts of excellent reception, volume, clearness, and ability to get—and hold—distant stations, are coming to hand each week in increasing numbers.

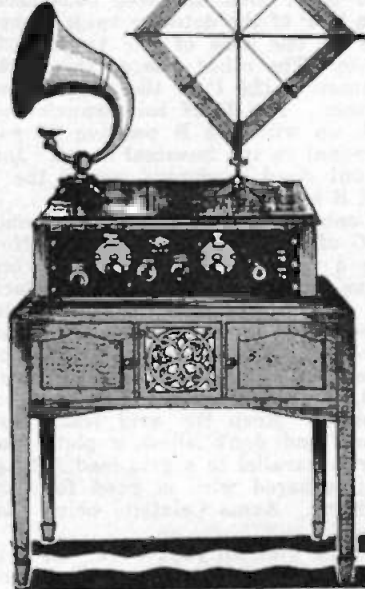

A typical letter from a Super-Heterodyne is reproduced:—

"I have not heard any set give such volume on the same valves. The selectivity is all that could be desired."

With one of these remarkable British Instruments in the home, the best programmes are always at your disposal—distance, volume and clearness are assured.

SOLE AGENTS:

**NOYES BROS (SYDNEY) LTD.**

Sydney: 115 Clarence Street.  
Melbourne: 495 Bourke Street.  
Adelaide: Darling Building, Franklin St.  
Brisbane: Perry House, Elizabeth Street.  
Newcastle: Devonshire Street.  
Hobart: 36 Argyle Street.  
Launceston: 123a Charles Street.

AGENTS FOR W.A.:

J. R. W. GARDAM & CO., 138 Murray Street, PERTH.

PRICE Including everything

**£75**

according to cabinet work

Terms may be arranged.

### Why Not Have a SET BUILT SPECIALLY TO SUIT YOUR LOCAL CONDITIONS ?

We will make a set to suit your local requirements or to your own specifications for less than it will cost to make it yourself, and at the same time you get a professional job covered with a twelve months guarantee.

Call and let us show you how we do it, or write for a quote stating your requirements, locality or specification, etc.

Some Standard Models:

- 5 Valve Solodyne, One Dial Control. Price ..... £14/15/
- 5 Valve Solodyne, One Dial Control, De Luxe Model ..... £18
- 5 Valve Neutrodyne ..... £10/2/6
- Special Selective Three Valve Set, Receives Interstate on Speaker ..... £5/-

All above in nicely polished maple cabinet. Accessories extra, at lowest prices. Quotes on Application.

#### HOW ABOUT HAVING YOUR OLD SET REMODELLED?

You will be surprised to see how little it will cost to make it into a first class set. We specialise in all rewiring, altering, repairing, etc. Our charges are low, and we guarantee all work for twelve months.

EASY TERMS may be arranged on all payments for sets, loud-speakers, B eliminators, etc. Full particulars on application.

COUNTRY CLIENTS.—Make use of our mail order department. We pay special attention to all country orders.

Call on us with your Solodyne troubles. We can help you. Advice is FREE, and a pleasure.

Call, or Write to

**R. W. PATTERSON,** RADIO ENGINEER

90 PITT STREET, SYDNEY (Near Martin Place)

## Rechargeable DRY!

Think what this means. Seven batteries for the price of one.



45 volts, Price 35/- ea.

The test made by Professor Laby, of Melbourne University, showed that the capacity of the TAB Battery is slightly greater on the fifth discharge than the first, and therefore does not deteriorate with the period of use for which the battery is needed.

AUSTRALIAN AGENTS:

**Latimers Wireless Supplies Ltd.**

151 Castlereagh Street, Sydney.

Phone: No. M3004.

# Use T.C.C. Condensers



Mica Condensers, all sizes, .0001 to .004 m.f.

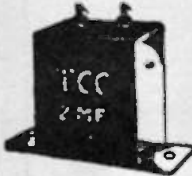

Genuine Mansbridge Condensers, all sizes, .005 to 4 m.f.

Next time you want fixed condensers for your set, buy T.C.C. British Condensers. They are fully guaranteed for Accuracy and Long Life, will eliminate noises, prevent short circuiting and wonderfully improve reception.

All Sizes are obtainable from Radio dealers everywhere.

WHOLESALE FROM

## Lawrence & Hanson Electrical Co. Ltd.

33 YORK STREET, SYDNEY.  
35-37 CHARLOTTE ST., BRISBANE.  
(W-MeF.)

# Dispel Summer Radio Troubles

## — WITH AN — **EVER-READY**

The approach of summer brings more worries for the radio enthusiast in the shape of static and fading.

At such a trying period does the need of an Ever-Ready Radio Battery become most acute, for without these sturdy long-life batteries, much of the joy and convenience of radio would be lost.

Wire them in now. You'll appreciate the difference they impart to the tone and volume of your reception.

### The New Ever-Ready No. 126 or A, B, or C Battery

Price ..... 2/9



One of a group of radio batteries. Useful in wireless, lighting, and amplification. Size, 3½ x 4 x 1½. Most useful for bells, telephones, burglar alarms, medical coils, etc. With three brass terminals. Voltages 1.5, 3 or 4.5 volts. Useful for all wireless purposes as well as general utility.

### The "Standard" "A" Radio Battery.

Price ..... 9/-

The Ever-Ready "Standard" "A" Battery (3-cell), 4.5 volt, specially designed for economical operation of 1, 2, or 3 valves, taking .06 amperes at 3 volts. For sets with four or more valves, the most economical service is obtained by using two "Standard" "A" Batteries connected in parallel.



If unobtainable locally, write for address of nearest source of supply to

**The Ever-Ready Co. (Gt. Britain) Ltd.**  
163 Pitt Street      ::      SYDNEY

## Manufacturers Products Pty. Ltd.

### IMPORTED SETS

Agents for all Styles of Radio Products, including Clyde Batteries

#### ARMAX BATTERIES

Elec. Meter Mfg. Co. "Emmco" Renrade Condensers, Leaks.

#### ASTOR SETS

#### G & R SETS

Airzone Coils and Loops.

#### BALDWIN SPEAKERS

Neutron Crystals  
Prompt shipments from Sydney.

Surplus Stocks sold Interstate.

H. J. HAPGOOD

Challis House, Martin Place,  
SYDNEY

Tel.: BW 1328

# Keep This Price List

There are eleven radio component parts illustrated on this page; most of them are essential in every type of receiver. If you are a home constructor, tear this leaf out and keep it by. It will act as a complete price list or catalogue to which to refer before visiting your dealer, or if you are situated in the country, before sending to the city for your next list of parts. If you are not a home constructor, tear it out anyway, for the parts in your set require replacing now and again.

## Emmco - Economy - Efficiency

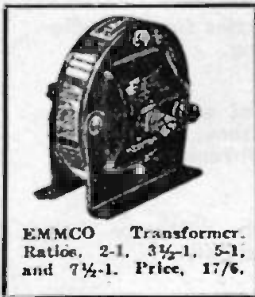

EMMCO Transformer. Ratios, 2-1, 3½-1, 5-1, and 7½-1. Price, 17/6.

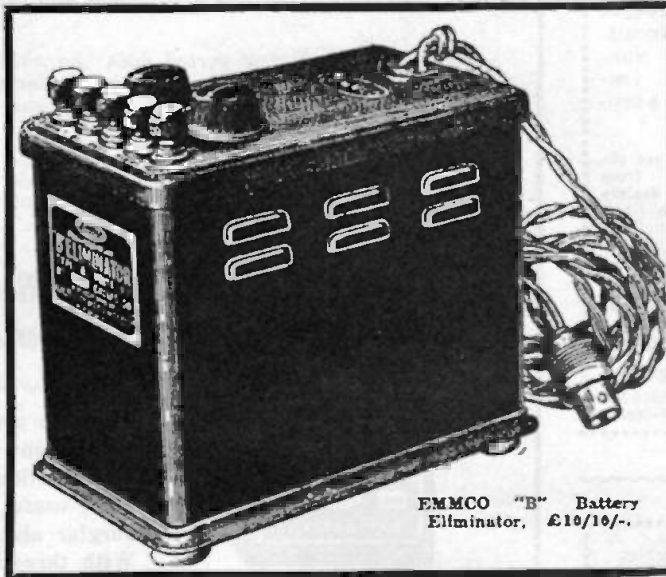

EMMCO "B" Battery Eliminator. £10/10/-.

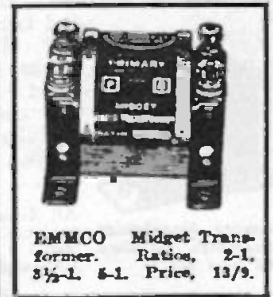

EMMCO Midget Transformer. Ratios, 2-1, 3½-1, 5-1. Price, 13/9.

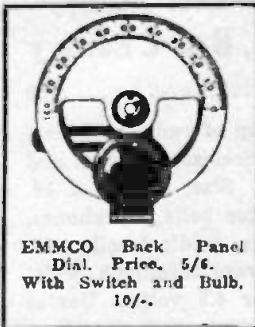

EMMCO Back Panel Dial. Price, 5/6. With Switch and Bulb, 10/-.



Cavalier Transformer. Ratios, 2-1, 3½-1, and 5-1. Price, 21/-.



Maurean Tone Purifier. Price, 21/-.



EMMCO Lightning Arrester. Price, 2/6.



EMMCO De Luxe Vernier Dial. Price, 9/6.



EMMCO Vernier Dial, finished in Black or Mahogany. Price, 7/6.



EMMCOSTAD. Price, 7/6.

Buy

**Emmco**  
**RADIO PRODUCTS**

AT ALL DEALERS



EMMCO Headphones. Price, 21/-.

# The RICE Neutrodyne

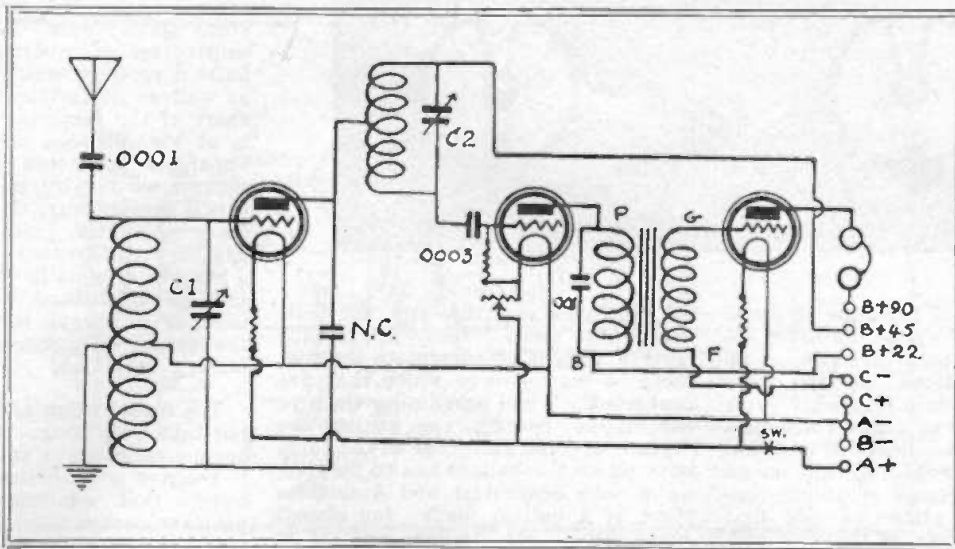

## With some Hints on Soldering

JUST the other day, looking through some old publications, the following sentence attracted attention: "The Rice system of neutralising in its original form appeared in 1918, and is, therefore, one of the original methods of neutralizing. It is an exceedingly efficient circuit, and its modified form is fully equal to the more conventional methods of neutralizing the inter-electrode capacity of R.F. Valves." Being inherently curious, further investigation revealed the circuit which is reproduced here. Recognising that neutralizing the inter-electrode capacities of valves was of importance and being anxious to try the system out, a receiver was built. It is in connection with this splendid little set that this article is being written.

Almost every radio enthusiast to-day knows the standard Hazeltine Neutrodyne. The peculiarly angled coils of the Hazeltine principle and the small neutralizing condensers are quite common sights nowadays. But how many people know why a receiver is neutralized? The dictionary says that a neutrodyne receiver is a special form of high-frequency valve amplifier and detector in which the stray capacity coupling between electrodes of the valves is neutralized by low-capacity couplings connected between the grids and suitable points on the windings of the high-frequency transformers. The inter-electrode capacity of a valve is of such a nature as to tend to set

up self-oscillation and, unless "Neutrodyne compensation is employed, it is a very difficult matter to prevent a multistage high-frequency amplifier from breaking into self-oscillation.

The veriest beginner knows that the electrodes of a valve are three in number, the filament, the grid and the plate. It may seem ridiculous knowing just how small in dimensions

these electrodes are to think that they could cause the trouble which they do. But that they do, is an accepted fact and can be proved. Not only is it necessary to neutralise many stages of radio frequency, but distinct advantage is gained in neutralising even one stage of radio frequency, for example, the Browning Drake, the Bayer, and many other popular forms of receivers. The early reader can take his mind back to the well-known old system of potentiometer control of radio frequency oscillations on the tuned anode receiver. This receiver has, practically speaking, entirely disappeared from our midst and the Neutrodyne principle has taken precedence.

That whistle which we hear, or that howl, as we call it, which we hear when listening in to our favorite station, is produced by radiation from receivers, and if all receivers were properly neutralised, no howling valves would trouble us at all. This, of course, would be the millennium, but we are gradually working towards it, and this Rice Neutrodyne will appeal to many who seek the inter-State stations on the ear 'phones and the local stations on the loud speaker. To this end, as can already be gathered, there is one stage of neutralised radio frequency, detector and one stage of transformer coupled audio frequency. The circuit diagram is extremely interesting. Looking at it we find a strong resemblance in this circuit to

### What You will Need.

- One panel, Dilecto, Radion, or hard rubber, size 18in. x 8in. x 3-16ths.
- Two 4-inch lengths of 3-inch diameter Dilecto or Radion tubing.
- Eight ounces of No. 24 D.C.C. wire.
- Two .0005 Emmco Stratelyne Condensers.
- Two Vernier Dials, Emmco or Pilot.
- One 30 ohms. Parker Aelous Rheostat.
- Two Brachstats or Amperites.
- Three All-American Valve Sockets.
- One BMS S.C. Jack.
- One BMS Battery Switch.
- One .00025 or .0003 Wetless Grid Condenser.
- One .0001 Wetless Condenser.
- One .001 Wetless Condenser.
- One F.M.C. 5 to 1 Audio Transformer.
- One terminal board.
- Baseboard, Wiring wire, screws, etc.

For Purest Music Use Only Philco.

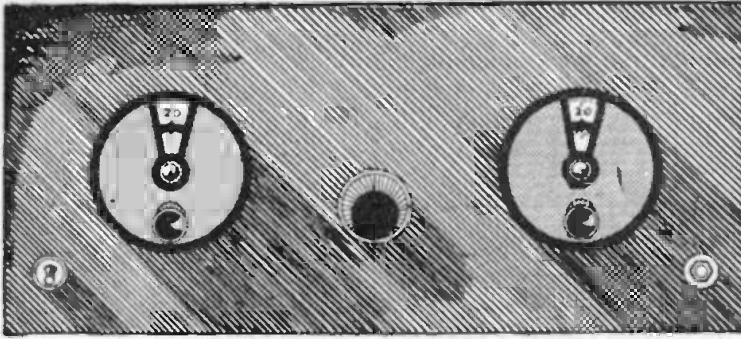

the well-known old principle of tuned anode. A mild form of Reinartz reaction is incorporated, the radio frequency oscillations passing from the plate of the radio frequency valve to the centre tap of anode coil which is naturally tuned. Reaction and neutralising is controlled by the small neutralising condenser which is connected from the plate of the first valve to the bottom of the first coil. The action of this condenser and the adjustment will be explained later on. Notice also the method of connecting the grid leak to the A positive direct, instead of across the grid condenser. This is most important and must be adhered to strictly if good results are desired. Notice, too, that the first tuning condenser is connected right across from the top of the coil to the bottom of the coil, not from the grid and filament, as is usual. The earth connection is taken from the centre tap, as is also the filament negative lead. Across the primary of the audio transformer there is a .001 fixed condenser. This should not be dispensed with, as its function is interesting.

Speaking of dispensing with a fixed condenser across the primary of an audio transformer brings back to mind how essential this condenser is in the well-known Browning-Drake receiver. Many readers have written in telling us of their inability to get the famous Browning Drake to work up to satisfaction. Invariably the trouble lies in the omission of this fixed condenser across the audio transformer, as without it the set will not oscillate satisfactorily, and although regeneration is present in both sets, as has been previously mentioned, radiation does not take place.

Comparing the circuit diagram with the front view of the receiver one may wonder why there is only one rheostat shown on the front view and yet three valves are employed. The rheostat on the panel is for controlling the detector valve filaments only, the radio and also the audio valve having a filament ballast as an automatic filament control. These Brachstats or Amperites are very useful, for besides

saving panel controls, and, incidentally, panel space, they supply the correct amount of current to the filament of the valve to which they are connected. When purchasing them be careful to specify the make, the voltage, and the amperage of the valve with which the ballast has to be used, as in both Brachstats and Amperites there is a ballast made for almost every valve sold to-day, and it is necessary always to obtain the correct amperage as well as voltage in the ballast in order that best results accrue.

The circuit diagram shows a small fixed condenser of the capacity of .0001 in series with the aerial. This gives a form of constant aerial tuning besides making the receiver a little more selective. If, in its present form on test, the receiver is not sufficiently selective for the constructor's purpose it can be made more selective by connecting another fixed condenser of .0005 in series with the .0001 and the aerial. This will produce an extreme form of selectivity, and when properly balanced with the neutraliser condenser very little loss in signal strength will be noticed.

Vernier dials are recommended: besides being very neat in appearance, the slow motion action produced in tuning makes reception of distant stations simpler than is the case with standard dials. There is a wide range of vernier dials in the market, and the

constructor may choose for himself his own favorites. The panel is balanced very neatly—so different from the early types of receivers with their protruding honeycomb coils and several knobs and dials and contact studs spread over the panel. The constructor of modern sets can now build a receiver which, in appearance as well as performance, is very little short of the factory-built set. There is at his disposal a vast range of apparatus to choose from, and although we specify particular brands this is done because they are the parts from which the receiver illustrated has been constructed. There is quite a number of equally good parts which may be substituted, but, at the same time, it is always wise to adhere to the values of components for satisfactory reception.

The construction of the receiver did not take very long. As there are no commercially built coils for this set, it behoves a constructor to make his own. Coil winding is always a pleasant occupation and has a strong fascination for the average man, for, besides saving his pocket, he can always tell his friends he built his own. Firstly, procure the number 24 D.C.C. wire and place the reel over a long nail driven into a board in such a way that the wire will run off freely. Then prepare the three-inch diameter formers. Half an inch from one end drill two small holes along the edge approximately half an inch apart. Through these holes thread the beginning of the wire in such a manner that it will be held securely, and then proceed to wind along the length of the former sixty turns of wire.

A space of half an inch is left at the 30th turn, the wire not being broken at all, but simply make this one turn spread over the area in question. The idea can be seen from the illustration. Finish off the coil by securing as you did at the beginning. If a reasonably good tension has been maintained with the wire when it is completed, it will not slip, but if you are afraid of slipping, one coat of shellac varnish will not injure them in any way, but will

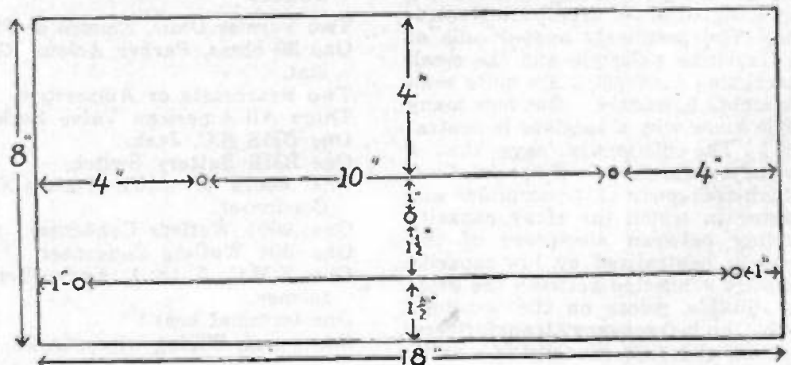

From Icy Pole to Tropic Jungle: Burgessa.



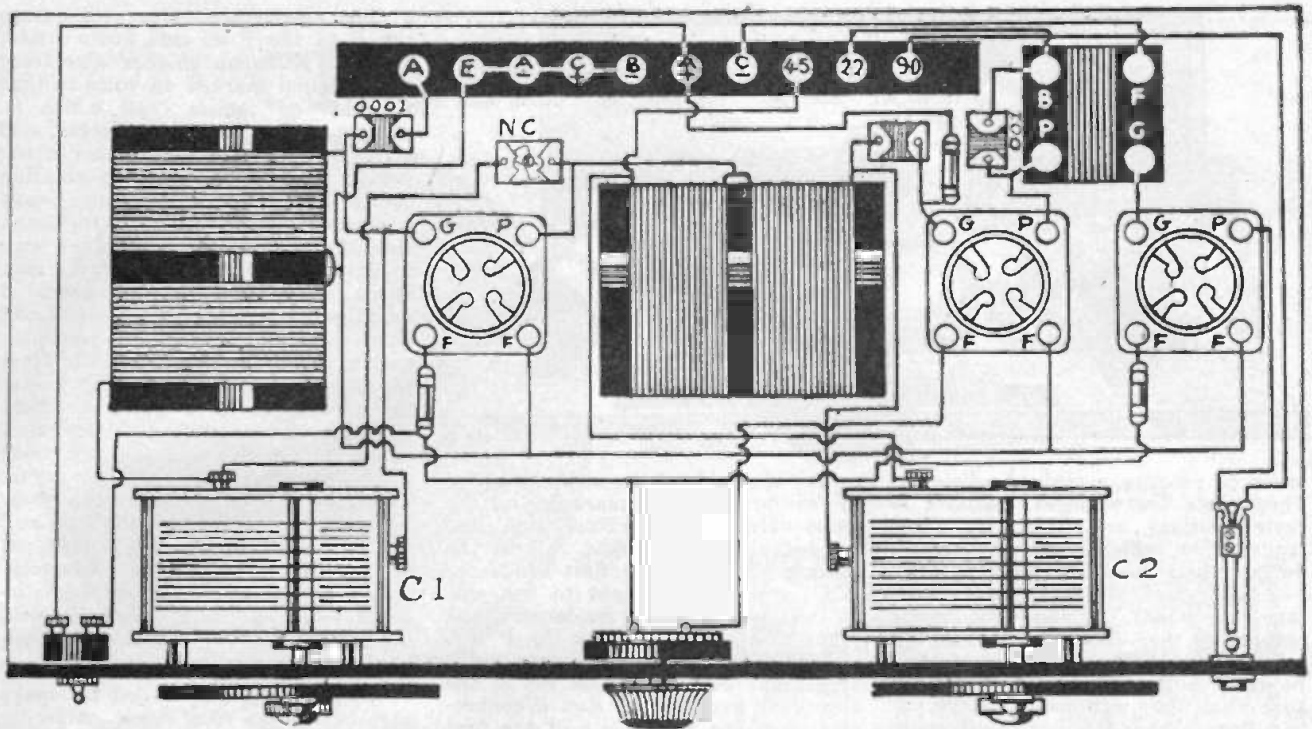

hold the turns in place nicely. Some people are under the impression that shellac varnish on a coil increases the self capacity. While this is true, at the same time the increase is so negligible that it is scarcely worth bothering about. On the other hand, it has the advantage of preventing moisture from soaking into the windings, and we all know how disastrous will be the result if moisture did succeed in creeping in.

The second coil in the receiver is the direct counterpart of the first coil—that is to say, it should be wound in an exactly similar manner with the same number of turns and the same gauge of wire as the first coil. This will mean that in actual reception both the dials of the variable condensers will read alike or almost so, and such being the case, simplicity will result.

The panel layout is indeed very simple. On the panel are mounted the two variable condensers, the rheostat below them, and the switch and jack in their respective positions as shown. The panel drilling diagram indicates the positions of all this apparatus, and the result is a very neat-looking receiver. Realise, of course, that only the centre holes of the spindles of the variable condensers are shown, the fixing screw positions being left to the constructor to use in accordance with template provided by the manufacturer of the condenser chosen. Don't forget at all times, when a vernier dial is being used, to

make provision for the catch screw which holds the dial in position on the panel. This saves time and trouble later on; also consider that the panel is to be fixed to the baseboard, so it is always necessary to drill three holes big enough to accept wood screws to pass through the panel and into the baseboard. These screws dispense with the necessity of employing brackets and holds the panel firmly in position, considering the small weight of apparatus that the panel holds.

Next prepare the baseboard. This baseboard should be seventeen inches long by nine inches deep and of a thickness of between half an inch and one inch. The edges should be planed off nice and smoothly, and the whole board given a coat or two of shellac varnish which, apart from the insulating properties it has, also dries very quickly.

Stopping at this stage to think for a moment, it seems hardly reasonable to expect that some readers don't know how to make shellac varnish. Well, it is just as simple as making tea, and to go about it is a very easy matter. First of all, procure the necessary ingredients, which are methylated spirits as sold by the grocer, and dry orange shellac, supplied by the ironmonger. The container should be a wide-necked pickle bottle or jam jar, but when selecting this latter article bear in mind that it is necessary to have a cork or some air-tight covering to fit this jar,

otherwise the unused quantity of shellac varnish will evaporate, or rather the methylated spirits will evaporate and leave you with a solid mass of dry shellac. To make good shellac fill the bottle with the dry shellac to about three parts its depth, and then pour in the top just sufficient methylated spirits to cover the shellac. Fit the cork in tightly and shake vigorously for a few moments, and then preferably leave over night. In the morning you will find that the dry shellac had dissolved in the methylated spirits, and ten chances to one you will find that when you attempt to remove the cork that it has stuck to the glass. You yourself can surely overcome this difficulty and remove the cork perhaps by the same medium as you remove the lid from a new tin of boot polish. This is how shellac varnish is made, and besides being very useful from the point of view of varnishing baseboards, it has its use in keeping wire in position on coils, as has been previously mentioned.

When the baseboard is varnished, then lay out the baseboard apparatus. Temporarily, rest the panel in position against the baseboard and follow out the suggested scheme of layout as is shown in the illustrations. It is a good plan to raise the coils off the baseboard, using short pillars of rod or timber and a wood screw at each end for this purpose. Next, place in position the valve sockets. Note carefully just how the sockets are laid in order that compactness is assured and shortness of leads is maintained in

The World's Flyers carried Burgess.

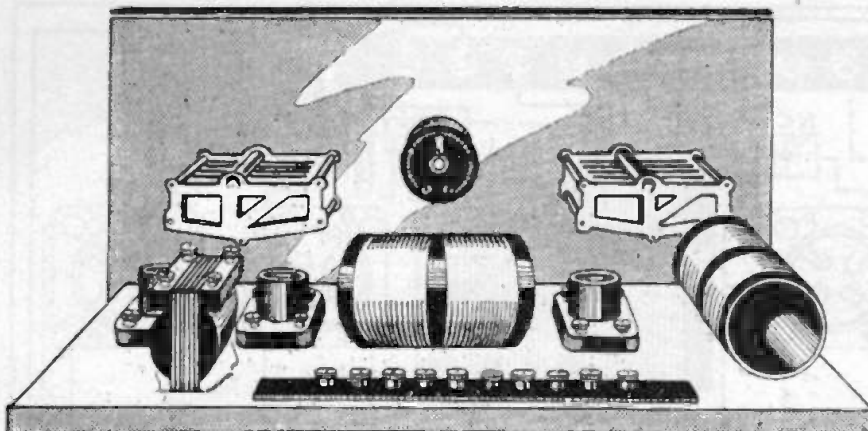

order to produce maximum efficiency. Then place the filament ballasts in their positions, and next the audio transformer, which is seen behind the detector and the audio valve sockets. For the present forget all about the terminal board. Round head wood screws of the required length are worth while for fixing these components to the baseboard, and make sure that they are held tightly, as "anything that is worth doing is worth doing well."

Now secure the panel in its position and commence the wiring. As there may be many readers who are not in the position of reading even a panel wiring diagram, let alone a circuit diagram, this matter will be dealt with at length in the ensuing paragraph or so. It is, of course, left to the judgment of the constructor to use either square cornered busbar or point-to-point spaghetti covered wire. To-day the constructor is catered for with many different brands of insulated wiring wire, such as Fort, Acme Celatite, and spaghetti covered wire, so it is in his province to select whichever system of wiring suits his purpose and his pocket. Very little can be said regarding the relative merits of any particular system, but the proof of the pudding is always in the eating, and as short leads play a most effective part in first-class reception, no doubt most readers will choose the spaghetti covered system.

Start off by linking up one F terminal of each valve socket together, and continue this right along to the centre tap of the first coil. Now run a wire from one side of the battery switch to one side of the radio frequency amperite, and also to the detector rheostat, and finally to the one side of the audio amperite. The remaining side of the radio amperite is joined to the remaining F terminal of the radio frequency valve socket. The remaining side of the detector rheostat is joined to the remaining side of the detector valve socket. Connect

up the open side of the audio amperite to the open terminal marked F of the audio valve socket. Now link the nearest side of the first coil to the moving plates of the first condenser (C1), and then straight to one side of the neutralising condenser, the other side of which joins the P terminal of the radio frequency valve socket and also the centre tap of the second or anode coil. Run a connection from the fixed plate of the first condenser to the G terminal of the first valve socket, and then to the furthest end of the first coil, "furthest" designating the distance from the variable condenser C1.

Next connect the moving plates of the second variable condenser to that side of the second or anode coil which is nearest to the first valve socket. The furthest end of this anode coil is joined firstly to one side of the grid condenser and then to the fixed plate of the second variable condenser C2. From the G terminal of the middle or detector valve socket join one side of the grid leak clips. The P terminal of this detector valve socket joins the P terminal of the audio frequency transformer. The G terminal of this audio frequency transformer connects direct to the G terminal of the audio valve socket. Run a connection from the P terminal of this valve socket to one side of the single circuit jack.

At this stage place the terminal board in position right at the back of the baseboard. If the terminal board you have is not equipped with soldering lugs, then proceed to fit them in position in order that soldering is made easy. Have these lugs sufficiently long enough to project over the edge of the terminal board, and they should be fitted underneath and not on top. Now solder the lead from the terminal marked 90 volts to the remaining side of the single circuit jack. That terminal marked 22 volts should be joined to the B of the audio transformer. Just here connect

a fixed condenser, size .001, from the B to the P of this audio transformer. Now run another wire from the terminal marked 45 volts to that side of the anode coil which is nearest to the first valve socket, and which joins the moving plates of the second condenser. Next in rotation comes the A positive terminal, one wire from which runs to the open side of the switch and the other wire to the remaining side of the grid leak clips. The next four terminals, B negative, C positive, A negative, and earth terminal, are all joined together and a connection taken from the earth terminal joins the centre tap of the first coil. Place the .0001 constant aerial tuning fixed condenser in position and join one side to the terminal marked A for aerial. The other side of this small condenser is joined to that end of the first coil which is connected to the G terminal of the first valve socket. This completes the wiring and should be checked off carefully, not only with the circuit diagram, but also the back panel wiring diagram.

When soldering is called for make certain always that your soldering iron has four clean faces, and that all these faces are properly tinned. Some people prefer resin cord solder, others like fluxite to use in conjunction with soft solder. Under no circumstances whatever attempt to use killed spirits as a flux, as this gives rise to corrosion which will create considerable trouble later on. Always allow the soldering iron to remain sufficiently long enough on the prospective joint in order that the solder runs in properly and not as has been seen over and over again, merely sticking the parts together. Where flux is used the smallest quantity is always advisable. Merely wipe the two surfaces to be joined with a small portion of flux sticking to a match. Then pick up only a small portion of solder and apply to the joint and note that the solder runs in as has been previously stated.

If the soldering iron is allowed to overheat and become red hot, you can generally rest assured that the tin surfaces are burnt off, so it is necessary to see that they are put back again. To do this, get a piece of block Salammoniac and rub this over the surface of the iron, this having a cleaning effect and removing all the carbon surface, as well as cleansing out the "pits," which will insist upon occurring irrespective of how careful a person may be. Apply the iron now to the stick of solder and it will be noticed that where the iron is clean the solder will run nicely, leaving what might be termed a nickel-plated surface. This is one method of tinning. Where Salammoniac is not

America's Submarines all use Burgess.

available it is then a good plan to file off the dirty surfaces, dip the cleaned iron in the fluxite paste and apply the solder to it as before. This will effectively tin the iron and it is surprising to note just how quickly a properly tinned iron will pick up solder and make complete adhesion of the joints a success. As a last word on soldering, always make it a practice of wiping the surfaces of the iron with an old cloth immediately before it is used for soldering purposes, that is to say, immediately after it comes away from the source of heat.

When everything has been completely assembled and wired, test the receiver out on the air. Connect up the aerial and the earth to their respective terminals, and also the batteries to their terminals. According to the valve used, so must these batteries be considered. Still, it is easy to apply the correct A battery to suit the valves, and always remember that invariably the red terminal on the accumulator or A battery denotes the positive which is generally also marked with the plus sign. Some batteries have a negative marked with black or green, but always have the minus sign alongside this terminal. Look now to the back of panel wiring diagram, and you will see the difference between the minus sign and the plus sign. Connect up the A battery correctly, then turn your attention to the B battery.

With almost every make of valve there is enclosed a slip which indicates the correct B battery to be applied to the valve. Keeping this in mind, connect up the B battery accordingly. If general purpose valves such as UX201A are used, then the suggested voltage as shown on the back of panel wiring diagram will prove of interest. On the other hand, if special purpose valves of Mullard, Cossar, or Radiokes are preferred, then adjust the B battery voltages to suit the valve in question. For example, some special purpose radio frequency valves function best on a plate voltage of 90 volts and the detector sometimes is at its best with 45 volts. The audio valve make have between 90 and 135 volts, but it is wise to notice the correct principle of applying grid bias to the audio stage.

Ordinarily, four and a half volts is satisfactory as a grid bias on a plate voltage of 90, but just the other day the writer had a set to test which made use of a special power valve in the last audio stage, and which calls for forty volts grid bias. Still, for our purposes in this set, between four and a half and nine volts will prove ample.

Actually on test at Marrickville, six volt Cossor Point One valves were used, one special HF valve for the radio frequency valve and another of a similar type for the detector. The audio end was fitted with a Cossor Point One LF or black label valve. The B battery connected was 60 volts for the radio frequency valve, 45 volts for the detector valve and 90 volts for the audio valve, with a corresponding grid bias of 7½ volts. Results were very satisfactory not only in the local stations, but also on the interstate stations.

As the aerial used on test was approximately 78 feet over all in length and as 2BL is situated only four miles away air line, it was necessary to include a .0005 fixed condenser, as well as a .0001 fixed condenser in series with the aerial lead. With careful tuning, 3LO could be heard nicely on the headphones and 4QG a little more loudly. 5CL could be heard to advantage, but again only on the earphones. Later on in the evening 3DB gave a most interesting programme, which was heard just faintly on the speaker. As this station is only a low power B class broadcasting station, this reception speaks highly for the Rice Neutrodyne. But before it could be nicely received, neutralisation had to take place.

Now neutralising is a very simple matter. To achieve this effective state, it is necessary to tune in to the local station bringing it up to the loudest point possible. Then remove the ballast governing the filament of radio frequency valve. It will be necessary now to use the earphones, and you will be surprised to note that although this valve is not lit up reception can still take place, although much more weakly than heretofore. With a long handled screw driver adjust the neutralising condenser to such an extent that the local station is silenced or if not completely silenced, is lowered in signal strength to such a point that the local station is weakest. Reinsert the Amperite which will immediately cause the first valve to come into operation and greatly build up the signal strength. Next seek the interstate station, say, Brisbane, for example. Carefully tune with the Vernier dials, using the earphones, of course, all the time. Fading will be present, but, nevertheless, good reception will be had apart from this. That little Melbourne station, 3AR, came through very well indeed, altogether the results were very satisfactory, and it is a fact that any person who drills this Rice Receiver will be pleased indeed with its performance.

## DECIDING ON THE RECEIVING VALVES.

Radio Talk by Dr. Fixit, of 5CL.

SO far as regular reception is concerned, the radio listener has to decide between just two issues, namely, will he use a storage battery or will he use a dry battery for operating the tube filaments. If it be the former, then his choice narrows down to the general utility tube 201A, with either the UV or the UX style base. If it be the latter, then there is a wider choice of tubes, involving the 199 type with UV or UX base, and the WD type with WD, UV or UX base. So far as operation is concerned, the 199 and the WD types perform about the same. If the listener is of an experimental turn of mind and seeks super-sensitive results, there is the 200A type with either the UV or the UX base, operating on storage battery.

Fortunately, most receiving set manufacturers specify the tubes to use, and these instructions should be followed. The practice to-day is to employ general utility tubes throughout the receiver, or for radio frequency sockets, detector socket, and audio frequency sockets, unless power amplification is desired and realised by placing a special power tube in the last audio socket. Of the high-volume output or power tubes, there are three kinds, namely, the UX-120 for dry battery sets, the UX-112 for storage battery and the UX-210 for power supply sets. On the other hand, the practice of using a super-sensitive detector tube in the detector socket has lost favor in the last two years, because of the critical adjustments called for and the high current consumption of the 200 type.

As to choice between dry-battery and storage-battery tubes, it is entirely a matter of personal preference. Formerly, there was a considerable discrepancy between the two, the dry-battery tube was neater and simpler, but lacked volume, while the storage-battery tube involved considerable trouble and mess. To-day, the dry-battery tube has the necessary power, while storage battery operation has been reduced to utter simplicity.

THE MARCONI CO. have completed preliminary tests with South Africa with the beam wireless stations which they are building at Bodmin and Bridgewater for the G.P.O. Should further tests under ordinary traffic conditions prove satisfactory, the stations will be handed over to the General Post Office for the official seven days' trial. During the tests so far made, speeds of between 200 and 250 words per minute have been maintained over long periods daily.

Ask any Radio Engineer about Burgess.

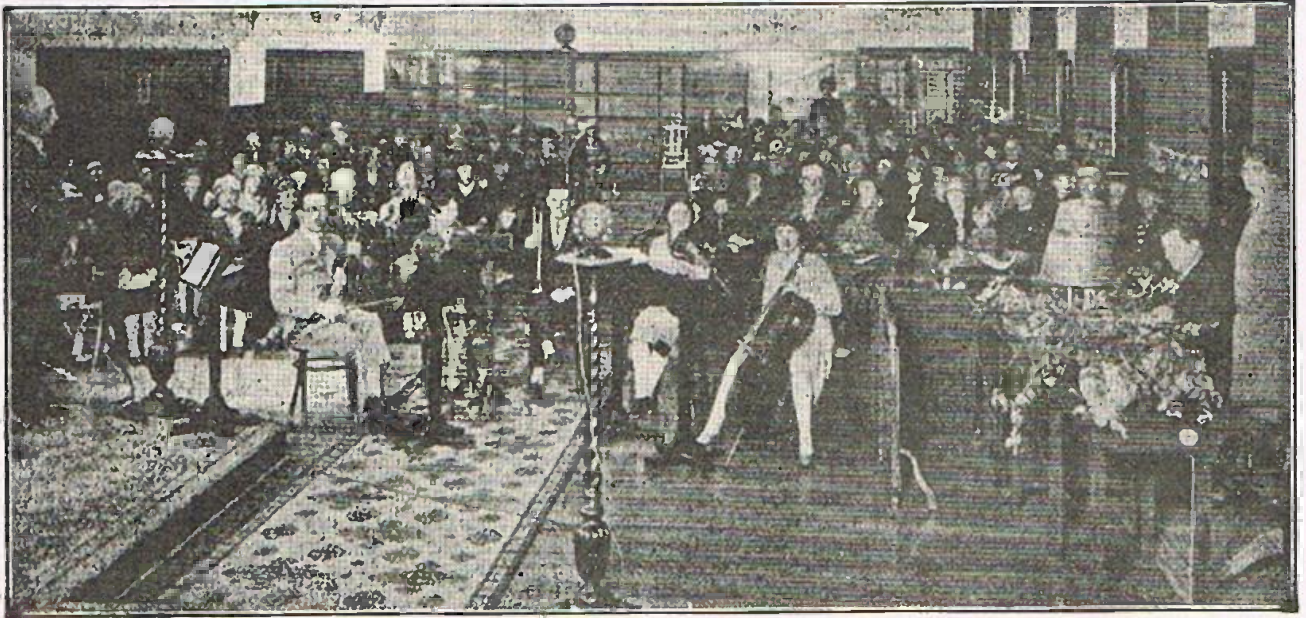

Community singing at the 3LO studio.

## Changes in the 3LO Studio

### 3LO STUDIO QUARTETTE.

**I**N order to concentrate on special effects 3LO, Melbourne, has lately reduced its Sudio Orchestra to a Quartette, under the enthusiastic leadership of Reginald Bradley, the station's excellent violinist.

3LO Melbourne's brilliant accompanist and solo-pianist, Miss Agnes Fortune, met with a serious motor-car accident recently, and listeners are still deprived of her services. During the first week of her absence Miss Elsie Bradshaw most capably filled her place at very short notice, and lately Miss Violet Parkinson is acting as locum tenens.

Tasma Tiernan, the popular 3LO, Melbourne, cellist, has returned to her accustomed chair on the platform with her beloved instrument, after a spell up the country recuperating, and is looking as well and playing as attractively as ever.

Those who remember Gaunson's fine work with 3LO Melbourne's Orchestra as first violin and leader for so long in the old studio, and for some time in the new, will be interested to hear that she paid a visit recently to her orchestral and other studio friends, who welcomed her very heartily, though regretful to hear that she is still unable to return to her wielding of the sounding bow.

Reginald Bradley's work with his cherished violin continues to bring fresh accessions of pleasure weekly to all who delight in that prince of instruments. 3LO Melbourne's pro-

grammes are never complete without several items from Reginald Bradley as a solo player, while he very frequently furnishes very interesting obligatos to some of the leading singers, much to the taste of a very wide audience.

\* \* \* \* \*

### WARDE MORGAN TO SING.

When a year or so ago Australian playgoers were shocked to read of the railway disaster in N.S.W., in which Miss Marie Burke and Mr. Warde Morgan were victims, it was announced that Mr. Morgan was injured beyond possibility of recovery.

Only an indomitable will and a determination to get better restored him, first of all to normal life, and then to physical strength. It is one of the romances of surgery that, after such shocking injuries, he should still be able to walk without crutches, and with but a slight limp as a reminder of the accident.

His career in musical comedy having finished, for the time being, Mr. Morgan has had to look around him for other means of using his great talents. On the 22nd October he has been timed to begin a season of song through 3LO, Melbourne. Apart from the intense interest the whole country feels in this plucky chap, his fine voice would make him a radio favourite under any circumstances. It is a noteworthy engagement and one that will prove very popular.

### MR. AMERY'S VISIT.

On October 24th the very important visit to Victoria begins of Mr. Amery, the Secretary of State for the Dominions, the first member of the British Cabinet who has visited us for many years. He will then be in Horsham on his way through to Melbourne via Ballarat and Geelong, examining the country as he goes. The object of his visit is to make personal inquiries on the spot into our conditions so that he will be able to acquire first-hand knowledge to assist him in dealing with Dominion problems when he returns. He has already been to South Africa.

At Horsham he will first come under the influence of 3LO, Melbourne. From that time on, it is safe to prophesy that Mr. Amery will not be allowed to say a public word that is not breathed into a microphone. He will be officially welcomed at Horsham, and his reply will be flashed all over Australia. He will journey on to Ballarat after the Horsham banquet, and once more his words will be caught. When he reaches Geelong, it will be to find a microphone up against him, and even in Melbourne he will be unable to get away from it, for his reception by the Lord Mayor will be as public as 3LO, Melbourne, can make it. This last function is scheduled for Wednesday, 26th October.

Burgess Went over the Pole with Byrd.

# 3000 English Schools now fitted with Wireless

## WIRELESS IN SCHOOLS.

3,000 schools in Great Britain are now fitted with wireless. An article in the current number of "The Journal of Education" states that the time has now come for the British Broadcasting Company to arrange an all-day programme for schools on a separate wave length, and to use this wave length for the benefit of more advanced students in various kinds of continuation schools at night. Mr. D. C. Temple, M.A., who writes this article, which is entitled "Modern Inventions as Educational Aids," says:

"The poorest agricultural labourer can, and apparently does, afford his crystal set, thus coming into contact with the great world at his own fireside. And what of his children? Are they using the headphones also, and if so, what do they hear? Has their schoolmaster grasped the potentialities of this new instrument, and has he yet installed a valve set and a loud speaker in the village school."

The provision of this aid seems peculiarly a matter for those enlightened enthusiasts, who are fortunately to be found in all classes, who really care for the cause of education. 3LO, Melbourne, has commenced an educational programme on Thursday afternoon, which it is prepared to extend as the demand increases. The community as a whole is not yet prepared to spend on its schools what it spends across the bar, or on the race course, but in every community there are to be found people who believe that human progress is coming through the widening of human outlook, the quickening of imagination, the broadening of human sympathies by education. "We would be happy but for our pleasures," an Irish statesman is reported to have said. The only way of displacing the pleasures that waste time, money, physique and talent is by replacing them with others of better quality. This lifting of taste, and quickening and broadening of interest in life is the special task of the radio in education, and 3LO, Melbourne, is anxious to be allowed to play its natural part in the education progress in this State.

\* \* \* \* \*

## COUNTRY BROADCASTING.

### The Policy of 3LO, Melbourne.

Every since the commencement of broadcasting 3LO, Melbourne, has made a special feature of relaying concerts, sporting functions and other ceremonies from every part of Victoria, and as far away as Sydney and Adelaide. These relays have always

been a huge success, and have been greatly appreciated by listeners. In many cases 3LO, Melbourne, has assisted in the success of the concerts by providing artists and bands to supplement the programmes.

It is not unusual for 3LO, Melbourne, to broadcast country relays almost every day in the week, and often it happens that in the large provincial cities two or three functions in one day are broadcast, and sometimes they are put on the air from many centres on the same day.

It does not affect 3LO, Melbourne, when trunk telephone lines are not available for these relays, because that station has always ready for emergency a portable transmitting plant which can be erected almost at a moment's notice on the location of the events to be broadcast, thus dispensing with telephone lines altogether.

Perhaps the record will be broken at Ballarat early in November when a huge charity concert will be broadcast, to be followed the next day with descriptions of the Agricultural Show, and at night the music of a grand Charity Ball. 3LO, Melbourne, is sending Joe Aronson's famous symphonists specially to Ballarat for these events, and the Mayor and Councillors of the City are co-operating. The local arrangements are being carried out by a strong committee of leading citizens. The third night's broadcasting from Ballarat will be the ever popular Community Singing. In between, a race and other events will be described and items of special interest broadcast.

\* \* \* \* \*

## 2UW.

WHATEVER is said about B class stations there can be no doubt that 2UW is making itself heard in many homes previously unaware of its existence. Since the installation of a new speech amplifier, this station has shown a vast improvement on its old transmission, and in its programmes.

It has inaugurated a "Women's Session" each morning at 9.45 conducted by "Auntie Flo," and at least five nights every week, artists broadcast from 2UW, among them being Miss Elsie Ross, soprano, who can always be heard on Thursdays and is accompanied at the piano by her sister, Miss Jessie Ross. Professor C. Sauer has lately been secured by this station. Amongst its other artists, 2UW includes Mr. Stuart Peters, and Mr. George F. Manuel, tenor, who also conducts talks on "Natural History" every Wednesday evening. Miss Esther McAlpine, a contralto, and Miss Jane Edwards, a soprano.

## BROADCASTING ERROR.

### Big Fight by Radio.

THE BROADCASTING of the world's championship fight between Tunney and Dempsey was like the polite curate's egg—good in parts. Listeners in most parts of Australia received the news of Tunney's victory within a few seconds of the finish, but the detailed description was far from satisfactory.

THE TROUBLE was that the radio announcers at the ringside, instead of being shut inside sound-proof glass boxes, had to try to make themselves heard above the yelling of 150,000 excited men. The American radio stations reached Australia right enough, but most of the description was drowned in the shouting. The Australian stations had intended to relay the Americans, but it was found better to gather up the fragments of the story, piece it together and broadcast it afresh. This was done and the roar of the ringside was allowed to accompany the words of the Australian announcer, thus conveying a vivid idea of the excitement.

\* \* \* \* \*

### ONE-ACT PLAYS ON THE AIR: IF

3LO is seeking a new and useful competition it will seek to foster the new technique of writing plays suitable for broadcasting. Far too few plays are broadcast. There is a love of drama inherent in each one of us. We naturally crave for the surprising and the unique or we are quite content to see the old dressed up in new clothes. Occasionally artists broadcast plays but they are plays written for visual acting. Too many explanations are necessary to enable listeners to follow the unseen. In England, regular features of the programmes are one-act plays specially written for the wireless. We have in Australia people who are capable of writing such things, given the encouragement. A prize of £100 offered for the best radio one-act play to take not more than half an hour would produce probably a score of plays worthy of production in a studio. 3LO could secure the rights to these on payment of a reasonable sum and the author could licence other stations to use them. If the programmes now broadcast lack one thing more than another, it is variety. Anything new in this way would be to the good. It's an idea, anyway, with which I present 3LO free of charge.

You can Recharge a Philco for a few pence.

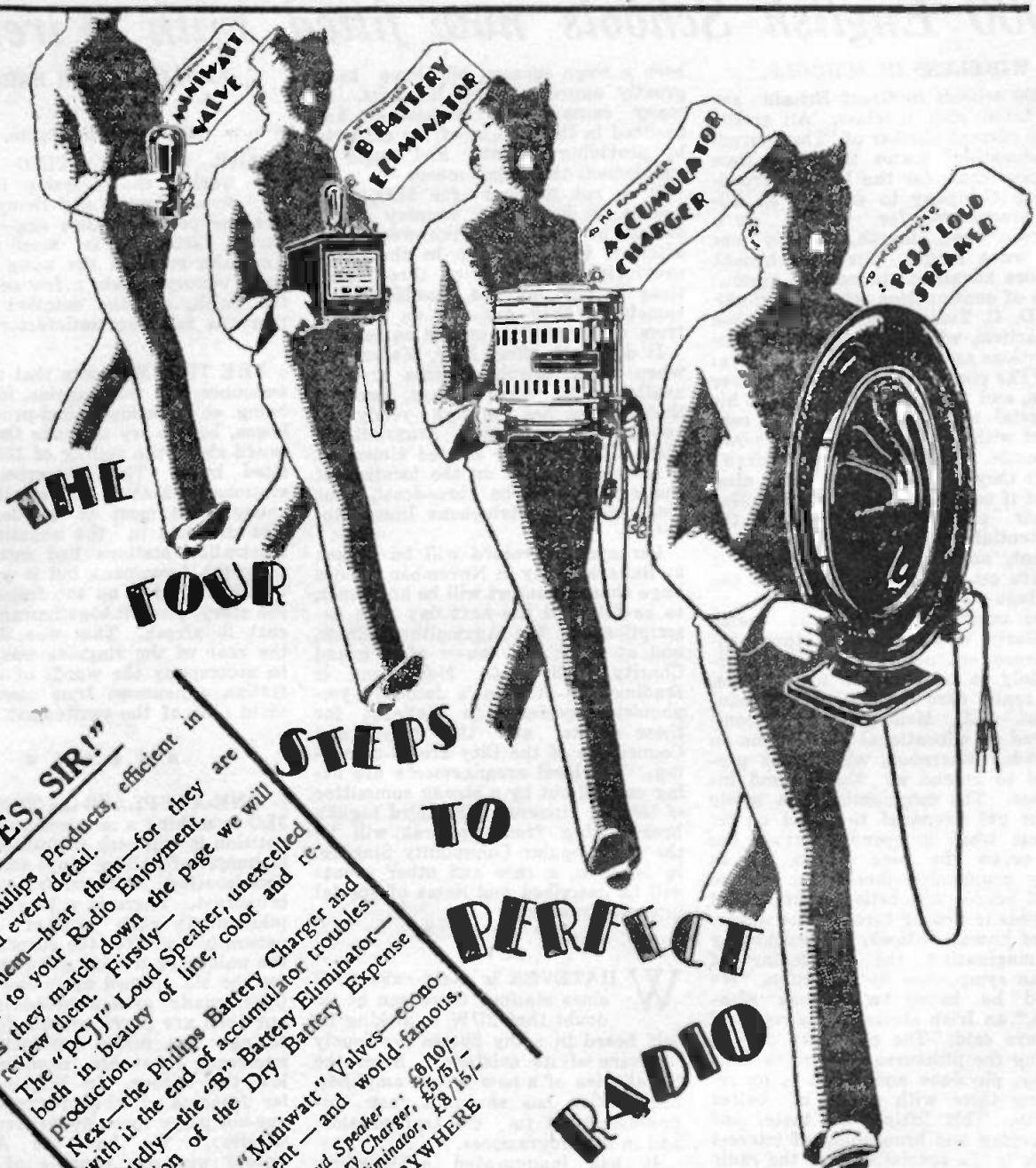

**THE  
FOUR**

**STEPS  
TO  
PERFECT  
RADIO**

**RECEPTION**

**PHILIPS  
RADIO**

**"YES, SIR!"**

Four Philips Products, efficient in each and every detail. As they march down the page we will review them—hear them—for they are vital to your Radio Enjoyment. The "PCJJ" Loud Speaker, unexcelled both in beauty of line, color and re-production. Next—the Philips Battery Charger and with it the end of accumulator troubles. Thirdly—the "B" Battery Eliminator—solution of the Dry Battery Expense problem. And lastly, "Miniwatt" Valves—economical—efficient—and world-famous. Philips Loud Speaker... £8/10/- Philips Battery Charger... £5/7/- Philips "B" Eliminator... £8/15/-

**SOLD EVERYWHERE**

7212

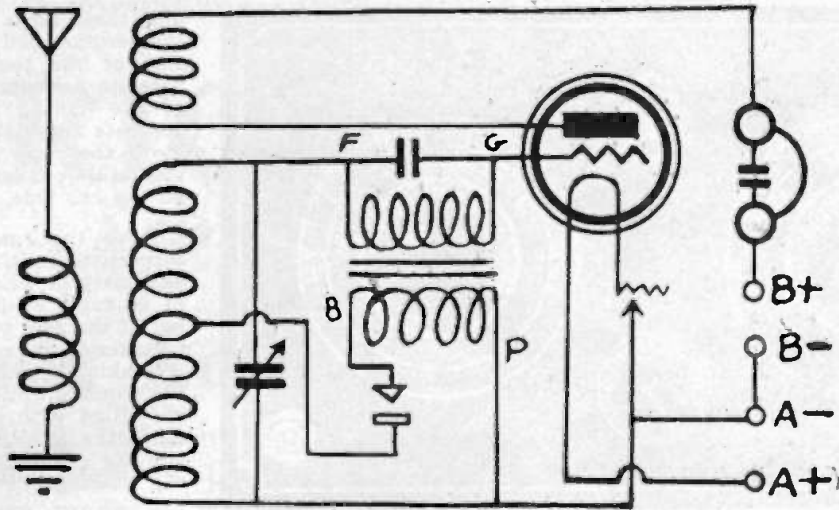

# A Single Valve Reflex Receiver

THE average man to-day is always trying to get the most out of a single valve set. Many and varied are the means put forth by skilful writers, but somehow or other reflexing is the most popular method in existence to-day. Virtually speaking, reflexing a receiver is very successful provided the system adopted is one which lends itself to fool-proof tendencies. Invariably too, a crystal is employed as a means of rectification, and many constructors contend that herein lies a weak point in every reflex receiver.

This is not true in every sense of the word, although as a matter of fact in many instances there is a certain amount of reason for these assertions. But the overcoming of this difficulty is not insurmountable and the receiver proposed to be described is one which is very stable indeed, and will therefore make its appeal to those many readers who are anxious to get loud speaker reception using only one valve.

In almost every reflex circuit it is usual to have the crystal rectifier in the plate circuit of the valve. This causes considerable damping and naturally results in broad tuning, the arch enemy of wireless receivers owned by city people. A glance at the circuit diagram of this receiver shows that the crystal detector is connected to the centre turn of the grid coil, thereby enabling the radio frequency current induced in the grid coil by the aperiodic aerial coil to reach the grid of the valve; here they are slightly amplified and fed back through the reaction coil to the grid

coil again; here is where a great increase in sensitivity is obtained.

As has been mentioned over and over again in these pages, a tendency of modern receivers is to increase the selectivity at the expense of the sensitivity. Now this is quite wrong, because there is no reason in life why

the combination of selectivity and sensitivity should not be maintained throughout. An effort has been made in this receiver to produce this effect, and just how far it is produced will be proved by those who constructed.

Many owners of standard 3 coil regenerative single valve receivers will welcome this reflex receiver, and it is only necessary to procure a fixed condenser, an audio transformer, and a crystal detector to convert their present receiver into this model with advantageous results. The sensitivity of the receiver will not be interfered with in any way, rather will the volume be increased to a very high standard. Incidentally, too, the purity of reception will be enhanced immensely, as there is no question of the fact that it is an extremely difficult matter to get better purity than is obtained by means of crystal rectification.

The beginner is sure to ask just what purpose the valve itself performs to enlighten them on this matter. The more experienced reader will perhaps pardon the writer for inserting the next paragraph. The valve performs a dual purpose. It does not detect, this being the right of the crystal, but it amplifies the incoming energy firstly at radio frequency, and in this manner boosting up the manner of the untuned oscillations, then after these are detected, they are fed back to the valve again to be amplified at audio frequency. Thus there is a combination of radio frequency amplification detection and audio frequency amplification, three distinct purposes and only one valve required to do this.

## Parts Required

Although the parts listed below and mentioned throughout the article were those actually used by us in the receiver described, it must be pointed out that it is not absolutely essential that they be rigidly adhered to.

Other parts of similar quality and technical values should function quite satisfactorily.

- 1 Dilecto, Radion or Hard Rubber Panel, 12 x 7 x 3-16.
- 1 .0005 mfd. Pilot Centraline Condenser.
- 2 4in. Dials.
- 1 Harlie Detector.
- 1 30 ohms. Rheostat.
- 1 Advance 5-1 A.F. Transformer.
- 1 Valve Socket.
- 1 .002 Wetless Condenser.
- 1 .001 Wetless Condenser (Optional).
- ½ lb. No. 20 D.C.C. Wire.
- 9in. of ½ or ¼ in. Diameter Dilecto or Radion Rod.
- 1 Small Piece of Panelling, 4 x 1 x 3-16.
- 1 Terminal Strip, with 8 Terminals.
- Sundries, Screws, Wiring, etc.
- 1 Baseboard, 11 x 9 x ¾.

Let Your Battery Save Your Purse: Philco.

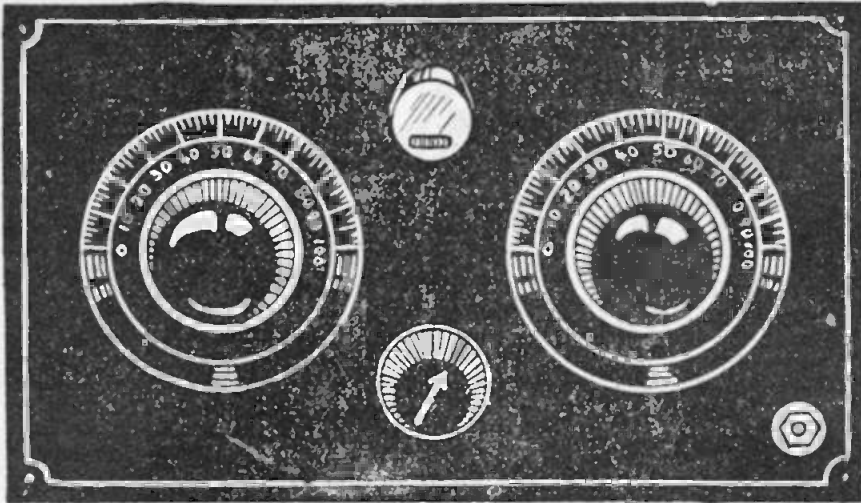

Here is a saving in the cost of upkeep and here is a means of listening in on a loud speaker to the local stations, and only one valve used.

But before proceeding any further, too much stress cannot be laid on the necessity of making use of only a high grade crystal detector, and this unit is the main spring of the whole receiver. A cheap ordinary crystal detector is less than useless, so it is incumbent upon the constructor to employ only a high grade crystal detector. Having this end in view, the writer has specified in the list of component parts necessary a Harlie detector, but other good quality detectors may be used, such as one of the well-known Lion family or a Carborundum, also a well-known product.

For the sake of neatness and appearance the front panel only has two dials, one for the condenser, and one for the reaction control and the crystal detector with the rheostat mounted below. All the terminals necessary are mounted on a terminal strip at the back of the baseboard, even the terminals for the loud speaker or headphones are there. This gives an exceedingly neat appearance besides providing a means of constructing short leads which are so necessary in every efficient wireless receiver.

The coils for this reflex set may be wound at home. For this purpose there is required half a lb. of No. 20 gauge D.C.C. wire. The primary or the aperiodic coil consists of 8 turns, the secondary coil of 40 turns, and the reaction coil of 35 turns, of this gauge wire. Early radio men will remember the basket wound style of low loss coil so popular in short wave receivers of 2 or 3 years ago. This is the method adopted for the coils required for this receiver.

To wind these coils a suitable former must firstly be prepared. Procure a piece of timber of any thickness, but at least 5in. square. Describe a circle on this timber 4in. in diameter. The circumference of this circle must be divided into 9 equal divisions. Spend a little time marking out these divisions, reasonably accurately. Then using ordinary nails, approx. 4in. long, drive them into the board one at each division. Drive them far enough in so that they are secure, and as near to upright as is possible. Now commence winding the coils. Selecting one nail, it doesn't matter which one, twist the beginning of the wire around this nail for a couple of turns, then wind the continuation of the wire by going outside one nail, inside the next, outside the third, inside the fourth, outside the fifth, and so on, in and out of the nails, until 8 complete turns are

wound on. Borrow some cotton, and bind these turns together. Next wind the reaction coil and securing as before at the beginning, wind on 35 turns in a similar manner, in and out of the nails. Bind this coil now, separate from the primary coils. Remove the nails altogether, and take both coils off, leaving them carefully on the one side.

Drive the nails back into their respective positions, and wind the secondary or grid coil. This consists of 40 turns as previously mentioned, but at the 20th turn, a tapping should be taken in the usual orthodox fashion of making a small loop, and continue the winding until 40 turns are wound on. Bind with cotton as before, remove the nails from the board, and slip the coil off. This completes the coil winding.

Next mark out and drill the panel in accordance with the panel drilling diagram accompanying this article. Lay the panel on a flat surface, mark out with a centre punch, then drill. Never forget it is always a wise policy when drilling standard panel material to use only a light pressure, but a high speed. No vernier dials are necessary in this receiver, so the constructor can forget about the catch screw which is usually necessary with the vernier dial, but attention should be paid to the fixing holes necessary for the fixing screws for the variable condenser. Also bear in mind that the panel has to be screwed to the baseboard so that it is necessary to provide 3 holes at the bottom of the panel for this purpose.

On the panel mount the condenser, and the rheostat, also the crystal detector. Prepare the panel by trimming off the edges and treating it to a coat of shellac varnish. Now screw

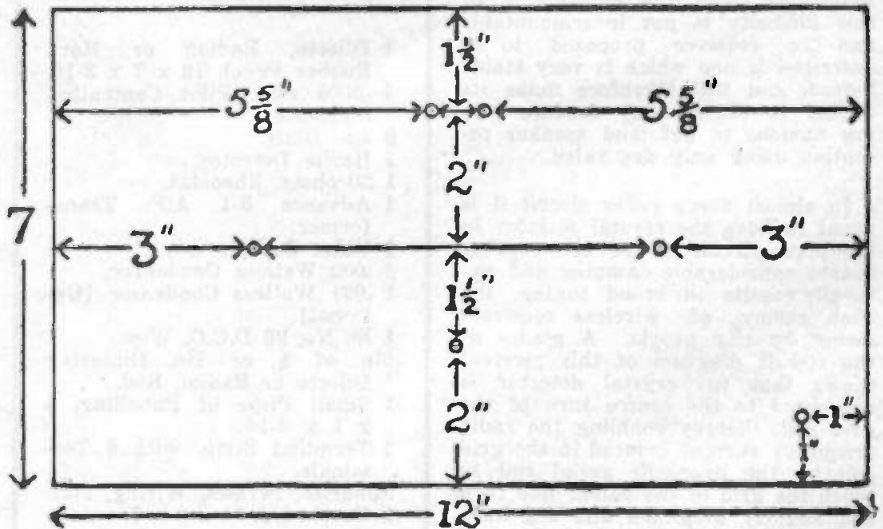

Leading Broadcasting Stations use Burgess Batteries.



the panel into position on the base-board.

At this stage it is wise to mount the reaction coil in its position, pick up the dilecto or radion rod, which should be drilled at each end in such a fashion that a short length of 3/16in. brass rod may be fitted into each end, in such a manner, that the rod is increased in length by means of this brass rod by approx. 1in., that is, a brass rod should protrude 1/2in. from each end of the rod.

Next bind the reaction coil to the rod, using again the family cotton. Bind this securely so that it does not slip. On the small piece of dilecto the size of which is as previously mentioned, 4 x 1 x 3/16in., drill a hole the same diameter as the brass rod, which protrudes from the dilecto or radion rod. Mount this small piece of dilecto at the back of the base-board in such a manner that the reaction coil mounted on this rod should spring through its own axis. There should be attention between the front panel and this small back supporting panel, so that the reaction coil does not flop all over the place, but will remain in any position according to the turning of the dial on the front panel, which controls the angle of this reaction coil.

Next mount in position the secondary coil, and the aerial coil. The secondary coil should be mounted close to the reaction coil so that the reaction coil may swing towards the secondary, therefore, it would be wise to mount this secondary coil on the same level as the reaction coil. The aerial coil is fitted to the grid end of the secondary coil, that is, the opposite side to the reaction coil. The aerial coil should be approx. 1 or 1/2 an inch away from the secondary coil, and may be held in position by means of 9 matches. It is absolutely necessary to note that all three coils are so mounted that the windings run in the same direction.

Now lay out the rest of the base-board apparatus, this consists only of a socket and a transformer, across the secondary of which is mounted the .002 fixed condenser. Fit the terminal board into position now, this terminal board should have 8 terminals, one for aerial, one for the earth, one for the A battery positive, one for A battery negative, one for B negative, one for B positive, and two for the loud speaker or earphones.

If the constructor prefers to make his own terminal board, a handy spacing for these terminals is 5in. apart. When mounting the terminals on the terminal strip, considerable time and trouble will be saved if the constructor fixes soldering lugs to each terminal; from these lugs can the connections be taken to the various components of the receiver.

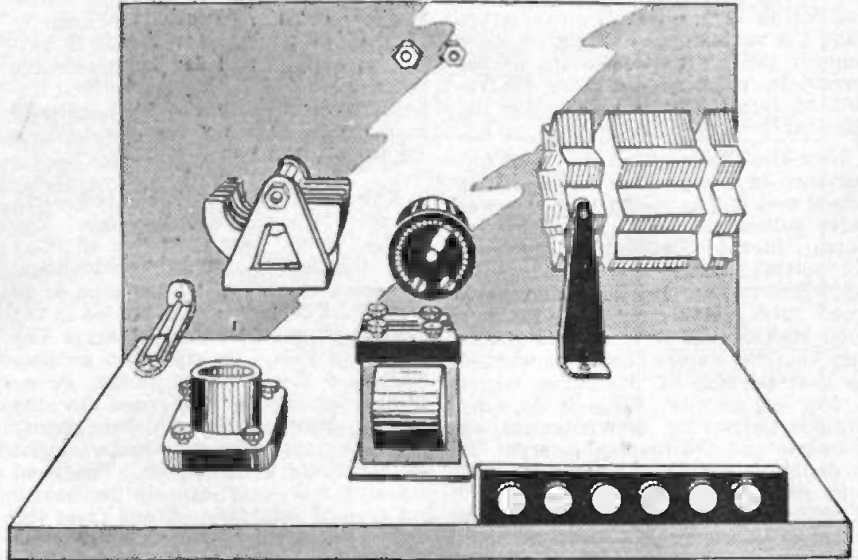

The wiring can be proceeded with at this stage, the choice of wiring wire is left to the constructor himself. Some prefer neat looking square busbar with right angle bend, while others display a strong partiality for the soft point to point insulated wiring. Commence the wiring by connecting the aerial terminal of the terminal board to the beginning of the aerial coil, the end of which join direct to the earth terminals. Now run a connection from one side of the rheostat, to one F terminal of the valve socket. Connect the other F terminal of the valve socket to the A positive terminal on the terminal board. Now the remaining side of the rheostat should be joined to the A negative terminal, and the B negative terminal. While on the terminal board, join the B positive to the nearest loud speaker terminal, the remaining loud speaker terminal connect to one side of the reaction coil, the other side of which join to the P of the valve socket.

Run a wire from G of the audio transformer to G of the valve socket. Now connect F of the audio transformer to the fixed plates of the variable condenser, and to the beginning of the grid or secondary coil. The beginning of this coil is that side nearer the aerial coil. Now join the end of this grid coil to the moving plate of the variable condenser, and to the P terminal of the audio transformer, also to the A negative and B negative terminals, on the terminal board. From the B terminal of the audio transformer run a connection to one side of the crystal detector, the other side of which to the centre tap of the grid coil. Naturally, in making this connection, the insulation should

be scraped from the wire, and a drop of solder applied.

The other day the writer had submitted to him, a single valve receiver for test purposes. This receiver had been made by a raw beginner, and not one joint was soldered; the constructor had similarly twisted his connections, hoping to make a good contact. Naturally he didn't, because the losses set up were so great, very poor signal strength resulted, and what did come through was very scratchy and noisy, a sure indication that the cause of the trouble lay in bad and loose connections. A few minutes with the soldering iron set these matters right, and this paragraph was inserted to impress the beginner that intermediate joints should be soldered. A few hints in soldering were given in "Wireless Weekly" of the 7th inst., and those readers who are not conversant with this side of the construction are referred back to this issue.

When everything has been wired correctly, test the receiver. First of all make certain that the B battery terminals and connections are not mixed up with the A batteries, because if by any chance this does happen, and the B batteries are connected to the A battery terminals, or if by any chance the B battery makes contact with the A battery wiring, when the receiver is connected up, the valve will be rendered useless by being burnt out.

Avoid this possibility at the very beginning, insert the valve in its socket, and connect the A battery itself, to the B battery terminals. Turn on the Rheostat, and if the valve lights up you can assure yourself that

Burgess Went over the Pole with Byrd.

there is a wrong connection somewhere, check over all your work in the wiring before proceeding further, and rectify this error. If on the other hand the valve does not light up, then connect the A battery to its proper terminals, which should give the result of lighting the valve when the rheostat is turned on.

Now the choice of a valve is of importance in every reflex receiver. On actual test it was found that a power valve suited best, valve used being a Cossor, Stentor Six, which requires a six volt A battery, and about 100 volts B battery. Radiokes and Radiotron, 201A valves, both gave very good results, but it is always necessary that the valves should be worked on that portion of the curve where it does not rectify. This is done by suitably adjusting the potential on the plate and the filament current. If in doubt as to the valve to use, ask your dealer to show you the curves of different valves, and select one whose characteristic curve has a good straight portion. To-day, there will be found a wide choice of valves to suit all purposes, and at various

prices to suit the pocket, so it should not be a hard matter for the constructor to pick a suitable valve. Follow out the directions enclosed in the valve packet, for A and B batteries supply, and for goodness' sake remember not to expect the best results from this receiver with only 45 volts plate battery. At least, have 80 to 90, more is preferable.

Now hook on the aerial and earth to their respective terminals. The aerial should not exceed 80 feet overall in length, and the earth should be direct to a clean water pipe or to a sheet of copper or iron buried in the ground in some moist place. The earthlead should be as short as possible and fairly stout, certainly no thinner than the wire used for the aerial. Now connect the headphones to their respective terminals. Light up the valve and tune in. The local stations will very quickly be heard, but free of interference, one from the other, excepting under adverse circumstances, such as a location in the shadow of a high-powered broadcasting station.

Adjust the reaction coil by bringing it closer to or further away from the grid coil. Find a good point on the crystal detector, try two or three different places on the crystal. A decided increase in volume will be found when a good spot is located. Retune with each different crystal adjustment. Use your rheostat to advantage. There will be found one position which yields best results. Adjust the B battery voltages. Finally, if reaction is difficult to obtain, reverse the connections on the reaction coil. This will adjust it satisfactorily.

This is a really good little receiver, and will find many friends everywhere. Don't be afraid of a reflex receiver, wonderful will be the results obtained, provided the constructor follows the instructions carefully. The remarks concerning the crystal should not be overlooked, nor should the question of B battery voltage be treated casually. Granted everything is correct, those who make up this receiver should get the same results as did the writer. The writer's home is

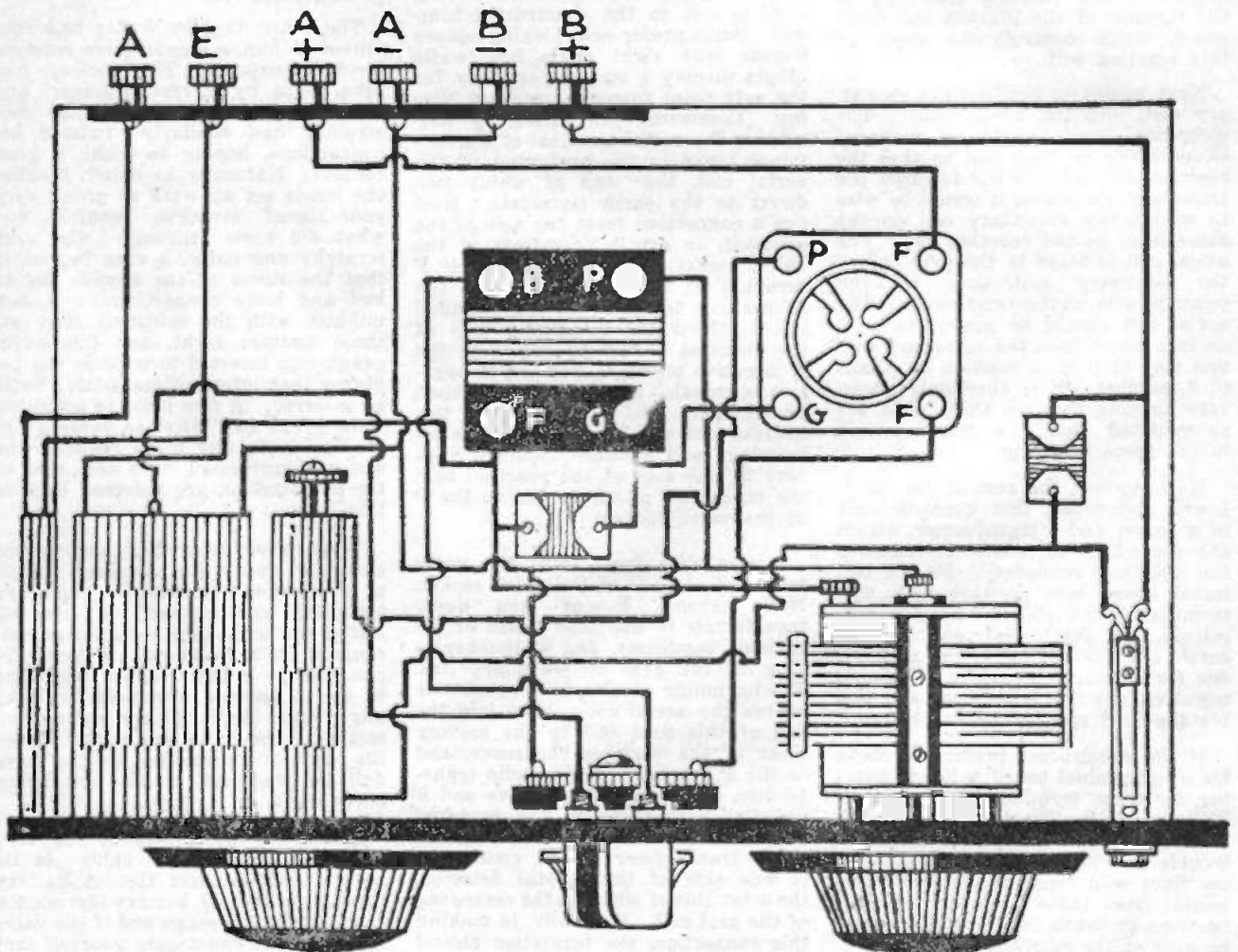

From Icy Pole to Tropic Jungle: Burgess.

at Marrickville, in a high position 3½ miles ailing from 2BL, and 17 miles airline from 2FC. All the local stations were heard very nicely on the loud speaker, not enough volume to deafen you, of course, but sufficient to fill the average size room with clear sweet music. And the Announcers' voices were very natural.

A certain amount of care is required in using the reaction coil, this being a feature worth while from the point of view of hearing long distance stations on the earphone. The speaker used was a Brandes Tablecone which, besides looking very attractive on top of the cabinet, is particularly sensitive, as the magnet of the unit is of generous proportions. All who heard this receiver expressed surprise at just what could be achieved with a simple set like this. For local reception it will be found ideal, and considering that the life of the A and B batteries depends greatly on the number of valves used, it is evident that these accessories should last a considerable time. Here is a saving to the pocket.

Finally, it will be found advisable to shunt the loud speaker terminals with a fixed condenser of .001 capacity. This will allow any radio frequency energy present in this portion of the circuit to be by-passed instead of flowing through the windings of the speaker or 'phones as the case may be. Try it with and without.

### MRS. H. R. HAMMER'S BORZOI DOG "AUTOCRAT OF ROOSKAYA."

In connection with the broadcast of the heart-beats of one of the largest dogs in the world, by 5CL recently, some interesting facts were given by the lecturer before the broadcast.

The borzoi or Russian wolf hound is used in Russia for hunting wolves. They are very fast and have great stamina and can chase the wolves for very long distances. The wolves are coursed with a brace of borzois in the same way as the hare is coursed in Australia with a pair of greyhounds. Sometimes a pack of borzois is used on a pack of wolves, the hunters riding after them on fleet horses.

This borzoi is Mrs. H. R. Hammer's well-known "Autocrat of Rooskaya," and was imported by that lady last April from England. He was procured in England by Mr. H. Thompson, of Bradford, who is a well-known borzoi breeder and judge. That gentleman stated that in his opinion "Autocrat" was the second best borzoi in England.

# Vacuum Tubes for Every Purpose

## When is the Vacuum Tube Worn Out?

OF vacuum tubes there are many kinds for many purposes. Tubes are primarily divided into transmitting and receiving tubes, the main difference being size and capacity, the basic design remaining the same.

For reception, there are two primary classifications, namely, receiving tubes proper and auxiliary special tubes. Taking up receiving tubes, we have general utility tubes operating on either storage battery or dry battery, according to preference. Formerly, and until the advent of dry-battery power tubes, one was virtually compelled to employ storage-battery tubes for powerful loud-speaker results. To-day, however, there is no longer the wide discrepancy between dry-battery and storage battery operation. General utility tubes may be employed as detectors, radio frequency amplifiers, audio frequency amplifiers, and small oscillators.

Then there are the special purpose tubes, divided into supersensitive detectors and high-volume output amplifiers. Of the former, there are two types of precisely the same characteristics but with different bases. Of the latter, there are three types, namely UX-120 for the last stage of a dry-battery amplifier, UX-112 for storage-battery amplifier, and UX-210 for use with electric-light-supply power amplifiers. So much for receiving tubes proper. Switching over to auxiliary special tubes, we have the regulator tubes for battery eliminators. There is UX-874, which controls the "B" voltage applied to the receiving set by a battery eliminator, as well as UX-876 which controls the alternating current line current going into the battery eliminator. There is protective tube, UV-877, which protects the tube filaments of a receiver against possible "B" battery potential due to faulty connection or short-circuit. Then there are the rectifying tubes or rectrons, UX-216-B and UX-213 used in battery eliminators.

You will notice that I have referred here to American type tubes, as these are more generally known to the average listener, but it must be understood that there are many makes all with their own denominations such as the B406, PM4, Stentor 6, and countless others that it would take hours to enumerate.

VACUUM tubes, like living things, grow old and finally come to the end of their existence. Formerly, when vacuum tubes had solid tungsten filaments, a tube was useful until the filaments would no longer light. To-day, however, economical vacuum tubes employ special filaments which continue to light even after the tube has become practically useless. So a lighted tube is no proof that the tube is still good.

Progressive radio dealers have tube testers with which to determine the characteristics of tubes. When possible, the radio enthusiast should have doubtful tubes tested by his radio dealer, and, as often as not, those same tubes, provided they be genuine radiotrons with the X-L or thoriated-tungsten filament, can be rejuvenated or reactivated as it is called, so as to deliver several hundred hours of additional service. To the radio listener in rural parts where a local radio dealer is a rarity, there is a simple home-made means for testing the efficiency of tubes. This involves nothing more than mere comparison between a tube of highest efficiency and the tube in the receiving set. First of all, the radio enthusiast should secure a new tube from a reliable dealer. This tube is now substituted for one tube after the other in the receiving set, noting the difference in signal strength and tonal quality. In this manner the radio enthusiast or listener can tell which tubes are getting weak, causing a loss in signal strength and even impairing the tonal quality, by direct comparison.

Reliable vacuum tubes have a life well in excess of a thousand service hours. Furthermore, while efficient tubes should be employed for the audio amplifier sockets, the older tubes can be used with good results for the radio frequency and detector sockets.

**CRICKET:** Mr. Rod. McGregor commences his talks on Cricket on Thursday evening, October 20th.

**DANCE MUSIC:** Thursday night, October 20th, being "Dance Night" at 3LO, Melbourne. Jos Aronson and his Symphonists will render some new numbers.

For Purest Music Use Only Philca.

# A Section for the Trade

## WIRELESS ON AIR 'PLANES.

To enable them to pick up news and weather reports en route, the United States Air Mail 'Planes are fitted with radio receivers. In this picture is shown at left Billy Brock, famous

Capacity reaction is also a feature of this kit, and this method of regeneration, which provides such delightful control, makes the logging of distant stations a comparatively easy matter.

phase difference approaching ninety degrees with the original disturbance, no oscillations would be created, because with such a difference there is no continuous reinforcement of the original impulse.

Full particulars of installation, operation and supplies were received from Messrs. Amalgamated Wireless (Australasia), Ltd., of 47 York Street, Sydney, who are the wholesale distributors in Australia for Electrad Certified Radio Products.



trans-Atlantic pilot, who has made many records as air mail pilot and stunt flier. With him is Mr. Souther, Chicago salesman for the All-American Radio Corporation, who fitted an all-American receiver to the 'plane. The set has shielded coils, and when carried on the first air mail flight from Chicago to Minneapolis picked up stations right along the route.

The coils are wound with green silk wire on celluloid formers; all ends are taken to soldering lugs clearly lettered, which reduces the chance of faulty wiring to a minimum.

The kit is of robust construction and good finish, and one we can thoroughly recommend to the novice.

The issue under review is printed throughout on art paper, and the front cover design in two colors shows a picture of a huge blue-gum tree, side by side with a motor car. It is somewhat difficult to link these two things together until one opens the book, and finds a neatly worded paragraph which draws an analogy between the handiwork of nature and that of man, and introduces a neat little climax by pointing out that it is from matured trees such as that

## CLYDE SPARKS.

We have received from the Clyde Battery Service a copy of their excellent little house organ entitled "Clyde Sparks." Although primarily intended for Service Stations and Radio Dealers, this chatty little volume contains a heap of matter which is of interest to anybody interested in batteries.

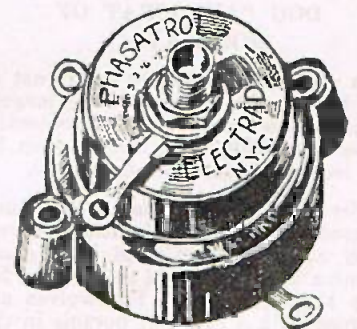

## THE PHASATROL.

The latest "Electrad" Product to reach the Australian market is the "PHASATROL," a true balancing device for Radio-frequency Amplifiers. It is suitable for any circuit which employs Radio-frequency Amplification—whether tuned, untuned or reflex. One Phasatrol must be used for each stage of Radio-frequency amplification and, when correctly installed and adjusted, Phasatrols will absolutely eliminate any tendency to radio-frequency oscillation or distortion. They should prove especially useful to the man who builds his own set, as a means of balancing and controlling the radio-frequency amplification. The principle of their operation is based upon the fact that when the actual impulse upon the grid shows a

shown on the cover that the wooden separators used in Clyde batteries are obtained.

W. R. Green, Production Manager of the Battery Department of the Clyde Company, contributes an article dealing with the progress of the manufacture of Clyde Batteries, and one learns from this that whilst in 1926 the production of batteries by this firm was approximately 40 per day, to-day no less than 250 batteries are turned out every day. Truly, big figures, and reflecting great credit

## THE AIRZONE MASTERDYNE KIT.

This Kit, which has recently been examined by us, utilises one stage of Radio frequency and differs from the



usual design in that it employs a loose coupled primary in the R.F. Coil. This feature reduces the tendency to oscillate, a point that should appeal to the amateur not versed in the art of neutralising, and also makes for greater selectivity.

Square Glass Cells with each Philco.

upon both the product and the method of merchandising it. Incidentally this particular article gives some figures regarding the big new battery plant which is now being installed by the Clyde Company. This has a concrete floor space of over 50,000 square feet. A double page spread neatly laid out illustrates the various types of literature, pamphlets, blotters, show cards, etc., which are produced from time to time by the Clyde Company, and supplied free to Service Stations. There is a detailed description of the new Clyde Radio "A" Power Unit, and various illustrations of Service Stations and other items related to the battery industry.

A number of snappy pars and news items scattered throughout the book complete the volume, and make it most interesting reading. A. R. Allen, the Editor, is to be congratulated upon his production.

**EMMCO SUPER POWER ELIMINATOR.**

Amongst the many new lines now produced by Emmco must be mentioned The Emmco Super Power "B" Eliminator, which is constructed particularly for supplying high tension current for multi valve sets. We tested this super power eliminator on a Nine Valve Receiver operating from a loop aerial, and found no trace whatever of hum, but vastly increased volume. It delivers 85 milliamps on 180/200 volts, and is supplied with a Raytheon B.H. Tube. It is adaptable for all types of valves.

The instrument is enclosed in a neat metal case with Bakelite top and aluminium base, the whole measuring 10½ x 9½ x 6½, weighing 23 lbs. It has five terminals, one Earth, one B—, one Detector+, adjustable by a knob for voltages of from 20 to 45, one Radio+, adjustable up to 180 volts, and one Audio+ for the full 180 volts.



If a lesser voltage is desired in one or more of the Audio valves, they may be connected to the Radio terminals and adjusted to suit. The voltages may be altered by the adjustable knobs while the Eliminator is in use.

With each Super Power Eliminator a fully explanatory pamphlet is supplied so that the operation entails

no difficulty whatever. From practical test, and from an appearance point of view, the Emmco Super Power Eliminator more than meets modern requirements, and we predict a very large sale for it in the future.

**TOO MUCH BRANDES?**

Two years ago the name "Brandes" was known to a few people who just happened to buy a pair of "Brandes" phones. When we consider it to-day, this seems remarkable, as Brandes have been acoustical component designers and manufacturers since 1908.

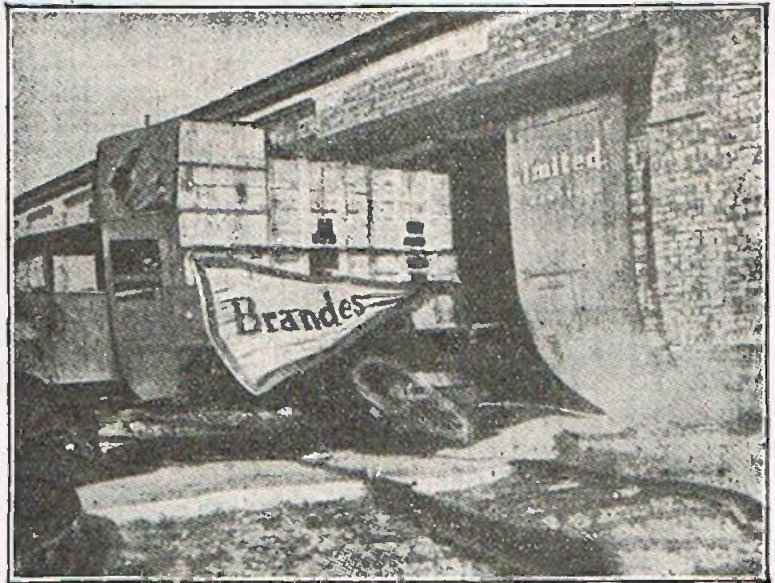

What a difference there is to-day. Even here in Australia, that wonder reproducer "The Ellipticone," which recently won the Holland Acoustical Medal against all comers, has been heard and applauded by thousands, whilst its small confrere, "The Tablecone," naturally appeals to those of more moderate means.

Brandes have not confined themselves to their world known speakers—The Table Talker, The Brandola, The Tablecone, and The Ellipticone, but have recently branched out and carried their master craftsmanship to condensers and sets.

As an example of the way Brandes goods are being received in Australia, the photograph shows a rather remarkable thing. It happens to be one of six trucks carrying goods for shipment to Australia. The weight probably with the name and size of the shipment were too much for the truck, so it gave up the ghost.

**A NEW BURGESS BATTERY.**

New System Telephones Pty., Ltd., announce the early arrival of a new and much bigger type of Burgess

Battery, to be known as the No. 21308, or the Super "B." The Burgess No. 21308 weighs about 16-lbs., or only 2-lbs. more than their well-known No. 10308. This slight additional weight and slightly larger dimensions makes it possible for this Super "B" to have 25 per cent. greater capacity. The Battery is especially designed to give efficient service on heavy currents, so that sets requiring heavy currents—that is, drains which exceed 20 milli-amperes, will operate efficiently and economically on the Super "B" service.

Cylindrical cells proved through

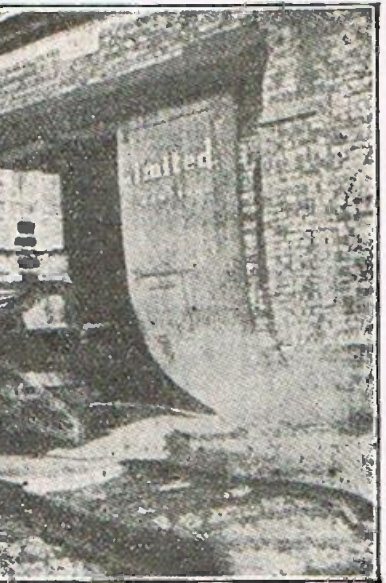

years of use, contain an improved mix. The paste electrolyte makes recuperation rapid and the insulation between selected cells is of the very best. The outer box is thoroughly paraffined and the posts equipped with insulated nuts.

It is sufficient to say that the Super "B" embodies all of the qualities which have worked for years to-

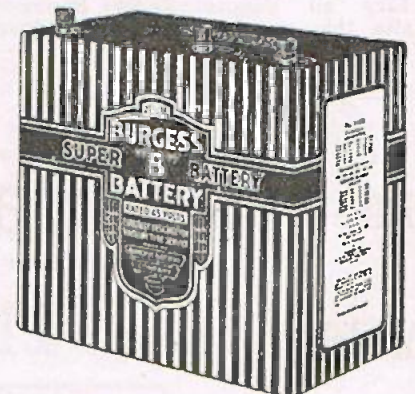

wards the success which Burgess has established, and also benefits through the new design and research of the Burgess engineers.

There is no "just-as-good" as Burgess.

# Standard Throughout the Radio World

NOW ONLY  
**£3/10/-**

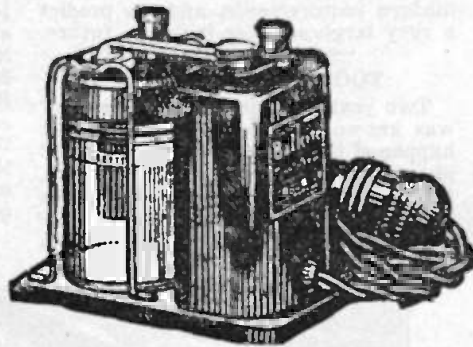

NOW ONLY  
**£3/10/-**

## Trickle Charging began with Balkite and Balkite still leads in popularity, service and number in use

Trickle charging, now the most convenient and most popular of all means of charging your radio "A" battery, was not possible until the development of the Balkite Trickle Charger. For Balkite was the first charger that could be connected permanently to your "A" battery and the light socket. It was the first charger that kept the battery always fully charged. And Balkite was the first charger that converted your battery into a complete power unit supplying "A" current from the light socket.

To-day there are over 400,000 Balkite Trickle Chargers in use. Just as it was first in making trickle charging possible, Balkite has always been first in popularity and number in use. Balkite is the standard trickle charger, tried and proved by use in the hands of its thousands of owners.

Like all Balkite Radio Power Units, this charger is a permanent

piece of equipment. It has no tubes and nothing to replace or renew. It is noiseless in operation and can usually be used during reception. It is very compact and small, and its current consumption is very low.

The Balkite Trickle Charger can be used as a trickle charger with any 6-volt radio "A" battery. Thus used it keeps your battery always at full power and in effect converts it into a light socket "A" power supply. With 4-volt batteries it can be used as an intermittent charger of the usual type. Or as a trickle charger if a resistance is added. Charging rate is approximately  $\frac{1}{4}$  ampere.

Add a Balkite Trickle Charger to your "A" battery. Know the convenience of permanent silent "A" power from the light socket always.

Balkite Trickle Charger. Over 400,000 in use. Charging Rate about  $\frac{1}{4}$  ampere. As a Trickle Charger automatically keeps your "A" Battery fully charged. Price ..... £3/10/-  
Balkite "B" eliminates "B" Batteries entirely, and supplies silent permanent "B" Current from the light socket. Over 150,000 in use.  
MODEL W for up to 5 valves .. £11/10/-  
MODEL X for larger sets .... £16/15/-  
The right to the use of Tantalum in Rectifiers is the exclusive property of the Fansteel Products Company Inc., under their Australian Patent No. 19988/24.

## The Famous **Balkite B** Eliminator

Absolutely in a Class by Itself.

Model W up to 5 Valves **£11/10/-** Model X for large Sets **£16/15/-**

**OBTAINABLE ALL DEALERS**

(Wholesale Only) O. H. O'BRIEN (Sydney), 39 Pitt St., Sydney; 516 Collins Street, Melbourne.  
W. E. PETERMAN, 160 Edward St., Brisbane.

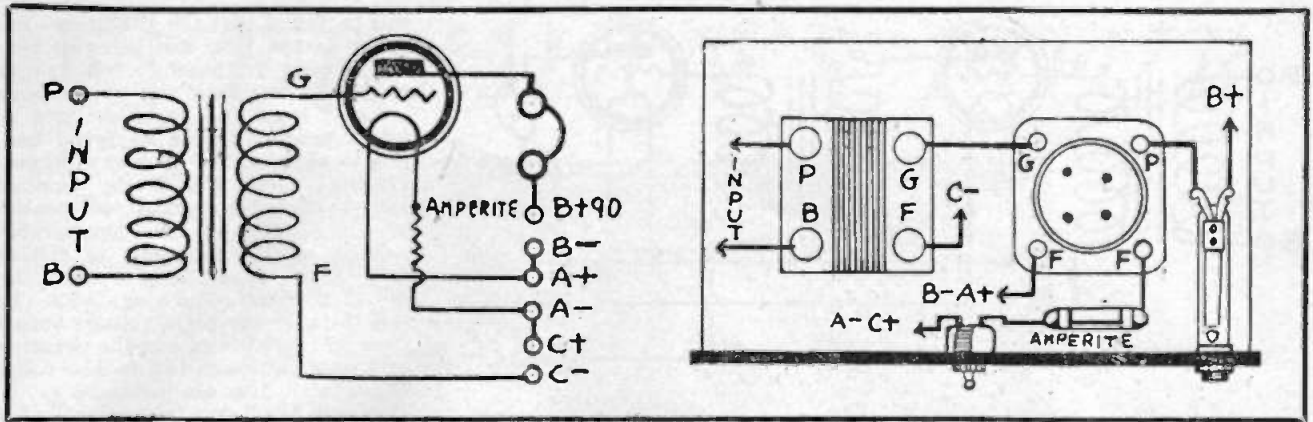

## Adding Audio Frequency Amplification to Your Present Receiver

A CONSIDERABLE number of readers have written us recently requesting information on how to add 1, 2, and 3 stages of audio frequency amplification to the existing set. There are many different means open to the radio constructor of today, and it is the object of this article to discuss these different means in their entirety.

The purpose of audio frequency amplification hardly need be discussed here, but for the benefit of the absolute beginner a brief note may be made. Over and over again have many people desired a little more volume from their sets, and to do this it is necessary to add audio frequency amplification, or as it is known in Great Britain, note magnification. This system increases the volume of signal strength after it is rectified by the detector and should not be confused with radio frequency amplification, which is used for the purpose of building up the strength of incoming energy before it is detected.

That there are certain sounds in existence which cannot be heard by the human ear is a known fact, and these sounds are known as being of a high frequency, so high that the human ear cannot respond to them. For the sake of this explanation, let it be understood that sound is generated by means of vibration. These sounds are conveyed through the atmosphere to the ear, by means of what are known as sound waves. They differ entirely in most effects from radio waves, their characteristics being altogether

dissimilar. It is not our wish to go into a deep technical discussion on this subject, but suffice it for the moment to say that any energy of a frequency above approx. 10,000 cycles per second cannot be heard by the human ear unless some form of step down or rectification takes place.

The purpose of the detector in any set is to rectify the radio or high frequency energy to such limits that the ear can respond to the vibrations by virtue of the headphones or the loud speaker. Now the average one valve receiver is not sufficiently strong enough to work a loud speaker, the exception being, of course, some form of reflex receiver where, although only one valve is used, the output of more than one valve is gained. This brings us to the point of realising that it requires generally more than one valve to produce loud speaker strength, so it is necessary that an additional valve or valves should be used. Now these valves must be added after the detector valve which renders signals audible to the human ear, hence the term audio frequency amplification.

There are 3 popular forms of this amplification, namely, transformer coupled, resistance coupled and impedance coupled. The first mentioned method is the most popular of all, and is, therefore, more common and better known to the average person than either of the other two methods.

Some people claim that transformer coupled audio frequency amplification, while it gives good volume loses

greatly in purity of signal strength; in fact, it causes a certain amount of distortion. This may or may not be true, but where it is found that distortion is present there is usually a reason for it. To-day now that there are such a number of special purpose valves available to the home constructor, distortion should be a thing of the past. The claims made for resistance couplings are known to most sections of this method proclaim that there is nothing to equal it for purity.

Resistance coupling, or as it is frequently known, resistance-capacity coupling, is a method of connecting valves of a resistance amplifier in cascade by means of resistances. A high resistance of the same order as the internal impedance of the valve is connected between the positive terminal of the B battery, and the plate of each valve. The signal oscillations which have been amplified by any one valve flow through the plate resistance of that valve, and in consequence an oscillating potential is set up across the resistance. This potential is applied to the grid of the next valve in the series, through the medium of a grid condenser, which allows the oscillations to pass, but prevents the B battery voltage from reaching the grid. A grid leak is connected between the grid and the negative end of the filament in order that the grid shall not accumulate too large a negative charge, and render the valve inoperative. This gives equal amplification for all audio frequencies and is thus conducive to distortionless amplification.

Philco Batteries Save Pounds in a Year.

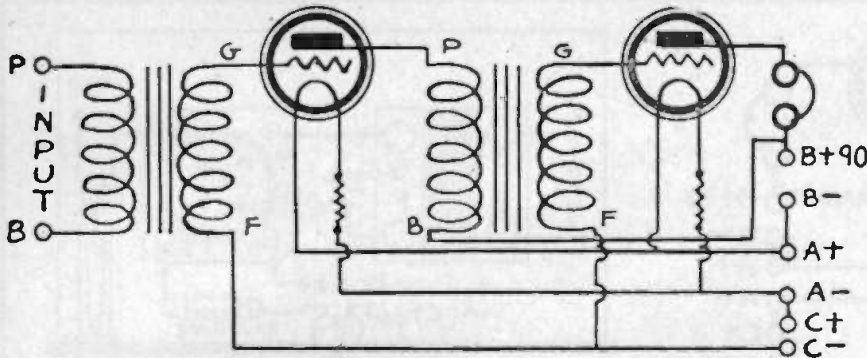

Like most other things in radio, quite a lot depends on the quality of apparatus used. Not only does this apply to the resistances, but also does it apply to the transformers used. The manufacturers the world over are today producing a well constructed, high quality audio transformer, the use of which in the average receiver in conjunction with the correct valves, B and C battery voltages, insures good quality reception.

Now, just how many audio stages can be added, is a question which crops up in the minds of most people, sooner or later. In answer to this, let it be known that it is not wise to use more than two stages of transformer coupled amplification, as it will be found in practice that a third stage of this form produces howls and screams; rendering its function inoperative. But not so with resistance amplification. Here it is always advisable to use three stages, in order that good volume is produced. On the average, three stages of resistance coupling yield much the same output as two stages of transformer coupling, the same applying to impedance coupling.

Now the choice of correct voltages and valves is of considerable importance, there are special valves to-day, for resistance amplification, and also for audio amplification, whether impedance or transformer coupled. Resistance coupled valves should be of the order of 20,000 to 35,000 ohms. impedance, and it is necessary that a high plate voltage be used, anything from 120 to 200 volts is advisable as the plate voltage in this instance, and most manufacturers produce a valve with suitable characteristics, notable amongst these valves being the Radiotron UX240, the Cossor Point One, R.C. Valve, and the Osram DE5B Valve. The Philips' A630 and A425 are two other well-known valves, which will render satisfactory service in a resistance amplifier.

In transformer coupled amplification there is a wide choice of valves. Almost everyone knows the standard Radiotron UX201A, which is a very good general purpose valve, and is eminently suited for this method. So also will be found similar valves in the Osram, Cossor, Mullard and Philips range, all of these manufacturers also making a last stage valve known as a power valve. There is quite considerable misconception with regard to power valves. A goodly number of folks think that if they put a power valve in the last stage of audio, louder, sweeter and better volume should result. So it should, provided other factors are considered. The other factors are correct value of B and C battery, and this is generally overlooked so that there are some disappointed people owning power valves wondering why they laid out the money for such an article.

This brings us to a most important point. In every valve packet will be found a slip, giving particulars of the valve it contains. On this slip is such information as the correct battery voltages for best results, and it must be borne in mind that the maker knows what he is talking about, and it is, therefore, necessary that the user should follow out his instructions. Taking a Radiotron UX120, which is a last stage power valve, it

will be found that the B battery required is 135 volts and the grid battery 22 volts. It, therefore, follows that to get the best from this valve, these voltages must be applied, and in actual practice it will be found useless to apply any smaller voltages. The Radiotron UX171 is another valve designed to operate loud speaker of low impedance at considerable volume, with a minimum of distortion, that is to say, it is intended for use in the last audio stage only. In this instance the plate voltage varies from 90 to 180 volts and the negative grid base bias from 16.5 to 40.5 volts. These two valves are instanced as examples in order that the reader should understand that a power valve should be fed properly and not starved, and should be used only for the purpose for which it has been designed. One cannot touch on the subject of audio amplification without referring to the latest type of power valve and their characteristics. Incidentally, it may be worth while mentioning here, that should any reader have mislaid instruction slip for his present valve a note to this effect to the agent for the valves in this country will bring him a booklet giving him all information that is required.

Now coming to the question of how many stages of audio amplification are required to produce loud speaker work, the answer to this depends on just what form of receiver the audio stages have to be used in conjunction with. If a well designed one valve receiver is giving splendid earphone reception, then one good stage of transformer coupled audio amplification will give moderately good loud speaker strength, provided, of course, the location of the receiver is not too far from the broadcasting station. Anywhere within 25 miles of broadcasting stations fairly good loud speaker results will be had on one stage of audio following the detector valve, but for the sake of reserve and in order to have plenty of volume, two stages are always advisable.

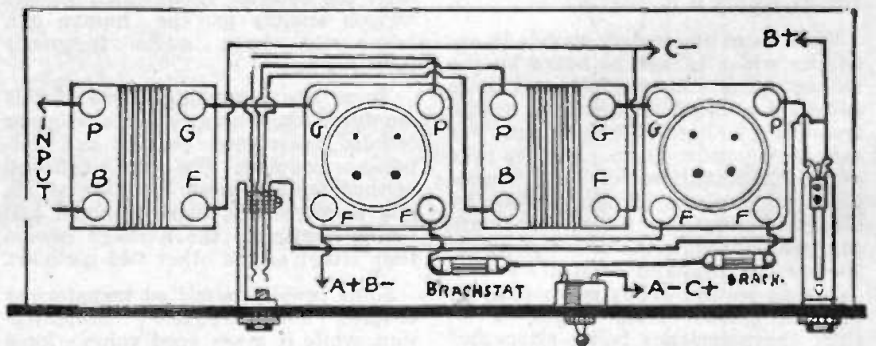

The Mighty 83X Philco is Supreme.



If there is one stage already equipped in the set, then the addition of an extra stage will be found beneficial if louder signals are required. Suppose, for example, it is decided to add one stage after the detector valve thereby making the receiver a two valve set. The following materials will be required:—

- 1 Audio Frequency Transformer, 5 to 1 ratio.
- 1 Valve Socket.
- 1 S.C. Jack.
- 1 Amperite or brachstat.
- 1 Baseboard.
- 1 Panel (optional).

Although a 5 to 1 ratio transformer is specified, any other ratio will be found satisfactory, provided it is of a good quality and has generous sized core. Quite a lot depends on the transformer, it is never prudent to choose a transformer simply because it is cheap; always procure well-known standard lines and don't take chances with unknown brands.

In the list of parts will be found mention of an Amperite or Brachstat. The purpose of this article is to control the filament current on the valve and dispenses with the necessity for a rheostat. In supplying this filament current to the valve the adjustment is not critical, and a filament ballast suited for the valve proposed to be used will suit the purpose admirably and will also save much space, dispensing entirely with the necessity for a panel.

Mount the transformer, valve socket and filament ballast on the baseboard, and if desired the single circuit jack into which may be plugged the loud speaker. This jack may be dispensed with and two terminals substituted. Place the socket right along side of the secondary terminals of a transformer and the filament valves close to one F terminal

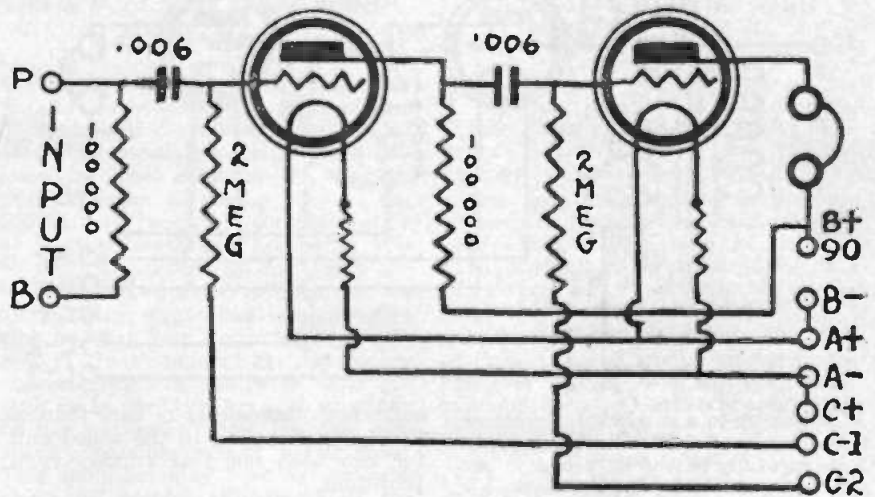

of the valve socket. Begin the wiring row.

At this stage it may be worth noting that some of the English made transformers are marked differently to the American made. Here is a comparison of the markings, and this will relieve the minds of quite a number of enthusiasts:—

American.		English.
P	=	I.P.
B	=	O.P.
G	=	I.S.
F	=	O.S.

The primary may be reversed in each instance, provided the secondary is reversed, so don't be afraid if these markings do not correspond with comparisons that may have been published elsewhere.

The wiring is very simple indeed, so simple, in fact, that there is hardly any need for a written description, the writer feeling quite certain that everyone will be able to follow the back of panel wiring diagram, which is reproduced here. Note that the C battery has been included, this being a distinct advantage inasmuch

as not only does it save the B battery current, it also increases the volume to a marked extent.

To connect this unit to the existing set, is a matter of a moment. Those flexible leads which are clearly marked A, B, and C battery, negative and positive respectively, are to be connected to the different batteries. If a crystal receiver is in use, then it is necessary for the constructor to obtain these batteries, as well as the valve. For certain valves dry cells may be used as an A battery, but be sure to ask your dealer of a correct size to be used with the valve you intend to employ. The B battery should be round about 90 volts, as this will give much more volume than any lower value. The C battery incidentally may be from 4½ to 9 volts according to the valve chosen. Connect the batteries correctly, then insert the valve in its socket. Join P of the audio transformer to one telephone terminal of the crystal set, and connect the other telephone terminal of the crystal set to B of the audio transformer, thus are the two units connected. Plug the 'phones into the jack, or if terminals are used, connect the 'phones to the terminals of the amplifying unit. Press the battery switch on to the on position, then tune in with the crystal receiver. A considerable increase in volume will be noted, when compared with what you have been used to heretofore.

Certainly, you can hardly expect to operate a loud speaker from a crystal plus one stage of audio, unless, of course, the owner is living very close to a very high powered broadcasting station. But as mentioned previously when this one stage of audio is connected to a single valve set, reasonably good loud speaker results will be available, provided the location is within 25 miles of a broadcasting station.

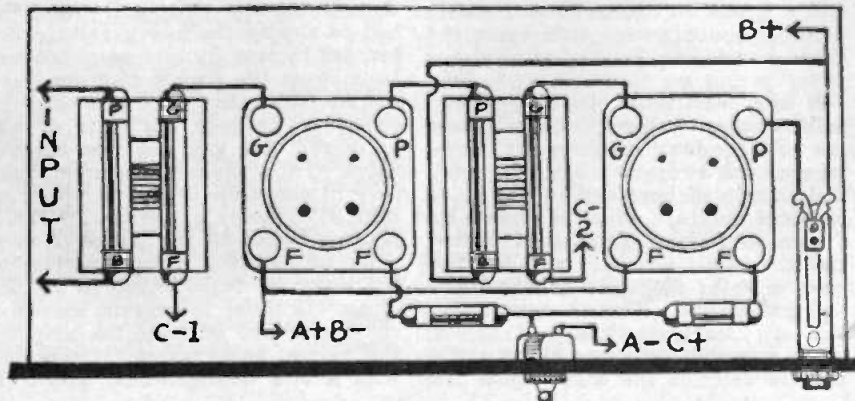

Philcos are Aristocrats among Batteries.

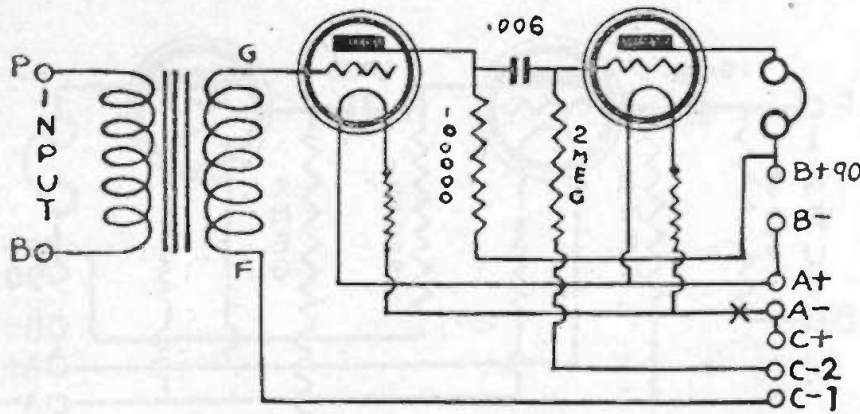

To link up to a single valve receiver may require a little more thought. Note carefully that if only one B battery is employed in the one valve set, it is essential if the best volume is desired to procure another battery bringing the B battery power up to approx. 90 volts by joining the B batteries in series. To join the B batteries in series, all that is necessary is to connect the positive terminal of one B battery to the negative terminal of the other B battery. Leave the B battery connections for the one valve receiver as they were before any alteration took place, but into the last B positive terminal, that is, the 90 volt terminal, connect the B positive lead from the jack.

Now connect up the C battery by joining to the negative terminal that flexible lead which comes from F of the transformer, and connect the positive of the C battery direct to the negative of the A battery. Examine your one valve set for a moment, and notice if the positive A is connected to the negative B. If such is the case, then notice if the rheostat is in the negative lead or in the positive lead. From your conclusion, connect up the flexible wires governing your A battery. If the rheostat is in the negative lead, then join to the negative of the A battery that wire which comes from the filament ballast, and join to the positive of the A battery that wire which comes from the filament terminal of the valve socket of the audio unit. Again it is necessary to connect the primary of the transformer across the telephone connection of the one valve receiver, just as has been described already for the crystal set.

Tune in with the one valve receiver as you have been used to, then you will notice a much greater volume than before. If you can lay the telephones on the table and standing two or three feet away can hear what is going on in the earphones, then you can depend that a loud speaker can be hooked on to give moderately good re-

sults. It is interesting to note that no tuning is necessary in the added unit for one need not fear further complications.

If there is already one stage of audio in the existing receiver, then it will be found necessary to substitute a lower ratio transformer for the higher ratio specified, unless, of course, a power valve is intended to be used in the second stage, where it may be found advisable to have the lower ratio transformer in the first stage, followed by the higher ratio in the second stage. More about this later. The method of connecting this one stage of audio to the two valve set is just the same as has been described before, but if on tuning in the receiver a high pitched whistle is heard permeating the whole of the reception, then reverse the primary connections of the audio transformer in the added unit, and it will be noticed that this effect will entirely disappear, giving a most remarkable volume, and making it possible for the very weak stations to be built up considerably in volume.

The valve used in the audio unit should be of the same voltage as that used in the detector or in any other portion of the set, and the unit, if needs be, may be housed at the back of the cabinet or inside of the cabinet itself if there is room for it. Very little ingenuity will be required to find a home for this addition, which need occupy only very little space indeed.

If the constructor desired a two-valve audio amplifier, the particulars are here for him. Look at the drawings of the two valve amplifier unit and there will be found on the back of panel diagram, or as it should be known the wiring diagram a double circuit jack, which permits the speaker to be plugged into one audio stage if desired. The connections for this are clearly marked. It hardly needs any elaboration on the writer's part to describe the construction of

this amplifier, as after all, it is purely a repetition of the one stage already described, and the methods of connections are entirely as before.

But one word regarding the use of a power valve in the last audio stage will not be out of place here. If one of the power valves or super power valves are used, as have already been stated, a very high plate voltage is necessary in order that the best may be had from the valve. It is certainly injudicious to allow this heavy plate battery to flow through the windings of the speaker, as it is very probable that some damage may be done to the speaker. To overcome this possibility, a slight alteration from the wiring and circuit diagram should be resorted to. Here's how to do it.

From the plate lead of the last valve take a connection to one side of a 50 or a 25 Henry audio frequency choke. To this same connection join one side of a 4 mfd. fixed condenser, the other side of which take to one side of the loud speaker jack, the other side of which is connected to the A negative terminal on the terminal board. The open end of the choke should now be connected to a separate B battery tapping, which should be joined to the maximum B voltage intended to be used. This little refinement is certainly worth while, and may be applied to all audio frequency circuits as a means of protecting the windings of the loud speaker.

Again it must be stressed that it is never wise employing more than two stages of standard transformer coupled audio frequency amplification. There is quite sufficient volume from a 2 stage amplifier to satisfy the needs of the average person. If three stages of audio amplification are sought, then turn to resistance coupling, where 3 stages can be used comfortably, but bear in mind that the resultant volume is only comparable with two stages of transformer audio.

Resistance coupling is certainly becoming more popular every day, now that B battery eliminators may be had to supply the heavy voltage demanded by this form of amplification. Looking at the circuit diagram there will be found that there is a coupling condenser between the plate of one valve and the grid of the ensuing valve. This coupling condenser may vary in size from .006 mfd. up to .01 mfd., it is really not critical. The B battery is fed to the plates of each valve by means of a fixed resistor of the order of from 50,000 to 100,000 ohms. In order to prevent excessive charges of the grids of the amplifying valves, each valve is equipped with a two megohm leak which is

Why Blame Static? Buy a Philcol

certainly effective for stabilising the whole system. The parts for a two stage resistance coupled amplifier are as follows:—

- 2 100,000 ohms. fixed resistors.
- 2 2 megohm fixed resistors.
- 2 .006 fixed condensers.
- 2 sets of double clips on basis.
- 2 valve-sockets.
- 2 Amperitcs or Brachstats.

Usual baseboard, battery switch, etc., etc.

The method of layout is clearly seen in the drawings and the means of connecting to the existing sets is certainly very easy. If desired varying plate voltages may be added, further particulars of this type of amplifier may be had from "Wireless Weekly" of the 12th August, 1927. For those who desire, there will be found different kits of resistance coupled units all complete ready to be assembled, or even it is possible to obtain completely assembled three stage resistance amplifier.

It is possible to combine transformer and resistance coupled methods of amplification to suit the constructor's own requirements. Some people prefer to use this system by placing the transformer stage first with the resistance stage afterwards. Again many would rather have the resistance stage first, all about a transformer stage. It is really a matter of choice, but reproduced here will be found diagrams showing the construction of one transformer and one resistance coupled stage. Some few years ago this system was popularised in this country by "Insulator," who described a unit similar to this and named it "Dulcie." Early readers will remember it.

Lastly, we come to the subject of impedance coupled amplifiers. The most effective system of this, is the double impedance type, and here again it is necessary to employ three stages of this idea to get the output of two stages of transformer coupled, and also will it be found necessary to use a high value of B battery. There is

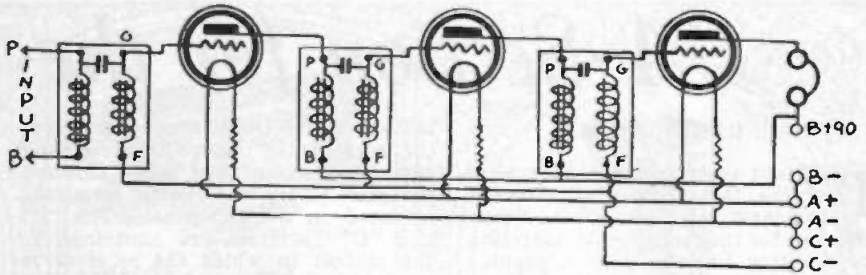

no question whatever that double impedance is very close to the ideal from the point of view of purity and of the reproduction of all under tones and over tones. The writer recently constructed three stages of this method and found it certainly very satisfactory. The kit used was a well-known F.M.C. double impedance kit and the natural tone was so charming that it was always a pleasure to listen in.

These are the three systems very much in evidence to day. Without wishing to draw comparison on their utility, it is felt that there is sufficient data for the constructor to build his own unit to suit his own purpose. Granted the unit is satisfactorily built and that the owner possesses a reasonably good loud speaker and that he pays attention to the correct valves and batteries, much pleasure can be had with loud speaker reception. And do not forget that the loud speaker itself plays a most important part, so choose one which is good and which will last.

Lastly, an excellent volume control may be had by connecting a Centralab potentiometer of, say, 500,000 ohms. resistance across the secondary of the first audio transformer, or if preferred, Maclurcan Tone Purifier may be shunted across the secondary of the last audio transformer. Both these systems are good, the Maclurcan Tone Purifier acting not so much as a volume control, as its name implies, but as a tone purifier, eliminating all raucous noises which may be generated in the set.

### Safeguarding the Valve.

#### Dr. Fixit's Radio Talk for 5CL

THE base of a vacuum tube fits the corresponding socket in just one way—the correct way. Nevertheless, there is an ever-present danger of connecting batteries or wiring in such manner that "B" battery current will be applied to tube filaments, with expensive consequences. Even a slipping screwdriver or pliers may inadvertently divert "B" battery current through tube filaments, rendering the tubes useless. Hence the exercise of due caution. Always disconnect the batteries when working on the radio receiver. In connecting batteries to the radio receiver, connect the "A" battery first. Then turn on the rheostats or operate the switch, and note if the filaments light. If they do, the connections are correct, and the other batteries may be connected. If not, check up on the wiring. This procedure prevents placing the "B" batteries where they do not belong, and also detects fault set wiring before expensive damage can be done.

In the home-made radio receiver or the receiver being remodelled or repaired, it is well to take no chances with burnt-out tubes. To this end, a 40 watt, 110-volt lamp should be placed in the "B" lead. The resistance of the lamp will prevent excessive amperage from passing through the filaments of the vacuum tubes if the "B" battery should be incorrectly connected. Furthermore, it will detect a short-circuit in the wiring, since the lamp will light up. However, because of its resistance, the lamp should be removed or shorted for normal operation. A still better plan is to place a radiotron UV-877 in the "B" lead. This radiotron is a protective lamp designed as a safety valve to prevent damage to vacuum tubes or transformers in the event of incorrect connections or short circuits. It introduces protective high resistance only while abnormal conditions exist, so it may be left in circuit.

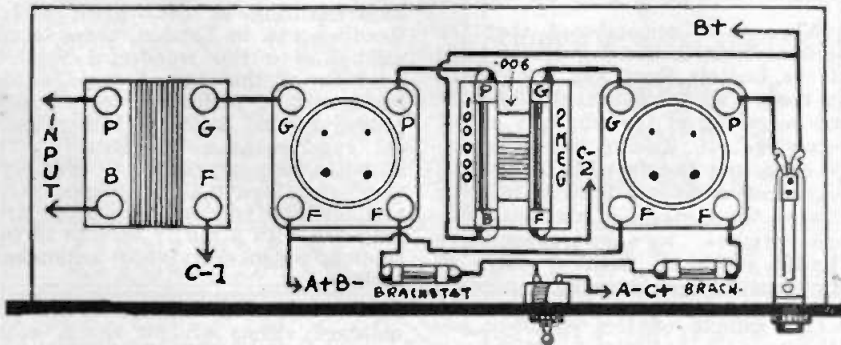

Ask any Radio Engineer about Burgess.

# A Section for the Trade

## THE RADIOLA FOUR.

**T**HE four valve receiver, by reason of the fact that its initial cost is comparatively low and its range sufficient for the reception of interstate broadcasting, has always been popular with listeners. However, the demand for a selective receiver has resulted in the scrapping of many early four

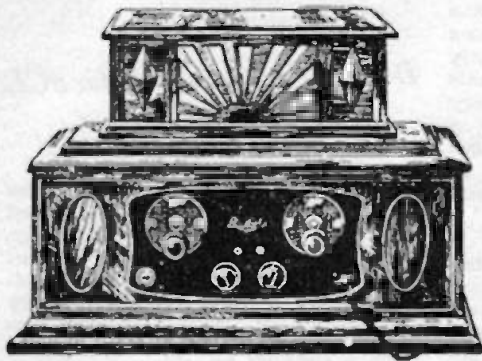

## RADIOLA FOUR

*1 Stage Radio Frequency, Detector and Two Stages of Transformer Coupled Audio Frequency.*

valve sets which were not selective enough to separate the local stations so that distant stations could be received.

In the last year or so considerable attention has been paid to radio frequency amplification, and it is now possible to obtain receivers in which the radio amplifier has reached a stage of efficiency and selectivity not previously thought possible.

It is to the credit of Amalgamated Wireless (Australasia) Ltd., that such a circuit has been included in this firm's latest four valve receiver marketed under the trade name of The Radiola Four.

This interesting receiver embodies all the latest improvements in radio, not the least of which is simplicity of operation. Tuning is controlled by means of two vernier dials, an "intensifier" control keeping the set in its most sensitive state. This control is really on the reaction of the detector valve, and the smoothness with which it acts allows a very fine control of regeneration. This is a great aid in searching for weak and distant stations.

The only other control on the panel is the battery rheostat for adjusting the filament voltages of the valves. As is usual with the A.W.A. receivers, connections for a pin-jack voltmeter have been provided. Although the meter is not supplied with the receiver, its use is manifest, and the provision for mounting such a meter is indicative of the fact that nothing which modern practice has shown will increase the efficiency of any receiver has been overlooked.

The loud speaker jack is mounted on the front panel, whilst the cabled

battery connections are taken from the rear of the set. The aerial and earth connections are made through the rear of the cabinet to terminals mounted on the sub-panel. The "B" and "C" batteries are contained in the cabinet in which the receiver is housed, but the "A" battery is kept outside so that the fumes will not affect the receiver.

## DETECTOR WITH SEVENTY CATWHISKERS.

A new type of trouble proof Crystal Detector has made a welcome appearance on the Australian Market.

This should be good news to all Crystal and Crystal Reflex users, as a really good and adjustable detector will fill a long felt want.

The new G. and S. Silk-core Crystal Detector is practically permanent, each Crystal being chemically treated by an exclusive and secret laboratory process, which guarantees its life indefinitely. Adjustable spring tension maintains and insures even and constant contact at all times.

A Single wire or Catwhisker cannot transmit the necessary electrical energy through it, without destroying the contact point or the Crystal face. To remedy this condition, use has been made of a silk core brush, composed of seventy strands, which distributes the energy equally, thus making it impossible to burn out either the Crystal or Contact points.

The silk brush used in the G. and S. Silk Core Crystal Detector is constructed of seventy silk cords, minutely wrapped with flat bronze tinsel, making contact on the full Crystal face, preventing burning out of Crystal and resulting in louder music.

This detector is easily fitted to your panel, by drilling one 7-16 inch hole.

The G. and S. Silk Core Crystal Detector can be obtained from the Economic Radio Stores, of 25, New Royal Arcade, Sydney; 569 Hunter Street West, Newcastle, or corner Church and Macquarie Streets, Parramatta, N.S.W.

## INTRODUCING TWO NEW RADIO "B" BATTERIES.

The popularity of Ever-Ready Radio Batteries will be further increased with the introduction of two new "B" Batteries. After months of experimenting at the great Ever-Ready works in London, these latest additions to the wonderful list of products of this great organisation underwent a series of tests which proved beyond doubt that they were far superior as a "B" Battery. Of 45 volts, they are called "Super-Service" and "Heavy Duty" respectively, and combine trouble-free service and long life with a purity of tone in reception, which every radio enthusiast seeks.

If your radio dealer has not yet obtained stocks of the above, communicate with THE EVER-READY COMPANY (Gt. Britain), LTD., 163 Pitt Street, Sydney, who will fulfil your needs immediately.

The circuit of the Radiola Four is a variation of the Browning Drake, and comprises one stage of radio frequency amplification, a regenerative detector, and two stages of transformer coupled audio frequency amplification. The latter are coupled by the well-known A.W.A. transformers, and give remarkable volume and clarity. Ballast resistors are used to control the audio frequency amplifiers, the master rheostat previously mentioned taking care of the filaments of the detector and radio frequency amplifier.

On test the Radiola Four behaved excellently, and no trouble was experienced in bringing in all the Australian "A" class stations on the loud speaker. The "B" class stations were also tuned in, but, of course, the volume in this case was slightly less. Donning the phones, a search was made for real "D.X.," and the operator's efforts were rewarded with New Zealand stations at good strength.

When it is remembered that the aerial system in use during the tests of the Radiola Four was remarkable by reason of its inefficiency, an idea can be gained of the efficiency of the receiving set. Tuning was found to be easy, and the excellent control of regeneration made it possible to bring in even the weakest of stations without recourse to the regenerative "howl" which is such a source of annoyance to neighbouring listeners.

Our sample of this excellent receiver was received from the manufacturers, Messrs. Amalgamated Wireless (A/sia), Ltd., of York St., Sydney.

**AMPLION, A/SIA, LTD.**, announce removal of premises to "Bradbury House," 53 York-street, Sydney, where fine office and show-room accommodation have been opened. Dealers and the general public are invited to call and hear demonstrations of the Amplion Loud Speakers and also of the now famous Amplion Public Speech and Band Repeater Equipment. Future correspondence for the firm should be addressed as above.

#### RADIOKES STANDARD REINARTZ COUPLER.

This recent product of "Radiokes" laboratory was submitted by the manufacturers, The Metropolitan Electric Co., Ltd., of King Street, Sydney.

This unit is of conventional design, being composed of three coils, two and three-quarters in diameter, and arranged for convenient baseboard or sub-panel mounting, and easily accessible wiring.

The windings are carried out in brilliant green silk covered wire, according to the distinctive Radiokes Low Loss method, which employs practically no dielectric in the coil field, which on test prove to be the most efficient form of winding yet devised, thus making for sensitivity and selectivity.

This instrument is equipped with six connections so that it may be used in either of the many adaptations of the Reinartz circuits. The blue print enclosed with unit illustrated the single control Reinartz receiver recently featured in "Radio."

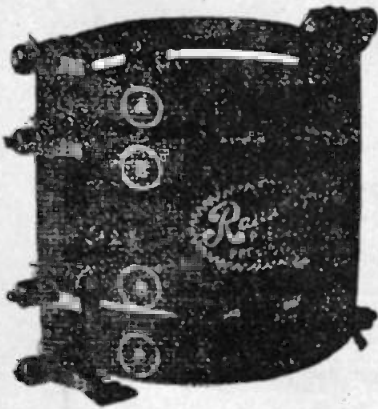

In addition to the now well known Radiokes "solder all the way" soldering lugs this unit is equipped with screw terminals for the experimenter who prefers not to use soldering outfit in constructing his receiver.

As the Reinartz method of regeneration control is becoming so popular, this instrument should prove of considerable interest to all fans anticipating construction of receivers employing this well known principle.

The instrument arrived in excellent packing, complete with mounting brackets and blue print of circuit,

#### THE NEW COSSOR VALVES.

To-day the British manufacturers are in the forefront with their radio components. Some years ago this could not be said truthfully, but typical of the race, every battle is lost but the last.

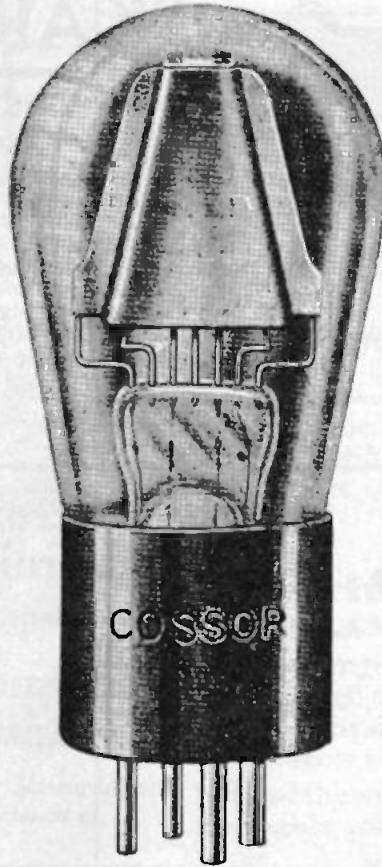

With valves in particular does this apply. Messrs. A. C. Cossor, Ltd., of London, have an entirely new range of valves, which promise to be world beaters. Mechanically they are wonderfully strong. The plate is firmly attached to the grid by means of a seonite insulator. Not even the hardest blow can disturb its alignment. There is a long Kalenised filament which ensures a terrific emission at a low temperature thus making for long life. This filament is firmly secured in five positions.

All the three elements—the filament, the grid and the plate—are locked in permanent alignment, true to one hundredth part of an inch. Therefore, Cossor valves possess a uniformity of characteristics so that all Cossor valves of the same class are identical; the slightest variation is impossible. To Neutrodyne and Super Heterodyne owners, where valves of uniform characteristics are essential in the radio frequency stages this is of vital importance. No other valve boasts of this wonderful Kalenised filament.

They are made in ranges to suit 2 volts, 4 volts and 6 volts, and are all special purpose valves, this being the modernised method of production to give maximum efficiency.

#### AIRPLANE RADIO.

Latest advices from F. H. Schnell, Chief of the Experimental Radio Laboratories of the Burgess Battery Company, United States, America, indicate that the company is directing its activities extensively towards airplane radio. A very small receiver and transmitter has just been designed and built, the total outfit, including Burgess batteries, weighing approximately 60 pounds. The first tests with the 'plane in the air showed that communication was held for a distance of 17 miles. The wavelength was about 79 metres.

We expect to have full particulars of this airplane transmitter and receiver in the near future, when they will be placed before our readers.

#### WIRELESS VALVES.

We are advised that by consent of the parties in the Equity suit of Phillips Lamps (Aust/asia), Ltd., against A. F. Price, trading as "Price's Radio Stores," Angel Place, Sydney, a decree was made by Mr. Justice Harvey, perpetually restraining the defendant, during the continuance of letters patent, covering Phillips and Mullard wireless receiving valves, from selling, or offering these goods for sale, at other than the retail price imposed and fixed by the plaintiff company.

Defendant is to pay the costs of the suit.

It was alleged that the defendant had infringed the plaintiff's letters patent by selling the valves below the fixed price.

Mr. C. D. Monahan (instructed by Messrs. A. J. McLachlan, Westgarth and Co.) appeared for the plaintiffs; and Messrs. Minter, Simpson and Co. for the defendant.

APART from unearthing much latent literary talent by their recent "One Act Play Competition," Studio 3LO, Melbourne, are affording listeners much pleasure in having the winning plays broadcast. In the capable hands of that very clever producer and popular announcer, Mr. Maurice Dudley, the playlets are being broadcast in a very masterly fashion, and no trouble is being spared to render the author every assistance. Not a few of the manuscripts submitted showed a remarkable amount of promise, and, as there is a great demand for pithy radio plays, writers of the winning playlets should feel encouraged to embark on this new road of literary work.

# When Quality Counts "KARAS" Has It

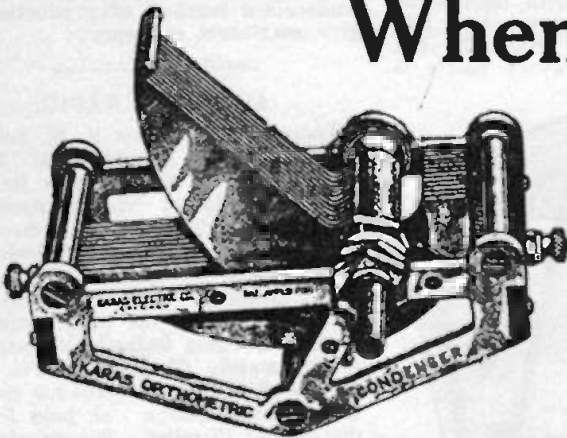

THE KARAS ORTHOMETRIC LOW LOSS CONDENSER.

## The "KARAS" Orthometric Low Loss Condenser

Karas Orthometric Condensers are of the highest possible quality, both electrically and mechanically. Constructed throughout of highest quality brass, stator and rotor plates soldered at every joint, wide copper pigtail connecting both ends of rotor plates. One or three hole fixing. Dielectric of highest quality hard rubber, placed outside the range of the electrostatic field. A most desirable condenser.

Size .00014.—For short wave work ..... 32/9	Size .00025.—For short wave or reaction work ..... 32/9	Size .00037.—The ideal Neutrodyne Condenser, 33/6.	Size .0005.—The general purpose size, 34/9
---	---	--	--



## "Karas" Micrometric Vernier Dial 17/6

Ratio of Movement, 63 to 1,

## "Karas" Harmonik Audio Transformer 34/9

They give surprising volume with clarity, equal to resistance coupling

# Build The "MARCO" FOUR

The Powerful Four-Valve Set featured in this issue. You will require the following parts:—

£ s. d.	£ s. d.
1 Best Quality Polished Hard Rubber Panel, 21 x 7 x 3-16 .....	2 Crecent Audio (6 and 3½ to 1) Transformers, 13/6 .....
3 Advance Centralign Condensers; Size .0005, 12/6 .....	(Or A.W.A. Super Audio Transformers, 18/- ea.) .....
1 B.M.S. Double Circuit Jack, with Fantail Connections .....	1 2 Megohm Gridleak and Holder .....
1 B.M.S. Single Circuit Jack, with Fantail Connections .....	1 Wetless Fixed Mica Condenser, .00025 .....
1 B.M.S. Push-pull Battery Switch .....	1 Wetless Fixed Mica Condenser, .0001 .....
4 30 ohm. Bakelite Super Rheostats, 2/6 .....	1 Wetless Fixed Mica Condenser, .002 .....
1 Kelford Anti-vibration UX Socket .....	2 3¼ in. length of 3in. Diameter Radion Tubing .....
3 Advance Porcelain UX Sockets, 2/6 .....	1 1½ in. length of 3in. Diameter Radion Tubing .....
<b>TOTAL, £5/17/6. COST OF PARTS.</b>	1 Standard Terminal Board .....
	½ lb. 24-Gauge Green D.C.C. Wire .....
	1 doz. Square Tinned Copper Buswire .....

Country Customers: We guarantee to return purchase price in full on any article you are not satisfied with, if returned to us in good condition within 10 days.

We pay carriage on all orders of 10/- and over, except on Speakers, Cabinets, Batteries and Value Payable Post Parcels.

"YOURS FOR LOWER PRICES."

# THE ECONOMIC RADIO STORES

PARRAMATTA:  
Cor. Macquarie and Church Sts.  
'Phone: UW 9601.

SYDNEY:  
25 NEW ROYAL ARCADE,  
'Phone: M 3049.

NEWCASTLE:  
569 Hunter St. West.  
'Phone: New. 1622.

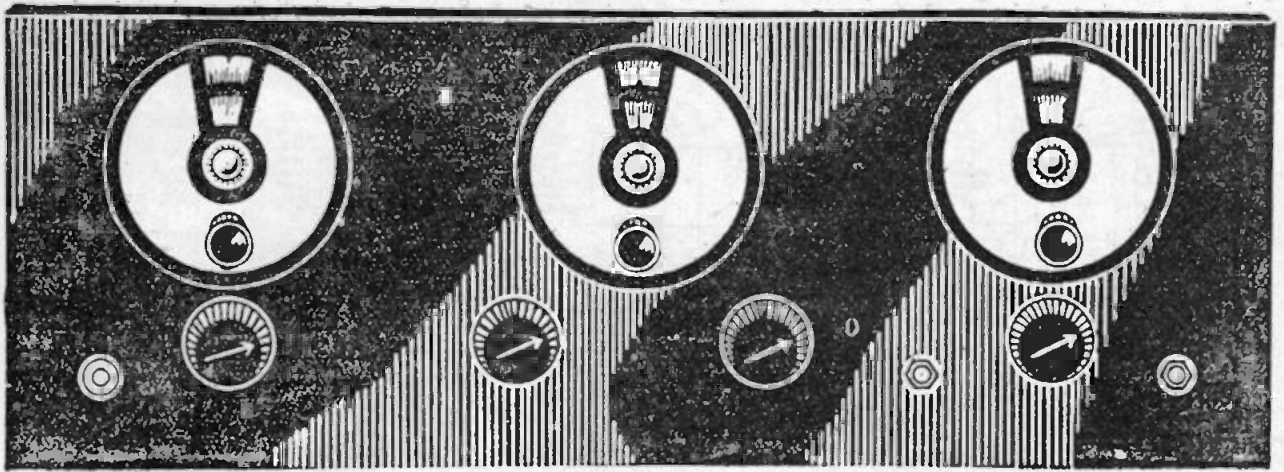

## The MARCO Four Valve Receiver

IN "Wireless Weekly" of 5/11/26 there was described the Marco Four. It has proved a most successful receiver, so successful, in fact, that many owners proclaim it a much better all-round receiver than the world-famous Browning Drake. We are reprinting the whole article to satisfy the demands of many readers, and it will be found of great interest to the new readers of our paper.

Incidentally, it is worth noting that since the article was written there is available a ready-made set of tuning coils, although this article describes how to make them at home.

The distance getting proclivities of the straight detector Reinartz is well-known all the world over. Until recently all attempts to add radio frequency were never very successful. It remained to Mr. D. L. Pendelton, Consulting Engineer to Martin Copeland Co., the makers of Marco radio material, to devise a system whereby radio frequency could be successfully applied to the Reinartz. Several different systems were tried out and discarded until finally the circuit published here was produced. Looking at this circuit the usual Reinartz will be recognised in coils L3 and L4, tuned with variable condensers C2 and C3. Preceding this is found the RF valve (V1.), the coil L2 being the coupling coil transferring the RF energy to L3, and the V2, which is the detector tube. Now the greatest difficulty connected with RF is stabilisation, hence the potentiometer in the tuned anode circuit, and neutralisa-

tion in the Neutrodyne. Unless some means of controlling oscillation is provided, considerable difficulty is met with in radio frequency amplification, thereby rendering it almost useless. The method adopted by Pendelton is simple yet particularly effective. It is always desirable with radio frequency to transfer as much energy as is possible without impairing selectivity, causing uncontrollable oscillation in the RF valve. The method

adopted in this instance is the coupling between the RF plate coil (L2) and the detector grid coil (L3). However, without going into the theory of this matter, be assured that this receiver is wonderfully selective, and although there are three condensers to tune, it is quite simple to bring in the different stations.

Before going on with the constructional details, a comparison of the circuit with the back of panel view of the receiver will clear up any difficulties which you may have in your mind. Aerial condenser C6, is a constant aerial tuning condenser of .0001 mfd., and assists greatly in selectivity. The incoming energy is tuned to the correct wave length by L1, C1, from which it is passed through the first valve to L2, which conveys its energy through L3 tuned by C2 and is detected by valve V2. Reaction is introduced per medium of C3 and L4, after which the volume is stepped up by transformers T1 and valve V3, thence to T2, and valve V2, these two last valves being audio frequency valves and will produce considerable strength on the loud speaker. Should it be desired to use only one valve for loud speaker work, a double circuit jack, J1, is provided after the first audio valve. In this case rheostat, R4, should be turned down, thus leaving the last valve out of circuit entirely. Condenser C5, is the standard by-pass condenser having a capacity of .002. The three variable condensers each have a capacity of .0005 mfd., whereas C4 is the usual .00025

### SHOPPING LIST FOR MARCO 4.

*Although the parts listed below and mentioned throughout the article were those actually used by us in the receiver described, it must be pointed out that it is not absolutely essential that they be rigidly adhered to. Other parts of similar quality and technical values should function quite satisfactorily.*

- 1 Dilecto, Radion or Hard Rubber Panel, 21 x 7 x 3-16in.
- 3 .0005 Advance Little Centralign Condensers.
- 3 Pilot Vernier Dials.
- 1 D.C. Jack.
- 1 S.C. Jack.
- 1 Battery Switch.
- 4 30 ohms. H. & H. Rheostats.
- 4 Advance Valve Sockets.
- 2 A.W.A. Super Audio Transformer, 1-5 to 1, and 1-3½ to 1.
- 1 .00025 Wetless End Condenser.
- 1 .0001 Wetless Condenser.
- 1 .002 Wetless Condenser.
- 8oz. No. 24 D.C.C. Wire.

"Burgess" spells "Quality; Life; Service."

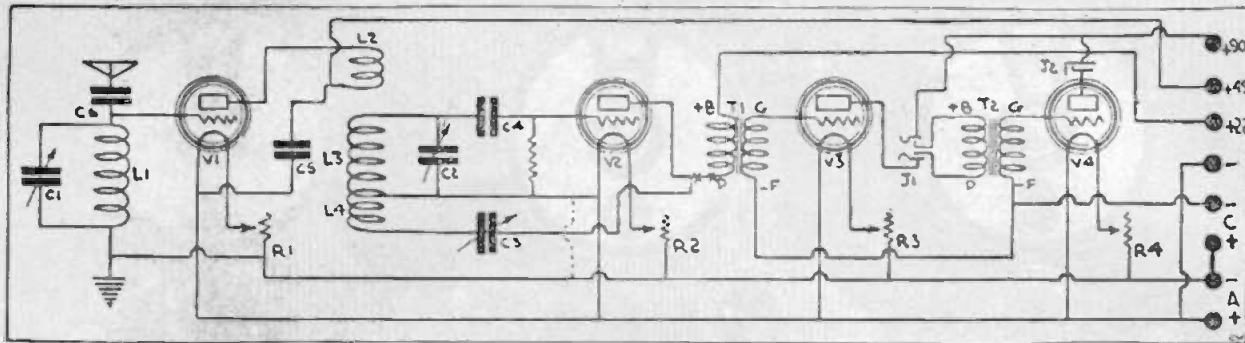

mfd. grid condenser. Looking at the back of panel diagram it will be seen that L1 is so arranged that it is at right angles to the other coils. The most important feature in this receiver is the position of the radio frequency plate coil L2. This is inductively coupled to L3, but its position is most critical. If it is brought too close the selectivity is not so great as when it is kept away. There is a certain position at which this coil gives the greatest signal strength on weak signals with noticeably sharper tuning, and as will be explained later, this position can only be determined by experiment. In the receiver illustrated herewith the best position was found to be when the edge of L2 was 2½-in. away from L3, that is to say, the actual coil itself, not the former.

However, the construction of this receiver will now be proceeded with. The coils themselves should, firstly, be wound. For L1, 47 turns of No. 24 DCC wire is necessary. Proceed to wind this, first of all, drilling two small holes through which the end of the wire has to be threaded, in order that it will be held securely. Wind on the 47 turns of wire and finish off by securing in a similar manner. One of the ¾-in. lengths of Dilecto tubing is required for this purpose, but if this size tubing is not available 2 1-8-in. or ¾-in. tubing will be found

perfectly satisfactory. Another of the same pieces of tubing has to be wound the same piece of tubing has to be wound with coils L3 and L4. Grid coil L3 has 45 turns of wire, whereas L4 has 20 turns of the same gauge wire. Both these coils are wound on the same former, the distance between L3 and L4 being one-quarter inch. The third coil, that is, the RF plate coil, comprises 25 turns of No. 24 gauge DCC wire, wound on the remaining portion, that is, the 1½-in. length of tubing. Take a little care and a few pains over winding these coils, as when correctly built, they look very nice and neat.

Leave these coils on one side while you attend to your panel layout and drilling. The diagram given herewith will show you the exact measurement suited to your different panel components. To understand this clearly, a consultation with the front view of the receiver reproduced here will be of great value. There can be seen the three condenser dials, which it will be noted are of the vernier type, and also the four rheostat knobs underneath these condensers. The battery switch is placed at the extreme left of the panel, while the single circuit SC jack is on the extreme right. Midway between the two audio valve rheostats is found the DC jack. Lay your panel on a flat surface and mark out the various positions. Never use lead

pencil for this purpose; rather measure each particular position with a rule and make a small scratch at the correct position and centre punch immediately. Pencil lines provide a path for radio frequency currents, and, as we wish to confine them to the circuit itself, and not the front of the panel, we stress the necessity of not using pencil lines. In drilling, don't forget the golden rule that with Dilecto a light pressure and a high speed quickly bores the panel. When everything is drilled, mount your components on the panel and then prepare for the base board layout.

Before going any further, it is, perhaps, advisable to carefully study the back of panel view of this receiver. As mentioned before, too much importance cannot be attached to the position of the RF plate coil L2, with relation to the detector grid coil L3. To achieve the maximum efficiency from this receiver, lay out the audio end of this receiver. Follow closely our own lay out, and you can then be assured of maximum results. There is nothing whatever to stop you from mounting the aerial coil L1 and the grid and reaction coils L3 and L4, provided you leave sufficient room for experimenting for the correct position of RF plate coil L2. Certainly screw down your valve sockets and transformers and temporarily lay in a near position the RF plate coil L2.

Having done this, carry on with the wiring of this receiver. In the wiring it is always advisable to start off at the audio end of your receiver. Back of panel wiring diagram will give sufficient detail of the wiring to enable you to proceed. Square bus-bar is ideal for this purpose, and make certain that each joint is tight, and when soldering is required, is carefully soldered. At some later time there will appear in these pages an article devoted entirely to the subject of soldering, which, for some unknown reason or other, from the experience of the writer, seems to

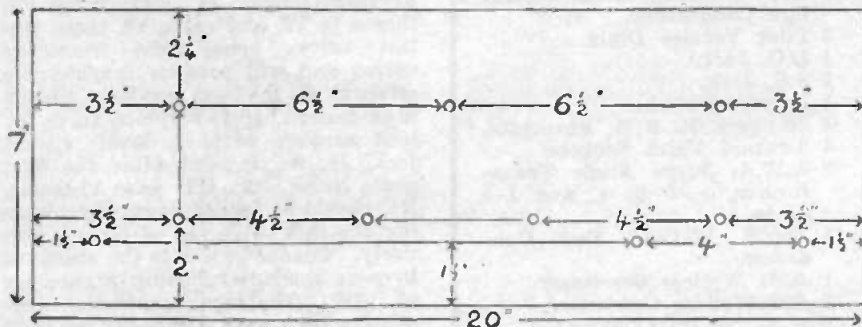

World's Best Rechargeable Battery: Philco.



present some difficulty to the average set constructor. This should not be so. Soldering is quite a simple matter, and should present no difficulty whatever. However, for the time being, when you come to wiring the connections of L3, use some ordinary flexible wire, in order that you may be in a position to vary the situation of this coil on actual tests. Take the wiring in easy stages, checking off with a circuit diagram and the back of panel diagram as you proceed; perhaps the back of panel wiring diagram will be of some assistance to you in wiring, as many of the wires as can be plainly seen in this photograph.

After everything is wired correctly you are now in a position to test your receiver on the air. Connect up your A, B and C batteries, 4½ volts being sufficient for the C battery. Insert your valves in their sockets, and hook on your aerial and earth. Insert your phones and jack, J1, and turn up your valve filaments. Leave condenser, C3, at a position when the movable plates are half way enmeshed into the fixed plates, and tune with condenser C1 and C2, using the right hand for tuning the middle condenser, C2. This condenser is very critical of adjustments, and should be rotated in unison with condenser C1. Presently you will hear one of the local stations, and by the careful adjustment of C2 and a final adjustment to C3, you will hear them at an excellent volume. Bear in mind that this time you have the RF plate coil L2, approximately 2in. away from L3. Without moving this coil in any way, tune through all the local sta-

tions, listening to each in turn, and bringing each up to maximum volume, keeping in mind all the time that if too much of condenser C3 is used a certain amount of distortion may occur. Watch this carefully. Now seek the distant station. Go for Brisbane, for example, and note the strength of this station. Plug your phones into jack J2, thereby including all four valves of the circuit. We must needs turn up rheostat R4, tune Brisbane to its loudest pitch, and then move RF plate coil L2 just a fraction away from L3, take away your hand and notice if result is stronger or weaker. Spend half an hour moving this coil closer to, or further away, from L3, until the position is reached where the maximum volume from Queensland is obtainable. At this stage you can make a permanent fixture of coil L2, which need never be disturbed again, and which will respond to all stations, both interstate and local.

Perhaps, it may happen that a slight distortion is perceptible through all reception. If this is so, it points out the necessity for the insertion of the radio frequency choke coil in the plate circuit of the detector valve. This has to be inserted between the two points marked with a cross on the P. lead of transformer T1. To make certain of this, one end of your choke is to be connected to the P. of this transformer, and the other end at the point where the busbar is running from the condenser C3 to the plate lead of the valve. Of course, that portion between the two crosses has to be broken, and to be left in such a posi-

tion that the radio frequency choke coil completes a circuit itself. This coil may take the form of a 200 turn honeycomb coil, or if this is not available, use 4-ozs. of a No. 24 cotton covered wire, wound in any old fashion, on a cotton reel. In actual practice, however, this choke coil was dispensed with and a receiver illustrated herewith, and no detriment was found with this exclusion.

Again, it may happen that a slight difficulty may be experienced in controlling oscillation. If this is the case, it will be advisable to take the grid return lead, that is, the lead which comes from the join of L3 and L4, to the moving plates of condenser C2, and to the bottom of grid lead; take this lead from the A positive where it is fixed in wiring diagram, to the A negative. A dotted line on the circuit diagram shows this alteration, which, if it is necessary, means that that portion which is joined to the filament of valve V2, is taken to the A minus battery wire lead, to which are connected all the rheostats. This alteration will be plain to you, and may even be necessary in order to hold in the oscillations, which may be produced in this receiver. A word about valves will not be out of place. In actual practice, UX201A valves were used to advantage, and the RF plate coil has been designed for this particular valve. Should, of course, UX199 or UV199 valves be used, it may be necessary to wind coil L2 with 50 turns of No. 32 gauge of D.C.C. wire.

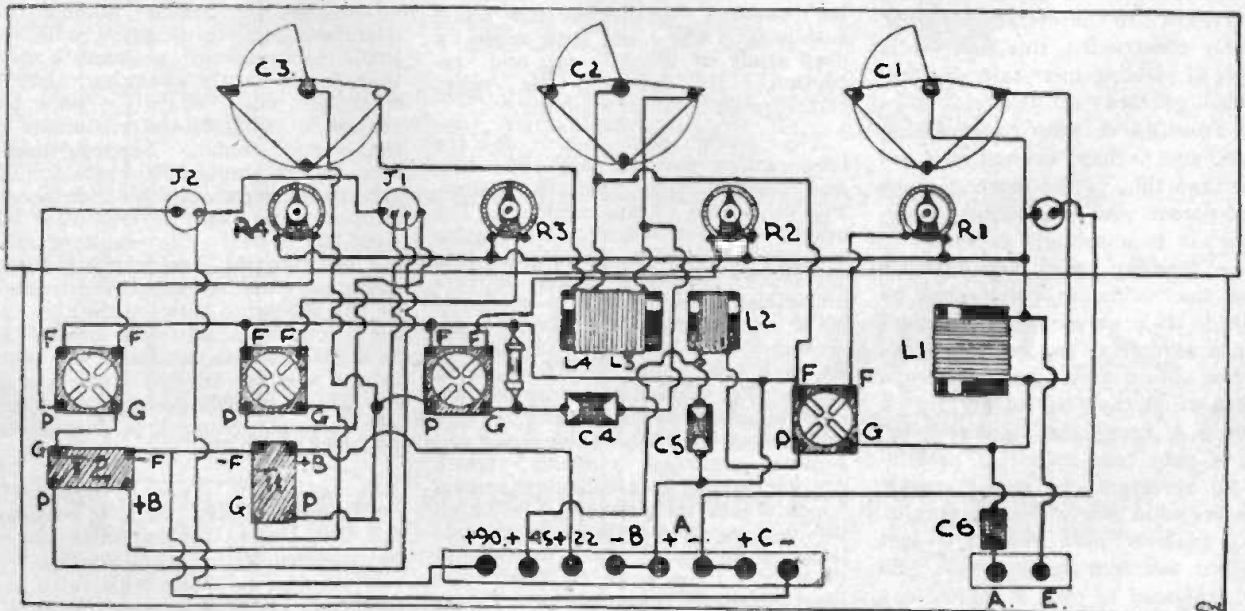

Let Your Battery Save Your Purse: Philco.

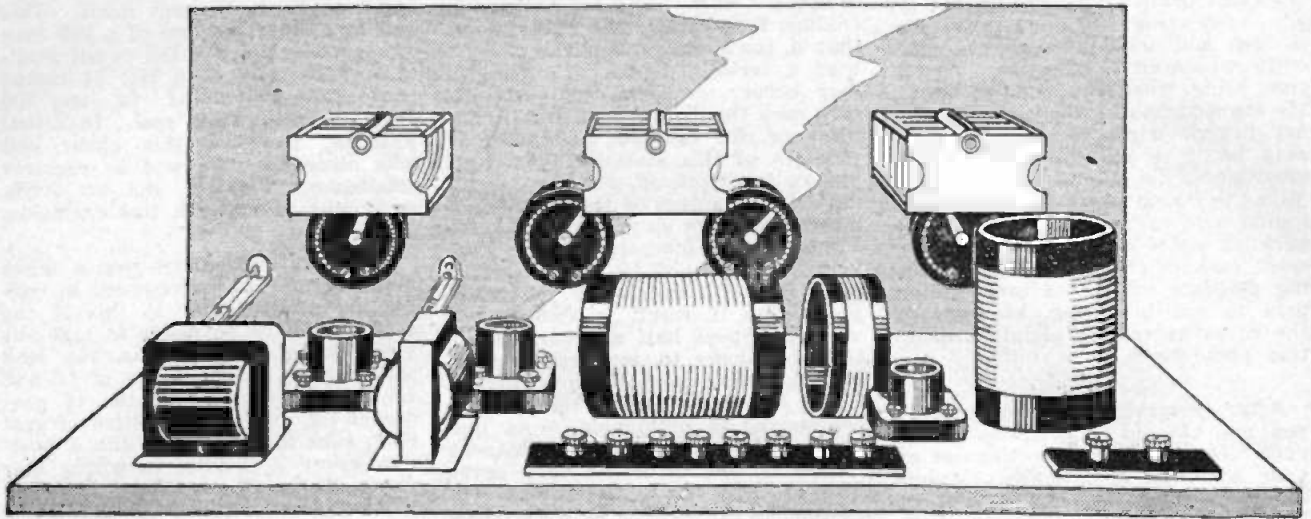

Still, this coil is not as critical as it may be, provided particular attention is paid to the coupling.

Before closing this article, it may be worth while mentioning that the most suitable aerial for this receiver was found to be one which did not exceed 50 feet long, that is, including the lead end. A short indoor aerial not exceeding 40 feet long, gave excellent results at Marrickville; the Melbourne station, 3LO, entertaining all present at excellent loud speaker strength. But my remarks of previous weeks must still be borne in mind with regard to interstate stations. Properly constructed, this receiver is capable of yielding interstate stations, provided you are at least 7 miles away from an A class broadcasting station, and perhaps even if you are closer than this, but so much depends on the person who is handling the receiver. It is absolutely essential to become familiar with any receiver before the maximum results can be obtained. It is only natural the more you use a receiver the better results you can obtain from it, and always keep in mind that old adage, that a circuited A keeps the signals away, as it is very true indeed of practically all receivers in every sphere. Persevere, and you will have results, and a receiver of this type just described will find many people who will be pleased to own it for quite a long time to come.

## Music in the Air?

“WHAT beautiful music is coming over the air these days!” exclaims the non-technically inclined enthusiast. At first blush it seems hard to realise that no music from a broadcasting studio comes over, through or under the air or ground. The station sends out a radio wave. When we speak of music or speech we mean something audible, and no radio wave is audible.

What is it all—some catch or trick? Is the art of equivocation being practised to beguile the radio enthusiast who has not made a deep study of transmission and reception? No, indeed. It's plain, certain science, and no fooling.

The work performed at the broadcasting stations may be divided into two parts, one the pickup, the other the transmission. The microphone is the first instrument to consider in regard to the pickup. Into the microphone the singer delivers vibrations which constitute music (if he or she knows how to sing). An orchestra may be playing, or a pianist, or a talker may be uttering chin music. The vibrations set up by the voice or musical instruments actuate the carbon in the microphone and become electrical currents, which are carried to an amplifying system which makes them louder. While all this is going on a system of regeneration or oscillation is independently creating a radio wave, at the wave length assigned to the station. Let us say it is 300 meters, which is the

equal to 1,000,000 cycles per second, for frequency in cycles is equal to the speed of light or electricity, 300,000,000 meters per second, divided by the wave length in meters.

The amplified voice currents or music currents are instantaneously mixed with the radio wave which the station is sending out. The radio wave is known as the carrier.

The audible frequencies have a normal range of from 25 cycles to 10,000 cycles. The phenomenon of mixing the fluctuating audible frequencies with the steady radio or inaudible frequency produces a wave that is constantly changing, but is changing only slightly, since the change is equal to the variations in the original sound. Suppose, therefore, that a single 5000 cycle audible note is being put into the microphone. Suppose the carrier frequency is 1,000,000 cycles. The result of mixing the two is several frequencies, principally the frequency represented by the difference between the two and the frequency equal to the sum of the two. Hence the resultant frequency in one case is 995,000 cycles and in the other 1,005,000 cycles. The human ear does not respond to frequencies much above 10,000.

**POCKET WIRELESS:** It is reported that United States police are to be provided with pocket wireless receiving sets, complete with valve and batteries. Portable set manufacturers, please note!

Let Your Battery Save Your Purse: Philco

# Your Solodyne Parts — — best bought at *Murdoch's*

The World's Finest  
Components—and  
Values Pre-eminent!

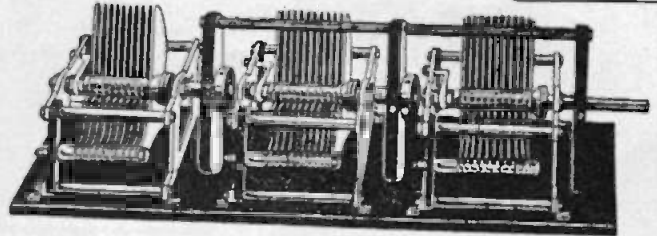

## Recommended Parts for the Wonderful 5 Valve Solodyne

Bakelite Panel, 21 x 7 ..... 12/3

### TRIPLE GANG CONDENSERS

Igranite ..... £5/12/6  
Utility ..... £3/15/-  
Ormond ..... £3/-  
Clydon Mid-Line Triple ..... £4/15/-  
Clydon Mid-Line, 4 Gang .. £6/1/6

### REACTION CONDENSERS.

.00085 Emmco Stratelline ..... 12/-  
.00085 Pilot ..... 13/-  
.0003 Ormond Low Loss ..... 11/-

### VERNIER DIALS.

Preferred Bakelite ..... 4/10  
Emmco Metal ..... 6/6  
Emmco Bakelite ..... 7/6  
Pilot-lite, Illuminated ..... 10/6

### SCREENED COILS.

Sovereign, English-make, per set of  
8 ..... 64/6  
Grodan ..... 67/6  
Radiokes ..... 75/-

### AUDIO TRANSFORMERS.

Eureka Concert Grand, per pair 60/-  
Emmco, 3½ to 1 and 5 to 1 .. ea. 17/6

Emmco Midget, 3½ to 1 and 5 to 1.  
each ..... 13/0  
Lissen, each ..... 12/6

### AMPERITES.

For All Makes of Valves, each . 6/9

### VALVE SOCKETS.

English, each ..... 1/-  
Buffalo U.X. .... 1/6  
Frost U.X. .... 3/9  
Benjamin, Cushioned, U.X., each 4/3  
Benjamin, Cushioned, English .. 4/3

### VOLUME CONTROLS.

Centrelab Radiohm ..... 10/6  
Emmco Stad ..... 7/6  
Bradleyohm ..... 13/6  
Maclurcan Tone Purifier ..... 21/-

### H.F. CHOKES.

H.F. Chokes, Lissen ..... 6/9  
H.F. Chokes, Radiokes ..... 8/6

### NEUTRODYNE CONDENSERS

Pilot ..... 5/9  
Advance ..... 6/6  
B.T. Mikro Mike ..... 6/9

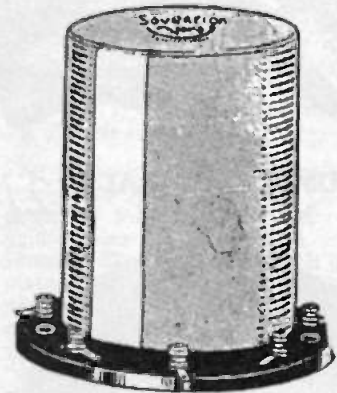

### SWITCHES.

Muter ..... 2/6  
Frost ..... 3/-

### ACCESSORIES.

Safety Lamp, with base ..... 1/6  
.00025 Dubilier Grid Condenser, with  
clips ..... 5/-  
3 meg. De Jur Grid Leaks, each . 1/4  
Terminal Strip, 12 x 1½ x 1-8, drilled,  
each ..... 9d.  
11 Engraved Terminals, each ... 4d.  
2 mfd. Lissen Condensers, each .. 5/9

For Other Accessories, Write  
for Complete Radio List—Post  
Free.

POSTAGE PAID on all Radio  
Goods, including Batteries up to  
5 lbs. in weight, to the nearest  
Post Office, Railway Station or  
Port anywhere in Australia.  
Over 5 lbs. in weight, half  
freight free.

## Special! —

Have you seen the new Loftin-White Receiver at Murdoch's?  
This most remarkable achievement in Radio is now open for  
your inspection at Murdoch's.

Full Particulars Free for the Asking.

When writing, kindly address your letter to Desk A.2.

# MURDOCH'S IN PARK STREET LTD SYDNEY

"Specialists in all Radio Equipment."

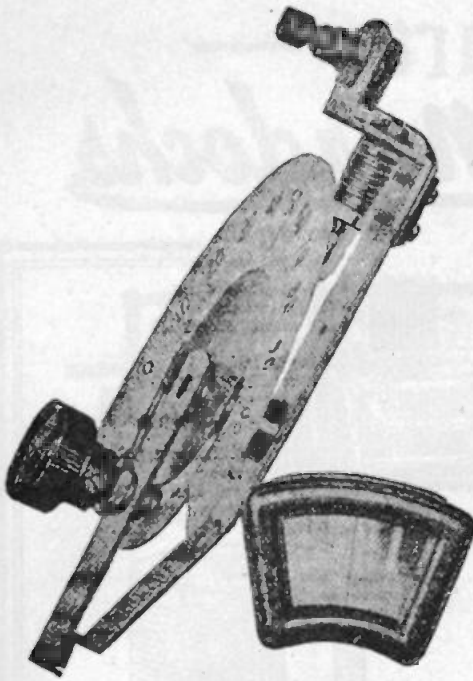

ILLUMINATED DIAL, No. 1277 12/-

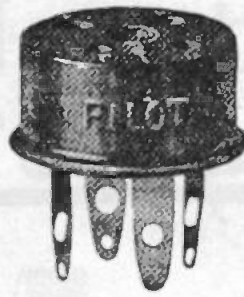

SUB-PANEL SOCKET, No. 205 1/3



NEW TYPE KILOGRAD DIAL, No. 1278. 7/6

# NEW PILOT PARTS

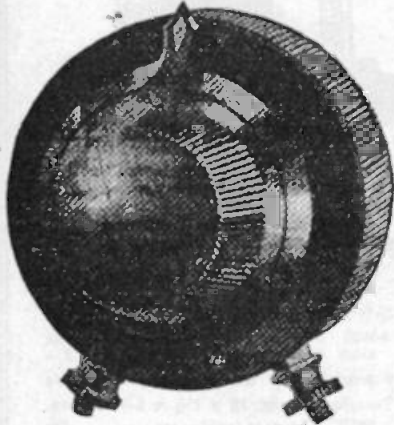

RHEOSTAT

- 906—6-ohm .....
  - 910—10-ohm .....
  - 920—20-ohm .....
  - 930—30-ohm .....
- } 3/6

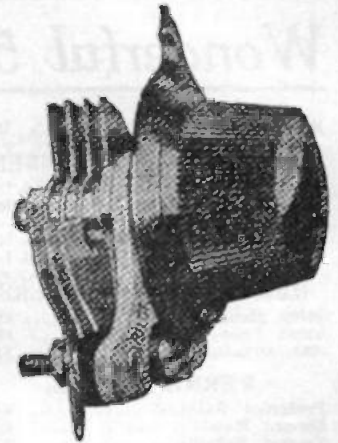

MIDGET CONDENSERS

- M7—7-plate ..... 5/6
- M13—13-plate ..... 6/6



RESISTOGRAD 8/6

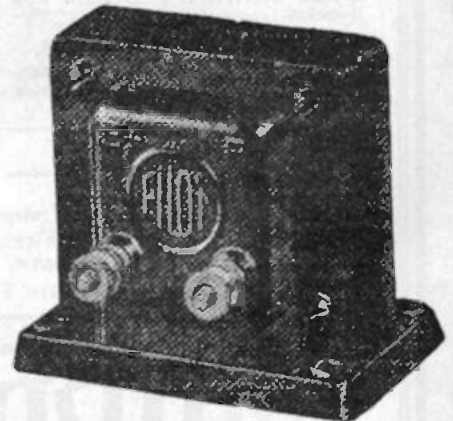

BAKELITE SHIELDED TRANSFORMER 15/9

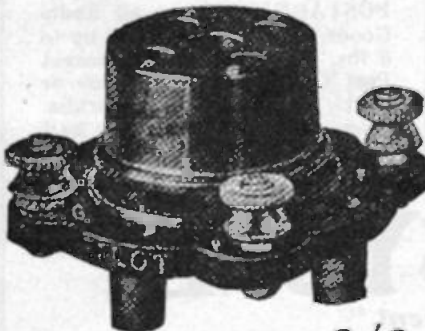

FLOATING SOCKET 3/3

UNITED DISTRIBUTORS LIMITED

72 CLARENCE STREET SYDNEY

# Radio Books Reviewed

## *The Admiralty Handbook of Wireless Telegraphy.*

MESSRS. Turner and Henderson, Ltd., of 16-18 Hunter-street, Sydney, have sent along to us a copy of the Admiralty Handbook of Wireless Telegraphy. This excellent publication is issued by the Lord Commissioners of the Admiralty, London, and has been prepared by Captain W. G. H. Miles, R.M., under the supervision of the Director of the Signal Department. It does not appear as an annual, but is published at irregular intervals, each new publication superseding the previous one. Primarily intended for the information and guidance of officers and men of his Majesty's Fleet, this handbook is one which no genuine experimenter should really be without.

Containing as it does 19 chapters, crammed full of information, it deals with every section of wireless and is written in such a manner that it can be clearly understood. There are approximately 370 line drawings, illustrating various points referred to in the book, which is printed on excellent paper, and well bound in cloth.

Among the subjects dealt with, there is electricity and magnetism, the Electron Theory, Ionization, and so on. There is a long chapter on Inductance and Capacity, another one on alternating currents, still more on continuous waves, receiving circuits—in which the subject of selectivity is discussed at a great length—Thermionic valves and their action, amplifiers, transmitting valves and transmitting circuits, radio telephony, wave meters and so on.

All the subjects are dealt with in a most comprehensive manner, and in addition there are many tables of which the average enthusiasts will find an every-day use. The person who wishes to make a study of this vast subject of wireless cannot do better than obtain a copy of this excellent publication, which is the finest of its type that has come into our hands. If the reader is intending to become a transmitter, then there is more than ample material in this handbook to give him a vast knowledge for the A.O.P. examination. From Messrs. Turner and Henderson, Ltd., we understand that the price is 7/6, and excellent value is given.

## *The Thermionic Valve.*

By Fred Goddard.

We have just received this excellent little publication for review. The author is a man who is fully conversant with this subject, and he deals with it from a very simple point of view. The book is free from involved technicalities and is copiously illustrated, a large number of circuit diagrams, ranging from single valves to super-heterodynes, being included, with constructive details.

The construction, action and control of valves is dealt with at length; the first chapter, in fact, deals with what a valve is, and is treated in such a manner that even the veriest school-boys reading this first chapter only would quickly get splendid working knowledge of valves. The other chapters in the book are written in an exactly similar strain, the whole from cover to cover being so simply explained, that it is a book for every wireless enthusiast, irrespective of just how little or how much he knows. One very interesting part is really worth the price of the book in itself and this portion deals with how to read a valve curve. This usually involved subject is so simply explained and illustrated that it is only a matter of five or six minutes' reading to grasp the essentials. Considering the great number of valves there are in use to-day, it is unquestionably a fact that the general standard of reception would be much higher than it is, if operators knew more of their valves, and the author of this book has succeeded in dealing with this subject in such a manner that he will appeal to everyone who owns a valve receiver. Further than this, there is furnished a fund of information hitherto available only to advance wireless experimenters.

Our copy has been received direct from the publishers, Messrs. Mills and Boon, Ltd., 49 Rupert-street, London. We understand that the price will be round about 3/6.

### AN OSCILLATING WAVE-METER.

Irate Father: "So, coming to listen to the new radio was only a blind. Here I find my daughter in your arms with her head on your shoulder."

Confused Suitor: "Er—no, sir. You see I was simply getting her wavelength," and he fondly pressed her new permanent wave.

## *The Four Electrode Valve.*

By Fred. Goddard.

This is another splendidly written book, by the same author as the one referred to above. These little known Four Electrode Valves are dealt with in a manner not before seen anywhere. The innate possibilities of the wireless valve which has four electrodes, instead of the three incorporated in the ordinary type, are intriguing the minds of wireless experimenters and constructors more than ever. The remarkable efficiency of this valve, its capacity for liberal amplification effects with very low high-tension voltage, and its adaptability to circuits inimical to its predecessor, are features combining to make it unique for wireless reception purposes.

This book, written by Mr. Fred. Goddard—a British engineer, who has had a long and intimate experience of all types of valves—is the first dealing exclusively with the four electrode valves, and those who desire to know more of these valves and how to get the best out of them, will find the facts set out in non-technical language of inestimable value.

The volume contains, with explanatory notes, over fifty circuits' diagrams, ranging from single to three-valve circuits, including a number of circuits dispensing with a separate high-tension battery.

Like "The Thermionic Valve," this excellent publication is printed on very good paper, and is cloth bound. There are over 64 diagrams, and circuits, from the simplest to the more complicated. Almost every known receiver has been discussed and described with relation to the four electrode valve, all circuits are particularly well drawn, and the most minute detail is entered into.

Certainly, this is the best book of its class which has so far been published, and great credit is due to Mr. Goddard, for dealing with it in such a comprehensive manner as he has done in this book. Messrs. Mills and Boon, Ltd., of London, forwarded us our copy, which will sell at a similar price to "The Thermionic Valve."

There is no "just-as-good" as Burgess.

# A Merry Xmas with a Radiola

The Ideal Xmas Gift

There's an



Radiola

to  
suit  
every  
purse

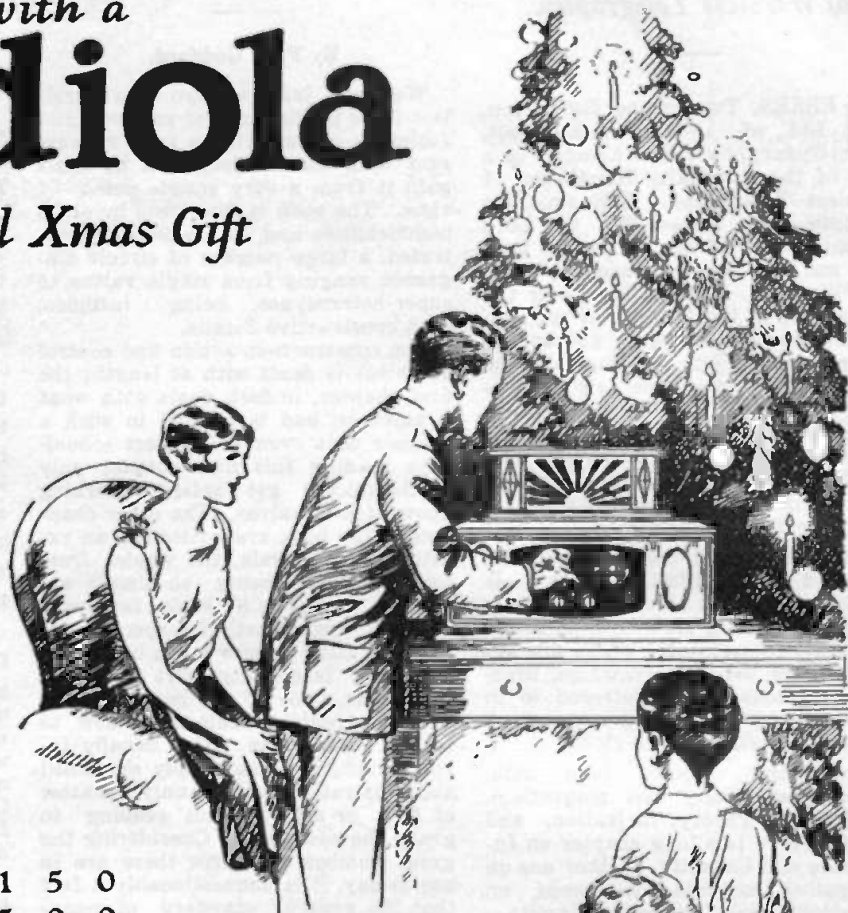

Radiola, Model 4c	£31	5	0
Radiola, Standard 6	£45	0	0
Radiola, Senior 6	£65	0	0
Radiola, Super 6	£75	0	0
Radiola, Super 8	£115	0	0

Payments may be spread  
over twelve months.

Order NOW

through your nearest

Authorised Radiola Dealer

or direct from

**Amalgamated Wireless**

(Australasia) Ltd.

"Wireless House"

47 YORK STREET :: SYDNEY

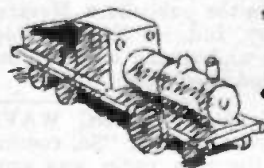

Illustrated Booklet gladly mailed on request.

# The COLE Five Valve Receiver

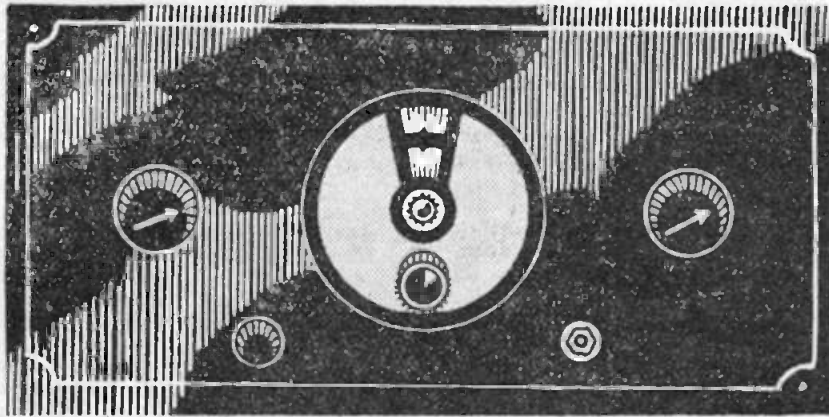

NOW that the summer months are creeping on us, it becomes more difficult each night to receive inter-State stations on the average 3 valve receiver, at a satisfactory volume. Old Father Static who sleeps most of the winter months, has ceased to rest, and his activities are now being felt and will be felt more so as the hot weather approaches. Of course, it must be understood that irrespective of what receiver may be used during this period, static will be, like the poor, always with us. Some nights are better for reception than other nights, in fact, even during the hottest nights it is quite possible to receive inter-State stations reasonably well.

It is asking quite a lot from the average receiver to expect consistent loud speaker results on these inter-State stations, during Summer, so in order to make a certainty of that which is doubtful, it is a good scheme to have a certain amount of reserve energy to play with.

To arrive at this, more valves are necessary, in order that the amplification may be built up, to sufficient strength to operate a loud speaker. It is common knowledge that more than two stages of audio frequency amplification of transformer coupled type, is impracticable, therefore, we have no choice but to make use of some form of radio frequency amplification, which builds up the weak incoming energy before it is applied to the detector valve, where it is rectified.

## An Efficient Receiver.

A neutrodyne receiver is known the world over to be one which lives up to its name of being a most efficient

all round receiver. A neutrodyne employs two stages of transformer coupled radio frequency, the trans-

former being the usual type associated with neutrodynes, that of the solenoid coils mounted at a given angle and spaced from 5 to 7 inches apart. It is admitted accordingly, that a considerable length of panel is required to allow this receiver to function at its maximum efficiency. Incidentally, too, three condenser controls are required, which, although quite simple to handle, cannot be compared with the more popular form of one control receiver, of more modern times.

One method of gaining the one control feature is by means of gauging the variable condensers, which are required for tuning purposes. When these condensers are spaced along the panel, some form of belt or chain drive must be resorted to, and as it is beyond the scope of the average home constructor to devise such a means, then we must, perforce, seek some other system. This brings us back to that popular method associated with the Solodyne, that of ganging the condensers one behind the other, on a long spindle. With the neutrodyne when this is done, we meet with the difficulty of long leads to the grids of the valves, and as these long leads spell lack of efficiency you must think of some other type of coil which need not be spaced so far apart as the neutroformers, but which can be fixed relatively close to one another and yet which must not give rise to interaction between these coils.

## Circloid Coils.

The writer has over and over again, come in contact with neutrodyne receivers which have not lived up to

## PARTS FOR THE COLE FIVE.

*Although the parts listed below and mentioned throughout the articles were those actually used by us in the receiver described, it must be pointed out that it is not absolutely essential that they be rigidly adhered to. Other parts of similar quality and technical values should function quite satisfactorily.*

- 1 Dilecto or hard rubber panel, 14 x 7 x 3-16.
- 3 Advance Centralign condensers, 0005 mfd.
- 1 Ebonite bush with  $\frac{1}{2}$  inch hole, and two set screws.
- 1 Electrad 400 ohms. potentiometer.
- 1 Electrad 6 ohms. rheostat.
- 1 S.C. Jack.
- 1 Battery Switch.
- 1 Kit of Radiokes Circloid Coils.
- 5 Valve sockets.
- 1 Advance midget condenser.
- 1 .00025 Wetless condenser (in aerial lead).
- 1 .00025 Wetless condenser, with clips.
- 1 2 Meg. grid leak.
- 1 Viking transformer, 5 to 1 (1st stage).
- 1 Viking transformer, 3 $\frac{1}{2}$  to 1 (2nd stage).
- 9 Terminals.
- 1 Terminal board.
- 1 Pilot Kilograd dial.
- 1 Baseboard, 13 x 14 x  $\frac{1}{2}$  inch. Spaghetti, busbars, screws, etc.

You can Recharge a Philco for a few pence.

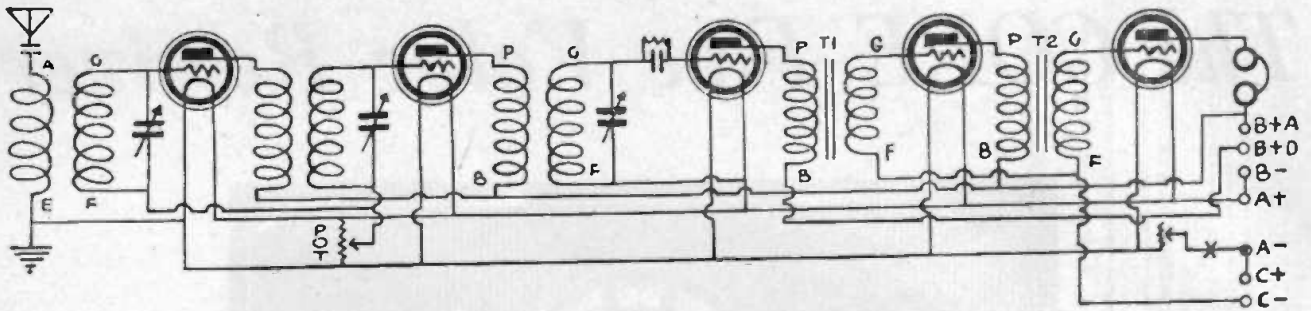

the good name earned by such an excellent receiver. Invariably, the trouble has been traced to badly spaced neutroformers, and incorrect neutralisation. These unfortunate set of circumstances have given rise to many complaints which could have been avoided if the constructor built his receiver according to the specifications laid down by the writer of the constructional article. These troubles can be overcome by making use of some form of coil where the magnetic field is confined within a small area. Screening or shielding is a means to an end, such as was demonstrated in the Solodyne previously referred to, but there is another type of coil which seemingly has been overlooked of recent months, which can effectively give excellent results in a very small space without the attendant troubles of magnetic coupling. This coil is known as Radiokes Circloid coil, and while not quite new in principle, in practice when built into a receiver, gives most phenomenal results.

Phenomenal is just the word to describe the results heard on the Cole Five. That the Circloid coils assist greatly in rendering these results possible, there is no doubt, as they are a splendidly constructed coil, designed locally to give extremely good results, and that they succeed in doing so, cannot be denied. The space occupied by the Cole Five is very small indeed, in fact, the whole receiver is so compact that it must make its appeal to most readers desirous of a super-excellent five valve receiver.

#### Compactness.

The whole receiver is very compact, the size of the front panel exactly 14 inches long by 7 inches high, and the depth of the baseboard, which contains most of the components, is 14 inches. Within this small space is contained all the apparatus necessary for this wonderful Cole receiver. The variable condensers numbering three, are ganged by means of one common spindle right through the three separate condensers. When it is said one common spindle goes right through the three condensers, this statement is not virtually correct, as the variable

condenser governing the detector circuit is electrically separated from the other two condensers. It is known that for best results, the grid returns of the radio frequency valve circuit, are connected to the A battery negative, while the grid return of the detector valve should be joined to the A battery positive.

#### Ganged Condensers.

If all the moving plates of the variable condensers—and usually the moving plates complete the return circuit—are connected to one long brass spindle, then it is necessary to make some alteration in the grid return or perhaps it should be said, the grid feed of the detector valve, so that proper control of this detector valve is arranged. In this receiver there has been a departure from the ordinary. The two radio frequency valves have their grid returns arranged in such a way that they may be placed at either positive or negative potential according to the whim of the owner. This is effected by means of joining the common grid returns to the centre arm of a potentiometer, the outside terminals of which are connected across the A battery, thus allowing the variation previously specified. This feature is one well worthy of incorporation in this receiver.

Instead of using one long brass spindle, right through the three Advance condensers, just sufficient brass spindle is used to allow it to protrude between the two radio frequency condenser controls, and that condenser which tunes the detector valve circuit makes use of a small portion of  $\frac{1}{16}$  in. Dilectro rod, which is an excellent insulating material, yet has sufficient tensile strength to allow this portion of the gang condenser to be turned in harmony with the other two portions. Thus is it possible for the grid return on the detector valve to be taken to the A positive.

Advance Centralign condensers have been chosen for this particular circuit, because they lend themselves very nicely to ganging, but at the same time it is quite possible that they may vary somewhat slightly in their capacities for the different

wavelengths to which they will tune with any given coils. To overcome any possibility of trouble in this direction, there has been connected in parallel with one section of this ganged condenser, an Advance mid-ganged condenser to act as a balancing arrangement. Some people may find it necessary to place one of these mid-ganged condensers across two of the three sections, in order to get the correct balance, but this will depend on actual results.

All the valve filaments are controlled with one 6 ohms. rheostat, which under actual conditions of reception has proved quite satisfactory, but were the writer to build this receiver to-day, he would use an Amperite for every valve. It may seem strange that the previous statement has been included in this article, but it is a fact, nevertheless, because this particular Cole Five has been in existence, and rendering yeoman service for a period extending over 8 months.

During this period of time, it may be interesting to annotate that not only have all the Australian Broadcast stations been received on the Cole Five, but also the two New Zealand stations. And when one comes to consider that actually only one control is essential, this speaks volumes for the performance of this receiver.

#### Construction.

The construction does not call for any great engineering skill in any way, as there are no coils to wind, the first act in construction is in marking out and drilling the panel. The panel drilling diagram shows the measurements and the spacing of the different parts. Lay the panel on a flat surface, mark out the positions with the centrepunch, then drill the necessary holes. With the Advance condenser, countersinking must be resorted to, for the fixing screws of the Advance condenser. A larger size drill than is usual may be used for this purpose, but be certain you don't drill too deeply, or right through the panel, as this will create an awkward situation. Make provision for three screws with which to fix the panel to the baseboard. Leave the panel on one side, then attend to the ganging of the condensers.

There are no rivals to the Philco.



A length of a  $\frac{1}{4}$  in. diameter round brass rod, five and five-eighths inches in length, is required for the two radio frequency portion of the ganged condenser. It is necessary to remove the existing spindles, although if preferred, existing spindle of the 2nd condenser may be forced into the back of the 1st condenser, that is the condenser nearest the panel, and with the moving plates of both condensers "all in" fix the set screw of the 1st condenser, so that it grips the spindle of the 2nd condenser. Now obtain an insulating bush of material, such as ebonite or Bakelite, and a length of Dilecto rod  $2\frac{1}{2}$  inches long, by quarter inch in diameter, and another short length of this rod one inch long, of the same diameter. Undo the back set screw, governing the moving plates of the second condenser, clamp the one inch length of rod into the back of this condenser, leaving approximately three-eighths of an inch protruding out the back. To this protruding portion grip one set screw of the ebonite bush. Now into the last condenser, that is, the third one from the panel, push the longer length of Dilecto rod right through from the back, allowing about half an inch to protrude beyond the front, and grip this protruding half inch with the other set screw of the Ebonite bush. The two set screws on the back condenser, should now be secured tightly, but make certain in doing so, that the moving plates of all three condensers are all in.

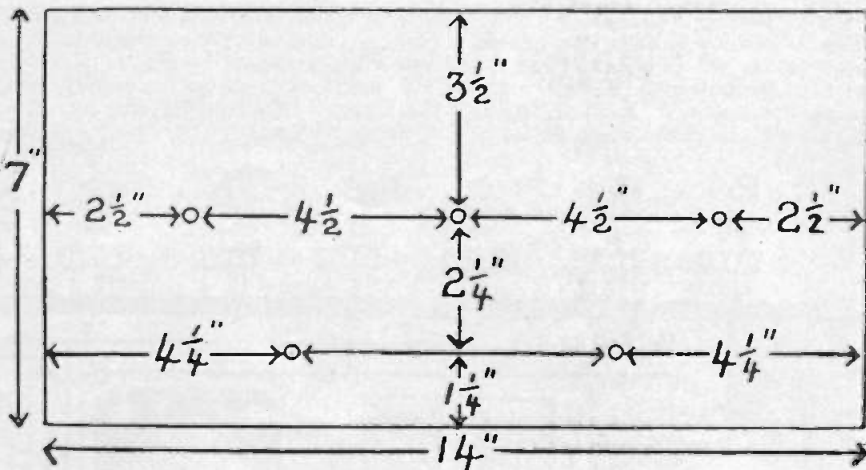

Now mount this condenser on to the panel, also the potentiometer, the rheostat, the jack, and the battery switch. Place the panel into position against the baseboard, and screw the panel to the baseboard. Now, in accordance with the plan view, lay out the rest of the baseboard components. It will be seen that one radio frequency valve socket is mounted on one side of this condenser and the other on the opposite side, then on this opposite side, right at the back of baseboard, fix the detector valve socket. Running right along the back of this baseboard, close to the terminal board, are the two audio transformers, and the two audio valve sockets. Looking from the back of the set on the left hand side near the rheostat is fixed the first radio frequency Circloid coil, close to the first radio frequency valve socket, alongside of which is the midget balancing condenser. On the opposite side of the condenser and near to the potentiometer, is found a position for the second radio frequency Circloid coil, at the back of which is a second radio frequency valve socket, to the left of which,

close to the variable condenser, is fixed the detector tuning Circloid. The rest of the layout is very apparent.

**Wiring.**

When the terminal board has been screwed into position the wiring may be commenced. To be quite frank, the system of wiring used in this receiver is the straight spaghetti covered soft wiring with point to point connections. No neutralising condensers are necessary, as Circloid coils seldom need to be neutralised. Even if they were, the use of the potentiometer in this circuit dispenses with this necessity. The back of panel wiring diagram is sufficiently clear for the average person to follow out the wiring. Begin with linking up the filament terminals of the different valve sockets, then come back to the audio stages, wiring these up completely. There is not one point in the wiring difficult of access in this set in spite of its compactness. Bear in mind that it is always advisable to mount the grid condenser and grid leak directly on to the G terminal of the detector valve socket.

**Valves.**

As it is the usual practice with all W.W. receivers the actual valves used in the set being described are always mentioned. To be quite frank about this matter the writer has no hesitation in stating that almost any good valves will give excellent results, and I actually have given excellent results. When the Radiokes valves were put on this market the writer happened to get a few and found them to be really worth the extra outlay—particularly the UX200A Radiokes special detector. When this valve was placed in the detector socket a distinct increase in volume was noticed, not only on the local stations, but also on the interstate stations, everyone without exception. This is a candid admission which may be of profit to many readers who are seeking an excellent detector valve.

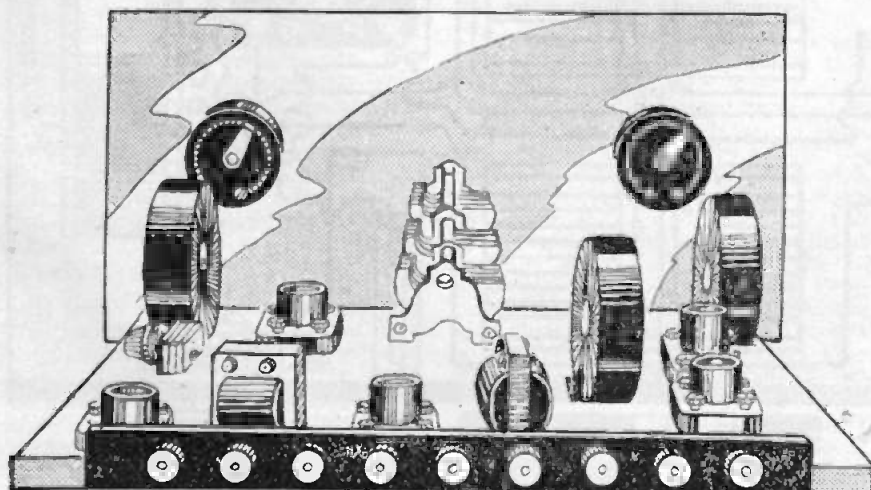

Why Blame Static? Buy a Philcol

Battery Voltages.

The A battery voltage depends on the particular valves chosen. For the Radiokes, Radiotron, 201A type, many Philips, Cosser, and Mullard valves six volt will be found quite satisfac-

tory, although for the latter, it might even be said all types, there is a four volt variety to be chosen. Regulate your accumulator to supply to the filament of all valves, the correct A battery voltage.

The B battery voltages depend very greatly on the valves to be used. For the average valve the detector voltage fixed at from 22½ to 45 volts will be found to give very satisfactory results and with 90 volts on both audio

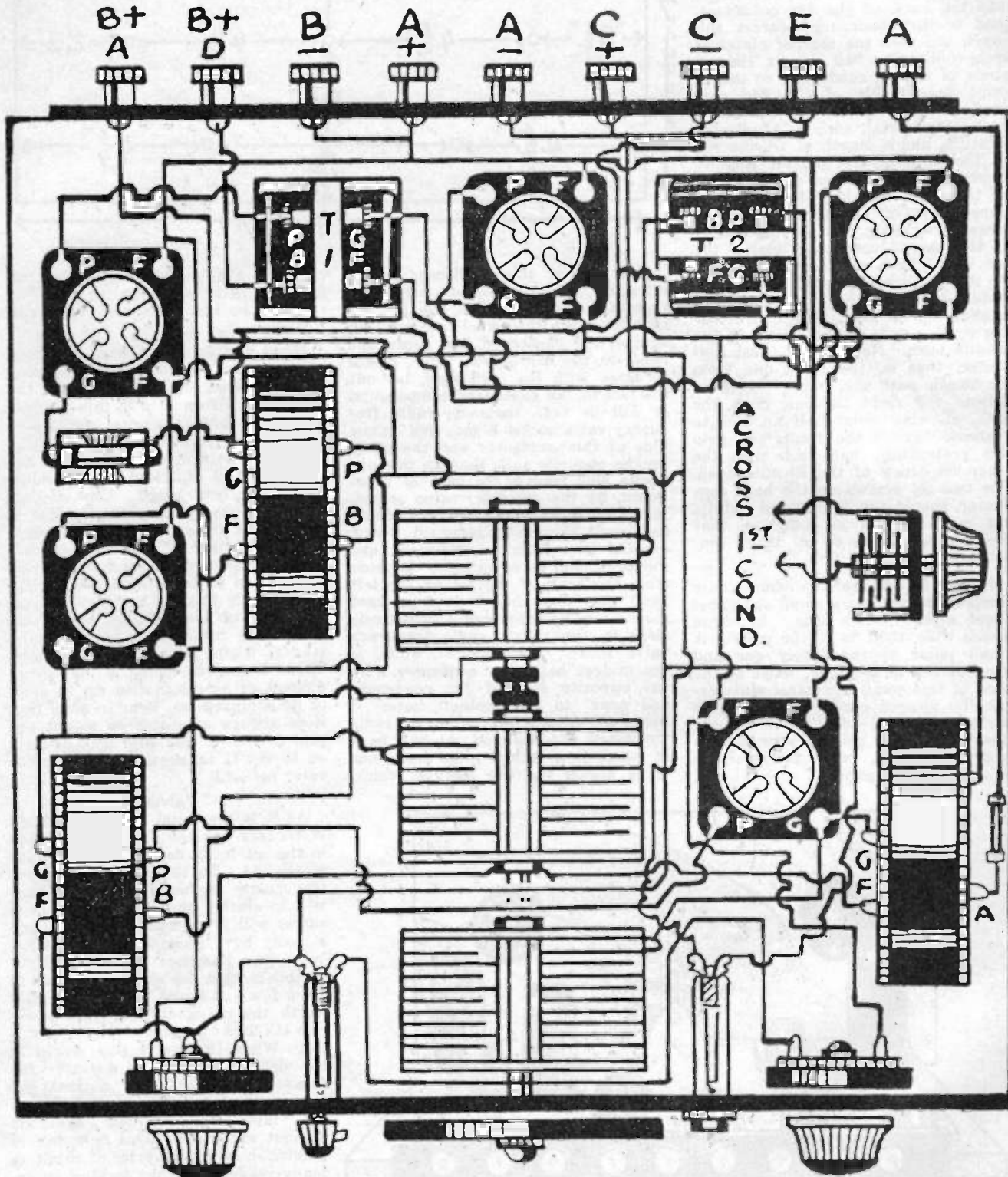

Philco Batteries Save Pounds in a Year.

and radio stages, a wonderful performance should be had from the Cole Five. The grid bias battery of 4½ volts will be found quite suited to a 90 volt audio B battery with a 201A type of valve, although with any other type up to 9 volts C battery will be necessary. It is always advisable to adjust both the B and C batteries to suit the particular valves and the actual receiver in which they are installed. Don't be afraid to vary the voltages, even to what may seem to be ridiculous, provided you are getting good results.

#### Testing.

For a trial connect up all the batteries as specified, plug in the loud speaker, and hook on the aerial and earth. The aerial need not exceed 60 feet in length, and the earth may be the usual water pipe or buried sheet iron or kerosene tin, as the case may be. Press the battery switch to the on position and turn the rheostat the whole way around. Set the potentiometer on midway between the two terminals, and tune with the vernier dial governing the ganged condenser. The local station will be heard at one setting at a wonderful volume.

Turn the rheostat back until the local station can just be heard in the speaker. Now, balance up the three gang condenser. Turn to the one midget and adjust this slightly, which most probably will bring in the local station a little more loudly. Bring it up to its loudest pitch with this condenser. Turn up the rheostat, then adjust the potentiometer until the loudest and clearest point is found. Now turn back the rheostat back again to the same position as it was when balancing and note if any increase in volume is present. Then turn your rheostat up again to its full, and seek the interstate station. Go for 3LO, Melbourne, which will be found very close to 2BL, Sydney. Work the potentiometer into such a position that the carrier wave of 3LO can be heard. Now carefully tune with the gang condenser and adjust the potentiometer until the carrier wave disappears, leaving only the modulated output of Melbourne station.

Perhaps the volume may not be what you expect. If such is the case, then loosen the set screws governing the moving plates of that section of the variable condenser which has no vernier to balance it. Very carefully and very slowly, a fraction at a time, turn the vernier dial till the loudest point of reception from Melbourne is available. It may be necessary to turn either one way or the other. Prove this for yourself. When this point is reached, adjust the set screws of the loosened condenser spindle, use

your potentiometer to advantage, then seek Brisbane. 4QG will be found easily, so will 5CL. Farmers will be very much present, when you reach their setting. A little further on the scale 3AR will present themselves, perhaps not so loudly as the other stations, but still at sufficient volume to be heard comfortably on the speaker. The Hobart station 7ZL may be found a bit difficult, for the writer has experienced a distinct variation in the reception of this station almost every night in the week. That is by the way, of course.

If any difficulty is met with, in bringing interstate stations up to the maximum pitch, the addition of another balancing condenser across that portion not already balanced, with a midget, will clear up this trouble in no time. Room for this additional midget will be found on the base-

board, and like its neighbor one set will always be found best in that given position. Trial and practice only proves this.

The Cole Five, as has been previously mentioned, is one which has been in existence, and found a tried and trued receiver, for over eight months. What it has done for the writer it can do for you, but a last word to the reader and to the perspective constructor governing the use of good parts will not be out of place. Itemised elsewhere in this article is a list of parts giving the brands of materials actually used in the receiver just described. These parts have given satisfaction in this particular receiver and will no doubt give the constructor similar satisfaction. Even although it is found inadvisable to stick to the letter, at the same time, it is absolutely essential to stick to the values.

## My Attempt at Broadcasting

By "CIEL"

I SAT down with a yawn in one of the deep and comfortable arm-chairs which are so attractively placed in 5CL's Artists' waiting room, and tried not to feel nervous. In a short time I was to broadcast a few short fairy stories to the children, and as it was my first attempt, I really did feel a little nervous.

I began to look through the small bunch of notes I had with me (strange how one forgets even the details of children's stories), and concentrate on the task in front of me, when a small head peeped round the doorway.

The head was followed by a small body and a tiny voice squeaked out "Good evening, pleased to see you here, no doubt you expected to see me. Probably you'll be mentioning me through the microphone later on, My name is 'Tom Thumb.'"

The young fellow continued talking volubly, but for some time I could not follow what he was saying. If the truth be told, I was a little dazed, I did not expect anything like this.

Finally, "Tom Thumb" invited me into the Studio and introduced me to others whom he mentioned as his friends.

I met "Old King Cole," who regretted the inability of his fiddlers to play suitable music for the occasion owing to the absence of fiddle strings (due, no doubt, to their high cost).

Little Bo Peep anxiously questioned me regarding the sheep sales, and "Tommy Tucker" (who sang for his supper) sat gloomily in a corner looking sadly on a notice upon which the word "Silence" was printed in large

letters. In another corner a "Fairy Queen" sat on a cane chair carefully polishing a glowing star on the end of a sparkling wand, and talked softly to a toothless witch who was picking dead leaves away from her broomstick. Then up came Prince Charming, introduced himself and showed me a huge picture book in which Robin Hood and his merry men played hide-and-seek with Four Jolly Robbers around a lattice-work radio mast.

When they got too rough in their game, Prince Charming closed the book with a snap, and before I had a chance to thank him for his kindness, Peter Pan was getting a fit of sulks with Alice in Wonderland because she would insist on holding my hand. She introduced me to the Duchess, who was beginning to complain about the weather when the Mad Hatter came along.

He was too late, however, Cinderella grabbed hold of me and said, "Come on," run quickly, I must hurry before the clock strikes twelve, run, quickly, run—

I began to run, faster and faster, and woke with a start to find Uncle Radio shaking my shoulder, "Come on," he said, "you can go on the air now." He turned and I bolted.

To my mind, 5CL's studio is haunted.

\* \* \* \* \*

There once was a young man of Kew,  
Whose aerial got somehow askew.

He climbed up the mast

To make the end fast,

And that is the last that he knew!

America's Submarines all use Burgess.

## Adventure!

### Thrilling Stories of World Exploits

Thirteen world-thrilling adventures are graphically described in a finely illustrated booklet (No. 100) which may be obtained without charge from New System Telephones Pty., Ltd., 280 Castlereagh Street, Sydney. The following is Captain Frank Hurley's Preface:

Australia was born too late to found an Empire, but there is no race on earth which is so boyishly eager to throw itself into the front trenches, to penetrate New Guinea jungles, tramp over Antarctic ice, or take wing across the world.

In France and Flanders and Palestine, I saw college boys stride forward, with a gallantry grander than life, into the last Great Adventure. I count it my highest honor to have been comrade of those Australians who are now citizens of an unknown nation!

My own New Guinea adventures have been described in books and shown on films, but I must add here my warmest tribute to the superb Burgess Radio Batteries, which kept us continually in touch with civilisation. I carried an 8 valve super het. set, the power being supplied by these batteries.

Sprayed with salt water, borne by native carriers through forests and over swamps, exposed to burning sun, tropical storm and hot damp air, the Burgess Batteries functioned magnificently.

Following these three months of the fiercest imaginable tests, the Batteries returned with me to Australia and were used in my home for another five months.

If the call of the blood sends me out on some new quest, whether it be to achieve or to become comrade again of the college lads, you will know of it through the good old Burgess.

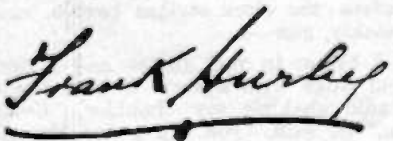

Steel and Quicksilver, Vision and Eternal youth are combined in Captain Hurley, gallant soldier, explorer, photographer, artist and film director!

No living Australian has had such an amazing career, nor so many hair-breadth escapes.

He has probed the heart of unknown Australia, three times explored the Antarctic, served as the official photographer in the advanced lines on three fronts in the Great War, and twice plunged into savage New Guinea.

No man is more beloved, none more respected!

Read what Mr. Maclurcan  
says about the

## “D. J. SUPER-SIX”

Messrs. David Jones Ltd.,  
Radio Department,  
22 York Street, SYDNEY.

Dear Sirs,

I have carried out some tests with your Six-valve "King" Neutrodyne wireless set with very good results.

The volume obtained from Interstate stations was all that could be desired and was equal to that obtained with any set that I have so far tested. The tone quality was very pleasing, and the single dial tuning made the set delightfully easy to handle.

Only a short aerial was used during the test—15 feet high and 60 feet long.

I am,

Yours faithfully,

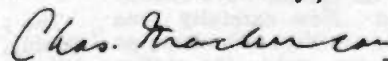

A.M.I.R.E.

The "D.J. Super-Six" is supplied complete with the highest grade accessories—speaker, valves, aerial equipment—everything ready to instal. Cash Price .. **£45**

Or you may take delivery on payment of £4/10/- deposit—the balance to be paid in 52 weekly instalments of 17/3.

## DAVID JONES'

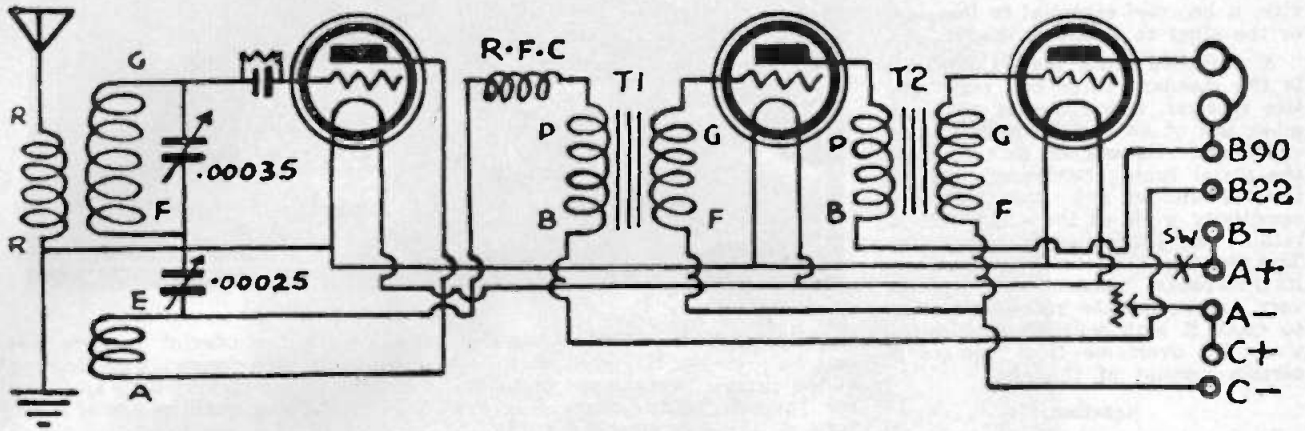

# THE WEAGANT THREE

ONCE again a three valve receiver is to be described. There are many possibilities with the average three valve receiver, and while it must be admitted that such a receiver is essentially good for local reception of stations at reasonably good loud speaker strength, it is yet even possible that inter-State stations may be heard at even weak loud speaker strength. It is not inferred of course, that every three valve receiver is capable of yielding loud speaker results on the inter-State stations. This may be possible perhaps during the winter season, and while not impossible in the summer months, is perhaps improbable. This state of affairs is brought about by atmospheric conditions. It is generally an accepted theory that inter-State reception is more difficult during the summer months, than is the case in the winter months. For many reasons winter time reception of inter-State stations is much simpler than summer time reception from the same stations.

Weather conditions play a most important part in this matter. During summer one cannot overlook the fact that inter-State stations may be received subject to attendant static, and while this static plays a most important part in preventing satisfactory inter-State reception on the loud speaker, it is even possible that earphone reception may be had from inter-State stations with a properly designed three valve receiver. It must be admitted, of course, that while winter is the ruling season, the self-same three valve receiver about to be described can and actually will deliver a reasonably good volume from the inter-State stations. This country is not in any way different from

any other country on the face of the earth as far as the long distance reception is concerned in summer time. In every country in the world it has been noted that reception during hot weather is not nearly so good as is obtained during the colder seasons of the year, and bearing this fact very much in mind, this week's receiver is

introduced to you as being typical of all receivers in their results during the summer period.

## CHOICE OF CIRCUIT.

Ask any old established wireless enthusiast and he will tell you that the well-known standard P1 receiver is perhaps the most sensitive of all receivers in which the detector valve is the first valve, that is the detector valve. The same person will also tell you that the only drawback to the P1 receiver lies in the fact that it is subject to very broad tuning, that is to say, all the local stations may be heard at excellent strength, but unfortunately, the inter-State stations, so much sought after are inclined to be mixed up with the local stations, and often with other stations.

This points out an important factor which must not be overlooked that the old P1 or single circuit regenerative receiver is extremely sensitive, and as such, it is necessary to go a long way to beat it. The one drawback, and it is a big one, lies in the fact that while being extremely sensitive, the P1 is not at all selective. This brings us to the most important factor, that of selectivity.

## Selectivity.

Selectivity cannot be overlooked with any receiver. It often happens—and this is true—that a receiver may be extremely sensitive yet not selective, and the contrary is true that a receiver may be selective yet may be far from being sensitive. The idea always is to use some sort of receiver wherein the sensitivity and the selectivity is more or less balanced. It must be admitted that it is difficult to arrive at such a re-

## LIST OF PARTS FOR WEAGANT THREE.

*Although the parts listed below and mentioned throughout the articles were those actually used by us in the receiver described, it must be pointed out that it is not absolutely essential that they be rigidly adhered to.*

*Other parts of similar quality and technical values should function quite satisfactorily.*

- 1 Dilecto or Hard Rubber Panel, 18 x 7 x 3-16.
- 1 Aladdin 3 Coil Tuner.
- 1 6 ohms. Rheostat.
- 2 Pilot Art-craft Dials.
- 1 Emmco Battery Switch.
- 1 S.C. Jack.
- 1 Emmco Stratelyne Condenser, .00035 mfd.
- 1 Emmco Stratelyne Condenser, .00025 mfd.
- 3 Valve Sockets.
- 1 Radiokes R.F. Choke.
- 1 Wetless .00025 Grid Condenser, with Clips.
- 2 A.W.A. Superaudio Transformers.
- 1 Terminal Strip.
- 9 Terminals.
- Sundries, Busbar, Screws, etc.

There's the right Burgess for every Sel.

ceiver, as it invariably happens that to gain both sensitivity and selectivity, it becomes essential to lose one or the other to a certain degree.

A variation from the P1 receiver is the standard three coil regenerative receiver, which may or may not make use of an aerial circuit tuning condenser. Experience tells us that the aerial tuning condenser may be omitted without any undue loss of sensitivity while at the same time it retains the properties of selectivity. This standard old reliable receiver has its drawbacks, inasmuch as it depends very greatly on the reaction system to make it both sensitive and selective. To overcome this requires a certain amount of thought.

**Reaction.**

It has been said over and over again, and in saying so, it has been partly true, that the accepted form of Reinartz reaction is one well worth while. This is certainly true, but the fly in the ointment lies in the reaction control. It must be admitted that irrespective of what type of Reinartz reaction control is used a certain variation in the wavelength of any given station has to be met with when reaction is applied in order to increase the volume from that station. The circuit employed in this receiver, is not quite new, in fact, is quite old, and is known as the Weagant system, the main advantage of which lies in the fact that reaction control does not in any degree interfere with the wavelength to which a receiver is tuned.

This particular circuit is one that has been tried and proved to be worth while for almost three years. Therefore, the writer has no hesitation in recommending it to even the veriest beginner. It is an accepted practice that this circuit is of extreme interest, on the short-waves ranging between 15 and 135 metres, so that it necessarily follows that if this receiver is capable of excellent reception on the ultra short wave band, it must be worth while using on the broadcast band.

That this is so is proved by actual results. The reaction system is

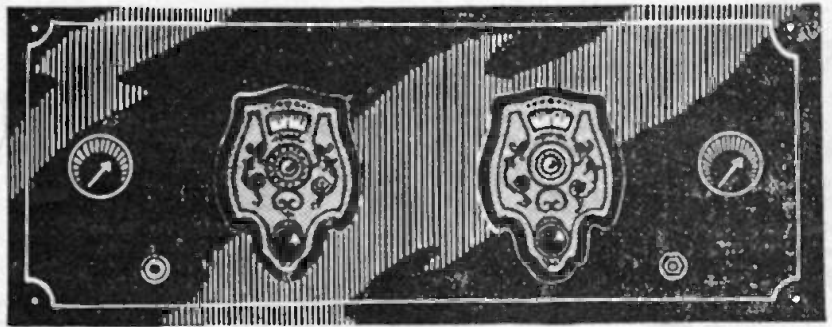

slightly different to that of the Reinartz on even the Hartley type. Look at the circuit diagram and prove this for yourself. The outstanding feature of this receiver even in the broadcast wave-band, is that after a given station has been received, no matter what amount of reaction is fed back to the grid of the first valve, the wavelength of the station being received is not interfered with in any way.

This is a most important factor, particularly during the summer months, where it is very difficult to receive consistently inter-State stations on any three valve receiver. The Weagant is one receiver which will go a long way to making possible the reception of inter-State stations during summer time, although it is not put forward as being a receiver which is certain to produce these results at any time or even at all times.

**Layout.**

It often happens that to achieve these results it is necessary to resort to a most peculiar layout. In this instance, this is not quite true, as the layout is quite orthodox, and is really speaking, exceedingly neat. The front panel illustration proves this to be the case. There can be seen the two Pilot Art Dials, which are used as a vernier control on each of the two variable condensers. On the left hand side of one of the dials is found the knob, which controls the reaction coil of the Aladdin Tuner. This Aladdin Tuner is a very worthy component, it lends itself to many different circuits, and incidentally, too,

makes this wonderful receiver possible. It is a very well designed article, taking up very little space, but its functioning qualities are of a very high order.

To the right of the second dial is seen the knob for the 6 ohms rheostat, which controls all the filaments of all the valves. While 6 ohms resistance is specified, if the constructor prefers to use such valves, as make use of .06 or .1 of an amp. each in the filament consumptions, then a 30 ohms. rheostat will serve the purpose admirably.

A circuit diagram points out that the well-known system of transformer coupled audio frequency has been found successful in this receiver. The writer makes no bones of the fact, that excellent tone has been produced and wonderful volume has been made possible, with this system of audio frequency, and recognises, of course, that there are many readers and prospective constructors who prefer to make use of some other system of audio frequency amplification—to these people it will be left to choose their own particular system. Suffice it to say that the scheme used here with the detector valve is quite novel, and is not affected by any system of audio frequency amplification which may be employed.

**Construction.**

The construction of the receiver, presents very little difficulty. The front panel view shows just how this set should look after it has been completed. It, of course, has to be realised that there is a certain amount of work necessary before this effect can be produced. Firstly, the panel must be drilled to accept the various components. The panel drilling diagram gives an indication of just the distances recommended on the panel to accept the various components. Lay the panel on a flat surface, and with a centre punch, or even a nail, for that matter, mark out the panel. Some people prefer to draw a full size template of the panel with the correct measurements as shown in the diagram. The absolute beginner can hardly do better than to accept this

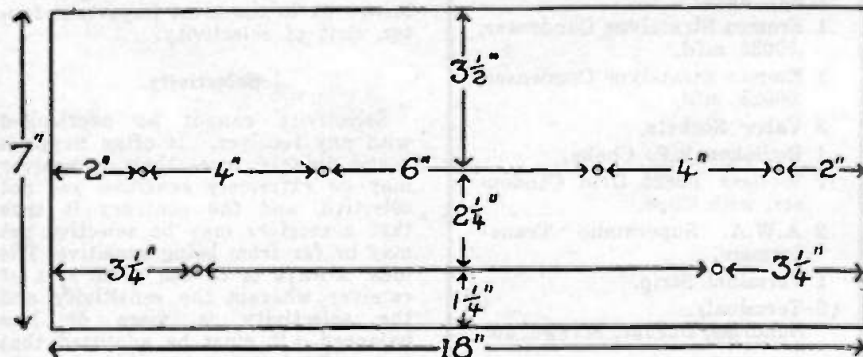

Let Your Battery Save Your Purse: Philco.

scheme, and having successfully drawn out this template, lay it on top of the panel, and, keeping it securely in position, use a centre-punch, and mark out the respective positions of the various components. It must be accepted, of course, that in our drawing there is no provision made for the fixing screws of the variable condensers, nor the cat-screws for the vernier dials. These positions must be determined by the constructor himself, as are the positions for the screw holes required through which the panel is attached to the baseboard. Now drill the panel, bearing in mind, of course, that a high speed and a light pressure accomplishes much.

Next, mount these panel parts, noting carefully that you have the different size condensers in the correct place. It sometimes happens that a certain jack to be used requires a fairly large hole. Possibly, too, the constructor has not the correct size drill or a drill big enough for the purpose. If such should be the case, then use a rat tail file and enlarge the hole. Sometimes the use of a three-cornered file as a reamer will settle a difficulty of this kind.

Prepare the baseboard by trimming the edges and give it a coat of shellac. When thoroughly dry place the parts on the baseboard and screw each of them in position as shown on the plan view. Mount the Wetless grid condenser directly on to the G terminal of the detector valve socket and bring the other end of the con-

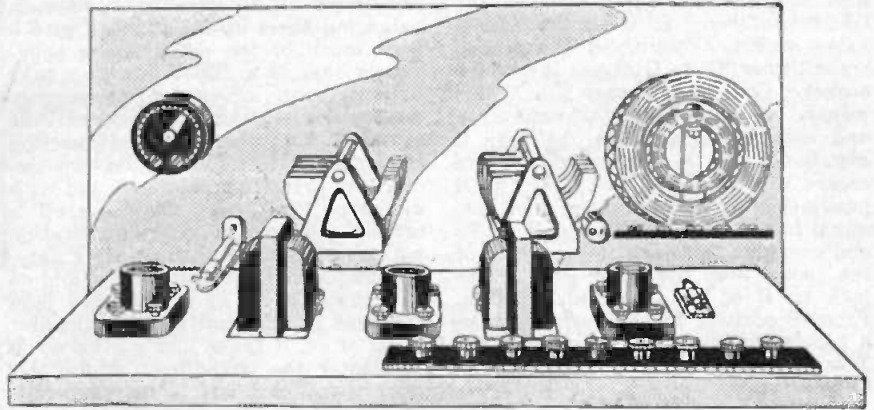

denser back in such a way that it is close to the G tag of the Aladdin tuner. The baseboard, of course, should be screwed to the panel.

**Wiring.**

Now commence the wiring. Begin by linking up one F terminal of each valve socket, then continue this lead to one side of the switch to the other side of which take straight through E, A positive and B negative on the terminal board. The nearest point to the moving plates of both variable condensers continue this connection. Note that this A positive wire runs from R2 and F of the Aladdin Tuner as well, then make connection with the moving plates of both variable condensers to the earth terminal, the

A positive terminal, and the B negative terminal with the switch breaking in between. Now link together the remaining F terminals of each valve socket, take a connection to one side of the rheostat, joining the other side to the A negative and C positive terminal. Now connect aerial terminal to R1 on the Aladdin Tuner. The fixed plates of the 00035 variable condenser join to G of the Aladdin Tuner, and to one side of the grid condenser and grid leak is connected directly to the G terminal of the detector valve socket. Now connect P of the detector valve socket to A of the Aladdin Tuner, joining E of this tuner to the fixed plates of the 00025 variable condenser, and also to one

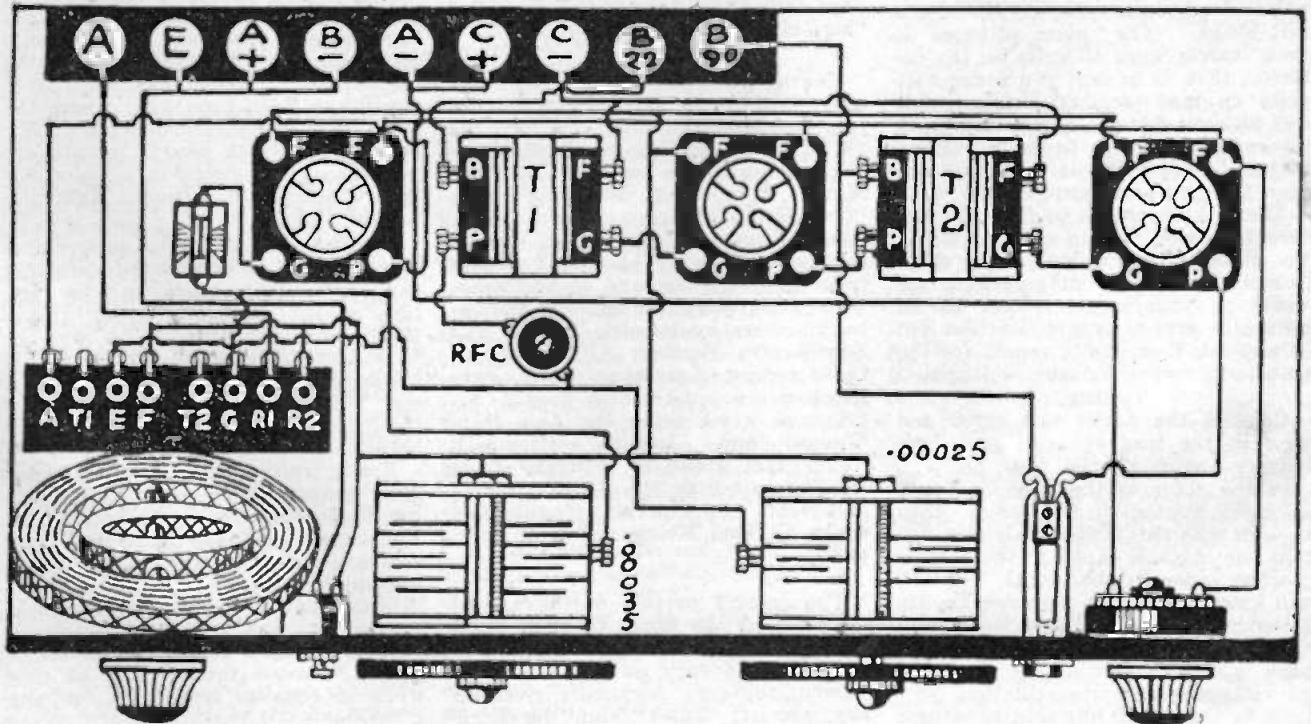

Hurley used Burgess in New Guinea.

side of the Radiokes choke. Join the other side of this choke to P of the first audio transformer. Join G of this transformer to G of the middle valve socket. Join G of the second transformer T2 to G of the last valve socket. Connect together the F terminals of both audio transformers and continue this lead to the C negative. Join P of the middle valve socket to P of T2. Now from the B positive 90 volt terminal on the terminal board, run a busbar to B on T2 and continue this right to one side of the jack. Join the other side of the jack to P of the last valve socket. From B positive 22 volt terminal take a connection to B of transformer T1. This completes the wiring. Check it very carefully.

This wiring should be carried out with busbar, spaghetti covered wire, just to suit the wish of the constructor. It will be noticed that there is no connections made to T1 and T2 of the Aladdin Tuner, these connections not being used in this particular circuit, and as this tuner may be adapted to many different tuners, these soldering lugs are present. It will be noticed that only one rheostat is used to control the filaments of all three valves, but if desired this rheostat may be used for the detector valve only, and Amperites to control the other two audio valves.

#### Valves and Batteries.

The range of valves suitable for this receiver is a wide one. Radiokes Radiotrons, Philips or Mullard valves all are suited, although on actual test Mullard valves were found useful. For the detector in the first audio PM3 valves were used with a PM4 in the last stage. The plate voltages on these valves were 45 volts on the detector, that is to say, you connect 45 volts on that terminal marked B22 and 90 volts for the audio, this being the connection made to the B positive 90 volt terminal. A 4½ C battery sufficed for grid base purposes.

There is no reason in life why different voltages should not be tried on the plates of the valve. Very often this makes all the difference in the world to your receiver, and as all naturally expect to get the best out of any set, then one is repaid for the trouble in trying different voltages.

#### Testing.

Connect the aerial and earth and plug in the loud speaker, press the battery switch to the on position, turn the rotor of the Aladdin Tuner at right angles to the stator, then tune in with the .00035 condenser. See that the rheostat is set in the correct position, one of the local stations will quickly make its presence known, bring it up to the loudest point with this larger condenser, turn the rotor back into the stator as far as it will go without setting up oscillation. Now turn to the 00025 variable condenser

and adjust this until best volume is received. Carefully tune with the rotor and this reaction condenser, balancing them up nicely, then give a final touch to the main tuning condenser that is a .00035. It may take half an hour or so to thoroughly master the relationship between the rotor of the tuner and the reaction condenser. It will be found this receiver is extremely selective, and with an aerial, say, 60ft. long overall a certain strength of interstate station will be brought in. It requires careful tuning to do this, of course, and no one unless he is an experienced man can tune in interstate stations the first night or so. It takes just a little while to master the handling of any receiver, and this one is by no means an exception.

On actual test at Marrickville, every one of the local stations were had on the speaker at remarkable volume and clarity. By careful tuning, 3LO could be had very softly on the speaker, but sufficient to be heard.

4QG also romped in, but unfortunately the distortion from this station rendered reception anything but a pleasure; the fault does not lie in the set.

This receiver is an excellent three valver, and will be found an all-round, efficient little set, which is not difficult to make and which will give splendid results on stations of a wavelength between 200 and 600 metres. The Aladdin Tuner is a very neat unit, and by adoption can other circuits be made with just simply altering the wiring. Here is quite some interest for the person who is of an experimental turn of mind, as the alteration of a few wires on the detector slide will give other circuits and comparisons can be made on the relative efficiency of different circuits. It is not an expensive receiver to build, and is certainly very neat looking, but that which counts more than anything else are the wonderful results which may be had from it.

## No Lack of High Class Music

WHILE it is true that every radio listener has likes and dislikes in regard to the programmes presented by the broadcasting stations, it is equally true that more is said by most listeners against the items they dislike than in favor of those they like. Opponents of jazz are particularly active in their criticisms, but a record of the programmes for a few days shows that there is no dearth of "high-class" music.

For instance, take last week but one. On Sunday, Madame Lillian Gibson, the noted contralto, sang over the air songs by Beethoven and Mendelssohn, and also the world-famed "Ave Maria" from that delightful opera, "Cavalleria Rusticana." Paul Vinogradoff was heard in classical piano selections, drawing his items mainly from Chopin, Liszt and Mendelssohn, while Miss Margaret James contributed numbers by Handel, Travers and Squire. On Monday, Alfred O'Shea, the foremost Australian tenor, gave listeners an outstanding recital, his principal items being the Aria from "Romeo and Juliette" (Gounod), "Your Tiny Hand is Frozen," from Puccini's romantic "La Boheme," "Life and Death" by Coleridge Taylor, and songs by Tom Moore, the Irish composer.

The concert portion of the annual reception by the Royal Colonial Institute, which was broadcast, included noted artists such as Madame Vera Tasma, soprano; Alexander Sverjensky, pianist; Jules Van der Klei,

'cellist; Alfred Cunningham, tenor, and Charles Lawrence, entertainer.

On Wednesday evening, the first part of the programme to be broadcast by 2FC was given from the Conservatorium of Music, where the State Orchestra played symphony music well known to the lovers of all orchestral work. Lionel Lawson was associated with the orchestra in Vaughan Williams' "The Lark Ascending," a tone poem written for violin and orchestra. The second half of the evening's programme was taken from the Peace Hall, Rose Bay, where the third monthly concert, directed by Mr. Oliver King, took place. Artists appearing on this occasion included Alfred Cunningham, Kenneth Hunt and Gerald Walenn.

On Thursday a special programme was arranged to suit all listeners, and ranged from the classics to jazz. "He, She, or It," a novelty group made their second appearance since arriving in Australia; Harrison White and his banjo helped entertain all and sundry, and Wilfrid Thomas, the baritone of the "Sparklers," sang favorite numbers.

Frank Hutchens and Lindley Evans were heard in two-piano items from the Beale Concert Salon, and H. W. Varna and Company presented from the Studio a radio version of "Nothing but the Truth."

These facts should satisfy lovers of music that the radio programmes contain enough for any reasonable person, because this review of one week is equally applicable to any other.

From Icy Pole to Tropic Jungle: Burgess.



# IMPORTANT Radiokes—Solodyne ANNOUNCEMENTS

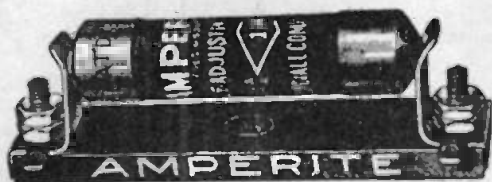

Owing to the growing popularity of Amperite, necessitating increasingly heavier shipments, Radiokes, in conformity with their policy, are pleased to announce a reduction in price of ninepence per unit. In future, the price of Amperite will be 6/9 each, from all good Radio Dealers.

## RADIOKES SUPER TUBES

are now available in all popular types and sizes and popular prices.

Enquire at your local dealer, and if he cannot supply, write direct to us.

## A.C. TUBES

Radiokes, as usual, lead the way in the Radio field. Arriving shortly—stocks of Radiokes Alternating Current Tubes, to make your Radiokes-Solodyne independent of all "A" Battery troubles. In conjunction with Mayolian "B" power supply unit, your Radiokes-Solodyne becomes the most up-to-date and efficient full-electric model Receiver possible to-day.



**IMPROVED RADIOKES CHOKES AND SOLODYNE COIL KITS** are still breaking all previous production and sales records, for the popularity of this wonderful Receiver has been unequalled in the history of Radio.

Radiokes-Solodyne Coil Kits, 75/- per Kit of three units.

Radiokes Radio-Frequency and Filter Chokes, 8/6 each.

At all High-Class Radio Dealers.

**METROPOLITAN ELECTRIC CO. LTD. :: 27-29 King St. Sydney**



BRITISH MADE  
AUDIO FREQUENCY  
TRANSFORMER

TYPE A.F. 3 42/6

TYPE A.F. 3 42/6

The charted performance of the Ferranti AF.3 Transformer is published below. Note the

UNIFORM AMPLIFICATION

and buy your transformers only from manufacturers who publish the curve showing actual charted performances of their product.

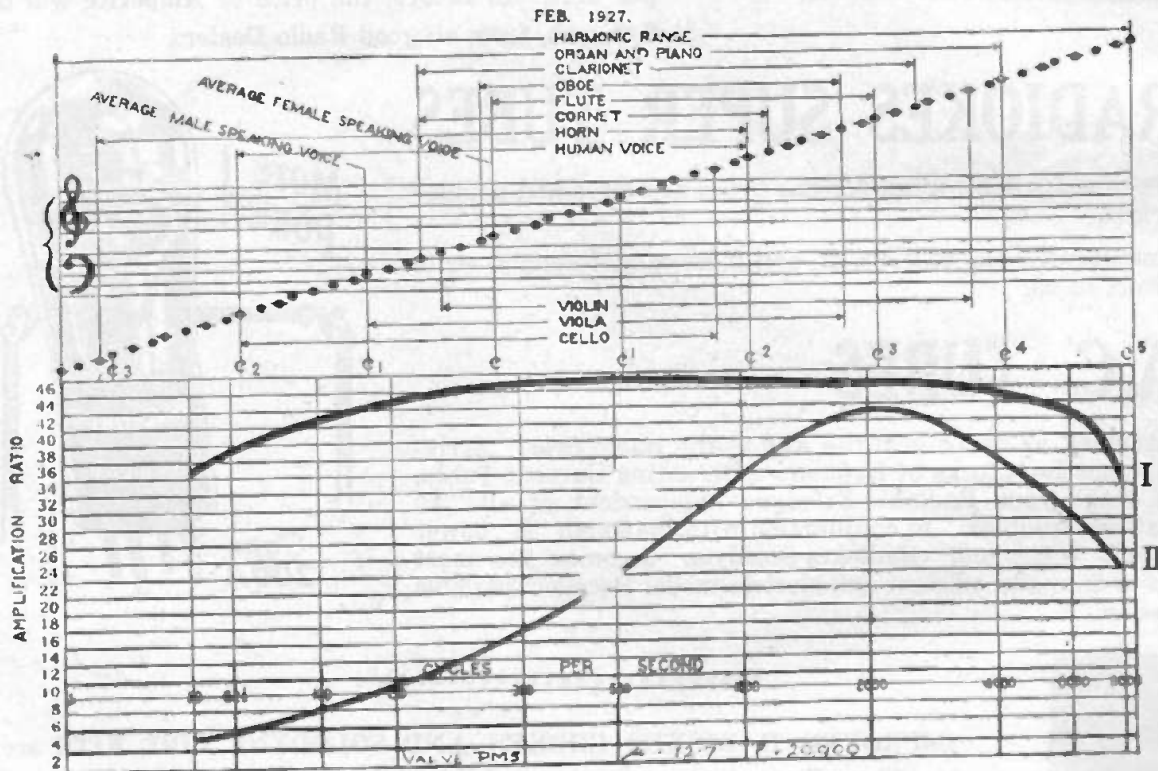

Curve 1. The Ferranti AF.3 Transformer.

Curve 2. A well-known transformer made in Australia.

*No better Transformer is available at any price.  
Obtainable from every radio dealer in Australia*

Dealers please communicate with:—A. BEAL PRITCHETT (Aust.) LTD., Sydney & Melbourne  
WEDMA LIMITED, Adelaide ——— EDGAR V. HUDSON, Brisbane

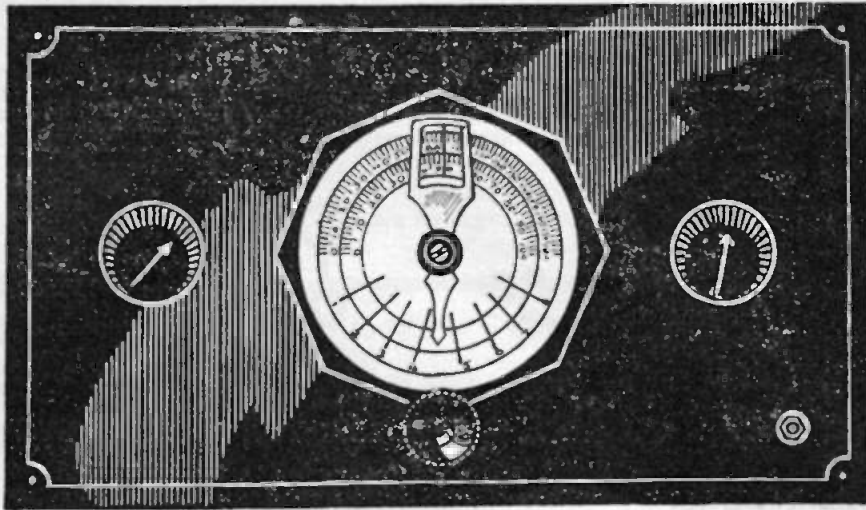

# THE ULTRAAUDION

PERHAPS one of the most popular single valve receivers ever described in "Wireless Weekly" has been the Ultraaudion. Very few people know it by this name, as it is better known as the Marnikay, and that it achieved much fame has been borne out by time. Results achieved by it have been outstanding, and certainly has rivalled its worthy confrere, the Extraordinary One Valver, in popularity. The parts required for it are few and far between, but they must be very well chosen in order that the best results are available.

Now what does one expect from a single valve receiver? In the summer time it is not possible to get anything like the same results as winter time produces. Still, when static permits the Ultraaudion will give splendid 'phone reception on inter-State stations. The local stations also are heard at remarkably good volume, but such a lot depends on handling that too much stress cannot be placed on the necessity for being discreet in tuning in this receiver.

### Discreet Handling.

It has to be admitted, too, that indiscreet handling will give very inferior results, and it is very possible that neighbours will have their reception marred by the owner of an Ultraaudion unless it is handled carefully. Actually this receiver is inclined to oscillate very violently, and in doing so will transfer energy to the aerial, thus making it, what might be termed, a transmitter. Now it is not too pleasant to be listening into any particular station and to hear that

station's programme with a whistle caused by a howling valve. This is very liable to occur with a mishandled Ultraaudion, hence these opening remarks.

Still, the prospective constructor is advised not to be afraid of the Ultraaudion, because really it is a splendid little receiver to own. It is surprising to know just what results may be had from such a simple set. The writer recently built one, and was surprised to hear on the earphones not only the local stations but every inter-State station excepting 6WF, Perth. These results are quite usual with the

Ultraaudion, and should be had by every one who builds one. It is not expensive to make up, although there are a Bradleystat and a Bradleyleak necessary in this construction. It is admitted that these parts are somewhat expensive, but the constructor who desires to keep down the cost can do so by substituting an Emmcostad for the Bradleystat and some form of variable grid leak in place of the Bradleyleak.

### Sharpness of Tuning.

Exceptionally sharp tuning is a feature of the Ultraaudion, so much so that a Vernier dial is almost indispensable. The front view of the receiver shows one of the finest vernier dials that the writer has so far handled. It is the Ormond vernier dial, and has absolutely no backlash whatever. Besides this the hairline reading is very accurate, a fact which is very necessary when best results are sought.

Plenty of room is provided for all the parts. A panel size is quite generous, being 12 inches long by 7 inches high. The appearance of the completed receiver is very neat with the big dial right in the centre, and the knobs one on each side. No switch is inserted, although if the constructor so desires, one can be included on the left-hand side of the panel to balance off the jack. The wiring will have to be slightly altered. There are no terminals on the front panel, all the connections being made at the back.

When this receiver was first described in our pages, it was during the

### List of Parts.

*Although the parts listed below and mentioned throughout the articles were those actually used by us in the receiver described, it must be pointed out that it is not absolutely essential that they be rigidly adhered to.*

*Other parts of similar quality and technical values should function quite satisfactorily.*

- 1-Dilecto or hard rubber panel 12x7x3-16.
- 1-0005 Emmco Variable condenser.
- 1-Bradleystat.
- 1-Bradleyleak.
- 1-Ormond vernier dial.
- 1-Valve socket.
- 1-00025 Wetless Grid condenser.
- 1-3-inch length of 3-inch Dilecto tubing.
- 4-oz. No. 24 D.S.C. wire.
- 1-Terminal board with 6 terminals.
- 1-S.C. jack.
- Busbars, screws, etc.

Philcos are Aristocrats among Batteries.

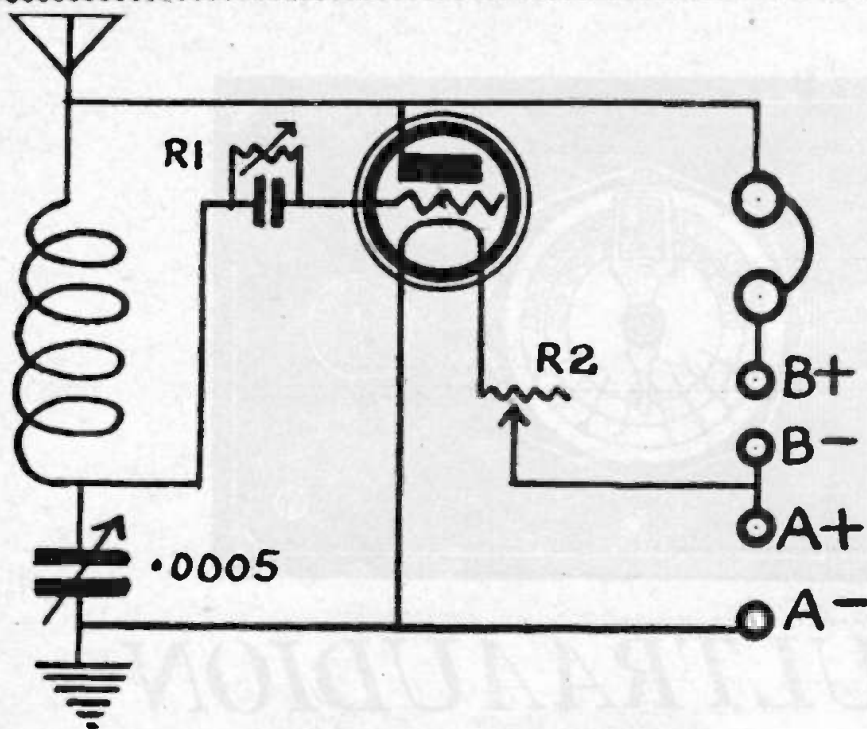

**Panel Layout.**

Now turn to the panel. The drilling here is a matter of a few moments. Firstly, centrepunch each position, making a neat indentation so that the drill will enter freely and not skid along the panel, leaving an ugly mark in its trail. The Emmco condenser used, required three fixing screws to hold it to the panel, and the manufacturers also always include in the packet a template, with the position of these fixing screws, clearly defined. This template should be placed in position on the panel, and marked out correctly. Always be certain that the panel is on an even surface, otherwise it will not be drilled true. Both the Bradleystat and the Bradleyleak only require one seven-sixteenth of an inch hole for mounting purposes. The knobs of both these units are screwed right out, the fixing nut which is of generous dimensions is removed and the body of each unit is pressed through from the back of the panel, allowing a certain portion to protrude through the front. The locking nut is easily fixed in position, a turn of the pliers being all that is necessary to hold it securely.

time that 2FC was on the high wave length, so it necessarily followed that the inductance used was of the interchangeable type of honeycomb coil. To-day this is not necessary, and consequently, a far neater looking receiver is the result. The inductance is one which may be wound at home, the usual three inch Dilecto tubing being required for the purpose. A length of this diameter tubing about 3½ inches long is required, but if desired good shellaced cardboard tubing may be substituted. Shellac varnish is easily made at home, and is useful for many purposes in wireless. For those who are not aware of how to make this shellac varnish, the following few words will be interesting.

**Making Shellac.**

Orange shellac may be purchased from any ironmongers and comes to you in thin flakes. Get half a pound of this dry shellac and put it in a wide-necked bottle or jar, such as a pickle bottle. Procure some methylated spirits and pour sufficient into the jar to cover the shellac. Put a stopper in the bottle and shake it a few moments, leaving it over night without disturbing it. In the morning it will be found that the shellac has dissolved, the result being a nice quick-drying varnish. It must be mentioned that a stopper should always be kept on the bottle when not in use, as the methylated spirits evaporates very quickly. It is quite usual to expect the cork to stick—all good shellac will do this. To treat the cardboard, coat the inside and the outside with the varnish, which has been previously mentioned; it dries very quickly.

**Coil Winding.**

The winding of the coil is a matter of a few moments only. Begin, half an inch from one end, pierce or drill two very small holes, then thread the beginning of the wire through these holes, so that it is held securely. Then wind on 60 turns of this 24 gauge wire, each turn close to the adjacent one, and finish off by securing as previously mentioned. If this coil is wound on cardboard, it may be found advisable to give this winding a coat of shellac varnish, which will keep the wires from slipping. This is really not essential, when Dilecto tubing is the basis for this winding.

**Wiring.**

Mount all the panel apparatus, not forgetting the hole for keeping the vernier dial in position, and fix the panel to the baseboard by means of three screws. It is not a hard matter to screw into position the valve socket and the coil and the terminal board on the baseboard. Two small brackets can easily be fashioned to raise the winding of the coil off the baseboard, this baseboard being given one or two coats of shellac varnish before any parts are mounted on it. The wiring can now be started and it must be impressed right here how careful one must be in wiring up a receiver of this description. The back

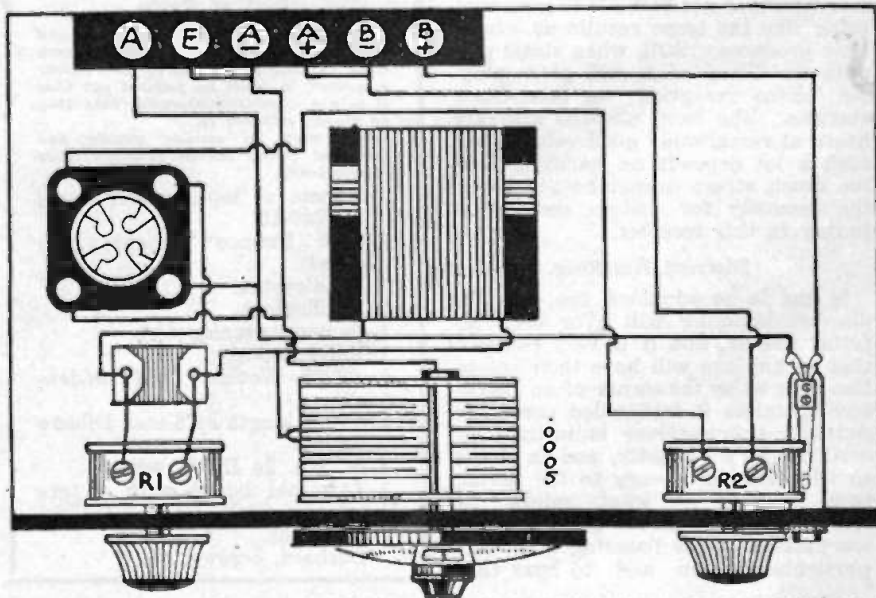

Four or more Valve Sets demand Philcos.

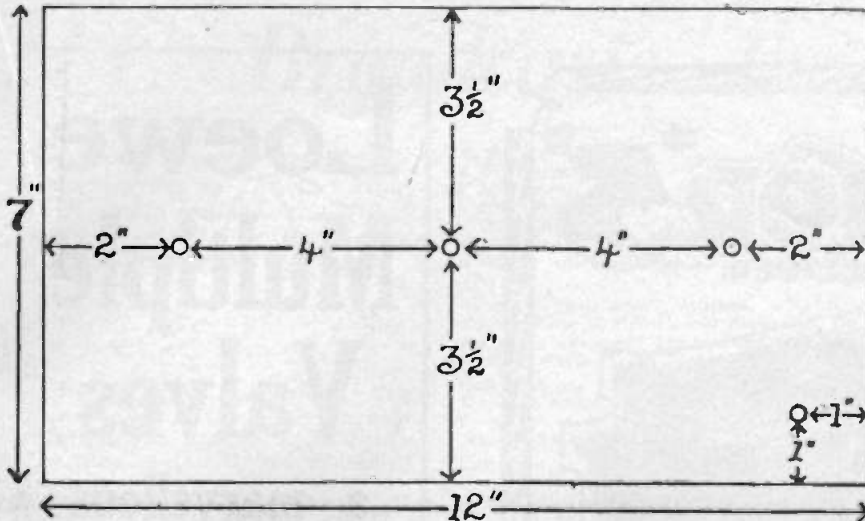

of panel wiring diagram shows you the destination of each connection, but for those who require it, the following written description will be of interest.

Using busbar, join the E terminal to the A negative terminal and continue this lead to the moving plates of the variable condenser, and also to one F terminal of the valve socket. Now join together the A positive and the B negative terminal, and continue this busbar to one side of the Bradleystat marked R2 on the diagrams, bringing the other side of this Bradleystat right back to the remaining F terminal of the valve socket. Now, shunt the Bradleyleak with the grid condenser, and continue one lead to the G terminal of the valve socket, taking the other side to the fixed plates of the variable condenser, and to one side of the coil. The other side of the coil, connect to one side of the jack and also to the aerial terminal on the terminal board. The remaining lug of the jack is connected to the B positive terminal on the terminal board. If desired, that screw which holds the vernier dial in position on the panel, may be connected to the moving plates of the condenser, these plates being at earth potential, and, therefore, any body capacity which may be present, will be overcome.

**Body Capacity.**

Body capacity in tuning a receiver is a decided nuisance, and is recognised by the awkwardness in receiving any station at its loudest point. It invariably happens that while your hand is on the tuning dial tuning in, the volume is very satisfactory, but when that hand is taken away the volume immediately drops and as often as not, the receiver breaks into oscillation, thereby running reception. With this dial this is overcome by earthing the metal front. In the event of some other dial being used, this body capacity may be lessened greatly by inserting a piece of brass or aluminium right on the back of

panel, and between the condenser. Cut out much larger size holes than is ordinarily necessary to allow the screws of the condenser as well as the spindle to pass through without touching this metal which should be connected to the earth terminal in the receiver. This brass or aluminium screen should be approximately 4 inches square, and fixed and sufficiently big to cover the particular area of the condenser plates.

Check over all the wiring very carefully indeed, with the back of panel wiring diagram, noting that the F terminals of the valve sockets are those on the right-hand side, whereas, the grid terminal is that one on the left at the back. The P terminal can easily be picked out now.

**Valve Used.**

A very good detector valve which proved admirably suited to this Ultraudion was the Radiokas UX200A special detector, which is a valve of the soft variety and is very flexible indeed with different plate voltages. This valve is sincerely recommended, as the valve plays such an important

part, particularly in receiving the distant inter-State stations. On actual test with this particular valve 45 to 60 volts applied to the plate gave wonderful results. The aerial used was about 70 feet long overall and the earth the usual waterpipe connection.

**Tuning.**

All three adjustments on the panel will be found very critical. The Bradleystat earns its keep, as does the Bradleyleak, and it is the correct adjustment of each of these units in conjunction with the condenser give give such wonderful results. The local stations will have a really wonderful volume for one valve, surprisingly good indeed, but it must not be overlooked that the Bradleystat is really the making of the receiver. You will notice when tuning in that as you turn the Bradleystat up, feeding more filament current to the valve, the volume of sound will increase proportionately, until it comes to one point when the receiver will break into oscillation, produced by supplying too much filament current. If, for example, you are listening into 3LO when this happens you will have to come right back with the Bradleystat and start over again. A little practice will soon give perfection in handling this Bradleystat, and it will be noticed that the Bradleyleak has got a slight toning effect on the whole receiver. Adelaide 5CL will be heard quite softly, and with this station in particular will the adjustment of the Bradleystat be found of extreme importance. The Vernier dial is absolutely indispensable for fine tuning, this will be found in actual practice to be very true. Too much stress cannot be laid on the necessity for careful handling of the Bradleystat, which will cause the receiver to oscillate violently and interfere with other listeners. Be a good radio neighbour and exercise prudence in handling this little wonder receiver.

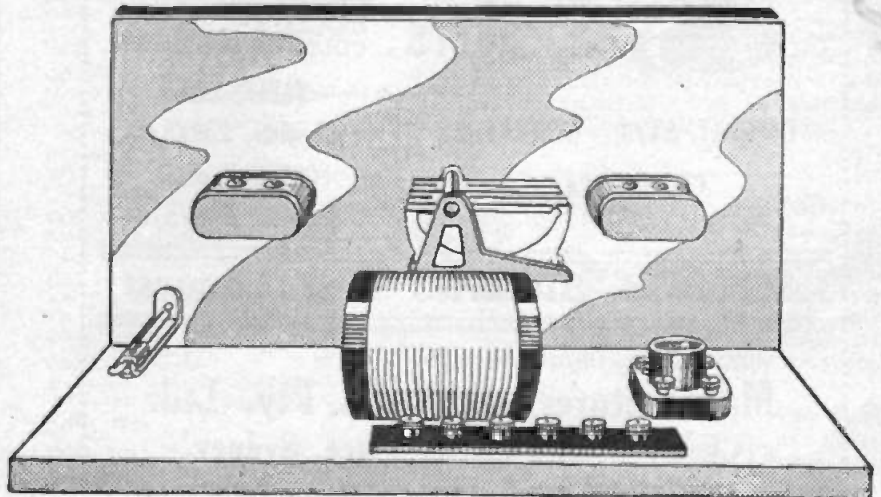

Philcos are Aristocrats among Batteries.

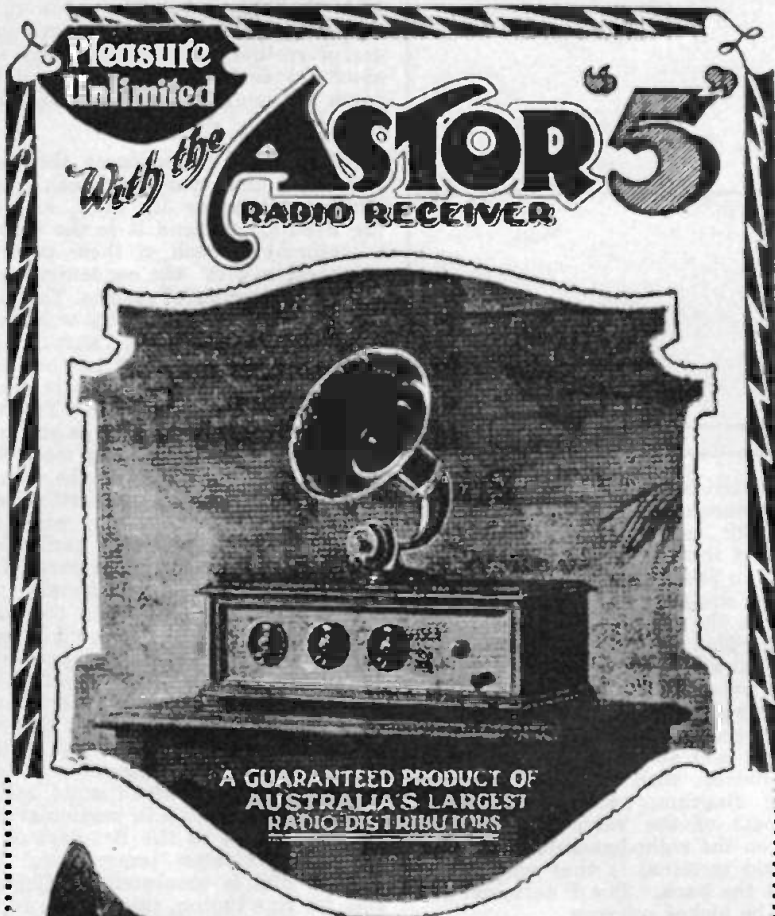

**The Astor "5"**  
will give the news and programmes of Interstate Stations at full Loudspeaker Strength, with unequalled Clarity and Volume, whether you live in the COUNTRY or in TOWN.

**Baldwin Speakers:**

TABLE, £26.  
Symphony, £3/3/- CONCERT, £5/5/- Complete, £39/5/6  
CABINET, £4/15/- CONSOLE, £35.  
Complete, £48/5/6

**Armax B. Batteries Last Longest**

Distributors to the Trade —  
**Manufacturers Products Pty. Ltd.**  
Challis House, Martin Place, Sydney.  
*Neutrons are the Best Crystals, 2/3*

**Loewe Multiple Valves**

a marvellous advance in radio art

are meeting with an exceptional success everywhere. Because of their high sensitivity and simplicity they permit of the construction of extremely powerful yet inexpensive local and long range sets, the ideal instruments for music lovers.

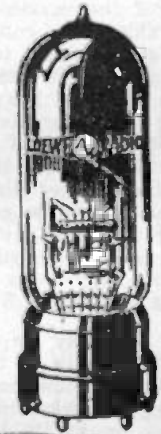

*Sole agencies open for various territories, Radio factors of good financial standing please apply.*

**Loewe Radio G.m.b.H.**  
BERLIN - STEGLITZ  
WIESENWEG 10

# All Readers' Queries Answered Here.

**D.X. (CROOKWELL):** It appears to me that there is an open circuit in the grid returns of each valve. Check this over carefully, or again perhaps one of the I.F. transformers have broken down in the primary circuit. It is possible that the filter transformer is defective. This will account for the rushing sound of which you complain.

**A.C. (CHATSWOOD):** This is quite in order. You would have to use a filament control jack in order to eliminate the current on the second valve. See "W.W.," 6/5/27.

**G.E.H. (NORTH SYDNEY):** The back of panel wiring diagram submitted to me is incorrect. You have omitted to connect G of the second R.F. transformer to G of the 2nd valve socket. This would account for your trouble.

**P.J.K. (TRUNDLE):** I would strongly advise you to employ Carboncels for an "A" battery. Any advertiser in "W.W." will give you the particulars and prices.

**L.F. (RICHMOND):** In your location an aerial 100 feet long should be quite satisfactory. The rest of the particulars which you supply are too meagre to give correct information. Write again.

**J.M.G. (HAY):** The G.B. positive is the C battery positive which is joined to the A battery negative. The valve you specify is quite satisfactory for the Solodyne without any alteration.

**G.B. (ROZELLE):** Glass tubes 6in. x 1in. are suitable. See "W.W.," 23/9/27.

**H.B. (BOTANY):** Your alterations are correct. Pay attention to your "B" battery and you will find the benefit of the midget condenser.

**C.J.S. (YOUNG):** The R.F. Transformer is generally known as the coupler. Look closely to the back of panel wiring diagram and also the circuit diagram and you will be able to pick out each separate unit. Follow the layout exactly as suggested and you may be assured of good results.

**F.N.N. (DUNDOO):** Write to Messrs. Colville Moore Wireless Supplies, Sydney, for particulars regarding their Neutrodyne receiver.

**NEW CHOOM (CANTERBURY):** I can't understand your first question, which reads, "What type of is best for this set?" The "B" battery recommended for the "Extraordinary One Valve receiver" is dependent upon the actual valve used. There is no apparatus necessary to determine the "B" battery voltage, it is a matter of common-sense. Look at a "B" battery itself.

**J.M. (HABERFIELD):** I can't understand your query at all. The receiver you have built is generally accepted as one of extreme selective value. Pay attention to the coil valves.

**S.J.B. (ESTELVILLE):** Look carefully to the wiring in your radio frequency stage, it is certainly wrong somewhere. The bell-ringing transformer is necessary in the "B" battery eliminator.

**G.J. (COONAMBLE):** I will communicate with you further on this matter.

**G.B. (SANDRINGHAM):** You have made an unwise choice with a 3 gang condenser used. I have viewed this condenser and would not expect to get satisfactory results were I to use it.

**WIRELESS (WEST MAITLAND):** I have no record of these stations.

**J.G.T. (MAROUBRA):** Alter the spacing of the coil bringing it closer so that it occupies only half the distance. The set I built proved satisfactory on the spacing suggested, but more so when it was altered as I mentioned here. Pay particular attention to your reaction portion.

**AERIAL (NEWCASTLE):** Your present aerial is quite good.

## QUERIES

*Will readers kindly note that all technical queries are answered through the columns of Wireless Weekly. There is no occasion to send either stamps or addressed envelopes. The only condition is that the number of questions be limited to four. We unfortunately cannot deal with technical queries by telephone or by personal callers.*

**W.T. (GYMPIE, Q.):** Why not build a modernised 3-valve receiver? See "Radio" of August for further particulars.

**H.N. (CRONULLA):** Purchase a Drummond Time Indicator from Swain and Co., Ltd., Pitt-street. The cost is 1/-. Your other query is altogether ambiguous.

**T.D.S. (NUNDAH, Q.):** Your circuit is quite in order, but you are employing wrong valves for radio frequency work. You would be better off with A425 valves in the radio frequency stages. Personally, I don't like the resistance coupled unit you have at all. I can't say more than this.

**W.G. (RICHMOND, Q.):** The 5th terminal is for connecting the frame of the transformer to earth. I.P. equals plate, O.P. equals B battery plus, I.S. equals grid, O.S. equals filament. Relatively these may be reversed.

**G.N. (GORDON):** A vernier dial is worth while. The valve you are using is not suitable for the circuit.

**R.F. (MANLY):** I regret to hear this news. I suggest that you use a high resistance grid leak of the order of 5 megohms and increase the spacing between the primaries and the secondaries of the R.F. transformers.

**P.S. (TEMPE):** Many thanks for your letter.  
**H.M.V. (DANDENONG):** Your letter is very welcome. This little receiver is well named the Extraordinary One Valver.

**J.B. (GLEBE POINT):** Build the Harkness Two Valve Reflex from "W.W.," 13/9/27.

**A.R.K. (TEMORA):** All the coils are wound in the one direction. Thanks for your remarks.

**L.N.M. (ROCKHAMPTON):** If you have an aperiodic primary this should not happen. The eliminator in question is prone to blow the fuses if the batteries are connected to the earth proper. Therefore, where the bottom of the primary coil joins the bottom of the secondary coil, this would earth the batteries, causing you trouble. Break this connection in your receiver, leaving the primary coil not connected electrically to any other portion of the circuit directly. This information was omitted in the article.

**H.W. (CESSNOCK):** I can't tell you any more than my own results with this set. Several readers have built it and have expressed their satisfaction on the distance getting proclivities of this receiver. Two C batteries would not do any harm. The valves you specify are O.K., but stick strictly to the letter regarding the audio side.

**J.B. (BELMORE):** Your valves need rejuvenating. Take them to your dealer.

**E.A.B. (PADDINGTON):** You would hardly need a power valve on this receiver. If you intend to instal one you would be advised to employ a Siftron Unit to accept the heavy "B" battery required to work this power valve. Again a power valve requires a heavy C battery current. For particulars of the frame aerial see "W.W.," 17/6/27.

**J.F.D.W. (COLLARENEBRI):** Reverse the connections of your reaction coil.

**J.S. (ASHFIELD):** The Jefferson transformer gives an output of 6 volts, therefore, it is always advisable to use a 6 volt valve in this eliminator. Do this and your trouble will disappear.

**M.D. (WEST KOGARAH):** I can't understand this at all. Either your choke or your filter condensers are at fault.

**V.F.N. (BROADWATER):** I wish you had told me the brand of regenerator you have. If you are using .00035 condensers then substitute for condensers of .0005 mfd. In your locality a single wire aerial of a length of 100 feet over all would be quite good.

**R.N. (ANNANDALE):** Pay attention to the "B" battery voltages, increasing the detector voltage, until an oscillation can be heard, then adjust for tuning.

**E.G.H. (WALKERVILLE):** Many thanks for your letter, and I am glad to hear of your good results.

**A.R.P. (GRACEVILLE):** See "W.W.," 23/9/27. This four-valve set would be more to your advantage.

**D.C. (BRISBANE):** Don't attempt this.  
**SAL (LEADVILLE):** This subject will be dealt with very shortly in "W.W."

**A.E.R. (CARLTON):** I am afraid that you will have to resort to some form of trickle charger until there is a more perfect system of "A" battery elimination known.

**N.C.W. (PICTON, N.Z.):** I regret I am not sufficiently familiar with the super het, you mention to be able to advise you. I understand it is a reflex receiver and while claiming to be competent to know a standard reflex receiver, when it comes to a super heterodyne, I must admit my knowledge is limited on reflexing.

**B.O.B. (ALEXANDRIA):** I hardly think it worth your while going to the trouble of altering your receiver to hear this station.

**E.M.D. (DOUBLE BAY):** This is not practical.

**W.H.E. (GLADESVILLE):** The Bradleyohm you have is quite in order. Pay attention to the "B" battery voltage on the detector valve to help you from the point of view of selectivity.

**R.H.S. (CRONULLA):** The Jefferson Bell-ringing transformer is absolutely essential, but the Ford coil may be used as the choke.

**E.E.H. (SYDNEY):** The installation of Macurean Tone Purifier will overcome this trouble.

**A.L.G. (HAMPTON, VIC.):** The circuit is quite suitable, as are your components, but don't add a stage of radio frequency.

**J.C. (ARNCLIFFE):** Obtain the Admiralty Handbook on Wireless from Messrs. Turner and Henderson, Bridge Street, Sydney.

**A.E.A. (WOOLLAHRA):** I certainly can't do this. You would not ask me to break a confidence, surely.

**J.E. (DOUBLE BAY):** Marvellous as the Marnikay was, the Extraordinary One Valver is a decided improvement. Build it. You should have had good results with the Marnikay provided you used a Bradleystat or a Filkostat, to control the filament current, and also the regeneration.

## TRANSFORMERS

Built up to a specification and wound, lamination iron cut to any size from stock. Prices and estimates on application.

O'DONNELL, GRIFFIN & CO., LTD.  
53 Druitt Street, SYDNEY.

Phones: C 4543 and 4546.

There is no "just-as-good" as Burgess.

# Built!

**NOT ASSEMBLED  
FROM RANDOM  
PARTS.**



MAMMOTH FACTORY  
DEVOTED TO THE  
CONSTRUCTION OF

## ATWATER KENT RADIO

**"MANUFACTURERS"** of Radio Receivers are a varied lot. But few of them are willing or able to take all the precautions that are necessary if each set they produce is to perform even as well as the first one.

In the fifteen-acre Atwater Kent factory (largest in the world) sets are made at the amazing rate of eleven per minute to standard proven designs. Each set passes through 140 gauges and physical inspections and nineteen electrical tests before it is O.K.'d. That this method of manufacture is successful is proven by the fact that every night several million American people listen in on Atwater Kent Sets. Whether on the Six Valve One Dial Set or on the Five Valve "Compact," station after station is brought in clearly, without interference, without distortion, howling, or any other defects.

**Prices from £29/10/-**  
CASH PRICE

(Five valve "Compact" — Set Only)  
Terms can be arranged from  
20/- weekly.

The Atwater Kent dealer nearest you will gladly demonstrate the sets to you—in your own home, if you like. Mail the coupon and receive, post free, literature giving all the facts about Atwater Kent Radio.

Metropolitan Distributors: **P. and R. WILLIAMS LTD**  
80-82 WENTWORTH AVE., SYDNEY  
Country Agents Everywhere  
(Names on request from A. G. Healing Ltd.)

CUT OUT AND POST FOR FREE LITERATURE—  
Messrs. A. G. Healing Ltd., 208-10 Castlereagh-st., Sydney  
Please send me the free literature on Atwater Kent Radio  
and the equipment supplied with the A-K. "Complete" Set.

Name \_\_\_\_\_

Address \_\_\_\_\_

W. W. 29-7-27

### SIX VALVE (ONE DIAL) Model 35

(Illustrated on right)

The unique design of this cabinet is executed in four beautifully blending colors—two shades of dull brown crystalline on the cabinet itself, a beautiful gold-plated name plate at the centre of the top, while the Station Dial and Rheostat Knob are of rich Brown Bakelite. Cabinet length, 17½ ins.; Depth, 7½ ins.; Height, 5½ ins.

MODEL 35—CASH PRICES:

Set Only - - £35. Complete - - £55.

Either of these sets occupies less room on a table than a few small books.

### FIVE VALVE "COMPACT" Model 20

(Illustrated on right)

Beautifully finished in polished mahogany. The operation of this set is almost as simple as the "One Dial," as the readings of the three Station Dials are uniform. 30 page illustrated Instruction Book with each set. Cabinet length, 19½ ins.; Depth, 5½ ins.; Height, 6½ ins.

MODEL 20—CASH PRICES:

Set only - - £29/10/- Complete - - £47/10/-

COMPLETE means not only that every piece of necessary equipment (except aerial mast only) is supplied, but also that each accessory is worthy of the Atwater Kent Set—no skimping. Included are Atwater Kent Speaker, P. and R. English-Made Storage Battery, etc. SET ONLY means the actual receiver without valves or accessories



SIX VALVE (ONE DIAL)



FIVE VALVE "COMPACT"



Printed in the interests of A.K. Radio Dealers by their Australian Wholesale Distributors, A. G. Healing Ltd



# BROADCASTING PROGRAMMES

For the COMING WEEK

## Friday, July 29 2FC, SYDNEY

Farmer's Broadcasting Service.  
Wave Length, 442 Metres.

### EARLY MORNING SESSION.

- 7 a.m.—"Big Ben" and announcements.
- 7.5 a.m.—Studio music.
- 7.15 a.m.—COUNTRY SESSION: Official weather forecast, rainfall, temperatures, astronomical memoranda, shipping intelligence, mail services.
- 7.25 a.m.—Investment market, mining share market, metal quotations.
- 7.35 a.m.—Wool sales, breadstuffs markets, interstate markets, produce markets.
- 7.45 p.m.—"Sydney Morning Herald" summary.
- 8 a.m.—"Big Ben." Close down.

### MORNING SESSION.

- 10 a.m.—"Big Ben" and announcements.
- 10.5 a.m.—Studio music.
- 10.15 a.m.—"Sydney Morning Herald" news service.
- 10.30 a.m.—Studio music.
- 10.35 a.m.—A Reading.
- 10.45 a.m.—Studio music.
- 11 a.m.—"Big Ben."
- Marching music for school children.
- 11.5 a.m.—A.P.A. and Reuter's Cable Services.
- 11.10 a.m.—Studio music.
- 11.15 a.m.—A talk on Home Cooking and Recipes by Miss Ruth Furst.
- 11.30 a.m.—Close down.

### MIDDAY SESSION.

- 12 noon—"Big Ben" and announcements.
- 12.2 p.m.—Stock Exchange, first call.
- 12.3 p.m.—Official weather forecast, rainfall.
- 12.5 p.m.—Studio music.
- 12.10 p.m.—Summary of "Sydney Morning Herald" news service.
- Rugby wireless news.
- 12.25 p.m.—Studio music.
- 12.30 p.m.—Marching music for school children.
- 12.40 p.m.—MURIEL BOSSLEY, soprano: "The Wind in the South" (Scott).
- 12.45 p.m.—Studio music.
- 1 p.m.—"Big Ben." Weather intelligence.
- 1.3 p.m.—"Evening News" midday news service.

### Producers' Distributing Society's Report.

- 1.20 p.m.—Studio music.
- 1.28 p.m.—Stock Exchange, second call.
- 1.30 p.m.—Marching Music for school children.
- 1.40 p.m.—MURIEL BOSSLEY, soprano: "Arcady is Ever Young" (Monckton).
- 1.45 p.m.—Studio music.
- 2 p.m.—"Big Ben." Close down.

### AFTERNOON SESSION.

- 3 p.m.—"Big Ben" and announcements.
- 3.2 p.m.—"DISMAL DESMOND" describes when he was a "Bad Boló Hussar" (Weston and Lee).
- 3.7 p.m.—CLYDE THORPE, violinist: "On Wings of Song" (Mendelssohn-Achren).
- 3.11 p.m.—Studio music.
- 3.15 p.m.—A Reading.
- 3.25 p.m.—CLYDE THORPE, violinist: "Canzonetta" (from "Concerto-Romantique") (Godard).

- 3.30 p.m.—Marching music for school children.
- 3.40 p.m.—EILEEN MOREAU, soprano: "Only the River Running By" (Hopkins).
- 3.45 p.m.—"DISMAL DESMOND" discourses on "Love and Girls Generally."
- 3.50 p.m.—EILEEN JUDKINS, soprano.
- 3.55 p.m.—Studio music.
- 4 p.m.—FRANK BOTHAM, baritone: "The Charmed Cup" (Rosekel).
- 4.5 p.m.—Studio music.
- 4.14 p.m.—CLYDE THORPE, violinist: (a) "Canto-Amoroso" (Sammartini-Elman). (b) "Minuet" (Beethoven-Janssen).
- 4.20 p.m.—EILEEN MOREAU, soprano: "Big Lady Moon" (Taylor).
- 4.25 p.m.—Studio music.
- 4.35 p.m.—EILEEN JUDKINS, soprano.
- 4.40 p.m.—FRANK BOTHAM, baritone: "Song of the Rover" (Georges).
- 4.45 p.m.—Stock Exchange, third call.
- 4.47 p.m.—Studio music.
- 5 p.m.—"Big Ben." Close down.

### EARLY EVENING SESSION.

- 5.45 p.m.—The Chimes of 2FC.
- 5.50 p.m.—The "Hello Man" talks to the children.
- 6.30 p.m.—Story time for the young folk.
- 6.40 p.m.—Dinner music.
- 7 p.m.—"Big Ben."
- Late sporting news by the 2FC Racing Commissioner.
- 7.10 p.m.—Dalgety's Market Reports (wool, wheat and stock).
- 7.18 p.m.—Fruit and vegetable markets.
- 7.20 p.m.—Shipping and weather intelligence.
- 7.26 p.m.—Late "Evening News" news service.

### NIGHT SESSION.

- 7.45 p.m.—Programme announcements.
- 7.50 p.m.—Studio music.
- 8 p.m.—THE TIVOLI THEATRE ORCHESTRA, conducted by WILL QUINTRILL.
- 8.10 p.m.—ALFRED CUNNINGHAM, baritone: (a) "Sombre Woods" (Lully). (b) "Rage, Thou Angry Storm" (Benedict).
- 8.17 p.m.—BOOK COMPETITION, No. 12.
- 8.24 p.m.—AD CREE, Scotch comedian: "Nae Friend like an Auld Friend" (Pether).
- 8.29 p.m.—GLADSTONE BELL, 'cello solos.

- 8.35 p.m.—"MIKE."
- 8.36 p.m.—EWART CHAPPLE, pianoforte solo.
- 8.42 p.m.—SCOTT ALEXANDER, in a Comedy Sketch, specially prepared for broadcasting.
- 8.48 p.m.—LANCE KENNEDY, flute solo.
- 8.53 p.m.—ALFRED CUNNINGHAM, baritone (a) "Child, what sings the morning?" (Mallinson). (b) "Eldorado" (Mallinson).
- 9 p.m.—"Bix Ben."
- An Act from the TIVOLI THEATRE.
- 9.15 p.m.—GLADSTONE BELL, cello solo.
- 9.20 p.m.—EILEEN BOYD, contralto: (a) "When all was young" from "Faust" (Gounod). (b) "You lovely thing" (Anderson).
- 9.30 p.m.—LANCE KENNEDY, Flute solo.
- 9.36 p.m.—AD CREE, Scotch Comedian: "It that a fact?" (Arthur).
- 9.42 p.m.—GLADSTONE BELL, cellist.
- 9.48 p.m.—ALFRED CUNNINGHAM, baritone. Two songs of Soho. (a) "Berwick Market". (b) "The Singer" (Drummond).
- 9.55 p.m.—SCOTT ALEXANDER, Radio Sketch.
- 10.8 p.m.—EILEEN BOYD, contralto: "Annie Laurie" (Lehmann) (request).
- 10.12 p.m.—LANCE KENNEDY, Flautist.
- 10.18 p.m.—AD CREE, Scotch Comedian: "At the Glaciarium" (Meighan).
- 10.25 p.m.—EILEEN BOYD, contralto: "Hayonia" (Ellott).
- 10.30 p.m.—THE WENTWORTH SYMPHONIC DANCE ORCHESTRA: conducted by Cyril Kaye.
- 10.57 p.m.—Late news and announcements.
- 11 p.m.—"Big Ben."
- THE WENTWORTH SYMPHONIC DANCE ORCHESTRA.
- 11.30 p.m.—National Anthem. Close down.

## 2BL, SYDNEY.

Broadcaster's Ltd.  
Wave Length, 355 Metres.

### Friday.

#### EARLY MORNING SESSION.

- 7 a.m.—G.P.O. clock and chimes.
- Metropolitan weather forecast.
- 7.2 a.m.—State weather report.
- 7.4 a.m.—News service.
- 7.15 a.m.—G.P.O. clock and chimes.
- Fruit market report.
- 7.18 a.m.—Vegetable market report.
- 7.20 a.m.—Australian Mercantile, Land and Finance Co.'s report.
- 7.24 a.m.—Dairy farm produce market report.
- 7.26 a.m.—Poultry market report.
- 7.30 a.m.—G.P.O. clock and chimes.
- Musical programme from the Studio.
- 7.36 a.m.—News service.
- 7.41 a.m.—Boats in call by wireless.
- 7.43 a.m.—Mail information, shipping arrivals and departures, and port directory.
- 7.45 a.m.—G.P.O. clock and chimes.
- News service.
- 8 a.m.—G.P.O. clock and chimes.
- Close down.

#### MORNING SESSION.

- 10.30 a.m.—G.P.O. clock and chimes.
- Musical programme from the Studio.
- 10.40 a.m.—News service.

NEW SOUTH WALES "A" AND "B" CLASS BROADCASTING STATIONS.

2FC.—Farmer's Broadcasting Station, Ltd., Sydney, wavelength 442 metres, power 5000 watts.

2BL.—Broadcasters' Ltd., Sydney, wavelength 263 metres, power 5000 watts.

2GB.—Theosophical Broadcasting Station, Ltd., Sydney, wavelength 316 metres, power 3000 watts.

2KY.—Trades and Labor Council, Sydney, wavelength 280 metres, power 1500 watts.

2UW.—Otto Sandel, Sydney, wavelength 267 metres, power 500 watts.

2MK.—Mockler Bros., Bathurst, wavelength 275 metres, power 250 watts.

2UE.—Electrical Utilities Supply Co., Sydney, wavelength 293 metres, power 250 watts.

2HE.—Burgin Electric Co., Sydney, wavelength 316 metres, 100 watts.

2HD.—H. A. Douglas, Newcastle, wavelength, 298 metres, 100 watts.

There are no rivals to the Philco.

10.50 a.m.—Musical programme from the Studio.  
 11 a.m.—G.P.O. clock and chimes. Announcements.  
 11.5 a.m.—Musical programme from the Studio.  
 11.15 a.m.—Talk on "Croquet" by Miss Gwen Varley. Broadcasters' women's sports authority.  
 Social notes. Replies to correspondents by Mrs. Jordan.  
 Talk on "Feeding the Family" by Mrs. Jordan.  
 12 noon.—G.P.O. clock and chimes. Special ocean forecast and weather report.  
 12.3 p.m.—Musical programme from the Studio.  
 12.15 p.m.—Information. Mails, shipping, and port directory.  
 12.18 p.m.—Boats in call by wireless.  
 12.20 p.m.—Fruit market report.  
 12.22 p.m.—Vegetable market report.  
 12.24 p.m.—London metal market report.  
 12.26 p.m.—Dairy farm produce market report.  
 12.30 p.m.—G.P.O. clock and chimes. Forage market report.  
 12.32 p.m.—Fish market report.  
 12.34 p.m.—Rabbit market report.  
 12.36 p.m.—News from the "Sun."  
 12.45 p.m.—Hillier's Instrumental Quartet. Direction, Caryl Castling.  
 1.30 p.m.—G.P.O. clock and chimes. Talk to children and special entertainment for children in hospital.  
 2 p.m.—G.P.O. clock and chimes. Close down.  
**AFTERNOON SESSION.**  
 Racing information broadcast immediately after each race, by courtesy of the "Sun."  
 3 p.m.—G.P.O. clock and chimes. News from the "Sun."  
 3.15 p.m.—Civil Service Stores Trio. Direction, Miss de Courcey Bremer.  
 3.30 p.m.—G.P.O. clock and chimes. News from the "Sun."  
 3.40 p.m.—Musical programme from the Studio.  
 3.50 p.m.—News from the "Sun."  
 4 p.m.—G.P.O. clock and chimes. Civil Service Stores Trio.  
 4.15 p.m.—Serial story.  
 4.35 p.m.—Musical programme from the Studio.  
 4.45 p.m.—News from the "Sun."  
 4.50 p.m.—Racing resume.  
 4.52 p.m.—Resume of night's programme.  
 4.54 p.m.—Announcements and What's On?  
 4.58 p.m.—Special ocean forecast.  
 5 p.m.—G.P.O. clock and chimes. Close down.  
**EARLY EVENING SESSION.**  
 5.45 p.m.—G.P.O. clock and chimes. Uncle George and the kiddies.  
 6.30 p.m.—Musical programme from the Studio.  
**SPECIAL COUNTRY SESSION.**  
 7 p.m.—G.P.O. clock and chimes. Australian Mercantile, Land, and Finance Co.'s report.  
 Weather report and forecast by courtesy of Government Meteorologist.  
 Producers' Distributing Society's fruit and vegetable market report.  
 Stock Exchange reports.  
 Grain and fodder report ("Sun").  
 Dairy produce report ("Sun").  
 7.15 p.m.—Country news from the "Sun."  
 7.20 p.m.—Talk on the prospects of Saturday's Soccer, by a member of the Metropolitan Soccer Association.  
 7.30 p.m.—Talk on "Gardening Science," by Mr. Cooper, Park Superintendent, City Council.  
 8 p.m.—G.P.O. clock and chimes. Broadcasters' Topical Chorus.  
 8.3 p.m.—The Versatile Two in piano and saxophone novelties.  
 8.13 p.m.—Miss Lena Murray, contralto.  
 8.20 p.m.—Mr. Reg. Harrison, comedian.  
 8.27 p.m.—Broadcasters' all-sports expert will talk on football.  
 8.42 p.m.—Miss Mab Fotheringham, soubrette.

8.49 p.m.—Broadcasters' Trio.  
 8.59 p.m.—Weather report and forecast by courtesy of Mr. C. J. Mares, Government Meteorologist.  
 9 p.m.—G.P.O. clock and chimes. Resume of following day's programme.  
 9.6 p.m.—Mr. Fred Lester, baritone.  
 8.13 p.m.—Ward Lear and Will Kenby, in a laughing, singing and whistling act.  
 9.33 p.m.—Broadcasters' Trio.  
 9.43 p.m.—The sporting editor of the "Sun" will talk on the prospects of Saturday's racing.  
 10.3 p.m.—Miss Lena Murray.  
 10.10 p.m.—Miss Edna Fenner, elocutionist.  
 10.17 p.m.—Mr. Reg. Harrison.  
 10.24 p.m.—News reports by courtesy of the "Sun" Newspapers.  
 10.29 p.m.—Miss Mab Fotheringham.  
 10.36 p.m.—Miss Edna Fenner.  
 10.43 p.m.—Mr. Fred Lester.  
 10.50 p.m.—Broadcasters' Trio.  
 11 p.m.—G.P.O. clock and chimes. National Anthem.

7.30 p.m.—Music.  
 7.38 p.m.—Mr. J. K. Powell.  
 7.50 p.m.—Announcements.  
 7.55 Instrumental Trio:  
 DAN SCULLY, MURIELLE LANG, ADA BROOK.  
 8.5 p.m.—Address.  
 8.20 p.m.—Songs.  
 8.28 p.m.—Talk on "Anton Dvorak" illustrated from his music, by PHYLLIS CAMPBELL:  
 1. "First movement from Quintette" (Dvorak).  
 9 p.m.—Topical Talk.  
 9.15 p.m.—Piano Solos: MISS MOLLIE LEAHEY.  
 9.23 p.m.—Songs.  
 9.31 p.m.—Instrumental Quartette:  
 DAN SCULLY, MONICA HARDER, MURIELLE LANG, ADA BROOK.  
 9.53 p.m.—Talk.  
 10 p.m.—Close down.

## 3LO, MELBOURNE.

Broadcasting Co. of Aust.  
 Wave Length, 371 Metres.

Friday

### MIDDAY SESSION.

12 noon.—Time Signal. Metal prices received by the Australian Mines and Metals Association from the London Stock Exchange this day. British Official Wireless news from Rugby. Reuter's and The Australian Press Association Cables. "Argus" news service.  
 12.20 p.m.—FRANK AND FRANCES LUIZ, Hawaiian Entertainers:  
 Duet, "Maui Girl."  
 Song, "Pua Mohe La."  
 Steel Guitar, "Waltz Medley."  
 Duet, "My Waikiki Mermaid."  
 12.30 p.m.—STUDIO ORCHESTRA:  
 "Pique Dame" (Suppe).  
 12.40 p.m.—Stock Exchange information.  
 12.43 p.m.—CLINTON AND LEIGH:  
 "Golden Dreams" (Stoneham).  
 "Mellow Mersey Moon" (Stoneham).  
 12.50 p.m.—STUDIO ORCHESTRA:  
 "Chiquita Valse" (Barnard).  
 "Souvenir" (Herbert).  
 1 p.m.—ETHEL FORSHAW, soprano:  
 "The Wainig is Good" (Grieg).  
 "Ingrid's Song" (Kjerulf).  
 1.7 p.m.—BERTHA JORGENSEN, violin:  
 "Menuet" (Popora-Kreisler).  
 "Menuet" (Strossel).  
 1.14 p.m.—Meteorological information. Shipping intelligence. Weather synopsis for Victoria, Tasmania, South Australia, and New South Wales. Ocean Forecast. River reports. Rainfall for Victoria, Tasmania, South Australia, and New South Wales.  
 1.22 p.m.—STUDIO ORCHESTRA:  
 "Quartet" (Haydn).  
 1.32 p.m.—ETHEL FORSHAW, soprano:  
 "The Wind's in the South To-day" (Scott).  
 "The Birth of Morn" (Leoni).  
 1.39 p.m.—TASMA TIERNAN, Cello:  
 "Gavotte" (Popper).  
 1.47 p.m.—CLINTON AND LEIGH:  
 "Ballarat" (Stoneham).  
 "Waikiki Moon" (Stoneham).  
 1.54 p.m.—STUDIO ORCHESTRA:  
 "Idyl Blumenge Fluster" (Blon).

### AFTERNOON SESSION.

2.45 p.m.—Description of Associated Public Schools of Victoria football, GEELONG GRAMMAR SCHOOL v. GEELONG COLLEGE; description by Mr. Wallace Sharland; transmitted from Geelong.  
 2.55 p.m.—Description of Associated Public Schools of Victoria football, MELBOURNE GRAMMAR SCHOOL v. WESLEY COLLEGE, by Mr. C. Brooksbank, from M.C.G.  
 3.5 p.m.—STUDIO ORCHESTRA:  
 "The Coquette" (Johnstone).  
 3.10 p.m.—Description of Associated Public Schools of Victoria football, GEELONG GRAMMAR SCHOOL v. GEELONG COLLEGE, described by Mr. Wallace Sharland, from Geelong. Quarter-time.

## 2GB, SYDNEY

Theosophical Broadcasting Service.  
 Wave Length, 316 Metres.

Friday.

### MORNING SESSION.

9 a.m.—Music.  
 9.5 a.m.—"Cheerio" Talk.  
 9.15 a.m.—Music.  
 9.25 a.m.—Psychological Class.  
 9.40 a.m.—Music.  
 9.45 a.m.—Health Talk and Diet.  
 10 a.m.—Close down.

### AFTERNOON SESSION.

3.30 p.m.—Music.  
 3.37 p.m.—Talk.  
 3.52 p.m.—Music.  
 4.7 p.m.—Talk.  
 4.22 p.m.—Music.  
 4.30 p.m.—Close down.

### EVENING SESSION.

6.30 p.m.—Music and Children's Session.  
 7 p.m.—Music.  
 7.5 p.m.—Address by Mr. R. E. Bennett.  
 7.15 p.m.—Music.  
 7.20 p.m.—Address.

### INTERSTATE "A" AND "B" CLASS BROADCASTING STATIONS.

3LO.—Broadcasting Company of Australia, Ltd., Melbourne, wavelength 371 metres, power 5000 watts.  
 4QG.—Queensland Radio Service, Brisbane, wavelength 385 metres, power 5000 watts.  
 6CL.—Central Broadcasters' Ltd., Adelaide, wavelength 395 metres, power 5000 watts.  
 6WF.—Westralian Farmers, Ltd., Perth, wavelength 1250 metres, power 5000 watts.  
 7ZL.—Tasmanian Broadcasters, Ltd., Hobart, wavelength 535 metres, 3000 watts.  
 3AR.—Associated Radio Co., Ltd., Melbourne, wavelength 484 metres, power 1600 watts.  
 3DB.—Draleigh Business and Technical College, Melbourne, wavelength 265 metres, power 500 watts.  
 3UZ.—O. J. Nilson & Co., Melbourne, wavelength 319 metres, power 100 watts.  
 4GR.—Gold Radio Electric Service, Toowoomba, Queensland, wavelength 294 metres, power 100 watts.  
 5KA.—Sport Radio Broadcasting Station, Adelaide, wavelength 250 metres, power 1000 watts.  
 5DN.—5DN Pty., Ltd., Adelaide, wavelength 313 metres, 500 watts.

Philcos are Aristocrats among Batteries.

- 8.20 p.m.—Description of Associated Public Schools of Victoria football, MELBOURNE GRAMMAR SCHOOL v. WESLEY COLLEGE, by Mr. C. Brooksbank, from M.C.G. Quarter-time.
- 8.40 p.m.—"AU FAIT": "Fashion Talk."
- 8.55 p.m.—ELSA STRALIA, soprano: (Violin Obligato by Bertha Jorgenson). "Ave Maria" (Gounod). "Gray Morn" (Standish).
- 9.2 p.m.—Description of Associated Public Schools of Victoria football, GEELONG GRAMMAR SCHOOL v. GEELONG COLLEGE, by Mr. Wallace Sharland, from Geelong.—Half-time.
- 9.9 p.m.—Description of Associated Public Schools of Victoria football, by Mr. C. Brooksbank, from M.C.G.—Half-time.
- 9.16 p.m.—MRS. M. CALLAWAY MAHOOD will speak on "Art in Modern Life."
- 9.30 p.m.—Description of Associated Public Schools of Victoria football, GEELONG GRAMMAR SCHOOL v. GEELONG COLLEGE, by Mr. Wallace Sharland, from Geelong.—Threequarter-time.
- 9.57 p.m.—Description of Associated Public Schools of Victoria football, MELBOURNE GRAMMAR SCHOOL v. WESLEY COLLEGE, by Mr. Brooksbank, from M.C.G.—Threequarter-time.
- 9.45 p.m.—"Herald" news service. Stock Exchange information.
- 9 p.m.—Associated Public Schools of Victoria, GEELONG GRAMMAR SCHOOL v. GEELONG COLLEGE. Final scores, by Mr. Wallace Sharland, from Geelong.
- 9.5 p.m.—Associated Public Schools of Victoria, MELBOURNE GRAMMAR SCHOOL v. WESLEY COLLEGE, from M.C.G. Final scores, by Mr. Brooksbank.
- 9.50 p.m.—Answers to Letters and Birthday Greetings, by "BILLY BUNNY."
- 9 p.m.—ELSIE BRADSHAW, Piano Solo for the children.
- 9.7 p.m.—ISOBEL BIDDELL, contralto: "Three Fishers" (Hullah). "My Child is My Treasure."
- 9.15 p.m.—MR. ROD MCGREGOR, Football: "Playing the Game."
- 9.25 p.m.—ISOBEL BIDDELL, contralto: "The Forge" (Rahmah). "Husheen" (Needham).

**EVENING SESSION.**

- 9.32 p.m.—ELSIE BRADSHAW will play again for the children.
- ROYAL AUTOMOBILE CLUB OF VICTORIA'S SAFETY MESSAGE FOR TO-DAY IS: CHILDREN: "To keep the doctor and nurses away. Play safe day after day."
- 9.40 p.m.—Official report of Newmarket stock sales, numbers of trucks for following week's sales, supplied by the Associated Stock and Station Agents, of Bourke Street, Melbourne.
- 9.45 p.m.—"Herald" news service. Weather synopsis. Shipping movements.
- 9.52 p.m.—Stock Exchange information.
- 9.57 p.m.—Fish market reports, by J. R. Borrett, Ltd. Rabbit prices.
- 9 p.m.—River reports.
- 9.3 p.m.—Market reports of fruit, by the Victorian Fruiters' Association, compiled by the "Fruit World," exclusive to 3LO.

**NIGHT SESSION.**

- 7.15 p.m.—Under the auspices of the Department of Agriculture, Mr. W. C. RUGG, Poultry Expert, will speak on "Export of Eggs."
- 7.30 p.m.—STUDIO ORCHESTRA: "Suite Andaluscan"—Part 1 (Meramonte).
- 7.40 p.m.—FRANK and FRANCES LUIZ, Hawaiian entertainers: Duet, "On the Beach at Waikiki." Song, "Old Plantation." Steel Guitar, "Kailma Waltz." Duet, "Naughty Hula Eyes."
- 7.50 p.m.—STUDIO ORCHESTRA: "Suite Andaluscan"—Part 2 (Meramonte).
- 7.55 p.m.—CAPTAIN of the NEW ZEALAND Hockey Team will speak to you for a few minutes.
- 7.57 p.m.—MR. H. K. LOVE: "Technicalities."

- 8.7 p.m.—COLLINGWOOD CITIZENS' BAND: March, "Peace and War." Overture, "Bohemian Girl."
- 8.17 p.m.—J. HOWARD KING, bass-baritone: "Had a Horse" (Korbay). "Shepherd. See Thy Horse's Foaming Mane" (Korbay).
- 8.24 p.m.—STATION TRIO: "Card Song and Sequidilla"—Carmen (Bizet).
- 8.34 p.m.—ELSA STRALIA, soprano: "Softly Awakes My Heart"—Samson and Delilah. "The Greatest Wish in the World" (Wilbey).
- 8.41 p.m.—COLLINGWOOD CITIZENS' BAND: Selection, "Harry Lauder's Songs."
- 8.51 p.m.—Announcements and ROYAL AUTOMOBILE CLUB OF VICTORIA'S SAFETY MESSAGE TO-DAY is for SAFETY FIRST: "Money will buy a lot of things, but it can't buy spare parts for your body that are as good as the original ones."
- 8.55 p.m.—NORMAN BRADSHAW, tenor: "Belle Marquise" (Rolt). "Virginian Love Song" (Harry).
- 9.2 p.m.—STUDIO ORCHESTRA: "2nd Symphony"—Part 1 (Beethoven).
- 9.9 p.m.—SOUTHERN CHORAL UNION, conducted by Graham Burgin. Pianiste, Olive McKillop. Test pieces which the society sang and won Newcastle Contest, Easter, 1927: "When Winds Breathe Soft" (Webbe). "God in the Thunderstorm" (Schubert).
- 9.16 p.m.—COLLINGWOOD CITIZENS' BAND: Trombone solo, "The Tyrolene"—A. Thorne. Hymn, "It is Well."
- 9.28 p.m.—"CARDIGAN"—Mr. H. A. Wolfe, Sporting Editor of the "Argus" and "Australasian," will speak on Saturday's races.
- 9.33 p.m.—ELSA STRALIA, soprano: "The Lost Chord" (Sullivan).
- 9.40 p.m.—STUDIO ORCHESTRA: "2nd Symphony"—Part 2 (Beethoven).
- 9.47 p.m.—MR. C. J. WILLIAMS will speak on "Saturday's Stadium Event."
- 9.57 p.m.—COLLINGWOOD CITIZENS' BAND: Waltz, "Casino Tane."
- 10.7 p.m.—NORMAN BRADSHAW, tenor: "From the land of the sky blue water" (Cadman). "Madrigal" (Chaminade).
- 10.14 p.m.—Meteorological information. Road notes supplied by the Royal Automobile Club of Victoria.

- 10.24 p.m.—STUDIO ORCHESTRA: "Madame Pompadour" (Fall).
- 10.34 p.m.—J. HOWARD KING, bass-baritone: "Tom Browne" (Squire). "Friend of Mine" (Sanderson).
- 10.41 p.m.—COLLINGWOOD CITIZENS' BAND: Duet, "Excelsior"—R. Spencer and F. Crawley.
- 10.51 p.m.—"Argus" news service. British Official Wireless News.
- 11 p.m.—OUR GREAT THOUGHT: "What a piece of work is man, how noble in reason, how infinite in faculty, in form and moving, how express and admirable in action, how like an angel in apprehension, how like a God."—Shakespeare.
- 11.1 p.m.—JOE ARONSON and HIS SYNCO-PATING SYMPHONISTS.
- 11.40 p.m.—GOD SAVE THE KING.

**3AR, MELBOURNE**

Associated Radio Co.  
Wave Length, 484 Metres.

Friday

MORNING SESSION—11 a.m. to 12 noon.  
MIDDAY CONCERT SESSION.  
Transmitted from Panatropa House, 252 Collins Street (by exclusive permission of Wills and Paton, Ltd.), on the Brunswick Panatropa.

**MATINEE SESSION.  
DANCE CONCERT.**

- 2.30 p.m.—Studio Orchestra: Overture, "The Calif of Bagdad" (Boieldieu). "March of the Dwarfs" (Moszkowski).
- 2.45 p.m.—Mr. Ernest Pettifer, clarinet: "Alicanto" (Le Thiere).
- 2.49 p.m.—Ayaz Dansonians.
- 3.5 p.m.—Miss Ethel Brearley, piano: "Evening Song" (Lehmann).
- 3.9 p.m.—Studio Orchestra: "Fantasie Espagnole" (Homer). "Overture to an Irish Comedy" (Ansell).
- 3.25 p.m.—Miss May Richards, contralto: "Unmindful of the Roses" (Lohr). "Elegie" (Massenet).
- 3.33 p.m.—Ayaz Dansonians.
- 3.56 p.m.—Mr. Herbert Pettifer, violin: "Romance" (Wieniawski).
- 4 p.m.—G.P.O. Clock says "Four."
- 4.1 p.m.—2nd Weather forecast.
- 4.4 p.m.—Interval Talk: Miss Emily Noble (Cooking Demonstrator of the Metropolitan Gas Company) will advise on "The Cooking of Fish."
- 4.4 p.m.—Studio Orchestra: "Four Spanish Pictures" (Lunzatti). "Piazza del Popolo" (Juel-Frederiksen).
- 4.20 p.m.—Miss May Richards, contralto: "O Lovely Night" (Ronald). "Down the Burn" (Moffatt).
- 4.28 p.m.—Ayaz Dansonians.
- 4.45 p.m.—Studio Orchestra: "By the Lake of Geneva." Part 2 (Bendel).
- 4.55 p.m.—To-night's entertainment.
- 5 p.m.—G.P.O. Clock says "Five." Close down.

**CHILDREN'S SESSION.**

- 6.30 p.m.—"The Farmyard Five."
- EVENING SESSION.**  
**QUARTETS AND COMEDY.**
- 7.30 p.m.—Mr. George Beattie (Principal of the Beattie College of Physical Culture): Physical Fitness.
- 7.45 p.m.—"Field Glasses": Special Review and Tips for to-morrow's Races.
- 7.50 p.m.—Market reports.
- 7.55 p.m.—Week-end Tourists' Guide.
- 8 p.m.—G.P.O. Clock says "Eight."
- 8.1 p.m.—Mr. Joseph Widdowes, tenor: "Passing By" (Purcell).
- 8.4 p.m.—Mr. James Scott, bass: "She alone charmeth my sadness," from "Irene" (Gounod).
- 8.7 p.m.—Mr. Harry Loft, banjo: "A Darkie Chuckle" (Morley). "Queen of the Burlesque" (Tilley).

**NEW ZEALAND STATIONS:**  
1YA, Auckland, The Radio Broadcasting Co. of New Zealand, Ltd.  
Power 500 Watts; Wave-length, 420 Metres. Silent Night, Monday.  
2YK, Wellington, The Radio Broadcasting Co. of New Zealand, Ltd.  
Power 120 Watts; Wave-length, 295 Metres.  
3YA, Christchurch, The Radio Broadcasting Co. of New Zealand, Ltd.  
Power 500 Watts; Wave-length, 400 Metres. Silent Night, Thursday.  
4YA, Dunedin, The Radio Broadcasting Co. of New Zealand, Ltd.  
Power 750 Watts; Wave-length, 435 Metres.

The Mighty 83X Philco is Supreme.

- 8.14 p.m.—The Leider Four, Male Quartet:  
"Picaninny's Lullaby."  
"The Mellow Melon" (Richardson).
- 8.21 p.m.—Mr. Walter Barker, harp:  
"The Bells of Aberdovey" (Thomas).
- 8.28 p.m.—Miss Minnie Marks, soprano:  
"Serenata" (Toselli).  
"Don't you mind the Sorrows."
- 8.35 p.m.—Announcements.
- 8.39 p.m.—Mr. Lauriston Burnett, English humorist:  
"I tried to keep from Laughing" (Moore).
- 8.47 p.m.—Signori Cera and Zotti, mandolin and guitar duo:  
"A Night in Venice," Serenade (Cera).
- 8.53 p.m.—Mr. James Scott and Jos. Wid-dowes, duet:  
"Watchman, what of the night?" (Sargeant).
- 8.57 p.m.—Mr. Ralph Thomson and Mr. Harry Fletcher, duet:  
"The Battle Eve" (Bonheur).
- 9 p.m.—Mr. Harry Loft, banjo:  
"The Darkey's Return" (Ellis).  
"Sunday" (Miller).
- 9.7 p.m.—Mr. V. Upton-Brown, narrator:  
"The Revolt of the Gladiators," a recon-structed scene from Roman History. The great revolt of the slaves under Spartacus, the gladiator, in 79, B.C.
- 9.15 p.m.—Mr. Walter Barker, harp:  
"Study in C Flat" (Thomas).
- 9.22 p.m.—The Leider Four:  
"Calm is the Sea" (Paell).  
"The Soldier's Farewell" (Purday).
- 9.30 p.m.—Announcements.
- 9.34 p.m.—Mr. Lauriston Burnett, English humorist:  
"Sally and de Girl" (Gordon).
- 9.42 p.m.—Miss Minnie Marks, soprano:  
"Alas Those Chimes," from "Maritana" (Wallace).  
"Bird of Love Divine" (Haydn Wood).
- 9.49 p.m.—Signori Cera and Zotti, mandolin and guitar duo:  
"The Belle of Cornville."
- 9.55 p.m.—Mr. Ralph Thomson, baritone:  
"To-morrow" (Keel).
- 10 p.m.—G.P.O. Clock says "Ten."
- 10.1 p.m.—The "Age" News Bulletin, exclusive to SAR.
- 10.5 p.m.—Dance Hour, Leggett's Ballroom Orchestra (direction, Mr. Harry Nangle).
- 10.55 p.m.—To-morrow's entertainment.
- 11 p.m.—G.P.O. Clock says "Eleven."  
"God Save the King."

**4QG, BRISBANE**

Queensland Radio Service.  
Wave Length, 385 Metres.

Friday

**MIDDAY SESSION.**

- 1 p.m.—Market reports, weather information, "The Daily Mail" and "The Daily Standard" news.  
**FROM HOTEL CARLTON:**  
1.30 p.m.—Lunch hour music played by Hotel Carlton Symphony Orchestra.  
**FROM THE OBSERVATORY:**  
1.58 p.m.—Standard time signal.  
2 p.m.—Close down.

**AFTERNOON SESSION.**

- FROM HOTEL CARLTON:**  
8.30 p.m.—Afternoon tea music played by Hotel Carlton Symphony Orchestra.  
**FROM THE STUDIO:**  
4.15 p.m.—News service supplied by "The Telegraph."  
4.30 p.m.—Close down.

**EARLY EVENING SESSION.**

- 6 p.m.—"Daily Standard" news, weather information, announcements.  
6.30 p.m.—Bedtime stories by "The Sandman."  
7 p.m.—Market reports, stock reports.  
7.30 p.m.—Weather news, announcements.  
7.43 p.m.—Standard time signal.

**NIGHT SESSION.**

**W.E.A. MUSIC CLASS.**

The Workers' Educational Association's Tutorial Classes in Music are being held this season in the reception hall at 4QG, and are being conducted by Mr. George Sampson (Musical Adviser, Department of Public Instruction; Lecturer in Music, Teachers' Training College).  
The object of holding the classes at 4QG is to broadcast both the lectures and the music, and so make available to a large audience the educational matter placed before the students. The classes will extend over a period, and will be held each Friday night.

The ordinary lecturette which is usually given at 7.45 p.m. will be dispensed with, and the classes will begin at that hour.

The tutor, Mr. Sampson, will lecture during the first portion of each evening, and chamber music will be played after such lecture.

**FROM THE RECEPTION HALL:**

- 7.45 p.m.—W.E.A. Music Class.  
The following artists will illustrate Mr. Sampson's lecture to-night:—Mrs. Stuart (piano), Miss Enid Stuart (first violin), Miss Erica Stuart (second violin), Miss Marjorie Stuart (cello).

**FROM THE STUDIO:**

- 9 p.m.—Metropolitan weather forecast.  
Week-end road information for motorists, officially supplied by the Royal Automobile Club of Queensland.

**SILKSTONE APOLLO CLUB.**

Male Chorus, "To Arms" (Laurent de Rille), the Apollo Club; song, selected, Mr. T. Westwood; chorus, "Bonnie Banks of Loch Lomond" (Vincent), the Apollo Club; song, "You Lovely Thing," Mr. D. Griffith; chorus, "Pilgrims' Chorus" (Tannhauser), the Apollo Club; elocutionary item, selected, Mr. D. Owen; chorus, "Anchored" (Watson), Apollo Club; duet, "Flow, Gentle Deva," Messrs. Westwood and Morris; chorus—(a) "When Evening's Twilight," pianoforte solo, "Hungarian Dance in F-Major" (Brahms), Miss T. Marsh; chorus, "The Volga Boatman" (Granville Bantock), the Apollo Club; bass solo, selected, Mr. V. Morris; chorus—(a), "Lullaby" (Brahms), (b) "Massa's in de Cold, Cold Ground" (Bell), Apollo Club; song, selected, Mr. A. Wilcox; chorus, "Comrades in Arms" (Adam), the Apollo Club.

**FROM THE STUDIO:**

- 10 p.m.—"The Daily Mail" news; weather news; football news.  
Close down.

**5CL, ADELAIDE**

Central Broadcasters, Ltd.  
Wave Length, 395 Metres.

Friday.

**AFTERNOON SESSION.**

- 3 p.m.—Chimes.  
3.1 p.m.—Relay from the Maple Leaf Cafe; Orchestral selections.  
3.45 p.m.—From the Studio:  
Recitals on the Sonora and the Autotone.  
4 p.m.—Chimes.  
4.1 p.m.—Relay from the Arcadia Cafe; Orchestral selections.  
Vocalist, Mary Edson.  
4.55 p.m.—Station announcements.  
5 p.m.—Chimes and close down.

**EVENING SESSION.**

- 6 p.m.—Chimes.  
6.1 p.m.—Relay from the Covent Garden Restaurant; Orchestral selections.  
6.44 p.m.—Running time of the East West Express.  
6.45 p.m.—Children's entertainment.  
7.20 p.m.—Market reports, Stock Exchange intelligence, Retail Grocers' reports, Automobile Association bulletin, and Fish Market reports.  
7.30 p.m.—General sporting talk by "Wind-bag."  
7.50 p.m.—Football talk by "Highmark."  
8 p.m.—Chimes.

8.1 p.m.—Melody Masters.

From the Studio:

- 9.1 p.m.—Weather report.  
9.2 p.m.—Daigety's wheat report.  
9.3 p.m.—Trude Mudie, dramatic soprano.  
Mrs. Hubert James, contralto.  
Gilbert Casey, violinist.  
The Railway Quartette in solos, duets and quartets.  
9.15 p.m.—Mr. R. C. Scott, experimentalist, of Roseworthy Agricultural College.  
10.57 p.m.—To-morrow's programme, weather bulletin, chimes.  
National Anthem.  
11 p.m.—Close down.

**6WF, PERTH**

Westralian Farmer's.  
Wave Length, 1250 Metres.

Friday

- 12.30 p.m.—Tune in.  
12.35 p.m.—Local News Items supplied by courtesy of "The West Australian," Newspaper Co. Market reports supplied by the Westralian Farmers Limited. Cables supplied by the Australian Press Association.  
1 p.m.—Time Signal from Perth Observatory.  
1.1 p.m.—Weather notes supplied by the Meteorological Bureau of Western Australia.  
1.2 p.m.—Studio Quintette.  
2 p.m.—Close down.  
3.35 p.m.—Musical Programme.  
5 p.m.—Close down.  
6.45 p.m.—Tune in.  
6.50 p.m.—Musical Evening for the Kiddies.  
7.20 p.m.—Stock and Share intelligence supplied by courtesy of Messrs. Saw and Grimwood Limited. Market reports supplied by the Westralian Farmers Limited. Second Local News Bulletin supplied by courtesy of "The West Australian" Newspaper Coy. Cables supplied by the Australian Press Association.  
7.45 p.m.—Talk by "Caller" on Saturday's Racing.  
8 p.m.—Time Signal from Perth Observatory.  
8.1 p.m.—Weather Notes supplied by the Meteorological Bureau of Western Australia.  
8.3 p.m.—Popular night.  
Items by Misses Sutton and Foley, Instrumental Duo, of the s.s. Katoomba.  
Cornet solos by Mr. Chas. Court.  
9 p.m.—"Gardening Notes" by Mr. E. A. Hughes, representing Messrs. Dawson and Harrison.  
10 p.m.—Late news items supplied by courtesy of the "Daily News" Newspaper Co. Weather forecast and report. Ships within range.  
10.30 p.m.—Close down.

**7ZL, HOBART**

Tasmanian Broadcasters, Ltd.

Friday.

**MORNING SESSION—11 a.m. to 12 noon.**

**AFTERNOON SESSION.**

- 3 p.m.—G.P.O. Clock Chimes.  
3.1 p.m.—Tune in selection.  
3.5 p.m.—Hobart Stock Exchange quotations. Weather information. Items of interest. Announcements.  
3.15 p.m.—Orchestral selections by 7ZL Orchestra.  
4.15 p.m.—Bridge instruction: Lesson-1.  
4.30 p.m.—Close down.

**EARLY EVENING SESSION.**

- 6.30 p.m.—Children's Corner with the "Radio Lady."  
7.15 p.m.—Young Folks' Gardening Chat by Mr. George Nation.

**NIGHT SESSION.**

- 7.30 p.m.—Fruit, Poultry and Produce Reports, through the courtesy of Roberts and Co., Ltd., Murray Street, Hobart.  
7.35 p.m.—Gardening Talk by Mr. George Nation, Glen Nurseries Cascades.

Ask any Radio Engineer about Burgess,



---

**The Brandola**

---

---

**£4:10:0**

---

# Brandes Products Surpass!

Everyone realises that ultimately Brandes must come to the fore by sheer merit. The Brandola, the largest of the Brandes Horn Type Speakers, is volumes ahead of any other. Its price is most reasonable for the quality. Ask for a demonstration, or write to us and mention your nearest dealer's name.

**INTERNATIONAL RADIO COMPANY LTD.**

**200 CASTLEREAGH STREET, SYDNEY**

*The Perfect Valve Receiver*

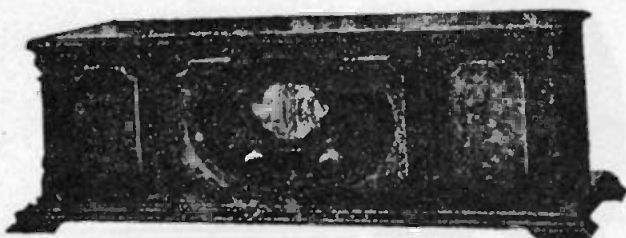

**Single Dial Control**

**F**ARMER'S present this perfect receiving set, featuring unsurpassed purity of tone and simplicity of control; it is capable of producing any volume desired.

This new model five-valve receiver is set in a handsome cabinet of Queensland Maple inlaid with walnut; beautiful "Duco" finish.

Control is effected from a central dial, and each stage is completely protected with copper shields. The cabinet has ample space for all batteries; supplied with accessories and loud speaker. Price .. .. . £52/10/-

*This set erected free in City or Suburbs.*

*Farmer's Standard 2-Valve Receiver*



Efficient and reliable! An ideal set for reception of all programmes. Interference of outside Stations is absolutely eliminated. Included with standard equipment are two "Radiotron" valves of a type specially adapted to this particular set. Price, with one pair of headphones.. .. £14/10/-  
With loud-speaker equipment. Price .. .. . £22/-

*Extra Equipment for the Enthusiast*

Headphones by all prominent makers:

"N. & K."	Price, per pair	..	..	..	..	..	..	17/6
"Peerless."	Price, per pair	..	..	..	..	..	..	21/-
"Radiola."	Price, per pair	..	..	..	..	..	..	35/-
New double-reading voltmeter; 0-10 and 0-100. Price, each,								12/6

**F A R M E R ' S**  
SYDNEY

*Wireless Department, Ground Floor, Market Street*

**Resin Cored Solder**

for all Radio and Electrical Work.

**O.T.L.**

**BRAND**

Patent 12453

Makes the use of acids or other fluxes unnecessary, and so avoids the risk of damage to delicate parts.

**Ask for O.T.L Brand**

**EASY TO USE**

Put up in tins for the amateur, 1, 7, and 10 lb. spools for the Radio and Electrical Trades, in Diameters of  $\frac{3}{32}$ ",  $\frac{1}{8}$ " &  $\frac{3}{16}$ ".

Obtainable from all leading Radio and Electrical Dealers in the Commonwealth.

If unobtainable locally, write for address for nearest source of supply to

The Manufacturers,  
**O. T. LEMPRIERE & Co.**  
Collins House, Sirius House,  
Collins Street, Macquarie Place,  
**MELBOURNE.** **SYDNEY.**

# BROADCASTING PROGRAMMES

For the COMING WEEK



Friday, Dec. 23

2FC, SYDNEY.

Farmer's Broadcasting Service.

Wave Length, 442 Metres.

**EARLY MORNING SESSION.**

7 a.m. to 8 a.m.

**MORNING SESSION.**

10 a.m. to 11.30 a.m.

**MIDDAY SESSION.**

- 12 noon.—"Big Ben" and announcements.
- 12.2 p.m.—Stock Exchange, first call.
- 12.3 p.m.—Official weather forecast, rainfall.
- 12.5 p.m.—Studio music.
- 12.10 p.m.—Summary of "Sydney Morning Herald" news service.
- Rugby wireless news.
- 12.25 p.m.—Studio music.
- 12.40 p.m.—Annie Sedger, mezzo: "Love's Lament" (Michael Head).
- 12.45 p.m.—Studio music.
- 1 p.m.—"Big Ben." Weather intelligence.
- 1.3 p.m.—"Evening News" midday news service.
- Producers' Distributing Society's Report.
- 1.20 p.m.—Studio music.
- 1.28 p.m.—Stock Exchange, second call.
- 1.50 p.m.—Studio music.
- 1.40 p.m.—Annie Sedger, mezzo: "Meadow Sweet" (Brahme).
- 1.45 p.m.—Studio music.
- 2 p.m.—"Big Ben." Close down.

**AFTERNOON SESSION.**

- 3 p.m.—"Big Ben" and announcements.
- 3.3 p.m.—The "Radio Triad" (Leader, Mr. Ewart Chapple).
- 3.15 p.m.—Fosse Brakell, contralto: "None, but the Lonely Heart" (Theowsky).
- 3.17 p.m.—A short talk.
- 3.25 p.m.—Jeanette Rooney, soprano: "The Carpet" (Sanderson).
- 3.29 p.m.—Kathleen Horne, soprano: "When You and I Were Seventeen" (Rosoff).
- 3.33 p.m.—The "Radio Triad" (Leader, Mr. Ewart Chapple).
- 3.43 p.m.—Muriel Watt, contralto: "Here in the Quiet Hills" (Carne).
- 3.47 p.m.—Studio records.
- 3.55 p.m.—Fosse Brakell, contralto: "The Wild Rose" (Schubert).
- 4 p.m.—A Reading.
- 4.10 p.m.—Jeanette Rooney, contralto: "Of the North I Sing" (Oliver).
- 4.15 p.m.—The "Radio Triad" (Leader, Mr. Ewart Chapple).
- 4.20 p.m.—Kathleen Horne, soprano: "Until" (Sanderson).
- 4.30 p.m.—Muriel Watt, contralto: "So Little Time" (Lohr).
- 4.35 p.m.—The "Radio Triad" (Leader, Mr. Ewart Chapple).
- 4.45 p.m.—Stock Exchange third call.
- 4.47 p.m.—Studio music.
- 5 p.m.—"Big Ben." Close down.

**EARLY EVENING SESSION.**

- 5.40 p.m.—The chimes of 2FC.
- 5.45 p.m.—The "Hello Man" talks to the children.
- 6.30 p.m.—Story time for the young folk.
- 6.40 p.m.—From Farmer's Oak Dining Hall: The Oak Hall Instrumental Trio (Leader, Mr. Horace Keats).
- 6.45 p.m.—Mavis Dearman, soprano: "Phyllis has such charming graces" (Willson).
- 6.50 p.m.—The Oak Hall Instrumental Trio.
- 6.55 p.m.—David Craven, baritone.
- 7 p.m.—"Big Ben."
- Latest Racing Information by the 2FC Commissioner (from the Studio).
- 7.10 p.m.—Dalcry's market reports (wool, wheat and stock).
- 7.18 p.m.—Fruit and vegetable markets.
- 7.20 p.m.—Weather and shipping news.
- 7.28 p.m.—"Evening News" late news service.

**NIGHT SESSION.**

- 7.38 p.m.—Programme announcements.
- 7.40 p.m.—Lionel Lunt, English baritone.
- 7.45 p.m.—Cricketing reminiscences, prepared by Mr. Frederick Harper.
- 7.55 p.m.—Lionel Lunt, English baritone.
- 8 p.m.—"Big Ben."
- From the Lyric Winter Garden Theatre, George Street, Sydney: Orchestral items.
- 8.20 p.m.—From the Studio: Alice Prowse, contralto: "How far is it to Bethlehem" (Geoffrey Shaw) (arr. Brash).
- 8.24 p.m.—Rus Garling: "Mirth and Melody."
- 8.30 p.m.—The "Crackerjack" Trio.
- 8.35 p.m.—Lionel Lunt, English baritone.
- 8.38 p.m.—Alice Prowse, contralto: "If there were dreams to sell" (John Ireland).
- 8.42 p.m.—From the Lyric Winter Garden Theatre, George Street, Sydney: Orchestral items.

**8.50 p.m.—From the Studio:**

- Rus Garling.
- 8.56 p.m.—The "Crackerjack" Trio.
- 9.4 p.m.—Late weather forecast.
- 9.5 p.m.—Alice Prowse, contralto:
  1. (a) "Dream o' Nights."
  - (b) "The man in the Moon" (Coates).
  2. "Doon the burn" (Old Scots Ballad).
- 9.12 p.m.—From Her Majesty's Theatre, Sydney (by permission of J. C. Williamson, Limited), the Second Act of the Musical Comedy.

**"WILDFLOWER."**

featuring Marie Bourke and Herbert Browne. Scene: The Benedetto Villa on Lake Como, Italy.

**Musical numbers:**

- "The best dance I've had to-night."
- "Course I will."
- "Casimo."
- "Cou can't blame a girl for dreaming."
- "Goodbye, Little Rosebud."
- "Finale."

**10.12 p.m.—From the Studio:**

- The "Crackerjack" Trio.
- 10.26 p.m.—Len Maurice, popular baritone.
- 10.30 p.m.—Late weather forecast.
- 10.31 p.m.—The "Crackerjack" Trio.
- 10.50 p.m.—Len Maurice: popular songs.
- 10.57 p.m.—Late news and announcements.
- 11 p.m.—"Big Ben."
- National Anthem.
- Close down.

2BL, SYDNEY.

Broadcaster's Ltd.

Wave Length, 353 Metres.

Friday

**EARLY MORNING SESSION.**

7.0 a.m. to 8.0 a.m.

**MORNING SESSION.**

- 10.30 a.m.—G.P.O. Clock and Chimes; Musical Programme from Studio.
- 10.40 a.m.—News from the "Daily Telegraph Pictorial."
- 10.50 a.m.—Musical Programme from the Studio.
- 11.0 a.m.—G.P.O. Clock and Chimes; Announcements.
- 11.5 a.m.—Musical Programme from the Studio.
- 11.15 a.m.—Women's Session: Talk on "Motoring," by Miss Gwen Varley, Broadcasters' Women's Sports Authority. Social Notes, Replies to Correspondents by Mrs. Jordan. Talk on "A last word about Xmas Cookery," by Mrs. Jordan.
- 12 noon.—G.P.O. Clock and Chimes; Special Ocean Forecast and Weather Report.
- 12.3 p.m.—Musical Programme from the Studio.
- 12.8 p.m.—Information, Malls, Shipping and Port Directory.
- 12.11 p.m.—Boats in Call by Wireless.
- 12.13 p.m.—Fruit Market Report.
- 12.15 p.m.—Vegetable Market Report.

**NEW SOUTH WALES "A" AND "E" CLASS BROADCASTING STATIONS.**

- 2FC.—Farmer's Broadcasting Station, Ltd., Sydney, wavelength 442 metres, power 5000 watts.
- 2BL.—Broadcasters' Ltd., Sydney, wavelength 353 metres, power 5000 watts.
- 2GB.—Theosophical Broadcasting Station, Ltd., Sydney, wavelength 316 metres, power 3000 watts.
- 2KY.—Trades and Labor Council, Sydney, wavelength 280 metres, power 1500 watts.
- 2UW.—Sandel Radio, Sydney, wavelength 267 metres, power 500 watts.
- 2MK.—Mockler Bros., Bathurst, wavelength 275 metres, power 250 watts.
- 2UE.—Electrical Utilities Supply Co., Sydney, wavelength 293 metres, power 250 watts.
- 2BE.—Burgin Electric Co., Sydney, wavelength 316 metres, 100 watts.
- 2HD.—H. A. Douglas, Newcastle, wavelength, 288 metres, 100 watts.

Philcos are Aristocrats among Batteries.

12.17 p.m.—London Metal Market Report.  
 12.19 p.m.—Dairy and Farm Produce Market Report.  
 12.22 p.m.—Forage Market Report.  
 12.24 p.m.—Fish Market Report.  
 12.26 p.m.—Rabbit Market Report.  
 12.28 p.m.—Stock Exchange Report.  
 12.30 p.m.—H.M.V. Gramophone Recital.  
 1.27 p.m.—Stock Exchange Report.  
 1.30 p.m.—G.P.O. Clock and Chimes; Talk to Children and Special Entertainment for Children in Hospital.  
 2.0 p.m.—G.P.O. Clock and Chimes; Close Down.

**AFTERNOON SESSION.**

Racing Information Broadcast immediately after each race by courtesy of the "Sun" Newspapers.  
 3.0 p.m.—G.P.O. Clock and Chimes; News from the "Sun."  
 3.15 p.m.—Civil Service Stores Trio, Direction, Miss de Courcey Bremer.  
 2.30 p.m.—G.P.O. Clock and Chimes. Talk on "Homecrafts" by "Priscilla."  
 4.0 p.m.—G.P.O. Clock and Chimes; Civil Service Stores Trio.  
 4.15 p.m.—Talk on "Women of the Orient of All Ages."  
 4.35 p.m.—Musical Programme from the Studio.  
 4.50 p.m.—News from the "Sun."  
 4.55 p.m.—Resume of Night's Programme.  
 4.57 p.m.—Racing Resume.  
 4.59 p.m.—Special Ocean Forecast.  
 5.0 p.m.—G.P.O. Clock and Chimes; Close Down.

**EARLY EVENING SESSION.**

5.45 p.m.—G.P.O. Clock and Chimes; Children's Session  
 6.30 p.m.—Musical Programme from the Studio.

**SPECIAL COUNTRY SESSION.**

7.0 p.m.—G.P.O. Clock and Chimes; Australian Mercantile Land and Finance Co.'s Report; Weather Report and Forecast by courtesy of Government Meteorologist; Producers' Distributing Society's Fruit and Vegetable Market Report; Stock Exchange Reports; Grain and Fodder Reports ("Sun"); Dairy Produce Report ("Sun"); Eucharistic Congress Notes.  
 7.15 p.m.—Country News from the "Sun."  
 7.20 p.m.—Talk by Mr. Gregory of the N.R.M.A.  
 7.30 p.m.—Talk on "Gardening Science," by Mr. Cooper, Park Superintendent, City Council.  
 8.0 p.m.—G.P.O. Clock and Chimes; Grand Opera Hour; Broadcasters' Topical Chorus.  
 8.3 p.m.—Broadcasters' Trio.  
 8.13 p.m.—Mr. Leslie McCallum (Baritone).  
 8.23 p.m.—Duet, Miss Leonore Gotsch and Mr. Alfred Wilmore.  
 8.33 p.m.—Miss Heather Kinnaid (Contralto).  
 8.40 p.m.—Mr. Moore McMahon (Violin Solos).  
 8.47 p.m.—Mr. Alfred Wilmore (Tenor).  
 8.54 p.m.—Miss Leonore Gotsch (Soprano).  
 9.0 p.m.—G.P.O. Clock and Chimes; Weather Report and Forecast by courtesy of Mr U. J. Maree, Government Meteorologist.  
 9.1 p.m.—Broadcasters' All Sports Expert will talk on "Cricket."  
 9.16 p.m.—Mr. Leslie McCallum.  
 9.23 p.m.—Mr. Moore McMahon.  
 9.30 p.m.—Miss Leonore Gotsch.  
 9.37 p.m.—Broadcasters' Trio.  
 9.47 p.m.—Mr. Alfred Wilmore.  
 9.54 p.m.—Miss Heather Kinnaid.  
 10.1 p.m.—The Sporting Editor of the "Sun" will talk on the prospects of Saturday's Racing.  
 10.16 p.m.—Dance Music by Danny Hogan's Frisco Six, transmitting from the Ballroom of the Bondi Casino. During intervals between dances "Sun" News will be broadcast.  
 11.0 p.m.—G.P.O. Clock and Chimes; National Anthem.

**2GB, SYDNEY**

Theosophical Broadcasting Service.  
 Wave Length, 316 Metres.

Friday.

**MORNING SESSION.**

9 a.m.—Music.  
 9.5 a.m.—Good Cheer Talk.  
 9.15 a.m.—Music.  
 9.25 a.m.—Psychological Class.  
 9.40 a.m.—Music.  
 9.45 a.m.—Health and Diet.  
 10 a.m.—Close Down.

**AFTERNOON SESSION.**

3.37 p.m.—Address.  
 3.52 p.m.—Music.  
 4 p.m.—Address.  
 4.22 p.m.—Music.  
 4.30 p.m.—Close down.

**EVENING SESSION.**

7 p.m.—Music.  
 7.5 p.m.—Address: R. E. Bennett.  
 7.15 p.m.—Music.  
 7.20 p.m.—Address: Mr. J. K. Powell.  
 7.30 p.m.—Music.  
 7.40 p.m.—Address: F. Houstone, B.A.  
 7.55 p.m.—Instrumental Trio:  
 LEN BREWER, MURIELLE LANG, ADA BROOK.  
 8.5 p.m.—Address by Dr. P. K. Roest.  
 8.20 p.m.—Songs by ELSIE BROWN:  
 "Let me wander not unseen." (Handel).  
 "The Plague of Love" (Dr. Arne).  
 8.28 p.m.—Instrumental Trio: DAN SCULLY, MURIELLE LANG, ADA BROOK.  
 9 p.m.—Address by Mr. J. K. Powell.  
 9.15 p.m.—Songs by ELSIE BROWN:  
 1. "The Little Damsel" (Novelle).  
 2. "Nymphs and Fawns" (Bemberg).  
 9.23 p.m.—Violin Solos: LEN BREWER.  
 1. "Andantino" (Mastino Kreisler).  
 2. "Libesleid" (Kreisler).  
 9.30 p.m.—Instrumental Quartette:  
 LEN BREWER, DAN SCULLY, MURIELLE LANG, ADA BROOK.  
 9.50 p.m.—"Good Cheer" Talk.  
 10 p.m.—Close down.

**INTERSTATE "A" AND "B" CLASS BROADCASTING STATIONS.**

3LO.—Broadcasting Company of Australia, Ltd., Melbourne, wavelength 371 metres, power 5000 watts.  
 3AR.—Associated Radio Co., Ltd., Melbourne, wavelength 484 metres, power 5000 watts.  
 4QU.—Queensland Radio Service, Brisbane, wavelength 355 metres, power 2000 watts.  
 4CL.—Central Broadcasters' Ltd., Adelaide, wavelength 395 metres, power 5000 watts.  
 6WF.—Western Australian Farmers, Ltd., Perth, wavelength 1250 metres, power 5000 watts.  
 7ZL.—Tasmanian Broadcasters, Ltd., Hobart, wavelength 516 metres, 3000 watts.  
 3DB.—The 3DB Broadcasting Co. Pty., Ltd., Capitol House, Melbourne, wavelength 255 metres, power 500 watts.  
 1UZ.—O. J. Nilsen & Co., Melbourne, wavelength 319 metres, power 100 watts.  
 4GR.—Gold Radio Electric Service, Toowoomba, Queensland, wavelength 294 metres, power 100 watts.  
 5KA.—Sport Radio Broadcasting Station, Adelaide, wavelength 250 metres, power 1000 watts.  
 5DN.—5DN Pty., Ltd., Adelaide, wavelength 313 metres, 500 watts.

**2 UW, SYDNEY**

Sandel Radio, Ltd.  
 Wave Length, 267 Metres.

Friday

**MORNING SESSION.**

9 a.m.—News, Shipping, mails, studio items.  
 9.45 a.m.—Women's session.  
 9.59 a.m.—Resume of forward programme.  
 10 a.m.—Close down.  
 12.15 p.m.—Special employees Luncheon session.  
 12.45 p.m.—Close down.

**AFTERNOON SESSION.**

2 p.m.—Studio selections.  
 2.59 p.m.—Resume of forward programme.  
 3 p.m.—Close down.

**EVENING SESSION.**

5 p.m.—Studio items.  
 5.59 p.m.—Resume of forward programme.  
 6 p.m.—Close down.

**NIGHT SESSION.**

7 p.m.—Studio chimes.  
 7.2 p.m.—Where to Go.  
 7.10 p.m.—Studio selections.  
 7.30 p.m.—Mrs. A. Dalton, pianoforte solos. Selection from: "Maid of the Mountains" (Lilman).  
 7.3 p.m.—Constance Cooper, soprano:  
 (a) "Robin Adair."  
 (b) "Open thy Blue Eyes" (Massinet).  
 7.42 p.m.—Studio selections.  
 7.47 p.m.—Mrs. A. Pearce, violin solos:  
 (a) Selected.  
 (b) Selected.  
 7.53 p.m.—Studio selection.  
 7.58 p.m.—Resume of forward programme.  
 8 p.m.—Clock chimes.  
 8.2 p.m.—Miss Constance Cooper, soprano: Selected.  
 8.7 p.m.—Mrs. A. Dalton, pianoforte solo:  
 (a) "Valse Parisienne" (Roberts).  
 (b) "Barcarolle" Tales of Hoffman (Offenbach).  
 8.15 p.m.—Miss Constance Cooper, soprano: Selected.  
 8.19 p.m.—Studio selection.  
 8.24 p.m.—Mrs. A. Pearce, violin solo, selected.  
 8.29 p.m.—Studio selections.  
 8.39 p.m.—Jeanette Paterson, pianoforte solo:  
 "Etude in C. Minor" (Chopin).  
 8.44 p.m.—G. F. Manuel, tenor:  
 (a) "Mary of Argyll."  
 (b) "Maire my Girl."  
 8.50 p.m.—Studio selection.  
 8.55 p.m.—Weather forecast and news items.  
 9 p.m.—Clock chimes.  
 9.2 p.m.—News items.  
 9.5 p.m.—G. F. Manuel, tenor:  
 "I'll sing thee song of Araby."  
 9.8 p.m.—Miss Jeanette Paterson, pianoforte solo:  
 "Shadow Dance" (McDowall).  
 9.14 p.m.—Studio selection.  
 9.19 p.m.—G. F. Manuel, tenor:  
 "Speak to me only with thine eyes"  
 9.24 p.m.—Studio selections.  
 9.30 p.m.—God Save the King.

**3LO, MELBOURNE.**

Friday.

Broadcasting Co. of Aust.  
 Wave Length, 371 Metres.

**MIDDAY SESSION.**

12 noon.—Melbourne Observatory time signal.  
 12.1 p.m.—Metal prices received by the Australian Mines and Metals Association from the London Stock Exchange this day. Reuter's and the Australian Press Association cables. British official wireless news from Rugby. "Argus" news service.  
 12.20 p.m.—STUDIO QUARTET:  
 Musical Melange, "Creme de la Creme" arr. (Tobani).

There is no "just-as-good" as Burgess,



12.30 p.m.—BERNARD THOMAS, tenor:  
 "Until" (Sanderson);  
 "Marcheta" (Schertzingler).  
 12.37 p.m.—Stock Exchange information.  
 12.40 p.m.—REGINALD BRADLEY, violin:  
 "Midnight Bells" (Husserger).  
 12.47 p.m.—STUDIO QUARTET:  
 Overture, "The Feast of Lanterns" (Langey)  
 1 p.m.—Melbourne Observatory time signal.  
 "Time is short, your obligations are infinite. Are your homes regulated, your children instructed, the afflicted relieved, Remember, the only way to be loved is to appear lovely; to possess and display kindness."  
 1.1 p.m.—Description of INTERSTATE CRICKET MATCH, Victoria v. New South Wales, at Melbourne Cricket Ground, by Mr. Rod McGregor.

FROM THE STUDIO.

1.11 p.m.—DAVID GRAHAME, baritone (by permission of J. C. Williamson, Ltd.):  
 "When a Maiden Takes Your Fancy" (Mozart).  
 "Youth" (Allitsen).  
 1.18 p.m.—Meteorological information. Weather forecast and rainfall for Victoria, Tasmania, South Australia and New South Wales. Ocean forecasts. River reports.  
 1.25 p.m.—STUDIO QUARTET:  
 "Musical Scenes from Switzerland" (Langey).  
 1.35 p.m.—BERNARD THOMAS, tenor:  
 "Moonlight and Roses" (Moret).  
 "I Hear a Thrush" (Cadman).  
 1.42 p.m.—STUDIO QUARTETTE:  
 "Sounds from Italy" (Kretschmer).  
 1.50 p.m.—DAVID GRAHAM, baritone:  
 "In Happy Moments" (H. V. Wallace).  
 "Arise, O Sun" (M. C. Day).  
 1.55 p.m.—Announcements.  
 2 p.m.—Close down.  
 2 p.m.—Description of INTERSTATE CRICKET MATCH, Victoria v. New South Wales, at Melbourne Cricket Ground by Mr. Rod McGregor.  
 2.30 p.m.—Close down.  
 2.45 p.m.—Description of INTERSTATE CRICKET MATCH, Victoria v. New South Wales, at Melbourne Cricket Ground, by Mr. Rod McGregor.

AFTERNOON SESSION.

3 p.m.—Melbourne Observatory time signal.  
 3.1 p.m.—STUDIO QUARTET:  
 "Three Eastern Sketches" (Hawgill).  
 3.10 p.m.—MISS FRANCES FRASER:  
 "Dickens and Christmas Time."  
 3.25 p.m.—ALBERT CARLISLE, tenor (by permission of J. C. Williamson, Ltd.):  
 "Ma Pari Tutt Amor."  
 "Kashmiri Song" (Finden).  
 3.32 p.m.—STUDIO QUARTET:  
 "Pierrot" (Berger).  
 3.39 p.m.—NELLIE JUDGES, soprano (by permission of J. C. Williamson, Ltd.):  
 "Stay with Me, Summer" (C. Morris).  
 "Here in the Quiet Hills" (Gamm).  
 3.45 p.m.—STUDIO QUARTET:  
 Medley, "A Musical Critic's Dream" (Dix).  
 3.53 p.m.—Description of INTERSTATE CRICKET MATCH, Victoria v. New South Wales, at Melbourne Cricket Ground, by Mr. Rod McGregor.  
 4.3 p.m.—ALBERT CARLISLE, tenor:  
 "In the Garden of To-morrow" (Deppin).  
 "A Love Nest Just for Two" (Lohr).  
 4.10 p.m.—STUDIO QUARTET:  
 "Santa Claus Suite" (Holland).  
 4.20 p.m.—NELLIE JUDGES, soprano:  
 "I Love the Moon" (Rubens).  
 "Musetta's Valse Song" (Puccini).  
 4.27 p.m.—MRS. M. CALLAWAY MAHOOD:  
 The Study and Use of Color—"Yellow."  
 4.45 p.m.—"Herald" news service. Stock Exchange information.  
 5 p.m.—Description of INTERSTATE CRICKET MATCH, Victoria v. New South Wales, at Melbourne Cricket Ground, by Mr. Rod McGregor.  
 5.20 p.m.—Close down.

EVENING SESSION.

5.30 p.m.—Answers to letters and Birthday Greetings by "BILLY BUNNY."  
 5.50 p.m.—Description of the final of to-day's INTERSTATE CRICKET MATCH, Victoria v. New South Wales, from Melbourne Cricket Ground, by Mr. Rod McGregor.  
 FROM THE STUDIO.  
 6 p.m.—Me'e greetings by "BILLY BUNNY."  
 6.7 p.m.—CLIFF BRADSHAW:  
 Carols for the Children.  
 6.14 p.m.—CAPT. DONALD MacLEAN:  
 Jolly Roger Gentlemen.  
 6.34 p.m.—"BILLY BUNNY":  
 More about Treasure Seekers.  
 6.40 p.m.—Official report of Newmarket stock sales by the Associated Stock and Station Agents, Bourke Street, Melbourne.  
 6.45 p.m.—"Herald" news service. Weather synopsis. Shipping movements.  
 6.52 p.m.—Stock Exchange information.  
 6.57 p.m.—Fish market reports, by J. R. Borrett, Ltd. Rabbit prices.  
 6.59 p.m.—River reports.  
 7.2 p.m.—Market reports by the Victorian Producers' Co-operative Co., Ltd. Poultry, grain, hay, straw, jute, dairy produce, potatoes and onions. Market reports of Fruit by the Victorian Fruiterers' Association. Retail prices. Wholesale prices of fruit by the Wholesale Fruit Merchants' Association. Citrus fruits.

NIGHT SESSION.

7.15 p.m.—MISS E. G. HARRIS, Publicity Officer of the Kindergarten Union will speak on:  
 "The Work of the Free Kindergartens."  
 7.30 p.m.—BRUNSWICK CITY BAND:  
 Overture, "The Great City" (Dawson).  
 7.40 p.m.—BERNARD THOMAS, tenor:  
 "Adieu Marie"  
 "Macushia" (MacMurrrough).  
 7.47 p.m.—MR. H. K. LOVE:  
 "Technicalities."  
 Mr. Love will be glad to attend to your wireless difficulties, and we ask you to write to him for any advice that you may require.  
 7.57 p.m.—BRUNSWICK CITY BAND:  
 Grand Chorus, "Hallelujah" (Handel).  
 8.4 p.m.—VAUDE AND VERNE, entertainers:  
 "Jolly Jokes."  
 8.14 p.m.—THE FRENCH BROS., banjoists:  
 "Blue Skies."  
 "Kentucky Babe."  
 8.20 p.m.—JESSIE IRWIN, soprano:  
 "The Waltz Song from Tom Jones" (German).  
 "Butterflies and Lilac" (Doadas).

NEW ZEALAND STATIONS:

1YA, Auckland, The Radio Broadcasting Co. of New Zealand, Ltd.  
 Power 500 Watts; Wave-length, 333 Metres. Silent Night, Monday.  
 2YA, Wellington, The Radio Broadcasting Co. of New Zealand, Ltd.  
 Power 5000 Watts; Wave-length, 420 Metres.  
 3YA, Christchurch, The Radio Broadcasting Co. of New Zealand, Ltd.  
 Power 500 Watts; Wave-length, 306 Metres. Silent Night, Thursday.  
 4YA, Dunedin, The Radio Broadcasting Co. of New Zealand, Ltd.  
 Power 750 Watts; Wave-length, 463 Metres.

8.27 p.m.—BRUNSWICK CITY BAND:  
 Selection, "The Cross of Jerusalem."  
 8.37 p.m.—HAROLD ELVINS, piano:  
 1. "Barcarolle" (Raff).  
 2. "Caprice" (St. Saens-Gluck).  
 3. "Minuet" (Zanella).  
 4. "Concert Study" (Goddard).  
 8.57 p.m.—Announcements.  
 The Royal Automobile Club of Victoria's Safety Message for to-day is for ALL DRIVERS. "Don't unnecessarily obstruct another driver by holding to the centre of the road after receiving his signal that he wishes to pass."  
 9.2 p.m.—BRUNSWICK CITY BAND:  
 Intermezzo, "Les Gloches de St. Maie" (Rimmer).

3AR, MELBOURNE

Associated Radio Co.

Wave Length, 484 Metres.

Friday.

MORNING NEWS SESSION.

11 a.m. to 12 noon.

MIDDAY CONCERT SESSION.

12.1 p.m.—Transmitted from Panatrophe House, 252 Collins Street (by exclusive permission of Willis and Paton Ltd.) on the Brunswick Panatrophe.  
 1 p.m.—Newmarket stock sales. Special "Snap" progress report on the progress of this morning's stock sales at Newmarket (by courtesy of John Macnamara and Co). To be repeated at 2.30 specially for our Country listeners.  
 1.2 p.m.—Close down.

MATINEE SESSION.

DANCE CONCERT.

2.30 p.m.—Newmarket Stock Sales. Special "Snap" progress report direct from the yards (by courtesy of John Macnamara and Co.).  
 2.31 p.m.—Studio Orchestra.  
 "Stars of the Desert" (Woodforde-Finden).  
 2.45 p.m.—Mr. Tom White, clarinet and Mr. Herbert Pettifer, violin.  
 Instrumental Duet: "Lo, hear the gentle lark" (Bishop).  
 2.4 p.m.—Ayaz Danzonians.  
 3.10 p.m.—Miss Ethel Brearley, piano:  
 "The Monastery Bells" (By request).  
 3.14 p.m.—Studio Orchestra.  
 3.25 p.m.—Mr. Arthur Shaw, baritone.  
 "Sometime when night is nigh" (trillips).  
 "Dreams of the Dusk" (d'Hardelet).  
 3.42 p.m.—Ayaz Danzonians.  
 4 p.m.—G.P.O. Clock says "Four."  
 4.1 p.m.—2nd Weather forecast.  
 4.3 p.m.—Announcements.  
 4.6 p.m.—Note: Miss Emily Noble, Cooking demonstrator of the Metropolitan University will resume her talks to house wives in January.  
 4.7 p.m.—Studio Orchestra:  
 "Melodious Memories" (Finck).  
 4.22 p.m.—Mr. Herbert Pettifer, violin.  
 "Serenade" (Pergament).  
 4.25 p.m.—Mr. Arthur Shaw, baritone:  
 "My Prayer" (Squire).  
 "Bird songs at eventide" (Cates).  
 4.32 p.m.—Studio Orchestra:  
 "Tatra Fantasy" (Leopold).  
 4.49 p.m.—Ayaz Danzonians.  
 4.55 p.m.—To-night's Entertainment.  
 5 p.m.—G.P.O. Clock says "Five."  
 Close down.

CHILDREN'S SESSION.

6.30 p.m.—The Farmyard Five.

EVENING SESSION.

XMAS CAMP-FIRE NIGHT.

7.30 p.m.—Mr. George Beattie, Principal of the Beattie College of Physical Culture—Physical Fitness.  
 7.45 p.m.—"Field Glasses" special review for tomorrow's races.  
 7.50 p.m.—Newmarket Stock sales.  
 7.55 p.m.—Week-end Tourist Guide.  
 8 p.m.—G.P.O. Clock says "Eight."

The World's Flyers carried Burgess.

- 8.1 p.m.—Instrumental Trio, piano, violin and cello:  
"Suite from India" (Poppy).
- 8.10 p.m.—Mr. Herbert Sanderson, baritone:  
"The Great Awakening" (Kramer).
- 8.14 p.m.—Mr. Jack Bell, entertainer:  
The Popular entertainer in a specially arranged performance of Leslie Harris' charming sketch:  
"Christmas Bells."
- 8.21 p.m.—Miss Violet Woolcock, violin:  
"Canto Amoroso" (Elman-Sammartini).  
"La Gitana" (Kreisler).
- 8.28 p.m.—"Irani" Brigands and Blood Series.  
The adventures of a British Secret Service officer in "The Sudan"
- 8.38 p.m.—"Ye Odle Englishe Christmas Partje."  
An original sketch specially written and produced for Radio by Mr. J. Harcourt-Bailey for the "Sundowners Radio Review Co."  
A delightful half hour of Christmassy music song and story.  
The Sundowners—Carol "Hark the Herald Angels sing."  
Mr. Robert Allen, Alto:  
"He shall feed His Flock" from The Messiah (Handel).  
Mr. Harcourt-Bailey:  
"Ghost Story" (Dickens).  
The Sundowners, Quartette:  
"Serenade" (White).  
"Kittys Disaster" (Wooler).  
Mr. Herbert Sanderson, baritone:  
"A Legend" (Tchaikowsky).  
The Sundowners:  
Carol: "Good King Wenceslas."
- 9.10 p.m.—Miss Elizabeth Lester, cello:  
"Spanish Dance—Vito" (Popper).
- 9.17 p.m.—"Round The Camp Fire" (Special Xmas Series).  
Music, story and verse by the writers and poets of Austrajasia.  
Narrator, Mr. V. Upton-Brown.
- 9.52 p.m.—The Sundowners:  
"Love is Just" (Baer).  
"Birth of the Blues" (Henderson).
- 10 p.m.—G.P.O. Clock says "Ten."
- 10.1 p.m.—Semi-Final Weather report, especially for our Country Listeners.
- 10.2 p.m.—Mr. Jack Bell, Society Comedian.  
The favorite entertainer in one of his most diverting comedy sketches:  
"At the Christmas Pantomime."  
The Dame explains her troubles.
- 10.8 p.m.—Mr. W. H. McLennan:  
"Bowls." More amusing and entertaining topicalities on Drakes' favorite pastime by a former international.
- 10.18 p.m.—Mr. Robert Gillard, bass:  
"Old Barty" (Grant) by request.
- 10.22 p.m.—Instrumental trio:  
"Musical Gems of Tchaikowsky."
- 10.32 p.m.—Mr. J. Harcourt-Bailey, Entertainer:  
Humorous Sketch: "Snorkins" (Spurr) by request.
- 10.42 p.m.—Mr. Alex Walker:  
"The Bush Mimic."  
The noted Australian mimic in some wonderful and realistic bird and animal imitations.
- 10.47 p.m.—Mr. Tom Temple and Mr. Herbert Sanderson:  
Duet: "O Lovely night" (Ronald).
- 10.51 p.m.—"Age" News Bulletin, exclusive to 3A.R.
- 10.57 p.m.—Tomorrow's Entertainment.
- 10.58 p.m.—Final weather forecast.
- 10.59 p.m.—Our Australian Good Night Quote is from the poem, "The Circling Hearths" by Roderic Quinn.  
"Six hearths are circled round our shores, and round  
The six hearths group a common race,  
Though leagues divide, the one light on their face;  
The same old songs and stories rise; the sound  
Of kindred voices and the dear  
Old English tongue make music; and men move  
From hearth to hearth with little fear  
Of aught save open arms and love."
- 11 p.m.—G.P.O. Clock says "Eleven."  
God Save the King.

**4QG, BRISBANE**  
Queensland Radio Service  
Wave Length, 385 Metres.  
Friday.

**MIDDAY SESSION.**  
1 p.m.—Market reports; weather information; "The Daily Mail" and "The Daily Standard" news.  
1.20 p.m.—Lunch hour music.  
1.58 p.m.—Standard time signal.  
2 p.m.—Close down.

**AFTERNOON SESSION.**  
3.30 p.m.—A programme of music from the studio.  
4.15 p.m.—"The Telegraph" News, Weather, news.  
4.30 p.m.—Close down.

**EARLY EVENING SESSION.**  
6 p.m.—"Daily Standard" news; weather information; announcements.  
6.10 p.m.—A talk on the teeth—"A General Discussion"—by Mr. W. G. Illingworth (Dental Surgeon).  
6.30 p.m.—Bedtime stories by "The Sandman."  
7 p.m.—Market reports; stock reports.  
7.30 p.m.—Weather news; announcements.  
"Daily Standard" news.  
7.43 p.m.—Standard time signal.  
7.45 p.m.—A review of to-morrow's racing.

**NIGHT SESSION.**  
To-night's programme will be in the form of a jazz night.  
During the evening dance music will be played by Alf Featherstone and his Studio Syncopators.  
Between dance items vocal and instrumental numbers will be provided by the following:  
Mr. and Miss Griffiths—some Christmas music on an English Concertina.  
The Hawaiian Melody Makers in selected numbers.  
Contralto solo:  
"Sleepy Hollow Tune" (Kountz).  
Miss Laura Loch,  
Soprano solo: "Give" (Lohr).  
Miss Jean McDougall.  
Pianoforte solo: "Rondo Brillante" (Weber).  
Miss Duleie Sampson.  
Soprano solo: Selected.  
Mrs. H. Huysh.  
Between 9.30 p.m. and 10 p.m. there will be jazz music only.  
10 p.m.—FROM THE STUDIO:  
"The Daily Mail" news.  
Weather News.

**FOREIGN BROADCASTERS**

- JOCK**—Nagoya Radio Broadcasting Co., Nagoya, JAPAN: 360 metres, 1000 watts. (Announcement in English and Japanese).
- JOBK**—Osaka Central Broadcasting Co., Osaka, JAPAN: 385 metres, 1000 watts. (Announcement in English and Japanese.)
- JOAK**—Tokyo Broadcasting Co., Tokyo, JAPAN, 375 metres, 1000 watts. (Announcement in English and Japanese.)
- JFC**—Bataviasche Radio Vereeniging, BATAVIA, 220 metres, 40 watts.
- KZRM**—Manila, PHILIPPINE ISLANDS: 413 metres, 1000 watts. (Announcement in English and Philippine.)
- KGU**—"Honolulu Advertiser," Honolulu, HAWAII, 270 metres, 500 watts.
- KGO**—Oakland, CALIFORNIA: 361.2 metres, 5000 watts.
- KFI**—Los Angeles, CALIFORNIA. 467 metres, 5000 watts.
- KOA**—Denver, COLORADO: 322.4 metres, 5000 watts.

**5CL, ADELAIDE**  
Central Broadcasters, Ltd.  
Wave Length, 395 Metres.  
Friday.

**MIDDAY SESSION.**  
12 noon.—G.P.O. chimes.  
12.1 p.m.—General information and "Advertiser" news service.  
12.30 p.m.—Musical numbers from the studio.  
12.50 p.m.—S. C. Ward and Co.'s Stock Exchange Intelligence.  
12.57 p.m.—Meteorological information.  
1.1 p.m.—Entertainment for sick children.  
1.30 p.m.—Musical numbers from the studio.  
1.57 p.m.—Meteorological information  
2 p.m.—Chimes and close down.

**AFTERNOON SESSION.**  
3 p.m.—G.P.O. Chimes.  
3.1 p.m.—Orchestral selections from the Maple Leaf Cafe.  
3.30 p.m.—Orchestral selections from Foy and Gibson's Showrooms.  
4.30 p.m.—Orchestral selections from Arcadia Cafe.  
4.57 p.m.—S. C. Ward and Co.'s Stock Exchange Intelligence.  
5 p.m.—G.P.O. Chimes and close down.

**EVENING SESSION.**  
6 p.m.—G.P.O. Chimes.  
6.1 p.m.—Dinner Music by the Covent Garden Orchestra.  
6.30 p.m.—Children's time.  
6.55 p.m.—Banjo solo, Hedley Smith.  
7 p.m.—Song, Mary Rainbow.  
7.5 p.m.—Pianoforte solo, Hedley Smith.  
7.10 p.m.—Quartette by the Kiddytime Quartette Party.  
7.15 p.m.—Banjo solo, Hedley Smith.  
7.20 p.m.—S. C. Ward and Co.'s Stock Exchange Intelligence. Market reports by A. W. Sandford and Co., A. E. Hall and Co., Dalgety and Co., S. A. Farmers Co-operative Union, Taylor Bros. Retail Grocers' Association, J. H. Young's special report on the Tomato Market.  
7.30 p.m.—Extracts from "News Bulletin" supplied by Commonwealth Minister of Markets and Migration.  
7.48 p.m.—"Willow" will talk on Cricket.  
8 p.m.—G.P.O. chimes.  
8.1 p.m.—Orchestral selections by Malcolm Reid's Orchestra relayed from Warehouse.  
8.20 p.m.—Soprano solo, Linda Wald.  
8.25 p.m.—Orchestral selection by Malcolm Reid's Orchestra.  
8.40 p.m.—Soprano solo, Linda Wald.  
8.45 p.m.—Orchestral selections by Malcolm Reid's Orchestra.  
9 p.m.—G.P.O. Chimes.  
9.1 p.m.—Meteorological information.  
9.3 p.m.—Dalgety's Wheat report.  
9.5 p.m.—Bass solo: Harold Durdin.  
9.9 p.m.—Banjo solo and Violin solo: Percy Gardner.  
9.17 p.m.—Comedy: Will Runge.  
9.26 p.m.—Bass solo: Harold Durdin.  
9.30 p.m.—Mr. D. L. Laurie (Poultry Expert): Talk on "Summer Hatching."  
9.45 p.m.—Mandolin Solo: Percy Gardner.  
9.48 p.m.—Comedy: Will Runge.  
9.57 p.m.—Baritone solo: Harold Durdin.  
10 p.m.—G.P.O. Chimes.  
10.1 p.m.—"Advertiser" General News Service.  
10.15 p.m.—Baritone solo: Harold Tideman.  
10.18 p.m.—Violin solo and Banjo solo: Percy Gardner.  
10.26 p.m.—Baritone solo: Harold Tideman.  
10.30 p.m.—Relay from the Maacon De Danse, Glenelg Dance selections.  
10.55 p.m.—Saturday's programme and Meteorological information.  
11 p.m.—G.P.O. Chimes and National Anthem.

Ask for the New 83X Philco Battery.

**6WF, PERTH**

Westralian Farmer's.  
Wave Length, 1250 Metres.

Friday.

- 12.30 p.m.—Tune in.
- 12.35 p.m.—Markets, News, and Cables.
- 1 p.m.—Time signal from Perth Observatory.
- 1.1 p.m.—Weather notes supplied by the Meteorological Bureau of Western Australia.
- 1.2 p.m.—Studio Quintette:
- 2 p.m.—Close down.
- 3.30 p.m.—Tune in.
- 3.35 p.m.—Organ music relayed from the Grand Theatre, Murray Street.
- Vocal interludes from the Studio.
- 4.30 p.m.—Close down.

**EVENING SESSION.**

- 6.45 p.m.—Tune in.
- 6.50 p.m.—Musical evening for the Kiddie by Uncles Henry and Duffy.
- 7.20 p.m.—Stock, Markets, News.
- 7.45 p.m.—Racing talk by the Sporting editor of "Truth" Newspaper Co.
- 8 p.m.—Time signal from Perth Observatory.
- 8.1 p.m.—Weather notes supplied by the Meteorological Bureau of Western Australia.
- Station announcements, such as alterations to programmes, etc.

**POPULAR NIGHT.**

- 8.3 p.m.—Musical programme, from the studio, including vocal and instrumental artides:
- 8.50 p.m.—Talk: "Surf Work and Life Saving" by Mr. C. Bader, President City of Perth Surf Club.
- Orchestral Music, played by the Grand Symphony Orchestra, conducted by Mr. Val. Smith, relayed from the Grand Theatre, Murray Street.
- 10 p.m.—Late news items by courtesy of "The Daily News" Newspaper Co.
- Ships within Range announcement.
- Weather report and forecast.
- 10.30 p.m.—Close down.

**104.5 METRE TRANSMISSION.**

Simultaneous broadcast on 104.5 metres of Programme given on 1250 Metres, commencing at 6.45 p.m.

**7ZL, HOBART**

Tasmanian Broadcasters, Ltd.  
Wave Length, 516 Metres.

Friday

**MORNING SESSION.**  
11 a.m. to 12 noon.

**AFTERNOON SESSION.**

- 3 p.m.—G.P.O. Clock chimes the hour.
- 3.1 p.m.—Tune in selection.
- 3.5 p.m.—Hobart Stock Exchange Quotations.
- Weather information.
- Items of interest; announcements.
- 3.15 p.m.—Selections by 7ZL Studio Trio:
- March: "National Game" (Souza).
- "Gondola d'Amore" (Candiolo).
- Selection: "Quaker Girl" (Moncton).
- Violin solo: Selected. (Mr. E. J. McCann).
- "Hungarian Eplode" (Bendix).
- Piano solo: Selected. (Mr. A. Roberts).
- "Dreams of Yesterday" (Humphries).
- 4.15 p.m.—Educational Talk.
- 4.30 p.m.—Close down.

**EARLY EVENING SESSION.**

- 6.30 p.m.—Children's Corner with the "Radio Lady."
- 7.15 p.m.—Young Folks gardening chat by Mr. George Nation.

**NIGHT SESSION.**

- 7.30 p.m.—Fruit Follies and produce report through the courtesy of Roberts and Co. Hobart.
- 7.35 p.m.—Gardening talk by Mr. George Nation—Glen Nurseries Cascades.

- 7.50 p.m.—"Mercury" special Tasmanian news service. Railway auction produce sales. Weather forecasts. Hobart Stock Exchange quotations.
- 8 p.m.—G.P.O. Clock chimes.
- 8.1 p.m.—Selections by 7ZL Studio Trio:
- "Minuet Beau Brommel" (Young).
- "Caprice Rege Dunsolo" (Brice).
- "Gavotte Premiere Tendresse" (Mouton).
- Clarinet Solo: Selected. (Mr. A. Cadda).
- "Romance, A tale of Two Hearts" (Roberts)
- Songs of Carrie Jacobs-Bond:
- "Berceuse" "Rose Blushed" (Drill).
- Pianoforte solo: Selected. (Mr. A. Roberts).
- "An Odd number" (Davis).
- Intermezzo: "Spirit of Youth" (Dahlquist).
- "Two Tsigan Dances" (Jacobs Bond).
- Interspersed with items from the following:
- Miss Mona McGuffie (soprano).
- Miss Dulcie Tate. (elocutionist).
- Miss Ruby Plesse (pianist).
- Miss Norah Freney (soprano).
- Mr. George Hook (comedian).
- Mr. Harry Bates (tenor).
- Mr. Vincent Webb (comedian).
- 9.30 p.m.—Chat on Cricket by "Mid-off."
- 9.40 p.m.—British Official Wireless News.
- 9.50 p.m.—"Mercury" special Interstate news service.
- Ships within wireless range.
- Tasmanian District Weather reports.
- Weather forecasts.
- Travellers week-end information.
- National Anthem.

- 1 p.m.—"Big Ben."
- Weather intelligence.
- 1.3 p.m.—"Evening News" midday news service.
- 1.20 p.m.—Studio music.

**AFTERNOON SESSION.**

NOTE: During the afternoon descriptions and results of the A.J.C. Meeting at Randwick will be given by the 2FC Racing Commissioner.

Intervals of Racing and Cricket will be filled with musical items as follows:

From the Crystal Palace Theatre, George Street, Sydney:

Orchestral music.

From the Studio:

Cliff Arnold, novelty pianist.

Syd Montigue, ukulele numbers.

4.30 p.m.—Complete resume of the day's Sporting Events.

5 p.m.—"Big Ben." Close down.

**EARLY EVENING SESSION.**

- 5.40 p.m.—The chimes of 2FC.
- 5.45 p.m.—The "Hello Man" talks to the children.
- 6.30 p.m.—Story time for the young folk.
- 6.40 p.m.—Studio music.
- 7 p.m.—"Big Ben." Weather intelligence.
- 7.3 p.m.—Late sporting news.
- 7.15 p.m.—"Evening News" late news service.
- 7.25 p.m.—Studio music.

**NIGHT SESSION.**

- 7.33 p.m.—Programme announcements.
- 7.35 p.m.—Lionel Lunt, English baritone.
- 7.45 p.m.—"Let's go around the World," a talk by the Rev. F. H. Raward. The third of the series.
- 7.59 p.m.—Announcement.
- 8 p.m.—"Big Ben."
- From St. Andrew's Cathedral, by arrangement with the Very Rev. Dean Talbot: Christmas Carols by St. Andrew's Cathedral Choir.
- 8.30 p.m.—From the Studio:
- Mr. Scott Alexander will present for the first time in the history of Radio a real old-fashioned Christmas Pantomime, specially written for 2FC by Codrington Hall, entitled

**"CINDERELLA."**

Act I:

- Scene 1. The Haunted Corridor.
- Scene 2. The Fairy Glen—where Cinderella meets the Prince, and helps the old witch to gather sticks.
- Scene 3. The bad Baron's library.
- Scene 4. The Kitchen. Invites for the ball.
- Cinderella and the page left at home—the Fairy's arrival. Cinderella becomes a Royal Princess and goes to the ball.
- 9.10 p.m.—SCROOGE:

**A Christmas Carol**

- by Charles Dickens, adapted especially for broadcasting by Maurice Dudley.
- CHARACTERS.**
- Ebenezer Scrooge ... MAURICE DUDLEY
- Bob Cratchitt (his Clerk) ... EDWIN J. LEWIS
- Fred Wayland (his nephew) ... ALAN BELL
- Mr. Worthington
- Mr. Middlemark ..... H. M. HILL
- GHOST OF JACOB MARLEY**
- J. HOWLETT ROSS
- The Cratchitt children.
- Martha ..... KATE CUTLER
- Bella ..... MYRA MATHESON
- Peter ..... SYD DALE
- Tiny Tim ..... PAT McLEAN
- The Boy Schooge ..... PAT McLEAN
- Fanny (his sister) ..... AILSA CAVAN
- Scrooge's Sweetheart ... MRS. DUDLEY
- Mrs. Cratchitt ..... MRS. DUDLEY
- Produced by Maurice Dudley.
- Incidental Music arranged by Wm. G. James.
- 9.47 p.m.—BERNARD THOMAS, tenor:
- "If With All Your Hearts" (Cooper).
- "Cujus Animum" (Rossini).

**Saturday, Dec. 42**  
**2FC, SYDNEY.**

**EARLY MORNING SESSION.**

7 a.m. to 8 a.m.

**MORNING SESSION.**

10 a.m. to 11.30 a.m.

**MIDDAY SESSION.**

- 12 noon—"Big Ben" and announcements.
- 12.2 p.m.—Stock Exchange, first call.
- 12.3 p.m.—Studio music.
- 12.20 p.m.—"Sydney Morning Herald" news service.
- 12.32 p.m.—Rugby wireless news.
- 12.35 p.m.—Studio music.

NOTE: From 11.30 a.m. results and descriptions of the Cricket Match, New South Wales versus Tasmania, direct from the Sydney Cricket Ground.

*Short Wave Broadcasters*

Schedules and Wavelengths Subject to Change.

- 2NM, Gerald Marcuse, Caterham, England, 23 and 33 metres (B.B.C. Programmes).
- PCJJ, Phillips' Experimental Station, Eidenhoven, Holland, 30.2 metres (B.B.C. Programmes).
- 2XAF, General Electric Co., Schenectady, New York State, U.S.A., 22.77 metres (W.G.Y. Programmes).
- 2XAG, General Electric Co., Schenectady, New York State, 14, 26 and 52 metres (W.G.Y. Programmes).
- KDKA, Westinghouse Electric Co., Pittsburgh, Penn., U.S.A., 63.5, 14 and 42 metres.
- WLW, Crosley Radio Corporation, Cincinnati, Ohio, U.S.A., 52 metres.
- 2XAL, "Radio News," New York City, U.S.A., 30.91 metres (WRNY Programmes).
- JB, Johannesburg Broadcasting Company, South Africa, 20 and 23 metres.
- 5SW, Marconi Company, Chelmsford, England, 24 metres.
- RPN, Moscow, U.S.S.R., 29 metres.

Perfect Reception Every Day Possible with Philco.

# AIRZONE REINARTZ COIL

A Coil to suit everybody's means  
Made from the best of materials by

**AIRZONE LIMITED**

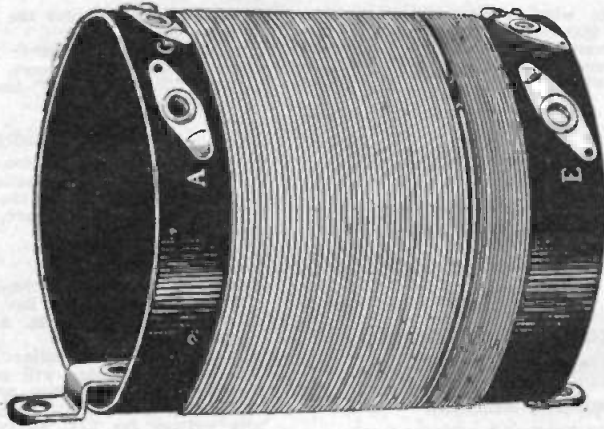

This unit is wound with silk enamel wire on a bakelite former. All terminals are engraved with designating letters.

*Obtainable from all Dealers.*

**Price, 15/-**

**A Circuit Diagram With Every Coil.**

Sales Agents to the Trade—

**Manufacturers' Products Pty. Ltd.,**

(H. J. HAPGOOD.)

Challis House, 4 MARTIN PLACE, SYDNEY.

Phone: BW 1328.

## WANTED.

Young Man capable of handling sales (to trade) of sets, parts and accessories. Preference to one who can do small repairs, if necessary. Apply, stating experience and salary required, to "Radio Wholesale," c/o "Wireless Weekly" office.

## GENERATORS NEW.

Imported for starting sets for Ford Motor Cars, £23/- each. Have been used for making miniature Motor Cars, etc.

**LARKE, HOSKINS, LTD.,**  
177 WILLIAM STREET, SYDNEY.

## TRANSFORMERS

Built up to a specification and wound, lamination iron cut to any size from stock. Prices and estimates on application.

**O'DONNELL, GRIFFIN & CO., LTD.,**  
53 Druitt Street, SYDNEY.  
Phones: C 4545 and 4546.



Registered Trade Mark.

Published by Arthur William Watt, of "Folkestone," Lavender Street, Lavender Bay, for the Proprietors, Wireless Newspapers Limited, 51 Castlereagh Street, Sydney; and printed by Marchant & Co., Ltd., 84a Goulburn Street, Sydney.

The Editor will be glad to consider Technical and Topical Articles of interest to Australian Readers. All Manuscripts and Illustrations are sent at the author's risk, and although the greatest care will be taken to return unsuitable matter (if accompanied by stamps), the Editor cannot accept responsibility for its safe return.

Subscription rates.—Twelve months, (52 issues), 15/- post free. Six months, (26 issues), 6/6 post free. Single copies 3d, each, or post free, 4d. Subscriptions should be addressed to Wireless Newspapers Ltd., 51 Castlereagh Street, Sydney.

Advertising:—Our advertising representative keeps in close touch with advertisers, and he is ready at all times to supply information concerning advertising.

Agents in Great Britain:—The Colonial Technical Press Ltd., Dudley House, Southampton Street Strand, W.C.2.

"Wireless Weekly" is fully protected by copyright, and nothing that appears in it may be reprinted, wholly or in part, without special permission. The use of our articles or quotations from them for any purpose whatsoever is never permitted without our written authority.

# IN 1985

## A UNIQUE OPPORTUNITY

To gain a beautiful and valuable moment of radio's "Golden Era".

**EXCITING VINTAGE RADIO KITSETS!**  
**FULLY WORKING RECEIVERS WITH ALL THE POLISHED WOOD, BAKELITE AND BRASS APPEAL OF THE PIONEERING DAYS OF "WIRELESS".**

**THE SETS ARE A PLEASURE TO BUILD & USE AND ALSO MAKE SUPERB DISPLAY ITEMS.**

**UNIDYNE**  
— MODE 1A —  
 one valve

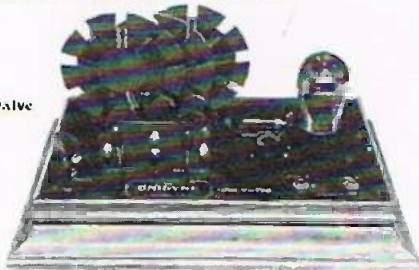

Our original and most popular kit. Over 200 have now been built by enthusiasts around the world. It has been praised both for its appearance and performance. Powered by easy to get batteries. Remaining stocks of the early valve and other parts used in this kit, make it definitely a LIMITED EDITION.

**KIT \$85.00**  
**FULLY BUILT \$135.00**

ALL PARTS AND FULL INSTRUCTIONS

The kits come with fully finished Bakelite panels and woodwork. You need only to follow the easy assembly and wiring instructions to complete your kit. Fully built sets are tested and ready to operate.

**HEADPHONES** — these are required for each kit. If you do not have your own we have available early-type 'phones which complement the vintage designs perfectly.



**STC 3400 Ω**  
**SENSITIVE AND RUGGED \$14.95.**



**BROWNS 4000 Ω**  
**SUPERSENSITIVE \$17.50**  
 Ideal for Crystal Sets.



**P.S.A. 1**  
**A & B SUPPLY WITH AUDIO AMP & SPEAKER**  
**\$39.50**  
 (includes 9V-AC plugpack)

ALL PARTS AND FULL INSTRUCTIONS

### PERSPEX DISPLAY COVERS

These are available as an easily assembled kit and give the sets a real "Museum Piece" appearance as well as protecting them from dust.

**KIT \$19.50**



The Unidyne shown with cover

Tune into the world with this two valve all-wave set. Using the famous REINARTZ circuit (introduced in 1922) and featuring plug-in "spiderweb" coils (3 in the kit) and genuine early valves. Also a Limited Edition. May be powered by a battery pack or the power supply (P.S.A. 1) shown below.

**KIT \$89.50**  
**FULLY BUILT \$145.00**

the Reinartz 2

## VINTAGE COMPONENTS

### 2 VOLT FIL TRIODES

**VR 22 (220 PA) \$10.00**    **HL2k \$10.00**



**SOCKETS — \$2.00 ea.**    **210.LF \$12.00**



**COIL KIT**  
 3x plug in SPIDERWEB coils  
 Enamel and DCC wire pack  
 and data — \$14.50.

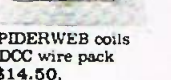

FOR THOSE WHO WANT TO GET INVOLVED IN THE GROWING "VINTAGE RADIO" HOBBY AND BUILD UP THE SETS AND CIRCUITS OF THE PAST.

### VARIOUS VALVES

**1J6 \$5**    **KT2 \$8**    **IL5 \$5**    **IH8 \$7**

**SPECIAL!**  
 One each of these  
 with sockets, data,  
 and circuits \$19.50.



**3S4 \$3**

### TAPPED SPIDERWEB COIL KIT

Incl. wire and  
 instructions  
**\$10.00**



**SPIDERWEB VARIOMETER**  
 Kit incl. wire and instructions  
**\$17.50**

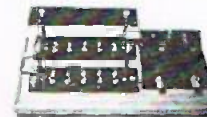

**KIT \$22.50**  
 (Batts not included)  
 Output 45V,  
 90V and 3V.

**VINTAGE BATTERY HOLDER BH 90/3**  
 Takes standard 9V and 1.5V Batteries



**AERIAL KIT 200ft. HEAVY DUTY \$15.00.**  
 With 3 Porcelain Egg Insulators  
 binding wire and instructions.

**ALSO CRYSTAL DETECTORS, DIODES, TUNING CAPACITORS, RHEOSTATS, POTS, LOW IMPEDANCE 'PHONES, KNOBS, TERMINALS, SOCKETS, IN FACT, ALMOST EVERYTHING**

**YOU MAY NEED TO RECREATE THAT OLD-TIME CIRCUIT**  
**SEND DOCUMENT SIZE S.A.E.**

**FOR CATALOGUE**  
**P & P — KITS = \$7.00**  
**— PARTS = \$5.00**

# TECHNICRAFT

ELECTRONICS

338 KATOOMBA ST. TEL. (047) 82 3418  
 KATOOMBA  
 N.S.W. 2780  
 AUSTRALIA

As seen  
on the  
radio for  
62 years.



One of Australia's most switched on companies.

# 1901 - 1985

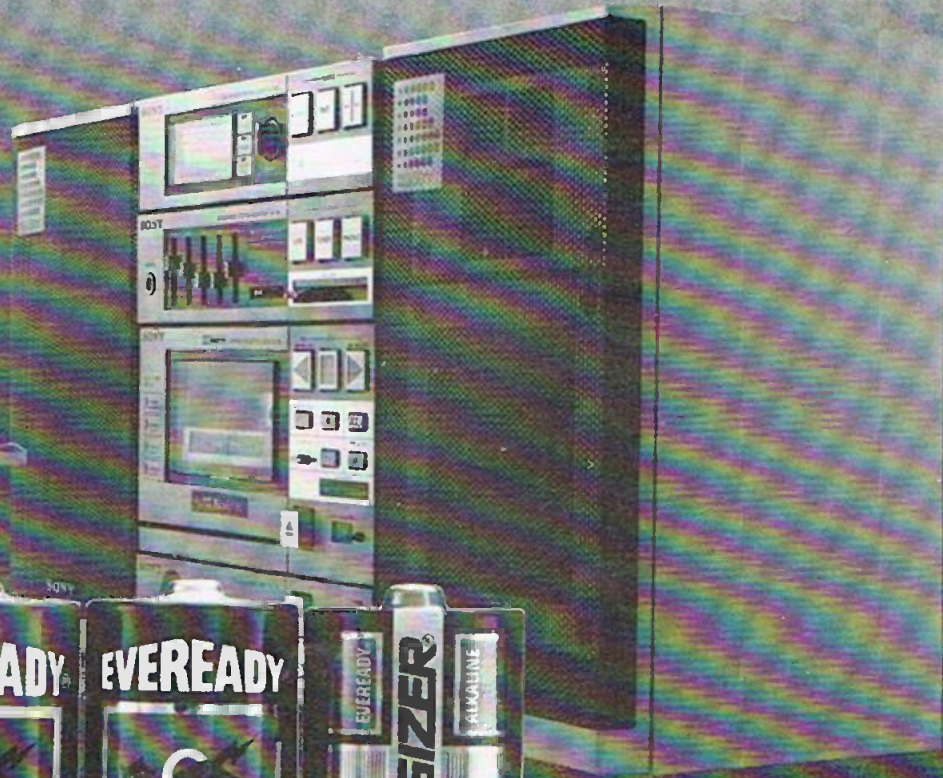

***Leaders in battery technology since 1901.***

When the first valve wireless crackled into the Australian way of life,  
Eveready was the battery Australia relied on.  
Today, Eveready are still leaders in battery design and manufacture.  
Today's advanced technology demands Eveready.



# Smart electronic components for your next challenge

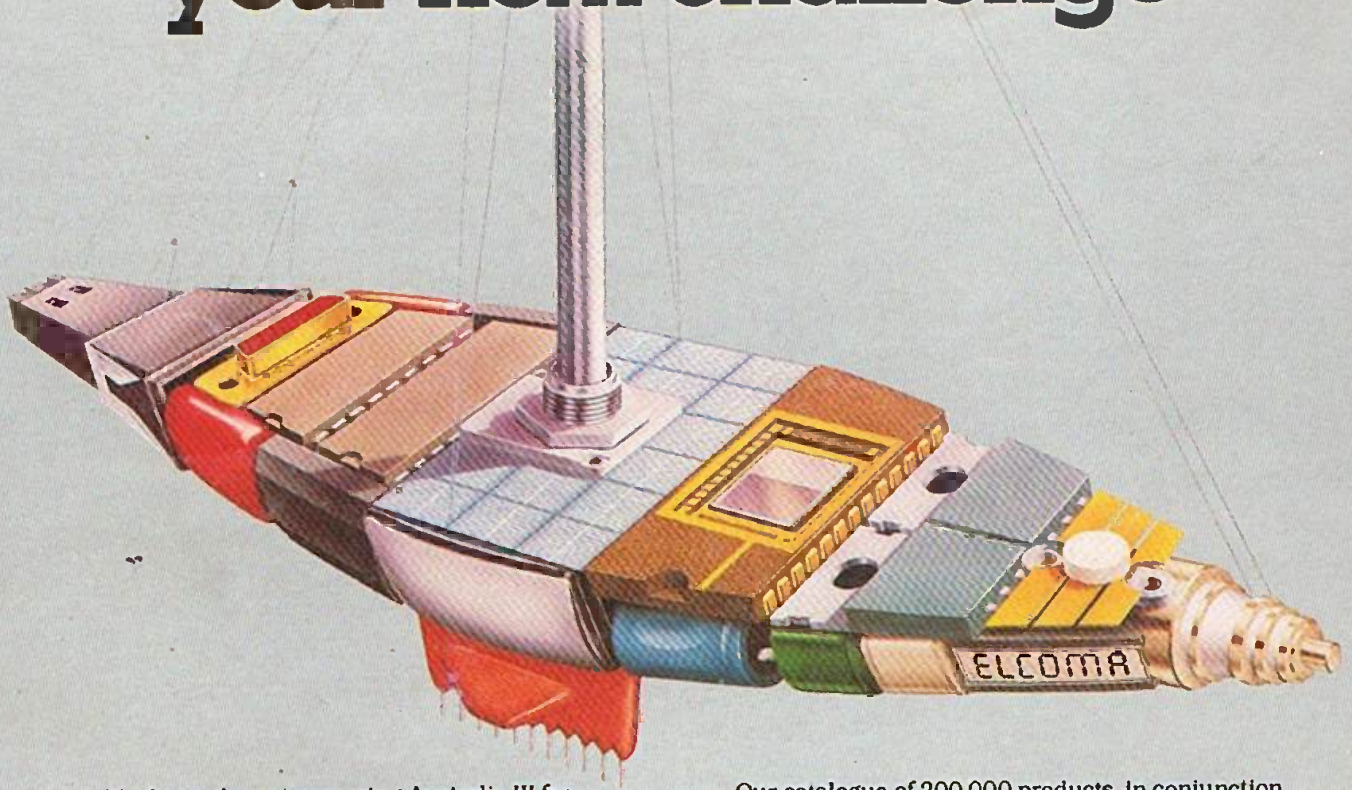

Maybe you're not preparing Australia III for the next cup challenge, but if you're an Australian manufacturer you are well aware of the international competition that you face. Their strategy and techniques to drive you out of the race will be very crafty indeed.

Perhaps you're wondering, "What could electronics really do for my product?" Up to this point, you've got by very nicely with conventional solutions. But just for a moment, think about the benefits you could offer your customers. If you build a unique product that has intelligence and is better suited to your market requirements, your product could stand head and shoulders above the rest.

Now, if you have considered electronic solutions before, but your production manager and technical advisors have said it's just not feasible to pay for the development of specialist electronics, then things have changed.

Our catalogue of 200,000 products, in conjunction with our local design laboratories, offer options and solutions to Australian manufacturers. We offer "hybrid technology" using discreet chip components with, standard or custom designed, integrated circuits. A specialist design group and factory right here in Australia can quickly give you a unique customised electronics package. Something very difficult for your competitors to copy.

Take the lead. Don't wait for your competitors to make a dash for the line, because you can win the tactical battle and carry off the prize.

Philips Elcoma are keen to join your crew.

Phone us in:

Sydney 439 3322

Adelaide 243 0155

Brisbane 44 0191

Melbourne 542 3333

Perth 277 4299

*We make electronics in Australia*



Electronic  
Components &  
Materials

# PHILIPS