

Detailed Broadcasting Programmes a Week in Advance

# Wireless Weekly 3<sup>d</sup>

INCORPORATING "RADIO IN AUSTRALIA & NEW ZEALAND"

VOL. 14. NO. 11

FRIDAY, SEPTEMBER 6, 1929

(Registered at the O.P.O., Sydney, for transmission by post as a newspaper.)



## Advances in Australian-Built Receivers

PRACTICAL BATTERY ELIMINATION

BROADCAST ENERGY DISTRIBUTION AND SERVICE AREAS

WE GET ALTERNATIVE PROGRAMMES

A King's Messenger Carrying Despatches of State —  
*Could not have been more prompt!*



"NO sooner had I hung up the receiver than your Beam messenger appeared. How do you manage your service?" So said a city business man last week who telephoned for a Beam messenger to collect his Beam Radiogram. Not an isolated case this, but one of many. For a wireless service, above all, must be efficient in every detail—and this requires a high degree of organisation. Week by week—new ideas—improved methods are being introduced by A.W.A. with but one object—better wireless communication service to the public.

# Beam it!

Amalgamated  Wireless  
(Australasia) Ltd.

AUSTRALIA'S NATIONAL WIRELESS ORGANISATION

# Stromberg-Carlson Radio



**S**TROMBERG-CARLSON receivers bring to you that realism in tone and reproduction for which they are known the world over. With all Stromberg-Carlson products, reliability and dependability are the keynotes, essentials with all radio sets, and especially so with all electric receivers. These Receivers are sold only through authorised Stromberg-Carlson dealers, who will gladly give you a demonstration without obligation.

**See and Hear the Stromberg-Carlson Range before you finally decide!**



**THE TREASURE CHEST  
ALL ELECTRIC 3**

**£27/5**  
SPEAKER EXTRA

*Obtainable from all authorised Stromberg-Carlson dealers  
Manufactured and Guaranteed by*

# Stromberg-Carlson (A/sia) LTD

72-76 WILLIAM STREET, SYDNEY.

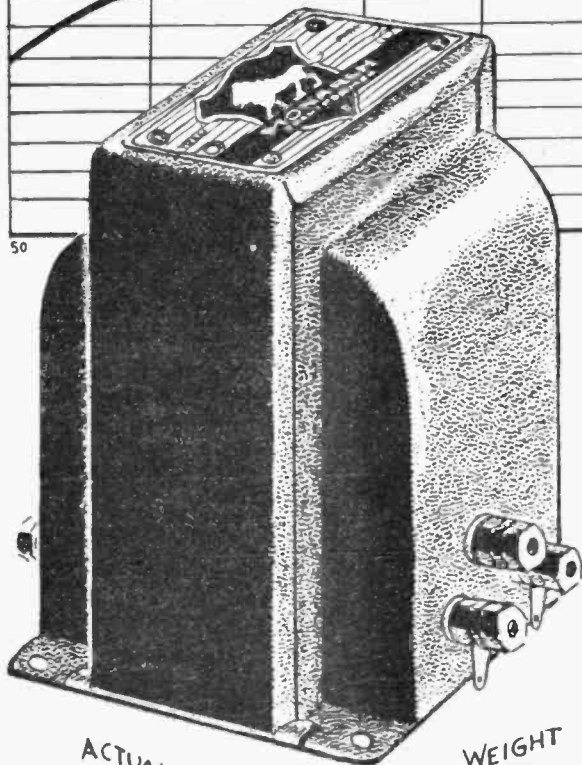
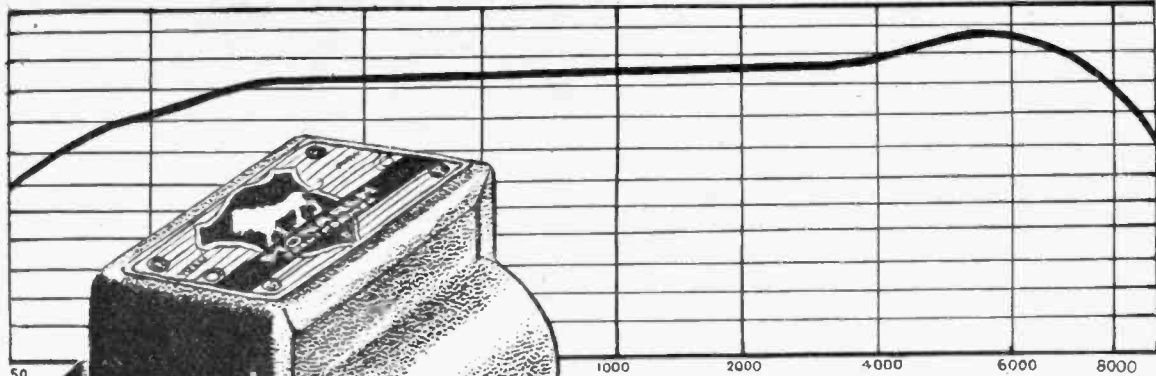

*The Power  
Transformer  
You should  
use*

ACTUAL  
SIZE

A NEW RELEASE

WEIGHT  
33ozs.

# MONARCH AUDIO *Transformers*

A last stage power transformer is now offered at a price within the reach of all. Carefully designed and manufactured to the highest degree of electrical and engineering efficiency, Monarch Transformers present the last word in Audio Frequency Amplification.

The illustration shows the actual size, whilst the weight is more than twice that of ordinary transformers.



AMPLION A/SIA., LTD., 53-55 York Street, Sydney



# SOLVE THIS!!!



**PRIZES!!**  
**£5'5'0**

**CLOSES 30th SEPTEMBER**

**ACROSS**

- 3. Radio Component (Pl.).
- 6. Pronoun.
- 7. Part of Radio Valve (Pl.).
- 12. A Radio Bug-bear.
- 13. Morse is no good without it.
- 14. Keep it off the footpath.
- 16. Part of a speaker.
- 18. Applied to grid of new type valve.
- 19. Get it from Price's.
- 20. A meadow.
- 21. A motor spirit.
- 22. Thee (Fr.).
- 23. Main part of an Army (Abb.).
- 24. On behalf of.
- 25. Helps weight reducing.
- 26. An outfit of Radio Coils.
- 28. Cat with its tail first.
- 29. Part of a speaker (Pl.).
- 30. A bedroom necessity.
- 31. Like a jelly.
- 32. A liquor.
- 33. Do Price's sell junk?
- 34. In every receiver (Pl.).
- 36. With reference to.
- 37. To sustain.

**DOWN**

- 1. Radio Panel Composition.
- 2. Used on wireless panels.
- 3. Found on Some Coil Holders.
- 4. For the Aerial.
- 5. A defunct radio component.
- 6. Faced by every announcer.
- 8. The bed of a child.
- 9. Treasurer (Abb.).
- 10. Established (Abb.).
- 11. An adverb.
- 13. Philips 415 is a good one.
- 14. Source of broadcasting.
- 15. Part of a valve.
- 16. Pronoun.
- 17. For everything reliable in radio.
- 18. For your terminals.
- 19. Completed assembly of receiving parts.
- 26. A toy for the air.
- 27. On every radio receiver.
- 34. Cubic (abb.).
- 35. Royal Academy (Abb.).
- 38. Forward.

For each of the first five correct answers opened, an order for £1/1/ on Price's Radio Service will be given. So that country competitors will have an equal chance with city, the replies will be completely shuffled before drawing.

*Address your entry to*

**"Competition," Box 3326PP., G.P.O., Sydney**

Additional copies of this puzzle are available on request to:—

## PRICE'S RADIO SERVICE

*The Corner Store.*

**WINGELLO HOUSE, ANGEL PLACE, SYDNEY**

## It's the Pitch that Matters

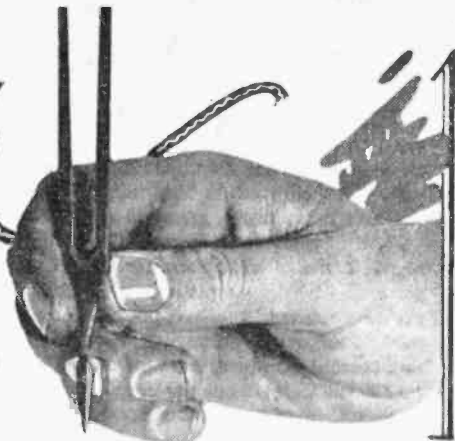

*Not many listeners know how to distinguish between pitch and volume, and, as a result, much confusion results when distorted reproduction is being tracked down.*

**E**XPERIMENTS with the reactions of the human ear and nervous system to comparative variations of volume and sound have shown that it is the pitch or tone of noise that is responsible for shattered nerves, and not the volume, as would at first seem to be the case.

It has been found, for instance, in experiments with students in a special sound-room that a small reduction in volume was accompanied by a great sense of relief, although in some areas of the musical scale an identical reduction brought much greater relief. This was due to the fact that it was the tone of the noise, rather than the volume, that irritated. The general reaction found was comparable to that of rubbing a finger over sandpaper, or biting into brittle candy. Given the right pitch, a room can be relatively quiet, but still annoying.

This condition is to be found in many Australian living-rooms to-day. By this we refer to the living-room as being, presumably, the radio room. Here the proud owner has installed his radio receiver, a set that he probably runs most of the time, with, perhaps, an occasional change of station, or even a reduction of the volume when it becomes too impossible. Otherwise it goes on playing, and he becomes accustomed to it. But because he does become accustomed to it does not necessarily mean that it is good. On the contrary, nine times out of ten the set is not "tone-adjusted," and even though the room be relatively quiet, it is still annoying.

Assuming that no radio set gives perfect response to all of the musical frequencies—that some of the high and some of the low frequencies are lost—it can be said that pleasant reproduction will only be obtained when a "balance of tone" has been caused to exist. In order to accomplish this, it is necessary that the reproduction contains the same number of octaves above a certain point as are reproduced below it. If the speaker out-

put is out of balance in one direction, the music will sound shrill and irritating. The if it is unbalanced in the other direction the music will sound shrill and irritating. The latter condition is that found in a great many receivers at the present time.

Without making any drastic changes in a receiver which operates under this disadvantage, a splendid improvement usually can be obtained merely by reducing the response to the high frequencies in order to obtain the "tone balance" which is so essential.

A control of this sort is really a soft pedal for the radio set, and it is very simple to make, being entirely external, and requires no tampering with the works. It consists of a stepless variable resistance of from about zero to 500,000 ohms, in series with a quarter-mfd. condenser. This combination is connected across the loud-speaker terminals of the set, and the variation of the resistance changes the tone of the output from clear and sharp to soft and deep, through the simple expedient of by-passing more or less of the higher frequencies. One may instantly vary the pitch for each particular selection

Men's voices, as a rule, should come out clear and crisp, while ambitious sopranos and jazz bands are generally greatly improved by application of the new soft pedal, gently muting the highs, and encouraging the lows.

It will be found that if the tone is always kept at the proper pitch, a great deal more volume may be used without the ear being conscious of it. Whereas, with the tone gone, even the gentlest murmur is irritating, and an otherwise perfect programme loses its charm.

It should be realised, of course, that this is only a short-cut to pleasant reproduction, and that the improvement is obtained actually by introducing more distortion than is already present. The desirable remedy is to re-fit the audio amplifier of the receiver, and to install a new speaker, so that the overall distortion is reduced to a very low value. With a satisfactory "tone balance" and comparative freedom from distortion, it will be found that a surprising amount of volume can be stood without the slightest discomfort. With a truly excellent amplifier, and a good moving-coil speaker, the volume can be turned up to the point where the windows almost start to rattle. Even with this crashing volume, the absence of distortion and the balance of high and low frequencies still allows the music to be pleasant in much the same way as a symphony orchestra is pleasant even if one is seated within a few yards of it.

### Radio Club at Liverpool

WITH the object of forming a radio club for the Liverpool district, a meeting of radio enthusiasts is to be held at "Cora Lyn," George Street, Liverpool, on September 10, at 8 p.m. Mr. H. W. Blue, from whom we have this information, desires to extend an invitation to any radio listeners or experimenters who would be interested in attending the first meeting.

### PRINCIPAL CONTENTS OF THIS ISSUE

James Goes on the Air .....	4
Extracts from 4QG Report .....	5
Broadcast Energy Distribution (H. W. Johnson) .....	6
The Advance of the Factory-Built Receiver (Ross A. Hull) .....	
The Gentle Art of Wrestling (Fred. Johns) .....	8
Alternative Programmes (Oswald Anderson) .....	11
Putting It Over (John Benson) .....	14
Getting Maximum Performance from the Speaker (Ross A. Hull) .....	19
Air Screw* (Norman Lyons) .....	23

# Between You & Me & the Microphone

## 2JJ Gets an Airing

**STAYSHYON** Toooh, Jai, Jai, Sydnee, suppling programmeS for the National AssoshiashoN of Spalce PillarS, calling on sevEN and A half poinTT Talpe.

4 . . . (Papers rustle.) Thee taimie is—air—foah and A quartar meenyoutes farst.

(Papers rustle again.) To-eir-Night. Laideees anDD Gentoomen, wee harve thee honorr too preezENT A PoTT Pewrrry PrOgram. Thee-oah-fursT Attem on ouah PrOgram is a Song—Oresteez be-foah Ceezah; Djewbake; sung bai Jeames Jaimes, celebrated Basso profundo.

(Pause; then pianoforte introduction to Orestes before Caesar.)

O Caesar, the Night is dark  
And the Wind storms, and the Lightnings roar!  
Hark! Hark!  
There is the cry of the Owl in the Woods!  
On the forest-floor  
The Red Rain rolls and glitters.  
A soaked bird flutters  
Over where muttering Vulcan broods  
Beware!  
Beware!

2JJ. Sydnee! Thee Jai, Jai, Jai Sym-fonee Orwkestrah, conDucTeD bai Jemsky Pjames, plaling thee thirD moovment of a Simfonee in Dee Malnor, bai ShoobalrT. . . . (A click. Sound of tuning instruments. Then the third movement of Schubert's Symphony.)

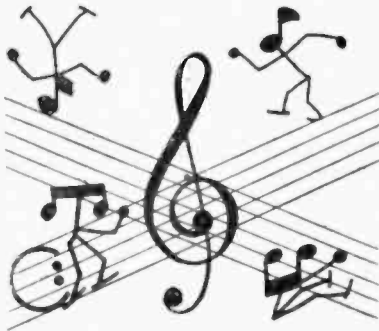

2JJ. Sydnee! Wee are now to bee en-terTaineD bai Jimmy James, comedianaN. in SonG andD Storee. . . . (Click.)

G'ni, foxe! All feelin' well this bri! Spring wethr? Ha! Ha! Ha! Y'kno—"treminds me, y'kno, a tha time I took me gurl an' mothr in lor out fa ra picnic—arh! She was a 'ard nut to crack—me mothr in lor—although, of course, she wuz cracked already—Ha! Ha! Ha! Well, annyhaow, I tuk them—me gurl—she's my wife now, Lor' save me!—Ha! Ha!—yus, me gurl and me mothr in lor. I tuk em out fa ra picnic—it wuz a fin' Spring day—jus like today. Well, me ma in lor's one uv them there gushy sorts y'kno; an she says, y'kno—she says, "Y'kno, Springs a Beautiful time of the year," y'kno, she says I sez, "Yes; but ya got to be careful." She says "Why?" "Well," I says, "y'kno," I says. "If

may come on to rain any time, y'kno." I says, "Y'kno. Goin' out fa a picnic in Spring's like bein' nard up, y'kno."

"Goin' out fa a picnic in Spring's like bein' nard up!" she says. "Yes," I says. "In the first case, ya've got ta watch the Spring, ya see? AND in the OTHER ya've got ta Spring the Watch! "Ha! Ha! Ha! Well, foxe, I'll sing ya 'll song."

I took mee gurl an mothr in lor  
Out walking in the Spring;  
And then me Ma in lor says well  
Let's all go picnickING:  
So then we bought a pint a tea  
An' biscuits an' bananas;  
An' sat beneath a shady tree  
Where motor cars couldn't harm us.  
An' then we —

(Sorry; got to cut it down; anyhow, it's usual sort of stuff.—ED.)

So never take your ma in lor  
Out walkin in the Spring!  
All asleep, foxe? Well, well! G'ni, evryone.

2JJ. Sydney! Wee harve weeth us to-night, Mr. James J. James, who weel delivah A talk on—Ma! Experiences in an Eastern Haireem. . . . (The voice sounds a little disconcerted. Pause. Then click.)

When I left off my last talk under this series I had just arrived at the door leading into the harem of the Sultan of Morocco. I suppose some of my listeners may have been anxious to hear what I saw on the other side of the door of the harem of the Sultan of Morocco. Well, after repeated knocking at the door, I at last heard a grating sound, and, looking up, I saw one of the ugliest faces I have ever seen, looking down at me. I explained in the Moorish language, in which I am adept, that I wanted to go in. The Mute, for I afterwards discovered it was a Mute, demanded my passport. I produced it, and he let me in. The interior was not what I had expected. There were a few dirty carpets on the floor, and a few divans lying about. On every wall hung faded tapestries, done in the rather provincial Moorish style. I was not very impressed with my surroundings, I repeat. The place was most untidy—cushions embroidered with fine gold were lying about everywhere. I noticed more evidences of Moorish untidyness in the diamonds and pearls that rolled away under my feet as I walked. Four ten-foot elephant tukk, which supported the mouth of a fountain playing languidly under the enormous dome, bore ample evidences of not having been dusted for weeks. I had almost forgotten to mention the Women who were lolling about on the divans. They also were extremely untidy-looking. The Moorish Women seem to take no interest in dress—no interest at all. As I was looking about me the women got off their divans and left the chamber, one by one—all except the last, who remained. She was rather attractive. I asked the Mute why she remained alone. He replied that she had been ordered to do so by the Sultan. He then withdrew, and left us. As my time is now up I shall have to say good evening; but I shall resume this series of Travel Talks next week at the same time.

2JJ. Sydnee! Thee-ar-Taimie is now six and A half meenyoutes past. Jamieson James, well-known Tenah, singing an ART Song bai Percoosay, entitled When sum-mah skies. . . . (Click. Pianoforte introduction to the song.)



When Summer skies  
Have blown your Youth away  
And when you say  
"A voice within me cries  
For freedom in a brighter, fairer day"  
Oh, pray  
For Me!

When Love is dead,  
And Youth is brushed asleep,  
And when you creep  
On weary limbs to bed,  
You'll lose your life in slumber long and deep—  
Thus led  
To Sea!

2JJ. Sydnee! Befoah wee close down for thee night, Mr. J. J. James will answer some questionS which have been addressed to him in the course of thee-ah-week. . . . (Click.)

Q—"Worried," Brisbane: "My dear James (yes, darling?). Please tell me through "Between you and the Microphone."

1. Why is the wire less?
- A.—Which wire?
2. What made the Oscil late?
- A.—Now, now! There are some things gentlemen leave unsaid. How did you hear about her being late?
3. Where can I purchase a dynamic speaker for 1/3?
- A.—Mr. Hull says you're living a hundred years before your time.
4. Do you like my writing?
- A.—And we say you're writing a hundred years before your time.

In conclusion let us thank you for writing. Yours is the only query we've received. We should like to make it plain to everyone that if anyone wants to know anything about artists, programmes, or broadcasting generally, all one has to do is to write in to James, c/o WIRELESS WEEKLY. We will dope up some sort of an answer. Good-night.

2JJ. Sydnee! Suppling programmeS for the Nasonal AssoshiashoN of Spalce Pillars, calling on sevEN and A half poinTT Talpe. . . . (Papers rustle.) The Stayshyon is now closing down for thee night. . . . Good - NAIGHT LaidEES andD Gentoomen!  
Gawsave.

*James*

# ANNUAL PROFIT of £5211 Declared By 4QG Despite Licence Drop

*How the Queensland Radio Service passed through one of the most difficult periods of its existence and remained financially sound, is told in the extracts from the annual report below.*



Mr. J. W. Robinson, director of the Q.R.S., whose report is quoted below.

THE annual report for the Queensland Radio Service, issued last week, shows a profit of £5211 for 4QG. This was made despite a decrease in licenses. In the course of his report Mr. J. W. Robinson, director, explains that:—

"The year 1928-1929, although a prosperous one financially for 4QG, constituted a somewhat difficult period. Many listeners reached a stage when that feeling of wonderment which is associated with the first ownership of a radio set had passed away, and, consequently, numbers of licenses were cancelled. Many of these were, however, renewed, and the year closed with only a hundred or so less licenses in force than was the case at the beginning. When it is remembered that in other States the yearly loss during similar periods of broadcasting history ran into thousands, Queensland must congratulate itself upon having passed so successfully through so trying a time.

"In previous years an effort was made by the Station to give as great an amount of variety as possible in the form of programmes, and with this object in view the services of large numbers of artists were used.

"In this respect it must be made clear that those at 4QG are not of the opinion that the employment of very large numbers of different artists does much towards improving the standard of programmes. On the other hand, they are of the opinion that the employment of a smaller number of trained and qualified performers results in a broadcasting station being able to give its listeners a better quality of entertainment.

"In the previous financial year 950 different artists contributed to 4QG's programmes, this number being arrived at by regarding bands as one artist, choirs as one artist, quartettes as one artist, and so on. During the year under review in this report 820 different individual artists were employed at 4QG.

"The services of so large a number of performers were used simply to please the public. It does not require the exercise of very much common sense to realise that there are not 820 first quality artists in Brisbane. Were an authority asked to estimate just how many of the above number were of first grade, the answer would doubtless surprise even the most casual listeners. It may be asked, therefore, why in one sentence it is definitely stated that there are not 820 good artists, and in the next it is pointed out that that number has been employed. Critics may contend that the two statements viewed simultaneously amount to an admission that a large number of people whose efforts have

been broadcast are not up to standard. The reply is a very simple one. Large numbers of artists have been broadcast in preference to a small number simply because the public (which pays to support the station) desires quantity and not quality.

"Some few months ago an effort was made by 4QG to limit the number of artists. The officers of the Station grouped around themselves a small number of performers who were considered of the highest standard Brisbane had to offer. Using the services of these people programmes were provided. The programmes given during that period were the best in the whole history of 4QG, but it is a significant fact that during that same period the station was subject to the bitterest criticism in its history, the bulk of that criticism being to the effect that "4QG broadcasts the same old artists."

"In the previous Annual Report of the Queensland Radio Service, it was stated that there is no such thing as public opinion, and that the criticisms received by any station differ in degree according to the individual tastes of the persons offering them. Such a state of affairs still continues, and the manager of a radio station whose one effort is to cater for the whole of the public must realise this fact and must endeavor to give a type of service which is appreciated by the majority. He must not, of course under any circumstances, neglect the minority — he must cater for them also—but he must expend most of his energies in the providing of a service which will prove popular to the majority. The majority in Queensland, at any rate, has definitely declared itself to be in favor of as much variety as possible in artists, and this fact accounts for the large numbers of performers who have been placed on the programmes.

"Were the director of any large station an autocrat with complete powers, he would doubtless refuse to hearken to the expressions of opinion of the majority, and would give programmes supplied by a few highly trained artists instead of programmes provided by many badly-trained performers.

"Some idea of the extent to which the almost incomprehensible desire for variety of performers, irrespective of their qualifications, exists, may be gained if one interesting case be quoted. Radio plays have been performed at 4QG, and, generally speaking, have met with very keen public approval. The bulk of the criticism levelled against the plays has not been on account of the time they have occupied, nor has it been against their inclusion in the programmes, but it has been on the grounds that the same artists have been included in the casts of different plays. In cases where these complaints have been made by telephone or

letter, it has been pointed out to listeners that artists who take a part in radio plays are specially trained for that work. It has also been pointed out that theatrical companies do not change their casts every time a play is produced, but that, on the other hand, they adhere to artists who know their work and perform it satisfactorily. Invariably, however, when these facts have been mentioned, listeners' replies have been to the effect that such might be the case, yet they would like variety in casts when radio plays are produced. Even the most hopelessly ignorant person must surely realise that radio plays may be broadcast much more satisfactorily if regular, qualified, and trained performers are used, rather than if a change be made every time and absolute novices be placed before the microphone, to try and produce radio plays. The average person is content to go to picture shows and see the same artists in different pictures; he is content to go to public parks on Sundays and hear the same bands perform; he is content to visit church and hear the same clergyman preach and the same choir sing, and yet as a radio listener he complains if the same cast is included in two different plays or if the same artist sings on two consecutive nights. One has yet to hear of the conductor of the Brisbane Municipal Concert Band being asked to include entirely new performers in his party each Sunday night at Wickham Park. Perhaps the reason for the absence of such a request lies in the fact that the band performers' names are not mentioned. Were a broadcasting station to refrain from mentioning the names of its artists, perhaps this type of criticism would vanish."

A resume of the outstanding 4QG programme features for the year follows, ending with a statement regarding the future of the station.

"Station 4QG is now about to pass from the control of the State Government of Queensland to the Commonwealth Government of Australia.

"During the year the Federal authorities indicated their intention of commencing a new system of broadcasting by the inauguration of a national service. The Commonwealth authorities signified their intention of purchasing all stations from their existing owners and of carrying out the technical work in connection with them. They also declared their intention of leasing the various stations to a person or persons prepared and competent to arrange programmes.

"The whole details of the Commonwealth

### The detailed accounts for the year are as follow:—

	EXPENDITURE	
	1928-1929.	1927-1928.
	£	£
Salaries .....	5,389	4,864
Maintenance .....	3,124	3,431
Royalties .....	.....	2,566
Artists .....	7,344	5,799
Copyrights .....	1,863	845
Incidentals .....	2,925	1,328
Interest on capital .....	1,240	1,471
Balance, excess of revenue over expenditure .....	5,211	3,310
	£27,216	£23,614
	REVENUE.	
Licence fees .....	23,276	21,555
Advertising .....	1,854	1,974
Miscellaneous .....	2,086	85
	£27,216	£23,614

scheme have appeared in print and it is not within the province of this report to set them out fully or to review them.

"It is sufficient to state that negotiations have proceeded for the purchase of the plant and equipment of 4QG by the Commonwealth, and doubtless as this report appears in print those negotiations will have been concluded. In terms of these arrangements 4QG will, therefore, pass to Commonwealth control. Its plant and apparatus will be purchased outright, and its buildings, offices, and other accommodation will be leased.

"The Commonwealth has also accepted from a group of very responsible amusement providers a tender for the supply of programmes, and the new arrangements will, it is expected, take effect, as far as 4QG is concerned, from 30th January, 1930.

**MODEL 'PLANE.**

Next week constructional details will be published for the Outdoor Twin Pusher, the 'plane that holds the world's record for length of flight—10 minutes 14 seconds.

It requires no more care in workmanship than the indoor models, but it takes longer to build. The fuselage is 40 inches long and the wing spread is 35½ inches. Order your copy now.

*Marjorie Skill, Soprano*

"I SANG out louder when I was stranded on the beach at Magnetic Island than I ever did on the stage," said Miss Skill, when asked what she considered her best performance. "Magnetic Island is seven miles from Townsville, and when the last boat left, a few minutes before six, I never thought I would be in time for the party to be given in my honor that evening. However, I hired a boatman and was rowed the seven miles to the mainland. I wasn't so late after all."

Miss Marjorie Skill needs little introduction to listeners. She has toured Australia and New Zealand, and has had great success both on the concert platform and over the air. Her next appearance is from 2FC on Sunday, September 8.

# Broadcast Energy Distribution And Service Areas . . . . .

BY H. W. JOHNSON

FROM time to time writers in this paper have given attention to the difficulties experienced by country listeners. In a recent article, the writer made some observations on the subject, maintaining that people who are located many miles distant from a broadcasting station obtain their service with many disabilities. Some exception has been taken to the remarks, one critic maintaining that the Government authorities foresaw the condition that has arisen, and stipulated a lower fee for the listeners in the second zone. Another reader pertinently referred to the fact that the battery problem—that is, the difficulty of charging batteries—would not be nearly so serious if the owners of sets used the special types of primary batteries of low-current consumption and long life for their valves. The same reader, in discussing the subject of valve sets in the country and crystal sets in the suburbs, maintained that the conditions were not as bad as represented, because signals and static were amplified alike.

The reference to amplification of signal and static has given the writer the suggestion that it would be opportune to review the subject exhaustively; that is, the subject of signal distribution over a given area, with due regard to the amount of signal energy necessary for satisfactory reception. The subject is an important one, and quite a lot of attention has been paid to it during the past two years. No scheme of stations for a national, or lesser, service can be designed without taking close note of the effect of the service range of a station or stations, and various definitions of service areas have been laid down. Perhaps the best known is that of Captain Eckersley, until recently chief engineer of the British Broadcasting Corporation.

The radiated energy from a radio transmitter is defined in terms of signal strength or field intensity; that is, the measure of the amount of energy that is available at the receiving aerial. It varies with distance from the transmitter, and with the character of the terrain over which it passes. For instance, transmission over water results in a better field strength at a given distance than if the intervening territory were all land; and if mountains or high hills intervene there will be a loss of energy—it is absorbed or deflected in process of the radiation. The unit of field strength is now well known as a millivolt per metre; some writers occasionally refer to it as a microvolt per metre. In each case the unit is written as the mv/m.

In those terms Captain Eckersley laid down the amount of energy required to give different grades of service over certain mileages from the station. He described four service areas, which he calls, respectively, Wipe Out, Class A, Class B, and Class C areas. The Wipe Out area is described as that portion of the area served by the station in which perfect reception is possible, but the reception of other stations is difficult. The radius of such an area is obviously small; for the 2LO station, London, the radius is given as six miles. The Class A area is one in which an uninterrupted service is practically certain; the radius from the London station was given as 12 to 14 miles. In the Class B area crystal reception is possible, but interference is more marked. The London radius is 18 to 20 miles. In the final area, Class C area, with a radius of 28 to 32 miles, the service is subject to interference by atmospheric, electric power plants, etc.

The field strengths for the different service areas was set down by Eckersley as follows:—

Wipe Out area, over 30 millivolts per metre  
Class A area, 10 to 30 millivolts per metre  
Class B area, 5 to 10 millivolts per metre  
Class C area, 2.5 to 5 millivolts per metre

From this basis many engineers are planning stations of different aerial powers, but designed to provide service up to great distances. And where high-power stations are established for the purpose of covering a large territory the station is kept outside the city's limits, so that the signal energy shall not be too great in the settled parts of the suburbs. We have experience already in Sydney of stations in thickly-settled parts of the residential areas whose field strength is so great that a very definite wipe out area exists; it is almost impossible to receive any other than the nearby station unless very selective receivers are used.

The wipe out and Class A area can be regarded as very good service, except when the figure reaches below 12 mv/m; the Class B area varies from good to fair, and anything

under 5 mv/m is not a service that can be regarded as at all satisfactory, except in special circumstances, such as in winter months and when no interference with reception is caused by atmospheric or other noises. The distance from a station of the power of our principal stations, where the field strength is about 2 mv/m, may vary from 50 to 70 miles. Beyond that distance the service is rendered unsatisfactory, not so much on account of the low signal strength as owing to the local noises interfering with reception. The relation between signal and noise—whether caused by atmospheric (static) or electric mains, etc.—is the most important factor in deciding the measure of the quality of the service rendered to listeners by the company. In all the literature dealing with station design and location, the ratio of signal to static is emphasised.

It is no use employing several amplifying circuits in a receiver if the signal strength is less than the strength of the noise—they both can be measured, of course. In the accompanying figure it will be seen that the signal strength of a station varies with distance from the station from 20 mv/m at five miles to one mv/m at 70 miles. The curve is purely arbitrary, but, as a matter of fact, is not far from a typical case. The figure also shows that the noise level is almost equal, at about 2 mv/m up to 100 miles. An examination of the figure discloses that after 50 miles or so the noise level is greater than that of the signal; the signal to static ratio is bad, and any amount of amplification will be of no use, because the noise will be boosted up at the same time as the signal, but the noise will, of course, predominate. The best or desirable condition is up to 40 miles from the station; the ratio is such that the signal always predominates. In that case, amplification of the received energy is advantageous.

It will thus be realised that distant listeners cannot obtain a satisfactory service, or even a moderately good one, if the noise level is above the signal strength. Some authorities assess the strength of static at 1 mv/m, but in some parts of Australia the noise level is much higher. In the figure it has been shown as 2 mv/m, which is nearer the mark. In some cases it is far above that figure. The remedy for that state of affairs is higher power in the transmitter, or a station put nearer the area where the signal strength is low. The establishment of relay stations will be the solution.

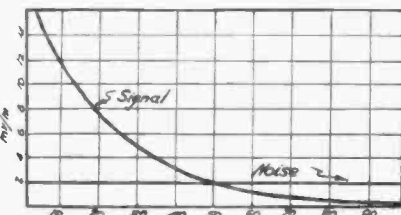



# The Advance of the FACTORY-BUILT RECEIVER

*The contrast between the present-day radio receiver and the receiver of two or three years ago is hardly realised until the listener makes a survey of what is offering on the market.*

By ROSS A. HULL

NEW listeners who so far have operated only home-built receivers appreciate the strides which have been made in commercial set production. The majority of them, it would appear, are still paddling along under the impression that the home-made set can not only be made more cheaply than the factory-built receiver, but also that it can be made to perform more effectively. Admittedly, this was the case in Australia a few years ago, but it certainly does not hold good at the present time. The commercially-produced receiver is rapidly approaching the status where it represents more value for the money than any possible collection of components assembled by the amateur set builder.

Way back in 1922 and 1923, when most of the broadcasting comprised the transmissions of amateur stations, the amateurs themselves undoubtedly built the finest receivers available at the time. They were, of course, designed for experimental work more than anything else, and, in consequence, were thoroughly splattered with knobs, dials, switches, and miscellaneous gadgets. Usually the only person qualified to operate it was the builder of the contraption.

During the few years that followed the opening of broadcasting activities on a large scale, interest in the commercial manufacture of receivers increased steadily. But it was a long time before manufacturers started to exploit the possibility of building receivers in such a way that individuals without the slightest technical knowledge could operate them. Also, it was a matter of four or five years before manufacturers could get away from the idea of screwing apparatus to a piece of board and wiring it with busbar in the same manner as amateurs had done for years previously.

The factory-built receiver of about 1926 was surely a fearsome looking animal in comparison with some of the present productions. Knobs, switches, and terminals were provided in abundance, and the idea still seemed to hold that a great many gadgets on the panel were definite evidence of the splendid capabilities of the receiver. Two and three main tuning dials were still tolerated at that time, and a sound knowledge of practical radio was still necessary to keep the outfit operating with any reasonable degree of consistency. We don't know much about the receivers built after that, since we were not in this country, but we do know that in 1926 far better value could be obtained for one's money by buying a pile of apparatus and building one's own receiver than by purchasing an Australian factory-built set.

At about this stage, when three dial tuners were still hot stuff out here, the single-control receiver was already firmly imbedded on the American market. At this stage, too, the home-building of receivers in America had started to wane, for the very simple reason that the factory-built sets provided a better performance for a given outlay than any conceivable concoction of components which could be created at home. Since that

time the factory-built receiver has been steadily squeezing the home-built set towards its doom, and the home construction of broadcast sets for listening purposes alone can now, relatively speaking, be described as extinct. The present-day American has little more thought of building up his own a.c. operated receiver than he would of assembling his own automobile from the component parts.

In England or in Australia this stage has not yet been approached. There is still definite evidence of an intensive interest in the home building of radio sets which would not appear at first sight to be very much less than that of a few years ago. However, with the present steady improvements in commercial set production, the waning of the home-building vogue is sure to come.

We do not mean to say that the set-building game will die out. It will change. There will always be hundreds of listeners who will build sets and experiment with new apparatus for its own sake—it is still the only hobby in the world. There will always be new problems to solve and new trends to develop also, and it will be the multitude of radio enthusiasts pursuing radio in this direction who will direct future research and manufacture. It will be this public who will be interested and entertained with technical writings of the future.

It is interesting to reflect on the changes in commercial set construction that the last few years have seen. Both the developments themselves and their significance apparently are unknown or at least unappreciated by many of the present listeners. They, it would seem, are quite content to charge their batteries every week and hitch them, after the charging period, to a receiver with countless knobs, and with its components strewn dizzily across a piece of board. Quite often,

the output valve is still a UX-201-A with 90 volts on its plate, and 1925 type audio transformers still try to make something more than noises—and fail.

About two years ago, when receivers with more than two major tuning controls gave their last dying yelps, commercial set construction was already of a high standard. Receivers were being engineered all the way through, and they were no longer a collection of odd parts which happened to serve the purpose. The better receivers at about this time were being planned from the ground up, and sound engineering was being employed in the design of every item in the receiver. Each component was engineered for operation in a particular receiver under a particular set of operating conditions, and, as a result, the performance of the receivers was increased steadily to the tune of decreased cost. By this time, all baseboards had long been displaced by metal chassis on which all the apparatus of the receiver was mounted as a unit. Metal construction, indeed, was carried to an extreme at first, and almost all of the table model receivers were enclosed in a metal box.

Following the universal adoption of a single tuning control—or something near to it—came the "electrification" of receivers. Full operation from the a.c. mains made possible a revolution in ideas of audio frequency amplification since the high voltages available permitted the practical adoption of output amplifier valves with a high value of undistorted output. The desirability of such a high output rating had been well appreciated before this, but its attainment had been impossible on account of the limitations of batteries as a source of plate supply.

With the improved amplifiers came the general adoption of the moving-coil speaker and, as a result, a splendid advance in musical reproduction. So general has been the incorporation of moving-coil speakers that in America more than 90 per cent. of this year's receivers are designed for use with it. Following this has been the wide application of the screen-grid valve, still greater simplification of control, and yet further improved mechanical and electrical design. One only needs to glance at a truly modern locally manufactured receiver and to operate it for a few moments to realise that even the most expert home builder of radio sets would have to be hard pushed to produce the equivalent of it even if he were allowed much more money to spend.

The present-day Australian factory-built receiver, in all sincerity, can be said to be of a very high standard. We believe that listeners, who have been in the habit of passing radio store windows and greeting their display with a sort of "just another crop of receivers" sigh, would be greatly surprised if they took the trouble to examine the outfits closely and listen to their performance. In most cases they would find that the modern a.c. single control receivers are highly finished and splendidly engineered productions, capable of a worth-while and what is more, consistent performance. Anyone who is at all familiar with commercial radio receivers could not fail to admit that at least



Mr. Justice Harvey will give the feature talk from 2FC at 6.40 on Sunday this week. "Law for the People" will be his subject.

the better Australian receivers represent more effective mechanical construction, more pleasant external appearance, and more satisfactory performance than present English productions of similar type.

Two definite and very much needed trends are already to be noticed in local set manufacturing. In the first place, greater attention is being paid to the audio frequency amplifier. The half-hearted "power" valves that have, until now, been used in the output amplifier are steadily giving way to heavier valves and push-pull output amplifier with which distortion can be reduced to a reasonably low value. To our way of thinking, there is no excuse whatever for fitting an a.c. type receiver with an output valve capable of less than an undistorted output of approximately one watt. We believe, further, that when the receiver is to operate a moving-coil speaker an undistorted output valve rating of less than about three watts should never be tolerated. Admittedly, the cost of receivers fitted with such output amplifiers will be above those fitted with the valves in vogue at present. At the same time, it can be said that recent advances

in the design of power amplifiers have made outputs of four or five watts possible without the necessity of increasing the plate voltages much above the values used at present. It is certain that the slight increase in production cost would be well justified by the improvement in musical reproduction.

The second commendable trend is towards the refinement of external appearance. Some of the many receivers we have inspected during the last few weeks would find an entirely satisfactory rococo setting in one of the more florid of our new motion picture theatres, but we fail to see why they would not make a garish and most metallic intrusion into the cool interior of any reasonably dignified living room.

Such comment, we admit, is really beside the point, and, in any case, could apply to such a few of the present productions as to be inconsequential. What is of interest and what we do not believe to be fully appreciated is that some of the locally-produced receivers represent the successful embodiment of all the features that a modern radio set should have. We have had the opportunity of testing receivers in which every

piece of apparatus, with the exception of valves and the grid-leak, was built locally. And we have found that their performance has been thoroughly comparable with that of the best overseas receivers of their type. Fitted with single control tuning, full a.c. operation, and entirely self-contained in a pleasing cabinet, these receivers could not fail to impress one with the fact that the development of the radio receiver has reached a very advanced status.

We still run across people who don't plan to buy a radio set on account of their belief that radio is still in its infancy. At one time we used to agree pleasantly with individuals who voiced such a belief, but these days we are prone to get annoyed instead. Like the automobile or the telephone, radio may still be in its childhood, but individuals who take that fact too seriously are likely to miss many, many years of added pleasure if they plan to wait until it grows to genuine maturity.

## ROBOT MEASURES ULTRA-VIOLET RAY TREATMENTS

THE first announcement of a new robot watchman for the elimination of danger from ultra-violet ray treatment, including a demonstration of the operation of this valuable "dosage meter," and the first description of using the rare element uranium in photo-electric cells, formed part of the introductory address of Dr. H. C. Rentschler, Westinghouse director of research, on assuming the presidency of the New York Electrical Society, to which he was elected recently.

"The danger lurking in the present concentrated treatments of ultra-violet rays, if given in excessive doses, is rapidly coming to be recognised as well by the general public as by professional men," said Dr. Rentschler, explaining the cause for the development of his apparatus. "Too much of this powerful radiation, while not felt at the time, can create sharp nervous reactions, and even burns of such intensity as to become serious. Other indirect effects are also attributed to the invisible rays; and the greatest difficulty with our present methods of dosage is that there is an unavoidable variation in intensity, which cannot be registered through measurement apparatus now in use, and yet which can actually cause an overdose (or for that matter, a too small dose) to be administered.

"It is desirable to obtain the most exact dose possible in these rays, especially in the case of treatment for rickets. Results can be better gauged and more effective treatment given if the guess work is eliminated. Loss of appetite, sleeplessness, and other nervous symptoms, common to ultra-violet overdose reactions, and, of course, detrimental to rickets cure, can be guarded against, and much more accurate histories of various cases can be kept."

Dr. Rentschler outlined the various materials used in photo-electric cells at present—the alkali metals, particularly caesium in certain forms, being more sensitive to the long wavelengths of the red and infra-red lights, cerium for the blues and violets, and thorium for certain parts of the ultra-violet spectrum. The problem of constructing a cell sensitive only to the antirichitic radiations of the ultra-violet region were solved by the speaker and his assistants in the laboratories of the Westinghouse Lamp Company, using the metal uranium, one of the rarer elements, which, when applied according to their methods, will respond only to the curative radiations sought.

### EXPERIMENTS ON THE FREQUENCIES BEYOND RADIO

To show the various regions of the ultra-violet spectrum, and also to demonstrate the sensitivity of his new cell to the invisible radiations, Dr. Rentschler used a quartz mercury arc and a quartz spectroscope (the latest in the world), loaned by Dr. E. E. Free, a former president of the society. By focusing on a fluorescent screen rather than a sheet of white paper, a wide band of ultra-violet radiations not seen against the paper were brought out on the screen.

Setting up a toy automatic sand conveyer, Dr. Rentschler showed how this would operate automatically, pouring sand from a hopper to a carrier of known capacity, which took away the load, discharged it, and came back for more—thus allowing a calculation of the amount of sand in the hopper by the number of trips of the carrier. So, by subjecting the uranium cell to one region of the normally invisible radiations as shown by the fluorescent screen, the electric current produced in the cell is passed into a condenser, which stores the charge until a given potential has been reached. It then is made to discharge through a special form of argon glow tube (in the actual demonstration a neon tube was used, as the red glow gives higher visibility), which gives a bluish flash as the discharge occurs. The number of flashes of the glow tube allows a close calculation of the amount of ultra-violet rays being given off by any lamp—carbon arc, mercury arc, or other type.

In order to simplify this still further, Dr. Rentschler explained, they had brought into use a modified glow tube with two anodes and one cathode, which, by breaking down the resistance of the main circuit as the condenser discharges through it, operates a counter or ink pencil against a piece of paper on a revolving drum moving at a constant speed. The number of marks gives the total quantity of ultra-violet light, while the frequency of these on the paper shows the average intensity of the radiation. (To show his audience the actual action of the apparatus, a bell was placed so as to be rung by the same lever arm that would ordinarily carry the pen for marking the graph.)

Thus any flickering of the light source will be allowed for, or a reduced intensity due to operation of a too-cool mercury arc can be checked up. This controlled dosage marks one of the most important steps forward in ultra-violet ray therapy, according to authorities on the subject.

"Thus," said the speaker in conclusion, "if you care to take the time to calibrate your skin sensitivity with the dosage meter, you can take the instrument out on the beach and develop a beautiful tan without the painful and often blistering burned period now so common to sun-baths."

### About Dogs

IF a plebiscite was taken to ascertain the most popular pet, there is little doubt that it would result in the dog heading the list. Apart from the appeal of the dog as a pet for young and old there is the utility aspect of this faithful servant of man. No one can estimate the value of the dog to the pastoralist, and few city folk realise what a good sheep or cattle dog means to the drover. Mr. J. L. Moore, who is one of the best known and most successful breeders of sheep dogs in the world, is to broadcast a talk on this remarkable animal in the lecturette session at 3LO on Thursday evening, September 5, at 6.40.

Next week model 'plane enthusiasts will learn how to make the Outdoor Twin Pusher, the 'plane that holds the world's record for length of flight—10 minutes 14 seconds.

It requires no more care in workmanship than the indoor models, but it takes longer to build. The fuselage is 40 inches long, and the wing spread is 35½ inches. Order your copy now.

# The Gentle Art of WRESTLING

A short article by the A.B.C.'s official describer of wrestling bouts at the Stadium

By FRED E. JOHNS

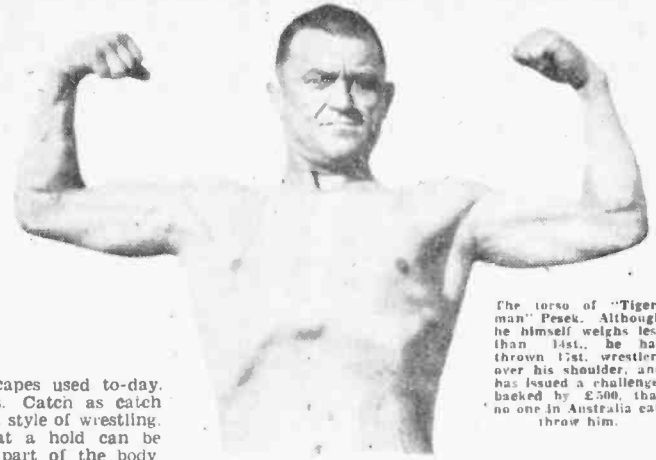

The torso of "Tiger-man" Pesek. Although he himself weighs less than 1st., he has thrown 1st. wrestlers over his shoulder, and has issued a challenge, backed by £500, that no one in Australia can throw him.

**W**RESTLING has only boomed in Australia since 1924, when it arose from the doldrums and entered a definite period of revival. This revival was due to the efforts of Walter Miller, a little pocket "Hercules," who claimed to be the middle-weight champion of the world. His personality dominated the ring in those days, and he will always rank here as the first of the really great wrestlers who established the sport on a real sound footing. He was an apostle of the new school, and an all-round skill combined with amazing strength for his size, rendered him a fascinating study. In September, 1925, Miller proved that weight, which hitherto had always been the deciding factor, now gave place to skill in wrestling. Although he weighed only twelve stone, he overcame and pinned a giant weighing over 17 stone.

Although wrestling dates back to the Greeks, the ancient Chinese and the Japanese, who developed many of the holds,

counters, and escapes used to-day, it still progresses. Catch as catch can is the modern style of wrestling, which means that a hold can be taken from any part of the body. This differs from the Graeco-Roman style, which forbids taking holds below the waist, but it must be borne in mind that many of these holds are used alone and in combination grips with ju-jitsu. They are used in modern matches regularly.

I well remember one match in particular, and that was between Ad. Santel and Bob Kruse. Santel had been a thorn in the side of Ted Thye for quite a while, and the latter had hopes that his pet pupil, Kruse, would be able to beat Santel. They met at the Sydney Stadium, but Santel was too old in the head and too strong for Kruse. It was a battle of giants, and the spectators were treated to a display of real heavyweight wrestling. Although it lacked the spectacular showmanship of other scraps, it was full of exciting thrills, and

100 per cent. wrestling efficiency. Graeco-Roman combination and ju-jitsu holds were used throughout, and Santel pinned Kruse with a further nelson and a hammer-lock, the only fall in the match.

Wrestling means a lot more than the mere struggling of two contestants on the mat. Any wrestler to be a success must be determined to succeed against adversity, and he must also cultivate everlasting persistency. The brain is developed, because he has to have an unforgettable knowledge of all the holds, tricks, blocks, and counters at his finger tips in an instant. An expert in the art of wrestling must possess a considerable amount of self confidence, because, in the ring, he cannot afford to hesitate for a fraction of a second. Should he encounter a thug or a hold-up man in the street he would automatically apply his knowledge. However, I would advise those who are trying to learn the art of self defence by wrestling to explain to the partner they are to practise with exactly what they are going to do, and also while practising to use every care, otherwise a serious strain may result, owing to the dangerous nature of the holds.

## How Pesek Defeated Browning on August 26



Top position: Browning and his trainer are here shown in the first stage of his terrible "leg body scissors," as described by Mr. Johns on Monday, August 26. Browning straddles his opponent while on his knees, using face bar to lever him over on that side.  
Lower position: In turning, Browning crosses his legs, gripping at ankles. Stiffens legs whilst turning his opponent on his back to force his shoulders down, and seizes his opponent's right arm and stretches out at an angle of 45 deg. to the body. Using his legs as a pair of scissors, he twitches and twists, and a fall is imminent. Pesek escaped this hold about twelve times by countering with a toe hold; finally he stood up with Browning still with leg scissors on him. Pesek then dropped backward on Browning and crushed the wind out of him in a back-slam.

The most outstanding personality of the wrestlers in Australia to-day is John Pesek, more commonly known as the "Tiger Man." He is generally known as an American, but I believe that he was born in Poland 33 years ago, but has lived in America for the greater part of his life. Pesek has a very striking personality, and in his presence one cannot help but feel that he is a man among men. He takes his training very seriously and is very restrained when chatting about his past successes or about the engagements in front of him. He trained very hard for his match with Jim Browning, whom he looked upon as a quantity unknown to him. He worried little about his match with Ad. Santel, however, because he has known him for many years, and has wrestled and beaten him before.

Pesek has only two meals a day, and eats little meat. He does about 10 miles road work and wrestles an hour daily, but he makes a speciality of fruit, vegetables, and nuts. Being a farmer in private life in Nebraska, America, he loves outdoor life, and his manager accounts for this method of living being the reason for his abnormal strength. Four of the leading athletic bodies of America have acclaimed Pesek as the legitimate world's heavyweight champion wrestler, the previous title holder, Sonenberg, being challenged and not accepting within six months of his last engagement. In the last nine months that he was in America, Pesek challenged Sonenberg to a title match, offering a side stake of ten thousand dollars if he (Pesek) did not pin Sonenberg twice in an hour. The latter did not accept the challenge, nor would he accept a title match, and therefore the athletic commissions have decreed that he has forfeited his title, and acclaimed the champion, as Pesek.

# CURVES AHEAD

The Experimenters Department of Technical Progress  
Conducted by Ross A. Hull M.I.R.E

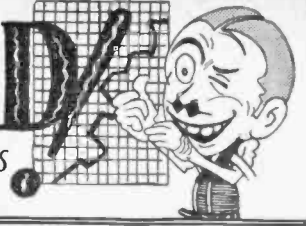

### Wiring A.C. Filaments

WITH the a.c. valves coming into general use there are many practices in set construction that require reconsideration. The set builder used to providing for .06 or .25 ampere valves, for instance, has the wiring of filament circuits so fixed in his mind that he is prone to adopt the same sort of procedure with the a.c. valves without consideration of the changes which have to be made. The first need, of course, is that the a.c. valve filament circuits be wired with twisted pair. This is necessary to prevent the possibility of the alternating current in the filament leads from inducing unwanted alternating voltages in other leads running near to or parallel with them. An equally important consideration is the high current taken by the a.c. valve filaments and the necessity for heavy conductors. The rated current of the UY-227 and UY-245 is 1.75 amperes, and the feeders for four of these valves would therefore have to be the equivalent of about No. 9 gauge wire in order that the wire should be loaded to its normal capacity for continuous work (1500 circular mils per ampere). In this particular case, two No. 14 wires in parallel would serve. About the most practical method of arranging the filament wiring is to use ordinary 5 ampere flexible pair for the leads from each valve, running these leads directly to a pair of supply terminals. In this way the 5 ampere wire will be carrying only the filament current of one valve. The supply terminals, of course, must then be connected to the filament transformer secondary with conductors heavy enough for the total filament current of all valves. In a six valve set this can be as high as 10 amperes, for which the leads would have to be the equivalent of No. 8 gauge. Obviously, smaller feeders would be practical if due allowance was made in the filament transformer for the voltage drops to be involved. The use of a meter would be almost essential in order to make certain that the actual voltage at the valve terminals was of the order of that given in the rating of the valve.

The mention of filament voltages brings up an interesting point. With the d.c. type valves the filaments were not often seriously overloaded (except in cases of accident) simply because the storage battery or dry battery was not capable of giving voltages much in excess of the rating of the valves. Filaments were designed for use with one, two, or three accumulator cells, or with a bank of dry batteries, and providing the right number of cells was used there was little cause for trouble. With the a.c. valves, however, the supply voltage is not necessarily to be depended on just because the rating of the transformer happens to be in accordance with that of the valves. In the first place there are the voltage drops in the wiring which, in the usual present-day receiver, may well amount to 25 per cent. of the full rating. Aside from this there is the frequent fluctuations in the supply voltages, which in the writer's experience, may amount to anything up to 40 or 50 volts. A rough guess would be that the majority of a.c. valves in operation at the moment in Sydney spend about half their working hours at voltages varying from the correct value by 30 or 40 per cent. It is quite certain that there is a pressing need for the general adoption of some sort of meter by which the voltage conditions may be made evident. In the factory built set, in which tapings are sometimes provided for different line voltages, and in

which the filament voltages are satisfactory whenever the line voltage is normal, all that would be required would be a d.c. meter of some sort—possibly a h.v. voltmeter—which could be set at some normal operating point by adjusting the transformer primary tapings. In the home built set, however, where the filament voltages may be anything at all even with the line voltage normal, the use of an a.c. filament meter is about as near to being essential as anything we know.

### Improving the Audio Amplifier

In running through the literature turned out by the radio manufacturers and their selling organisations (as is our habit) we unfortunately often come across some awful tripe—the word in this case means hokum—and we are tempted to wonder whether the organisations turning out the "information" really think they are getting away with it. In pleasing contrast, however, we frequently find some level, sane sort of stuff over which we can wax enthusiastic. One example of it is found in a recent release from the Ferranti people. Even at the risk of being told that we now run this page for the benefit of the trade, we will publish some extracts from it. The material deals with the commendable practice of using resistance filters in all grid and plate leads in the audio amplifier. Though no figures are given for the resistances—on account of the different conditions under which they will be used—it can be stated that those in the grid circuits might well be of the order of a half megohm, while

those in the plate circuits should be of such a value that the voltage drop at the rated plate current will not result in a drastic cut in plate voltage. This is the extract:

The Ferranti engineers have delved into the question of regeneration in audio frequency amplifiers and devised methods for rendering it ineffective. One of the circuits recommended by them is shown in Fig. 1. This circuit is for battery operated tubes. It will be noted that there is a resistance-capacity filter in every grid and every plate circuit. The condenser in each instance goes direct to the filament, while the resistor is placed in series with the plate or grid return lead below the condenser. This effectively reduces feedback to a point where it will not cause oscillation or even slight frequency distortion. While no filter is shown in the last stage, it will not hurt to put a large condenser from the B plus terminal of the output transformer to the negative end of the filament.

In Fig. 2 is shown the filtering treatment given a circuit having a push-pull output stage. The arrangement of the resistors and the condensers is the same. Condenser C4 serves both the tubes in the last stage. So does resistor R4. In a push-pull stage which is well balanced the need of a filter either in the grid or the plate circuit is not so great as in a single-sided circuit. But it is well to use filters just the same, for there is often a considerable unbalance in a push-pull stage.

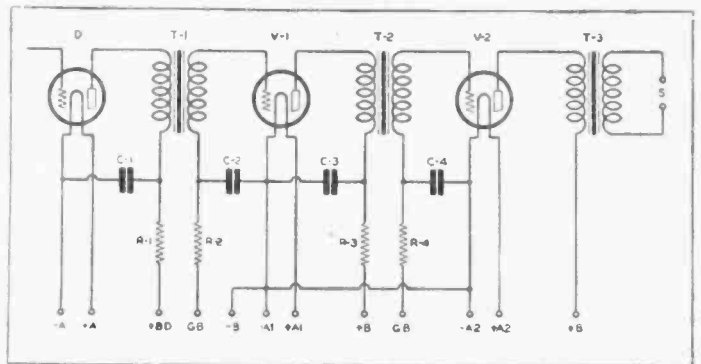

FIG. 1  
DIAGRAM OF A FERRANTI AUDIO AMPLIFIER SHOWING HOW RESISTANCE-CAPACITY FILTERS SHOULD BE USED TO PREVENT REGENERATION.

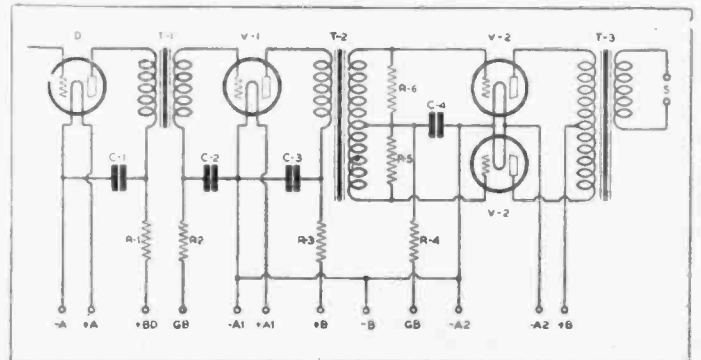

FIG. 2  
FERRANTI AUDIO AMPLIFIER CONTAINING A PUSH-PULL STAGE, SHOWING HOW THE RESISTANCE-CAPACITY FILTERS SHOULD BE CONNECTED TO STOP REGENERATION.

# Alternative PROGRAMMES

The arrangements made to provide listeners with alternative programmes are here outlined by the N.S.W. manager of the Australian Broadcasting Company.

By OSWALD ANDERSON

WIRELESS listeners are settling down to a more general appreciation of the new programmes supplied by the Australian Broadcasting Company in New South Wales than was the case during the first few weeks of the new company's existence.

The new rosters introduced carried with them many alterations in time and position on programmes, with the result that many listeners at first were not accustomed to the alteration in the regime of newer broadcasting. Every listener is entitled to his own opinion, as to whether he would like his sporting news at 3 p.m. Instead of 7.45 p.m. and his orchestral fare at 5.30 p.m. instead of 6.30 p.m., and so on. It is impossible to please everybody. There is not an organisation in the world that has not had, at some time or other, a certain amount of adverse criticism to contend against. It's only human nature to find fault with something or other in our daily existence, and broadcasting is no exception. However, the settling down process has gone on gradually and successfully, and little irritations which at first seemed so important have been relegated into their right perspective, and the majority of listeners are realising the vast improvement in the programmes presented, and they are not hesitating to send in letters of appreciation. Every letter which reaches the Australian Broadcasting Company from a listener who has not been asked to write, is worth a hundred letters from listeners who have been offered some inducement to express their opinion.

Rome was not built in a day. Hence the service that the executive programme committee of the A.B.C. is rendering listeners has not yet been able to make its presence seriously felt. They are introducing certain innovations and making several adjustments which, when put into effect, will make broadcasting programmes better than they have ever been before.

Many listeners have written in to the company asking for a definition of "Alternative Programmes," that we announced were going to be brought into vogue under the A.B.C. regime.

In effect listeners are divided into two classes—those who like classical and semi-classical programmes, and those

who prefer the lighter and more popular type. Bearing this in mind, it is interesting to note how the weekly roster of evening programmes is constructed. For example, on Monday night we note listeners are divided into two groups. From 2FC there is a programme for those who are in the mood for an orchestral and high-class programme, interspersed with an interest talk, and in direct contrast to this is the more frivolous offering from 2BL, in which comedians, novelty instrumentalists, patter sketches, and a vivid description of a wrestling match strive to please those who prefer lighter fare with their broadcasting palate. This will forcibly bring home to listeners our desire to place broadcasting on a higher plane than formerly.

If a classical item is introduced immediately after a humorous one, the susceptibilities of the musician are upset. There was need for an admixture on broadcasting programmes when in the old days they were separate entities. It became necessary to develop a programme that would cater for all tastes in order to retain the interests of listeners. Usually a banjo solo followed an operatic tenor, and so forth. But with the introduction of amalgamation between the two stations co-operation of programmes is possible to a far greater degree than has been the case before.

Our Tuesday night programme of opposite types is giving general satisfaction to the majority. Through 2FC from 8

o'clock right through till 11.30 the A.B.C. Dance Band, probably the finest combination of its kind in Sydney, plays groups of dance numbers, with small intervals between the groups broken by items from popular artists who appear only once on the programme. As these dance nights are a regular feature, listeners in both city and country are given an opportunity of arranging their dances on that night. From 2BL a semi-classical programme is provided. This is a programme consisting of trio music, songs by accepted singers, song cycles, and a programme calculated to give satisfaction to lovers of more serious and better type music. This is carried on to 9.30. A talk is given by a speaker again, dealing with a subject that will appeal to the more serious type of listeners, and then from 9.45 as a set-off against the first portion of the programme, a revue is presented in which a number of popular artists appear, till 2BL closes down at 10.30.

On Wednesday night the contrast, although marked, is not quite as obvious as in the preceding two evenings, for, through 2BL a brass band is playing, with singers giving items of a comic opera type, chorus with excerpts from some of the older operas. There will also be violin or 'cello solos; and this musical programme will carry right through from 8 o'clock to 10.30.

Tuning-in to 2FC on Wednesday night, the programme opens with an hour from the State Theatre, followed at 9.5 by a play which will run for about 30 minutes. Following this, a pianoforte recital by one of our leading pianists, and then with instrumental and vocal items, the programme is brought to 10.20, when the Dance Band plays.

On Thursday night, through 2FC, we have "A Night of Contrasts." This is an experiment which should please listeners. Every 20 minutes is divided into a different type of programme—humor follows pathos, old-time melodies will follow modern harmonies, and so on. Then on 2BL the "Capitol" programme is heard till 9 o'clock, and then instrumental and vocal items completing the night's programme till 10.30.

Friday night, through 2BL, can be safely called a "Ballad Night," with the orchestra playing well-known numbers, and artists contributing

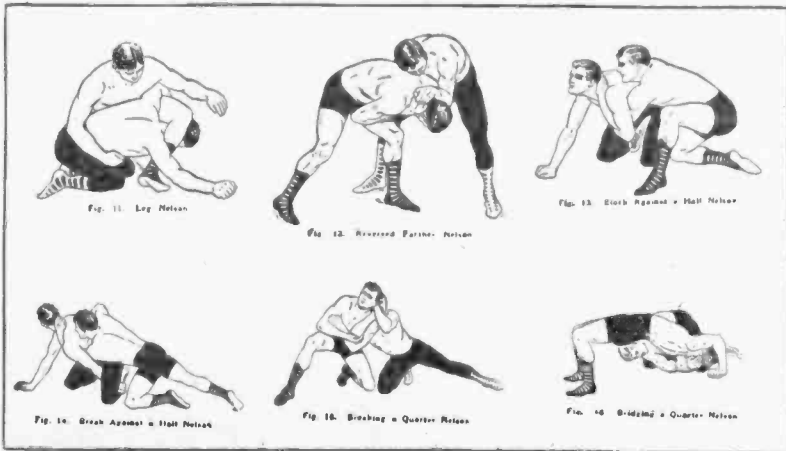

Illustrating various wrestling holds for the benefit of the listeners to the wrestling broadcast. From Walter Withrow's book on wrestling.

(Continued on Page 24.)



**M**R. HARRY THOMAS was born in Sydney some years ago. As a boy he became interested in elocutionary and dramatic art, and while he was still young he became a member of a dramatic company, touring Australia with stock drama. He played in "The Merchant of Venice" (Shylock, Antonio, and the Duke), "Romeo and Juliet" (Romeo, Friar Lawrence, and Thibault), "Niobe," "David Garrick," "Caste," "Uncle Tom's Cabin," "East Lynne," "Macbeth," and many others. He took prominent parts in the local productions of Madame Ray Boulton, an Australian playwright, for whose help and encouragement he expresses extreme gratitude.

Nearly twenty years ago he began teaching elocution, and has become well known in Sydney as an authority on Dickensian and Shakespearean presentations. During these years he has also been constantly before the public on the concert platform, giving recitals of poetry, short plays, and character sketches. He was adjudicator to the 1913 Sydney Eisteddfod, five years adjudicator to the Drumoyne Eisteddfod, and has adjudicated at eisteddfods in Newcastle, Kurri Kurri, Hamilton, Armidale, Taree, Brisbane, and Wellington (N.Z.).

To say nothing of films. Mr. Thomas was specially engaged to fill the role of Dean Maitland in "The Silence of Dean Maitland," one of the more successful Australian productions. When this film was shown privately at the Criterion in 1913 or '14, Mr. Thomas anticipated synchronisation by speaking the Dean's concluding sermon from the wings of the theatre. He also played in another Australian film, "Just Peggy."

Recently, Mr. Thomas has been producing a series of Dickens plays—his own dramatisation—in St. James's Hall. In David Copperfield he played Dan'l Peggotty and Uriah Heep. In "Oliver Twist" he played Fagin the Jew. Then he collaborated with Mr. Tom Taylor in producing "The Tale of Two Cities," in which he played the parts of Charles Darnay and Sydney Carton.

Mr. Thomas began broadcasting on the same night that Messrs. J. C. Williamson put over their first theatre broadcast of "The Maid of the Mountains," which, he says, came through very well. He was an instant success on the air, and in about nine weeks put over something like 120 recitations, repeating only three, by special request. Since then he has been appearing regularly from both 2BL and 2FC in recitations, sketches, and character studies.

At present he is putting over a series of Dickens stories from 2FC every Wednesday

# Harry Thomas

## Alias—Uriah Heep, Fagin— Dan'l Peggotty, Sydney Carton David Copperfield & others

morning, at 12. He has already given three recitals from "Oliver Twist" and "David Copperfield." The next set will be from "The Tale of Two Cities," which should be useful to intermediate students, as this is one of the books set for the year.

"Dickens' characters," says Mr. Thomas, "have often been represented as caricatures, but I think almost every man Dickens drew is a living being. Dickens has the gift, certainly, of creating fanciful people; but below the coloured waistcoats, the typical sayings, the smirks and smiles, and unusual actions, their hearts beat just the same. Uriah Heep, for instance, has often been criticised as being too much a villain, and has been represented on the stage as an unspeakable villain; yet I think him capable of more subtle presentation, as a human being acting in a very human manner. It may be interesting that the pronunciation of the word 'humble' was 'umble' in England before Uriah Heep appeared; but the 'h' was quickly brought back again as his character became known: such was Dickens' power in English letters!

"I am very pleased that the Australian Broadcasting Company has given me the opportunity of presenting Dickens' stories over the air. Dickens is not so widely read these days; it seems a pity; but it is a sign of these hustling times that few people will spare time to read an author whose plot unfolds comparatively slowly, in an atmosphere of comparative serenity. But to people who can spare the time, Dickens opens a world of living people unparalleled, perhaps, by anyone but Shakespeare. His dramatic power, his command of imagery, his knowledge of the heights and depths, the faults and redemptions of human nature, place him on a level with the greatest writers in the common English language. The line begins with Chaucer.

"Broadcasting thus does a service in enabling people to hear the works of this great man. While I am talking of broadcasting plays, let me make a suggestion. The Broadcasting Company has its permanent orchestra. Why not a permanent dramatic company?

A company of this nature would be able to choose well-trained voices, and put many great works, specially adapted for broadcasting, into rehearsal. The public would then be assured of regular and well-produced

plays, which, I am sure, are always highly appreciated."

Mr. Thomas, in his readings, always attracts the people who are talking. This keeps the story very much alive over the air, and lends it more the character of a recital. This Wednesday, for instance, his characters were, Micky Walker, Mealy Potatoes, David Copperfield, Mr. Quinion, Mr. Micawber, Betsy Trotwood, Mr. Wakefield, and Uriah Heep. They keep him busy, but his preparations are always made beforehand—scenes mapped out, inflections marked—everything arranged so that the reading may go over without a hitch.

### Victor M'Mahon

VICTOR M'MAHON studied the flute in Melbourne under John Amadio, a very great flautist, who considered him the most promising pupil he had taught; so much so, indeed, in fact, and so forth, that before the departure for the Continent of John Amadio, Victor M'Mahon, the pupil of John Amadio, was understudying John Amadio at various concert engagements.

After several appearances at municipal concerts, a tour with Mr. Fred Collier and Miss Elsie Treweek, a two years' tour through the Victorian "Smalls," whatever they may be (we suppose they have something to do with lingerie, e.g., "Smalls"—small-clothes, an old term for underclothes although where the application . . .), and the New South Wales "Smalls," Mr. M'Mahon settled down in Sydney.

He was engaged by Mr. Roland Foster to obligate for Miss Ethel Osborne in Sydney and Brisbane; and when Dame Clara Butt heard him playing in the Sydney Town Hall she decided to engage him to play solos for her two final appearances in Sydney. Then she went home and said Melba said to give 'em muck. We just quote this to show she didn't follow the ALLEGED advice.

Mr. M'Mahon has been a member of the Prince Edward Theatre Orchestra since the theatre opened; and has frequently been broadcast. We understand, from well-informed musical hands, that if Mr. M'Mahon had lived two or three thousand years ago, the celebrated Orpheus, who, with his lute made trees, would have snuffed out under the strain of competition.





# In the Air 'and On the Air

DAISY RICHARDS  
Violinist 2BL  
Sunday night

MAY CRAVEN  
Soprano 2BL  
Sunday night

ESTHER KAHN  
Composer Pianist  
2BL Sunday

NEVILLE AMADIO  
Flautist 2BL  
Friday

## Sunday Services

MR. STUART F. DOYLE has returned from Melbourne after attending a conference with Mr. H. P. Brown, Director-General of Posts and Telegraphs, in which the question of Sunday services was fully discussed, and it was ultimately decided that the present arrangement should continue.

"Whilst the Australian Broadcasting Company regrets that, owing to technical difficulties, there are many sections of the country that cannot get 2BL on Sunday night, and thus have a church service at their disposal," he states, "the action that is being taken by the Postmaster-General's Department will, it is hoped, ultimately enable 2BL to be satisfactorily heard in various parts of the country, by relay or other means. After carefully analysing the situation, the company has decided that, in view of the fact that there are two church services in the morning, and one in the evening available, the greatest number of listeners desire a musical programme from one station on Sunday nights."

Mr. Doyle also stated that if the company and the Postmaster-General's Department were satisfied that the majority of listeners desired two church services on Sunday nights they would not hesitate to introduce them, but there is undeniable evidence that satisfies them that the present arrangement pleases the majority of listeners.

## Sunday Feature Talk

THE feature talk for the week from 2FC on Sunday, September 8, at 6.40 p.m., will be given by Mr. Justice Harvey, who will speak on "Law for the People."

## Major Sandford Morgan—Travel and Adventure

SINCE his boyhood, Major Morgan has consistently sought those places little known to the average person. He has had a distinguished career in the army and the civil service. His travel talks have made him well known to listeners who like to hear of action and adventure in far countries, and his method of narrating his experiences is both interesting and original. It holds the attention of the listener from the first word to the last. Besides their novelty and vivid description, these talks are of great educational interest. They have been appreciated widely by invalids, and those who have found no opportunity to indulge a desire for travel. There is no part of the East, and particularly Iraq, which Major Morgan cannot describe from the fund of his lone experience, and listeners who have not yet had the pleasure of travelling in fancy with Major Morgan through these entrancing countries will be well advised to tune in on 2FC for his next address.

## Miss May Craven, Soprano

MISS MAY CRAVEN, dramatic soprano, will appear from 2BL on Sunday, September 8. Miss Craven is a pupil from Bennett North's studio, and she has been associated with broadcasting for 3½ years. The day after Miss Craven's first appearance from 2FC she received an anonymous letter from a listener, and the letter contained two red rosebuds and "lots of love and kisses." With all her curiosity Miss Craven has failed to find the writer's identity. She will feature classical and semi-classical ballads from 2BL on Sunday, September 8.

## Old-time Dance Night

THE Australian Broadcasting Company's Dance Band, under the direction of Mr. Cec. Morrison, thoroughly enjoyed themselves on Tuesday night, August 27. It was the "Old Time Dance Night," and the band played 54 old-time numbers. To show how versatile this band is, they played 12 of the latest modern dance numbers on the close of the old-time programme at 10 p.m. The programme was entirely composed of request numbers, and it took the leader two weeks to arrange. The feature was a huge success, and no less than 21 telephone calls were received congratulating the band, and inquiring for the date of the next night. It has been decided that the next one will take place on September 24, and Cec. Morrison and his A.B.C. Dance Band will be well to the fore again.

## Neville Amadio, Flautist

THE average of good flute players is lower than that of performers on any other instrument. Neville Amadio, however, is one of the few really good performers on that difficult instrument that we have. He is following in the footsteps of his English uncle, the famous John Amadio, who is one of the best flute players in the world. Two vices which this talented young gentleman must overcome are his extreme bashfulness and his youth. He is so young that he hates to mention his real age, and extracting information from him is like drawing teeth.

"I am very absent-minded," said the youth blushing. "I once turned up at the studio on an important night wrapped in an overcoat with what I thought was evening dress underneath. But, unfortunately, I had slipped the overcoat on when I was half dressed, not thinking what I was doing, and when I took it off before the assembled company, I found I had only my more intimate garments on underneath. That is the worst thing, I think, that ever happened to me."

Neville Amadio will be heard from 2BL on September 12.



MAJOR SANDFORD MORGAN  
Travelgraphologist  
2BL Friday

## Esther Kahn, Musician and Composer

THE most versatile of composers, Miss Esther Kahn's songs and instrumental music enjoy a large sale, not only in Australia, but abroad. Miss Kahn's career began when she was only five. At her first concert she was hailed as a child wonder. She received her early training from the late Herr Kretschmann, and has had many successes, both as a musician and a composer.

She was the first to inaugurate the idea of a duet between piano and organ and is associated in the minds of listeners with Miss Lilian Frost, with whom she has broadcast very successfully for a long time. After every performance over the air she receives scores of letters and 'phone calls, congratulating her on the excellent programme she always arranges. Miss Kahn will be heard next from 2BL on Sunday, September 8th.

## Sporting Announcement

FOLLOWING arrangements made with Mr. Frank Underwood, a description will be given of some of the events each night during the New South Wales amateur boxing and wrestling championships, to take place from the Stadium. On September 3 and 5 the transmission will be through 2BL, and the finals on the nights of September 10 and 12 will be taken at different periods through 2BL and 2FC.

## W. E. Lewis, Baritone

MR. W. E. LEWIS, baritone, appeared on the first programme arranged by the original 2BL, and incidentally he was on the last programme to be transmitted by that station. Mr. Lewis has toured New South Wales, Brisbane, and Melbourne, appearing in all the leading concert halls. He has a fine voice, and will be heard from 2BL on Wednesday, September 11.

# PUTTING IT OVER

*The broadcasting Stations' lack of individuality constructively criticised*

By JOHN BENSON

FIVE years ago, broadcasting was a thrilling business chiefly because it was new. There wasn't much money to spend on programmes; but artists were found, and any lack of quality in the programmes was made up for by an ardent enthusiasm, which forced the managers and announcers to work, think, and live for nothing but broadcasting; and which blinded an eager public to small defects of presentation or artistry.

And there was competition: Two A class stations in Sydney fought tooth and nail for supremacy, fought for artists and features, fought, above all, for novelty. If one station was first down the mine, the other was first on the racecourse. If one station did the first great Empire broadcast, the other broadcast the trans-Pacific flight of the Southern Cross. And if one station could, by some strange circumstance

have taken a microphone to Heaven, the engineers and announcers of the other would have gone cheerfully to Hell; just to make things even. You knew the announcers in those days; and you talked of their latest exploits, and their sicknesses and their whims and fads and foolishnesses just as you talked about those of your next-door neighbor or of your aunt's cousin on your father's side.

Amalgamation modified this, conferring other benefits in place of the competitive spirit, which dwindled away and finally died when the Australian Broadcasting Company took over both studios. You must, of course, give the Australian Broadcasting Company its due: its programmes are becoming better and better as the weeks advance; there is evidence everywhere of better arrangement, better material and better artists. Indeed, the sectionalising of the programmes, recently, has done much towards satisfying every kind of radio listener; and if the improvement is maintained on this sectionalised basis, we shall not have much left to wish for so far as the programmes themselves are concerned.

Yet we sigh for the old days; because then the programmes satisfied us: now they don't. The difference is essentially of character or call it personality. It is true that the old wonder of radio has left us. It is true that there are few radio novelties left to amaze us. Still, these modern programmes, so carefully arranged, so carefully rehearsed, do not strike us as they should. Inspid is a strong word; but inspid is the word we apply to the programmes we hear over the air from 2FC and 2BL.

Boil it all down, and you find two causes of the trouble. The first is the lack of competition between the two stations. Imagine, in the days when there WAS competition, managers and announcers and programme directors and typists and office boys all

thinking and working to beat the other station to it. Imagine the announcer, on reading a race report from 2BL ten minutes before it came over from 2FC doing a step dance in 2BL's corridor to the tune of "We've beat 'em again! "We've beat 'em again!" (Such regrettable things really happened.) Then imagine a sober committee, representative of each station, meeting every Tuesday morning to deliberate calmly and cold-bloodedly on the forthcoming events from 2BL and 2FC.

Now, we must allow this Programme Committee one merit—it is able to prevent overlapping of the programmes; and to arrange matters, so that when a programme for high-brows goes over from one station, a programme for low-brows goes over from the other. Having allowed it its merit, subtract its demerit, that it brings down two

stations to a unified non-entirety, crushing out the character of each by attempting to give each the character of the other. Which is absurd. As has been said: What listener has not thought of 2BL, say, as a first-class low-brow station, with a splendid jazz band, sporting talks and descriptions, and plenty of light entertainment; and 2FC, on the other hand, as a first-class high-brow station, with a

fine symphony orchestra, dramatic pieces, and good vocalists? Definite classing of these stations would provide the listener with an alternative programme, with different and distinct attractions, according to his mood.

There are arguments for and against this proposition; but they do not concern us. What we are trying to get at is this, that the arrangement by a central programme committee of programme policies for two stations takes away all interest in those programmes from men directly concerned in putting them over from either station. The programmes are neatly cut on stencil paper and placed in the player piano; the announcer presses the switch, and the "presentation" proceeds. The method of arranging programmes, therefore, militates against character in their presentation.

The second cause of the trouble is an exaggerated conception of dignity and formality. "Ladies and Gentlemen," say the announcers, keeping carefully away from the pitfall of "lady's n' gentlemen." "Our evening programme is now completed. Good NIGHT, Ladies and Gentlemen."

Such announcements are now incorporated in the studio routine; and must not be varied. In fact, formality is the keynote of the stations, and to a listener the general effect is that the announcer wishes to say as little as possible of the performers he is introducing. Yet, in the old days, announcing and personality were synonymous terms. In America to-day they still talk of

their great announcing personalities. In New South Wales the tendency is to make the announcer a gramophone reproducer of a series of formal recordings. It won't work.

An announcer is not a voice, speaking the thought of the managers of his company. He is the presenter of their programmes. He sits in his studio and presents a programme to an audience of three or four people, multiplied by 100,000. He is not addressing a public gathering; but a hundred thousand fireside groups, each group representing an essentially homely audience. Under these circumstances, set forms of announcing conduce to nothing but extreme boredom. We must not forget that the announcer is the one link between the management and the public, and between the artists and the public. It is in his power to make or break the presentation. Listeners will remember the many times Mr. Charles Lawrence has been announcing for Hospital Concert Parties, when his humorous announcements were prominent features of the programmes, and had the effect of binding a presentation into an attractive whole. One doesn't expect an announcer to be humorous—in fact, one would soon grow tired of such announcing, but one does expect an announcer to present programmes in an interesting manner. This is only possible when his personality and initiative are given full play. Formality prevents it.

The method of arranging programmes, then, militates against character in their presentation; and formal restrictions to announcing methods bury the personality of the announcer. What can be done about it?

In the first place, every station should have its own programme director. The general scheme of presentations from each station could be outlined by a central committee, so as to prevent overlapping or duplication; then the programme directors for each station could arrange details. This would encourage competition, and in the resultant rivalry the public would be assured of the best and most original presentations obtainable. The arrangement would also have the effect of stimulating the personnel of the rival stations to greater and greater efforts to achieve public favor.

Secondly, the stereotyped forms of announcing should be dropped, as far as possible, leaving the announcers free to present programmes of distinct character in an original and personal manner.

Soldiers were never so great as when Napoleon presented them; Chopin was never so great as when Brailowsky presented him; and programmes will only be great when they are presented by corresponding genius in announcers.

**Maurice Dudley**

**MAURICE DUDLEY**, the popular 3LO announcer, is off the air on account of a severe cold.

*Lack of competition between 2FC and 2BL and stereotyped formality in announcements have destroyed the personality in the programmes, according to our contributor.*



# Community Singing featured in MELBOURNE PROGRAMMES

EDNA DAVIES  
Xylophonist in the  
3LO programmes on  
Sept 14

NO SECTION of the broadcast programmes is responsible for more letters being received by the Broadcasting Company in Melbourne from listeners than community singing. These letters come from every part of Australia and New Zealand, and in almost every one expressions of appreciation are accompanied by requests for more broadcasting of this popular feature.

A suggestion has been made by a Ballarat listener that 3LO should hold regular weekly Ballarat, Bendigo, and Geelong community singing days, when the Mayor of each city should be invited to attend at the Melbourne Town Hall on their respective day and address the gatherings. Invitations would be broadcast to old residents to assemble and sing, and artists who hailed from the respective cities would be invited to render items. The practicability of this proposal is being considered. It is interesting to note in this respect that old Ballarat residents and their children living in Melbourne outnumber the present population of Ballarat, which is officially stated as 40,000. This being so there can be no doubt as to the popularity and success of the proposed gatherings.

Some of the most successful community singing efforts broadcast by 3LO and 3AR are those held at Geelong and Ballarat. They are enormously popular and listeners are always provided with rare musical feasts from those cities. Bendigo has not fallen into line yet with regular gatherings, but lately there has been an agitation there for the organisation of community singing for broadcasting.

### On With the Dance

DANCE music is now broadcast by 3LO on Thursday nights from 8.30 until 11.30, whilst lively tunes for merry steppers are broadcast every night, excepting Sundays, from 10.30 to 11.30. These dance programmes are always interspersed with vocal and other numbers.

### Repertory Theatre Production

UNDER the direction of Frank D. Clewlow, the Melbourne Repertory Theatre Company will present through 3LO on Saturday night, September 7 the one-act comedy, "The Constant Lover," by St. John Hankin. John Guyatt will take the part of Cecil Harburton, and Winifred Collins will appear as Evelyn Rivers.

### Music Explained and Illustrated

AN illustrated talk on "Style in music—it's romantic charm," by Mr. A. E. H. Nickson, F.R.C.O., C.M. This talk, which is one of a series, will be broadcast from 3LO on Thursday, September 5, during the Educational Session, at 2.25 p.m.

### Dot Dot Dash—D-a-s-h

NO, those buzzing dots and dashes you hear from 3LO are not signals to the announcer that he's off the air or has forgotten to switch this microphone on or something like that, but cold matter-of-fact time signals direct from the Melbourne Observatory. The end of the last dash indicates the hour of day precisely.



RUSSELL CALLOW  
Popular radio  
baritone who will  
be heard shortly

MAROLINE KNIGHT. Contralto.  
who will also be heard next week

### Brother Bill's Popularity

BROTHER BILL, whose fine, manly talks to the children each Sunday evening are a feature of the programme, will take for his subject on September 8 "No Money—No Pie," through which he will illustrate that few things at all worth-while can be achieved without the necessary effort.

### Dem Golden Slippers

A PROGRAMME of plantation melodies will be given from 3AR on September 14, to which the popular contralto Madoline Knight will contribute the familiar numbers "Lily of Laguna" and "Dem Golden Slippers." It is interesting to recall the circumstances under which the "Golden Slippers" was written. At the close of a minstrel show held in New York some years ago one of the "corner men" suddenly said, "Get me a pencil and paper, and this darkey will write a song that will be sold for a hundred dollars." The song was written, and the darkey did sell it for a hundred dollars, and it immediately became immensely popular. Arranged as a waltz, polka, quadrilles, and lancers, it was played in every dance room on both sides of the Atlantic, and netted the fortunate purchaser some thousands of pounds.

### Eskimo High Priest's Charge

A SERIES of talks, "Strange People in Strange Lands," is now being given from 3LO by Mr. H. G. J. Edwards, who is uniquely qualified to deal with the subject. It is interesting to learn that Mr. Edwards was born in the far north of America, and at the age of three was placed under the guardianship of the Eskimo High Priest. This prepared the way for much travel in little known parts of the world, and his graphic word pictures of people and places are much enjoyed by his wide circle of listeners.

### St. Mark's Choristers at 3LO

A PLEASING feature of the Children's Hour of 3LO on Sunday, September 8, will be the singing of the St. Mark's Choir Boys, who have provided many enjoyable programmes for listeners, and who are recognised as one of the finest juvenile choirs in Melbourne. Under the direction of Mr. Albert Emery, a past Cathedral chorister, the boys do some remarkably fine ensemble work, while there are one or two solo voices of great promise among the number. On September 8 they will be heard in several anthems, and the solo "Cherry Ripe" is to be included by special request.

# Wireless Weekly

Incorporating "Radio in Australia and New Zealand."

FRIDAY, SEPTEMBER 6, 1929.

## PUBLIC OPINION AND £5211 PROFIT

ONE of the few occasions on which the radio public receives some genuinely authoritative information on the conduct of the broadcasting stations occurs each year at the presentation of the report of the Queensland Radio Service to the Queensland Government. The Service operates 4QG, the only publicly-owned broadcasting station in Australia, and the figures of the report and the remarks of the director, Mr. J. W. Robinson, are interesting chiefly because they give an indication of the position of the other A class stations, which, being privately-owned do not make public their operations.

This year Mr. Robinson, who often surprises us with some frank, if not always precise, observations on broadcasting generally, goes into the question of variety, as opposed to quality, in programme material. Having informed us in a previous report that there was no such thing as public opinion, he tells us that this year he compromised with so mythical an institution as to put on 820 different artists simply to meet listeners' demands; although this was against his better judgment, which told him that there were not 820 first-class artists in Brisbane, and that better programmes would have been provided had the station restricted its performers to a limited number of first-class artists.

Mr. Robinson is by no means disturbed over this; he is there to give the public what it wants, and experience (he says) has taught him that it wants quantity, and not quality. He learnt this as a result of the experiment during the year, when the broadcasters were limited to a few first-class artists. During this period (despite the non-existence of public opinion) the station was subjected to so much criticism that a return was made to the old routine.

There is no doubt, as Mr. Robinson intends to convey, that the problem of variety is a formidable one for the small broadcasting station. Familiar voices over the air have a tendency to become so deadly monotonous as to make the listener wish for anything else, be it ever so poor. But this does not necessarily imply that the listener prefers programmes of an inferior quality. Constant repetition, in itself, no matter how great the rendering, is the mark of inferior programmes. A song

well rendered twenty times is just as poor at its twentieth rendering as a song poorly rendered once. It is the effect of the rendering upon the listener which counts, not the rendering itself.

This, of course, does not in any way ameliorate the conditions of broadcasting in the smaller centres. The solution lies in an exchange of artists and the relaying of programmes from other States. Perhaps this will come about, as Mr. Robinson hints, when the Queensland Government's license expires shortly. Queensland listeners may still ask, however, why some part of the £5211 profit by the station for the past year was not spent on such services, since it is publicly owned, and run solely for public benefit. But, then, of course, there is no such thing as public opinion.

## Travel and Adventure Talks

### Malaria Memories

AT the latter part of last year, Mr. Price Conigrave visited the great Owen Stanley Range, in the centre of Papua. Mr. Conigrave and his party were two days gone, and passing through hostile territory when his companion was struck down with malaria. Ten hours later Mr. Conigrave and another member contracted the disease. He will relate some of his experiences in the disease-infected jungle through 2BL on September 9.

### Fred Arlington-Burke

MR. FRED ARLINGTON-BURKE, the traveller who has been delighting listeners with his interesting travelogues, will continue his talk from 2BL on Tuesday, September 10. Mr. Arlington-Burke has had a remarkable career. Prior to the Great War, he saw active service in the gun-running trade of the Persian Gulf, for which he received medal and clasp. He took part in the defence of Egypt and Suez Canal; was present when the fort and dockyards of Smyrna were destroyed, and then went to Gallipoli. He was actively engaged during the war, and was decorated by the Belgian Government for his heroic conduct in the memorable Zeebrugge Blockade. He has described many of his thrilling experiences over the air, and his subject for September 10 will be: "Inside Anecdotes of the Great War."

### T. S. Gurr

MR. T. S. GURR, the well-known Sydney journalist, will be heard from 2BL on September 10, speaking on "Assam and the Manipur Disaster." Mr. Gurr is a vivid raconteur, and is an authority on this subject. He will describe Assam's geographical and climatic position, the British occupation, the Royal House and Palace, and the Resident and his wife. He will tell of the usurpation of the Maharajah and the visit of the High Commissioner, Sennaputti's refusal to attend the Durbar, and the assault on the palace and citadel. The counter-attack on the Residency, the heavy fighting and bombardment, and, finally, the retreat; the terrible sufferings of Mrs. Grimwood, the relief column, and the horrible murder of the High Commissioner and his suite, concluding with the decoration of Mrs. Grimwood by Queen Victoria.



Dad: H'm, the man who said that radio brought the world to your door was just about right.



# The Safety Valve



## Suggestions for Variety

Dear Sir,—I fully endorse the remarks of both A. C. Caldwell (W.W., 2/8/29), demanding detailed programmes; and Chas. F. Gerard (W.W., 9/8/29), having same artists on at both stations, also rebroadcasting one station from another. Why does not the A.B.C. put on a programme at 2FC and rebroadcast same from all other stations? They might as well do the job thoroughly.

Comparing the old companies with the A.B.C.: Of the two the old companies put on much better programmes than the A.B.C. is doing. This is the opinion of all subscribers, about twenty in number, that I have asked, with the exception of one, who said he did not see any difference other than that the A.B.C. orchestra was better than previous orchestras he had heard. I can supply names and addresses of the aforementioned subscribers.

If Mr. Stuart Doyle and his associates wish to improve and encourage wireless, let them sit in a room listening for, at least, three hours to one of their programmes—I mean without anyone else in the room—no books, no papers—but just listen-in and be entertained by their programmes from any one station, like thousands of others have to do. I am sure that they would sympathise with those of us who have to take the trouble to write complaints. While the artists engaged do their best, and some of them are very good, still one must say a good artist from a record is far better than an indifferent local artist. This should be borne in mind.

Now for the remedy. My idea is that variety is the spice of wireless, as in other things. Instead of so much organ and orchestral music, which becomes monotonous, vary with lectures and talks, the same as Captain McLean has been giving us, and more solos—both vocal and instrumental. They come over much better than choruses and orchestras. At the same time, remember that a good record is far better than bad local artists. And when the gramophone artist is of the type belonging to the world's best, it is an education to those who are endeavoring to become singers and musicians. I would suggest a request night for a gramophone record recital from one of the "A" class stations. Followed, at a later date, by a programme of the world's very best artists, especially Melba and Clara Butt. Of course, a certain amount of jazz stuff for those who like it. The items in the recital should be printed in detail for the benefit of those who have only a short time to listen-in, so that they could hear their favorite artists. This sort of programme would lend variety to listening-in. One other thing I would stress, i.e., in talking, a great number of speakers talk so quickly that their words become a jumble, one word running into the following one. This is most aggravating.—Yours, etc.,

Cessnock.

RADIO.

North Dorrigo.

*Readers are urged to express their opinions on matters pertaining to broadcasting. If you have some grievance, if you have some constructive criticism to offer, here is your chance of expression—your safety valve. The editor assumes no responsibility for statements made by readers and published on this page, as opinions of correspondents do not necessarily represent our editorial policies. Anonymous letters are not considered.*

## Wavetrap

Dear Sir,—About three weeks ago I wrote you about shock excitation, in the vicinity of 2BL, under the nom-de-plume of "Sixth License." I notice a Mr. W. H. Williams, of Randwick, is complaining of the same thing. I don't want Mr. Williams to think I am an expert, as I am not; but I would like to know what he has done in the way of "wavetraps." I have two stations to cope with 2BL and 2UE—the latter being only 500 yards distant; and I have practically no interference from either using the Furness wavetrap, without which I cannot get 2YA; with it, it roars in—when conditions are favorable, of course. I have a home-built neodyne, and I extend a hearty invitation to Mr. Williams to call at my home and I will demonstrate the Furness wavetrap to him. If Mr. Williams cares to get in touch with me. I will be at home one evening, if arranged.—Yours, etc.,

B. L. GOODGER.  
18 Royal Street, Maroubra.

## JOACK and BK

Dear Sir,—Re Japanese stations: Your correspondent, D. R. Gill (W.W., 23/8/29) is correct in stating that one Japanese station announces JOACK. Moreover, I have frequently heard the Japanese station just above 4QG announce as JOABK, the letter "B" being said rapidly, whilst the others are drawn out. I have had other listeners check up on this, and can vouch for it.—Yours, etc.,

E. W. LUKINS.

Taree.

## Scraps of News

Dear Sir,—I am with "Country Listener" re the news sessions. What's wrong with the old 2BL'S half-hour news service, and why must 't be cut out to give city listeners gramophone records? I bet they have no time to listen to either, at 8 o'clock in the morning. So why deprive us? Once each day would satisfy me, if the paper were read fully, not a scrap here and there. Otherwise the programmes are excellent, and I hope they continue. Has anyone noticed the "hum" and distortion in the transmission from 2FC?—Yours etc.,

WAYBACK.

## Country Listeners

Dear Sir,—Following are some remarks on the new programmes. It is no use sitting down and saying nothing. I am also writing the A.B.C. There is indignation in all directions, but it is difficult to get the average man to complain when he should if he wants redress. Most of them say: "What is the use, my machine is no good to me, and I am going out of wireless. I only got it for the news."

The last figures of the P.M.G. showed that 37 per cent. of the licenses in N.S.W. were held by country subscribers. This would work out that they spend far more on wireless than city residents when you consider the cost to the former against what the latter pays for his outfit. Hope you keep this matter going as we find ourselves going to New Zealand for news.—Yours etc.,

LEN BROWN.

Ballamin Station, Q.

## Cutting

Dear Sir,—I would like to express my great disappointment at the new service that is being put through 2FC and 2BL. It seems to me that the country listeners are not being catered for at all. Most of the news is cut out, and you will hear 2FC, 2BL, and 3LO all on market reports at the same time. Surely one station is enough. All sporting news is cut out of Sydney stations on Saturday evening, and I should say that most of the transmission power has been cut out in the day as well. But the worst cut of all is the cutting out of a station in Sydney by having the same artists on the two stations on the same night (see Monday, August 5) and I suppose the same thing will happen in Melbourne when they take over 3AR. Also, what was wrong with each item being set down to time? I am sure I don't want to stay on one station all night just to hear a few items I like and miss some more on another station.

It is time that the new company realised that they are not up to the standard of the old 3LO company by a long way, and there will be more licences cancelled than renewed in the three years they are carrying on unless they alter very much.—Yours etc.,

A. WOODEY.

Moruya.

## Programmes

Dear Sir,—Please allow me to express my opinion in reference to the programmes that are being broadcast by 2FC since it has been taken over by the Government. In the first place, in the reception there is a lot of hum and buzz, and the voice is very muffled and mushy. They publish a programme of items, but, when you come to listen in, you find that they do not follow the programme in many cases. And then, again, we get no early 7 a.m. news, which was a boon to the country listeners. I also find fault with the class of gramophone records used, the dreary organ recitals, and so forth. I do not object to good lively records—band music or comic songs. I should like to hear some other listener's opinion.—Yours etc.,

Tarana.

OLD TIMER.

# FRANKLY!

## ARE YOU SATISFIED WITH THE RESULTS FROM YOUR SET?

We leave the answer to you—BUT:--  
**READ THESE LETTERS BEFORE YOU ANSWER**

*They are from Customers we have helped*

### 3LO AS GOOD AS 2BL

(Extract from Letter.)  
 Cremorne, N.S.W.,  
 24/8/29.

Economic Radio Stores,  
 126A Pitt Street, Sydney.

Dear Sirs,—I wish to congratulate you on the "RENEWN THREE," which is simple to build and simple to operate. The results are, as you say, equal to a five-valve set. 3LO, Melbourne, can be tuned in to give as good volume quite as 2BL, Sydney.

My aerial is not good, only 40ft., and very close to the roof. As far as clarity is concerned, we cannot wish for anything better.

Yours faithfully,  
 C.K.P.

### WHAT DO YOU THINK OF THIS PERFORMANCE ?

Toongabbie, N.S.W.,  
 24/7/29.

Economic Radio Stores,

Dear Sirs,—What do you think of this performance on one of your "3 VALVE RENEOWN SETS"?

I have got the following stations, and have brought them all in on our "OPERADIO SPEAKER."

N.S.W.: 2FC, 2BL, 2GB, 2UE, 2KY, 2UW, 2AD, 2AR, 2ZN, 2JO, 2AY, 2JR. Victoria: 3LO, 3AR, 3BY, 3MI, 3FR, 3KX. Queensland: 4QG. New Zealand: 2YA. South Australia: 5CL. Tasmania: 7ZL.

Yours truly,  
 C.G.W.

## "OUR RENEOWN 3 now REVISED"

SEE  
 ABOUT  
 OUR  
 REVISED  
 RENEOWN

3

### OUR RENEOWN 3 GIVES ASTOUNDING RESULTS

(Extract from Customer's Letter.)  
 To Economic Radio Stores. Auburn, N.S.W., 9th June, 1929.  
 Dear Sirs,—Having heard so much about the "Renown 3," I thought I would try it, and am sending you a letter of appreciation. Below is a list of the stations I have logged in less than a week, my latest being 3LO this morning. 2FC, 2BL, 2GB, 2KY, 2UE, 2UW, VK2AG, VK2AR, VK2LD, VK2PS, VK2FK, 3LO, 3AR, 3UZ, 3DB, VK3BY, VK3EF, VK3ES, VK3JR. S. Australia, 5CL, 5KA, 5DN. Queensland, 4QG. Tasmania, 7ZL. N. Zealand, 1YA. Japan, JOBK, JODK. My set is built to directions given in the book of the year's best circuits.—I am, yours etc., R.K.

SEE  
 ABOUT  
 OUR  
 REVISED  
 RENEOWN

3

**25 TO 50 PER CENT. IMPROVEMENT GUARANTEED**

SEE SPECIAL WINDOW DISPLAYS

## You Too Can Obtain Wonderful Results

IF YOU ASK FOR OUR FREE ADVICE AND ASSISTANCE  
 WE WILL HELP YOU WITH PLEASURE  
 REGARDLESS OF WHERE YOU BUY

*"Yours for Lower Prices and Service that Satisfies"*

# The Economic Radio Stores

Address Mail Orders, 492 GEORGE STREET

COUNTRY CLIENTS.—Our Mail Order Service reaches every corner of the Commonwealth. Send your orders to us conditionally that your money is refunded if you are not satisfied with goods. Returns must be made within ten days of receipt. We pay carriage on all orders of 10/ and over, except on Batteries, Cabinets, and Loud Speakers. Articles specially procured cannot be exchanged. Terms Cash, or Cash on Delivery. No Discounts.

SYDNEY: 25 New Royal Arcade, near Palace Theatre. Phone, M6138. NEWCASTLE: 13 Union Street, off Hunter Street West. Phone, New 1622.  
 PARRAMATTA: Corner Church and Macquarie Streets. Phone, UW9501. SYDNEY: 126A Pitt Street, near King Street. Phone, New. 1622.

# Getting Maximum Performance from the Speaker

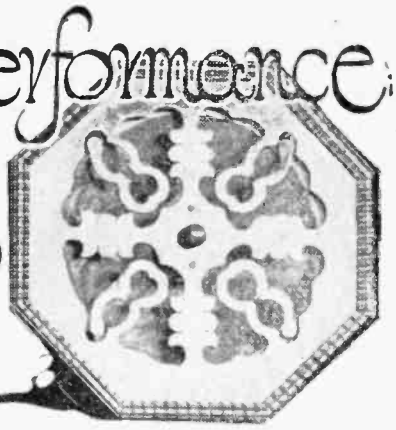
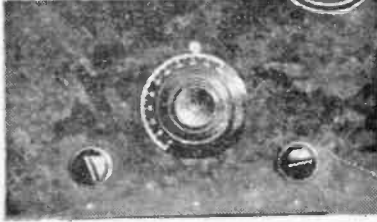

**M**OST listeners have at one time or other wondered whether their speaker was connected to the radio set in the proper manner. At one time the speaker was merely hitched in the plate circuit of the last valve, but in recent years, when so much consideration has been given to reproduction, it has been found that that simple connection is insufficient except in relatively few cases. It can be said definitely that the speaker must be coupled to the radio set with some sort of output device if the reproduction is to be of the very high standard at present possible. The question does not come up, of course, when the receiver and speaker comprise one unit, built up in its complete form by some reputable manufacturing concern. In cases where the receiver is home-built, or where the receiver is some antiquated affair, consideration might well be given to the matter of providing a suitable connection between the set and the speaker.

An output device performs several useful purposes aside from being the connecting link between the last amplifier valve and the unit of the speaker. In the first place, it keeps the d.c. plate current of the amplifier valve from passing through the speaker windings, and, secondly, it may serve to adjust conditions when a loud speaker alone is unsuited for operation with a certain amplifier valve, on account of differences in their electrical characteristics.

For the work of keeping the d.c. plate current out of the windings of the loud speaker, the output device is only necessary when a power valve is used—that is, when the plate current is above about 10 milliamperes. For high-quality reproduction, however, such a valve is almost invariably a necessity. From the standpoint of fidelity, the device is necessary when the impedance of the speaker differs considerably from that of the valve from which it is to work. In this case, only one kind of output device—the transformer—does any good, the choke-condenser type serving no useful purpose from the standpoint of reproduction, unless the choke has taps on it when it becomes an auto-transformer, and not really a choke in the technical sense of the word.

When d.c. flows through the winding of the loud speaker, the armature is pulled from its neutral position with respect to the winding, and is much more liable to strike the pole pieces of the magnet under strong signals. In other words, the armature is working under a permanent bias, which is neither necessary nor desirable; it forces the armature to work under a hardship that is easily removed by means of the output device.

Some types of output devices have the additional advantage that they remove d.c. plate voltages from the loud speaker tips with the result that these tips, or any part of the loud speaker mechanism, or the output jack or terminals may be touched while the "juice" is on, without danger of shock.

---

*Considering one of the most important accessories of the radio set with a view to improved results. Various types of output devices.*

---

No output device, however, will protect one from being shocked by the loud-speaker voltages produced by strong signals.

Output devices, then, are used to keep d.c. from the loud-speaker winding; to prevent serious loss in plate voltage; to prevent placing a mechanical bias on the loud-speaker armature; and to adjust serious impedance differences, and therefore, improve fidelity.

As mentioned previously, there are two types of output devices. There is the true transformer, with two windings of copper wire insulated from each other, and wound on an iron core, which is insulated from the windings; and there is the choke and condenser combination. The transformer, by its very nature, keeps the d.c. from the loud speaker and d.c. voltages from the terminals. It has the added advantage that, by proper design, differences in impedance which may exist between the loud speaker and the power valve may be adjusted.

The choke-condenser combination consists of a high-inductance copper coil of many turns on an iron core—and the condenser. If the choke is tapped, impedance differences may be adjusted, but for purposes of discussion it then becomes a transformer, although the two windings are not insulated from each other, but possess a certain part of the copper wire in common. This com-

bination of a coil and a condenser may be connected into the power valve circuit in two ways, one of which is better than the other. The transformer may be connected in only one way, which corresponds to the poorer of the condenser-choke connections.

The diagrams "A" and "B" illustrate two methods of connecting the choke-condenser type of output filter. These arrangements are suited only for feeding a magnetic cone, or horn, type of speaker from a single-power valve. Of these two arrangements, that shown in "A" is the more effective. The scheme "B" is one that is quite generally used, but it has the disadvantage that the currents through the speaker must return to the filament circuit through the plate-supply system. Assuming that the power valve is of the usual type—with a plate impedance of about 2000 ohms—and that the speaker is also of a standard type, the choke used in this filter might well be one of about 25 or more henries inductance. The condenser in the speaker lead should be of two or more microfarads capacity. It is very necessary that consideration be given to the plate current of the last valve, in order that a choke will be obtained which not only will carry the plate current without serious voltage drop, but one that will carry it without a serious sacrifice of its inductance. It must be remembered that the inductance of the choke will vary with the current passing through it. The diagram "C" shows the connection of an output transformer with a magnetic speaker. Usually a one to one ratio transformer will be most effective under these conditions—several of which are available on the market at present. When two-power valves are used in push-pull to feed the same type of speaker it is desirable to arrange the connections as shown in the diagram "D."

Though it may interest only the technical readers, we might mention that the choke-condenser combination, or a one to one transformer, is not always ideal just because the valve has an impedance of 2000 ohms, and because the speaker is of the magnetic type. The difficulty is that the impedance of different makes of speakers are not by any means the same, and hence not all of them

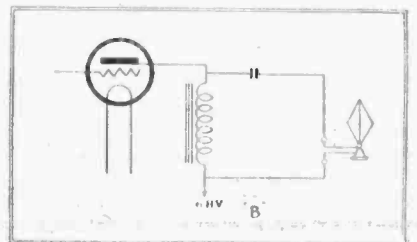
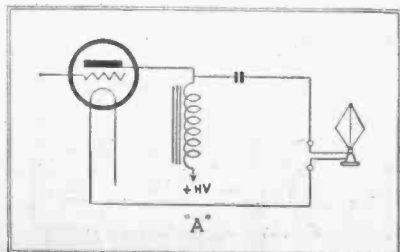

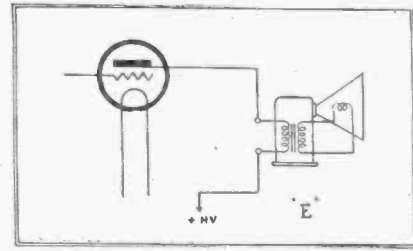
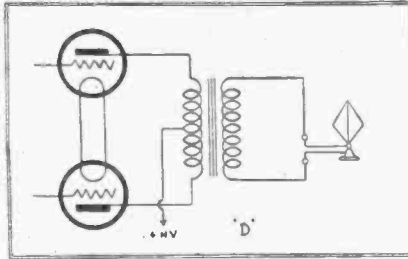
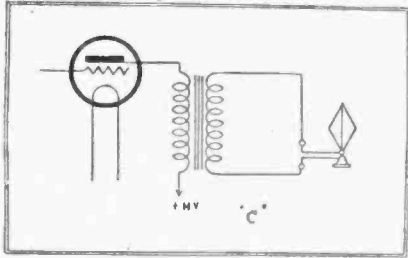

are suited for direct feeding from a 2000-ohm valve. Of course, the impedance of any speaker varies with the frequency, and for this reason it can be suited ideally for the valve only at one frequency. For maximum undistorted output from the power valve, the effective impedance of the speaker should be twice that of the valve feeding it. This relationship between the impedances will change with the frequency, but if it is made to be two to one at a frequency of about 200 cycles, the result will generally be satisfactory in the case of magnetic speakers. Unfortunately, the speaker manufacturers rarely give any information about the impedance of their speakers at any frequency, and consequently about the only thing to do is to hitch them up to the output valve, and hope for the best.

In some circles it is held that with the magnetic speaker impedance should not necessarily be twice that of the valve. In the literature of one well-known manufacturer of transformers, it is said that since the impedance of the magnetic speaker varies so greatly with frequency this two to one ratio does not hold good. A formula is then presented, by which the correct ratio of the output transformer may be found, providing the impedance of the speaker at 200 cycles and the impedance of the output valve are known quantities. In this formula, the ratio necessary equals the square root of the valve impedance, divided by the speaker impedance. It would appear that this formula is the equivalent of saying that the speaker impedance should be twice that of the valve at some frequency other than 200 cycles. However, it undoubtedly works out in practice.

Let us look at the requirements for output transformers when a push-pull output amplifier is used. For the sake of discussion, we will consider that the two to one impedance ratio should hold at 200 cycles.

Assuming that the magnetic speaker happens to have an impedance of 4000 ohms at 200 cycles, it is then ideal for connection to a 2000-ohm valve by means of a one to one transformer, or a choke-condenser output filter. However, if the speaker is to be supplied from a push-pull stage, employing two valves of similar impedance, the plate circuit impedance will now be 4000 ohms, and the required speaker impedance twice that value. Of course, it is impractical to buy another higher impedance speaker for the work, and instead, we use a step-down transformer to give the same effect. The effective impedance of the speaker will then be its own impedance, multiplied by the square of the turn ratio of the transformer. If we used a two to one transformer, as is common practice,

the effective impedance would be 4000, multiplied by 4, or 16,000 ohms, which is just twice the value we really want. On the other hand, a one to one transformer would give us only 4000 ohms, or half the value required. In this particular case, then, some ratio of about one to one point four really would be desirable. The trouble is that any speaker available may not have an impedance of 4000 ohms at 200 cycles, and any worry over the transformer ratios may, therefore, have been in vain. It is our opinion, by the way, that very few magnetic speakers at present available fulfil this requirement. We think that it is this fact that is responsible for so much of our reception being shrill and thin. With most of the magnetic speakers the impedance of the unit is so low that a couple of 2000-ohm valves in parallel are necessary to get anywhere near the desirable impedance ratio.

With the moving-coil speakers, another set of conditions exist. In these speakers—which we will call dynamic speakers, for short—the impedance of the unit itself—the moving coil—is only of the order of a few ohms. An output transformer is, therefore, necessary, in which a high ratio has the effect of boosting up the effective impedance to twice that of the valve or valves feeding it. The impedance of a moving coil is much more nearly constant over the band of musical frequencies than is that of the magnetic speaker. This is one reason for its superiority. The ratio of the output transformer in this case can be considered as simply the square root of twice the valve impedance, divided by the speaker impedance, which is the same thing as saying that the effective impedance of the speaker and output transformer is the moving-coil impedance, multiplied by the square of the turn ratio of the transformer.

And now, to get away from technicalities and back to earth, we will show the connections suited for the moving-coil speaker.

In the diagrams shown on these pages are illustrated several of the optional connections that may be employed to secure maximum effect from the speaker. In the drawing "E" it will be readily seen that a dynamic is connected directly into the plate circuit of the power valve. In this case the plate current from the power valve passes through the primary windings of the input transformer inside of the dynamic housing. This transformer then passes the alternating current fluctuations in the primary into the secondary, where they are impressed upon the voice coil of the speaker. This type of connection is quite satisfactory for practically all purposes, except where the plate current drawn by the power tube is in excess of the safe current-handling capacity of the

primary winding in the dynamic speaker itself.

When an individual is using an output transformer in the power stage, and then taking the output of the secondary, and feeding it into the primary of the dynamic input transformer, there is a possibility the best results will not be achieved. Under some conditions, largely depending upon electrical characteristics of the transformer, operation will be satisfactory. However, there are occasions when such will not be the case, and in that event it is best to revert to the scheme of connections shown in "E," eliminating the output transformer in the radio receiver.

In diagram "F" we have a push-pull output transformer, whose secondary feeds directly into the primary of the dynamic input transformer. Here again there is a possibility that, due to the electrical characteristics of the output transformer, satisfactory results will not be secured. However, in this case it is not possible to put through the primary of the dynamic input the plate current in a push-pull circuit, so another method has to be employed, one of these methods being the one described in diagram "G," and the other being illustrated in sketch "H."

It will depend largely on the individual user as to which method is most satisfactory. In some cases the presence of the secondary of the push-pull output transformer in the circuit will contribute to distortion. Generally speaking, the idea outlined in "H" is most satisfactory, when it is desired to retain the push-pull output transformer.

In the scheme shown at "G" the conditions in the circuit will not usually be those that the designer of the speaker had intended. If the primary of the transformer contained in the speaker was planned to be fed from a 2000-ohm valve, the use of the two valves in push-pull will upset the normal conditions, since the effective valve impedance is now 4000 ohms. The normal conditions would only be restored if two 2000-ohm valves were used in parallel on each side of the push-pull arrangement. In actual practice, the scheme "G" works quite well with some speakers, notwithstanding the fact that the conditions are not what was intended. The reason is probably that the transformer in some of the speakers was designed to provide the desirable impedance ratio at a very low frequency, in order to heavily accentuate the low notes. The use of a higher impedance on the valve side of the transformer then serves to offset this characteristic of the unit, and restore a more natural balance of the high and low frequencies.

In the connections shown in diagram "H" it is essential that the output transformer be (Continued on page 24.)

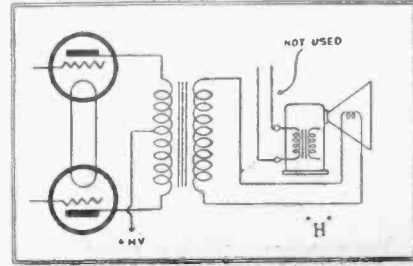
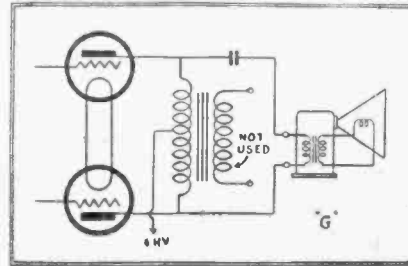
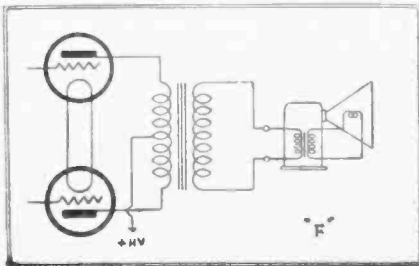

# YOUR A.C. OPERATED RECEIVER

Should Employ Component Parts Only of Recognised Merit.

Radiokes Quality products are now widely used in the manufacture of some of the finest factory-built receivers on this market.

Is this not sufficient evidence to convince you? Most modern custom built A.C. powered sets for home construction are employing components designed and built by RADIOKES.

The Famous 1930 A.C. and D.C. 3.33 receivers embody many excellent Radiokes Quality components.

The only successful screen grid circuit yet offered here employs the famous Radiokes made Band pass filter system. This Coil Kit allows maximum selectivity with great sensitivity, and this without sacrificing any of the finer tonal quality of the Broadcast transmission.

**THIS 3.33 COIL KIT SELLS AT 32/6 PER KIT.**

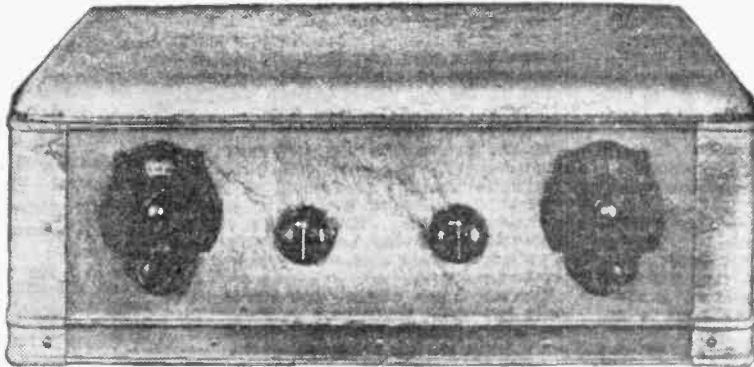

The truly excellent receivers now possible as a result of power operation certainly lay claim to a metal cabinet of distinction.

The modern vogue is for RADIOKES' two tone, wrinkle finished, bronzed metal cabinets, which, owing to their peculiar beauty of finish, are quite adaptable to any scheme of room decoration.

Manufacturers and home assemblers ask to see the new design Radiokes collapsible metal cabinet. Unexcelled for beauty, and considered as the finest cabinet yet offered to Radio public.

**PRICE, £2/2/6 EACH.**

The now famous Radiokes R.F. Choke plays an important part in modern R.F. circuits.

This choke is too well known to call for description here. Suffice it to say that this choke has been accepted as standard for efficient receiver design throughout all Australasia.

Radiokes R.F. Chokes are applicable for use on the short waves, because the excellence of their design is such that they will efficiently cover a wave band from say 15 to 700 metres.

**PRICE, 8/6 EACH.**



RADIOKES' midget condensers are probably the finest procurable on this or any other market.

They are made in several sizes, sufficient to cover most ordinary requirements.

Ask your dealer to show you one of these little condensers, feel its velvety action, study the precision of its workmanship, and notice the high-grade finish.

Radiokes thereafter will be your choice.

**PRICES FROM 4/3 TO 8/6 EACH.**

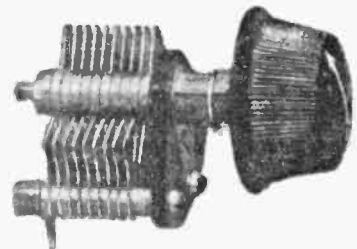

RADIOKES SUB-PANEL BRACKETS are the best for mounting and strengthening your sub-panel. Made from hard-pressed aluminium, girder pattern, and finished in Black Crystalline Lacquer.

**PRICE, 3/3 PER PAIR.**

RADIOKES BOX SHIELDS, for housing and isolating the stages of your R.F. Amplifier. These are made in a standard size for all ordinary uses, of 9in. x 6in. x 5in. **PRICE, 15/- EACH.** Special sizes for A.C. and D.C. 3.33 Sets at slightly higher rates.

*Obtainable from your dealer or direct*

## Metropolitan Electric Co. Ltd.,

RADIOKES HOUSE, 126-130 SUSSEX ST., SYDNEY

# RADIO Proficiency

This week we learn something about voltmeters, ammeters, wattmeters, galvanometers, etc., discuss moving coil and hot wire types in both kinds of instruments, ammeter shunts, series resistances, and learn where the various instruments should be connected in the circuit to be tested. Readers will see how the "Dead Beat" rule applies to instruments used in measuring the pressure flow of electricity.

**I**NSTRUMENTS used for measuring electric voltages and currents are called "voltmeters" and "ammeters." The product of volts and amps gives watts, so that the meter used for measuring the product of pressure and flow is called a "wattmeter." For small currents the millimeter is used. This measures thousandths of an ampere.

Essentially a voltmeter is an instrument used to measure the potential difference between the mains of a power system, between the brushes of a dynamo, or across a battery. The good types are designed to take as small a current as possible, and, therefore, to have a high internal resistance.

An ammeter is an instrument used to measure the current flowing in a circuit. It is joined in series with the mains at any convenient point.

Those of you who have read my previous remarks on galvanometers in "Proving Radio" will know that this instrument is also used to indicate when a current is flowing in a circuit. The galvanometer, however, is not calibrated to read the value of the current in amperes.

A wattmeter measures the product of volts x amperes. It has one coil joined in series with the mains, and one coil joined across the mains.

Suppose we connect a lamp of 108 ohms resistance across the mains. In fig. 1 the positive line is shown as AB, and the negative as CD. Suppose the resistance of the line AB is 1 ohm, and the resistance of CD is also 1 ohm. The voltage at AC is 110 volts. Then the voltmeter V will read 110 volts. The current flowing will be:

$$I \text{ equals } \frac{E}{R} = \frac{110}{108 \text{ plus } 2} \text{ equals } 1 \text{ ampere}$$

This will be indicated by the ammeter at A, which could equally as well have been joined in the line CD.

As the voltage drop A to B and C to D in each case equals  $I \times R$ , equals  $1 \times 1$ , equals 1 volt, the P.D. between B and D equals 110 minus 2, equals 108 volts; this will be indicated by the voltmeter V2. The wattmeter would read  $110 \times 1$ , equals 110 watts. In this statement the current through the voltmeter V2 is neglected.

The diagram shows the correct positions for placing meters in an electrical circuit.

The types of ammeter and voltmeter generally in use are the moving coil and hot wire instruments. The working parts of each one are very similar. A coil energised by current from the circuit in which measurements are to be made is free to rotate between the poles of a permanent horseshoe magnet. The magnet has shaped pole-pieces, between which—leaving narrow air gaps—is a fixed iron cylinder to intensify the magnetic flux.

In the space between poles and cylinder the coil moves. It consists of a coil of fine insulated wire on a rectangular aluminium frame, held by two pivots in jewelled bearings, and carrying an aluminium pointer. Two spiral springs, the inner ends fixed to a pivot and the outer ends to the standing part of the instrument, return the pointer to zero position. They also serve to carry the current to and from the coil. The coil, when carrying current, tends to move so that its flux is at right angles to the magnet

flux, thus enclosing as many lines of force as possible. That is, a "clockwise" twisting torque (proportional to the current flowing) is exerted between the magnet and coil against the "counter clockwise" torque of the springs. According to the strength of the current flowing, the pointer will take up a certain position on the scale.

The instrument is said to be "dead beat" when its pointer comes to rest quickly. This is caused through three things: (1) The moving parts being very light; (2) the currents induced in winding and aluminium frame as the coil moves through the flux; (3) some "damping" device usually incorporated in the meter.

As the fine winding can only carry very small currents, the greater part of the current to be measured is shunted off by an ammeter shunt, which is placed in parallel to the instruments. This shunt is usually made of strips of alloy, i.e., "manganin," and has a very low resistance, unaffected by temperature changes.

The resistances of the instruments and leads, and of the shunt, bear a definite relation to one another. For all ordinary purposes, however, the resistance of the leads is neglected. Thus, an ammeter moving-coil carries a definite fraction of the main current, but is graduated to measure the main current.

Note also that the combined resistance of ammeter and shunt in parallel is very small, and has no appreciable effect on the resistance of, or the current in, the circuit.

Ammeter terminals are always marked plus and minus. The ammeter must be connected correctly, i.e., positive terminal to positive lead. Shunts are not necessary with ammeters designed to measure very small currents.

A voltmeter is connected across two points in a circuit to measure the P.D. In order that it will not appreciably affect the resistance of the circuit, and so that it will carry only a small current, a high resistance (usually contained in the instrument) is placed in series with it.

In the hot wire ammeter, the current is carried by a hairspring to a bridge wire through which it divides to two terminals connected to a brass plate. The current leaves the circuit from the brass plate.

Near the centre of the bridge wire is a much thinner one, which is fixed at its other end to an insulated terminal; a piece of silk fibre is also attached to this wire and the other end of the fibre is wrapped round a grooved metal roller to which the pointer is fixed, the other end of the fibre terminating in an eyelet attachment to a flat spring.

When the current flows through the wire connected to the brass plate, the heat causes

it to expand, and its sag, therefore, increases, this enabling the wires to change their position. This permits the movement of the thin silk fibre, which turns the pulley and moves the pointer.

A damping device is attached to the spindle of the needle, generally consisting of a thin aluminium disc moving between the poles of a strong, permanent horseshoe magnet.

On motion taking place, the current induced in the disc produces a magnetic field opposing the motion and thus delaying it. The object of this disc is to damp out mechanical vibration. For use as an ammeter a shunt is used as before, and for use as a voltmeter a high resistance is fitted in series.

Besides the meters mentioned and discussed, the milliammeter, which measures current flow in thousands of an ampere, is often used in experimental and testing work in connection with radio receivers and transmitters.

In the receiver, a constant jerking of the needle, when the meter is in the plate circuit of the output valve, indicates a distorted output. The milliammeter is useful here for testing various types of amplifiers for undistorted output.

In the transmitter, it is necessary to adjust until a certain plate current is shown on the milliammeter. In one circuit, for instance—the Hartley—a certain type of valve, when used, must be supplied with a certain plate current. This is adjusted by means of grid excitation and other factors.

A simple experimental meter of the magnetic type is easily constructed. If an electromagnet of the single core type be constructed as per instructions given in "Proving Radio," and the core left out, a piece of soft iron, flattened out into a thin, narrow bar, and suspended so that it can be slid in and out of the centre of the coil without friction, can be made, and if a needle is attached to this, its position will vary when the voltage varies. By marking a dial according to the reading given, the meter can be made use of practically.

Meters are usually made in two types. One is the projecting type, and the other is known as the flush type. The latter's face is level with a panel on which it is mounted, whilst the former will project. These two types are placed under one category, i.e., panel mounting type.

In addition to these, there is the hand-type meter. This usually has one contact (on the base), and another contact through a flexible cord.

Single range instruments are those which can measure up to a certain figure only, such as 0-10 volts, or 0 to 5 milliamps. Double range instruments are those which can give two different readings, i.e., 0-10 volts and 0-100 volts. The reason for this is that if only the 100 volt-meter was available, and it was desired to test a  $1\frac{1}{2}$  volt cell, there would be practically no reading on the 100 volt scale. The reading would be shown, however, on the 10 volt scale. On the other hand, if one wished to test a 45 volt "B" battery, and his meter only read up to 10 volts, he would burn the meter out if he connected it across the battery.

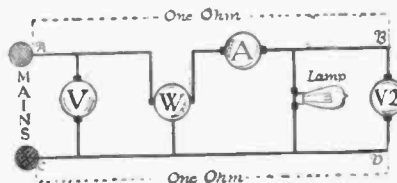

Fig. 1.



# AIR SCREWS

How to make bent-wood propellers for model 'planes

By NORMAN LYONS

There is no doubt making propellers is the hardest job of all, and upon the propeller hinges the success or failure of a model.

**A**LTHOUGH most crack aero-modellists use carved propellers, some prefer bent-wood propellers, as they are easy to make and are light.

Propellers are bent from any of the light woods such as spruce, Queensland maple, clear pine, or cedar. The first step is the choice of design and size, next comes the setting out of the blank, and, finally, the bending.

The first step is covered by the plans of the model which you have selected for construction. If you are making an original model, the suggestions shown in Fig. 1 will help you, as these are the blade patterns which represent modern usage. Sketch A shows what is known as the Langley type, made famous through its use on the successful aircraft of the pioneer, Samuel Pierpont Langley, in the year 1896. Lawrence Hargrave, the Australian pioneer, used the same type in 1891. Sketch B may be described as the Langley type with one corner cut off. Sketch C is known as the Columbia type, which is similar to the second type, but with the corners rounded off. Sketch D shows the type used extensively by the United States navy on its man-carrying 'planes. It differs from the Columbia in having both edges rounded. Sketch E is the diamond pattern which performs well. Sketch F is the Carter type, which differs from the diamond in that the projection of the leading edge is advanced from that of the trailing edge. It is used on many of the thin-bladed metal propellers that are so efficient on full-sized 'planes.

The next step is setting out the blank, which is quite a simple operation. The blank is now cut out. The ideal tool for this is a fret saw, but if one is not available use a penknife, being careful not to cut against the grain and so start a split which will run the length of the blade as soon as the bending operation is commenced.

The curved edge should be chosen for the entering edge of the prop. This is in accordance with the best practice, as curved entering edges have proved to be better than straight ones. If the propeller is used on a pusher model, the hook of the shaft will be on the convex side of the blade; if on a tractor, it will be on the concave side.

Now, before the blades can be bent a press is necessary. This is shown in Fig. 2. It consists of a base A, a block with a slit in it (B), a rectangular block with a curve cut out of one corner (C), and the piece cut from C shown at D. The size of the press will depend on the size of the propeller. The blocks B and C are fastened to the base by nails or screws up through the bottom. The blank for one blade is cut to the design selected, and a small cut is filed across the hub at F. This blank is made of veneer, and should be about 1-16 of an inch in thickness. The blank is placed in a pan of water and boiled for half an hour to soften it, then it is put in the press with its hub in the slot and the blade in the curve

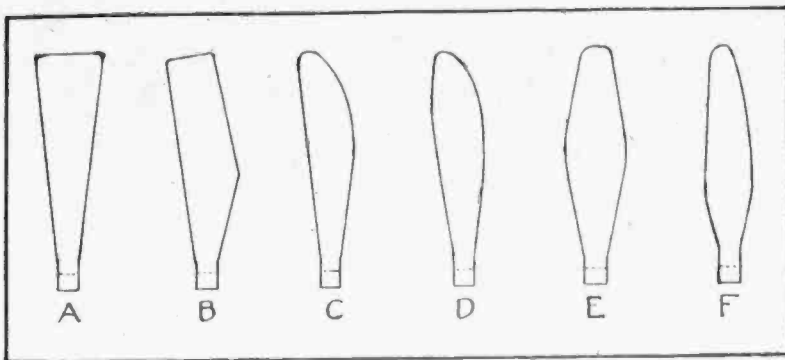

FIG 1

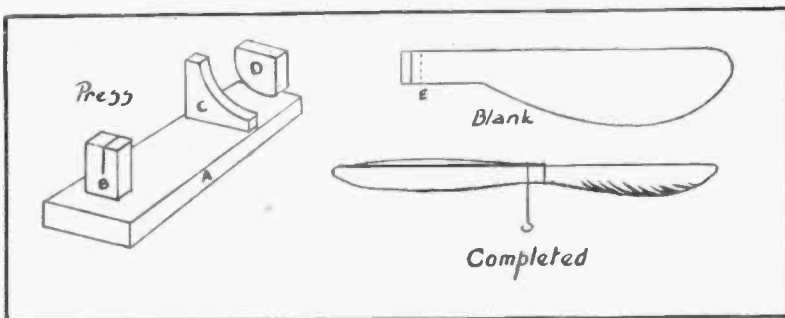

FIG 2

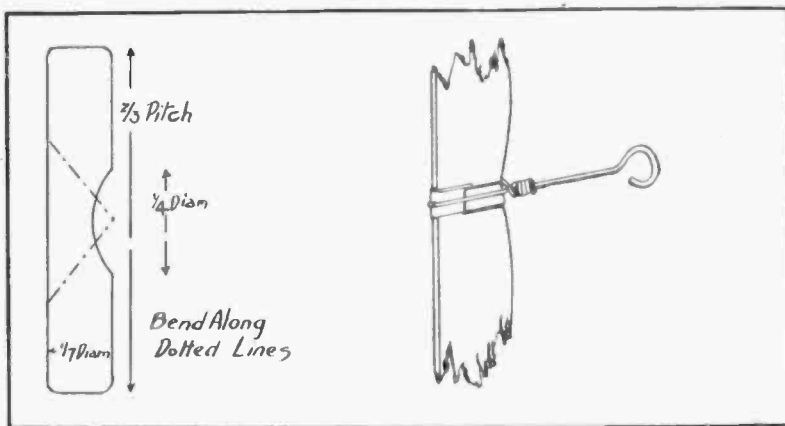

FIG 3

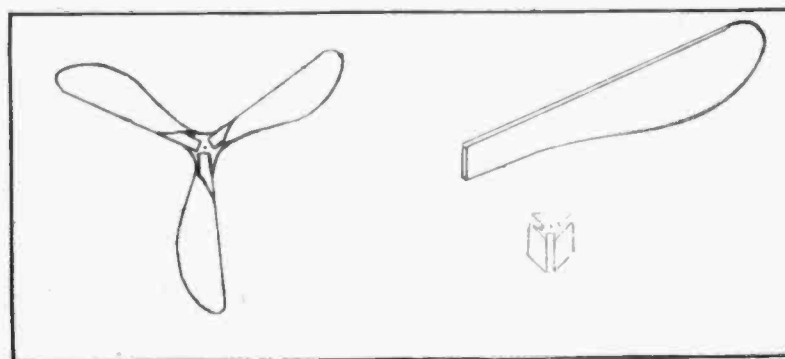

FIG 4

of C, held down by D, which is cramped or lashed in place. It should remain in the press about 24 hours, it will then keep its shape after removal. A second blade is bent the same way. The process may be speeded up by using two presses. Finally, the two hubs are placed together as shown in the completed view where they are glued together and lashed. The shaft is passed through the hole made by the joining of the two file cuts.

Another form of bent-wood propeller may be made by taking a single piece of veneer as long as the complete propeller with its two blades shaped as in the illustration for the previous type. This method requires expert work to ensure accuracy. The shaft is attached as shown at Fig. 3.

The Camm type, which is very much in favor in England among model builders, is shown in Fig. 3. The proportions are given for any size of propeller, and require no explanation beyond the fact that it is bent along the dotted lines. Fig. 3 also shows the method of attaching spindles to bent-wood screws, a strap of tin being wrapped round the blank centre to which the shaft is soldered. Care should be taken to ensure that the shaft is quite central, both sectionally and diametrically.

When the screws are finished they should be coated several times with dope. This strengthens the tips and also prevents the screws straightening out under damp weather conditions. Some prefer to cover the tips with silk to prevent breakage, which is a good idea, but it must be done neatly to keep down the skin friction. Dope is the best adhesive for this, and covering of one side is sufficient.

Some model designs call for three-bladed props. These are made by bending three identical blades with a slight hub projection, and fitting these into a hub which has three slots 120 degrees apart. Fig. 4 illustrates this. The hub may be either triangular or round, but after the blades have been glued in their slots the hub should be carved to shape into the blades. Be sure all blades rotate in the same track, and that the balance is perfect.

As the model-maker progresses, he will find that propellers are a very important part of his product. He will learn that different models require different propellers, and that a propeller that may produce records on one model will not do for another, so it is necessary that the constructor should experiment in order to obtain the best results.

### Getting Maximum Performance From the Speaker

(Continued from page 20.)

suitable to the particular speaker used. The idea is that the secondary of the output transformer must match the impedance of the moving coil. Since the characteristics of the coils vary in the different speakers, any one transformer will not necessarily suit them all. Fortunately, most of the transformers are accompanied by some details of the speakers and valves for which they are suited.

We need hardly mention that the moving-coil speaker is quite unsatisfactory unless it is used in conjunction with an effective baffle-board.

### Alternative Programmes

(Continued from Page 11.)

songs of a ballad type. No talks are heard till 9.45. Through 2FC on Friday night there is a mixed programme divided into half-hour sections, including organs, male and mixed quartettes, novelty instrumentalists, and from 9 o'clock to 10.15 relays and brass band music from Melbourne.

Saturday's programme is not defined so clearly, as it is always uncertain how many outside concerts are available for broadcasting, but an endeavor is made to keep

## Model R.O.G. Flying Competition



Free rides in this Air Taxi 'plane will reward the winners in the competition.

**WIRELESS WEEKLY** is conducting a Model Aero Competition for Baby R.O.G.'s. The rules are very simple. All competitors must fly a Baby R.O.G., built to the sizes given in WIRELESS WEEKLY, the time of flight to be the moment the under-carriage leaves the platform until the under-carriage touches the ground again. The decision of the time-keeper and judge will be final. In the event of a tie, those trying to fly off.

**Third prize, five minutes' flight in an "Air Taxi" Moth.**  
If you desire to enter the competition, sign the form and return to WIRELESS WEEKLY, Phillip St., Sydney.  
There is no entrance fee.  
Application forms must be received not later than 31st August, 1929.

Please enter me in the R.O.G. Competition, to be held early in September, 1929.

NAME .....

ADDRESS .....

**First prize, 15 minutes' flight in an "Air Taxi" Moth.**

**Second prize, 10 minutes' flight in an "Air Taxi" Moth.**

2BL a popular programme of sporting descriptions, and through 2FC outside concerts a revue or a concert given by a hospital concert party.

Sunday's programme in the evening is calculated to give pleasure to the great majority. Through 2FC an instrumental programme will be given from 6 o'clock till 6.40, when a talk by a prominent personality is broadcast until the concert programme at 8 o'clock is given. These concert programmes have become very popular, and are presented by Mr. Will Prior, Mr. Ted Henkel, and Mr. Albert Cazaban. From 10 o'clock to 10.30, when 2FC closes down, Meditation music is played.

Through 2BL on Sunday night is given a children's session for the hospitals. Organ recital, a Church service, and from 8.30 till close down at 10 o'clock, studio programmes, alternating each second Sunday night with a relay from Melbourne.

It is difficult for a programme committee to enlarge on the problems of organisation in improving the entertainment for listeners. The taste of every individual listener must be gauged, and as far as possible gratified. Therefore the executive programme committee of the Australian Broadcasting Company will leave no stone unturned to see that all tastes and all classes are catered for. Whilst there may be a few who will level criticism at their efforts, the majority of listeners, however, will be satisfied. Bear a little while longer with them until they get into their proper stride. Broadcasting programmes of the future will be something to think about.

#### Correction

In the advertisement for Price's Radio Service, "Wireless Weekly," August 30, 1000v Tested 4mf. Fixed Condensers were misquoted at 2/9. The correct price is 7/6.

#### Lance Jeffree, Tenor

MR. LANCE JEFFREE, tenor, who is appearing from 2BL on Friday, September 6, appeared from 2BL when the studios were in Elizabeth Street. Now, that is a long time ago, isn't it? He has toured Australia and worked in conjunction with Vladimir Ellin, the Russian baritone. He will feature operatic and classical ballads on his next broadcast appearance.

#### A.B.C., Boys' Sessions

MR. LYONS' sessions are growing and growing, especially the Model Aero Club Session. The membership of the Model Aero Club has passed the 700 mark. Members are enrolled from Queensland, Victoria, South Australia, Tasmania, New Zealand, and New South Wales. In the Clyde Police Station, near Otago, New Zealand, there is dead silence while the 2BL Model Aeroplane Session goes over, so a correspondent wrote and told Mr. Lyons. Organisation of district clubs is also proceeding rapidly, on the plans put forward weekly by Mr. Lyons in WIRELESS WEEKLY. A young enthusiast wrote in to Mr. Lyons, enclosing a list of proposed club rules. The sixth rule was "To help aviation in every possible way; and to endeavor to do credit to our commander-in-chief, Mr. Lyons."

The Scouts' Sessions are justifying their existence. Lately, the cubs were told the story of "Mogli the Wolf." The 1st St. Peters Pack gave its war cry, and there was a demonstration of the various yells by which the Scout Cubs make themselves known to one another. A special Scout session on the same lines will be put over in the near future.

The interesting and informative boys' session maintains its interest and informativeness. Soon Dr. Bradfield will talk during this session on the "Construction of the North Shore Bridge."

#### Auntie Goodie's Children's Session

EVERY Thursday night, through 2FC, from 5.45 till 6.45, Miss Goodie Reeve, otherwise known to thousands of children as "Auntie Goodie," will have charge of that session. For the very small there will be a fairy story; it will take the form of a play. "The Three Bears" will be the first. For the not-so-small there will be something entirely new and novel. Each week she will request an essay on a certain subject, in return for which the winner will have a song, especially written for her by "Auntie Goodie," which will be sung and played over the air. "Auntie Goodie" will have the assistance during this hour of several children, whom she will periodically "mind" for their parents, and listeners will have the benefit of their ingenious remarks.



Stromberg Carlson Loud Speakers. The Genuine article. £5/15. NOW 63/.



De Jur Battery Strips 2/9. Ameco Battery Strips 7/6. NOW 3/8.

Like a Flash. UX 201A Valves, 6/8. UX 199 4-valves, 8/6. B.T.H. Britlah Valves UX Base, 2 or 6 volt series. 13/6. 22/6. NOW 6/8.

Cleartron 6-volt Special Detector Valve, 22/6. NOW 6/4. English 4-volt valves, 1/6.

Continental Cone Speaker Unit, 13/9. Cones, ready made, 1/9.

Dora Midget Vernier Dials, 3/6. By Pass Condensers, 1000 volt test. 1mf. .... 2/9. 2mf. .... 3/3. 4mf. .... 7/.

Alphe Spring Sockets, UX 1/9. De Jur UX Sockets, 1/7. Magnus 3 gang V.T. Sockets, 10/6. NOW 3/.

Amplon A.R. 23 Loud Speakers. £9/9/. Now £4. Large type. Oak Flares.

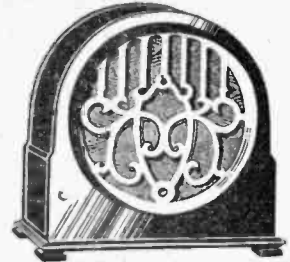

Amplon Cabinet Speaker, £8/8/. NOW 70/. Selling Fast. Get Yours Now.



Lissen Choke. British and Best. 6/9.



2in. Bakelite Dials 1/6. 3in. Bakelite Dials 7/6. Varlo Coupler parts, 2/3. 25ft. Hook-up insulated wire, 2/6. 10ft. hook-up insulated wire, 9d. 20ft. speaker cords, 2/3. Amplon Speaker Units or gramophone Half-price. NOW 30/ & £2. Bakelite Trickie Chargers, 5/6. German Cone Speakers, 15/. Bell Ringing Transformers 7/6. 200,000ohm Resistances, wire-screened Potentiometer type, for Eliminators or volume control, 11/6. NOW 8/.

The Greatest Radio Loud Speaker Snap ever offered—Book orders now to arrive S.S. Port Bowen, August 30. A.R. 19, now to be offered at 50/. The best speaker at six times the price ever made. Satisfaction guaranteed. Book orders NOW.

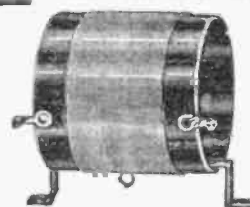

De Jur Browning Drake 1929 Coil Kit. Nothing to equal it. 22/6.

Amplon A.R. 88 Loud Speakers, a job to be re-illed upon. 90/. list price. NOW 45/.

Lissen Loud Speaker Units 13/6. Ameco Twin .0005 Condensers, 17/6. NOW 7/6.

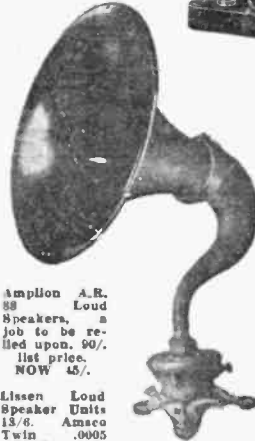

Genuine English Geophone Loud Speakers. Bakelite Flare. £8/10/. NOW 30/-. Equals any speaker offering in the trade to-day.

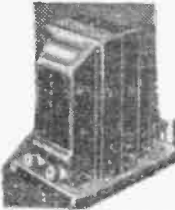

S.C.O. Continentals Audio Transformers. Bakelite Moisture-proof case, 12/6.

Morris all-direction Ball Aerials, 30/ and large type, £3. Copper Ball Aerials, 16/.

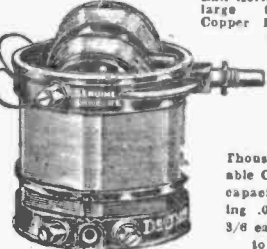

De Jur Inter-State 3-coil Tuner, 1-hole Panel Mount. Nothing to equal it. 15/6.

Thousands of Variable Condensers, all capacities excepting .0005. NOW 3/ 3/6 each. Value up to 15/ each.



Day Fan 6-valve American Shielded Radio Receiver. Worth £20. Set only without accessories, NDW £10.

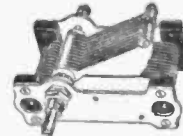

English Variable Condensers. Aluminum Plates and End Pieces. Ball-bearing action. 10/6 value. NOW 5/9.

## Day-Fan RADIO A YEAR AHEAD

Magnus professional Headphones, 4000ohms, 35/6. NOW half-price, 17/6. Ormonde S.L.F. .00035 Ormonde Condensers, 8/6, with Dial.

De Jur Gramophone Pick-up, Now 45/-.

With tone arm, 12/6 extra. Pick-up includes Tone Control and Adaptor.

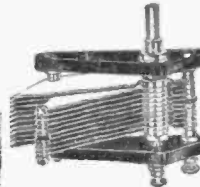
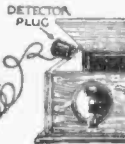

English Variable Condensers. .0005 Bakelite End plates. 9/6 value. NOW 5/.

Semco Audio Transformers. Made in U.S.A. by the Scanlan Electric Co. 21/. NOW 12/6.

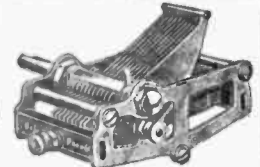

De Jur Variable Condensers. The Best Radio Has Brass Plates, single hole mount. .0005 ..... 12/6. .00035 ..... 12/6. .00025 ..... 11/6. .00014 Low Loss ..... 10/6. Silver Knight Short Wave Kit, 27/6. Renown Coil Kit, 19/6. Reinart Tuner, 4/9. Set of 3 Radio Frequency Coils, 17/6. NOW 3/.



# LEVENSON'S RADIO

THE PALACE OF WIRELESS.  
226 PITT STREET, SYDNEY  
Opp. PALACE THEATRE.  
BRANCH: 86A PITT STREET  
Between Martin Place and Hunter Street.

Special attention to Mail Orders. Please add freight. Satisfaction assured.



Like a Flash! Heavy Duty 45-volt B Batteries. 25/ value. Up-right type. NOW 15/.

The Catalogue that will save you pounds!

Send 9d in stamps for it to-day. 4/ concession coupon enclosed, allowed off for £1 purchase.



# Local Programmes, Friday, September 6

## 2FC

Australian Broadcasting Company, Ltd., Market St., Sydney (Wavelength, 442 Metres).

### EARLY SESSION, 7 to 8.15 a.m.

- 7.0: "Big Ben" and meteorological information for the man on the land.
- 7.3: This morning's news from the "Daily Guardian."
- 7.8: Early rising music
- 7.45: Mails and shipping.
- 7.48: What's on to-day.
- 7.50: Children's birthday calls.
- 8.0: Music from the studio
- 8.15: Close.

### MORNING SESSION, 10.30 a.m. to 12.30 p.m.

- 10.30: Announcements.
- 10.32: To-morrow's sporting events by Oscar Lind
- 10.45: Recital on the Grand Organ by Edgar Stone
- 11.0: Household Helps: Cooking, by Miss Ruth Furst.
- 11.10: Cables, A.P.A. and "Sun"-Herald" news service: British official wireless press
- 11.15: Morning devotion.
- 11.30: Australdo Musical Reproduction.
- 12.0: "Big Ben" Stock Exchange and metal quotations.
- 12.5: Illustrated musical lecture.
- 12.20: Midday weather forecast and weather synopsis. Special produce market session for the man on the land, supplied by the State Marketing Board
- 12.30: Close.

### THE LUNCH HOUR, 1 p.m. to 2.30 p.m.

- 1.0: Lunch to music with the National Broadcasting Orchestra.
- 1.9: Stock Exchange, second call
- 2.2: A glance at the afternoon "News."
- 2.7: Popular education, W. S. Reay
- 2.27: Announcements.

### THE RADIO MATINEE, 2.30 to 4.30 p.m.

- 2.30: The 2FC Instrumental Trio
- 2.42: William Bower, basso—
  - (a) "Drake's Spirit" (Stewart).
  - (b) "The Flower of Love" (Sanderson)
  - (c) "Wander Thirst" (Ronald)
- 2.49: Kathleen Logue, violinist—
  - (a) "Midnight Belts" (Heuberger-Kreiser).
  - (b) "Habanera," from "Carmen" (Bizet)
- 2.56: The 2FC Instrumental Trio
- 3.8: Laurel Mather, popular vocalist—
  - (a) "Where is the Song of Songs for Me?" (Berlin)
  - (b) "Some Sweet Day" (Shilkret and Pollack)
- 3.15: James Walker, pianist—
  - (a) "Impromptu in F Sharp Major" (Chopin)
  - (b) "Nocturne in E Flat Major" (Chopin)
- 3.23: The 2FC Instrumental Trio.
- 3.35: William Bower, basso—
  - (a) "Tommy Led" (Margeson)
  - (b) "Thou Art Risen, My Beloved" (Taylor)
  - (c) "Cavalier" (Hickey)
- 3.42: Kathleen Logue, violinist—
  - "Scene de Ballet" (de Berlioz)
- 3.49: The 2FC Instrumental Trio.
- 4.9: Laurel Mather, popular vocalist—
  - (a) "Mr. Aeroplane Man" (Conrad and Shennan)
  - (b) "When Love Comes Stealing" (Rapee, Pollack, and Hirsch)
- 4.16: James Walker, pianist—
  - (a) "Etude in F Major" (Chopin)
  - (b) "Arabesque in G Major" (Debussy)
- 4.28: Stock Exchange, third call.
- 4.30: Close.

### EARLY EVENING SESSION, 5.45 to 7.55 p.m.

- 5.45: Kiddies' "Goodnight" stories told by the "Hello Man," assisted by the Farmyard Five
- 6.45: National Broadcasting Orchestra will play dinner music.
- 7.30: A.B.C. sporting service.
- 7.37: Special country session. Stock Exchange resume markets. Weather forecast. Late news service from the "News."
- 7.58: To-night's programme.

### THE EVENING PRESENTATION, 8 p.m. to 11.30 p.m.

Christian Hellmann has arranged an Organ Recital for 2FC to-night, and at 9.15 the

## INDEX

### To Local Programmes

	Page.
<b>FRIDAY, SEPTEMBER 6.</b>	
2FC, 2BL	26
2GB, 2UW, 2KY, 2UE	27
<b>SATURDAY, SEPTEMBER 7.</b>	
2FC, 2BL, 2GB, 2KY, 2UW	32
2UE	47
<b>SUNDAY, SEPTEMBER 8.</b>	
2FC, 2BL, 2GB, 2UW	36
2UE	39
<b>MONDAY, SEPTEMBER 9.</b>	
2FC, 2BL, 2GB	38
2UW, 2KY, 2UE	39
<b>TUESDAY, SEPTEMBER 10.</b>	
2FC, 2BL, 2GB, 2UW, 2KY	42
2UE	43
<b>WEDNESDAY, SEPTEMBER 11.</b>	
2FC, 2BL, 2GB	46
2UW, 2KY, 2UE	47
<b>THURSDAY, SEPTEMBER 12.</b>	
2FC, 2BL, 2GB, 2UE, 2KY	50

### To Interstate Programmes

<b>FRIDAY, SEPTEMBER 6.</b>	
3LO, 3AR, 3DB, 4QG, 5CL	30
6WF, 7ZL	31
<b>SATURDAY, SEPTEMBER 7.</b>	
3LO, 3AR, 3DB, 4QG, 5CL, 6WF	34
<b>SUNDAY, SEPTEMBER 8.</b>	
3LO, 3AR, 3DB, 4QG, 5CL, 6WF, 7ZL	37
<b>MONDAY, SEPTEMBER 9.</b>	
3LO, 3AR, 3DB, 4QG, 5CL, 6WF	40
<b>TUESDAY, SEPTEMBER 10.</b>	
3LO, 3AR, 3DB, 4QG, 5CL, 6WF, 7ZL	41
<b>WEDNESDAY, SEPTEMBER 11.</b>	
3LO, 3AR, 3DB, 4QG, 5CL, 6WF, 7ZL	48
<b>THURSDAY, SEPTEMBER 12.</b>	
3LO, 3AR, 3DB, 4QG, 5CL	52
6WF, 7ZL	53

relay from 3LO will be taken 2BL have a ballad night arranged.

- 8.0: The Famous Four Quartette.
- 8.10: From Christ Church, St. Laurence Organ Recital by Christian Hellmann
- 8.42: From the Studio: Ann and Her Violin—
  - (a) "Serenata" (Toselli).
  - (b) "Fiddlin' the Fiddle" (Rubincff)
- 8.50: The Famous Four Quartette.
- 9.14: The Countryman's weather session—
  - (a) New South Wales forecasts
  - (b) Inter-State weather synopses
- 9.15: Relay from 3LO, Melbourne—Collingwood Citizens' Band—March, "On to Victory"
- 9.25: Billie King, songs at the Piano
- 9.32: "The Original We Four" Quartette—
  - "De Ole Banjo" (Scott Gally)
  - Cello recital.
- 9.42: Iris Shaw, two character sketches—
  - (a) "Emma's Imagination."
  - (b) "All the Year Round."
- 10.2: Collingwood Citizens' Band—Overture, "Semiramide."
- 10.12: The "We Four" Quartette—
  - "Uncle Rome" (Own Arrangement)
  - Duet, "Solenne in Quest-ora" (Verdi)
  - Edwin E. Hooke and Raiphee Daly
- 10.15: Announcements. Late official weather forecast.
- 10.20: From the Sydney Town Hall, on the occasion of the B.M.A. Ball: Montgomery Evans Orchestra.
- 11.30: Close. National Anthem.

## 2BL

Australian Broadcasting Company, Ltd., Market St., Sydney (Wavelength, 353 Metres).

### OPENING SESSION, 8.15 a.m. to 11 a.m.

- 8.15: G.P.O. chimes. Music for every mood
- 8.45: Meteorological data for the country.
- 8.50: A musical interlude.
- 9.30: British official wireless news.
- 9.35: New music.
- 10.8: News from the "Guardian"
- 10.10: The Australian Broadcasting Company's Women's Association, conducted by Miss Gwen Varley.
- 10.30: Celebrity items.
- 10.45: A morning story.
- 11.0: G.P.O. chimes. Close.

### MIDDAY SESSION, 12 noon to 2.30 p.m.

- 12.0: G.P.O. chimes. Announcements.
- 12.2: The National Broadcasting Orchestra.
- 1.0: Afternoon news from the "Evening News."
- 1.5: Studio music.
- 1.15: Women's interest talk.

1.30: A recital of instrumental music, reproduced on the radio metre.

2.0: J. Knight Barnett at the Wurlitzer.

2.12: Studio music.

**AFTERNOON ENTERTAINMENT, 2.30 to 5.45 p.m.**

2.30: Talk on "Architecture" by James Peddle.

2.45: "The Magic Carpet," by Major H. Sandford-Morgan, "Bagdad—the City of Haroun Al-Raschid"

3.0: From the ballroom of the Oriental, Sydney Simpson's Syncopators in dance music.

3.12: From the studio: Anne Melhuish, soprano.

3.19: Popular number.

3.22: From the ballroom of the Oriental: Sydney Simpson's Syncopators in dance music.

3.32: From the studio: Dismal Desmond, comedian, "It May Be Influenza—But I Think It's Love" (Longstaffe).

3.40: The latest dance music.

3.45: From the ballroom of the Oriental: Sydney Simpson's Syncopators in dance music.

3.53: From the studio: Anne Melhuish, soprano.

4.0: Kathleen Roe, pianoforte solos.

(a) "Prelude and Fugue in E Flat" (Bach).

(b) "Movement Perpetuel" (Poulenc).

4.12: Dismal Desmond, comedian.

(a) "That Rests Entirely With Me" (Vernon)

(b) "I Want to be Somebody's Baby" (Castling).

4.20: From the ballroom of the Oriental: Sydney Simpson's Syncopators in dance music.

4.30: From the studio: Kathleen Roe, pianoforte solos.

(a) "Etude in A Flat" (Chopin).

(b) "Rhapsody" (Ireland).

4.37: Popular numbers.

4.45: "The Trade Hour," demonstration music.

5.45: Weather information. Close.

**THE DINNER HOUR, 6.15 to 7.55 p.m.**

6.15: The National Broadcasting Orchestra.

6.45: The "Younger Set" Session. The Boy Scouts' Club, conducted by Mr. Norman Lyons.

7.5: Claude Corbett, "Sporting." The Country Man's market session, wool, wheat, stock, farm produce, fruit, vegetables, pig, and poultry markets.

7.30: The National Broadcasting Orchestra.

7.45: Celebrity music.

7.55: What's on the air to-night?

**TO-NIGHT'S PRESENTATION, 8 p.m. to 10.30 p.m.**

8 p.m.: G.P.O. chimes. Keith Grant and Marjory Allomes, vocal duets.

8.8: Neville Amadio, flute solos.

8.15: The National Broadcasting Orchestra, "Four Ways" (Coates).

8.30: Lance Jeffree, tenor.

(a) "Spirito Gentil" (Donizetti).

(b) "Eleanore" (Coleridge-Taylor).

(c) "Row Gently, Here, My Gondolier" (Schumann).

8.37: G. Vern Barnett, piano solos.

8.47: Marjory Allomes, contralto.

(a) "Ah, Rendimi" (Rosse).

(b) "Hindoo Song" (Bemberg).

8.54: The National Broadcasting Orchestra.

(a) "Happy Moments" (Jonas).

(b) "Prelude in G Minor" (Rachmaninoff).

9.9: Keith Grant, baritone.

"Largo al Factotum" (Rossini), from "The Barber of Seville."

9.16: Neville Amadio, flute solos.

9.23: The National Broadcasting Orchestra.

(a) "The Lilac Domino" (Cuvillier).

(b) "Deux Petite Danseuses" (Levy).

9.37: Late weather forecast for the man on the land.

9.38: Lance Jeffree, tenor.

"The Requit" (Blumenthal).

9.45: V. C. Bell, a short address.

10.0: The National Broadcasting Orchestra.

(a) "The Desert Song" (Romberg).

(b) Overture, "Der Leberman" (Grünfeld).

10.25: Official weather forecast; metropolitan and country. Late news from the "Evening News."

10.30: Close. National Anthem.

**2GB**

Theosophical Broadcasting Station, 29 Bligh St., Sydney (Wavelength, 316 Metres).

10.0: Music. 10.10: Happiness talk by A. E. Bennett. 10.20: Music. 10.30: Women's session by Miss Helen J. Beegling. 11.45: Close down.

2.0: Music. 2.5: Women's Radio Service by Mrs. Dorothy Jordan. 2.50: Music. 3.0: Address. 3.30: Close down.

5.30: Children's session by Uncle George. 7.0: Music. 7.45: Feature story. 8.0: Miss Doris Hocking, contralto. 8.7: Violin solos. 8.15: Madame Betts-Vincent in an illustrated talk on the Sonatas of Beethoven. 8.30: Mr. Norman Williams, baritone. 8.37: Humorous interlude by Mr. Jack Win and Mr. Heath Burdock. 8.42: Symphony Orchestra. 8.50: Miss Gwen Selva, soprano. 9.0: Weather report. 9.3: Address. 9.15: Violin solos. 9.25: Miss Doris Hocking, contralto. 9.35: Humorous interlude by Mr. Jack Win and Mr. Heath Burdock. 9.40: Mr. Norman Williams, baritone. 9.50: Symphony orchestra. 9.55: Miss Gwen Selva, soprano. 10.5: Instrumental music. 10.30: Close down.

**2UW**

Radio Broadcasting, Ltd., Palling's Building, Ash St. Sydney (Wavelength, 267 Metres).

**MIDDAY SESSION.**

12.30: Request numbers. 1.0: G.P.O. clock and chimes. Music. 1.15: Talk on Home-craft by Pandora. 1.40: Music and request numbers. 2.30: Close down. 4.30: Musical programme.

**EVENING SESSION.**

5.30: Children's hour, conducted by Uncle Jack. 6.30: Close down. 7.0: G.P.O. clock and chimes. Request numbers. 8.0: Popular orchestral recital. 9.0: G.P.O. clock and chimes. Comments on Foreign Affairs by Mr. J. M. Prentice. 9.10: Music and request numbers. 10.30: Close down.

**2KY**

Trades and Labor Council, Goulburn St., Sydney (Wavelength, 280 Metres).

**MORNING SESSION.**

10 a.m.: Tune in to the ticking of the clock. 10.3: Popular fox trots. 10.15: Hawaiian steel guitar selections. 10.30: Request numbers. 10.50: Vocal items. 11.0: A few laughs. 11.5: Pianoforte selections. 11.15: Calls and announcements. 11.20: Musical interlude. 11.30: Request numbers. 11.40: Music and vocal numbers. 11.55: Where to go to-night. 12 noon: Closing announcements.

**CHILDREN'S SESSION.**

6.0 p.m.: Birthday calls, request numbers, and kiddies' entertainment. Aunt Jemima and Uncle Bert.

**EVENING SESSION.**

7.0: Musical interlude. 7.5: Birthday calls. 7.15: Sporting feature. Turf topics. Review of candidates and their prospects for to-morrow, Mr. Geo. A. Davis. 7.40: Request numbers. 8.0: Hawaiian steel guitar selections. 8.15: Request numbers. 8.30: Music and vocal items from the studio. 9.10: Sporting feature. Presented by Tooth and Co., Ltd., Kent Brewery. From ringside of M'Hugh's Leichhardt Stadium. Full description of main 15-round fight, Mr. Jack Dunleavy. 10.0: Closing announcements.

**2UE**

Broadcasting Station 2UE, Everett Street, Maroubra Sydney (Wavelength, 293 Metres).

**EARLY MORNING SESSION**

7.15 a.m.: Breakfast Time Hour Orchestral music. 8.30: Weather report. Close down.

**MIDDAY SESSION**

11.30 a.m.: Orchestral and vocal music. 12.30: Close down.

**AFTERNOON SESSION**

1.0: Orchestral selections. 1.45: Organ recitals. 2.0: Orchestral items. 2.30: Close down.

**EVENING SESSION**

7.15: Orchestral dinner music. 7.59: Programme announcements. 8.0: Overture, "Dance of the Hours." 8.10: Orchestral and vocal music. 10.15: Close down.

**AND NOW—**

THE  
**Delco  
Battery**



**ANOTHER DELCO-REMY  
PRODUCT**

MANUFACTURED BY THE FAMOUS

**DELCO-REMY CORPORATION**

The World's Foremost Manufacturers of Car Electrical Equipment

# THEY GIVE BETTER RESULTS BECAUSE THEIR CHARACTERISTICS ARE BETTER

The characteristic curve of each Philips Valve is undeniable proof of its superiority. Look at their Mutual Conductance (slope) and compare them with those of other valves designed for the same purposes. As stated in the headline, Philips Valves are BETTER. Not only do the characteristics show it, but results prove it.

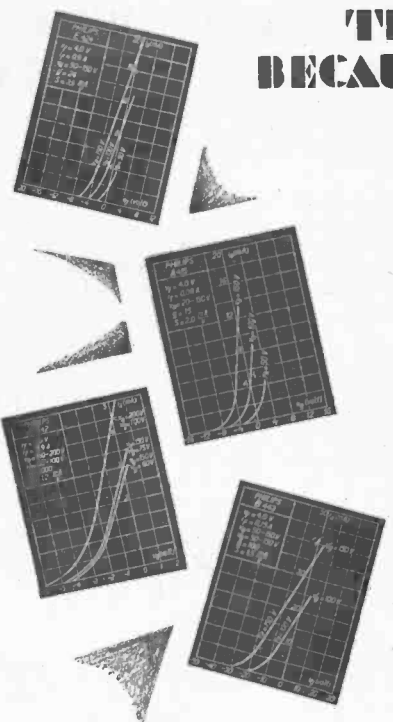

### POPULAR I.C. TYPES

Type/Purpose	Grid Bias at			Notes
	0V	120V	240V	
6X5 (A.C. Power)	1.5	1.2	0.8	12.5%
6X4 (A.C. Power)	1.5	1.2	0.8	12.5%
6X3 (A.C. Power)	1.5	1.2	0.8	12.5%
6X2 (A.C. Power)	1.5	1.2	0.8	12.5%
6X1 (A.C. Power)	1.5	1.2	0.8	12.5%

### POPULAR A.C. TYPES

Type/Purpose	Filament Voltage (Volts)	Amp. (Amps)	Temp. (Celsius)	W. (Watts)	Notes
6X5 (A.C. Power)	6.3	0.5	1,000	0.5	12.5%
6X4 (A.C. Power)	6.3	0.5	1,000	0.5	12.5%
6X3 (A.C. Power)	6.3	0.5	1,000	0.5	12.5%
6X2 (A.C. Power)	6.3	0.5	1,000	0.5	12.5%
6X1 (A.C. Power)	6.3	0.5	1,000	0.5	12.5%

To be obtained of Distributors.  
P.O. Valves only A.C. operation.

# PHILIPS AC MINIWATTS DC

# Interstate Programmes, Friday, September 6

## 3LO

Australian Broadcasting Co., 120A Russell St., Melbourne (Wavelength, 371 Metres).

### MORNING SESSION.

10.30: Current happenings in sport by Mel. Morris. 10.45: A.B.C. Studio Orchestra. 12.0: Melbourne Observatory (time signal, 12.1: Orchestra. 12.15: News service; British official wireless news; Corn Exchange report; Newmarket stock sales, official report; Associated Stock and Station Agents. 12.30: Close down.

### MIDDAY SESSION.

1.0: Melbourne Observatory time signal; Stock Exchange information; meteorological data; weather forecast for Victoria, New South Wales, South Australia, and Tasmania; ocean forecast; river reports; rainfall; comments on the day's news.

### EDUCATIONAL SESSION.

2.0: Strange People of Strange Countries, Mr. H. J. G. Esmond. 2.15: Musical interlude. 2.30: Gems of English Literature. "Krat's Odes," Professor G. H. Cowling, M.A. 2.35: Musical interlude. 2.40: A talk in German, Mr. G. E. Green, M.A., Dip. Ed. 2.55: Musical interlude.

### THE RADIO MATINEE

3.0: National Broadcasting Orchestra, under direction Wm. G. James; conductor, Percy Code—Overture "La Gazza Ladra" (Rossini). 3.10: Bessie Douglass, contralto—"My Prayer" (Squire). "Sink Red Sun" (Del Riego). 3.17: Merela Rudd, violin—"Second Movement D Minor Concerto" (Vieuxtemps). 3.22: Thomas George, bass—"Song of Hyblax the Cretan" (Elliott). "Tally-Ho" (Leon). 3.29: Orchestra—"Gavotte and Musette" (Raff). "Two Songs by Wakefield" (Cudman). 3.30: Bessie Douglass, contralto—"Beyond the Hills" (Frank Fay). "The Street of Lost Time" (Besley). 3.46: Colin Binks, recital—Selection from "The Deemster" (Hail Caine). 3.53: Orchestra—Selection, "The Love Song" (Offenbach). The Land of Romance. 4.0: The Spanish Serenaders—"Moonlight in Madrid." "Summer Time in Seville" (F. Gaby Du Valle, soprano—Cillito Lindo). "Granada." 4.14: Marion Lightfoot, Spanish guitar, "Gems from the Alhambra." 4.20: Gaby Du Valle, soprano—"Estrellita" selected. 4.27: The Spanish Serenaders, "Moorish Memories" (L.). 4.35: Close down.

### THE CHILDREN'S CORNER

5.45: "Billy Bunny" has a story to tell. 6.0: Musical interlude. 6.5: Birthday greetings.

### EVENING SESSION.

6.20: For the Older Boys and Girls—"Brave Deeds by Boys and metals." 6.40: Musical interlude. 6.45: What's Wrong with your Radio? Mr. H. Kingsley Love, Countryman's Session. 7.0: Melbourne Observatory (time signal). 7.1: Stock Exchange information; Corn Exchange report, Associated Stock and Station Agents' official report; Wool Exchange report; mines and metals; fish and rabbit prices; farm and dairy produce report supplied by the Inter-State Dairy Produce Committee; wholesale fruit prices supplied by the Wholesale Fruit Merchants' Association; retail fruit prices supplied by the Victorian Fruit-growers' Association; citrus fruit prices supplied by the Victorian Central Citrus Association; weather synopsis; river reports; rainfall data.

### THE LECTURETTE SESSION.

7.25: Gardening Hints (under the auspices of Royal Horticultural Society of Victoria). "Gladoli Culture." 7.40: News. 7.45: Marriage Customs of Mankind, Mr. J. R. Lyall, B.A.

### NIGHT SESSION.

8.0: Collingwood Citizens' Band—Quartette, "Hymn to Music" (Buck). "Take a Pair of Sparkling Eyes" by request. 8.10: The Original "We Four" Quartette—Quartette, "The Lost Chord" (Sullivan). Walter D. Burileigh, basso—"O, Star of Eve" (Wagner). 8.17: Orest Manzoni, mandolin—"Le Cygne" (Saint-Saens). 8.24: Iris Shaw—"The Message." 8.31: Programme arranged by Fritz Hart. 9.15: Collingwood Citizens' Band—March, "On to Victory." 9.25: Billie King—"Songs at the Piano." 9.32: The Original "We Four" Quartette—"Quartette, "De Ole Banjo" (Scott Gally). Fred, J. Watsford, tenor solo—"The Gates of If Ever" (Coates). Quartette, "Please Let Me Dream in your Arms" (Sherman). 9.42: Louis Hattenbach—"Reverie" (Schumann). "Souvenir" (Drda). "Serenade" (Schubert). "Menuets" (Becker). 9.55: Iris Shaw—Two Character Sketches. "Emma's Imagination." "All the Year Round." 10.2: Collingwood Citizens' Band—Overture, "Semiramide." 10.12: "We Four" Quartette—Quartette, "Uncle Rome" (own arrangement). Edwin E. Hook and Ralph E. Daly—Duet, "Solenne in Quest'ora" (Verdi). 10.20: Grest Manzoni, mandolin—"Medley" (arranged O. Manzoni). 10.25: Eric Welch will talk on to-morrow's sporting events. 10.35: Meteorological information; British official wireless news; items of interest. 10.45: The "Rex" Dance Band. 11.30: God Save the King.

## 3AR

Australian Broadcasting Co., 120A Russell St., Melbourne (Wavelength, 484 Metres).

### MORNING SESSION.

8.15: Morning music. 8.45: Weather data. 9.0: G.P.O. chimes. 9.1: News service. 9.5: Reproduced music. 10.0: G.P.O. chimes. 10.1: British official wireless news. 10.10: Reproduced music. 10.30: Arnold Coleman at the Wurliitzer. 10.50: A message for the day. 11.0: Close down.

### MIDDAY SESSION.

12.0: G.P.O. chimes. 12.1: Famous Women. (5) Lady Mary Wortley Montague. Mrs. Ian Maxwell. M.A. 12.15: Fifteen minutes' reproduced music. 12.30: Luncheon music supplied by the National Broadcasting orchestra. Under direction Wm. G. James. Conductor: Percy Code. 2.0: G.P.O. chimes.

### AFTERNOON SESSION.

A Modern English Programme. 2.1: Classic Quartet, Fantasia on Folk Songs (Percy Godfrey.) 2.10: Jessie M'Michael, soprano. "April Moods" (Carey). "Dainty Little Maiden" (Dunhill). 2.17: Estelle Sheehan, piano: "An English Waltz" (Cyril Scott). "The Princess" (Frank Bridge). 2.27: Thomas George, bass: "Pill Glass with Golden Wine" (Quilter). "Music When Soft Voices Die" (Besley). 2.35: Arion Trio—"The Swing Song" (Barnes). "Cossack Revels" 2.43: Jessie M'Michael, soprano. "One Spring Morning." "When Love is Kind." 2.50: Classic Quartet: "Serenade" (Drigo). 2.55: Mona Nucent, soprano with the Arion Trio: "Way, Though My Heart Should Break" (Tschalkowsky). 3.0: Half an hour of reproduced music. 3.30: A Chat by a Prominent Woman. 3.45: Musical interlude. 3.50: Home management. The Home Laundry—Miss Kathleen Benningfield. 4.5: Musical interlude. 4.10: What Science is doing for Women. Mr. E. S. Richards, M.Sc. Traders' Demonstration Session. 4.25: Reproduced music. 5.0: G.P.O. chimes. 5.30: Weather data. 5.45: Close down.

### EVENING SESSION.

6.15: Dinner Music, supplied by the A.B.C. Studio Orchestra. 7.30: What's on the air to-night? 7.32: Latest musical releases. 7.50: Mel. Morris will speak on "Football." 8.0: G.P.O. chimes.

### NIGHT SESSION

8.1: Australian Problems in Economics—Mobility of Labor in Australia—Mr. F. R. E. Mauldoud, B.A., M.Sc. 8.15: Transmission from Geelong. Community Singing. Conductor: W. Sampson. God Save the King. God Bless Australia. Drink to Me Only. Two Little Girls in Blue. The Old Grey Mare. Sweet Adeline. It Isn't Any Trouble Just to Smile. Won't You Buy My Pretty Flowers? Cockles and Mussels. Oh, Dem Golden Slippers. The Miser Farm. Evening by the Moonlight. Forever With the Lord. Old Mother Hubbard Nursery Rhymes. Just Let a Smile be your Umbrella. Who Killed Cock Robin? Shivering. Good Night. I Lift up My Finger and I Say Tweet, Tweet. Rubber Dolly. It Goes Like This. Come Back to Erin. You can't be Unhappy. 10.20: FRM THE STUDIO. 10.25: Weather information and "Herald" news. 10.30: God Save the King.

## 3DB

The "Herald" Broadcasting Station, Flinders Street, Melbourne (355 Metres).

### MORNING SESSION.

11.0: Ted Lewis and his band. "When the Curtain Comes Down." 11.40: "Vogue." "The World's Fashions and Follies." 11.35: The Rounders. "Song of the Swamp." 12.0: Plaza Theatre Orchestra. "The Busy Bee." 12.30: Paul Robeson (bass). "Seem Lak' to Me." 1.0: Eddie's Hawaiian Orchestra. "Down in Waikiki." 1.30: Evelyn Scootney. "Where the Bee Sucks." 1.45: Close down.

### AFTERNOON SESSION.

2.15: G. T. Pattman (organ). "Prelude." 2.30: San Francisco Symphony Orchestra—"Aubade." 3.15: E. T. Muir 4.0: Close down.

### EARLY EVENING SESSION.

5.30: J. H. Squire Octet. "Evening Lullaby." 6.0: Children's Hour, Billy Bunny. 6.30: Gatty Sellers (organ). "Gipsy Caravan." 7.0: Mark Weber and his orchestra. "Potpourri o' Waltzes." 7.15: Market reports by John M'Namara and Co. Pty., Ltd. 7.25: Jack Shilkret (piano) "To-morrow." 7.30: Market reports by Cappeland and Northern Co-operative Co., Ltd. 7.40: Gladys Moncrieff. "Euguetto." 7.45: Close down.

### EVENING SESSION.

8.0: Stuart Robertson (bass). "In Summertime on Breton." 8.30: Band of the Royal Air Force. "Invercaigill." 9.0: Sir Harry Lauder. "Just Got Off the Chain." 9.30: Art G'Phnam "My Heart is Aching." 10.0: John M'Carthy. "Just For Today." 10.30: Royal Philharmonic Orchestra. "Summernight on the River." 10.40: News. 10.45: God Save the King.

## 4QG

Queensland Government Radio Service, Brisbane (Wavelength, 385 Metres).

### EARLY MORNING SESSION.

7.43: Time signals. 7.45: News service. 8.0: Records. 8.15: News service. 8.30: Close down.

### MORNING SESSION.

11.0: Music. 11.5: Social news. 11.15: Lecturette, a cookery and household talk by "The Etiquette Girl." 12.0 (noon): Close down.

### MIDDAY SESSION.

1.0: Market reports and weather information. 1.30: Lunch-hour music. 2.0: Close down.

### AFTERNOON SESSION.

3.0: Records. 3.30: Mail train running times. 3.31: More records. 4.15: News. 4.30: Close down.

### EARLY EVENING SESSION.

6.0: Mail train running times; mail information; shipping news. 6.25: Commercial announcements. 6.30: Bedtime stories, conducted by "The Sandman." 7.0: News in brief. 7.5: Stock Exchange. 7.6: Metal quotations. 7.7: Market reports. 7.25: Penwick's stock report. 7.30: Weather. 7.42: Time signals. 7.45: To-morrow's sporting fixtures reviewed.

### NIGHT SESSION.

8.0: The 4QG Mouth Organ Band. Conductor, J. Tyson.—A medley of 1914 War Tunes, including: "Long, Long Trail." "Keep the Home Fires Burning." "Tipperary." "Madenoiselle from Armentieres." 8.10: Kathleen Kelly, soprano—"A Heart that's Free" (Robyn). 8.15: The Studio Orchestra—Valse, "Tesoro Mio" (Beucchi). 8.20: Stanley Tamblin, baritone—"Vulcan Song" (Gounod). 8.25: The 4QG Mouth Organ Band—Fox trot, "My Blue Heaven." Hymn tune, "Abide with Me." 8.31: Harry Humphrey, tenor. In a "Dame" sketch. 8.45: J. Tyson and his accordeon. 8.50: James Martin, tenor—"Macushla" (M'Murrough). 8.55: The Studio Orchestra—"Entr'acte, "Les Parisiennes" (Lee S. Roberts). 9.0: Metropolitan weather forecast. Week-end road information for motorists, officially supplied by the R.A.C.Q. 9.15: The 4QG Mouth Organ Band—"Old Black Joe" (Foster). "Last Night I Was Dreaming." 9.22: Kathleen Kelly, soprano—"The Dream Canoe" (Squire). 9.26: The Studio Orchestra—March, "Step Lively" (Allan). 9.32: Stanley Tamblin, bass-baritone—"Sea Fever" (Clark). 9.37: Merina Gillies, pianist—"By the Sea" (Schubert-Liszt). "Humoreske" (Dvorak). 9.45: James Martin, tenor—"Thora" (Adams). 9.50: The Studio Orchestra—Ten minutes' dance music. 10.0: From the Studio—News supplied by the metropolitan dailies. Weather information; close down.

## 5CL

Central Broadcasters, Ltd., 114 Hindmarsh Square, Adelaide (Wavelength, 309 Metres).

### MORNING SESSION.

11.15: Chimes. 11.16: Recordings. 11.45: Kitchen Craft and Menu Talk. 12.1: Recordings. 12.15: News service. 12.40: Recordings. 12.52: Railway; Stock Exchange, and meteorological information. 1.1: Community singing from the Adelaide Town Hall. 1.59: Meteorological. 2.0: Close down.

### AFTERNOON SESSION.

3.0: Chimes. 3.1: Programme review and announcements. 3.4: Studio concert. 3.15: Rupert Hazell and Elsie Day. 3.25: Wurliitzer organ recital. 3.30: "Austrian" will give a true story, entitled, "A Bush Romance," part I. 3.45: Vocal items. 4.1: Rupert Hazell and Elsie Day. 4.25: Stock Exchange. 4.30: Close down.

### EVENING SESSION.

6.0: Chimes. 6.1: Birthday greetings. 6.15: Children's request numbers. 6.30: Dinner session: Rupert Hazell and Elsie Day. 7.1: 5CL's sporting service; Adelaide wool sales report; general market reports. 7.20: "Mo" Manning on "Football." 7.35: Wilfred Thomas on "The Folk Songs of Hungary." 7.45: Mr. A. Grenfell Price, M.A., F.R.G.S., will continue his series of talks on "Pioneers of Australia."

### NIGHT SESSION.

8.0: Chimes. 8.10: Under the auspices of the Adelaide University. Elder Conservatorium concert, in which the following artists will take part:—Piano: William Silver. Violin: Sylvia Whitlington. Cello: Harold Parsons. Contralto: Hilda Gill. Pianist and accompanist: George Pearce. Lecturer: Harold Denton. 9.1: Meteorological. 9.2: Overseas grain report. 9.3: General news service. 9.5: Elder Conservatorium concert continued. 10.15: General news service. British official wireless news. Meteorological information. 5CL's sporting service. 10.30: Modern dance records. 11.0: Close down.

**6WF**

10.0: Gramophone records. 11.0: Close down. 12.30: Markets, news, etc. 1.1: Weather bulletin. 1.3: Music by the Radio Trio. 2.0: Close down. 3.30: Afternoon concert. 4.30: Close down. 6.45: Bedtime stories by Uncle Duffy. 7.5: Light music by the Radio Trio. 7.30: Commercial and general information. 7.45: Talk on "Racing." 8.0: Time signal. 8.1: First weather bulletin. 8.3: Popular programme. 8.50: Late news: ships within range announcement; late weather-bulletin. 8.58: "Gardening" talk by Mr. James Conarty. 10.30: Close down. 104.5 Metre Transmission.—Simultaneous broadcast on 104.5 metres of programme given on 1250 metres, commencing at 6.45 p.m.

**7ZL**

Tasmanian Broadcasters Pty., 35 Elizabeth Street, Hobart (Wavelength, 316 Metres).  
 11.30: Selections. 11.34: Mjdlands weather forecast. 11.35: Selections. 11.55: Weather report. 12.0: Chimes. 12.1: Shipping information; mail notices; housewives' guide. 12.8: Selections. 12.30: News service; announcements. 12.40: Selections. 1.5: British official wireless news; railway auction sales. 1.10: Selections. 1.30: Close down. 3.0: Chimes. 3.1: Selections. 3.4: Weather. 3.5: Selections. 4.15: Readings. 4.30: Close down. 6.15: Children's Hour with "Uncle David" and "The Story Lady." 7.10: News session. 7.15: Sid Jones will speak on "Football." 7.25: The managers and captains of the visiting teams competing in the Australasian cross country championships will speak to listeners. 7.35: A Studio concert by 7ZL artists (interspersed with gramophone records). 7.42: Fred Heraud, baritone, "Nothing to Say" (Brshe); "Song of the Waggoner" (Smith). 7.49: Record recital. 7.52: George Huxley, concertina solos, "Kathleen Mavourneen" (Crouch), "Melody in F" (Rubinstein). 7.59: Record recital. 8.2: Jean Allen, contralto, "So Little Time" (Wilnot); "Thank God for a Garden" (Del Riego). 8.9: Record recital. 8.12: Fred Heraud, baritone, "Mistress of the Muster," "Five and Twenty Sailormen" (Taylor). 8.22: George Huxley, concertina solos, "Tyrolean Airs and Variations" (Birch), "Quand tu Chantes" (Gounod). 8.30: Jean Allen, contralto—"O, Western Wind" (Taylor), "My Prayer" (Squire). 8.45: James Counsel, "The History and Development of Music." 9.45: News session. 10.0: G.P.O. clock chimes the hour. 10.1: Close down.



**MANUFACTURERS !**

Do Not  
 Compromise with  
 Quality

USE

**HYDRA**

FIXED  
 CONDENSERS

SAMPLES FOR TEST ON  
 APPLICATION.

Sole Distributors:

**Eastern Trading Co., Ltd.**

Aberdeen House,  
 204 Clarence St.,  
 SYDNEY.  
 'Phone, M2945-6.

McEwen House,  
 Little Collins St.,  
 MELBOURNE.  
 'Phone, F2528.



**Which battery type ?**

The greatest efficiency and economy from your "Ever-Ready" Radio Batteries is obtained by simply selecting the "Ever-Ready" type most suitable for your particular requirements. In this regard, any good radio dealer will readily show you the "Ever-Ready" Chart, listing for your information the best battery connection for each and every radio set extant. You will then be co-operating with "Ever-Ready" to avail yourself of the finest reproduction possible. Once you ascertain the right type, it's easy enough to remember. And it's easier and more profitable to remember, too, that an "Ever-Ready" is **BRITAIN'S BEST BATTERY!**

N.S.W. Wholesale Distributors:

**The Ever-Ready Co. (Gt. Britain), Ltd.,**  
 163 Pitt Street, Sydney.



**2/6**

Illustrated is the largest and most powerful of the "Ever-Ready" line of radio batteries—the SUPER SERVICE 45-volt "B" Battery. 30 large cells, in moisture-proof case, give 25 per cent. greater output than most heavy duty batteries on the market selling at a higher price. Specially recommended for sets with 4 or more valves, or power valves. Australian-made, and **FRESH FROM THE FACTORY TO YOU!**

**EVER-READY**  
**RADIO BATTERIES**  
 SAFETY FIRST — UTILITY ALWAYS  
 LOOK FOR THE TRADE MARK





PRICE  
**41/-**

Isolate Your Loud  
Speaker

WITH A



BRITISH MADE

OUTPUT  
TRANSFORMER

Type OP1—(Ratio 1 to 1) for use with ordinary Loud Speakers of the diaphragm and cone type. Type OP2—(Ratio 25 to 1) for operating Loud Speakers of the coil driven cone type. The use of a FERRANTI Output Transformer is preferable to a choke filter unit because (a) the majority of chokes are inefficient with a large plate current passing through them, and (b) the blocking condenser has to be large if the lower notes are to be reproduced properly. The result is that the lag caused by charging and discharging the condenser as the signal varies, spoils music involving sharp changes, such as given by drums, plucked strings, the harp and even the piano.

Obtainable from every Radio  
Dealer in Australia.

J.2.

Write to A. Beal Pritchett (Aust) Ltd., 17 Parker St., Sydney, for Ferranti Booklet W.B. 416, dealing with the construction of B Eliminators.

Also for a Copy of the Ferranti Painting Book for Children.

## Local Programmes, Sat., September 7

### 2FC

Australian Broadcasting Company, Ltd., Market St., Sydney (Wavelength, 442 Metres).

#### EARLY SESSION, 7 to 8.15 a.m.

- 7.0: "Big Ben" and meteorological information for the man on the land.
- 7.3: This morning's news from the "Daily Guardian."
- 7.8: Early rising music.
- 7.45: Mails and shipping.
- 7.48: What's on to-day.
- 7.50: Children's birthday calls.
- 8.0: Music from the studio.
- 8.15: Close.

#### MORNING AND AFTERNOON SESSIONS.

- 10.30: Announcements.
  - 10.32: A.B.C. racing observer.
  - 10.45: Recital on the Grand Organ by Edgar Stone.
  - 11.0: Household Helps: Week-end suggestions by Miss Ruth Furst.
  - 11.15: Morning devotion.
  - 11.30: Austradio musical reproduction.
  - 12.0: "Big Ben," Stock Exchange and metal quotations.
  - 12.5: Studio music.
  - 12.20: Midday weather forecast and weather synopsis. Special produce market session for the man on the land supplied by the State Marketing Board.
  - 12.30: Basil Rye, baritone—
    - (a) "Stock Rider's Song" (James)
    - (b) "Messmates" (Lohr).
  - 12.37: Studio music.
  - 12.43: Basil Rye, baritone—
    - (a) "Where the Milestones End" (Sharpe).
    - (b) "On the Road to Mandalay" (Hedgecock).
  - 12.50: From Canterbury: Description of the races in the running. During intervals items by the Arabesques. Instrumental Trio Note: Race results from Rosebery will be given as received.
  - 4.35: Complete sporting resume
  - 4.45: Close.
- #### EARLY EVENING SESSION, 5.45 to 7.55 p.m.
- 5.45: Kiddies' "Goodnight" stories told by the "Hello Man," assisted by Aunt Willa and Cousin Gwen and Cousin Clarice.
  - 6.45: The National Broadcasting Orchestra will play dinner music.
  - 7.25: A.B.C. sporting service.
  - 7.37: Special country session. Stock Exchange resume. Markets. Weather forecast. Late news service.
  - 7.58: To-night's programme.
  - 8.0: From the Melbourne Town Hall: Jascha Spivakowsky in association with the Melbourne Conservatorium Symphony Orchestra, conducted by Professor Bernard Heinz.
  - 10.0: From the Oriental Cafe: Sydney Simpson's Synconaters in dance music.
  - 11.30: Close. National Anthem.

### 2BL

Australian Broadcasting Company, Ltd., Market St., Sydney (Wavelength, 353 Metres).

#### OPENING SESSION, 8.15 a.m. to 11 a.m.

- 8.15: G.P.O. chimes. Music for every mood
- 8.45: Meteorological data for the country.
- 8.50: A musical interlude.
- 9.30: British official wireless news.
- 9.35: New music.
- 10.8: News from the "Guardian."
- 10.10: Talk on "Gardening." by J. G. Lockley.

10.30: Celebrity items.

- 10.45: Studio music
- 11.0: G.P.O. chimes. Close.

#### MIDDAY SESSION, 12 noon to 2.30 p.m.

- 12.0: G.P.O. chimes: announcements.
- 12.2: The National Broadcasting Orchestra
- 1.0: Afternoon news from the "Evening News."

- 1.5: Studio music
- 1.30: A recital of instrumental music.
- 2.0: J. Knight Barnett at the Wurlitzer.
- 2.12: Studio music

#### AFTERNOON ENTERTAINMENT, 2.30 to 5.15 p.m.

- 2.30: 2BL Instrumental Trio.
- 2.42: Lotys Lescaut, soprano.
- (a) "I Sometimes Wonder" (Ross).
- (b) "The Netmender" (Clarke).

(c) "Do You Know My Garden?" (Haydn Wood).

- 2.49: Edythe Cowley, entertainer.
- "The Guild of Fine Souls" (Constanduros).
- 2.58: 2BL Instrumental Trio.
- 3.10: Laurence Macaulay, basso.
- (a) "Beating Up the Channel" (Sanderson).
- (b) "Ould Plaid Shawl" (Haynes).
- 3.17: Phyllis Bateman, violinist.
- (a) "Minuet" (Beethoven).
- (b) "Romance" (Beethoven).
- 3.24: 2BL Instrumental Trio.
- 3.36: Lotys Lescaut, soprano.
- (a) "Hindoo Song" (Bemberg).
- (b) "The Merry Heart" (Del Riego).
- 3.43: Edythe Cowley, entertainer.
- "Her Night Thoughts" (Fisk)
- 3.50: 2BL Instrumental Trio.
- 4.0: Laurence Macaulay, basso.
- (a) "Three for Jack" (Squire).
- (b) "Jolly Old Cavalier" (Dix).
- 4.7: Phyllis Bateman, violinist.
- (a) "Romance" (Sitt).
- (b) "Snake Dance" (Burleigh).
- 4.24: A programme of popular numbers.
- 5.0: Complete sporting resume.
- 5.15: Official weather forecast. Close.

#### THE DINNER HOUR, 6.15 p.m. to 7.55 p.m.

- 6.15: The National Broadcasting Orchestra
- 6.45: The "Younger Set" session. Travel and adventure, by the "Captain."
- 7.5: The A.B.C. sporting resume
- 7.17: Studio music.
- 7.30: The National Broadcasting Orchestra.
- 7.45: Celebrity music.
- 7.55: What's on the air to-night?

#### TO-NIGHT'S PRESENTATION, 8 p.m. to 12 Midnight.

- 8 p.m.: G.P.O. chimes.
- A popular presentation, arranged by Madame Evelyn Grieg, in association with Harry Graham.
- 9.30: Late weather forecast for the man on the land.
- 9.31: The Australian Broadcasting Dance Orchestra.
- 9.43: Lionel Lunt, baritone.
- (a) "Rose of My Heart" (Logan).
- (b) "God Gave Each Rose a Garden" (Acre).
- 9.50: The Australian Broadcasting Dance Orchestra.
- 10.5: Lionel Lunt, baritone.
- (a) "Alone" (Lohr).
- (b) "This Was a Man" (Anderson).
- 10.12: The Australian Broadcasting Dance Orchestra.
- 10.25: Official weather forecast; metropolitan and country late news, from the "Evening News."
- 10.30: The Australian Broadcasting Dance Orchestra.
- 11.30: Romano's Dance Orchestra, conducted by Bennie Abrahams.
- 12.0: Close. National Anthem

### 2GB

Theosophical Broadcasting Station, 29 Bligh St., Sydney (Wavelength, 316 Metres).

- 3.0: Musical session. 5.30: Children's session by Uncle George. 7.0: Request hour.
- 8.0: Dance programme by Sutton's Dance Orchestra. 10.30: Close down.

### 2UW

Radio Broadcasting, Ltd., Pallin's Building, Ash St., Sydney (Wavelength, 267 Metres).

- 5.30 p.m.: Children's hour, conducted by Uncle Jack. 6.30: Close down. 7.0: Musical programme and request numbers. 10.30: Close down.

### 2KY

Trades and Labor Council, Goulburn St., Sydney (Wavelength, 280 Metres).

- 6 p.m.: Birthday calls, request numbers, and kiddies' entertainment, Aunt Jemima and Uncle Bert.

#### EVENING SESSION.

- 7.0: Musical interlude.
- 7.5: Birthday calls.
- 7.15: Sporting feature Turf topics they ran to-day.
- 7.50: Request night.
- 10.0: Closing announcements.

# THE "SALONOLA" ALL ELECTRIC TABLE MODELS

Mechanically identical with our famous  
"Salonola"

**Full-Size Console  
Cabinet Models**

---but much more convenient, because  
you can place it just where you want it.

A new device---

**DETACHABLE  
LEGS**

---are fitted as standard (Patent  
applied for). If you wish to place your  
Set on a table or a cabinet you can  
dispense with the legs in a moment.



**SALONOLA  
"DE LUXE"  
TABLE  
MODEL**



**SALONOLA  
"STANDARD"  
TABLE  
MODEL**

**NO EXTRAS TO BUY  
AMPLION CONE LOUD  
SPEAKER INCLUDED**

## Salonola "Threes"

	CASH			or		TERMS
	£	s.	d.			
All Electric "Standard"	27	10	0	6/9	wkly.	
All Electric "De Luxe"	31	0	0	7/9	"	
Battery "Standard"	25	0	0	6/3	"	
Battery "De Luxe"	26	0	0	6/6	"	

## Salonola "Fives"

	CASH			or		TERMS
	£	s.	d.			
All Electric "Standard"	42	0	0	10/9	wkly.	
All Electric "De Luxe"	43	10	0	11/-	"	
Battery "Standard"	32	10	0	8/-	"	
Battery "De Luxe"	34	0	0	8/6	"	

## Salonola "Sixes"

	CASH			or		TERMS
	£	s.	d.			
All Electric "Standard"	47	0	0	12/-	wkly.	
All Electric "De Luxe"	48	10	0	12/3	"	
Battery "Standard"	42	10	0	10/9	"	
Battery "De Luxe"	44	0	0	11/-	"	

OPEN UNTIL 9 P.M. FRIDAYS

**HOME RECREATIONS (AUSTRALIA) LTD**

# Interstate Programmes, Saturday, September 7

## 3LO

Australian Broadcasting Co., 120A Russell St., Melbourne (Wavelength, 371 Metres).

### EARLY MORNING SESSION.

7.0 to 8.15: See Friday.

### MORNING SESSION.

10.20: Current happenings in sport, Eric Welch. 10.45: A.B.C. Orchestra. 12.0: Melbourne Observatory time signal. 12.1: Orchestra continued. 12.15: News; Corn Exchange midday report; Newmarket stock sales. Associated Stock and Station Agents' official report. 12.30: Close down.

### MIDDAY SESSION.

1.0: Melbourne Observatory time signal. 1.1: Stock Exchange information; meteorological data; weather forecast for Victoria, New South Wales, South Australia, and Tasmania; ocean forecast; river reports; rainfall; comments on the day's news.

### AFTERNOON SESSION.

2.0: Melbourne Observatory time signal. 2.1: Sporting descriptions—Races described by Eric Welch; football described by Mel Morris. 5.30: Final football scores and resume of sporting results. 5.45: Close down.

### THE CHILDREN'S CORNER

5.45: "Little Miss Kookaburra," second instalment of "The Guides at Calamity Hill." 6.0: Birthday greetings. 6.20: For the Old Boys and Girls—"Stamp Collecting." 6.30: Musical interlude.

### EVENING SESSION.

6.40: Sporting results. 6.55: Musical interlude. 7.0: Melbourne Observatory time signal; Stock Exchange report; Associated Stock and Station Agents' official report; Wool Exchange report; mines and metals; fish and rabbits prices; farm and dairy produce report supplied by the Inter-State Dairy Produce Committee; wholesale fruit prices by the Wholesale Fruit Merchants' retail fruit prices, supplied by the Victorian Fruitgrowers' Association; citrus fruit prices, supplied by the Victorian Central Citrus Association; weather synopsis; river reports; rainfall data.

### EDUCATIONAL SESSION.

7.25: Stories of our Mining Fields—"Bendigo." Mr. Charles Daley. 7.40: News service. 7.45: Come with U Round the World—5. "The Siberian Eskimos." Mr. H. J. G. Esmond.

### NIGHT SESSION.

8.0: Brunswick City Band—Overture, "The Barber of Seville" (Rossini). 8.10: Madame Mina Hesseleva—"L'Eté" (Chaminade). "He Loves Me Not" (Mascagni). 8.17: Edouard Lambert, violin—"Romance in F" (Beethoven). 8.24: The Melbourne Repertory Theatre Company present "The Constant Lover." A comedy in one act, by St. John Hankin. Persons of the play (in order of speaking)—Cecil Harborton and 25 John Guyatt. Evelyn Rivers, aged 18; Winifred Collins. The scene is a glade in a wood. The play produced by Frank D. Clewlow. 8.45: A special programme has been arranged. 10.0: Transmission from the Bijou Theatre. 10.20: Meteorological information; British official wireless news; items of interest. 10.30: The Rex Dance Band. 11.30: God Save the King.

## 3AR

Australian Broadcasting Co., 120A Russell St., Melbourne (Wavelength, 481 Metres).

### MORNING SESSION.

8.15: Morning music. 8.45: Weather data. 9.0: G.P.O. chimes. 9.1: "Sun" news pictorial; news service. 9.5: Reproduced music. 10.0: G.P.O. chimes. 10.1: British official wireless news. 10.10: Reproduced music. 10.30: Arnold Coleman at the Wur Hlzer. 10.50: A Message for the day. 11: Close down.

### MIDDAY SESSION.

12: G.P.O. chimes. 12.15: Fifteen minutes' syncope. 12.30: Luncheon music, supplied by the National Broadcasting Orchestra. Under direction Wm G. James. Conductor: Percy Code.

### EDUCATIONAL SESSION.

2: G.P.O. chimes. 2.1: The Story of Hiawatha (Longfellow). Rev. W. Bottomley. 2.15: Musical interlude. 2.20: The Retreat (from Mons. Mr. Howlett Ross. 2.35: Musical interlude. 2.40: Personal adventures while exploring. Lt.-Col. Eldred Pottinger. D.S.O. P.R.O.S.

### THE RADIO MATINEE

3: National Broadcasting Orchestra. Under direction Wm G. James. Conductor: Percy Code. "Fra Diavolo" (Auber). 3.10: Arthur Douglas, Scotch comedian—"Sergeant Jock McPhee." "The Postman." 3.17: "J. and G."—"The Confidential Two." "Kiss Me Again," piano novelty. "Lady Fingers." "Louise." 3.24: Doreen Berry, humorous monologue—"By Aero plane." 3.30: Orchestra—"In the Soudan" (Sevck). 3.35: "The Two Busy Bees" present a Humorous Duo—Telling the Biggest Lie. 3.42: Russell Callow, tenor—"God Touched the Rose" (Brown). "An Evening Song" (Blumenthal). 3.49: Doreen Berry—Bertram at the Bachelor's Club. 3.56: Orchestra—Selection. "June Love" (Primi). 4.6: Jessie Smith, contralto—"Rosebud" (Drummond). "A Fat Little Fella." 4.13: George Findlay, piano—Waltz in C Sharp Minor (Chopin). "Humoresque" (Rachmaninoff). 4.20: Russell Callow, tenor—Popular numbers. 4.27: Orchestra—"Egyptien" (Zamecnik). Two Hun-

## 5CL

Central Broadcasters, Ltd., 114 Hindmarsh Square, Adelaide (Wavelength, 409 Metres).

### AFTERNOON SESSION.

12.0: Chimes. 12.1: Special late selections for Aspendale Park by our Melbourne representative. 12.3: Probable starters and selections for race at Cheltenham to-day by Julius. 12.15: General news service. 1.15: Cheltenham, riders and positions for Port Adelaide Hurdles, about 2 1/4 miles. 1.20: Aspendale Park race results. 1.30: Cheltenham, running description of Port Adelaide Hurdles by Arnold Treloar. 1.55: Cheltenham, riders and positions for Albert Park Three-year-old Handicap, one mile one furlong and 40 yards. 2.0: Resume of Aspendale Park race results. 2.10: Cheltenham, running description of Albert Park Three-year-old. 2.35: Cheltenham, riders and positions for Royal Park Handicap, 1 mile and 3 furlongs. 2.50: Cheltenham, running description of Royal Park Handicap. 2.55: Resume of Aspendale Park race results. 2.51: Description of League football by "Mo" Manning. 3.15: Cheltenham, riders and positions for Cheltenham Steeplechase, about 2 miles and 3 furlongs. 3.20: League football. 3.30: Cheltenham, running description of Cheltenham Steeplechase. 3.35: League football. 3.55: Cheltenham, riders and positions for Quebec Welter, 1 mile and 1 furlong and 40 yards. 4.0: Resume of Aspendale Park race results and League football scores. 4.10: Cheltenham, running description of Quebec Welter. 4.15: League football. 4.30: League football scores. 4.35: Cheltenham, riders and positions for Flying Handicap, 6 1/2 furlongs. 4.40: League football. 4.50: Cheltenham, running description of Flying Handicap. 4.55: League football. 5: Dividend of Flying Handicap; resume of Aspendale Park and Cheltenham race results; football scores. 5.10: Close down.

### EVENING SESSION.

6.0: Chimes. 6.1: Birthday greetings. 6.15: Children's request numbers. 6.20: Dinner session. 7.1: Senior Birthday League greetings; Stock Exchange; announcements. 7.10: Rev. G. E. Hale, B.A., on "Is Church-going Worth While?" 7.25: Mr. C. G. Riley on "Items of Interest." 7.40: 5CL's sporting service, including Aspendale Park and Cheltenham race results; League football scores; country sporting; Soccer three grades; Inter-State basketball scores; hockey, cycling, lacrosse, and other sporting results.

### NIGHT SESSION.

8.0: Chimes. 8.10: The South Australian Railways Band. Conducted by J. Radcliffe. Overture, "Tancredi" (Rossini). 8.20: Stella Sobels, soprano—"Daffodils" (Cyril Scott). "The Cuckoo Clock" (Grant Scheffer). 8.27: The South Australian Railways Band. Fox trot, "Chinky Leo" (Franklin). March, "The Elephant" (Hume). 8.35: Rupert Hazell and Elsie Day. 8.45: Jean Finlay, pianist—"Prelude" (Chopin). "Fantasie Impromptu" (Chopin). 8.52: Haydn Male Quartet—"Honey, I Want You Now" (Coe). "Obituaries" (Parker). 9.0: G.P.O. chimes. 9.1: South Australian Railways Band—Selection, "Squire's Popular Songs" (Hume). 9.10: Wilfred Thomas, bass—"Oh, Rudder than the Cherry" (Handel). "Sylvia" (Speaks). 9.17: A. McEwens, cornetist—"Arbucleanian Polka" (Hartman). 9.24: Rupert Hazell and Elsie Day. 9.32: South Australian Railways Band—Romance, "Popples" (More). 9.39: Stella Sobels, soprano—"If No One Ever Marries Me" (Liza Lehmann). "Dying Moon Slower" (Leuraence). 9.46: South Australian Railways Band—"Contest" (Hume). 9.54: Hadya Male Quartet—"I Want a Dear Little Girl" (Thompson). "In the Rain" (Parker). 10.1: South Australian Railways Band—Selection, "Top of the Bill" (Hume). 10.11: Wilfred Thomas, bass—"Si mes vers" (Huhn). "Courage" (Schubert). News session. 10.18: 5CL's sporting service, including Aspendale Park and Cheltenham race results; League football scores; country sporting; Soccer, three grades; Inter-State basketball scores; hockey, cycling, lacrosse, and other sporting results. 10.30: Modern dance recordings. 11.0: Close down.

## 6WF

Commonwealth Government Broadcasting Station, Perth (Wavelength, 100 Metres).

10.0: Gramophone records. 11.0: Close down. 12.0: Racing anticipations. 12.7: Pianoforte solos by Miss Audrey Dean. 12.44: Markets; news. etc. 1.0: Time Signal; weather bulletin. 1.3: Close down. 3.30: Sporting session, race results and quarter-time scores of the football matches; musical items from the Stud Book (30 approx). Close down. 5.45: Bed-time stories by Auntie Amy. 7.12: Sports results. 7.30: Commercial information. 7.45: Music. 8.1: First weather bulletin. 8.3: Variety programme. 8.30: Dance music. 8.50: Late news; ships within range; late weather bulletin. 10.30: Close down. 10.5: Metre Transmissions—Simultaneous broadcast on 104.5 metres of programme given on 1250 metres, commencing at 6.45 p.m.

garian Dances (Brahms). 4.37: "The Two Busy Bees" will buzz in Songs and Laughter. 4.44: J. Barrille and A. Anderson—Duet, Flute and Clarinet. "The Magpie and the Parrot." 4.48: Arthur Douglas, Scotch comedian—"Dr. McGregor." "I'm Eighty in the Morning." 4.55: Orchestra—"Two Spanish Dances." 5.0: G.P.O. chimes. 5.1: Reproduced music. 5.30: Weather data. 5.45: Close down.

### EVENING SESSION.

6.15: Dinner music. Supplied by the A.B.C. Studio Orchestra. 7.30: What's on the Air Tonight? 7.32: Latest musical releases.

### NIGHT SESSION.

8.0: G.P.O. chimes. 8.15: A Special Programme has been arranged. 10.5: Weather information and "Herald" news. 10.10: Brunswick City Band—Selections—"Chu Chin Chow" (Norton). 10.20: Joe Brennan and Ida Newton—"Up-to-the-Minute Jests and Melodies." 10.27: Norman's Royal Hawaiians—"Wallane Waltz." "Love Time." "The Kahlika March." 10.34: Jack Hocking, tenor—"Lates Melody." 10.40: Brunswick City Band—"Prelude" (Rachmaninoff). 10.45: Joe Brennan and Ida Newton—More Quips and Jests. 10.52: Norman's Royal Hawaiians: Hawaii Calling—Blues: "Come and Dance With Me." Banjo Melodies. 10.58: Jack Hocking, tenor—"Popular Hit." 11.5: Keno Cotton's Syncopeation Hour. 12.0: God Save the King.

## 3DB

The "Herald" Broadcasting Station, Flinders Street, Melbourne (255 Metres).

### AFTERNOON SESSION.

2.0: Albert Keteley's Orchestra—"Moonlit Glade." "Keteley." 2.30: John McCormack (tenor). "Thro' All the Days to be." 3.0: William Murdoch (piano). "Hark, Hark, the Cark!" 3.30: Ernest Butcher. "Come to the Fair." 4.0: Lavton and Johnstone. "Up With the Lark." 4.30: Symphony Orchestra. "Salut d'Amour" (Sgarbi). 5.0: G. T. Fatman organ. "Dull Days." 5.15: Close down.

### EARLY EVENING SESSION.

5.30: Olive Kilne and Edie Baker. "Rockin' in de Wind." 6.0: Childra's session. 6.30: Sporting results. 6.45: New York Symphony Orchestra. "Flying Dutchman Overture." 7.0: Walter Kingsley (organ). "Dear Little Irish Mother." 7.30: George Olney and his music—"Where the Sky Little Violets Grow."

### EVENING SESSION.

8.0: The Fillmore Band—"Whistling Farmer's Boy." 8.30: Percy Henning (baritone). "Before the Dawn" (Lang). 9.0: J. H. Sharwood's sponsored hour. Joe Watson and the Green Mill Orchestra. 10.0: Charles Hackett. "I Hear a Thrush at Eve." 10.30: Zee Conroy and his orchestra. "Jumping Jack." 10.40: News. 10.45: God Save the King.

## 4QG

Queensland Government Radio Service, Brisbane (Wavelength, 385 Metres).

For day sessions, see Friday.

### NIGHT SESSION.

8.0: A programme of classic music by 4QG artists under the conductorship of Mr. Geo. Sampson. F.R.C.O.—Instrumental Trio: "Trio in D Minor" (Arensky). (Cello, Mary Jeffries; violin, Eric Hayne; piano, Jack Ellis). Beatrice Pugh, soprano—"The Young Nun" (Schubert). Les Edey, baritone—"If Thou Wert Blind" (Johnson). "The Call" (Oliver). Duet for two pianos, Helen Collings and Louise Grimes, "Scherzo" (Saint-Saens). Beatrice Pugh, soprano—"Snowflakes" (Mallinson). "The Rosebud" (Mallinson). Les Edey, baritone—"Star Vicino" (Salvator Rosa). "Castilian Lament" (Del Rio). Mary Jeffries, cellist—"Reverie" (Fischer). "Cantabile" (Gesar Cui). Mrs. W. F. Hamilton, mezzo soprano—"Far Greater in His Lowly State" (Gounod). Beatrice Pugh and Les Edey—Duet, selected. Eric Hayne, violinist—"Sonata in D" (Corelli). Hilda Cooper, contralto—"Lascia ch'io pianga" (Handel). Walter Land, tenor—"Go, Lovely Rose" (Quilter). "O, Mistress Mine" (Quilter). Mrs. W. F. Hamilton, mezzo soprano—"Homage" (De Eleoso). Duet for two pianos: Helen Collings and Louise Grimes—"Le Revour" (Arensky). "La Coquette" (Arensky). Walter Land, tenor—"Eleanor" (Coleridge-Taylor). Mrs. W. F. Hamilton and Hilda Cooper—Vocal duet, "Hear Me, Norma" (Bellini). Instrumental Trio—Selected. 10.0: News; weather; close down.

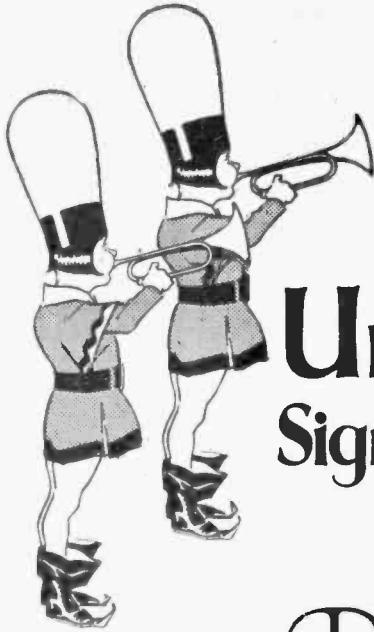

# Uniform Signal Strength

**D**ISTANCE ..... comes in just as clear and strong as ever when you replace a Radiotron with a Radiotron.

Radiotrons are closely matched—they undergo 41 different inspections and tests, to ensure that every valve of the same type number is *absolutely uniform* in characteristics.

Tone, Volume, and all round quality are as dependable in one Radiotron as in another.



**RADIOTRON UX226** is an amplifier Valve, the A.C. filament of which can be operated by alternating current direct from a power transformer.

**OTHER A.C. RADIOTRONS.**  
 UY227.  
 A.C. Heater.  
 UX171 A.  
 Power Amplifier, Last Audio Stage only.  
 UX280.  
 Full Wave Rectifier.

**AUSTRALIAN  
 GENERAL ELECTRIC**  
*Australian General Electric Company, Ltd.*

93-95 Clarence Street, Sydney.

55 King Street, Civic Centre, 621 Dean Street, Keen Street.  
 NEWCASTLE. CANBERRA. ALBURY. LISMORE.



From all  
 the best  
 Radio  
 Dealers

# RCA Radiotron

# The Latest in Radio

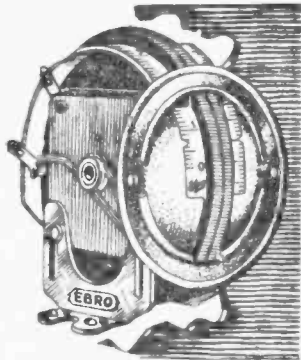

## NEW---

# The "Ebro" Condenser

Everyone has been waiting for a condenser giving economy in space and weight, with exceptional fine tuning. Well, here it is—the "EBRO." made in Single, Twin, and Gang, in 4 capacities—000125, 00025, 00035, 0005, all adaptable to Panel and Sub-Panel mounting.

Single 14/-; Twin 27/-

### Radio Dealers!

We have full stocks  
of the following:--

Silver Knight  
Chokes

Eagle Arrestors

Marco Drum Dials

Frieze Ebonite

and all other Radio Lines

Write for Particulars.

GUARANTEED BY THE AGENTS



32 Clarence St., Sydney

'Phone, B2002.

## Local Programmes, Sunday, Sept. 8

### 2FC

Australian Broadcasting Company, Ltd., Market St., Sydney (Wavelength, 442 Metres).

#### CHURCH HOUR, 10 a.m. to 12.30 p.m.

10.0: Announcements.  
10.5: Studio music.  
10.30: This morning's news from the "Sunday News," "Sunday Times," and "Truth."  
10.35: British official wireless news.  
10.45: Musical items.  
11.0: From All Saint's, Woollahra: Morning service conducted by Canon W. L. Langley—

Organist and Choirmaster, Victor Massey.  
"Keep Innocency" (Macfarren).  
Versicles and Responses.  
Venite and Psalm 39.  
Lesson.  
Te Deum.  
Holy Communion (music, Stainer in F).  
Kyrie.  
Creed.  
Hymn 514 (A. and M.).  
Sermon, Canon W. L. Langley.  
Hymn 322 (A. and M.).  
Agnus Dei.  
Sanctus.  
Gloria.

Benediction  
12.15: Studio music.  
12.30: Close.

#### AFTERNOON CONCERT, 3 p.m. to 4.30 p.m.

3.0: From the Lyceum Hall, Pitt Street: Pleasant Sunday Afternoon Programme arranged by the Central Methodist Mission. Chairman, Rev. H. C. Foreman, M.A.  
Bass solo, Herman Tremayne.  
Contralto solo, Bessie Cooke.  
Violin selection, Daisy Richards.  
Soprano solo, Amy Ostinga.  
Address on the Empire by the Hon. T. R. Bavin, P.C., K.C., Premier of New South Wales.

4.30: Close.

#### EVENING PROGRAMME, 6 p.m. to 10.30 p.m.

6.0: Monaco Quartette—  
(a) "Student Prince" (Romberg).  
(b) "Intermezzo."  
(c) "Humoreske" (Dvorak).  
6.20: Roy Scrivener, baritone—  
6.27: Monaco Quartette—  
(a) "I Love You Truly" (Jacobs-Bond).  
(b) "Before the Dawn."  
(c) "Salaam" (Lang).  
(d) "Marigolds" (Lang).  
(e) "Waiaata Poi" (Hill).  
6.40: An address by Justice Harvey.  
7.0: Monaco Quartette—  
(a) "Chant Sans Paroles" (Tschalkowsky).  
(b) "Just a Wearyin' for You."  
(c) "Ave Maria" (Gounod).  
(d) "La Paloma" (Yradien).  
(e) Selected.  
7.20: Marjory Skill, soprano.  
7.30: Monaco Quartette—Selected.  
7.40: Roy Scrivener, baritone.  
7.47: Monaco Quartette—Selected.  
8.0: Will Prior's musical ensemble, with Price Dunlavy at the Grand organ.  
10.0: Meditation music.  
10.30: Close. National Anthem.

### 2BL

Australian Broadcasting Company, Ltd., Market St., Sydney (Wavelength, 335 Metres).

#### MIDDAY SESSION, 10.55 a.m. to 3 p.m.

10.55: Announcements.  
11.0: From the Chalmers Street Presbyterian Church, the Morning Service, conducted by Rev. D. F. Brandt.  
12.15: From the studio, musical items.  
12.30: News from the "Sunday News," "Sunday Times," and "Truth."  
12.38: Studio presentation of the programme of music specially arranged and reproduced on the "Radio Metre."  
2.15: "Cheer Up" session, conducted by Uncle Frank.  
2.30: Celebrity records.  
3.0: Close.

LATE AFTERNOON, 4.30 p.m. to 6 p.m.  
4.30: A recital of grand opera, by Madame Evelyn Grieg, "La Traviata."

EVENING SESSION, 6 p.m. to 10 p.m.  
6.0: For children in hospital, session conducted by Uncle Steve, assisted by Aunt Goodie.

6.40: From Pitt Street Congregational Church, organ recital by Lillian Frost.

(a) "Fantasia on a French Carol" (Dethier).  
(b) "Andante" from "Sixth Symphony" (Tschalkowsky).  
(c) "Traumerl" (Schumann).  
7.0: Divine service, conducted by Rev. T. E. Ruth.  
8.30: From the studio. Concert programme, arranged by the Kretschmann Club, Dorothy Curran and Edith Kilminster, violinist and pianist.

"Sonata in D Minor," for violin and piano (Brahms); first movement Allegro; second movement, Adagio.  
May Craven, soprano.  
(a) "Adieu Forests" (Tschalkowsky).  
(b) "At the Well" (Hageman).  
Mario Gustino, baritone.  
(a) "Woo Thou Thy Snowflake" (Sullivan).  
(b) "Viena la Mia Vendetta," from "Lucrezia Borgia."

Madame Bennett-North and Mario Gustino, vocal duet.  
"How Sweet the Moonlight" (Lehmann)  
Madame Bennett-North and May Craven vocal duet.  
Alexander Sverjensky, pianist.  
(a) "At the Fountain" (Arensky).  
(b) "Prelude C Minor" (Boscoff).  
(c) "Rustic Dance" (Boscoff).

A. Willmore, tenor.  
(a) "She Rested by the Broken Brook" (Coleridge-Taylor).  
(b) "Eleanor" (Coleridge-Taylor).  
Helena Stewart, soprano.

(a) "Deh Vieni Non Tardar" (Mozart).  
(b) "Oh Sleep, Why Dost Thou Leave Me?" (Handel).  
Victor Evans, baritone.  
(a) "Bois Epais" (Lully).  
(b) "I Whisper my Name" (Kucken).  
A. Willmore and Victor Evans, vocal duets.  
Helena Stewart and Victor Evans, vocal duet.

Duet from "Il Trovatore" (Verdi).  
Daisy Richards, violinist.  
(a) "Musette" (Rameau).  
(b) "Menuet" (Beethoven).  
Ethel Friend, contralto.  
(a) "In Questa Tomba" (Beethoven).  
(b) "None But the Weary Heart" (Tschalkowsky).  
(c) "Ingrid's Song" (Kjerulf).  
Esther Kahn, pianist.

(a) "Two Magyar Tone Poems."  
1. The Soothsayer.  
2. Gipsy song.  
(b) "Cupid and the Bee" (Kahn), first performance over the air.  
Gwladys Edwardes, soprano, and Anne Stuart Gurr, mezzo duets.  
(a) "Sing, Joyous Bird" (Montague Phillips).  
(b) "Passing By" (Purcell).  
(c) "O Lovely Night" (Landon Ronald).  
10.0: Close.

### 2GB

Theosophical Broadcasting Station, 39 Bligh St., Sydney (Wavelength, 316 Metres).

10.0: Music from studio. 10.15: Organ music from St. Alban's Church, Regent St., Sydney. 10.30: Morning service from St. Alban's Church. 12 noon: Music from studio. 12.30: Close down. 3.0: Musical session 5.30: Children's session by Uncle George. 7.0: Lecture from St. Alban's Church. 7.35: Lecture from Adyar House. 8.15: Sacred concert, by courtesy of Suttons, Ltd.; player-piano solo. 8.23: Mr. William Green, tenor. 8.30: Mr. Gregory Valentine, violinist. 8.38: Miss Kathlene Cracknell, contralto. 8.45: Mr. Cecil Chaseling, baritone. 8.52: Player-piano solo. 9.0: Weather report. 9.1: Miss Kathlene Cracknell, contralto, and Mr. Wm Green. 9.5: Mr. Gregory Valentine, violinist. 9.13: Mr. Cecil Chaseling, baritone. 9.20: Miss Kathlene Cracknell, contralto. 9.25: Mr. William Green, tenor. 9.30: Close down.

### 2UW

Radio Broadcasting, Ltd., Palling's Building, Ash St., Sydney (Wavelength, 367 Metres)

10.30 a.m.: Music and request numbers. 1 p.m.: Close down. 5.30 p.m.: Children's hour, conducted by Uncle Jack. 6.30: Close down. 7.0: Musical programme. 10.30: Close down.

# Interstate Programmes, Sun., Sept. 8

## 3LO

Australian Broadcasting Co., 120A Russell St., Melbourne (Wavelength, 371 Metres).

### MORNING SESSION

10.0: Melbourne Observatory time signal. 10.1: A special programme of reproduced music. 10.23: British Official Wireless news and items of interest. 10.30: Express train information. 10.31: Bells of St. Paul's Cathedral. 10.45: Morning service from St. Paul's Cathedral, Melbourne. 12.30: Close down.

### AFTERNOON SESSION

3.0: Pleasant Sunday afternoon service from Wesley Church Central Mission; speaker, Rev. Dr. Boreham. 4.30: Close down.

### CHILDREN'S HOUR

6.0: "Billy Bunny" talk with his little friends. 6.15: Birthday greetings. 6.35: St. Mark's Choir Boys—"Let the Bright Cherubim." "Cherry Ripe." "Every Morning Mercies New." 6.50: "Brother Bull"—"No Money, No Pie."

### EVENING SESSION

7.0: "The Rossignol String Quartette"—"Variations sur la 'Thema'" (Tschalkowsky).  
7.10: Beth Corrie, Contralto—"Like to the Damask Rose" (Elgar). "Vale" (Kennedy Russell).  
7.17: Zisserman, cello—A recital from the masters.  
7.27: J. Howlett Ross will tell the story of—"The Cleansing of Naaman."  
7.42: Beth Corrie, Contralto—"The Living God" (O'Hara).  
7.45: "The Radiant Air" (W. C. James).  
7.50: The Rossignol String Quartette—"Andante Cantabile" from the "First Quartette" (Tschalkowsky). "Scherzo."

### NIGHT SESSION

8.0: Stan Porter's Orchestra and Bob M'Questen's Band—Overture, "Morning, Noon, and Night" (Suppe). Stan Porter and his Orchestra.  
Piano solo, (a) "Consolation" (Mendelssohn), (b) "The Bar Wedding" (Carl Bartling).  
Vocal item, selected.  
Melody number, a Symphonic Jazz arrangement of "Faust" (arr. by Lange), Bob M'Questen and his Band.  
viola solo, selected, William Whittingham.  
Orchestral, "Air De Ballet" (Chaminade). Stan Porter and his Orchestra.  
Vocal item, selected.  
Trombone solo, "Adelaide" (Beethoven). G. Whestland, acc. by Stan Porter and his Orchestra.  
Melody number, "Deep Night," Bob M'Questen and his Band.  
Bassoon solo "Charlie is My Darling" with variations, B. Good.  
String Quartette, 1st Movement Quartet in F Op. 18, Allegro con brio (Beethoven).  
Vocal item, selected.  
Orchestral item, (a) "Serenade" (Chaminade), (b) "Pierrette" (Chaminade), Stan Porter and his Orchestra.  
Tenor Saxophone solo, "Waltz Inspiration" (Hazzlett), C. Taylor, acc. by Stan Porter and his Orchestra.  
Violin solo, "Serenade Espagnole" (Chaminade-Kreisler), Arved Norit.  
Melody numbers, (a) "My Tonia," (b) Angela Miss " (c) "Judy," Bob M'Questen and his Band.  
Cello solo, Second Movement from Concerto Adagio (Haydn).  
Melody number, "I'm Just a Vagabond Lover," Bob M'Questen and his Band.  
Vocal item, selected.  
Orchestral, "Il Trovatore" (Verdi), Stan Porter and his orchestra.  
10.15: British Official Wireless news: weather forecast; items of interest.  
10.30: God Save the King.

## 3AR

Australian Broadcasting Co., 120A Russell St., Melbourne (Wavelength, 484 Metres).

### MORNING SESSION

11.0: G.P.O. chimes. 11.1: Service from the Collins Street Baptist Church. Sermon, Rev. W. D. Jackson; subject, "Christ Takes a Snapshot;" soloist, Miss Winifred Mayberry.

### MIDDAY SESSION

12.30: Recordings.

### AFTERNOON SESSION

2.0: Frank Lanterman at the famous Wurliitzer organ. 3.0: Close down.

### EARLY EVENING SESSION

4.30: "Symphony No. 5 in E Minor" (Tschalkowsky). 5.15: The Week's Good Cause. A Hospital conscience. Mr. W. J. G. Turner (Austin Hospital). 5.30: "The Sacred Hour" (Ketelevy). "Prelude in G Sharp Minor," organ solo (Rachmaninoff). "Humoresque," organ solo (Dvorak). "O Sleep, Why Dost Thou Leave Me," Anna Case (soprano). 5.50: Piano recital on the grand reproducing piano. Benno Moiseiwitch; "Jeux de Feu" (The Fountain), (Ravel). "Hark, Hark, the Lark" (Schubert-Liszt). "Nocturne" (for the left hand only). (Scriabine). "Refrain de Berceau," Cradle Song (Palmgren). "Danzas Espanolas" (Spanish dance), No. 8, D Major. "Waltz," op 39, No. 1, 3, 14, 16, 23 (Brahms). 6.30: A specially selected programme of request num-

bers. 6.45: What's On the Air To-night? 6.47: St. Paul's Cathedral bells.

### NIGHT SESSION

7.0: Divine Service from Wesley Church. Sermon, Dr. T. W. Boreham. Subject: "A Command for the Kitchen."  
8.30: Transmission from Sydney, relayed by 2PC. programme by Will Prior (State Theatre).  
9.59: Weather information.  
10.0: God Save the King.

## 4QG

Queensland Government Radio Service, Brisbane (Wavelength, 385 Metres).

### MORNING SESSION.

The complete morning service will be relayed from the City Congregational Church.

### AFTERNOON SESSION.

2.15: The band concert provided by the Brisbane Citizens' Band will be relayed from the bandstand, Botanic Gardens. 4.30: Close down.

### EARLY EVENING SESSION.

6.0: Greeting to little listeners and replies to letters.

### NIGHT SESSION.

7.0: The complete evening service will be relayed from the City Congregational Church.  
7.30: Evening service.  
8.30: At the conclusion of the church service the concert by the Brisbane Municipal Concert Band will be relayed from Wickham Park.  
9.30: Close down.

## 3DB

The "Herald" Broadcasting Station, Flinders Street, Melbourne (255 Metres).

### AFTERNOON SESSION

3.0: Chamber music. 3.30: An organ and some choral items. 4.0: Symphony Orchestra and Livede Singers. 4.30: Close down.

### EVENING SESSION

6.30: Children's Hour. 7.0: Requests. 8.0: The Astor session, with Eddie Fitch at the Wurliitzer. and a request programme.  
10.0: God Save the King

## 5CL

Central Broadcasters, Ltd., 114 Hindmarsh Square, Adelaide (Wavelength, 400 Metres).

### MORNING SESSION.

10.45: Carillon of bells from Adelaide Town Hall. 11.1: Service from Parkside Baptist Church. 12.10: From 5CL Studio; British official wireless news. 12.15: Close down.

### AFTERNOON SESSION.

3.0: Chimes. 3.1: A Pleasant Sunday Afternoon Service from Maughan Methodist Church, Franklin Street. 4.0: Close down.

### EVENING SESSION.

6.0: Chimes. 6.1: Birthday greetings. 6.40: Church Choir numbers. 7.0: G.P.O. chimes. 7.1: Service from Flinders Street Lutheran Church.

### NIGHT SESSION.

8.20: Announcements.  
8.30: The Station Quartette—"Golden Sceptre" (Schleppergrell). "Hungarian Dance" (Brahms).  
8.40: Wilfred Thomas, bass—"It is Enough" from "The Elijah." "But Who May Abide" from "The Messiah."  
8.47: Pianoforte recital by Edith Harry (emireux Welsh pianiste).  
9.2: The Station Quartette—Suite, "Omar" (Frederick Hall).  
9.10: Wilfred Thomas, bass—"Sylvia" (Oley Speaks). "Long Ago in Alcalá" (Messenger).  
9.17: Geoff. Goldsworthy, "cellist"—"Arlequin" (Pepper). "Sour la Feuille" (Thome).  
9.24: A short lecturette by Horace Perkins, Mus. Bac. A.M.U.A.  
9.39: Vern Rogers cornetist—"Sincerity" (Clarke). "Down the Vale" (Noir).  
9.48: The Station Quartette—"Birds and Butterflies" (Vely). Poem, "Passion" (Edwards).  
9.55: General news service; announcements.  
10.0: Close down.

## 6WF

Commonwealth Government Broadcasting Station, Perth (Wavelength, 100 Metres).

10.25: "Adapting of receivers to the new wavelength of 6WF." 11.0: Morning service. 12.15: Close down. 3.30: Tune in. 3.25: Music and song. 4.30: Close down. 6.45: Tune in. 6.48: Bedtime stories for the kiddies. 7.15: Music. 7.30: Evening service. 8.45: After church concert by the Perth City Band. 10.5: Close down. 10.4.5 Metre Transmission—Simultaneous broadcast on 104.5 metres of programme given on 1250 metres, commencing at 6.45 p.m.

# You'll Appreciate these BETTER Radio Components

If you are one who believes that only the best is good enough for your radio, you will follow the example of thousands of engineers and set builders by installing only ELECTRAD components of PROVED quality.

## The "ELECTRAD" Rheostat.



THE resistance element is the finest material known. Its value is guaranteed within 5 per cent. High-grade Bakelite insulation. Metallic bearings. Oversized contact arm of phosphor bronze. Milled shaft with square hole in contact arm prevents shaft or knob from burning without moving contact arm.

Single or three-hole mounting. For three-hole mounting, the base is tapped, eliminating use of nuts behind panel. Construction provides greatest radiation without loss of mechanical strength.

## "ELECTRAD" Certified Mica Fixed Condensers.

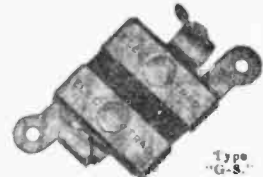

SUBSTANTIALLY made of quality materials. Ingenious riveting and binding fastens parts securely at six different points and exerts even pressure upon the largest possible surface. Of scientific design ensuring perfect electrical contact always.

Type "O.S." with grid lock clips for attaching direct to socket terminal.

Standard, Type "S," with soldering lug and binding strap in one piece.

Obtainable at all Radio Dealers

Amalgamated Wireless A/asia, Ltd.,  
47 York Street,  
Sydney

SPECIFY!

175 Varick St., New York, N.Y.

# ELECTRAD

# Local Programmes, Monday, September 9

## 2FC

Australian Broadcasting Company, Ltd., Market St., Sydney (Wavelength, 442 Metres).

### EARLY SESSION, 7 to 8.15 a.m.

- 7.0: "Big Ben" and meteorological information for the man on the land.
- 7.3: This morning's news from the "Sydney Morning Herald."
- 7.8: Early rising music.
- 7.45: Mails and shipping.
- 7.48: What's on to-day.
- 7.50: Children's birthday calls.
- 8.0: Music from the studio.

### MORNING SESSION, 10.30 a.m. to 12.30 p.m.

- 10.30: Announcements.
- 10.32: A.B.C. racing observer.
- 10.45: Recital on the grand organ by Edgar Stone.
- 11.0: Household Helps: Cooking, by Miss Ruth Furst.
- 11.10: Cables, A.P.A. and "Sun"-Herald news service. British official wireless press.
- 11.15: Morning devotion.
- 11.30: Austradio musical reproduction.
- 12.0: "Big Ben," Stock Exchange and metal quotations.
- 12.5: V. C. Bell, B.A., will speak from "The Public Forum."
- 12.20: Midday weather forecast and weather synopsis. Special produce market session for the man on the land supplied by the State Marketing Board.
- 12.3: Close.

### THE LUNCH HOUR, 1 p.m. to 2.30 p.m.

- 1.0: Lunch to music with the National Broadcasting Orchestra.
- 2.0: Stock Exchange second call.
- 2.2: A glance at the afternoon "Sun" and "News."
- 2.7: Popular Education. W. S. Reay.
- 2.27: Announcements.

### THE RADIO MATINEE, 2.30 p.m. to 4.30 p.m.

- 2.30: The Melody Makers.
- 2.42: Irene Duncan, soprano—(a) "My Wonderful Garden" (Bigelow). (b) "In April" (Phillips).
- 2.49: Annie Hughes, sketches—"Infidelity" (Hughes).
- 2.56: The Melody Makers.
- 3.8: Roger Jones, baritone—(a) "A Dream Garden" (Phillips). (b) "Westward by the Devon Seas" (Lohr).
- 3.15: Gladys M'Master, pianiste—(a) "Loneliness." (b) "Sunset."—From "Reminiscences of a Land of a Thousand Seas" (Sibelius).
- 3.25: The Melody Makers.
- 3.37: Irene Duncan, soprano—(a) "Forest Echoes" (Phillips). (b) "Winds in the South" (Scott).
- 3.44: Annie Hughes, in a sketch—"Moonlight" (Hughes).
- 3.52: Roger Jones, baritone—(a) "The Little Green Balcony" (Coates). (b) "Sometimes When Night is Nigh" (Phillips).
- 4.0: Gladys M'Master, pianiste—(a) "Prelude in A Minor" (Debussy). (b) "Old Vienna" (Godowsky). (c) "Gavotte" (Gardiner).
- 4.10: The Melody Makers.
- 4.28: Stock Exchange, third call.
- 4.30: Close.

### EARLY EVENING SESSION, 5.45 to 7.55 p.m.

- 5.45: Kiddies' "Goodnight" stories told by the "Hello Man," assisted by Aunt Eily.
- 6.45: National Broadcasting Orchestra will play dinner music.
- 7.30: A.B.C. sporting service.
- 7.37: Special country session. Stock Exchange resume. Markets. Weather forecast. Late news service from the "Sun" and "News."
- 7.58: To-night's programme.

THE EVENING PRESENTATION from 2FC is devoted mainly to orchestra and vocal music.

2BL's programme to-night is in lighter vein.

8.0: From Aeolian Hall: Opening recital of the Aeolian residence pipe organ, by Mr. W. F. G. Steele, organist, Scots Church, and hon. organist, Philharmonic Society, Melbourne.

Organ: "Fantasia and Fugue in G Minor" (Bach), (played by Joseph Bonnet, Paris)  
Organ: Prelude, "Lohengrin" (Wagner).  
Mr. W. F. G. Steele.  
Song with Organ: "Hymn to the Almighty," Helen Stewart.

Organ Fantasia: "The Storm" (Swinnen). (played by the Composer).

Violin Solos with Organ, Cyril Monk—

(a) "Hindoo Song" (Kreisler).  
(b) "Londonderry Air" (arr. Cyril Monk).  
Organ: "Adagio from Symphony in G Minor" (Lemare).

Organ: "The Bells of St. Anne" (Russell), (played by Archer Gibson, New York).

8.45: From the Studio: Ila Turnbull, soprano—

(a) "Loreley" (Liszt), with orchestral accompaniment.

(b) "My Mind is Like a Peak Snow-crowned" (Grieg).

8.52: The Countryman's weather session—

(a) New South Wales forecasts.  
(b) Inter-State weather synopsis.

8.53: Lindley Evans, pianist—

(a) "Melody" (Rachmaninoff).  
(b) "Prelude in C Sharp Minor" (Rachmaninoff).

(c) "Prelude in G Major" (Rachmaninoff).

(d) "Polichinelle" (Rachmaninoff).

(e) "The Island Spell" (Ireland).

(f) "Barcarolle" (Rubinstein).

(g) "Music Box" (Liadow).

(h) "Dr. Gradus" (Debussy).

9.16: Olive King, basso, with orchestral accompaniment—

(a) "Arise, Ye Subterranean Winds" (Purcell).

(b) "The Trout" (Schubert).

9.23: Leslie McCallum, flautist—

(a) "Adagio from 2nd Sonata" (Moquet).

(b) "Andalouse" (Pessard).

(c) "In Herbst" (Anderson), bass flute solo.

9.31: The National Broadcasting Orchestra—"Siberia" (Giordano).

9.40: Oliver King, basso—

(a) "Rogues Like You" (Mozart).

(b) "I Love My Love in the Morning" (Irish Air arr. Fisher).

(c) "The Low-backed Car" (Lover arr. Fisher).

9.47: Leslie McCallum, flautist—

(a) "By Ocean's Strand" (Kohler).

(b) "The Broken Melody" (Blene), bass flute solo.

9.54: Ila Turnbull, soprano—

(a) "The Trust" (Sibelius).

(b) "Spring Waters" (Rachmaninoff).

(c) "If My Songs Were Only Winged" (Hahn).

(d) "My Mind is Like a Peak Snow-crowned" (Grieg).

10.0: A talk by Annie Hughes.

10.15: Announcements. Late official weather forecast.

10.20: From the Oriental Cafe: Sydney Simpson's Syncopaters in dance music.

11.30: Close. National Anthem.

## 2BL

Australian Broadcasting Company, Ltd., Market St., Sydney (Wavelength, 355 Metres).

### OPENING SESSION, 8.15 a.m. to 11 a.m.

8.15: G.P.O. chimes. Music for every mood

8.45: Meteorological data for the country

8.50: A musical interlude.

9.30: British official wireless news.

9.35: New music.

10.5: News from the "Sydney Morning Herald."

10.10: The Australian Broadcasting Company's Women's Association, conducted by Miss Gwen Varley.

10.30: Celebrity items.

10.45: A morning story.

11.0: G.P.O. chimes. Close.

### MIDDAY SESSION, 12 Noon to 2.30 p.m.

12.0: G.P.O. chimes; announcements.

12.2: The National Broadcasting Orchestra.

1.0: Afternoon news from the "Evening News" and "The Sun."

1.5: Studio music.

1.15: Women's interest talk.

1.30: A recital of instrumental music.

2.0: J. Knight Barnett at the Wurlitzer.

2.12: Studio music.

**AFTERNOON ENTERTAINMENT, 2.30 p.m. to 5.45 p.m.**

2.30: Business efficiency talk, by C. R. Hall.

2.45: "The Magic Carpet" (C. Price Conigrave), "Malaria Memories."

3.0: From the ballroom of the Oriental, Sydney Simpson's Syncopaters, in dance music.

3.12: From the studio. Esther Gunton, mezzo.

(a) "Just Awearying for You" (Jacobs Bond).

(b) "April is a Lady" (Phillips).

3.19: A dance number.

3.22: From the ballroom of the Oriental, Sydney Simpson's Syncopaters, in dance music.

3.32: From the studio. Bob Graham and his Spanish guitar.

(a) "Glorious Feeling" (Ager).

(b) "Sonny Boy" (Jolson-Henderson).

(c) "The Man in the Moon" (Monaco).

3.40: Len Maurice, popular vocalist.

3.47: From the ballroom of the Oriental, Sydney Simpson's Syncopaters, in dance music.

3.57: From the studio. Esther Gunton, mezzo.

(a) "Country Folk" (Brahe).

(b) "Happy Song" (Del Riego).

4.4: Bob Graham and his Spanish guitar.

(a) "Lucky Day" (Henderson).

(b) "Just Like a Melody" (Donaldson).

(c) "She's Funny That Way" (Moret).

4.11: From the ballroom of the Oriental, Sydney Simpson's Syncopaters, in dance music.

4.21: From the studio. Len Maurice, popular vocalist.

4.28: A popular number.

4.32: From the ballroom of the Oriental, Sydney Simpson's Syncopaters, in dance music.

4.45: "The Trade Hour," demonstration music.

5.45: Official weather forecast. Close.

**THE DINNER HOUR, 6.15 p.m. to 7.55 p.m.**

6.15: The National Broadcasting Orchestra.

6.45: The "Younger Set" session, the Boys' Aero Club, conducted by Mr. Norman Lyons.

7.5: Studio music.

The Country Man's market session: Wool, wheat, stock, farm produce, fruit, vegetables, pig and poultry markets.

7.30: The National Broadcasting Orchestra.

7.45: Celebrity music.

7.55: What's on the air to-night?

**TO-NIGHT'S PRESENTATION, 8 p.m. to 10.30 p.m.**

8 p.m.: G.P.O. chimes.

Margaret Grimshaw, popular vocalist.

(a) "Some Sweet Day" (Pollack).

(b) "Love Dreams" (Harris).

8.7: Carlton Fay, novelty pianist.

8.17: Two Old Cronies, entertainers, will talk on topicalities, and present popular melodies of past years.

8.28: Foreword.

8.30: From the Stadium, description of the wrestling contest, by the A.B.C. wrestling expert.

10.0: From the studio.

Margaret Grimshaw, popular vocalist.

(a) "The Sun is at My Window" (Meyer).

(a) "Happy Days and Lonely Nights" (Fisher).

(c) "Weary River" (Silvers).

10.7: Carlton Fay, novelty pianist.

10.17: The Two Old Cronies will present melodies and memories of the past.

10.25: Official weather forecast, metropolitan and country. Late news from the "Evening News" and "The Sun."

10.30: Close. National Anthem.

## 2GB

Theosophical Broadcasting Station, 29 Bligh St., Sydney (Wavelength, 316 Metres).

10.0: Music. 10.10: Happiness talk by A. E. Bennett. 10.20: Music. 10.30: Women's

session, by Miss Helen J. Beegling. 11.30: Music. 11.45: Close down. 2.0: Music. 2.5: Women's Radio Service, by Mrs. Dorothy Jordan. 2.50: Movie Know All. 3.0: Address by Mr. H. Morton. 3.30: Close down. 5.30: Children's session, by Uncle George. 7.0: Music. 7.45: Feature story. 8.0: Miss Mary Neal, contralto. 8.7: Symphony Orchestra. 8.15: Mr. Edward Barry, baritone. 8.22: Instrumental Trio. 8.30: Mr. Jack Win and Mr. Heath Burdock, humor. 8.35: Miss Gladys Aubin, soprano. 8.45: Address. 9.0: Weather report. 9.1: Symphony Orchestra. 9.10: Miss Mary Neal, contralto. 9.20: Instrumental Trio. 9.30: Mr. Jack Win and Mr. Heath Burdock, humor. 9.35: Mr. Edward Barry, baritone. 9.43: Symphony Orchestra. 9.50: Miss Gladys Aubin, soprano. 10.0: Instrumental music. 10.30: Close down.

**2UW**

Radio Broadcasting, Ltd., Palling's Building, Ash St., Sydney (Wavelength, 267 Metres).

**MIDDAY SESSION.**

12.30: Request numbers. 1.0: G.P.O. clock and chimes. Music. 1.15: Talk on Home-craft by Pandora. 1.40: Music and request numbers. 2.30: Close down. 4.30: Musical programme.

**EVENING SESSION.**

5.30: Children's hour, conducted by Uncle Jack. 6.30: Close down. 7.0: G.P.O. clock and chimes. Request numbers. 7.45: Radio talk by Mr. E. Homfray. 8.0: Gilbert and Sullivan recital. 9.0: G.P.O. clock and chimes. Comments on Foreign Affairs, by Mr. J. M. Prentice. 9.10: Music and request numbers. 10.30: Close down.

**2KY**

Trades and Labor Council, Goulburn St., Sydney (Wavelength, 280 Metres).

**MORNING SESSION.**

10.0: Tune in to the ticking of the clock. 10.3: Popular fox trots. 10.15: Hawaiian steel guitar selections. 10.30: Request numbers. 10.50: Vocal items. 11.0: A few laughs. 11.5: Pianoforte selections. 11.15: Calls and announcements. 11.20: Musical interlude. 11.30: Request numbers. 11.40: Where to go to-night. 12 noon: Closing announcements.

**CHILDREN'S SESSION.**

6 p.m.: Birthday calls, request numbers, and kiddies' entertainment, Aunt Jemima and Uncle Bert.

**EVENING SESSION.**

7.0: Musical interlude. 7.15: Dance music. 7.45: Militant Women's Group. 8.0: Overture. 8.8: Tenor solos, Mr. A. Hillman. 8.15: Dance music. 8.30: Request numbers. 8.45: Soprano solos, Miss Wright. 9.0: Novelty interlude. 9.10: Request numbers. 9.30: Selection of latest Parlophone, Columbia, Regal, Brunswick, and Golden Tongue records. 10.0: Closing announcements.

**2UE**

Broadcasting Station 2UE, Everett Street, Maroubra Sydney (Wavelength, 293 Metres).

**EARLY MORNING SESSION**

7.15: Breakfast Time Hour Orchestral music. 8.30: Weather forecast. Close down.

**2UE**

**Sunday, September 8**

Broadcasting Station 2UE, Everett Street, Maroubra Sydney (Wavelength, 293 Metres).

11.0 a.m.: Mass from St. Mary's Church, Ridge Street, North Sydney. 12.15 p.m.: Orchestral music. 1.0: Close down. 6.0: Music from Catholic Studio. 6.10: Session arranged by Rev. Father T. Walsh, S.J. 6.30: Music. 6.35: Question Box talks by Dr. L. Rumble, M.S.C. 7.30: Announcements. 7.33: Evening devotions from St. Mary's Church, North Sydney. 8.20: Announcements. 8.22: Overture, "Bohemian Girl." 8.31: Vocal and instrumental concert. 10.15: Close down.

**MURDOCH'S**

*Sensational Valve purchase*

**THE Season's biggest Radio Snap!**  
Never has the Radio enthusiast had an opportunity to secure Valves of such merit at these prices. Every one tested. A special purchase of 25,000 accounts for the abnormally-low price.

**8' - to 13'6 Valves**  
**Now offered for**



|| Sockets for these Valves, 9d each ||

VALVE.	BASE	A. BATT.	Consump. in Amps.	SPECIAL USE	SPECIAL PRICE
Cosmos Red Spot.	U.X.	2-V. Accum.	.6	Gen. Purpose	1/6
105	U.X.	1 1/2-V. Dry Cell	.1	Gen. Purpose, 1 dry cell only is required for each Valve	4/6
306	F (U.V. 199 type)	3 Dry Cells or 4-V. Accum.	.06	Gen. Purpose. Ideal for Sets using U.V. 199 type valves	3/6
306	U.X.	Ditto.	.06	Gen. Purpose	3/6
310	U.X.	Ditto.	.06	High Frequency or Detector	3/6
303X	U.X.	Ditto.	.06	Super-power (U.X. 120) type	4/6
P.R.41	Eng.	4-V. Accum.	.1	Power	3/6
P.R.48	Eng.	4-V. Accum.	.06	Gen. Purpose	3/6
101X	U.X.	6-V. Accum.	.25	Gen. Purpose. 201a type	3/6
P.R.52	U.X.	6-V. Accum.	.25	Gen. Purpose. 201a type	3/6

**EVERY VALVE TESTED !**

Special Discount allowed for 12 or more Valves.

Postage 6d extra on 1 to 4 Valves, over 4 post free.

Be sure to state base required, and if writing address your letter to Desk "A.2."



*'Specialists in all matters pertaining to the science of Radio.'*



# Interstate Programmes, Monday, September 9

## 3LO

Australian Broadcasting Co., 120A Russell St., Melbourne (Wavelength, 871 Metres).

### EARLY MORNING SESSION

7.0 to 8.15: See Friday.

### MORNING SESSION

10.30: Current happenings in sport, by Mel. Morris. A.B.C. Studio Orchestra. 12.0: Melbourne Observatory time signal. 12.1: Orchestra continued. 12.15: News service. British Official Wireless Exchange midday report. Newmarket stock sales. Associated Stock and Station Agents' official report. 12.30: Close down.

### MIDDAY SESSION

1.0: Melbourne Observatory time signal. Stock Exchange information. Meteorological data. Weather forecast for Victoria, New South Wales, South Australia and Tasmania. Ocean forecast. 1.30: Relay from Constitutional Club luncheon.

### EDUCATIONAL SESSION

2.0: Boys and Girls of Other Days, Miss D. Babington. 2.20: Musical interlude. 2.25: Science in everyday life. Dr. Loftus Hills. D.Sc. 2.40: Musical interlude. 2.45: Our Australian writers, 6 "C. J. Dennis." Mr. Percival.

### THE RADIO MATINEE

3.0: The National Broadcasting Orchestra (under the direction of W. G. James, conductor, Percy Code)—Overture. "Rosamunde" (Schubert). 3.10: Margery Jacoby, soprano—"Magdalene at Michael's Gate" (Lehmann). "Ave Maria" (Gounod). 3.17: John Simons, piano—"Tempo and Minuetto" (Zanella). "Waltz Capriceuse" (Frank Bridge). "Prelude Waltz—Canzonetta" (Zincenzo Davico). "Viennese Dance No. 2" (Friedman-Gartner). The "Funscope." 3.30: Gordon Ireland, "The Apostle of St. Peter"—"Adoree" (West). "Sally of My Dreams" (Kernell). 3.37: Orchestra—"The Rustle of Spring" (Sinding). "The Pollywogs' Frolic"—a characteristic novelty (Rapee). 3.45: A comedy in one act, "In the Future," produced by Frank Pearson. Cast—Myrtle, the wife, Vety Landau, Ralph, the husband, Frank Pearson; Helen, the friend, Dorothy Bethune. Scene, sitting-room at Myrtle's home. Time, To-morrow or any old time in the future. 4.0: Gordon Ireland, "The Apostle of St. Peter"—"Like a Virginia Creeper." "You Were Meant for Me" (Brown). "A Precious Little Thing Called Love" (Cattol). In Graver Mood—4.7: A.B.C. String Quartette. "Adagio from No. XV." (Mozart). 4.15: Margery Jacoby, soprano—"Songs My Mother Taught Me" (Dvorak). "Carissima" (Penny). 4.22: Orchestra—Selection from musical comedy.

### THE CHILDREN'S CORNER

5.45: "Billy Bunny" entertains. Birthday greetings.

### EVENING SESSION

8.20: Illustrations of the forthcoming examination in music, conducted by Lindsay Biggins. 6.40: Public school activities, Mr. E. C. H. Taylor. 6.55: Musical interlude. 7.0: Melbourne Observatory time signal. 7.1: Countryman's session. 7.25: Recent discoveries and inventions. 7.40: News. 7.45: The world's kaleidoscope. Prof. K. H. Bailey, B.A., LL.B.

### NIGHT SESSION

8.0: National Broadcasting Orchestra (under the direction Wm. G. James, conductor, Percy Code)—Overture. "Prometheus" (Beethoven). "Serenade" (Heraclitus). 8.10: A Special Programme will be transmitted from a country centre. 10.20: From the studio—Meteorological information. British Official Wireless news. Items of interest. 10.30: "The Rex" Dance Band. 11.30: God Save the King.

## 3AR

Australian Broadcasting Co., 120A Russell St., Melbourne (Wavelength, 484 Metres).

### MORNING SESSION

8.15 to 11.0: See Friday.

### MIDDAY SESSION

12.0: G.P.O. chimes. 12.1: Food and Cookery. Cooking for Invalids. Miss Kathleen Benningfield. 12.15: Fifteen minutes' synopsation. 12.30: Luncheon music supplied by the National Broadcasting Orchestra, under direction Wm. G. James; conductor, Percy Code. 2.0: G.P.O. chimes.

### AFTERNOON SESSION

2.0: Electric Synopsation from the home of jazz. 2.10: Laughter from London. 2.13: Recordings. 2.28: A Playlet. A scene from the "Vikings of Heligeland." (Hsen), produced by Whitford Moverley. 2.43: The Melody Three, baritone, cello, and piano. 3.5: Music for the Milton. 3.20: Your Clothes, Miss M. Nicholson. 3.35: Musical interlude. 3.40: Your garden. What to Grow in Window Boxes. 3.55: Musical interlude. 4.0: Travelling Abroad. Through Feminine Eyes. Mrs. Maurice Posner. 4.15: Reproduced music. 5.0: G.P.O. chimes. 5.30: Weather data. 5.45: Close down.

### EVENING SESSION

6.15: Dinner music, supplied by the A.B.C. Studio Orchestra. 7.30: "What's On the Air To-night?" 7.32: Latest musical releases. 8.0: G.P.O. chimes.

### NIGHT SESSION

8.1: Heidelberg Musical Society. Conductor, Frederick Heip; pianist, Louise Dean. Part Songs. "Sing We and Chant It" (Purcell). "In These Delightful Groves" (Purcell). Piano Solo. Harpsichord Music of 17th Century, Louise Dean. Madrigal, "While the Bright Sun" (Byrd).

8.10: Merlena Llewellys (harplist)—"Arabeque" (Debussy). "Song of the Volga Boatmen." 8.17: Isabel Biddell (contralto)—"Out of My Soul's Great Sadness" (Franz). "Autumn Storms" (Grieg). 8.24: St. Vincent de Paul's Band. Conductor, Les. Hoffman. Selections. "The Pink Lady" (Oaryl). 8.34: Isabel Biddell (contralto)—"Love Went a-Riding" (Frank Bridge). "At Night" (Rachmaninoff). 8.41: Heidelberg Musical Society—Part Songs, "Lullaby" (Elgar). Song, "Cloths of Heaven," E. M'Henry. Part Song, "The Dance" (Elgar). 8.50: Colin Thomson (tenor)—"Oh, Sleep a Little While." "Resurgam." "Indian Serenade" (accompanied by the composer, Edwin O. Burchett). 8.57: Recent Books of Note—Mr. A. A. Phillips, B.A. 9.12: St. Vincent de Paul's Band—Humoresque, "A Musical Switch" (Alford). Laughter and Sighs from Ervin's Isle. 9.20: Colin Thomson (tenor)—Irish Folk Songs.

9.27: Heidelberg Musical Society—Irish Folk Songs. "Erib, the Tear and the Smile." "Avening and Bright." "Follow Me Down to Carlou." "The Cruiskeen Lawn." 9.37: Merlena Llewellys (harp)—"The Harp that Once." "Melody of Irish Airs." 9.44: Charles O'Mara—Irish Song and Stories. Song, "Molly Brannigan" (traditional air). Irish Stories. 9.52: St. Vincent de Paul's Band—Selection of Irish airs. 10.0: Charles O'Mara, Irish Song and Recitation—"Phil the Fluter's Ball." "Taking Lay at Riley's." 10.10: Weather information and "Herald" news. 10.17: St. Vincent de Paul's Band—March, "Hungarian March" (Berlioz). Melody, "Traumer" (Schumann). Fox Trot, "Broadway Melody," arranged by L. Hoffman. 10.30: God Save the King.

## 3DB

The "Herald" Broadcasting Station, Flinders Street, Melbourne (255 Metres).

### MORNING SESSION

11.0: Thelma Ready's Band transmission, from King's Theatre. 12.0: Community Singing, conducted by G. J. Mackay, transmitted from King's Theatre; accompanist, Reg. Brown. 12.30: Market reports, by John M'Namara and Co. Pty., Ltd. 12.40: Community singing. 1.45: Close down.

### AFTERNOON SESSION

2.15: Bournemouth Municipal Orchestra—"Zampa Overture" (Herold). 2.30: Colin O'More (tenor)—"When Irish Eyes are Smiling" (Ball). 3.0: Atwater Kent Radio Hour, sponsored by A. G. Healing, Ltd. and E. T. Muir. 4.0: Close down.

### EARLY EVENING SESSION

5.30: Paul Whiteman and his Orchestra—"Cradle of Love." 6.0: Billy Bunny's Children's Session. 6.30: Henry Burr (tenor)—"Cross Roads." 7.0: Edith Lorand Orchestra—"Vienna by Night" (Komsak). 7.15: Market reports, by John M'Namara and Co. Pty., Ltd. 7.25: Ninon Vallin (soprano)—"L'Heure Equise" (Hahn-Verloine). 7.30: Market reports, by Gippsland and Northern Co-operative Co. 7.40: Erem Zimbalist (violin)—"Ave Maria" (Schubert).

### EVENING SESSION

8.0: Aeolian Company's Sponsored Session. 8.30: J. H. Squire, celeste octet—"Classical Selection." 9.0: Frank Beaurerale's sponsored programme. 9.30: G. T. Palmant organ—"Cherie." 10.0: Masses Military Bands—"Gladstors' Farewell." 10.30: Lottie Lehmann (soprano)—"Largo" (Handel). 10.40: News. 10.45: "God Save the King."

## 4QG

Queensland Government Radio Service, Brisbane (Wavelength, 385 Metres).

For day sessions, see Friday.

### NIGHT SESSION

8.0: The Studio Orchestra—Overture, "Norna" (Bellini). 8.7: Niobe Pegus, soprano—"Just a Ray of Sunlight" (Squire). 8.10: Kennedy Allen—The eleventh and last of a series of talks on Shakespeare and his works. "The Limitations of the Elizabethan Stage, and how Shakespeare Overcame Them." 8.20: The Anglo Male Quartette—"Love Time in Hawaii" (Spink). 8.24: Merna Gillies, pianist—"At the Convent" (Borodin). 8.30: Jack Land, tenor—"Desiree" (Parker). 8.55: Merna Gillies, pianist—"The Shadow Air" (Meyerbeer). 9.0: Metropolitan weather forecast. 9.2: The Studio Orchestra—Valse, "Oriental Roses" (Ivanovici). 9.8: The Anglo Male Quartette—"Piccaninny's Lullaby" (May). "Hey, Diddle, Diddle" (Goebel).

9.15: Dorothy Sanders, soprano—"Les Cloches" (Debussy). 9.20: E. F. Kelly, flautist—"Valse Gracieuse" (Babathel). 9.25: From the Stadium.

The main bouts in connection with the Brisbane amateur boxing and wrestling championships meeting will be described from the Stadium. The Studio Orchestra will broadcast from 4QJ between bouts. 10.30: From the Studio—News supplied by the metropolitan dailies. Weather information; close down.

## 5CL

Central Broadcasters, Ltd., 114 Hindmarsh Square, Adelaide (Wavelength, 409 Metres).

### MORNING SESSION

11.15 to 2.0: See Friday.

### AFTERNOON SESSION

2.0 to 4.30: See Friday.

### EVENING SESSION

6.0: Chimes. 6.1: Birthday greetings. 6.15: Children's request numbers. 6.30: Dinner session. 7.0: Chimes. 7.1: Senior Birthday League greetings; 5CL's sporting service; general market reports. 7.20: Under the auspices of the South Australian Agricultural Department, Mr. H. B. Barlow (Chief Dairy Instructor) will speak. 7.35: The 5CL Twinkler Boys' Club entertainment by "The Twinkler," Mr. F. J. Mills.

### NIGHT SESSION

8.0: Chimes. 8.10: Walter Barratt and his Maison Masters of Melody—"The Wedding of the Painted Doll" (Brown). "Louise" (Whiting). "A Precious Little Thing Called Love" (Davis). 8.20: Rupert Hazell. 8.27: Walter Barratt and his Maison Masters of Melody—"Roses of Remembrance" (Curtis). "Marie" (Berlioz). "I Can't Give You Anything but Love" (Fields). 8.37: Elsie Day, soprano. 8.41: Walter Barratt and his Maison Masters of Melody—"Chiquita" (Wayne). "Rio Rita" (Tierney). "The Kinkajou" (Tierney). "The Savoy American Medley." 8.54: Walter Barratt, saxophonist. 9.0: G.P.O. chimes. 9.1: Meteorological information, including Semaphore tides. 9.2: Overseas grain report. 9.3: General news service. 9.5: Walter Barratt and his Maison Masters of Melody—Rhythmic classic "Rigoletto Rigles," transcription of quartet from "Rigoletto." "Promise Me" (Van Cooth). "Honey" (Simon). 8.15: Rupert Hazell. 9.22: Walter Barratt and his Maison Masters of Melody—"Kashmir" (A. Woodford-Flinden). "I Knew It was You" (Murray). "Jeannine" (Wayne). 9.32: Elsie Day, soprano. 9.36: Walter Barratt and his Maison Masters of Melody—"A Room with a View" (Coward). "Glad Rag Doll" (Ager). "Could It Be You" (Winegar). 9.46: Reg. Hollow, pianist. 9.52: Walter Barratt and his Maison Masters of Melody—"I Faw Down and Go Boon" (Brahm). "Broadway Melody" (Brown). "Oh! What a Night to Love" (Ellis). 10.2: Elsie Day, soprano. 10.6: Walter Barratt and his Maison Masters of Melody—"Carolina Moon" (Davis). "Dance of the Paper Doll" (Tucker). "Happy Humming Bird" (De Sylva). 10.15: General news service. British official wireless news. Meteorological information. 10.30: Walter Barratt and his Maison Masters of Melody—"I Kiss your Hand, Madam" (Erwin). "The Desert Song" (Bomberg). "Lucky in Love" (De Sylva). "Me and the Man in the Moon" (Leslie). "Flowers of Love" (Theyer). Request numbers. 11.0: G.P.O. chimes; close down.

## 6WF

Commonwealth Government Broadcasting Station, Perth (Wavelength, 100 Metres).

10.0: Gramophone records. 11.0: Close down. 12.30: Markets, news, etc. 1.0: Time signal. 1.1: Weather bulletin. 1.3: Panatropé Hour. 2.0: Close down. 3.30: Musical programme. 4.30: Close down. 6.45: Bedtime stories by Uncle Duffy. 7.5: Light music. 7.30: Commercial information. 7.45: Talk by Lieut.-Colonel Le Souef, Director, Zoological Gardens, South Perth. 8.0: Time signal. 8.1: First weather bulletin. 8.3: Programme by the "Specialty Four." 8.50: Late news items; ships within range announcement. 10.30: Close down. 10.4: 5 Metre Transmission—Simultaneous broadcast on 104.5 metres of programme given on 1250 metres, commencing at 8.45 p.m.



*Raise the standard of Reception*

*In your*

**5 VALVE  
NEUTRODYNE**

*with these* **Osram  
Valves**

IF your set uses this popular circuit, change over now to Osram, using this range of valves. Each has its special function, each is the best fitted to perform its particular part in perfect reception.

MADE IN ENGLAND

	1st R.F.	2nd R.F.	Det.	1st Audio.	2nd Audio.
4-volt .....	DEL. 410	DEL. 410	DEL. 410	DEL. 410	DEP. 410 or P425
6-volt .....	DEL. 610	DEL. 610	DEL. 610	DEL. 610	DEP. 610 or P625A

These Valves in the last stage enable your set to operate the latest types of loudspeakers.

**Ask for them by number, and say OSRAM**

Your "B" Batteries last longer when used with "Osram Valves."

Ask your dealer for the Osram Valve Guide, free on request.

Advertisement of the British General Electric Co., Ltd., Magnet House, 104-114 Clarence Street, Sydney. Branches at Newcastle, Melbourne, Adelaide, Perth, and N.Z. Cities. Sole Agents at Brisbane and Hobart.

# Local Programmes, Tuesday, September 10

## 2FC

Australian Broadcasting Company, Ltd., Market St., Sydney (Wavelength, 442 Metres).

### EARLY SESSION, 7 to 8.15 a.m.

- 7.0: "Big Ben"; meteorological information for the man on the land.  
 7.3: This morning's news, from the "Sydney Morning Herald."  
 7.8: Early-rising music.  
 7.45: Mails and shipping.  
 7.48: What's on to-day?  
 7.50: Children's birthday calls.  
 8.0: Music from the studio.  
 8.15: Close.  
**MORNING SESSION, 10.30 a.m. to 12.30 p.m.**  
 10.30: Announcements.  
 10.32: A.B.C. racing observer.  
 10.45: Recital on the grand organ, by Edgar Stone.  
 11.0: Household helps, hints to housewives, by Miss Ruth Furst.  
 11.10: Cables, A.P.A. and "Sun"- "Herald" news service; British Official Wireless Press  
 11.15: Morning devotion.  
 11.30: Austradio musical reproduction.  
 12.0: "Big Ben." Stock Exchange, and metal quotations.  
 12.5: A talk by C. N. Baeyertz.  
 12.20: Midday weather forecast and weather synopsis; special produce market session for the man on the land, supplied by the State Marketing Board.  
 12.30: Close.

**THE LUNCH HOUR, 1 p.m. to 2.30 p.m.**  
 1.0: Lunch to music with the National Broadcasting Orchestra.  
 2.0: Stock Exchange, second call.  
 2.2: A glance at the afternoon "Sun" and "News."  
 2.7: Popular education, J. R. Kinghorne.  
 2.27: Announcements.

**THE RADIO MATINEE, 2.30 p.m. to 4.30 p.m.**  
 2.30: The Arabesques.  
 2.42: Ann Luciano, soprano.  
 (a) "It is Only a Tiny Garden" (Wood).  
 (b) "Heigh Ho" (German).  
 2.49: Bernice Arthur, pianist.  
 (a) "Study" (Paganini-Liszt).  
 (b) "Rush Hour in Hongkong" (Chosins).  
 2.59: The Arabesques.  
 3.11: Dorothy Nall, in a sketch "Her First Call on the Witches" (Fisk).  
 3.18: David McKissock, cellist.  
 (a) "Pavane Favorite" (Brisson).  
 (b) "La Cygne" (St-Saens).  
 3.25: The Arabesques.  
 3.37: Ann Luciano soprano.  
 (a) "Butterfly Wings" (Phillips).  
 (b) "Deep in My Heart a Lute Lay Hid" (Aylward).  
 3.44: David McKissock, cellist.  
 (a) "Liebestraume" (Liszt).  
 (b) "An Old Melody" (arr. Squire).  
 3.51: Bernice Arthur, pianist.  
 (a) "Study in A Minor" (Chopin).  
 (b) "Juba" (Dett).  
 (c) "Papillon" (Lavallee).  
 4.1: Dorothy Nall, in a sketch, "Mrs. Murphy on Health" (Pain).  
 4.8: The Arabesques.  
 4.28: Stock Exchange, third call.  
 4.30: Close.

**EARLY EVENING SESSION, 5.45 to 7.55 p.m.**  
 5.45: Kiddies' "Good-night" stories, told by Aunt Willa, assisted by Cousins Gwen and Clarice.  
 6.45: The National Broadcasting Orchestra will play dinner music.  
 7.30: A.B.C. sporting service.  
 7.37: Special country session; Stock Exchange resume; markets; weather forecast; late news service, from "The Sun" and "News."  
 7.58: To-night's programme.

**THE EVENING PRESENTATION, 8 p.m. to 11.30 p.m.**  
 To-night is now recognised as the State-wide Radio Dance Night. Dance items will be given in groups from 8 p.m. to 11.30 p.m., interspersed with songs and comedy. 2BL is in more serious vein this evening.  
 8.0: The Australian Broadcasting Dance Orchestra.  
 8.12: Charles Lawrence, entertainer.  
 8.20: The Australian Broadcasting Dance Orchestra.  
 8.32: Rene Rich, violinist.  
 (a) "Nocturne" (Chopin).  
 (b) "Wedding of the Painted Doll" (Brown).  
 8.40: The Australian Broadcasting Dance Orchestra.  
 8.52: Victor Evans, baritone.  
 8.59: The Country Man's weather session.  
 (a) New South Wales forecasts.  
 (b) Inter-State weather synopsis.  
 9.0: The Australian Broadcasting Dance Orchestra.  
 9.12: Frank Ryan, comedian.  
 (a) "Tit Bits."  
 (b) "It's an 'Ot Day" (Newman).  
 9.20: The Australian Broadcasting Dance Orchestra.  
 9.32: Simon Philpoff, ballalala.  
 (a) "You Were Meant for Me" (Brown).  
 (b) "Broadway Melody" (Brown).  
 9.40: The Australian Broadcasting Dance Orchestra.  
 9.52: Bernice Patterson, popular vocalist.  
 (a) "Celia" (Robin and Whiting).  
 (b) "Weary River" (Silvers).  
 10.0: The Australian Broadcasting Dance Orchestra.  
 10.15: Announcements; late official weather forecast.  
 10.20: The Australian Broadcasting Dance Orchestra.  
 11.30: Close. National Anthem.

**OPENING SESSION, 8.15 a.m. to 11 a.m.**  
 8.15: G.P.O. chimes. Music for every mood.  
 8.45: Meteorological data for the country  
 8.50: A musical interlude.  
 9.30: British official wireless news.  
 9.35: New music.  
 10.2: News from the "Labor Daily."  
 10.5: News from the "Sydney Morning Herald."  
 10.10: The Australian Broadcasting Company's Women's Association, conducted by Miss Gwen Varley.  
 10.30: Celebrity items.  
 10.45: A morning story.  
 11.0: G.P.O. chimes. Close

**MIDDAY SESSION, 12 Noon to 2.30 p.m.**  
 12.0: G.P.O. chimes. Announcements  
 12.2: The National Broadcasting Orchestra  
 1.0: Afternoon news from the "Evening News" and "The Sun."  
 1.5: Studio music.  
 1.15: Women's interest talk.  
 1.30: A recital of instrumental music.  
 2.0: J. Knight Barnett at the Wurlitzer.  
 2.12: Studio music.

**AFTERNOON ENTERTAINMENT, 2.30 p.m. to 5.45 p.m.**  
 2.30: Talk by Fred Arlington Burke, "Inside Anecdotes of the Great War."  
 2.45: "The Magic Carpet"—Tom Gurr "Zanzibar—Past and Present."  
 3.0: Romano's Dance Orchestra, conducted by Bennie Abrahams.  
 3.12: From the studio.  
 Olga Le Gray, popular vocalist.  
 3.19: A dance number.  
 3.22: Romano's Dance Orchestra, conducted by Bennie Abrahams.  
 3.32: From the studio.  
 Nellie Ferguson, monologues.  
 3.40: A popular item.  
 3.43: Romano's Dance Orchestra, conducted by Bennie Abrahams.  
 3.50: From the studio. Hilda Grace novelty pianist.  
 (a) "Lady Fingers" (Zimmerman).  
 (b) "Little Spinning Wheel" (Platzonau).  
 (c) "I Kiss Your Hand, Madame" (Erwin).  
 3.57: Olga Le Gray, popular vocalist.  
 4.4: Romano's Dance Orchestra, conducted by Bennie Abrahams.  
 4.12: From the studio.  
 Nellie Ferguson, monologues.  
 4.19: The latest dance music.  
 4.23: Romano's Dance Orchestra, conducted by Bennie Abrahams.  
 4.32: From the studio. Hilda Grace novelty pianist.  
 (a) "Moussie on the Piano" (Keden).  
 (b) "Un Sonnet d'Amour" (Gabriel Morel).  
 (c) "Casa Lopez" (Damasek).  
 4.40: Romano's Dance Orchestra, conducted by Bennie Abrahams.

**2BL**  
 Australian Broadcasting Company, Ltd., Market St., Sydney (Wavelength, 353 Metres).  
**OPENING SESSION, 8.15 a.m. to 11 a.m.**  
 8.15: G.P.O. chimes. Music for every mood.  
 8.45: Meteorological data for the country  
 8.50: A musical interlude.  
 9.30: British official wireless news.  
 9.35: New music.  
 10.2: News from the "Labor Daily."  
 10.5: News from the "Sydney Morning Herald."  
 10.10: The Australian Broadcasting Company's Women's Association, conducted by Miss Gwen Varley.  
 10.30: Celebrity items.  
 10.45: A morning story.  
 11.0: G.P.O. chimes. Close

**MIDDAY SESSION, 12 Noon to 2.30 p.m.**  
 12.0: G.P.O. chimes. Announcements  
 12.2: The National Broadcasting Orchestra  
 1.0: Afternoon news from the "Evening News" and "The Sun."  
 1.5: Studio music.  
 1.15: Women's interest talk.  
 1.30: A recital of instrumental music.  
 2.0: J. Knight Barnett at the Wurlitzer.  
 2.12: Studio music.

**AFTERNOON ENTERTAINMENT, 2.30 p.m. to 5.45 p.m.**  
 2.30: Talk by Fred Arlington Burke, "Inside Anecdotes of the Great War."  
 2.45: "The Magic Carpet"—Tom Gurr "Zanzibar—Past and Present."  
 3.0: Romano's Dance Orchestra, conducted by Bennie Abrahams.  
 3.12: From the studio.  
 Olga Le Gray, popular vocalist.  
 3.19: A dance number.  
 3.22: Romano's Dance Orchestra, conducted by Bennie Abrahams.  
 3.32: From the studio.  
 Nellie Ferguson, monologues.  
 3.40: A popular item.  
 3.43: Romano's Dance Orchestra, conducted by Bennie Abrahams.  
 3.50: From the studio. Hilda Grace novelty pianist.  
 (a) "Lady Fingers" (Zimmerman).  
 (b) "Little Spinning Wheel" (Platzonau).  
 (c) "I Kiss Your Hand, Madame" (Erwin).  
 3.57: Olga Le Gray, popular vocalist.  
 4.4: Romano's Dance Orchestra, conducted by Bennie Abrahams.  
 4.12: From the studio.  
 Nellie Ferguson, monologues.  
 4.19: The latest dance music.  
 4.23: Romano's Dance Orchestra, conducted by Bennie Abrahams.  
 4.32: From the studio. Hilda Grace novelty pianist.  
 (a) "Moussie on the Piano" (Keden).  
 (b) "Un Sonnet d'Amour" (Gabriel Morel).  
 (c) "Casa Lopez" (Damasek).  
 4.40: Romano's Dance Orchestra, conducted by Bennie Abrahams.

**2GB**  
 Theosophical Broadcasting Station, 29 Bligh St., Sydney (Wavelength, 316 Metres).  
 10.0: Music.  
 10.10: Happiness talk, by A. E. Bennett.  
 10.20: Music.  
 10.30: Women's session, by Miss Helen J. Beegling.  
 11.30: Music.  
 11.45: Close down.  
 2.0: Music.  
 2.5: Women's Radio Service, by Mrs. Dorothy Jordan.  
 2.50: Movie Know All.  
 3.0: Music.  
 3.30: Close down.  
 5.30: Children's session, by Uncle George.  
 7.0: Music.  
 7.30: Talk from Sutton's 2GB Radio Service Department, by Mr. Stan Crittenden.  
 7.45: Feature story.  
 8.0: Miss Elsie Condon, contralto.  
 8.7: Instrumental Quartette.  
 8.15: Mr. Clifford Lathlean, baritone.  
 8.22: Symphony Orchestra.  
 3.30: Mr. Jack Win and Mr. Heath Burdock, humor.  
 8.35: Miss Elsie Brown, soprano.  
 8.43: Violin solos.  
 8.50: Miss Elsie Condon, contralto.  
 9.0: Weather report.  
 9.3: Address.  
 9.15: Symphony Orchestra.  
 9.25: Mr. Clifford Lathlean, baritone.  
 9.32: Mr. Jack Win and Mr. Heath Burdock, humor.  
 9.37: Instrumental Quartette.  
 9.50: Miss Elsie Brown, soprano.  
 10.0: Instrumental music.  
 10.30: Close down.

**2UW**  
 Radio Broadcasting, Ltd., Paling's Building, Ash St., Sydney (Wavelength, 267 Metres).  
**MIDDAY SESSION.**  
 12.30: Request numbers.  
 1.0: G.P.O. clock and chimes.  
 Music.  
 1.15: Talk on Home-craft by Pandora.  
 1.40: Music and request numbers.  
 2.30: Close down.  
 4.30: Musical programme.  
**EVENING SESSION.**  
 5.30: Children's hour, conducted by Uncle Jack.  
 6.30: Close down.  
 7.0: G.P.O. clock and chimes.  
 Request numbers.  
 8.0: Tenor and baritone songs.  
 9.0: G.P.O. clock and chimes.  
 Comments on Foreign Affairs, by Mr. J. M. Prentice.  
 9.10: Music and request numbers.  
 10.30: Close down.

**2KY**  
 Trades and Labor Council, Goulburn St., Sydney (Wavelength, 280 Metres).  
**MORNING SESSION.**  
 10 a.m.: Tune in to the ticking of the clock.  
 10.3: Popular fox trots.  
 10.15: News items.

**2FC**  
 Australian Broadcasting Company, Ltd., Market St., Sydney (Wavelength, 442 Metres).  
**EARLY SESSION, 7 to 8.15 a.m.**  
 7.0: "Big Ben"; meteorological information for the man on the land.  
 7.3: This morning's news, from the "Sydney Morning Herald."  
 7.8: Early-rising music.  
 7.45: Mails and shipping.  
 7.48: What's on to-day?  
 7.50: Children's birthday calls.  
 8.0: Music from the studio.  
 8.15: Close.  
**MORNING SESSION, 10.30 a.m. to 12.30 p.m.**  
 10.30: Announcements.  
 10.32: A.B.C. racing observer.  
 10.45: Recital on the grand organ, by Edgar Stone.  
 11.0: Household helps, hints to housewives, by Miss Ruth Furst.  
 11.10: Cables, A.P.A. and "Sun"- "Herald" news service; British Official Wireless Press  
 11.15: Morning devotion.  
 11.30: Austradio musical reproduction.  
 12.0: "Big Ben." Stock Exchange, and metal quotations.  
 12.5: A talk by C. N. Baeyertz.  
 12.20: Midday weather forecast and weather synopsis; special produce market session for the man on the land, supplied by the State Marketing Board.  
 12.30: Close.  
**THE LUNCH HOUR, 1 p.m. to 2.30 p.m.**  
 1.0: Lunch to music with the National Broadcasting Orchestra.  
 2.0: Stock Exchange, second call.  
 2.2: A glance at the afternoon "Sun" and "News."  
 2.7: Popular education, J. R. Kinghorne.  
 2.27: Announcements.  
**THE RADIO MATINEE, 2.30 p.m. to 4.30 p.m.**  
 2.30: The Arabesques.  
 2.42: Ann Luciano, soprano.  
 (a) "It is Only a Tiny Garden" (Wood).  
 (b) "Heigh Ho" (German).  
 2.49: Bernice Arthur, pianist.  
 (a) "Study" (Paganini-Liszt).  
 (b) "Rush Hour in Hongkong" (Chosins).  
 2.59: The Arabesques.  
 3.11: Dorothy Nall, in a sketch "Her First Call on the Witches" (Fisk).  
 3.18: David McKissock, cellist.  
 (a) "Pavane Favorite" (Brisson).  
 (b) "La Cygne" (St-Saens).  
 3.25: The Arabesques.  
 3.37: Ann Luciano soprano.  
 (a) "Butterfly Wings" (Phillips).  
 (b) "Deep in My Heart a Lute Lay Hid" (Aylward).  
 3.44: David McKissock, cellist.  
 (a) "Liebestraume" (Liszt).  
 (b) "An Old Melody" (arr. Squire).  
 3.51: Bernice Arthur, pianist.  
 (a) "Study in A Minor" (Chopin).  
 (b) "Juba" (Dett).  
 (c) "Papillon" (Lavallee).  
 4.1: Dorothy Nall, in a sketch, "Mrs. Murphy on Health" (Pain).  
 4.8: The Arabesques.  
 4.28: Stock Exchange, third call.  
 4.30: Close.  
**EARLY EVENING SESSION, 5.45 to 7.55 p.m.**  
 5.45: Kiddies' "Good-night" stories, told by Aunt Willa, assisted by Cousins Gwen and Clarice.  
 6.45: The National Broadcasting Orchestra will play dinner music.  
 7.30: A.B.C. sporting service.  
 7.37: Special country session; Stock Exchange resume; markets; weather forecast; late news service, from "The Sun" and "News."  
 7.58: To-night's programme.  
**THE EVENING PRESENTATION, 8 p.m. to 11.30 p.m.**  
 To-night is now recognised as the State-wide Radio Dance Night. Dance items will be given in groups from 8 p.m. to 11.30 p.m., interspersed with songs and comedy. 2BL is in more serious vein this evening.  
 8.0: The Australian Broadcasting Dance Orchestra.  
 8.12: Charles Lawrence, entertainer.  
 8.20: The Australian Broadcasting Dance Orchestra.  
 8.32: Rene Rich, violinist.  
 (a) "Nocturne" (Chopin).  
 (b) "Wedding of the Painted Doll" (Brown).  
 8.40: The Australian Broadcasting Dance Orchestra.  
 8.52: Victor Evans, baritone.  
 8.59: The Country Man's weather session.  
 (a) New South Wales forecasts.  
 (b) Inter-State weather synopsis.  
 9.0: The Australian Broadcasting Dance Orchestra.  
 9.12: Frank Ryan, comedian.  
 (a) "Tit Bits."  
 (b) "It's an 'Ot Day" (Newman).  
 9.20: The Australian Broadcasting Dance Orchestra.  
 9.32: Simon Philpoff, ballalala.  
 (a) "You Were Meant for Me" (Brown).  
 (b) "Broadway Melody" (Brown).  
 9.40: The Australian Broadcasting Dance Orchestra.  
 9.52: Bernice Patterson, popular vocalist.  
 (a) "Celia" (Robin and Whiting).  
 (b) "Weary River" (Silvers).  
 10.0: The Australian Broadcasting Dance Orchestra.  
 10.15: Announcements; late official weather forecast.  
 10.20: The Australian Broadcasting Dance Orchestra.  
 11.30: Close. National Anthem.

**2BL**  
 Australian Broadcasting Company, Ltd., Market St., Sydney (Wavelength, 353 Metres).  
**OPENING SESSION, 8.15 a.m. to 11 a.m.**  
 8.15: G.P.O. chimes. Music for every mood.  
 8.45: Meteorological data for the country  
 8.50: A musical interlude.  
 9.30: British official wireless news.  
 9.35: New music.  
 10.2: News from the "Labor Daily."  
 10.5: News from the "Sydney Morning Herald."  
 10.10: The Australian Broadcasting Company's Women's Association, conducted by Miss Gwen Varley.  
 10.30: Celebrity items.  
 10.45: A morning story.  
 11.0: G.P.O. chimes. Close

**MIDDAY SESSION, 12 Noon to 2.30 p.m.**  
 12.0: G.P.O. chimes. Announcements  
 12.2: The National Broadcasting Orchestra  
 1.0: Afternoon news from the "Evening News" and "The Sun."  
 1.5: Studio music.  
 1.15: Women's interest talk.  
 1.30: A recital of instrumental music.  
 2.0: J. Knight Barnett at the Wurlitzer.  
 2.12: Studio music.

**AFTERNOON ENTERTAINMENT, 2.30 p.m. to 5.45 p.m.**  
 2.30: Talk by Fred Arlington Burke, "Inside Anecdotes of the Great War."  
 2.45: "The Magic Carpet"—Tom Gurr "Zanzibar—Past and Present."  
 3.0: Romano's Dance Orchestra, conducted by Bennie Abrahams.  
 3.12: From the studio.  
 Olga Le Gray, popular vocalist.  
 3.19: A dance number.  
 3.22: Romano's Dance Orchestra, conducted by Bennie Abrahams.  
 3.32: From the studio.  
 Nellie Ferguson, monologues.  
 3.40: A popular item.  
 3.43: Romano's Dance Orchestra, conducted by Bennie Abrahams.  
 3.50: From the studio. Hilda Grace novelty pianist.  
 (a) "Lady Fingers" (Zimmerman).  
 (b) "Little Spinning Wheel" (Platzonau).  
 (c) "I Kiss Your Hand, Madame" (Erwin).  
 3.57: Olga Le Gray, popular vocalist.  
 4.4: Romano's Dance Orchestra, conducted by Bennie Abrahams.  
 4.12: From the studio.  
 Nellie Ferguson, monologues.  
 4.19: The latest dance music.  
 4.23: Romano's Dance Orchestra, conducted by Bennie Abrahams.  
 4.32: From the studio. Hilda Grace novelty pianist.  
 (a) "Moussie on the Piano" (Keden).  
 (b) "Un Sonnet d'Amour" (Gabriel Morel).  
 (c) "Casa Lopez" (Damasek).  
 4.40: Romano's Dance Orchestra, conducted by Bennie Abrahams.

**2GB**  
 Theosophical Broadcasting Station, 29 Bligh St., Sydney (Wavelength, 316 Metres).  
 10.0: Music.  
 10.10: Happiness talk, by A. E. Bennett.  
 10.20: Music.  
 10.30: Women's session, by Miss Helen J. Beegling.  
 11.30: Music.  
 11.45: Close down.  
 2.0: Music.  
 2.5: Women's Radio Service, by Mrs. Dorothy Jordan.  
 2.50: Movie Know All.  
 3.0: Music.  
 3.30: Close down.  
 5.30: Children's session, by Uncle George.  
 7.0: Music.  
 7.30: Talk from Sutton's 2GB Radio Service Department, by Mr. Stan Crittenden.  
 7.45: Feature story.  
 8.0: Miss Elsie Condon, contralto.  
 8.7: Instrumental Quartette.  
 8.15: Mr. Clifford Lathlean, baritone.  
 8.22: Symphony Orchestra.  
 3.30: Mr. Jack Win and Mr. Heath Burdock, humor.  
 8.35: Miss Elsie Brown, soprano.  
 8.43: Violin solos.  
 8.50: Miss Elsie Condon, contralto.  
 9.0: Weather report.  
 9.3: Address.  
 9.15: Symphony Orchestra.  
 9.25: Mr. Clifford Lathlean, baritone.  
 9.32: Mr. Jack Win and Mr. Heath Burdock, humor.  
 9.37: Instrumental Quartette.  
 9.50: Miss Elsie Brown, soprano.  
 10.0: Instrumental music.  
 10.30: Close down.

**2UW**  
 Radio Broadcasting, Ltd., Paling's Building, Ash St., Sydney (Wavelength, 267 Metres).  
**MIDDAY SESSION.**  
 12.30: Request numbers.  
 1.0: G.P.O. clock and chimes.  
 Music.  
 1.15: Talk on Home-craft by Pandora.  
 1.40: Music and request numbers.  
 2.30: Close down.  
 4.30: Musical programme.  
**EVENING SESSION.**  
 5.30: Children's hour, conducted by Uncle Jack.  
 6.30: Close down.  
 7.0: G.P.O. clock and chimes.  
 Request numbers.  
 8.0: Tenor and baritone songs.  
 9.0: G.P.O. clock and chimes.  
 Comments on Foreign Affairs, by Mr. J. M. Prentice.  
 9.10: Music and request numbers.  
 10.30: Close down.

**2KY**  
 Trades and Labor Council, Goulburn St., Sydney (Wavelength, 280 Metres).  
**MORNING SESSION.**  
 10 a.m.: Tune in to the ticking of the clock.  
 10.3: Popular fox trots.  
 10.15: News items.

10.30: Vocal items. 10.50: Hawaiian steel guitar selections. 11.0: A few laughs. 11.5: Pianoforte selections. 11.15: Calls and announcements. 11.20: Musical numbers. 11.30: Request numbers. 11.40: Music and vocal items. 11.55: Where to go to-night. 12 noon: Closing announcements.

**CHILDREN'S SESSION.**

6 p.m.: Birthday calls, request numbers, and kiddies' entertainment, Aunt Jemima and Uncle Bert.

**EVENING SESSION.**

7.0: Musical interlude.  
7.15: Sporting feature. Turf topics. How they should run to-morrow, Mr. Geo. A. Davis.

7.45: Request numbers.  
8.0: Novelty numbers, Miss Billie Underwood.

8.10: Soprano solos.  
8.18: Baritone solos, Mr. Higgins.  
8.26: Pianoforte solos, Mr. Hancock.  
8.30: Music and request numbers from the studio.

9.0: Sporting feature. Presented by Tooth and Co., Ltd., Kent Brewery. From the ring-side of M Hugh's Leichhardt Stadium. Results of early events and full description of main 15-round event.

9.40: Dance music from the studio.  
10.0: Closing announcements.

**2UE**

Broadcasting Station 2UE, Everett Street, Maroubra Sydney (Wavelength, 293 Metres).

**EARLY MORNING SESSION**

7.15: Breakfast Time Hour Orchestral music. 8.30: Weather forecast. Close down.

**MIDDAY SESSION**

11.30 a.m.: Orchestral and vocal music. 12.30: Close down.

**AFTERNOON SESSION**

1.0: Orchestral and vocal music. 1.45: Organ solos. 2.0: Vocal and orchestral music. 2.30: Close down.

**EVENING SESSION**

7.15: Orchestral dinner music. 7.58: Programme announcements. 8.0: "Pique Dame" Overture. 8.10: Orchestral and vocal music. 10.15: Announcements. Close down.

**Convert Your Present  
Wireless Set into an**

**"All Electric"**

This can easily be done by installing a "Stedipower" L.T. Unit—the greatest advance in Radio for many years.

**Stedipower  
L.T. Unit**

No alteration required to your set. No Rectifying Valves to Burn Out. "The Stedipower" L.T. Unit gives pure, hum-free, direct current, at a voltage of either 2, 4, or 6, as required.

**SWITCHED ON AND OFF LIKE AN  
ELECTRIC LIGHT.**

You can buy the Unit complete or build your own. The component parts required are:—

- 2 T.C.C. Electrolytic Condensers, at . . . . . each 25/-
- 1 Westinghouse (British) Dry Rectifier . . . . . 49/-
- 1 "Stedipower" Step-down Transformer . . . . . 50/-
- 1 "Stedipower" Double Choke . . . . . 55/-

Get FREE BOOKLET—"How to Build Your Own 'Stedipower' L.T. Unit," obtainable from all Radio Dealers.

**ALL RADIO DEALERS.**

W. McF.

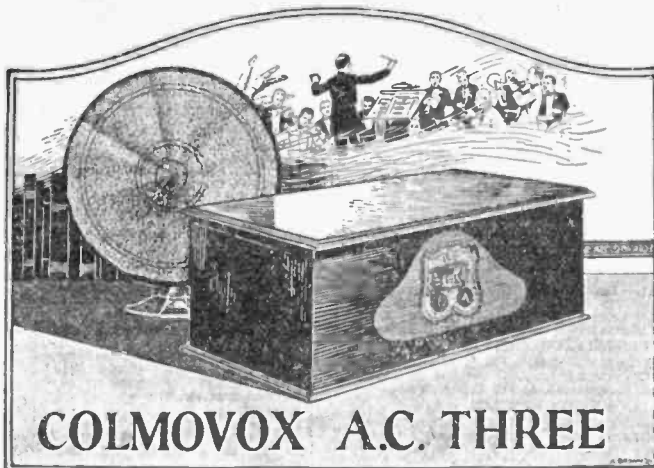

**COLMOVOX A.C. THREE**

*A TRIUMPH IN TONE*

*and*

*MECHANICAL PERFECTION*

**BATTERYLESS RADIO**

**RIGHT OFF YOUR POWER POINT**

*No fuss or bother*

**JUST SWITCH ON**

**A.C. THREE (table model), CASH PRICE, £29**

TERMS, £6 deposit, £2 2 9 Monthly

**A.C. THREE (Console), CASH PRICE, £34**

TERMS, £7 deposit, £2 10 1 Monthly

**DEMONSTRATIONS** given in your own home. **DAY OR NIGHT**, without any obligation. Just ring B2261 and make arrangements to hear this wonderful Receiver.

**AGENTS WANTED**

**METROPOLIS AND COUNTRY.**

**TERMS:** Parts, Loudspeakers, Eliminators, etc., may be purchased on easy terms. Small deposit and small repayments.

**COUNTRY:** 25 per cent. deposit and balance in 5 monthly payments.

**COLVILLE-MOORE WIRELESS SUPPLIES LTD.**

'PHONE B2261. 10 ROWE ST. (Next Hotel Australia), Sydney

# Interstate Programmes, Tuesday, September 10

## 3LO

Australian Broadcasting Co., 129A Russell St., Melbourne (Wavelength, 351 Metres).

### EARLY MORNING SESSION

7.0 to 8.15: See Friday.

### MORNING SESSION

10.30: Current happenings in sport, by Eric Welch.  
10.45: A.B.C. Studio Orchestra 12.0: Melbourne Observatory time signal. 12.1: Orchestra, continued.  
12.15: News service; British official news; Corn Exchange midday report; Newmarket stock sales; Associated Stock and Share Agents' official report.

### MIDDAY SESSION

1.0: Melbourne Observatory time signal. 1.1: Stock Exchange information; Meteorological data; Weather forecast for Victoria, N.S.W., S.A., and Tasmania; Ocean forecast; river reports; rainfall; comments on the day's news. 1.30: Melody Broadcast.

### EDUCATIONAL SESSION

2.10: Stories from the Operas, with musical illustrations. Miss D. Babington. 2.40: Musical interlude. 2.45: A talk in French, Mons. Th. Rouel, B.A.

### THE RADIO MATINEE

3.0: National Broadcasting Orchestra (under direction Wm. C. James, Conductor, Percy Code. "Casse Noisette Suite" (Tschikowsky). 10: "J. and C." the Confidential Two, in "All the Latest Hits." 3.17: The Spanish Serenades—Sweet Sicilian Airs on Steel and Spanish Guitars.—"Juanita," "First in Line." 3.22: Russell Callow, Tenor. 3.30: Orchestra—Suite, "Three Fours" (Coleridge-Taylor). 3.40: Jessie Smith, contralto—"Thou Art Eaten, my Beloved" (Coleridge-Taylor). "Sorrow Songs" (Coleridge-Taylor). 3.47: George Pindlay, piano. 3.54: Orchestra—"Petite Suite de Concert" (Coleridge-Taylor). 4.5: Russell Callow. 4.12: The Spanish Serenades—"Blue Hawaii." "Gat Out and Get Under the Moon." 4.20: Orchestra—Selection from the musical comedy, "Gloriana" (Prinny). 4.20: Close down.

### CHILDREN'S HOUR

5.45: "Bobby Bluegum." Ector and Orace are Here Again. 6.0: Birthday greetings. 6.25: A talk of interest to the older boys and girls. 6.35: Musical interlude.

### EVENING SESSION

6.40: Careers for our boys and girls. 5. Trends in Vocational Guidance. Mr. J. M' Rae, M.A. 6.55: Musical interlude. 7.0: Melbourne Observatory time signal. 7.1: Countrymen's session. 7.25: For the Man on the Land—"Irrigation Agriculture—Economic Use of Water." Mr. L. C. Bartels, B.Ag.Sc. 7.40: News. 7.45: The Things we drink. Naming Australian Wines. 8.0: Melbourne Observatory time signal.

### NIGHT SESSION

8.0: Revueful National Broadcasting Orchestra—under Direction Wm. C. James, Conductor: Percy Code—Overture—"Pique Dame" (Suppe). 8.7: Joe Brennan and Ida Newton, in "Piquant Reminiscences." 8.15: Folk Songs—"The Synchronising Quartette." 8.22: "We Four Quartette." 8.33: Dawn Harding, soprano—"O'er the Liltie Lily" (Korbay); "My Brown Boy" (Korbay); "List to the Rosebud" (Korbay). 8.37: National Broadcasting Orchestra—"Londonderry Air." "Country Gardens." "Shepherds, Hey." 8.52: "We Four Quartette." 9.0: University Extension Series—"The King" (English). Prof. S. A. Cowling M.A. 9.15: Jack O'Hagan in all the latest song hits. 9.45: Orchestra—Selection. "Rio Rita" (Tierney). 9.55: Joe Brennan and Ida Newton hold the Mike. 10.10: Orchestra—Selection. "Gelshia" (Jones). 10.20: Meteorological information; British official wireless news; Items of Interest. 10.30: The "Rex" Dance Band. 11.30: God Save the King.

## 3AR

Australian Broadcasting Co., 129A Russell St., Melbourne (Wavelength, 351 Metres).

### MORNING SESSION

6.15 to 11.0: See Friday.

### MIDDAY SESSION

12.0: Chimes. 12.1: Beautifying the Home. Furniture—Its Characteristics and Development. Mr. P. M. Carew-Smythe, A.R.C.A. (London). 12.15: Fifteen Minutes' Syncopeation. 12.30: Luncheon music. Supplied by the National Broadcasting Orchestra, under direction Wm. C. James; conductor, Percy Code. 2.0: Chimes.

### AFTERNOON SESSION

2.1: Special reproduced band music. 2.10: Madge Vivian (contralto). Selected. 2.17: Harry Bennett (xylophone). "By the Waters of Minnetonka" (Lieuwenaar). "Dainty Miss" (Brown). 2.22: Agnes St. Clair. Extract from "Handy Andy" (Samuel Lovell). 2.28: Special reproduced band music. 2.33: Madge Vivian (contralto). Selected. 2.40: Special reproduced band music. 2.48: Agnes St. Clair (monologue). "The Selfish Giant" (Oscar Wilde). 2.55: Special reproduced band music. 3.5: Harry Bennett (xylophone). "Carolina Moon." "There's a Rainbow Round My Shoulder." 3.10: Reproduced music. 3.20: The Bab. Proper Feeding. Sister Anne Purcell. 3.35: Musical interlude. 3.40: Useful Crafts at Home. Home-made Carpets. Mrs. Henrietta Walker. 3.55: Musical interlude. 4.0: The latest fashions. Madame la Mode. 4.15: Reproduced music. 5.0: G.P.O. chimes. 5.30: Weather data. 5.45: Close down.

### EVENING SESSION

6.15: Dinner music, supplied by the A.B.C. Studio Orchestra. 7.30: What's On the Air To-night? 7.32: Latest Musical Releases. 8.0: Chimes.

### NIGHT SESSION

8.1: "The Wanderers" in Song and Story. 8.30: Leslie Barkham (flute)—"Rhapsodie Hongroise" (Poppl). 8.35: Victor Harding (bass-baritone)—"The Sea Gypsy" (Herd). "When Dull Comes" (Tully). 8.42: The Peerless Trio—Selected. 8.52: Rita Hilton (entertainer)—Reminiscences of 1919. "He'd Say 'Go-la-la, Oul.'" "Love Got My Captain Working for Me." 9.0: Norman's Royal Hawaiians—"Dreaming Hawaii." "Hawaiian March." Banjo Trio. "Lay My Head Beneath a Rose." Banjo Trio, Selected. 9.7: Victor Harding (bass-baritone)—"You Along o' Me" (Sanderson). "The Bellman" (Forsyth). 9.14: The Peerless Trio—Selected. 9.25: Dawn Harding (soprano)—"The White Dawn is Stealing" (Cadman). "From the Land of Sky Blue Water" (Cadman). 9.32: Donald M'Beath (violin)—"Gavotte" (Gossiel). "Minuet" (Mozart). "German Dance" (Mozart). 9.40: Rita Hilton (song at the piano). 9.47: Norman's Royal Hawaiians—"Trippoli Waltz." "Wakkaiki Medley." "Moonlight on Kalure." "La Paloma." 9.55: Weather data and "Herald" news. 10.30: God Save the King.

## 3DB

The "Herald" Broadcasting Station, Flinders Street, Melbourne (235 Metres).

### MORNING SESSION

11.0: Grand Symphony Orchestra—"Caliph of Bagdad" (Boieldieu). 11.30: Charles Hackler—"I Look Into Your Garden." 12.0: The Troubadours—"Live and Love." 12.30: Market reports, by John McNamara and Co. Pty. Ltd. 12.35: Clyde Twelvemets. (cello). "Elegie" (Massenet). 1.0: Robert Watson (baritone)—"Border Ballad." 1.30: Bournemouth Municipal Orchestra—"Idylle Bretonne." 1.45: Close down.

### AFTERNOON SESSION

2.15: Reginald Goss Custard (organ)—"La Campanella" (Paganini-Liszt). 2.30: W. H. Squire (cello)—"Sarabande." 3.0: Atwater Kent Radio Hour, sponsored by A. G. Healing, Ltd., and E. T. Muir. 4.0: Close down.

### EARLY EVENING SESSION

5.30: Anna Lunde (harpsichord)—"La Tambourin." 6.0: Stories for the children, by "Uncle Ted." 6.30: John McCormack (tenor)—"Kathleen Mavourneen" (Crouch). 7.0: St. Clara Colliery Prize Band—"Plymouth Squad." 7.15: Market reports, by John McNamara and Co. Pty. Ltd. 7.30: Prudhoe Gleemen—"How Can I Bear to Leave Thee." 7.30: Market reports, by Gippsland and Northern Co-operative Co. Ltd. 7.40: Gus Arneheim's Orchestra—"A Tale of Alsace Lorraine."

### EVENING SESSION

8.0: Geoffrey Gilbey and His Kettlers Five—"Funny Face." 8.30: Hubert Eisdell—"Thank God for a Garden." 9.0: National Military Band—"Birds and the Brook." 9.30: Berlin State Opera House Orchestra—"Rustle of Spring" (Sinding). 10.0: Fraser Gange (baritone)—"Nancy Lee." 10.30: Jesse Crawford (organ)—"A Dream" (Bartlett). 10.40: News. 10.45: "God Save the King."

## 4QG

Queensland Government Radio service, Brisbane (Wavelength, 385 Metres).

For day sessions, see Friday.

### NIGHT SESSION

8.0: From the Studio—The Jumping Jacks (conductor, Fred David). Fox Trot, "Old Man Sunshine" (Rixon and Warren). 8.8: Annie Adams, soprano—"Your Voice" (Teschemacher). 8.11: Brass Quartette—"Fanny that Way" (Moré). 8.15: Arthur Adridge, tenor—"A Real Sweetheart." "In a Bamboo Garden." 8.24: Bert Harrow, entertainer. 8.33: The Jumping Jacks, nautical comedy—"Forty-seven Ginger Sealed Sailors" (Sarony). 8.38: J. P. Cornwell, bass—"Let the End of the World Come To-morrow" (Ball). 8.45: Fred. David saxophonist—Solo, "Saxaphobia" (Widow). 8.50: Bert Harrow, entertainer. 9.0: Metropolitan weather forecast. 9.1: The Jumping Jacks—Their interpretation of a musical party. "I Fall Down and Go Boom" (Stevens). 9.6: Arthur Adams, soprano—"Dear Love, Remember Me" (Marshall). 9.10: Winnie Trackson, violinist—"Lieslel" (Kreisler). 9.14: Jumping Jack Members—Saxophone and Vocal Trio, "Girl of My Dreams."

9.20: Harry Borradaile, entertainer. 9.30: Jumping Jack Members—Violin, Saxophone, and Trombone Trio. "La Golondrina." 9.36: J. P. Cornwell, bass—"Bells of the Sea" (Solman). 9.42: Winnie Trackson, violinist—"On Wings of Song" (Mendelssohn). 9.50: The Jumping Jacks—Fox trot, "Ten Little Miles from Town" (Davis). Waltz, "Some Day, Somewhere" (Davis). 10.0: News supplied by courtesy of the metropolitan dailies; weather information; close down.

## 5CL

Central Broadcasters, Ltd., 114 Hindmarsh Square, Adelaide (Wavelength, 400 Metres).

### MORNING SESSION

11.15 to 2.0: See Friday.

### AFTERNOON SESSION

3.0 to 4.30: See Friday.

### EVENING SESSION

8.0: Chimes. 8.1: Birthday greetings. 8.15: Children's recitations. 8.30: Dinner session. 7.1: Birthday League greetings; general market reports. 7.20: Under the auspices of the Workers' Educational Association, Dr. Eleanor A. Allen, B.A., Ph.D., will speak on "New Knowledge from Old." 7.35: Mr. H. Brewster-Jones will give a pianoforte recital of "Bird Calls." 7.45: Dr. Herbert Baseow.

### NIGHT SESSION

8.0: Chimes. 8.10: The Station Quartette—Selection, "The Five O'clock Girl." "Spanish Dance" (Moszkowski). 8.20: Rupert Hazell and Elsie Day. 8.30: A musical presentation of "In a Persian Garden" (Omair Khayyam). (Arranged by Wilfred Thomas). In which the following artists will take part—The Madrigal Singers. Wilfred Thomas. The Station Quartette. 9.0: Chimes. 9.1: Meteorological information, including Semaphore tides. 9.2: Overseas grain report. 9.3: Extracts from the "Advertiser." General news service. 9.10: Rupert Hazell and Elsie Day. 9.20: Dayne Roland's Revue, entitled "Hull's Prosperity." In which the following artists will take part—The Madrigal Singers. Dayne Roland. Bessie Francis. Jack Burgess. 10.15: General news service. British official wireless news. Meteorological information. 10.24: Modern dance recordings. 11.0: Close down.

## 6WF

Commonwealth Government Broadcasting Station, Perth (Wavelength, 100 Metres).

10.0: Gramophone records. 11.0: Close down. 12.30: Markets, news, etc. 1.0: Time signal. 1.1: Weather bulletin. 1.35: Luncheon music. 2.0: Close down. 3.0: Tune in. 3.35: Pianoforte solos by Miss Audrey Dean; violin solos by Mr. Frank Romaine. 4.30: Close down. 6.45: Bedtime stories by Uncle Duffy. 7.5: Light music. 7.30: Commercial information. 7.45: Talk by Mr. J. Bathgate, "Books of the Month." 8.0: Time signal. 8.1: First weather bulletin. 8.3: A relay. 8.50: Late news; ships within wireless range; mail notices; housewives' guide. 12.8: Selections. 12.30: News service; announcements. 12.40: Selections. 1.5: British official wireless news; railway auction produce sales held at railway. 1.10: Selections. 1.30: Close down. 3.0: G.P.O. clock chimes the hour. 3.1: Selections. 3.4: Weather information. 3.5: Selections. 3.45: Miss Joyce Walker will speak on "Homecraft." 4.0: Record recital. 4.15: An educational talk on "Oil Fuel." Estonian Oil Shale Industry." 4.30: Close down. 6.15: Children's Hour with "Uncle David" and "The Story Lady." 6.45: Ellen Carter will play the piano for the week folk. 7.0: Answers to letters and birthday greetings by "Uncle David" and "The Story Lady." 7.15: News session. 7.30: Under the auspices of the Agricultural Department, E. R. Hudson will continue his talk on "Sheep Husbandry." 7.45: W. E. Fuller will speak on "Literary Lapses and Library Lists." 8.0: G.P.O. clock chimes the hour. 8.1: Record recital. 8.15: A programme of dance music by the Discus Dance Ensemble. 8.27: Joseph Coyne. "Ten for Two" ("No. No. Nanette"). 8.30: Dance numbers. 8.42: Gregor Stroud. "Those Eyes So Tender." 8.45: Dance numbers. 9.12: Len White, "Roses of Yesterday." 9.15: Dance numbers. 9.27: Billy Murray, "Dye Love Me." 9.30: News session. 9.40: Dance numbers. 9.52: Slumber music. 10.0: G.P.O. clock chimes the hour. 10.1: Close down.

## 7ZL

Tasmanian Broadcasters Pty., 95 Elizabeth Street, Hobart (Wavelength, 516 Metres).

11.30 a.m.: Selections. 11.34: Midlands weather forecast. 11.35: Selections. 11.55: Tasmanian stations 9 a.m. weather report. 12.0: G.P.O. clock chimes the hour. 12.1: Shipping information; ships within wireless range; mail notices; housewives' guide. 12.8: Selections. 12.30: News service; announcements. 12.40: Selections. 1.5: British official wireless news; railway auction produce sales held at railway. 1.10: Selections. 1.30: Close down. 3.0: G.P.O. clock chimes the hour. 3.1: Selections. 3.4: Weather information. 3.5: Selections. 3.45: Miss Joyce Walker will speak on "Homecraft." 4.0: Record recital. 4.15: An educational talk on "Oil Fuel." Estonian Oil Shale Industry." 4.30: Close down. 6.15: Children's Hour with "Uncle David" and "The Story Lady." 6.45: Ellen Carter will play the piano for the week folk. 7.0: Answers to letters and birthday greetings by "Uncle David" and "The Story Lady." 7.15: News session. 7.30: Under the auspices of the Agricultural Department, E. R. Hudson will continue his talk on "Sheep Husbandry." 7.45: W. E. Fuller will speak on "Literary Lapses and Library Lists." 8.0: G.P.O. clock chimes the hour. 8.1: Record recital. 8.15: A programme of dance music by the Discus Dance Ensemble. 8.27: Joseph Coyne. "Ten for Two" ("No. No. Nanette"). 8.30: Dance numbers. 8.42: Gregor Stroud. "Those Eyes So Tender." 8.45: Dance numbers. 9.12: Len White, "Roses of Yesterday." 9.15: Dance numbers. 9.27: Billy Murray, "Dye Love Me." 9.30: News session. 9.40: Dance numbers. 9.52: Slumber music. 10.0: G.P.O. clock chimes the hour. 10.1: Close down.

# PEP UP YOUR SET, USING T.E.C. BRITISH BATTERIES!



*No. 1. Ord. Capacity, 12/6*

COUNTLESS Radio enthusiasts will tell you their T.E.C. Battery-operated sets are giving 100 per cent. efficiency—assuring them a remarkable standard of reception, coupled with battery economy never previously obtained.

A set equipped with the suitable T.E.C. Battery is perfectly powered for perfect reception. The reliability of T.E.C. uniform constant power is being proved by more and more users.

## T.E.C. Radio Batteries

amply reward those who select them. It is as easy to order a T.E.C. as just "a battery." But note the difference in result. Ample, uniform, and reliable power—with economy. Far greater satisfaction with your set, and more enjoyment.

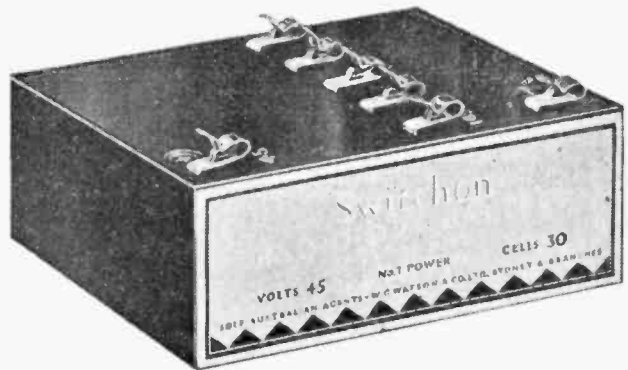

*No. 3. Double Capacity, 23/6*

T.E.C. Batteries are made to suit sets of all sizes—also to suit Australian conditions. Their growing popularity is enabling the makers to reduce their cost.

We back the T.E.C. Batteries to give satisfactory Service by placing our name on them.



*No. 4. Triple Capacity, 32/6*

Courteous attention to all inquiries—personal or postal.



## Pocket Lamp Cell

The range of T.E.C. Batteries also includes Torch Re-fills—and all needs can be supplied with the same high standard assured in every re-fill.

# W.G. Watson & Co. Ltd.

279 CLARENCE ST. (near Town Hall), SYDNEY

'Phone, M4331 (5 lines).

29 Hunter Street, Newcastle. 200 Queen Street, Melbourne. 28 Coromandel Place, Adelaide. 931a Hay Street, Perth. Queensland Representatives: Intercolonial Boring Co., Ltd., Ann Street, Brisbane

# Local Programmes, Wednesday, September 11

## 2FC

Australian Broadcasting Company, Ltd., Market St., Sydney (Wavelength, 442 Metres).

### EARLY SESSION, 7 to 8 15 a.m.

- 7.0: "Big Ben" and meteorological information for the man on the land.
- 7.3: This morning's news, from the "Sydney Morning Herald."
- 7.8: Early rising music.
- 7.45: Malls and shipping.
- 7.48: What's on to-day?
- 7.50: Children's birthday calls.
- 8.0: Music from the studio.
- 8.15: Close.

### MORNING SESSION, 10.30 a.m. to 12.30 p.m.

- 10.30: Announcements.
- 10.32: General sporting talk, by Oscar Lind.
- 10.45: Recital on the grand organ by Edgar Stone.
- 11.0: Household helps, cooking by Miss Ruth Furst.
- 11.10: Cables, A.P.A. and "Sun"- "Herald" news service: British Official Wireless Press.
- 11.15: Morning devotion.
- 11.30: Australian musical reproduction.
- 12.0: "Big Ben," Stock Exchange, and metal quotations.
- 12.5: A Dickens story.
- 12.20: Midday weather forecast and weather synopsis; special produce market session for the man on the land, supplied by the State Marketing Board.

### THE LUNCH HOUR, 1 p.m. to 2 30 p.m.

- 1.0: Lunch to music with the National Broadcasting Orchestra.
- 2.0: Stock Exchange second call.
- 2.2: A glance at the afternoon "Sun" and "News."
- 2.7: Studio music.
- 2.27: Announcements.

### THE RADIO MATINEE, 2 30 to 4 45 p.m.

- Note.—Race results from Mascot will be transmitted as received.
- 2.30: Tom King, novelty pianist.
  - (a) "Butterfly" (Ralton)
  - (b) "A Few Minutes with the Talkies" (arr. Tom King)
- 2.37: Nea Hallett, popular vocalist.
  - (a) "The Sun is at My Window" (Young)
  - (b) "Love Dreams" (Mendoza)
- 2.44: Al Hammett, saxophonist.
  - (a) "Dars l'Orient" (Weldofft)
  - (b) "Velma" (Rosebrook)
- 2.51: Popular dance music.
- 3.0: Romano's Cafe Dance Orchestra, conducted by Bennie Abrahams.
- 3.12: From the studio, Nea Hallett, popular vocalist.
  - (a) "Poor Butterfly" (Hubbell)
  - (b) "I Loved You Then" (Mendoza)
- 3.19: The latest dance numbers.
- 3.22: Romano's Cafe Dance Orchestra conducted by Bennie Abrahams.
- 3.32: If reception is satisfactory, a relay will be broadcast of KGO, California.
- 4.0: Romanos Cafe Dance Orchestra, conducted by Bennie Abrahams.
- 4.12: From the studio, Tom King, novelty pianist.
  - (a) "Log Cabin of Dreams" (Hanley)
  - (b) "Bits of Everything" (arr. Tom King)
- 4.19: Al Hammett, saxophonist.
  - (a) "Valse Erica" (Weldofft)
  - (b) "Saxophone Scandals" (Doraherger)
- 4.28: Stock Exchange third call.
- 4.30: Popular items.
- 4.45: Close.

### EARLY EVENING SESSION, 5.45 to 7.55 p.m.

- 5.45: Kiddies' "Good-night" stories, told by Uncle Ted and "Sandy."
- 6.45: The National Broadcasting Orchestra will play dinner music.
- 7.30: ABC sporting service.
- 7.37: Special country session; Stock Exchange resume; markets; weather forecast; late news service, from the "Sun" and "News"; truck bookings.
- 7.58: To-night's programme.

### THE EVENING PRESENTATION, 8 p.m. to 11 30 p.m.

- To-night 2FC present for your approval "The Hour from the State," after which H.

W. Varna, in a radio play; Iris de Calros-Rego, pianist; Raymond Beatty, basso; and Victor M'Mahon, flautist, will contribute to our programme. To-night 2BL have a band programme, interspersed with items by the Wireless Singers, W. E. Lewis, and Dorrie Ward.

8.0: The Hour from the State Theatre.  
9.0: From the studio, The Country Man's weather session.

- (a) New South Wales forecasts.
- (b) Inter-State weather synopsis.

9.1: H. W. Varna and Company present "Murder Will Out."

#### Characters:

- Simon (an innkeeper) . . . . . H. J. Salier
- A Police Officer . . . . . William Hulme
- Tom and Andrew (brothers) H. W. Varna
- Grandfather . . . . . Foster Dean
- Isabel (maid at the Inn) . . . . . Felix Clark

Scene—A Taproom in a Seashore Inn.

100 years ago.

- 9.30: Iris de Calros-Rego, pianist.
- 9.50: Raymond Beatty, basso.
  - (a) "More Sweet is that Name" (Handel).
  - (b) "My Old Shako" (Trotter).
- 10.0: Victor M'Mahon, flautist—
  - (a) "By the Brook" (Idylle) (Wetzger).
  - (b) "Carnival of Venice" (Bricclaldi)
- 10.7: Raymond Beatty, basso—
  - (a) "She Alone Charmeth My Sadness" (Gounod).
  - (b) "Youth" (Allitsen).
- 10.15: Announcements; late official weather forecast.
- 10.20: Romano's Cafe Dance Orchestra, conducted by Bennie Abrahams.
- 11.30: Close. National Anthem.

## 2BL

Australian Broadcasting Company, Ltd., Market St., Sydney (Wavelength, 353 Metres).

### OPENING SESSION, 8 15 a.m. to 11 a.m.

- 8.15: G.P.O. chimes. Music for every mood.
- 8.45: Meteorological data for the country.
- 8.50: A musical interlude.
- 9.30: British official wireless news.
- 9.35: New music.
- 10.5: News from the "Sydney Morning Herald."
- 10.10: The Australian Broadcasting Company's Women's Association, conducted by Miss Gwen Varley.
- 10.30: Celebrity items.
- 10.45: A morning story.
- 11.0: G.P.O. chimes. Close.

### MIDDAY SESSION, 12 Noon to 2 30 p.m.

- 12.0: G.P.O. chimes. Announcements.
- 12.2: The National Broadcasting Orchestra
- 1.0: Afternoon news from the "Evening News" and "The Sun."
- 1.5: Studio music.
- 1.15: Women's "Interest talk."
- 1.30: A recital of instrumental music.
- 2.0: J. Knight Barnett at the Wurlitzer.
- 2.12: Studio music.

### AFTERNOON ENTERTAINMENT, 2 30 p.m. to 5 45 p.m.

- 2.30: Business efficiency talk, by the doctor, "Regularity v. Regulations."
- 2.45: "The Magic Carpet," The Storyteller "Romance of Bridge-building"
- 3.0: 2BL Instrumental Trio.
- 3.12: Alfred Wilmore, tenor.
  - (a) "Drink to Me Only with Thine Eyes" (Quilter)
  - (b) "Still as the Night" (Bohm).
- 3.19: Brunton Gibb, entertainer. "Bus Conductor's Story" (Barry Pain).
- 3.26: 2BL Instrumental Trio.
- 3.36: Eleanor Stanton, contralto.
  - (a) "A Summer Night" (Goring Thomas)
  - (b) "The Scarecrow" (Davies).
- 3.43: Marcus Burkitt, pianist. "Appassionata Sonata," first movement (Beethoven).
- 3.53: 2BL Instrumental Trio.
- 4.3: Alfred Wilmore, tenor.
  - (a) "If My Songs Were Only Winged" (Hahn).
  - (b) "I Wish" (Sands).
  - (c) "The Little Red Lark" (Stanford).
- 4.10: Brunton Gibb, entertainer.
  - (a) "Some Boys as Got Muvvers" (Stevens).
  - (b) "The Vicar in Defence of Parsons" (Poster).

4.17: Marcus Burkitt, pianist. "Prelude in G Minor" (Rachmaninoff).

- (b) "Valse Triste" (Sibelius).
- (c) "Valse Troisième" (De Beausupis).
- 4.27: Eleanor Stanton, contralto.
  - (a) "Lie There, My Lute" (MacCunn).
  - (b) "The Shepherd's Song" (Elgar).
- 4.34: 2BL Instrumental Trio.
- 4.45: "The Trade Hour," demonstration music.

5.45: Weather information. Close.

### THE DINNER HOUR, 6.15 p.m. to 7.55 p.m.

The National Broadcasting Orchestra plays dinner music.

- 6.45: The "Younger Set" session, Boys Radio Club, conducted by Mr. Norman Lyons
- 7.5: Talk on "Bridges," by Graham Kent.

The Country Man's market session: Wool, wheat, stock, farm produce, fruit, vegetables, pig, and poultry markets.

- 7.30: The National Broadcasting Orchestra
- 7.45: Celebrity music.
- 7.55: What's on the air to-night?

### TO-NIGHT'S PRESENTATION, 8 p.m. to 10 30 p.m.

- 8 p.m.: G.P.O. chimes.
- Marrickville Silver Band.
  - (a) March, "The Yellow, Red, and Blue."
  - (b) Selection, "In This Hour of Softened Splendor."
  - (c) Solo, "Ombra Mai Fu."
- 8.15: The Wireless Singers, a chorus of voices specially trained for broadcasting (H. Sherlock, conductor).
  - (a) "O Hush Thee, My Babe" (Sullivan)
  - (b) "Dear Little Shamrock" (Vincent)
  - (c) "Tally Ho" (Cellier).
- 8.27: W. E. Lewis, baritone.
  - (a) "Meeting at Night" (Clarke)
  - (b) "Sunset on the Water" (Clarke)
  - (c) "To Sea" (Clarke)
  - (d) "The Sea Road" (Haydn Wood)
- 8.34: Marrickville Silver Band.
  - (a) Selection, "Australian Melodies."
  - (b) Selection, "Excerpts from 'Maritana'."
- 8.49: The Wireless Singers.
  - (a) "My Love Dwelt in a Northern Land" (Elgar)
  - (b) Male quartet, "Spin, Spin."
  - (c) "When Evening's Twilight" (Hatten).

- 9.1: Dorrie Ward, soprano.
  - (a) "Blackbird's Song" (Cyril Scott).
  - (b) "To You" (Oley Speaks).
  - (c) "The Call of the Mavtime" (Brahe).
- 9.8: Marrickville Silver Band.
  - (a) Waltz, "Memories of Otrava."
  - (b) Fantasia, "The Chief's Last Call."
- 9.25: W. E. Lewis, baritone.
  - (a) "Like to the Damask Rose" (Elgar).
  - (b) "The Poet's Song" (Elgar).
- 9.32: Late weather forecast for the man on the land.

- 9.33: Dulcie Blair, violinist.
  - (a) "Andante" from "Symphonie Espagnole" (Lalo)
  - (b) "La Precieuse" (Counerin-Kreisler).
- 9.40: Marrickville Silver Band. Fantasia "While the Days are Going By."
- 9.55: Dorrie Ward, soprano.
  - (a) "June" (Quilter).
  - (b) "The Leaves in the Wind" (Leoni).
  - (c) "A Song of Waiting" (Wright).
- 10.2: Muriel Lang, cello solo, "Prayer" (Squire).

- 10.9: Stanley Clarkson, basso.
- 10.16: Dulcie Blair, violinist.
  - (a) "Adagio" (Goldmark).
  - (b) "Serenade" (Drdla).
- 10.25: Official weather forecast, metropolitan and country; late news from the "Evening News" and "The Sun."
- 10.30: Close. National Anthem.

## 2GB

Theosophical Broadcasting Station, 39 Blich St., Sydney (Wavelength, 316 Metres).

- 10.0: Music. 10.10: Happiness talk, by A. E. Bennett.
- 10.20: Music. 10.30: Women's session, by Miss Helen J. Beegling.
- 11.30: Music. 11.45: Close down. 2.0: Music. 2.5: Women's Radio Service, by Mrs. Dorothy Jordan.
- 2.50: Music. 3.0: Movie Know All.
- 3.30: Close down. 5.30: Children's session by Uncle George. 7.0: Music. 7.45: Feature story. 8.0: Miss Molly Long, contralto. 8.7: "Cello solos. 8.15: Mr. Tom Harrison, baritone. 8.22: Symphony Orchestra. 8.30: Mr. Jack Win and Mr. Heath Burdock, humor.

8.35: Miss Gladys Verona, soprano. 8.45: Instrumental Trio. 8.50: Miss Molly Long, contralto. 9.0: Weather report. 9.3: Address. 9.15: 'Cello solos. 9.25: Mr. Tom Harrison, baritone. 9.35: Mr. Jack Win and Mr. Heath Burdock, humor. 9.40: Symphony Orchestra. 9.50: Miss Gladys Verona, soprano. 10.0: Instrumental music. 10.30: Close down.

**2UW**

Radio Broadcasting, Ltd., Palling's Building, Ash St., Sydney (Wavelength, 267 Metres).

**MIDDAY SESSION.**

12.30: Request numbers. 1.0: G.P.O. clock and chimes. Music. 1.15: Talk on Homecraft by Pandora. 1.40: Music and request numbers. 2.30: Close down. 4.30: Musical programme.

**EVENING SESSION.**

5.30: Children's hour, conducted by Uncle Jack. 6.30: Close down. 7.0: G.P.O. clock and chimes. Request numbers. 8.0: Violin and 'cello recital. 9.0: G.P.O. clock and chimes. Comments on Foreign Affairs, by Mr. J. M. Prentice. 9.10: Music and request numbers. 10.30: Close down.

**2KY**

Trades and Labor Council, Goulburn St., Sydney (Wavelength, 280 Metres).

**MORNING SESSION.**

10.0 a.m.: Tune in to the ticking of the clock. 10.3: Popular fox trots. 10.15: Hawaiian steel guitar selections. 10.30: Request numbers. 10.50: Vocal items. 11.0: A few laughs. 11.5: Pianoforte selections. 11.15: Calls and announcements. 11.20: Musical interlude. 11.30: Request numbers. 11.40: Music and vocal items. 11.55: Where to go to-night. 12 noon: Closing announcements.

**CHILDREN'S SESSION.**

6.0 p.m.: Birthday calls, request numbers, and kiddies' entertainment, Aunt Jemima and Uncle Bert.

**EVENING SESSION.**

7.0: Musical interlude.  
7.15: Sporting feature. Complete review of to-day's racing, Mr. Geo. A. Davis.  
7.40: Health feature.  
8.0: Hawaiian steel guitar selections.  
8.15: Tenor solos, Mr. Chas. E. Macdonald  
8.30: Banjo solos, Master Harry Weir.  
8.36: Al. Rosenberg at the piano.  
9.10: Sporting feature. Presented by Tooth and Co., Ltd., Kent Brewery. From Sydney Stadium. Full description of main 15-round event.  
9.50: Music from the studio.  
10.0: Closing announcements.

**2UE**

Broadcasting Station 2UE, Everett Street, Maroubra Sydney (Wavelength, 293 Metres).

**EARLY MORNING SESSION**

7.15 a.m.: Breakfast Time Hour Orchestral Music. 8.30: Announcements. Close down

**EVENING SESSION**

7.15: Orchestral dinner music. 7.58: Programme announcements 8.0: Overture, "La Traviata." 8.10: Orchestral and vocal concert. 10.15: Close down.

**2UE**

Broadcasting Station 2UE, Everett Street, Maroubra Sydney (Wavelength, 293 Metres).

**Saturday, September 7**

**EARLY MORNING SESSION**

7.15: Breakfast Time Hour Orchestral items. 8.30: Close down.

**EVENING SESSION**

7.15: Orchestral dinner music. 8.0: Overture, "La Tosca." 8.10: Orchestral and vocal items. 10.30: Close down.

# Wireless Weekly

**52 ISSUES  
DELIVERED  
POST FREE FOR  
ONE YEAR**

**13/-**

"WIRELESS WEEKLY" gives you the complete broadcasting programmes from every important station in Australia a week in advance, in addition to topical news and articles, and a technical constructive article by a qualified radio man.

**SUBSCRIPTION FORM**

To the Editor, "Wireless Weekly," Box 3366PP., G.P.O., Sydney.

Please forward "Wireless Weekly" for a period of ..... for which I enclose ..... for ..... (Add Exchange to Country Cheques.)

NAME .....

ADDRESS .....

Subscription Rates: 12 months (52 issues), 13/-, post free; 6 months (26 issues), 6/6, post free.



## RADIO A. B. & C. BATTERIES

Because more electrical energy is packed into BOND Batteries, they contain more power. Their exceptional recuperative qualities during rest periods restore that electrical energy—and make BOND Batteries Cost less per Radio Hour.

- 3071—45 volts B Upright, extra large cells
- 3061—45 " B Upright, large cells
- 3045—45 " B Flat large cells
- 1512—22½ " B Flat
- 312—4½ " C

For clear, steady volume; for even, uniform reception month in and month out; for enjoyable, less costly radio hours—demand BOND Batteries!

**THERE'S A BOND BATTERY FOR EVERY BATTERY NEED**

General Australasian Agents:

ATKINS, MACLEAN, Ltd., 119 York Street, Sydney  
BOND ELECTRIC CORPORATION, Jersey City, N.J., U.S.A.

**OBTAINABLE AT ALL DEALERS**



# Interstate Programmes, Wednesday, September 11

## 3LO

Australian Broadcasting Co., 120A Russell St., Melbourne (Wavelength, 371 Metres).

### EARLY MORNING SESSION.

7.0 to 8.15.—See Friday.

### MORNING SESSION.

10.30: Current happenings in sport, by Mel Morris. 10.45: A.B.C. Studio Orchestra. 12.0: Melbourne Observatory Time Signal. 12.1: Orchestra. 12.15: News service; British Official Wireless; Corn Exchange; midday report; Newmarket stock sales; Association Stock and Station Agents' official report. 12.30: Close down.

### MIDDAY SESSION

1.0: Melbourne Observatory Time Signal; Stock Exchange information; meteorological data; weather forecast for Victoria, New South Wales, South Australia, and Tasmania; ocean forecast; river reports; rainfall; comments on the day's news. 1.30: Transmission from the Rotary Club luncheon.

### EDUCATIONAL SESSION.

2.0: Reading aloud. Miss Alice Smith. 2.15: Musical interlude. 2.25: Rambles in the Bush. Mr. Chas. Daley. 2.35: Musical interlude. 2.45: How Our Laws Are Made. Hon. J. H. Keating, LL.B.

### THE RADIO MATINEE

Transmission from the Melbourne Town Hall. 3.0: An orchestral programme for the State School Students, arranged by Professor Bernard Heinze, with the University Symphony Orchestra, in conjunction with the National Broadcasting Orchestra. 4.30: Close down.

### THE CHILDREN'S CORNER.

5.45: "Little Miss Kookaburra"—Stories for the children. 6.0: Musical interlude. 6.5: Birthday Greetings.

### EVENING SESSION.

6.40: Romantic Historical Stories, Mr. J. R. Lyall. 6.45: Musical interlude. 7.0: Melbourne Observatory Time Signal. 7.1: Countrymen's session.

### THE LECTURETTE SESSION.

7.25: Technical talk for Mechanics, Iron and Steel in Australia. Professor J. Neill Greenwood. 7.40: News. 7.45: How to Attain and Retain Good Health. "Building Strong Teeth for Children Before and After Birth." Mr. T. J. Ryan, L.D.S., B.D., B.Sc.

### NIGHT SESSION.

8.0: A special programme arranged by Professor Bernard Heinze. 9.0: A playlet, "The Camberly Triangle," produced by Terence Crisp. 9.20: National Broadcasting Orchestra. Under direction Wm. G. James; conductor, Percy Code. March, "Procession of Bacchus," from the ballet, "Sylvia" (Delibes). 9.25: The A.B.C. Christy Minstrels, in a complete little programme of Fun and Melody. 9.35: Orchestra—"Valse Triste" (Sibelius); Waltz; "Allegro from Fifth Symphony" (Tschaiikowsky). 10.5: Elsie Stewart and Victor Drinkwater—"What a Girl! What a Night" (Sanders); "Blue Hawaii" (Bauer); "Nobody's Fault but your Own" (Noble); "Stay at Home Girl" (Jack O'Hagan). 10.20: Meteorological information. British official wireless news, items of interest. 10.30: The "Rex" Dance Band. 11.30: God Save the King.

## 3AR

Australian Broadcasting Co., 120A Russell St., Melbourne (Wavelength, 384 Metres).

### MORNING SESSION

8.15 to 11.0 See Friday.

### MIDDAY SESSION

12.0: Chimes. 12.1: Food and Cookery Meal Planning.—Miss E. Chisholm, B.A., Melb., M.A. (Toronto). 12.15: Organ Recital from the Melbourne Town Hall, Dr. W. G. Price. 12.45: Luncheon Music, supplied by the National Broadcasting Orchestra, under direction Wm. G. James; conductor, Percy Code. 2.0: Chimes.

### AFTERNOON SESSION

2.0: Piano recital by Rachmaninoff. 2.15: Selected Dances. 2.33: Zex Conifery the Master of Rhythm. 2.45: A specially selected programme of request numbers. 3.20: The Pre-school Child. The Educational Contribution of the Nursery School. Miss M. Lush. 3.35: Musical interlude. 3.40: The Wrong and Right Thing to Say. Miss Eva Leon. 3.55: Musical interlude. 4.0: Home Life in Other Countries. (4) Holland. Miss D. Babington. 4.15: Reproduced music. 5.0: G.P.O. chimes. 5.30: Weather data. 5.45: Close down.

### EVENING SESSION

6.15: Dinner music, supplied by the A.B.C. Studio Orchestra. 7.30: What's On the Air To-night? 7.32: Latest musical releases. 8.0: G.P.O. chimes.

## NIGHT SESSION

8.1: A special reproduction of "La Traviata" (Verdi), with the Milan Symphony Orchestra and full chorus, conducted by Cav. Lorenzo. 9.0: Why We Behave as Human Beings—(5) The Emotion of Fear. Prof. J. A. Gunn, M.A., B.Sc., Ph.D. 9.15: "La Traviata" continued. 10.0: Weather information and "Herald" news. 10.10: "La Traviata" continued. 10.30: God Save the King.

## 3DB

The "Herald" Broadcasting Station, Flinders Street Melbourne (355 Metres).

### MORNING SESSION.

11.0: Hal Swan's Dance Band—"Virginia" 11.30: "La Vogue"—"The World's Fashions and Fables." 11.35: Victor Salon Trio—"Mother Machree." 12.0: New Queen's Hall Orchestra—"Ride of the Valkyries" (Wagner). 12.30: Geo. Brown—"My Mother's Eyes." 1.0: The Millmore Band—"Whistling Farmer's Boy." 1.15: Pioneer Motors' sponsored session. 1.45: Close down.

### AFTERNOON SESSION.

2.15: Percy Grainger (piano)—"Shepherds, Hey." 2.30: Mrs. Dorothy Silk—"Homesteads." 2.45: Fred Hall and His Sugar Babies—"She Only Laughs at Me." 3.0: Atwater Kent Radio Hour, sponsored by A. G. Heising, Ltd., and E. T. Muir. 4.0: Close down.

### EARLY EVENING SESSION.

4.45: Choral evensong, transmitted from St. Paul's Cathedral. 5.30: Milan Symphony Orchestra—"Semi-ramide." 6.0: Kirkby Lunn (contralto)—"A Memory" (Goring-Goldass). 6.30: Cass Hagan and his Orchestra—"Golden Gate." 7.0: Syd Smith (comedian)—"Ma, Look at Charlie." 7.15: Market reports, by John M'Namara and Co. Pty., Ltd. 7.25: Ball Room Orchestra—"Paul Jones." 7.30: Market reports, by Gippsland and Northern Co-operative Co., Ltd. 7.35: The Trix Sisters—"Rock-a-bye, Baby." 7.45: Mr. Harman, of Burns, Philp, and Co.—"A Travel Talk."

### EVENING SESSION.

8.0: Paul Whiteman and his Orchestra—"Mother Goose Parade." 8.30: Rhodes Motors' sponsored session. 9.0: Leslie Sarony—"Daddy Om Bom Bom." 9.30: Regimental Band of H.M. Grenadier Guards—"The Sisters." 10.0: Arnold Grier (organ)—"Blind Ploughman." 10.30: Henry Millidge (tenor)—"Have You Seen But a Whyle Lillie Grow." 10.40: News. 10.45: "God Save the King."

## 4QG

Queensland Government Radio Service, Brisbane (Wavelength, 385 Metres).

For day sessions, see Friday.

### NIGHT SESSION.

8.0: Alf Featherstone and his Orchestra—"Fox trots, "Deep Night" (Henderson). "A Stay-at-Home Girl" (O'Hagan). 8.10: The Albert Trio. A quarter of an hour's fun. 8.25: Alf Featherstone and his Orchestra—"Fox trots, "Happy Humming Bird" (Dixon). "When Summer is Gone" (Wilhite). 8.35: Kathleen Kelly, soprano—"Break, Dawn of Delight" (Maundrell). "Little Orphan Coon" (Wood). 8.45: Alf Featherstone and his Orchestra—"A quarter of an hour's dance music." 9.0: Metropolitan weather forecast. Movements of Travelling Dental Clinic. 9.5: The Hoot Owls, twenty minutes' fun. 9.25: Alf Featherstone and his Orchestra—"Jazz waltz, "Nadina" (Pola). 9.30: From the Studio—The main bouts held in connection with the Brisbane amateur boxing and wrestling championships meeting will be described from the Stadium. Dance music will be broadcast between bouts. 10.30: From the Studio—News supplied by courtesy of the metropolitan dailies; weather information. 10.40: Alf Featherstone and his Orchestra—"Twenty minutes' dance music." 11.0: Close down.

## 5CL

Central Broadcasters, Ltd., 114 Hindmarsh Square, Adelaide (Wavelength, 409 Metres).

### MORNING SESSION.

11.15 to 2.0: See Friday.

### AFTERNOON SESSION.

3.0 to 4.30: See Friday.

### EVENING SESSION.

5.45: Port Adelaide acceptances. 6.0: Resume of Strathalbyn and Sandown Park race results. 6.1: Birthday greetings. 6.30: Dinner session. 7.0: Chimes. 7.1: Senior Birthday League greetings; general market reports. 7.25: "Who" Manning on "Football." 7.25: Boy Scouts' Corner. 7.35: 5CL Bluebird Girls' Club.

### NIGHT SESSION.

8.10: A Fireside Evening—Captain Rupert Hazell and his Jolly Jack Tars, including the following artists:—Angelo Demodena. Luigi Patrucco. The Madrigal Singers. Elsie Day. Bert. Woolley. Don Wildsmith. 9.0: Chimes.

9.1: Meteorological information, including Semaphore tides.

British official wireless news. Meteorological information. Announcements. 5CL's sporting service, including a resume of Strathalbyn and Sandown Park race results. 10.30: Modern dance recordings. 11.0: Close down.

## 6WF

Commonwealth Government Broadcasting Station, Perth (Wavelength, 160 Metres).

10.0: Gramophone records. 11.0: Close down. 12.30: Markets, news, etc. 1.0: Time signal. 1.1: Weather bulletin. 1.3: Music. 1.30: Close down. 3.30: Afternoon programme. 4.30: Close down. 6.45: Bedtime stories by Uncle Duffy. 7.5: Light music. 7.30: Commercial information. 7.45: Talk by Mr. Hal M'Kail. 8.0: Time signal. 8.1: First weather bulletin. 8.3: A relay. 8.50: Late news; ships within range; late weather bulletin. 10.30: Close down. 10.4: 5 Metre Transmission.—Simultaneous broadcast on 104.5 metres of programme given on 1250 metres, commencing at 6.45 p.m.

## 7ZL

Tasmanian Broadcasters Pty., 95 Elizabeth Street, Hobart (Wavelength, 516 Metres).

11.30 a.m.: Record recital. 11.34: Midlands weather forecast. 11.35: Record recital. 11.55: Tasmanian stations 9 a.m. weather report. 12.0: G.P.O. clock chimes the hour. 12.1: Shipping information; mail notices; housewives' guide. 12.8: Record recital. 12.30: News service; announcements. 12.40: Record recital. 1.5: British official wireless news; railway auction sales. 1.10: Record recital. 1.30: Transmission from the Imperial Hotel, Collins Street, Hobart; speeches at the Rotary Club luncheon. 2.0: Close down. 3.0: G.P.O. clock chimes the hour. 3.1: Record recital. 3.4: Weather information. 3.5: Record recital. 4.15: Readings from the "Illustrated Tasmanian Mail." 4.30: Close down. 6.15: Children's Hour with "Bertha Southey Bramhall." 7.15: News session. 7.30: Belle St. Lawrence will continue her "Travel Talks." 7.45: V. C. Webb will speak on "Driving Hints." 8.0: G.P.O. clock chimes the hour. 8.1: Record recital. 8.6: A Columbia recital, including latest releases, specially arranged by Findlay's Music Warehouse. 9.30: News session. 9.45: Record recital continued. 10.0: G.P.O. clock chimes the hour. 10.1: Close down.

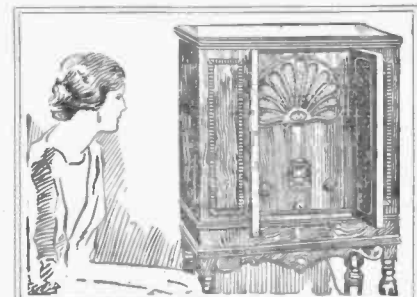

IMPORTED

# FADA Radio

Built in FADA WITH Dynamic Speakers—Push-pull Power Amplifiers—Radio Phono-graphic Combination.

All Electric Sets that leave nothing to be desired by lovers of Radio. Before buying any set call and listen in to the full range of Fada models. Compare the Tone—Selectivity—Price—Quality.

## 7-8-9 VALVE RECEIVERS

Special Plugs for Using Gramophone Pickup. OPEN FRIDAYS TILL 9 P.M.

# Winkworth's

337 George Street (nearly opp. Martin Place). SYDNEY; and at 160-164 Parramatta Road, ANNANDALE.



**MULLARD  
A.C. VALVES**  
*do their duty.*

To-day, as in Nelson's day, the Empire is beset with competition from without. Then, it was armed aggression—to-day it is commercial competition—and the famous signal, "England Expects" . . . is still the watchword of Mullard.

Those who use Mullard Valves are always sure that Mullard will never "let them down."

DO  
YOUR  
DUTY



*Mullard Loud Speakers  
speak volume of quality.*

Ask your Dealer for Booklet  
describing Mullard Valves and  
Speakers, or write

A. SEAL PRITCHETT (Aust.), LTD.  
17 Parker Street, Sydney, or  
150 Queen Street, Melbourne.



G&G

A14-29

**Mullard**  
**THE MASTER VALVE**

# Local Programmes, Thursday, September 12

## 2FC

Australian Broadcasting Company, Ltd., Market St., Sydney (Wavelength, 432 Metres).

### EARLY SESSION, 7 to 8.15 a.m.

7.0: "Big Ben" and meteorological information for the man on the land.  
7.3: This morning's news, from the "Sydney Morning Herald."  
7.8: Early rising music.  
7.45: Mails and shipping.  
7.48: What's on to-day?  
7.50: Children's birthday calls  
8.0: Music from the studio.  
8.15: Close.

### MORNING SESSION, 10.30 a.m. to 12.30 p.m.

10.30: Announcements.  
10.32: A.B.C. Racing Observer.  
10.45: Recital on the grand organ, by Edgar Stone.  
11.0: Household helps, domestic notes by Miss Ruth Furst.  
11.10: Cables, A.P.A. and "Sun"-Herald" news service, British Official Wireless Press  
11.15: Morning devotion.  
11.30: Austradio musical reproduction.  
12.0: "Big Ben," Stock Exchange, and metal quotations.  
12.5: "With the Poets," Eleanor Ross.  
12.20: Midday weather forecast and weather synopsis; special produce market session for the man on the land, supplied by the State Marketing Board.  
12.30: Close.

### THE LUNCH HOUR, 1 p.m. to 2.30 p.m.

1.0: Lunch to music with the National Broadcasting Orchestra.  
2.0: Stock Exchange, second call.  
2.2: A glance at the afternoon "Sun" and "News."  
2.7: To-day's acceptances by the A.B.C. Racing Observer.  
2.17: Popular education, "Spoken English," by C. N. Baeyeritz.

### THE RADIO MATINEE, 2.30 to 4.30 p.m.

2.30: The Harmonists.  
2.42: Aldyth Hern, soprano.  
2.49: Dorothy Farmer, pianist.  
(a) "Minuet and Trio," from "Sonata in E Flat Major" (Beethoven).  
(b) "Consolation E Major" (Liszt).  
3.0: The Harmonists.  
3.15: William Bowyer, basso.  
3.22: Clyde Thorpe, violinist.  
(a) "Serenade" (Haydn-Auer).  
(b) "Bolero" (Burlleigh).  
3.29: The Harmonists.  
3.41: Aldyth Hern, soprano.  
3.48: Dorothy Farmer, pianist.  
(a) "Consolation D Flat Major" (Liszt).  
(b) "Concerto Studio D Flat Major" (Liszt).  
3.58: Clyde Thorpe, violinist.  
(a) "Negro Chant" (White).  
(b) "Mazurka" (Meyer-Helmund).  
4.5: William Bowyer, basso.  
4.12: The Harmonists.  
4.28: Stock Exchange, third call.  
4.30: Close.

### EARLY EVENING SESSION, 5.45 to 7.55 p.m.

5.45: Kiddies' "Good-night" stories told by Aunt Goodie, assisted by Cousin Marjory.  
6.45: The National Broadcasting Orchestra will play dinner music.  
7.30: A.B.C. sporting service.  
7.37: Special country session; Stock Exchange resume; markets; weather forecast; late news service from the "Sun" and "News"; truck bookings.  
7.58: To-night's programme.

### THE EVENING PRESENTATION, 8 p.m. to 11.30.

2FC to-night offer a pot-pourri programme. 2BL's programme includes an "Hour from the Capitol."  
8.0: Virginia Bassett, soprano, in a group of Irish songs, with instrumental accompaniment, and popular airs by the Trio.  
8.20: "Cameos of Our City," by C. R. Hall.  
8.40: Laurence Godfrey Smith, pianoforte recital.  
9.5: The Country Man's weather session.  
(a) New South Wales forecasts.  
(b) Inter-State weather synopsis.  
3.8: B. R. Strother and William Everard. "Impressions of Eugene Swattan."

9.30: Organ recital by Ewart Chapple.  
9.40: Jack Lumsdaine, radio rascal.  
10.0: A scene from Dickens, "Bardell v. Pickwick," arranged by Gilbert Howell.  
10.20: Hilda Lane and Dorothy Benbow, in a pot-pourri of popular duets.  
(a) "Rose-Way" (Leoncavallo).  
(b) "I Wish I Were a Tiny Bird" (Lohr).  
(c) "In Springtime" (Newton).  
10.30: From the Stadium, description of the finals of the amateur wrestling and boxing contests.  
11.0: From the Hotel Australia, Cec. Morrison's Dance Band.  
11.30: Close. National Anthem.

## 2BL

Australian Broadcasting Company, Ltd., Market St., Sydney (Wavelength, 333 Metres).

### OPENING SESSION, 8.15 a.m. to 11 a.m.

8.15: G.P.O. chimes. Music for every mood.  
8.45: Meteorological data for the country.  
8.50: A musical interlude.  
9.30: British official wireless news.  
9.35: New music.  
10.2: News from the "Labor Daily."  
10.5: News from the "Sydney Morning Herald."  
10.10: The Australian Broadcasting Company's Women's Association.  
10.30: Celebrity items.  
10.45: A morning story.  
11.0: G.P.O. chimes. Close.

### MIDDAY SESSION, 12 Noon to 2.30 p.m.

12.0: G.P.O. chimes; announcements.  
12.2: The National Broadcasting Orchestra.  
1.0: Afternoon news, from the "Evening News" and "The Sun."  
1.5: Studio music.  
1.15: Women's interest talk, "Actresses," by Annie Hughes.  
1.30: A recital of instrumental music.  
2.0: J. Knight Barnett, at the Wurlitzer.  
2.12: Studio music.

### AFTERNOON ENTERTAINMENT, 2.30 p.m. to 5.45 p.m.

2.30: Business efficiency talk, by Brunton Gibb.  
2.45: "The Magic Carpet," a story of travel and adventure, by F. H. Raward.  
3.0: From the ballroom of the Oriental, Sydney Simpson's Syncopaters, in dance music.  
3.12: From the studio, The Ahad Duo, steel guitars.  
(a) "Hawaiian Lullaby" (Bridges).  
(b) "Southern Blues" (Fererra).  
3.19: A popular number.  
3.22: From the ballroom of the Oriental, Sydney Simpson's Syncopaters, in dance music.  
3.39: From the studio, Kathleen Roe, pianoforte solos.  
(a) "Nocturne" (Chopin).  
(b) "Gigue" (Bach).  
3.44: From the ballroom of the Oriental, Sydney Simpson's Syncopaters, in dance music.  
3.52: From the studio, William Everard, tenor.  
4.0: From the ballroom of the Oriental, Sydney Simpson's Syncopaters, in dance music.  
4.12: From the studio, The Ahad Duo, steel guitars.  
(a) "Hawaiian Hula" (Cunha).  
(b) "A Popular Medley" (Christy and Meyer).  
4.19: A dance number.  
4.22: From the ballroom of the Oriental, Sydney Simpson's Syncopaters, in dance music.  
4.32: From the studio, Kathleen Roe, pianoforte solos.  
(a) "Londonderry Air" (Grainger).  
(b) "Molly on the Shore" (Grainger).  
4.40: Popular music.  
4.45: "The Trade Hour," demonstration music.  
5.45: Weather information, Close.  
THE DINNER HOUR, 6.15 p.m. to 7.55 p.m.  
6.15: The National Broadcasting Orchestra plays dinner music.  
6.45: The "Younger Set" session, Girls Radio Club, conducted by Miss Gwen Varley.  
7.5: Studio music.

The Country Man's market session: Wool, wheat, stock, farm produce, fruit, vegetables, pig, and poultry markets.  
7.30: The National Broadcasting Orchestra.  
7.45: Celebrity music.  
7.55: What's on the air to-night?

### TO-NIGHT'S PRESENTATION, 8 p.m. to 10.30 p.m.

8 p.m.: G.P.O. chimes.  
From the Capitol Theatre: Ted Henkel and the Capitol Orchestra; Fred Scholl at the Wurlitzer.  
8.30: From the Stadium, description of the finals of the amateur boxing and wrestling contests.  
10.25: From the studio. Official weather forecast, metropolitan and country; late news from the "Evening News" and "The Sun."  
10.30: Close. National Anthem.

## 2GB

Theosophical Broadcasting Station, 29 Bligh St., Sydney (Wavelength, 316 Metres).

10.0: Music.  
10.10: Happiness talk, by A. E. Bennett.  
10.20: Music.  
10.30: Women's session, by Miss Helen J. Beegling.  
11.30: Music.  
11.45: Close down.  
2.0: Music.  
2.5: Women's Radio Service, by Mrs. Dorothy Jordan.  
2.50: Music.  
2.55: Gardening talk, by Mr. Prior.  
3.0: Labor-saving demonstration from Buckingham's, Ltd.  
4.0: Close down.  
5.30: Children's session, by Uncle George.  
7.0: Music.  
7.15: Gardening talk, by Mr. Prior.  
7.30: Music.  
7.45: Feature story.  
8.0: Miss Florence Day, contralto.  
8.7: Symphony Orchestra.  
8.15: Mr. Leslie Herford, baritone.  
8.22: Violin solos.  
8.30: Mr. Jack Win and Miss Nora Windle, in a humorous sketch.  
8.40: Miss Dorothy Stacey.  
8.50: Symphony Orchestra. Weather report.  
9.3: Address, Miss Florence Day, contralto.  
9.25: Symphony Orchestra.  
9.30: Mr. Leslie Herford, baritone.  
9.40: Mr. Jack Win and Miss Nora Windle, in a humorous sketch.  
9.50: Miss Dorothy Stacey, soprano.  
10.0: Instrumental music.  
10.30: Close down.

## 2KY

Trades and Labor Council, Goulburn St., Sydney (Wavelength, 280 Metres).

### MORNING SESSION

10.0 a.m.: Tune in to the ticking of the clock.  
10.3: Popular fox trots.  
10.15: Hawaiian steel guitar selections.  
10.30: Women's Session. Home Hints and Information; conducted by Mrs. Gray.  
11.0: A few laughs.  
11.5: Pianoforte selections.  
11.15: Calls and announcements.  
11.20: Musical interlude.  
11.30: Request numbers.  
11.40: Music and vocal items.  
11.55: Where to go to-night.  
12.0 noon: Closing announcements.

### CHILDREN'S SESSION

6.0 p.m.: Birthday calls, request numbers and kiddies' entertainment; Aunt Jemima and Uncle Bert.

### EVENING SESSION

7.0: Musical interlude.  
7.5: Birthday calls.  
7.15: Request numbers.  
7.30: Hawaiian steel guitar selections.  
7.45: Humorous interlude.  
8.0: Orchestral selections.  
8.10: Tenor solos. Mr. G. Mason.  
8.17: A humorous interlude.  
8.30: Frederick Holt presents a recital of Australian composers and compositions, with musical and vocal illustrations.  
8.45: Selection of humorous records.  
9.10: Request numbers.  
9.40: Continue record recital.  
10.0: Closing announcements.

## 2UE

Broadcasting Station 21E, Everatt Street, Maroubra Sydney (Wavelength, 293 Metres).

### MIDDAY SESSION

11.30 a.m.: Orchestral and vocal music.  
12.30: Close down.

### AFTERNOON SESSION

1.0: Vocal and instrumental items.  
1.45: Organ recitals.  
2.0: Orchestral music.  
2.30: Announcements. Close down.

### EVENING SESSION

7.15: Orchestral dinner music.  
7.58: Programme announcements.  
8.0: Overture, "Barber of Seville."  
8.10: Musical items.  
10.15: Close down.



# EMMCO'S

BOTH ARE SYMBOLS  
OF PROTECTION & UNSFAILING SERVICE

## GUARANTEED RADIO PRODUCTS

- ELIMINATORS
- CHARGERS
- VERNIER DIALS
- RHEOSTATS
- A.C. PRODUCTS
- CONDENSERS
- ETC.

### De Luxe Vernier Dial

A most up-to-date De Luxe Bakelite Vernier Dial, which exemplifies Emmcos high-grade workmanship.

Body capacity Eliminated. Simply operated, accurate tuning, no backlash. Logging windows right and left.

PRICE ..... 9/6  
SAME ILLUMINATED ..... 13/6



### Super Stratelyste Condenser

A most perfectly constructed Condensers with cast Bakelite Base. Gives correct minimum and maximum capacities. Perfectly insulated. True alignment. Pig-tailed connections. Brass plates for either base or panel mounting.

Prices .0005 12/6, .00035 and .00025 12/-



### Mello Vernier Drum Control

A highly efficient Vernier Drum Control, with handsome escutcheon finished in either Oxy Copper or Oxy Silver. Will carry five or more condensers on 1-4 shaft. (Specially adapted for screened grid valves).

PRICE ..... 25/-  
ILLUMINATED ..... 28/-  
With 3 Condensers mounted £4/4/-, with 4 Condensers £5/5/-, with 5 Condensers £6/6/-, in 2 capacities, .0005 and .00035.



### Mello Metal Vernier Dial

The Mello Metal not only adds to the appearance of your set, but adds to its efficiency. Wonderfully smooth action, strong friction drive, fine adjustment. Clockwise or anti-clockwise.

The handsome escutcheon is finished in Oxy Silver or Oxy Copper.  
PRICE ..... 9/6  
ILLUMINATED ..... 12/6



### Maxum "B" Eliminator

The exceptional features of the Emmco Maxum "B" have quickly brought it into prominence. It is designed to operate sets up to and including seven valves, and has a variation of 20 volts for all tapplings.

PRICE ..... £8/15/-  
A Maxum "B" and an "A" Socket Power Supply make your set All Electric.



### A.C. Transformer

An A.C. or Power Pack Transformer made up in an attractive metal case.

Type F325, for Radiotron or Mullard Valves, 3 pairs Tapplings.  
PRICE ..... 35/-

Type FA15, for Arcturus Valves, 15-volt Tapplings.  
PRICE ..... 30/-

Type FP4, for Philips Valves, 2 pairs Tapplings.  
PRICE ..... 30/-

Type FO538, for Osram Valves.  
PRICE ..... 35/-



### Puratone Transformer

A real quality Transformer at a moderate price, gives the maximum amount of amplification without distortion. Allows the reproduction of the most natural tone. Solidly impregnated. Made up in all metal case.  
IN 3 RATIOS. PRICE ..... 15/6



### New Bakelite Rheostat

The new Bakelite Rheostat is most efficient. Very compact and only 1 1/2 inches in diameter. Moisture proof and made with special resistance wire. Remarkably smooth operation. Single Hole mounting. Strong and perfect striking plates, made up in 6, 10, 20, and 30 ohms.

PRICE ..... 4/6  
Potentiometer, same quality ..... 5/6



Made by Electricity Meter Mfg. Co., Ltd.

SOLE FACTORY REPRESENTATIVES:

## MANUFACTURERS PRODUCTS PTY., LTD.,

SYDNEY: 137-9 Clarence St. Phone: BW 1328 (3 lines).  
MELBOURNE: Sugden Place. Phone: F 2355.

# Interstate Programmes, Thursday, September 12

## 3LO

Australian Broadcasting Co., 120A Russell St., Melbourne (Wavelength, 371 Metres).

**EARLY MORNING SESSION.**  
7.0 to 8.15: Bee Friday.

**MORNING SESSION.**  
10.30: Current Happenings in Sport by Eric Welch.  
10.45: A.B.C. Studio Orchestra. 12.0: Melbourne Observatory time signal. 12.1: Orchestra. 12.15: News service; British official wireless news; Corn Exchange report; Newmarket stock sales; Associated Stock and Station Agents' official report. 12.30: Close down.

**MIDDAY SESSION.**  
1.0: Melbourne Observatory time signal; Stock Exchange information; meteorological data; weather forecast for Victoria, New South Wales, South Australia, and Tasmania; ocean forecast; river reports; rainfall; comments on the day's news. 1.20: Community Singing, transmission from the Melbourne Town Hall.

**EDUCATIONAL SESSION.**  
2.0: Great Australians. 5. Charles C. Kingston, Mr. J. Howlett Ross. 2.15: Musical interlude. 2.25: Music Explained and Illustrated, "Music of To-day." Mr. A. E. H. Nickson, F.R.C.O., A.R.C.M. 2.40: Musical interlude. 2.45: Romantic stories of Australia's Early Days, Mr. C. N. Long, M.A.

**THE RADIO MATINEE**  
3.0: National Broadcasting Orchestra, under direction Wm. G. James; conductor, Percy Code. March, "Hero" (Saint-Saens). "Scene de Ballet" (Glazanov). 3.10: Etta Bernard, contralto. 3.17: J. Geary, trumpet solo, "Macushla" (M'Murrough). 3.21: Tom Sempie, tenor—"In Beauty Moulded" (Sandford). "The Coming of Spring" (Rachmaninoff). 3.28: The Mayana Trio—"The Bonnie Blue Kerschiel." "The Marriage Moon." "Sheridan's Ride." 3.38: Lillane Gay, soprano. 3.45: Orchestra—"The Music Box" (Friml). "Reconciliation" (Drigo). serenade, "Les Millions d'Arlequin" (Drigo). 3.55: Etta Bernard, contralto. 4.2: Marion Lightfoot, banjo—"Peach Blossoms" (Mosley). "Banjo Oddity." 4.7: Tom Sempie, tenor—"Sometimes in Summer" (Steread-Bennett). "Phyllis has such Charming Graces" (Anthony Young). 4.12: Orchestra—"Two Light Syncopated Pieces" (Coates). 4.16: Lillane Gay, soprano. 4.23: Orchestra—Trumpet solo, "Geary." "Where my Caravan has Rested." Orchestra, "Prelude in C Sharp Minor" (Rachmaninoff). 4.30: Close down.

**THE CHILDREN'S CORNER**  
5.45: "Bobby Bluegum" in song and story. 6.5: Birthday greetings.

**EVENING SESSION.**  
6.40: Let's Talk about our Animals. 5. "The Sheep Dog." Mr. J. L. Moore. 6.55: Musical interlude. 7.0: Melbourne Observatory time signal. 7.1: Countrymen's Session. 7.25: For the Man on the Land. "Potato Cultivation Preparation for Cropping." Mr. J. T. Ramsay. 7.40: News. 7.45: Novels and Authors of To-day, Mr. A. E. M'Nicken.

**NIGHT SESSION.**  
8.0: National Broadcasting Orchestra, under direction, Wm. G. James. Conductor, Percy Code. Overture, "Sakuntala" (Goldmark). 8.10: Bessie Dougall, contralto—"Home is Calling" (Hill). "Carmens" (Lane Wilson). 8.17: Interlude—"You will hear the outstanding personality of a subject of the week." Our Dance Night. 8.30: Ken. Cotton's Dance Band—"Blue Night" (Rollins). "Give Me the Southland" (Sissel). "A Room with a View" (Coward). 8.39: Austin Anderson—Entertainer at the piano. 8.42: Ken. Cotton's Dance Band—"I'm Crazy Over You" (Sherman). "I Can't Do Without You" (Berlin). "Watching the World Go By" (Bail). 8.50: Arthur Douglas, Scottish comedian—"We a' Go Hame the Same Way." 8.53: Ken. Cotton's Dance Band—"You're Just a Flower" (Dennit). "Some of these Days" (Brooke). "All Over You" (Leode). 9.2: Bessie Dougall, contralto—"Little Northern Window" (Anthony Dares). 9.5: Ken. Cotton's Dance Band—"Hugs and Kisses" (Altar). New numbers. 9.14: Russell Callow, tenor—"Come, for It's June" (Forster). 9.17: Ken. Cotton's Dance Band—"Stay at Home Girl" (C'Hagen). "Deep Night" (Henderson). Selected. 9.25: Austin Anderson—Entertainer at the piano. 9.30: Ken. Cotton's Dance Band—"Forever More" (Burnet). "Old Man Sunshine" (Dixon). Request number. 9.40: Arthur Douglas, Scottish comedian—"She is my Rosie." 9.43: Ken. Cotton's Dance Band—"My Heart Stood Still" (Rogers). "Where the Shy Little Violets Grow" (Kahn). New number. 9.52: Bessie Dougall, contralto—"Down Here" (May Brahe). 9.55: Ken. Cotton's Dance Band—"Ten Little Miles from Town" (Kahn). "She's Funny that Way" (Morek). "Sally of my Dreams" (Kernel). 10.4: Russell Callow, tenor—Latest popular song. 10.7: Ken. Cotton's Dance Band—"When Summer is Gone" (Wilnite). "Wedding of the Painted Doll" (Brown). Request number.

10.17: Austin Anderson—Entertainer at the piano. 10.20: Ken. Cotton's Dance Band—"I Always Knew I'd Find You" (Waynet). "If I Had You" (Campbell). "Another Kiss" (Schertzingler). 10.30: Meteorological information. British official wireless news; items of interest. 10.40: Ken. Cotton's Dance Band—"All by Yourself in the Moonlight" (Wallis). "Sleep, Baby, Sleep" (Tucker). Request item. 10.49: Russell Callow, tenor—Latest song hit. 10.52: Ken. Cotton's Dance Band—"Humoreskino" (Wendling). "In a Little Town called Home, Sweet Home" (Donaldson). "I Paw Down and Go Boom" (Brockman). 11.0: Arthur Douglas, Scottish comedian—Request items. 11.5: Ken. Cotton's Dance Band—Latest and brightest jazz numbers. 11.30: God Save the King.

## 3AR

Australian Broadcasting Co., 120A Russell St., Melbourne (Wavelength, 484 Metres).

**MORNING SESSION**  
8.15 to 11.0: See Friday.

**MIDDAY SESSION**  
12.0: Chimes. 12.1: Community Singing from the Melbourne Town Hall. Conductor, Frank Hatherley. 1.1: Luncheon music, supplied by the National Broadcasting Orchestra, under direction Wm. G. James; conductor, Percy Code. 2.0: G.P.O. chimes.

**AFTERNOON SESSION**  
2.1: Recordings. 3.20: A "First Night," as viewed by one of the Gallery Queue. Miss Hattie Knight. 3.35: Reproduced music. 3.40: Food and Cookery. Gas Cooking. Miss E. Noble. 3.55: Reproduced music. 4.0: Your Health and Appearance. How to Minimize Fatigue. Miss Evelyn N. Ellis. 4.15: Reproduced music. 4.45: Evenson transmitted from St. Paul's Cathedral. 5.30: From the studio. Weather data. Acceptances and barrier positions for the Moonee Valley Race, on Saturday, September 14. 5.35: Reproduced music. 5.45: Close down.

**EVENING SESSION**  
6.15: Dinner music, supplied by the A.B.C. Studio Orchestra. 7.30: What's On the Air To-night? 7.32: Latest musical releases. 8.0: Chimes.

## 3AR

**NIGHT SESSION**  
8.1: The Harmonists' Male Quartette—"A Medley." "They Kissed." 8.10: Helen Hamerton (violin)—"Chanson Arabe" (Kerschoff-Kriesler). "Liebeslied" (Kriesler). "Humoresque" (Tschaiowsky). 8.17: Frank Nicholson (bass)—"Give a Man Horse" (O'Hare). "Sylvia" (Speaks). 8.24: National Broadcasting Orchestra, under direction of Wm. G. James; conductor, Percy Code. "The Andante Cantabile," from Fifth Symphony" (Tschaiowsky). 8.30: One-act play—"The Burglar Who Failed" (St. John Hankin). Produced by Terence Crisp. Characters. Mrs. Maxwell ..... Ruby May Dolly, her daughter ..... Bessie Williams Bill Bludgeon ..... Terence Crisp Scene: Dolly's bedroom in the Maxwell's house at Wimbledon. 8.45: The Harmonists' Male Quartette—"Love's Old, Sweet Song." "My Bonnie Lass." 8.52: Helen Hamerton (violin)—"Bouree" (Beach). "La Gracieuse" (Couperin-Kriesler). "Anglaise" (Dittersdorf). 9.0: An Entertaining Interlude—Joe Brennan and Ida Newton will entertain. 9.15: Light Music, Orchestra. Selection, "Kissing Time" (Caryll). 9.25: Harry Kittis (tenor)—"Little White Rose." "In Pensive Mood." 9.32: Pat M'Lean—Impersonations. 9.40: Norman's Royal Hawaiians—"Drowsy Waters." "Palakko Blues." "Yackahula Medley." 9.47: The Harmonists' Male Quartette—"At Dawning." "Watermelon." 9.52: Orchestra—"Trombone solo, "Thora" (Adams). "Rustic Festival" (Zamenich). 10.0: Weather information and "Herald" news. 10.10: Harry Kittis (tenor)—"I Heard You Singing." "I'm Alongin' for You." 10.17: Pat M'Lean—More impersonations. 10.22: Norman's Royal Hawaiians—Waltz, "Down Hawaii Way." "Blue Moon Blues." Banjo Trio, "Memories of the South." 10.30: God Save the King.

## 3DB

The "Herald" Broadcasting Station, Flinders Street Melbourne (365 Metres).

**MORNING SESSION.**  
11.0: Thelma Ready's Band, transmitted from King's Theatre. 12.0: Community Singing, transmitted

from King's Theatre; conductor, G. J. Mackay; accompanist, Reg. Brown. 1.45: Close down.

**AFTERNOON SESSION.**  
2.15: Arcadians' Orchestra—"Singapore Sorrows." 2.30: Gladys Moncrieff—"Sweetheart." 3.0: Atwater Kent Radio Hour, sponsored by A. G. Healing, Ltd., and E. T. Muir. 4.0: Close down.

**EARLY EVENING SESSION.**  
6.30: Arthur Meale (organ)—"Cavatina" (Raff). 6.8: The Ponce Sisters—"Sallin' On." 6.30: Derek Oldham (tenor)—"Absent" (Metcal). 7.0: Continental Novelty Quartette—"On Board." 7.16: Market reports, by John M'Namara and Co. Pty., Ltd. 7.25: Venetian Players—"Romanza" (Mozart). 7.30: Market reports, by Gippsland and Northern Co-operative Co., Ltd. 7.40: Peter Dawson—"At Santa Barbara." 7.45: E. L. Coulter, of Sydney Keek, Son, and Coulter—"A Book Talk."

**EVENING SESSION.**  
8.0: Plaza Theatre Orchestra—"Bell of New York." 8.30: Foster Richardson (bass)—"Little Dolly Daydreams." 9.0: Besses o' the Barn Band—"Dot and Carrie" Polka. 9.30: Elsie Southgate (violin)—"Rose in the Bud" (Forster). 10.0: Sophie Tucker—"He's Tall, Dark, and Handsome." 10.30: Ted Weems and his Orchestra—"Dream River." 10.40: News. 10.45: "God Save the King."

## 4QG

Queensland Government Radio Service, Brisbane (Wavelength, 385 Metres).

For day sessions, see Friday.  
7.45 p.m.: Lecture, "The Farmer's Pocket," by Mr. J. F. Reid.

**NIGHT SESSION.**  
8.0: The Citizens' Band (conductor, A. Kaeser)—Paraphrase on "Grandfather's Clock." 8.10: Double Male Quartette—(Conductor, Tom Muller). "Heroes and Gentlemen." 8.14: The Citizens' Band (supported by Double Male Quartette)—A selection of Home Songs, including: "When You and I were Young, Maggie." "Little Brown Jug." "Believe Me, If I Only." "Pop Goes the Weasel." "My Bonnie Lies over the Ocean." "Pins and Needles." "Home, Sweet Home." "Auld Lang Syne." 8.39: Francis Lane, contralto—"Blue Hawaii" (Baer and Caesar). 8.44: Double Male Quartette—"Where my Caravan has Rested" (Lohr). 8.48: The Citizens' Band, supported by Double Male Quartette—Selection, "In Days of Old," including: "A Warrior Bold." "The Midshipmite." "Sailing." "Danube River." "When the Green Leaves." "Rocked in the Cradle of the Deep." "Whisper Low." "Jingle Bells." 9.0: Metropolitan weather forecast. 9.1: Movements of the Travelling Dental Clinic. 9.2: Double Male Quartette—"Old Kentucky Home" (Foster). 9.4: Ernest Harper, baritone—"Sincerity" (Clarke). 9.8: The Citizens' Band—Comedy sketch, "The only Tune the Band Could Play was 'Auld Lang Syne.'" 9.20: George Williamson, tenor—"What a Wonderful World It Would Be" (Lohr). 9.25: The Citizens' Band and Double Male Quartette—Selections "Childhood Days," including: "Girls and Boys—Come Out to Play." "London Bridge." "Pussy in the Well." "Ring-a-Rosie." "Tom, Tom." "Three Blind Mice." "Pop Goes the Weasel." "Jingle Bells." "Hickory, Dickory, Dock." "Rock-a-bye, Baby." 9.40: Francis Lane, contralto—"Kiss Me Again" (Herbert). 9.45: Double Male Quartette—"In the Parkin' (Gams). 9.50: The Citizens' Band—"The Holy City" (Adams). "Blue Danube Waltz" (Strauss). 10.0: News supplied by courtesy of the metropolitan dailies; weather information; close down.

## 5CL

Central Broadcasters, Ltd., 114 Hindmarsh Square, Adelaide (Wavelength, 409 Metres).

**MORNING SESSION.**  
11.15 to 2.30: See Friday.

**AFTERNOON SESSION**  
3.0 to 4.30: See Friday.

**EVENING SESSION.**  
6.0: Chimes. 6.1: Birthday greetings. 6.30: Dinner session. 7.1: Senior Birthday League greetings; 5CL's reporting service; general market reports. 7.20: Dr. G. Wright, M.A., will continue his series of Literature Talks. 7.35: Transmission from the Adelaide Children's Hospital. The speakers will be Sister B.S. Rossman; a Child Patient; Rev. W. A. Cann, who will give a talk, entitled, "Wrecked and Battered." From 5CL Studio. 7.45: Mr. A. M. Whittebury. "Hints to Poultry Breeders."

**NIGHT SESSION.**  
8.0: Chimes. 8.10: The News Symphony Orchestra—Overture, "Poet and Peasant" (Suppe).

8.20: Dino Pelardi, tenor—  
"Elegie" (Massenet).  
"A May Morning" (Benna).  
8.27: The News Symphony Orchestra—  
"Oxford Symphony, Second Movement" (Haydn).  
8.37: Rupert Hazell and Elsie Day.  
8.47: C. J. Emery, trumpeter.  
8.53: Marcelle Berardi (soprano) and  
Dino Pelardi (tenor), vocal duettists.  
9.1: Meteorological information.  
9.2: Overseas grain report.  
9.3: General news service.  
9.5: The News Symphony Orchestra—  
Tone Poem, "Finlandia" (Sibelius).  
9.15: Rupert Hazell and Elsie Day.  
9.25: E. V. Graham, trombonist.  
9.29: A Tennyson Interlude by P. H. Nicholls and  
Bessie Francis, entitled "Guinevere."  
9.29: The News Symphony Orchestra—  
Selection, "The Gondoliers" (Sullivan), by request.  
10.0: Marcelle Berardi, soprano—  
"Blue Danube Valse" (Strauss).  
"Little Birdies" (Buzze-Peccia).  
10.7: The News Symphony Orchestra—  
Professional, "Entry of the Gladiators" (Pulci).  
10.15: General news service.  
10.29: Modern dance recordings.  
11.0: Close down.

**6WF**

Commonwealth Government Broadcasting Station,  
Perth (Wavelength, 160 Metres).

10.0: Gramophone records. 11.0: Close down.  
12.30: Tune in. 12.35: Markets news, etc. 1.0:  
Time signal. 1.1: Weather bulletin. 1.3: Organ  
recital by Mr. E. S. Craft, A.R.C.M., L.Mus. A.  
2.0: Close down. 3.30: Tune in. 3.35: Afternoon  
programme. 4.30: Close down. 6.45: Bedtime stories  
by Uncle Duffy. 7.5: Light music. 7.30: Commer-  
cial information. 7.45: Talk by Mr. A. T. Bowden.  
B.Sc. 8.0: Time signal. 8.1: First weather bulletin.  
8.3: Concert by the Perth City Band. 8.50: Late  
news: ships within range; late weather. 9.45:  
"Health" talk by Mr. Hutton. 10.30: Close down.  
104.5 Metre Transmission.—Simultaneous broadcast  
on 104.5 metres of programme given on 1250 metres,  
commencing at 6.45 p.m.

**7ZL**

Tasmanian Broadcasters Pty., 95 Elizabeth Street,  
Hobart (Wavelength, 516 Metres).

11.30 a.m.: Record recital. 11.34: Midlands weather  
forecast. 11.35: Adeline Fager will speak on "House-  
hold Hints." 11.50: Record recital. 11.55: Tasmanian

**RADIO CABINETS  
AND  
SPEAKER BAFFLES**

Combine Beauty and Efficiency in  
Radio Construction.

- \*We manufacture Console Radio Cabinets.
- \*Combined Radio and Phonograph Cabinets.
- \*METAL CABINETS, lacquered in gold or silver.
- \*FANCY BAFFLE BOARDS for Dynamic Speakers.
- \*ALUMINIUM SHIELDS, PANELS, and SUB-PANELS, beautifully lacquered in crystalline gold.
- \*We invite you to call at our Show-rooms and inspect the various lines we manufacture, or send for Price List.

DEALERS SUPPLIED

Open Friday Nights.

**PRIMA DONNA RADIO AND  
CABINET CO.,**

264 Oxford Street, opp. Denison St., Woolfara,  
Near Bondi Junction. Phone. FW2328.

stations 9 a.m. weather report. 12.0: G.P.O. clock  
chimes the hour. 12.1: Shipping information; mail  
notices; housewives' guide. 12.8: Record recital.  
12.30: "Mercury" news service; announcements. 12.40:  
Record recital. 1.5: British official wireless news;  
railway auction sales. 1.10: Record recital. 1.30:  
Close down. 3.0: G.P.O. clock chimes the hour. 3.1:  
Record recital. 3.4: Weather information. 3.5: Re-  
cord recital. 4.15: A representative of the Child  
Welfare Association will speak on "Using the Teeth."  
4.30: Close down. 6.15: Children's Hour with "Uncle  
David" and "The Story Lady." 7.15: News session.  
7.30: Under the auspices of the "Come to Tasmania"  
Organisation P. D. O'Reilly will speak on "Sandy Bay  
Regatta." 7.45: H. J. Corrigan will speak on "Soccer."  
8.0: G.P.O. clock chimes the hour. 8.1: Record re-  
cital. 8.15: 7ZL's Community Artists—J. Patterson,  
C. Cliffe, F. Kummer, F. Mourant, E. Rowe, W.  
Thompson, H. Poster. 9.30: News session. 9.45: Re-  
cord recital. 10.0: G.P.O. clock chimes the hour.  
10.1: Close down.

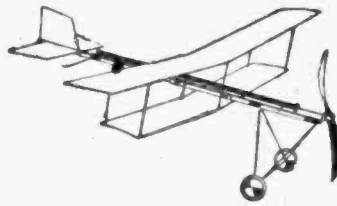

**Flying Model Aeroplanes**

BRITISH BIPLANE, 21in., 22 1/2; PUSHERS,  
21in. 7/6, 24in. 10/6; JAP. MODELS WITH  
WIRE FRAMES, 8 1/2in. 1/9, 10in. 2/6, 12in. 3/6,  
18in. 8/6; JAP. BIPLANES, 15in., 5/6 ea.

**Materials for Making Aeroplane  
Models.**

SPRUCE WOOD, IN FOUR FEET LENGTHS.

3/4 x 3/4	1/-	3/4 x 1/2	6d
3/4 x 1-16	5d	1/2 x 5-16	8d
3/4 x 1-16	6d	1/2 x 3/4	1/2
3/4 x 3-16	7d	3/4 x 3/4	7d
3/4 x 1-16	3d	3-16 x 3-16	5d

AERO-WIRE, IN 6FT. COILS, 18 S.W.G. 6d,  
20 S.W.G. 4d, 16 S.W.G. 6d, 30 S.W.G. 3d.  
JAP. CARVED PROPELLERS, 6 1/2in. 1/-,  
7 1/2in. 1/6, 8 1/2in. 2/-.

SILK FOR WINGS, 2/6 Per Yard, 10d Per  
Foot.

DOPE FOR WINGS, 1/4 Per Bottle.

RUBBER ELASTIC, 1-16in. Square 5d, 3/4in.  
6d Yard

**WORKING MODELS.**

- WATER TURBINE MOTOR, attach to tap, 37/6
- STUART TURNER DYNAMO, 4 Volt 35/-
- STUART TURNER REVERSIBLE ELEC-  
TRIC MOTOR, 4 to 6 Volt 11/6
- JAP. ELECTRIC MOTORS, 3 Volt 10/6
- MECCANO SIX-VOLT MOTOR 27/6
- MECCANO CLOCKWORK MOTOR 10/6

POSTAGE MUST BE ADDED.

**WALTHER & STEVENSON, LTD.**

395 GEORGE ST. (Opp. Dymock's), Sydney.

**REDUCED  
PRICES  
IN VALVES**

Owing to the enormous de-  
mand for the new A.C.  
Valves, we are clearing  
portion of our stock of the  
above well-known D.C.  
Valves at considerably be-  
low the ruling wholesale  
prices.

509x 6-volt 201a General Purpose	4/11
508x 6-volt 112 Power	7/6
A310 4-volt 199 General Purpose	4/6
A310 4-volt 199 General Purpose, U.V. Base	2/-

Have you heard the  
"Natural Tone"

**ROLA**

Dynamic Speaker?

Let us demonstrate it to you

**UNITED  
DISTRIBUTORS  
LTD.,**

151 Castlereagh St., City.

Also Melbourne, Brisbane, and  
Wellington, N.Z.

MAKERS OF UDISCO RADIO  
SETS

**Pounds of Pennies**

"Take care of the pennies, and the pounds will take care of themselves." There is more in that old saying than perhaps you realise. Pennies are more easily come by than pounds; they are more easily saved, for a penn'orth of self-denial is easier to practise than a pound's worth at a time.

Think it out—better still, try it out—the steady, sincere saving of the small coins; the practical appreciation of the small things and their cumulative value.

Turn your pennies into pounds by the aid of a Commonwealth Savings Account, and the 4 per cent. per annum interest it pays.

**Commonwealth Savings Bank of Australia**

(Guaranteed by the Commonwealth Government.)

# TRADE IN YOUR OLD SPEAKER!

Become the Owner of a Modern Cone Speaker for Next to Nothing

We'll Make an Offer on ANY Speaker

Realising that so much depends upon the speaker nowadays, we have purchased large stocks of BRANDES' ELLIPTICON CONE Speakers, recently selling at £6/10/-, and DE FOREST AUDALION CONES, at one time costing £10/10/-, which we are offering at the astounding price of

**59/-** LESS THE TRADE-IN VALUE  
OF YOUR PRESENT SPEAKER

Suppose you bring that old-fashioned, unsatisfactory horn speaker to us, and, at a conservative estimate, its value is £1/-/-. you can obtain an up-to-date Ellipticon Cone, superior in every way, for £2/19/-, less £1/-/-.  
 IN OTHER WORDS, **£1'19'=-** in Cash. Hear These Speakers Demonstrated.— Every One is Tested.

## THIS UNPRECEDENTED OFFER CAN'T LAST LONG

Bring Your Old Speaker in To-day, or Write Us, and We Will Give You an Estimate.

*We Sell EVERYTHING for Radio*

Same day Service  
for  
Country Clients

**"THE WIRELESS SHOP"**

Miss F. V. Wallace, 6 Royal Arcade, Sydney,  
THE OLDEST RADIO FIRM IN TOWN.

Money Back  
Guarantee

Established 8 Years.

'Phone, MA5543 — Two Doors from George Street, opp. Q.V. Markets.

# EVERYBODY WHO OWNS A CASSOR MELODY MAKER

*Can Now get Ultra-Short Wave  
Stations*

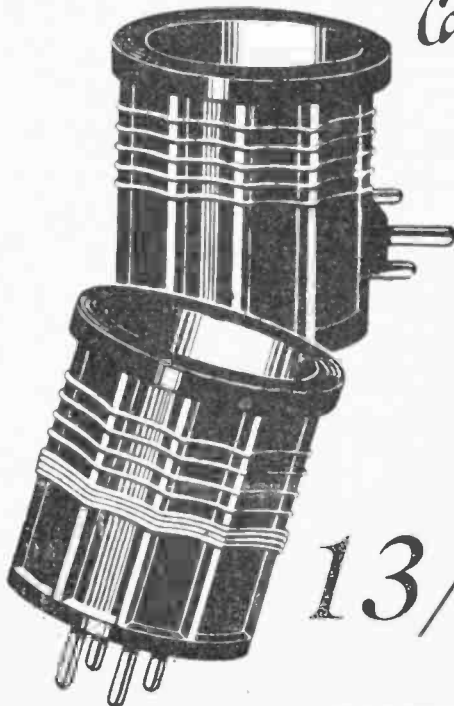

THE Casson ultra short wave coils are the newest development of radio research. Fitted to the Cassor Melody maker, these coils will bring in stations from overseas with surprising volume and clarity. American, English, and Continental programs are easily within the reach of the Cassor Melody maker with these short wave coils.

Merely replace the existing coils with the short wave coils, and you have all the stations of the world at your finger tips.

Call at Harringtons—See this wonderful invention. Ask for full details of operation.

The cost per set, 13/6, is in keeping with Harrington's policy of "best for least."

**Harringtons Ltd.**

Radio, Photo, and Cine Merchants (Established 1880).

386 GEORGE STREET, SYDNEY.  
'PHONE MA6001.

Branches in all States and New Zealand.

13/6

# The WIRELESS WEEKLY RADIO INFORMATION SERVICE

Under the direction of Ross A. HULL

## Renown Three Troubles

**KILOCYCLE** (Cremorne): (1) "I have made a Renown Three with an eliminator (latter home-made), and wish to know if I should be able to get Melbourne as easily as I get 2UE or 2UW."

**Answer:** The Renown Three is only a Reinartz detector with two stages of audio and a wave trap. It is a very selective circuit, but no more sensitive than the Reinartz Three, and you cannot expect under any circumstances to receive inter-State stations at the same volume as local stations. Though 2UE and 2UW are "B" class stations, they have plenty of power. At least one stage of radio-frequency amplification is necessary for good reception of inter-State stations.

(2). "I am getting a loud hum from my eliminator. How could it be stopped?"

**Answer:** As the eliminator is home-made you have probably erred somewhere, not necessarily in wiring, but probably in choice of parts. If a 201A or other receiving valve is being used as a rectifier advise you to replace with proper rectifying valve. Eliminator may be too near set; should be about two feet away, and screened. Earth the screen and core of transformer. Keep A.C. leads away from grid and plate wiring of set, and well away from coils.

(3). "Could I successfully add an extra stage? If so, how would I do it?"

**Answer:** This query only serves to show how well-founded was Mr. Hull's recent article on "Common-sense about Circuits." The fact that the Renown Three is nothing but a Reinartz Three with a wave-trap, and that the Marco Four is nothing more marvellous than a Reinartz Three with a stage of R.F., has been mentioned many times. The R.F. stage, if added to your receiver, will make it a Marco Four, and this is the circuit you require.

**M.F. (Northbridge):** "Being desirous of building and trying out the Renown Three, I read the notes on construction of coils, and find you have set a rather difficult proposition—viz., No. 1 coil, 70 turns, tapped every fifteenth turn, five tapplings, and two spare ends. This would make 90 turns in all."

**Answer:** An error which I have mentioned a great many times. Wind 70 turns, and tap every tenth turn.

**C.K.P. (Sydney):** "Some months ago I built the Renown Three," which did all that was claimed of it. Having learned a little of radio since then I decided to make certain alterations in the circuit so that each audio valve would receive grid bias. Also I made the grid return positive. The results obtained were well worth the little trouble in re-wiring, and I get some inter-State stations with fairly good volume, with no distortion from low bass notes to high treble. If you think this of sufficient interest to other Renown builders' insert in query columns."

**N.C. (Parker):** "I have just built the Renown Three, and I cannot get the results I expected. There is a continual squeak all the time. I have tried varying the grid bias, but it makes no difference. 2FC and 3LO can be heard, but other stations are poor. I tried changing the B plus tapping on the second transformer, but the squeal still continued. Transformers and sockets are closer together than suggested layout."

**Answer:** Probably inter-action. Place transformers at right angles. It is this does not remove oscillation try an R.F. choke in series with the plate of the detector valve. Reduce detector plate voltage. Keep grid leads and plate leads short, and as far apart as possible. Try changing detector valve. If two different transformers are used try reversing connections to primary of one of them. Make certain that batteries are in good condition.

**G.M.F. (South Pambula):** "I have built a Renown Three, which gives me good reception at night, but poor results during daytime. I have a 3½-1 Viking transformer on hand. Can I add this to boost up the signals?"

**Answer:** We do not reply by post. Daylight reception is always inferior to night reception. Two stages of transformer coupled audio constitute a practical unit. You would probably get distortion if you added another stage. Power valve may help matters, but it would be better to add a stage of R.F. as per the Marco Four (not the A.C. edition or the S.C. edition), which was republished a few months back.

**C.H. (Yenda):** "I built the Renown Three in Sydney about four months ago, and got good reception of Sydney stations, and could just get 3AR and 3LO on the speaker at night. I have since moved to Yenda, on the Murrumbidgee area. I can get the carrier waves of 11 stations, but can only just hear 3AR, 3LO, and 2FC faintly on the speaker. I have tested all parts, and they seem O.K. Should this set give good results here? What would you advise?"

**Answer:** Cannot advise what to expect of reception conditions in this area, but suggest it would be easier if you made inquiries yourself. Perhaps a valve became damaged in transit. Try changing valves over. "flow" is aerial-earth system? The wavetrap is not required for your location, and you would probably find an improvement if you removed the wavetrap part of the set, and connected aerial to grid of detector valve, and earth to moving plates of main tuning condenser.

**A.H.M. (Bexley):** "Will the Renown Three work a dynamic speaker? What alterations or additions would be necessary, if any?"

**Answer:** Dynamic speaker could be used with Renown Three, but suggest you improve the audio side of your receiver by using power valves in push-pull if maximum results are expected.

**"Renown Three" (Lidcombe):** See reply to "Kiloh-cycle" (Cremorne). Answer No. 3.

**F.W.M. (Leichhardt):** "I have built a Renown Special Three, and have made it neat and easy to look at. However, it won't deliver the goods. All components O.K., but all I receive is a continued hum like a motor car running. Cannot get any oscillation or whistle. Is there any way of taking an extra tap off one of the B plus tapplings of my eliminator? I have tried various grid leaks without fixing set, and have spent a lot of time over these 'wire-works' of mine, and now sit back vanquished. No valves have gone west, so filament wiring is O.K. I have checked off wiring of set half a dozen times."

**Answer:** If you have checked over the wiring of the receiver six times and found everything O.K., this should turn your attention to the eliminator, which is evidently of a cheap or home-made type. The hum you complain of assists this theory. If you are willing to have the set examined why not take it to the Economic Radio Co., who make a lot of these receivers? It is possible that there is a faulty transformer or a broken grid lead in the set.

**GENERAL:** It has been pointed out repeatedly that six questions is the maximum. Many inquirers sit down to write out one query, and find they can write dozens. It has been suggested now that readers be asked to forward one query only at a time, or, in the case of readers ignoring this, only their first query will be answered. This would be a deplorable state of affairs, and readers are asked to adhere to instructions, which are here repeated once more. No more than six queries to be sent in any one letter. Queries' coupon to be attached. Write on one side of the paper only. Attach all loose papers. Be brief and to the point. Leave out description of receiver from angle of 45 degrees, and what mother said to the next-door neighbor till the end of the letter. Number questions. Where possible submit circuit of receiver. Do not enclose stamps for a postal reply. Stamps may, of course, be enclosed for back numbers required. If a home-de-plume is to be used, place it where it can be seen, not in an odd corner. Though we appreciate kind remarks and helpful criticism we appreciate these things till the end. Finally, please write plainly.

**GENERAL:** Can any reader please supply Mr. D. Hilton, 26 Membrey Street, Granville, with a copy of WIRELESS WEEKLY, dated April 27, 1927, containing a circuit under the name "Five Valve De Luxe," for Toroid Coils?

**GENERAL:** Mr. F. C. Bray, Bimbi Road, Grenfell, N.S.W., writes: "I have a number of WIRELESS WEEKLIES to be placed at the services of your readers. They number from Vol. 13, No. 12, to the present date. These are in excellent order, and may be had at the usual rates."

**GENERAL:** Mr. J. Boxall, who only gives as his address "Strathfield," writes: "I should be obliged if any of your readers could supply me with the following numbers of WIRELESS WEEKLY:—January 18, 1929; February 8, 1929; March 1, 1929; April 19, 1929; May 10, 1929. I am willing to pay postage or call for same."

**C.M. (Gladsville):** "Would you please tell me how to convert a crystal or one-valve set into a small transmitter?"

**Answer:** The valve receiver could be made into a transmitter, but it is first necessary to hold on amateur's transmitting license, the possession of which entails sitting for an examination. When you have passed the examination you will know all that you require about this subject. Further, we have often repeated the statement that transmitting circuits, etc., will not be given to inquirers unless they state their call sign—this latter being allotted by the P.M.G.'s department after the amateur operator's certificate of proficiency has been gained. A wired transmitter for use between two points was treated in "Proving Radio."

**J.K.H. (West Ryde):** Use "Twenty Mule Team Borax" in the rectifier. Sparking might occur between the plates. Do not know which rectifier you refer to. Several have been treated lately. If 240-volt A.C. mains are rectified output may be as much as 200 volts D.C. If you wish to step this down to 6 or 30 volts D.C. a transformer must be used before rectification. A bell transformer will step down the 240-volt A.C. mains to 6 or 18 volts. Current very low.

**H.S.H. (Kensington):** Perhaps your friend connected set up wrongly, or forgot some battery connections. His aerial-earth system may not have been efficient. The receiver is a good one.

**J. McC. (Earlwood):** You are quite correct. Thanks for advising us. Correction to B.I.S. appears hereunder.

**B.R.S. (Croydon):** This should have read 1000-2200, not 990-2200.

**Marco (Lakemba):** Valves O.K. Do not advise use of only one rheostat, as valve characteristics are so varied. Use one rheostat for the R.F., and one for the detector. Filament ballasts should be used on other valves. Use .0025 variable condenser for reaction. Hope the Beginner's Number came up to your expectations.

**G.T. (Dean):** Sorry, never heard of the kit. It would probably be necessary to increase size of primaries if the Screen Grid Solodyne was built with the same kit. Blue prints obtainable from Colville Moore, Economic Radio, Levensons, etc.

**E.B. (Wollongong):** Replace valve with a proper rectifier, and use another filter choke and condenser.

**S.H.K. (Leeton):** Aerial to one terminal, and earth to the other. Change about for best results. A difference in the reaction reading would cause a slightly different reading on the main tuning condenser.

**W.G.M. (Wallsend):** Aerial coil 30, secondary 80, reaction 50 turns.

**A.E. (Bradley Heads):** Your circuit incorrect. Reverse grid and plate leads.

**J.D. (Taree):** I wish to listen in to commercial stations on the higher wavelengths. Will you please give me details of coils, condensers, etc., to use for these long waves?"

**Answer:** Use the Schnell circuit, two 43-plate condensers, and coils as follows:—For 250-700 metres primary 75, secondary 50, reaction 35. 450-1500 metres 150, 100, 75. 700-2200 metres 200, 150, 100, 100-4000 metres 300, 250, 150. One of the condensers is used in series with the aerial, and the other is placed across the secondary coil. Honeycomb coils can be used. These can be obtained quite cheaply now.

**N.S. (Willoughby):** The bell transformer did not supply enough current. When the resistance was decreased the voltage was increased, and consequently the filament would not stand up to the pressure. Take one lead from the "neutral" end of the transformer, and the other from the five-volt tapping. It would be advisable to use a rheostat in series with one of the leads, as the output is seldom as rated in the cheaper types of bell transformers. The writer has one rated at 3, 4, 6, 8, 12, and 18 volts. The lowest tap gives ten volts at about .25 amp., and the other taps are in proportion.

## QUERY COUPON

If you are in difficulties about reception or set-construction, let us know, and we will endeavor to see you right. Make your questions brief to the point, and, where possible, show lay-out and wiring design. Under no circumstances will answers to queries be made by letter or by telephone. All answers will appear in the columns of this department of this department in the order in which they are received.

The Radio Information Service, WIRELESS WEEKLY, Box 3584, C.F.O., Sydney. Please answer the accompanying queries in your earliest convenience. If possible, this coupon in order to indicate that I am a bona-fide reader.





**DIAMOND**  
**THE BATTERY OF SILENT POWER**  
 45V SUPER CAPACITY **20-**  
**REG. ROSE & CO.**  
 AGENTS  
 MADE IN DIAMOND  
 KEMBLA Bldg  
 MARGARET ST. SYDNEY.  
 Phone B-3872

**VAR-LAC**  
 Multi-Way Battery Cable  
 is Sold by the Yard.

Seven different colored leads under one water, acid and flame proof covering. No matter how far your batteries may be from your set VAR-LAC will reach them. Strip these untidy wires and use VAR-LAC Battery Cable. For Neatness, Convenience and Efficiency. Supplied in any length. If dealer is out of stock, write direct.

1/8 Per Yard.

A. BEAL PRITCHETT (Aust.) Ltd.  
 11 PARKER STREET, SYDNEY

**TRANSFORMERS**

Eliminator and Power Pack Transformers, Battery Charging Transformers, Choke Coils of all capacities.

**WIRELESS GENERATING SET.**

500 Volts D.C., 10 M.A. direct coupled to 210-Volt Single Phase Motor. In splendid condition. Transformer Cores Cut to Size, 1 1/2 lb. plus postpaid. "E" Eliminator Chokes, 5/ each (limited quantity only).

O'Donnell, Griffin & Coy., Ltd.,  
 51-53 DRUITT ST., SYDNEY.

**"EXELTRON"**

B ELIMINATORS ..... £3 15 0  
 A CHARGERS ..... £3 0 0  
 A.B.C. POWER PACKS ..... £3 10 0  
 Usually sold £6 to £12—Sold direct from factory to you: hence these low prices. Fully guaranteed, 12 months. Installed Free. Easy Terms. Mail Order, add Carriage. EXELTRON ELECTRICS, 51 Oxford Street, Sydney.

S.E.S. (Enfield): Place a 1 mfd. fixed condenser in series with the earth lead.  
 D.C. (Punchbowl): Open grid circuit, most probably.  
 R.E. (Palm Beach): It does not matter which way round filament leads are connected to socket.  
 E.F.C. (Marriekville): Try changing R.F. valve.  
 E.A. (New Zealand): An error appeared in the circuit. This was corrected in the following issue (August 9), when the correct circuit was shown.  
 P.E.W. (Sydney): Please briefly state a number of methods for improving selectivity.

Answer: Use of wavetrap; shorter aerial; counterpoise instead of earth; a fixed .0001 condenser of a midget condenser in series with the aerial; decreasing coupling between primary and secondary; use of tapped primary.

W.J.S. (Sydney): Messrs. Mingay Radio are now out of business. Try 20 Mule Team Borax in a saturated solution—water.

J.J. (Queanbeyan): Try a 100,000 ohm resistor across the transformer secondary. Resistor should be variable. If unsatisfactory here try across primary. Reduce detector plate voltage, and place .002 fixed condenser across telephones.

W.R.A.R. (Tasmania): We appreciate your remarks. The Stromberg Carlson condensers will be quite satisfactory, the scheme regarding R.F. coupling, though in order and quite practical, is by no means ideal, as can be demonstrated mathematically in a moment.

"Tommy" (Adeloid): Probably a short circuit in battery leads. Pull all leads to see if they are tight. Messrs. Murdoch's, Ltd., Park Street, Sydney are agents for the "World" radio receiver.

H.B.L. (Willoughby): "Re the Economist 'B' eliminator. I have constructed this, using parts as described, but using a power transformer giving 290 volts each side of centre tap, but cannot get any results at all. After the A.C. has been switched on for a few minutes transformer becomes very hot, and emits smoke, and a bubbling noise can be heard inside.

Answer: Wiring, condensers, or transformer faulty. Windings may be shorted, and, owing to heavy current, become hot. Insulation burning off would cause smoke, and bubbling noise is probably the wax boiling. Circuit is O.K.

A.G.R. (Artarmon): Cannot be used as a short-wave receiver unless coils and condensers are changed. If desired to make the necessary alterations coils and condensers as per Go-Getter (published recently), will suit.

H.L. (Coatmundra): Sorry; don't know the preparation. Probably O.K. Try totally shielding receiver, using counterpoise instead of earth, and shortening aerial. Wavetrap may also help.

F.B. (Carlewiss): Speaker O.K. Reduce detector plate voltage. Three megohm grid leak.

R.F.C. (Carlingford): A stands for aerial, E earth, G grid, F filament, B B plus, P plate. Yes, reaction coil is B and P. Primary is A and E. Secondary is G and F.

HUM (Waverley): It is necessary in a job like this to totally screen, if not the whole job, at least the power transformer. Earthing transformer coil will not always help. Keep all double A.C. leads in twin flex.

P.S. (Maroubra): Bell transformer is probably not supplying enough current to rectifier. In any case the filter is inefficient. Yours is only half a filter. Keep well away from receiver.

W.E.L. (Lismore): Have published your request below. Your idea impractical, since the additional leads to the shortwave coils would cause losses in the coils besides altering their inductance. There would be a lot of loss between leads when ten of them are tapped to one coil.

"Anxious" (Haberfield): "I am using a Cossor Melody Maker, two-volt set, with a Somoehorde cone speaker, a two-volt 'A' battery, and 90 volts 'B' batteries, from which I am getting good results; but I wish, if possible, to cut out the batteries. Can I purchase apparatus to cut out A, B, and C batteries without altering internal wiring of my receiver?"

Answer: Yes; an A. B. C. eliminator will be O.K.

(2) The input is usually 240 volts, A.C. Output may be varied up to about 200 volts.

(4) "How would I connect up the apparatus?"

Answer: In exactly the same manner as you would connect the batteries. You could also use a Power pack with two-volt filament transformer, but this would entail use of A.C. valves, and would mean slight alterations in the receiver.

M.T. (Narrabeen): Try a .00025 variable condenser for reaction. Reduce detector plate voltage, which may be too high.

GENERAL: Can many reader please supply Mr. R. J. Ferguson, 15 Merley Road, Homebush, with copy of WIRELESS WEEKLY dated February 1, 1929, containing the Marco Four circuit?

GENERAL: Can any reader please supply Mr. R. J. Heerk, Golf Parade, Manly, with a copy of WIRELESS WEEKLY dated August 10, 1928, containing the Remartz Three?

GENERAL: Mr. W. E. Langdon, Box 286C, Lismore, wishes to know if Mr. Calvin A. Walls, of Eastwood, or any other reader who has had practical experience with the construction of Exponential horns would get in touch with him.

F.B. (Wollongong):—Reduce plate voltage and increase grid bias. O.K. for valves to get hot, as plate voltage is high. Do not advise you to use more than 135 with these valves.

E.S. (Hawkesbury River):—"I made up your Pentavox set, and used one Cossor S.G., one Cossor R.C., and one Mullard Pentode. The coils were constructed from an article in WIRELESS WEEKLY entitled 'Coils and How to Wind Them.' I got good results from the receiver, but the reaction is of no use. I am using a Pilot midget condenser for reaction control. Without any reaction, I got JOAK

last Sunday. I only use 90 volts. Have tried 150, but 90 volts is plenty.

Answer: Increase detector plate voltage. Try a .001 fixed condenser across primary of first transformer, and a .002 across the midget condenser.

RADIO MUG (Darling Harbor):—Your log is a good one, and reception of JOAK proves that the receiver is sensitive.

R.A.H. (Blisney):—Doubt if you would get daylight speaker reception on three valves. Suggest a Marco Four. This would be much better than the receiver you propose. We cannot, for obvious reasons, compare our advertisers' receivers through these columns.

GENERAL:—Many readers are inquiring for the correct way to neutralise a Browning Drake or Neutrodyne. Several submit methods of which they have heard, and advise they are doubtful of the procedure to adopt. The methods enumerated are only to be carried out under certain conditions, such as, for instance, when no rheostat is included in each R.F. filament. However, the following instructions can be applied to any set. Remove any fixed or variable condensers that may be placed in series with the aerial. Tune in a local station in the centre of the dial (say 2BL) using as much reaction as possible, without distortion. Adjust tuning till station is at full volume. Remove first R.F. valve, place a piece of paper over one of the 1st (filament) prongs, and replace valve. Volume will now be diminished, but by adjusting the neutralising condenser, the station may be brought to full volume again. Remove paper, and replace valve, then treat each R.F. stage the same way. Then try for an inter-State station in the centre of the dial (say 3LO), and make final adjustments. Another method is to tune in the local station in centre of dial, insulate first R.F. filament prong, adjust neutralising condenser till station can just be heard, remove paper, and treat each R.F. valve the same. When paper is removed from filament prongs, volume should be stepped up greatly.

GENERAL:—Mr. George C. Oxlade, Irving Street, Newmarket, Brisbane, writes: "Having been a constant reader of WIRELESS WEEKLY since July, 1925. I have on hand quite a number of copies of same, which any of your readers are welcome to on payment of postage. It is more easy to tell you the copies I haven't got than the ones I have. The following copies are missing: 1926: 25/6, 2/7, 30/7, 24/9, 19/11, 26/11, 31/12, 1927: 21/1, 28/1, 18/2, 15/4, 22/4, 9/9, 16/9, 23/9, 16/12, 23/12, 1928: 6/1, 13/1, 23/3, 6/4, 13/4, 4/5, 15/6, 12/10, 19/10, 26/10, 2/11, 21/12, 28/12, 1929: 4/1, 11/1, 22/2, 29/3, 5/5, 5/7. I have the following copies for 1925: 31/7, 14/8, 2/10, 16/10, 23/10, 13/11, 20/11, 27/11, 4/12, 11/12." He also adds "At the present time I have an eight valve super het. with loop. It may interest some of your readers to know that I am using a trap coil directly behind the loop, which boosts up signals wonderfully. The volume is quite 100 per cent. greater than when the loop is directional. It gives me 2FC, 2BL, and 3LO quite as loud as the local 4GG. The trap is not directly coupled to the loop, the boosting being quite sufficient, although I have a lead from the condenser to the centre tap of the loop through a switch. Circuit shows how this is done"—(readers please note that, owing to pressure of space this circuit has been unavoidably held over till next week). "The 75-turn coil is wound about the size of a honeycomb coil, Lorenz winding—two under and two over, etc., with the 15-turn wound into this booster. Trust this will be of use to anyone looking for volume. Get 2YA as loud as local station, 4GG."

**RADIAR**

for 5-Valve Screen Grid Sets, with Speaker, £39/10/-. The Screen Grid is the most dependable for Country Daylight Reception.

3-Valve All-electric (4 valves in all), with Speaker, £29/10/-.

5-Valve All-electric (6 valves in all), with Speaker, £39/10/-.

Your Old Set can be traded in. Repairs and Remodelling.

THE RADIAR WIRELESS CO., 114 Castlereagh Street. 'Phones, M2037, Ryde 978.

**RADIAR**

for 5-Valve Screen Grid Sets, with Speaker, £39/10/-. The Screen Grid is the most dependable for Country Daylight Reception.

3-Valve All-electric (4 valves in all), with Speaker, £23/10/-.

5-Valve All-electric (6 valves in all), with Speaker, £39/10/-.

Your Old Set can be traded in. Repairs and Remodelling.

THE RADIAR WIRELESS CO., 114 Castlereagh Street. 'Phones, M2037, Ryde 978.

**STAMPINGS**

and **PRESS WORK**

catered for.

SALISBURY TRAVEL GOODS CO., 28 to 25 Booth St., Annandale. 'Phone MW1251.

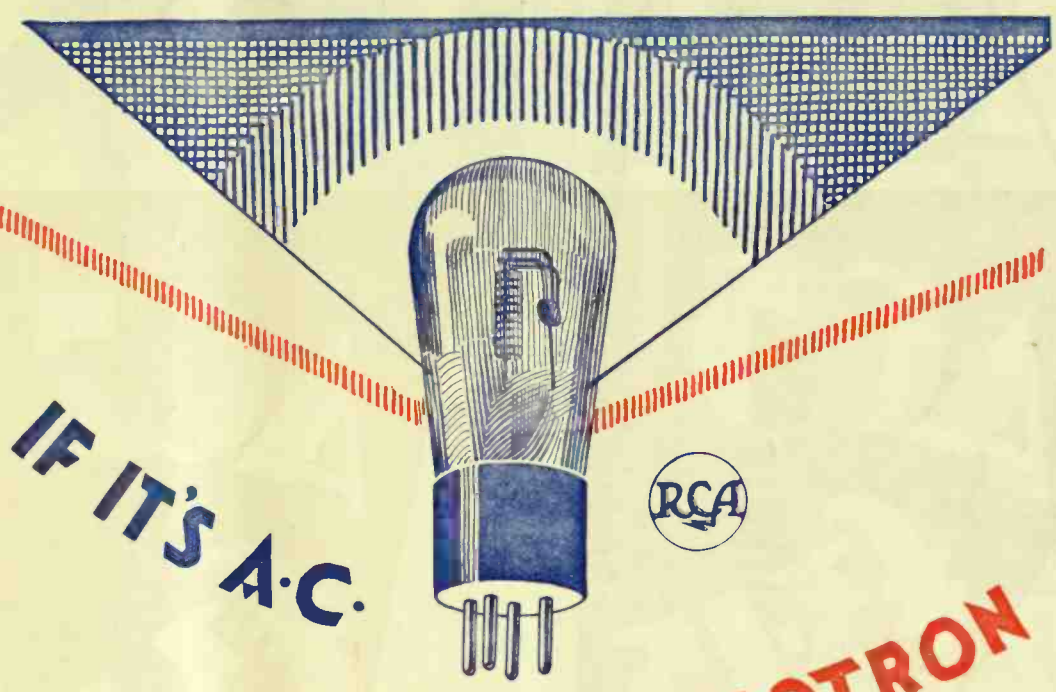

IF IT'S A.C.

THEN IT MUST BE **RADIOTRON**



Look for this Seal.

- Radiotron—
- UX 226 Amplifier . . 15/-
  - UY 227 Detector £1/7/6
  - UX 171A Power Amplifier 19/-
  - UX 280 Rectifier £1/10/-

**B**ECAUSE Radiotron Valves are subjected to over 40 individual laboratory tests before they are released—because leading manufacturers of quality receivers specify Radiotrons for initial equipment and for replacements—and because of their world wide reputation for dependability, most owners of Electric Receivers choose Radiotron A.C. Valves.

Distortionless performance due to watchlike assembly, long life and economy resulting from sturdy construction are assured with Radiotrons.

RADIOTRON A.C. VALVES ARE OBTAINABLE AT ALL RADIO DEALERS.

**Amalgamated Wireless**  
*(Australasia) Ltd*  
 47 YORK STREET, SYDNEY.

**J. B. CHANDLER & CO.,**  
 45 ADELAIDE ST.,  
 BRISBANE.

# AMPLION

AC5

£3.15



AC7

£3.15



**A**LL the features you look for when buying a Speaker will be found in these two dignified inexpensive Amplion Cabinet Cones. Both are Loud Speakers of exceptionally good performance, of very pleasing appearance and at a price within the reach of everyone. Amplion has never offered greater value.

DISTRIBUTORS IN ALL STATES.

INSIST ON AN  
AMPLION WITH  
YOUR RECEIVER.

ADVT. OF AMPLION A/SIA LTD., 53-55 YORK STREET, SYDNEY.