

WIRELESS WEEKLY

Vol. 9. No. 3.

Registered at the G.P.O., Sydney, for transmission by post as a newspaper.

Friday, Nov. 12, 1926.

RESCO RADIO

Announcement
Extraordinary

Before purchasing your radio we invite you to inspect other offers. Then visit our showrooms and save 30% on a high class 6 valve Neutrodyne Set.

Complete with Cabinet, Exide Accumulator, Ever-Ready B Battery, Philips Valves, Headphones, Aerial

PRICE \$19/10/-

RADIO & ELECTRICAL
SUPPLY CO.,

40 Pitt St. (near Quay)
B 1817.



The Selectrodyne

is the only 6-valve set that will bring in 8LO without interference from 2HL. Constructed in Sydney from all Australian material. Complete, £26/10/- to £36/10/-.

Take one home to-night!
Deposit, £2/17/6; Weekly, 6/9

Radio-W'less Mfg. Co.
317 George Street, Sydney
B 5747

Mr. Matt. Charlton, M.H.R.
on a Political Radio Station



A simple way to construct a
cheap Cone Loud Speaker

ELIMINATE THOSE "B" battery noises

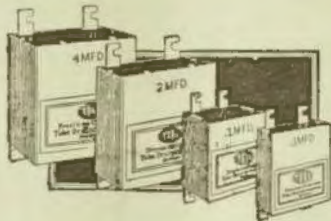

Tobe Bi-pass Condensers

are an *absolute essential* for all Bi-pass work. Used in the construction of almost every type of "B" Battery eliminator manufactured in the United States.

	£	s.	d.
Type 705, capacity .1 mfd.	0	4	6
Type 706, capacity .25 mfd.	0	5	0
Type 707, capacity .5 mfd.	0	5	6
Type 708, capacity 1. mfd.	0	7	9
Type 709, capacity 2. mfd.	0	11	3
Type 710, capacity 3. mfd.	0	18	6
Type 711, capacity 4. mfd.	1	3	6
Type 712, capacity 5. mfd.	1	10	0

BREMER TULLY SHORT WAVE OUTFIT.

12½ TO 200 METRES.

THE B. T. Short Wave Outfit represents the best tuning arrangement for short wave reception to-day. Perfect construction, rigid support with constant control. The coils are interchangeable, covering 12½ to 25, 25 to 50, 50 to 100 and 100 to 200 metres.



PRICE £37/1/-

IF YOUR DEALER DOES NOT YET STOCK THESE PARTS, WRITE TO US

UNITED DISTRIBUTORS LIMITED

72 Clarence Street, Sydney

343 Queen St., BRISBANE. 27 Chesser St., ADELAIDE. 26 Queen St., PERTH. Cr. Jervois Quay & Harris St., WELLINGTON, N.Z. 66 Charles St., LAUNCESTON, Tas.

ELECTRAD

Certified Radio Products

Electrad Certified Condenser

The Six Pressure Points.—Ingenious riveting and binding method fastens parts securely at six different points and exerts EVEN PRESSURE upon the largest possible surface.

Thin sheet copper is used in place of tin-foil. A slip of the soldering iron cannot damage the copper and thereby ruin this condenser.



.001 • • • Price 2/6
.0025 • • • " 3/-

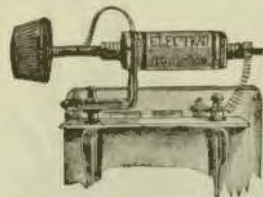

Electrad Audiohm

Converts noisy distorted volume into clear true tones by a simple twist of adjusting knob. Mount across secondary of your audio transformer as illustrated. Price 9/-

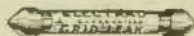

Electrad Glass Grid Leaks

Electrad Grid Leaks are made by a new and controlled process. Each Grid Leak is individually tested before it leaves the Electrad factory. They are non-microphonic and moisture proof, while the resistance is constant.

Sizes 1/2 to 5 megohms, plain. Price 2/3
Sizes 1/2 to 5 megohms, de luxe. Price 3/9



Electrad Lightning Arrester

Consists of an air gap between two copper conductors, arranged in an improved manner, so that it is impossible for the spacing of the gap to vary. It is then hermetically sealed and the gap is therefore absolutely watertight. The housing protecting the air gap is moulded in glazed porcelain with a highly ornamental finish. These arresters comply with Fire Underwriters regulations. Price 3/-

OBTAINABLE AT ALL RADIO DEALERS

Amalgamated  Wireless
Australasia Ltd.

187-9 Queen St., Melbourne
King and King Chambers, Queen St., Brisbane

97 Clarence St., Sydney

Now that 2FC has reduced its wavelength to 412 metres, you can get ALL the big Australian and New Zealand broadcasting **WITHOUT INTERFERENCE**

on a Genuine Neutrodyne

(Manufactured under and licensed by Genuine Hazeltine Patentees).



The Neutrodyne is easily the most selective circuit yet evolved, and the Gilfillan engineers leave nothing to be desired in the design and workmanship of their Neutrodyne.

THE

Gilfillan Neutrodyne

5 VALVE (Illustrated here)

is a powerful but compact Set, containing the latest developments in Neutrodyne design. It has remarkable volume under absolute control. When turned on, the full and undiluted value of conversation, instrumental or vocal music is faithfully reproduced free from oscillation noises.

SPECIAL AND EXCLUSIVE FEATURES:

SIMPLICITY—No complicated switches. No interchanging of coils. No interference between stations.

MATCHED DIAL OPERATION—Just tune in the three vernier dials, e.g.: to pick up 3LO, Melbourne, just set each dial on Number 40, and the station comes in with strong, clear volume.

Detector and Volume Control Rheostats; First and Second Audio Listening Jacks; Filament Switch for turning on or off; Special Low Loss S.L.F. Condensers; Aerial, Earth, and Battery Connections at rear; Copper-shielded condensers to eliminate hand capacity; Cabinet of selected American walnut, with handsome two-tone finish.

£10 DEPOSIT

Balance over 12 Months.

Complete with all Accessories, Accumulator, Loud Speaker, etc., £59/10/-

Obtainable from leading Radio Dealers—

SOLE AUSTRALASIAN AGENTS

Harringtons Ltd

Wholesalers and Retailers
Photo. and Radio
Warehouses

Sydney	258 George Street
Newcastle	84-86 Hunter Street
Katoomba	Katoomba Street
Melbourne	266 Collins Street
Brisbane	93 Queen Street
Adelaide	10 Rundle Street
Wellington, N.Z.	42 Willis Street
Auckland, N.Z.	149 Queen Street



WIRELESS WEEKLY

VOL. 9, No. 3.

FRIDAY, NOV. 12, 1926.

Could You Credit It?

THE British Postal authorities find that they cannot refuse acceptance of radiograms for Mars because of their unorthodox address alone. A hundred newspapers take up the story and the world spends a few minutes creating imaginative pictures of our Martian neighbours. Serious astronomical articles follow, the probability of life on the Moon is discussed, and new theories for inter-planetary radio communication are advanced.

Our credulity is enormous. Twenty years ago we enjoyed Wells and laughed at Marconi. The subtle interweaving of fact and fiction since then has caused us to increase our capacity for belief in the most amazing claims. Our stock of credulity never seems exhausted.

What is not quite used up by our newspapers and novelists is worked overtime by astronomers who tell us the Sun is almost a hundred million miles away and that Betelgeuse is ten times the size of the universe, physicists who balance Betelgeuse by describing the incredible smallness of the atom, and a host of other marvel mongers whose credulity would have dissolved the middle ages in a roar of sceptical merriment.

In the middle ages people believed that the earth was flat, for which they had at least the evidence of their senses. We believe it to be round, not because as many as one per cent. of us could give the physical reason for so quaint a belief, but because modern science seems to have convinced us that everything that is improbable, extraordinary, gigantic, or microscopic is scientific. This is the age of wonders far greater than those of Egypt or Greece. There is a news feature bureau in London which aims at producing at least one miracle each day.

In this editorial we are not to be taken as believing that the world is flat, nor are we to be taken as discrediting the mathematical deductions of scientists. Our moral is that a degree of common sense should be used when crediting the claims of inventors and discoverers now that the production of miracles has become a business.

Wireless, as a miracle which actually does take place, is often pointed out as logical reason why other marvels should happen. Its future possibilities are exaggerated, so that we forget that Mars is a long way off and Martian communication even further.

Ferry Granger, world famous Australian pianist, who will be heard from NJO on November 14 and 15, is seen on our cover this week.

Between You and Me and the Microphone

WIRELESS OPERATORS on duty at VIS recently held direct communication with the Jervia Bay in the Bay of Biscay, almost 10,000 miles distant.

A SILVER replica of an African springbok, the national symbol of South Africa, was offered by the Rand Daily Mail of Johannesburg, South Africa, as a prize to the American amateur effecting the greatest number of two-way contacts on short waves with South African amateurs during the months of September and October.



THOUGH the body of the saxophone is made of brass, according to a well-known maker, it is not half so brazen as some of the saxophonists who inflict themselves upon us.

THE HIGH SCHOOL for physical development at Spandau, Berlin, has installed a low powered broadcasting station. The programmes include the transmission of heart beats and biological sound phenomena.

BROADCASTING progress in Denmark may be gauged from the fact that the number of licensed listeners has increased from 30,000 to 90,000 since January. An interesting scheme is under review for extensive co-operation between the broadcasting authorities of Denmark, Norway, and Sweden.

A WORLD-WIDE project to determine the accuracy of present longitude lines is now being undertaken by the principal observatories of the world, one of the results of which will be to prove or disprove the theory that the continents are drifting apart. The accuracy of our time will also be tested.

THE ESTABLISHMENT of a broadcast station at Sydney for the transmission of news to the country newspapers in N.S.W. was advanced considerably at the annual conference of the Country Press Association last week. Technical details were given to the conference by Mr. E. T. Fisk, Managing Director of Amalgamated Wireless, and Mr. C. C. Faulkner, Director of the Radio Broadcast Bureau. A sub-committee was appointed to establish a station.

Conducted by
R. E. CORDER

JAPAN imports wireless goods from Britain to the value of £250,000 each year.

ALMOST a thousand letters of appreciation were received from 2FC following Capt. Hurley's talk on the Head Hunters of Papua.

SPEAKING in the State Parliament of Queensland recently, the Premier, Mr. W. McCormack, M.L.A., said that the establishment of 4QG by the Government had fully justified itself. He praised the director of the station and the staff.

ANNUAL SALES of radio equipment in the United States exceeds £100,000,000.

A WRITER in Melbourne says that wireless is a powerful agent for keeping people quiet. Melbourne must be free from oscillators!

WHY LOWER the status of the radio set. This advertisement appeared in a recent issue of the "Daily Telegraph":

"For sale, 5 valve set, complete, accumulator, loud speaker, cash or terms; or will accept Ford Motor Lorry, balance adjusted. Apply."

"DO YOU KNOW that Eau de Cologne is a great thing to remove soft corns," wrote a woman to Mrs. Jordan, 2BL domestic lecturer, recently. She explained that she had been tormented by corns between her toes for years, the pains shooting up her legs until she suffered excruciatingly. She tried Eau de Cologne which effected a complete cure, and she was passing on the hint for the information of other women who listen to the radio.

IN VIEW of the reports that American amateurs rely on non-radiating sets, it is interesting to hear the result of a 500 dollars competition (organised by "Radio Broadcast," New York), for a non-radiating short-wave receiver. Of all the sets submitted for the judge's approval not one was found which failed to radiate. A consolation prize of 100 dollars was awarded to Frank C. Jones (5ACF), of Borkesley, California.

COURAGEOUS tenants of municipal houses are now demanding aerial poles as part of the household equipment. Several years ago municipal councils contemplated placing restric-



tions on the erection of wireless aerials, but the foot is now on the other foot. Why, in these enlightened days, should a house boasting of "every modern convenience" be handed over to a tenant minus its wireless pole and insulated chimney bracket?

AN INFANT PRODIGY.

*The cable is conservative,
And very circumspect.
It goes the straight and narrow
path—
The line that's most direct.
The radio is radical—
A wanton in its play.
It's free for all and also free
To wander any way.
The cable often feels a shock
That wireless acts so wild;
But that is nat'ral in old age
When it observes a child.*

—C. I. Curwin

THE BROADCASTING of the "October Radio Bride's" wedding on October 28, did not eventuate although elaborate preparations had been made. The authorities of the Church of England concluded that to broadcast a wedding ceremony from St. Andrew's Cathedral would savor of irreverence, although Dean Talbot had consented to perform the ceremony in front of the microphone.

THE ISSUE raised is interesting. Two years ago Rev. A. Hay Holden, of Palmer Street Presbyterian Church celebrated a wedding ceremony which was broadcast. When the winner of the recent Melbourne September bride competition was married, the ceremony was broadcast, although the Anglican Archbishop forbade the ceremony being performed in any Church of England. In that case, the Methodist minister tied the knot.



Mr. Matthew Charlton, M.H.R.

THE young politician was enthusiastic. With an ardour quite old fashioned he cross questioned the broadcast manager.

"Despite all that has been written about politics," he said, dismissing the cynical humour of the comic strip cartoonists with a sweeping gesture, "it is the nation's business and the people have a right to hear just how their business is being conducted."

"You wish them to hear it by radio?"

"Exactly. In the country district which I represent there are hundreds of listeners in who heard with intense interest the Referendum speeches some months ago. Many of my constituents have asked me why more political matter is not broadcast. I would like to hear from you why this is?"

"The question is whether or not it is a good thing to permit the broadcasting stations to be used for disseminating political propaganda,"

replied the broadcast manager. "There may not have been much of it so far, but the possibility of extending the use of stations for that purpose is there. And because there may not have been any strong protest from listeners, we should not assume that the listeners would stand for unlimited or partisan use of the service. The broadcasting services offer unexampled opportunities to politicians and candidates for political honors and it is only natural that they will take advantage of them—even unfair opportunities—unless checked."

"But provided that a careful and tactful supervision and censorship is applied," said the young politician, "surely it is a good thing to permit political propaganda to be broadcast. Broadcasting is a medium of communicating news or opinions to the public as does a newspaper and consequently the newer and perhaps more effective medium should be availed of widely."

The broadcasting manager smiled as one who had heard the same argument advanced many times.

"The analogy with the newspaper is not correct," he said. "When seeking advice on political questions from a newspaper, one generally knows the politics of the paper, and the opinions he will expect to find ventilated or favoured. Thus he selects his paper. And if on the other hand he finds in another paper political opinions or views expressed in a manner that does not please the reader he has his remedy in withdrawing his subscription to the paper if he feels sufficiently aggrieved."

The famous leader of Australian Labor supports the suggestion of a political radio station at Canberra in an interview below.

Matthew Charlton Enters into a Discussion on Politics by Radio

The radio man paused.

"What is the position with broadcasting, you ask? First of all the listeners—all listeners—are compelled more or less to listen to the station. They have no remedy in transferring their subscriptions to another station. They are thus entitled to the consideration by the broadcasting company to the extent that nothing offensive or objectionable to them will be transmitted. And in political elections or other occasions when it may be desirable in the public interest to allow partisan political addresses to be broadcasted the listeners should be entitled to hear both sides of the question fairly."

"But suppose the desires of the listeners were made known to the effect that only a small portion of the programmes should be given to politics?" answered the young politician quickly. It was evident that he had spent some time canvassing his district for information.

"To their credit it must be said that is just what the broadcasting companies in Australia are doing. One hears very little complaint, although the difficulties experienced by broadcasting directors may not be appreciated.

"Political opinions that may be open to objection are not all contained in speeches delivered at election meetings," continued the broadcast manager. "It is possible for a speaker in a studio or in a hall, from which a programme is being broadcast, to include in an otherwise colourless speech some remarks that have a distinct political flavour with an obvious bias. How is the studio mana-

ger to ensure that the speaker will avoid such questions? A copy of the speech cannot always be obtained in advance by the broadcasting company, and even if it could be arranged is it a fair thing to expect the company to act as censor. The most that can reasonably be expected in such circumstances is that the company make known to the speaker the condition that political questions must not be treated, or at all events must not be treated in a partisan spirit.

"There will be occasions on which partisan speeches will be delivered at political gatherings that may be worthy of being broadcast. For example, a Labor Prime Minister may speak at an Eight Hours' dinner. Should his speech be blocked? I should say on such special occasions the broadcasting of the speech would not be considered objectionable, provided that at a similar gathering of the opposing political party equal opportunity be granted. And further that the speeches be not too long. Speakers in the studio would be managed easier, as it would be more readily possible to warn the speaker against continuing in a certain strain or to cut him off."

When the broadcasting manager had finished he lay back in his arm chair and sipped an amber coloured liquid with a little fragment of ice floating on the surface. He had gone over the old argument many times and was satisfied that he had answered every question the young politician was likely to ask.

"We have wandered from my argument," said the young man after a pause. "You have told me why you cannot broadcast political propaganda and I fully appreciate your difficulty. But political propaganda as distributed by the opposing parties is not the nation's business. Why are the more important debates at the House of Representatives not broadcast?"

"For these reasons," replied the broadcasting manager. "Important debates occur unexpectedly while we compile our programmes at least three weeks before they are broadcast. It would not be wise to break into a musical programme with a political

harangue without warning. And even supposing it were a practical possibility I believe that it would not find favour with our listeners. As a novelty it might be a success but as a regular item it would be boring to the majority of our listeners."

The young politician seemed non-plussed. The answers of the broadcasting manager had shown that the subject had been thrashed out many times before and his dream of starting the House with a series of questions fell about him. The broadcast manager leant over and tapped him on the knee.

"There is one answer to your argument," he said. "If you believe that there is a sufficiently large body of listeners-in interested in politics to warrant broadcasting then why not let the House of Representatives have its own broadcasting station?"

At this stage the reader is wondering where Matthew Charlton, famous leader of the Australian Labor Party, enters into the argument. It is here.

Having listened to the discussion above the writer approached Mr. Charlton one day last week and placed before him the broadcasting manager's suggestion.

"Undoubtedly there is a large body of people, mostly in the country, who take a keen and active interest in politics," he said. "They have to rely on the newspapers for their information and it is my experience that the newspapers rarely give long reports of political questions without in some way garbling the account. Often a speaker finds an entirely different meaning attributed to his statements when they appear in print.

"If they were able to hear the speeches as delivered it would make an enormous difference. I believe that if the House of Representatives had its own broadcasting station there would be a great reawakening of interest in politics throughout the Commonwealth.

"It would also be an advance movement for broadcasting. Many programmes now lack a more solid and instructional side which would be well catered for by the political station. There must be hundreds of

political followers now who would become listeners-in solely through such a station. And unlike the regular A class stations there would be no need for a listener-in to listen unless he wished to.

"Do I think that the presence of the microphone would have any effect on political speakers?" said Mr. Charlton, laughingly in answer to a question.

"Well, it certainly wouldn't restrain any of the speakers, as for microphone fright, well whoever heard of a politician who was afraid to speak. I rather believe it would be an enjoyable sensation to most speakers until the novelty wore off."

In addition to the broadcasting of the debates do you believe that it would be a good idea for Ministers and Heads of Departments to broadcast a talk for a few minutes say once a month on the business in hand?

"That would depend entirely on what was broadcast and I doubt very much whether Ministers would find time," answered Mr. Charlton. "During a session they are the busiest people in the House and it would be difficult for them to find time enough to prepare a talk on their work.

"But all this is mere supposition. If listeners-in really wish for a broadcasting station at the Federal Parliament House there is only one way to go about it. They must approach private members in a body. Having then something to go on the members could call a private conference and approach the Speaker.

"As regards the broadcasting of political propaganda that is a different matter for each party to settle, leaving the A class stations out of the question altogether.

"In Australia, we have class B stations as well as our main stations. There is no sound objection to a class B station being utilised for political propaganda within reasonable limits. The owner of such stations have not the same obligation to listeners as have the class A stations. Listeners do not pay any fee to a class B station whose service is voluntary, and wherever there is a class B station there is also the regular class A service obtainable."



Heinrich Rudolph Hertz, the first to confirm by actual experiment the predictions of Clerk Maxwell. He was born in 1857 and died in 1894.

Men Who Made Radio

By E. T. FISK

Managing Director of Amalgamated Wireless
(Australasia) Limited

This is the second article written by Mr. E. T. Fisk on the history of radio. In our last issue he dealt with the early development of electrical science up to the stage where it divides into several branches of applied electrics.



James Clerk Maxwell, whose theories led to research into the practical development of radio. He was born in 1831 and died in 1879.

SELECTING the branch that leads to wireless or radio, the world's most wonderful entertainer, the simplest and most effective system of international telegraphy and the greatest human life-saver ever known, we must travel some distance before reaching the first practical attempt at communication and the first great wireless invention. The early stages were constructed by men who had no thought of wireless communication and whose discoveries gave no indication of such a possibility.

Shortly after the discoveries made by Galvani and Volta, a professor at Leyden University in Holland, discovered that he could cause electricity from a Voltaic battery to flow into two pieces of metal, one on the inside and the other on the outside of a glass jar; that he could disconnect the battery, leave the jar standing and recover the electrical charge some time later by connecting the two metal coatings together through a wire extending from the inner to the outer coating. He found that this charge was not given off slowly, as it was put in by the battery, but that it was very sudden, and if it passed through his body he felt a severe shock, and if he used a broken wire the discharging current would jump across a small air gap and produce a brilliant spark. This apparatus has been known always by the prosaic title, Leyden jar. It was

the first electrical condenser and the forerunner of the various types of condenser used in wireless apparatus to-day. Its discoverer failed to realize that he had produced a new type of electrical energy, namely, the electrical oscillating current, without which our present-day method of wireless communication would be impossible, and it was left for an experimenter in the United States to make the next discovery which ultimately led to the recognition of the Leyden jar as a producer of electrical oscillations. This next stage was due to Joseph Henry. Henry had read of the discovery of the Leyden jar, and he knew of Faraday's earlier experiment in



Lord Kelvin, undoubtedly the greatest physicist the world has known, whose mathematical researches formed the basis of the design of early transmitters and receivers. He was born in 1824 and died in 1907.

magnetising a knitting needle and he tried to repeat Faraday's experiment, but using the discharge current from a Leyden jar instead of the current from a Galvanic battery. He found, to the astonishment of himself and his contemporaries in Europe and America, that the needle became magnetised but not always in the direction anticipated. Faraday's experiment had been repeated by all electrical research workers, and there was an invariable law connecting the direction of the current from the battery and the resultant direction of the magnetic effect in the needle, but in Henry's experiments he found that, although he always connected his electrical apparatus in the same direction, there was no such consistency in the resultant magnetism of the needle. Lord Kelvin (then Sir William Thomson) eventually brought forward a theory to explain away the apparent inconsistency of Henry's needles. He suggested, for the first time, that the electrical charge stored by the Leyden jar would not be dissipated instantaneously but would oscillate to and fro around the connecting wire in a similar manner to the swing of a pendulum or to the up and down vibration of a coiled spring when compressed by the hand and suddenly released.

This theory attracted the attention of Professor James Clerk Maxwell, who said that if it were correct



Luigi Galvani.



Alessandria Volta.

the space surrounding the apparatus would be in a condition rapidly alternating between electrical and magnetic and by mathematical reasoning he proved that Kelvin's theory was correct.

The scientific reasoning of Kelvin and Maxwell had explained the apparently erratic behaviour of Henry's needles, but so far the ideas were purely theoretical and lacked complete experimental proof.

Before travelling further along our road, we must pause awhile to contemplate some work being carried on by Professor James Clerk Maxwell in another direction, which, although not so intended, supplied an important part of the knowledge that was gradually accumulating and leading toward the practical invention of our methods of wireless communication. This work of Clerk Maxwell's related to the nature of light, which, since the days of Newton, was believed to consist of tiny particles or corpuscles thrown off from the sun and other luminous bodies, and that those particles impinging on the human eye produced the sensation of light.

This idea was unacceptable to Clerk Maxwell, who suggested that light was an undulatory or wave motion in some intangible medium which filled all space. Observers and researchers had already established the fact that light from the sun and other heavenly bodies travelled through space at a speed of approximately 186,000 miles per second. Clerk Maxwell, being an able mathematician, became interested in the intimate relationship between electricity and magnetism as found by Faraday and Oersted, and set out to discover what mathematical relationship existed between the

two forces. His work in that direction produced a result which corresponded with the abovementioned velocity of light through space. This result led him to conclude that light consisted of an electromagnetic wave, thereby strengthening his belief in his wave theory of light, and advancing it to a stage where the nature of the wave could be defined. Piecing together his own theories, the results of his mathematical investigations and the discoveries of Faraday and Oersted, also Kelvin's idea of the oscillatory discharge from the Leyden jar, Clerk Maxwell was able to contribute another step in the direction of our selected road.

In this great prognostication, which it will be remembered arose



Michael Faraday, whose discoveries subsequently made possible the telephons and telegraph. He was born in 1791 and died in 1867.

from Henry's puzzling experiment with the needle that refused to follow the supposed law of polarity, Maxwell put forward the masterly idea that if Henry's result was due to the discharge from a Leyden jar being oscillatory, as suggested by Kelvin, that discharge would set up an electromagnetic wave which would travel through space with the speed of light and would be subject to all the laws that were then known to affect visible light, i.e., it could be reflected, or refracted and would pass through certain materials that were transparent and be stopped by others that were opaque.

Here was a new theory of great scientific importance affecting the knowledge and use of the laws of light, affecting all the remarkable

discoveries that had been made in electricity and magnetism and linking the two rapidly advancing sciences of optics and electromagnetism, but none of these great workers carried this theory to the necessary stage of experimental proof. Clerk Maxwell's theory, of electromagnetic waves however added a new and highly important piece to the great road leading from the fundamental discoveries of electricity and magnetism to the invention and development of practical wireless communication.

The next stage was due to a famous German physicist, Heinrich Hertz, who, in the year 1886, conducted a series of careful experiments in his laboratory at Bonn with the object of testing the theory of the oscillatory discharge of a Leyden jar and Clerk Maxwell's theory of the resultant propagation of electromagnetic waves.

These experiments occupied a period of two years, but they established a complete experimental proof of Clerk Maxwell's theory. Under Hertz's able and patient control, these electromagnetic waves crossed and recrossed his laboratory with a velocity corresponding exactly to that of light from the sun, while they lent themselves to reflection and other tests with the same exactness as light waves. This great work proved to the scientific world the correctness of Clerk Maxwell's great theory that light is propagated by means of electromagnetic waves, and his equally great deduction that an oscillatory electrical current would set up waves of a similar nature, capable of following all the known laws of optics. These electrically

(Continued on Page 49.)



Joseph Henry.



Hans C. Oersted

Broadcasting, the Press, and the Broadcast Press

Now that the Country Press Association is debating whether or not to use radio to distribute news, this article is particularly interesting. It is translated from "Der Serchische Funk," a German radio journal, by

W. G. WOOLNOUGH, D.Sc., F.G.S.

WHEN, only about a couple of years ago, broadcasting began to rise like a phoenix in Germany scarcely any one dreamt that, in so short an interval, it would reach the gigantic development it has actually attained. To the seventh, and until recently, the newest of the great forces of civilising power in Europe—the press—there has been added, overnight, as it were, an eighth—broadcasting. One would be wilfully blind were he to despise or to fail to appreciate the wizardry of this unique phenomenon, possible only through the harnessing of the electric spark. It is practicable today, from a single point, to get into touch with a million subscribers and, through them, with many millions of individual listeners by means of the co-operation of a number of transmitting stations broadcasting simultaneously. The transmission of the rejoicings in the evacuation of Cologne, and the broadcasting of the speeches of the presidential candidates last year are cases in point. In any case, broadcasting shows itself to be a force of mighty import.

But where there is power it is absolutely essential that there should be regulation and control of the machinery for production of that power. The uncontrolled and sometimes uncontrollable, possessor of dictatorial power, is an exception, for whom there is no room in periods of normally regulated activity. Where is the controlling authority? Really it is non-existent. We have neither a censorship regulating all

stations, nor a legal institution analogous to the Press Law. (The Programme Board is perhaps the initial step in this direction). The programmes of different stations take the general course determined in advance by their directors. In individual cases the policy is strictly defined; but, for the most part the production of the different stations is left to the responsibility and the individual taste of its executive officers.

This practice is well tested, and may well suffice in the future. It has been tested out, however, in quiet, normal times, times not subject, at all events, to revolutionary violence. When and where would the control be assumed in periods of unrest? Who would wield the power?

The daily press, which might possibly have been appealed to in this connection, some time ago took up the attitude of ignoring broadcasting, and to a large extent, it continues to do so. For instance, it gives far more space to the stage, the admirers of which are far less numerous amongst its readers than are broadcast listeners. This attitude is well founded. Against broadcasting the press has a certain right to feel itself in the position of the peasant,

who warmed the frozen snake in his bosom until it showed its gratitude by turning round and biting him. In its earlier stages it was only through the press that broadcasting could give any indication of its existence, its hopes, and its intentions. Scarcely had it got on to its feet, thanks to this support, and, with extraordinary rapidity, gathered together a constantly growing army of subscribers, than it "revolted." Now, before the close of the evening session, it broadcasts the latest news, which, previously, people used to look for in their morning paper, and in this way it robs the papers of much of their freshness. Also broadcasting has sometimes shown itself a serious competitor in the matter of advertising. During a printers' strike in Brisbane (1924) in addition to sending out handbills, one great emporium had notices of a sale broadcast at intervals daily, and found that the immediate results were in no way inferior to those attained by the ordinary methods previously employed. Certainly this does not prove that the insertion of a newspaper advertisement is useless and superfluous, but only that it is possible to obtain a substitute even if only under very

special circumstances.

All the same, whether and to what extent broadcasting is or can be a competitor of the press, the daily press has no obligation to act as mentor to broadcasting, and to warn it as to shoals and quicksands. This is rather the function of a specialised broadcast press.

(Cont. on Page 39.)



3LO artists now appear before regular studio audiences.

BURGESS—Nearly "twice the life."

Nation-wide Co-operation of Traders Needed

WE recently spent some time considering the co-operative aspect of broadcasting. It was clear that there was work to be done by more than the broadcasting company. The successful development of the business depends, as does any other class of business, on the degree of public appreciation it earns, and on stimulating a desire for more broadcasting. Like selling land or any other commodity, the parties concerned must interest the prospective purchasers or users in the commodity offered for sale or use.

It is thus obvious that the battle of publicity must be taken into distant parts—the public must be told more and more about the advantages of broadcasting. It is not sufficient merely to broadcast and to display receiving equipment in shop windows; the general public must be convinced that broadcasting is a good thing to have. For it certainly is a good thing to possess the means whereby music, song and story may be brought into the home. And it is because so many people are unaware of the opportunities they are missing that there are not more listeners.

The part to be played in developing broadcasting by the wireless traders is all-important. The success of their business and of broadcasting generally largely depends on the activities of wireless traders. They are in closest touch with the public; it is to them that the sceptics and initiates come for information, and a great deal depends on the manner in which the trader treats them. Unfortunately it is probable that some prospective radio enthusiasts have their initial enthusiasm damped by the casual and careless manner in which enquiries regarding receiver troubles are answered.

Even with satisfactory and obliging attention by traders' assistants, the great opportunities for extending the business are not grasped. It is not sufficient just to sell a set; the wise trader will endeavour to ensure that the purchaser obtains satisfaction from it, and that his interest in broadcasting is active enough to in-

The N.S.W. Radio Broadcast Bureau has done excellent work in the development of broadcasting. This article is a plea for a more extensive scheme of nationally organised traders.

fluence other purchasers. The element of service should never be lost sight of. Once again let us say broadcasting is a co-operative affair and the traders, if they are wise, must keep in close touch with the users of the service.

Broadcasting service stations for attending to batteries, sets, etc., may not be as necessary as automobile service stations; but they certainly will be wanted. Such a service is needed now in every city. Dealers individually endeavour to provide such service, but the attempts are not sufficient and are not co-ordinated. Co-ordination of dealers' activities will benefit dealers and listeners alike and is calculated to benefit the trade in no inconsiderable way.

A definite scheme of propaganda by organised traders is essential. It should not be difficult for an association to be formed for mutual benefit and primarily for bringing the benefits of broadcasting nearer to the public who are still hesitating. Very useful work in this direction is being taken now in New South Wales, but it does not go far enough. Well organised "drives," concentrated and attractive publicity could be utilised more extensively. Exhibitions and demonstrations on large scales should be more frequent. The broadcasting companies would of course co-operate in such movements. It is only necessary to point to the success of the Melbourne exhibition last year when 3LO co-operated with the wireless trade in exciting the interest of many thousands of people in broadcasting and in the variety of receiving sets.

The production of thoroughly efficient receivers is a matter of prime importance. Users of sets are becoming more particular if not fastidious. They know that it is possible to have better sets without unreason-

ably increasing the cost. By better sets is meant sets that are sufficiently selective; constructed so as to give good reproduction of music and to have a minimum of controls. Now that the authorities responsible have crowded the stations into a narrow band of wavelengths a selective set is essential. And in obtaining that selectivity it is the business of the trader to give the purchaser of the set proper advice regarding the construction of the aerial and earth. Many good sets become bad advertisements for the trader who neglects that precaution. It is not only a precaution; it is a necessary part of the transaction of selling the set.

How many traders make any enquiry as to the location where the set is to be used—whether it is near a station that may interfere? Not many I am afraid. And when an irate or disappointed listener complains that he cannot shut out an interfering station, how many wireless shop assistants give the unsatisfying reply, "get a wave trap." The elimination of the interfering station may be brought about by easier means—and cheaper means if information is gathered by a few suitable enquiries and sound advice.

The usefulness of the press in obtaining publicity is not properly exploited. It should not be difficult to obtain. And especially in country districts is this propaganda desirable. An exhibition in a country town would do more to increase the number of set users than individual demonstrations by travelling representatives of city traders. And it would not be much more costly, if at all. The country man is probably more sceptical than the city dweller, and there is nothing like "letting him hear it," and demonstrating to him that manipulation of a receiver is not as fearsome as description of sets often suggests.

There are many more ways in which an organised trade could say to the public "let us help you," but the first essential is the organising of the trade for the purpose of publicity and service.

Coming Programme Features

News and notes from the Studios about items to be broadcast. Some outstanding features in coming programmes from 2FC and 2BL



Above: Mariel Humphries, contralto, winner of the 2FC Radio Voice Contest, a regular broadcasting artist. Right: Miss Ella Gaudman, 2FC soprano.



Mr. Walter Kingsley, famous Australian operatic baritone, who has been responsible for many splendid programmes from 2FC.



Above: Mr. Eudley Turner, well-known Diskensian and Shakespearian artist, and 3LO speaker.

Left: Mr. Colin Crane, Sydney baritone, who is now performing at M.O.

LISTENERS to 2FC on a recent Monday night heard the Sydney Flute Club in action, conducted by Mr. John Lemmone, one of the world's famous flautists. The symphonic effect of the 30 flautists was remarkable. It was hard to realise that so limited an instrument could be so effectively used, and the solos by Mr. Lemmone and the obligatos played by him to the songs sung by Miss Mabel Batchelor, were exquisitely received. 2FC is anxious to arrange with the Sydney Flute Club to broadcast further performances.

ANTOINE KONSTANT, the French pianist, whose first recital in Australia was broadcast by 2FC, will be heard again through that station on Friday, November 19, when he will play a special broadcasting programme from Paling's Concert Hall.

MANLY'S Municipal Band, one of the finest military bands in Australia will be broadcast from 2FC regularly. It is hoped to transmit the band from the Manly band stand, Manly Beach, every second Sunday night and every second Sunday afternoon.

THE DELIGHTFUL musical comedy, "The Chocolate Soldier," will be heard from 2FC on Monday evening, November 20, when the 1st and 2nd Acts will be broadcast. The 3rd Act will be transmitted on Tuesday, No-

concert Hall by 2FC on November 17. The first portion of the programme will be devoted to compositions by Grieg, with solos by Madame Vera Taama, soprano, and dulcetone accompaniments by Madame Evelyn Grieg. The First Movement of the Grieg Concerto for two pianos will be played by Madame Grieg at one grand piano and Mr. Oswald Anderson, 2FC studio manager at the grand player piano. The second half of the programme will be taken over by Miss Rosalie Duvali and Mrs. Norman Thomas, in a joint recital of the evolution of the harp, in which the two musicians will play the old Grecian harp and the most modern instrument, with a story of the evolution of the sweet toned instrument from the earliest record, which goes back 3000 years. Then as a novelty, the mandolin will be utilised, showing the contrast between the early string instruments and the modern. Songs will be sung typical of the various periods, with harp accompaniment.

STATION 2BL will feature a racing talk by an expert Pressman, giving the racing form for the next day's races, on November 12. Informative and interesting talks are listened to by a huge sporting public, who are keen to take advantage of the information that is broadcasted.

November 27. The principal parts will be taken by two well-known 2FC artists, Mr. James Donnelly, and Mr. Bryson Taylor.

FURTHER Comic Operas are promised from 2FC, including the 1st Act of the "Orchid," on November 24, and the 2nd Act on November 25. The whole of "Very Good, Eddie," on Saturday, December 4, and the whole of "High Jinks," on Saturday, November 27.

ON SATURDAY, November 13, Miss Dorrie Ward and Mr. W. E. Lewis will be featured in solo and duet numbers from 2BL. These favourite artistes have been figuring on Broadcasters' programme almost since the inception of the Station, and by the constant presentation of fresh numbers have received a great measure of appreciation.

A COMPLETE studio programme will be transmitted from Paling's

Broadcasting as an Influence in Family Life

There is no likelihood of interest in radio abating says our 3LO correspondent in this article. It has too firm a grip on family life

WHETHER or not broadcasting is a public necessity, it is becoming a great factor in family life. Indeed it is gradually making itself felt in national life, as evidenced by the use made of it in the recent elections. It may not be correct to style it a public utility, because a public utility is indispensable, like the gas, water, and electric light services, the post office, and the railways, but broadcasting is certainly developing as an influence in family and community life much more rapidly than any of the services mentioned.

There is no likelihood of the interest in broadcasting abating. The number of people who listen-in every night will diminish as the service becomes more familiar, but the number of new listeners will always be greater than the number of losing interest in it sufficiently to abandon the service. At first, people are charmed by the novelty and tempted to don the earphones every night, but after the first few months of such enthusiasm their arduous slackens and they seek the programme for special items. But they will not easily relinquish the service. They will keep the set and listen-in to special items in the programme. Hence it is apparent what are the problems confronting the programme directors of the broadcasting stations. Their audience is so wide and so varied that a programme on a restricted plane will not suffice. The programme must within a certain period contain something for everyone. Some people will prefer a "highbrow" programme; others want lighter music or stories, and quite a number demand jazzy music all the time. Then there is the sporting enthusiast who buys the set primarily to hear the sporting results and



Mr. F. C. Cochrane relieving Mr. Alfred Andrew at the 3LO microphone this week. Mr. Andrew has exchanged places with Mr. Cochrane, and will be heard from 2FC for a short time.

no item to him is better than the description from 3LO Melbourne of a wrestling match. And not by any means least, judging by the plebiscite of listeners' preferences in programme items, are the numerous people who want to have the church services brought to them.

In the endeavour to satisfy all these desires it is small wonder then that some one writes occasionally to the papers and complains of the programme. Some item or items are objectionable to him or some item he wants has not been given. And at the same time there will be many listeners writing to 3LO congratulating the director on the excellence of the items complained of.

How then is a satisfactory service to be given, but by seeking to fit in to the programme something that will have a special appeal to me to-night and to you to-morrow night, and to the others on Saturday afternoon and Sunday evening. It is extremely dif-

icult to say what is a good programme. And it is futile to say what programme supplies the needs of all listeners. No enquiry or plebiscite would determine that. At least it would be impossible to compile a programme that satisfied all the requirements in one night.

As in the case of newspapers or more particularly the periodical press it seems as if the broadcasting company must try to tell the public what it should want. To depend on ascertained views and opinions is a hopeless proposition. The company apparently will have to set its own standard, keeping in mind the requirements of all the varied multitude of listeners. There are many people who do not appreciate good music simply because they do not know it or have never had the opportunity to enjoy its charms without the tedium of studying it. Here is where a broadcasting service can be of great use. The explanation of musical items as given by Dr. Floyd at 3LO will

go far in creating a desire for the better class of music.

The influence exerted by a broadcasting station in the correct usage of the English language will be far-reaching. Even the announcer will be accepted as an authority on pronunciation. It becomes him to be constantly on his guard, and to realise always the responsible position he occupies in indirectly acting as a teacher. The various lecturers both in the matter and the manner of their talks become educators and may influence public opinion.

It will be a comparatively easy matter for a broadcasting station to form a musical taste and develop public opinion on various topics. The medium of influence is more direct than the newspaper. But the responsibility is greater on the broadcasting company. When we consider how many children listen-in—how many impressionable minds are ready to be influenced we can imagine the anxiety of the thoughtful and conscientious programme director.

The station must set its own standard and that, of course, must be first and foremost a dignified one—a dignified one without any aloofness or surplus of "highbrow" ideas. The value of the service will be degraded and the dignity of the station lowered if there is too much "stunting." It may be all very well to cause comment or publicity by broadcasting uncertain noises and sounds from the bottom of a coal mine, but that sort of thing can be overdone. There are other ways in which publicity may be given to the service, and appreciative public comments earned without risking the dignity of the influence a broadcasting service can always exert if carefully managed with a view to its ultimate place—in the influencing factors of public and family life.

ANY large broadcasting station has countless numbers of visitors who are so keen about radio that they are compelled to call at the station just to see "where the programmes come from." With hardly an exception the first question asked by a visitor is "which is the microphone."

Get Anything
"on the air" in seconds
Perfectly—
with certainty

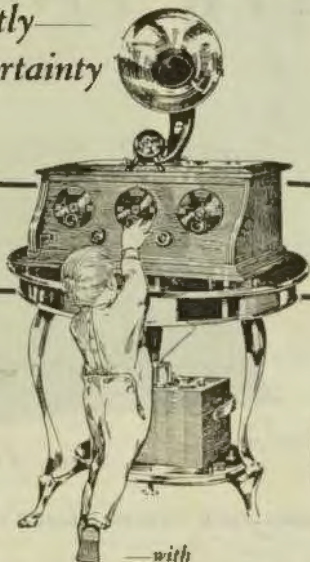

AGENTS
WANTED.

An attractive
dealer agency
proposition is
available in many
districts. Write to
the manufacturers
for the facts.

—with

at the
amazing
price of

£34

complete,
or easy
terms if you
wish

The
MINGAY
(UNIQUE)
SUPER-FIVE

You are cordially invited to the pleasure of seeing, hearing, operating, knowing the wonder of the wonderful MINGAY SUPER FIVE. Any child could tune in and immediately get results equal to an expert. If you cannot call, send for free particulars.

Manufactured exclusively by

MINGAY'S WIRELESS MANUFACTURING LTD.

Alma Street, Darlington, N.S.W.

On view at the Sydney Radio Company, 238 Pitt St., Sydney
Premises of Direct Furnishing Company

COLMOVOX SUPER FIVE MODELS 1926

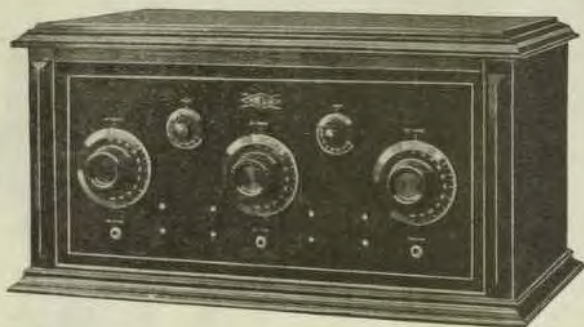

Price, £49/10/-

FULFILLS YOUR UTMOST DESIRE IN BEAUTY AND PERFORMANCE

THE 1926 SUPER COLMOVOX is beautiful to look at—lends an atmosphere of dignity and worth to Library or Drawing Room. Naturally you expect unusual performance from so beautiful a Radio Set and unusual performance is exactly what you get. Tuning, for example, is controlled by three dials only—so perfectly adjusted that each station comes in always at the same dial settings. It never varies. Powerful locals may be on full blast, yet you can tune them out completely and bring in distant stations. Tone reproduction is always clear and true, the volume always adequate. Non regenerative and extremely silent in operation, this Receiver comprises two stages of tuned Radio Frequency Amplification, Detector and Two stages of Distortionless Audio Amplification. Before you choose the receiving set to occupy the place of honour in your home, be sure to see and try the COLMOVOX. Its beauty you will recognise at a glance. Its extraordinary capabilities we will be always glad to demonstrate.

COLVILLE MOORE WIRELESS SUPPLIES LIMITED

10 ROWE ST., Near Hotel Australia, SYDNEY



The Collingwood Citizens' Band performing in the new M.O. Studio.

Beam Stations Progressing Slowly

Australian Beam Stations at Balan and Rockbank, Victoria, will be ready for tests with the reciprocal stations in England in a few weeks.

THE beam service between England and Canada has successfully passed the seven days' test required by the British Post Office, and will be opened for public traffic in the course of a few days.

The contract between the British Government and the Marconi Company required a speed of 200 words per minute for 18 hours daily, and the stations under the recent official test have exceeded the guarantee. Speeds up to 500 words per minute were maintained for many hours on end. Throughout the test, which was for a consecutive period of seven days, an average speed of 260 words per minute was maintained for 24 hours a day. The Marconi Company states that this gives a better and more rapid service than exists on any long distance communication by wireless, cable or landline throughout the world.

In England last year, Mr. E. T. Fisk, managing director of Amalgamated Wireless, held that the beam service between Australia and England would be at least as efficient, if not more efficient, than the service between England and Canada, the reason being that the high frequencies employed by the beam system have been found in many experiments to produce better results at long distances than at short distances. It is

too early to say whether this will actually be the case, but even at half the speeds obtained between England and Canada, the beam stations that are being constructed would be capable of handling in a year more than the total overseas telegraph traffic of Australia.

Australian stations will be ready for tests in a few weeks, and it is now possible to incorporate all the valuable experience that has been gained during the construction and testing of the stations in England and Canada. Although very little has been published about those experiments during the past two years, these have been going on continuously between England and Australia since early in 1924, valuable scientific information has been obtained. With much less power than will be employed in the beam stations, test messages have been received in Australia from England throughout continuous periods of 24 hours.

We have recently been having a controversy in Melbourne as to the merits of many pictures bought under the Felton Bequest. How interesting it would be to have one or two talks by famous artists, illustrated by reproductions of the best and worst of the pictures, to 'point to the moral and adorn the tale.'



Captain Frank Hurley, who has just returned from Torres Strait and Thursday Island, where he filmed "The Hound of the Deep." His travel talks have created a sensation at 28c.

"I Used Burgess"

"I cannot speak too highly of Burgess Radio Batteries. During the filming of my picture, "The Hound of the Deep," in the Tropics, I chose them as the heart of my radio equipment. Despite the initial immersion of the Batteries in sea-water, they stood up to the severe test of tropical steaming heat marvellously; in fact they appear to be immune to climatic conditions, and whatever drain I made upon them. After 5 months' continual service, they are still operating the set in my home."



Burgess Radio Batteries

"The Dry Battery Supreme"

Constructional data for a cheap and simple Cone Loud Speaker.

IT is the aim of most radiolists to possess a loud speaker some day. Quite a number of people have two and three valve sets, capable of operating a loud speaker, but only use earphones. Of course, this is not satisfactory, and considering the number of speakers there are on the market to-day, it is hard to understand.

There are many types of speakers to choose from, some with horns and a goodly number without. Without attempting to disparage the horn type of speaker, it may be pointed out that most of the latest types of speakers arriving on the market to-day, are those of the cone type. From experience, it appears that the cone type of loud speaker is very sweet indeed, although in many cases the volume is not quite so loud as with other types. Still, the trend of radio reception at the present time is not for enormous volume, but rather for very good clear tonal quality.

With this object in view, I constructed the loud speaker illustrated on these pages, and on test it was found very satisfactory indeed. All the overtones are reproduced without distortion, the lower notes of the musical scale sound especially well, thereby endearing a speaker of this type to the heart of even a musical critic.

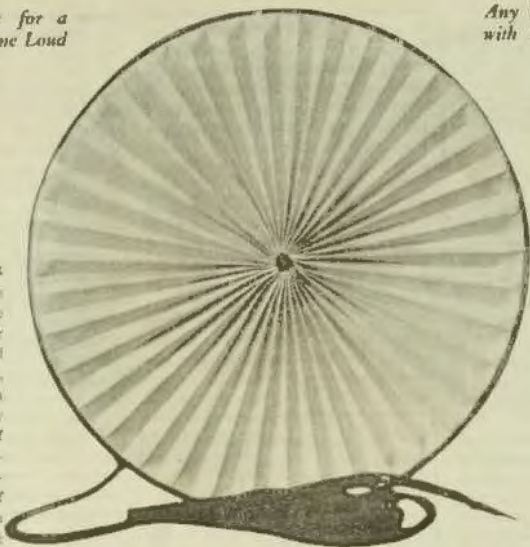

How to Build Your Own Loud Speaker

It is quite simple indeed to make, using a good quality paper, and an ordinary head phone, or loud speaker unit, or, as I myself used, a Baldwin Unit. Several different types of paper were experimented with, with a view to locating the most suitable for the purpose. Ordinary drawing paper was discarded as being unsuitable, and many other types of paper were found to be of little value for the purpose. As an after-thought, imitation parchment was tried, and found to be the most successful of all. Again, various experiments were carried out on different sized frames, finally the choice resting on a 12in. embroidery frame as being the best size for both volume and clarity.

The actual parts used for this speaker are itemised herewith:—

Any listener-in can build it with ordinary household tools.

- 1 Baldwin Unit,
- 1 12in. embroidery frame,
- 1 sheet imitation parchment,
- 1 cork, 1in. long x 1in. thick,
- 2 brass angles (gridleak clips),
- 1 piece of wood, 12 in. x 3in. x 1in.
- 3in. Busbar (square).
- 2 Csk. Head, wood screws, 1in. long,
- 2 contact studs with nuts,
- Seccotine, etc.

The 12in. embroidery frame was obtained from Mr. George Bridges, Art Linen Shop, 180 Pitt Street, although almost any similar store could

cater for your requirements. The imitation parchment was purchased from Martins, 8 Castlereagh Street, the cost being just a few pence per sheet. The brass angles were robbed from the Muter Gridleak container, sold by any of the advertisers in this paper. The wood, busbars, screws, etc., were raked up from the "Junkheap" at home. A small cork for the centre of the diaphragm was commandeered from the medicine chest, and I was lucky to find one there on account of the small size. Still, if this is not available at home, hang around outside any chemist's shop and make faces at him every time the chemist looks at you, and he will throw quite a number at you, to get rid of you. Another suitable substitute for this cork will be found in a Rawlplug of suitable dimensions.

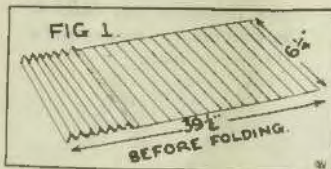

Showing how to mark and fold the parchment paper.

The parchment comes to you in a sheet sized 26in. x 20in., and from this cut two strips longways, 8in. wide. Place these two strips together, using secotone for the purpose, and allowing exactly 1in. for overlap. From this long strip now measure off 39in. exactly, discarding that portion which is left over. Spread a sheet of clean paper on the table, and lay this strip flatly thereon. With a rule and a pencil rule lines down the width of the paper 1in. apart, as shown in the sketch accompanying this article. Be very careful with your 1in. measurement, and rule very lightly, otherwise, when completed, big ugly black lines will mar the appearance.

When nobody is looking sneak into the pantry and commandeer an egg—a fresh egg of course. Separate the yolk from the white, and quietly replace the yolk on the shelf of the pantry. Using the white of the egg coat the parchment both sides, using a soft brush for the purpose. This action stiffens the paper and helps to keep it waterproof. If you happen to have some of that transparent lacquer so frequently used for lacquering brasswork, this could be used instead of the white of the egg. While the paper is drying, the embroidery frame should be treated with a coat of nice shellac.

For the benefit of those who are not domesticated, I might mention that the embroidery frame consists of two rings, one fitting very snugly inside the other, a tight fit, as a matter of fact. The shellac takes away the bareness of the appearance as well as rendering the frame impervious to moisture. Leave the frame on the one side too, and come back to the ruled parchment. Pleat this paper along the ruled lines, thus giving it 1in. pleats. Be careful with

this pleating, making certain that you do not overlap the ruled line. When finished it will look something like a fan closed up, and if overlapping takes place it will be difficult to form into a circle later on. Next, bring the ends together, and lap them over 1in., and glue with secotone, or with that liquid cement known as "Gluit." Place something heavy on this glued portion until it sets. Bear in mind, of course, that the cement should be applied along the whole length of one of the pleats, the surplus being pressed out with the back of a table knife, or something similar.

When this is dry, form the paper into a disc. Do this by placing one end of the corrugated cylinder, for such it seems to be, on the table, and with one hand press down on the top,



Attaching the hoop holding the cone paper to the unit standard.

and the paper will spread out in the form of a pleated disc. Release the pressure a bit, and the centre will rise up, leaving a hole in the middle. Smear the cork or Rawlplug, with some of the Gluit, and insert into the centre of the hole in the disc, and press the whole flat down on the table. Place a book, or something equally heavy, on the top of this cork in the centre, and leave for about an hour until the cement sets.

When everything is dry, this pleated disc has to be pressed into the embroidery frame. Separate the two rings, leaving the smaller of the two flat on the table, place the disc over the top of this smaller ring, the disc overlapping, about 1in. all round. Take care to note that this overlap is even all the way round, otherwise the cork will not be in the centre, which is the correct place for it. Now place the larger ring on the top of the disc, and press into place, making sure that an even grip all round results.

This operation is a bit difficult for one person, as it is generally found that as you press down one side of the ring, the other side comes up, therefore, two heads and four hands are better than one and two respectively. Borrow a darning needle, and through the centre of the cork pierce a hole, as the Bus-bar which forms the reed, has to be pressed into this cork. Place this tambourine-like affair out of harm's way, and carry on with the woodwork necessary. Shape the 12in piece of wood, as shown on one of the sketches, bringing each end down to 1in. in width, allowing the 3in. wide portion to remain for a distance of 3 1/2ins., that is, 1 1/2ins. each side of the centre. Right in the centre drill a hole 1/2in. in diameter. This is to allow the reed to pass through to the cork.

Fix the two small angle brackets at each end, as shown in the sketch. A terminal may be used to attach this bracket to the framework, or a wood screw will serve the purpose equally well. Note carefully that the distance between the two upright portions of the brackets is the exact distance between the inside of the smaller ring. This is most important.

Next, remove the cap from your Baldwin Unit, or earphone, and drill two small holes, seven-eighths inch from the centre, that is 1 1/2 inches apart. Drill these holes from the inside of the phone cap, and countersink each, so that when the countersunk head wood screws are pushed through, their heads are slightly below the level of the back of the cap. Using this cap as a template, mark off in the centre of the 12-inch wood-piece, positions for the wood screws. Notice, of course, that these positions are equi-distant from the centre hole

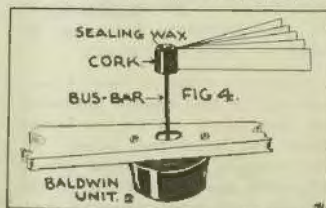

How the parchment cone is connected to the Baldwin Unit. This unit is mounted on the wooden standard—a section of which is shown.

already ruled. If desired, one-eighth in. bolts may be used, instead of the wood screws for attaching this cap to this wooden framework. However, irrespective of the method employed, screw or bolt this cap to the wooden frame, the cap to be on the underneath side, that is, on opposite sides to which you have the clips mounted.

Now, comes, perhaps, a little ticklish part, that is, the attaching of the 3-inch length of busbar as a reed from the centre of the diaphragm. Examine the Baldwin unit closely, and you will find a small spot of solder right in the centre of the corrugated aluminium diaphragm. Apply a very small piece of flux, merely a wipe, with the end of a match, and treat one end of the busbar in a similar manner. Using a small hot soldering iron, apply a small spot of solder to this end of the busbar.

Place this tinned end of the busbar right in the centre of the diaphragm and on top of the small spot of solder already mentioned. Holding this busbar erect, and be sure it is quite erect, apply the heated soldering iron to the base, and solder this busbar in the centre. Be very careful to do this operation quickly and not allow the soldering iron to rest for any length of time on the diaphragm. This is particularly important. This busbar now becomes the reed on which so much depends. Lay aside for a few moments.

Now, fit your embroidery frame, complete with the pleated disc, over the wooden frame, on which is mounted the brackets and the cap of the Baldwin unit. Locate the position of the contact studs, which go

Rear view of the completed loud speaker. The fan shaped cone is held in between the hoops. The centre is connected by a bus-bar to the diaphragm of the Baldwin Unit, which is seen mounted on the wooden standard. The phone cord is attached to the set in the usual manner.



through the embroidery frame, and through the clips, in order to attach the two portions together. Drill two holes sufficiently big to allow the contact studs to pass right through the frame and through the brackets. Don't attach these two portions together just yet; make provision for the assembling a few moments later.

Assembling is a simple matter indeed, but a little bit of care is necessary to ensure thorough satisfaction. Hold the wooden frame, on which is mounted the cap and brackets, in the left hand, and push your reed through the centre of hole of this cap, and through the large hole in this wooden frame, and screw your Baldwin unit to the cap. This leaves the reed protruding right through this frame. Carefully indeed press

this reed into the centre of the cork and through the other side, making sure at the same time that the brackets, when pressed home, will fit snugly on that portion of the rings, through which the holes have been drilled. Push your contact studs through from the outside of your rings through the brackets, and hold in place with the nut. Do this each side. Now place your hand on the reed and gently press out the pleated disc away from the Unit, not too far, mind you, otherwise you may upset all your good work. A gentle pressure will soon tell you just how far to ease this pleated disc away. Cut off the excess portion of the busbar protruding on the other side, and, holding at this tension, ask someone to heat up a stick of sealing wax, and apply it to the cork on the outside, in order that this busbar or reed may be held in place. Don't be afraid to make a nice little cone of the sealing wax, as quite a lot depends on this being done correctly, as, if this is not so, the busbar will simply vibrate, and will have no effect on the pleated disc.

The speaker is now completed, with the exception of a stand suitable for the purpose. Try it out on your receiver. Wonderful tones, hasn't it? Sweet, mellow. Just the thing you have been looking for, and very inexpensive, when all is said and done,

(Continued on Page 37.)

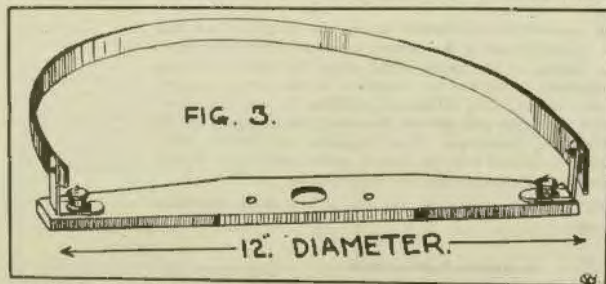

Illustrating the method of mounting the hoop on the wooden standard. Only a section of the hoop is shown.

"SFERAVOX"



For
Faithful and
Distortionless
Reproduction

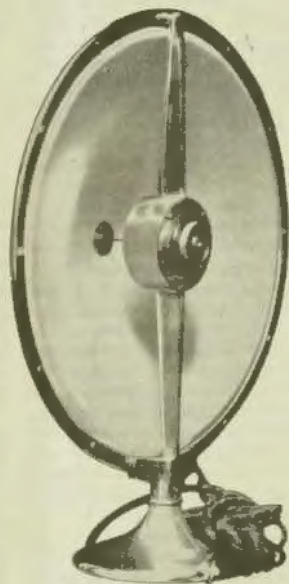

£5-5-0

THE INCOMPARABLE CONE SPEAKER

In most existing instruments of a similar nature the design is such that distortion cannot be avoided and in this respect we would refer particularly to the differences arising in the forces acting either by attraction or by repulsion in the magnetic circuit and the magnitude of the current required to obtain sufficient volume, such differences resulting in very unfavourable conditions for the valves and the low frequency transformers of the receiver. Furthermore, diaphragm of an excessive size induce sound reverberations and this coupled with the causes quoted above, are all contributory to distortion and disagreeable tone reproduction.

The "SFERAVOX" Loud Speaker is an example of how these difficulties have been overcome.

Australasian Representatives:

And at Melbourne, Perth, Brisbane
Auckland & Wellington, N.Z.

BROWN & DUREAU, Ltd.

Broughton House
Clarence St., SYDNEY

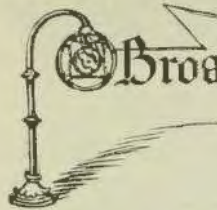

Broadcasting Programmes

for the Coming Week.



Friday, Nov. 12

2FC

EARLY MORNING SESSION

- 7.—The Chimes of "Big Ben."
Announcements.
7.5—Weather information, rainfall, temperatures, astronomical observations, shipping intelligence, mail services.
7.25—Investment Market, Mining Share Markets, Metal quotations.
7.35—Wool Sales, Broadstuffs Markets, Intermediate Markets, Produce Markets.
7.45—"Sydney Morning Herald" News Service.
8—Chimes of "Big Ben" Music from the Studio.
8.15—Close down.

MORNING SESSION.

- 9.15—The Chimes of 2FC and Announcements.
9.30—Marching Music from the Studio.
9.35—Marching Music for the School Children.
9.45—Music from the Studio.
10—"The Chimes of 'Big Ben.'" Music from the Studio.
10.5—Late "Sydney Morning Herald" News Service.
10.15—Music from the Studio.
10.45—A Morning Reading.
11—"The Chimes of 'Big Ben.'" Australian Press Association and Reuter's Cable service.
11.10—Music from the Studio.
11.15—Cooking talk and recipes, by Miss Ruth Furst.
11.30—Marching Music for the School Children.
11.35—Close down.

MIDDAY SESSION.

- 12—"The Chimes of 'Big Ben.'" Announcements.
12.5—Stock Exchange, First Call.
12.10—Music from the Studio.
12.30—Marching Music for the Children.
12.40—Music from Studio.
12.45—From Farmer's Tea Rooms: The Oak Hall Trio.
12.50—Rusby Wireless News.
12.55—Music from the Studio.
1—"The Chimes of 'Big Ben.'" Weather Intelligence.
1.10—"Evening News" midday news service.
1.20—"From Farmer's Tea Rooms: The Oak Hall Trio."
1.25—Stock Exchange—Second Call.
1.30—Marching Music for the School Children.
1.40—Music from the Studio.
1.50—"From Farmer's Oak Hall: The Oak Hall Trio."
2—"The Chimes of 'Big Ben.'" Close down.

AFTERNOON SESSION.

- 2.30—"The Chimes of 2FC and Announcements."
2.35—Broadcast from the Haymarket Theatre, Sydney: Operatic orchestra, under the baton of Mr. Stanley Porter (by permission of the management).

- 3.15—A serial story, by Miss Annie Hughes.
3.30—Marching Music for the School Children.
3.40—"From Farmer's Oak Hall: Miss Katherine Hovavsky, soprano.
3.45—"From Farmer's Oak Hall: The Oak Hall Trio.
3.55—Music from the Studio.
4—Mr. Frank Rotham, baritone.
4.5—"From Farmer's Oak Hall: The Oak Hall Trio."
4.20—Miss Katherine Beverley, soprano.
4.25—"From Farmer's Oak Hall: The Oak Hall Trio."
4.35—Music from the Studio.
4.40—Mr. Frank Rotham, baritone.
4.45—Stock Exchange, Third Call.
4.45—Close down.

Farmer's Barvier, Sydney, call sign 2FC, wave length 442 metres

Broadcasters Ltd., Sydney, call sign 2BL, wave length 358 metres

Trades Hall Broadcasting Station, call sign 2KY, wavelength, 250 metres

Theosophical Broadcasting Service, call sign 2UB, wavelength, 214 metres

Bargin Electric Coy. Ltd., Sydney, call sign 2BE, wavelength, 214 metres

Broadcasting Co. of Australia, Melbourne, call sign 3LO, wave length 311 metres

Associated Radio Co., Melbourne, call sign 5AR, wave length 284 metres

Queensland Radio Service, Brisbane, call sign 4QG, wave length 285 metres

Central Broadcasters Ltd., Adelaide, call sign 5CL, wave length 295 metres

Radio Broadcasting Co. of N.Z., Auckland, call sign 3YA, wave length 320 metres

Western Australian, Perth, call sign 5WF, wave length 1258 metres

Tasmanian Broadcasting Pty. Ltd., Hobart, call sign 7ZL, wave length 535 metres

EARLY EVENING SESSION.

- 6.45—"The Chimes of 2FC."
6.50—"The 'Hello Man'" Talks to the children.
6.55—A serial story for the older children.
6.57—Broadcast from the Hotel Australia, items by the hotel orchestra, under the direction of Miss A. J. Kern.
7—"From the Studio: Last minute sporting information, by the 2FC Racing Commissioner.
7.15—"Evening News" late news service; weather information.
7.30—Daley's Market Reports (wool, wheat, stock), fruit and vegetable markets.
7.40—A talk on next week's film releases.
7.50—News.
7.55—Broadcast from Her Majesty's Theatre (by permission of Messrs. J. C. Williamson Ltd.) the first Act of the musical comedy, "Rose Marie," featuring Miss Harriet Bennett and Mr. Frederick Bentley.
From the Studio: Mr. Harold Tollman, baritone; Mr. Harrison White, in band solo.

NIGHT SESSION.

- 10—Broadcast from the Lyceum Picture Theatre (by courtesy of the Union Theatres Ltd.), items by the theatre orchestra, under the baton of Mr. Emanuel Amos. During the playing of this orchestra, a description of next week's principal film releases will be given direct from the projection room of the Union Theatre Film House.
10.30—"From the Studio: Mr. Harold Tollman, baritone.
10.35—Broadcast from the Wentworth Hotel.
10.40—Broadcast from the Wentworth Hotel, items by the Wentworth Cafe Orchestra, conductor, Mr. Sydney Simpson.
10.50—Mr. Harrison White, in band items.
11—"The Chimes of 'Big Ben'" and announcements.
11.5—Further items by the Wentworth Cafe Orchestra, under the baton of Mr. Sydney Simpson.
11.5—"The Chimes of 'Big Ben.'" National Anthem. Close down.

2 BL

EARLY MORNING SESSION.

- 7.15—Physical Training and Health Exercises.
7.30—Broadcasters Special News Service.
7.45—Physical Training and Health Exercises.
8—G.P.O. Clock and Chimes. Close down.
MORNING SESSION
8—G.P.O. Clock and Chimes: Musical programme from the studio.
8.15—Special News Service from the Daily Telegraph.
8.30—Musical programme from the studio.
8.45—Special News Service from the Daily Telegraph.
9—G.P.O. Clock and Chimes: Market Reports and London Moral Quotations.
11.10—Musical programme from the studio.
11.25—Broadcasters' Information Service, including Mail, Shipping, Weather, Rain-fall.
11.40—Women's Section: Social Notes by Mrs. Jordan.
11.55—Mrs. Jordan Replies to Correspondence.
12—G.P.O. Clock and Chimes: Feeding the Family, Mrs. Jordan.
12.25—A Talk by Miss Helen Jean Deeging.
12.30—Sydney Stock Exchange Calls.
12.40—Hiller's Instrumental Quartette, under the direction of CARL Cassing.
1.20—Sydney Stock Exchange calls.
1.45—Latest sporting information from the "Sun."
2—G.P.O. Clock. Close down.

AFTERNOON SESSION.

- Racing Information broadcast by courtesy of The Sun.
3—G.P.O. Clock and Chimes: Weather Report and Forecast by courtesy of Mr. C. J. Maso, Govt. Meteorologist.
3.15—Civil Service Restaurant Trio, under the direction of Miss De Carey Bremer.
3.30—Musical programme from the Studio.
4—G.P.O. Clock and Chimes: Civil Service Stores Trio.
4.15—Serial Story.
4.30—Musical programme from the Studio.
4.55—Producers' Distributing Society's Market and Fruit Report: Shipping Information when available.
4.50—News from the Sun.
4.55—Remains of night's programme.
5—G.P.O. Clock and Chimes: Close down.
EARLY EVENING SESSION.
6.45—G.P.O. Clock: The pupils of Miss Monica Seally will entertain the kiddies.

8.40—Pavilion Dinner Orchestra, under the direction of Mr. C. Morrison. Special Country Session.

7—G.P.O. Clock and Chimes; Australian Mercantile Land and Finance Coa Stock, Wool and Hide Report.

7.5—Weather Report and Forecast, by courtesy of Mr. C. J. Mares, Government Meteorologist.

7.3—Stock Exchange Reports.

7.16—Producers Distributing Society's fruit and vegetable report.

7.24—Fruit and vegetable Report (Sun).

7.24—Grain and Fodder Report (Sun).

7.27—Egg and Poultry Report (Sun).

7.30—Country News from the Sun.

7.40—Talk in The Electrical part of a Car. By Mr. Fred Brown.

NIGHT SESSION

8—G.P.O. Clock and Chimes, Broadcasters Topical Chorus.

8.3—Broadcasters Trio.

8.13—Miss Elsie Findlay, soprano.

8.27—Mr. Norman Wright, tenor.

8.27—Mr. Bobby Watson, comedian.

8.34—A Talk concerning your valve set.

8.44—Miss Bessie Cooke.

8.52—Mr. Cyril James, baritone.

8.55—Resumé of following day's programme.

9—G.P.O. Clock and Chimes; Weather Report and Forecast, by courtesy of Mr. C. J. Mares, Govt. Meteorologist.

9.4—Broadcasters Trio.

9.14—Interval.

9.16—Miss Elsie Findlay.

9.26—Mr. Norman Wright.

9.53—Miss Bessie Cooke.

10—G.P.O. Clock and Chimes.

10.1—Mr. Bobby Watson.

10.8—Mr. Cyril James.

10.15—Ambassadors until midnight.

12—G.P.O. Clock and Chimes; National Anthem.

2 KY

LUNCHEON HOUR SESSION:

12.15—Popular fox trots; Orpheus Gramophone.

12.25—Musical Interlude.

12.40—News Items.

1.5—Vocal Items.

2.15—Hawaiian steel guitar selections.

1.50—Union news and meetings.

1.30—Vocal and musical items closing down at 1.45 p.m.

CHILDREN'S HOUR:

0.20—The Storyman, Mr. Thompson.

EVENING SESSION:

7—Sporting feature, Turf Topics, Review of Candidates and their Prospects for Tomorrow, Mr. G. Hopkins.

7.40—Lecturette: Industrial History, Mr. J. Ryan, Director, Labor Research and Information Bureau.

8—A talk on Motor Cracking, by Mr. J. R. Hoskins.

8.10—Pianoforte solos, Miss Gwen Aaron.

8.15—Soprano solo, Miss Edith Welsh.

8.27—Monologue, Mr. David Edelstein.

8.53—Musical Interlude by Palms Royal Californians, Mr. Walter Beehan, leader (by kind permission of J. C. Hendrick, Ltd.).

9—Sporting Feature: Full description of match contest from ringside of McHugh's Leitchfield Stadium.

9.55—Music from Studio.

10—Closing Announcements.

2 GB

EVENING SESSION.

6.45—Talks to children, by "The Dream Fairy."

7.15—Talks to Women.

7.30—Music from the Studio.

7.45—Announcements.

7.55—Duets for two violins and piano.

8.5—Address by Prof. Ernest Wood.

8.20—Songs by Miss Cecillie Adkins.

8.28—Instrumental Trio.

8.40—Address by Dr. J. J. Van der Leeuw.

8.58—Songs, by Clement Hosking.

9.5—Vocal solos, by Lloyd Davies.

9.10—Announcements.

9.10—Songs, by Miss Cecillie Adkins.

9.20—Talks on Wireless, by Mr. E. G. Beard.

Constructional Engineer 2GB.

9.38—Instrumental Quartette.

9.50—"Great Thoughts from Great Minds," by Prof. Ernest Wood.

9.54—God Save the King.

3 LO

MIDDAY SESSION.

12—Time Signal, British Official Wireless News from Rugby, Reuter's and the Australian Press Association cables. "Argus" and "Herald" news services.

12.45—Stock Exchange Information.

12.50—Meteorological information. Weather forecasts for Victoria, Tasmania, South Australia, and New South Wales. Ocean Forecast.

1—Time Signal.

2.1—Studio Orchestra.

1.10—Colin Crane, baritone (by permission of J. C. Williamson Ltd.), selected.

1.17—Walter Smith, cornet.

1.23—Gwen Barham, contralto.

1.30—Franklin Stobham, clarinet.

1.35—Colin Crane, baritone.

1.42—Studio Orchestra.

1.47—Gwen Barham, contralto.

1.54—Studio Orchestra.

2—Close down.

AFTERNOON SESSION.

2—Studio Orchestra.

2.10—Report Hazel and Elsie Day, Harmony-party.

2.17—Thelma Beady, banjo.

2.25—Vera Spaul, soprante.

2.32—"All Felt," of Messrs. Buckley & Nunn Ltd., "Fashion Talk."

2.47—Studio Orchestra.

2.53—Report Hazel and Elsie Day (instal on, appearing again).

4—Thelma Beady, banjo.

4.5—Mrs. M. Callaway Mahood, "Art in Pursonary."

4.58—Vera Spaul, soprante.

5.30—Studio Orchestra.

6.45—"Herald" news service. Stock Exchange information.

7—Close down.

EARLY EVENING SESSION.

7.45—Children's Hour Answers in letters and Birthday Greetings.

8.7—Mollie Ick wants to know "Do you want a fairy?" "The Lamp-lighter."

8.7—"Billy Boney," "The Littlest Fairy Story."

8.17—Mollie Ick will tell you about "The Green Grass Fairy," "Medicine Boxes."

8.23—"Billy Boney," "Black Beauty," "The Lost Princess."

8.40—"Argus" and "Herald" news services. Reuter's and the Australian Press Association cables.

8.53—Weather synopsis, Shipping movements.

8.57—Stock Exchange information.

9.0—"Argus" and "Herald" news services. Reuter's and the Australian Press Association cables.

9.53—Weather Synopsis, Shipping Movements.

9.57—Stock Exchange Information.

7.5—Fish Market Reports, by Messrs. J. R. Horrett Ltd.

7.6—Rivar Reports.

7.6—Market Reports, by the Victorian Producers' Cooperative Co. Ltd. Haymarket Sheep Sales, Poultry, Grain, Chaff, Hay, Straw, Jute, Dairy Produce, Potatoes and Onions. Market prices of Oranges and Lemons, supplied by the Victorian Central Citrus Association Pty. Ltd.

NIGHT SESSION.

7.20—Under the auspices of the Department of Agriculture, Mr. J. E. Thomas, B.V.Sc., "Diseases of Poultry."

7.40—Mr. Hilton Allen, now appearing in "Brown Sugar," at the King's Theatre, will speak to you from his dressing-room, by permission of J. C. Williamson Ltd.

8—Studio Orchestra, selection "Floradora."

8.10—Mr. E. C. H. Taylor, "School Life and School Sport."

8.30—Gwen Barham, contralto.

8.37—Thelma Beady, banjo.

8.45—Colin Crane, baritone (by permission of J. C. Williamson Ltd.), selected.

8.52—Studio Orchestra.

9.2—"Cardigan," Mr. H. A. Wolke, sporting editor of the "Argus," "Armada Cup and other Races."

9.17—Report Hazel and Elsie Day, in Harmony-party.

9.24—Thelma Beady, banjo.

9.30—Mr. Leslie Brunning, "Dabbles for the Home Garden."

9.45—Collingwood Citizens' Band.

9.53—British Official Wireless news, from Rugby. Road Notes, supplied by the Royal Automobile Club of Victoria.

10.5—Colin Crane, baritone.

10.12—Collingwood Citizens' Band.

10.23—"Argus" news service. Announcements. Meteorological information.

10.30—Gwen Barham, contralto.

10.40—Studio Orchestra.

10.50—Report Hazel and Elsie Day, in a few minutes.

11—Our great thought for to-night: "Peace is the fairest form of happiness,"—William Ellery Channing.

11.1—3LO Dance Orchestra.

11.40—God Save the King.

3 AR

MORNING SESSION.

11.30—British Official Wireless Press, received from Rugby Super Wireless Station, England, by 3AR's operator. Express Train information. "Argus" news bulletin.

12—Time Signal Chime. Studio Barometer Readings. First Weather Forecast. Events of the day.

12.5—Musical Selections, relayed from Hoy's de-Luxe, Bourke Street; Mr. T. L. Campbell, at the Warbler.

13.30—Market Reports, Stock Exchange news.

13.40—Musical selections.

12.55—Shipping movements. Mail notes.

1—Close down.

AFTERNOON SESSION.

2.30—Hoy's Premier Orchestra, Cecil W. Fraser, conductor.

3—Musical items from Studio, by the Ron Hearnley Quartette.

4—Time Signal Chime. Second Weather Forecast. Hoy's Orchestra.

4.5—Miss Emily Noble, cooking lectures by courtesy of Metropolitan Gas Coy.

4.30—Gardening talk to children, by Mr. B. Stanley Haines.

4.55—Evening Amusement.

5—Time Signal Chime. Studio Barometer Readings. Close down.

EARLY EVENING SESSION.

4.45—Children's Corner, by Uncle Rad.

EVENING SESSION.

7.45—British Official Wireless Press. Studio Barometer Readings. Racing Anticipations and Sporting Events, reviewed by "Field Glasses."

8—Time Signal Chime. Miss Amy Wheatland, soprano.

8.7—Mr. Edwin Alexander, oboe-player.

8.14—Mr. Rupert Thomas, baritone.

8.31—The Harmony Instrumental Trio.

8.30—Mr. R. Stanley Haines, talk: "Gardening."

8.40—Mr. Milo Davine, baritone.

8.52—Miss Doris Cookson, soprano.

8.59—Miss Hazel Guest, violinist.

9.5—Miss Amy Woodland, soprano.

9.13—Mr. Edwin Alexander, entertainer.

9.21—The Harmony Instrumental Trio.

9.32—Mr. Rupert Thomas, baritone.

9.39—Miss Doris Cookson, soprano.

9.46—Miss Elizabeth Lester, cellist.

9.53—Mr. Milo Davine, baritone.

- 16.—Time Signal Chime. Spidre Barometer Readings. "Age" News Bulletin.
19.10.—Leggett's Ballroom Orchestra, under the leadership of Mr. Harry Nangle.
11.—Time Signal Chime. Close down.

4QG

MIDDAY SESSION.

- 12.55.—Tune In.
12.58.—Time Signal.
1.—Market reports; weather information; "The Daily Mail" news; "The Daily Standard" news.
1.20.—From Hotel Carlton: Lunch music from the Lounge. Hotel Carlton, played by Hotel Carlton Symphony Orchestra.
2.—Close down.

AFTERNOON SESSION.

- 3.50.—From Hotel Carlton: Afternoon tea music from the Lounge. Hotel Carlton, played by Hotel Carlton Symphony Orchestra.
4.15.—From the Studio: "The Telegraph" news.
4.30.—Close down.

EARLY EVENING SESSION.

- 6.25.—Tune-in.
6.30.—The Children's Session—Stories by "The Sandman."
7.—From the Council of the Agriculture Station: The Farmer's Session; Market Reports; Lectures. "Lessons from Rural Denmark" by Mr. J. F. Edal, Editor Queensland Agricultural Journal. "The Standard" news. Stock Exchange.
7.40.—Announcements.

NIGHT SESSION.

- 7.45.—Lecture Session: "Wireless" by Mr. Monkhouse (president, Wireless Institute of Australia, Queensland Division).
8.—The Studio Orchestra and musical items.
8.10.—Weather information, officially supplied by the Commonwealth Weather Bureau. Announcements: Week-end road information for motorists, officially supplied by the Royal Automobile Club of Queensland.
8.20.—Studio Orchestra and musical items.
10.—"The Daily Mail" news service. Close down.

5CL

MORNING SESSION.

- 11.30.—G.P.O. Chimes.
11.31.—Stock Duo Art.
11.40.—"Advertiser" News Service.
11.55.—Vacation number.
12.—G.P.O. Chimes.
12.1.—"Advertiser" news service.
12.16.—Stock Duo Art number.
12.30.—The 5CL Studio Orchestra will play.
1.55.—Apprentice—Ward & Co's. Stock Exchange Intelligence. Weather Reports and Station Announcements.
2.—G.P.O. Chimes.

AFTERNOON SESSION.

- 3.—G.P.O. Chimes.
3.1.—Relay from "Maple Leaf" Cafe—Orchestra numbers.
3.45.—Stock Duo Art numbers.
4.—G.P.O. Chimes.
4.1.—Relay from "Arcadia" Cafe—Orchestra numbers.
4.45.—Stock Exchange reports, general information, and station announcements.
5.—G.P.O. Chimes.

EVENING SESSION.

- 6.50.—G.P.O. Chimes.
6.51.—Bedtime Stories, by "Auntie Peggy."
7.30.—Market Reports.
7.45.—Sporing Talk, by "Old Timer."
8.—G.P.O. Chimes.
8.1.—Relay Mainira Reid's Orchestra.
8.30.—Right Rev. Bishop Arundell, "Australia, her power and purpose."
8.45.—Breakie Duo.
8.50.—Merry-makers' Orchestra.
8.55.—Mr. D. Wildsmith, baritone.

9—G.P.O. Chimes.

- 9.1.—Weather reports.
9.3.—Miss Jean Rinder, solo.
9.6.—Merry-makers' Orchestra.
9.16.—Mr. Ray Pearcey, solo.
9.20.—Karoola Duo.
9.25.—Mr. D. Wildsmith, solo.
9.28.—Merry-makers' Orchestra.
9.30.—Miss Jean Rinder, solo.
9.43.—Mr. H. Piper, cornet.
9.47.—Mr. Ray Pearcey, solo.
9.51.—Dulciana solo.
9.55.—Merry-makers' Orchestra.
10.—Karoola Duo.
10.11.—Mr. D. Wildsmith, solo.
10.15.—"Advertiser" News Service.
10.25.—Merry-makers' Orchestra.
10.35.—Miss J. Rinder, solo.
10.39.—Merry-makers' Orchestra.
10.44.—Karoola Duo.
10.48.—Mr. Ray Pearcey, baritone.
10.55.—Merry-makers' Orchestra.
10.58.—Station announcements.
11.—Close down.
11.—G.P.O. Chimes. National Anthem. Close down.

7ZL

MORNING SESSION.

- 13.—G.P.O. Clock Chimes. The "Merry" news, stock market, shipping commercial intelligence, weather information. "Salute" selections.
13.—G.P.O. Clock Chimes. Close down.

AFTERNOON SESSION.

- 5.—G.P.O. Clock Chimes.
5.10.—Hubert Stock Exchange quotations.
5.55.—Weather information.
4.—G.P.O. Clock Chimes. Close down.

EARLY EVENING SESSION.

- 7.—Children's Corner. "Big Brother" chats to his pals.

EVENING SESSION.

- 9.—G.P.O. Clock Chimes. "The Mercury" special Tasmanian news service. Railway auction produce sales. Weather information.
8.5.—Hubert Stock Exchange quotations.
8.10.—Weekly Gardening chat, by Mr. George Nation.
8.20.—Sports Budget, supplied by Mr. T. W. Newton, of Bolnet Sports Desk.
8.30.—Concert from the Studio: Miss Bertha Marshall, soprano; Miss Dulcie Tait, alto; Miss Jessie Kim, mezzo-soprano; Miss R. Pinner, pianist; Mr. S. J. Hall, baritone; Mr. Hubert Loran, baritone; Mr. E. Williams, mouthorgan.
8.15.—Practice reports from Roberts & Co., Ltd., Murray Street, Hobart, Tasmanian District Street reports.
9.50.—"The Mercury" special interstate news service. Weather synopsis. Station announcements. National Anthem.

Saturday, Nov. 13

2FC

EARLY MORNING SESSION.

- 5.—Chimes of "Big Ben" and Announcements.
7.6.—Music from the Studio.
7.10.—Official Weather Forecast; Rainfall; temperatures; Astronomical Memoranda; Shipping Intelligence; Mail Services.
7.25.—Investment Market, Mining Share Market, Metal Quotations.
7.35.—Wool Sales, Broadstuffs Markets, Interstate Markets, Produce Markets.
7.45.—"Sydney Morning Herald" News Service.
8.—The Chimes of "Big Ben."
8.15.—Close down.

MORNING SESSION.

- 8.15.—The Chimes of 2FC and Programme Announcements.

- 9.20.—Music from the Studio.
9.45.—Last minute sporting information, by the 2FC Racing Commissioner.
10.—Chimes of "Big Ben" and music from the Studio.
10.5.—Late "Sydney Morning Herald" news service.
10.15.—Music from the Studio.
11.—The Chimes of "Big Ben." Music from the Studio.
11.15.—A talk on Gardening by "Red Gum" (Mr. J. G. Towler).

MIDDAY SESSION.

- 12.55.—The Chimes of 2FC and Announcements.
1.—The Chimes of "Big Ben" and Announcements. "Evening News" Midday News Service, Weather information. Music from Studio by the Winchell Instrumental Trio.
4.45.—A complete resume of the afternoon's sporting events.
5.17.—Close down.

EARLY EVENING SESSION.

- 6.45.—The Chimes of 2FC and Announcements.
6.50.—The "Hello Man" talks to the children.
6.58.—A Story for the older children.
6.45.—Broadcast from the Hotel Australia, Orchestral items.
7.—Late sporting information, by the 2FC Racing Commissioner.
7.40.—A Motor Talk, by Mr. J. L. Austin.

NIGHT SESSION.

- 7.55.—Programme Announcements.
8.—The Chimes of "Big Ben."
Broadcast from the Crystal Palace Theatre (by courtesy of the management), the overture and incidental music by the theatre orchestra, under the baton of Mr. Harry Stone.
8.50.—From the Studio: Miss Mary McCormick, mezzo-soprano.
8.54.—Mr. James Donnelly, tenor.
8.58.—The Sydney Instrumental Trio, comprising: Mr. James Lawson, violinist; Mr. Gladstone Bell, cellist; and Mr. Lindley Keenan, pianist. Trio, by Raff.
9.30.—Miss Daisy Morgan, soprano.
9.54.—Mr. Ford Adams with various songs; recitals by "The Spring Chicken" and "The Tovarich," including items "Everybody's awfully kind to me," and "Aroche."
9.6.—Mr. Lindley Evans, piano solo.
9.16.—Mr. Laurence Halbert, baritone.
9.20.—Miss Mary MacCormick, mezzo-soprano.
9.28.—Mr. James Donnelly, tenor.
9.36.—Mr. Gladstone Bell, solo solo.
9.44.—Miss Daisy Morgan, soprano.
9.54.—A radio play, specially written for 2FC by Mr. James Donnelly, dealing with a thrilling description of a fire which culminated in a humorous climax in which radio plays a big part.
10.0.—Miss Mary MacCormick, solo.
10.10.—The Sydney Instrumental Trio.
10.13.—Miss Daisy Morgan, soprano.
10.25.—Lawrence Halbert, baritone.
10.30.—New Symphony Orchestra, Wentworth.
10.—"Big Ben." Close down.

2BL

EARLY MORNING SESSION.

- 7.15.—Physical Training and Health Exercises.
7.30.—Broadcasters Special News Service.
7.45.—Physical Training and Health Exercises.
8.—G.P.O. Clock and Chimes; Close down.

MORNING SESSION.

- 11.—G.P.O. Clock and Chimes. Special news service from the "Daily Telegraph."
11.10.—Musical programme from the Studio.
11.25.—Special news from the "Daily Telegraph."
11.45.—Musical programme from the Studio.
12.—G.P.O. Clock and Chimes; Women's Socialist Social Notes by Mrs. Jordan and a talk on Simple Cooking for Children.

12.10—London Metal Quotations.
12.45—Broadcasters Information Service, including Mails, Shipping, Weather Rainfall.

AFTERNOON SESSION.

1—G.P.O. Clock and Chimes: News from Sun Cable Edition.
1.10—Musical Programme from the Studio.
1.20—Talk on Sporting and Athletic Features for the Day—Lacrosse, Hockey, Tennis, Cricket, Sailing, Boating, Athletics, Rifle Shooting, Golf, Bowls, Turfing, Baseball, Racing, Trotting, Coursing.
During the afternoon sporting information will be broadcast by courtesy of "The Sun" Newspapers.
5—G.P.O. Clock and Chimes. Close down.

EARLY EVENING SESSION.

5.45—G.P.O. Clock and Chimes: Duke George and the Kiddees.
6.10—Pavilion Dinner Orchestra, under the direction of Mr. C. C. Morrison.
7.15—Results of all sporting information, including Sailing, Swimming, Racing, Coursing, Bowls, by courtesy of Sun Newspapers.
7.30—Country News from the Sun and results of all sporting and athletic fixtures.
7.45—Close down.

NIGHT SESSION.

8—Ambassadors Sain Quartette under the direction of Mr. Claude McElynn.
8.30—Concert from the Studio.
10.15—Gen. Morrison and his Gloucesters' broadcast from the ballroom of the Bondi Casino.
11.15—Al. Hammett and the Ambassadors Dance Band broadcast from the ballroom of the Ambassadors. During the intervals between dances, news reports by courtesy of The Sun will be broadcast.
12—G.P.O. Clock and Chimes. National Anthem.

2 KY

EVENING SESSION.

7.15—Sporting Feature: Complete review of today's racing by Mr. T. G. Hopkins.
7.30—News items.
7.45—Centralia Station, Miss Joan Walsh.
8.10—Sketch, Miss Upson and Mr. Bob. Corben.
8.30—Musical Interlude: Palau Royal Calliopeans, Mr. Walter Weston, leader (by kind permission of J. C. Redford, Ltd.).
8.45—Items from Railway and Tramway Eisteddfod.
9.15—Labor Legislation Service, Mr. J. C. Eldridge.
9.30—Sporting Feature: From the track at the Speedway Royal, Results of early events and description of motor cycle racing.
9.45—Items from Railway and Tramway Eisteddfod.
10.00—Description and results of semi-finals from Speedway Royal.
10.5—Items from Railway and Tramway Eisteddfod.
10.15—Descriptions and results of finals from Speedway Royal.
10.20—Items from Railway and Tramway Eisteddfod.
10.35—Closing Announcements.

3 LO

MORNING SESSION.

11—Harold Rodgers, organ.
11.10—Colin Crane, baritone.
11.15—Sonora Recital.
11.25—Harold Rodgers, piano.
11.33—Colin Crane, baritone.
11.40—Sonora Recital.
11.47—Harold Rodgers, organ.
12—Time Signal. British Official Wireless news from Rugby. Reuters' and the Australian Press Association cables. "Argus" and "Herald" news services. Shipping intelligence.
12.45—Stock Exchange information.
12.50—Meteorological information. Weather forecast for Victoria, Tasmania, South

Australia, and New South Wales. Ocean forecast. River reports.

1—Time signal.
1.1—Studio Orchestra, overture.
1.30—Rupert Hazel, in Harmonyland.
1.37—C. Richard Chubb, flute.
1.24—Elsie Day will now sing to you.
1.30—Studio Orchestra.
1.38—Result of the Kaasooka Hurdle, Caulfield Races.
1.40—Rupert Hazel, in more Harmonyland.
1.47—Studio Orchestra.
2—Close down.
2.35—Result of the Stanmore Two Year Old, Caulfield Races.

AFTERNOON SESSION.

3—3 LO Orchestra.
3.10—Result of Armadale Cup, Caulfield Races.
3.11—3 LO Dance Orchestra.
3.45—Result of Tara Steeplechase, Caulfield Races.
3.46—3 LO Dance Orchestra.
3.48—Result of Ormond Stakes, Caulfield Races.
4.21—3 LO Dance Orchestra.
4.45—"Herald" News Service: Stock Exchange information.
5—Result of Bonastown Plate, Caulfield Races. Close down.

EARLY EVENING SESSION.

5.30—Sporting results.
5.45—Children's Hour: Answers to letters and birthday greetings.
6—Mollie Ink, will sing.
6.5—"Mary Gumleaf" Poems: "A Little Mousie's Tea Party," Story for the littlest ones, "Felinees."
8.15—Mollie Ink will sing again.
8.24—"Mary Gumleaf" story for the boys and girls, "Magic Mirror." Story and music by Betty Boronia and Mary Gumleaf.
8.40—"Argus" and "Herald" News Service: Sporting results. Reuters and Australian Press Association cables.
8.53—Weather synopsis, Shipping movements.
8.55—Stock Exchange information.
9.25—Fish Market Reports, by J. R. Borrett Ltd.
9.4—River reports.
9.6—Market Reports, by Victorian Producers Co-operative Co. Ltd. Grain, chaff, hay, straw, jute, dairy produce, potatoes and onions.

NIGHT SESSION.

7.20—Mr. Frederick Chapman.
7.30—Mr. E. E. Prescott, "Flowering Gum Trees."
7.45—Newport Workshops' Brass Band.
8.12—Colin Crane, baritone (by permission of J. C. Williamson Ltd.).
8.19—Harry Woodman, in a concertina melody of old time favourites.
8.25—Rupert Hazel tells some very old ones.
8.33—Miss Marjorie Smith, one of 3 LO's most (September) beautiful brides, will speak to listeners.
8.48—Studio Orchestra.
8.55—Elsie Davies, soprano, will sing to the grandmothers.
9.45—Mr. R. Clemson, official Starter of V.A.A., will give a talk under the auspices of the Associated Amateur Sports Committee, "Experience at starting champions, and the starter's duties."
9.21—Newport Workshops Brass Band.
9.31—Colin Crane, baritone.
9.38—Harry Woodman, and his concertina.
9.48—Rupert Hazel and Elsie Day in Harmonyland.
9.56—Studio Orchestra.
10.5—British Official Wireless news from Rugby. Announcements. Sporting results.
10.18—Newport Workshops Brass Band.
10.36—Elsie Davies, soprano, in more old-time songs.
10.38—"Argus" and "Herald" news services. Weather forecast. Announcements.
10.44—Studio Orchestra.
11—Our Great Thought for To-night is:—"Genius begins great works; labor alone finishes them."—Joubert.

11.1—3 LO Dance Orchestra.
11.40—God Save the King.

4 QG

NO MIDDAY TRANSMISSION.

AFTERNOON SESSION.

3.30—Complete service from the Seventh Day Adventist Church, Buranda.
4.30—Close down.

NIGHT SESSION.

7.45—A Sporting Talk.
8—Portion of the finals in connection with the Catholic Church choir. Competitions will be relayed from the Albert Hall.
9—From the Studio: Weather information of- ficially supplied by the Commonwealth Weather Bureau. Announcements.
9.10—From Lennon's Hotel: Dance music, by the Ajax Novelty Band (Mr. A. B. Jack, conductor).
10—From the Studio: "The Sunday Mail" news service. Close down.

5 CL

MORNING SESSION.

10.30—G.P.O. Chimes.
10.31—5 CL Studio Orchestra, Selections.
11.45—"Advertiser" news service.
12—G.P.O. Chimes.

AFTERNOON SESSION.

Relay from Victoria Park—description of racing, Waterfalls Club Meeting, by Mr. Arnold Trollope.
Interstate sporting results from Studio.

EVENING SESSION.

6.30—G.P.O. Chimes.
6.31—Radio stories.
7.30—Market reports.
7.40—Results of the chief sporting results throughout the Commonwealth.
8—G.P.O. Chimes.
8.1—Mr. Ken Hughes, solo.
8.4—Miss Jean Finlay, pianoforte solo.
8.8—Miss Lorna Kerrison, solo.
8.12—Relay from Henley Beach Rounda:—Holden's Band.
8—G.P.O. Chimes.
9.1—Relay Floating Palais—Dance Music.
9.16—Solo, Mr. Ken Hughes.
9.19—Solo, Miss L. Kerrison.
9.23—Relay Henley Beach—Holden's Band.
9.45—Relay Floating Palais—Dance Music.
10—G.P.O. Chimes.
10.1—Relay Henley Beach—Holden's Band.
10.15—Sporting results.
10.30—Mr. Ken Hughes, solo.
10.34—Miss L. Kerrison, solo.
10.35—Relay Floating Palais—dance music.
10.39—Static announcements.
10.41—Relay Henley Beach—Holden's Band.
10.45—Sporting results.
10.50—Mr. Ken Hughes, solo.
10.54—Miss L. Kerrison, solo.
10.35—Relay Floating Palais—dance music.
11—G.P.O. Chimes. National Anthem, and close down.

7 ZL

MORNING SESSION.

11—G.P.O. Clock Chimes. The "Mercury" stock market, shipping, commercial, intelligence, Weather information and sporting anticipation. "Salonika" Selections.
11.45—Hobart Stock Exchange quotations.
12—G.P.O. Chimes. Close down.

EVENING SESSION.

7—Children's Corner: "Big Brother" chats to his Pals.

NIGHT SESSION.

8—G.P.O. Clock Chimes. The "Mercury" special Tasmanian news service. Railway auction produce sales; weather information and sporting results.
8.5—Hobart Stock Exchange quotations.
8.16—"Come to Tasmania" movement, by Mr. W. L. Lake.
8.30—Dance numbers from the Studio.
9.45—British Official Wireless News, copied direct from Rugby by our own operator. Weather synopsis. Station Announcements.

Sunday, Nov. 14

2 FC

MORNING SESSION.

- 10.55—Announcements.
11.—Broadcast from St. Mark's Church of England, Darling Point, the Morning Service, conducted by the Rev. Howard Lee.
10.15—Midday News Service.
12.30—Close down.

AFTERNOON SESSION.

- 2.56—Programme Announcements.
3.—Chimes of "Big Ben." A talk by Captain Fred Parsons on "The Tongue we Speak."
3.15—Broadcast from the Band Rotunda, Manly Beach. The Sunday afternoon band recited by the Manly Municipal Band, conducted by Mr. J. Phelan.
5.—Chimes of 2FC. Close down.

EVENING SESSION.

- 6.—The Chimes of 2FC and Announcements.
6.5—Broadcast from Pitt Street Congregational Church, an organ recital by Miss Lilian Frost.
7.—The Evening Service from Pitt Street Congregational Church, conducted by the Rev. T. E. Rath.
8.30—From the Studio, items by the Leichhardt District Band (Champion Band of N.S.W.), conducted by Mr. E. P. Kerry.
8.45—Mr. Charles Stephens, soprano tenor.
8.55—Further items by the Leichhardt Band.
9.10—Miss Joyce Hadley, soprano.
9.14—Duet by Mr. Charles Stephens and Miss Joyce Hadley, soprano.
9.23—The Leichhardt District Band, under the baton of Mr. E. P. Kerry.
9.38—Mr. Charles Stephens, tenor.
9.45—Items by the Leichhardt District Band.
9.55—Miss Joyce Hadley, soprano.
9.56—Duet by Miss Joyce Hadley, soprano, and Mr. Charles Stephens, tenor.
10.—Items by the Leichhardt District Band.
10.10—Close down.

2 BL

MORNING SESSION.

- 51.—Service broadcast from Baptist Church, Petersham.

AFTERNOON SESSION.

- 8.50—Bible Class conducted by Mrs. W. "Calro" Bradley.

EVENING SESSION.

- 7.—Service broadcast from Church of Christ, Auburn.
8.30—Concert from the Studio.

2 GB

MORNING SESSION.

- 10.20—Organ music from St. Alban's Church, Redfern.
10.30—Morning Service from St. Allen's Liberal Catholic Church. Celebration of Holyucharist. Sermon.
12.—Close down.

EVENING SESSION.

- 8.45—Music from Studio.
9.—Lecture from Adyar Hall, by Dr. Van Der Loeuw.
9.—Music from Studio.
8.15—Canterbury District Band, J. M. Herron conductor.
8.30—Songs by Mr. Herman Treumann.
8.40—Canterbury District Band (J. M. Herron conductor).
9.10—Announcements.
9.15—Songs, by Mr. Herman Treumann.
9.25—Canterbury District Band.
9.38—"Great Thought from Great Minds" by Prof. Wood.
9.42—God Save the King.

3 LO

MORNING SESSION.

- 10.40—Express Train Information.
10.45—Service from St. Paul's Cathedral, Melbourne.
12.15—British Official Wireless News.
12.25—Close down.

AFTERNOON SESSION.

- 3.—Pleasant Sunday Afternoon Service: Central Mission Wesley Church, Lonsdale Street, Melbourne.
4.30—Close down.

EARLY EVENING SESSION.

- 6.45—Children's Hour: Chorus by Billy Bunny and his Brer Rabbits.
6.—Answers to letters and birthday greetings.
6.45—Another Hymn by Billy Bunny and his Brer Rabbits.
6.23—Stories by Billy Bunny: Mimosa and Lovelost Life.
6.45—Close down.

NIGHT SESSION.

- 8.45—Organ Recital (Mr. William G. James) from Wesley Church.
7.—Evening Service.
8.30—Malvern Tramways Band.
8.40—Southern Choral Union.
8.47—Percy Grainger, pianist.
9.17—Southern Choral Union.
9.24—Malvern Tramways Band.
9.34—Southern Choral Union.
9.41—Malvern Tramways Band.
8.50—"Argus" News Service: Weather Forecast; Announcements.
9.53—"Our Great Thought for to-night is:—There is great beauty in going through life fearlessly. Half our fears are baseless, the other half incredible."—Bovee.
10.—God Save the King.

4 QG

MORNING SESSION.

- 11.—The complete Morning Service will be relayed from St. Paul's Presbyterian Church.
12.35—Close down.

AFTERNOON SESSION.

- 3.15—The concert, provided by the Federal Band, will be relayed from the Brisbane Botanical Gardens.
4.30—Close down.

NIGHT SESSION.

- 7.30—The complete evening service will be relayed from St. Paul's Presbyterian Church. At the conclusion of the Church Service, the concert by the Greater Brisbane Municipal Concert Band, will be relayed from Wulham Park.
9.50—Close down.

5 CL

MORNING SESSION.

- 11.—Relay from Parkside Baptist Church—Divine Service.

EVENING SESSION.

- 8.30—G.P.O. Chimes.
8.31—Sunday stories for the children.
7.—Relay from Black Forest Baptist Church—Divine Service.
8.15 (approx.)—Relay from Henty Beach Rotunda—Holden's Silver Band.
8.45—From the Studio: Mr. P. H. Nicholls, "Emersau."
8.—P.P.O. Chimes.
9.1.—Weather reports.
8.3—Relay Henty Beach—Holden's Band.
10.—G.P.O. Chimes. National Anthem. Close down.

7 ZL

EVENING SESSION.

- 7.—Divine Service from St. David's Cathedral, Macquarie Street, Hobart.

- 8.45—Concert from the Studio: Miss Amy Rutterworth, pianist; Mr. Holt Lyons, baritone; Mr. William P. Harwood, tenor; Mr. Joseph Blight, new soloist; Mr. Ch. G. Trueman, baritone.
8.45—The "Mercury" Special Interstate news service: Weather Synopsis; Station Announcements; National Anthem.

Monday, Nov. 15

2 FC

EARLY MORNING SESSION.

- 7.—The Chimes of "Big Ben" and Announcements.
7.10—Music from the Studio.
7.10—Weather Information; Commercial News; Shipping Intelligence; Rainfall; Temperature; Astronomical Memoranda.
7.25—Investment Market. Mining Share Market; Metal Quotations.
7.35—Wool Sales; Exchange Markets; Interstate Market; Produce Markets.
7.45—"Sydney Morning Herald" News Service.
8.—The Chimes of "Big Ben." Music from the Studio.
8.15—Close down.

MORNING SESSION.

- 8.15—The Chimes of 2FC and Programme Announcements.
9.20—Music from the Studio.
9.30—Marching music for school children.
10.—Chimes of "Big Ben."
10.5.—Late "Sydney Morning Herald" News Service.
10.15—Music from the Studio.
10.45—A Morning Reading.
11.—The Chimes of "Big Ben." Australian Press Association and Booter's Cables.
11.10—Music from the Studio.
11.30—Marching Music for School Children.
11.35—Close down.

MIDDAY SESSION.

- 12.—The Chimes of "Big Ben." Announcements.
12.5—Stock Exchange, First Call.
12.10—Music from the Studio.
12.30—Marching Music from the Studio for School Children.
12.40—Music from the Studio.
12.45—From Farmer's Oak Hall: The Oak Hall Trio.
12.50—Rugby Wireless News.
12.55—Miss Florence Barrow, contralto.
1.—Chimes of "Big Ben." Weather Intelligence.
1.8—"Evening News" midday news service.
1.20—The Oak Hall Trio.
1.30—Stock Exchange Second call.
1.50—Marching Music for School Children.
1.40—Miss Florence Barrow, contralto.
1.45—Music from the Studio.
1.50—The Oak Hall Trio.
2.—Chimes of "Big Ben." Close down.

AFTERNOON SESSION.

- 2.35—Chimes of 2FC and Announcements. Broadcast from the Tivoli Theatre, by courtesy of the management, items by the Tivoli orchestra, under the baton of Mr. Will Quintrell.
3.—From the Studio: Miss Nellie Judges, soprano.
3.5—Piano solos.
3.25—Miss Nellie Judges, soprano.
3.50—From Farmer's Oak Hall: Oak Hall Trio.
5.40—Miss Diana Booth, solo.
2.45—From Farmer's Oak Hall: Oak Hall Trio.
3.55—Music from the Studio.
4.—Miss Annie Farmer, mezzo.
4.6—A serial story, told by Miss Annie Hughes.
4.15—Music from the Studio.
4.30—Miss Diana Booth, solo.
4.25—From Farmer's Oak Hall: Oak Hall Trio.

- 4.25—Music from the Studio.
4.40—Miss Annie Payne, mezzo.
4.45—Stock Exchange—Third Call.
4.46—Close down.

EARLY EVENING SESSION.

- 5.45—The Chimes of 2 P.C.
5.50—A story for the older children.
6.15—Broadcast from the Hotel Australia.
6.20—Sydney Orchestral Items.
6.25—From the Studio: "Evening News"
Late News Service and Weather Information.
7.30—Distributors' Market Reports (wheat, wheat, stock), fruit and vegetable markets.
7.40—Talk on Ballets, by M. Dolosoff, late of the Anna Pavlova Co., taking for his subject "Grecian Ballets."
7.55—Close down.

NIGHT SESSION

- 7.55—The Chimes of "Big Ben" broadcast from the Haymarket Theatre (by courtesy of the directors and artists) items by the Haymarket orchestra of 20 members, conducted by Mr. Stanley Porter.
8.25—From Studio: Lyric Male Quartette, making first appearance with 2 P.C.
8.37—Miss Virginia Bassett, contralto.
8.42—Lyric Male Quartette.
8.54—Miss Dorothy Dewar, comedienne.
8.58—Miss Virginia Bassett, contralto.
9.5—From Haymarket Theatre: The vocal set
9.56—From Studio: A talk by Madame Evelyn Greig on "The American at Home."
9.55—Lyric Male Quartette.
9.47—Miss Virginia Bassett, contralto.
9.52—Miss Dorothy Dewar, comedienne.
9.56—Lyric Male Quartette.
10.10—Miss Dorothy Dewar, comedienne.
10.15—Broadcast from the Haymarket Picture Theatre, items by the operatic orchestra, under the baton of Mr. Stanley Porter.
10.30—Items by the Old Time Dance Band.
11—Chimes of "Big Ben" and announcements.
11.5—Further items by the Old Time Dance Band.
11.50—The new Westacorch Symphony Orchestra, in dance numbers.
12—National Anthem. Close down.

2BL

EARLY MORNING SESSION.

- 7.15—Physical Training and Health exercises.
7.20—Health Hints.
7.30—Physical Training & Health Exercises.
7.40—Weather Forecast.
7.47—Sporting Information.
7.53—Broadcasters' Special News Service.
8—G.P.O. Clock and Chimes; Close down.

MORNING SESSION.

- 10—G.P.O. Clock and Chimes; Musical programme from the Studio.
10.10—Special News Service from the "Daily Telegraph."
10.25—Musical Programme from the Studio.
10.40—Special News Service from the "Daily Telegraph."
11—G.P.O. Clock and Chimes; Market Reports.
11.5—Broadcasters' Information Service, including Mails, Basis in call by wireless Shipping; Weather and Rainfall.
11.40—Women's Session; Social Notes by Mrs. Jordan.
11.50—Mrs. Jordan replies to correspondents.
12—G.P.O. Clock and Chimes; A Talk by Mrs. Jordan.
12.25—A Talk by Miss Helen Jean Beaulieu.
12.30—Shopping Guide.
12.35—Sydney Stock Exchange Calls.
12.40—Hiller's Instrumental Quartette, direction Caryl Castling.
1.30—Sydney Stock Exchange Calls.
1.45—Latest Sporting Information and Race results, on race days.
1.50—Sun Newspaper's News Service.
2—G.P.O. Clock and Chimes; Close down.

AFTERNOON SESSION.

- Receiving Information broadcast by courtesy of The Sun.
3—G.P.O. Clock and Chimes; Weather Report and Forecast by courtesy of Mr. C. J. Macce, Govt. Meteorological.
3.5—Social Notes from the Sun.
3.10—Sun Newspaper's News Service.
3.15—David Jones' Tea Room Trio.
3.16—Sun Newspaper's News Service.
3.45—Musical programme from the studio.
4—G.P.O. Clock and Chimes; David Jones' Tea Room Trio.
4.15—Social Story.
4.30—Musical programme from the studio.
4.45—Producers' Distributing Society's Vegetable and Market Fruit Report; Shipping Information when available.
4.50—News from the Sun.
4.55—Resume of to-night's programme.
5—G.P.O. Clock; Close down.

EARLY EVENING SESSION.

- 5.45—G.P.O. Clock; Uncle George and the Kitties.
5.55—Pavilion Dinner Orchestra under the direction of Mr. Geo. Harrison.
Special Country Session.
7—G.P.O. Clock and Chimes; Australian Mercantile Land and Finance Co.'s Stock Word and Hide Report.
7.5—Weather Report and Forecast by courtesy of Mr. C. J. Macce, Govt. Meteorological.
7.55—Stock Exchange Reports.
7.10—Producers' Distributing Society's Fruit and Vegetable Report.
7.20—Fruit and Vegetable Reports (Sun).
7.25—Grain and Fodder Reports (Sun).
7.27—Egg and Poultry Reports (Sun).
7.30—Primary Producers' Newspaper Report on London Butter Market.
7.45—Country News from the Sun.
7.45—Lecture.

NIGHT SESSION.

- 8—G.P.O. Clock and Chimes; Broadcasters' Topical Chorus.
8.5—Newtown Band, broadcast from Industrial Hall, Newtown.
9.24—Mr. Jack Gainsford, baritone.
9.30—Madame Phyllis Howe, soprano.
9.37—Mr. Reg. Harrison.
9.43—Joy and Eric Butterfield, steel guitars.
9.54—Resume of following day's programme
9—G.P.O. Clock and Chimes.
9.1—Mr. William Everard, tenor.
9.5—Miss Phyllis Atkinson, mezzo soprano.
9.10—Newtown Band, broadcast from Industrial Hall, Newtown.
9.25—Interval.
9.40—Madame Phyllis Howe.
9.45—Joy and Eric Butterfield.
9.57—Mr. Jack Gainsford.
10.4—Mr. Reg. Harrison.
10.11—Mr. W. Everard.
10.18—The Ambassadors until Midnight.
12—G.P.O. Clock and Chimes; National Anthem.

2KY

LUNCHEON HOUR SESSION:

- 12.15—Popular Fox Trots. Musical Interlude.
News Items. Hawaiian Steel Guitar Selections.
Union News and Meetings. Vocal items. Closing down at 1.45 p.m.

CHILDREN'S HOUR:

- 6.30—The Storyman. Mr. Thompson.

EVENING SESSION.

- 7.30—Tune-in to the ticking of the clock.
7.35—Latest news items.
7.40—Industrial and political topics, by Mr. J. S. Garden.
7.55—Shipping Log.
8—Banjo solos, by Mr. W. Thompson.
8.15—Mezzo soprano solos by Miss Nellie Graves.
8.20—Monologue, by Miss Amy Ruwald.
8.25—Musical Interlude: Palais Royal Call-girls; Mr. Walter Bebban, leader (by kind permission of J. C. Bendroit Ltd.).
8.55—Soprano solos, Miss Ethel Mitchell.

- 9.5—Items from the Railway and Tramway Elatediff.
9.15—Music Interlude.
9.30—Contralto solos, by Miss Amy Ruwald.
9.40—Dance music.
10—Closing Announcements.

2GB

EVENING SESSION.

- 6.40—Talks to children, "Tales from Dreamland."
7.15—Talks of special interest to women.
7.30—Music from Studio.
7.45—Announcements.
7.55—Instrumental Trio.
8.3—Address by Dr. J. J. Van der Leeuw, M.A.
8.20—Songs by Miss Gladys Edwards.
8.25—String Quartette; Lloyd Davies, M. Harder, Chas. Wood, M. Lang.
9—Announcements.
9.5—Violin solos by Dan Scully.
9.12—Talk on Wireless by Mr. E. G. Beard.
9.17—Cello solos by Marjell Lane.
9.30—Songs by Miss Gladys Edwards.
9.54—Great Thoughts from Great Minds, by Prof. Wood.
9.59—God Save the King.

3LO

MIDDAY SESSION.

- 12 noon—Time Signal; British Official Wireless News from Rugby; Reuters and the Australian Press Association Cables; "Argus" and "Herald" News Services.
12.45—Stock Exchange Information; Shipping Intelligence.
12.50—Meteorological Information; Weather Forecasts for Victoria, Tasmania, South Australia, and New South Wales; Ocean Forecast; River Reports.
1—Time Signal.
1.1—Studio Orchestra.
1.10—Cullin Crane, baritone.
1.15—Evelyn Turner, in an original sketch.
1.30—Health Week Talk.
1.35—Frank Stumham, clarinet and Agnes Fortune, piano.
1.45—Cullin Crane, baritone.
1.49—Studio Orchestra.
2—Close down.

AFTERNOON SESSION.

- 2—Studio Orchestra.
2.10—Mrs. Dorothy Sisk, Homecrafts talk.
2.20—Alma Horlock, soprano.
2.30—Agnes Fortune, pianoforte solo.
2.40—John and Pauline Allen, ukulele items.
2.47—Health Week Talk.
2.52—Studio Orchestra.
3.25—Alma Horlock, soprano.
3.40—Miss Flora Pell, Supervisor of Domestic Arts, Education Department; Domestic Economy.
3.55—John and Pauline Allen, ukulele items.
4.02—Studio Orchestra.
4.45—"Herald" News Service; Stock Exchange Information.
5—Close down.

EVENING SESSION.

- 5.45—Children's Hour; Answers to Letters and Birthday Greetings.
6—Yety Landau, monologues.
6.7—Little Miss Kookaburra.
6.20—Yety Landau.
6.37—Little Miss Kookaburra will tell the next instalment of The Trials of the Twins.
6.40—"Argus" and "Herald" News Services; Reuters and the Australian Press Association Cables.
6.53—Weather Synopsis; Shipping Movements; Overseas Shipping.
7—Stock Exchange Information.
7.2—Fish Market Reports by J. R. Borrett Ltd.
7.5—River Reports; Aerial Mail Information by the Australian Aerial Services Ltd.
7.8—Market Reports by the Victorian Producers' Co-operative Co. Ltd.; Haymarket Sheep Sales; Poultry, grain, chaff, hay, straw, nuts, dairy produce, potatoes and onions; Market prices of oranges and lemons, by the Victorian Central Citrus Association Pty. Ltd.

NIGHT SESSION.

- 7.29—Under the auspices of the New Settlers League, Mr. George Kirby, What Lionartha Grows.
- 7.46—Under the auspices of the Department of Agriculture, Mr. G. H. F. Baker, Senior Dairy Supervisor, Pigs for Bacon.
- 8—Health Week Talk.
- 8.5—Studio Orchestra.
- 8.15—Round the Campfire—Music, Story and verse—grave and gay, by the writers and poets of Australasia, Narrator, Mr. V. Upton Brown.
- 8.45—Reginald Bradley, violin.
- 8.55—Cludio Thompson, tenor.
- 9—Studio Orchestra.
- 9.15—Cecily Granger, pianist.
- 9.45—Cludio Thompson, tenor.
- 9.52—British Official Wireless News from Rugby. Announcements. The 3143 Girl.
- 10—Studio Orchestra.
- 10.10—"Katie" 1st Act, transmitted from His Majesty's Theatre, by permission of J. C. Williamson Ltd.
- 10.35—"Aryna" News Service; Weather Forecast; Announcements.
- 11—Our Great Thought for To-night is—"Give every man his due, but reserve thy voice; take each man's course, but reserve thy judgment."—Shakespeare.
- 11.1—M.O. Dance Orchestra.
- 11.46—God Save the King.

4QG

MIDDAY SESSION.

- 12.55—Tone-in.
- 12.58—Time Signal.
- 1—Market Reports, supplied by the Council of Agriculture. Weather information, supplied by Commonwealth Weather Bureau. News, supplied by "The Daily Mail." News Service, supplied by "The Daily Standard."
- 1.26—From Hotel Carlton: Lunch Music from the Lounge, Hotel Carlton, played by Hotel Carlton Symphony Orchestra.
- 2—Close down.

AFTERNOON SESSION.

- 3.36—From Hotel Carlton: Afternoon Tea Music, played by Hotel Carlton Symphony Orchestra.
- 4.15—From the Studio: News Service, supplied by "The Telegraph."
- 4.56—Close down.

EARLY EVENING SESSION.

- 6.25—Tone in.
- 6.39—Children's Session: Stories by "The Sandman."
- 7—From "The Council of Agriculture Studio: The Farmers' Session: Market Reports; Lecturette; Pic Club Pictures and Fetes (4 boys and girls' talk by Mr. E. J. Shelton—Pig Instructor.)
- 7.36—From the Studio of 4QG, Stock Reports; Announcements.

NIGHT SESSION

- 7.45—Lecture Session: The Children's Music Corner (conducted by "The Music Man.")
- 8—Studio Concert, including The Clarwin Orchestra.
- 9—Metropolitan Weather Forecast; Studio Concert, Continued.
- 9.36—From the Crystal Palace, Dance Music.
- 10.15—"The Daily Mail" News Service; Close down.

5CL

MORNING SESSION.

- 11.30—G.P.O. Chimes.
- 11.31—Featuring a Stock Duo Art number.
- 11.46—"Advertiser" news service.
- 11.55—Vocalion number.
- 12—G.P.O. Chimes.
- 12.1—"Advertiser" news service.
- 12.18—Featuring a Stock Duo Art number.
- 12.30—5CL Studio Orchestra. In concerted numbers.
- 1.55—Ward & Co's Stock Exchange Intelligence, official weather synopsis, and station announcements.
- 2—G.P.O. Chimes.

AFTERNOON SESSION.

- 3—G.P.O. Chimes.
- 3.1—Relay from "Maple Leaf" Cafe—Orchestral numbers.
- 3.45—From the Studio: Stock Duo-Art and Vocalion numbers.
- 4—G.P.O. Chimes.
- 4.1—Relay from "Arenasia" Cafe—Orchestral numbers.
- 5—G.P.O. Chimes.

EVENING SESSION.

- 6.30—G.P.O. Chimes.
- 6.31—Holiday services.
- 7.36—Market reports.
- 7.46—Mr. Frederickson, automotive engineer, Vacuum Oil Company.
- 8—G.P.O. Chimes.
- 8.1—Tone music, Mr. Jas. Riley.
- 8.46—Relay, Railways Institute: Railways Band.
- 8.56—"Tinkles" original humorous talk.
- 9.46—Solo, Mrs. D. Back.
- 9.44—Railways Band.
- 9—G.P.O. Chimes.
- 9.1—Weather reports.
- 9.1—Studio Concert, continued.
- 10.15—"Advertiser" news service and ships within wireless range.
- 10.36—Studio Concert, Continued.
- 10.55—Station announcements.
- 11—G.P.O. Chimes. National Anthem. Close down.

7ZL

MORNING SESSION.

- 11—G.P.O. Clock Chimes. The "Mercury" news, Stock Market, Shipping, Commercial Intelligence, Weather information, "Salvo's" selections.
- 12—G.P.O. Clock Chimes. Close down.

AFTERNOON SESSION.

- 3—G.P.O. Clock Chimes. Musical items from the Studio.
- 3.30—Hobart Stock Exchange quotations.
- 3.45—Weather information.
- 4—G.P.O. Clock Chimes. Close down.

EVENING SESSION.

- 7—Children's Corner. "Big Brother" chats to his pals.
- 8—G.P.O. Clock Chimes. The "Mercury" special Tasmania news service. Railway station practice sales. Weather information.
- 8.5—Hobart Stock Exchange quotations.
- 8.16—Talk by Mr. T. Hyten, P.A. Subject, "Classic China."
- 8.36—Vocal items and selections on the Gulbransen Registering Piano, broadcast by direct wire from Findlay's Showroom, Edinburgh, Scotland.
- 9.15—Isamarian District Weather Reports.
- 9.46—The "Mercury" special interstate news service. Weather synopsis, Station announcements, National Anthem.

NIGHT SESSION.

- 8—G.P.O. Clock Chimes. The "Mercury" special Tasmania news service. Railway station practice sales. Weather information.
- 8.5—Hobart Stock Exchange quotations.
- 8.16—Talk by Mr. T. Hyten, P.A. Subject, "Classic China."
- 8.36—Vocal items and selections on the Gulbransen Registering Piano, broadcast by direct wire from Findlay's Showroom, Edinburgh, Scotland.
- 9.15—Isamarian District Weather Reports.
- 9.46—The "Mercury" special interstate news service. Weather synopsis, Station announcements, National Anthem.

MORNING SESSION.

- 9.12—The Chimes of 2FC and Programs Announcements.
- 9.26—Music from the Studio.
- 9.30—Marching Music for School Children.
- 9.45—Last-minute Racing Information by the 2FC Racing Contingent.
- 10—The Chimes of Big Ben.
- 10.5—Late "Sydney Morning Herald" News Service.
- 10.15—Music from the Studio.
- 10.46—A Morning Reading.
- 11—The Chimes of Big Ben; Music from the Studio. Australian Press Association and Butler's Calles.
- 11.5—Music from the Studio.
- 11.15—A Talk on Home Cooking and Recipes by Miss Ruth Purst.
- 11.30—Marching Music for School Children.
- 11.35—Close down.

MIDDAY SESSION.

- 12—The Chimes of Big Ben; and Announcements.
- 12.55—Stock Exchange, First Call.
- 12.46—Music from the Studio.
- 12.30—Marching Music for the School Children.
- 12.46—Music from the Studio.
- 12.46—Rugby Wireless News.
- 12.55—Miss Gleditsa Flinister, soprano.
- 1—Chimes of "Big Ben." Weather Intelligence.
- 1.5—"Evening News" midday news service.
- 1.20—Oak Hall Trio.
- 1.40—Marching Music for School Children.
- 1.46—Music from the Studio.
- 1.50—The Oak Hall Trio.
- 2—The Chimes of Big Ben; Close Down.

AFTERNOON SESSION.

- 2.30—Chimes of 2FC and Announcements.
- 2.36—A Recital by the pupils of Mr. Gordon V. Javers.
- 2.45—A talk by Mr. S. H. Bowden on "The Luck of Killarney."
- 3.30—Marching Music for the School Children.
- 3.46—From Farmer's Oak Hall; Miss Joyce Gillespie, soprano.
- 3.46—Oak Hall Trio.
- 3.50—Music from the Studio.
- 4—Miss Jeannette Rooney, contralto.
- 4.15—The Oak Hall Trio.
- 4.15—Music from the Studio.
- 4.26—Miss Joyce Gillespie, soprano.
- 4.25—From Farmer's Tea Rooms, the Oak Hall Trio.
- 4.35—Music from the Studio.
- 4.46—Miss Jeannette Rooney, contralto.
- 4.46—Afternoon Call. Stock Exchange.
- 4.46—Close down.

EARLY EVENING SESSION.

- 6.46—The Chimes of 2FC and Announcements.
- 6.59—The "Hello Man" talks to the Children.
- 6.56—A story for the older children.
- 7.2—Broadcast from the Hotel Australia, Orchestral Items.
- 7.16—From the Studio, "Evening News" Service, late news, Weather information.
- 7.36—Dalbey's Market Reports (Wool, Wheat, Stock, Fruit, and Vegetable Markets).
- 7.40—A talk by Mr. J. E. Lueckley, on "Old and New Manly Ferries."

NIGHT SESSION.

- 7.55—Announcements.
- 8—"Big Ben." Broadcast from the Royal Naval House, Margaret Street, City, a Band recital by the N.S.W. State Military Band.
- 8.15—From the Studio; Mr. George Sykes, English baritone, makes his first broadcast appearance in Australia.
- 8.16—Luna by the N.S.W. Military Band.
- 8.30—From the Studio; Miss Millicent Angles.
- 8.38—From the Royal Naval House, further items by the N.S.W. State Military Band.
- 8.52—From the Studio; A talk by Mr. W. F. Jackson, on "Modern Italy and Mussolini."
- 9.7—Mr. George Sykes, English baritone.

Tuesday, Nov. 16

2FC

EARLY MORNING SESSION.

- 7—The Chimes of Big Ben; and Announcements.
- 7.5—Music from the Studio.
- 7.18—Weather Information; Commercial News; Shipping Intelligence; Rainfall; Temperatures; Astronomical Memoranda.
- 7.45—Investment Market; Mining Share Market; Metal Quotations.
- 7.25—Wool Sales; Breadstuffs Market; Inter-state Markets; Produce Markets.
- 7.45—"Sydney Morning Herald" News Service.
- 8—The Chimes of Big Ben; Music from the Studio.
- 8.15—Close down.

- 9.12—From the Royal Naval House, items by the N.S.W. State Military Band.
 9.38—From the Studio: Mr. Courtney Ford, comedian.
 9.54—Miss Millicent Angles, soprano.
 9.46—Mr. Lionel Lawson, violinist.
 9.54—Mr. Herbert Watson, comedian.
 10.7—Mr. George Sykes, baritone.
 10.14—Mr. Lionel Lawson, violinist.
 10.22—Mr. Courtney Ford, comedian.
 10.32—Broadcast from the Wentworth Hotel, items by the new Symphony Orchestra, under direction of Mr. Sydney Simpson.
 11—"Big Ben." Announcements.
 11.5—Wentworth Symphony Orchestra, until midnight.

2 BL

EARLY MORNING SESSION.

- 7.15—Musical programme from the Studio.
 7.18—Physical Training and Health Exercises.
 7.25—Health Hints.
 7.30—Physical Training and Health Exercises.
 7.45—Weather Forecast.
 7.47—Sporting information.
 7.51—Broadcasters' Special News Service.
 8—G.P.O. Clock and Chimes: Close down.

MORNING SESSION.

- 10—G.P.O. Clock and Chimes: Musical programme from the Studio.
 10.10—Broadcasters' Special Rugby News Service.
 10.17—Shipping information, Arrivals and departures.
 10.20—Information re Interstate and Overseas mails.
 10.23—Musical Programme from the Studio.
 10.35—Sydney "Daily Telegraph" News Service.
 10.50—Musical programme from the Studio.
 11—G.P.O. Clock and Chimes: Fruit and Vegetable Markets Report.
 11.5—London Metal Quotations.
 11.10—Broadcasters' Information Service, including Mails, Boats in call by wireless Shipping, Weather and Rainfall.
 11.20—Musical Programme from the Studio.
 11.40—Women's Session: Social Notes by Mrs. Jordan.
 11.50—Mrs. Jordan replies to correspondents.
 12—G.P.O. Clock and Chimes: Talk on "Talent Birds" by Mrs. Jordan.
 12.25—A Talk by Miss Helen Jean Douglas on "Swimming."
 12.30—Broadcasters' Shopping Guide.
 12.35—Sydney Stock Exchange cable.
 12.45—Hiller's Instrumental Quartet, direction Cyril Castling.
 1.30—Sydney Stock Exchange Cable.
 1.45—Latest Sporting Information and News from the Sun.
 1.50—"Sun" Newspapers news service.
 2—G.P.O. Clock and Chimes: Close down.

AFTERNOON SESSION.

- Racing information, broadcast by courtesy of the Sun.
 3—G.P.O. Clock and Chimes: Weather Report and Forecast by courtesy of Mr. C. J. Mares, Government Meteorologist.
 3.5—Social notes from "The Sun."
 3.10—"Sun" Newspapers news service.
 3.15—Civil Service Stores' Trivia, direction Miss de Curcy Bremer.
 3.30—G.P.O. Clock and Chimes. "Sun" Newspapers news service.
 3.45—Musical programme from the Studio.
 4—G.P.O. Clock and Chimes. Civil Service Stores' Trivia.
 4.15—Serial Story, entitled "Stories Near and Far."
 4.30—Musical Programme from the Studio.
 4.45—Producers' Distributing Society's Vegetable and Fruit Markets Report.
 4.50—Shipping information when available.
 4.53—Day's Racing Resume on Race Days.
 4.55—News from "The Sun."
 4.58—Resume of night's programme.
 5—G.P.O. Clock and Chimes: Close down.

EARLY EVENING SESSION.

- 5.45—G.P.O. Clock and Chimes. Uncle George

- and the Kiddies.
 6.40—Pavilion Dinner Orchestra, under the direction of Mr. Cec. Morrison.
 Special Country Session.
 7—G.P.O. Clock and Chimes: Australian Mercantile, Land and Finance Co.'s Report.
 7.5—Weather Report and Forecast, by courtesy of Mr. C. J. Mares, Government Meteorologist.
 7.9—Stock Exchange Reports.
 7.15—Producers' Distributing Society's Fruit and Vegetable Report.
 7.20—Fruit and Vegetable Reports (Sun).
 7.23—Grain and Fodder Report (Sun).
 7.26—Eggs and Poultry Report ("Sun").
 7.30—Country news from "The Sun."
 7.45—A talk on "The Fruit Industry of Tasmania

NIGHT SESSION.

- 8—Classical Concert from the Studio, including Broadcasters' Miniature Orchestra, Miss Gladys Verross soprano, Mr. Raymond Pechacki violinist, Mr. George Costas tenor.

2 KY

LUNCHEON HOUR SESSION.

- 12.15—Popular Fox Trot: "Orphans" Gramophone.
 12.25—Musical Interlude.
 12.40—News items.
 1—Hawaiter Steel Guitar Selections.
 1.15—Union news and meetings.
 1.30—Vocal and musical items, closing down at 1.45 p.m.

AFTERNOON SESSION.

- 3.15—Tune in to the ticking of the clock.
 3.18—Popular Fox Trot.
 3.30—Short Story.
 3.45—Musical Interlude.
 4—Popular Science Talk.
 4.15—Hawaiter Steel Guitar Selections.
 4.25—Musical and Vocal Items.
 4.40—Where to go To-night.
 4.45—Closing Announcements.

CHILDREN'S HOUR.

- 8.30—The Storyman Mr. Thomson.
 EVENING SESSION.
 7.30—Tune in to the ticking of the clock.
 7.33—News Items.
 7.40—A Talk on New Guinea gold fields, by Mr. J. S. Hopkins.
 7.55—Shipping Log.
 8—Pianoforte solos, Miss Mary Dean.
 8.10—Tenor Solos, Mr. A. Jamieson.
 8.20—Mezzo Soprano Solos, Miss Helen Cameron.
 8.30—Musical Interlude, Palais Royal Call-ferrians, Mr. Walter Bechan, leader (by kind permission of J. C. Brendorf Ltd).
 8.55—Special Announcements.
 9—Soprano solos, Miss Zara Neilson.
 9.10—Items from McHugh Leichhardt Station and "Herald" News Services.
 9.30—Reverial of Lincoln Records.
 10—Closing Announcements.

3 LO

MIDDAY SESSION.

- 12 noon—Time Signal; British Official Wireless News from Rugby; Reuters and the Australian Press Association Cables; "Argus" and "Herald" News Services.
 12.45—Stock Exchange Information; Shipping Intelligence.
 12.50—Meteorological Information; Weather Forecasts for Victoria, Tasmania, South Australia, and New South Wales; Ocean Forecast; River Reports.
 1—Time Signal.
 1.1—Studio Orchestra.
 1.10—Daphne Whitehead, contralto.
 1.17—Daphne Whitehead, whistling solos.
 1.24—Station Trio.
 1.30—Health Week Talk.

- 1.35—Gwen Barham, contralto.
 1.42—Yasna Tietman, alto.
 1.47—Daphne Whitehead.
 1.52—Studio Orchestra.
 2—Close down.

AFTERNOON SESSION.

- 5—Will Page and his Popular Players.
 5.10—"Au Fait" of Messrs. Buckley and Nunn Ltd., "Fashion Talk."
 5.25—Will Page's Popular Players.
 5.30—Eulalie Blong, soprano.
 5.35—Will Page and his Players.
 5.45—Health Week Talk.
 5.55—Will Page and his Popular Players.
 6—Matron Moreland, will give a talk on Infant Welfare.
 6.10—Will Page and his Players.
 6.25—Eulalie Blong, soprano.
 6.30—Will Page and his Players.
 6.45—"Herald" News Service; Stock Exchange Information.
 5—Close down.

EVENING SESSION.

- 6.45—Children's Hour; Answers to letters and Birthdays Celebrations.
 6—The Vanishing American Indians will entertain the kiddies.
 6.15—Mary Gumball, poems.
 6.25—Yvety London, monologues.
 6.34—Mary Gumball, stories.
 6.40—"Argus" and "Herald" News Services; Reuters and the Australian Press Association Cables.
 6.55—Stock Exchange Information.
 7—Fish Market Reports, by J. R. Borrett, Ltd.
 7.6—River reports. Aerial Mail information by the Australian Aerial Services Ltd.
 7.8—Market Reports by the Victorian Producers Co-operative Co. Ltd.; Haymarket Sheep Sales; Poultry, grain, chaff, hay, straw, late, early produce, potatoes and onions; Market prices of oranges and lemons, by the Victorian Central Citrus Association Pty. Ltd.

NIGHT SESSION.

- 7.26—Mr. R. H. Wilmut, Every-day Chemistry.
 7.40—Under the auspices of the University Extension Board, Mr. P. R. E. Maudson, B.A., M.Sc., Senior Lecturer in Economics, Commerce Department, University.
 8—Health Week Talk.
 8.10—A Scotch Concert, by the Brighton and District Scottish Society.
 8.15—Quintette, The Melodious Four.
 8.23—Miss Nell Richards, solo.
 8.28—Miss Madge Agnew, solo.
 8.35—Mr. Percy Bunsell, solo.
 8.44—Mr. Jas. Hill, song.
 8.55—From the Studio: Dr. Loftus Hills: Popular Science.
 9.10—National Nights, German Night, Part 4.
 10.15—British Official Wireless News from Rugby; Announcements; The MLO Girl; "Argus" News Service.
 10.45—The MLO Melody Masters.
 10.57—Weather Forecast, Announcements, etc.
 11—Our Great Thought for "Today": "To become an able man in any profession, there are three things necessary—stature, study, and practice."—Aristotle.
 11.1—The MLO Melody Masters.
 11.40—God Save the King.

4 QG

MIDDAY SESSION.

- 12.55—Tune in.
 12.58—Time Signal.
 1—Market Reports; Weather information. "The Daily Mail" and "The Daily Standard" news.
 1.20—From Hotel Carlton: Lunch Music from the Lounge, Hotel Carlton, played by Hotel Carlton Symphony Orchestra.
 2—Close down.

AFTERNOON SESSION.

- 3.10—A programme of Music from the Studio.
 3.15—"The Telegraph" news.
 4.30—Close down.

EARLY EVENING SESSION.

- 6.25—Tune in.

- 6.59—The Children's Session. Stories by "Uncle Ben" and "Uncle Jim."
 7—From the Council of Agriculture. Studio: The Farmers' Session. Market Reports. Lectures: The Value of a University Faculty of Agriculture, by Professor Goddard (University of Queensland).
 7.15—From the Studio: Stock Reports & Announcements.
 7.40—Announcements.

NIGHT SESSION.

- 7.45—Lecture Session: Photography, by Mr. F. L. South, Manager, Kodak Ltd.
 8—From the School of Arts: The Brisbane Art Club.
 8.15—Concert from the Studio.
 9—Metropolitan Weather Forecast; Studio Concert, continued.
 9.30—From the Centennial Hall: Half an Hour's Dance Music.
 10—From the Studio: "The Daily Mail" news service. Close down.

5 CL

MORNING SESSION.

- 11.00—G.P.O. Chimes.
 11.31—Featuring a Stock Dow Art number.
 11.40—"Advertiser" news service.
 11.55—Variation number.
 12—G.P.O. Chimes.
 12.1—"Advertiser" news service.
 12.15—Featuring a Stock Dow Art number.
 12.30—M.C.L. Studio Orchestra.
 1.55—Ward & Coa. Stock Exchange intelligence, official weather synopsis, and station announcements.
 2—G.P.O. Chimes.

AFTERNOON SESSION.

- 3—G.P.O. Chimes.
 3.15—Relay from the "Maple Leaf" Cafe—Orchestral numbers.
 3.45—From the Studio: Stock Dow Art and Vocalion numbers.
 4—G.P.O. Chimes.
 4.1—Relay from the "Arcadia" Cafe—Orchestral numbers.
 5—G.P.O. Chimes.

EVENING SESSION.

- 6.30—G.P.O. Chimes.
 6.51—Bellini stories.
 7.30—Market reports.
 7.40—Mining talk, by Mr. Jackett.
 8—G.P.O. Chimes.
 8.1—Relay from Wondergraph Theatre—Wondergraph Operatic Orchestra under direction of Mr. Bert Smith.
 8.15—Concert from Studio.
 8.41—Relay Wondergraph Theatre.
 8.56—Solo, Miss Grace Gunnin.
 9—G.P.O. Chimes.
 9.1—Weather Reports.
 9.5—Studio concert continued.
 9.17—Relay Wondergraph Theatre.
 9.57—Studio concert, continued.
 10—G.P.O. Chimes.
 10.1—Relay Wondergraph Theatre.
 10.15—"Advertiser" news service.
 10.30—Studio concert continued.
 10.55—Station announcements.
 11—G.P.O. Chimes. National Anthem.

7 ZL

MORNING SESSION.

- 11—G.P.O. Clock Chimes.
 11.15—"The Mercury" News; Stock Market; Shipping; Commercial Intelligence; Weather Information; Saluoca Selections.
 12—G.P.O. Clock Chimes; Close Down.

AFTERNOON SESSION.

- 3—G.P.B. Clock and Chimes; Musical Items from the Studio.
 3.30—Robert Stock Exchange Quotations.
 3.45—Weather Information.
 4—G.P.O. Clock Chimes; Close Down.

EVENING SESSION.

- 7—Children's Corner. "Big Brother" chats to his pals.

- 7.15—The Adventures of George, the Bookshelf Cat, by "Aunt Stella."
 NIGHT SESSION.

- 8—G.P.O. Clock Chimes; the "Mercury" Special Tasmanian News Service; Railway Auction Produce Sales; Weather Information.
 8.5—Robert Stock Exchange Quotations.
 8.10—Literary Lapses and Library Lists by Mr. W. E. Fuller.
 8.30—Musical items from the Studio—special request numbers.
 9.15—Tasmanian District Weather Reports.
 9.50—"The Mercury" Special Interstate News Service; Weather Synopsis; Station Announcements; National Anthem.

Wednesday, Nov. 17

2 FC

EARLY MORNING SESSION.

- 7—The Chimes of Big Ben; and Announcements.
 7.5—Music from the Studio.
 7.15—Weather information, astronomical memoranda.
 7.5—Investment Market; Mining Share Market; Metal Quotations.
 7.55—Wool Sales; Broadstuffs Market; Interstate Markets; Produce Markets.
 8—Chimes of Big Ben. Music from the Studio.
 8.15—Close down.

MORNING SESSION.

- 9.15—The Chimes of 2FC and Programme Announcements.
 9.20—Music from the Studio.
 9.30—Marching music for the School Children.
 9.45—Music from the Studio.
 10—The Chimes of Big Ben and Announcements.
 10.5—Late "Sydney Morning Herald" News Service.
 10.15—Music from the Studio.
 10.45—A Morning Reading.
 11—The Chimes of Big Ben; Australian Press Association and Reader's Exiles.
 11.10—Musical items.
 11.15—A Talk on Home Cooking and Recipes by Miss Ruth Furst.
 11.20—Marching Music for the School Children.
 11.55—Close down.

MIDDAY SESSION.

- 12—The Chimes of Big Ben; and Announcements.
 12.5—Stock Exchange; First Call.
 12.10—Music from the Studio.
 12.30—Marching Music for the School Children.
 12.40—Music from the Studio.
 12.45—From Farmer's Oak Hall: Oak Hall Trio.
 12.50—Rusty Wireless News.
 12.55—Miss Ruby Swaddling, soprano.
 1—The Chimes of Big Ben; Western Intelligence.
 1.15—"Evening News" Mid-day Service.
 1.20—Oak Hall Trio.
 1.25—Stock Exchange—Second Call.
 1.30—Marching Music for the School Children.
 1.45—Music from the Studio.
 1.55—From Farmer's Oak Hall: The Oak Hall Trio.
 2—Close down.

AFTERNOON SESSION.

- 2.25—Chimes of 2FC and Announcements.
 2.30—A Recital on the "Behning" player piano.
 2.35—A talk on "Java, Garden of the East," dealing with the Sultan's Palace.
 2.40—Marching Music for School Children.
 2.45—From Farmer's Oak Hall: Miss Ethel Muller, soprano.

- 3.45—From Farmer's Oak Hall: Oak Hall Trio.
 3.55—Music from Studio.
 4—Miss Eva Webb-Jones, mezzo.
 4.5—The Oak Hall Trio.
 4.15—Music from the Studio.
 4.30—Miss Ethel Muller, soprano.
 4.35—From Farmer's Tea Rooms, the Oak Hall Trio.
 4.5—Music from the Studio.
 4.45—Miss Eva Webb-Jones, mezzo.
 4.45—Afternoon Call, Stock Exchange.
 4.10—Close down.

EARLY EVENING SESSION.

- 6.45—Chimes of 2FC.
 6.50—The "Hello Man" talks to the Children.
 6.50—A Story for the older children.
 6.45—From the Hotel Australia, Sydney, orchestral items, directress, Miss A. J. Egan.
 7.15—From the Studio, "Evening News" Service; and Weather Information.
 7.30—Dalgety's Market Reports (Wool, Wheat, Stock, Fruit, and Vegetable Markets).
 7.40—Close down.

NIGHT SESSION.

- 7.55—Programme Announcements.
 8—Broadcast from Palling's Concert Hall, Sydney, a programme of Greg music, arranged by Madame Evelyn Greig (pianist), entitled "An Hour with Greg," Associate artists: Madame Vera Taama soprano, Miss Roma Kalm violinist, Mr. Oswald Anderson player pianist.
 8.10—Madame Vera Taama soprano solo.
 8.15—"Concerto" in A Minor for two pianos—1st Movement. At the Behning Grand Piano; Madame Evelyn Greig. At the Behning Player Piano: Mr. Oswald Anderson.
 8.45—Madame Vera Taama, soprano solo.
 8.40—Songs for violin and piano: Miss Roma

ANNOUNCEMENT

FREE to every purchaser of goods to value of £1 and upwards, One 2 Volt 20 Amp. Accumulator.

Homecome Colla	1/3
Natron Crystal	1/6
"Horn" Audio Transformers	7/6
3 Volt Dull Emitters (German)	3/0
Val Mat "B" Batteries, Gv.	9/-
Vernier Dial	4/6

IMPORTANT NOTICE.

If your Set is giving trouble, ring, write, or call. Our Radio Doctor will put it right in your own home at a moment's notice.

Sets repaired, re-wired, modernised. Lowest Charges.

WIRELESS SERVICE COY.

1 Rawson Place . . . SYDNEY.

(Next Lewis.)

*Phone M 2119.

Kohn violinist, Madame Evelyn Greig pianist.

- 8.50—Mariane Vera Tasma, soprano.
8.54—Pianoforte solo, Madame Evelyn Greig.
9—Tenor solo, Signor Alberto Mucchi.
9.5—"The Evolution of the Harp," the story of which will be told by Mrs. Norman Thomas, who will explain the various stages in the use of the harp, with musical illustrations by Madame Rosalie Duranti (harpsichord), using an ancient and a modern harp.
9.42—Tenor solo, Signor Alberto Mucchi.
10.10—From the Lopez Watergarden Theatre, item by the theatre orchestra, conducted by Mr. Alfred Mauldin.
10.30—From the Studio: 2PC Danne Band, under the direction of Mr. Eric Pearce, will play until midnight.

2 BL

EARLY MORNING SESSION.

- 7.15—Musical programme from the Studio.
7.18—Physical Training and Health Exercises.
7.25—Health Hints.
7.30—Physical Training and Health Exercises.
7.45—Weather Forecast.
7.51—Broadcasters' Special News Service.
8—G.P.O. Clock and Chimes; Close down.

MORNING SESSION.

- 10—G.P.O. Clock and Chimes; Musical programme from the Studio.
10.10—Broadcasters' Special Rugby News Service.
10.17—Shipping Information, Arrivals and Departures.
10.20—Information re Interstate and Overseas Mail.
10.23—Musical programme from the Studio.
10.28—Sydney "Daily Telegraph" news service.
10.50—Musical programme from Studio.
11—G.P.O. Clock and Chimes. Fruit and Vegetable Reports.
11.5—London Metal Quotations.
11.10—Broadcasters' Information Service. Items in call by wireless, shipping, weather and rainfall, etc.
11.20—Musical programme from the Studio.
11.40—Women's Section, conducted by Mrs. Jordan; Social Notes.
11.50—Mrs. Jordan replies to correspondents.
12—G.P.O. Clock and Chimes; A Talk by Dr. Morris on Infant Welfare.
12.25—A Talk by Miss Helen Jean Bevilacqua on "Tennie."
12.30—Broadcasters' Shopping Guide.
12.33—Sydney Stock Exchange Calls.
12.45—Musical Programme from the Studio.
1—G.P.O. Clock and Chimes. Pianoforte Lesson—Recital by Mr. Arnold R. Moore, B.A., from the Fine Art Gallery, Anthony Hordern's.
1.40—Sydney Stock Exchange Calls.
1.45—Latest Sporting Information and race results on race days.
1.58—"Sun" Newspapers news service.
2—G.P.O. Clock and Chimes. Close down.

AFTERNOON SESSION.

- Racing Information broadcast by courtesy of the Sun.
3—G.P.O. Clock and Chimes; Weather Report and Forecast by courtesy of Mr. C. J. Marra, Government Meteorologist.
3.5—Social notes from "The Sun."
3.16—"Sun" Newspaper's news service.
3.15—Musical Programme from the Studio.
3.30—"Sun" Newspaper's news service.
3.45—Musical programme from the Studio.
4—G.P.O. Clock and Chimes. "Sun" Newspaper's news service.
4.16—Musical programme from the studio.
4.11—Serial story, entitled, "Stories, Near and Far" (Lucky).
4.30—Musical Programme from the Studio.
4.45—Producers' Distributing Society's Vegetable and Fruit Market Reports.
4.50—Shipping information—when available.
4.55—Day's racing resume on race days.
4.55—News from "The Sun."
4.55—Resume of night's programme.
5—G.P.O. Clock and Chimes; Close down.

EARLY EVENING SESSION.

- 5.15—Uncle George and the Kiddies.
6.40—Pavilion Dinner Orchestra under the direction of Mr. Cec. Morrison.
Special Country Session
7—G.P.O. Clock and Chimes; Australian Mercantile Land and Finance Co's. Stock, Wool and Hide Report.
7.5—Weather Report and Forecast, by courtesy of Mr. C. J. Marra, Government Meteorologist.
7.9—Stock Exchange Reports.
7.16—Producers' Distributing Society's Fruit and Vegetable Report.
7.20—Fruit and Vegetable Reports (Sun).
7.45—Grain and Fodder Reports (Sun).
7.47—Eggs and Poultry Report (Sun).
7.50—Country news from the Sun.
7.45—Talk on Books, Wine and Otherwise.

NIGHT SESSION.

- 8—G.P.O. Clock and Chimes. Broadcasters' Tonal Chorus.
8.3—Sydney Orpheus Society, under the direction of Mr. Penman.
8.18—Miss Malise Barnett, contralto.
8.25—Mr. Stanley Crittenden will talk on "Buildings & Values."
8.45—Mr. Raymond Beatty, basso.
8.52—Mr. Bert Warne, comedian.
9—G.P.O. Clock and Chimes.
9.1—Miss Millie Hughes, soprano.
9.5—Miss May Sannerson, elocutionist.
9.15—Sydney Orpheus Society.
9.30—Interval.
9.35—Miss Malise Barnett.
9.42—Mr. Bert Warne.
9.49—Mr. Raymond Beatty.
9.54—Miss May Sannerson.
10.3—Miss Millie Hughes.
10.10—Duet, Miss Millie Hughes and Mr. Raymond Beatty.
10.25—Al. Hammett and the Ambassadors Dance Band, broadcast from the ballroom of the Ambassadors. During the intervals between dances, News Reports by courtesy of the Sun will be broadcast.
11—G.P.O. Clock and Chime; National Anthem.

2 GB

EVENING SESSION.

- 8.45—Take from Dreamland by "The Dream Fairy."
7.15—Special talks of interest to Women.
7.30—Music from the Studio.
7.45—Announcements.
7.55—Instrumental Trio.
8.3—Address by Prof. Ernest Wood.
8.20—Vocal Quartette.
8.30—Talk, "Bobby Comes to Town."
8.40—Songs by Mr. Herbi Hinceck.
8.46—Violin Solo by Lloyd Davies.
8.54—Announcements.
9.5—Piano Solos by Miss Ada Brook.
9.5—Talk, "Ocean Pronounced Piers," by Commander Holleston.
9.15—Songs by Clement Hawking.
9.20—Talk on "Radio," by Mr. E. G. Beard, Constructional Engineer, 2GR.
9.25—Violin solos by Monica Horder.
9.30—Duets for two Violins and Piano, Dan Sully, M. Horder, Ada Brook.
9.45—Vocal Quartette.
9.52—"Great Thoughts from Great Minds," by Prof. Wood.
9.56—God Save the King.

3 LO

MID-DAY SESSION.

- 12—Time Signal; Reuter's and the Australian Press Cables; "Arx" and "Herald" News Services; Shipping Intelligence.
12.45—Stock Exchange information.
12.50—Meteorological information. Weather forecast for Victoria, Tasmania, South Australia and New South Wales. Ocean forecast. River reports.
1—Time signal.
1.1—Rita Hilton in song at the piano.

- 1.8—Ham Johann's Monte Carlo Band.
1.30—Hearth Week Talk.
1.35—Ham Johnson's Monte Carlo Band.
1.53—Rita Hilton, entertainer.
2—Close down.
2.30—Description of Maiden Race, transmitted from Woodend Plate Course, by "Musket" of the Sporting Globe.

AFTERNOON SESSION.

- 2—First Act of "Katju," transmitted from His Majesty's Theatre, by permission of J. C. Williamson Ltd.
2—Description of the Pony Race, Woodend Races.
2.10—The Studio Orchestra.
2.20—Miss Frances Froyer.
2.40—Description of Novice Handicap.
3.35—Reginald Bradley, violin.
3.45—An original sketch, written by Eardley Turner.
4—Description of Spring Handicap.
4.5—Robert Hazell and Elsie Day, in harmony-larry.
4.12—Spater Peck, Infant Welfare.
4.20—Studio Orchestra.
4.32—Robert Hazell and Elsie Day.
4.45—"Herald" News Service, Stock Exchange information.
5—Close down; Description of Flying Hand and Encourage Mile at 4.30 and 5 p.m.

EVENING SESSION.

- 8.45—Children's Hour: Answers to letters and Birthday Greetings.
9—A Musical Programme by the Sunbeam Singers, direction, Miss E. Pascoe Webb.
9.45—"Arx" and "Herald" News Service; Reuters and the Australian Press Association Cables; Shipping Movements; Overseas Shipping; Weather Synopses.
7—Stock Exchange Information.
7.4—Fish Market Reports, by J. R. Borrett Ltd.
7.6—River Reports.

GEORGE FIELD

RADIO AND ELECTRICAL SUPPLIES.

HUNTER STREET, NEWCASTLE.

"CROIX," the famous French Audio Frequency Transformer, 5-1 ratio — 9/6. Best quality coil plugs, 50. Franco plugs and sockets, with the de luxe spring contacts, 5d. pair. Hytron Valves, 5/1A and 9/9 types. Improved non micro-phonous, with beaded glass filament supports, 6/3 each. Ajax phone plugs, 1/8. Black celluloid strip, 2d. ft. Budget Receivers, 1/4. Bostels, 1in. and 1 1/2 in.—6d. and 8d. English American adapters, 2/6. Acwaver Kent 2 stage audio units, 5/3/10. Peerless metal frame rheostats, with antistatic shield, 3/6. Grid and phone condensers, 1/2. Best bakelite, in stock sizes, 4d. square inch. Special sizes cut to order, 4d. square inch.

Country Dealers supplied.

Write for Discants.

Same day Service at best city prices. All Standard Radio lines at best "weekly" prices. Ring Newcastle 1155 for prompt delivery.

THE LARGEST AND OLDEST RADIO HOUSE OF THE NORTH

THIS BATTERY IS GUARANTEED

Invariably the radio enthusiast, seeking the utmost in battery value, chooses an Ever-Ready. This radio battery has received the endorsement of the leading wireless firms and experimenters in Australia. It emphasizes one life and efficient service. There is a type to suit your requirements.

EVER-READY

RADIO BATTERIES

SAFETY FIRST—UTILITY ALWAYS

LOOK FOR THE TRADE MARK



New Ever-Ready No. 126, 4 A, B, or C Battery.
Price 2/6.

One of a group of Radio Batteries. Useful in Wireless, Lighting and Amplification. Size 2 1/2 x 4 x 1 1/2. Most useful for Bells, Telephones, Burglar Alarms, Medical Coils, etc. With three Brass Terminals. Voltages 2.5, 3 or 4.5 volts. Useful for all wireless purposes, as well as general utility.



The "Standard" Dry Cell Radio Battery
Price 3/4.

The Ever-Ready Radio "Standard" Dry Cell as illustrated, is fitted with two screw terminals, and since its introduction has met with great success, users recognizing its immense capacity over any imported cell. Size 2 1/2 x 6 1/2. Weights, 2 lbs. Also for Bell, Telephones, Signalling and Electro-medical apparatus, etc.



"STANDARD" "A" BATTERY.
Price 3/6.
The Ever-Ready "Standard" "A" Battery (3 cells) 4.5 volt, specially designed for economical operation of 1, 2 or 3 valves, taking .06 amperes at 2 volts. For sets with four or more valves, the most economical service is obtained by using two "Standard" "A" Batteries connected in parallel.



"Wanda" Plug Radio Battery.

This illustrates the new Radio High-tension "B" Battery, which (can be obtained 1 1/2, 42 or 48 volts—fitted with a Wanda Plug, and 2 Screw Terminals.

Price:

Small size, type WP, 31.5 volt 0/6
Small size, type WP, 45 volt 12/6
Small size, type WP, 63 volt 18/6
Large size, type XP, 31.5 volt 16/6
Large size, type XP, 45 volt 21/6

If unobtainable locally, write for address of nearest source of supply to

The Ever-Ready Co. (Gt. Britain) Ltd.
163 Pitt Street SYDNEY

7.8—Market Reports by the Victorian Producers' Co-operative Co. Ltd.; Haymarket Sheep Sales; Poultry, Grain, Cattle, Hay, straw, jute, dairy produce, potatoes and onions; Market prices of oranges and lemons, by the Victorian Central Citrus Association Pty. Ltd.

NIGHT SESSION.

- 7.20—Under the auspices of the Department of Agriculture, Mr. T. A. J. Smith, Tobacco Planting.
7.40—Mr. P. W. Pearce, Physical Culture.
8—Health Talk.
8.1—Rupert Hazell and Eids Day, Harmony-Songs.
8.5—Salvation Army Staff Band.
8.10—1 Neilson, Violin.
9.14—Male Quartette.
9.25—Salvation Army Staff Band.
9.35—Bandman R. Small, tenor.
9.40—Capt. Peters, Books, Wise and Otherwise.
9.44—Capt. R. Neilson.
9.5—A. Thompson, bass.
9.14—The Salvation Army Staff Band.
9.15—Neilson, violin.
9.20—Band Glen.
9.30—Mr. A. D. McIntosh, Training for Waikato, Kaveri.
9.45—Bandman Small, tenor.
9.50—Salvation Army Staff Band.
9.55—British Official Wireless News: Announcements; The B.O. Girl Competition.
10.5—A. Thompson, bass.
10.10—Rupert Hazell and Eids Day in a few humorous moments.
10.27—Salvation Army Staff Band.
10.27—"Argus" News Service; Meteorological Information; Announcements.
10.37—Male Quartette.
10.45—Eids Day, soprano.
10.40—Salvation Army Staff Band.
11—Our Great Thought for to-night is—"No really great man ever thought himself out"—Hazell.
11.3—B.O.'s Dance Orchestra.
11.40—God Save the King.

4QG

EARLY MORNING SESSION.

- 6.30—Physical Culture Session.
7—Close down.

MIDDAY SESSION.

- 12.30—Tune in.
12.50—Time Signal.
1—Market Reports: Weather information, "The Daily Mail" and "The Daily Standard" news.
1.20—From Hotel Carlton: Lunch Music from the Lounge, Hotel Carlton, played by Hotel Carlton Symphony Orchestra.
2—Close down.

AFTERNOON SESSION.

- 4.30—From Hotel Carlton: Afternoon Tea Music from the Lounge, Hotel Carlton, played by Hotel Carlton Symphony Orchestra.
6.15—"The Telegraph" news.
6.30—Close down.

EARLY EVENING SESSION.

- 6—"Daily Standard" News, Weather Information, Announcements.
6.30—The Children's Session: Stories by "Little Miss Brisbane."
7—From the Council of Agriculture: Market Reports; Lectures: "A Review of the Sheep Industry of Queensland," by Mr. W. G. Brown (Instructor in Sheep and Wool).
7.30—From the Studio: Stock Reports; Announcements.

NIGHT SESSION.

- 7.45—Lecture Session: A Talk by Mrs. J. H. Fairfax (Country Women's Assn.).
8—A programme by the Silkestone Apollo Club supported by the Studio Orchestra and Artists; Metropolitan Weather Forecast.
10—"The Daily Mail" news, Close down.
10.20—National Anthem; Close down.

THE ORIGINAL BEE-BATS

You can make your own Accumulator
"B" Battery

We supply the parts direct at bedrock
price

You assemble your battery in half an hour, and join the hundreds of our clients who tune in stations they could not get before.

Size I.—2,000 milliamp hours, 8 pence per volt. Battery case supplied for 60 or 90 volt units.

Size II.—1,500 milliamp hours, 6 pence per volt. (Only a few hundreds of these left.) Battery case for 60 volt units only.

FULL SIMPLE INSTRUCTIONS SUPPLIED

Parts include positive and negative plates cast, formed, and charged in pairs, glass cells, celluloid separators (battery topping compound for size I.)

Every radio fan with direct current in his house, to recharge his own battery, should order while the price lasts. If you have A.C. and understand rectifiers, we supply, lead, pure aluminium and borax for a four jar rectifier at 5/-.

Hundreds have been sold by post, we send all orders same day that money order, cheque, or telegraph remittance is received.

These prices will only last till agents are appointed, when BEE-BATS will be 1/- per volt.

ORDER TO-DAY AND SAVE MONEY

W. WYNNE

6 WILLIAMS STREET, GEELONG, VICTORIA.

Circular on request.

5CL

MORNING SESSION.

- 11.30—G.P.O. Chimes.
- 11.31—Featuring a Stock Duo Art number.
- 11.40—"Advertiser" News Service.
- 11.55—Vocalion Number.
- 12—G.P.O. Chimes.
- 12.1—"Advertiser" News Service.
- 12.16—Featuring a Stock Duo Art number.
- 12.30—5CL Studio Orchestra.
- 1.25—Ward & Co's. Stock Exchange Intelligence; Official Weather Synopsis and Station Announcements.
- 2—G.P.O. Chimes.

AFTERNOON SESSION.

- 3—G.P.O. Chimes.
- 3.1—Relay from "Maple Leaf" Cafe—Orchestral Numbers.
- 3.45—From the Studio—Stock-Duo Art numbers.
- 4—G.P.O. Chimes.
- 4.1—Relay from Arcadia Cafe—Orchestral and vocal numbers.
- 4.56—Stock Exchange Reports; General Information and Station Announcements.
- 5—G.P.O. Chimes.

EVENING SESSION.

- 6.30—G.P.O. Chimes.
- 6.31—Bedtime Stories.
- 7.30—Market Reports.
- 7.40—Boy Scouts' Corner.
- 8—G.P.O. Chimes.
- 8.1—Programme of Instrumental and Vocal numbers, arranged by Messrs. F. H. Faulding & Co.
- 8.40—Listeners' League Concert, continued.
- 9—G.P.O. Chimes.
- 9.1—Weather Reports.
- 9.3—Concert Continued.
- 10—G.P.O. Chimes.
- 10.1—Listeners' League Concert, continued.
- 10.15—"Advertiser" News Service.
- 10.25—Relay from the Floating Palace—Dance Music.
- 10.55—Station Announcements.
- 11—G.P.O. Chimes; National Anthem.

7ZL

MORNING SESSION.

- 11—G.P.O. Clock and Chimes; the "Mercury" News; Stock Market; Shipping; Commercial Intelligence; Weather Information, and Sporting Anticipations; Salonnica Selections
- 12—G.P.O. Clock Chimes; Close Down.

AFTERNOON SESSION.

- 3—G.P.O. Clock Chimes; Musical Items from the Studio; Story from Illustrated Tasmanian Mail.
- 3.5—Hobart Stock Exchange Quotations.
- 3.55—Weather Information.
- 4—G.P.O. Clock Chimes; Close Down.

EVENING SESSION.

- 7—Children's Corner. "Big Brother" chats to his pals; Story from Illustrated Tasmanian Mail.

NIGHT SESSION.

- 8—G.P.O. Clock Chimes; the "Mercury" Special Tasmanian News Service; Railway Auction Produce Sales; Weather Information and Sporting Results.
- 8.5—Hobart Stock Exchange Quotations.
- 8.10—Auntolra and Stock Market Reports from Roberts and Co. Ltd., Murray St., Hobart.
- 8.15—Physical Culture talk by Mr. George Collins.
- 8.30—Concert from the Studio.
- 8.15—Tasmanian District Weather Reports.
- 9.50—The "Mercury" Special Interstate News Service; Weather Synopsis; Station Announcements. National Anthem.

Thursday, Nov. 18

2FC

EARLY MORNING SESSION.

- 7.—The Chimes of Big Ben; and Announcements.
 7.5—Music from the Studio.
 7.10—Weather Information; Commercial News; Shipping Intelligence; Rainfall; Temperature; Astronomical Memoranda.
 7.25—Investment Market; Mining Share Market; Metal Quotations.
 7.30—Wood Sales; Breadstuffs Market; Interstate Markets; Produce Markets.
 7.45—"Spiny Morning Herald" News Service.
 8.—Chimes of "Big Ben." Music from the Studio.
 8.15—Close down.

MORNING SESSION.

- 8.15—The Chimes of 2FC and Programme Announcements.
 8.20—Music from the Studio.
 8.30—Marching Music for the School Children.
 8.40—Musical Items.
 8.45—Last minute sporting information, by the 2FC Racing Commissioner.
 9.—"Big Ben" Musical Items.
 9.15—Late "Sydney Morning Herald" News Service.
 10.15—Music from the Studio.
 10.45—A Morning Reading.
 11.—"Big Ben"; Australian Press Association and Butler's Cable.
 11.5—Music from the Studio.
 11.30—Marching Music for the School Children.
 11.35—Close down.

MIDDAY SESSION.

- 12.—The Chimes of Big Ben; and Announcements.
 12.5—Stock Exchange, First Call.
 12.10—Music from the Studio.
 12.15—Marching Music for the School Children.
 12.40—Music from the Studio.
 12.45—From Farmer's Oak Hall; The Oak Hall Trio.
 12.50—Rugby Wireless News.
 12.55—Music from the Studio; Miss Kathleen Cracknell, contralto.
 1.—The Chimes of Big Ben; Weather Intelligence.
 1.5—"Evening News" Mid-day News Service; Producing Distributing Society's Report.
 1.20—From Farmer's Oak Hall—The Oak Hall Trio.
 1.25—Stock Exchange—Second Call.
 1.30—Marching Music for the School Children.
 1.40—Miss Kathleen Cracknell, contralto.
 1.45—From Farmer's Oak Hall—The Oak Hall Trio.
 1.50—Last Minute Sporting Information by the 2FC Sporting Commissioner.
 2.10—Close Down.

AFTERNOON SESSION.

- 2.30.—The Chimes of 2FC; and Announcements; Broadcast from the Haymarket Theatre, items by the Theatre Orchestra, conducted by Mr. Stanley Porter (by permission of the Management).
 2.39.—Marching Music for the school children.
 3.40.—From Farmer's Oak Hall; The Beeds Trio in vocal items.
 3.45.—From Farmer's Tea Rooms, the Oak Hall Trio.
 3.55.—Music from the Studio.
 4.—The Beeds Trio.
 4.5—The Oak Hall Trio.
 4.15.—Music from the Studio.
 4.25.—The Beeds Trio.
 4.35.—From Farmer's Oak Hall—The Oak Hall Trio.
 4.35.—Music from the Studio.
 4.45.—The Beeds Trio.
 4.45.—Stock Exchange—Third Call.
 4.48.—Close down.

EARLY EVENING SESSION.

- 5.45.—The Chimes of 2FC and announcements

- 5.59.—The "Hello Man" talks to the Children.
 6.30.—A Story for the Older Children.
 6.40.—Broadcast from the Hotel Australia, Orchestral items under the direction of Miss A. J. Egan.
 7.15.—"Evening News" Late News Service; Weather Information.
 7.20.—Dialysis Market Reports (Wool, Wheat, Stock, Fruit, and Vegetable Markets).
 7.49.—A Talk by the Rev. S. J. Kirby, on "Adventures Out-back."
 7.45.—A Talk to listeners by the Technical Editor of "Wireless Weekly."

NIGHT SESSION.

- 7.58.—Announcements.
 8.—Broadcast from the Adyar Hall, the second broadcast concert by the British Music Society, presenting vocal and instrumental items, by leading professionals.
 8.40.—From the Studio; Miss Annie Hughes presents a Radio Comedy Sketch entitled, "Two Cronies over the Tea Cup"; Characters: Mrs. O'Shananessy, Mrs. Stella Kaynor, Mrs. Maroney, Miss Annie Hughes.
 9.53.—Mr. Wilfrid Thomas, bass.
 10.2—Miss Kitty Elliott, comedienne.
 10.10—Miss Annie Hughes will present a One-act sketch, "The Lady Help"; Characters: The Lady, Mrs. Stella Kaynor; The Lady Help, Miss Annie Hughes.
 10.26.—Mr. Wilfrid Thomas, bass.
 10.35.—Miss Kitty Elliott, comedienne.
 10.44.—From the Wentworth Hotel, items by the new Symphony Orchestra.
 11.—"Big Ben"; Announcements.
 11.5.—Further Dance Music from the Wentworth Hotel.
 12.—National Anthem; Close Down.

2BL

EARLY MORNING SESSION.

- 7.15.—Musical Programme from the Studio.
 7.18.—Physical Training and Health Exercises.
 7.25.—Health Hints.
 7.30.—Physical Training and Health Exercises.
 7.45.—Weather Forecast.
 7.47.—Sporting Information.
 7.51.—Broadcasters' Special News Service.
 8.—G.P.O. Clock and Chimes; Close down.

MORNING SESSION.

- 9.—G.P.O. Clock and Chimes; Musical programme from the Studio.
 10.10.—Broadcasters' Special Rugby News Service.
 10.17.—Shipping Information: Arrivals and Departures.
 10.23.—Information re Interstate and Overseas Mails.
 10.23.—Musical Programme from the Studio.
 10.38.—Sydney Daily Telegraph News Service.
 10.50.—Ten minute's talk supplied by the S.R.M.A.
 11.—G.P.O. Clock and Chimes; Market Reports.
 11.5.—London Metal Quotations.

- 11.10.—Musical programme from the Studio.
 11.25.—Broadcasters' Information Service, including Mails, Boats in call by wireless; Shipping; Weather and Rainfall.
 11.30.—Women's Session; Social Notes by Mrs. Jordan.
 11.50.—Mrs. Jordan replies to Correspondents.
 12.—G.P.O. Clock and Chimes; A Talk by Mrs. Jordan.
 12.25.—Miss H. J. Douglas will talk on "Cherfulness."
 12.30.—Broadcasters' Shopping Guide.
 12.35.—Bye-bye Stock Exchange Calls.
 12.45.—Hilber's Instrumental Quartette, direction Caryl Castling.
 1.5.—Sydney Stock Exchange Calls.
 1.10.—Latest Sporting Information and Race Results re Race Days.
 1.50.—Sun Newspapers News Service.
 2.—G.P.O. Clock and Chimes; Close Down.

AFTERNOON SESSION.

- Having information broadcast by courtesy of the Sun.
 3.—G.P.O. Clock and Chimes; Weather Report and Forecast, by courtesy of Mr. C. J. Marrs, Govt. Meteorologist.
 3.5.—Social Notes from the Sun.
 3.10.—Sun Newspaper's News Service.
 3.15.—David Jones' Tea Room Trio; Phyllis, Miss Caspers, violinist, Mr. Arshaw, cellist, Mr. Cleaver.
 3.30.—G.P.O. Clock and Chimes; Women's Session.
 3.45.—Music from the Studio.
 4.—G.P.O. Clock and Chimes; David Jones' Tea Room Trio.
 4.10.—Serial Story.
 4.30.—Musical programme from the studio.
 4.45.—Producers' Distributing Society's Vegetable and Fruit Markets.
 4.50.—Shipping Information when available.
 4.52.—Day's Racing Resume on Race Days.
 4.55.—News from the Sun.
 4.58.—Resume of Night's Programme.
 5.—G.P.O. Clock and Chimes; Close down.

EARLY EVENING SESSION.

- 5.45.—Duke George and the Kiddies.
 6.40.—Daffion Dinner Orchestra, under the direction of Mr. Cec. Murrison.
 Special Country Session.
 7.—G.P.O. Clock and Chimes; Australian Mercantile Land and Finance Co's. Stock, Wool and Idle Report.
 7.5.—Weather Report and Forecast, by courtesy of Mr. C. J. Marrs, Govt. Meteorologist.
 7.10.—Stock Exchange Reports.
 7.15.—Producers' Distributing Society's Fruit and Vegetable Report.
 7.20.—Fruit and Vegetable Report (Sun).
 7.23.—Grain and Fodder Report (Sun).
 7.26.—Dairy Produce Report (Sun).
 7.30.—Country News from the Sun.
 7.45.—Lecture.

NIGHT SESSION.

- 8.—G.P.O. Clock and Chimes; Broadcasters' Tropical Clock.



This radio equipped mail plane flies between Chicago and Minneapolis daily. Pilots are kept in constant touch with weather conditions through broadcast reports. All planes are equipped with All-American receivers.

REDUCED

Was £10-5-0 Now £9-5-0



LOG THE WORLD
Build your SUPER with
ALL-AMERICAN

SUPER-FINE PARTS

LONG WAVE TRANSFORMER
(Intermediate Frequency)
For Amplification at 4,000 to 20,000 meters (75 to 15 Kilocycles)
R-110 - Each £2/2/6

10,000 METER TRANSFORMER
(Filter or Input)
High selectivity and wide band distortion.
R-120 - Each £2/2/-

RADIO FREQUENCY COUPLER
(Oscillator Coupler)
A uniform output at 150 to 650 meters.
R-130 - Each £1/15/6

SUPER-FINE PARTS:
J R-110's Price
1 R-120
1 R-130 **£9/5/-**

Maximum amplification at intermediate frequencies, with absolute quietness of operation.

When you build your ultimate set, take no chances with parts of unknown quality. Use the tried and dependable products of the world's leading transformer maker.

The SUPER-FINE PARTS represent the highest expression of ALL-AMERICAN Reliability through Precision Manufacturing.

RADIO KEY BOOK.
So great has been the demand for this excellent little publication that every copy has been sold.
It is intended to rescue stocks within the next eight weeks.
Watch our advertisements for further particulars.

LARGEST SELLING TRANSFORMERS IN THE WORLD.

ALL-AMERICAN

Sole Agent:

O. H. O'BRIEN (LATE O'BRIEN) (AND NICHOLL)

37-39 PITT STREET, SYDNEY
516 COLLINS STREET, MELBOURNE

W. E. PETERMAN, PERRY HOUSE, BRISBANE

- 8.3—Broadcasters' Trio.
8.18—Miss Heather Kinnaird, contralto.
8.20—Mr. Edward Barry, baritone.
8.27—Miss C. L. Robertson, clarinetist.
8.34—Miss Heather Kinnaird.
8.41—Rosina Palmerston and Malame Stephano, harmony duo.
9—G.P.O. Clock and Chimes; Weather Report and Forecast, by courtesy of Mr. C. J. Mares, Govt. Meteorologist; Resume of following day's Programme.
9.6—Broadcasters' Trio.
9.16—Miss Helena Stewart.
9.23—Broadcasters' Trio.
9.30—Interval.
9.38—Miss Helena Stewart; Miss C. L. Robertson; Mr. Edward Barry.
10.15—Al. Hammett and the Ambassadors' Dance Band broadcast from the Ballrooms of the Ambassadors. During the intervals between dances, News Reports by courtesy of the Sun Newspapers will be broadcast.
12—G.P.O. Clock and Chimes; National Anthem.

3 L O

MID-DAY SESSION.

- 12 noon—Time Signal; British Official Wireless News from Rugby; Reuters and the Australian Press Association Cables—"Armas" and "Herald" News Services; Shipping intelligence; Stock Exchange information.
12.56—Meteorological information; Weather Forecast for Victoria, Tasmania, South Australia, and New South Wales; Ocean Forecast; River Reports.
1—Time Signal.
1.1—Studio Orchestra.
1.10—Tanya Tierrani, cello.
1.15—Gwen Humphrey, contralto.
1.26—Piano Quartet.
1.34—C. Richard Chubb, Guit.
1.40—Health Week Talk.
1.45—Gwen Humphrey, contralto.
1.52—Studio Orchestra.
2—Close down.

AFTERNOON SESSION

- 3—Studio Orchestra.
3.10—Mr. C. R. Long: A Talk on Shakespeare's Plays.
3.30—Bessie Gaumond, violin.
3.33—Rupert Howard and Elele Day.
3.42—Health Week Talk.
3.47—Studio Orchestra.
3.57—Elele Day, soprano.
4—"Mary Gamble's" "Literary Gems I love and Why."
4.24—Franklin Statham, clarinet.
4.38—"Herald" News Service; Stock Exchange information.
4.45—Evening from St. Paul's Cathedral.
5.30—Close down.

EVENING SESSION.

- 5.45—Children's Hour; Answers to letters and holiday greetings.
6—Yety Landau will recite.
6.7—"Mary Gamble" will recite.
6.20—Yety Landau, will recite.
6.27—"Mary Gamble" for the boys and girls.
6.46—"Armas" and "Herald" News Services; Reuters and the Australian Press Association Cables; Shipping Movements; Overseas Shipping; Weather Synopsis.
7—Stock Exchange information.
7.4—Fish Market Reports by J. R. Dorrett Ltd.
7.6—River Reports.
7.8—Market Reports by the Victorian Producers' Co-operative Co. Ltd.; Haymarket Sheep Sales; Pottery, grain, chaff, hay, straw, jute, dairy produce, potatoes and onions; Market prices of oranges and lemons by the Victorian Central Citrus Association.

NIGHT SESSION.

- 7.20—Mr. John March, Vice-president Electrical Federation. "Electric Light."

- 7.40—Rev. Kenneth Henderson, "Bible Personal Experiences of Migration."
- 8.—Health Week Talk.
- 8.5.—SLO Melody Masters.
- 8.50.—Mr. E. M. Pascoe, talk on Golf.
- 8.50.—SLO Melody Masters.
- 8.50.—Robert Hazel in some funnyness.
- 8.54.—SLO Melody Masters.
- 9.—Eagle Day, soprano.
- 9.—SLO Melody Masters.
- 9.16.—Cantor and White, Yodeller solo.
- 9.16.—SLO Melody Masters.
- 9.25.—Rob Molyneux, baritone.
- 9.25.—SLO Melody Masters.
- 9.39.—SLO Melody Masters.
- 9.39.—Robert Hazel.
- 9.45.—SLO Melody Masters.
- 9.53.—British Official Wireless News; "Africa" News Service; Meteorological information; Announcements.
- 10.—SLO Melody Masters.
- 10.15.—Eagle Day, soprano.
- 10.22.—SLO Melody Masters.
- 10.32.—Cantor and White, yodelling solo.
- 10.36.—SLO Melody Masters.
- 10.40.—Rob Molyneux, baritone.
- 11.—Our Great Thought for To-night is:—"Character is the diamond that scratches every other stone"—Barlow.
- 11.—SLO Melody Masters.
- 11.40.—God Save the King.

4QG

MIDDAY SESSION.

- 12.55.—Tune in.
- 12.58.—Time Signal.
- 1.—Market Reports, Weather information, "The Daily Mail" and "The Daily Standard" news.
- 1.10.—From Hotel Carlton: Lunch Music from the Lounge, Hotel Carlton, played by Hotel Carlton Symphony Orchestra.
- 2.—Close down.

AFTERNOON SESSION.

- 3.50.—A programme of Music from the Studio.
- 4.15.—"The Telegraph" news.
- 4.50.—Close down.

EARLY EVENING SESSION.

- 6.—"Daily Standard" News, Weather information; Announcements.
- 6.25.—The Children's Session, Stories by Sambo and Pete.
- 7.—From the Council of Agriculture, Stock Market Reports; Lectures, "Common Allments of Dairy Stock," by Mr. A. J. McKenzie, Queensland Agricultural High School and College.
- 7.31.—From the Studio: Stock Reports; Announcements.

NIGHT SESSION.

- 7.45.—Lectures: "A Talk on Books," Mr. W. A. Brindley.
- 8.—Portion of programme will be provided by the West End Salvation Army Silver Band (conductor, Mr. G. H. Woodland); other musical items.
- 9.—Metropolitan Weather Forecasts; Concert, continued.
- 10.—From the Studio: "The Daily Mail" news service. Close down.

5CL

AFTERNOON SESSION.

- 3.—G.P.O. Chimes.
- 3.1.—Relay from "Maple Leaf" Cafe—Orchestral Numbers.
- 3.45.—From the Studio—Steak-Duo Art numbers.
- 4.—G.P.O. Chimes.
- 4.1.—Relay from Arcadia Cafe—Orchestral numbers.
- 5.—G.P.O. Chimes.

EVENING SESSION.

- 6.50.—G.P.O. Chimes.
- 6.91.—Reading Stories.

Now is the time for
Toroidal Coils! Maximum Efficiency. No magnetic field.



Range with .00035 Condenser 175 to 550 Metres

Type T1. Antenna Coupler Type T2. R.F. Transformer

FOR GREATER EFFICIENCY.

In the past, the desire of the radio public to listen to distant stations has been responsible for the manufacture and use of many types of radio frequency transformers, which embody such features as lower losses by the elimination of dielectric material, or greater efficiency through the use of heavier wire. These transformers, however, have the disadvantage that when used in an unshielded set, each unit acts as a miniature loop aerial, enabling the receiver to pick up strong signals from all local stations, and causing the set, when brought to point of sensitivity, to distort and squeal almost invariably. This is due to the unshielded magnetic field of these types of coils. It was not until the advent of the Toroidal Coil that an efficient

inductance, embodying more than one idea, has been offered to the public. The ALL-AMERICAN Toroid Coil represents a departure from the standard design of radio frequency transformers, and is the only coil having no external field. Thus the spacing of coils and setting at critical angles to minimize coupling, when used in multi-stage amplifiers, is rendered unnecessary. In brief, ALL-AMERICAN Toroid Coils have the following advantages:—

1. Elimination of unwanted signals because coils are not subject to outside inductances.
2. Feed-back between stages eliminated because this type of coil possesses no external magnetic field.
3. More compact and efficient set construction made possible because of the above features.

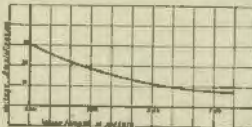

Amplification

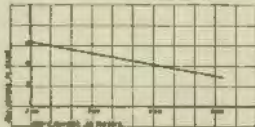

Resistance

KIT COMPLETE £3 19

SOLE AUSTRALIAN DISTRIBUTOR —

O. H. O'BRIEN, Sydney

LATE O'BRIEN AND NICHOLL

37-39 PITT ST., SYDNEY

516 COLLINS ST., MELBOURNE

W. E. PETERMAN, Perry House, Brisbane

THE SUPREME WIRELESS VALUE



THE
"D. J. STANDARD 4"

For £2/10/0 Deposit

Under DAVID JONES' easy system of Deferred Payments you may have the convenience and enjoyment of the "D. J. Standard 4" at once—without any delay. £2/10/- deposit secures immediate delivery of this Wireless Set—full payment to be completed within 12 months at the rate of 9/6 per week. We invite you to take full advantage of this additional convenience.

The "D. J. STANDARD 4" is a powerful, highly selective set, which stands alone for simplicity of reception. This set has but two dials, and will receive, equally well, all Interstate Broadcasting Stations at Loud Speaker strength (with the exception of Perth working on a high wavelength). Being powerful and highly selective, there is no difficulty in picking up whichever station you want—merely by tuning two dials. Once you have tuned in the "D. J. STANDARD 4" remains stable; there is no variance for a whole evening's entertainment.

Here is what you get complete in polished Maple Cabinet—4 B406 Philip Valves, 4 Volt 33 amp Peto-Radford Accumulator, 2 "Volton" "B" Batteries, Trimm Entertainer Loud Speaker, Pair Trimm Dependable 'Phones, 2 'Phone Plugs, 100 feet Aerial Wire, 30 feet Lead-in Wire, 6 feet Flex for connecting batteries, Lightning Arrester. CASH PRICE, £25.

DAVID JONES'
For Service — SYDNEY

- 7.10—Health talk, arranged by Mr. Whittenbury.
7.30—Market Reports.
7.40—Poultry Talk arranged by Mr. Whittenbury.
8—G.P.O. Chimes.
8.1—Relay from a leading Adelaide Picture Theatre.
8.15—Tenor solo, Mr. H. Bauerochse.
8.20—Recitation, Miss T. Baulderstone.
8.31—Studio Orchestra.
8.41—Baritone Solo, Mr. H. Mellish.
8.45—Relay Picture Theatre.
9—G.P.O. Chimes.
9.1—Weather Reports.
9.3—Harp, Mr. J. Lenthall.
9.7—Tenor, Mr. H. Bauerochse.
9.11—Studio Orchestra.
9.17—Baritone, Mr. H. Mellish.
9.21—Relay Picture Theatre.
9.26—Recitation, Miss T. Baulderstone.
9.41—Harp, Mr. J. Lenthall.
9.45—Studio Orchestra.
9.50—Baritone, Mr. H. Mellish.
10—G.P.O. Chimes.
10.1—Relay Picture Theatre.
10.15—"Advertiser" News Service.
10.25—Tenor, Mr. H. Bauerochse.
10.29—Studio Orchestra.
10.36—Recitation, Miss T. Baulderstone.
10.41—Studio Orchestra.
10.54—Harp, Mr. J. Lenthall.
10.59—Station Announcements.
11—G.P.O. Chimes; National Anthem.

7 Z L

EVENING SESSION.

7—Children's Corner. "Big Brother" chats to his pals.

7.15—The Adventures of George, the Bookshelf Cat, by "Aunt Biella."

NIGHT SESSION.

6—G.P.O. Clock Chimes; the "Mercury" Special Tasmanian News Service; Railway Auction Produce Sales; Weather Information.

8.5—Robart Stock Exchange Quotations.

8.18—Selections by Jones' T.X.L. Band, conductor, Mr. L. H. Bennett.

9.15—Tasmanian District Weather Reports.

9.50—The "Mercury" Special Interstate News Service; Weather Synopsis; Station Announcements; National Anthem.

**Amalgamated Wireless Special
Notice**

**Radiotron UX 201A
Valves Price Reduction**

Amalgamated Wireless (A'sia) Ltd., advise that the retail price of genuine Radiotrons, UX201A, has been reduced to 12/-. The price of other genuine Radiotrons remains the same.

FOR SALE: Most up-to-date and central cycle and motor cycle business for sale in country town, combined with radio as a side line. Excellent prospects for live man. Health reasons for selling. Apply to "Regenerative," C/o "Wireless Weekly."

A Cone Speaker

(Continued from Page 19.)

considering the high quality speaker which you now possess. The whole secret of this speaker lies in the straightness of the bushbar reed. If your results are not to your satisfaction, look to this portion, but be very careful not to tear apart the reed from the diaphragm. It may happen that you may have to alter the distance of the disc from the Unit. Don't be afraid to do this, as sealing wax application will become very simple.

I have not given you any details of how to construct a stand or a base for this excellent article, leaving this to your own particular taste. But let me emphasize the necessity for having a fairly heavy base, otherwise the whole speaker may tittle over and get out of adjustment. Personally, I have my eye on one of these statue clocks, which are invariably given as wedding presents, and never keep time satisfactorily. I propose to remove the clock, and in its place, fit the Unit. To complete the appearance a coat of gold or bronze lacquer on the plated disc, and also on the frame for that matter, will make it harmonize with the statue. I feel sure it will look all right.

Of course, not everyone is fortunate enough to have one of these statues. In this case, no difficulty will be found in using an ordinary wooden base, with a pillar to support the Unit, or again, perhaps you desire to hang the speaker from the picture rail in the room. This is what I did, and the effect was very pleasing, the cord being draped along the picture rail out of sight, coming down to the set behind some curtains on the window. Still, I leave it to yourselves to either make a base or hang it to your own satisfaction.

You will be very pleased with this speaker on account of its faithful reproduction, as, was previously mentioned, the tone is excellent, and is not in any way harsh or distorted in the slightest degree.

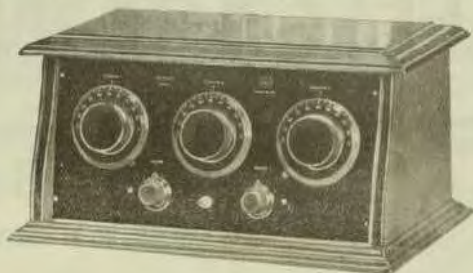

FARMER'S Five Valve Receiver

*Complete with All Accessories
and ready for immediate use*

Farmer's Five Valve Receiver — an ideal instrument for Australian conditions — is supplied in a handsome oak-stained cabinet, which is worthy of a prominent position in any home. All Australian stations, with the exception of Perth, are received at loud speaker strength, and perfect reproduction of broadcast programmes is assured.

The receiver is ready for immediate operation, complete with all accessories; there is absolutely nothing more to buy. Moreover, each set is thoroughly tested before being sent out, and, since only the best components are used in its construction, it will give the utmost in service and satisfaction. Accessories supplied are as follows:

- 5 "Radiotron" Valves, UX 201A.
- 1 Peto and Radford Accumulator.
- 2 "Ever-Ready" 60 "B" Batteries.
- 1 "Ever-Ready" "C" Battery.
- 1 "Amplion" De Luxe Speaker and Loud Speaker cord.
- 1 Set of Aerial equipment, including 100 ft. aerial wire.
- 6 Insulators, 25 feet lead-in wire.
- 1 Lead-in tube, 1 lightning Arrestor.

Price, complete with all accessories £10/-

FARMER'S, SYDNEY
BOX 497 AA, G.P.O.
RADIO SUPPLIES, GROUND FLOOR

ELECTRON WIRE

THE PERFECT AERIAL



Made Broadcasting Popular in Great Britain

For long-distance reception, ELECTRON, the Perfect Aerial, has no equal. Its heavily tinned strands, protected by vulcanised rubber insulation, covered with waxed braiding, makes insulators unnecessary and greatly improves reception.

That is why ELECTRON WIRE is the best Aerial in Great Britain. Its simplicity brought wireless within the reach of everybody—even a child can fix up ELECTRON WIRE and obtain perfect reception in a few moments.

Whether you have only a crystal set or even a large multi-valve set, you cannot obtain better results than those provided by ELECTRON WIRE—The Perfect Aerial.

IT'S SO EASY TO FIX, TOO!

You can simply sling it over a tree, over the roof, round a chimney, run it along the fence, around the picture rail, across the room, hang it out of the window, or where and how you like, and the results are there. Connect one end to your set, let the other be free, use a short piece of an earth and—there you are! Perfect reception and immediate satisfaction.

Proprietors:

The New London Electron Works Ltd., London, England.

ELECTRON WIRE BRINGS WIRELESS WITHIN THE REACH OF EVERYBODY.

- | | |
|-------------------------|---------------------|
| It Abolishes Insulators | It Promotes Comfort |
| It Abolishes Masts | It Saves Money |
| It Abolishes Renewals | It Brings Results |

Fool-Proof—Storm-Proof—Trouble-Proof

PRICE:
2/6
RETAIL

THE ELECTROLEON CO. LTD.,

Manchester Unity Buildings, 185 Elizabeth St., SYDNEY.

Phone: MA 1431.

Proprietors.

The New London Electron Works Ltd., London, England.

THE ELECTRON WAY



The Broadcast Press

(Continued from Page 9.)

This latter activity owes its origin and to a somewhat varying extent, its very existence, to the wide split between broadcasting and press. This is particularly the case in connection with the official notices of programmes of transmitting stations to a less extent with the more technical publications for the experimenters, and not at all in connection with those magazines which are widely circulated throughout the whole country and in foreign lands.

Official programme publications, so far as they are limited to detailed accounts of their own particular programmes, which are illustrated by pictures, short introductory sketches, particular arrangements and details of items, might meet with sharp competition in the daily press, if the latter were to give more space to the printing of these programmes, either directly in their columns, or in an illustrated supplement. The possibility of this kind of competition is likely to be encountered almost immediately by such specialized journals where the extension of broadcasting has reached its limit and a widespread satisfaction has become apparent. Under such circumstances the daily press must give more space to broadcasting, since almost all its readers are broadcast subscribers as well.

It is different with the technical publications for experimenters; these cater, not for the general public, but for a more restricted class of broadcast subscribers, and will flourish so long as there are experimenters. No daily paper can take the risk of sacrificing a notable amount of its space for their sake. But here, as in the great unofficial "specialised press" as we may perhaps term any publication dealing with multifarious sensational items, time and the increasing stabilisation of broadcasting activities, will sift the wheat from the chaff.

There is, at all events, the possibility that the two great forces, press and broadcasting, which, if not actually inimical to one another, are, at best, only on terms of armed neutrality, may some fine day come to peaceful reconciliation.

Exide

WIRELESS BATTERIES

STANDARD EQUIPPED IN ALL THE MARCONI'S SYSTEMS
THROUGHOUT THE WORLD.

Made by the oldest and largest Battery Makers in the World
The Chloride Electrical Storage Co. Ltd., England.

Exide "A" Batteries in 2 Volt Units

Type.	Capacity.	Price each Cell fully charged.
		£ s. d.
D.T.G.	20 amp. Hours intermittent	0 5 6
C.Z.2.	40 amp. Hours intermittent	1 1 0
D.F.G.	45 amp. Hours intermittent	0 15 0
C.Z.3.	60 amp. Hours intermittent	1 5 0
C.Z.4.	80 amp. Hours intermittent	1 9 6
C.Z.5.	100 amp. Hours intermittent	1 14 0
C.Z.6.	120 amp. Hours intermittent	1 19 0

Exide "B" Batteries

Type.	Capacity.	Price for bat. fully charged.
		£ s. d.
W.J.	20 volts, 2,500 milliamp. Hours	1 10 0
W.H.	24 volts, 5,000 milliamp. Hours	2 15 0

All Batteries when discharged can be recharged.

If these cells are not fully discharged and left idle, they will stand
6 months without sulphating.

N.S.W. Distributors and Service Station:

GIBSON BATTLE & CO. LTD.

HUNT STREET, SYDNEY
(Off Westworth Avenue)

Tel.:
M 3080

Tel.:
City 2174

EMMCO

FOR EXCELLENCE



Emmco Rheostat

A rheostat that is fine right throughout—in design and construction! It is a creation of Emmco—the name made famous by fine radio parts. Its adjustable contact sliding lever operates smoothly and silently. The contact springs and double inside grip maintain a constant, uniform pressure. Besides, it offers the new style metal frame and handsome bakelite knob, demanded by the up-to-date set builder.

Price, 4/6



Emmco Vernier Dial

Not only does the handsome, lustrous finish of Emmco Vernier dials lend an air of richness to your set, but they actually insure better, clearer, reception. Even those stations now so closely grouped on the lower wavelengths may be easily and entirely segregated by its hair-line tuning accuracy. On this up-to-date style recording dial, ample space has been provided to jot down call-signs, thus insuring a permanent record of dial settings that you may return to, one and all, in the space of a minute. No fumbling.

Bakelite Frame
9/6

Metal Frame
6/9



Emmco Transformer

What you look for in an audio transformer is a uniform, all frequency amplifier—an instrument capable of fully amplifying all notes audible to the human ear, plus improved long distance reception, and better volume control.

Emmco transformers are designed and built to give just that.

Emmco transformer amplification is expressly for those who seek the finest reproduction of radio broadcast programmes to be had.

Price, 21/-

MANUFACTURED BY

Electricity Meter Mfg. Company Limited
Sydney

A new principle makes this Receiver super selective

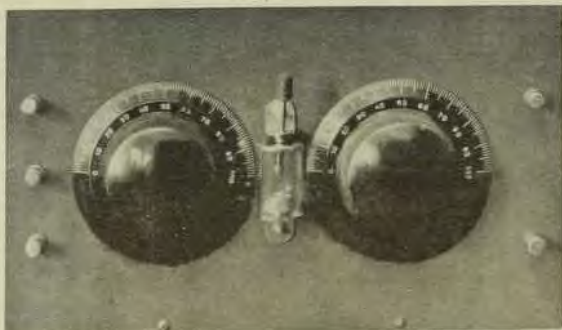

The double circuit split primary coil is the secret

The Hamil Crystal Receiver

DO you want a crystal set which is selective in the extreme?

Would you like a crystal receiver which will cut out the close-by broadcasting station in a few degrees of the dials?

Would you be interested in a receiver, just a simple crystal receiver at that, which will give you the programmes of one station, entirely apart from interference from any other station? In other words, would you like the finest crystal set that I have ever built? If so, read on, read about it. To the crystal user it will be to your advantage.

At the outset, it must be admitted, that the crystal man is difficult to cater for. Many and varied are the different types of selective valve receivers, which will serve the purpose of the average person, but when it comes to crystal reception, this is not quite the case. Until recently, a popular crystal receiver was a straightout direct coupled receiver, satisfying the purposes of most folks, but the advent of 2GB and 2KY and the dropping of the wavelength of 2FC, put these single circuit receivers entirely out of action. Some form of loose coupling was necessary, and the crystal receiver described in "Wireless Weekly" on October 8, was a step in the right direction. The receiver I am about to describe is a

further step in this direction; in fact, it is so extremely selective that I feel sure it will solve the problem with the many crystal users in this State, as well as in other States.

Those crystal users living in Mosman or in Darlinghurst, or anywhere close to 2FC station in Sydney, will find that this is the type of crystal receiver they have been looking for, for a long while. Also in Victoria, around Braybrook Station, those people who desire to hear 3AR will find this receiver will allow them to hear this station.

The whole secret of selectivity lies in the coupling of aerial circuit to the secondary or closed circuit. Look at the circuit diagram, and you will see the reason why. Notice the split aerial coil. That portion which is at right angles to the secondary coil is a honeycomb coil of a given number of turns to be specified later on. From the end of this, you will notice, is taken a coupling coil to the secondary of between one and four turns, thereby transferring the energy from the aerial circuit to the secondary circuit. This ensures maximum selectivity, and to prove for yourself that this is so, consider the Neutrodyne, which is, perhaps, the most selective of all 5-valve receivers. It is a generally known fact that the primary of the Neutrodyne con-

sists of 5 turns, closely coupled to the secondary of 65 turns. The secondary coil is tuned with a variable condenser, the primary not being so.

This is an ideal arrangement, but it has its drawbacks when applied to a crystal receiver, as an aerial coil consisting of only five turns will not pick up sufficient energy to energise the secondary coil. It, therefore, behoves one, when designing a crystal set of this type, to provide sufficient capacity in the primary to accommodate the powerful incoming signal. As 5-turn primary has been proved insufficient for the purpose, it is therefore incumbent on us to build up this primary to a size big enough for the purpose. But, the aerial coil, in its entirety, must not be coupled to the whole of the secondary coil. Hence the reason for splitting the primary coil into two portions, placing the greater portion at right angles to the secondary, and winding the smaller portion, that is, one to four turns, over the top of one end of this secondary.

Here is the reason for your selectivity, and I will relate my actual experience when testing the set on the standard outdoor aerial. I hooked on the aerial and the earth connections, as well as my phones, and listened in. At the time of listening, both 2BL and 2FC were transmitting,

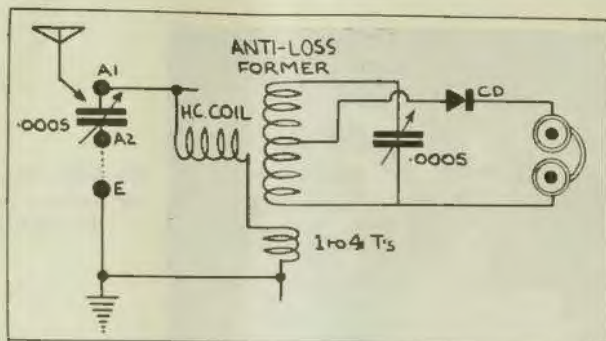

The circuit diagram. Note the split primary.

and I twiddled my dials in the hope of locating either one of these stations. But I didn't. Again I swung my dials round to be tended with similar results, that is, complete silence. Of course, I got quite excited, and checked over my circuit very carefully, only to find that everything was correct. Once again I tuned in, and could hear very faintly the sound of "Uncle George's" voice announcing that 2BL was transmitting. Cheerily, indeed, did I bring both dials round, and presently located this popular announcer very loudly and clearly and sweetly. A slight movement away from this setting yielded almost complete silence, and by carefully turning my condensers round did I locate "Station 2FC, Farmer's Broadcasting Service."

Certainly it must be admitted that I used S.L.F. Condensers, which allowed me a fairly good distance on the dials between these two stations, but the complete silence in between really astounded me, and I am quite used to operating crystal sets. I was, of course, very pleased in the long run, although earlier in the day I really thought that I would have to swallow a few Aspros, on account of what seemed to me a strange silence of the receiver. I ask you again, at this stage, does the receiver of this type appeal to you? If so, build it. This is the way:—

Get these parts first:—

- 1 Dilecto Panel, 12 x 7 x $\frac{1}{4}$.
- 2 .0005 Advance S.L.F. Condensers.
- 1 Crystal Detector.
- 5 N.P. Terminals.

- 1 Fixed Coupling Plug.
- 1 Grodan Anti-loss Former.
- 2 Grid Leak Clips.
- 4 Miniature type terminals or binding posts.
- 2 feet of Bellflex.
- 2 Battery Clips.
- 2 Contact Studs and Nuts.
- 4 ozs. of No. 24 gauge enamelled or D.C.C. Wire.
- 10 feet of No. 22 gauge, D.C.C. Wire.

- 1 35-turn honeycomb coil mounted.
- 1 50-turn honeycomb coil mounted.
- 6 lengths of square Bus-bar.
- 1 Baseboard, 11 x 8 x $\frac{1}{2}$ in.
- 2 3in. or 4in. Dials.
- Sundry screws, etc.

Although I mention the brands of the apparatus actually used in the construction of the receiver photographed, and while, of course, I would prefer you to use these particular parts, at the same time this is not actually compulsory, but, no doubt, similar results may be obtained with other equally good parts. Still, always be certain that your parts are of a reasonably good quality, as no receiver, however efficient, will prove satisfactory if the components are not up to the mark.

The Anti-loss former is clearly shown in this back view. The aerial coil plug is in the correct position.

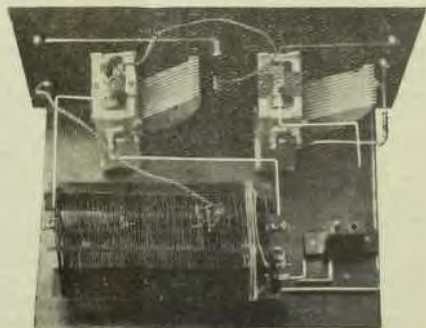

Construction.

A panel layout diagram is produced here, showing the actual dimensions of the panel used by the writer. There is no doubt of the fact that it looks quite symmetrical, therefore the prospective constructor is well advised to follow this out. Mark out and drill your panel, making suitable provision for your own type of crystal detector, as well as your own brand of condenser, as far as the affixing screws are concerned. Don't forget to provide the holes for the wood screws, which are required, to screw your panel to the baseboard. All being drilled, mount your crystal detector, terminals and condensers on the panel, turn your moving plates of your condensers to make sure that they do not foul one another, or the crystal detector.

Coil Winding.

The Grodan Anti-loss Former is purchased unassembled, and it will not take a vivid stretch of imagination to assemble the parts to produce the effect seen in the photograph.

The four internal octagonal portions have a hole drilled on two opposite sides. On the two outside octagonal portions, fit one of the miniature terminals just loosely for the time being, and on the two inside portions grip a small piece of Bus-bar by means of a contact stud and nut; allow these small pieces of Bus-bar to protrude approximately 3in. above the level of the coil former. On one side, in a lower portion of one of the outside octagonal portions, provide two holes 3in. apart, to which

affix two terminals. These latter two terminals are for the coupling portion of a primary coil. The back of panel view of the receiver will show you just what I mean with regard to these terminals, and protruding pieces of Bus-bar.

Having prepared your former accordingly, proceed with the winding of the secondary coil. Underneath one of the terminals, that is, one of the terminals provided for the secondary not the primary coils, grip the end of your enamel wire and proceed to wind in the small grooves provided for the purpose as many turns of wire as this former will accommodate. Keep a fairly good tension on your wire, and a neatly wound coil will result. Secure the end by clamping under the remainder of the secondary terminals. At those two points where a turn of the wire rests against the protruding Bus-bars scrape



The panel layout. Drill from this plan.

away the insulation on the nearest turn and solder this nearest turn to each respective piece of Bus-bar. Alter your two grid leak clips so that they become small brackets and fix these to the bottom of the former, using a contact stud and nut for the purpose.

Complete this coil by winding on your aerial coupling turns. The ten feet of cotton covered wire is required, and is wound over the last few turns of the secondary in the same groove. Clamp the beginning and end of these few turns underneath the extra terminals provided for the purpose. Make sure that this coil is wound in the same direction as the secondary coil.

Now screw your panel to your baseboard, and locate the position of this Anti-loss former behind your condensers, leaving sufficient room at the aerial end to permit the placing

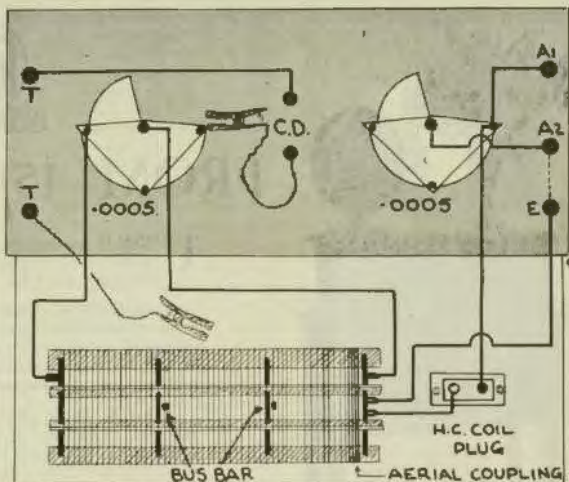

Wire from this wiring diagram. The clips are explained in the article.

of your fixed coupling plug for the honeycomb coil. Note carefully, of course, that the few turns of double cotton-covered wire are at the end nearest to this honeycomb coil. A good method of affixing this fixed coupling plug to the baseboard is per medium of a small sub-panel 2in. long and 2in. wide. Drill four holes in this sub-panel, two within an $\frac{1}{4}$ of each end and two according to the template suited to your coupling plug. Now attach your coupling plug to this panel, but underneath the screws attach two small pieces of Bus-bar, one to protrude to each side of the sub-panel. These are for the connections for this coil. Now, using two small distance pieces about 1in. long, screw this coupling plug and sub-panel to your baseboard in such a position that when the honeycomb coil is plugged in it will be at right angles to the secondary coil, right in the middle thereof. Everything is now ready for wiring, which is very simple indeed, provided you follow out the back of panel wiring diagram given here. Compare this with the circuit diagram, you will see how things match.

Perhaps you will be doubtful of the

flexible leads. To further explain this, take one flexible lead from the bottom telephone terminal, and one from the bottom side of the crystal detector. To the end of these flexible leads is soldered a battery clip, which will allow either of these leads to wander about on the various connections at will. Again, the aerial coil may require further word of explanation. Follow me closely in these connections. From the top aerial terminal a wire is taken to the fixed plates of the aerial condenser and from thence to one side of the fixed coupling plug for the honeycomb coil. The other side of this fixed coupling plug is taken to the beginning of the four-turn portion of the primary wound over the secondary, the other end of this four-turn primary being connected to the earth terminal. The middle aerial terminal is taken direct to the movable plates of aerial condenser. The rest of the wiring is perfectly simple.

Operation.

All the time you have been reading this, no doubt, you are somewhat curious as to the reason for the two aerial terminals as well as the separate earth terminal. These terminals



The R. D. A. III.

R. D. A. Receivers are supplied absolutely complete in all details.



FROM 15/- DEPOSIT

THERE is no longer any reason why the splendid entertainment provided by our Broadcasting Stations need be denied to anybody.

An R. D. A. Receiver which is a guaranteed product and which embodies every modern factor essential to perfect radio reproduction, may be had for a very small deposit—the balance to be paid on our well-known easy payment system.

An R. D. A. Receiver is not only a highly efficient Broadcast Receiver, but as will be seen from the illustration on this page, it is an article of furniture that enhances the beauty of the home.

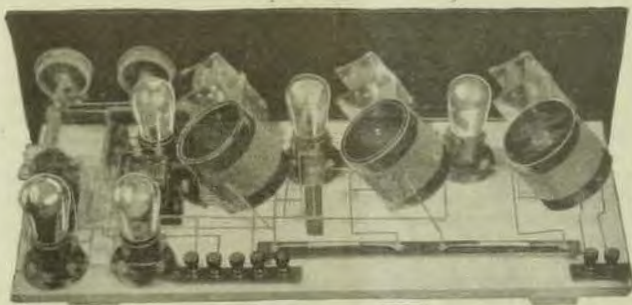

The R. D. A. Standard Neutrodyne

.....

CALL, TELEPHONE OR WRITE

.....

Open Friday Nights

RADIO DISTRIBUTORS

29 Royal Arcade
(Near Palace Theatre)

MA 1790 MA 1744

10a Victoria Arcade
(Opp. Hotel Australia).

provide an arrangement whereby the aerial tuning condenser can be placed in either the series or the parallel position. In view of the proximity of 2FC wavelength to 2BL this series parallel arrangement will be found most satisfactory. Firstly, connect your aerial to the middle aerial terminal, and your earth to the earth terminal. Slip your phones to the correct terminal and locate a suitable point in your connector, grip your flexible lead from your crystal detector to the end terminal of your secondary coil, that is, the end far away from your aerial coupling coil.

The flexible lead from the telephone terminal is clipped to one of your protruding Bus-bars above the secondary coil. Into your fixed aerial plug insert a 50-turn honeycomb coil. Slowly, but very slowly indeed, take both your condenser dials until you hear one of the other local stations. You will find the tuning very sharp, so do not slip over them, the same as I did. Now move your flexible lead from your crystal detector to a different position, on the secondary. Re-tune slightly, noting your results. Now, take your aerial from the middle aerial terminal to the top aerial terminal; join the middle aerial terminal to the earth terminal, leaving your earth connected with this terminal, and re-tune. The aerial condenser is now in the parallel position, whereas in the previous instance, it was in a series position. You may have to substitute a 35-turn coil instead of a 50-turn aerial honeycomb coil, but this you will notice for yourself very quickly.

Again you will be impressed by the sharpness of the receiver. Do not be afraid to transfer your clips into different positions, noting your results. If it is desired that a plain single circuit receiver be used, simply take the flexible clip from your crystal detector direct to the top aerial terminal. The other flexible lead from your telephones direct to the earth terminal. This completely eliminates the secondary portion of your receiver, permitting you to use the straight-out single circuit portion, which, of course, is non-selective.

Some people living very close to a high power broadcasting station may find a slight background of a local station when listening-in to another station. If this is so, the trouble is easily remedied. That coupling portion of your primary, that is the four-turn portion wound on the top of your secondary coil may be reduced to a 3 or perhaps 2, or even 1 turn, the fewer turns included in the circuit, the more selective does it become.

Read this last paragraph over again, and see that you understand it clearly. Go back to the beginning of this article and read where I pointed out that the selectivity of this excellent receiver depends on the number of turns coupled to the secondary. In the vicinity of Mosman, the home of 2GB station, or over in Pymont, close to 2KY station, and even in Essendon, close to 3LO, one turn from the primary will be sufficient coupling to ensure maximum signal strength and maximum selectivity. Brisbane people are not at all worried with their crystal sets, as the only broadcasting station is liable to be heard on a crystal set is 4QG. Those people living in the Port Adelaide line, in South Australia and around Henley Beach, in the same State, may find 5CL permeate the whole atmosphere, this precluding them from hearing 5DN, will find that a one turn coupling will meet their requirements. I cannot tell you exactly just how many turns may be required, but it is a very easy matter for the constructor to determine this for himself.

I have every faith in this receiver, and I have no hesitation in stating that it has filled a long-felt want. I don't know of another receiver quite as selective, and as selectivity is the object of every radioist to-day, this will just about solve the problem.

BACK COPIES

Copies of "Wireless Weekly" for October 1 and 8 can now be obtained.

WANTED.—All kinds secondhand Wireless Sets, Parts, Speakers, etc. Best prices given. JACK RAKPEN, 16 George Street West. MA 1198.

T.C.C. CONDENSERS



T.C.C. Condensers are quality products from first to last. They are permanent, accurate, calibrated, and fully guaranteed against break down. Duplex terminals allow for perfect electric contacts being made either with or without soldering.

Full range of sizes from .0001 to 2 m.f., also 3 m.f., 6 m.f., and 2 m.f. Condensers for battery eliminator.

FREE! T.C.C. Broadcasting Log, giving wavelengths of principal A and B class stations in Australia, and of the principal overseas broadcasting stations. Invaluable to listeners-in. Obtainable from radio dealers or.

Lawrence & Hanson
Electrical Co Ltd

Sale Agents, N.S.W. & Queensland:
21 YORK STREET, SYDNEY.

SLINGSBY & COLES Limited

Under Central Station,
482 PITT STREET.

OUR WONDERFUL 5-VALVE
SUPERTONE TUBOIDAL
COIL SET.

Complete with Histories, Valves,
and Speaker.

PRICE £21/10/-



See our Window
for the New
Features.

Every week a Set will be on view,
which is described in "Wireless
Weekly" for home assembly.
Easy Terms for Sets and Parts.

Wavelength Queries Answered Here

In conjunction with Farmer's Broadcasting Service the Technical Editor of "Wireless Weekly" will answer all listeners' queries arising from the wavelength change. Answers will appear in these columns and will be broadcast from 2FC each Thursday night.

A. J. S. (Melbourne, Vic.)—

Q: Please tell me if the four-valve loop aerial receiver described in "W.W." Vol. 3, No. 34 would be suitable for a portable set?

A: Yes, but interstate stations would be receivable on picnic only.

Q: G. T. (Coomamble)—
Q: I wish to add another valve to the four-valve receiver in "W.W." p. 26. Please tell me how to go about it.

A: We would prefer you to build a Neutrodyne.

G. C. B. (Dubbo)—
Q: Is it possible to add another stage of audio to the Harkness 50 that loud speaker results could be obtained in this town?

A: 1: There is nothing to stop the Harkness Reflex from producing loud speaker results in Dubbo. Try it.

Q: 2: Can grid leak be added to the set?
A: 2: Yes, break the E—lead from the A.F. transformer and join the E—lead of such A.F. transformers to the C—of the bias battery. Connect C— to A— thus completing the circuit.
Thanks for the nice remarks. We hope to continue to work them.

C. A. (Ashfield)—
Q: I have my aerial running parallel to tramway and telegraph wires running past my home. I experience most annoying crackling noises. Can you please advise me?

A: Erect your aerial at right angles to the tramway lines, and install a MacLaren Tone Purifier.

C. W. G. (Woolloomooloo, Q.)—
Q: Do my two-valve receiver I can receive 2FC, 3LD, and 3QT, using a 50 and a 70 turn coil. How can I receive 2HL?

A: Use 35 and 36 turn coils for 3LD. The 50 and 75 turns are suitable for Farmer's and 3AR.

A. R. K. (Quirindi)—

Q: 1: Is it possible to neutralize a 20A valve in the Browning-Drake?

A: Yes, connect Neutrodyne from grid of valve to 15th turn from the bottom of the secondary of the Regenerformer. Perhaps two Neutrodynes in parallel will assist you. We will endeavour to locate the booklet you require and forward it to you. So far we have been unsuccessful.

A. G. (Ashfield)—
Q: I have heard a Regenerative Interflex receiver and it was found necessary to change the setting of the Regenerformer and microphoner in tuning. Also a loud squeal is heard when coming to the station. Should this be so?

A: No, the receiver you heard has not been built or balanced correctly.

P. S. (Tempe)—
P: Please tell me the difference in time between Sydney and Brisbane and Melbourne and Perth and Adelaide.

A: Sydney, Brisbane and Melbourne are all at the same time, but Adelaide is approximately 1/2 an hour behind Sydney, whereas Perth is 2 hours behind Sydney.

A. F. J. (Perth)—
Q: Would you kindly supply me with information on the following points in connection with the Browning-Drake receiver?

Q: 1: Which is the better method of making the regenerformer on the original Browning-Drake type, or on the Hammerford Roberts type?

A: 1: Browning-Drake type.

Q: 2: In the original Browning-Drake circuit given in "Wireless Weekly," Vol. 4, No. 20,

at what turn is the secondary is the tap taken for the connection to the neutrodyne?

A: 2: At the 15th turn.

Q: 3: In the Hammerford Roberts circuit is the neutrodyne connection exactly in the middle of the primary of the regenerformer?

A: 3: Yes.

Q: 4: To which end of the rotor should the pin of the detector be connected?

A: 4: Try receiving foreign leads.

J. H. B. (Hurstville)—

Q: I am desirous of adding a stage of audio to the Neutrodyne, since Naeco. Are separate B batteries necessary for the audio valve?

A: 1: Yes, separate B batteries for the audio valve are strictly necessary. The circuit you suggested showing this is quite O.K. A separate rheostat is also required for the audio valve.

Aerial (Auburn)—

Q: 1: I intend building the Neutrodyne in "W.W." 22.10.26, and I am desirous of following your advice regarding secondary. Would an aerial for overall be satisfactory?

A: 1: Yes, leave your poles as they are.

Q: 2: The shortest lead to a waterpiped for an earth 35 ft. I have buried a kerose. Which is the better earth?

A: 2: Try each and determine for yourself.

M. W. (Young)—

Q: 1: Can I expect good loud speaker reception in the darlings from a Neutrodyne?

A: 1: We cannot answer this definitely as many controlling factors have to be considered. Ask Mr. Purshaw of your town or perhaps the Town Clerk. Both are enthusiasts.

K. M. B. (Eufeld)—

Q: Would a chemical rectifier be suitable for carrying a 4 volt accumulator?

A: No, certainly not. A chemical rectifier is not at all suitable for charging a 4-volt accumulator as the solution becomes too hot when passing sufficient current to make an impression on the accumulator. A lamp of 60 watts only passes approximately one-quarter of an amp. Even a carbon filament lamp of 25 W. (inc. 100 watts) is useless. We know that a so-called Radio Dealer in your neighbourhood is advocating a chemical rectifier for charging an accumulator. Be wary of this advice. It is bad and seems only a means of selling his old stock of rectifiers.

G. M. D. (Chatswood)—

Q: 1: I find some difficulty in neutralising my Browning-Drake receiver. Can you assist me? I am using a Philips 400 valve in the radio frequency stage.

A: 1: The writer hasn't had experience with this valve, but still it should be possible to neutralize it. Try taking your Neutrodyne from the C grid of the valve to the 15th turn from the bottom of the secondary of the Regenerformer. See reply to A. R. K. (Quirindi).

X. Y. Z. (Newcastle)—

Q: Please advise me how to erect the hall aerial?

A: The writer hasn't considered the hall aerial at all, as it hasn't appeared to him in any way. Any short aerial of between 15 and 40 feet long will be found selective.

N. H. (Newcastle)—

Q: 1: Should I get all Sydney stations on the loud speaker with the Harkness Reflex?

A: 1: Yes, most assuredly.

Q: 2: Would Conner Point One valve be suitable for this set?

A: 2: Ideally.

Q: 3: Would Greenlee 6 to 1 and 50 to 1 be quite O.K.?

A: 3: Certainly.

Q: 4: Will you please show me how to connect up the Carburandum aerial?

A: 4: Just the same as the Harkness Reflex. No potential is required. If your receiver doesn't function, don't blame the Harkness, something else may be amiss.

A. L. P. (Dubbo)—

Q: 1: I have a commercially built 6-valve Neutrodyne with 3 stages of resistance coupling which although O.K. at first now works exceedingly. I have tried many different condensers which have proved of little value. Can you assist me?

A: 1: I am afraid this is a difficult job without knowing the make of the receiver. Perhaps your resistances are worn out. Tell us the make of set. Tell us if the bowls are present when you plug your phones into your detector valve.

R. W. (Manly)—

Q: 1: Kindly inform me the number of turns necessary on a Schnell Tuner for the following wavelengths?

A: 1: 20-20 metres, use 3—5—4.
40-50 metres, use 3—7—4.
80-100 metres, use 3—12—10.
150-200 metres, use 3—18—20, using a 7 to 11 plate condenser.

B. J. T. (Marrickville)—

Q: 1: What makes of transformers were actually used in The Old Reliable?

A: All American 5 to 1 and 15 to 1.

BRIEF REPLY—

A. J. M. (Hamilton, N.S.W.)—

See reply to J. H. D. (Hurstville).

A. R. C. (Carlingford)—

We cannot supply this information.

G. B. (Brisbane)—

With 22 gauge wire in the wave trap use 10000 condenser or cut your aerial down a few feet.

P. H. L. (Horswade, Q.)—

The "W.W. Reflex" is certainly critical in tuning and the effect you are getting is quite rational. It is almost impossible to successfully log receivers employing a variable coupling for the coils. Your Baldwin unit is a splendid unit. It is the writer's favourite.

G. L. D. (Willoughby)—

The valve used by us in the extraordinary Single Valve set is the Conner Point One.

J. S. M. (Waverley)—

Build the crystal receiver in this week's "Wireless Weekly."

W. R. B. (Chatswood)—

Electrostatic in the neutral lead.

H. W. S. (Concord, Q.)—

Connect a 500 p.f. condenser across the primary of the first A.F. transformer and shunt the B battery with a 2 mfd. condenser. Perhaps a 200 p.f. condenser across the secondary of the A.F. transformer will help you.

Subscriber (Mandurama)—

Your circuit is O.K., but use 9500 condensers.

A. W. C. (Eastwood)—

Cut your aerial down to 50ft. overall.

R. McC. (Burlington Park)—

Conner Point One.

PHILCO

REG. U.S. PAT. OFF.

Now Obtainable

All High-Class Dealers

THE NEW EIGHTY-THREE X



Replaces 90 volt Dry Battery

THE WORLD'S FINEST Rechargeable "B" Battery

Super Heterodyne and other Multi-valve Sets are too costly to operate without this PHILCO.

Requires recharging only every 3 or 4 months.

PHILCO
DYNAMIC RADIO
BATTERIES

Wholesale Distributors:

New System Telephones Pty. Ltd.

280 CASTLEREAGH STREET

ALFRED O'SHEA AND OTHERS

"An outstanding figure among radio artists in Australia is Mr. Alfred O'Shea, whose magnificent tenor voice is being heard from Broadcasting Station 2FC. Anyone who broadcasts has certain technical points to learn if he would give listeners of his best.

It must be remembered that the notes of the singer are gathered up by the microphone, an instrument no bigger than a man's hand, and if a singer shouts at the mike from too close a range, or whispers the words of his song from the other side of the room, listeners will hear too much or too little of what he is singing. Mr. O'Shea seems to have learnt the precise manner of coaxing the best out of this sensitive instrument. When he is in the studio, the officials whose job it is to amplify or reduce the volume of sound, can sit back and take a rest. When Mr. O'Shea sings the loud notes, he withdraws from the microphone as if automatically, and at the grand finish of his famous soft top A, he steps up to the mike, literally lifts it in his hands, and tenderly whispers to it the last note of his song.

Many favorite concert performers thoroughly at home before a large audience are most uncomfortable before a broadcasting microphone with no audience to applaud them. Noted actors and actresses have been seen in Sydney broadcasting studios dumb with nervous trepidation and with perspiration pouring down their faces, as if in fear of the unseen audiences who are listening to them.

\$50 IN PRIZES.

A distinctly novel stunt has been inaugurated by Electricity Meter Manufacturing Company Limited, makers of Emmco Radio products, who are searching for a slogan featuring the word "Emmco." The prizes to the winners are to be allotted as follows:—

First £25, Second £10, Third £5. An entry form is enclosed with every Emmco carton, representing an individual purchase to the value of 4/6 or over. In initiating the idea, the Emmco people explain that it gives an equal opportunity to both old and young to win a decently sized cash prize.

MEN WHO MADE RADIO

(Continued from Page 8.)

Next week Mr. Fisk will tell the romantic story of Marconi dealing with the development of broadcasting as apart from telegraphy. Don't miss it.

produced waves were not visible to the eye because their wavelength is greater than the human eye can detect, but in all other respects they are identical with light. For some years after the publication of Hertz's results the electrically produced waves were termed Hertzian waves to distinguish them from light waves.

The road we have traversed so far has been limited in its characteristics to features of the discovery of fundamental principles of electricity and magnetism and the conduct of laboratory experiments leading to the discovery of new principles and functions or the confirmation of theoretical reasoning. Very little has appeared in the nature of design or invention of new apparatus and nothing had been done so far in applying these wonderful discoveries to utilitarian purposes and thus making them valuable to the world at large and something more than wonderful scientific discoveries of academic interest.

Scientific discoveries, no matter how wonderful, have nothing beyond academic value and interest unless and until they can be applied to some useful human purpose and while every credit belongs to those great thinkers and workers whose patient labours uncover the hidden secrets of nature, still greater credit goes to those who take abstract scientific knowledge, and, by a combination of far seeing genius, scientific knowledge and practical skill, mould these laws and principles, which alike with all nature, fall unaided, into new channels and invent the apparatus through which they can function along new and useful lines. The value of such work is measured by the nature and degree of benefit con-

GRODAN "Anti-Loss" COIL FORMER ...

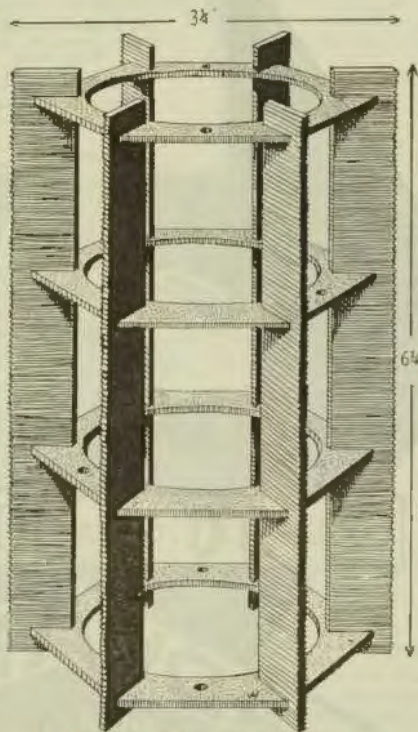

PRICE . . . 3/- EACH.

Experiments all over the world have proved that air wound coils are the most efficient for sharpness of tuning and low resistance. The Grodan Anti-Loss Former conforms to all the specifications for low loss and coils wound on them are extremely selective. They are just what you have been looking for.

Obtainable at all the principal Radio Stores, or from

GROSE & DANIELL
HOLDEN STREET, REDFERN, SYDNEY

Phone—Red. 373

Write for Catalogue

STRAIGHT LINE FREQUENCY CONDENSERS

Sole N.S.W. Distributors:
Fox & MacGillycuddy Ltd.,
"Daily Telegraph" Buildings,
King Street.

Atkins, McLean Ltd.,
National Buildings,
350 George Street.

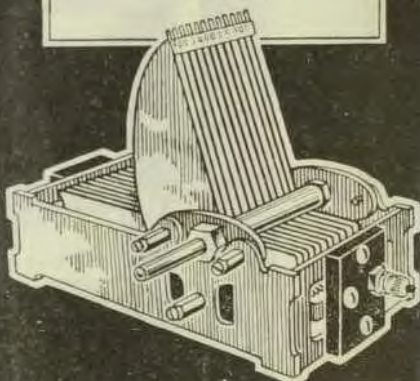

·00025-9'6 : ·00035-10' - : ·0005-10'6

-ADVANCE-
All Australian

RADIO PRODUCTS

RADIO CORPORATION of AUSTRALIA, Melbourne, Sydney, Adelaide, Brisbane

ferred on mankind and the quality of the genius is proportionate to the simplicity and effectiveness of the newly invented apparatus. Our travel is now leading us toward the fields of practical application and we must examine the landscape in somewhat greater detail.

To properly appreciate the nature and importance of the work in the next stage, that is the work of bringing these abstract scientific discoveries to a useful application, we must forget the widespread familiarity which exists to-day in the subject of wireless communication. Given such familiarity it would appear a simple matter to take the steps leading from Hertz to Marconi, but such an idea would be incorrect and misleading. Even great scientific minds such as those heretofore referred to failed to discover and develop their wonderful knowledge into a system of practical utility.

In the first article of this series we noted the inherent desire of men to communicate effectively and speedily across great distances. That desire has been one of the most persistent and widespread of humanity's wishes. It was expressed in the primitive megaphone, the war drum, and the beacon. The invention of the semaphore, a machine with wooden arms, worked by levers, was hailed as a great triumph, but its successful operation was restricted to comparatively short distances and limited by intervening objects and weather conditions; it was useless at night or in day through fog, smoke, mist, or heavy rain. The electric telegraph and the submarine cable followed amid great wonder and acclamation throughout the civilized world, but mankind dreamed of something that could carry its messages across the world with the speed of the electric telegraph but without requiring the laying of thousands of miles of cables or the stringing of overhead wires. "Practical" people (the parenthesis is essential) of course, believed such a dream was wild and impossible of realization; the same type of people most probably opposed and derided the electric telegraph when it first appeared, but once established they

A Remarkably Clear Speaker

PRICE 25/-



Equipped with a non-metal horn, the Western Electric Loud Speaker illustrated, reproduces broadcasting with a purity of tone superior to some loud speakers selling at many times the price.

Only a limited number are available, so if you would secure a REMARKABLY CLEAR Speaker at a price less than that charged for head receivers, place your order without delay.

STANDARD TELEPHONES AND CABLES

(AUSTRALASIA) LIMITED

Formerly

Western Electric Company (Australasia) Ltd.

1914 CASTLREAGH STREET, SYDNEY

accepted it as the "last word."

Less practical but more enterprising people were seeking for wireless telegraphy, and some approached closely to what has, so far, been the only successful method. Morse in India and Steinheil in Germany sought for the solution in the way of conducting electrical currents through the earth or through water. Graham Bell, famous for his inven-

tion of the first successful telephone, actually spoke along a beam of light. John Bowman Lindsay and Sir William Preece successfully applied the law of electromagnetic induction and established communication without connecting wires across short distances, but they found their method to be impracticable for anything beyond half a mile.

(To be Continued.)



Valves with the Wonderful P.M. Filament

THE wonderful P.M. Filament offers you three times more for your money. It is so tough that even after 1,000 hours' life it can be tied in knots and cannot be broken except by the very roughest handling—*result, safety against accidents.*

There is more than strength in the P.M. Filament. It has up to 3 times greater length and up to 5½ times greater emission than an ordinary filament. *This is where the P.M. Filament gives you real value.*

Another big point, the P.M. Filament requires only one-tenth ampere giving 7 times the life to each of your accumulator charges.

For great economy, great life and great results secure the valves with

THE

WONDERFUL P.M. FILAMENT

For 4-cell accumulator or 2 dry cells

THE P.M. 3 (General Purpose) 0.1 amp. 13/6

THE P.M. 4 (Power) 0.1 amp. 13/6

For 6-cell accumulator or 4 dry cells

THE P.M. 5 (General Purpose) 0.1 amp. 13/6

THE P.M. 6 (Power) 0.1 amp. 13/6

For 2-cell accumulator

THE P.M. 1 H.F. 0.1 amp. 13/6

THE P.M. 1 L.F. 0.1 amp. 13/6

THE P.M. 2 (Power) 0.13 amp. 13/6

All Mullard Valves are made at the Mullard Works, Balfour, London, England.

Mullard

THE MASTER-VALVE

ARKS 7

Advertisement of THE MULLARD WIRELESS SERVICE CO. LTD., "MULLARD HOUSE," Denmark Street, London, W.C. 2., England.

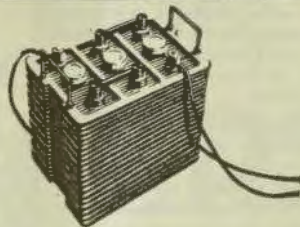

It's a limpet

We can say only this about a P. & R. Battery. It sticks to its job. There are many reasons why. Here are a few:

The P. & R.'s case is "Dagenite" (the secret of P. & R. acid-proof and heat-proof, which looks like ebonite, but is tougher and not so brittle). Paste is "keyed" in place by a special grid section. You don't need any expensive, always-rotting crate. Terminals are protected by special petroleum-jelly glands. Vents are spill-proof and spray-proof. Carrying handles are part of the battery. And—above all note this—the stated capacity is real, steady-discharge, valve-burning, working capacity.

Here's a battery worth thinking about. Since it costs no more than the other kind, it's worth asking about. Ask your dealer.

P AND R
PETO & RADFORD
ACCUMULATORS
The beginning and the end in.
POWER.

177

DIRECT FACTORY REPRESENTATIVE

JOHN ARNOLD

DEGRAVES BUILDING

DEGRAVES STREET, MELBOURNE



Gelston S. Gow, technical director of the Metropolitan Electric Co.

STUDIO PERSONALITY.

With the admission of an audience to SLO, Melbourne's new studio, opportunity is given to study the personalities of performers close up. Singers or speakers or orchestral players accustomed to public appearances cultivate little graces and mannerisms of gesture and what is called "attack" that they are loth to relinquish even before the microphone, but when alone in the old-fashioned studio there was always a feeling of unreality and pose that reacted on the sincerity of the performance. Even the omnipresent Announcer, busy man, had sometimes to remove himself, and leave in his place an aching void that never could be filled in the imagination of the artist. Now that has been remedied by allowing appreciative folk to walk in and sit down and provide attention and applause. During a recent evening session of SLO Melbourne it was most interesting to watch the ever-genial Charles Pope "playing up to" his opposite, the stolid microphone, and to note how he appreciated and made use of the background of spectators. Even that experienced concert artist, Elsie Davies, was evidently conscious of bodily presences in addition to her unseen audience and sang none the less delightfully on that account.

The New RADIOKES COIL KIT

For use in the Famous

Neutrodyne Circuit



The Coils you will eventually buy
At all leading Radio Dealers

32/6 per set

Wholesale only

Metropolitan Electric Co., Ltd.

27-9 King Street, SYDNEY.

Late

Keith Stokes Pty., Ltd.

Manufacturers Products Pty. Ltd. (M.P.)

(H. J. HAPGOOD)

Chalks House, Martin Place
SYDNEY

Tel: HW 1228

—52—

Agents for all styles of Radio Products.
Including Ultra Batteries.

Elec. Meter Mfg. Co. "Kumara."

Refracto Condensers, Leaks and
Fixed Rheos.

Airline Rheos, Pots, Special Coils
and Loupes.

Neutron Crystals, Bruner Phones.
Prompt Shipments from Sydney.

We represent 34 Foreign Radio
Manufacturers

Write for Indent List.

Surplus Stocks sold Interstate.

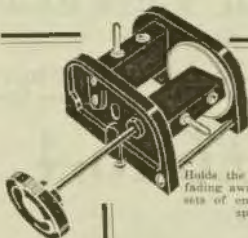

Helicite mouldings for the side plates, coil blocks and knobs; heavy nickel plating for the metal parts.

Tuning is Accurate, because the Moving block cannot fall

Holds the heaviest coil securely in position and prevents the facing away of volume. The vernier movement consists of three sets of enclosed precision machines cut gears and reduces the speed of the moving coil block by eight times.

From all Radio Dealers.

LOTUS

VERNIER COIL HOLDERS

GARNETT, WHITELEY & Co., Ltd.,

Lotus Works, Broadgreen Road . . . LIVERPOOL.

Makers of the new Lotus Emergency Valve Holder.

Manufacturers' Representatives:

John Arnold, G.P.O. Box 471, Degraeve Blides, Degraeve St., Melbourne; and 35 Taranaki St., Wellington, New Zealand.

BRITISH
AND
GUARANTEED

CLARKE'S ATLAS

BRITISH
AND
GUARANTEED

Aperiodic Coupler

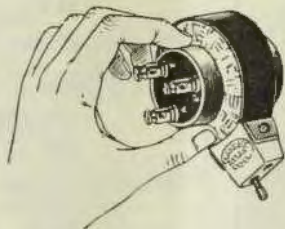

Cuts out local stations, when you can tune in others.
Separates stations which are close together in wavelengths.
No alteration to wiring of your set.
Suitable for all wavelengths.
Not necessary to get any special coils.

A USER'S RECOMMENDATION.

"Alloa,"
Duncan St., Maroubra,
23/10/6

"Manager,"
General Trading Co.
Dear Sirs,—

I promised to let you know the result of my trial with the Aperiodic Coupler. Well, I must say that it has fulfilled every promise on the side of the Box a lot better than I really expected. I can tune out any station I wish, or tune any one in, with the Coupler my 4-valve set is very selective. You can confidently recommend it to anyone.

Yours truly,
(Sgd.) S. PATERSON.

Say "ATLAS" and be "SAFE" PRICE 12/6 each

Ask your dealer—If he cannot supply, please communicate with—

THE GENERAL TRADING COMPANY

"Wingello House," Martin Lane (near Martin Place) SYDNEY.

Telephones: BW 6938; B 4917.

Sole Australian Distributors.

The Marco Four Valve Reinartz Receiver

as described in last week's "Wireless Weekly"

Don't forget that you can buy all the parts of High Quality for building this latest selective set for the Low Price of—

£6-16-4

ACCESSORIES REQUIRED:—

	£	s.	d.
4 Radex Valves, 201A or 199, 6/9 each	1	7	0
1 60 volt Hellesen B Battery	0	17	6
3 Dry Cells, 2/9	0	8	3
	£2	12	9

Yours for Lower Prices:

THE ECONOMIC RADIO STORES

25 New Royal Arcade, SYDNEY.
'Phone: M 3049.

569 Hunter St. West, NEWCASTLE
'Phone: New 1822.

Subscription Form

The demand for copies of "Wireless Weekly" has so far exceeded the supply from the printing presses, despite increased output each week, that many listeners-in have complained that news-dealers were sold out before they could obtain their copy. In order to insure delivery, fill in this subscription form and forward to the Editor, "Wireless Weekly," 51 Castlereagh Street, Sydney.

Please forward "Wireless Weekly" for a period of

for which I enclose for (add exchange to country cheques).

Name

Address

Subscription Rates: 12 months (52 issues), 13 - post free; 6 months (26 issues), 6/6 post free.

ABSORBS SHOCK—PROTECTS THE VALVES

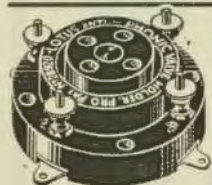

Valve sockets and springs are locked together by a mechanical process, making a definite and permanent connection. Bake-life mouldings, nickel silver springs and phosphor bronze valve sockets, nickel plated.

You know it's good because of the name "LOTUS"

Don't have your valves spoiled by shock. The Lotus Valve Holder has been specially designed to counteract the microphonic noises that are so injurious to the delicate valve filaments.

The unique and original springs of the Lotus Valve Holder absorb any shock and eliminate all microphonic noises. Protect YOUR valves by fitting the Lotus Holder.

With Terminals,
1/6.

Without Terminals,
4/6.



From all Reliable Radio Dealers
GARNETT, WHITELEY & Co., Ltd.,
Broadgreen Road, Liverpool
Makers of the famous LOTUS Coil Holder



Registered Trade Mark.

Published by Arthur William Watt, of "Folkestone," Lavender St., Lavender Bay, for the Proprietors, Wireless Newspapers Limited, 51 Castlereagh St., Sydney and printed by Publicity Press Limited, 11-75 Regent St., Sydney.

The Editor will be glad to consider Technical and Topical Articles of interest to Australian Experimenters. All Manuscripts and Illustrations are sent at the author's risk, and although the greatest care will be taken to return unsuitable matter (if accompanied by stamps), the Editor cannot accept responsibility for its safe return.

Subscription rates.—Twelve months (52 issues), 13/- post free. Six months (26 issues), 6/4 post free. Single copies, 3d, each, or post free 4d. Subscriptions should be addressed to Wireless Newspapers Ltd., 51 Castlereagh Street, Sydney.

Advertising.—Our advertising representative keeps in close touch with subscribers, and he is ready at all times to supply information concerning advertising.

Agents in Great Britain.—The Colonial Technical Press Ltd., Dudley House, Southampton Street, Strand, W.C. 2.

"Wireless Weekly" is fully protected by copyright, and nothing that appears in it may be reprinted, wholly or in part, without special permission. The use of our articles or quotations from them for any purpose whatsoever is never permitted without our written authority.

Manufacturers' Representative:
John Arnold,
G.P.O. Box 871,
Deuxvies Street,
MELBOURNE,
and 55 Taranaki St.,
Wellington,
New Zealand.

The Best Crystal! The Best Results!!
 ————— Now The Best Price!!! —————

REDUCED TO

1/6

REDUCED TO

1/6

Thousands of Authentic
 Testimonials prove its
EFFICIENCY

LOUD SPEAKER can be operated with
 a Neutron Crystal on your crystal set

Australian Distributors:
LOUIS COEN PTY. LTD.
 260 Flinders Lane, Melbourne.

ON SALE at 1/6
EVERYWHERE

Carried in stock and distributed in
 New South Wales by
**MANUFACTURERS PRODUCTS
 Pty. Limited,**
 Challis House, Sydney.

NO
 MORE
 DISTORTED
 MUSIC

*Even the poorest Receiver with its harsh reproduction
 can be converted into a mellow-toned musical instru-
 ment with the new*

MACLURCAN
 TONE PURIFIER AND STATIC REDUCER

(Patent app. 25112)

AN
 EMMCO
 PRODUCT

NOW READY
 FOR SALE

Price, 21/-

WITH A MONEY
 BACK GUARANTEE

Particulars from
CHAS. D. MACLURCAN
 PRATTEN BUILDING, JAMIESON STREET, SYDNEY
 Manufactured by Electricity Meter Manufacturing Co. Ltd., Sydney



Genuine

RADIOTRONS

bear the above seal

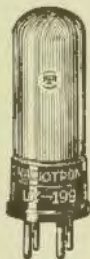

RADIOTRON UX 199

Equally serviceable as a detector or as a high efficiency radio or audio frequency amplifier. Extremely economical in operation. Adaptable to dry battery operated sets.

Filament voltage 3. Current 0.6 amps.

Price 13/6

RADIOTRON UX 201A

The standard all-round flexible storage battery valve—good in any detector or amplifier circuit—sure to give the best results at the lowest operating cost.

Filament voltage 5. Current 2.5 amps.

Price 13/6

RADIOTRON UX 120

New dry cell Radiotron for use in the last stage of audio amplification only. Exceptionally high filament emission. Volume equal to that of two UV 199's.

Filament voltage 3. Current 1.25 amps.

Price 17/6

RADIOTRON UX 112

A new power valve similar to the familiar UV 201A, but several times as powerful. Designed for use as last valve in accumulator operated sets, when it will deliver far more energy than the average load speaker requires. Two of these valves will give exceptional results.

Filament voltage 5. Current 5 amps.

Price £2 5/0

AT ALL DEALERS

Amalgamated  Wireless
Australasia Ltd

97 Clarence Street, Sydney
16/9 Queen St., Melbourne.

Bowyer's Building, Charles Street, Adelaide
King & King Chambers, Queen St., Brisbane

Write to-day for your copy of the Radiotron Booklet—"A wealth of information"

Radiotron

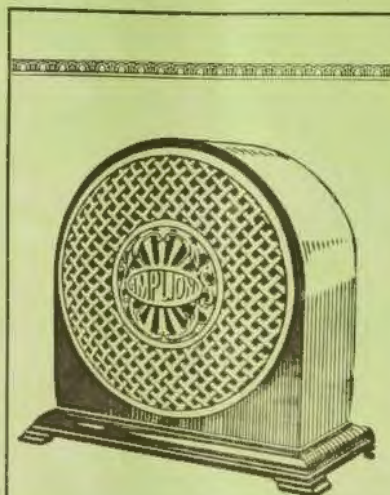

**Radiolux
AMPLION**

British and Australian Made

Made in two sizes and
five distinctive finishes
and
Obtainable from all radio
dealers and manufacturers

AMPLION now humanizes RADIO



The voice of radio is no longer metallic and mechanical, but mellow, human, and musical.

To everything that is broadcast from the full, rich resonance of the human voice, to the stirring syncopation of dance-music, the Radiolux Amplion gives unbelievable animation, life, and a remarkable quality of humaneness.

No incoherence, no oscillating jumble of noises—every instrument, every octave, every tone of the voice is reproduced in its true value. A magic achievement!

With its unique cabinet design, the Radiolux Amplion is designed to harmonise with the setting of any home.

It provides ineffable charm and beauty for the eye.

Sole distributors for A/sia:

Amalgamated Wireless
Australasia Ltd.

87 Clarence Street . . . SYDNEY.

Advt. of Amplion (Australasia) Ltd.,
64 Margaret Street, Sydney.