

WIRELESS WEEKLY

Registered at the G.P.O., Sydney, for

transmission by post as a newspaper.

VOL. 7. No. 3

FRIDAY, NOV. 13, 1925



"Grodan" Radio Appliances

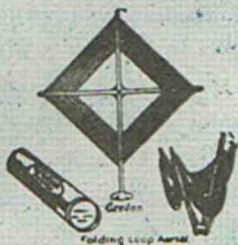

39/6 Each

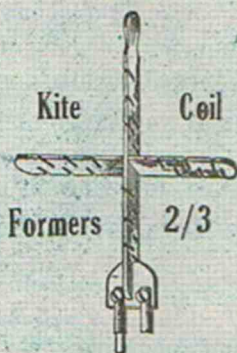

Formers 2/3

The Latest
Inductance Device



6d. Per Packet

There is a use for "Ecs"
in every Set. Price 9d.



Grose & Daniell

Note New Address:
HOLDEN ST., REDFERN
(off Eveleigh Street)
SYDNEY

Kindly Write for Catalogue

FEATURE:

The Three
Coil Weagant
Circuit

Popularity of 'SIGNAL' TRANSFORMERS

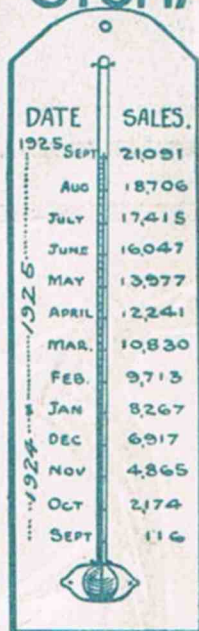

BAROMETER
OF SALES

Proved!

SIGNAL TRANSFORMER

THESE sales figures can be absolutely proved and are a convincing argument, proving that "Signal Transformers" are Australia's most popular transformer.

Used in any stage in a radio receiver they are supreme because of their unequalled ability to amplify without distorting, and to bring in smooth, clean, clear-cut reproductions of broadcasted programmes.

"SIGNAL" AUDIO FREQUENCY TRANSFORMER—A high-grade amplifying transformer, in a magnetically shielded case, made in 7 to 1, 5 to 1, 3½ to 1, and 2 to 1 ratios. Give loud, clear amplification, free from distortion.

RETAIL PRICE, 21/.

"SIGNAL" RADIO FREQUENCY TRANSFORMER—An efficient air-core transformer with simplified control of adjustment to various wave lengths. In nickelled brass cases to reduce any stray couplings.

RETAIL PRICE, 32/6.

"SIGNAL" PUSH PULL TRANSFORMER—For best results in all push pull circuits.

RETAIL PRICE, per pair, 63/.

At All Dealers.

United Distributors Limited

(WHOLESALE ONLY.)

72 Clarence Street,
Sydney.

343 Queen Street,
Brisbane.

Cnr. Jervois Quay and
Harris Street, Wellington, N.Z.

664 Bourke Street,
Melbourne.

27 Chesser Street,
Adelaide.

26 Queen Street,
Perth.

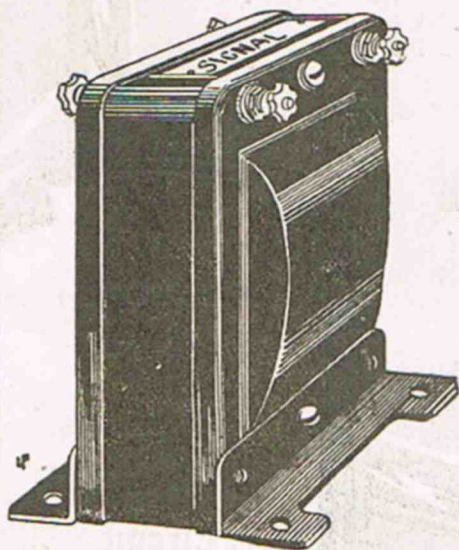

DE FOREST - The Quality Valve

De Forest Valves
17/6 each
Everywhere



Filament, 3 Volts .06 Amp.
Detector, 16 to 45 Volts.
Amplifier, 70 Volts to 150 Volts
Fits Standard American Socket.



De Forest Valves
were the first
made.

Lee De Forest in-
vented the valve,
so you can rest
assured that De
Forest Valves are
the best.

DON'T BE MIS-
LED.

DE FOREST is
the "QUALITY
TUBE," and is
correct in design
and manufacture.



Filament, 5 Volts $\frac{1}{2}$ Amp.
Detector, 12 to 22 $\frac{1}{2}$ Volts.
Amplifier, 90 to 180 Volts.
Fits Standard American Socket.

INTERNATIONAL RADIO Co. LTD.

200 Castlereagh Street, Sydney.

91-93 Courtenay Place, Wellington, N.Z.

SPECIAL ANNOUNCEMENT—

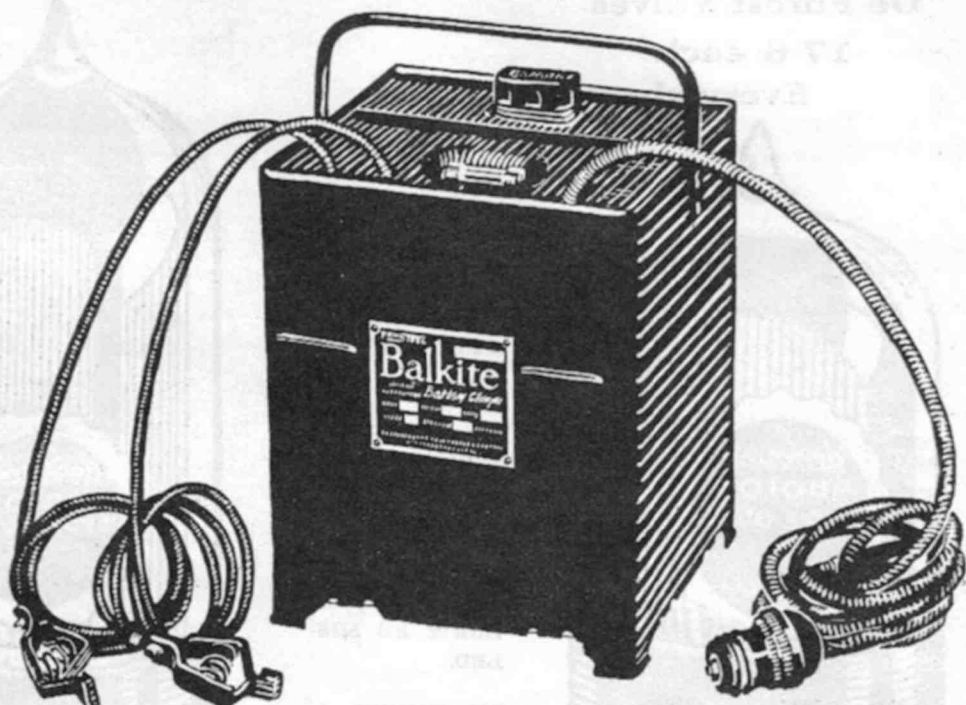
BALKITE, the Nois

FANSTEEL

Balkite Battery Charger

Price £8/15/-

Sold by Leading Radio

Manufactured by The Fansteel Products

SOLE AUSTRALIAN DISTRIBUTOR:—

O. H. O'BRIEN SYDNEY (LATE O'BRIEN)
(and NICHOLL)

516 Collins St.,

Just arrived per s. s. "Tahiti"

Noiseless Battery Charger

Ends the nuisance of weak Radio Batteries

No owner of a radio set need ever again be caught with weak batteries. For Balkite—the Noiseless Battery Charger—may be used while the set is in use. Its operation does not create disturbances in either your set or your neighbours. Balkite has no bulbs or moving parts, and nothing to adjust, break or get out of order. It will charge a completely discharged Battery. It delivers a taper charge and cannot discharge, short circuit or over-charge the battery. It is simple, efficient and unfailing. It consumes less current than a 60 watt lamp. Keep your batteries charged, prolong their life, and enjoy the full benefit from your radio set by buying Balkite now.

The Balkite Battery Charger charges the ordinary 6 volt "A" Battery from 220-240 AC 50 cycle current. It will also charge "B" Batteries of the lead type in multiples of 6 cells. A special adaptor for charging 2 and 4 volt batteries can be supplied.

FAN STEEL
Balkite Battery
Charger
 Price £8/15/-

Dealers EVERYWHERE

Company Inc., North Chicago

37-39 PITT ST., SYDNEY
 Melbourne

BUELL

E. J. Flewelling

RADIO APPARATUS DE LUXE

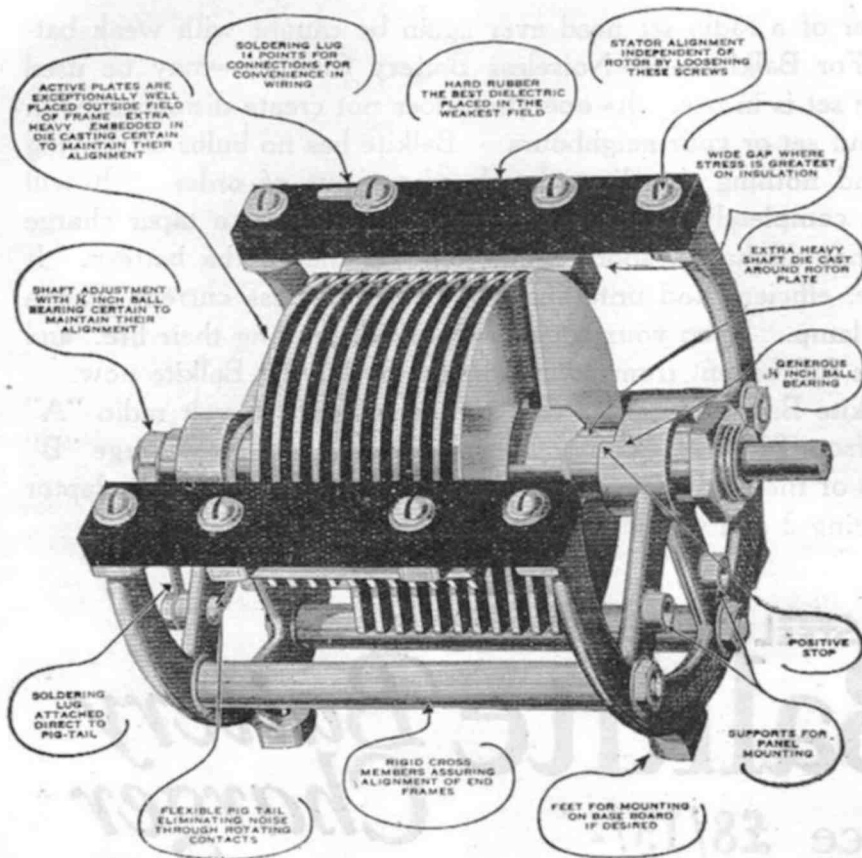

11 Plate, 30/- Each 23 Plate, 32/6 Each

A FEW WORDS ABOUT OUR SERVICE.

All these lines are guaranteed for 12 months
 If your dealer is out of stock, ask him to ring us (MA 1744), and we will deliver within the city area in 10 minutes.

All Dealers, or—

RADIO DISTRIBUTORS

Broughton House, King and Clarence Sts., Sydney

Our 3-Valve Sets

ready for immediate use., complete with Valves, Accumulator, 2 B Batteries and Dulcivox Loud Speaker £19/- Terms arranged. A very selective 3 coil set with vernier adjustments and De Luxe mountings.

As above, but without vernier adjustments and ordinary mountings, £17/- Terms arranged

Cabinets from £1 to £25

Duolateral Coils

	Unmounted.	Mounted		Unmounted.	Mounted
20 Turns	1/5	2/10	100 "	2/1	3/8
25 "	1/5	2/10	150 "	2/3	4/-
35 "	1/6	2/11	200 "	2/6	4/4
50 "	1/7	3/-	250 "	3/3	4/8
75 "	1/10	3/4			

SLINGSBY & COLES

482 Pitt Street

Under the Railway, opp. Marcus Clarks

Wm. Lambert Hamilton

Radio Specialist

Bring your troubles to me. What I will do for you.

I will remodel or re-wire your receiver, making every valve give of its best. Let me modernise your receiver.

I will build you a set to suit your local conditions.

I will answer any enquiries immediately.

My charges will be moderate.

I will buy your components for you at ruling city prices and despatch them to you within 24 hours of receipt of order. I will advise you as to the quality of the goods. This service is free.

I am at your service in any radio wants.

City address:

VICKERY'S CHAMBERS,
82 Pitt Street,
SYDNEY.

Phone: B4543.

Private address:

16a Ness Avenue,
Dulwich Hill.

HOWELL'S Sale & Exchange

.00025 Square Law Condensers, 6/-.
.0005 Square Law Condensers, 7/6.
.0005 All Brass Low Loss, 15/-.
Genuine Bakelite Terminal Boards complete with engraved terminals and soldering lugs, 3/3.
Jefferson Star Transformers, 18/6.
Modern Transformers, 19/-.
HALF SPECIALS PRICE.
.001 Variable Condenser, Bakelite Ends, 9/-.
.001 with Vernier, 12/6.
Adjustable Switch Arms, 9d. ea.
Switch Studs, 6d. doz.
Egg Insulators, 8d. doz.
400 ohm Headphones, 12/6, 15/-

19 Barlow Street
SYDNEY

PHONE: MA 1133
OPEN TILL 9.30 FRIDAY NIGHT

Up to the Minute!
Progress in Radio

QST

A Magazine Devoted
Exclusively to the
Wireless Amateur.

Published Monthly.

Subscription, 20/- per
annum, post free.

Obtainable at all Bookstalls

Distributor for Australia:

Phil Renshaw

DALTON HOUSE,

115 Pitt Street, Sydney

Box 2816, G.P.O., Sydney.

RADIO on Easy Terms. NO INTEREST.

All sets complete with De Forest valves, phones, A and B battery and Aerial.

Single Valve £9 10 0
Deposit 0 18 6
Weekly 0 3 3

Two Valves £13 15 6
Deposit 1 7 6
Weekly 0 4 9

Three Valves £21 0 0
Deposit 2 0 0
Weekly 0 7 4

Four Valves £25 0 0
Deposit 2 10 0
Weekly 0 8 8

Five Valves £29 10 0
Deposit 3 0 0
Weekly 0 10 0

OPEN ON FRIDAY NIGHT.

Radio W'less Mfg. Co.

289 George Street,
Opposite Hunter Street.
B5747.



WIRELESS WEEKLY

Phones: Redfern 964 and 930.

Official Organ of the New South Wales Division of the Wireless Institute of Australia, with which are incorporated the Affiliated Radio Societies and the Australian Radio Relay League.

Editor: A. W. WATT

The Editor will be glad to consider Technical and Topical Articles of interest to Australian Experimenters. All Manuscripts and Illustrations are sent at the author's risk, and although the greatest care will be taken to return unsuitable matter (if accompanied by stamps), the Editor cannot accept responsibility for its safe return.

Subscription Rates.—Twelve months (52 issues), 13/-. post free. Six months (26 issues), 6/6, post free. Single Copies 3d. each, or post free 4d.

Advertising.—Advertising Rates may be had on application to the Advertising Manager. Copy must be in the hands of the Editor by the Friday preceding each issue. If copy is not received in time, the previous week's advertisement will be repeated.

"Questions and Answers." All requests calling for technical advice or drawings MUST be accompanied by postal note or stamps to the value of 1/-. A maximum of four questions is allowed.

Agents in Great Britain.—The Colonial Technical Press Ltd., Dudley House, Southampton Street, Strand, W.C. 2.

All accounts should be made payable to Publicity Press Ltd., 12/16 Regent Street, Sydney.

"Wireless Weekly" is fully protected by copyright, and nothing that appears in it may be reprinted, wholly or in part, without special permission. The use of our articles or quotations from them for any purpose whatsoever is never authorised.

Published by Publicity Press Ltd., 12/16 Regent St., Sydney, Australia.

CONTENTS

	Page
Wireless Institute.	8
Club Notes	9
Amateur Notes	10
Esperanto News	14
N.Z. Broadcasting	15
The Three-Coil Weagant Circuit.	17
The Neutrodyne Receiver	20
Three Circuit & Crystal Combined	26
Victorian Notes	28
Notes from Queensland	32
Broadcasting	33
Radio Cures.	40
Children and Song	48

BUY WISELY.

RECENTLY this paper was successful in rectifying an unfortunate incident which occurred between a purchaser of radio goods and a radio dealer. The customer was located in the country, and according to the information supplied by him to Wireless Weekly, the transaction was far from satisfactory, to put it mildly.

Quoting from this gentleman's letter, he says: "Your letter to him (the dealer) was effective. I immediately heard from him, and to-day received the goods, ordered, or rather, re-ordered."

It is significant that the dealer referred to above does not advertise in Wireless Weekly, and it is perfectly safe to say that such action would not have been necessary in the case of any firm whose announcements appear in the advertisement columns of this paper.

There is no intention in this article to impugn the business methods of any concern which does not advertise in Wireless Weekly, but readers of this paper, in justice to themselves, and in order to prevent any possibility of disappointment or trickery, should stick to our advertisers, all of whom are conducting straight-forward businesses. It should be pointed out that no advertisement is accepted

where it is believed that the goods are not strictly as represented, and this ensures a square deal for the purchaser.

There is another matter which should be dealt with here, and that is the eternal question of what to buy. It can be answered in a brief sentence: "Stick to advertised lines." Any goods that are consistently advertised may be absolutely accepted as genuine and efficient, because no one can afford to go on advertising a thing which is not backed by those two qualities.

Behind all nationally advertised lines, especially in the wireless world, there are technical brains, skilled workmanship and the weight of organisations which cannot afford to put inferior articles on the market, any more than any responsible dealer can afford to handle them. High reputations in business are gained only by fair dealing and a true interpretation of the meaning of that much abused word "Service." They take time to build up, and are much too precious to jeopardise by one single unfair action.

That is why we advise readers of this paper to do their purchasing from Wireless Weekly advertisers. It means "Service" and a fair deal.

A. W. WATT.

Brandes

The name to know in Radio

GRANDPA reflects on how fine it is to be quiet and restful, yet still finding a full measure of amusement for the leisure hours. The armchair presses comfortably against the back of his head; his broad shoulders sink luxuriously into its padded depths. Glancing down the stem of his pipe he sees the deep, rich colour of the polished bowl, and just beyond, into his uninterrupted line of vision comes a glass—and a "finger" of mellow liquid with the thousands of tiny bubbles hurrying to the top. Across his head is the dark, comfortable-looking headband of a Brandes. The **Matched Tone** receivers, clasped gently but firmly to his ears, bring the world and its news; its pleasures and achievements. No need to have it bawled at you across the club smoking-room by a choleric ex-colonel. "Great!" he sighs contentedly.

Ask your Dealer for Brandes.

Brandes Ltd., 296 Regent St., London, W.1. England Works: Slough, Buck

Matched Tone
TRADE MARK
Headphones



British Manufacture (B.B.C. stamped).

All Brandes products carry our official money-back guarantee, enabling you to return them within 10 days if dissatisfied. This really means a free trial.

Sole Agents for Australia and New Zealand:

International Radio Company Limited

200 Castlereagh Street, Sydney, N.S.W., Australia

91-93 Courtenay Place, Wellington, New Zealand

Trade Enquiries Invited

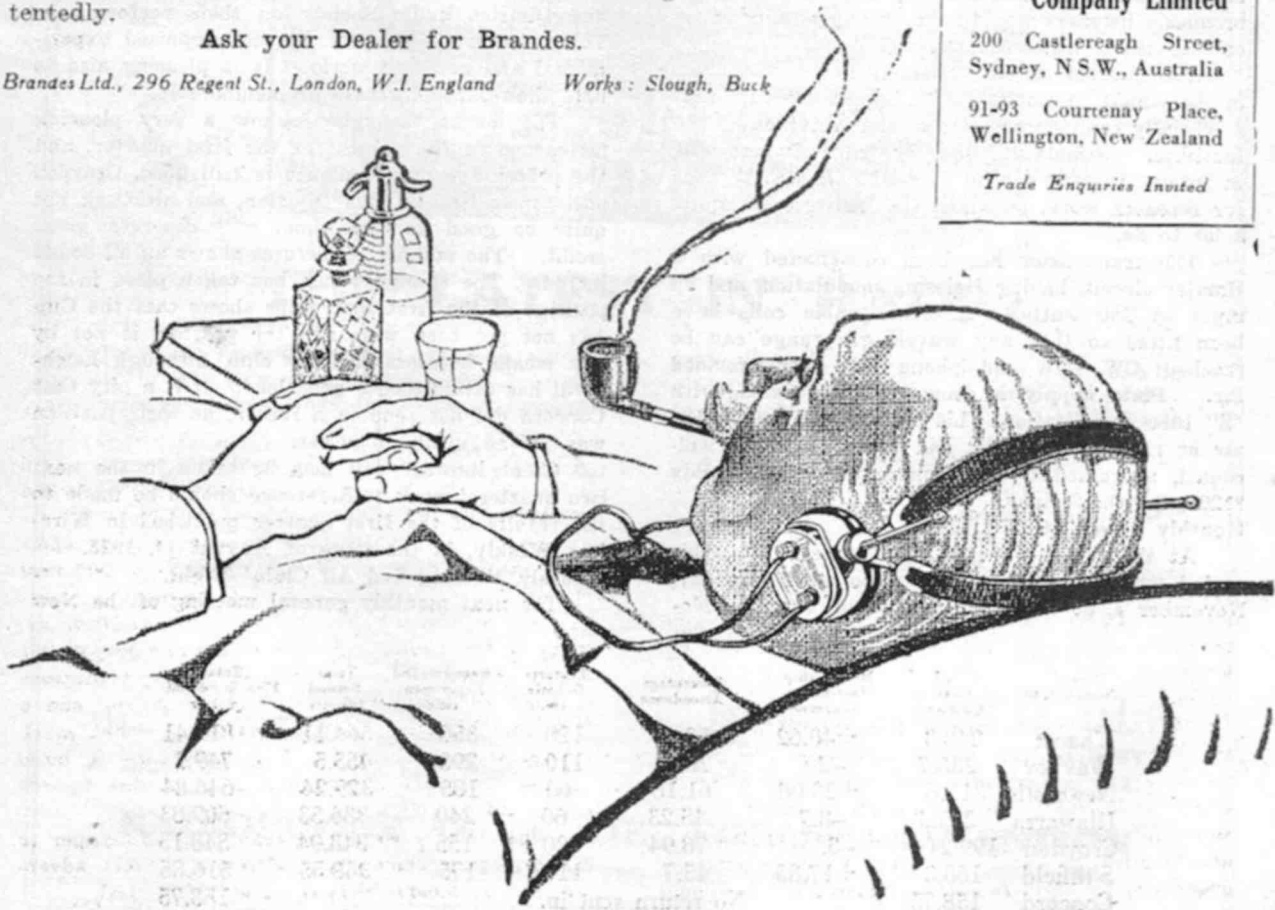

HEADQUARTERS
Royal Society's House
5 Elizabeth St
SYDNEY, N.S.W.

Wireless Institute of Australia

N.S.W. Div. Inc.

Incorporating the Affiliated Societies and The Australian Radio Relay League



W.L. Carter, Hon. Sec.
Box 3120 G.P.O. Sydney
Phone B2235
A.H. Perrett, Publicity Officer.

Official Opening of A2WI.

The New South Wales Division of the Wireless Institute of Australia officially opened their new transmitter for work on Monday, November 9th. The ceremony was an interesting one, and Mr. Malone, Chief Manager, Telegraphs and Wireless, was present, as was also Mr. W. T. S. Crawford, Radio Inspector for New South Wales. The speeches were broadcasted by special permission on a wavelength of 200 metres, so that not only experimenters, but broadcast listeners would have an opportunity of receiving these transmissions.

The interest of this ceremony lies not so much in the actual ceremony itself, but in the fact that it officially commences some of the activities of the Institute. Standard frequency transmissions will, in future, be sent out by 2WI. It will also be used for research work, of which the Institute has quite a lot to do.

The transmitter has been constructed with a Hartley circuit, having Heissing modulation, and an input of 250 watts. Interchangeable coils have been fitted so that any wavelength range can be reached; CW, ICW and 'phone have been provided for. Plate supply is from the AC mains, with "S" tube rectification. This station will be on the air at regular intervals, and reports will be welcomed, addressed to the Honorary Secretary, Box 3120P G.P.O., Sydney.

Monthly Period at 2FC.

At the request of Messrs. Farmers Ltd., this period was arranged to take place on Wednesday, November 4, at 7.40 p.m., instead of Tuesday, No-

vember 3, at 7.45 p.m. On this occasion, Mr. A. H. Perrett, Publicity Officer, New South Wales Division, Wireless Institute, and Chairman of the Delegates' Council, spoke on the subject of "Interference."

Maclurcan Cup Competition.

The results of the second quarter of this competition are published herewith, and also the position to date.

Our congratulations are offered to Leichhardt and District Radio Society on their performance. Their position is largely due to organised experimental and research work. It is pleasing also to note their large increase of membership.

The marks throughout show a very pleasing increase over the values for the first quarter, and the percentage of attendance is still good. Croydon still comes first in this Division, and although not quite so good as last time, still deserves great credit. The number of lectures shows an all round increase. The change which has taken place in the position of the first four clubs shows that the Cup has not yet been won, and the position is not by any means hopeless for any club, although Leichhardt has established a good lead. It is a pity that Concord did not send in a return, as their position was by no means hopeless.

Great interest will now be taken in the next two quarters' work. Reference should be made to the results of the first quarter published in Wireless Weekly, in the issue of August 14, 1925.

Monthly Meeting and All Clubs' Night.

The next monthly general meeting of the New

Name of Club	Total First Quarter	Membership Increase or Decrease	Percentage Attendance	Lectures Debates etc.	Research and Experimentation	Total Second Quarter	Total First & Second Quarter
L'hardt	248.3	+40.62	53.49	120	350	564.11	812.41
Wav'ley	238.7	-20	70.5	110	295	455.5	749.2
Newcastle	317.6	+23.08	61.16	60	185	329.24	646.84
Illawarra	273.3	-8.7	45.23	60	240	336.53	609.83
Croydon	199.21	-5.	78.94	120	155	348.94	548.15
S'thfield	168.3	+17.85	45.7	110	175	348.55	516.85
Concord	158.75						158.75

No return sent in.

South Wales Division of the Wireless Institute of Australia will be held at the Royal Society's Hall, 5 Elizabeth St., Sydney on Thursday, 19th November, 1925. On this occasion all members of affiliated clubs are invited to attend, it being intended to constitute this an all clubs' night. Arrangements are being made for a lecture of extreme interest, particulars of which will be forwarded to members of the Institute and Secretaries of Clubs in plenty of time for the meeting.

Round the Clubs

The asterisk denotes clubs affiliated with the Wireless Institute of Australia (N.S.W. Division).

THE LEICHHARDT AND DISTRICT RADIO SOCIETY *

(Licensed Experimental Transmitting Station 2LH)

On Tuesday, November 3rd, members of the Leichhardt and District Radio Society held their 36th monthly business meeting at the club-room, 176 Johnston Street, Annandale.

Although always good, the attendance on this particular occasion was exceptionally so, and this fact marks an excellent beginning for the fourth year of the Society's activities.

The meeting began with the 10th lecture of Syllabus No. 4, under the title of "Magnetic Rectifiers," and members were treated to a very interesting and instructive talk by Mr. J. R. Alexander, who, by the aid of a magnetic rectifier of his own construction, explained the action and construction of this particular piece of apparatus. The lecturer also supplied members with particulars of the dimensions and materials used by him in the building of the rectifier exhibited at the meeting, and as other members have already successfully constructed similar instruments, it is expected that others will not be long in following suit. The lecture was followed by the usual batch of questions relative to the subject lectured upon, and a hearty vote of thanks was carried by acclamation.

Formal business was then dealt with, and this included the election of four new members, a lengthy discussion on the whys and wherefores of the A.R.R.L., the adoption of the minutes of the Delegates' Council Meeting, held on October 9th, and the presentation to the Society by Mr. R. H. Payne of a nicely executed blue print of the Howell-Reinartz Circuit. The Society's wavemeter, which has now been calibrated, was returned to members by Mr. Thrum, of Croydon Radio Club, and who was present at the meeting as a visitor.

Next Tuesday evening the Society will hold its

151st general meeting, when the 11th lecture of Syllabus No. 4 will be delivered by Mr. F. Basil Cooke. Mr. Cooke will deal with "The Electronic Theory," and in the capable hands of this gentleman, the subject should prove of great interest to all. On the following Tuesday evening, Mr. H. W. Loomes will have something to say regarding the 5BG receiver, and this lecture, too, should be most interesting.

Inquiries regarding the activities of the Society are invited from those interested, and these should be addressed to the Hon. Secretary, Mr. W. J. Zech, 145 Booth St., Annandale.

CONCORD AMATEUR RADIO CLUB *

(A-2GD)

The above Club met on Thursday, 5th October, for the usual weekly meeting. The President, Mr. J. V. Stephenson, occupied the chair, and opened proceedings at 8.6 p.m.

After the minutes of the last meeting had been dealt with, the roster for the ensuing quarter was discussed.

As several members intend to sit for A.O.P. Certificate in the near future, it was decided to confine our quarter's lectures, etc., to the transmitting side of the question. Each phase of transmitter construction will be taken and fully explained in sequence, and a heap of interesting and useful information is assured.

Attendance was again good, only one member being absent.

The meeting closed at 10 p.m. for transmission tests. QSL's of these transmission are required, and any report received will be acknowledged by card.

A line to the Secretary, W. H. Barker, "Euripides," Wallace Street, Concord, from anyone interested in amateur radio will be promptly dealt with.

SOUTH RANDWICK DISTRICT RADIO CLUB *

In place of the usual weekly meeting of the above club, a euchre party and dance was held at the O'Dea Democratic Theatre, and from a social and financial standpoint, was a great success.

We have to thank the united efforts of Mr. Southerwood, Mr. Launer, Mr. Baillie, and Mr. Horne, our Secretary, for their good offices in connection with this function for which further details will follow.

All enquiries concerning club matters should be addressed to Mr. L. Horne, Austral Street, Long Bay.

Have you got your Philco yet?

SOUTH SUBURBAN RADIO CLUB (S.A.)

On Monday, November 2nd, the members met at the club-room, Castle St., Parkside. Prior to the lecture, a representative of the Harley Davidson Motor Cycle Club, addressed members and extended an invitation to about a dozen of the club members to take their sets and visit the week-end house at Sellick's Beach, on November 14th. This offer was gratefully accepted. The club members then decided to hold a working bee on Saturday, November 7th, to erect the club's mast. Mr. Barker, a well known South Australian amateur, 5RM, then gave a very interesting lecture on X-rays, demonstrating with photos of the body. A hearty vote of thanks was passed to Mr. Barker, and the meeting closed.

THE WIRELESS SOCIETY OF NEWCASTLE.*

Third Annual Report for Year ending Oct. 31, 1925.

The beginning of the third year saw the society in its new quarters at the Y.M.C.A. Building, King Street, Newcastle.

The office-bearers for the year were:—President, Mr. L. T. Swain; Treasurer, Mr. J. Shaw; Secretary, Mr. S. L. Childs; Assistant Secretary, Mr. G. Seward; Publicity Officer, Mr. L. Wilson.

Mr. Olsen and Mr. Stewart held office as publicity officers for short periods during the year.

A transmitter employing the reversed feed back circuit was erected, but results not being satisfactory, owing to lengths of lead-in employed, it was decided to shift to the present quarters, thereby shortening leads-in and making for a more efficient aerial system.

A 10ft. x 3ft. table for the accommodation of the transmitting and receiving sets was constructed by the members, and has proved a useful acquisition.

It was decided in June to construct a new transmitter. Subscriptions were invited and sufficient money was raised to carry out this programme. The various parts of the transmitter were constructed by individual members and duly assembled, but the speech frequency choke proved unequal to the job and broke down, and beyond preliminary trials it has been impossible to get the society's transmitter on the "air" up to date of writing.

The society has expressed its willingness to cooperate in the Australian Radio Relay League movement, but up to the present final notice regarding the operation of the league has not been received.

In February, Mr. Maclurean, of A2CM fame, offered as a stimulant to club activities a shield, which has to be competed for by the various clubs annually, the winning club having its name and names of officers in office at the time of writing inscribed on the shield.

It was decided by members that the society

should enter this competition, and the soundness of their judgment and hard work in experimentation and research has been proved by the society obtaining first place in the first quarter of the competition. The good work is still being carried on, and it is the desire of members to win the shield this year.

Home Recreations Ltd. has expressed its willingness to lend the society a cabinet Salonola with a supply of the latest records for radiophone tests (we are going to tackle Heissing Modulation), an offer which will be taken advantage of as soon as the transmitter is operating efficiently.

Mention must be made of Mr. W. Opie, secretary of the Y.M.C.A., to whom thanks are due for kindness in interviewing the Home Recreations people re the Salonola.

Mr. Swain and Mr. Wilson represented the society at the annual dinner of the W.I.A. Mr. Swain again represented the society at the reception tendered to Lieut. F. Schnell, A.R.R.L., on the occasion of his visit to Sydney.

Members are looking forward to the next annual dinner of the W.I.A., as it is their intention to roll up in force to collect the Maclurean Cup.

Wireless Officers**LIST OF MARINE STAFF CHANGES FOR WEEK ENDING OCTOBER 22, 1925.**

G. B. Fullwood (2nd) signed off "Maunganui" in Sydney.

G. B. Fullwood (Sen.) signed on "Esperance Bay" in Sydney.

H. E. Young (Sen.) signed off "Esperance Bay" in Sydney.

H. E. Young signed on "Maunganui" in Sydney.

L. E. Ashby signed off "War Spray" in Newcastle.

S. A. Ash signed on "War Spray" in Newcastle.

R. J. Webb signed off "Ulooloo" in Sydney.

L. E. Ashby signed on "Ulooloo" in Sydney.

E. W. Baker (3rd) signed off "Change" in Sydney.

E. W. Baker's services terminated.

A. L. Batten signed off "Allara" in Melbourne.

S. J. McVeigh signed off "Burwah" in Melbourne.

S. J. McVeigh signed on "Allara" in Melbourne.

J. C. Draffin (2nd) signed on "Largs Bay" in Sydney.

C. W. Carthew (3rd) signed on "Largs Bay" in Sydney.

W. R. Talbot (2nd) signed off "Largs Bay" in Sydney.

S. A. Ash (3rd) signed off "Largs Bay" in Sydney.

C. Williamson signed on "Dilga" in Sydney.

W. R. Talbot signed on "Baldina" in Sydney.

**LIST OF MARINE STAFF CHANGES FOR WEEK
ENDING OCTOBER 29, 1925.**

G. H. Hugman signed off "Zealandia" in Sydney.

R. T. Murray signed on "Zealandia" in Sydney.

F. L. Scott signed off "Time" in Sydney.

G. H. Hugman signed on "Time" in Sydney.

S. J. McVeigh signed off "Allara" in Sydney.

S. J. McVeigh signed on "Corio" in Sydney.

F. L. Scott signed on "Delungra" in Sydney.

A. V. Zoppi signed off "Werribee" in Geelong.

A. V. Zoppi signed on "Burwah" in Melbourne.

**LIST OF MARINE STAFF CHANGES FOR WEEK
ENDING NOVEMBER 5, 1925.**

V. P. Rippingale signed on "Querimba" in Newcastle.

M. Prior (2nd) signed off "Ceramic" in Sydney.

G. Donaldson (3rd) signed off "Ceramic" in Sydney.

D. N. Quinn (2nd) signed on "Ceramic" in Sydney.

W. P. D'Arcy (3rd) signed on "Ceramic" in Sydney.

M. A. MacGoun signed on "Allara" in Sydney.

M. A. MacGoun signed off "Urilla" in Sydney.

R. Jordan signed off "Melusia" in Sydney.

R. T. Murray signed on "Melusia" in Sydney.

E. F. Hayes (Sen.) signed on "Montoro" in Sydney.

F. C. Davies (Sen.) signed off "Montoro" in Sydney.

E. F. Hayes (Sen.) signed off "Arafura" in Sydney.

R. Jordan (Sen.) signed on "Arafura" in Sydney.

H. E. Young signed off "Maunganui" in Sydney.

G. B. Fullwood signed on "Maunganui" in Sydney.

G. B. Fullwood (Sen.) signed off "Esperance Bay" in Sydney.

H. E. Young (Sen.) signed on "Esperance Bay" in Sydney.

F. L. Dawes signed off "Mareeba" in Sydney.

G. Donaldson signed on "Mareeba" in Sydney.

E. Meissner signed on "Arkaba" in Sydney.

W. L. Boyd (3rd) signed on "Changte" in Sydney.

FOR SALE—Super Crystal Set (portable), in leather case, complete with phones, coils, etc.; £2. Perfect reception all wavelengths; operates loud speaker. Cost £6. Demonstration. 56 Mount Street, Coogee.



From the ends of the Earth

*If it's on the air you'll hear
it clearer with*

EDISWAN VALVES

They change the delicate current on your aerial, rectifying and amplifying it, until the sounds you hear are full, clear tones, free from any trace of distortion.

*There is an EDISWAN
Valve for every purpose*

ONE POPULAR TYPE

A.R. A.R.—4-volt
Bright Emitter.
The Amateur's
friend. Detector
and amplifier.

Price :: 10/-

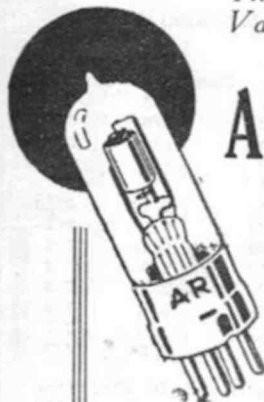

Sold in English or
American Caps
by all Leading
Dealers

Edison Swan Electric Co Ltd.

Sydney: 58 Clarence Street
Melbourne: 368 Little Collins
Street.
Adelaide: 102 Gawler Place.
Brisbane: 32-34 Adelaide
Street.

"Ediswan for Wireless"

WETLESS

Duo-Lateral Coils

"WETLESS" DUO-LATERAL COILS are wound by a special process of constant tension on the wire ensuring uniformity throughout. The self-capacity is extremely low, and the wire used is of the highest grade, the result being very sharp tuning, low high frequency resistance, and maximum signal strength.

"WETLESS" DE-LUXE MOUNTED.

The Mounted Coils have Black Celluloid strip inside Coil former, and the outside of Coils is protected with a layer of Celluloid strip, and only

Genuine Bakelite De-luxe Plugs are used,

being bound to the Coils with

Waxed Thread

and connections to plug soldered. If you are wanting high-grade Coils you cannot do better than select these.

SIZES TO SUIT ALL AERIALS.

Coil No.	Wavelength.		Unmounted.	Mounted
	Min.	Max.		
20	74	210	1/5	6/5
25	96	272	1/5	6/5
35	130	350	1/6	6/6
50	180	370	1/7	6/7
68	250	530	1/9	6/9
85	310	660	1/10	6/10
100	330	1030	2/1	7/1
120	350	1240	2/2	7/2
136	380	1400	2/3	7/3
150	430	1590	2/3	7/3
170	480	1800	2/6	7/6
200	700	2090	2/6	7/6
250	920	2150	3/3	8/3

Wavelength Calibrations by Mr. C. D. MacLurean, with parallel Condenser minimum capacity .000055 M.F. to .0005 M.F. maximum.

If YOUR DEALER cannot supply you, send postal note direct to MANUFACTURER, post paid.

J. Wetless

Bexley — N.S.W.

*Phone: Kog. 1155.

Australian Made.



Amateur Notes

By Q.T.C.

WHEN broadcasting was first attaining popularity, one question occupied the minds of the general public for quite a time. This was the matter of wireless and the gramophone—would the former displace the latter, or vice versa? I think that it can now be fairly definitely stated that neither of these alternatives was, or ever will be, likely to occur. It was thought that the two amusements were essentially antagonistic to one another, but it has been proved to be quite the opposite to this. Far from repelling each other, the gramophone and radio have established an excellent mutual attraction. This is how the wheels go round:—John Juggins, while listening to 2BL punching holes in the ether, hears the Gloomchasers' Band playing "Bringing Home the Bacon," and, supposing that it catches his fancy, he is enticed into trying the record in order that he may play it at his own pleasure. Now, from the other point of view, the gentleman aforementioned probably has some classical records of Melba or other noteworthy artists, and on hearing that she is to be broadcast is tempted to buy a radio set, which otherwise he might not consider. This last instance is continually occurring, as, for some inscrutable reason, one always likes to compare the original with the copy. From these two instances out of many it can readily be seen that the record and the ether wave are very far from being enemies; rather they are allies for each other's good.

This night I am looking forward to hearing Broadcasters produce "The Magic Flute." This was one of the first productions put over in England, and was a howling success all the way.

It would appear that the Institute is making a determined effort at forming a Relay League at long last. When one is to consider that Australia, which, from the point of view of results, is the leading amateur country of the world, has no definite organisation of communication—well, it makes me laugh. However, better late than never!

The Institute has shown a commendable spirit in its State tests. The papers for filling in have been very well compiled, and the amount left to guesswork is absolutely nil. It is to be hoped we shall learn something from these tests.

N.Z. Watches Australia

RESTRICTIONS ON AMATEUR MESSAGES

THE reports recently to hand from Australia stating that amateurs of that country have to some extent succeeded in securing the relaxation of restrictions on amateur transmissions, are received with interest amongst N.Z. transmitters.

As yet, although the N.Z. authorities concerned have been exceedingly just—even lenient—in the administration of the regulations governing wireless operation in the Dominion, no attempt has been made officially to relax the restrictions on the type of message that may be transmitted by amateurs, who are not yet allowed to send messages of a social nature.

It is sincerely hoped by all progressive amateurs that the N.Z. Government will profit by the experience of the United States, and soon allow amateurs absolute freedom in transmitting and receiving messages no matter of what nature. Amateurs state that it can easily be proved that messages exchanged by amateur radio do not in any way affect the telegraph revenue, while knitting together people in various parts of the country in an interchange of goodwill.

The fact that amateurs in Maoriland have not



Mr. G. W. Theodor, of Burndept Wireless Ltd., London, who is visiting the Australian Branch, Burndept (Australasia) Ltd., Broughton House, Clarence Street, of which company he is a director. Mr. Theodor intends staying some time in Sydney, before visiting other centres in the Commonwealth and New Zealand

All Good Radio Stores

W. H. Wiles,
E. R. Cullen,
Farmers,
Horderns,
Murdochs,
Swains,
Colville-Moore,
David Jones,
Radio House,
2 U.W.,
Miss Wallace,
Mick Simmons,

are selling the

Wonderful True Blue Valves



True Blues are sold in Special
Safety Cases of 1, 3 & 5

THE ONLY VALVE

FREE FROM MICROPHONIC NOISES.
WHAT YOU SAVE IN CHEAP PARTS YOU
LOSE IN RECEPTION.

HEATH CONDENSERS

CHEAP CONDENSERS WILL NOT GIVE SELEC-
TIVITY OR DISTANCE.

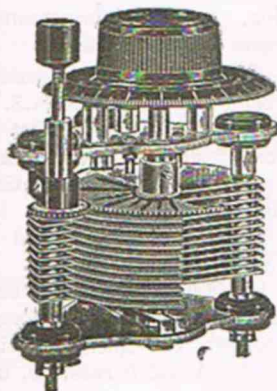

HEATH VARI-
ABLE CON-
DENSERS ARE
BUILT LIKE A
WATCH. Non-
dielectric, Strictly
Low Loss.
Improve your
Set with Heaths.
Prices with
Geared Vernier,
.001, 35/6;
.0005, 30/-;
.00025, 27/-.
Without Vernier
9/- less, dials
4/- extra.

Obtainable at
above Stores.

PARSONS & WHITEMORE LTD.,
30 Market Street, Sydney.

(Mail orders by V.P. Post. Pay the post-
man.)

yet a league or association of any nature is mostly due to the lack of a man with sufficient time and energy to act as organiser. A movement is afoot to inaugurate a branch of the I.A.R.U., but, although most amateurs approached are enthusiastic, it is making little progress for the same reason. The progress of the Australian Relay League is being watched with interest.—R.S.

Wireless on All-Australian Exhibition Train

A UNIQUE feature of the All-Australian Great White Exhibition Train, leaving Sydney on November 11, is the $\frac{1}{2}$ kilowatt broadcasting transmission set installed thereon.

This set was manufactured at the radio electric works of Amalgamated Wireless (A/sia) Ltd., and is being operated by that company. It is to operate on 850 metres. The best combination of coils for listeners in to use is a 75 turn coil on the primary, 100 or 150 on secondary, and 75 or 100 on the reaction.

In designing the aerial special attention had to be given to the fact that it would be necessary to drop the mast while the train was in motion. This difficulty was got over by erecting an aerial of the sheerleg type at one end of the carriage. The height of the aerial above ground is 70 feet, while the flat top length is 100 feet. By means of pulleys the aerial can be erected or dismantled in a very short space of time.

At each centre the train stops at, there will be broadcasted the speeches made at the various functions, together with short lectures on the various Australian manufacturing industries represented on the train. In addition, musical programmes will be put on the air from time to time.

This is the first occasion that a broadcasting transmitting station has been erected on the N.S.W. Railways, and there can be little doubt that it will be not only a source of distinct interest and entertainment to listeners in, but at the same time it will serve to demonstrate to visitors to the train the high efficiency that has been attained by Australians in the design and manufacture of wireless equipment, for in addition to the transmitter there will also be exhibited the very latest types of broadcasting receivers, the chief of which will be the Radiola Super, a six valve receiver, operating without aerial or earth.

The Australian-made Preference train which carries a complete radio telephone transmitter will use the call-sign 2XT.

Esperanto News

HERE, THERE, and EVERYWHERE

2KY, Sydney ("The world's first high-power labor broadcasting station") proposed to transmit a complete course of Esperanto lesson shortly. Watch this column.

When testing on the new European wavelength scheme, suggested by the International Broadcasting Bureau, Copenhagen Radiofoni Station, working on 308 m., employed Esperanto.

Milan Radio Technicians' Club is actively engaged in teaching Esperanto to all its members.

Radio terms in Esperanto will appear in the next issue of "The Year Book of Wireless Telegraphy," published by Etienne Chrion, Paris.

A Spanish amateur, EAR7 (Madrid), broadcasts lessons in Esperanto twice a week from midnight to 2 a.m.

"Literatura Mondo," an Esperanto monthly magazine, published in Hungary, recently arranged a two hours' Esperanto programme at the Hungarian Postal Administration's experimental wireless station, Budapest. QSL cards come from all parts of Europe.

An unauthorised report that the new broadcasting station at Kiev, Russia, intended using an international language other than Esperanto, has been officially contradicted.

"Radio-Geneva" is the first station owned by Esperantists. All announcements are made in French and Esperanto.

Senor Enrique Legrande, a Uruguayan amateur, sends out Esperanto lessons thrice weekly. With an output of only 10 w., he has been heard on loud speaker strength 500 km. from Monte Video.

"Allgemeines Freies Radio," "Radio Woche," and "Radio Wien" wireless journals issued in Vienna, Austria, all devote regular space to Esperanto news.

During international tests from WJAX station, Cleveland, U.S.A., Esperanto was extensively used.

Z-2YM, Gisborne, radiates lessons in Esperanto every Thursday evening. Encouraged by its success New Zealand Esperantists are endeavoring to arrange an Esperanto conference whilst Dunedin Exhibition is in progress.

The Czecho-Slovakian Minister for Public Works in opening the Prague Trade Fair, said that radio badly needed that unifying influence, Esperanto.

N.Z. Broadcasting

NEW STATIONS DUE IN FEBRUARY

THE plant for the first two high-power broadcasting stations for New Zealand under the new broadcast scheme is expected to arrive in Auckland and Christchurch next February, according to the first official statement issued by Mr. W. Goodfellow, director of the new Radio Broadcasting Company of N.Z. Ltd.

The stations will each have an input power of up to 5000 watts, guaranteeing an output of 500 watts radio frequency power in the aerial. The apparatus, according to advice, will be high in first cost; but is considered to be the most modern and efficient radio equipment in the world to-day. Improved speech circuits, the reduction of harmonics, a quieter carrier wave and better facilities for the monitor and control are some of the advantages claimed for the modern plant, which is the result of experience gained in 40 of the best-known broadcasting stations overseas.

The station at Auckland will be erected on the new building of Messrs. George Court & Co., in the Karangahape Road. The aerial will be strung between two lattice towers spanning 220 ft., and over 100 ft. from the roof, which in turn is 80 ft. above the street. The operating room, also situated on the roof, will measure 20 ft. by 30 ft.

Outlining the progress of the new company, Mr. Goodfellow stated that the negotiations with the Government commenced in June of this year, and when arrangements between the Government and another company could not be finalised, a trustees' agreement was entered into on August 1. On August 26, the present company was incorporated to provide radio broadcasting in New Zealand in return for a certain portion of the revenue to be collected by the 30/- per annum tax on listeners.

It is expected that the Christchurch broadcasting station will be in operation a few weeks after the completion of the Auckland station. Meanwhile the new company has taken over three of the existing broadcasting stations with which to continue a service in the interim, and is conduct-

ing negotiations with a fourth, the station at Wellington.

In connection with the offer of Amalgamated Wireless to broadcast, free of charge, items from the New Zealand and South Seas Exhibition from November 17 to April, the Minister has announced definitely that a license to broadcast at the exhibition will not be granted this company. The new company is expected to carry out this project, using the old station at Dunedin, 4YA. Listeners in the Dominion are wroth that the offer of broadcasting from a brand-new station should have been turned down in favor of broadcasting from a station which, although probably the best station in New Zealand, is by no means new.—R.S.



THE Red Seal Headset, designed exclusively for the reception of broadcasting programs, has no troublesome natural periods which accentuate one or more notes of the musical scale. Reproduction remarkably accurate in rendition. Comfortable to wear. Provided with sanitary head band of soft rubber.

Made by the makers of the famous
Red Seal Dry Batteries

Red Seal
HEADSET

Stocked by All Radio Dealers

Factory Representatives—

Atkins, Maclean
Ltd.

350 George St.,
Sydney



Keep up-to-date. Have "Wireless Weekly" mailed you direct every week—!

We have those—

“Hard to Get”

Parts

Marshall-Stats: The best rheostat for detectors	£0 10 6
Amperites: Automatic Filament Rheostat, 199 or 201A Type . .	0 7 6
Low Loss Condensers: The Artcraft, various sizes	0 15 0
Neutralising Condensers: For Browning Drake	0 4 6
Push Pull Transformers: The Crescent, per pair	1 18 3
Rheostats: 30 or 6 ohms, high grade	0 2 3
Valve Sockets: Standard American or 199	0 2 0
Battery Switches: Push Pull Pattern	0 1 9
Terminal Boards: Engraved with Seven Terminals	0 2 9
Indoor Aerials: Spring Pattern	0 6 6
Ear Cushions: No more sore ears, fit any phone, pair	0 3 0
Audio Transformers: Karas Harmonic	1 19 0
Non Solder Jacks: Single 2/6; Double	0 4 3
Three Coil Holders: Fitted with anti-capacity handles	0 8 3
'Phone Cords: Double	0 2 3
Extension Cords: 20 feet for Loud Speakers	0 5 9
'Phone Plugs: Automatic or Double	0 2 0
Jacks: Best Quality, single 2/3; double	0 2 10
Sockets: Porcelain Low Loss	0 2 6
Sockets: Brown Bakelite	0 3 0
Potentiometers: 400 ohms	0 3 3
Dials: 3in., 1/6; 4in., 2/10; 4in. Bakelite	0 4 6
Vernier Adjusters: Ajax	0 1 2
Battery Clips	0 0 5
Fixed Condensers, .006	0 3 6

We pay carriage on goods to the value of 10/- or over, except on Batteries and Loud Speakers

“Yours for Lower Prices”

The Economic Radio Stores

28 Royal Arcade, Sydney

Phone B 5891

The Three Coil Weagant Circuit

WITH INTERNALLY MOUNTED HONEYCOMB COILS.

By A. ALEXANDER.

SINCE the advent of the thermionic valve in wireless receivers some hundreds of different circuits have been evolved, each of which incorporate one or more improvements in certain sections. Almost daily one reads that new combinations of the components have been found to be more meritorious than those already in use. Certainly some of these new circuits are just old friends in new garments with a slight alteration, but for all that they are none the less interesting.

The "Improved Armstrong" falls in this category, as does the "Weagant" Circuit, both of which owe their origin to the Armstrong Regenerative Circuit. The Weagant Circuit, from inspection, is evidently the origin of the famous Reinartz design, which everyone knows to be excellent. It has one serious disadvantage, at least to New South Wales enthusiasts, inasmuch as it is not an easy matter to design a receiver using this circuit, with standard components, to cover the large band of frequencies covered by the broadcasting stations. If the reception of 2FC and 6WF is not desired, then the design of a Reinartz receiver is simplified, but as most New South Wales listeners wish to hear 2FC, then the Weagant arrangement is the better of the two.

It may be as well here to add that of the three circuits the Improved Armstrong is undoubtedly the best, but this latter necessitates the placing of the inductance coils outside the cabinet in order to ob-

tain full and efficient control over regeneration. With the Weagant arrangement the coils can be readily mounted inside the cabinet, as regeneration is controlled from the panel by means of the variable condenser C3— (see diagram of circuit illustrated in Fig. 1).

In this particular design it is necessary to employ different coils for stations 2FC and 2BL, and to change over from one station to the other; the correct coils are plugged into their respective mountings. By means of switches it is quite possible to arrange the design so that the change over can be made instantly without withdrawing or replacing any of the honeycomb coils, but for the present it is not proposed to include this feature. Those who have had sufficient experience in building receivers will be able to arrange for its inclusion if desired, and for the benefit of others a description of the arrangement will be furnished in a future issue.

Selectivity is obtained by making use of inductive coupling between the aerial and grid circuits, an additional terminal being provided to allow for direct coupling when required.

The variable condensers, of which there are three, are each of .0005 mfd. capacity, and for preference C2 and C3 may be fitted with verniers, although when using large 4in. dials, as indicated, they are not essential, but are merely a refinement. The grid condenser is of .00025 mfd. capacity, and

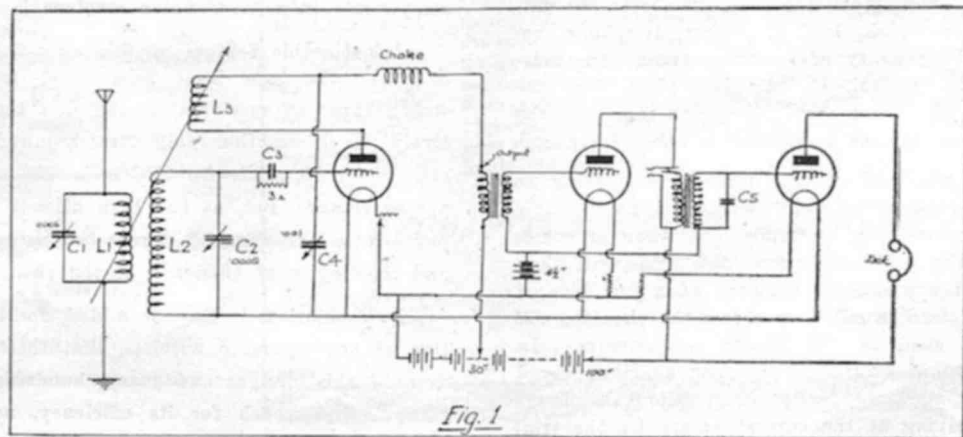

Philco Drynamic for less worry and better results.

the grid leak has a resistance of from 2 to 5 megohms as required by the valve.

Between the reaction coil and the phones or output terminals is placed a choke coil, which may be a 200 or 250 Honeycomb coil. It may be fixed in its position when wiring, but it is better to mount it on a standard plug and to provide a fixed plug screwed to the baseboard and wired into the circuit. By this means the wavelength range of the receiver is not limited in any way, and the choke coil being removable other coils can be used which are better suited to either shorter or longer wavelengths, say below 250 metres or above

which are guaranteed by the manufacturers to have the exact capacity and resistance as stated on the labels.

The variable condensers, coils, and rheostats are mounted on a panel 18in. x 8in. x 3/16in., the coil mountings, if of the detached type, being mounted together on a scrap of Bakelite, the assembly being screwed to the back of the panel as indicated in Fig. 2. All terminals are mounted on a scrap of Bakelite screwed in a vertical position to the back of the baseboard, and packed out a distance sufficient to allow it to project out through the back of the cabinet and flush with the outside surface.

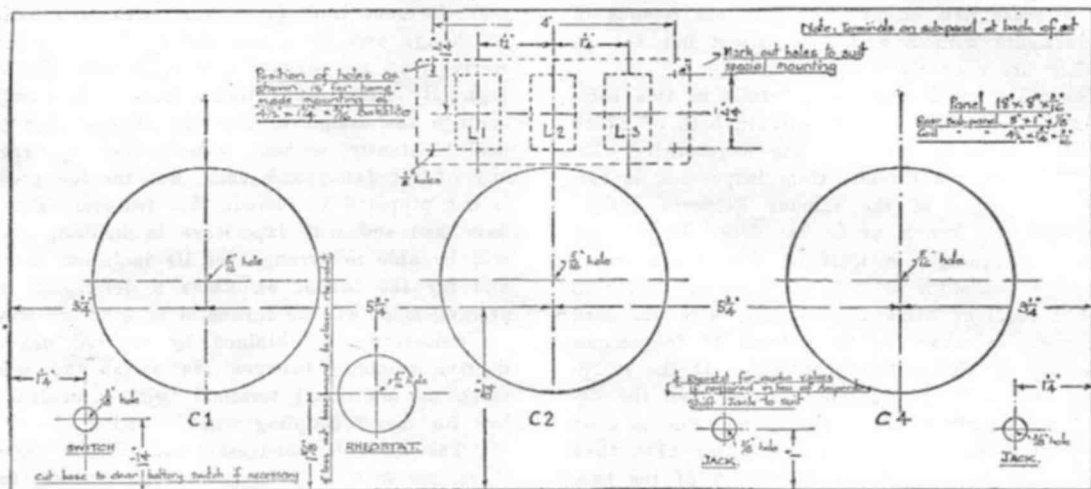

Figure 2.

1500 metres, for example. It will generally be found that the 200 turn coil will be suitable as a choke over this band of wavelengths, but it is dependent to a certain extent upon the capacity across the output terminals which lead to either telephone receivers or the primary of an audio frequency transformer. In general, it may be taken that the greater the capacity across the output terminals the greater should be the inductance of the choke coil.

Just a word of caution before commencing to detail the construction. It is noticed that people will spend pounds on materials, but when it comes to buying the grid condensers and grid leak they imagine that any old arrangement of a few bits of tinfoil, with lead pencil lines across the ebonite, will function as good as the proper components. In this they are in error, for the few shillings saved are not an adequate compensation for the hours spent in arriving at the correct values by the trial and rub-out method, and set builders are advised to pay a good price for grid leaks and grid condensers

This arrangement allows for the use of one, two or three valves as may be required, and in Fig. 3, which is a plan view of the set, the layout of the components in a three valve receiver is indicated.

A noticeable feature of this circuit, particularly to those who have been accustomed to the Armstrong types of receivers, is the fact that comparatively large reaction coils are required—for 2BL coils 50 or 75, while for 2FC coils 200 or 250 turns are necessary. But, as has been already stated, this depends on the capacity across the output terminals and the degree of efficiency of the choke coil.

In conclusion, it may be added, for the information of newcomers to wireless, that there is nothing new in this design, and many hundreds of "old-timers" can vouch for its efficiency, not only for broadcast reception, but also on the shorter amateur wavelengths below 100 metres.

The "New System" Phone is matched in tone.

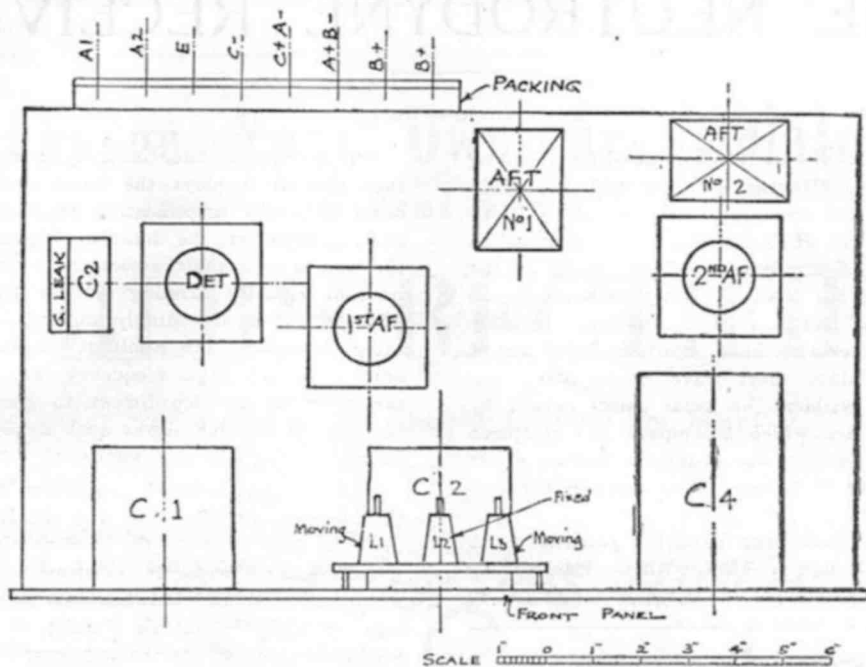

FIG 3

Inter-changeable Inductance Mounting

GET HIGH OR LOW WAVES WITHOUT CHANGING WIRING OF SET.

There are many interesting programmes broadcasted on the low wavelengths now. Numerous tests from all parts of the United States and foreign countries as far away as Australia are being made, and there are many great opportunities for real experimenting in this field. Most radio men are building

their sets so that they will receive both long and short waves. Some are using two sets of tuning units; others are tapping the regular units. We are showing by the illustrations what has proved to be best. Where you have two sets of tuners the set is naturally large and the panel has a number of controls. Tapping the present tuners is all right and the easiest method, but it is not efficient. Dead end losses are certain to be present, and tap contacts are always noisy.

The diagram shows the method of making an inter-changeable mounting for any type of tuner. With this you wind two tuners and use whichever you desire, by merely taking off the lugs from the binding posts and removing the coil. To hold the coil in place put a small screw through the strip on the bottom of the coil. The wiring can therefore be left the same for both.

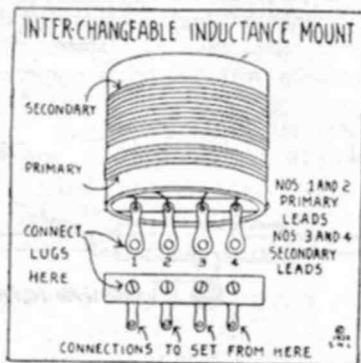

Telephone B 5925

CHARLES D. MACLURCAN
Consulting Radio Engineer

Pratten Building,
26 Jamieson Street,
SYDNEY

CALIBRATIONS

It's probably your "B" Battery. Get a Philco.

THE NEUTRODYNE RECEIVER

By "Wireless Weekly."

THE present conditions of broadcasting in Australia on wavelengths between 250 and 1250 metres do not encourage the use of the very efficient method of H.F. amplification, such as is employed in the Neutrodyne Receiver, owing to the fact that it will not tune efficiently to wavelengths higher than 600 metres. It is, however, greatly favoured by those who have built it, because it brings in the distant short wave broadcasting stations very well, without the usual noises caused by howling valves, etc., which accompany the reception of interstate stations in the provincial towns, where local broadcasting is taking place and regenerative sets are numerous.

Many people have been inquiring recently as to how they can bring in 3LO without interference from 2BL (and vice versa). These inquiries led to

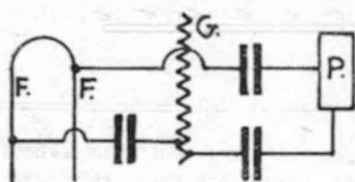

Fig. 1

extensive experimenting, with the result that we published the article "The Sure Fire Circuit for 3LO" ("W.W.," July 31). The hook-up employed was the two coil tuner circuit (both primary and secondary tuned), with regeneration and a stage of H.F. amplification, tuned plate method. This circuit undoubtedly does all that is claimed of it, but as with all regenerative receivers, whether H.F. is employed or not, the feeble carrier waves emitted by other regenerative receivers, which are also attempting to receive interstate stations, cause severe interference, inasmuch that practically every night reception from other States cannot be appreciated here in Sydney or in Melbourne.

We have experimented exhaustively with different types of loops, but still the nuisance is always evident, perhaps enough to spoil reception. With a properly balanced Neutrodyne no foreign noises whatever are heard; furthermore, if there are twenty people situated next door to one another, each and every one may tune-in the interstate stations without interfering with each other.

The secret of the Neutrodyne circuit lies in the fact that it employs the basic principle of tuned radio frequency amplification, together with complete neutralisation of the inherent capacity coupling of the valves and their associated circuits. While the internal capacity existing between the plate or grid and filament is exceedingly small under certain operating conditions, the resultant oscillation and regeneration in the high frequency amplifier valves is somewhat of an impediment to good reception, especially in crowded towns such as Sydney and Melbourne, where sets are somewhat numerous.

Fig. 1 illustrates the condition existing between the elements of the valve, and the lines representing the capacities between the various elements.

The small capacity existing between the filament and grid and between the plate and grid are, together with the outside circuits, responsible for the production of an oscillating current in the plate circuit. In the Neutrodyne circuit this valve capacity is neutralised by means of another very small capacity of equal value, so inserted in the circuit as to balance the capacity effect with the valve. The critical adjustment of the Neutrodyne depends upon this small variable condenser, sometimes termed a Neutrodon.

The Neutrodyne Receiver is covered by patent rights, which are strictly enforced. The radio frequency units, termed Neutroformers, are supplied in the complete kits, three of which are used; one as the tuner and the other two as air core radio frequency transformers. The correct position of the tap on the secondary winding is without a doubt the secret of the correct neutralisation, together with the small variable condensers which are also supplied for this purpose. These condensers consist of an insulating tube of high dielectric value, over which slides a metal tube, the latter performing a condenser capacity with two wires connected to two

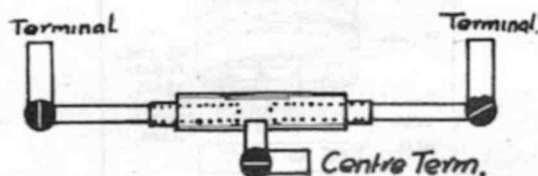

Fig. 2

Burgess—Power, Harmony,

Endurance—Burgess.

terminals and separated by about 3/16in. inside the insulating tube. The effect is equivalent to two condensers in series. Adjustment of the metal tube with relation to the wires permits a very minute control of low capacity value. Fig. 2 shows a top view of these condensers.

In order to comply with several requests received concerning the Neurodyne Receiver we are fully explaining the method of neutralisation. As stated previously, manufacturers of Neurodyne parts supply three neutroformers and two neutralising condensers. The oft-repeated advice to buy and use only the best applies particularly to equipment for this hook-up. If made by a reliable firm, the constructor can rest assured that these transformers have been previously tested and calibrated, thus ensuring that the two used as H.F. transformers will function at practically identical dial settings for any given wavelength.

The three Neuroformers should be mounted on

connections to these condensers it will be noticed that three terminals are provided, thus furnishing three different ranges of capacity in each condenser by changing the connections to the three terminals. The usual practice, however, is to make connections to the terminals at each end. However, when it is not possible to obtain correct neutralising in this way, one connection should be changed round to the centre terminal.

The writer has had extensive experience with Neurodynes, and has found the alteration of connections as described above very helpful, indeed.

The Best Method of Balancing Out.

Most of the complete Neurodyne kits on the market at the present time supply instructions, but the following method as used by the writer might prove instructive. There are two ways of exciting the coupled receiver circuits for the balancing out procedure. One is by the local or nearest broadcast station. The second method is by exciting the re-

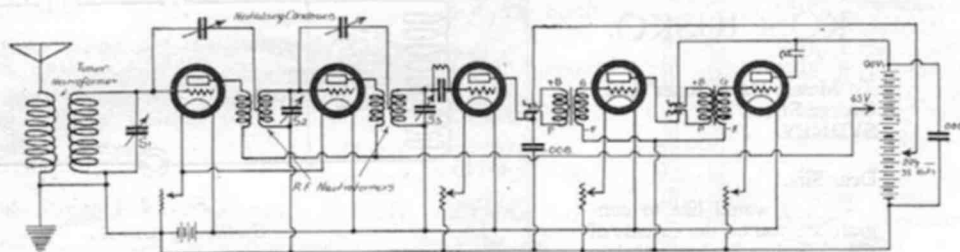

Fig. 3. Circuit Diagram, showing Centre Taps of Neuroformer.

the panel first. The drilled panel, if not supplied with the kit, should be such as to place the Neuroformers at a distance of six inches from centres. Accurate tests, and those used by the famous Fada One Sixty Neurodyne Receiver, have demonstrated that best results are obtained by placing each Neuroformer at an angle of 54.7 degrees. This angle prevents magnetic coupling or interaction between each one.

Most of these Neuroformers are supplied fitted with a bracket all ready for mounting, so that if care is taken not to alter the shape of the bracket correct angle of coils must follow.

In connecting up the Neuroformer coils care should be taken not to make any connection to the tap on the secondary winding of the first Neuroformer. All three are alike, but the leads from the secondary taps of the Neuroformers in the radio frequency stages only should be connected to one terminal of the corresponding neutralising condenser. The taps are shown clearly in Fig. 3. In making

connections to these condensers it will be noticed that three terminals are provided, thus furnishing three different ranges of capacity in each condenser by changing the connections to the three terminals. The usual practice, however, is to make connections to the terminals at each end. However, when it is not possible to obtain correct neutralising in this way, one connection should be changed round to the centre terminal.

receiver by an external oscillating circuit such as was described in a recent issue of "Radio." We will deal with the second method only, as this is probably the best for country readers.

Fig. 4 shows the oscillating circuit required. It is advisable to place the oscillator some distance away from the receiver, leading one wire to the aerial terminal. With the phone jack plugged in to the detector jack and the necessary rheostats turned on, make the buzzer switch. Next turn all three of the condenser dials about in step with each other, in order to pick up the buzzer signals. When the three condensers have been carefully adjusted to give the loudest buzzer signals it will be found that the two right-hand condensers show almost identical settings. The left-hand one may be a few degrees below; if so, it is advisable to carefully unscrew the set and advance the dial till it reads the same as the other two dials.

The next step in the balancing out programme consists in removing the first radio frequency valve

With "Philco" your set will go.



A REPORT from KOSCIUSKO

To Messrs David Jones' Ltd.
George Street,
SYDNEY.

Dear Sirs,

I would like to congratulate you on the success of the "Wireless Set" supplied by you to the Hotel Kosciusko.

Kosciusko, as is well known, is a difficult location for good wireless results. From what I have seen of your set however, the reception, the entire absence of foreign noise and the volume, are far beyond any expectations I may have had. The following Stations we brought in—5CL; 2FC; 3LO and 2BL. 4QC was also brought in by Mr. Cooke, but as I was not at Kosciusko at the time I cannot give my personal opinion about the reception.

Any results other than those stated will be communicated to you if thought of sufficient interest.

P. Speet, P.M.,
Manager,
Hotel Kosciusko.

DAVID JONES'

from its socket and readjusting the three dials carefully for maximum strength of buzzer signals again. A small piece of paper is next placed over one of the filament contact pins of the valve mentioned above, after which the valve is inserted again in its socket. In this connection the plate and grid of the valve will be connected in the circuit, but the valve will not light because the paper prevents proper contact. Caution should be taken here not to turn off the rheostat, because the balancing process should neutralise all capacity effects, including filament battery connections.

With the valve rendered inoperative as stated, faint signals will still be heard in the phones, due to the existing capacity coupling, which is now to be neutralised. It will be found that the signal strength of the buzzer is adjustable over quite a range by moving the metal tube of the first neutralising condenser. The correct adjustment, however,

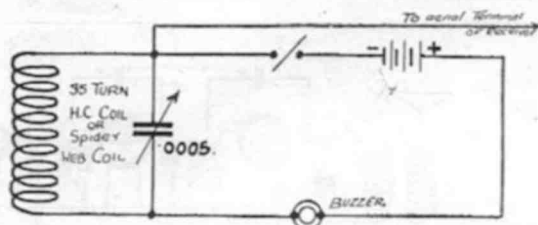

Fig. 4
Oscillating Circuit.

is for minimum or inaudible signals from the buzzer. To prove correct neutralising, removing this first valve from its socket again will permit loud reception, and replacing it with the paper still under the filament pin will cause the signals to disappear. The same procedure should now take place with the second valve and second neutralising condenser. This time, of course, the first valve is lit, and the paper is placed under the filament pin of the second valve.

Care should be taken when regulating either of the neutralising condensers that all three large variable condensers are adjusted for maximum signal strength before final neutralisation is effected.

In checking up the receiver on the broadcast reception by adjusting the dials controlling condensers S1, S2, and S3, the broadcast music or speech should be heard without any howling, whistling, or beat notes whatever. If these objectionable noises are heard, the circuit is not functioning in accordance with the Neutrodyne principle, and consequently you must readjust the neutralising condensers.

Radio for the Country

QUESTION OF RELAY STATIONS RIVALRY OF THE TOWNS.

Some of the larger cities and towns in New South Wales are preparing for an argument as to which will be the sites of radio relaying stations for relaying or re-broadcasting of matters broadcast from Sydney.

The State Government intends to establish its own station at Sydney almost immediately, and to dot the State with relay stations so that owners of small receiving sets will be within easy range of a station from which everything broadcast from Sydney will be repeated.

There are two methods of linking up a main station with relay stations. The first is by land line the same copper wire used for ordinary telegraphing. As the main transmitting station is operated, the matter is received practically instantaneously at the relay station and sent out again.

The other method is simply to send out the wireless waves, pick them up by means of a receiver and send them out again. The first is the more reliable, pending the perfecting of wireless transmission and reception.

Herein lies the Government's difficulty. No land lines are available, and it is announced that for a couple of years it will be impossible to provide extra land lines between (say) Sydney and Bathurst, Sydney and Tamworth, or Sydney and Goulburn.

But for this fact Farmer's broadcasting station (2FC) would already have had relay stations at three or more country centres.

It may be that the State Government will not wait for the provision of land lines, but will go straight ahead with its relay stations to which its programmes will be sent on specially short waves for rebroadcasting, while the main station is simultaneously sending out the same items on its ordinary wavelength.

This is highly probable, so that there will doubtless be much rivalry as to the locality of the relaying stations. Already advocates have put forward the claims of Dubbo, Orange, Bathurst, Goulburn, Wagga, Wollongong, Newcastle, Tamworth, Armidale, Glen Innes and Lismore as probable sites, and it may be expected that radio fans in and around these centres will keep the agitation alive until a settlement is reached. In the meanwhile an ordinarily good set can pick up Sydney and Melbourne.

BURGINPHONES

Australia's Best By Test

If you wish to build your own receiver the "Burginphone" "JUNIOR KITS" will interest you! Each Kit contains all the essential parts for the construction of an efficient receiver. Blue print diagrams and full instructions make the assembly of these kits an easy and pleasant matter, and the result is an efficient receiver built at home.

Prices on application to—

BURGIN ELECTRIC

Co. Ltd.

340 Kent Street, Sydney

Box 734 G.P.O.—Phone City 141. M3069

Your inspection of our Sets at
—our Radio Room is invited.—

Ever Ready Radio Batteries

are manufactured from the finest material obtainable. Owing to the exceptional demand for "EVER-READY" B. Batteries we have new and fresh stocks arriving from the factory almost daily, and all Batteries are tested on a special testing instrument before despatch.

Small Size:

W.P. 30 v. . . 9/6
W.P. 40 v. . 12/6
W.P. 60 v. . 18/-



Large Size:

X.P. 30 v. . 16/-
X.P. 40 v. . 21/-
X.P. 60 v. . 34/6

Illustration of W.P. 40 B. Battery

Each Ever-Ready Battery is supplied with winder plug.

No. 126, suitable for either A. B. or C. Batteries, Telephones, Burglar Alarms, Medical Coil, etc., with 3 Brass Terminals, Voltages 1.5-3 or 4.5 v.,
PRICE . . . 2/9 each



Illustration of No. 126 A. B. or C. Battery.

Complete Stocks of all types of Ever-Ready Torches and Batteries.

OUR MAIL ORDER DEPARTMENT, 60 Goulburn Street, is under supervision of a Mail Order Inspector, and all details necessary for an efficient Mail Order Service. We despatch within 24 hours.

Open Friday Nights until 9.30 p.m. Complete Parts for all circuits. Advice Gratis. Your own Set re wire

Wiles' Wonderful Wireless

BRANCH:
384 PITT STREET
(near Goulburn Street).

HEAD OFFICE AND SHOP:
56-60 GOULBURN STREET
(1 door from Pitt Street),
SYDNEY.

Add a distance THE " in Radi completely simply device i suring enclosed

Tapped self-tun condens required.

Free circuit you

Build sen Pho

Bring in that Distant Station

Add a stage of Radio Frequency Amplification to your Set and tune in the long distance stations.

THE "WONDERTONE" ALL WAVE TRANSFORMER is the latest development in Radio Frequency Amplification. Incorporates Studs and Tapping Switch completely wired in self-contained form ready for use, so that they can be fixed by simply mounting a one-hole bush in the panel and connecting. A dead ending device is incorporated, so that unused portions of the coil are short circuited, ensuring maximum efficiency over the whole band of wavelengths. Windings are enclosed in airtight cover, giving protection from dust and damage.

Tapped primary with self-tuned secondary. No condenser tuning required.



Wavelength: 150 to 2600 meters
40/- each

Free circuit for connections supplied with each order. Write us describing the circuit you are using, and we will mail you a drawing showing how to add a stage of "Wondertone" High Frequency to your Set.

SPECIAL ANNOUNCEMENT

Build your own Loose Coupler Crystal Set. Complete parts ready to assemble. Accessories include Aerial Wire and one pair of 4000 ohm. Head Phones £1/8/9

Full building instructions supplied with each order.

a Mail Order Expert, which ensures prompt despatch, careful attention to pack-
within 24 hours. May we have your order?

own Set re wired by Experts. Satisfaction guaranteed.

Established over 20 years

less & Electrical Stores

AND SHOP:
JRN STREET
Pitt Street),
NEY.

BRANCH:
23 PITT STREET
(near Circular Quay).

Three Circuit and Crystal Combined

TUBE MAY BE OUT FOR ECONOMY ON LOCAL STATIONS.

During the summer, when the range of one-tube sets is rather limited, a crystal set will give almost as good results as a tube set. There is no question also that a crystal set will deliver music of a tone hardly equalled by any tube set.

For those who have three-circuit regenerative sets with an aperiodic primary, the circuit shown illustrates the method of adding a crystal to the set so that it can be used as either a crystal or tube receiver at will. There are few wiring changes necessary, and anyone can make them in a few minutes' time. The efficiency of either circuit is in no way affected. To switch from tube set to crystal the switch is closed and the tube turned out. The setting of the variable condenser dial will be the same on the tube as on the crystal. To change back to the tube, merely throw the switch out and light the tube. Simple, isn't it?

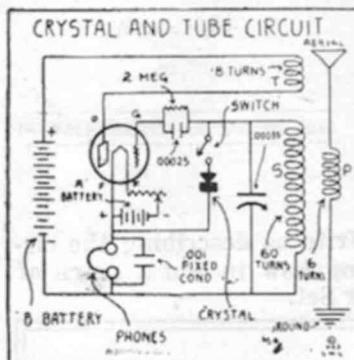

A big feature of this arrangement is the battery saving that it allows. When tuning for distance use the tube, and for local use the crystal.

Holder for Vacuum Tubes

PREVENTS DANGER OF BREAKING AND KEEPS THEM IN ORDER.

The most delicate instrument used in radio is the vacuum tube. This is far more delicate than the electric light bulb, not because it is built less sturdily, but because it consists of three distinct elements, while the electric light bulb has only one. In spite of this it is common practice among radio men as well as experimenters to treat the vacuum tube as if it were made of cast iron instead of glass. The best place to keep the tubes when not in use is wrapped in their original cartons. The packing pro-

TECTS the glass from breaking and absorbs accidental jars. This is not handy, though, and is a lot of bother. The illustration shows a handy arrangement.

The boxes and wrapping that came with the tube are kept. From these the top flaps are removed and the wrapping placed inside with a hole left just large enough for the tube. The corrugated wrappings placed back in box as they were originally provides

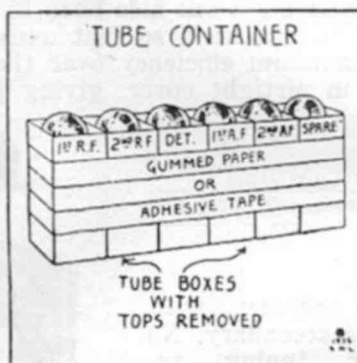

a close compartment for the tube. Place these boxes in a row and bind together with adhesive or gummed paper.

Each box is marked for its own particular tube. For instance, on a superheterodyne you should have, say, ten boxes, one for the first detector, oscillator, three intermediate frequency amplifiers, second detector, two audio amplifiers, and two spare tubes. In this manner you can keep your tubes in order, so that the best tube for a certain position can always be placed there.

WIRELESS BARGAINS

RADIO, ELECTRICAL DEALERS
AND EXPERIMENTERS—TAKE
NOTE!

Thousands of Accessories at remarkable prices.

Receiver Cabinets of exceptional workmanship, from . . . 12/6 each
Fixed wavelength Receivers, with cabinet, Easily altered for receiving all broadcasting stations £2

BASEMENT

Amalgamated Wireless A/sia, Ltd
97 Clarence Street, Sydney

AMATEUR TRANSMITTERS !

It may interest you to know that the "RADIO DEPARTMENT" of Mick Simmons Ltd., is one of the largest and most comprehensive in Sydney. Further, the fact that we buy in such large quantities enables us to sell every article at the lowest possible price. Amateur Transmitters, you will be interested in the component parts listed below.

3/16in. Sheet Bakelite	6/- lb.
Kenotron Rectifier Valves, UV 216, 5 watts	47/6 each
Phillip's Type G Transmitting Valve, 20 watts	75/- "
Faradon Condensers 1 MFD—1750 volts D.C., Model UC490	18/6 "
Magnetic Modulator, R.C.A., Model, 5-1.5 amps	£3/4/- "
Radio Frequency Choke Coils, UL1655	26/6 "
Oscillation Transformers, UL1008	£4/5/6 "
Microphone Transformers, UP414	50/6 "
Red Seal Headsets, for DX work and comfort	40/- pair

Write or Call for our Specially Illustrated Catalogue

:: Terms arranged if required on Radio Sets ::

We invite you when next passing to call in and inspect this Department and talk over your Radio troubles with our chief wireless man. He may perhaps be able to help you.

Mick Simmons Ltd.

THE WORLD'S GREATEST SPORTS STORE

Headquarters: HAYMARKET, SYDNEY

Q.S.L.

The meaning of the three letters QSL is: "Please give me a receipt" — or, in other words—"Send me an acknowledgement."

There isn't a transmitter on the air now who is not glad to get a report on his signals, whether they are phone or C.W.

You can put everything you want to say on a Publicity Press QSL card. It takes only a minute to fill in and conveys all the information the transmitter wants.

Over the last few months we have printed thousands of these cards for both transmitters and receivers, among them 2UW, 2CX, 2BF, 2LM, 2WW, 4CK, etc.

There is a QSL card for every purpose and they may be had either from stock or to suit individual tastes.

Write, phone or call.

Publicity Press Ltd.

Printers and
Publishers -

12-16 Regent Street
SYDNEY

Phones Red. 964 & 930.

What they Write

The Wireless Weekly Service Car

(To the Editor)

Dear Sir,—Having seen in "The Herald" a notice that Mr. Slade, of your paper, would be passing through Shell Harbour I kept a look out for him, and was lucky enough to catch him.

I asked him to have a look at a wireless set belonging to my nephew, in which the condenser was not working. I already had the machine overhauled by wireless experts in Kiama and Wollongong, both of whom declared it was O.K.

As soon as Mr. Slade saw it he said it was impossible for the condenser to work, as the machine was wired up wrongly. He very kindly cut away a lot of useless wire, and wired it up in an entirely different manner and now the set works splendidly. He left some Wireless Weeklies with me, which I have distributed with those I knew had sets. You can put me down as a subscriber, and send me one weekly. Yours etc.,

E. S. ROWE.

Shell Harbour.

MORE ABOUT GLASS PANELS.

(To the Editor)

Dear Sir,—As a reader of Wireless Weekly and appreciating the tips it contains from time to time, I was thinking perhaps it may be of interest to others to know per your magazine, how to drill glass to build a set with glass for a panel. I have just successfully drilled ten 3/8in. holes in a 1/4 in. piece of glass. I find that if the glass is placed on the table of a drilling machine, and a bit composed of copper tubing to whatever size required is used in conjunction with coarse grade emery powder, kept well thinned with fine oil, by lifting the drill the whole time and bringing it down with a little pressure each time, it will soon find its way through the glass. I drilled the holes almost through, and finished from the other side, otherwise as the drill goes through it breaks the glass around the hole. With a breast drill the job is next to impossible, but with a power drill, with a little patience, it is not too bad. I drilled ten holes in just three hours. Hoping this may be perhaps of interest to fellow readers of your magazine. Yours etc.,

GEO. H. PETERSEN.

Victoria Street, Parkes.

Victorian Notes

Experimenting and Recording.

Probably the biggest shortcomings in what is popularly regarded as experimenting by wireless and amateurs lies in the lack of systematic recording and publishing of the results observed, and of how those results were arrived at. From time to time we read incidentally in some amateur or other paper that interesting tests have been made, and valuable information gained by some amateur or body of amateurs, but science has learned to regard with suspicion all so-called facts that rest on the mere ipse dixit of any person, however prominent he may be in his club or profession. He may have arrived at definite conclusions all right, but one wants to know how he got there. It is now quite a long while, for example, since the Victorian Division set out to collaborate with the Meteorological Bureau in a series of tests to investigate fading, but although the Institute has an official organ of its very own, there can be found there, nothing so dreadingly scientific as information as to what was done and what concluded from those



Miss LEE WHITE and CLAY SMITH
Popular artists appearing at 310, Melbourne

Philco Dynamic for less worry and better results.

Charge Your Own Accumulator
at Home with a
PHILIPS' RECTIFIER

at a cost of less than 1 farthing per hour

SEVEN REASONS WHY IT
WILL PAY YOU TO USE A
PHILIPS' RECTIFIER

1. AUTOMATIC IN ACTION
NEEDS NO ATTENTION.
2. COMPACT, CLEAN, AND
SILENT IN OPERATION.
3. CANNOT OVERCHARGE
OR SHORT - CIRCUIT
BATTERY.
4. HAS NO MOVING PARTS
AND NO CONTACTS TO
BE RENEWED.
5. FULLY CHARGES A
STANDARD 6 VOLT 22
a.h. "A" BATTERY FOR
LESS THAN 2d.
6. WILL CHARGE ANY "A"
BATTERY FOR A
SINGLE CELL UP TO
SIX VOLT ACCUMU-
LATORS.
7. CAN BE SWITCHED ON
AT NIGHT, AND BAT-
TERY IS RECHARGED
READY FOR USE NEXT
MORNING.

*Charges while
you sleep*

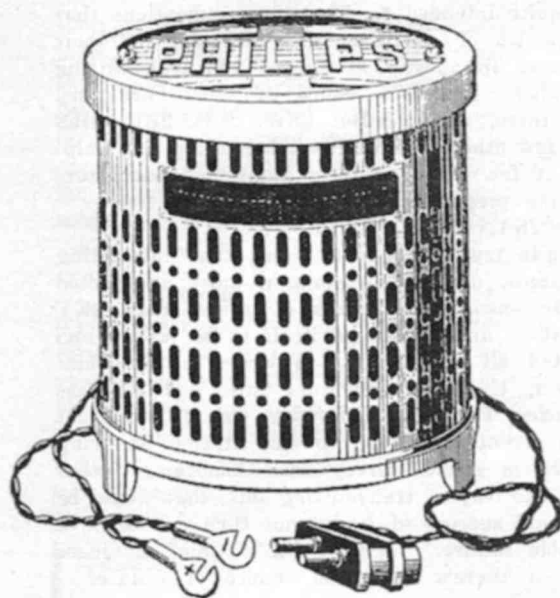

OBTAINABLE FROM ALL RADIO DEALERS AND GARAGES

tests. Meanwhile the world languishes although we are asked to rest assured that much valuable data was gained. In all probability all that was gained was the pleasure of week-end trips into the country and the spiritual uplift of collaborating with a Government Bureau.

It is true that we have been told that North of Melbourne an aerial was rigged up roughly in some scrub by the wayside and indications of fading were noted. That's all. They tell us, too, that around Warburton and by the Gippsland Lakes, not forgetting also Hamilton, that some stations come in more strongly than others, and take it in turns to reverse their strength according as it is daylight or dark. But any local listener-in knows just exactly that much. The proposal of the Brighton Club to compile an audibility map of Victoria is indeed a step far in advance of anything hitherto attempted, and even if it produces as a first attempt such a map of only twenty miles round Melbourne it will have done something well worth doing that has not hitherto been done.

Reports on Amateur Music.

As was expected, not many letters were received to the suggestion that listeners-in willing to send along systematic reports an amateur transmissions of music should send their names along to the Victorian representative of Wireless Weekly. But a few did write and probably a few more quite intended to. There are indications that quite a lot of amateurs are returning to their first love, up above 100 metres and transmitting gramophone records. Some of them are very nice; others, nasty. But 3SW, 3CR, 3BU, 3HB and a few others are well worth hearing and helping. A few notes on these amateur broadcasters are being prepared for an early issue.

Station 2KY.

While trying out one night, that interesting 5BQ circuit of Mr. Kauper's, a most unexpected pleasure ensued. No less a station than 2KY came along and announced itself to be testing and requested all and sundry to write to the Chief Engineer, United Distributors Ltd., c/o Wireless Committee, Trades Hall, Sydney. One of our great papers recently referred to this station as being installed in great secrecy with something rather new in the way of transmitting sets, that would be a splendid success of it did not turn out to be a miserable failure. With U.D.L.'s Chief Engineer behind it there's not much chance of failure.

The Mandarin Coat.

The Repertory Theatre is a distinct "find" for 3LO. The kind of plays it stages are just of the right type for broadcasting purposes. That truly brilliant little play, "The Mandarin Coat," could hardly have been bettered either in itself or in its

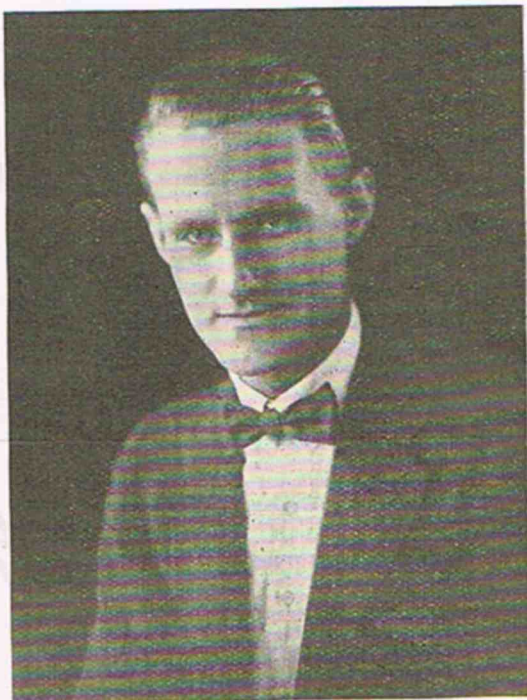

Mr. J. CASTLE HARRIS
Frequently heard at 3LO, Melbourne

players, or in its broadcasting. The dialogue was natural and carried the story along with it, and truth to tell, one was indebted also to the listener-in for its useful little resume of the plot. Miss Isabel Handley is not only to be complimented on the delicate morsel of stagecraft she has served up to us, but also to be looked to with confidence, to produce even better things. The ability to write such atmosphere - creating dialogue should carry her far.

The Perfect Broadcast Receiver.

The natty little receiver described by Mr. Grove in "Radio" recently as perfect for reception within 20 miles of a broadcasting station is well worth serious attention. It is curious to note how the crystal is coupled direct to the grid of the first valve. In that position it appears to act almost as if it were a combined grid condenser and grid leak. At any rate, it does tend to stop undesirable oscillations. One night recently it surprised Mr. Grove by handing out selections from 5CL after 3LO had closed down, as if in mild protest against its constructor's opinion that it was good only for 20 miles. Mr. Grove was much struck with the way 5CL simply slid into tune without preliminary oscillations. That is the beauty of

"What is a Double Seven?"

"The world's best value."

Before you
Expend
Money on
Radio
Equipment
Consult
Anthony
Horderns'
Wireless
Experts.

Your inspection of the big display of everything that is new in the world of Wireless, is invited.

(Wireless -- Second Floor)

Anthony Hordern & Sons
Limited,

Brickfield Hill, Sydney

Phone City 94

Box 2711 G.P.O.

SET THE **WE** STANDARD

150 American stations logged by Tasmanian amateur using Weco valves

EXTRACT from a letter dated April 21, 1925, sent to Western Electric Coy. Ltd., London, by Mr. W. A. Smith, 37 Cascade Road, Hobart.

"I am writing to you for the purpose of bringing before your notice some very interesting experiences I have had with a couple of your Weco valves (white spots).

I purchased these two little valves about six months ago to build a portable low loss receiver. This consisted of detector and one-step audio frequency amplification, and I received all Australian and New Zealand experimenters working below 100 metres at loud speaker strength on a small loud speaker. Also, with phones, about 150 American Amateur Stations have been logged (between 70 and 90 metres).

American Broadcasting Station K.D.K.A. 63 metres quite a fair strength on small speaker. This set has been worked under all conditions. On the top of Mt. Wellington, 1466 ft. above sea level, these valves gave us some very fine results, Australian and American stations being received again, three pairs of phones being used. While on the mountain a heavy fog or mist came over and not having any cover for ourselves or the set, we decided to continue experiments and note the effect moisture had on signal strength, the set, etc. Well, signal strength dropped considerably, but the valves oscillated freely while the induction coils were quite wet. I think, sir, this is quite a severe test and speaks highly for the Weco.

Another test is that of robustness and after trying hard I am satisfied that these little tubes are very nigh unbreakable. On one occasion I placed them in my coat pocket and a little later forgetting they were in my coat took the coat out and shook it well. Remembering valves were in the pocket I at once tested them and found them to be quite undamaged.

On another occasion a friend of mine was helping me test some transmitting circuits and chokes and in rushing along the test bench to reach the ammeter knocked the set containing these doomed valves on to the floor, a drop of 3 ft. 6 ins. Well a few remarks passed between us and my friend offered to stand the expense. 'Anyway,' I said 'we'll test them in case one is alright.' 'Not worth your while,' replied my friend. However, I tested them and found them both to be O.K. to my great surprise, and I think this wonderful for valves and it speaks well for the makers."

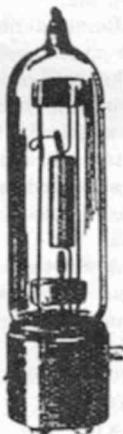

REDUCED
PRICE

WECOVALVES
are now available
from regular radio
dealers, at

17/6

Western Electric Company
(Australia) L. I.

192-4 Castlereagh Street, SYDNEY. Phone: City 336 and 356.
And 588 Bourke St., MELBOURNE. Phone: Cent. 8336 and 8949.

R261

WE

a well-made set. It always has some pleasant surprise to spring on its maker.

Presumably, 2FC will sooner or later find its ways to the crystal threshold of that set, and without any preliminary janglings of the bell or knockings at the door or scraping of boots on the mat, will just lift up the latch and walk in. It will be very welcome, but not altogether unexpected. **Selectivity.**

It is well known that the Controller of Wireless is a great stickler for selective receivers. In his opinion most of the complaints about interference and inability to sort out one station from another is due to broadness of tuning, not in the broadcasting station but at the receiving end. A circuit recently made round some of the city wireless dealers with a view to discovering the best that could be thought and said on this subject, not in their engineers' sanctums, but across

their counters, revealed the interesting fact that 3LO is uniformly blamed for being excessively broad. It was asserted that any set that could be made selective enough to tune in 2BL, 5CL and other desirable distant stations while 3LO was working would be too sensitive and delicate in adjustment for the ordinary listener-in to be bothered with.

Be this as it may, one has only to experiment a little at home with a home-made basket and single-layer coils to find that quite a lot of 3LO's alleged breadth of tuning is about as big a bogey as Bolshevism, and if one is content with a tuning condenser of no more than 23 plates and learns the function of rheostat control he will not only get other stations but also better results from 3LO and 3AR also. Even the small untuned stationary aerial coil alongside the usual 2 coil tuner is a revelation in selectivity.

Notes from Queensland

Temporary 4QG.

Although the Queensland Radio Service Station—4QG—is only temporary, much can be said about the excellence of that station's programmes.

The programmes given by 4QG do not run far short of those transmitted by the high powered southern stations. The musical talent of the northern city has been sifted and only high-class talented artists are engaged by the management of 4QG.

The station also uses many land lines, one being from the Tivoli Theatre, and others which are used temporarily on churches, halls and band stands.

It may also be noted that station 4QG was the first station in Australia to broadcast a Roman Catholic church service.

Amateur Notes.

Since the commencement of broadcasting in Queensland, most of the amateurs who used to transmit on the broadcasting bands, now work on low wave.

One well known amateur transmitter, who is known all over Australia, is 4CM; he is doing excellent work on 35 metres—his latest two way communication is with 6CTO (Hollywood, Cal.). In the above test the input power was 50 watts, and wave length 36 metres.

A young Queenslander who has met with success on the low wave is 4RB, who tuned no less than 143 Australian and Tasmanian stations, 49 New Zealanders and 319 Yanks, to say nothing about the other countries of the world, most of which were logged on a three valve low loss set.

Although the Inland Mission station, 8AC, has not been heard in Southern Queensland, many amateurs here are trying to get in touch with it—

4HR (Barcaldine) reports having heard him lately.

Reception.

Being a nightly listener to most of the Interstate stations, one must admit that the strength of the transmission from 2BL is far superior to any of the other stations. It is rather hard to say which is the louder, 5CL or 3LO; the programmes broadcasted by 5CL are not quite up to the standard of 3LO, but as the station is only quite an infant, much is expected from 5CL in Australia.

A South Australian "B" class station to which is due much praise is 5 Don N and Mr. and Mrs. Hume must be thanked for their worthy effort in establishing a broadcasting station at their own expense, and entertaining the people of Australia so well.

Although quite a difference has been noticed since the change, 3AR is not of the strength it should be for the power; 5CL overpowering the strength of its transmissions easily.

2FC has lost most of its old popularity since the influx of the "A" class stations on the lower wave, many sets here being unable to tune the station.

The New South Wales "B" class stations, 2BE, and 2UE, are heard here very well, but in the case of 2BE a generator hum is heard during their transmission.

Many listeners here complain that the local station has too wide a tuning and that this affects their getting the Interstate programmes—this is really not the station's fault, but the listeners' who complain, are in possession of unselective sets, such as the P1 circuit. The standard three coil regenerative circuit I find to be quite selective for my purpose.

Broadcasting

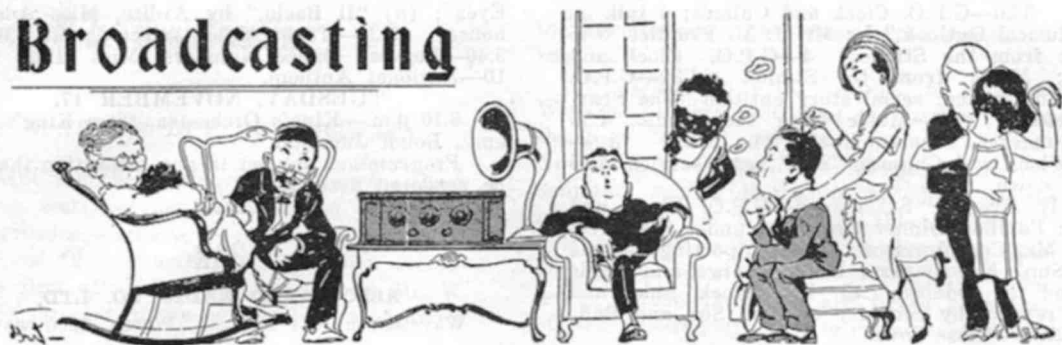

2BL

BROADCASTERS (SYDNEY) LTD. SERVICE.

Call Sign, 2BL. Wavelength, 353 Metres.

FRIDAY, NOVEMBER 13.

Afternoon Session: 3 — G.P.O. Clock and Chimes; Weather and Commercial Reports and Social Notes from "The Sun." 3.15—Music from the Studio. 3.30—G.P.O. Clock and Chimes; a talk on "Modern Psychology," by Mr. J. M. Prentice. 3.45—Music from the Studio. 4—G.P.O. Clock and Chimes; Music from the Studio. 4.30 — G.P.O. Clock and Chimes; Serial Story entitled "The Scarlet Circle." 4.45—Music from the Studio. 4.55—Late market reports from "The Sun." 5 — G.P.O. Clock and Chimes; "Sun" news service. 5.15—Close down.

Early Evening Session: 6—G.P.O. Clock and Chimes; Pavilion Dinner Orchestra, under the direction of Mr. Cec Morrison. 6.30—Sporting resume from "Sun" Newspapers; the pupils of Miss Monica Scully will entertain the kiddies. 7.45—Late stock, hides and market reports by courtesy of Pitt, Son and Badgery. 7.50—Close down.

Evening Session: Popular programmes from the Studio including Celebrity Trio, in harmony numbers; Richard McClelland, basso cantante; Round the World Travelogue by Mr. J. M. Prentice. At 9 p.m.—Mr. Morgan will speak on "Motoring."

SATURDAY, NOVEMBER 14

Afternoon Session: 2 — G.P.O. Clock and Chimes; Special sporting news; Music from the Studio. 5.15—G.P.O. Clock and Chimes. Close down.

Early Evening Session: 6—G.P.O. Clock and Chimes; Pavilion Dinner Orchestra, under the direction of Mr. Cec Morrison. 6.30—Sporting resume from "Sun" Newspapers; Uncle George and the kiddies. 7.50—Close down.

Evening Session: Hoyt's Imperial Orchestra, under the direction of Mr. Lionel Hart; Hilda Boyle, soprano; Brass Quartet; Ward Lear, comedian. Dance music until midnight broadcast from Manly by the Dungowan Modern Dance Band, under the direction of Mr. C. J. Little. During the evening Mr. W. Fitzpatrick will speak on "Life at Sea," and Brin-ga about the "Aborigines."

SUNDAY, NOVEMBER 15.

11 a.m.—Service broadcast from Baptist Church, Petersham. 3.30—Concert from the Studio. 7.15—Service broadcast from Church of Christ, Enmore.

8.30—From the studio: Marjorie Skill, soprano; Maisie Barnett, contralto; Broadcasters' Trio.

MONDAY, NOVEMBER 16.

Afternoon Session: 3 — G.P.O. Clock and Chimes; weather and commercial reports and social notes from "The Sun." 3.15—David Jones' Tea Room Trio. 3.30—G.P.O. Clock and Chimes; a talk on "A Course in English Literature," by Mr. J. M. Prentice. 3.45—Music from the Studio. 4 —G.P.O. Clock and Chimes; David Jones' Tea Room Trio. 4.30—G.P.O. Clock and Chimes; serial story entitled "The Scarlet Circle." 4.45—Music from the Studio. 4.55—Late market reports from "The Sun." 5—G.P.O. Clock and Chimes; "Sun" news service. 5.15—Close down.

Early Evening Session: 6—G.P.O. Clock and Chimes; Pavilion Dinner Orchestra, under the direction of Mr. Cec Morrison. 6.30—Sporting resume from "Sun" Newspapers; Uncle Jack and the kiddies. 7.45—Late stock, hides and market reports by courtesy of Pitt, Son and Badgery. 7.50—Close down.

Evening Session: Popular programme from the Studio, featuring Florence Yates, contralto; Stanley Catlett, tenor; Dorne and Montfort, musical comedy duo. During the evening, Mr. Crabbe will speak, and Mr. C. H. Bertie, City Librarian, will deliver a lecture.

TUESDAY, NOVEMBER 17

Afternoon Session: 3 — G.P.O. Clock and Chimes; weather and commercial reports and social notes from "The Sun." 3.15—Music from the Studio. 3.30—G.P.O. Clock and chimes; special Operatic Session. 4—G.P.O. Clock and Chimes; Music from the Studio. 4.30—G.P.O. Clock and Chimes; serial story entitled "The Scarlet Circle." 4.45—Music from the Studio. 4.55—Late market reports from "The Sun." 5—G.P.O. Clock and Chimes; "Sun" news service. 5.15—Close down.

Early Evening Session: 6—G.P.O. Clock and Chimes; Pavilion Dinner Orchestra, under the direction of Mr. Cec Morrison. 6.30—Sporting resume from "Sun" Newspapers; Uncle George and the kiddies. 7.45—Late stock, hides and market reports by courtesy of Pitt, Son and Badgery. 7.50—Close down.

Evening Session: Miscellaneous programme from the Studio, featuring Pauline Hartford-Foster, soprano, and other well known artists.

WEDNESDAY, NOVEMBER 18

Afternoon Session: 3 — G.P.O. Clock and Chimes; Weather and commercial reports and social notes from "The Sun." 3.15—Music from the

Burgess Radio Batteries.

Studio. 3.30—G.P.O. Clock and Chimes; a talk on "The Musical Outlook," by Mr. J. M. Prentice. 3.45—Music from the Studio. 4—G.P.O. Clock and Chimes; Music from the Studio. 4.30—G.P.O. Clock and Chimes; serial story entitled "The Scarlet Circle." 4.45—Music from the Studio. 4.55—Late market reports from "The Sun." 5—G.P.O. Clock and Chimes; "Sun" news service. 5.15—Close down.

Early Evening Session: 6—G.P.O. Clock and Chimes; Pavilion Dinner Orchestra under the direction of Mr. Cec Morrison. 6.30—Sporting resume from "Sun" Newspapers; Uncle George and Uncle Jack and the kiddies. 7.45—Late stock, hides and market reports by courtesy of Pitt, Son and Badgery. 7.50—Close down.

Evening Session: Popular programme from the studio featuring Leonore Gotsch, coloratura soprano; C. Bignall, cornetist; also other well-known artists and lecturers.

THURSDAY, NOVEMBER 19.

Afternoon Session: 3—G.P.O. Clock and Chimes; weather and commercial reports and social notes from "The Sun." 3.15—David Jones' Tea Room Trio. 3.30—G.P.O. Clock and Chimes; a talk on "The Musical Outlook," by Mr. J. M. Prentice. 3.45—Music from the Studio. 4—G.P.O. Clock and Chimes; David Jones' Tea Room Trio. 4.30—G.P.O. Clock and Chimes; serial story entitled "The Scarlet Circle." 4.45—Music from the Studio. 4.55—Late market reports from "The Sun." 5—G.P.O. Clock and Chimes; "Sun" news service. 5.15—Close down.

Early Evening Session: 6—G.P.O. Clock and Chimes; Pavilion Dinner Orchestra, under the direction of Mr. Cec Morrison. 6.30—Sporting resume from "Sun" Newspapers; Uncle Jack and the kiddies. 7.45—Late stock, hides and market reports by courtesy of Pitt, Son and badgery. 7.50—Close down.

Evening Session: Miscellaneous programme from the studio featuring Ray Beatty and Millie Hughes in solos and duet. During the evening interesting talks will be given by well-known lecturers.

2UW—Otto Sandel

BELLEVUE HILL

WAVELENGTH — 267 METRES

Programme for Sunday, November 15th

7 to 7.30 p.m.—Bedtime stories. 7.30 to 8—King's Academy, Bondi Junction: Pianoforte Solo, Papillon Etude de Concert Op. 18, by C. Lavallee, Miss Ada Althouse. 8.5—Contralto Solo, "The Blind Ploughman"; "Five Little Piccannies," Miss Dorothy Allen. 8.20—Tenor Solo: "La Donne Mobile," Mr. Manuel. 8.25—Duet: Soprano and Contralto: "Carmena," Misses Althouse and Allen. 8.30—Piano Solos (a) "Waltz in C Sharp"; (b) "The Minuet Waltz," Miss Ada Althouse. 8.40—Tenor Solos, selected operatic numbers, Mr. Manuel. 8.50—Soprano Solos: (a) "Lullaby," by Cyril Scott; (b) "Sing, Sweet Bird." 9—Interval. 9.5—Popular pianoforte numbers: Miss Hilda Grace. 9.15—Soprano Solos: (a) "The Night has a Thousand

Eyes"; (b) "Il Bacio," by Ardite, Miss Ada Althouse. 9.30—Tenor Solo, selected, Mr. Manuel. 9.40—Popular Dance Numbers, Miss Hilda Grace. 10—National Anthem.

TUESDAY, NOVEMBER 17.

8.10 p.m.—King's Orchestra, from King's Academy, Bondi Junction.

Programmes subject to any alteration that may be rendered necessary.

3AR

ASSOCIATED RADIO CO. LTD.

Wavelength, 484 metres. Power, 1600 watts.

OFFICIAL PROGRAMMES.

SATURDAY, NOVEMBER 14

12 noon—Time signal, market and weather reports, "Age" news, musical items. 1—Close down. 1.30—Result of Hurdle Race. 2.30—Result of Stanmore Two-year-old. 3.5—Result of Armadale Cup. 3.30—Musical items from the Studio. 3.40—Taro Steeple. 4.15—Result of Ormond Stakes. 4.30—Result of Roostown Plate. 5—Close down. 6.15—The Georgian Cafe Orchestra. 7.15—The Children's Corner, by Uncle Peter. 8—Time Signal. 3.15—Dance Night, the Rhythmic Dance Orchestra, under the direction of Mr. George Lewis, relayed from the Maison De Luxe, Broadway, St. Kilda. 9.25—Week end travellers' information: railway information supplied by the Victorian Railways' Department; tramway information supplied by the Tramways' Board; road information supplied by the Royal Automobile Club. During the evening at the following times, the results of the Federal Elections will be given from the studio of 3AR: 9.30, 10, 10.30, 11, 11.30, 12, 12.30 1.15 a.m., 1.45, 2.15. During the intervals dance music will be relayed from the Maison De Luxe, Broadway, St. Kilda.

SUNDAY, NOVEMBER 15

11 a.m.—Service from Independent Church, Collins Street. 3 p.m.—The People's Sunday Hour, from St. Mark's Church, Fitzroy. Service conducted by the Rev. R. G. Nicholls. 7 p.m.—Service from The Independent Church, Collins Street. 8.30—Mr. A. N. Bishop (F.A.I.S.) will talk on "The Voice from the Ballot Box," Progress results of the Federal Elections. 9.30—Mr. M. J. Bloomfield will talk on "The Religion, Philosophy, and Science of Spiritualism." Further results of Federal Elections will be continued until midnight.

MONDAY, NOVEMBER 16

12 noon—Time signal; market and weather reports, "Age" news, musical items. 1—Georgian Cafe Orchestra. 2—Close down. 3.30—Musical items from the studio. Graphic social talk; racing results as received. Richmond Ponies. 5—Close down. 6.15—The Georgian Cafe Orchestra. 7.15—The Children's Corner, by Uncle Peter. 7.30—The Boy Scouts' Bulletin. 8—Time Signal. 8.1—Ex-Sub Inspector D. G. O'Donnell, late C.I.D., will talk on "Crooks I have Handled." 8.28—Mr. Lyle Clegg (bass): (a) "The Company Sergeant Major"; (b) "Kashmiri Song," Amy Woodforde-Finden. 8.35—Mr. Sydney Henry, in his own original sketches: (a) Politics from Geebung; (b)

Burgess—Ask Any Radio Engineer.

Mrs. Hannigan on things in general. 8.45—Miss Phyllis Shattock (solo pianiste): (a) Study in C Sharp Minor (Chopin); (b) Spinning Song (Mendelssohn). 8.52—Mrs. Henry Johnson (contralto): (a) Out on the Rocks; (b) O Western Wind (Brahe). 8.59—Mr. Austin D. Peters in numbers recently done by Milton Mayes, including The Meanderings of Monty. 9.14—Miss Flora Beckett (soprano): (a) "Pleading" (Elgar); (b) "A May Morning" (Denza). 9.21—Miss Constance Evans (mezzo): (a) "Serenade" (Gounod); (b) "The Carnival" (Molloy). 9.28—Mr. Edward Stock (humorist): (a) "Memories"; (b) "The Country Magistrate." 9.38—Miss Phyllis Shattock (pianiste): (a) Prelude in C Sharp Minor (Rachmaninoff); (b) Fairy Scherzo (Mendelssohn). 9.45—Mrs. Henry Johnson (contralto): (a) "O Dry Those Tears"; (b) "My Prayer" (Squire). 9.52—Miss Flora Beckett (soprano): "Vilanelle" (del 'aqua). 9.56—Mr. Austin D. Peters in selected items. 10.—Time Signal; "Age" news, exclusive to 3AR. 10.15—The Georgian Cafe Orchestra. 11—National Anthem and close down.

TUESDAY, NOVEMBER 17.

12 noon—Time Signal, market and weather reports, "Age" news service, musical items. 1—Georgian Cafe Orchestra. 2—Close down. 3.30—"Bon Ton" of the Mutual Store Ltd., will give a Fashion Talk. 4—Musical items from the Studio. 5—Close down. 6.15—The Georgian Cafe Orchestra. 7.15—The Children's Corner, by Uncle Peter. 8—Time Signal; Dr. Northey Du Maurier will lecture, "Health Talk" (Household Pests), second series. 9.15—Miss Marchesi Leonard, L.A.B.: (a) "Humoreque" (York Bowen); (b) "Sequedellan" (Albenez), pianiste. 8.22—Mr. Kenneth Sutherland (baritone): (a) "The Lute Player" (Allitsen), (b) "Up from Somerset" (Sanderson). 8.29—Mr. Wilfred Kane (tenor): (a) "The Gelida Manina" (La Boheme), Puccini; (b) "Now Sleeps the Crimson Petal" (Quilter). 8.36—Miss Marjory Derum (elocutioniste): (a) Good-bye at the Train; (b) Mother's Darling. 8.43—Miss Myrtle Blight (violiniste): (a) The Swan (Saint Saens); (b) Orientale (Cui). 8.50—Miss Isobel Harris (lyric soprano): (a) Good-bye (Tosti); (b) In the Garden of my Heart (Ball). 9—Mr. Herschell, managing director of Herschell's Pty., Ltd., will speak on "How Movies are Made." 9.15—Miss Margaret From (contralto): (a) My Ships (Narrett); (b) Salaam (Lang). 9.22—The Brighton Glee Party: Conductor, Mr. Gerald Whitton; Pianiste, Madame Whitton; Misses Kathleen Treaty (soprano), Kathleen McCarthy (contralto), Messrs. Basil Albury (tenor), Gordon Robertson (baritone): (a) Old Mother Hubbard; (b) Hey Diddle Diddle (Wheeler). 9.29—Miss Myrtle Boight (violiniste): (a) Serenade (Pierve); (b) Andantino (Lenare). 9.36—Miss Margery Derum (elocutioniste): (a) Greetings Old and New; (b) Mother's Maxime. 9.43—Mr. Wilfred Kane (tenor): (a) The Blind Ploughman (Clarke), (b) Thy Beaming Eyes (McDowell). 9.50—Miss Marchesi Leonard (pianiste): (a) Concert study in D Flat (Lizt); (b) Black Note Study (Chopin); Accompanist, Miss Marchesi Leonard. 10—Time Signal; "Age" news service, exclusive to 3AR. 10.15—Georgian Cafe Orchestra. 11—National Anthem and Close down.

WEDNESDAY, NOVEMBER 18

12 noon—Time Signal, market and weather reports, "Age" news, musical items. 1—Georgian Cafe Orchestra. 2—Close down. 3.30—Georgian Cafe Orchestra Graphic social talk. Woodend Races: During the afternoon the results of the following races will be broadcast as they come to hand: Result of Novice, result of 14.2 Pony; result of Spring Handicap; result of Flying Handicap; result of 14.0 Pony; result of Encourage Handicap. 4—Musical items from the studio. 4.45—Girl Guides' Bulletin. 5—Close down. 6.15—Georgian Cafe Orchestra. 7.15—Children Corner by Aunt Betty. 8—Time Signal. 8.5—Miss Ethel Dunn (Pianiste): (a) F Major Novellete (Schumann); (b) Shadow Dance (McDowell). 8.15—Miss Edna Morrison, recitation, selected. 8.22—Miss Marguerite Chisholm (contralto): (a) La Serenata (Braga), with 'cello obligato by Mr. May. 8.30—Mr. Archibald Shearing (tenor): (a) Down the Vale (Moir); (b) Rosebud (Drummond). 8.37—The Felix Jazz Orchestra: China Girl, Moonlight and Roses, Mandalay, Midnight Waltz, etc. 8.52—Miss Minnie Marks (soprano): (a) At Dawning (Cadman); (b) When the Birds Go North (Willeby). 8.59—Mr. Harry Webster (tenor): (a) A Brown Bird Singing (Wood); (a) Pale Moon (Logan). 9.6—'Cello Solo by Mr. May (selected). 9.13—Miss Hermione Trevillian (soprano): (a) O Lovely Night (Ronald); (b) Rose Softly Blooming (Spohr); (c) Vorli (Tosti). 9.20—Miss Pearl Campbell (violinist) selected. 9.27—Mr. Walter Pearl (male soprano): (a) Japanese Love Song (Brahe); (b) Ave Maria (Gounod). 9.34—Mr. Alan Herschell (baritone): (a) I did not know; (b) I

All Going Cheap!

STILL SOME LEFT.

Last week I advertised many half-price bargains. There are still a few left, and it will pay you to look them over. They comprise portion of the stocks of two Sydney wireless concerns which have gone out of wireless. This stock includes English Valves, Condensers, Complete Sets, Transformers, Variometers, Vario Couplers, Accumulators, Loud Speakers, etc., $\frac{1}{2}$ K.W. X-Ray Transformer. Gear may be seen any time day or night at New Address—

140 Balfour Road, Bellevue Hill

(Leave Tram at Bundarra Road.)

Tel.: FM 2111.

Love you Truly (Bond). 9.41—Mr. Heymansson, recital, selected. 9.48—Miss Marguerite Chisholm (contralto): (a) Angels Guard Thee (Goddard); cello obligato by Mr. May. 9.55—The Felix Jazz Quartette, Miss Florence Marks, accompaniste. 10—Time Signal, "Age" news service, exclusive to 3AR. 10.15—Georgian Cafe Orchestra. 11—National Anthem and close down.

THURSDAY, NOVEMBER 18.

12 noon—Time Signal, market and weather report, "Age" news service, musical items. 1—Georgian Cafe Orchestra. 2—Close down. 3.30—Musical Items from the Studio. 4.40—Special pig and calf report by Messrs. McPhail, Anderson & Co. 5—Close down. 6.15—Georgian Cafe Orchestra. 7.15—The Children's Corner by Uncle Peter. 8—Time Signal; lecturette on the Care and Feeding of Infants. 8.15—Musical items from the studio. 8.30—Weekly radio chat, under the auspices of the Popular Radio Weekly, "Radex," Mr. J. Len Bain will talk on "Wireless." 9—Dance Night: Rhythmic Dance Orchestra, under the direction of Mr. George Lewis, relayed from the Maison de Luxe, Broadway, St. Kilda. 9.50—"Age" news service, exclusive to 3AR; Maison De Luxe Orchestra. 11—National Anthem and close down.

FRIDAY, NOVEMBER 20.

12 noon—Time Signal, market and weather reports, "Age" news, musical items. 1—Georgian Cafe Orchestra. 2—Close down. 3.30—"Bon Ton" of the Mutual Store Ltd. will give a Fashion Talk. 4—Mr. R. Stanley Haines will give a Gardening Talk to the children. 5—Close down. 6.15—The Georgian Cafe Orchestra. 7.15—The Children's Corner by Auntie Betty. 8—Time Signal. 8.1—Mr. R. Stanley Haines, of Brunnings Ltd., Gardening Talk. 8.16—Miss Fanny Lyndhurst (contralto): (a) Take all thy Sorrows (d'Hardelot); (b) Call Me Back (Denza). 8.21—Mr. Fred Smyrk (bass-baritone): (a) The Floral Dance (Moss); (b) Selected. 8.25—Miss Hazel Ralph (soprano): (a) Robin Adair; (b) The Garden of Your Heart. 3.30—French Talk by Madam Royster-Easton: "Remarques pour aider a comprendre le francais prle—comment on prononce 'eq'—Le Cavalier et le cordonnier." 8.41—Mr. Roy Ramage (cello solos): (a) Oriental (Cui), (b) Selected. 8.48—Mr. J. Lloyd-Jones (elocutionist), selection by O'Henry. 8.56—Miss Nellie Walls (soprano) (a) Flower Song from Faust. 9.—Mr. Lance Warrenn (baritone): "Infelice e fu credoci" (Verdi). 9.7—Miss Fanny Lyndhurst (contralto): (a) To-night (Zado); (b) The Crown (Rae). 9.12—Miss Marie Bevan (pianiste), selected. 9.16—Mr. Fred Smyrk (baritone): (a) Invictus (Kahn); (b) The Rebel. 9.22—Miss Nellie Walls (soprano) At Dawning (Cadman). 9.25—Mr. Lance Warrenn (baritone), "Nirvana" (Adams). 9.30—Fred Nitty, racing anticipations. 9.40—Mr. Roy Ramage (cello solo) O Star of Eve (Wagner). 9.45—Mr. J. Lloyd Jones (elocutionist), humorous selections. 9.52—Miss Marie Bevan (pianiste) selected. 9.56—Miss Fanny Lyndhurst (contralto) selected. 10—Time Signal, "Age" news service, exclusive to 3AR. 10.15—Georgian Cafe Orchestra. 11—National Anthem and close down.

Programme continued on page 38

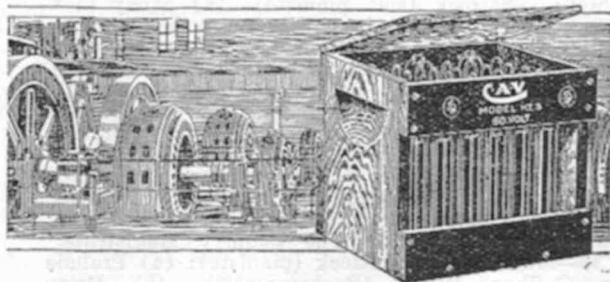

C.A.V.

Wonder Wireless Battery

An investment enabling you to SAVE MONEY. Whilst the initial cost is slightly more than dry cells, it is a positive economy because it can be recharged over and over again for about 2/6.

60 v. 1 Ampere Hour Model H.T.3.

Obtain particulars from **BENNETT & WOOD Ltd.**, 284 Pitt Street, Sydney, N.S.W.

C. A. Vandervell & Co. Ltd.

Acton Vale, London, W. 6



*A book for radio experimenters
—more than a catalogue*

RADIO Accessory Booklet No. 3 contains interesting descriptions of new-type Igranic Devices—of the latest in Brown Loud Speakers and Headphones. All the instruments described are English-made, covered by the makers' full guarantee. If you cannot call, write to the nearest address below for a post free copy.

NOYES BROS. (Sydney) Ltd.

Phones: City 3870 (6 lines), MW1905.

115 Clarence St., Sydney. 11 Watt St., Newcastle

What is Philco going to do in Radio?

ROUND THE WORLD with a UDISCO SUPER SIX

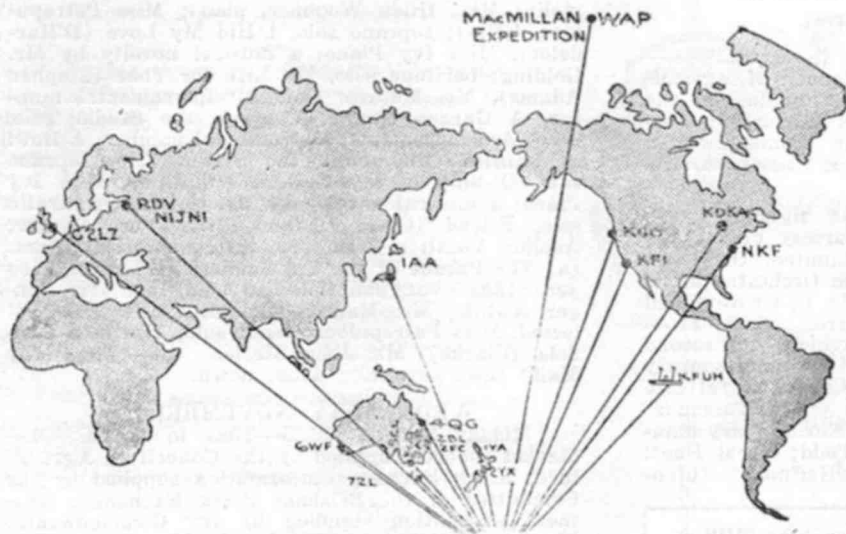

DISTANT stations are being tuned in daily throughout Australasia by satisfied owners of Udisco Super Sixes.

These sets are perfect. Multiple genius is built into every one. For the past three years the most eminent radio engineers of America and Australia have collaborated and the Super Six is the result.

The Udisco Super Six covers a wave band ranging between 20 and 2000 metres, and is the only set in the world employing radio frequency that will do this.

To select any desired station just turn one knob. Cumbersome plug-in coils are altogether done away with.

The tone of the Super Six is a special feature and experts have volunteered the opinion that it is superior to any other set they have yet heard in Australia. Music and speech comes through with wonderful clarity, volume and naturalness of tone.

The Udisco Six is built into a polished cabinet with an inclined panel, and is a remarkably handsome piece of furniture.

Until, by the appointment of Agents throughout Australia our receiving sets are made readily available to the public, we shall continue to sell receiving sets at retail.

Radio parts we will continue to sell wholesale to certified Dealers only.

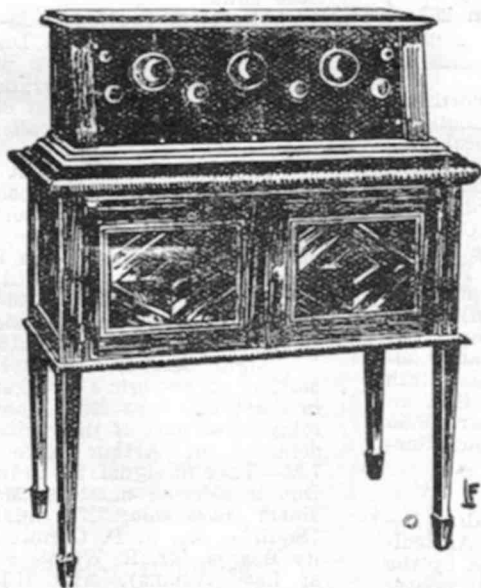

Retail Prices

Udisco Super Six on Stand complete with Music Master Loud Speaker, Batteries, Valves, and Aerial Equipment.

£110

UNITED DISTRIBUTORS LIMITED

72 Clarence Street,
Sydney.
343 Queen Street,
Brisbane.

Cnr. Jervois Quay
and Harris Street,
Wellington, N.Z.

502 Bourke Street,
Melbourne.
28 Queen Street,
Perth.

27 Chesser Street,
Adelaide.

Programme Continued from page 36

4QG

QUEENSLAND RADIO SERVICE.

Wavelength, 385 metres.

Midday Session: 12.55—Tune in signal. 1—Market reports supplied by the Council of Agriculture; Stock Exchange information supplied by the Committee of the Brisbane Stock Exchange; weather information supplied by the Commonwealth Weather Bureau; "Daily Standard" news service. Close down.

Night Session: 7.55—Tune in signal. 8—From the Tivoli Theatre: By courtesy of the Directors of Haymarket Theatre Limited, the overture played by the Tivoli Operatic Orchestra of 20 performers (under the baton of Mr. C. Groves) will be relayed from the Tivoli Theatre. 8.10—From the Studio: Lecturette: "Life Saving," the second of a series of four by Mr. J. C. Deeney (Honorary Lecturer to the Queensland Head Centre, Royal Life Saving Society); Soprano solo: "My Toreador" (Paul Rubens), Mrs. Robert Bell; Elocutionary number, "Seein' Things," Miss Feo Todd; Vocal Duet: "Barcarolle" (from "Tales of Hoffman"—Offen-

Listeners will be glad to learn that 2UW is now back on a regular schedule. He may be received any night between 8 and 10 on 267 metres.

bach), Mrs. Robert Bell and Miss Ruth Portrate; Flute Solo, selected, Mr. H. C. Marshall; Contralto solo, O Flower of all the world (Woodforde-Finden), Miss Audrey Iff. Elocutionary number: The Story of Pierrot, Miss Feo Todd; tenor solo, La Donna E Mobile (from Rigoletto—Verdi), Mr. Wm. Green; flute solo, selected, Mr. H. C. Marshall; contralto solo, Poppies for Forgetting (Clark) Miss Audrey Iff; violin solo, Dance of the Dragonflies (Rieding), Mr. H. Scott MacCallum; tenor solo, Che Geleda Manine (La Boheme—Puccini), Mr. Wm. Green; pianoforte solo: (a) Evening, (b) Dreaming (Schumann), Mr. Arthur Sharman; soprano solo, The Piper of Love (Carew), Miss Ruth Portrate. 9.30—From the Tivoli Theatre: Half an hour's music by the Tivoli Operatic Orchestra. 9.55—From the Studio: "The Daily Mail" News Service. Close down.

TUESDAY, NOVEMBER 17.

Midday Session: 12.30—Tune in signal. 1—Market reports supplied by the Council of Agriculture; Stock Exchange information supplied by the Committee of the Brisbane Stock Exchange; weather information supplied by the Commonwealth Weather Bureau; "Daily Standard" News Service. Close down.

Night Session: Brisbane Apollo Club: Portion of to-night's programme will comprise choral numbers by the Brisbane Apollo Club (formerly Liedertafel) under the leadership of Mr. Leonard Francis. 7.55—Tune in Signal. 8—Choral number: Trelawney (Thayer), the Brisbane Apollo Club (Mr. Leonard Francis, conductor); contralto solo, Beloved it is morn (Aylward), Miss Vera Parker; choral number, An Evening's Pastoral (Shaw), the Bris-

bane Apollo Club; tenor solo, Hame o' Mine (MacKenzie-Murdoch), Mr. John Steel; choral number, Care Killed a Cat (Kingsmill), the Brisbane Apollo Club; instrumental number, Valse Danseuse (Miles), the Studio Trio (Mr. Scott MacCallum, violin; Mrs. Hilda Woolmer, piano; Miss Petropoulos, 'cello); soprano solo, I Hid My Love (D'Hardelot), Miss Ivy Plane; a musical novelty by Mr. Golding; baritone solo, My Life for Thee (Stephen Adams), Mr. Maurice Goldhill; instrumental number, A Garden Dance (Vorges), the Studio Trio. 8.55—Announcements; instrumental number: A Bowl of Pansies (Raymond), the Studio Trio; soprano solo, O Ship of my Delight (Phillips), Miss Ivy Plane; a musical novelty by Mr. Golding; contralto solo, Friend (Clara Davies), Miss Vera Parker; Aeolian Vocalion Selections, instrumental numbers: (a) The Parade of the Tin Soldiers (O'Hagan), (b) Sea Songs (Vaughan Williams); baritone solo, Linger Awhile, Mr. Maurice Goldhill; 'cello solo, selected, Miss Petropoulos; tenor solo, You in a Gondola (Clarke), Mr. John Steele. 10—"The Daily Mail" news service. Close down.

WEDNESDAY, NOVEMBER 18

Midday Session: 12.55—Tune in signal. 1—Market reports supplied by the Council of Agriculture; Stock Exchange information supplied by the Committee of the Brisbane Stock Exchange; weather information supplied by the Commonwealth Weather Bureau; "Daily Standard" news service; close down.

Afternoon Session: 2.25—Tune in signal. 2.30 — By courtesy of the Directors of Haymarket Theatres Ltd., an hour's programme of music played by the Tivoli Operatic Orchestra of 20 performers (under the baton of Mr. C. Groves) will be relayed from the Tivoli Theatre. 4 — Close down.

The Children's Hour: A special children's bedtime story session is held each Wednesday and Saturday evening. At a later date this session will be made a nightly feature, but in the immediate present, while transmission is being effected under temporary conditions, it will be held twice weekly. 6.25—Tune in signal. 6.30—The Children's Hour. Nursery Rhymes and music. Bedtime stories by Little Miss Brisbane. 7.15—Close down.

Night Session: Albert Hall Recital—The first portion of to-night's programme will be provided in the Studio, the second portion will comprise the relaying of part of the recital by the advanced students of Mr. Arthur Boyle from the Albert Hall. 7.55—Tune in signal. 8—From the Studio: Hawaiian Duo in selected numbers, Messrs. Bleek and Gardiner; bass solo, If I might only Come to You, (Squire), Mr. J. P. Cornwell; lecturette, Commodity Boards, Mr. R. Wight; contralto solo, The Bells of Lee (Adams), Miss Hilda Cooper; banjo selections by Mr. W. G. McGrath; contralto solo, The Brightest Day (Martin), Miss Clarice Cox; Hawaiian Duo in selected numbers, Messrs. Bleek and Gardiner; A talk to Women, Recipes, by Veronica; contralto solo, Steel Away (Brown), Miss Hilda Cooper; Hawaiian Duo in selected numbers, Messrs. Bleek and Gardiner; contralto solo, The Star (Rogers), Miss Clarice Cox; group of banjo numbers by Mr. W. G. McGrath; bass solo, Rheaugh Ranzo (Coates), Mr. J. P. Cornwell. 9.—From the Albert Hall Recital by the advanced students of Mr. Arthur Boyle; Duet, Snowdrops (Liza

Burgess—Ask Any Radio Engineer.

Lehmann), Miss Beatrice Pugh and Mr. John Steel; song, Lord God of Abraham (Mendelssohn), Mr. Leigh Besly; song, Voi la Sapate (Mascagni), Miss Wyn Binnie; song, Invictus (Huhon), Mr. Victor Westacott; song, Porgi Amor (Mozart), Miss Beatrice Pugh, L.A.B.; song, Ah, Moon of my Delight (Lehmann), Mr. William Ashlin; song, The Lament of Issis (Granville Bantock) Miss Ellen Saville; song, Dalla sau pace (Mozart), Mr. John Steel; duet, Miserere (Il Trovatore—Verdi), Miss Beatrice Pugh, L.A.B. and Mr. Wm. Ashlin; from the studio: 10—"The Daily Mail" news service; Close down.

THURSDAY, NOVEMBER 19

Midday Session: 12.55—Tune in signal. 1—Market reports supplied by the Council of Agriculture; Stock Exchange information supplied by the Committee of the Brisbane Stock Exchange; Weather information supplied by the Commonwealth Weather Bureau; "Daily Standard" news service. Close down.

Night Session: Aeolian Night: Raymond and Bett Duo. Portion of to-night programme has been arranged by the Aeolian Company Ltd., and includes a special recital of high-class piano player and Aeolian vocalion music. The second portion comprises a recital by the Raymond and Bett Duo. A lecture on books will be included. 7.55—Tune in signal. 8—Duo Art Pianola selection, Autumn (Chaminade), played by Clarence Adler; Aeolian Vocalion selections: bass solo (a) Out on the Deep, (b) I Love Someone in Zimmerset, Mr. Malcolm McEachern; soprano solo, Golden Dancing Days (Clarke), Miss Mary McNeish; Aeolian Vocalion selection: instrumental numbers: Hawaiian guitar and violin trio, (a) O Sole Mio, (b) Mari, Mari; Bookman's Radiette—a talk on books by Mr. W. A. Braiden (McLeod's Bookstore); soprano solo: Happy Song (Del Riego), Miss Mary McNeish; Duo Art pianola selection, Love's Last Word (Chimeaux), played by Felix Arndt; Aeolian Vocalion selections, contralto solos: (a) Just a Ray of Sunlight, (b) Christina's Lament, Miss Ethel Hook; instrumental number, Water Lillies (St. Clair), Studio Trio; Duo Art pianola selection, Felicia Waltz (Eville), played by Felix Arndt; Aeolian Vocalion selections: vocal duets (a) The Lute Player, (b) The Moon hath Raised, Mr. Malcolm McEachern and Mr. Frank Titterton; tenor solo, The Yeoman of England (German), Mr. Ernest Bayton; instrumental number, In Poppyland (Albers), the Studio Trio. 8.55—Announcements. 9—Aeolian Vocalion selections, vocal duets: (a) The Battle Eve, (b) Flow Gently Deva, Mr. Malcolm McEachern and Mr. Frank Titterton; soprano solo, Yonder (Oliver), Miss Millicent Baker; Duo Art Pianola selection, fox trot, Linger a While (Rose), played by Ray Perkins; tenor solo, My Dreams (Tosti), Mr. Ernest Bayton; instrumental number, Waltz, Mon Plaiser (Roberts), the Studio Trio; soprano solo, The Tryst (Sibelius), Miss Millicent Baker. 9.30—A special entertainment by Raymond and Bett: duet, Peach in Georgia, Raymond and Bett; banjo solo, selection from Poet and Peasant (Suppe), Mr. Roy Raymond; monologue, My Idea of a Girl, Miss Nessie Bett; duet, Homesick, Raymond and Bett; banjo solo, selection of popular airs, Mr. Roy Raymond; monologue, I Thought I'd Die, Miss Nessie Bett; pianoforte solos: (a) Kitten on the Keys (Confrey), (b) Kismet (Hen-

lere), Miss Nessie Bett; banjo solo, Stars and Stripes for Ever (Sousa), Mr. Roy Raymond; duet, Turned Up, Raymond and Bett. 10.15—"The Daily Mail" news service. Close down.

3LO

BROADCASTING COMPANY OF AUSTRALIA. PROPRIETARY LIMITED.

Call Sign, 3LO. Power, 5 kilowatts. Wave Length, 371 metres.

SATURDAY, NOVEMBER 14.

Morning Session (11 a.m. to 2 p.m.): 11—Time Signal. Express Train information. 11.3—Musical items by the Buckley and Nunn Studio Orchestra. 12—Time Signal. 12.2—Buckley and Nunn Studio Orchestra. 12.30—"Argus" and "Herald" news services. Reuter's and the Australian Press Association cables. 12.45—Buckley and Nunn Studio Orchestra. 1—Time Signal. 1.3—Result of the Kasouka Hurdle from the V.A.T.C. Meeting at Caulfield. 1.6—Buckley and Nunn Studio Orchestra. 1.40—Result of the Stansmore 2-Year-Old from the V.A.T.C. Meeting at Caulfield. 1.45—"Herald" and "Argus" news services. Stock Exchange information. Weather forecast. River reports. 2—Close down. 2.30—Result of the Armadale Cup from the V.A.T.C. Meeting at Caulfield.

Afternoon Session (3 to 5.15 p.m.): 3—Time Signal. 3.2—Buckley and Nunn Studio Orchestra. 3.10—Result of the Tara Steeple at Caulfield. 3.15—Buckley and Nunn Studio Orchestra. 3.45—Result of the Ormond Stakes at Caulfield. 3.50—Buckley and Nunn Studio Orchestra. 4.25—Result of the Ross Town Plate from Caulfield. 4.30—Musical items from the Studio. 5—All the sporting results. 5.15—Close down.

Evening Session (5.45 to 7.15 p.m.): 5.45—Sporting results. 6—Children's Hour. "Billy Bunny" Stories by Miss Gum Leaf. For the young ones, "The Wolf and the Seven Little Kids"; for the boys, "Puss in Boots"; for the girls, "The Sleeping Beauty." 6.45—"Herald" and "Argus" news services. Reuter's and the Australian Press Association cables. Market reports. Weather synopsis. Closing Stock Exchange information. Shipping movements. Market reports by the Victorian Producers' Co-operative Co. Ltd.: Haymarket sheep sales, poultry, grain, chaff, hay, straw, jute, dairy produce potatoes and onions.

Night Session (7.40 to 11 p.m.): Speaker, Dr. J. A. Leach. The Northcote Musical Society; conductor, Mr. Bert Cox; pianist, Miss Elsie Selwood; soloists, Mr. Reg. Huddy (tenor), Miss Elsie Selwood (contralto), Mr. Bert Cox (baritone), Miss Carrie Gray (soprano), Miss Elsie Anthony (mezzo). The Thelma Quartette Party. Buckley and Nunn Studio Orchestra; musical director, Miss Bessie Gaunson. 7.40—Dr. J. A. Leach, "Birds of Australia—Smaller Honeyeaters, Blackeaps and Spinebills." 8—Transmission from Brunswick Band Carnival, "A" Grade Bands, "The Flying Dutchman." 8.15—The Northcote Musical Society, anthems, "Hail, Gladdening

(Programme Continued on Page 42)

Radio Cures

THERE seems to be no doubt that wireless will, in the future, make us all healthier. At sea, many lives have been saved, because ships which carry no doctor can easily get in touch with a medical man on another vessel and the treatment is received back on the spot. It might be awkward if a weather forecast happened to get mixed up with "the mixture as before"; the further outlook of the patient may be rather unsettled.

The talks on "Health" by Dr. Stanley Argyle, from 3LO, Melbourne, do more good than half a dozen lectures in a public hall. People will listen where they will not go out, and also, staying at home means they do not run the risk of being run over by a motor car or bus.

Does music have any effect upon our well being? You feel much better, when you hear a stirring march, played by the Australian Royal Air Force Band, but again, when the girl in the next flat, tries "Hark, the Lark," and misses the top note, your appetite fades away. I visited my doctor recently and found him gazing in a catalogue at a picture of a long pipe with a gramophone horn on the end. He explained it wasn't a stethoscope, but a saxophone, and he was wondering if he ought to learn to play one. Since the entry of wireless into everyday life, many people had informed him that music had certain curat-

ive powers, and he expected that in a few years' time he would be prescribing a carefully made up sonata, instead of a dose of castor oil. In further conversation he said that everything in nature oscillates to a certain rhythm, and when you're ill, it means that your electrons are out of step, and are causing atmospherics, so to speak, in your system. Fortunately, these electrons have an ear for music and a little bit of jazz would soon put them in their proper place, and they go happily one-stepping again. The time will come when doctors will ask, not what you've been eating, but what sort of a wireless set you've got. If you complain of a headache, he will put it down to too rich programmes by the Brunswick City Band, and order a course of instrumental music by the Buckley and Nunn Studio Orchestra, to be taken thrice daily. The time may come when the Health Department may ask the broadcasting companies to transmit something effervescent, during an epidemic of influenza, as a tonic; whilst during a heat wave all sentimental songs would be barred. Something cool would be required, as "Sea Shanties" or a talk about "Adventures in Greenland."

Probably this is exaggerating but there may be something in it. Some advertisements on the back page of journals, will read: "Buy our 10-Crystal Set; worth a Guinea a Box," or a picture of Grandpa jumping over a fence with headphones on. He will have got that 3LO feeling.

Columbia 22½ Volt "B" Battery No. 4766

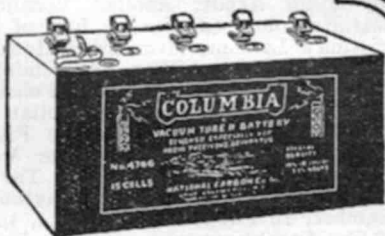

ESPECIALLY adapted for use with soft detector tubes. Large size cells make it the most economical. Six Fahnestock spring clip connectors with a range of 16½ to 22½ volts.

FACTORY REPRESENTATIVE
ELLIS & CO. (AUSTRALIA) LTD.
516 KENT STREET, SYDNEY, N.S.W.

Columbia Radio Batteries

Made by the manufacturers of the Famous Columbia Dry Cell

His
Daddy's
Choice



His
Daddy's
Choice

THE LATEST IN RADIO

De Forest leads the field in 1925 with its new D-17. This new instrument has the great features that have made De Forest Radiophones famous alike with experts and the unskilled—plus refinements that simplify its operation, give increased selectivity, sensitivity and distance range.

Note these points:

1. A clear, natural tone common only to De Forest instruments—a tone so rich and pure that the living performer seems to be present.
2. No aerial—no ground wire.
3. Simplicity of operation—detector tube in place of crystal gives immediate results, eliminates all detector adjustments.
4. Disturbing squeals have been eliminated.

5. The D-17 can easily be moved from room to room on a tea waggon or carried by hand.
6. A handsome instrument that is a handsome piece of furniture.
7. Lee De Forest, the greatest name in radio, made present-day radio possible.

The D-17 has built-in loud speaker, valves, loop, and "A" and "B" batteries.

Write us direct for further information and name of nearest De Forest dealer.

PRICE OF D-17—COMPLETE, £75
with everything complete

International Radio Co. Ltd.

200 CASTLEREAGH STREET, SYDNEY.
91-93 Courtenay Place, Wellington, N.Z.

RADIOPHONE IS A DE FOREST INVENTION

(AGENTS WANTED EVERYWHERE.)

Programme continued from page 39

Light" (Martin) "At even, ere the sun was set" (Turner). 8.26—Mr. Walter Smith, cornet solo, "Castles in the Air" (Clay Smith). 8.31—Mr. Reg Huddy, tenor, "Thank God for a Garden" (Del Riego), "Sleep and the Roses" (A. Tate). 8.36—Orchestral trio, "Valse des Fleurs" (Tchaikowsky). 8.46—Northcote Musical Society, glees, "May Day" (Muller), "Lullaby of Love" (Lesley). 8.53—Miss Dorothy Roxburgh, viola solo, "Bereuse" (Arensky). 8.58—Miss Elsie Selwood, contralto, "O Love from thy Power" (St. Saens), "Silent Noon" (Vaughan Williams). 9.5—Election results. 9.15—Thelma Quartette Party, "Tom the Piper's Son," "Little Tommy went a-fishing." 9.20—Miss Tasma Tiernan, 'cello solo, "Chant Sans Paroles" (Tchaikowsky). 9.25—Mr. Bert Cox, baritone, "The Vagabond" (Vaughan Williams), "We Sway Along" (Mallison). 9.30—Buckley and Nunn Studio Orchestra, "Songs from Shakespeare's Time" (Borch). 9.40—Northcote Musical Society, anthems, "By Babylon's Wave" (Gounod), "Ring Out, Wild Bells" (Fletcher). 9.52—Miss Bessie Gaunson, violin solo, "Serenata" (Nolek). 9.59—Miss Carrie Gray, soprano, "Cradle Song" (Schubert), "When Love is Kind" (Moore). 10.52—"Argus" and "Herald" news services and election results. 10.15—Thelma Quartette Party, "Awake, Little Kate," "The Torpedo and the Whale." 10.20—Miss Dorothy Roxburgh, viola solos, "Siellienne" (Ambrosio), "Zampognara" (Princibe). 10.25—Northcote Musical Society, anthem, "Sing unto the Lord" (Mauder). 10.31—Orchestral trio, "Lady Madeap" (Dan Godfrey). 10.41—Miss Elsie Anthony, mezzo, "Ave Maria" (Bach-Gounod), "Ships that Pass in the Night" (Stephenson). 10.47—Miss Tasma Tiernan, 'cello solo, introduction, "Song of Evening Star" (Wagner). 10.52—Northcote Musical Society, glees, ladies, voices, "Minnehaha" (Loring), combined—"Old Mother Hubbard" (Wheeler). 10.57—Buckley and Nunn Studio Orchestra, "Il Trovatore" (Verdi). 11—Election results. 11.15—National Anthem. 12 midnight—Election results.

SUNDAY, NOVEMBER 15.

Morning Session (11 a.m. to 12.15 p.m.): 11—Service relayed from Scots Church, Collins Street, conducted by Rev. W. Borland, M.A., B.D.; musical director, Mr. Mansley Greer. Hymn 438, "Jesus shall reign"; Prayer; Psalm (Metrical) 89, 15-18, "O greatly blessed the people are"; Lesson, 1 Samuel 16, 1-13; Psalm (Prose Psalter) 72, "Give the King Thy judgments, O God"; Prayer of Intercession; Lesson, St. Matt. 22, 15-33; Anthem; The Lord's Prayer; Sermon, "Christ and Politics" (St. Matt. 22, 17); Prayer; Intimations; Offering; Hymn 204, "O God of Bethel"; Benediction.

Afternoon Session (3 to 4.30 p.m.): 3—Fourth Annual Memorial Church Service, Scots Church, Collins Street; the Rt. Rev. James Crookston, Moderator Gen. Presbyterian Church of Australia, will preside. Preacher, Rev. C. Neville, Chaplain of the 5th Battalion. National Anthem; Prayer of Invocation; Psalm 100th; "All people that on earth do dwell"; New Testament Lesson; Hymn, "O God, our Help in ages past"; Prayer; Hymn, "Onward, Christian Soldiers"; Lord's Prayer; Footscray Choral Society, "Land of Hope and Glory," conductor Mr. E. Sim-

mons; collection in aid of proposed memorial; Address, Chaplain Rev. C. Neville; Prayer; Hymn, "Abide with me"; Lament, "Flowers of the Forest" (Pipe-Major L. Cunningham), "The Last Post" (Bugler E. P. Taylor, 5th Battalion); Benediction.

Evening Session (6 to 6.45 p.m.): 6—Children's Hour. "Billy Bunny" Stories, "Pilgrim's Progress." 6.45—Close down.

Night Session (7 to 10 p.m.): Evening Service from the Collins Street Baptist Church. Preacher, Rev. F. G. Benskin, M.A., Flinders Street Baptist Church, Adelaide. 6.45—Organ Prelude. 7—Sanctus; Call to Worship; Invocation; Lord's Prayer (Choral); Hymn 32, "Father and Friend"; Scripture, Trio, "On Thee each living soul awaits"; Scripture; Hymn 70, "Eternal Light, Eternal Light"; Notices; Offertory; Offertory Prayer; Anthem, "I was glad when they said unto me"; Prayer; Hymn 31, "Lord of all being, throned afar"; Sermon, "The Medicine of Immensity"; Hymn 230, "Rock of Ages"; Benediction; Vesper; Organ Postlude. From the Studio—Speaker, Mr. J. Howlett Ross. The British Musical Society's Quartette (Mr. Alberto Zelman, Miss Bertha Jorgenson, Miss Tasma Tiernan, Miss Dorothy Roxburgh). Miss Beatrice Kendrick, contralto; Mr. Harold Rodgers, pianist and accompanist. 8.30—The British Musical Society's Quartette in a quartette in G Major (No. 50) by Haydn, for 1st and 2nd violins, viola, and 'cello, in four movements. 1st movement, Allegro; 2nd movement, Allegretto; 3rd movement, Minuet; 4th movement, Finale, Presto. 8.50—Miss Beatrice Kendrick, contralto (by permission of J. C. Williamson Ltd.), "The Birds go North Again" (Willeby), "Sink, Red Sun" (Del Riego). 8.57—Mr. Harold Rodgers, pianoforte solo "Upward and Onward" (Schumann). 9.2—Mr. J. Howlett Ross, "Notable Australians—W. B. Dalley," 9.22—Mr. Harold Rodgers, pianoforte solos, "Romance in D Flat" (Sibelius), "Folk Song Intermezzo" (Palmgren). 9.27—Miss Beatrice Kendrick, contralto, "Nature's Hymn" (Beethoven), "Less than the Dust" (Finden). 9.34—The British Musical Society's Quartette in a quartette in C Minor (No. 4) by Beethoven, for 1st and 2nd violins, viola and 'cello, in four movements. 1st movement, Allegro ma non tanto (quickly, but not too much); 2nd movement, Scherzo Andante seherzoso quasi Allegretto (rather slow, in a playful mood); 3rd movement, Minuet (Allegretto, rather quickly); 4th movement, Allegro (quickly). 9.54—"Argus" and "Herald" news services. 10—Close down.

MONDAY, NOVEMBER 16.

Morning Session (11 a.m. to 2 p.m.): 11—Time Signal. Express Train information. 11.3—Musical items by the Buckley and Nunn Studio Orchestra. 12—Time Signal. 12.2—Buckley and Nunn Studio Orchestra. 12.30—"Argus" and "Herald" news services. Reuter's and the Australian Press Association cables. 12.45—Buckley and Nunn Studio Orchestra. 1—Time Signal. 1.2—Buckley and Nunn Studio Orchestra. 1.45—"Herald" and "Argus" news services. Stock Exchange information. Weather forecast. River reports. 2—Close down. The results of the pony races at Richmond will be given immediately at the conclusion of each race.

Afternoon Session (3 to 5.15 p.m.): 3—Time Sig-

Have you got your Philco yet?

nal. 3.2—Musical items by the Paramount Theatre Orchestra, under the baton of Signor Vincent Ricco. 3.40—Matron Moreland on "Infant Welfare." 3.55—Musical items by the Paramount Theatre Orchestra. 5—"Herald" and "Argus" news services. Reuter's and the Australian Press Association cables. 5.15—Close down. The results of the Richmond pony races will be given immediately at the conclusion of each race, and all results repeated at the hours 4 and 5 p.m.

Evening Session (6 to 7.15 p.m.): 6—Children's Hour. "Billy Bunny" Stories: "Nursery Rhymes," "The Enchanted Forest," "Houses of the Eagle." 6.45—"Herald" and "Argus" news services. Reuter's and the Australian Press Association cables. Market reports. Weather synopsis. Closing Stock Exchange information. Shipping movements. Market reports by the Victorian Producers' Co-operative Co. Ltd.: Haymarket sales, poultry, grain, chaff, hay, straw, jute, dairy produce, potatoes and onions.

Night Session (7.15 to 11 p.m.): "Pot Pourri." Speakers: Mr. Keith Cheetham, Arvia; Mr. T. P. Court, Mr. J. C. Boyce. Victorian Railways Institute Military Band. The Studio Orchestral Trio. Mr. Russell Callow, tenor; Mr. Bert Hopping, entertainer. Gladys Monerchief in "The Street Singer." 7.15—Under the auspices of the Town Planning Association, Mr. Keith Cheetham, Arvia, "Some of Melbourne's Notable Buildings." 7.30—Mr. T. P. Court, Technical Adviser to "The Listener In" in a wireless talk, "Radio Frequency Amplification." 7.45—Mr. J. C. Boyce, Government Tourist Officer. 8—The Victorian Railways Institute Military Band, march, "Colonel Bogey" (Alfred); overture, "Morning, Noon, and Night" (Suppe); selection, "Don Giovanni" (Mozart); overture, "Les Cloches des Corneville" (Planquette). 8.45—Mr. Russell Callow, tenor, "Doloroso" (Phillips), "A Dream" (Bartlett). 8.52—The Studio Orchestral Trio, "Op. 05, No. 1" (Berens). 9.7—Mr. Bert Hopping, entertainer, "The Pigtail of Li Fang Foo." 9.15—The Victorian Railways Institute Military Band, selection, "Arlette" (Novello); cornet solo, "A Perfect Day" (Bond); selection, "Ballet Egyptian" (Luigini); march, "Sword and Lance" (Starke). 10—"Argus" and "Herald" news services. 10.4—Mr. Russell Callow, tenor, "At Dawning" (Cadman), "The Living God" (O'Hara). 10.11—The Studio Orchestral Trio, "Liebesgarten" (Schumann). 10.19—Mr. Bert Hopping, entertainer, "Oh, Star of Eve," "Girl from County Clare." 10.25—Gladys Monerchief in the third act of "The Street Singer," transmitted from His Majesty's Theatre, by permission of J. C. Williamson Ltd. The House of the Duchess of Versailles; opening music; song, "Too Late," Noel Leyland; duet, "That's what you are to me," Nellie Payne and Arthur Stigant; reprise, "Just to hold you in my arms," Gladys Monerchief and Noel Leyland. 11—"God Save the King."

TUESDAY, NOVEMBER 17.

Morning Session (11 a.m. to 2 p.m.): 11—Time Signal. Express Train information. 11.3—Musical items by the Buckley and Nunn Studio-Orchestra. 12—Time Signal. 12.2—Buckley and Nunn Studio Orchestra. 12.30—"Argus" and "Herald" news services. Reuter's and the Australian Press Association cables. 12.45—Buckley and Nunn Studio Orchestra. 1—Time Signal. 1.2—Buckley and Nunn

Studio Orchestra. 1.45—"Herald" and "Argus" news services. Weather forecast. Stock Exchange information. River reports. 2—Close down.

Afternoon Session (3 to 5.15 p.m.): 3—Time Signal. 3.2—Musical items by the Paramount Theatre Orchestra, under the baton of Signor Vincent Ricco. 3.40—"Au Fait," of Buckley and Nunn Ltd., will discuss latest modes in a fashion talk. 3.55—Musical items by the Paramount Theatre Orchestra. 5—"Herald" and "Argus" news services. Reuter's and Australian Press Association cables. 5.15—Close down.

Evening Session (6 to 7.15 p.m.): 6—Children's Hour. Stories by "Little Miss Kookaburra," who, in response to several requests, will tell the story of "Cinderella" and last instalment of "The Plucky Patrol." 6.45—"Herald" and "Argus" news services. Reuter's and the Australian Press Association cables. Market reports. Weather synopsis. Closing Stock Exchange information. Shipping movements. Market reports by the Victorian Producers' Co-operative Co. Ltd.: Haymarket sheep sales, poultry, grain, chaff, hay, straw, jute, dairy produce, potatoes and onions.

Night Session (7.15 to 11 p.m.): Speakers—"A Country Banker" Sir James Barrett, K.B.E., C.B., C.M.G., M.D.; Dr. Loftus Hills. Salvation Army Headquarters Staff Band. The Melbourne Repertory Society. Mr. Herbert Walton, comedian; Mr. Harold Rodgers, organist; Miss Agnes Fortune, accompanist. 7.15—Under the auspices of the New Settlers' League, "A Country Banker" on "The Place of the Local Bank in District Development." 7.30—7.45—University Extension Lecture, Sir James Barrett, K.B.E., C.B., C.M.G., M.D., "Open Spaces." 8—The Salvation Army Headquarters Staff Band, march, "Wellingtonian" (Scotney). 8.10—Lieut. Saunders, baritone, "Shipmates o' Mine" (Sanderson). 8.14—Salvation Army Headquarters Staff Band, selection, "Genius of Great Masters" (arr. McAually). 8.20—Male Quartette, "Sunshine." 8.25—Conductor Dutton, cornet solo. 8.30—Salvation Army Headquarters Staff Band, meditation, "Man of Sorrows" (arr. Coles). 8.40—Bandsman B. Small, tenor, "Good-bye" (Tosti). 8.44—Salvation Army Headquarters Staff Band, song, "The long day closes" (Sullivan); march, "Yellow, Red and Blue" (Marshall). 9—Dr. Loftus Hills, Popular Science, "The Oil Age," Part 6. 9.15—Salvation Army Headquarters Band, march, "Boston" (Broughton). 9.23—Male Quartette, "Comrades in Arms." 9.27—Salvation Army Headquarters Band, "The Village Blacksmith" (Hawkes). 9.32—Meditation, "Bridgethorpe" (Ostby). 9.36—Two hymn tunes. 9.40—March, "Collingwood" (Dickens). 9.45—The Melbourne Repertory Society in a one-act play, "The Boy Comes Home" (by A. A. Milne). Cast in order of appearance: Mary (maid), Leonie Levy; Philip, Walter Armstrong; Aunt Emily, Edith Appleton; Mrs. Higgins (cook), Betty Rae; Uncle James, Robert Guthrie. Scene: A room in Uncle James's house, London. Time: The day after the war. Play produced by Isabel Handley. 10.10—"Argus" and "Herald" news services. 10.14—Mr. Harold Rodgers, organ solo, "Christmas Offertory" (Leninen). 10.29—Mr. Herbert Walton, comedian (by permission of J. C. Williamson Ltd.),

Programme continued on page 46

Your Chance!

£21 in prizes

In the hope of producing a portable wireless set, we have decided to donate £21 in prizes. The set must be portable, have volume and selectivity and one that will have features to satisfy the week-ender and motorist. The only thing we stipulate is the use of Philips' Valves, and the nomination of your Entry by November the 20th. Sets to be judged by the Editor of the Wireless Weekly on December the 18th. Every assistance will be given to entrants, by our Experimental Department, both in charts and on problems encountered in your own work. Here is a good opportunity to earn a substantial Xmas gift.

LODGE YOUR ENTRY NOW

NOTICE

Through an error in our copy of the last week's issue, we stated that by using Philips' B6 Valves the B Battery would not be required. This is an error for which we apologise. By consulting our Experimental Department, advice can be given on ways of obviating the use of the B Batteries.

NOTE: We reserve the right to purchase the winning set, but all sets, it is clearly understood, are the sole property of the Competitors.

Country Customers: Our same day Mail Order Service guarantees immediate attention to your inquiries and orders. All goods are carefully packed.

"You Have My Word For It."

ER. Cullen

Late
A.I.F.

Radio and Electrical Store

96 Bathurst Street.

Phones, City 869 and 2596

COL-MO LITTLE GIANT SETS

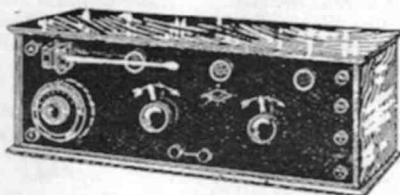

The Little Giant Sets are sold complete with all accessories, including aerial wire. The three valve Little Giant is complete with all Accessories and Atlas Loud Speaker.

- One Valve Set £7 10 0
- Two Valve Set £12 10 0
- Three Valve Set £20 0 0

THE LITTLE GIANT ALWAYS LIVES UP TO ITS NAME. A GIANT IN TONAL QUALITIES, EFFICIENCY, AND SIMPLICITY OF OPERATION ARE FEATURES NOT SURPASSED IN LARGER HIGH-PRICED INSTRUMENTS.

Col-Mo Ready to Wire Sets

GENUINE RADIO SETS THAT WILL WORK

WIRING TAKES TIME, AND TIME IS MONEY.

DO THE JOB YOURSELF AND SAVE MONEY.

ONE-VALVE SET: Complete with Cabinet, £2/15/0.

TWO-VALVE SET: Complete with Cabinet, £4/10/0.

THREE-VALVE SET: Complete with Cabinet, £6/5/0.

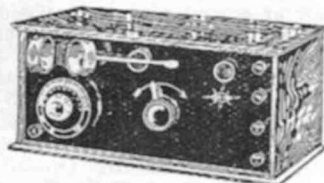

Our Ready-to-Wire Sets are complete with wiring diagrams. No previous experience necessary to wire a COL-MO Ready-to-Wire Set.

SALE OF GENUINE PARTS.

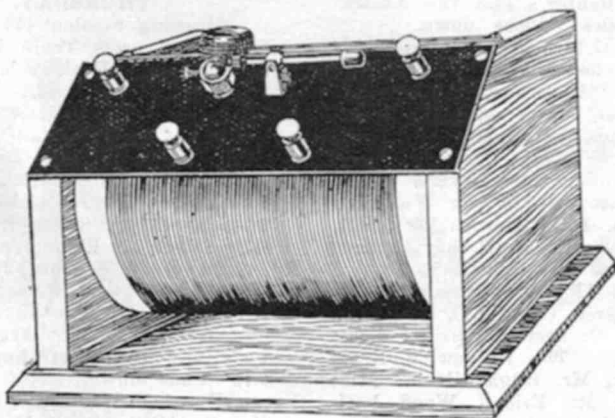

Complete with Phones and aerial equipment. 25/-

Clearing off a number of lines at cost.

CALL AND INSPECT

COLVILLE-MOORE

Wireless Supplies Limited
10 Rowe Street, Sydney

Programme continued from page 43

in a few merry moments. 10.36—Mr. H. Rodgers, pianoforte solo, "Brun Polonaise" (Chopin). 10.46—Mr. Herbert Walton, comedian, in a few merry moments. 10.52—Mr. Harold Rodgers, organist, Ballet Music, Nos. 1 and 2, from "Rosamund" (Schubert), Coronation March from "The Prophet" (Meyerheir). 11—"God Save the King."

WEDNESDAY, NOVEMBER 18.

Morning Session (11 a.m. to 2 p.m.): 11—Time Signal. Express Train information. 11.2—Musical items by the Buckley and Nunn Studio Orchestra. 12—Time Signal. 12.2—Buckley and Nunn Studio Orchestra. 12.30—"Argus" and "Herald" news services. Reuter's and the Australian Press Association cables. 12.45—Buckley and Nunn Studio Orchestra. 1—Time Signal. 1.2—Buckley and Nunn Studio Orchestra. 1.45—"Herald" and "Argus" news services. Weather forecast. River reports. Stock Exchange information. 2—Close down. 2.30—Result of first race from Woodend Racing Club Meeting.

Afternoon Session (3 to 5.45 p.m.): 3—Time Signal. 3.1—Result of second race from Woodend Racing Club Meeting. 3.4—Musical programme by the Paramount Theatre Orchestra, under the baton of Signor Vincent Ricco. 3.30—Result of third race from Woodend Racing Club Meeting. 3.35—Musical items by the Paramount Theatre Orchestra. 4—Result of fourth race from Woodend Racing Club Meeting. 4.5—Paramount Theatre Orchestra. 4.30—Sister Peck, of the Victorian Baby Health Centres Association, will speak on "Mothercraft." 4.44—Result of the fifth race from Woodend Racing Club Meeting. 4.45—Choral Evensong from St. Paul's Cathedral. 5.30—Sporting results. "Herald" and "Argus" news services. Reuter's and the Australian Press Association cables. Close down.

Evening Session (6 to 7.15 p.m.): 6—Children's Hour. "Billy Bunny" Stories: "Nursery Rhymes," "The Enchanted Forest," "Houses of the Eagle." 6.45—"Herald" and "Argus" news services. Sporting results. Reuter's and the Australian Press Association cables. Market reports. Weather synopsis. Closing Stock Exchange information. Shipping movements. Market reports by the Victorian Producers' Co-operative Co. Ltd.: Newmarket sales, cattle, pigs, carcase meat, grain, chaff, hay, straw, jute, dairy produce, potatoes and onions.

Night Session (7.15 to 11 p.m.): Speakers—Mr. G. A. Curtis, Mr. P. W. Pearce, Captain C. H. Peters. Buckley and Nunn Studio Orchestra; musical director, Miss Bessie Gaunson. The Brunswick Brass Quartette; musical director, Mr. Hugh Niven. Miss Jessie Batchelor, contralto; Mr. Eric J. Wood, baritone; Mr. Albert Durand, banjoist; Miss Doris McInnes, soprano; the First Croxton Troop of Boy Scouts, under Scoutmaster E. Davis. 7.15—Mr. G. A. Curtis, member of Betterment Board, Victorian Railways, "A Day at the North Melbourne Loco. Depot." 7.30—7.45—Mr. P. W. Pearce, physical culture talk—chest exercises. 8—The Buckley and Nunn Studio Orchestra, selection, "Rigoletto" (Verdi). 8.20—Miss Jessie Batchelor, contralto, "Abide with me" (Liddle), "The Fuchsia Tree" (Quilter). 8.27—The Brunswick Brass Quartette,

"Tschaiakowsky" (Hume). 8.37—Mr. Eric J. Wood, baritone, "The Lord is my Light" (Allitsen). "Together" (Wynne). 8.44—Mr. Albert Durand, banjoist, "The Darkies' Lament," banjo imitation of "A Church Service." 8.54—Captain C. H. Peters, "Books, Wise and Otherwise." 9.9—Boy Scouts' Camp Fire by the First Croxton Troop of Boy Scouts—(1) Introduction and explanation by Cub Master Fraser; (2) the opening of the camp fire, Scoutmaster Davis; (3) solo and chorus by all the Scouts and Cubs, "Under the Mellow Moon," soloists Cubs F. and M. Hughson; (4) camp fire rattle of tongues; (5) song chorus, "Sambo," by the Troop; (6) chorus, "Red Moon," by the Troop; (7) grand howl of salute by the Cubs; (8) song and chorus, "Three Jews," by the Troop; (9) camp fire rattle of tongues; (10) song and chorus, "Sleep," by the Troop; (11) troop war-cry, follows the call to alert, then dismissal, then the motley sound of Scouts and Cubs getting to bed. 9.29—Brunswick Brass Quartette, cornet duets, (a) "Tasmania" (Lithgow), (b) "Larboard Watch" (Williams). 9.39—Miss Doris McInnes, soprano, "Rosebuds" (Arditi). 9.46—Buckley and Nunn Studio Orchestra, a selection of American Student Songs, "College Life" (Hinrichs). 10.1—"Argus" and "Herald" news services. 10.5—Miss Jessie Batchelor, contralto, "Castilian Lament" (Del Riego), "The Bitterness of Love" (Dunn). 10.12—Brunswick Brass Quartette, "Wendouree" (Hume). 10.22—Mr. Eric J. Wood, baritone, "A Barque at Midnight" (Lambert), "The Trumpet Call" (Sanderson). 10.29—Mr. Albert Durand, banjoist, "Dinky's Patrol," "Virginny." 10.39—Miss Doris McInnes, "Dawn" (Curral), "The Piper of Love" (Carew). 10.46—Buckley and Nunn Studio Orchestra, selection, "Wildflower" (Youmans and Stothart). 11—National Anthem.

THURSDAY, NOVEMBER 19.

Morning Session (11 a.m. to 2 p.m.): 11—Time Signal. Express Train information. 11.3—Musical items by the Buckley and Nunn Studio Orchestra. 12—Time Signal. 12.1—Buckley and Nunn Studio Orchestra. 12.30—"Argus" and "Herald" news services. Reuter's and the Australian Press Association cables. 12.45—Buckley and Nunn Studio Orchestra. 1—Time Signal. 1.1—Buckley and Nunn Studio Orchestra. 1.45—"Herald" and "Argus" news services. Stock Exchange information. Weather forecast. River reports. 2—Close down.

Afternoon Session (3 to 5.15 p.m.): 3—Time Signal. 3.1—Musical items by the Paramount Theatre Orchestra. Musical director, Signor Vincent Ricco. 5—"Herald" and "Argus" news services. Reuter's and the Australian Press Association cables. 5.15—Close down.

Evening Session (6 to 7.15 p.m.): 6—Children's Hour. "Billy Bunny" Stories by Little Miss Kookaburra, who will tell the story of "Bunny Fluffkins" for the little ones and a thrilling story for boys. 6.45—"Herald" and "Argus" news services. Reuter's and the Australian Press Association cables. Weather synopsis. Market reports. Shipping movements. Closing Stock Exchange information. Market reports by the Victorian Producers' Co-operative Co. Ltd.: Newmarket cattle sales, pigs, grain, chaff, hay, straw, jute, dairy produce, potatoes, onions, hides, skins and tallow.

Night Session (7.15 to 11 p.m.): "Synecopation." Speakers: Madame S. E. Soward, Mr. J. Howlett Ross, Mr. John Shirlow. Will Quintrell and the Tivoli Orchestra (by permission Musgrove Theatres Ltd.). Sonora Recital; Tom Swift's Embassy Band; Mr. Bert Hopping, entertainer; Mr. Norman Bradshaw, tenor; Mr. T. J. with John and James Mitchell. 7.15—Madame S. E. Soward in a French talk, "L'eccele buissonniere." 7.45—Mr. John Shirlow, "Famous Pictures of the National Gallery." 8—Will Quintrell and the Tivoli Theatre Orchestra, transmitted from the Tivoli Theatre by permission of Musgrove Theatres Ltd., and a little surprise. 8.30—Sonora Recital: 1, overture, "Tosca," Royal Albert Hall Orchestra; 2, song, "Heart's Desire," Gladys Monerleiff; 3, cello solo, "Traumerci," C. Sharp; 4, vocal duet, "Piangi Piangi," Galli-Curel and De Luca. 8.40—Mr. J. Howlett Ross, "Victoria's Birthday and the Hentys." 9—Tom Swift's Embassy Band: "Flag that Train," "Rain or Shine," "Maisie," "Keep Smiling at Trouble," "Dream Isle," "Sweet Little You," "Out of a Million," "I'll Take Her Back," "On the Way to Monterey." During the intervals at the Embassy the following order of programme will be observed:—Mr. Norman Bradshaw, tenor, "Spirito Gentile"—"La Favorita" (Donizetti); Mr. T. J. with John and James Mitchell in mouth organ imitations; Mr. Bert Hopping, entertainer, "I've been over to the Isle of Man," "I want to go down the dear old Strand"; "Argus" and "Herald" news services; Mr. Norman Bradshaw, tenor, "Sometimes in Summer" (Bennett), "Dawn" (Leoni); Mr. T. J. with John and James Mitchell in auto-harp selections; Mr. Bert Hopping, entertainer, monologue, "Is Pipe." 11—"God Save the King."

FRIDAY, NOVEMBER 20.

Morning Session (11 a.m. to 2 p.m.): 11—Time Signal. Express Train information. 11.3—Musical items by the Buckley and Nunn Studio Orchestra. 12—Time Signal. 12.2—Buckley and Nunn Studio Orchestra. 12.30—"Argus" and "Herald" news services. Reuter's and the Australian Press Association cables. 12.45—Buckley and Nunn Studio Orchestra. 1—Time Signal. 1.2—Buckley and Nunn Studio Orchestra. 1.45—"Herald" and "Argus" news services. Weather forecast. River reports. Stock Exchange information. 2—Close down.

Afternoon Session (3 to 5.15 p.m.): 3—Time Signal. 3.1—Dr. Dumont Dunn, Ph.B., D.Litt., "Stars of the Literary Firmament—William Blake." 3.15—Musical items by the Paramount Theatre Orchestra, under the baton of Signor Vincent Ricco. 4.45—"Au Fait," of Buckley and Nunn Ltd., in a fashion talk. 5—"Herald" and "Argus" news services. Reuter's and the Australian Press Association cables. 5.15—Close down.

Evening Session (6 to 7.15 p.m.): 6—Children's Hour. "Billy Bunny" Stories: "Nursery Rhymes," "The Enchanted Forest," "Houses of the Eagle." 6.45—"Herald" and "Argus" news services. Reuter's and the Australian Press Association cables. Market reports. Closing Stock Exchange information. Weather synopsis. Shipping movements. Market reports by the Victorian Producers' Co-operative Co. Ltd.: Dairy cattle, sheep, carcass meat, grain, chaff, hay, straw, jute, dairy produce, potatoes and onions.

Night Session (7.30 to 11 p.m.): "Melody and Variety." Speakers: Mr. Alfred Peters Miss Nellie Payne, Mr. Leslie Brunning. Collingwood Citizens' Band; musical director, Mr. F. C. Johnson. Len Gibson's Banjo and Mandolin Quartette. Miss Violet Jackson, soprano; Miss Effie Armstrong, contralto; Mr. Bert Hopping, entertainer; Miss Wish Wynne and Mr. Bernard Kitchen. 7.30—Under the auspices of the Develop Australia League, Mr. Alfred Peters, "Problems." 7.45—Miss Nellie Payne, now playing "Violette" in "The Street Singer," will speak from her dressing-room at His Majesty's Theatre, by permission of J. C. Williamson Ltd. 8—Collingwood Citizens' Band, march, "Victor's Return"; waltz, "Irene." 8.15—Miss Violet Jackson, soprano, "The Nightingale and the Rose" (Thompson), "Lass with the Delicate Air" (Arne). 8.22—Len Gibson's Banjo and Mandolin Quartette in musical memories. 8.37—Mr. Bert Hopping, "Thermogene," "Who put Ham in Abraham?" 8.44—Collingwood Citizens' Band, fox trot, "Bouquet"; gavotte, "Even Bells." 8.57—Mr. Leslie Brunning, gardening notes. 9.12—Miss Effie Armstrong, contralto, "A Londonderry Air" (Needham), "The Silver Ring" (Chaminade). 9.22—Collingwood Citizens' Band, march, "Our Director." 9.27—Miss Wish Wynne, London's famous character comedienne, in selections from her repertoire, accompanied by Mr. Bernard Kitchen. 9.42—Collingwood Citizens' Band, trombone trio, "Comrades in Arms," soloists—A. Thorn, T. Murphy, A. Le Masurier; minuet, "Bocherini." 9.58—"Argus" and "Herald" news services. 10.2—Miss Violet Jackson, soprano, "L'air de Salome" (Massenet), "Le Nil" (Leroux). 10.9—Len Gibson's Banjo and Mandolin Quartette in musical medleys. 10.24—Miss Effie Armstrong, contralto, "At Night" (Strauss), "Where Corals Lie" (Elgar). 10.31—Collingwood Citizens' Band, euphonium solo, "Out on the Deep," soloist—R. Spencer. 10.40—Mr. Bert Hopping, entertainer, "A Smile will go a Long Way," "Red Hot, Mama." 10.47—Collingwood Citizens' Band, hymn, "Edwinstone"; grand march, "Aux Flambeaux." 11—"God Save the King."

RADIO FOR THE PRESS. NEWSPAPERS PERSISTENT

At the annual conference of the Country Press Association general indignation was expressed by delegates at the refusal of the Postmaster-General to permit the association to establish its own wireless station in Sydney for the transmission of news to the country newspapers.

Mr. J. Ryan, M.L.C., suggested that further representations be made to the Government, and this was agreed to. It was also decided to ask every candidate for the Federal Parliament whether he favoured permission being granted for the establishment of a special news broadcasting station.

A CORRECTION

In another portion of this issue appears an advertisement of Mr. J. Wetless. The minimum capacity of the condenser is quoted as .00005. This should read .000055.

Children and Song

ONE often hears the expression, "With a smile on his lips, and a song in his heart," referring to some acquaintance who radiates good fellowship, hasn't a care in the world, and altogether illustrates that this old earth is a good place to be alive in. It will be remembered too, that it was with song that our gallant men advanced to battle in Gallipoli, Egypt and France, symbolic of the whole British stock. The community singing concerts too, are always full to overflowing, but this liking for music is not suddenly thrust upon us as we grow into maturity. It seems to be born in us, memories of yesterday bringing back to us the martial strains of the school anthem—how we thrilled as we sang it with all our hearts, and made us feel proud of the old school and its traditions.

During recent tours of the Prince of Wales, massed school choruses have welcomed him at various places he has visited, and only a few weeks ago our late Governor-General, Lord Forster, was farewelled by the school children of Melbourne at Government House. "How lovely," exclaimed one visitor, but there was more in it than that; it was awe-inspiring, and demonstrated to our departing leader that although the parting was not easy, the best way to do it, was—and should be all through life—with song. If only all of us could carry with us throughout the years the care-free and joyous spirit of childhood the world indeed would be a Paradise.

It has been recognised of late years that singing is the chief factor of the right spirit, and helps more and more than any mathematics or political economy could ever do to mould our character and destiny, and the education authorities have made it one of the most important in the school curriculum. To further this movement, 3LO, Melbourne, have started a children's song competition, open to all under the age of 14 years. That it will help in the education of the youngsters there is no doubt at all, as the pieces for the different ages of the children are taken from all classes of song. In the senior section from 11 to 14 years, the song has to be taken from "Bush Songs" or "Australian Songs" composed by the famous Georgetts Petersen, and in these books, almost every phase of life in the bush is illustrated from "A Little Aborigine," to the "Baby Bear." The latter describing the antics of our native bear, now unfortunately becoming extinct. Another favorite song is "Good-night," and as the title suggests, is a bed-time song, with Goblins and Sandmen in the Land of Nod.

In the intermediate section which is open to all between the ages of 8 and 11, the songs are taken

from Schneider's "Nature Lyrics for Children." The music in this publication is within the range of almost every child's voice and the songs are not only rich in poetic thought, but, also in melody, thus endeavouring to convey the thought of the poem as the musical theme, cultivating the musical appreciation of the children, and inspiring them to sing well. On a perusal of this edition, it will be seen that the majority of the songs are to be sung joyfully. Indeed this could be applied with great success throughout the whole repertoire in the competition and if this spirit is kept up, "listeners in" amongst all ages, will be enthralled. Included in this book are "The Brown Thrush," "Spring," "Blue Bird," in fact all the songs are typical of the open air flower and bird life.

The tiny tots—those under 8 years, are asked to sing any one from "Songs the children love to sing," edited by Mr. A. B. Lane, of the Victorian Education Dept. This edition is divided into numerous sections, including song games, nursery rhymes, songs of the seasons, animal songs, etc. Of course, the game songs are familiar to us all, with "London Bridge is falling down," "Mulberry Bush," "Ten little Indians" to quote only a few. Of all songs of childhood which we may hear again later in life, the "Nursery Rhymes" are most wrought with pleasant recollections, for they revive the days when a loving mother taught them to us, "Baa, Baa, Black Sheep," and "Old King Cole," being perhaps the first choice.

There are also a few nature songs, and although worded perhaps in a fanciful way cannot be other than helpful and elevating to the youngsters, as they describe the forces of nature which are daily at work all around them. There are songs of the stars, the sun, the winds, the snow, moon and trees, all with lyrics which point pretty word pictures of these forces of nature which do their tasks silently but surely, year in, year out.

The adjudicator for these contests is Mr. Alfred B. Lane, and he has had great experience in this direction in the teaching of children in the Victorian schools. He is also well known to the "grown-up" listeners-in too, as he is one of the favorite conductors of the community singing broadcasted by 3LO, Melbourne, weekly. The entries—which must be in before 1st November—are already pouring into the studio in Collins Street, and a busy time is anticipated during the next few weeks. The prizes in each section consist of a gold and silver medal for the first and second respectively, and winning one of these is sure to be imprinted on the memory of the lucky youngster, who succeeded in doing what we all should do—"A smile on the lips, and a song in the heart."

New A.W.A. Product



Super Radio Frequency Transformer



30/-

Points of Superiority!

1. Gives constant amplification over a wide range of wavelengths without adjustment.
2. No switching or other mechanical device is used in the A.W.A. Super R.F. Transformer.
3. The elements have been made moisture-proof by sealing in an insulating compound.
4. Efficient electrostatic and magnetic screening has been provided for in the container, and the aim has been to reach perfection in the mechanical and electrical construction.
5. **GUARANTEE.** We undertake to make good any defect in the A.W.A. Super Transformer that may arise within ninety days of date of invoice in respect of either material or workmanship, provided the apparatus is not tampered with, and is returned to us carriage paid and duly advised.

Our responsibility is limited to making good the defect free of charge.



At all Radio Dealers

Amalgamated  **Wireless**
(Australasia) Ltd.

97 Clarence Street
SYDNEY

167-9 Queen Street
MELBOURNE

GEC^oVALVE

*GEC^oVALVES now being
used in thousands of sets
all over Australia.*

GEC^oVALVES — in many specialised types for wireless enthusiasts everywhere. every particular required — are used by

The long life and entire dependability of these valves, plus the fact that there is a specific type for each purpose, are reasons for this wonderful popularity. The wireless enthusiast knows that he can go to any reliable dealer and get every type of valve he needs—all backed by the name GEC^oVALVE.

Constantly improving design by exhaustive research, and unrivalled manufacturing experience have made GEC^oVALVES supreme for modern wireless reception under all conditions. Made at the Osram G.E.C. Lamp Works, England—the largest valve and lamp works in the British Empire. Their design is directed from the Wembley Research Laboratories of the General Electric Co. Ltd., England.

Always insist on GEC^oVALVES — there is a dealer near you who stocks them.

At All Reliable Radio Dealers

British General Electric Co., Ltd.

"Magnet House"

154-6 CLARENCE STREET, SYDNEY

*and at Melbourne, Adelaide, Perth, Newcastle
Dunedin, Wellington, Auckland, N.Z.*

GEC^oVALVES ARE BRITISH MADE