

The  
Queensland

# RADIO NEWS

RN



A MAGAZINE for the  
SET CONSTRUCTOR &  
BROADCAST LISTENER

6<sup>d</sup>

**FEBRUARY 1st 1929**

VOL. V.

NO. 1

# RADIOKES

## 1928 Browning Drake Kit

is eminently suitable for adapting this popular Receiver for  
**SCREEN GRID OPERATION**



**PRICE . . . £2 Per Kit**

The Browning-Drake has been perhaps the most popular receiver ever known in all parts of the world. The latest improvement in utilising the inherent stability and great amplification of the Screen Grid Valve in the radio stage, with the much better sensitivity and ease of operation, places the Browning-Drake once more in the front rank of popularity; it will be built this season more than ever.

### THE 1928 RADIOKES BROWNING-DRAKE KIT

is most satisfactory for building in and has been featured by leading radio technical journals (including the "Broadcast Bulletin," January 14th, 1929). Once more Radiokes have demonstrated that there is a Radiokes coil for every circuit, and further, that the leading authorities appreciate Radiokes coils as being the finest procurable, and do not hesitate to recommend Radiokes make for every purpose.

**Radiokes Browning-Drake Coil Kit is PERPETUALLY and UNCONDITIONALLY GUARANTEED** —*Think of that!*

Costing no more than inferior, unknown productions; but with a definite guarantee of satisfaction and a lifelong assurance that wear or breakage will not deprive you of the services of this excellent product. This Kit is constructed of the best materials procurable by Radiokes master craftsmen. Having convenient mounting facilities, this Kit is easy to build into your receiver and simple to wire. Being of correct electrical design and precision manufacture, your success is at once assured, and you are obliged to waste no time "messaging about" to get your completed receiver to function satisfactorily.

**Buy Radiokes always and be safe for all time**

51  
Charlotte  
Street,  
Brisbane.

**EDGAR V. HUDSON**

Phone:  
Central  
8622.

P.O.  
Box  
522H.

*Knife Edge Selectivity*  
with the  
**Pontynen Tuning Unit**

PATENTED

SELECTIVITY  
VOLUME  
SIMPLICITY

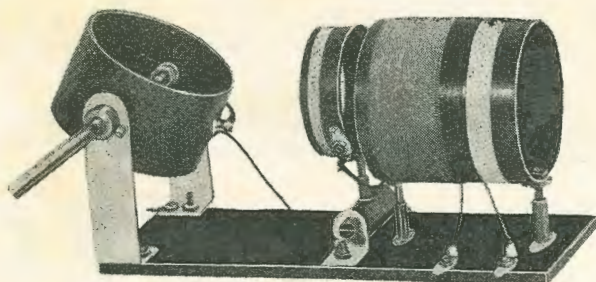

Scientifically constructed of highest-grade materials.

It is now possible to build a simple three-valve receiver that will cut clean through the powerful local station without the use of a wavetrap, and bring in far-distant transmissions at full loudspeaker strength—volume equal, in fact, to that of the average five-valve set. Such a receiver is the "PONTYNEN THREE," featured in this issue of "The Queensland Radio News." The secret is the use of the wonderful

# PONTYNEN FILTER

Described by the Technical Editor as "a revolutionary development in the field of broadcast reception."

Supplied complete with full instructions and a blue-print of connections.

# £3

Just as easy to instal as any standard type of tuner.

Buy the Pontynen Tuning Unit DIRECT from the Manufacturers, and save dealers' profits.

## THE PONTYNEN RADIO MANUFACTURING COY.

REGENT ST., off O'Keefe St. SOUTH BRISBANE

(Alight from tramcar at Stone's Corner Bridge).

PHONE:  
J 3370

**COME IN  
AND  
HEAR IT!**

You've heard and read such a lot about these new MAGNAVOX Dynamic Speakers, that you must be curious to know just what they can do. **COME IN and HEAR THEM**—we have a special demonstration parlour, and you do not incur the slightest obligation by calling.

**COUNTRY  
READERS!**

Let us send you some interesting pamphlets that give you full details about this—the wonder speaker of the century.

**Now—**

**MAGNAVOX  
DYNAMIC  
POWER SPEAKERS**

**—for £10!**

**New Low Prices**

*Bring these incomparable Speakers  
within the reach of every set owner*



**BEVERLEY JUNIOR  
MODEL**  
Fitted with Unit to work  
from accumulator or  
trickle charger,  
£10/-/-.



**BELVEDERE (Fire-  
screen) MODEL.**  
For "A" battery opera-  
tion, £11/10/-.  
For A.C. power point  
operation, £14/10/-.

The enormous output by the Magnavox Company, created by the open preference of set-owners throughout the world for this new Dynamic Speaker, and the adoption exclusively of the Magnavox Power Speaker as built-in by famous makers of fine sets in England and America. . . . these dominant facts alone have brought about the revised Magnavox prices now prevailing throughout Australia.

Magnavox Dynamic Power Speakers differ from other speakers both in principle of operation and construction. Made under exclusive Magnavox patents covering principles which are acknowledged by leaders in radio science as the only type of speaker construction capable of flawless radio reproduction. This new Magnavox Dynamic realism has caused a furore everywhere. . . . a low whisper. . . . pure and clear . . . or a glorious cascade of volume . . . without the slightest distortion.

*Special Discounts for Dealers*

*Wholesale and Retail Distributors—*

**Mick Simmons Ltd**

"The Home of Sport and Radio."

**Queen Street, BRISBANE !**



# The QUEENSLAND RADIO NEWS

ALFRED T. BARTLETT  
*Editor*



LEIGHTON GIBSON  
*Technical Editor*

FRIDAY, 1st FEBRUARY, 1929.

## “Broadcasting is Doomed...”

**L**IKE the voice of some great mis-shapen ogre, the wail of the pessimist rises into the heavens: “Broadcasting has failed—its future is doomed.” Were we to believe such dismal forebodings, the usefulness of this or any other radio journal would be at an end. But a sheaf of evidence is at hand to shatter the distorted gospel of pessimism—evidence that is too strong to be ignored and too logical to be discounted.

Broadcasting has become an integral part of the daily life of the people of the universe. As a hobby, radio never grows “stale.” As a utility, radio is becoming more and more valuable every day. As a medium of entertainment, broadcasting is attracting millions nightly, despite the fact that the human ear has become a very critical organ in relation to the loudspeaker.

No other branch of science can boast of the advancement achieved by radio in such an incredibly short span of years. New developments are seeing the light with startling rapidity and we, who are prone to think that the very pinnacle of radio perfection has been reached, are finding out how little we really know of the art. Always there is some new development in the offing—something to stimulate fresh interest and to revive any waning interest in the bosom of the amateur.

That is the fascination of radio—it is alive; it is virile; it is inexhaustible. It is unlike anything that savours of the mechanical. Radio reproduction can and will be made practically perfect, and in the accomplishment of this ideal the experimenter will find much to interest him. Telephony and television are well within range, inextricably allied with broadcasting and exerting an undeniable influence upon it.

The next few years promise to be the greatest in radio history. As far as the trade is concerned, an era of comparative stability will dawn which will be far more profitable than the alternate “boom” and depression periods that are inseparable from all new industries. We believe that the gramophone—erstwhile competitor of radio—will join forces with it to an extent only dimly foreseen at the present time.

And so to the pessimist who bemoans the trifling fact that a handful of people are cancelling their listeners’ licenses, and would have us believe that, because of this, broadcasting is doomed, we point to the future, brilliant with promise. Broadcasting has gone far, but it will go much farther, and the day is in sight when the puny voice of the pessimist will be lost in the grand paean that will rise from appreciative mankind.

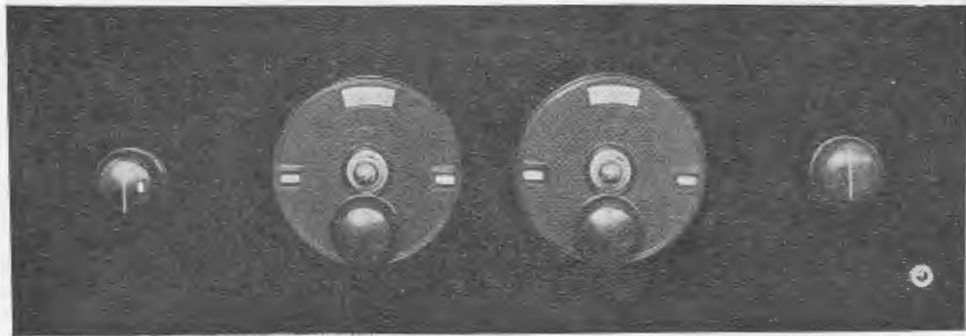

FIG. 1.—Front view of panel. From left to right are the filter control, filter condenser, tuning condenser, reaction, and loudspeaker jack, which also acts as a battery switch.

SOME six months ago, the writer was privileged to be present at a private demonstration of an experimental model three-valve receiver for which revolutionary features were claimed. These claims, it may be said, were such that they were met on all sides with a great deal of scepticism, and the writer, at any rate, fully expected to see and hear "just another three-valver," outstanding in the eyes of its creator, but in reality little or no better than the ordinary run of three-valve receivers.

Briefly, the attributes claimed for the new circuit were these: Selectivity of a Super-Heterodyne, volume of a five-valve set, and extreme simplicity withal. The demonstration took place at the home of Mr. Harry Pontynen, the inventor of the circuit, and was attended by perhaps half-a-dozen interested persons, including, as has been said, the present writer. In appearance, the receiver held out no promise of the remarkable properties we were told it possessed. It seemed to bear a strong resemblance to the orthodox Reinartz arrangement, with an extra coil or two thrown in. It was quite unimposing in dimensions, and had few controls.

What a surprise, though, was in store for that little knot of sceptics! After turning on the battery switch, Mr. Pontynen proceeded with great calmness to "run through" the entire list of Australian and New Zealand broadcast stations, tuning-in one after another at full loudspeaker volume, and with absolutely no trace of interference from 4QG, two miles distant. Small, "B" class stations which we had been accustomed to pass over because of the weakness of their signals, appeared in some miraculous fashion to have been transported to a point some two or three hundred miles closer, while the main Southern "A" class stations were received with just the same strength as the local station. In fact, as far as volume was con-

cerned, it was impossible to be sure, at times, whether one was listening to 2FC or 4QG. So sharp was the tuning that it was a very easy matter to tune past 4QG without hearing him; at the same time, the operation of tuning-in distant stations was not a critical one, and the reaction effect was pleasantly smooth in action.

**A THREE-VALVE** receiver that will tune-in all the Southern stations within one mile of 4QG, and with a total absence of interference from that station, is something of a curiosity, to say the least. Yet this is what the Pontynen Three does, and does with ease. Most three-valve sets require the use of a wavetrap in order to permit reasonable freedom from interference, and while a well-designed trap may have very little weakening influence on the distant stations, it certainly contributes nothing towards the efficiency of the receiver. The Pontynen system, however, actually increases the efficiency of the circuit, with the result that the receiver develops an amazing volume of sound when tuned to receive stations a thousand and more miles distant. It is a remarkable receiver in many respects, and is well worth the attention of those who are interested in the quest for a highly selective and powerful broadcast set.

The Pontynen circuit is the result of some years' work on the part of its inventor, who has now obtained patent protection for his idea. The principles involved in the circuit's action are not fully understood, but there is no doubt as to the effectiveness of the idea. Basically, the circuit incorporates a variable filter which, tuned to the wavelength on which it is desired to receive, eliminates completely any background from a nearby station. Until recently, the company formed by Mr. Pontynen to develop the idea has confined its attention to the production of complete receivers embodying the Pontynen tuning system. At our suggestion, however, they have decided to make the filter unit only, available to the public, so that any enthusiast with average capabilities may assemble a simple receiver giving all the advantages to be gained by the Pontynen system. These units are supplied complete with a blue-print showing the connections, and really take the place of the tuning coils usually used in a three-valve set of conventional design.

**Construction of the Pontynen Three.**

The actual building of a Pontynen Three offers little difficulty; it is, indeed, not a bit more complicated than any three-valve set of the ordinary type, and the model to be described has been so carefully designed and laid out that the wiring is simplicity itself. In this regard, we have followed the design worked out by the manufacturers, as it has proved to be an ideal one in practice, and there appears to be no room for improvement here.

Extreme Selectivity plus Volume plus Tone with

# The Pontynen Three

A Three-valve Receiver of Amazing Capabilities

DESCRIBED BY THE TECHNICAL EDITOR

The panel may consist of bakelite, radion or plywood suitably stained and polished. A metallic panel may be used if desired, provided care is taken to insulate the filter-coil spindle, filter condenser C1, and the jack J from it. Fig. 3 supplies full details of the measurements between the centre-holes for the various parts. The vernier dials require an extra hole each for their catch-screws, but the position of these can easily be ascertained by the use of the template always packed with the dials. Sharp "metal drills should be used, run at high speed. If the panel is bakelite, it must be laid out on a flat board when drilling, and the pressure applied to the drill should be gradually reduced as it is about to break through; this is done in order to prevent—or, at any rate, minimise—the danger of chipping on the reverse side of the panel. The edges of the panel will look the better for a thorough smoothing down with a with fine sand-paper, after which a little oil rubbed into the edges will give a dark finish. The surface of the panel can be cleaned and polished with Brasso or methylated spirit and a soft rag, after which it is screwed to the wooden baseboard in the usual way. The three variable condensers and the single-circuit filament

control jack are mounted on it, and the two vernier dials secured to the condenser spindles.

In our model of the Pontynen Three, it will be noticed that we have used a .001-mfd. variable condenser (C1) in the filter circuit. This capacity is employed in order that the circuit may cover a very wide band of wavelengths—the receiver illustrated tunes from above 7ZL (Hobart) down to well below 5KA (Adelaide). However, it is possible to dispense with a condenser of this size—a size that may be rather difficult to procure in some localities—without sacrificing much. Provided the Pontynen filter unit is suitably designed, a .0005-mfd. variable condenser may be substituted at C1, and the set will then comfortably cover the wavelengths between 7ZL and 2KY—a band in which all the worthwhile stations are operating. One must be sure, though, to mention when ordering the Pontynen unit that it is required for operation with a .0005-

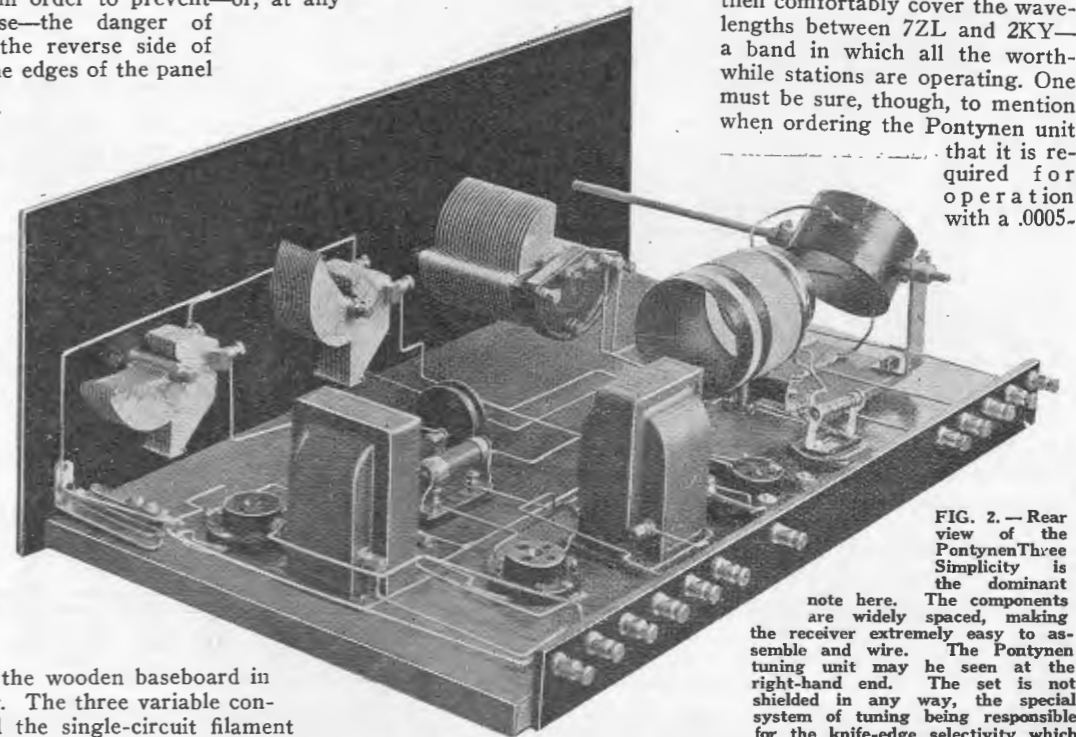

FIG. 2.—Rear view of the Pontynen Three. Simplicity is the dominant note here. The components are widely spaced, making the receiver extremely easy to assemble and wire. The Pontynen tuning unit may be seen at the right-hand end. The set is not shielded in any way, the special system of tuning being responsible for the knife-edge selectivity which the circuit demonstrates.

mfd. filter condenser.

The filter unit L is screwed to the base-board in the position indicated in the pictorial diagram (fig. 4), care being taken that the long spindle on which the filter coil is mounted will line up with the hole which has been drilled for it in the front panel. The remainder of the construction is explained by the drawing, in which every component is illustrated very clearly. As has been mentioned, the work involved in building the Pontynen Three is no more difficult than in the case of any ordinary type of three-valve receiver. Indeed, it is easier to construct than many sets on account of the liberal spacing that has been allowed between the various instruments. It is important to remember that the valve sockets and audio transformers must be mounted so that the markings on their terminals correspond with the indicating letters in the pictorial diagram, otherwise mistakes are almost certain to be made in the wiring.

**Wiring.**

The wiring in the present receiver has been carried out with 16-gauge bare tinned copper wire, no insulating sleeving being used at any point. This gauge of wire is stiff enough to be self-supporting, and if it is bent to the proper shape, there will be no danger of any two wires touching and thus causing damage.

Note the row of terminals mounted in line on a bakelite strip, which is screwed to the back edge of the baseboard. These terminals are located in such positions that the wires connecting them to the components are as short and direct as possible. All joints must be well soldered, and wherever a wire is to be joined to another, a hook should be made and clamped securely onto its mate, after which the union is heated and solder run into it. This type of joint is far stronger mechanically and immeasurably superior in every way to the commonly used "budded" joint, which is extremely unreliable.

**Valves and Batteries.**

Good results will be secured with valves of the 2-, 4- or 6-volt class, but it is recommended that either 4-volt or 6-volt types be used in conjunction with an accumulator. "A" battery of small capacity. In our own model of the Pontynen Three, we are using Mullard 4-volt valves—a PM-4D in the detector socket V1, a PM-3 in the first audio socket V2, and a PM-254 in the last audio socket V3. The Mullard PM-4D is a highly-sensitive valve designed especially for use as a detector, and will give much greater signal strength on distant stations than the "general-purpose" type of valve. The PM-3 is a high-amplification valve ideally suited to first audio stage operation, while the PM-254 is a power-valve, capable of handling comparatively large volume without distortion. As regards current

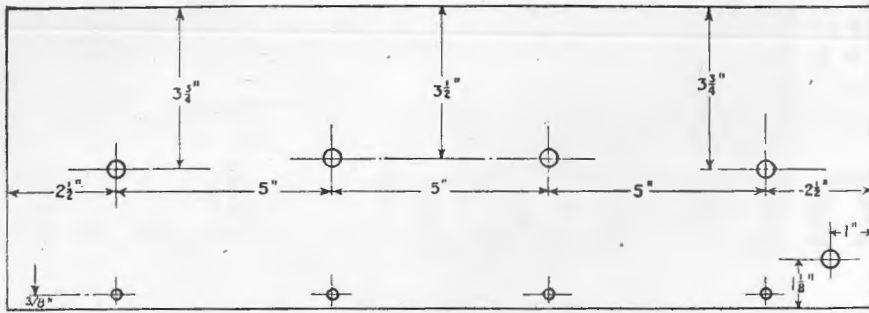

FIG. 3.—Measurements between the centre-holes are shown in this panel drilling diagram. The panel measures 20 x 7 x 3/16 inches.

consumption these valves are very economical, the total filament current drawn from the "A" battery being less than 1/2 amp. when the combination mentioned is used.

Too much stress cannot be laid

upon the importance of utilising the correct type of valve in each socket. This remark applies to every receiver—not merely to the Pontynen Three—and it is a factor that is far too often neglected, with a tremendous sacrifice of efficiency. It should be clearly understood that by "type" we do not mean any particular "make" of valve. The leading valve manufacturers of to-day produce a range of types of which one can be selected for every purpose likely to be met with in modern radio reception, and, as a general rule, the novice can be guided by his dealer in this matter. As an alternative, the information may be obtained by making use of the "Questions Answered" page of this journal, or of the "I'd Like to Know" page of "The Broadcast Bulletin," the latter offering a much quicker service, being a weekly production.

Important as this matter of valves is, it is not one whit more important than the provision of adequate "A" (filament), "B" (plate or H.T.) and "C" (grid bias) supplies. No valve can operate at maximum efficiency if an insufficient or otherwise incorrect value of voltage is applied to any one of its three elements—filament, plate and grid. Fortunately, one need never be in doubt as to the voltages required by any particular type of valve. All this information invariably is supplied in the leaflet of instructions packed with the valve, and it may be taken that these particulars are authentic and may be followed with safety.

In the course of the last two paragraphs we have been generalising. Now let us analyse the requirements of the receiver in which we are particularly interested at the moment. We will assume that the valves mentioned are being used—Mullards PM-4D, PM-3 and PM-254. First of all, a four-volt accumulator must be provided; referring to the pictorial diagram, the terminals marked "A—" and "A+" are connected to the negative and positive terminals, respectively, of this battery. Alternatively, of course, a dry-cell "A" battery may be employed—three dry cells connected in series—but the storage battery is strongly recommended as being less expensive in the long run, and considerably more satisfactory in every respect. Now for the "B" battery. Unless a "B" eliminator is available two 45-volt heavy duty "B" batteries should be provided. Terminal "B—" is connected to the "—" terminal of the first "B" battery, and "B+DET" to the "+22 1/2" point of the same battery. A short piece of wire is run from the "+45" point of this same battery to the "—" terminal of the second "B" battery, thus connecting them together. The terminals marked "B+" and "B+PWR" are both connected to the

"+45" point of this second "B" battery, thus completing the "B" connections.

Two 4½-volt "C" batteries are needed, and are connected up in the following way: Terminal "C+" goes to the "+" terminal of the first "C" battery, and "C-" to the "-3" point of the same battery. A short wire joins the "-4½" point of the same battery to the "+" terminal of the second "C" battery, while the terminal marked "C-PWR" is joined to the "-4½" point of the same battery.

If one is prepared to make the small extra outlay, it is a great improvement to add one more 45-volt unit

to the "B" battery, thus increasing its maximum value to 135 volts. In this case, the "B+PWR" wire is removed from the "+45" terminal of the "B" battery, and attached instead to the "+45" point of the **third** "B" battery, while a short wire joins the "+45" of the **second** to the "-" of the **third**. When an increase is made in the plate voltage applied to any valve, it is always necessary to make a corresponding increase in the "C" voltage, so it will now be necessary to add two more 4½-volt "C" batteries, thus making the voltage up to 18. The alteration is made in this way: The "C-PWR" wire is transferred from the "-4½" ter-

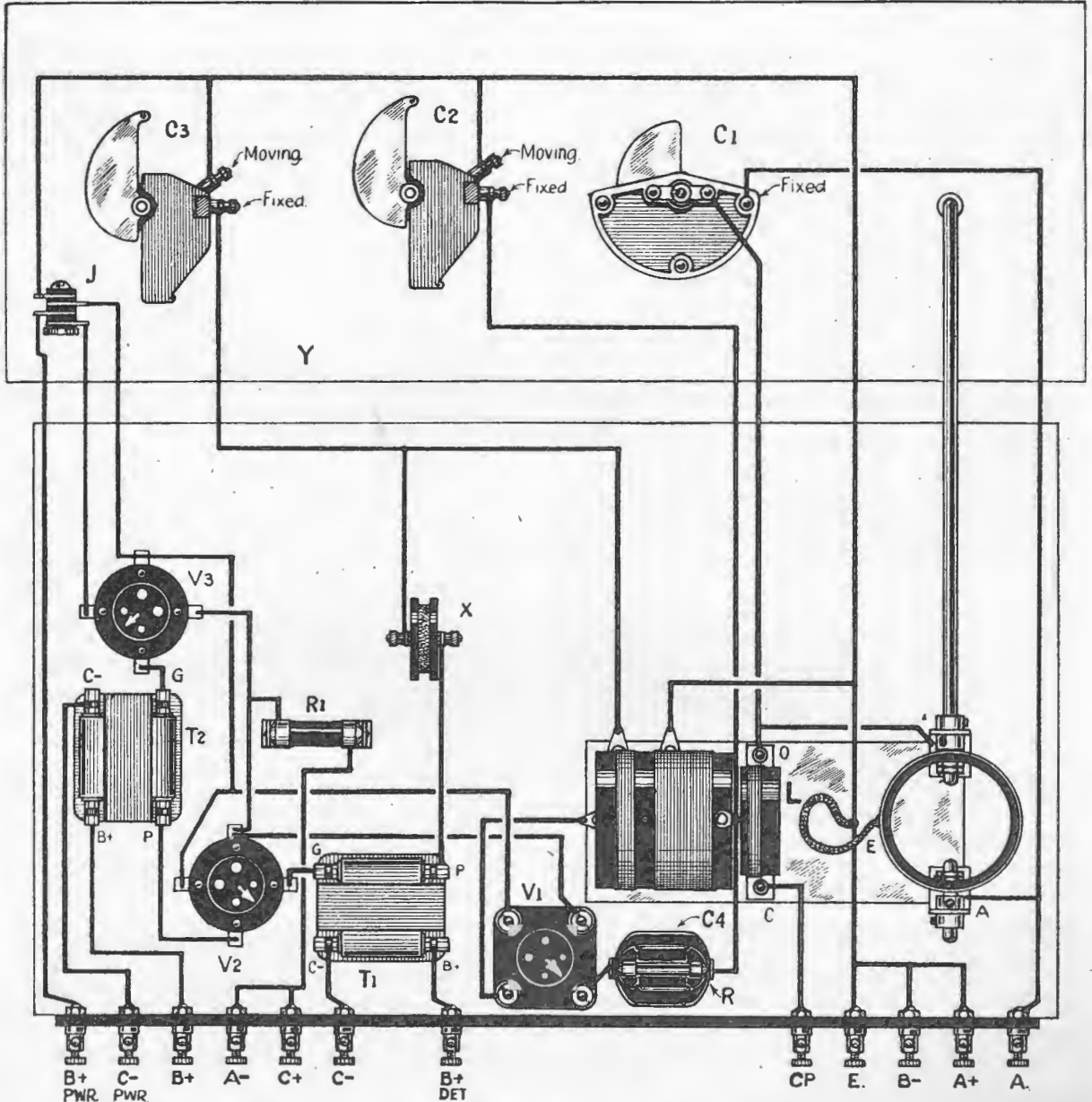

FIG. 4.—Pictorial diagram. Note that the flexible connection from the variable filament coil is joined to the wire running from the earth terminal ("E"). Also notice that the wire running from the grid condenser C4 to the fixed plates of C2 is connected to one terminal of the large coil. This is mentioned because the connection does not show very clearly in the drawing.



terminal of the second "C" battery to the same terminal of the fourth "C" battery. The "-4½" of the second is joined to the "+" of the third, and the "-4½" of the third to the "+" of the fourth. While the set will give excellent results with only the 90 volts of "B" and 9 volts "C" first mentioned, a distinct improvement in tone and some slight increase in volume will be secured by the use of the higher values. Note that the increased voltage is applied to the last valve only—the PM-254 power valve. It is for this reason that separate "B" and "C" terminals are incorporated for the two audio valves, the abbreviation "PWR" referring, of course, to "power."

#### Aerial System.

As far as the aerial itself is concerned, an elevated outdoor wire of average length and height will give good results with the Pontynen Three. The earth system must be good. A connection to a city water-pipe will serve if it is made at a point close to where the pipe enters the ground. Generally, however, it is found that some form of buried earth gives better results—particularly in dry ground. This may take the form of a buried zinc or other metallic plate, or even a kerosene tin, buried as deeply as possible in ground that is kept in a moist condition.

Now we come to a feature of the Pontynen Three that has no parallel in any other receiver, as far as we are aware. In addition to the aerial and earth, a counterpoise is **absolutely essential** for correct operation. The type of counterpoise does not appear to matter greatly, as we have had every satisfaction from a length of insulated wire tacked around the skirting board inside the house. Improved signal strength is secured by the use of a regular counterpoise, erected underneath the aerial about 8 feet from the ground. The dimensions are not important, except for the fact that the counterpoise always should be smaller—that is, shorter in overall measurements—than the aerial. Experiment has shown that the ideal ratio between aerial and counterpoise—including lead-in in both cases—is 1½ to 1, which means that the counterpoise should be about two-thirds of the length of the aerial.

The aerial is connected to the terminal marked "A," the earth to "E," and the counterpoise to "C." The loudspeaker must be equipped with a plug, which is inserted in the jack "J." This jack, it should be noted, is of the filament-control variety, which eliminates the necessity for a battery switch. The action of inserting the loudspeaker plug in the jack automatically switches on the filament supply, and withdrawing it cuts everything off again.

#### Tuning.

A close examination of the rotating coil of the Pontynen filter unit will reveal the fact that the connections from the end of this coil are taken on the inside of the tube to the ends of the nickel-plated spindles. As an initial adjustment, the coil should

be turned so that the wire joined to the long spindle is upwards. The coil will then be at right-angles to the fixed coils.

It will also be noticed that the small coil which is mounted close to one end of the large fixed coil can be rotated about a vertical axis, and may be moved towards or away from its neighbour. To begin with, it should be placed close to, and parallel with, the large coil.

To tune in a station, first insert the loudspeaker plug in the jack "J," when the receiver should sound "live." The reaction condenser C3 is now turned into mesh until the set oscillates, this state being indicated by a soft hissing sound. Now the centre tuning condenser C2 is slowly rotated until the carrier-wave or whistle of, say, 2BL is heard. Rotate the filter condenser C1 until the circuits are in resonance, when the whistle is at maximum strength. Now reduce reaction until music or speech is heard. Interference will probably be evident from the local station, and this is eliminated by varying the filter coil of the Pontynen unit either way **very slowly**. If it is found impossible to eliminate the interference by this means, it is probable that the small rotatable coil previously mentioned is reversed; it should be turned completely round on its axis, and the filter coil again varied. As soon as interference is eliminated, the distant station is brought up to maximum strength by carefully re-tuning with the main condensers C1 and C2, and adjusting the reaction condenser C3 for the desired volume. The distance between the small coil and the large fixed coil will be found to exert a marked effect upon both selectivity and volume, and a little experimenting here is well repaid.

No doubt all this sounds very complicated. In reality it is not, and once the dial readings for each station are noted, it is a simple matter to return to them at any future date. It will be found that the adjustment of the filter coil is critical, and it must be handled very lightly. It must be borne in mind that the tuning of the filter unit is totally different from that of the conventional type of wavetrap, which is set to eliminate a given station, and is not thereafter adjusted. The Pontynen filter coil must be re-adjusted for each station tuned in, the tuning procedure being the same in every case—close reaction condenser, pick up whistle on C1, tune to maximum with C2, clear up with reaction C3, vary filter coil to eliminate background. Finally re-tune slightly with all controls.

Just a final word or two: The reader who constructs the Pontynen Three should not expect too much from the set until he has become thoroughly familiar with the controls. As has been said, the tuning of this remarkable receiver is quite different from the ordinary type of three-valve set, and the wonderful results of which the circuit is capable will be obtained only after some measure of proficiency is attained in the handling of the tuning controls.

#### PARTS FOR THE PONTYNEEN THREE.

- 1 .001-mfd. variable condenser, C1 (or .0005-mfd.—see text).
- 2 Formo .0005-mfd. variable condensers, C2, C3.
- 1 Sangamo .00025-mfd. grid condenser with clips, C4.
- 2 Emmco bakelite vernier dials.
- 2 Emmco bakelite arrow knobs.
- 1 Emmco single-circuit filament-control jack, J.
- 1 Pontynen tuning unit (specify for .001 or .0005 condenser), L.
- 1 Electrad 5-meg grid leak, R.

- 1 Cydon Temptryte, 1½ ohms., R1.
- 2 A.W.A. "Ideal" 3½-1 audio transformers, T1, T2.
- 1 Emmco balanced socket, V1.
- 2 Buffalo U.K. sockets, V2, V3.
- 1 Radio-frequency choke, X.
- 1 Bakelite panel, 20 x 7 x 3/16 inches, Y.
- 1 Stained pine baseboard, 19 x 11 x ¾ inches, Z.
- 1 Bakelite terminal strip, 18½ x 2 x 3/16 inches.
- 12 Nickelled phone terminals.
- Wire, screws, etc.

#### ACCESSORIES:

- 1 Mullard PM-4D valve.
- 1 Mullard PM-3 valve.
- 1 Mullard PM-254 valve.
- 2 45-Volt "B" batteries.
- 1 4-Volt accumulator.
- 2 4½-Volt "C" batteries.
- 1 Loudspeaker with plug.
- Aerial and counterpoise.

# Wireless in the Desert

*In the following article a famous woman explorer writes, among other things, about the mysterious native "wireless" of the desert. "Radio may beat desert forms of communication—yet desert news travels faster than a telegram!"*

By ROSITA FORBES.



Present the apparent rate of communication in the desert ranges from the two miles an hour of a baggage caravan to six of a trotting camel. Yet news travels faster than an Australian telegram! Every African or Arabian traveller is well aware of the unseen "desert wireless," by which mysterious means information leaps from one isolated village to another.

## Uncanny "Transmission."

For instance, when Sir Lee Stack was killed in Cairo, a friend of his was shooting ibex in the Red Sea mountains, six hundred miles away. The journey had taken him twenty-four days by camel and there was no other means of doing it. His camp was in those spectacular hills inhabited by shock-headed Haddendowe, separated from Egypt and the nearest telegraph or telephone by the Eastern desert. Yet he received the news of the Sirdar's assassination three hours after it had happened!

Further south, this particular miracle may be attributed to bush fires, to smoke or sound signals. In Central Africa, if you want to warn a distant chieftain of your approach, the local drummer will beat out the message on a hollow tree-trunk. The next village will hear the signal and repeat it in the same way, so that through forests and along river banks the news reverberates from one mighty-muscled "telegraphist" to another.

## No Sign of Life.

But there are no drums in the desert. Sometimes, for several hundred miles there is no human being. There is neither stick, nor bush, nor blade of grass with which to make a fire, yet all that happens on this sunburnt waste is known the same evening in the surrounding camps and villages.

When I travelled across the Libyan Desert to Kufra, no caravan passed us for fifteen days. We saw no human being, let alone a fast rider to carry the news of our coming. We camped in hollows, lighting no fires, for fear of enemies. Our powerful field-glasses showed us, day after day, an uninhabited world as blank as a gramophone disc. Yet, when we left the desert, every hostile village expected our arrival and knew how and whence we came!

Can wireless do much better than this? Of course, it would be invaluable to the explorer as a means of fixing his position, and it has already been used for that purpose by several Saharan expeditions.

The frontier forts south of the Atlas, where the Foreign Legion guard the edge of the great Hamada desert, depend on their wireless rather than on their guns. Every movement on the scarlet sands is recorded for the benefit of Bou Denib, from which reinforcements can be despatched at a moment's notice.

I was talking to a French officer in one of these forts, impaled like a beehive on the top of a cliff. It appeared, by its isolation, its inadequate water supply and its garrison, limited in number and ammunition, to invite attack, but the Commandant assured me: "As long as our wireless holds out, we're all right." In fact, before the nomads could pierce the barbed wire which forms an outer defence, mounted Legionaries would be on their way from the next post and aeroplanes hurrying from Bou Denib.

## Preventing Lawlessness.

Wireless is the worst enemy of lawlessness, and, in time, it will conquer the last stronghold of African Touareg or Arabian Wahabi. Already Iba Saoud, the Puritan Sultan of Nejd, is experimenting with an aerial on the mighty expanse of mud root which dominates his capital of Ryadh. His subjects, who impose their conservatism at the sword's point, imagine it a symbol of Western magic and disapprove as vigorously as they dare.

When the Sultan was at Ryadh, it used to take six weeks for his officials at Mecca to get an answer to their often despairing letters, and the peace of Western Arabia hung on the pace of a camel! Wireless will consolidate the power of Arabia's strong man, as surely as, in conjunction with the aeroplanes of Basra and Baghdad, it has limited the activities of border raiders.

When I first crossed the Sahara in 1919, there were forts wherein the solitary white officer was cut off from every echo of civilisation, from even the sound of his own language, for six months at a time. If anything happened to him his native corporal carried on, and, if he remembered it, sent a messenger on a dromedary to report the tragedy over several hundred miles of sand.

In Zululand, before the war, I stayed in the hut of a missionary who spoke his own English haltingly, because it was so long since he had heard it.

## Invisible Companionships.

Wireless has put an end to such solitary confinement, and the vanguard of French advance in the Sahara is an absurd little mud pillar box with an aerial on top of it: Herein lives quite contentedly a Legionary who has specially applied for the job because it entails slightly higher pay. He rarely sees a fellow creature, but he has the whole world of sound at his disposal. These men live, move and have their being by wireless to such an extent that they become the votaries and the priests of the science they serve.

They are among its greatest experts, for their experiments are their only amusement. A Bedouin once assured me: "You will find a Franzi over the dune. He is mad and he keeps his god in his house with him!"

(Continued on Page 18.)

## February Programmes from 4QG

**Friday, February 1st.**—A nautical night.

**Saturday, February 2nd.**—Orchestral music from the Savoy Theatre, interspersed with Speedway races and dance music from Lennon's Ballroom.

**Sunday, February 3rd.**—Complete morning and evening services from St. Stephen's Roman Catholic Cathedral. Excelsior and Municipal Concert Bands concerts.

**Monday, February 4th.**—Half-an-hour's programme by the Brisbane Esperanto Society. A radio pot-pourri, "Four and Twenty Blackbirds."

**Tuesday, February 5th.**—A programme arranged by Mr. Sydney May's party.

**Wednesday, February 6th.**—A dance night by Alf. Featherstone and his orchestra, interspersed with vocal numbers.

**Thursday, February 7th.**—Act II. of the opera, "Satanella." One-act radio play, "Sydney Carton's Sacrifice"—an adaptation from "A Tale of Two Cities."

**Friday, February 8th.**—Radio play, "The Eye of Tayo Lang." Studio programme.

**Saturday, February 9th.**—Orchestral music from the Savoy Theatre, interspersed with a description of races at the Speedway, and dance music from Lennon's ballroom.

**Sunday, February 10th.**—The complete morning and evening services from St. Andrew's Presbyterian Church. Usual band concerts.

**Monday, February 11th.**—A description of the Queensland Woollen Mills at Ipswich. Studio concert.

**Tuesday, February 12th.**—A programme by Mr. Erich John's party.

**Wednesday, February 13th.**—Dance music by Alf. Featherstone and his orchestra.

**Thursday, February 14th.**—Classical programme by the Richmond party. Annerley Choral Society.

**Friday, February 15th.**—Concert relayed from the Orange Hall, Dayboro.

**Saturday, February 16th.**—Orchestra music from the Savoy Theatre, interspersed with Speedway races, and Lennon's Ballroom dance music.

**Sunday, February 17th.**—Complete morning and evening services from St. Barnabas Church of England. Usual band concerts.

**Monday, February 18th.**—Second and concluding part of the radio mystery, "The Eye of Tayo Lang." Studio programme.

**Tuesday, February 19th.**—The Studio Instrumental Quartette. The Apollo Club Quartette Party.

**Wednesday, February 20th.**—Dance night by Alf. Featherstone and his orchestra. Vocal numbers.

**Thursday, February 21st.**—Acts 3 and 4 of the opera "Satanella."

**Friday, February 22nd.**—The Studio Orchestra. Short recital by Frank Warbrick (pianist).

**Saturday, February 23rd.**—Orchestral music from the Savoy Theatre, interspersed with Speedway races and Lennon's Ballroom music.

**Sunday, February 24th.**—Complete morning and evening services from the City Congregational Church. Welsh singing meeting in the afternoon. Usual band concert at the conclusion of the evening church service.

**Monday, February 25th.**—Studio programme. Short piano recital by Frank Warbrick.

**Tuesday, February 26th.**—Concert by Mr. Sydney May's party.

**Wednesday, February 27th.**—Dance music by Alf. Featherstone and his orchestra, interspersed with vocal numbers.

**Thursday, February 28th.**—George Sampson's party. Studio programme.

## THE WINNER

### Q.R.N. Question Competition for January

Evidently the experience of a broken-down audio transformer is no new one to a very large number of our readers. Either that, or last month's question was too easy, for fully 80 per cent of the answers received were, in their essentials, correct. However, there can be only one winner, and we do not think the common practice of selecting one entry at random from a pile of "probables" is a fair one to the competitors. Therefore, every answer received was carefully perused by the Technical Editor, and a process of elimination commenced. By this system, we finally arrived at a comparatively small number of answers which were quite correct, and showed a better understanding of the trouble than the average entry revealed. After giving these very careful consideration, we selected the answer sent in by—

**R. V. BISHOP, Todd Street, Ashgrove, Brisbane,**

This gentleman submitted an answer in which the conclusion of a broken-down primary winding of the last audio-transformer was reached by commendably clear reasoning, and we congratulate him on his success. The prize of a "Ship" cone loudspeaker, offered by Messrs Trackson Bros. Ltd. to the successful entrant, will therefore be presented to Mr. Bishop.

It is interesting to note that answers to the January competition were received from such far-away places as Ayr, Townsville, Rockhampton, Mt. Larcom, Maryborough, Innisfail, Landsborough and Cairns, in the North; St. George in the West; Tweed Heads, and even as far South as Caulfield, Victoria! Practically every suburb of Greater Brisbane was represented, and numerous entries came in from the nearer towns and townships, such as Ipswich, Laidley, Toowoomba, Beerburrum and Linville (Boyne Valley line).

This popular competition is expected to continue for some considerable time, the prizes offered being well worth the attention of our readers. Those readers who were unsuccessful in the January competition need not, therefore, give up hope, as it will cost them nothing to enter the future monthly competitions, and they stand a good chance of being rewarded with a piece of apparatus that will be very valuable to them in their radio activities. Particulars of the February competition will be found on page 58 of this issue. Fill in the coupon and send in your answer without delay!

# At the Berlin Radio Show

*Judging by the following discussion of the Great Radio Exhibition recently held in Germany, great progress is being made in that country in the realms of Television and Telephony. German broadcasting also reaches a very high standard.*



THE Berlin Radio Exhibition has once again presented the radio wares of its country to the listening public of Germany in a form that is palatable and pleasing. There is little doubt that other Radio Exhibition authorities could learn a good lesson from Berlin as to how to present radio to the world, whether that public be radio "fans" or mere sight-seers.

The Berlin Exhibition has grown considerably since last year, and in order not to crowd the various exhibitors, the show was extended into a further hall.

The exhibition this year synchronised with two notable radio events. First, the celebration of the twenty-fifth year of Germany's premier radio company, the Telefunken Company, and secondly the autumn meeting of the delegates of the Union Internationale Radio-phonie, which is the union of broadcasting organisations of the various European countries. This latter-named event synchronised no doubt rather by arrangement than coincidence.

As was the case last year, the best exhibit can be attributed to the State department of Germany, which in a very comprehensive manner presented to the public all the ramifications of the existing German broadcasting system. Under this exhibit were to be seen displays by the State broadcasting department, the State post office, and the police department.

Dealing with these exhibits in detail, and taking the State broadcasting department's effort: Here the public were treated to a eulogy and tribute to Professor Hertz, who can be termed, perhaps the father of radio, since he was the discoverer of the electro-magnetic wave. This exhibit consisted of a series of photographs and descriptions depicting the life of this famous scientist. There were also to be seen various pieces of his apparatus as were used in his original experiments.

In addition to this the State broadcasting department showed a number of statistics which were set out in such a manner as to be of interest to all. It was interesting to note that the licenses in Germany for the reception of broadcasting had increased from 1,713,899 listeners to 2,284,248 since last year.

Other statistics were also interesting, showing the numbers of listeners in the various countries of the world, which placed Germany third on the list after America and England.

Another interesting exhibit under this section was the display of a number of cartoons that had appeared in the different papers all over the world many years ago, long before the invention of wireless, just after the introduction of the telephone, which prophesied the coming of broadcasting.

One of these pictures depicted a wealthy gentleman in his home showing this "new" invention to some of his guests, the "broadcasted" music being turned on from taps from what resembled the ordinary bathroom hot and cold water system.

The State post office department had on exhibit a collection of valves and radio receivers dating from the commencement of radio to the present time. This department also sponsored a television exhibit of apparatus designed by Von Mihaly.

This apparatus was in operation, and there were two separate demonstrations, one a simple one transmitting merely shadows, and the other the transmission of photographs held in front of the television "eye." The reproduction of this latter case was quite reasonably good and made use of the neon lamp at the receiving end, so that the image was of an orange hue. Movement was also registered by the apparatus.

The other television exhibit was due to the Telefunken Company and consisted of a very elaborate display of apparatus, but the results could not be described as very much better, if at all, than that of Von Mihaly. There was, however, one interesting experiment given, and that was the transmission of a cinema picture. The film was projected by means of a projectoscope, having behind it a very powerful illuminant, on to a ground glass screen about four inches square.

This screen was fitted directly in front of the television "eye" and traversing disc. The remainder of the transmitter appeared to be similar to that with which we are already familiar.

At the receiving end a special form of apparatus was used employing the usual revolving discs, and the "light signals" so obtained were thrown on to a revolving drum around the edge of which were fixed a very large number of small mirrors arranged parallel to the central axis of the revolving drum. From these mirrors the pictures, through a series of optical instruments, were then projected on to a ground-glass screen about three feet square in size.

The resulting moving picture to be seen was quite good, but the definition was rather poor. These two demonstrations go to show what we may expect at future exhibitions, and to prove that television has come to stay, whether it be of the system to-day employed or whether it be of some new process.

The Fulton picture transmission was also on display and was shown actually working. The results obtained appeared to be very good, and this exhibit was particularly popular with the visiting public. This was not the only exhibit showing the transmission of "still" pictures as there were two other firms, Telefunken and Lorenz, who displayed this new application of radio. The former firm actually demonstrated their apparatus, but it would appear from the gear employed that this system was not intended at the moment for the use of the general listening public, which is simplicity itself.

The Lorenz system was being displayed by the police departments, which employ it for the transmission of thumb prints and photographs of criminals.

There was one other "stunt" exhibit worthy of mention, and that was the display of a Phonofilm. It

was rather different from our ideas of such a film, where a picture is shown of some persons singing or talking with sound reproduction synchronised with the movement of the object photographed. Here in the German film a picture is given of, say, a travel round Britain, and the pictures are accompanied by a synchronised talk of what is being shown—the talk was given in the first place when the picture was actually photographed.

So much for the out-of-the-ordinary exhibits, and now for a description of the apparatus available for the listening public. Generally speaking, it can be said that the standard of reproduction by German sets is far behind that found in this country, and that at the same time the sets do not present a very attractive appearance.

This latter may be due to the fact that the desire for cheap receivers appears to be the cry of the day. Portable sets again do not appear as yet to have found a market in Germany, there being only two such sets shown. In one case six valves were employed to give results inferior to those with which we associate portable sets to-day. In this six-valve portable a penthode was employed in the last stage, so that the set may be set to be practically equivalent to a seven-valve set, although in practice the penthode does not quite give the same output as two valves.

Screen grid valves have made their appearance in Germany, and there are one or two valve manufacturers putting these valves on the market, but, strange

to say, the set manufacturers do not seem to have taken advantage of this fact, as there were only two sets to be seen at the exhibition that employed such valves.

Generally speaking, there is little worthy of notice amongst the German receivers, but considerable attention seems to have been given to the production of sets that work direct off the electric-light supply. There was a large number of such sets shown, and a special series of A.C. valves have been produced by the more important German valve manufacturers in order to meet this situation.

These valves consist of both indirectly-heated and directly-heated cathode valves, the latter, perhaps, being the most popular. There was also a large number of eliminators for use in conjunction with existing sets. There is no doubt that there is a big campaign afoot to popularise mains working, and so to remove the bugbear of radio reception, the battery trouble.

There was the usual plethora of loudspeakers. These in general were fitted in gaudy cabinets, and the results obtained from the majority of them were far from good, the quality being bad so that racous signals resulted.

In conclusion it is safe to say that Germany has made most progress on the transmission side of broadcasting. The German broadcasts are excellent, the programmes are well chosen, and the blending of items is very good indeed.

## Grid-Leak Values

Because a .00025-mfd. condenser and a 2-megohm grid leak are generally specified in connection with valves used as detectors, it has become a religious belief that these values are correct and beyond reproach.

Anyone who has done a bit of experimentation soon arrives at the conclusion that the grid leak may run anywhere from  $\frac{1}{2}$  to 8 megohms, depending on the valve, the circuit, and the signal strength, while the grid condenser may give better results when of .001-mfd. capacity than the dogmatic .00025-mfd.

However, the condenser is not as critical in its contribution towards better radio results as the grid leak, hence we shall confine ourselves to the latter.

With the usual three-electrode valve there are two methods of obtaining rectification, namely: (1) by means of a bias battery, and (2) by means of a grid leak, which is the more popular method. The grid-leak method is more sensitive than grid-bias detection.

However, marked distortion may take place with this method on powerful signals unless the resistance value of the grid leak is materially reduced. Thus for distant reception, or the detection of weak signals, grid-leak values as high as 5 megohms may be employed, with surprising increase in loudspeaker response, while on local and powerful signals the grid-leak value may be reduced to 2, 1 or even  $\frac{1}{2}$  megohm, with ample loudspeaker volume accompanied by far less distortion.

The indirectly-heated valves require a critical grid-leak for best detection. The value is not known with-

out trial, as valves and other conditions vary widely. Certain A.C. valve manufacturers recommend trying several values between  $\frac{1}{2}$  megohm and 9 megohms.

In short-wave reception the grid leak is critical in value. Experimenters sometimes try as many as fifty grid leaks before the satisfactory value has been found. The best value is usually between 4 and 8 megohms.

### On the Audio Side.

Aside from the detector, the grid leak has an important function to serve in resistance and impedance coupling. While the plate coupling resistance usually is not critical, the grid resistor is of considerable importance. By means of precise resistance of grid leak it becomes possible to employ larger coupling condensers, therefore passing lower frequencies for the desired bass notes, while effectively preventing blocking or choking by lowering the grid-leak resistance.

It is well to note in passing that resistance coupling is capable of responding to very low frequencies, with the result that there is sometimes set up a low-frequency oscillation, due to coupling between circuits, known as "motor-boating."

The simplest way to offset motor-boating when it does occur is to use a lower resistance of grid leak for one or more stages, together with smaller blocking or coupling condensers. Often the lowering of the grid-leak resistance in the first or second stage will serve the purpose.

FIG. 1.—In this photograph will be seen the layout and general appearance of the finished amplifier. It has been designed so that the grid and plate connections are exceptionally short and direct, making for maximum efficiency and stability. The push-pull output stage is on the right-hand side, while the light-coloured objects are the by-pass condensers.

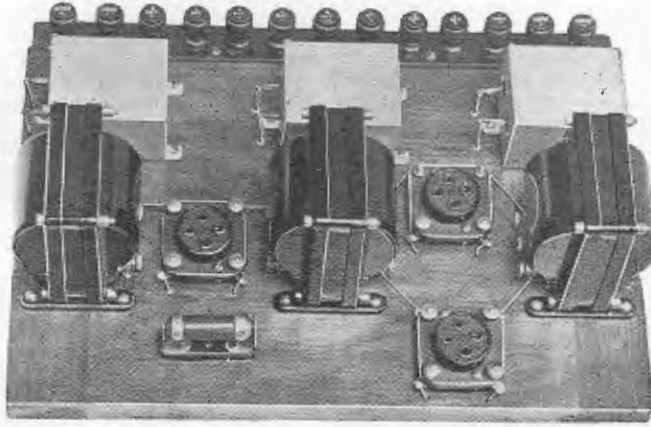

THIS article is the third of a series dealing with the design and construction of modern high-quality audio-frequency amplifiers of various types. The amplifiers are described as complete units, capable of being incorporated in newly-constructed receivers or of being added to any existing type of set, including the crystal receiver. Quite apart from this, the information furnished will be of value to those who are interested in the latest developments in this important branch of the science.

# The Push-Pull Amplifier

*Gives Distortionless Reception with Great Volume*

By the TECHNICAL EDITOR



SEVERAL years ago, in the days when audio transformers fell very far short of the high standard reached by the present-day instrument, the "push-pull" system of amplification attracted a considerable number of adherents, and came to be fairly extensively used as the newly-awakened desire for natural reproduction came into effect. The fact that the push-pull amplifier's bid for popularity was short-lived is no condemnation of the value of the system; this was only to be expected when one considers the rapid improvements that were being made in the ordinary inter-stage transformers, and the comparative cheapness of the ordinary two-stage transformer-coupled amplifier. It is a fact, too, that the push-pull transformers themselves left a good deal to be desired; breakdown of the windings was by no means unknown, and the design of core and windings was not faultless. Add to this the many shortcomings of the valves available at that time, and it will be seen that the apparent passing of the push-pull amplifier was only natural.

During the last year or so, however, this interesting method has been re-born. Recognising the many inherent advantages of the push-pull system, one or two manufacturers of high-grade transformers have gone very thoroughly into the problem of the design of suitable transformers, guided, of course, by the experience gained in the manufacture of the orthodox inter-stage transformers. The result is that push-pull transformers of heretofore unknown quality are available which, used in conjunction with the special types of valves produced nowadays, yield a quality of output that must be heard to be appreciated. The push-pull system has one important advantage over any contemporary method. Even with valves of small power-handling capacity, supplied with relatively low

plate and grid bias voltages, it is quite possible to obtain very good reproduction indeed.

It must be admitted that the push-pull method of amplification is more costly than the straightout transformer-coupled system, since, in the final stage, two valves are used to give the same degree of amplification that is obtainable with one. It would be more correct to call this system the "push-pull output amplifier," as the push-pull idea is applied only to the pre-speaker stage, and is always preceded by an ordinary transformer-coupled stage. Reference to Fig. 3 will show the scheme of connections in the push-pull amplifier. The first stage is simply the conventional transformer-coupled stage, equipped with separate terminals for the input from either a radio set or an electric gramophone pick-up, and for "B" and "C" power supply. The push-pull output stage consists of two valves of identical electrical characteristics, connected to two transformers, each of which has one centre-tapped winding. In the case of the input transformer T<sub>2</sub>, the secondary winding has twice the customary number of turns, so that the portion of the winding between each end and the centre-tap is approximately equal to the secondary of the ordinary audio transformer. The two ends of this winding are connected to the grids of the output valves, while the centre-tap goes to the "C" battery. It is commonly thought that the last two valves in a push-pull stage operate in parallel, dividing the load equally between them. This is not the case; since the energy that is induced in the secondary of T<sub>2</sub> is an alternating current, flowing first in one direction and then the other, it follows that the two valves operate alternately, one on one half-cycle, and the other on the half-cycle of opposite polarity, with the result that one valve is idle while the other is working, and vice-versa. The output transformer T<sub>3</sub> is fitted with a centre-tapped primary winding, each section being approxim-

ately equal in size to the primary of an ordinary audio transformer. The two ends are connected to the plates of the valves, and the centre tap to the "B" battery. Thus it will be apparent that the steady D.C. plate current supplied by the "B" battery flows in opposite directions in the two sections of this winding, with the result that, as far as this component of the plate current is concerned, there is no magnetising effect on the core of the transformer, so that the signal impulses can produce comparatively large magnetic effects. This means that the transformer is more effective than if it were strongly magnetised by the steady plate current of the valves.

Now that the theoretical considerations have been briefly touched upon, it is time to proceed with the actual constructional details. The parts that have been used in our own amplifier are listed at the end of this article; they need not, of course, be adhered to to the letter, although their use will ensure the duplication of the results that are obtained with the unit illustrated. A push-pull kit of transformers manufactured by the well-known English firm of Ferranti was chosen on account of the excellence of design and construction, which is evident in all this company's products. The large by-pass condensers may be of any reliable make; these are paper-dielectric condensers, tested at 500 volts D.C., and serve to by-pass the audio-frequency currents around the battery or eliminator power supply, thus minimising the possibility of distortion or instability arising from this cause. For most valves, it would be quite permissible to dispense with a filament-controlling resistance; as a precaution against the use of special types of valves, however, an automatic filament control R has been included. The valve sockets are all of the balanced or anti-microphonic variety, these being preferable on account of the protection they afford the valves, and the freedom from disagreeable noises which would be caused should vibration reach the valves. A row of Belling-Lee bakelite lettered terminals completes the list of components, with the exception of the baseboard and one or two "sundries."

The baseboard is raised above the table by means of rubber feet screwed to the underneath side at each corner, thus leaving room for the wiring.

**Construction.**

The various instruments are screwed down to the wooden baseboard in the positions indicated in the pictorial diagram, Fig. 2. This arrangement is an ideal one, as it permits the use of extremely short leads in the audio-frequency portion of the circuit—a point which is of great

importance. The valve sockets V2 and V3 of the push-pull stage are located in such positions relative to the transformers that the grid and plate connections from each socket are of equal length. Notice the indicating symbols marked against each terminal of transformers and sockets; care must be taken to see that these parts are mounted with their terminals correspondingly placed. The first transformer T1 is a Ferranti AF-5, the second an AF-5C, and the third an OP-3C.

It will be seen in the photograph of the completed amplifier, that practically all of the wiring is carried out beneath the baseboard, holes being drilled just below the terminals for this purpose. The exceptions are the grid and plate leads of all three valves; these are run directly to the corresponding transformer terminals above the baseboard, as it is essential that they be as short as possible. Provided a well-seasoned dry board is used, no insulation is necessary on the wires where they pass through the baseboard, but it is advisable to slip a piece of spaghetti sleeving on the wires wherever there is any danger of contact being accidentally made with adjacent connections. Bare 18-gauge tinned copper wire is used in our model, although there is no reason why any of the flexible insulated wires at present on the market should not be employed; this is a matter purely for the choice of the constructor. The 13 terminals are mounted in line, 1 inch apart, on a bakelite terminal strip which is screwed down along the rear edge of the baseboard. This method of mounting the terminals allows easy connections to be made, the various connecting wires coming under the baseboard directly to the shanks.

**Valves and Batteries.**

As far as valves are concerned, it is an easy matter to select a suitable combination for the push-pull amplifier. The first-stage valve may be any ordinary first stage amplifier valve if the volume desired is only what may be termed "average" volume—that is, volume sufficient for an average-sized room. If large volume is to be handled, this should be one of the

small power-valves that are available in many different makes. The two push-pull valves, as has been remarked, must be of the same type, and for best results should be of the same age, so that their characteristics will match as far as possible. Two power-valves should be used, their size depending not so much upon the volume they are to handle as upon the value of plate voltage that is available. Provided a sufficiently high plate voltage can be provided—either from batteries or, preferably, from a

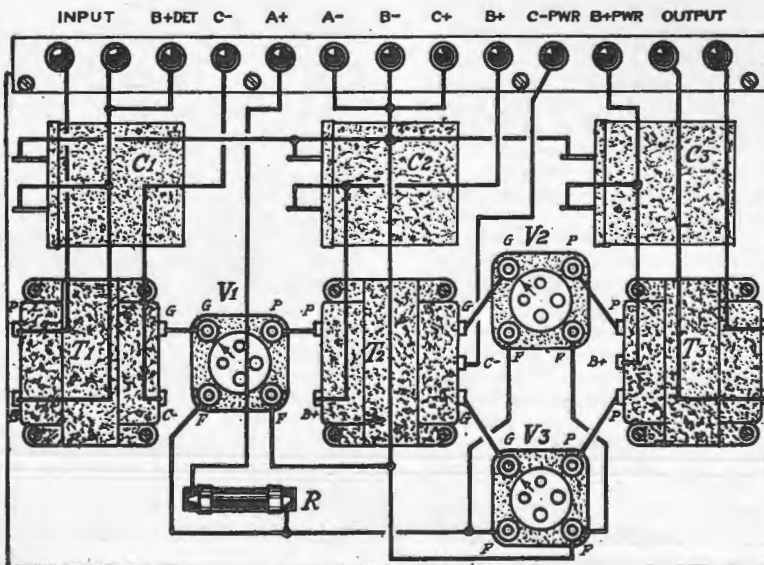

FIG. 2.—Pictorial diagram. Each instrument is marked with an indicating symbol which corresponds with those printed in the list of parts, thus making identification of the various parts easy.

"B" eliminator—it is an advantage to use large valves—which means, of course, "large" from the current-handling viewpoint.

At the beginning of this article, we said that high quality reproduction is obtainable even with small valves, and this is so—provided only small or "average" volume is required. For instance, in the amplifier illustrated, we obtained very good quality by using one UX-199 Radiotron in the first stage, and two UX-120's in the push-pull stage. The maximum "B" battery voltage that was applied to these valves was 60 in the case of the first stage UX-199, and 90 on the plates of the two UX-120's. Under these conditions the tone quality was far and away better than that which could be obtained from any ordinary two-stage amplifier using the same valves and plate voltages, showing that the push-pull amplifier is especially valuable for this type of work.

It is when large power-valves are used in conjunction with comparatively high plate voltages, however, that the real superiority of the push-pull system becomes apparent. With a UX-112A in the first stage, and two UX-171A Radiotrons in the push-pull stage, supplied with power from a Philips "B" and "C" eliminator at 135 and 180 volts, respectively, the quality was wonderful indeed. The bass portion of the musi-

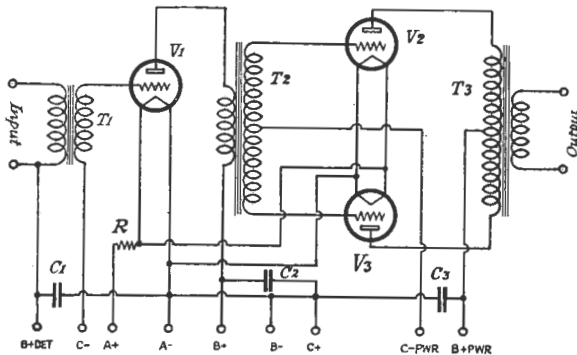

FIG. 3.—Conventional circuit diagram of the two-stage amplifier, comprising one transformer-coupled input stage and a two-valve push-pull output stage.

cal scale became really audible for the first time—not merely the faint suggestion to which it usually is reduced, but a decided clearly-defined sound, literally throbbing with life. That is the chief difference between the use of small and large valves. It is not generally realised what a great amount of energy is required for proportionate reproduction of the bass notes, but one can easily appreciate the truth of this when a comparison is made between the same amplifier using different valves. The moral is, of course, to use the largest valves you can afford in the last stage of any well-designed amplifier, **but only if you can supply them with the plate voltages recommended by the manufacturers.**

#### Connections.

It will be as well at this point to run through the various battery connections, so that no doubt will exist with regard to the markings of the terminals. First of all, the two terminals marked "Input" are to be connected either to the output terminals of the receiver which is placed in front of it, or to the volume control of an electric gramophone pick-up. The amplifier may be used in conjunction with any existing receiver,

crystal or valve, or may be built as a unit into a new receiver. In the latter event, the baseboard may be dispensed with and the parts mounted directly on the large baseboard or sub-panel of the set, preserving the layout illustrated. The amplifier may be connected either following the detector of an existing set, or following the existing first audio stage, in which case a total of three audio stages will be in use. This arrangement has been tried, and was found to work very well in practice, as the receiver could be operated a long way below oscillation-point and the first and second audio stages were not "forced" in any way.

As a general rule, though, it is advisable to connect the amplifier following the detector, and it should always be remembered that the end terminal of the amplifier is connected to the **plate** side of the detector circuit. When the amplifier is connected to a valve detector, the same "B" batteries being used for both, it is only necessary to connect **one** wire, from the plate side of the detector circuit to the end terminal of the amplifier. The remaining "Input" terminal is left blank, while the "B+DET" terminal is connected to the "B" battery at the voltage previously applied to the detector. When used in conjunction with a crystal detector, both "Input" terminals are used, but the "B+DET" terminal is left blank. When an electric pick-up is employed, it (or its volume-control) is connected to the two "Input" terminals, and it is immaterial whether or not the "B+DET" terminal is connected to the "B" battery. No doubt these instructions seem rather confusing the first time they are read over; afterwards it will be seen that they are quite straightforward, and are mentioned because this amplifier has been designed for an utmost of flexibility, and it is just as well to make quite sure about the connections which apply to the particular purpose for which it is required.

The next terminal, "C—," is connected to the "C" battery voltage advised by the makers for the first-stage valve, this being governed by the "B" voltage which is applied to the "B+" terminal, which serves this valve with plate current. "A+" and "A—" connect to the positive and negative terminals, respectively, of the filament or "A" battery. "B—" goes to the negative terminal of the "B" battery or "B" eliminator and "C+" to the positive "C" battery terminal. "C—PWR" is connected to the negative "C" voltage recommended by the makers for the two push-pull valves, this again depending on the plate voltage applied. "B+PWR" feeds plate current to **these two** valves, and should be connected to the highest value of "B" battery or eliminator voltage available—provided suitable valves are used, naturally. The two "Output" terminals are connected to the loudspeaker, no external output filter being required, as one is already furnished by the last transformer T3. The resistance of the Tempryte automatic filament control R is determined by the valves used, but it is safe to insert a 1½-ohm. size here for all but the very large power-valves. When these are used, it will probably be advisable to short-circuit the Tempryte altogether.

#### Conclusion.

The push-pull amplifier unit described in this article is representative of the very highest type of audio amplifier that can be built, in the light of present knowledge of the subject, and with the components available at this time.

It is most heartily and sincerely recommended to those to whom the chief consideration is that of high-quality reproduction—**natural** reproduction. At



the risk of being condemned as traitors to the gospel of good tone quality, we will say that, in our opinion, ample volume is a most important counterpart of natural reproduction.

We have no time for the enthusiast who offends all the residents of his locality with a blaring loud-speaker. Neither, on the other hand, do we agree with the ideas of the fanatic who reduces the volume of his set down to a whisper, even though no actual distortion is apparent. When we listen to a loud-speaker reproduction of a brass band, for instance, we like to have volume at least approaching that of the band itself, and we want the fortissimo passages of a pianoforte solo to be rendered with the same crash of melody that would be heard in the concert hall; similarly, the voice of a vocalist should be reproduced with full, life-like volume. Otherwise, surely it is not a reproduction at all in the true sense of the word!

The practice common to many listeners of sitting with one hand on the volume control, ready to reduce amplification at every loud passage and on every high note, owes its origin wholly and solely to the inability of the receiver's amplifier to handle these passages without causing distortion. Yes—distortion for which the broadcasting station usually gets the blame, but

which is, in actual fact, nine times out of ten, a product of the receiver alone.

Use a modern, high-quality amplifier such as the push-pull unit described, and you will know the satisfaction of being able to set your volume-control for the strength desired, and the enjoyment not only of having pure, full, life-like tone-quality, but of all the subtleties of expression, of light and shade, originally woven into it by the artist—a true reproduction of the original, and not a distorted likeness.

### Parts Required

- 1 Ferranti AF-5 audio transformer, T1.
- 1 Ferranti AF-5C input transformer, T2.
- 1 Ferranti OP-3C output transformer, T3.
- 1 Cyldon 1½-ohm. Tempyte, R.
- 3 Benjamin UX sockets, V1, V2, V3.
- 3 Hydra 2-mfd. fixed condensers, C1, C2, C3.
- 13 Belling-Lee bakelite terminals.
- 1 Stained pine baseboard, 15 x 9 x ¾ inches.
- 1 Bakelite terminal strip, 14 x 1 x 3/16 inches.
- 4 Perdriau rubber basin buffers.
- 18 Gauge tinned copper wire.
- 2 Lengths spaghetti tubing.
- Screws.

## A Common Misconception

*It is absolutely necessary to use an Audio Transformer of first quality—even with a cheap set!*

In the course of a circular letter, Messrs Philips Lamps (Australasia) Ltd., raise a point on which a very widespread misconception exists. Because it is a subject which will interest many of our readers, we publish an extract:—

Several times it has occurred that set-makers have made the following remark to our representative: "The Philips transformer is excellent indeed, but I don't want such an excellent transformer; a cheap brand is quite sufficient in my set, as the difference in quality can hardly be observed." We will at once demonstrate the fallacy of this conclusion, thus:—

The Philips transformer gives a quite uniform amplification of all frequencies from 200 to 10,000 cycles, and still 56 per cent. of the normal amplification even at 50 cycles. With this result, practically the ideal has been reached of A.F. amplification by means of transformers. In the last instance, however, the quality of the reproduction is determined by the loudspeaker, and very often the latter is far from perfection. Excellent transformers are not of much use with loudspeakers which do not bring into relief their special qualities and so, indeed, the difference between a good transformer and a bad one is hardly audible.

However, the sale of good loudspeakers increases continually, especially because at the present time some really good loudspeakers can be obtained in the cheaper price classes. Gradually more and more excellent sets are used, and as most people are inclined to compare their own set with that of others, many will try to improve the reproduction of their set by buying new valves or a new loudspeaker. However, the exchange of fixed components is not usually attempted by those who are not radio experts.

Very often a listener-in hears better reproduction at some of his friends', or in a radio shop. After having bought the loudspeaker, he finds that the reproduction at home is not so good; now he will throw the blame upon his set, and here the cheap transformer is a drawback for the future sale of the set.

Consequently a Philips transformer is not too good for any set; whatever make it may be, it will stimulate its sale—not only in the first instance, but also in the future. A radio set can operate for years, and so the set-maker must take into consideration the increasing demands of the public. Should the set not give satisfaction after a year, then it will not be recommended to friends, and another make will be bought. It should be apparent, therefore, that the set-maker injures his own interests by trying to economise on A.F. transformers.

(Continued from Page 11.)

In my own case, wireless would have saved many troubles, for, on several occasions, my caravan has lost itself in a sandstorm, in a maze of dunes, or in the flat, uncharted desert wherein there is no landmark and no route but a sense of direction. Once, with a party of seventeen—Egyptians, Bedouins, and black slaves—we missed our way going south in the middle of a two hundred mile waterless stretch. We had neither sextant, theodolite, nor chronometer. The guide completely lost his head, which, in the desert, is as much a disease as any other fever, and if we had not discovered by chance an unknown spring, we should all have died of thirst.

Another Saharan traveller wandered out of his route for ten days, and lost most of his camels in consequence because a compass is not a sufficient weapon when mirage and sandstorm do their worst!

The modern expeditions, whether by motor or caravan, will be armed with wireless, and the legendary desert drums played by dead victims welcoming an addition to their range will be silent.

In fact, there will be no more mystery in the desert!

The 1929 Model  
**“KING”**  
 Electric 6 Valve Set

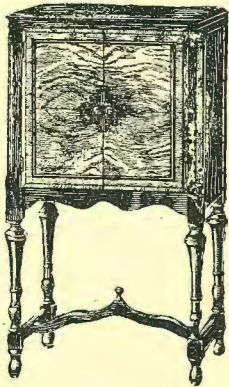
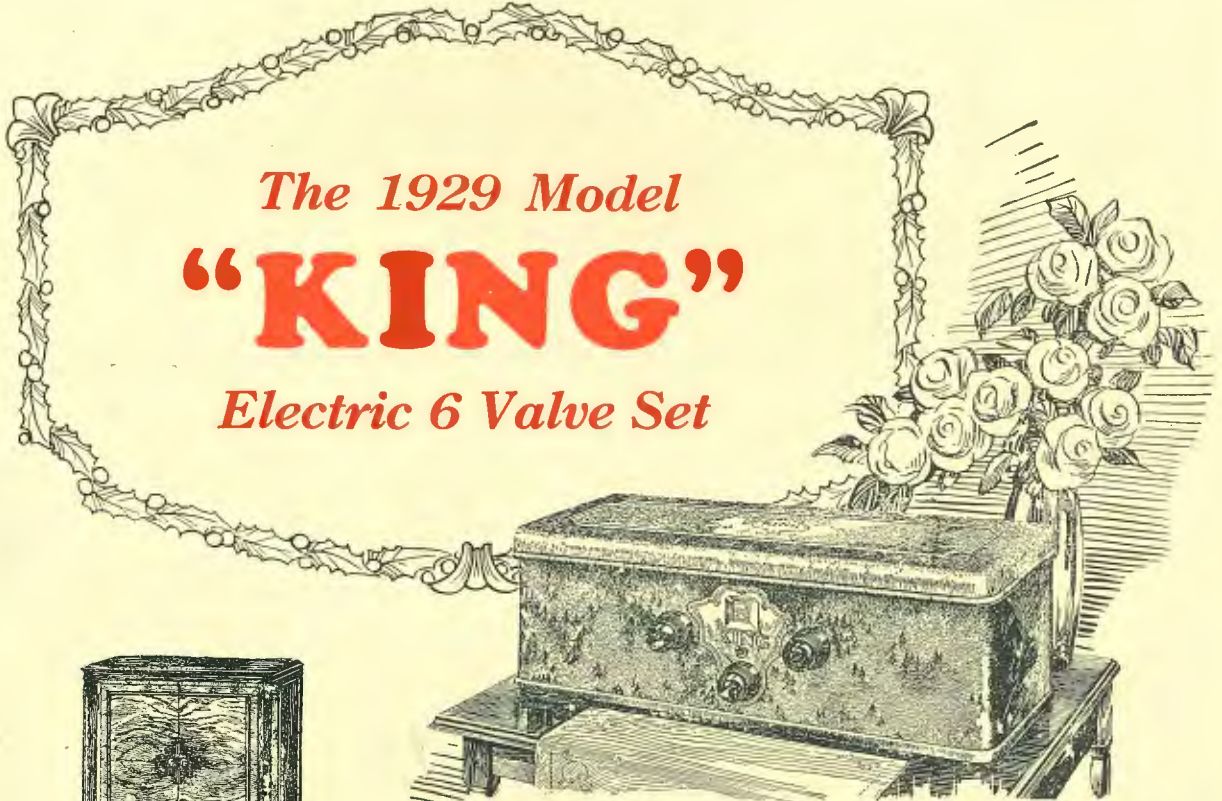

THE GEORGIAN CABINET FOR “KING” RADIO SETS.

This charming Cabinet has been specially designed to accommodate any “KING” Radio Set. It incorporates a built-in tonal chamber of the long air column type, and a high-grade loudspeaker unit.

Complete with “KING” Radio Set and all accessories, the cabinet may be purchased as follows:—  
 With Model “G” ..... £55 0 0  
 With Model “F” ..... £49 10 0  
 With Electric Model ..... £65 0 0

# KING in RADIO

If there is someone you know who hasn't a Radio Set, or you haven't a really up-to-date set in your home, why not buy a “KING” RADIO.

Nothing could give greater pleasure. The new 1929 Battery and Electrically-operated models—the very peak of radio perfection—are just out.

They are fully shielded, marvellous distance-getters, and capable of great volume. Control is by a single dial.

**MODEL “G”—6-Valve Genuine Neutrodyne** built into rich bronzen-finished metal case as illustrated above.

**PRICE, without accessories** ..... **£24**

**MODEL “F”** is similar to Model “G,” but has only five valves.

**PRICE, without accessories** ..... **£19**

**ALL ELECTRIC MODEL**—This is complete in itself, the only accessory to be bought being the loudspeaker. In appearance this model is identical with Model “G.”

**PRICE** ..... **£46/6/**

**THE AEOLIAN COMPANY [Aust.] Ltd.**

**436 QUEEN STREET, BRISBANE**

*Opposite Custom House*

264 PITT ST., SYDNEY, N.S.W.; 123 SWANSTON ST., MELBOURNE; and 58 RUNDLE ST., ADELAIDE.

.....  
 THE AEOLIAN COMPANY (Australia) LTD.  
 Please send me details of the 1929 “King” Radio:  
 Name .....  
 Address .....

ECLIPSING ALL PREVIOUS RECORDS!

# The CRAMMOND Super 3 for 1929

Built by Crammond Radio Manufacturing Coy.

Subsidiary to

MELTON & CO., 8 QUEEN STREET, BRISBANE

The Set  
that  
has taken  
Queensland  
by  
Storm

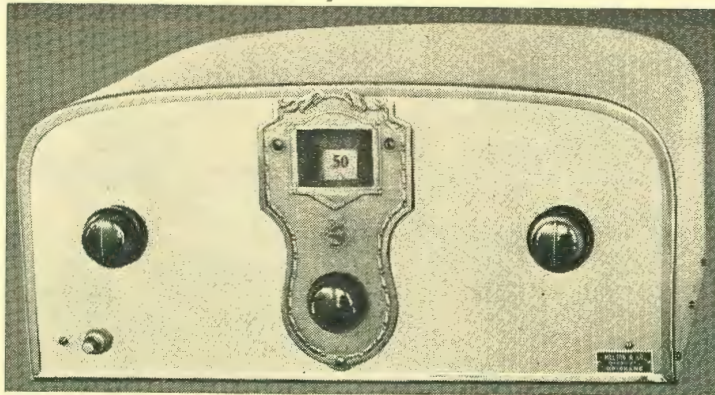

Never before  
such  
Performance  
  
Never before  
such  
Beauty

Read what the Technical Editor of this Paper wrote  
in the December Issue—

"The Firm's New Shielded Three's performance certainly justifies their action in resorting to shielding . . . The task of testing the Crammond Shielded Three was a most congenial one . . . the receiver was a positive delight to handle, and we know of no set that permits easier tuning . . . it seems to do all that a first-class receiver should do, and a bit more . . . The quality will satisfy the most exacting, and volume is there in plenty. . . . "In conjunction with the set we used the beautiful little Crammond Shielded Wave-trap . . . the resulting selectivity being such, we were

able to tune in 5CL while 4QG was on the air, without interference. . . . The reaction control is so smooth we were able to tune from station to station by means of the tuning dial alone, without touching reaction knob. . . . The interior of receiver is an excellent piece of work, while the exterior is uncommon and distinctly attractive. . . . our considered opinion is that the Crammond Shielded Three is a receiver the manufacturers have every reason to be proud of. . . and we believe it ranks with the best that can be produced anywhere in the world."

## THE CRAMMOND SUPER 3

First Queensland Made All Metal Receiver

Complete with first-grade accessories, including Philips Valves, Amplion Cone Speaker, Columbia High Capacity Batteries.

PRICE

£22/10/0

All sets carry our 12 months' guarantee.

Terms arranged.

Of Solid Brass in Several Finishes—Duco, Oxidised and Nickel, Etc.

Right at  
North Quay  
BRISBANE

# MELTON & CO.

PHONES: C-3542,  
J-4859, Toowong 2180

# What a Radio Valve Is

## and What it Does

By CLYDE A. RANDON

**A** THOROUGH understanding of the functions of the vacuum valve, the heart of broadcast transmitting and receiving apparatus, is of fundamental importance to the radio beginner if he wishes to understand even the most elementary principles under which his equipment operates. Articles explaining the action of these valves have been published many times in this and other magazines; but they have been usually so technical that the ordinary listeners, the rank and file of the vast audience which now enjoys the pleasure of radio entertainment, find considerable difficulty in apprehending the meaning. Too often a valuable article is made puzzling for them by the presence of electrical terms which, though elementary, are not frequently used in ordinary conversation.

In this article the writer will attempt to explain the operation of a vacuum valve, in language which the average reader is able to understand; and he will avoid, as far as possible, the special terms used by scientists. Of course, it will be impossible to explain here some of the more complicated application of radio valves, as these require a fundamental knowledge of radio circuits in order to learn what takes place; but the way in which a valve functions as an **amplifier** will be described. This is the use of the majority of valves in radio receivers and, therefore, this explanation should clear up many problems which perplex the mind of the beginner.

### Use of the Filament.

A valve consists of a filament, a grid and a plate, all "hermetically" sealed in an "evacuated" bulb, which is provided with convenient external terminals for making contact with these three "elements" inside.

The filament is simply a thin wire of special composition which usually becomes "incandescent" when in operation, but not necessarily so. Some filaments must be heated to incandescence (glowing whiteness) for best results, while others perform more satisfactorily when operating at a cherry-red heat; different filaments require different temperatures for highest efficiency, but all operate in a similar manner. A filament may be looked upon as composed of a "volatile" substance, which evaporates when heated and thus gradually disappears. Water at ordinary room temperatures, for example, evaporates slowly, but, as it is heated, more and more evaporates! and finally there is violent "ebullition" (boiling) and the water becomes steam and passes into the atmosphere. The action of evaporating water and the escape of particles of matter from a heated filament are very similar. (See Fig. 1.)

All substances are composed of almost inconceivably small particles called "molecules." At ordinary temperatures, these small bodies are continually collid-

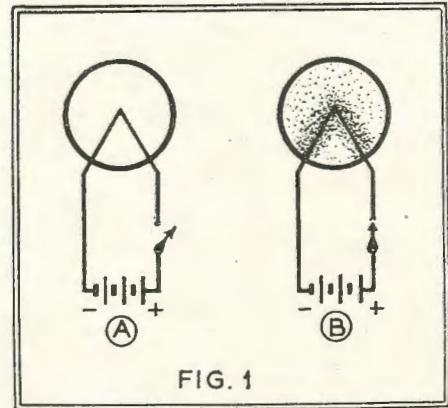

FIG. 1

FIG. 1.—At A we have no current in the filament, no electrons evaporating. At B, with the battery switch closed, the filament is lighted and from it electrons in countless billions are escaping.

ing with each other, and in a liquid or gas they are travelling in random directions. If a body is heated, these molecules speed up and thus bombard their neighbours with greater velocities. At high temperatures ("high" for one substance may be "low" for others; this is only relative) the molecules reach such velocities that some are capable of breaking away from the influence of the others, and thus pass away from the substance, in the form of **vapour**; that is, "evaporation" takes place.

Due to the influence of neighbouring molecules, there is a tendency on the part of a solid or liquid substance to "cohere," or hold on to its constituent parts. In the case of water, for instance, there is what is called "surface tension"; that is, the surface of the liquid acts like a **stretched membrane** and it is thus made more difficult for molecules to escape (or the liquid to evaporate) at ordinary temperatures. (One can easily perform a simple experiment in this connection. A small needle can be made to float by laying it carefully and perfectly flat on the surface of a glass of water; thus showing that there is "surface tension." The needle must be perfectly dry or even oily; otherwise the water will "creep" around the needle and it will sink.)

### "Evaporating" the Filament.

If water is heated, the molecules reach such velocities that the surface tension is no longer strong enough, and they simply break through in large numbers and leave the liquid—as we have explained, **evaporate**. This is almost exactly what takes place in a heated filament. At high temperatures (very much greater than the boiling-point of water, of course) the

velocity of the "electrons" or particles of **negative** electricity in the filament becomes so great that they simply shoot out into the surrounding space, with relatively large velocities.

If another element (such as the "plate," found in all radio valves) were placed around the filament, but **insulated** from it, some of these electrons would strike the plate; the rest would tend to form a "cloud" around the filament, some electrons leaving the filament and others again entering it. A condition approaching **equilibrium** would be reached; that is, there would be the same number of electrons leaving the filament as returning, and no useful result would occur. (See Fig. 2.)

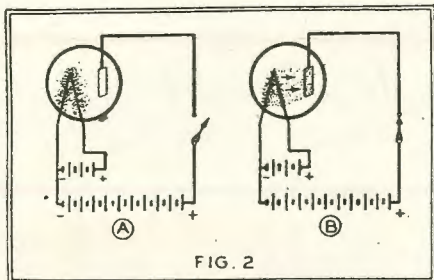

FIG. 2

FIG. 2.—At A, the "B" battery switch is open, and the electrons gathered in an aimless crowd around the filament. At B the plate is positively charged by connection to the "+" of the "B" battery, and electrons are attracted in a steady stream from filament to plate.

"If however, a **positive** charge (compared with that on the filament) or voltage is placed on the plate, electrons will flow to the plate and continue to do so as long as the filament is heated and the positive charge maintained; since electrons constitute **negative** electricity, they are attracted by a positive voltage (for **unlike** electrical charges attract each other).

**The Electron Stream.**

In the vacuum valve, when connected in this way, there would thus be a **continuous flow of electrons**, and this constitutes an electric "current." It is to be noted that such a stream can proceed in only one direction, from filament plate—negative to positive. It is often said that the current travels from positive to negative, and this is because in the early days the scientists had their choice of two guesses and they guessed wrong. To this day, this erroneous assumption is still prevalent, in common speech, just as we say "the sun rises;" but if the reader will remember that

the electrons proceed from filament to plate, there need be no confusion in his mind.

**The Electron-Control Grid.**

By introducing a third element, called for short a grid, the stream of electrons between plate and filament can be **controlled**. The grid consists only of very fine wires, spaced at definite distances apart so that a large proportion of the electrons can pass between them. Just as the positive charge on the plate tends to cause a flow of electrons from the filament, so a **positive charge on the grid will also tend to increase this flow**. (See Fig. 3.)

The grid, however, is much nearer to the filament than the plate is; and any charge or "voltage" on the grid will thus have a much greater effect on the electron flow than an equal charge on the plate. A **negative** charge on the grid will decrease the electron flow to the plate (the "plate current") and the amount of decrease will depend upon the strength of the charge on the grid.

It is readily seen, therefore, that the grid acts as a delicate control of the plate current. Since a very small charge on the grid has a relatively large effect on the plate current, the valve "amplifies" the small electrical impulses which are "impressed" on the grid. Very small effects thus give large response.

**Use in a Receiver.**

In the simple circuit shown in the diagrams, the valve is used to amplify the weak "signal" impulses which arrive from a broadcast station. A passing wave induces a small current in the aerial and this flows through the coil between the aerial and ground. (Note that the current **oscillates**—reverses its direction, back and forth—between the aerial and ground and, therefore, for best results the ground connection must be well-designed also). The current in the primary coil gives rise to a **magnetic field**, which induces another current in the secondary. This gives rise to a difference of voltage between the filament and grid which may be compared to placing a charge on the grid.

As explained before, the plate current is continually changing in accordance with whatever variations are present in the original signal from the broadcast station; and, therefore, these electrical variations are transformed into **sound variations** which may be heard in the telephones, and reproduce the sounds originally converted into electrical variations by the "microphone" in the broadcast studio. A valve used in this manner is called a "detector."

No matter how rapid are the fluctuations that are impressed on the grid, the plate current faithfully follows these. Even such extremely rapid variations

FIG. 3.—At A, the disconnected grid has little effect on the electron flow from filament to plate; but at B the "+" charge on the grid adds attraction and greatly increases the flow. On the contrary, the "-" charge on the grid, shown at C, will drive back the electrons and let few or none reach the plate.

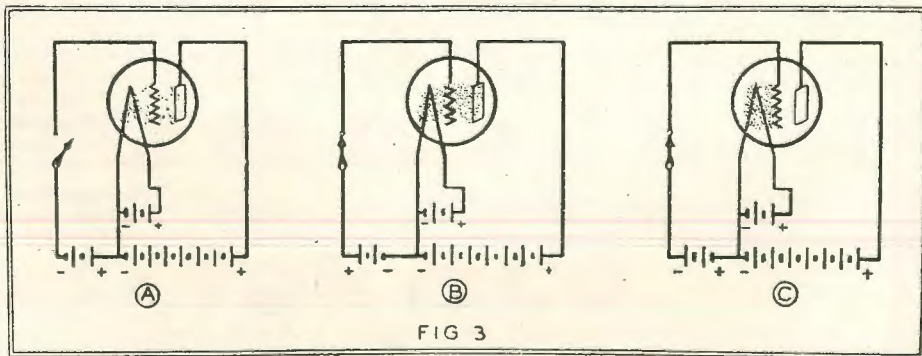

FIG 3

as "radio frequencies," thousands of times more rapid than the musical or speech ("audio") frequencies, may be successfully amplified also. For further amplification, it would be necessary only to connect the grid and filament of another valve in the position occupied by the head telephones in the case described in the previous paragraph, and the incoming audio-frequency pulsation could be still further amplified by the second valve. There is no limit to the amplification that can be obtained, but various "extraneous" or outside noises are also amplified; so that enormous amplification may give too much importance to useless noises.

**Various Uses.**

Although the action of all common radio valves is the same in principle, there are other factors which determine which **type of valve** should be used for a given purpose. Certain features of construction or the spacing of elements may adapt a valve to some particular use. Different materials and designs in filament wires may be used; so that different valves require different battery voltages to operate them. Certain filaments require more current than others for proper heating and "evaporation"; some valves successfully operate from alternating current merely

greatly influenced by the use which is to be made of it; it may justly be said that there is a particular valve for each and every use in a radio receiver if best results are to be obtained.

**Care of Valves.**

The filament of a valve is designed to give best results at a definite voltage or current, and at this value, a certain length of life for the filament is obtained. If the valve is operated at a filament volt-

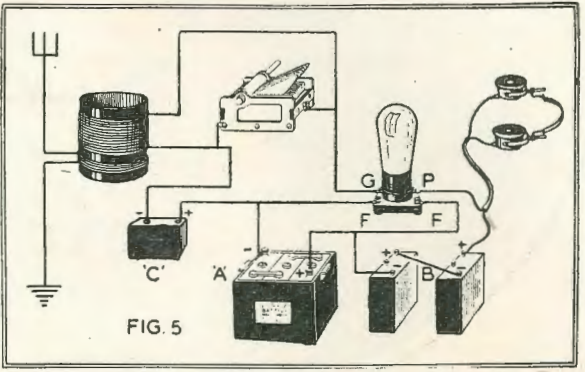
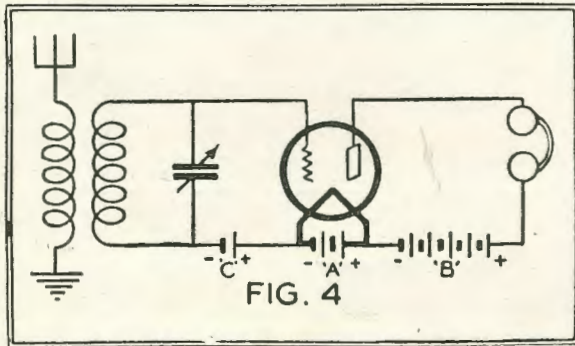

FIG. 5.—This type of circuit drawing explains more clearly the meaning of the different parts diagrammed in Fig. 4, the connections being exactly the same.

age higher than the rated value, the electron evaporation is greatly increased, with little useful gain; but the life of the filament is very greatly reduced. Some filaments do not actually burn out when the voltages are exceeded, but they become "deactivated"; that is, the useful material has disappeared from the surface of the filament. This may often be restored by turning on the valve with somewhat above normal voltages on the filament, and **with the plate ("B") battery temporarily disconnected**; but prevention is much easier than a cure.

The new "screen-grid" valves makes use of a second grid, which surrounds the plate completely, and shields the first or control-grid from the plate. It thus makes negligible the "capacitive" effect between grid and plate, which causes complications in the use of ordinary valves for radio-frequency amplification. The screen-grid valve, when used as a radio-frequency amplifier, has this second grid connected to a source of positive voltage, about one-third or one-half as high as that applied to the plate. The capacitive effect within the valve is thus reduced to a negligible amount. The action of this valve is otherwise the same as that of the ordinary valve, which has been described.

**A COUPLE OF EAR TWISTERS.**

What words do you think would be the best to test transmission and reception? In the Bell Telephone Laboratories (America), where telephones are tested, two sentences are repeated over and over by phonographs: "Joe took father's shoe bench out," and "She was waiting at my lawn." The radio "ham" who can get these across by phone to his fellow-workers may know that his modulation is good.

"stepped down" from the house-lighting circuits, while others require batteries or power units which contain rectifiers.

For **detection**, a small quantity of certain gases, introduced into the glass bulb, often gives a valve greater sensitivity to small grid charges, "weaker signals." A valve to handle large amounts of power, and such are necessary for good loudspeaker operation, must be of special construction so that the plate voltages necessary and the power handled will not **overload** the valve, overloading may give rise to valve failures, or distortion in the speech or music.

One of the governing factors in the use of a valve as a radio-frequency amplifier is the **capacity** between the elements of the valve. A special construction may, therefore, give better results for such purposes. It is evident, therefore, that the design of a valve is



# TONE

Tone—the character of a sound . . . quality . . .  
harmony . . . light and shade . . .  
You realise how true a description that is as soon as you  
put Mullard 1929 P.M. Radio Valves in your Receiver.  
Then it is that your radio takes on character—and tone  
—only equalled by the original performance itself.  
The secret of the remarkable tone you enjoy with  
Mullard Valves is in the wonderful 1929 Mullard P.M.  
Filament—4 years ahead in design. Ask your radio  
dealer to-day for a set of Mullard P.M. Valves for your  
receiver.

# Mullard

**THE MASTER VALVE**

ADVT. THE MULLARD WIRELESS SERVICE CO. LTD., DENMARK HOUSE, DENMARK STREET, LONDON, W.C.2

Art.

# When the S-O-S Flashes!

Very seldom indeed does the dreaded S.O.S. signal disturb the serenity of our Australian ether. On the Atlantic seaboard of the United States of America, though, it is by no means an uncommon happening, and the following article is of interest because of the vivid word-picture it paints of the chain of events set in motion by the call for aid from some stricken vessel.



**D**ID you ever tune-in on the radio and find it "dead" for no apparent reason? The valves burn in all their glory, but all is silent. You rush to the roof to see if the aerial is still there. Then you test the batteries; the voltmeter needle jumps to a high mark. Well, you do about everything imaginable in an effort to bring back the music, but every diagnosis fails. Why is the set "dead"? A radio service man will have to perform an autopsy. It is Sunday, of course; the radio store is closed, so the "doctor" cannot be summoned until morning. The home seems "lost" without its radio!

So you decide to go out to the movies, but you don't enjoy the show because, all the time, there is that tingle in your brain that such a fine radio set as yours **cannot** have anything wrong with it. It never failed before. No one was tinkering with it. And what makes it more aggravating is the fact that there is absolutely no symptom of anything out of order. You reason it all out in the movie theatre. At 10.30 you return home determined to perform the autopsy on the receiving set yourself. The switch is snapped and—lo and behold—the loudspeaker pours forth its music! What a grand and glorious feeling!

But what could have been the trouble? The next morning you read in the paper that "An SOS silenced broadcasting for an half hour last night." The moral is—when the radio set goes "dead," have more confidence in it. Call up a neighbour and see if his loudspeaker is silent, too, before you become "expert" and begin the hunt for trouble. When a radio set owner begins to look for trouble he will find it, or, more precisely, create it, nine times out of ten. An SOS applies the most exacting test of the confidence you have in your receiver.

## The Programmes Go On.

But what happens in a broadcast studio when the three dots, three dashes and three dots of distress flash in from the sea? It matters not who is facing the microphone, whether it be a staff bedtime-story teller or £13,000 worth of talent—the SOS has the right of way!

An SOS does not necessarily suspend the activities of all broadcast transmitters. The "key" stations of the radio "chains," as they are on the Atlantic seaboard, may go off the air; but the programme is sent out over the wire lines to the inland network, unaffected by the call from the sea. In fact the artists continue to entertain, blissfully unaware that an SOS has greatly reduced their audience.

When an SOS silences broadcasters along the Atlantic seaboard at night, it opens up for the DX fan an excellent opportunity to tune for the elusive waves of distant stations. An SOS clears the New York air for broadcast reception, like the arrival of midnight when many of the eastern announcers bid their audience good-night.

It is seldom that such broadcasters as KDKA Pittsburgh, and others west of "the smoky city" sign off because of an SOS. But the fifty-two transmitters nestled in the metropolitan area of New York go off the air immediately; because the big transmitter known as WNY at Bush Terminal, in Brooklyn, N.Y., or that of NAH at the Brooklyn Navy Yard, instantly endeavours to calm the ether and establish communication with the ship in distress, or with other vessels in the immediate vicinity. A two-kilowatt "spark" transmitter is used at such times, because it radiates a much broader wave than a vacuum-tube outfit, and therefore is more likely to be intercepted by a greater number of stations when it broadcasts "QRT (stop transmitting), ship in distress."

## The Right of Way.

The Federal Radio Commission is authorised to designate radio stations the communications of which are liable to interfere with the transmission or reception of distress signals from ships. Such stations are required to keep a licensed radio operator listening-in on the wavelengths designated for distress calls, during the entire period while the broadcast transmitter is in operation.

Every radio station on shipboard must be equipped to transmit distress calls on the frequency or wavelength specified by the licensing authority, with apparatus capable of transmitting and receiving messages over a distance of at least 100 miles by day or night. When sending signals of distress, the transmitting set may be adjusted in such a manner as to produce "a maximum of radiation irrespective of the amount of interference which may be caused."

The radio law stipulates that, "All radio stations, including government stations and stations on board foreign vessels when within the territorial waters of the United States, shall give absolute priority to radio communications or signals relating to ships in distress; shall cease all sending on frequencies or wavelengths which will interfere with hearing a radio communication or signal of distress, and, except when engaged in answering or aiding the ship in distress, shall refrain from sending any radio communications or signals until there is assurance that no interference will be caused with the radio communications or signals relating thereto, and shall assist the vessel in distress, so far as possible, by complying with its instructions."

So while you are sitting comfortably at home enjoying the Goldman band, the Edison String Ensemble or the New York Philharmonic Orchestra, just picture the licensed radio operator on his tiresome watch, wearing the headphones connected to a set tuned to the 600-metre wave, not so far above the broadcast band. What does this man do if he hears the three dots, three-dashes and three more dots?

When a radio watchman in the New York area hears a plea for assistance, he first verifies it by telephone with the District Communications Superinten-



dent of the Navy Department in the Whitehall Building, which is in constant touch with the Brooklyn Navy Yard Station NAH.

#### The Code Signals.

Many times, before the watchman at the broadcast transmitter has had time to verify the call with the District Communications Office, NAH flashes "QST DE NAH QRT SOS"—meaning, in the parlance of dots and dashes, "General call from NAH, clear the air because of an SOS!" This is an order to all stations in the district to sign-off, whether they be broadcasters, ship or shore transmitters. When this call is heard—or before that time, in the case of an SOS which has been intercepted by the watchman and verified by the District Communications office—the operator at the broadcast transmitter immediately tips a little switch which cuts the station's programme from the air. Then speaking into a microphone, he announces that the station is signing off because of an SOS. The transmitter is silent, but the valves are kept burning because, generally within a short time, the air will be clear again.

In the meantime, code transmitters from Cape Race to Key West are endeavouring to communicate with the disabled vessel, using for this purpose every fraction of the power they possess. The Navy Yard station continues to send out its warning, in case a ship unaware of the SOS begins to transmit.

Broadcast listeners who are able to read International Morse code and the quick flashes of radio abbreviations, can often follow the rescue arrangements; for the broadly-tuned signals will penetrate into the upper reaches of the broadcast band. Usually, one shore station will direct the rescue, and within a short time this station will have communicated with vessels close to the ship in need of assistance. In communicating with the coast station, ships first ascertain the position of the disabled vessel and then report their distance from the ship in hours. One or two vessels will be assigned to speed to the rescue and, once they have changed their courses, the "All clear" signal, which is two dots-space-dot, is sent out by the land station and broadcasting is resumed.

#### Early Days of "Wireless."

Do you know the evolution of the cryptic "SOS" that silences your radio? It really begins with the first marine accident to be reported by "wireless," on April 28th, 1899 (long before the days of broadcasting), when the steamer "R. F. Matthews" collided with the East Goodwin Sands Lightship, off the coast of England. The call for help was picked up by a shore station twelve miles away and a rescue party was dispatched to the scene of the wreck, reaching it in time to save all lives. This proved the value of radio at sea, and revealed the necessity of an international distress signal which could be understood easily by the operators of all nations, despite differences in language.

The call "SOS" passed through a process of evolution. The first suggestion for an international distress call for ships was made by the Italian delegates at a preliminary meeting to consider radio telegraphy, held at Berlin in 1903. The Italians suggested the adoption of "SSSDDD." All agreed that such a call was needed, but the choice was left to a special conference. Shortly after this the Marconi Company instituted "CQD."

Erroneously, "CQD" was translated by the public to mean "Come Quick, Danger." It was one of the signals radio adopted from the land telegraph which, because of its higher state of development, was go-

verned by rules formulated and established by an international convention. Among the telegraph rules was the authorisation of a group of double-letter symbols used by operators to abbreviate and speed-up traffic.

"Q," being one of the least-used letters in the English alphabet, is distinctive and can be recognised easily. The call "CQ" on a railroad or commercial telegraph line means that the operator sending it desires all other operators along the wire to listen to his message. When radio adopted "CQ," it took the meaning "Stop sending and listen." Alone, it is important, but no cause for immediate alarm. But, in the early days of radio, if the operator followed the "CQ" with the letter "D"—the signal of danger and distress—it became a message of general alarm.

So harmless is the "CQ" without the "D" that even to-day it is a custom among amateurs and commercial operators to send "CQ" in dots and dashes as a signal that the station is on the air and free to handle traffic.

#### "SOS" from the "Titanic."

Several minor emergencies at sea revealed that "CQD" did not sufficiently express the urgency required for distress purposes. This prompted the Marconi Company to issue a General Order "Circular No. 57" on January 7th, 1904, establishing "CQD" as the official distress signal on and after February 1st, 1904.

At the Radio Telegraphic Conference in Berlin, in 1906, the German Government suggested "SOS" to replace "CQD." German ships had previously used a call "SOE" when they desired to communicate with all other vessels within range. Since the letter "E" consists of only one dot, it is easily susceptible to loss by interference; so the delegates suggested that "S" be used as the last letter. "CQD" was superseded in July, 1908, by "SOS," selected as the international distress call by the Radio Telegraphic Convention held at Berlin. (To be exact, this call differs from the letters "SOS" by the fact that the groups of dots and dashes are not separated like separate letters. This gives it a striking and attention-compelling note.)

The acts of the convention were not ratified by all nations until about a year later, so "CQD" remained in force long enough to call rescue ships to the wreck of the "Republic" in 1909.

"SOS" came into prominence when the "Titanic" sank in the North Atlantic, April 14th, 1912. As soon as the plight of the big ship was realised, Captain E. J. Smith ordered Operator Jack Philips to broadcast the distress call. Immediately the aerial of the sinking vessel radiated "Come at once! We've struck a berg! It's a CQD, OM!" (The "OM" is the radio sign meaning "Old Man," which adds a friendly personal touch to the dots and dashes.)

Then Junior Operator Harold Bride suggested, "Send 'SOS.' It's a new signal and it may be your last chance to send it." So Philips flashed "CQD" and then "SOS."

"CQD, 'SOS' from MGY. We have struck iceberg. Sinking fast. Come to our assistance. Position Lat. 41.45 N., Long. 50.14 W. MGY." (MGY was the radio call of the "Titanic.")

Philips went down with the ship, but Bride was among those rescued by the "Carpathia." That tragic scene enacted in mid-ocean proved without a doubt the true value of "SOS," the call that still vibrates the ether as a signal for help and silence.

And so loudspeakers become quiet when it sounds—as if to pay tribute to those who have "gone down to the sea in ships."

# Short Wave Operation

Pointers for the broadcast enthusiast who has just constructed a short-wave tuning unit and who is going out after the ten-thousand-mile reception he has heard about.

By H. M. BAYER.



**N**OTWITHSTANDING all that has been written on the simplicity and ease of short-wave reception, the beginner in this field should not feel that the reception of transoceanic broadcasting is merely a matter of snapping the switch, twirling the dial and, inmediately thereafter, annoying the neighbours with the blasts of PCJJ or 5SW. It simply isn't done. Long-distance reception on short waves is much like DX work on the broadcast bands; for the same amount of patience, a double quantity of perseverance, and an expert knowledge of the working characteristics of the receiver are essential for the former, just as they have been found necessary for successful results on the latter.

In operating his short-wave receiver, the beginner should forget that it has been "slapped together in a jiffy"; instead, he should go after his stations with the same nicety of operation that he would employ if he were before a twelve-valve superheterodyne. It is on the short waves, more than anywhere else, that the finger tips must be, almost, sandpapered and the clock turned toward the wall.

## Counteracting Hand Capacity.

While the short-wave receiver is being built, the usual precautionary methods for the prevention of hand-capacity effects should be employed in the construction. The simplest of these is **grounding the**

**rotor plates** of the variable condensers used in the set; that is, those condenser leads running to the "bottom" of the circuit diagram are connected to the rotors. For example, the tuning condenser should be so wired that the stationary plates are connected to the **grid** end of the coil, and the moving plates to the **filament return**.

Usually, this method has been found entirely satisfactory for the elimination of hand capacity troubles of the average variety; but conditions are often encountered where this is not sufficient. To overcome stubborn cases, shielding is placed behind the panel and grounded. It may be very thin sheet cop-

per or brass, and need be placed only behind the tuning controls. The simplest shield is made from heavy tinfoil, which may be pasted on the panel and cut with a penknife wherever there is danger of making contact with any of the instruments.

The finest preventative measure, however, is the use of a complete brass or aluminium cabinet. This not only makes for an electrical efficiency that cannot be equalled by any other shielding system, but also results in a very pleasing finish and the appearance of professional quality. Such cabinets are not difficult to construct if the job is tackled in the right way, and suitable metal sheet is readily obtainable.

In rare cases, where hand-capacity effect will not respond to the aforementioned treatments, it may be found necessary to place on the dial knobs extension rods made of insulating material. These may be of any shape or type, depending upon the ingenuity of the builder; six- to eight-inch rods will be found quite sufficient for the worst cases. Ordinary wooden dowel sticks are fine for the purpose.

## Regeneration and the Aerial.

After hand-capacity effects have been overcome to such an extent that they do not interfere with efficient operation, the next step will be to obtain a fair degree of oscillation, with every coil, over as much as possible of the tuning dial. By this is meant that each coil should oscillate smoothly over the whole tun-

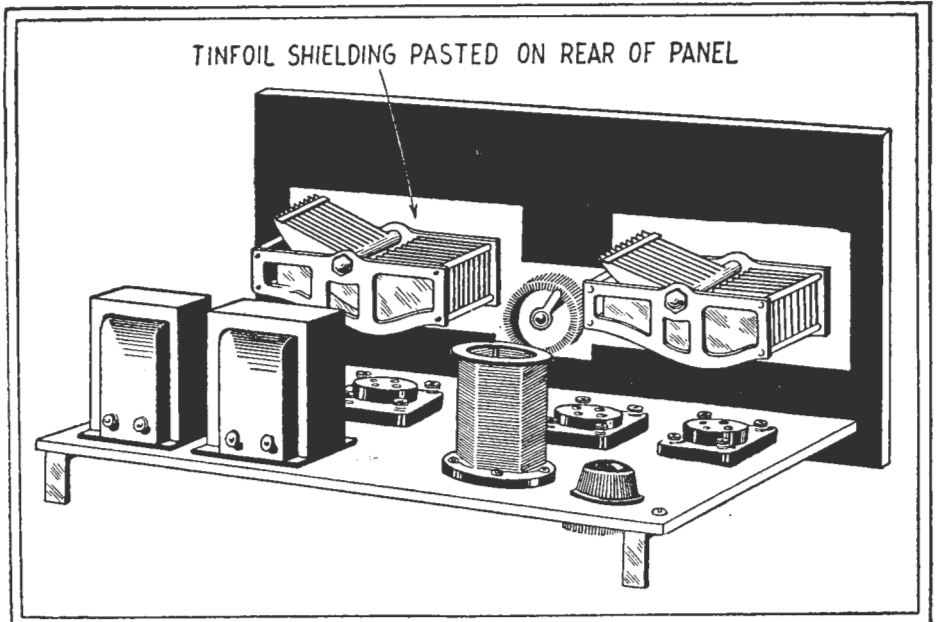

FIG. 1.—The delicate tuning of a short-wave receiver is much more sensitive to hand-capacity than that of a broadcast receiver; and the simple shielding method shown is highly advisable.

ing-condenser dial. Quite often it will be found that regeneration is difficult to obtain on the very short waves; this trouble generally can be overcome by the use of a short aerial; 25 or 30 feet should be sufficient for all short-wave work. If an aerial series condenser has been provided in the set, try varying it until the desired regeneration is obtained; once adjusted, this value may usually remain fixed. Short-wave reception and uniform controllable oscillation go hand in hand; for it must be remembered that only the latter makes possible the former. Therefore, it would be well for the builder to spend all the time necessary to solve the problem of controlling regeneration in his set satisfactorily.

**Valve Operation.**

This period of experimenting offers a good opportunity for selecting the proper grid leak; the determination of which is considered quite an important item in short-wave work. After the receiver has been brought to the point where it will oscillate with any of the coils, the next step is to bring regeneration to a state of control in which the receiver will go in and out of oscillation with a dull puff or a mild thud, instead of a loud squawk or a sharp pop. The manner of the "breakover" will make all the difference in the world when it comes to bringing in that elusive foreigner; and its importance in short-wave work cannot be underestimated.

To control the regeneration "breakovers," first choose the valve which functions best as a detector; this can be determined simply by interchanging valves until the right one is found. After this has been determined, obtain a fairly complete set of grid leaks and, by the substitution method, find the value that gives the smoothest puff on the oscillation "breakover." If no success is had with any grid leak, try

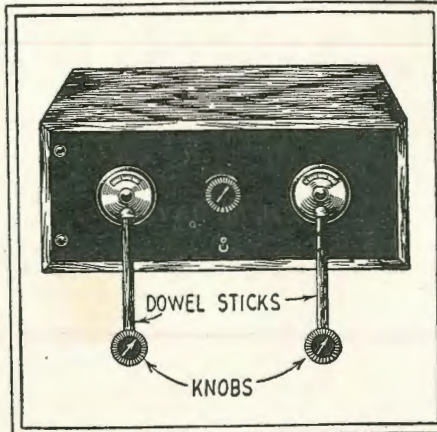

FIG. 2.—Cut the dowel sticks six inches long. Drill a small hole in one end of each; remove the knobs from the vernier dials and force instead the drilled ends of the dowels over the shafts. Fasten the knobs to the other ends of the dowels.

reducing the voltage on the plate of the detector valve, or its filament voltage. An extreme case may require the removal of a turn or two from the tickler winding; though this is a rarity with manufactured coils; and should not be attempted unless one is sure of his mechanical proficiency.

The extremely critical and hairbreadth tuning required with a short-wave receiver must, of necessity, continue for the full period of listening-in. As a general rule, the fingers are not taken from the knobs of the dials unless a station is being received with sufficient volume and stability to warrant such an action. As a rule, when a signal, either code or voice, is heard on short waves (if it is from any distance at all) it develops so many knacks of slipping in and out of the phones that the situation becomes somewhat of a wrestling match between the signal and the operator. It is quite a stunt to bring in a DX signal—it's another feat to hold it. And this can be accomplished only by maintaining one's touch on the dials.

The receiver should be mounted, preferably, on sponge-rubber blocks, regardless of the number of shock-proof sockets in the receiver. Rubber bath sponges serve the purpose admirably and are inexpensive as well; one may be mounted under each corner by screwing down each sponge.

A simple arrangement for more than one pair of phones is made by placing 4 or 5 open-circuit jacks on a small hard-rubber or bakelite panel. These are wired in parallel and connected to two binding posts, the leads from which run to the receiver. This phone block may be placed under the front edge of the table where it will be conveniently located.

"Radio News."

**Good Soldering Prevents Corrosion**

The average experimenter's mistaken idea that solder is used to make both a mechanical and electrical joint is responsible for most of the trouble due to loose and faulty soldered connections, according to P. C. Ripley, of the Chicago Solder Company.

Mr. Ripley, a recognised authority on soldering, goes on to say that solder should be used primarily to protect a joint from corrosion. Its use in making a joint mechanically tight is a secondary function.

The practice of making "butt joints"—that is, of crossing one wire over another or butting the end of one wire up to another and soldering the intersection—is not conducive to permanency, because soldered joints of that type are mechanically weak and can be loosened by jarring or by the tension which often exists in making them, especially when solid bus bar wire is used.

Conductor connections should always be made mechanically secure and electrically conductive without solder, by twisting or wrapping one conductor

around the other. Then solder should be applied as a protection against corrosion, as a means of bringing the greatest surface of one conductor in contact with the other to reduce resistance and as an additional mechanical re-enforcement.

Subscription  
**6/6**  
year



A CROSS in this square  
denotes that your subscrip-  
tion expires with this issue.

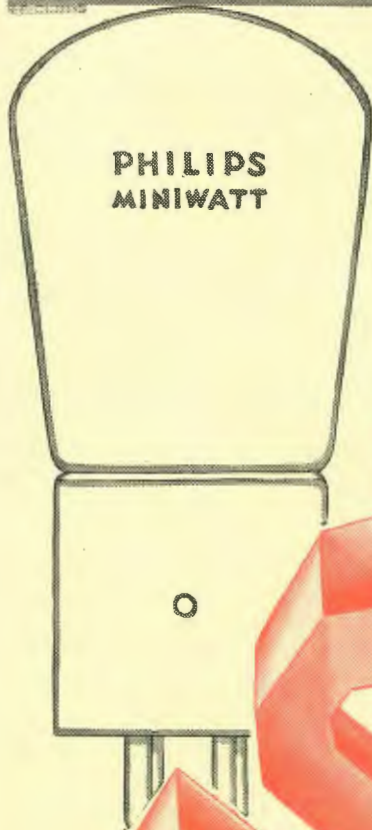

**WHY  
PHILIPS  
"MINIWATTS"  
ARE BETTER!**

**S**HEER! That's the only word that describes how steep is the slope of a modern Philips Valve.

It's the slope (or Mutual Conductance if you like) that determines the efficiency of a tube, for the higher it is the greater the change in plate current for a given grid voltage.

[ Ask for a  
Philips Valve  
Folder. ]

IT'S THE SLOPE THAT MAKES  
PHILIPS VALVES SO GOOD.

**USE A PHILIPS "B" AND "C" POWER UNIT—SIMPLICITY ITSELF.**

**PHILIPS**  
**"MINIWATTS"**

**Tone, Quality, Range, Volume, Selectivity,**  
*all these features are perfect in RADIOLA*

Tone-quality, range, volume, selectivity—all these desirable features are perfected in the New RADIOLAS. But you must own a RADIOLA to realise the difference these features mean. The amazingly pure tone and volume create the illusion of having the musician or speaker right with you in the room. As you turn the single illuminated dial stations come in clearly and sharply one after the other, and the finely finished appearance of the New RADIOLAS is outward indication of the quality within. RADIOLAS are built by the same engineers who built and installed all Australia's most important broadcasting stations. They never give trouble—never fail. Call at our Showrooms or have any authorised RADIOLA Dealer demonstrate to you. RADIOLAS may be obtained from as low as £ 10 Deposit and the balance in easy terms.

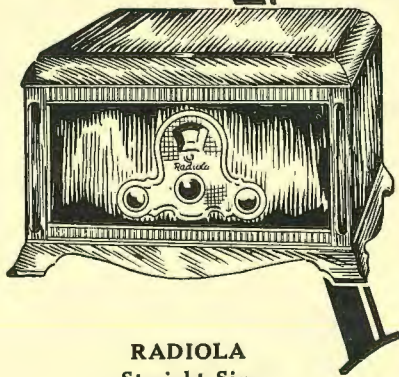

**RADIOLA**  
 Straight Six.

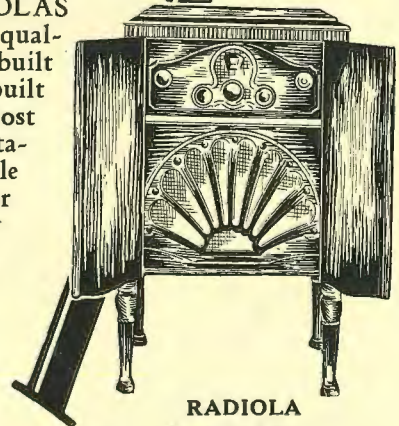

**RADIOLA**  
 Screened Six.

Authorised RADIOLA Dealers  
 are Wanted in Centres Where  
 Not Already Represented.

# RADIOLA

Queensland Distributors:

**Amalgamated Wireless**  
*(Australasia) Ltd.*

**J. B. CHANDLER & CO.**

"Queensland's Largest Radio Store,"

ADELAIDE STREET : : : BRISBANE

# THE LEWCOS 1928 SOLODYNE COIL KIT

The Screen Grid Valve Kit that reproduces the "B" Class Stations  
as if they were "A" Class

One enthusiastic user writes: "I have finished building the 1928 Solodyne and find that it is all that is claimed for it. The tone and volume are the best that I have heard from any wireless set."

This Kit has been specified and used by leading English Radio Journals for incorporation in the popular Solodyne receiver.

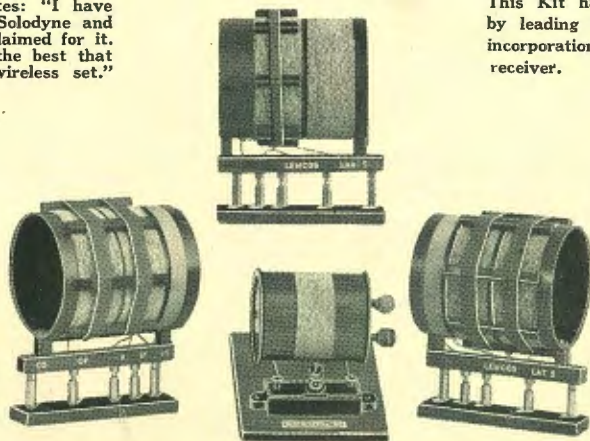

The Kit Comprises— One Aerial Coupler, Two Radio Frequency Transformers, Three Plug-In Mountings and a Compact Wavetrap.

**PRICE £5/10/0 COMPLETE**

An outstanding feature of the LEWCOS KIT is that the grid coils are wound with Litzendraht wire, making for a very low radio-frequency resistance. The two radio-frequency transformers have restricted magnetic fields due to the primaries and secondaries of both following the astatic system of winding.

The strongly-made plug mountings make mounting and wiring easy and convenient. The wavetrap, which is so compact, is extremely efficient. It may be permanently mounted behind the panel, and once set to eliminate an interfering station, needs no further attention. Your inspection is cordially invited.

## J. B. CHANDLER & CO.

"Queensland's Largest Radio Store"

ADELAIDE STREET

BRISBANE



Fancy  
Meeting  
YOU  
Here!!

Well  
Well!!



## BELLING Electric STOVES

### Why there are so many Belling Stoves in use—

**Cleanliness.**—There are no fumes, no odours, no dirt or ashes, no black spots or pans to clean, while the electra porcelain enamel itself is very easily cleaned with a dry cloth.

**Better Cooking.**—Better cooking and baking has also been proven. Thousands of women have joyfully realised the savings effected by the preservation of the valuable juices in roasts of all kinds, thus reducing shrinkage.

**Economy.**—A close study of your monthly cooking bills before and after you buy a Belling will prove to you beyond all argument the economy of buying a Belling Stove.

**Durability.**—Belling Electric Stoves are famous for their hidden values. Nothing but positively the best materials and superior workmanship are put in every range.

**Beauty.**—From the standpoint of appearance, Belling Stoves are unexcelled anywhere; indeed the Belling models and designs are accepted as standards wherever electric stoves are built.

**Compactness.**—A close inspection of the new models will reveal the fact that Belling Stoves are the most compact and workmanlike made. They carry ovens that will take large size roasts and provide ample room for cooking and boiling.

**Elements.**—Belling elements enjoy super-heating capabilities, are very economical of power, and will last longer than ordinary elements.

**Porcelain Enamel.**—Every surface that is exposed to grease splashes, steam or the fumes of cooking is coated with Porcelain Enamel.

PRICE £10/10/0 Write for Literature

# TRACKSON BROTHERS LTD.

*The Electrical and Radio People*

157-159 ELIZABETH ST. Phone Cent. 6080

BRISBANE

# The Transmitting License

By Q.R.N.

Article No. V.—Dealing with Inductance and Power Supplies for Transmitters.

(All Rights Reserved)



In the last article, consideration was given to capacity; this will commence a study of induction and of inductance. While capacity is the attribute of condensers, coils are measured in terms of their inductance. Explanations of the phenomena of induction are usually given in terms of lines of force and the number and disposition of such lines of force determine the inductance of the coil.

The ordinary bar magnet affords a good starting ground. When a magnet is brought into close proximity to a metallic object, say, of iron or steel, the metal tends to move towards the magnet. Obviously, there is no visible or physical connection between the magnet and the iron, so recourse must be had to other modes of explanation. Briefly, it is assumed that a bar magnet is surrounded by lines of force—so called because these imaginary lines indicate the direction in which each particle in the magnet is tending to strain in order to link itself with certain other particles within the magnet. This it is assumed that all the particles of the North Pole of a magnet are straining to reach the complementary particles at the South Pole, and it is imagined that the magnet is in the middle of an envelope of lines of force surrounding it on all sides and both ends.

If now a piece of iron be brought within the sphere of action or field of these lines of force, it is found that polarity is manifest in the iron. That is, the nearer end of the piece of iron will exhibit conditions which are similar to those exhibited by magnetic poles of opposite sign to the energising pole. If the energising pole be of North polarity, then the nearer end of the piece of iron will be a South and the further portion a North Pole. A long cylindrical coil, when energised by an electric current, exhibits similar characteristics. That is, it becomes a magnet—or more correctly, an electro-magnet—and possesses a magnetic field. The polarity of such a solenoid may be determined by noting the direction of current flow when looking at one end of the coil. If the flow be round the coil in a clockwise manner, the end looked at will be the South and the anti-clockwise end the North Pole.

The magnetic strength, so to speak, of an energised solenoid may be greatly increased by filling the hollow space inside the coil with an iron core—and it is for this purpose chiefly that such cores are used, for example, in the electro-magnets of the common bell and telephone. From this discussion it will be seen that as a current is applied to and removed from a coil, the lines of force round such coil will alternately build up and collapse. While the current applied is constant, there will be no variation in the strength of the field covered by the lines of force. As a consequence it may be assumed that the lines of force are at rest.

Now, if a second coil in a closed circuit be brought within the field of the first coil, the effects of induction are noticed. As soon as the current is switched on to the first coil—the energising coil—it is noticed that a current is flowing in the second coil. The lines of force from the first coil, while spreading out to their ultimate position, have “cut” the turns of wire forming the second coil—and this cutting produces an electric current in the second coil. When the current—and consequently, the field of force around the first coil—reaches its maximum, there is no movement in the lines of force, and therefore no current induced in the second coil. From this it is understandable that the inductive effect is only noticeable in the second coil, when the current in the first coil is being switched on and off, or more commonly, as in the case of alternating current, when the current is constantly varying from positive to negative, and vice-versa.

The direction of the current in the second coil is given by a principle known as Lenz Law, which states basically that the direction of an induced current is opposed to that of the inducing current and, in the case of the two coils considered above, the coils will tend to repel each other.

A practical illustration of the phenomenon of induction is given in the action of an ordinary transformer. Usually the secondary coil has many more turns of wire upon it than the primary, so that lines of force radiating from the primary coil cut a large number of secondary turns, and thereby give an increased secondary voltage because, in theory, the E.M.F. induced in every turn of the primary coil, will be equalled by the E.M.F. in each turn of the secondary coil, and the ratio of “primary coil” voltage to “secondary coil” voltage will depend directly upon the ratio of turns in the coils.

The inductance of a coil is measured in units known as Henries, after Joseph Henry, a noted American physicist. One Henry is the inductance of a coil in which an E.M.F. of one volt is induced by a current in it changing at the rate of one ampere per second. Inductance coils, more especially those with an iron core (choke coils) are often connected together in series or parallel, and for purposes of calculation they follow the same rules as in the case of resistances in series or parallel. Such simple calculations will, however, be true only so long as there is no magnetic coupling between the coils.

This virtually completes the basic knowledge required to understand the deeper parts of this series of articles. The reader should have now a fairly good knowledge of such sections of radioelectricity as capacity, inductance, resistance, reactance, current voltage, and the like, and be quite fitted to go on to the remaining articles.

## ( Power Supplies.

A transmitting set, to function efficiently, must have an adequate supply of power to feed the plate and



# FERRANTI

Dear Sir,

CONSIDER  
THESE  
PERFORMANCES

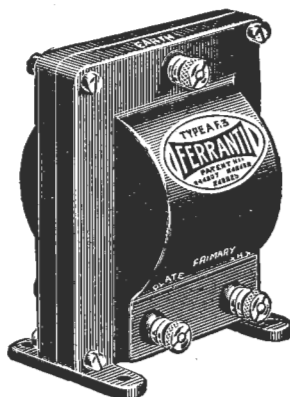

BEFORE  
YOU  
BUY

## Audio Frequency Transformers

- A.F.4 Uniform amplification from 300 cycles upwards. 50% of maximum amplification, even at 50 cycles. Price, 34/-.
- A.F.3 Uniform amplification from 100 cycles upwards. Over 80% amplification at 50 cycles. Price, 45/-.
- A.F.5 Uniform amplification from 100 cycles upwards. Over 90% amplification at 50 cycles. One can almost say uniform amplification from 50 cycles upwards. Price, 57/-.
- A.F.5. is still and will remain for a very long time the best Intervalve Transformer that can be made.
- A.F.3 is still better than anything else offered (except the A.F.5) whatever its price.
- A.F.4 is still the best Intervalve Transformer in its price class.

DO NOT BUY AN AUDIO FREQUENCY TRANSFORMER  
UNTIL YOU HAVE EXAMINED ITS AMPLIFICATION  
CURVE DRAWN ON THE MUSICAL SCALE.

Yours faithfully,

## FERRANTI LTD.

filament circuits of the valve. It is quite feasible to use accumulators or dry cells for either circuit, but this method is too costly for popular use. Generally there are two systems of plate power supply used in Queensland. The first—and commoner—is by means of high voltage transformers to “step-up” the municipal power supply from the usual 220-240 volts to 1000, 2000 or other higher voltage, depending upon the type of transmitting valve to be employed. However, seeing that the holder of an Amateur Operator’s Proficiency Certificate is limited to a power of 10 watts as measure in the plate circuit, a terminal voltage of 400/600 is ample. Powers exceeding 10 watts may be permitted for experimental work at the discretion of the Radio Inspector, to whom application for such permission should be made.

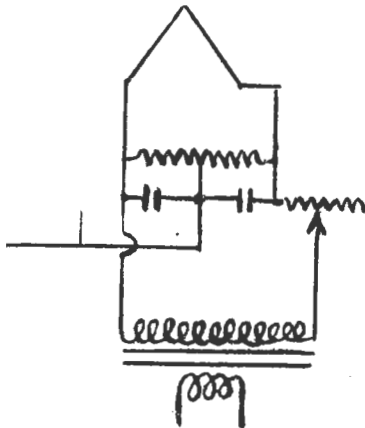

FIG. 1

The second source of plate supply is the motor generator, which has an output depending upon the mechanical and electrical construction of the machine. In either case a separate tapping or winding is incorporated to give a suitable voltage for purposes of filament lighting. It is very desirable that alternating current should be supplied to the filament to conserve the life of the valve. Where a filament is lit from a direct current source, the attraction exerted by the positive plate causes the bulk of the electrons emitted by the filament to issue from that side of the filament which is connected to the negative pole of the high tension battery. Also, this side of the filament has a larger current to carry, and consequently, is subjected to greater stress and is unduly weakened. By utilising alternating current for the purpose of filament heating this effect is dissipated. The filament voltage transformer is usually constructed to give a voltage lying between 5 and 15, and the output is controlled by a rheostat or resistance in the primary circuit. These two ends of the secondary coil are connected across the valve filament, and the filament return lead brought to a centre tap on the transformer, which lead also serves as the negative lead to the high voltage supply.

Where a filament heating transformer has no centre-tap an artificial one is easily made by connect-

ing a centre-tapped choke or resistance across the output terminals of the transformer and utilising this. The correct way of doing this is shown in Fig. 1. It is essential for efficient working that the centre tap should be at the electrical centre of the filament circuit for two reasons. First of all, so that the stress on the filament due to the plate current may be evenly divided between either leg of the filament; and secondly, to prevent the A.C. filament voltage from entering into the grid circuit of the tube.

**Dynamos and Motors.**

In its essentials an electric generator consists of three parts—the field magnets, the armature, and the collecting apparatus, known either as the slip rings (in the case of alternating current machines), or the commutator (in the case of a machine delivering direct current).

The armature is a framework—usually of soft iron laminae—upon which an insulated coil of wire is wound lengthwise. The usual armature is shaped like a bobbin and is mounted to spin freely upon its long axis. The field magnets are usually the two poles of a strong horseshoe magnet with their ends so shaped as to allow the armature to spin between them with the least practicable clearance. This is so that the magnetic field set up around the poles may be utilised in the armature to the fullest extent. This is shown in Figs. 2a and 2b. Usually the poles of the field

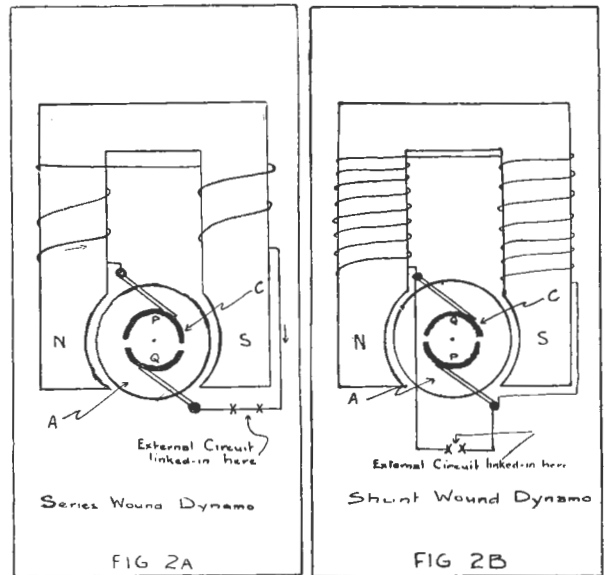

magnets are wound with several layers of wire connected with some source of current supply, thereby turning them into electro-magnets and intensifying their field of force.

Slip rings are two unbroken copper rings mounted on the spindle of the armature, to which the ends of the armature winding are connected. Needless to say, these rings are very carefully insulated from each other and from the spindle itself. Contact is made to these rings as they revolve by means of brushes—which are usually blocks of carbon pressing against the slip rings—whereby the voltage generated at the slip rings may be led away to an external circuit.

A commutator is merely a segmented slip ring. Only one commutator is usually used, as against two slip rings. The two brushes are arranged in such a fashion as to be contacting on opposite segments of the commutator at any instant.

The segments of a commutator are even in number and the several coils of wire that are wound on the armature have their one end attached to one segment and their other end attached to the next segment. The reason of course is that the brushes make contact on opposite segments and so complete the electrical circuit through the coils. Further, it is usual to connect the beginning of each coil to the segment of the armature, which carries the end of the preceding coil, though occasionally the same result is obtained by making the brushes so wide as to bridge the gap between any two neighbouring sections of the commutator. This has the ultimate effect of making all the windings on the armature into one big coil.

The principles on which a dynamo (as such a machine is usually termed) works have been dealt with in the article on induction; suffice it to say that the movement of a conductor (the armature) across the lines of force of the field magnets sets up a voltage in the armature capable of being tapped and utilised in an external circuit.

The windings on the field magnets may be excited from an external source—in which case the dynamo is said to be "separately excited." It is usual, however, to utilise some of the current produced by the rotation of the armature, and such dynamos are known as shunt wound, series wound or compound wound.

A series winding is shown in Fig. 2a, wherein it is seen that the whole of the output at the brushes is fed through the field coils, and the external circuit in series. In shunt winding the field coils (Fig. 2b) are in shunt or in parallel with the external circuit. In a series wound dynamo the field coils consist of a few turns of heavy wire, while for a shunt wound dynamo a large number of turns of fine wire is used.

A compound wound dynamo simply incorporates both series and shunt windings.

Next, to discuss the working of such machines, suppose one considers one coil on an armature in a dynamo fitted with slip rings. As shown in Fig. 3 this

coil continues its rotation, the conducting wire of the coil cuts more and more lines of force, until it cuts a maximum number when passing for an instant across the line NS. Continuing its rotation, the coil cuts a decreasing number of lines of force until it reaches, at its next "perpendicular" position, another zero point, but one where the former "top" of the coil (A) is occupying the position formerly held by (B).

Thus, in a complete rotation of 360 degrees, there will be two zero and two maximum points, the zero points occurring when the coil takes up a position at right-angles to NS and the maximum points occurring half-way between these positions.

If brushes leading to an external circuit be connected to the slip rings an opportunity will be afforded of noticing that the current derived from the rotation of the coil starts at a zero value, rises to a maximum, decreases to zero again, and then rises to a maximum in the opposite direction, and again falls to zero. A consideration of the earlier articles will show that this is due to the fact that the direction of the induced current depends upon the direction in which the conductor or coil cuts the magnetic field. Thus such a machine, known as an alternating current dynamo, gives an output of alternating current the frequency of which depends upon the rate of rotation of the armature.

Now, using such a machine as a starting point, one comes to consider the changes necessary to change the output to direct current. This is done by using a commutator in place of the previous slip rings.

The best way of illustrating the working of a commutator is by a diagram. Suppose that Figs. 2a and 2b are utilised. Herein is shown a two-segment (or two pole) commutator (C) firmly fastened to the arma-

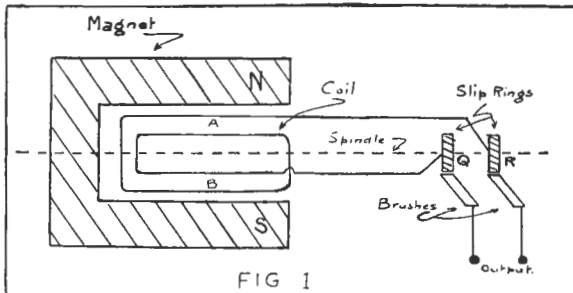

coil is free to spin within the field of the magnets marked N and S, and its ends are carried out to the slip rings Q and R. If now this coil be rotated the effect of the magnetic field is noticeable. So long or for such instants as the coil is in a position at right angles to the line NS there will be no voltage generated, for at these instants the conductor is not "cutting" any of the lines of magnetic force between N and S (it may be regarded as sliding along the lines of force, but so soon as the coil swings past this posi-

## HENLEY

# Winding Wires

**SCC, DCC, SSC, DSC.**  
**Enamelled, Enamelled SCC.**  
**WHITE & GREEN.**

In 4oz., 8oz., 1lb., and larger reels. No. 6 to No. 47

### Special Flexible For Radio Work

Also all types of Insulated and bare, and Cables for Aerials.

Insulating Tapes.      Resin Cored Solder.

**THE HENLEY**  
 Wiring System

## W. T. Henley's Telegraph Works Co. Ltd.

Central: 7044.      59 ELIZABETH ST.

ture (A). The field magnets (N and S) and the brushes are as shown.

Now, it is obvious that when the armature is in the position 2a the current derived from the brushes will be in a certain ascertainable direction, say as shown. But when the armature revolves 180 degrees the current direction in the coil will be reversed.

However, the brush which was formerly contacting with the segment (P) of the commutator has now made contact with segment (Q) which is, after the half-turn of the armature, now of the same polarity as was P formerly—Fig. 2b.

Thus, the output of such a machine will always flow in one direction—it will be direct current—though there will be a decided ripple necessitating some method of smoothing and filtering. By using many coils on the armature and a corresponding increase of commutator poles a steadier output with less fluctuation will be obtained.

#### Electric Motors.

Such a machine—the direct current dynamo—may be turned into an electric motor by a reversal of the normal order of procedure. If in this case the armature fed with current through the commutator and brushes instead of having current drawn from it, the coils on such armature will exhibit magnetic polarity—as described earlier in this article.

Suppose in Fig. 2a that any point (X) on the armature close to the magnetic pole N becomes of north polarity, and an opposite point (Y) close to the magnetic pole S simultaneously becomes of south polarity (these points are not lettered in the diagram to obviate confusion, but readers should have no difficulty in following the description), then the two north poles

(N and X) will repel each other, and the two south poles (S and Y) will do likewise. Similarly there will be strong attraction between S and X and between N and Y. Thereby a torque or twisting force is applied to the armature, and it commences to rotate into a position where Y is close to N and X close to S. This, due to the principles of magnetic attraction, would be the final position if it were not for the action of the commutator, for while the rotation was continuing, the brush formerly in contact with P is now in contact with Q. Thereby the current flowing round the coil has been reversed in direction, and the side of the armature that was formerly north is now south, and matters are back in the position shown in 2a. Then commences again a period of repulsion between the pairs of like poles with a corresponding rotation of the armature. This rotation will obviously continue so long as current is applied to the armature and the rotation of the spindle may be utilised by means of a belt to drive machinery or other mechanical appliances.

#### PCJJ NOW PCJ.

#### RESULT OF NEW REGULATIONS.

From the 1st January, 1929, the call-sign of Philips popular short-wave station was altered by omitting the last letter of the previous call. This was necessitated by the new regulations drafted by the recent Washington Conference.

All reports on PCJ should be forwarded to Messrs. Philips Lamps (A.'sia.) Ltd., where they will be most welcome.

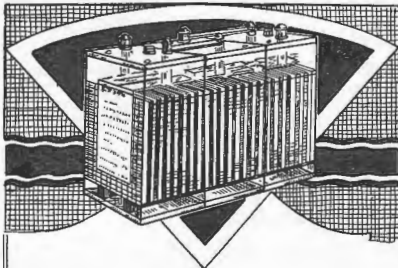

## For the Best in Radio Entertainment—

Make sure that the batteries hidden away in the cabinet of your receiving set deliver their power unheard as well as unseen by using EXIDE Wireless Batteries. They

add to the complete efficiency of your receiving equipment — contribute more to your radio entertainment—because they embody every lesson learnt in over 35 years of storage battery manufacture. That's why when you use EXIDE "A," "B," and "C" Batteries you get the most in dependability, longer life, and complete satisfaction. Sold at all Wireless Stores.



### EXIDE BATTERY SERVICE [Q.] LIMITED

ADELAIDE STREET — — BRISBANE

Also at Stanley Street, South Brisbane

# Exide

## WIRELESS BATTERY



# ELECTRON AERIAL WIRE and

## 'SUPERIAL'

*Two Famous British  
Products*

Throughout the world Electron Aerial Wire—and Superial (Electron's Super Aerial)—are justly famous. No other wire compares with them; they produce results far better than any other wire used as aerial. On using them, enthusiasts write glowing testimonials, stating the wonderful improvement in reception—volume is increased, reception is purer, selectivity is greater.

SIMPLE TO FIX ~ ~ WILL LAST FOR YEARS

ELECTRON WIRE: Especially good as an indoor aerial, and perfect for outdoor use also. Easily fixed round the picture rail of a room or simply tied to a tree and attaching the other end to the set (in one continuous length); no lead-in tubes being necessary. 100ft. Coil ..... 2/6

SUPERIAL is specially made for Long Distance Reception. Extra heavy insulation of vulcanised rubber gives perfect protection against leakage—there can be no loss of incoming signals. Wonderful testimonials are received from all over the world. 100ft. (on wooden spool to facilitate un-winding.) ..... 4/6

BRITAIN'S BEST-USED ALL OVER THE WORLD

*Sole Distributors for Queensland:*

CANADA CYCLE & MOTOR AGENCY LIMITED

CORNER OF CREEK AND ADELAIDE STREETS, BRISBANE

**Sole Manufacturers: The NEW LONDON ELECTRON WORKS LIMITED, EAST HAM, LONDON, ENGLAND**

# The New Telephony Transmissions

In view of the prevalent impression that the various broadcasting authorities are remaining idle in the matter of television and the transmission of "still" pictures by radio, the following statement issued by the British Broadcasting Corporation is interesting. It serves to illustrate the point that while they are watching the situation very keenly, the broadcasting companies are not prepared to spend large sums of money until a system has been devised that shows at least some promise of attaining a reasonable standard of reproduction at the receiving end, and one that will not be obsolete within a very few months. As neither television nor "telephony" can be said to have reached such a stage as yet, the attitude appears to be a very reasonable one.



**I**n case listeners who have been on tiptoes with anxiety or expectation over the question of picture reception by wireless should think that this latest development is being held up by the broadcasting authorities, let it be clearly understood that no one is watching events more closely than the B.B.C. itself, and that any invention which is of proved value and for which a sufficient demand exists in connection with the broadcasting service will always receive full consideration at Savoy Hill.

### Marvel of Science.

Wireless, the marvel of science, is still so much in its infancy that it were foolish to imagine that, having reached the present stage of efficiency, no further territory remains to be explored.

The speech and music which are being received in millions of homes to-night are merely symbolic and transitory. Even when the mystifying capabilities of the ether are brought still further under control and the efforts of great brains materialise into the inclusion of pictorial representations flashed through space to the listener's fireside, we shall still be wandering within the realm of the symbolic and transitory.

### Still More Wonderful.

Something still more wonderful may be found outside that realm. As one of the great thinkers of our time has put it, a means may be discovered to ally thought with ether direct and to broadcast and communicate thought without the intervention of the senses or any mechanical device in the same manner as a receiving set is to-day tuned to the wavelength of a transmitter so that there may be a free passage between them.

Having this possibility in mind, the B.B.C. regards picture transmission as nothing more than yet another transition stage along the pathway of advancement. But when will that transition stage definitely be reached? Is it to be taken that the tests which have been made by the B.B.C. engineers in connection with "still" pictures mark its advent? Again, what are these tests?

They have generally been regarded as telephotographic tests; but the meaning of telephotography is now accepted, mainly, as photography with a camera fitted with a long-distance lens, like a telescope, to

provide a close-up view of a scene which for some reason or other the photographer cannot approach closely.

### Telephony—What it Means

Phototelegraphy, on the other hand, is interpreted as meaning the transmission of photographs by means of telegraph lines. It is, perhaps, more correct to describe the picture broadcasting tests as telephony (compare telephony), meaning the transmission of pictures by electric current.

Having arrived at a definition of what the tests were concerned with, let us study the attitude of those responsible for their performance. As in the case of the exhaustive experiments with contrasted programmes from the Daventry experimental station, which have been going on for fifteen months past and are even yet uncompleted, the B.B.C. has adopted the policy of "festina lente," preferring to await actualities rather than to indulge in promises that have their roots in over-zealousness.

When any change or innovation is contemplated, it is always necessary to experiment widely both from the engineering and the programme points of view to ensure that the decisions as regards service are taken with full knowledge of the problems involved.

Hence it was that on the conclusion of a certain amount of preliminary technical experiment carried out in the first place between the B.B.C. research station at Clapham and the Oxford Street transmitter during the early summer, the Corporation decided after several months to widen the scope of the experiment by arranging for a very short picture transmission daily from Daventry (5XX) outside regular programme hours.

### Regular Programmes.

If, and when it is discovered that there is a sufficient public demand for "still" pictures radiated in this way, similar transmission may be included in regular programme hours; but it will be in the light of the interest shown by listeners themselves that any development of this nature will be considered.

Various systems of picture broadcasting have received consideration during the past two years, one which was regarded as holding out a certain promise being a transmission which took the form of a ray of light scanning a photograph rolled round a drum, the varying electric current being received by a stylus passing over a roll of sensitised paper.

## EASE OF TUNING

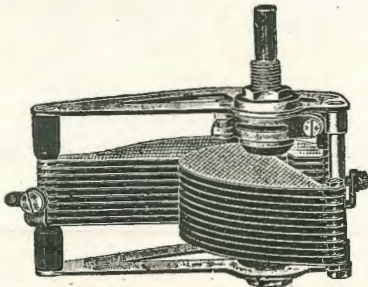

*J.B. True Tuning S.L.F.*

The J.B. True Tuning S.L.F. gives the wide wave-length range and overlap of a normal condenser with the ease of tuning usually associated with condensers of much lower capacity. This is a notable achievement in condenser design, which has only been attained after much research.

As the majority of stations work on frequencies between 500 and 1,000 kilocycles, the J.B. True Tuning S.L.F. is arranged to give greater variation on the high frequencies. This means that the whole of the scale is being used to the best advantage.

The J.B. S.L.F. models are the high-water mark in S.L.F. design.

Prices J.B. (True Tuning S.L.F.):  
 .0005 mfd., 16/6; 100035 mfd., 16/-;  
 .00025 mfd., 15/9. For Short Wave  
 Receivers, 100015 mfd., 15/9. Write  
 for full particulars of Logarithmic  
 and Neutralising Models.

# JACKSON

## CONDENSERS

Dealers communicate with:

**A. BEAL PRITCHETT  
 (AUST.) LTD.,**

SYDNEY AND MELBOURNE.

EDGAR V. HUDSON, BRISBANE.

WEDMA LTD. :: ADELAIDE.

GIBBS, BRIGHT & CO., PERTH.

A

### Picture Immediately Visible.

In this case, on completion of the reception, the paper had to be detached from its cylinder and developed and fixed after the manner of an ordinary photograph. This system resembled most nearly that which the B.B.C. finally decided to adopt for its experiment, but the accepted system has the advantage that the picture as recorded is immediately visible to the eye, although it is little more permanent than a photographic proof, which dissolves on exposure to light.

### Storing in a Dark Place.

It is necessary, therefore, that recipients who wish to retain any illustrations should store them in a dark place. The pictures produced on the receiving machine measure 5in. x 4in., and are transmitted in three minutes. The receiver has the appearance of a small dictaphone or phonograph, except that the cylinder round which the sensitised paper is wrapped is of brass.

As the cylinder revolves, a platinum needle travels over the paper, making a brown dot whenever electric current is flowing and making no mark at all when the current is broken. Like broadcast listening, however, successful reception is likely to be marred by atmospheric conditions at times.

If sufficiently powerful apparatus is used, it should be possible for owners of the apparatus to tune-in to Vienna and other Continental stations which are using or are about to use a similar device to that with which the B.B.C. is experimenting. Distances of upwards of 850 miles have already been covered, one of the earliest long-distance transmissions being a photograph of the Prince of Wales, which was sent out from Vienna and received in London.

In what way can picture transmission of this character be of value to the broadcasting service? It must be remembered that telephoty can take place both by day and by night. This permits the broadcasting of weather charts, or photographs of missing persons for whom S.O.S. messages are broadcast at any time of the day during transmission hours. Photographs of artists and speakers can also be given prior to their broadcasts, as well as illustrations of scenes from radio plays which listeners are to hear.

Of greater utility, perhaps, are pictures and diagrams to illustrate broadcast talks on fashions, while children's stories could also be elaborated pictorially. Photographs of topical events, such as the opening by the King of some great national museum, or scenes from the Derby, could also be transmitted. These ideas will all be considered as the necessity arises.

The system used for the present experiments is in the nature of telephoty, that is, the broadcasting of photographs, drawings, or diagrams, in contradistinction to television, or instantaneous motion pictures.

### Possible Television Developments.

As regards the latter, in which rumour has stated that the B.B.C. is on the eve of playing an important part, at the time of writing no apparatus had been placed before the Corporation of so practical a nature as to make a service possible to the listener.

But here, again, the B.B.C. is watching developments closely; and when the inventive genius of some master-mind has produced results which will guarantee a service that will benefit listeners, the officials at Savoy Hill are prepared, subject to the approval of the Postmaster-General, to lend their co-operation.

**PHILIPS  
MINIWATT**

50  $i_a$  (mA)

$V_f = 4,0 V$   
 $i_f = 0,15 A$   
 $V_a = 50-150v$   
 $i_s = 50 mA$   
 $'g = 100$   
 $S = 18 \frac{mA}{V}$



**IT'S THE SLOPE THAT MAKES THEM BETTER**

**THE  
STEEPER  
THE  
SLOPE  
THE  
BETTER  
THE  
VALVE**

The curves of Philips 'Miniwatts' SOAR up—they're higher—they're steeper.

The slope of a valve tells you much—for the steeper it is the greater the change in the plate current—grid voltage ratio, higher efficiency, and of course the louder and clearer your music.

[You can pick out the *INDIVIDUAL INSTRUMENTS* with a Philips Loudspeaker.]

-50 -40

**PHILIPS**

**"MINIWATTS"**



Special Activation Process

# OLDHAM

BATTERIES

ALREADY DRY & CHARGED—ONLY NECESSARY TO ADD ACID

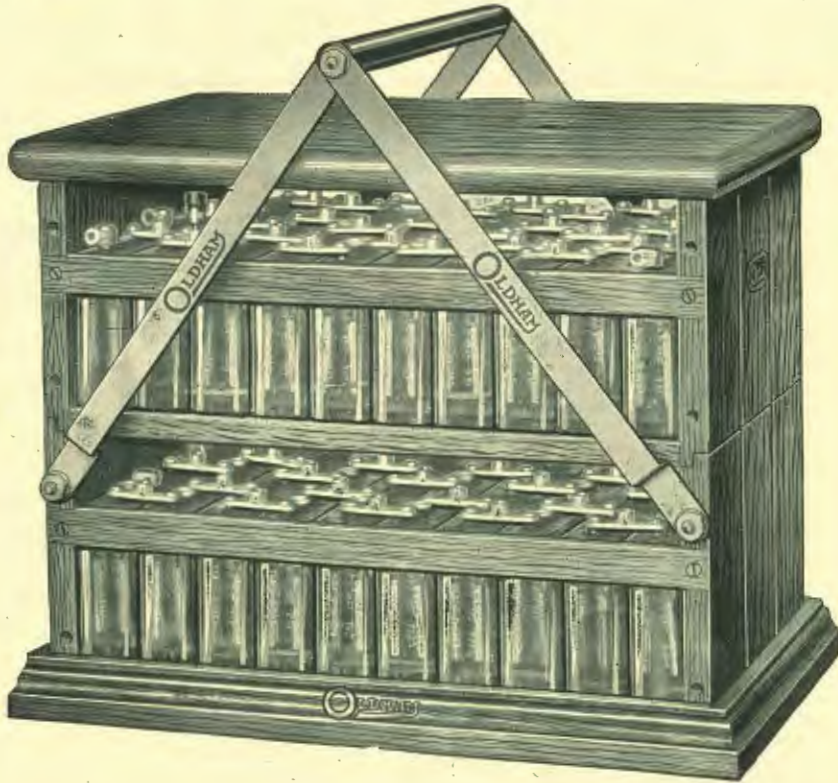

Supplied  
in  
20 Volt  
Units

Can be  
Built  
to any  
Voltage

**1/3**

PER VOLT FOR YOUR HIGH TENSION  
"B" BATTERY POWER

WRITE FOR ILLUSTRATED PRICE LIST

**Noyes Bros. Ltd.**  
(Sydney)  
PERRY HOUSE BRISBANE

# The Wonderful Radio Furnace

*The Latest Application of Radio-frequency Currents is concerned with the Melting of Metals and is described in this Interesting article*



SINCE the dawn of industry, and, indeed, since the very beginning of history, the melting and refining of metals and alloys has been a very laborious and wasteful process. For hundreds of years, steel and iron have been smelted in large and complicated furnaces which necessitated large amounts of fuel to actuate them, and which needed, also, a period of time extending over many hours to bring the metal or alloy completely to a molten condition.

Platinum and some other metals needed special electric-arc furnaces of their own to effect their complete melting; furnaces which, needless to say, were costly and consumed large amounts of heating power.

A study of the possibilities inherent in radio-generated currents, however, has within very recent times resulted in the development and successful practical application of what may be termed the "radio furnace."

So successful has this invention proved in the steel and iron industry alone, that it is safe to say that in years to come the radio furnace operating on radio-frequency currents will displace most of the other methods of metal refining. The radio furnace, again, has other important applications of especial interest to the wireless enthusiast, as we shall see later.

Essentially, the radio furnace consists of a heat-insulated metal box or container, inside which is arranged a coil of wire of about fifty turns. Sometimes the coil is composed merely of wire, at other times it may be composed of copper tubing, along which a current of water flows for cooling purposes. Within the copper tubing is placed a smaller container of some heat-insulating material, such as asbestos, and the metal to be melted is placed in this. Such, in its essentials, is the construction of the radio furnace.

The mode of operation of the furnace is as simple as its construction. Radio-frequency currents are led into the copper coil, which acts as the primary of a large step-down transformer. The mass of metal to be melted acts as the secondary of the transformer. Under these circumstances, the radio-frequency current at high voltage is stepped-down by the transformer arrangement to a current of lower voltage in the transformer secondary (consisting of the mass of metal to be melted), but at the same time is greatly increased in amperage.

The result is that whilst the radio-frequency current flowing through the primary coil of the furnace hardly heats the coil at all, the stepped-down current induced in the mass of metal within the coil rapidly heats the latter, owing to the production of eddy currents within the metal. The rapid pulsations of the stepped-down currents serve to keep the molten metal in constant motion, and thus a metal or alloy of the highest possible degree of homogeneity is obtained.

It should be borne in mind that, despite the enormous temperature developed inside the furnace, the outside of the latter remains almost perfectly cold. In fact it is possible to place one's hand *inside* the furnace without feeling any ill-effects. This, of course, is due to the fact that the radio-frequency currents flowing through the primary coil of the furnace can only induce the stepped-down heating currents in metal objects, and therefore if these are absent the furnace remains cold.

With a medium-sized furnace, a temperature of 2500 degrees centigrade can be obtained in about 20 minutes, whilst with the furnaces specially constructed for the melting of platinum and similar metals, a still higher temperature can be obtained.

The first radio furnace in England to be used for iron and steel work has been developed and installed in the works of Messrs. Edgar Allen and Co., the well-known steel manufacturers of Sheffield. It is interesting to contrast the diminutive and neat appearance of this furnace with that of the older types of rotary furnaces such as the Bessemer Converter.

In general, there are two methods of generating the radio-frequency current which is required for the operation of the furnace. In the first place, a 60-cycle alternating current may be transformed by means of a converter into a higher-frequency current of the order of anything from 5000 to 300,000 cycles. This method is the one employed by Messrs. Edgar Allen for the production of their high-frequency current. On the other hand, many of these types of furnace utilise a bank of oscillating valves for the production of their radio-frequency currents.

It is well-known by wireless enthusiasts that during the last stages of exhaustion of radio valves, the valves themselves have to be heated in order to boil out, as it were, the last traces of air which are absorbed and retained by the metal electrodes within the valves.

Now, previous to the application of the radio furnace, this process of "boiling out" absorbed gases from the electrodes within the valve was a very difficult one, for the reason that it was almost impossible to heat the electrodes within the valve without at the same time softening the glass bulb. Thus all the earlier valves contained residual traces of air absorbed or "occluded" by the metal parts within the valve.

A modification of the radio furnace, however, has rendered it a very simple matter to rid completely the inner electrodes of the valve from their absorbed or occluded air. The method is to connect a specially-constructed coil to the output terminals of a valve oscillator, and during the last stages of the valve-exhausting process, just before the valve is ready to be sealed off, in fact, to slip the coil over the valve.



**P.S.**

Dear Radioites,

The Advertising Manager has gone away for a week. The boss says we've got to do this week's advertisement. We don't know a thing about advertising, so all we can tell you is what we know about the battery we're selling. It's a great thing to have confidence in what you're selling. We have confidence in Clyde because we know from long experience it's a darned good battery—and we know how it's made at the factory.

We know the months of patient research and testing that went on before the plates in the Clyde Battery were brought up to their present-day standard. That means that if you give a little care to your Clyde, those extra solid plates will never buckle. A little distilled water and a recharge occasionally is all that's needed. The carrying handle makes transportation simple. The exhaustive processes that the wooden separators go through to make them sturdy and acid-resisting mean exceptionally long life in the Clyde. That hard rubber case is absolutely non-leakable. You can put a Clyde anywhere in the house and have no fear of the acid spilling and ruining something.

There's lots more we could say, but this is all we've got time for. We're far too busy writing up orders.

Yours for a good battery,

THE CLYDE BATTERY SALES STAFF

P.S.—Here's some of the things the Advertising Manager writes about Clyde Batteries. They're all true, of course, but we couldn't think of them.

- DEPENDABILITY
- PERMANENT POWER
- LONG LIFE
- DURABILITY
- RUGGED POWER
- NATURAL FORCE
- MORE POWER TO YOU
- Etc., Etc.

# CLYDE

RADIO BATTERIES

THE CLYDE ENGINEERING CO., LTD.  
Brisbane Branch: 115 Albert Street, BRISBANE. Telephone 1425.

# NEW RECEIVERS REVIEWED

As each new receiver appears upon the market, a sample is thoroughly tested in the "Queensland Radio News" Laboratory. For the benefit of interested readers, we offer in this department, a candid and unbiassed criticism of its performance.

## THE KING ELECTRIC SIX-VALVE SET.

The 1929 model King electric six-valve set, which was submitted to us for test by the Aeolian Company, (Aust.) Ltd., 436 Queen Street, Brisbane, proved to be a great surprise in several respects, when one takes the performance of the average all-electric receiver as a standard. First of all, it is selective to a remarkable degree—a feature not often found in the present-day electric sets. So much so that, even with a large outdoor aerial, there was not the faintest trace of 4QG on 3LO's wavelength at a point  $2\frac{1}{2}$  miles from the former station.

Power is there in plenty—in fact, for all ordinary purposes, it is necessary to reduce the output of the receiver by means of the admirable control furnished for that purpose. As far as tone quality is concerned, the King Electric Six is eminently satisfactory. Due to the use of large valves, operating in a specially-designed amplifier circuit and supplied with adequate plate-power by the power-pack incorporated in the set, the loudspeaker output is free from distortion, even when delivering enormous volume. The fullness and roundness of the high notes is a delight to the ear, while the bass portion of the scale receives very satisfying treatment.

Nothing could be simpler than the tuning of this up-to-date receiver—one knob controls the ganged tuning unit with a beautifully smooth action, an illuminated dial, calibrated directly in metres and kilocycles, being provided. For extremely fine tuning on weak distant stations, and for compensating for variations in the aerial-earth system characteristics, a small "balancing condenser" is included. This is decidedly not a tuning control; indeed, we found it unnecessary, except for bringing far-distant stations up to maximum strength.

In appearance, the King Electric Six is a triumph of artistic design and good taste. The receiver mechanism, valves and power-pack are completely enclosed in a pressed metal case with detachable lid. This case is most attractively finished in dull stipple bronze, with dull gold ornamentation. It is very nicely proportioned, and no doubt will harmonise perfectly with most furnishing schemes. The controls are grouped, the tuning knob in the lower centre, with on-off switch and illuminated dial-window above it, and the aerial balancing condenser and volume control knobs to left and right. The knobs are of lustrous mahogany-finished bakelite, moulded to a shape and size that is calculated to provide a comfortable grip for the fingers. The aerial and earth terminals are mounted on a platform of the receiver assembly, large openings being cut in the rear of the case for the passage of the wires. For aerials of average dimensions, a series condenser is incorporated; this may easily be short-circuited if it is desired to use a very short indoor wire. A length of twin flexible wire emerges from

the receiver, terminating in a bakelite two-pin adapter, which is inserted in any lamp-socket of an A.C. lighting system.

The sensitivity of the King Electric Six may be judged by the fact that, with only a three-foot length of wire as an aerial and no earth connection, it was possible to receive 2BL and 2FC (Sydney) with greater volume than was comfortable. No additional proof is needed as to the efficiency of the three-stage radio-frequency amplifier system with which the set is equipped. On the ordinary aerial, all the Australian stations—"A" and "B" class—were tuned-in at full loudspeaker strength, the amplification on practically all of them having to be reduced. New Zealand and Japanese stations also were heard, although the bad static conditions made the identification of the latter a matter of some difficulty.

Our tests conclusively showed the King Electric Six to be a highly satisfactory receiver in every way, and we have no hesitation in recommending it to the consideration of those who are interested in a modern batteryless radio set.

## THE 1929 CRAMMOND SUPER THREE.

The manufacturers of the Crammond Super Three, which was reviewed on this page of our December issue, have just shown us the 1929 Model of this fine receiver. Essentially, the set is similar to the 1928 version, with the addition of one or two refinements. It is totally shielded, and reveals the same high standard of workmanship which characterised its forerunner.

Provision has been made in the 1929 Super Three for the use of an electric gramophone pick-up, a simple plug arrangement being mounted on the back of the receiver for this purpose. A good type of variable resistance also is incorporated in order to regulate the input to the amplifier from the pick-up. Because of the excellent design of the audio amplifier, very good results are assured in the electrical reproduction of gramophone records.

An improvement has been made in the external appearance of the receiver by re-designing the metal cabinet along entirely original lines. The top of the cabinet is now rounded, while the panel is set at an angle, facing the operator. The result is very striking and the general appearance is graceful in the extreme. Several finishes are available—nickelled, oxidised or duco—so that the purchaser may select one to suit his personal taste, and one that will not clash with the furnishings of his home.

The Crammond Super Three is manufactured by the Crammond Radio Manufacturing Company, North Quay, Brisbane.



## Mr. W. G. BEST

*Newly appointed Brisbane Manager for  
Messrs. United Distributors Ltd.*

It has been said—with a good measure of truth—that this is the age of the young man. Youth is stepping out and taking the helm with a degree of confidence and ability that would have startled our commercial forefathers had it happened in their day. The young man of today is proving himself to be an equal and sometimes a superior to his elders in the great game of commerce. His keen brain, his energy and his enthusiasm help him to tackle and accomplish much that an older executive may hesitate to attempt.

Thus when we see Mr. W. G. Best (better known as "Wally" Best) taking up the reins of the Brisbane house of Messrs United Distributors Ltd., we are reminded that here is another case where youth is coming into its own.

Mr. Best has barely reached his thirties, but he has crammed much valued experience into his business career. In the days when broadcasting was in a similar stage to television to-day, he was a well-known experimenter in Sydney. Deciding that a radio career held great promise, the young enthusiast sought employment with the Australian Wireless Supplies, who were pioneering the manufacture of apparatus for broadcasting receivers in Australia, their only rivals at that time being A.W.A. Mr. Best helped to build and instal Station 2LI for the Radio Company Ltd.—one of the first stations to give regular nightly programmes in Sydney. Subsequently this station was replaced by the present 2GB, which is now installed on the same spot as its predecessor.

With the entry of Messrs. United Distributors Ltd. into the radio field, Mr. Best joined up with this company as engineer and factory manager. He continued in this capacity for about 12 months, when he gradually transferred his activities to the sales organisation of the company.

With the opening of the Brisbane branch four years ago, Mr. Best was sent to Brisbane as manager of the radio department for a period of two years, but as our friend has not yet returned to the head office, his services in Brisbane must have proved very valuable.

Asked if he had any hobbies, Mr. Best stated laughingly that he had two: Science and business—the former by inclination, the latter by necessity.

Most young men profess to have some hazy knowledge of astronomy, even if it does limit itself to "counting the stars," but Mr. Best has for years delved earnestly into the fascinating science of astronomy, and in 1922 was a member of the British Astronomical Society's Expedition to Stanthorpe for Solar Eclipse observation.

In recent years, however, Mr. Best has been making endeavours to get a mile or two nearer the stars by interesting himself in aviation. Being a modest young fellow, he would not admit his proficiency as a pilot, but we have it on good authority that Mr. Best is quite an expert with the joystick.

Being an enthusiastic airman, Mr. Best is confident of the future of aviation. We can only hope and pray that his hobby does not put him among his favourite constellations for a good many years to come.

## B.B.C.'s New Home in London

**STUDIO TO HOLD 1000 PEOPLE—£400,000  
SCHEME.**

Arrangements have been completed for the transfer of the headquarters of broadcasting from Savoy Hill to Portland Place, Oxford Circus, as soon as a new building is ready.

The site, with an area of about 20,000 square feet, is in the form of a peninsula facing south, visible from Oxford Circus. The western facade will dominate Portland Place, the eastern front will face Langham Street. The building will be ready for occupation in 1931.

It is estimated that the new building, which will cost between £400,000 and £500,000, will provide more than 100,000 square feet of useful floor space.

There will be nine studios, four of which will be more than double the size of the largest studio at Savoy Hill, which is forty-four feet by twenty-five feet. There will also be a super-studio, three storeys high, approximately 4000 feet square, which, with its gallery, will be capable of accommodating an audience of 1000, as well as a large orchestra.

The studios and their suites will be insulated from all external noise. They will be grouped one above the other in a vast control tower of heavy brickwork, ventilated artificially and protected from street noise by the complete outer layer of offices. Wide corridors and thick brick walls will insulate the studios from the offices. Each of the four large studios will have a suite attached, comprising waiting room, band room, engineers, announcers' room, listening room, and echo room. There will be eight rehearsal rooms, six waiting rooms, a reception suite, and a special dramatic effects studio.

On no account should the liquid from a cell be poured into any kind of metal container, as the acid immediately attacks the metal, and both will be ruined.



If when charging a battery violent gassing starts, do not let this continue, but reduce the charging rate until the recharging is finished.

# Club Activities



## Wooloowin Radio Club (VK4WN)

With holidays over, the members of VK4WN are settling down to another year of club life. Talking of holidays, "the gang"—well, some of them—had some holiday. At a recent club meeting, Nim Love told of his Bay trip aboard the good ship "Sweetheart" with transmitter and receiver. Oh, yes, Nim has his A.O.P.C. now. Congrats, O.M.—another "4." Nim reported nothing doing with the transmitter, but the receiver worked OK. Better weather next time, O.M.

Clyde George arrived back from the bush, and told entertainingly of his varied experiences (?) Ask the gang—Hi! VK4GA—Gordon Spencer, our country member—arrived in the assistant secretary's car the other night. Gordon has sprained his ankle. Howcum, Gordon—too much back E.M.F.? Hope to hear you on the air soon with plenty of kick.

Bill Blaikie and Charlie Stephenson (VK4RG) are now well over their indisposition. Hope to see you both at next meeting. Frank Nolan has been found, but we are still looking for Pat Kelly. I believe VK4JG has a mo-car now. Say, Vic, you will have

to tune up your old bus, because I believe it's the world's economy car.

The club x'mitter, VK4WN, should be well on the air by now, and reports of reception will be welcomed. Keeping skeds is all right, but drop a line or two to the club, VK4FK, and let us all know about Townsville and radio. The gang desires to congratulate those responsible for the merger of the A.R.T.L. and the W.I.A. This has now been finalised, and in future the amateurs will be represented by one body.

Members of the 4WN Sub-committee met one lunch-hour recently, and it was noticed that they were discussing something of great importance. Another treasure hunt? Oh, no! Don't mention that. 4JG says he doesn't like treasure hunts without a speed limit! Was it in connection with a field day? I don't think so; you know, they're too common nowadays. Perhaps a week-end radio camp. Wait and see next month's report—perhaps they will tell us then.

Our zecktree (George Payne) has been QRL lately, keeping the gaslight burning. Is it to be pure D.C. or G.A.S.? 4LJ? Yes; he is a Major now, having passed his exam. for that rank. He has been down South in connection with the merger between the A.R.T.L. and W.I.A. Now that this has been settled, we hope to see Leo at club meetings regularly in future.

VK4TC and the Indooroopilly gang have been quiet lately. I think this is a "lull before a storm." So watch out, 4WN!

The club meets every Thursday evening at club headquarters, Wilmington Street, Wooloowin. Anyone interested in VK4WN doings is cordially invited to attend.

## Resistance Coupling Essential in Television

While the usual amplifier as now employed for broadcast reception may be utilised in experimental television, the pronounced peaks, together with the limited frequency response of most transformer-coupled amplifiers, will produce distorted television images.

We all recall the early amplifiers which operated our first loudspeakers, states Mr. Ehle, president of the International Resistance Company. Because of the novelty of radio in those days, more or less distortion made little difference. It must be much the same with television. In the first thrilling days of experimental television, even the mere outline of a man or hand or other object will suffice, despite splotches and breaks and disfiguration of all kinds, due to faulty amplification at the receiving end.

However, while the ear may pardon much in the way of distorted music, and even get to like it for that matter, the eye is far more critical. With the eye, a thing must be right. Therefore, better amplifiers will be required, and resistance coupling is certain to find extensive use for a nearer approach to uniform amplification over a wider range of frequencies than is necessary in sound reproduction. I understand that even the present admittedly crude television experiments call for frequencies varying from 18 to 25,000! This is far in excess of the 200 to 5000 cycle range which is the average for radio rendition.

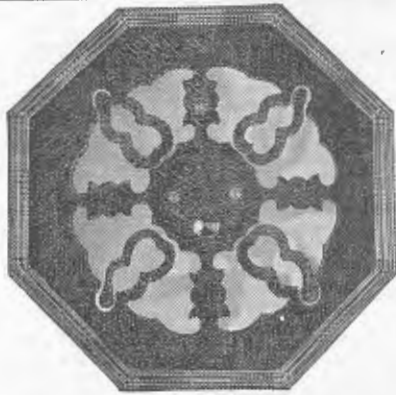

*The All British*

**M. P. A. PLAQUE  
SPEAKER**

*The Diaphragm is Sprung*

That's why the M.P.A. will handle so much volume without distortion

Of All Dealers—£2/10/0

Agents for Queensland:

**T. H. MARTIN & SON**

B. & F. CHAMBERS, ADELAIDE ST., BRISBANE.

Sole Australian Concessionaire:

CHAS. D. MACLURCAN, Pratten Bldg., 26 Jamieson Street, Sydney.



Burnside, Pearamon, Dec. 26th, 1928.  
(The Editor, "Old. Radio News.")

Sir,—I want to say how much I appreciate the articles on static that have appeared in the "Radio News" from time to time. We are having quite a time with atmospheric just at present. We are now living in a wet belt 2600 feet above sea level; there is thunder about every day and the static is very persistent—the real thing, too—not home made; it stops when you disconnect the aerial.

We used to live at Oak Forest, 60 miles from here, and about 100 feet above sea level. It was a dry belt with but few clouds about, and reception was passable part of the time in summer, but volume was not quite so good.

There are anything up to 2000 farms here on the Atherton Tableland, and very few aerials are to be seen. The reason is plain: if some of these people came in and listened to 4QG putting out music to the accompaniment of something that sounded like a terrific hailstorm coming down on a tin roof, I could imagine them saying "None of that for me!"

Well, here is just the place for wireless sets if we could control static. My object in writing is to ask you to discuss in "Q.R.N." various methods of overcoming the difficulty. I don't remember having seen

## British Built and therefore Better

Most radioists know that C.A.V. BATTERIES last longer, give greatest power with least trouble. They are British built—thoroughness is the keynote of their construction. Yet—they cost no more than ordinary makes. Get the most out of your set—instal C.A.V. BATTERIES.

# C.A.V. "A" & "B" Batteries

Agents:

## Barnes Auto Co.

CORNER NORTH QUAY & QUEEN ST.  
BRISBANE.

in print any details of what are called "Sub-aerials" in U.S.A. I enclose a cutting taken from an ad. in "Popular Mechanics" for November, and if that "notion" can deliver the goods it is just the thing for these parts—nearly a thousand miles from a broadcasting station and half-way to the Equator.

Yours, etc.,

ALEX LOWE.

Here is the clipping referred to by our correspondent:—

Why go on listening to terrible static and other maddening outside noises? Now you can get the real music your present Radio is capable of giving, by hooking your set on to the clear, practically static-free ground waves with Sub-Aerial. The air is always full of static and your overhead aerial picks it up and brings it to your speaker. So why stay in the air—when you can use the whole earth as a static and noise filter with Sub-Aerial?

[While the underground aerial mentioned above appears to give some relief from the static annoyance, it is a fact that their use has not become popular in any part of the world. The reason probably is that the signal strength is considerably reduced at the same time, thus rendering the underground aerial no more effective than any other static-reducing scheme that has been mooted. At the present time, we know of no more effective method than the use of a short indoor aerial. Admittedly, this system is far from perfect, for it reduces signal strength in approximately the same ratio to static, but it is a real help in many cases. During many nights of the Queensland summer, there appears to be only one positive way of eliminating static—turn off the battery switch. Sans static, sans radiol.—Tech. Ed.]

## An Interesting Short Waver

### THE PILOT "WASP."

The Pilot "Wasp" short-wave receiver, for 17 to 500 metres, certainly should be the last word in this type of equipment. There are, surely, many listeners desirous of exploring the short-wave bands, but who refrain from going to the expense of building a valve receiver solely for this purpose. A combination of the two may be accomplished with correct inductance and capacity values.

The arrangement consists of five interchangeable coils, each unit comprising a grid, plate, and aerial inductance. As the aerial coupling coil is fitted and "dead spots" may be found on the tuning dial, a small .00015 variable condenser should be connected in series with the aerial. There are two controls, tuning and regeneration, and since the feedback is quite constant over a fairly wide band, with a correct adjustment of the aerial series condenser the operation is quite simple. Two variable condensers are required to obtain the correct wavebands. A .00014 S.L.F. condenser must be used for the grid tuning circuit, while the regeneration control may be any .00025 condenser of good construction. A Philips A-415 in the detector socket is recommended, and a B-443 Penthode for the audio stage.

The filament circuit may or may not be grounded. Now, with the receiver hooked up for test, first try for oscillation. Some short-wave receiving sets go into oscillation with a bang or howl instead of a steady hiss. Next try changing the detector grid return, and you will find one—either positive or negative—return which will give steady and smooth oscillation control. It is also advisable to experiment with the grid condenser and leak. If howling is found the capacity must be raised, and leak lowered in resistance. This receiver can be built into a compact set, and, if correctly constructed, will give excellent results. Good loud phone strength on overseas short-wave broadcasting stations at the correct periods, and good loud-speaker volume for a room on the local broadcasting stations is assured.

This department is conducted for the benefit of our readers. We cannot answer queries by mail.

# Questions Answered

By the TECHNICAL EDITOR

Questions received before the 20th of the month will be answered in the following issue.

**"A.W.F.," Hawthorne.**—"Could you give me any idea how to build a short-wave adapter, and could I use it with the '£5 Three' described in the July 1928 'Radio News'?"

**Answer.**—We have mailed you a copy of our issue of April, 1928, in which a Short Wave Adapter was described. However, I would advise you to wait for our next issue (March), in which a splendid little adapter will be featured. It is very small in size and remarkably inexpensive, but tests have shown that, as far as results are concerned, it would be very hard to beat. It utilises home-made coils wound on old valve bases.

**"W.W.," Toowong.**—"Would you kindly tell me which would be the best speaker for the 'Victory Two,' described in your January issue—the Philips PCJJ, Junior or Baby Grand? (2) What is the ratio of the audio transformer?"

**Answer.**—I would advise the PCJJ model. All three are good, but naturally the higher priced instrument is to be preferred. (2) About 3 to 1. Any good transformer having a ratio of something like this may be used successfully.

**"J.W.," Newmarket.**—"With regard to the Screen Grid Booster (October issue), can I use a .001-mfd. variable condenser instead of the .0005-mfd. specified? (2) If the answer is in the affirmative, which would be preferable—to reduce the capacity of the variable condenser by connecting a fixed condenser across it, or to cut down the number of turns on the coil? (3) Please give size of fixed condenser or number of turns on coil, whichever is the case."

**Answer.**—Yes, you may make use of the .001-mfd. variable condenser. The only difference it will make will be that the wavelength range of the Booster will be extended up to somewhere about 650 metres, and the tuning will be more critical in adjustment, neither of which need cause you any worry. (2) It would be better to reduce the size of the coil. By the way, you should note that a fixed condenser connected across (in parallel or shunt with) a variable condenser has the effect of increasing the maximum capacity of the combination, while a fixed condenser connected in series with a variable condenser reduces the maximum capacity, to a value corresponding to the capacity of the fixed condenser. We shall publish an article on this subject shortly, as it is a matter on which much misconception exists. (3) Use 45 turns on the coil instead of 65.

**"L.N.H.," Sandgate.**—"I am the owner of a 6-valve '—' screened receiver, and have been an enthusiast for a number of years. For exactly five months now we have been troubled every evening by a persistent hum or frying noise—sometimes intermittent and varying in volume, but more or less always with us. The noise is so violent some nights that it blots 4QG completely out. I have tried the use of a counterpoise with no better results; I have approached the City Council—their lines are perfect, they inform me. Is there any way to detect and rectify this trouble? Under present circumstances my £57 set is entirely useless."

**Answer.**—There is not the slightest doubt but that the noise which is troubling you is the product of some minor fault in the power and light distribution system in your locality. I can sympathise with you in this, as it happens that I have suffered from the same complaint for a number of years, and so far have found no actual redress for it. It appears to be useless approaching the Authorities—their answer invariably is the same: "Their

sensitive tell-tale instruments show that no fault exists at any point in the system." At the same time, many people will remember the devastating roar that made reception impossible for some miles around Brisbane some three or four years ago. Despite similar assurances to the one given you, the trouble eventually was traced to a leakage in the power lines. The exact nature of the fault was never disclosed, but the incident is sufficient to disprove the theory that the line "tell-tale" instruments are infallible—as far as radio interference is concerned, at any rate. At the writer's home, no solution to the problem has ever been found—that is, in the matter of stopping the nuisance at its source. Undoubtedly leaky insulators are to blame; these exist in every distribution system, and are very difficult to locate in an extensive network. However, fairly good reception has been made possible by eliminating the earth connection entirely, and substituting instead a form of "capacity earth." This consists of a piece of 24-gauge cotton-covered wire, which runs from the earth terminal of the set (a five-valve) round about 15 feet of skirting-board, and then is joined to the metal frame of a piano. The wires and metallic structure of the piano act as the plate of a condenser, the opposite plate being the earth itself. This is, in effect, a counterpoise, but a very small one. It was found that 90 per cent of the interference entered the set via the earth—not through the aerial—and a large counterpoise gave no relief. The frame of the piano is not, of course, strictly necessary. The best way is to start with a short length of wire running along the floor or under the house. It will be found that while the noise is practically absent, signal strength will have suffered considerably. The wire is then gradually lengthened until the best compromise is found between noise and signal strength. I have given you my experience in my own particular case; it might not apply to yours, but I think it will, and you will find this scheme well worth trying.



*DROP the Technical Editor a line if your set is not "perking" as it should. Be brief and to the point—ten-bage epistles strictly prohibited!*

**"E.H.B.," Degilbo.**—"I am thinking of making the Globe Trotter Screen Grid Four (September issue), commencing with the detector unit first, as you advise. Would I be able to get anything at any strength on the headphones, using this detector unit only on an indoor aerial? I am not in a position to erect an outdoor aerial. (2) What is the correct way to solder the joints in the wiring? I have never done any before. (3) Will three 1.5-volt dry cells do for the 'A' battery? (4) Will headphones of 2000 ohms resistance be OK?"

**Answer.**—You should be able to hear 5SW (London) and the main overseas short wave broadcasting stations at fair headphone strength, using an indoor aerial with the detector unit only. Naturally, they will not be loud, but it will be quite possible to understand the announcements. I have tried this for myself. (2) It is rather beyond the scope of this department to give you detailed instructions for such an art as soldering. However, these few hints will help you: Use a fairly small, light iron. Heat it until a piece of resin-core solder melts readily when touched on the copper "bit." It must never be allowed to become red-hot. First of all "tin" the iron by heating it to the correct temperature, filing it smooth, heating again, and rubbing it in a small pool of molten solder (in the lid of a tin) until a bright silvery coating covers the point. Now heat again to correct temperature—until solder runs readily when touched on iron. Hold the point of the iron (which must be clean) against the joint to be soldered for a few seconds, then touch the joint with the resin-core solder until it runs well into the joint. A good soldered joint is one which is covered with a very thin coating of bright solder—as little as possible should be used. The chief



points to be remembered are: Keep the iron hot and tinned and clean (wipe it occasionally when hot with a rag); be sure that the job to be soldered is clean and free from grease. In the case of bare brass or copper surfaces, it is advisable to smear a very small amount of "Fluxite" over the joint before soldering. With surfaces that are already tinned—such as tinned copper wire and most soldering lugs—this is generally unnecessary, but a tin should always be kept on hand for dealing with surfaces which show a reluctance to "tin." Excessive Fluxite should be wiped off while the joint is hot. (3) Yes; you may use a dry cell "A" battery, although it is not, as a rule, an economical proposition. It will be quite OK, however, for a single valve. (4) 2000-ohm phones are just the thing. Sorry we cannot answer queries by mail.

"O.B.," East Brisbane.—"Have you published a suitable circuit for gramophone amplification in any past issue of the 'Radio News,' or are you likely to publish any in the near future? (2) What is the most suitable number of valves to use, so as to give good amplification for an average sized room? (3) Is it preferable to use Penthode valves in preference to the ordinary tetrode? (4) What is the better form of amplification—transformer-coupled or resistance-coupled?"

Answer.—In our November and December, 1928, issues, we described the construction of ideal forms of transformer-coupled and resistance-coupled audio amplifiers. Both these units, when used with suitable valves and an adequate power supply, will give satisfactory results with an electric gramophone pick-up. In this issue you will find constructional details of a push-pull amplifier unit, and this again is eminently suitable for this class of work. (2) Two transformer-coupled stages, using tetrode valves; one stage using a Penthode; three resistance-coupled stages; three choke-coupled stages; one transformer and one push-pull stage in a push-pull amplifier. (3) That question is very hard to answer. One Penthode will give an amplification equal to slightly less than two ordinary stages, when used with a sufficiently high plate voltage. Whether it is to be preferred on the score of tone quality is open to question. Personally, I would hesitate to recommend it when large volumes of sound are desired, as the Penthode cannot handle the heavy currents that some of the larger power valves can, without overloading. (4) There is no doubt that a well-designed resistance-coupled amplifier, operating under ideal conditions (that is, with correctly chosen valves and "B" and "C" voltages) gives a naturalness of reproduction that apparently cannot be surpassed. This remark applies to ordinary room volume. Transformer-coupled amplifiers are capable of giving very good quality, but I am inclined to favour the push-pull amplifier for most purposes, and particularly where the provision of high plate voltages and the use of large valves is a matter of some difficulty. A push-pull amplifier, using ordinary "dull-emitter" valves and no more than 90 volts on the plates, will give remarkably natural reproduction—provided, of course, the volume is not "forced" too high. With large valves and a high plate-voltage, the tone quality from such an amplifier leaves absolutely nothing to be desired, whether applied to the reproduction of gramophone or radio music. So you see your questions are not easy to answer satisfactorily; it is impossible to treat them in a general way, for each particular type of amplifier has its own special advantages and disadvantages, and it would take a great deal more space than is at our disposal to deal impartially with each type. Another factor which always creeps in is that of economy. Radio, it seems, follows one of the laws of civilisation—nothing "good" is "cheap," and you can always have quality if you care to pay for it.

"H.W.M., Pomona.—"I wish to replace the valves in my three-valve set. Would it be advisable to use two general purpose and one power-valve? (2) Does a power-valve eat up a lot of the 'B' battery? About how much does it reduce the life of them, compared with ordinary valves?"

Answer.—You should use one special detector valve, such as the Philips A-415 or the Mullard PM-4D, in the detector socket; one general-purpose valve in the first audio socket, and a small power-valve in the last socket. (2) A small power-valve, such as is commonly used in the last stage of broadcast receivers, does not consume a large amount of plate current. Certainly it is a little heavier on the "B" battery than the ordinary valve, but I should think it would not reduce your "B" battery life by more than about a month. The tremendous gain in tone quality and sometimes volume more than compensates.

"C.L.S.," West End.—"Which do you think is the best three-valve—the Reinartz circuit or the Screen Grid Three (recently described in the 'Broadcast Bulletin'). Is there any better three-valve circuit?"

Answer.—The Screen Grid Three is the most powerful three I know, when used, as you say, with a Penthode in the last stage. This is similar to the "Holiday Portable," featured in our December, 1928, issue. For extreme selectivity combined with great power, I would recommend the "Pontynen Three," which you will see described in this issue.

"R.S.," Mundubbera.—"I am interested in building the 'Holiday Portable' described in the December 'Radio News.' Could you tell me the specifications of the coils used in this circuit?"

(2) I have some 1-mfd. and .05-mfd. fixed condensers on hand. May I use these for C4, C6 and C8? (3) Is C5 necessary if C2 is a .0035-mfd. condenser? (4) How much larger would the baseboard have to be should I wish to add another stage of audio? (5) I have some heavy copper sheet, and will use this for panel and base. However, it soon becomes discoloured and looks unattractive; can you recommend any paint or lacquer to paint it?"

Answer.—The specifications of the coils used were set out in a paragraph on page 56 of the same issue (December, 1928). No doubt you will be able to adapt your B.-D. kit to suit these requirements. (2) Yes; use the .05-mfd. for C4 and C6, and the 1-mfd. for C8. (3) The fixed condenser C5 is connected in series with the variable tuning condenser C2, not to reduce its capacity, but in order to safeguard the "B" battery in the event of the plates of the variable condenser touching or approaching very close to one another. By following out the circuit, you will see that C2 has to withstand the full "B" battery potential (120 volts), and it is never safe to trust to a variable condenser under such conditions. Sometimes a particle of dust is sufficient to break down the insulation between the closely-spaced plates and so cause a spark to jump; an arc is thus formed which, being in the ease out of sight, is not readily detected, and may cause damage. This actually occurred in our first experimental model, in which no fixed condenser was incorporated. By placing the fixed mica condenser in series, however, one makes assurance doubly sure, as the fixed condenser is quite capable of withstanding voltages as high as 300. Provided the capacity of the fixed condenser is larger than the maximum capacity of the variable, it will have no effect upon the tuning characteristics of the circuit. (4) Make the base 3 inches longer. (5) The copper is quite suitable. Paint it with "Olasta" lacquer, which is a wine-coloured preparation made especially for this class of work. It is applied with a brush, and dries with a hard, lustrous finish, quite colourless. It is obtainable in half-pint tins for 2/6 from Messrs. J. D. Sloan, Adelaide Street, Brisbane.

"H.M.," Dutton Park.—"I made the set outlined by you in the July 'Radio News,' called 'A Good Three for £5.' Being very much an amateur at the work, I have not got best results. However, after persevering for some time, I seem to have it going well except for one thing—the music as reproduced is very distorted. Could you suggest anything likely to cause this trouble, and the remedy?"

Answer.—You are missing the most important thing if you are not getting good tone quality. Sure your grid-leak is OK? Transformers correctly connected? Using suitable valves? Batteries in good condition? Using proper value of "C" battery? Loudspeaker OK? Careful attention to these suggestions should put you right, as there is something radically wrong if you are getting distortion.

"W.A.B.," Kelvin Grove.—"I have built the Peridyne Five, as described in August 'Radio News,' but the results are not very satisfactory. I am using four UX-201A's and a UX-171A, and a moving-coil speaker. My accumulator is new, and is kept fully charged by a trickle charger, and I am using a Philips 'B' and 'C' eliminator. First I must say the purity of tone is wonderful, but the volume is far from satisfactory, 2FC, 3LO and 2BL being received at weak speaker strength and 3AR and others almost inaudible. I am experiencing trouble in balancing the Peridyne units. Suppose, for instance, I am tuning in 3AR. I turn down the variable resistance until the set is just oscillating feebly. Then, tuning in the 'dead spot,' I can just hear the music faintly, and, of course, by altering the tuning slightly the carrier wave comes in. This is with all the trimming units tuned full out. Then, when I turn one of the knobs down, in comes the carrier wave just as though I turned the condenser dial slightly, but I cannot succeed in raising the volume at all. I am reasonably sure that the components are all OK. I notice that reversing the crystal makes no difference. Can you throw any light on this matter?"

Answer.—We have had several complaints from readers who have built the Peridyne, all of the same nature—lack of volume. From our own experience, we are satisfied that the Peridyne is capable of giving enormous volume—more, in fact, than any receiver we had tested previous to its advent. Generally, the trouble appears to be in the adjustment of the shields. Unfortunately, it is next to impossible to give any directions for accomplishing this adjustment satisfactorily, as it is purely a "cut and try" process. However, we had best results with the first shield almost right out, the second half-way, and the third about two-thirds in. In case you find it impossible to balance the three circuits, try connecting a small balancing condenser across the second and third sections of the three-gang condenser. This is, of course, a direct departure from the Peridyne system of variable shield tuning, but may show you just where the trouble lies. Try also a higher plate voltage on the r.f. valves. I presume you have tried changing the valves round. Possibly you have a faulty carbicrondum detector; the fact that reversing it makes no difference suggests this possibility. In our own model reversing the detector made all the difference between a poor and a remarkable receiver. Make sure your r.f. choke is OK. I cannot suggest anything further, but it might be advisable to take the set to a dealer who specialises in repair work; probably he will be able to put his finger on the trouble at once.

# Secrets of Success with The Screen Grid Valve

*An Article of Outstanding Interest*

By W. JAMES.

**H**AVE found that the screen grid type of radio-frequency valve is not so popular with amateurs as it should be, for the very good reason that the best method of using the valve is seldom explained to them.

For reasons which are not at all clear, a plain tuned-plate coupling is nearly always recommended. But according to my understanding of the properties of the screen grid valve, this is the wrong coupling.

My experiments indicate that the tuned-plate circuit should only very occasionally be employed—otherwise broad tuning, poor amplification, and lack of stability are bound to result. These are, of course, the very matters of which amateurs complain.

**Unsatisfactory Results.**

Why should the results tend to be so unsatisfactory when a tuned-plate coupling is used? There are several reasons. Let us examine a typical circuit such as Fig. 1. The screen grid valve we will as-

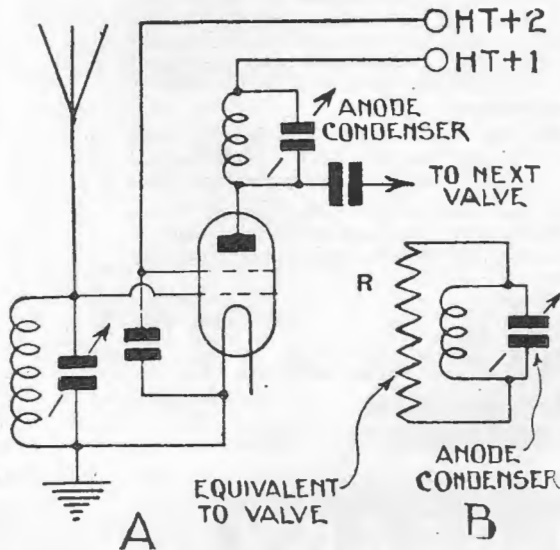

FIG. 1.—Typical Screen-Grid Circuit.

sume has an amplification factor of 140 and a plate impedance of 160,000 ohms.

Then the pure radio-frequency amplification that will be obtained when the plate circuit is quite an ordinary one, comprising a coil of solid wire and a

.0005-microfarad tuning condenser, is about 70. That is, the plate circuit voltage is about 70 times the grid circuit voltage. We have assumed the plate coil to be 3 inches in diameter and wound with No. 24-gauge double silk-covered wire.

**Considerable Amplification.**

The amount of amplification for the single stage is therefore considerable, for with certain balanced or neurodyne radio-frequency circuits employing ordinary valves, an amplification of only 15 to 20 is obtained.

It therefore seems that there is no difficulty in securing theoretically, at all events, a large amplification with a tuned-plate circuit. But how about selectivity? High amplification is of no great value unless we are able to select the desired signals.

Fig. 1 may be re-drawn to show clearly that the selectivity of the tuned-plate circuit when connected to the valve is much poorer than that of the circuit by itself. In fact, the selectivity of the plate circuit when joined in series with the valve, as in Fig. 1, is approximately equivalent to that of a circuit with approximately twice the losses taken by itself.

The tuned-plate circuit is, in effect, shunted by a resistance equivalent to that of the valve. As a result, when the impedance of the valve is low the selectivity will be poor, whilst when the valve has a high plate impedance it will not greatly affect the selectivity of the circuit.

To explain this point more fully, let us assume the impedance, or more correctly, the effective resistance, of the circuit at the resonant frequency is 100,000 ohms. Then if the valve has an impedance of 100,000 ohms, the coil will tune as though its losses were twice as great as they actually are. This is because the impedance of the valve is equal in magnitude to the effective resistance of the tuned circuit.

Thus, the circuit of Fig. 1B, where R represents the impedance of the valve, is equivalent to Fig. 1A, as regards selectivity. Obviously if the impedance of the valve is reduced, the tuning is made broader as the effect is as though the losses of the coil were greatly increased, while increasing the impedance of the valve will make the tuning sharper.

**Poor Selectivity.**

The theoretical characteristics of a plain tuned-plate circuit such as Fig. 1 are therefore large amplification and poor selectivity.

The screen grid valve has a grid which is screened from the plate, but the screen actually comprises a wire mesh which does not perfectly shield the grid. In addition, the supporting wires for the electrodes, and the external connections to the grid and plate, have a little capacity. The screen is, therefore, not perfect



Look for this Trade mark. It guarantees the genuine British article and ensures greater value for your money.

# EVER-READY

**THE  
LARGEST MANUFACTURERS  
OF DRY BATTERIES  
IN THE EMPIRE!**

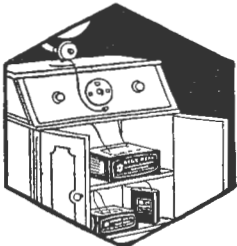

for RADIO

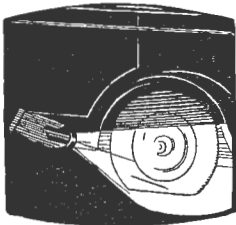

for TORCHES



for DOORBELLS  
BUZZERS ETC.

"EVER-READY" DRY BATTERIES are famed the world over for their long life, absolute reliability, and unexcelled economy in operation. Modern machinery, improved methods of manufacture, and mass production have evolved an entirely new and more efficient product, ensuring for "Ever-Ready" a marked preference by users of Dry Batteries everywhere.

You still get the same QUALITY which made "Ever-Ready" famous over a quarter of a century ago, but at a price which forcibly emphasises what unusual value an "Ever-Ready" Dry Battery offers. Get yours to-day from any good radio dealer. There is an "Ever-Ready" type for every Dry Battery requirement. Interesting free booklet, containing much useful information and many economy hints, sent upon application to:

Wholesale Distributors

**EDISON SWAN ELECTRIC CO. LTD.**

156 Creek Street  
BRISBANE

**EVER-READY  
DRY BATTERIES**

by any means, and there is a small but definite capacity between the plate and grid.

We will assume the plate coil and tuning condenser to be enclosed within a metal box in order that they will not couple with the grid circuit or aerial. Then the only factor which need concern us is the plate-grid capacity of the valve and its connections.

Although this is very small, it is sufficient to pass a current from the plate circuit to the grid circuit, and, obviously, the strength of the current will depend upon the difference in voltage of the plate and grid.

It will also vary with the frequency, increasing as the frequency is increased. Thus, if the difference in voltage remains constant there will be twice as much current flowing from the plate to the grid circuit at 250 metres as at 500 metres, because the frequency corresponding to 250 metres is twice that of a 500-metre wave.

The difference in voltage between the plate and grid obviously depends upon the nature of the tuned-plate circuit. If the tuned-plate is a good one, the amplification will be considerable. We have assumed an ordinary coupling with which an amplification of about 70 is obtained, and as a result the voltage of the plate is approximately 70 times that of the grid.

A plate circuit having a very poor tuning coil might give an amplification of only 30. In this instance the plate voltage would be only about 30 times as great as the grid voltage. The amount of current which passes through the stray capacities from the plate circuit to the grid circuit therefore depends on two factors.

One of these is the amount of amplification and the second is the wavelength or frequency. With ordinary circuits the amplification increases as the wavelength is reduced and, therefore, the amount of current passed from the plate to the grid circuit increases by two factors as the wavelength is lowered.

Now the current which passes from the plate circuit to the grid circuit through the residual capacity produces a reaction effect, which may be so strong

losses shall remain reasonably low, the circuit will oscillate with only a small amount of reaction.

What happens in practice? Experience indicates that with an amplification of 70 the grid circuit will oscillate unless the coil used is an extremely bad one. And when it is a bad one its tuning will be very broad and the signal strength poor. It is therefore necessary so to modify the aerial circuit that reasonable selectivity will be obtained.

This can be accomplished by connecting the aerial to a point on the coil or by employing a primary winding as in Fig. 2. A two-fold gain is, therefore, ob-

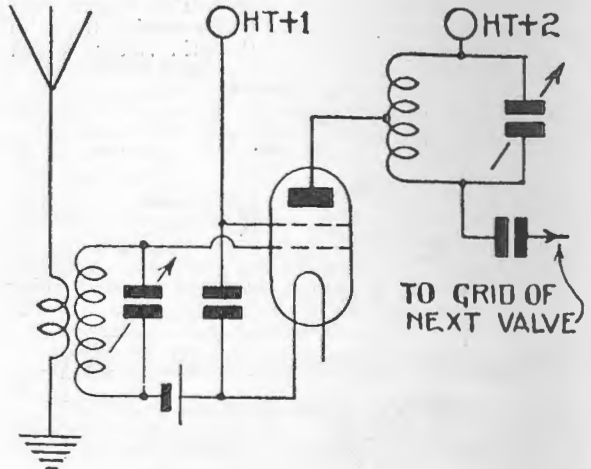

FIG. 3.—Plate Circuit.

tained, for by increasing the selectivity we have also improved the signal strength. But with a selective grid circuit of this type the circuit will be unstable.

Steps are, therefore, usually taken to reduce the amount of amplification, because by so doing, the difference in voltage between plate and grid is reduced, which in turn lessens the reaction and so stabilises the circuit.

This, however, is not a satisfactory procedure. Surely it is bad practice to throw away amplification and selectivity in order to obtain stable working when there is an alternative.

Let us connect the plate circuit as in Fig. 3. Using the same plate coil as before the voltage actually developed at the plate of the valve will be approximately 30 times the grid voltage. But the voltage set up across the ends of the whole plate coil will be about 60 because there is two to one ratio step-up in voltage.

We have, therefore, lost very little amplification in the plate circuit, but we have gained several things. In the first place, the amount of current which passes from the plate to the grid through the stray capacity is approximately halved. Therefore, the amount of reaction is reduced and the circuit will now probably be quite stable, even though a well-made grid circuit is employed.

Secondly, the selectivity of the whole circuit is greatly improved, because now the damping effect of the plate of the valve is considerably reduced. The

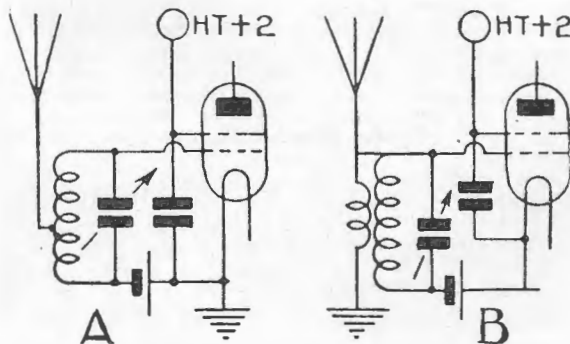

FIG. 2.—Aerial Couplings.

as to cause the grid circuit to oscillate. Naturally the amount of reaction required for oscillation will depend upon the nature of the grid circuit.

If this is a poor one including a coil with large losses, a relatively great amount of reaction will be necessary before it oscillates. But, on the other hand, if a reasonably well-made grid coil is used and the aerial is coupled to it as in Fig. 2 in order that its

damping effect is actually only about one quarter as much as it was before.

The circuit of Fig. 3 is, therefore, much superior to that of Fig. 1 in all respects. It is much more selective and will in all probability be quite stable. Further, on the whole it gives much greater amplification. This is because the aerial circuit may be reasonably efficient, and it will, therefore, develop larger voltages across the grid and filament connections than the circuit of Fig. 1.

The total amplification provided by the stage is, of course, the product of two factors. One of them is the ratio of the voltage set up across the ends of the plate coil and the grid voltage. This is the pure radio-frequency amplification. The second is the ratio of the actual grid voltage to the grid voltage which

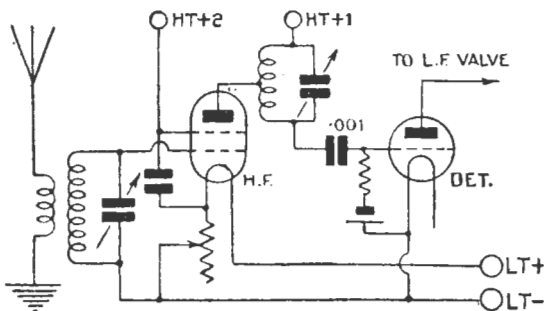

FIG. 4A.—Tuned-plate Coupling.

would exist without the valve. This second ratio represents the amplification due to reaction.

A signal of one-tenth of a volt might, for example be set up across the ends of the grid coil when the radio-frequency valve is not working, that is, when its filament is disconnected. With the tapped plate coil the total pure radio-frequency amplification is 60 and the voltage across the ends of the plate coil would be 6, were there no reaction effects.

But, owing to the reaction, produced as a result

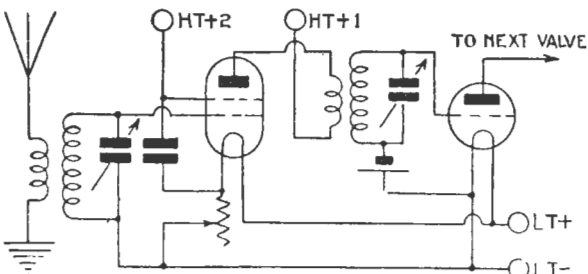

FIG. 4B.—Transformer Coupling.

of the current which passes from the plate to the grid circuit, the signal is further increased in strength. This amplification due to reaction may amount to two or three; therefore, the total amplification obtained is 60 multiplied by two or three, and the actual voltage developed across the ends of the plate coil will be from twelve to eighteen.

The circuit of Fig. 3 is one that I can confidently recommend. Naturally, a transformer may be used as in Fig. 4. The best ratio of the primary and secondary

windings, or the best position of the tap on the plate coil, will obviously depend upon the effectiveness of the coils and the characteristics of the valve.

In practice one alters the primary winding or the position of the tapping until the best results are obtained from the receiver.

A plate bend detector may be connected as in Fig. 4. The bottom end of the grid leak is joined to the negative side of a grid-bias battery. A leaky grid detector would, of course, lower the amplification and broaden the tuning, and is, therefore, not recommended except when a very sensitive circuit having adjustable reaction is required.

A screen grid valve radio-frequency amplifier may be used in such a manner that considerable amplification with stability is obtained. But many circuits that I have seen are not suited to the valve.

—“The Wireless Magazine,” London.

## Licenses for December, 1928

### ALL STATES.

	New Licenses.	Re-newals.	Total Issues	Can-cellations.	In Force 31/12/28
N.S.W. ....	2,673	5,277	7,950	1,141	91,709
Victoria .....	2,088	7,181	9,269	3,445	141,890
Queensland ...	394	1,653	2,047	404	25,224
Sth. Australia .	369	902	1,271	268	22,120
W. Australia .	65	227	292	81	3,828
Tasmania .....	211	232	443	42	4,117
Commonwealth	5,800	15,472	21,272	5,381	288,888

	Increases for December.	Ratio: 100 per Population.
N.S.W. ....	1,532	3.78
Victoria (Decrease) ....	1,360	8.11
Queensland (Decrease) .	11	2.77
Sth. Australia .....	101	3.81
W. Australia (Decrease)	2	.96
Tasmania .....	171	1.95
Commonwealth .....	431	4.59

### Twelve Months' Figures.

	31/12/27.	31/12/28.	Population.
N.S.W. (Increase) .....	72,162	91,709	19,547
Victoria (Increase) .....	134,825	141,890	7,065
Queensland (Increase) ..	24,433	25,224	791
S. Australia (Increase) .	18,792	22,120	3,328
W. Australia (Decrease) .	3,872	3,828	44
Tasmania (Increase) ....	3,403	4,117	714
Commonwealth (Increase)	258,179	288,888	30,609

## FOR SALE.

ANY reader who intends building “The Holiday Portable,” described in the December, 1928, issue of “Q.R.N.,” may secure the specially-built FLAXITE CARRYING-CASE (equal to new), used by the Technical Staff in the laboratory model, at HALF-PRICE—

10/- (POSTAGE EXTRA)

Apply “The Queensland Radio News,” Box 1095N, G.P.O., Brisbane, or Douglas Chambers, Adelaide Street, Brisbane.



# TESTED AND RECOMMENDED

A Department of Investigation, conducted for the benefit of our readers. Every piece of material featured on these pages is subjected to a rigorous and searching test before publication. No remuneration is received for the publication of these paragraphs.

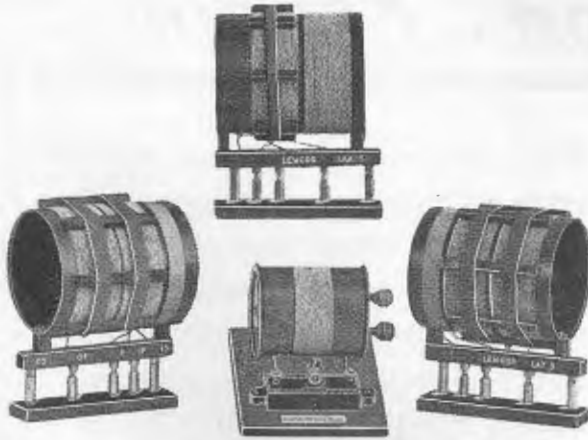

## The Lewcos 1928 Solodyne Coil Kit

From Messrs. J. B. Chandler & Co., 45 Adelaide St., Brisbane, we have received a sample of the Lewcos coil kit for the 1928 Solodyne. This is an English production, and is a worthy product of the painstaking craftsmanship for which the Old Country is justly famous. In appearance, it is striking, the windings being carried out with wire having coloured insulation on lustrous black composition tubing. The kit is a very complete one, comprising one aerial coupler, two radio-frequency transformers, three plug-in mountings, and a specially designed wavetrap.

An important feature of the Lewcos kit is that the grid coils are wound with Litzendraht wire—a conductor composed of a number of extremely fine insulated wires twisted together, the resultant stranded cable having a very low radio-frequency resistance. The primaries are wound with solid wire on a series of ebonite blocks, which space the coils away from the secondaries, and make them practically self-supporting. In the case of the two radio-radio-frequency transformers, the reaction coils are wound on the same tube as the grid coils, close to one end. Both the primaries and the secondaries of the radio-frequency transformers follow the astatic system of winding, which has the advantage of restricting the magnetic field of the coil to a minimum space, without interfering with the inductive action. For convenience in mounting and wiring the receiver, the coils are attached to well-made plug-mountings, which fit into appropriate sockets, these being equipped with soldering lugs.

The wavetrap is an excellent piece of work, cleverly thought-out and uncommonly compact. It utilises a tapped Litzendraht coil in conjunction with a small

condenser of the "adjustable" type, in which the capacity is varied by rotating a small bakelite knob. The complete unit is permanently mounted behind the panel, since the wavetrap, once adjusted to eliminate an interfering station, may be ignored thereafter.

Under actual operating conditions, the Lewcos coil kit has yielded remarkable results in the 1928 Screen Grid Solodyne—undoubtedly one of the greatest of all radio receivers. The kit has been designed with such care, and with such obvious attention to detail, that it would be surprising indeed if the results obtained were anything else but excellent. It is worthy of note, also, that the Lewcos 1928 Solodyne coil kit has been used and specified by many leading English radio journals for incorporation in this very popular receiver.

## The Paillard Electric Pick-up

The number of electrical pick-ups for gramophone work is increasing rapidly. Many are very creditable pieces of work, while some can only be described as mediocre. The Paillard Electric Pick-up, a sample of which we have been able to test, most decidedly belongs to the former category. When tested under ideal conditions with a push-pull amplifier and high-grade speaker, the quality of reproduction reached a very high standard indeed. No volume control or modulator is supplied, but a variable high resistance may easily be incorporated in the amplifier or receiver itself for this purpose.

In order to test the capabilities of the Paillard electric pick-up under average conditions, we connected it (through a volume control resistance) to the audio amplifier of a five-valve receiver of well-known manufacture, using the ordinary battery power supply and a cone loudspeaker. This combination gave very good volume and tone quality, although the bass portion of the scale did not receive the same treatment that it was accorded at the hands of the push-pull amplifier.

This may be accounted for by the fact that the so-called "power" and "super-power" valves used in the last audio stage of the majority of radio receivers are totally unable to furnish the extremely large amount of power that is required for natural reproduction of the lower portion of the musical scale—a fact that the average listener utterly fails to realise.

However, unless they have heard the remarkably natural reproduction that can be secured by the use of large valves supplied with a high value of plate voltage, most people will be quite content with the performance of a good radio set amplifier and an electric pick-up, and the Paillard pick-up is ideal for this purpose. It is small in size, light in weight, beautifully finished and may be placed in any gramophone without making alterations. The Paillard pick-up, which is distributed by Messrs. Edgar V. Hudson, 53 Charlotte St., Brisbane, bears our full recommendation.



# The Condenser

## of Precision & Efficiency

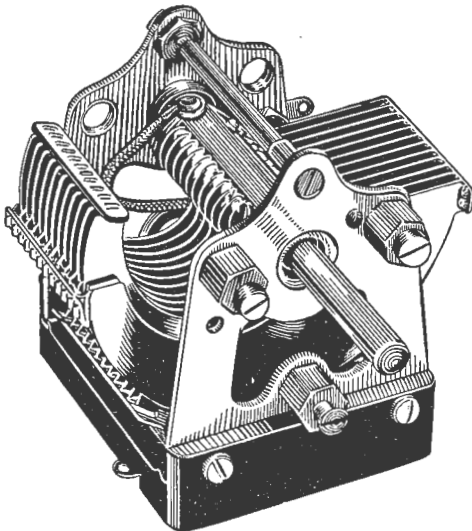

EMMCO SUPER-STRATLYNE CONDENSER

This improved Condenser, with its cast Bakelite base and improved brass frame, gives absolutely correct minimum and maximum capacities.

Perfect insulation, true alignment, easily adjustable brass frame, cut away brass plates in both Stator and Rotor, pig-tailed, and adaptable for either base or panel mounting, adjustable cone bearings.

### Super-Stratlyne Condensers

#### Prices

.0005, 12/6; .00025 and .00035, 12/-; Short Wave, all capacities, 11/6

Simplex Three Gang One Control Condenser, Two Capacities, .0005 and .00035, Price £3

*Unsurpassed  
by any imported make*

*Ample Stocks Available*

**Made by ELECTRICITY METER MFG. CO., LTD.**

Exclusive Factory Representatives:

**MANUFACTURERS' PRODUCTS PTY., LTD.**

Sydney: 137 Clarence Street.

Melbourne: Sunden Place

# Short Wave Activities

*Adequate Power ~ 5SW Unsatisfactory ~ Hearing a Page Turned in Paris ~ PCJJ now PCJ ~ Amateur Notes*

By F. W. NOLAN.



**M**R. HITT, engineer of W2XAF, the Schenectady short-wave station of the General Electric Company, remarked to 2ME during their tests a short time ago: "Waal, we found that if you want to get out successfully you must have power and plenty of it." This, obviously, is the feeling also at "Radio Paris," France, for no matter how bad the atmospheric conditions, he is just as strong as what would be expected on a "perfect radio night." He never surges and never fades far enough to become unintelligible, while as far as speech modulation is concerned, he is perfect. It is possible to hear him turn the pages of a book or paper over as he reads! I cannot understand much of what he says, as it is all in the French tongue, but it's very interesting to listen to such strength and clarity of speech. Radio Paris is, in my opinion, easily three times as strong as 5SW (Chelmsford), W2XAF (Schenectady), PCLL (Holland), and the Japanese station. ANE (Java), operating on about 27 metres, on January 10th, was as strong as Paris, but this would be expected on account of the much shorter distance. RFM (Russia) came in at about half of Paris' strength on January 11th. Radio Paris, I believe, uses a power of 30 kilowatts, and has what is claimed to be the most up-to-date transmitter in the world.

2ME (Sydney) recently informed 5SW (Chelmsford) that it is thought that 5SW will have to make an alteration in the times of transmission to be successfully received in Australia and New Zealand. Canada appears to be the only country that hears 5SW consistently, and with good quality of reception. PCLL broke in on this test, and carried out work with ANE and 2ME. PCLL relayed a British delegate speaking at Washington. Mr. Viffer rang PCLL, who put him straight on the air to 2ME. He asked 2ME for the scores in the Second Test, and was given them. A Mrs. McDonald then exchanged the season's greetings with another lady in Holland.

On the 26th of December last, WFAT (the Byrd Expedition) was heard, calling CQ. He calls every night about 11 o'clock our time, and comes in at R9 here. On the 28th of the same month, 2ME took over the Beam Service, owing to the fire which caused a lot of damage and temporary disorganisation at the Beam Station situated at Ballan, Victoria. PCLL broadcast a beautiful organ solo on the 2nd of January, and on the same date ANE broadcast many well-known items, including "Always" and "Barcelona." The announcer then spoke to Holland, Germany, Spain, France, Italy, Russia, China, Japan, and lastly to England, in each particular country's own language. He said: "Ladies and gentlemen,—I regret to say that this will be the last transmission of these programmes, owing to the fact that we commence our telephone service between Holland and Java with PCLL on January 7th. We would like our listeners to report on this transmission, and we again thank those listeners who have already reported to us, and for the apprecia-

tion they have met. We will try and arrange a programme for Sunday nights, but will advise you by radio and through your local radio papers. Thank you once again, ladies and gentlemen. I wish you good-night." Thus is another forward stride made by radio.

5SW (Chelmsford), on the 3rd of January, completed the London programme, transmitted on 25.53 metres, with a choral number. The strength would be about R5 or R6—the loudest I've heard 5SW at night. On January 6th, RFM (Russia) came in well on 60 metres at about 8 o'clock at night. This station usually transmits a Russian playlet, followed generally by orchestral items. January 10th saw ANE using increased power, and testing with a form of varying wave; he has been carrying out experimental work with this innovation for months. KDKA came in weakly on 43 metres, and RFM on 60 metres a little stronger.

WIZ, a morse station belonging to the Radio Corporation of America, may serve as a guide to some of the "hams" in the matter of wavelength. He operates on 43.35 metres. RFM (Russia) may be recognised by his scheme of sending a few words in morse by means of a buzzer immediately before the final musical item.

No doubt many readers are aware that the famous Philips short-wave station, formerly known as PCJJ, now operates under the call of PCJ. On January 15th, this station was heard at R6 to R7, and the transmission was easily the finest I have ever heard from this universally-known station. Among the many musical numbers transmitted, we recognised selections from "The Blue Train," "The Vagabond King," "Lady Loch," "Sunny," "Tip-Toes," and "The Blue Mazurka." On this occasion, PCJ had two announcers, one speaking English, and the other Dutch. This was a special test with ANE (Java). The concert was followed throughout on the loudspeaker at fair volume, using detector and two audio stages, and the announcements were particularly clear: "This is PCJ, of the Philips Radio Service, Eindhoven, operating on a wave of 31.4 metres, making a special test with Bandoeng, Java." Bandoeng, by the way, is pronounced "Bandung."

The Dutch stations, ANE and ANH, have just commenced the use of new calls. ANE is now PLE, while ANH has become PLF. This latter station is to be used exclusively for a telephony service with Australia. PLR is a new Dutch station about which no details are available at present.

## With the Amateurs.

4AB hasn't got his new 40-metre transmitter going yet; he has just increased the capacity of the oscillator circuit condenser for the time being. Nevertheless, he is getting out well, and with a better note than on the old 32-metre band. Recently 4AB hooked-up with KFBO, the yacht "ARA," at present on a world tour. The yacht was at the time lying at Kugie, in the Caroline Islands. All the members of the party on board were in good health, and they



exchanged the Season's Greetings with 4AB. They gave him a report of R7, and wanted him to test on 36 metres in order to compare signal strengths. 4AB hopes to have a quartz crystal in working order soon.

4AL tested on phone all Xmas and Boxing Days, and gradually worked up from poor to excellent quality and depth of modulation. 7LJ reported him R7, with 75 per cent. modulation, and he also worked 2JT and 3JK on telephony. He uses 360 volts of "B" battery on the plate and batteries for filament supply as well. You certainly worked hard for what you gained, OM. 4PN thinks 42 metres is a bad wave for DX, but heard him on the 6th working with Japanese 3CH. The Japanese hams are now officially recognised, and J3CH is one of the registered men. 4PN had a good D.C. signal on 32 metres, but is R.A.C. on 42. I believe he will be leaving us shortly; if so, the most active and consistent "4" will go when he leaves, and his signals will always be welcome wherever he is.

4RM was QSO 4AL on phone on Boxing Day, with a wavelength of 42 metres. His quality is as good as ever, and the phone comes in with a splendid punch. 4RB has been working 4BH on phone. He puts out

a good, steady D.C. signal, with a modulation depth of 60 to 70 per cent., and his speech is quite good. His transmission of musical numbers, however, is only fair; it appears to suffer from microphone trouble, as frequently happens in amateur work. 4BB connected lately with 3BQ (Melbourne) on 10 metres, which is very good work. He says it's difficult to duplicate results on the 10-metre wave. Someone said something about buying his locality out. Hi! On the higher wavelength, he has worked several Yanks during the last few weeks.

On 42 metres, old 4NW punches out a good D.C. signal. Tom has been experimenting with different types of aerials. He worked OM1TB recently, besides several Yanks, and transmitted some excellent 250-metre phone on January 6th. 4CN expects to be down on the short waves soon. 4LJ is busy as usual, but manages to put out good telephony on 220 metres. 4RO is on the air sometimes with good R.A.C. signals.

4CM—"Born 1820, . . . ." 4BH has had some filter trouble, and is kept very busy.

Heard from 5WH the other day: "Some cow pinched my set." Quite a "moving" affair!

## "Q.R.N." Question Competition

This is the second question in a novel competition for our readers, for which good prizes are being donated by Messrs Trackson Bros., Ltd. Each month a question relating to some usual trouble experienced with a radio set will be given, the prize being awarded to the sender of the correct or most nearly correct answer:—

As we wish this competition to become popular with our readers, the questions will be kept as simple as possible, so that those with only an elementary knowledge of radio may compete.

The following are the conditions governing the competition:—

- (1) The closing date of the competition will be the 20th of the month in which the question appears.
- (2) Answers must be forwarded to the "Queensland Radio News," box 1095N, G.P.O., Brisbane, the envelope being marked "Question Competition."
- (3) Competitors may send in as many answers as they wish, but each answer must be accompanied by the coupon printed below.
- (4) The prize will consist of an order on Messrs. Trackson Bros., Ltd., for the radio apparatus mentioned each month as the prize.

- (5) The decision of the Technical Editor of the "Queensland Radio News," who will act as judge, will be final.

### THIS MONTH'S QUESTION:

In a three-valve Reinartz receiver, previous to the development of trouble, the variable condenser was very critical in its tuning. During the course of a few days, the tuning condenser has become very broad in its adjustment, and apparently has little or no effect on the tuning of the receiver. The detector valve has been tested and found to be O.K. What are the possible cause or causes of this loss of selectivity?

**PRIZE: One Wetless Reinartz Tuner, as used in "The Victory Two," featured in our January issue.**

### COMPETITION COUPON.

This coupon must accompany each answer sent in for the FEBRUARY Competition.

NAME .....

ADDRESS .....

.....

### TIPS AND TECHNICALITIES.

A shilling's worth of distilled water from a chemist is sufficient to keep an accumulator "topped-up" for twelve months or more.

If you charge your own accumulators, do not let them go on gassing too long at the end of the charge.

A jar of petroleum jelly ("Vaseline") with which the terminals can be coated to prevent their being eaten away is an investment that every valve-set owner should afford.

After an accumulator has been used for twelve months or so it is a good plan to renew the electrolyte, and this should be done at a charging station which can be trusted to put in new acid of the correct specific gravity.

Even a "B" battery eliminator will not provide satisfactory and undistorted service unless it is capable of supplying the full plate current required by the receiver.

# HIGH GRADE Products Selling at a LOWER PRICE

GUARANTEED **"WETLESS"** RADIO PRODUCTS

Build the **'VICTORY TWO'** As described in the January 1929 Issue of the "Queensland Radio News"

The  
 Technical Editor  
 Recommends the  
**"Wetless"**  
**Reinartz Tuner**

It is Guaranteed  
 Price  
**10/6**

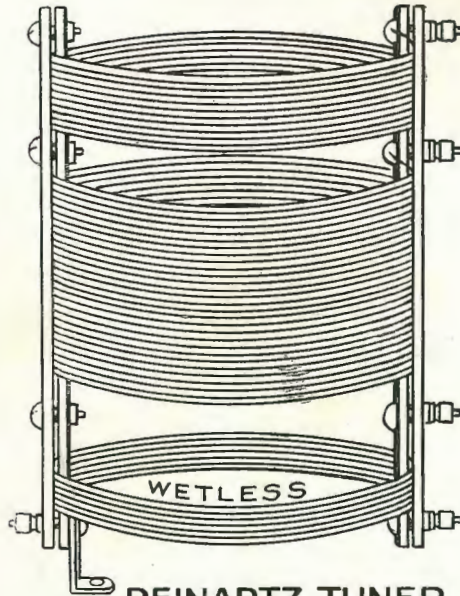

REINARTZ TUNER

The  
 "Victory Two"  
 incorporates  
 a  
 Wavetrap  
 thus ensuring  
 reception  
 of  
 Southern  
 Stations

### List of Parts Required for the "Victory Two"

1 Wetless Reinartz Tuner .....	10/6	1 Battery Switch .....	2/3
1 Wetless .00025 Variable Condenser .....	8/6	1 Bakelite Panel, 21 x 7 x 3/16ths .....	12/6
1 Knob (with pointer) for same .....	1/-	2 Bakelite Terminal Strips .....	6d
2 .0005 Cariable Condensers (9/- each) .....	18/-	5 Terminals .....	1/3
2 Vernier Dials for same (4/- each) .....	8/-	1 Bakelite Tube, 3 x 2 .....	1/-
1 Wetless Type B Grid Condenser with clips .....	2/6	4 Ounces No. 20 Gauge DCC Wire .....	1/-
1 5-meg. Grid Leak .....	2/-	Hook-up Wire .....	9d
1 Amperite .....	5/9		
1 Audio Transformer .....	9/-		
2 Non-microphonic Sockets (2/6 each) .....	5/-		
1 Battery Cable (7 wires) .....	2/9		
		<b>Total £4/12/3</b>	

### Accessories

2 Valves (A-415 and B-406) .....	27/-	1 Dinkie Speaker .....	15/-
3 1½-Volt "A" Batteries (3/- each) .....	9/-	Aerial Equipment and Earth Wire .....	5/-
2 60-Volt "B" Batteries (18/- each) .....	36/-		
3 4½-Volt "C" Batteries (1/3 each) .....	3/9		
		<b>Total £4/15/9</b>	

"Wetless" Products obtainable from all Radio Dealers or from the Distributors :

**TRACKSON BROS. LTD.**

The Radio and Electrical People **157-159 Elizabeth St., BRISBANE**  
 Manufactured by **J. WETLESS, 28 King St., SYDNEY, N.S.W.**

Assure Maximum Results from your Radio Set by using~

# DEAL RADIO BATTERIES

**—THEY LAST LONGER—**

As the Direct Factory Representatives, we are in a position to make lower prices for equivalent quality than Batteries which have to pass through two and three factors before reaching the Queensland Distributors. That is why

**—THEY COST LESS—**



45-Volt HEAVY DUTY VERTICAL  
22/6.  
Guaranteed Seamless Cells.



1 1/2-Volt "A" BATTERIES, 2/9.



45-Volt HEAVY DUTY FLAT,  
22/6.  
60-Volt HEAVY DUTY FLAT,  
30/-.  
Guaranteed Seamless Cells.

The only make that has sixty volts and they are better.

Next time order two 60-volt Deals. All dealers can supply.

SOLE DISTRIBUTORS

51  
Charlotte  
Street  
Brisbane

# EDGAR V. HUDSON

*The Leaders in Radio Merchandising*

Phone  
Central  
8622

P.O.  
Box  
522H