

THE AUSTRALASIAN

PRICE, 1/-

Registered at the G.P.O., Sydney, for transmission by post as a periodical

# Radio World

VOL. 6 . . . . . NO. 11

APRIL 15 . . . . . 1942

FULLY TUNED  
SIGNAL TRACER

TEST BENCH  
ARRANGEMENT

HIGH FIDELITY  
AMPLIFIER

ALL LATEST  
S.W. SCHEDULES

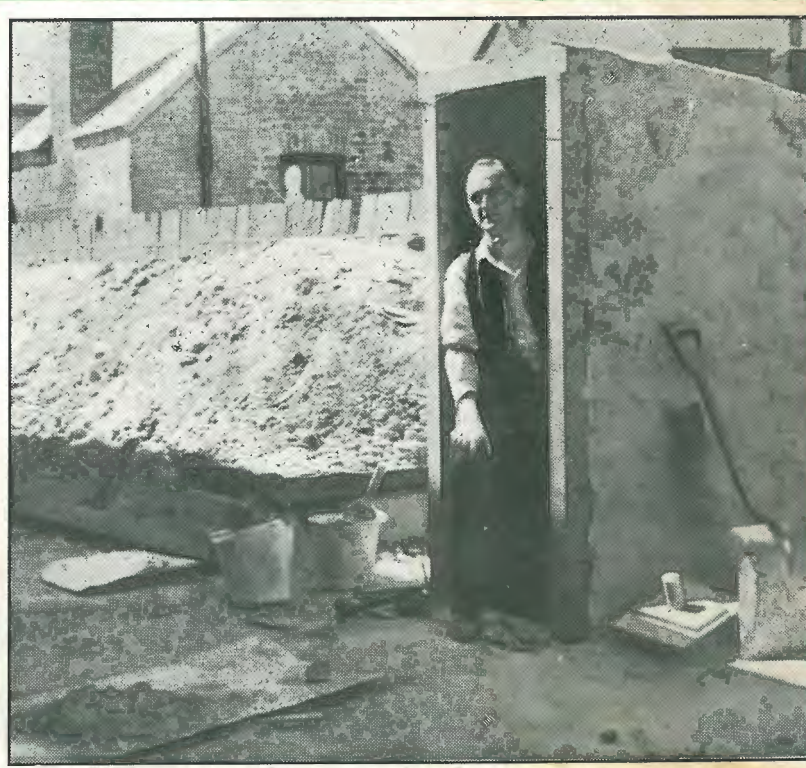

AIR RAID SHELTER FOR R.C.S. EMPLOYEES  
(See Page 3)



**The RESPONSIBILITY  
RESTS WITH YOU —  
The RADIO DEALERS  
and SERVICE MEN**

★ **A**ND a big responsibility it is too. With the partial curtailment of radio manufacture it  
★ becomes of the utmost importance to keep the old receivers in efficient working order.  
★ To give your clients the best possible satisfaction, and gain for yourself a reputation  
★ of reliability and efficiency, it is vitally important to use the most modern, reliable and  
★ efficient components. Crown Radio Products have for years enjoyed an unparalleled nation-  
★ wide reputation for reliability. Direct all your enquiries for Crown Radio Components to one  
★ of our authorised distributors as published in the March issue of this journal.

*Crown*



**RADIO PRODUCTS PTY LTD**

**51-53 MURRAY STREET  
PYRMONT - SYDNEY**

*Telephone MW 2628  
(2 Lines)*



# THE AUSTRALASIAN RADIO WORLD

*Devoted entirely to Technical Radio*

and incorporating  
**ALL-WAVE ALL-WORLD DX NEWS**

★ Proprietor —

★ Publisher —

★ Editor —

A. G. HULL

★ Editorial Offices —

117 Reservoir Street, Sydney  
Phones: M 4078 - M 4079

★ Office Hours —

Week-days: 9 a.m. - 5 p.m.  
Not open Saturday morning

★ Subscription Rates —

6 issues ..... 5/3  
12 issues ..... 10/6  
24 issues ..... £1  
Post free to any address

★ Service Departments —

Back Numbers, 6d. ea., post free  
Reply-by-mail Queries, 1/- each  
Laboratory Service, 2/6 per set

★

## OUR FRONT COVER

Our photograph shows Mr. Ron Bell, managing director of R.C.S. Radio Pty. Ltd., at the mouth of a large concrete air-raid shelter which has been built at the R.C.S. factory.

Mr. Bell has the interests of his employees at heart, and is also keen to make certain that there will be no interruption in the supply of R.C.S. components, which are used so extensively for both civil and defence requirements.

Vol. 6

APRIL, 1942

No. 11

## CONTENTS

### CONSTRUCTIONAL —

The Latest Signal Tracer ..... 5  
High Fidelity Amplifier ..... 11

### TECHNICAL —

Test Bench Arrangement ..... 16  
"Radio Step by Step"—Part 1 ..... 18

### SHORT-WAVE SECTION —

Contempt for Tokyo Propaganda ..... 17  
Short-wave Review ..... 20  
New Stations ..... 21  
Loggings of the Month ..... 22

### THE SERVICE PAGES —

Answers ..... 26

## EDITORIAL

Pioneers often have a tough time of it before their work receives proper recognition.

John Bristoe, author of our series of articles on signal tracers, might be considered a pioneer, and accordingly his articles have not been accepted by all our readers.

Quite a few have their doubts about the value and efficiency of the signal tracer, and the subject is a fertile one for arguments.

Frankly, we have not had much experience with them in our own laboratory, but there are two factors which influence us to put our backing behind Mr. Bristoe.

Firstly, we know that Mr. Bristoe is a practical man, in charge of a radio department, handling hundreds of sets, and, secondly, we note that those who doubt the value of the signal tracer are mostly those who have not actually tried them in practice. They base their opinions on theoretical considerations, which are not, to our way of thinking, sufficient in themselves in a case like this.

To those in doubt we can only suggest that a little practical work with one or another of the signal tracer outfits will soon convince them that they are well worthwhile for those who have a volume of servicing work to handle.

# In the Fully Tuned Signal Tracer featured in this Issue

Use

# R.C.S.

## D.W. UNITS

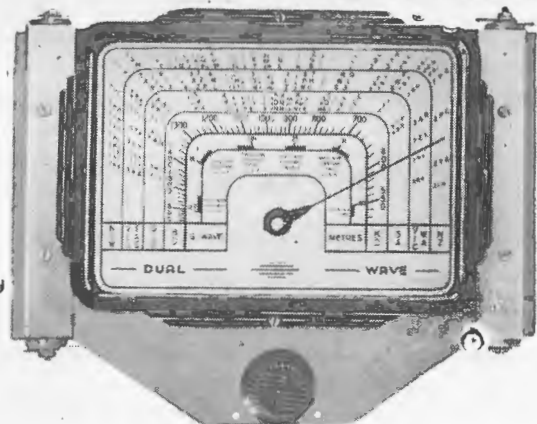

### R.C.S. DIALS

Types DA1 and DA2 are single glass dual-wave, the type DA2 having been designed especially for use with the Five-Band Communications Coil Kit and "H" type condenser. Type DA1 is a standard dual-wave dial for use with R.C.S. coils and "F" type condenser. The DA-5 dial is for use on the 1600 to 550 k.c. and 13.7 to 40 metre bands, with "H" type condenser. All this series is edge-lit and wedge-driven. Aperture for the escutcheon is approximately 7" x 4-7/8."

DA1—Standard D/W Dial, "F" condenser ..... 22/6  
DA2—Communications Dial ..... 22/6

DA-5—13.7 to 40 metres D/W condenser 22/6

DA-6 Mantel Set Dial, D/W "H" gang ..... 18/9

DA7 Portable Kit Dial D/W "H" gang ..... 9/-

DA8 Same as DA7 but ready assembled .. 13/6

For best results in all your constructional work use only genuine R.C.S. components. Made to extreme precision limits and featuring Trolitul, the improved, transparent insulating material, wherever possible, they are your best guarantee of satisfaction. Used by the designers of constructional sets, they enable you to duplicate the performance of the laboratory test sets exactly . . .

### R.C.S. UNIT DW36

Type DW36, as illustrated, consists of Aerial and Oscillator Coils, Wave Change Switch, the necessary B.C. and S.W. Trimmers and Padder mounted together, wired up ready to assemble into a set utilising 465 k.c., the bands being S.W. 13.7 to 40 metres, and B.C. 1600 to 550 k.c.  
Code DW36 .. £17/6

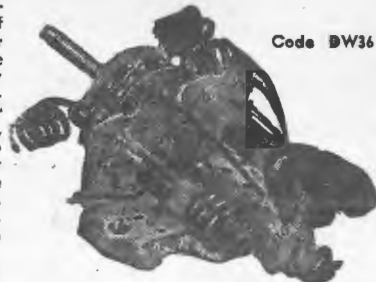

Code DW36

### R.C.S. D.W. UNIT DW35

Type DW35, as illustrated, consists of Aerial, R.F. and Oscillator Coils, Wave Change Switch, the necessary B/C and S/W Trimmers and Padder mounted on a rigid steel base, wired up ready to assemble in a set utilising 465 k.c. and R.F. stage. The bands are S/W 13.7 to 40 metres, and B/C 1600 to 550 k.c.  
Code DW35. Price .... £37/6

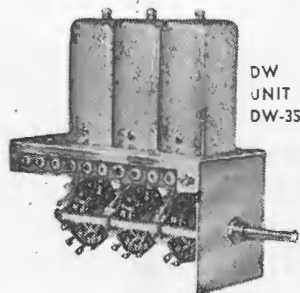

DW UNIT DW-35

### R.C.S. AUDIO TRANSFORMERS

Long experience in the production of highly efficient transformers, combined with extensive research into raw materials and design, has resulted in the production of an audio transformer of excellent performance and complete reliability.

Cat. No.	Description	Retail Price
TA1	Audio Choke, bakelite case	18/6
TM1	Modulation Transformer — Power	30/-
TB4	Single Input "A" Class, bakelite	20/-
TB5	Push-pull "A" Class, bakelite case	21/-
TB6	Input "B" Class, bakelite case	18/6
TB35	"A" Class High Fidelity, steel case	67/7
TB36	"B" Class Input High Fidelity, steel case	67/6
TB37	"AB" Class, bakelite	28/6



TB6—"B" Class

### R.C.S. PRODUCTS ARE OBTAINABLE ONLY THROUGH THESE DISTRIBUTORS:

**SYDNEY:** Bloch & Gerber — Martin de Launay — Fox & MacGillycuddy — Lawrence & Hanson Electrical — John Martin — Radio Equipment — Radio House — United Radio Distributors — Homecrafts Ltd.

**ADELAIDE:** Gerard & Goodman — A. G. Healing — Newton, McLaren Ltd.

DO NOT WRITE DIRECT TO —

## R.C.S. RADIO Pty. Ltd., SYDNEY, N.S.W.

**BRISBANE:** Chandler's — Trackson's — Homecrafts.

**TASMANIA:** W. & G. Genders, Launceston — W. & G. Genders, Hobart — W. & G. Genders, Burnie.

**MELBOURNE:** A. J. Yealls — Homecrafts — Hartley's.

**WEST AUSTRALIA:** Carlyle & Co., Perth.



# RADIOKES



"The name  
to know  
in Radio"

For the F.T. Signal Tracer announced in this paper, follow the lead of expert radio men everywhere and use only genuine Radiokes D.W. Units and components. Technically superior in every way because of improved design and production processes you can't go wrong when you use these precision-built parts . . .



**DWU3** — Radiokes engineers have developed the newly-released Dual-Wave Unit with R.F. stage, attaining new peaks of technical perfection! Broadcast 1550 to 550 k.c., short-wave 13.7 to 40 metres, with Aerial, R.F. or Oscillator Coils. For A.C. or battery operation.  
Type DWU3, illustrated ..... £3/7/6

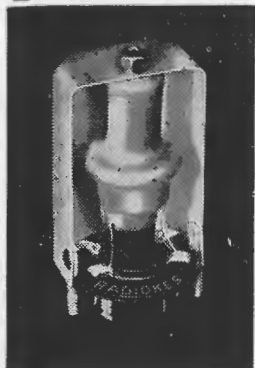

**DWU-1**  
This is a highly attractive unit with an exceptionally high range. The DWU-1 matches "H" type condenser, and incorporates a 4-in-1 padder. Solidly mounted with coils.

Type DWU-1:  
Price, £1/7/6

AVAILABLE FROM ALL LEADING STORES  
**RADIOKES Pty. Ltd.**  
P.O. Box 90  
BROADWAY - - - SYDNEY

## SIGNAL TRACER

(Continued from page 5)

set I usually wave the probe about an inch away from the wiring, starting near the detector and working back. If a sound is heard in the signal tracer near the detector the trouble is almost certain to be in the detector or audio stages. If no sound is heard, take the probe towards the intermediate and oscillator stages until a signal is received. Apply the probe to the nearest plate or grid. If a signal is obtained, then work back until the signal cuts out.

(2) Although a very low capacity condenser is used in the probe, the sensitivity is greater and less detuning occurs on the R.F. and I.F. frequencies.

(3) As the signal tracer is tuned, one knows exactly which frequency the signal is on in the R.F. and I.F. sections.

(4) Selectivity. — Untuned models, used in a city area where a number of stations are operating, bring them in together. This model tunes only the required frequency.

### How to Use

If servicing a set and the I.F. frequency is not known, apply the probe to the plate of the mixer with the wave-change switch in the untuned position. This is to check the presence of the signal. Now turn wave C switch to band 4. If, on rotating the dial on the signal tracer, the signal comes in very loudly, the frequency is located. However, be sure that the oscillator on the set is working, or the broadcast frequency signal is received.

The tuned section can also be used to check the efficiency of the oscillator signal. Turn the dial to the oscillator frequency of the set, have the eye switched to the diodes, and apply the R.F. probe to the oscillator plate and grid. The oscillator grid voltage can be checked with the eye or V.T.V.M. without affecting the operation very much.

### How to Adjust the Signal Tracer

Line up the tuned circuits on the instrument in the same manner as you would a T.R.F. set. Then take readings from various parts of the dial with a reliable oscillator, otherwise it means working in the dark. Actually a dial, calibrated for all bands from about 20 m.c. to 150 k.c., is needed, together with an all-wave coil kit. Due to war conditions it is not likely that coil manufacturers would make these coils, so details are given on how to make the kit up with ordinary I.F. transformers and R.F. coils.

### To Construct the Coil Unit

This requires one I.F.T., 465 k.c., and R.F. coils for whatever bands are to be included in the instrument. The most important are all usual I.F. bands. The two coils from the I.F.T. will cover all these, i.e., from 150 k.c. to 470 or thereabouts.

All you require are the actual windings from the I.F.T., so remove the can and trimmers and there is usually a former with two pie-wound coils, probably covered with wax.

To remove the wax, hang the former in a warm oven long enough for the wax to melt and leave the two coils exposed. Now, between the windings, cut the former with a hacksaw. This gives two separate coils.

### Coil Alterations

Remove about 10 turns from each coil or it will not be possible to tune up to 470 k.c. When using an ordinary standard two-gang condenser, I found that 175 k.c. could not quite be reached when the blades were fully meshed. So, to avoid including an-

### Further Data

If you have not already seen the previous articles on Signal Tracers you can obtain the September, November and December, 1941, issues from our Back Number Department, price 6d. each, post free.

other set of coils, I shunted a .0001 condenser across each of the I.F.T. coils. This condenser is switched in when the wave-change switch is on No. 4 position. If possible, avoid using I.F.T. coils wound with Litz wire, as this is very fragile and care must be taken to see that all strands are soldered or the inductance of the coil is affected. I fitted all the coils into a two-stage five-band coil box, but they can be mounted direct on to the chassis if desired, as close to the gang as possible.

Be sure that both sets of coils are shielded from each other or oscillation will occur. It may also be necessary to shield the R.F. chokes. All coils used in the coil box have small trimmers across them. The types generally used for aerial and R.F. trimmers in modern radios are suitable. Provided the coils are reasonably accurate no great capacity is needed.

If desired, the R.F. coil primaries can also be switched into the circuit instead of the R.F. choke. But, as this involved extra switching and owing to the fact that my coil unit had to be mounted above the gang, I did not worry about them. I think the system

used will be found effective for all requirements.

### Vacuum Tube Volt Meter

This vacuum tube volt meter (V.T.V.M.) has ranges of zero to plus or minus five, twenty-five, one hundred, and five hundred volts. With it voltages can be measured in any part of a radio set with practically no current being drawn, as the input resistance is 11 megohms. Furthermore, it is almost impossible to overload the meter.

No special meter is required for the construction of this section. An ordinary 0-1 milliammeter similar to that used in most volt ohmmeters is suitable.

### Calibration

The calibration of the V.T.V.M. is as follows:—Using good dry batteries, or some other source of constant reliable d.c., adjust the 2,500-ohm potentiometer until the V.T.V.M. reads the correct voltage (using the first input switch tap), then remove the probe from the voltage and re-zero by means of the zero adjustment, 10,000-ohm potentiometer, in the when the voltage is removed. (Zero is in centre of meter scale. In fact, when the V.T.V.M. is in operation it looks and works just like a car ammeter, only it shows voltage—positive and negative—instead of charge and discharge.)

After this point is found, the 2,500-ohm potentiometer will not need to be touched again unless the valve is changed. The 10,000-ohm potentiometer adjustment is readjusted whenever the V.T.V.M. is to be used, the same zero setting applying to all ranges.

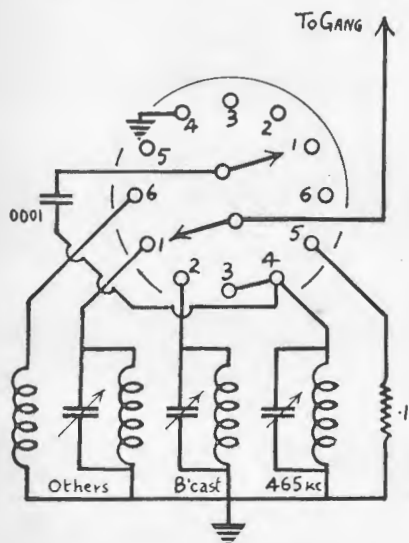

Diagram showing the switching arrangement for the coil unit, as detailed in the article.



A photograph of the front panel of the latest Signal Tracer unit.

middle of the panel. Continue this procedure until a point is found on the calibrating resistor 2,500-ohm potentiometer, where the V.T.V.M. will read the correct voltage and return to zero

### To Correct Zero

If it is found that the V.T.V.M. will not zero correctly it may be necessary to alter the size of the plate resistor on the 76 valve. This is shown in the diagram as 20,000.

This V.T.V.M. will be found to be a big improvement on many other types as no switching system is required to reverse the meter. Just apply the probe and it shows the exact voltage, and if it is positive or negative.

I do not intend to attempt to give all the advantages of a V.T.V.M. or describe its many uses as it is too comprehensive a subject at this stage. Perhaps Mr. Hull will arrange some articles on this subject later on.

### Gain Tests

However, it can be used for making gain per stage tests right through any receiver. There are many voltages in a radio that cannot be checked with ordinary meters without upsetting the operating efficiency.

If desired, the meter may be removed from its case and, where there is sufficient space, the calibrations of the various scales of the V.T.V.M. may be marked on the meter face. If not, make the complete scale in ten divisions and a good indication can be obtained of the voltage reading.

### Switch Wiring

The switch wiring of the voltmeter section is shown fully and needs very little explanation. When the contacts

are on points 7, 8, 9 and 10 the V.T.V.M. is in action, and when in the other positions the meter needle will resume its normal position and return to the end of the scale. It will be noticed that two contacts of the switches were not used. These could be used to extend the voltage range if required or another deck could be added and milliamps included.

The tuned signal tracer is not meant to entirely supersede the previous models designed. Those who have built the various types can alter them very easily. The others were good, but this model is better and warrants any trouble taken to make up the coil unit and V.T.V.M.

### Eye

It will be noticed that the magic eye grid can be switched to the diodes where it acts as the usual tuning indicator, or audio sections, where it operates as an output indicator. Also it can be switched to the master switch and used with the probe to test A.V.C., etc. Actually it is not really essential to include the eye circuit at all as the V.T.V.M. can do these operations just as effectively. However, I prefer to have a visual as well as audible check of the signal picked up by the tracer and at the same time leave the V.T.V.M. free for other operations simultaneously. Sometimes in intermittent or noisy sets, two probes can be used at the same time and, in some cases, the three probes. It is an advantage to have small alligator clips that will attach to the end of the probe. Then they can be clipped on the various parts of the set being tested and watched for voltage alterations, etc., whilst still having an audible check. This is particularly

(Continued on page 9)

# **ROLA** LOUD SPEAKERS

*The World's Finest Sound Reproducers*

MADE IN THE WIDEST RANGE OF MODELS  
AVAILABLE IN AUSTRALIA - - - -

**W**HEN the highest quality of sound reproduction is required, together with robustness, efficiency and economy, there is only one loud speaker—ROLA. There is a specially-designed Rola Speaker that ideally fulfils every purpose, whether in theatre or public address systems, in high quality radio receivers or the midget personal radio.

**R**OLA Speakers are on service with the Navy, R.A.A.F., Army, A.R.P. Organisations and Police. In war, as in peace, Rola is the BEST of all Loud Speakers.

**Y**OUR local Distributors have a full stock of Rola Speakers and Parts, and are equipped to carry out repairs and adjustments.

**The Rola Company [Aust.] Pty. Ltd.**  
The Boulevard, Richmond, Victoria

N.S.W.: 116 Clarence Street, Sydney

The Australasian Radio World, April





## SIGNAL TRACER

(Continued from page 7)

effective if used correctly in tracing intermittent faults, also both audible R.F. or I.F. and audio sections can be checked at the same time, with a visual indication on one or the other or both.

### Probes

Diagrams are given of three different types of probes:—

- (1) A probe with a small fixed condenser inside. Used on R.F. and I.F. section.
- (2) With a 1 meg. resistor inside and used on V.T.V.M. and eye sections.
- (3) This probe is straight through and is used on audio circuits, etc.

When using the R.F.-I.F. probe have the signal tracer turned to the

### The Front Panel

The front panel of the signal tracer was made of sheet steel. However, I have a workshop with lathes and presses at my disposal and, unless you have the same, do not use steel. Masonite is a good substitute and is easy to cut and drill and presents a nice appearance.

### Conclusion

In conclusion.—The signal tracer is an instrument which will never become obsolete, because it can be used on any type of radio or sound apparatus. In the future there will come frequency modulation and television, and the signal tracer of to-day will be ready for that time.

### Correspondence

I have received a number of letters since the first articles on signal

tracers were published—some very appreciative and asking for further details, some of which were too involved to answer by letter. If further articles on the subject of signal tracing will be of interest I shall be pleased to submit same at a later date.

I advise those who have not yet tried servicing with signal tracing to do so as soon as possible. I am convinced that a signal tracer used in a proper and intelligent manner will locate faults more quickly and accurately than any other known method, and, after all, when the fault is found, the cure is usually simple.

Bear in mind, however, a signal tracer does not cure faults—it locates faults quickly and accurately, thus saving your time and time means money.

The new telephone numbers for

A. G. HULL

publisher of the

**"AUSTRALASIAN  
RADIO WORLD"**

are

**M 4078 and M 4079**

(two lines)

Please note that technical queries are NOT answered by telephone.

frequency to be checked, i.e., on R.F. frequency tune to the broadcast frequency, and from the mixer plate to the second detector should be tuned to the I.F. frequency.

### Low-capacity Cable Needed

The lower capacity cable used in the probes, the better the general effect. I have tried all types of cables and find that good-quality microphone cable is most satisfactory. However, if you can obtain a length of coaxial cable all the better.

It will be noticed that contact L on the master switch connects to the screen of the first 6U7G about 100 volts. I include this because a source of H.T. is useful for various purposes. By turning the switch to this position, there is available 100 volts that can be applied with the probe anywhere desired. Also contact A is connected direct to 250 volts. This can be used in the same way.

The 1000-ohm per voltmeter and ohms can be used with the probe or two ordinary test prods can be plugged into the banana sockets on the panel. This leaves the probe free for other work.



# BRITANNIC

RULES THE RADIO WAVES

YES, the "Aegis" kit for the "Little Companion" contains every component you need for the assembly of an efficient dual-wave mantel model.

Insist on the "Aegis" kit as featured in last month's issue.

WRITE FOR QUOTATIONS

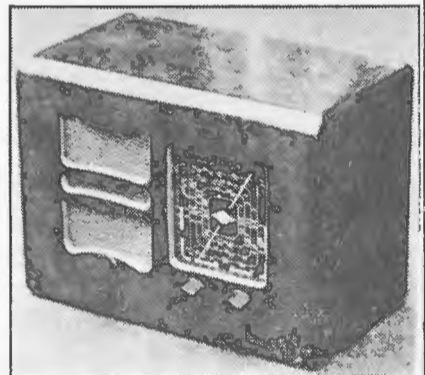

The original "Little Companion" as built from the "Aegis" kit.

★  
INTER-OFFICE COMMUNICATORS AND SIGNAL TRACERS ARE OUR SPECIALTIES

★

MAGRATH'S are also Agents for:

MARQUIS PRODUCTS — W.W. Potentiometers, Knobs, Formers, etc.

WESTERN CABINETS — As recommended by "Radio World."

UNIVERSITY TEST EQUIPMENT — Oscillators, Voltmeters, etc.

AGIS — Power Transformers, Chassis and a complete range of quality Kitsets.

## J. H. MAGRATH PTY. LTD.

208 LITTLE LONSDALE STREET, MELBOURNE, C.1

Phone: Central 3688-4414

# The Evolution of Radio

## SOME EARLY HISTORY OF THE INVENTION OF BROADCASTING

**I**N these modern days when every tank and Bren gun carrier has its own radio equipment and when every home has its own radio receiver, there is a chance to forget that radio is such a modern feature in civilisation. Or is it?

It is only a few years since broadcasting was introduced, but it is many years since the foundations of radio were laid. For example, it is said that the Chinese discovered magnetic ores somewhere about three thousand years before the birth of Christ.

Surprisingly few modern radio technicians know the full story of the development of radio, and are content to dismiss the subject by saying that radio was "invented by Marconi."

Actually the evolution of radio was considerably involved and it is hard to define which developments should be credited to electricity rather than radio. It was upon the early work of the scientists who gave us electricity that much of radio became possible. The close relationship between the radio terms and the names of early electrical scientists is only too evident. For example, we have the volt, after the Italian scientist named Volta. Ampere was originally the name of a Frenchman, as Ohm was the name of a German. Watt as a Scotsman. All of them had a con-

siderable part in the development of radio, yet their fame is more closely associated with electricity. Considerable credit, however, is usually given to Maxwell and Hertz for their radio work, although their efforts still left a lot of ground to be covered before radio became what it is to-day. Marconi's part in radio development might be considered more as commercial than inventive. It was Marconi who formed the business enterprises which did so much to demonstrate the possibilities of radio communication. A couple of years before the opening of this twentieth century of ours, Marconi's companies had demonstrated that radio signals could be sent over distances of up to a couple of hundred miles. They faced up bravely to plenty of official red tape and public scepticism, and forced the acceptance of radio as a means of communication.

It was in 1901 that the Atlantic Ocean was spanned by a radio signal, and by 1903 the art had progressed to such an extent that a full message was sent from the President of the United States to the King of England.

A big factor in the progress of radio was the proving of its value to shipping when it was directly responsible for the saving of over 200 lives when the S.S. "Republic" sank in the Atlantic.

Modern radio owes a lot to the introduction of the valve, which was more or less directly due to the efforts of Edison when he invented the electric lamp, although the credit is usually placed to Fleming, who demonstrated the diode detector in 1904 and to De Forest, who offered the original triode with its ability to amplify signals, and to oscillate. Both these properties have proved of immense value in bringing radio technique to its present standard.

Radio broadcasting of programmes of music is of much more recent years, this type of broadcasting having been practical for a matter of only about 20 years or so.

## SPEAKER ENERGISING

The field coil of an electro-dynamic speaker requires to be energised with a certain wattage of electrical power. Small speakers need only two or three watts, medium-sized speakers need four to eight watts, and the bigger speakers may need from 8 to 12 watts. A speaker which is not sufficiently energised cannot handle power properly nor give good quality reproduction. A speaker which is overloaded with energising power will overheat, resulting in the voice coil housing warping and fouling the pole piece.

The calculation of wattage is merely a matter of the application of the Ohm's Law, it being necessary to know the field coil resistance and the current passing through it or the voltage drop across it.

There's an

# AMPLION

for every purpose . . .

In the AMPLION range of fine speakers there is a type that is exactly right for your set or amplifier. Offering greater power-carrying capacity, completely electrically-welded construction throughout, insulated core and tropically sealed transformers, and true undistorted tone, they add immeasurably to the success of your work. Write for catalogue, prices, etc.

## Amplion [A/sia] Pty. Ltd.

382 KENT STREET - - - SYDNEY

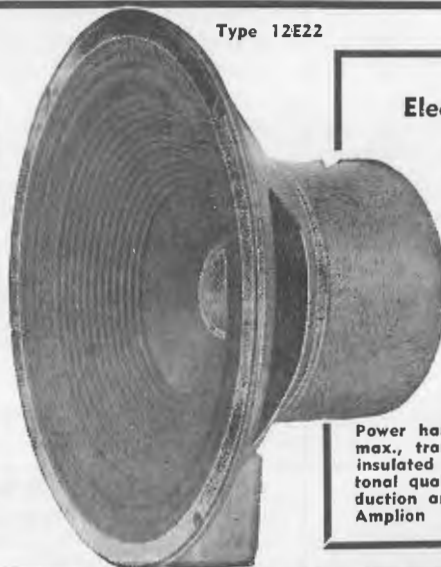

Type 12E22

### 12E22 Electrically welded

- Greater Output
- Sealed Transformers
- Complete Dust-proofing
- Extended Frequency Range

Unrivalled for P.A. or receiver equipment, the AMPLION 12E22 offers features not to be found in any other speaker, regardless of type or price.

Power handling is 13 to 20 watts max., transformers are sealed and insulated from the core, and the tonal quality and fidelity of reproduction are unequalled.

Amplion 12E22 ..... 62/-

# HIGH FIDELITY AMPLIFIER

Featuring triodes with inverse feedback.

From the latest issue of the well-known American technical journal, "Radio," comes this design for a high fidelity amplifier which should be of great interest to our readers.

NOW that the amateurs are, for the most part, off the air and the amateur recording fiends are faced with a shortage of new equipment and blanks, such time as can be spared from defence work will be diverted into new channels. One field of activity which seems to be attracting the interest of a goodly number is the building of high-fidelity phonograph players from such equipment as is on hand or can be borrowed or obtained from the rather depleted stocks of the parts supply houses.

Two of the essential components of the phonograph player can be constructed by the amateur or experi-

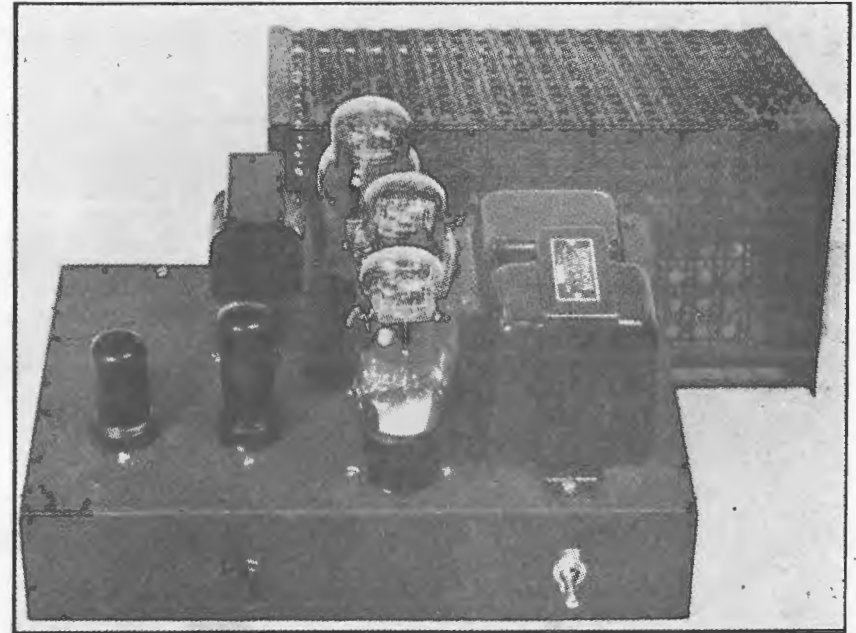

menter: the amplifier and the speaker housing. The different types of housings have been described in previous issues, and the construction of a simple amplifier that almost

every experimenter can build from parts on hand is described herein. It is assumed that a good-sized loudspeaker (12 inches or greater cone diameter) of modern design will be used and that a good crystal pick-up with low needle point damping will be employed.

## The Output Stage

The design of any audio amplifier hinges, quite naturally, upon the type of output power amplifier stage that is to feed the loudspeaker. All the other sections of the unit—voltage amplifier, phase inverter and power supply—will then be designed around the excitation voltage and plate power requirements of the power stage.

## Experiments Carried Out

In the course of casual experimentation to determine a satisfactory output amplifier arrangement, quite a large number of different tube combinations and circuits were lashed up. Naturally, the first tubes tried were beam tetrodes, 6L6's and 6V6's. The high power sensitivity of these tubes, plus their high power output and reasonable plate power requirements, made it appear at first that they would be the ideal combination. Preliminary tests showed that all the above suppositions were true, and in addition showed that distortion arising from the stage could be cut down to

(Continued on page 13)

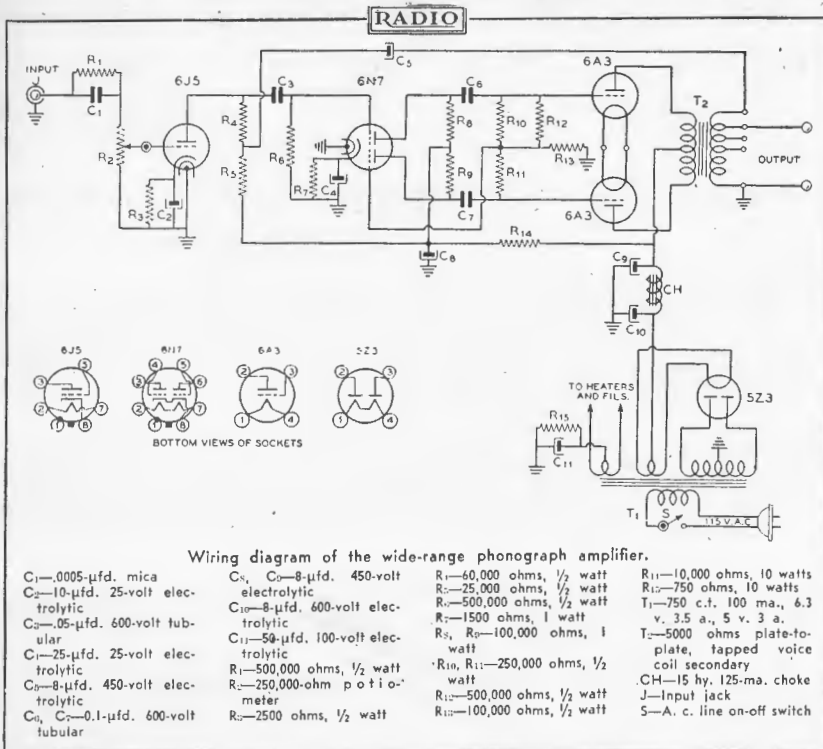

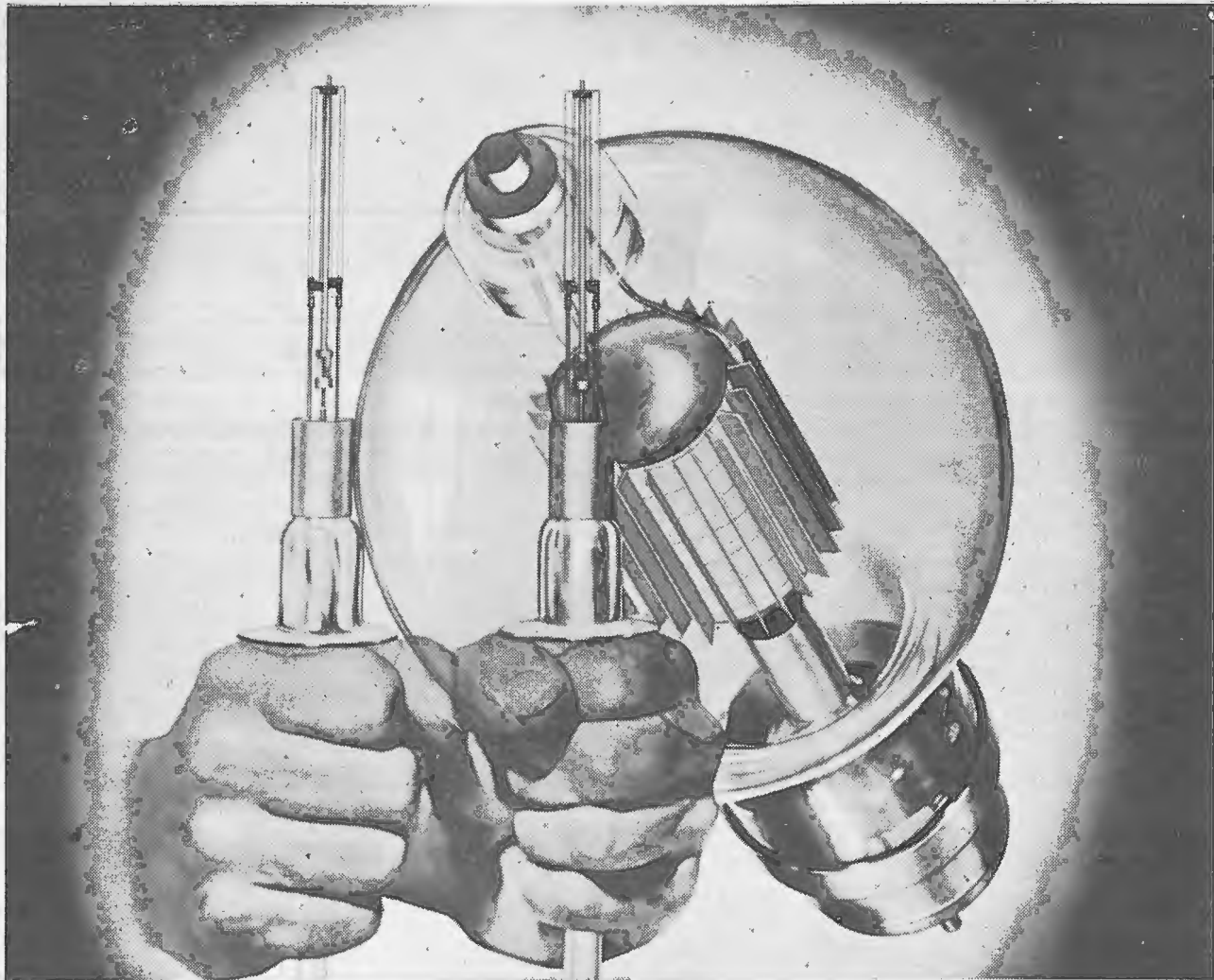

## How Important is a Filament?

**I**t's a well known fact that the vacuum valve is the heart of radio communications, but it is important to remember that the filament is the heart of the vacuum valve! Thus, the efficiency with which these tiny strands of tungsten wire perform may mean the difference between success and failure of the valve itself ...victory and defeat for tanks or battleships ...life and death for millions of people.

You can't always tell by appearance whether a filament is efficient or not. The two assemblies shown above look exactly alike but when put to the test one may not do its job. Into the production of filament for Eimac valves has gone much research and experimentation. Among many special instruments designed and perfected by Eimac to insure perfect filaments, none is more interesting than the electron microscope which virtually gives a moving picture of how a filament works under actual operating conditions.

Behind every Eimac valve is the assurance that its filament will function at top efficiency. Contributing factors to this efficiency are: Tantalum plates and grids and the super-vacuum which removes all contaminating gas particles. All these factors and more are what make it possible for Eimac valves to carry the unconditional guarantee against emission failure caused by gas released internally.

• • •

*Eimac's unusual performance capabilities are receiving enthusiastic acceptance in all branches of the service... ARMY, NAVY and AIR CORPS*

Follow the leaders to

**Eimac**  
TUBES

Eitel-McCullough, Inc.  
San Bruno, California

Foreign Division: FRAZAR & CO., LTD., 301 Clay Street, San Francisco, California, U. S. A.

## HIGH FIDELITY AMPLIFIER

(Continued from page 11)

a negligible amount through the use of degenerative feedback.

But when the checkups were made upon the frequency response of the tetrode amplifier, the results were not quite so encouraging. True, the highs were good, their normal predominance in a tetrode amplifier being flattened out by the feedback. But the low frequencies, considering the medium-priced output transformer and speaker we were using, were not satisfactory. The amplifier was good down to about 60 cycles (it was considerably down at this point without the feedback) but below this point the waveform rapidly approached a sawtooth form and the amplitude dropped. This type of result would have been considered satisfactory for a medium-priced broadcast receiver or record player, but since we were just experimenting it was decided to see what could be done with the same power supply, output transformer, and speaker using triodes in the output stage.

### Triodes Give Improvement

A pair of 2A3's were used in the first version of the amplifier, without feedback and with the same phase inverter (a 6SC7 was being used as phase inverter). An improvement in response was immediately apparent; the low frequency response was substantially flat down to 30 cycles and the highs were as good as had been

obtained with the tetrodes and feedback. But we immediately ran into difficulty in obtaining sufficient voltage output from the phase inverter to excite the grids of the 2A3's.

### Phase Inverter Circuits

A pair of 2A3's require a peak grid-to-grid swing of about 140 volts. This means that each side of the phase inverter must be capable of putting out about 70 volts without distortion at the lowest and highest frequencies to be handled by the amplifier. An inspection of the Resistance-Coupled Amplifier Chart in the R.C.A. Receiving Tube Manual shows that about the only triode which is capable of delivering this output voltage, at 300 applied plate volts, is one section of the 6N7. With a supply voltage of 300, a plate load resistance of 100,000 ohms, and a grid leak on the next tube of 250,000 ohms, each section of the 6N7 has a voltage output of 83 volts. This value gives a satisfactory safety factor over the 70 volts or so actually required.

### Self-balancing Circuit

Several phase-inverter circuits were tried, but the conventional "self-balancing" circuit was found to be the most satisfactory for an output voltage of the magnitude required above. But it is important to note that this so-called "self-balancing" circuit will only give the same voltage on each grid of the output stage when the proper resistor values have been used. Once the proper resistor values have been determined the circuit is actually self-balancing regardless of supply

voltage variations and small differences in tube characteristics.

### Essential Resistor Values

The phase inverter circuit is really comprised of the essential resistors R8 through R13 in the main circuit diagram. It is the value of these various resistors which determines the effectiveness with which the circuit operates. The most satisfactory manner in which to get the circuit operating properly is to check the amplifier with a constant tone of about 400 cycles on the input, and R12 removed from the circuit. An oscilloscope will usually indicate (assuming that R8 and R9 are the same and that R10 and R11 are the same value) about 20 per cent. more voltage from the grid of the top 2A3 (in the diagram) to ground than from grid-to-ground on the other tube. For exact balance in the circuit it is necessary that R10 (or the parallel combination of R10 and R12) be somewhat lower in resistance than R11. The exact value for these two resistors can be determined mathematically, but the normal tolerance in resistors is great enough so that the adjustment is best made experimentally. In fact it is only necessary to place different values of resistance at R12, continually checking the ratio of the two 2A3 grid-to-ground voltages with an oscilloscope, until an exact balance is obtained.

### Practical Examples

In two of the amplifiers built following this circuit diagram the values for the three resistors given in the

(Continued on next page)

## FOR CERTAIN SATISFACTION

No piece of equipment is better than the valves it uses . . . no one can afford to take the risk of breakdowns or unreliability. That is why every set-builder should —

### SPECIFY and INSIST on MULLARD VALVES

Mullard Valves have that extra reserve of efficiency and dependability that has made the name of Mullard a household word wherever the British flag flies.

FOR ANY PURPOSE THERE NEVER HAS BEEN A BETTER VALVE THAN MULLARD

MULLARD-AUSTRALIA PTY. LTD.  
367-371 Kent Street, Sydney, N.S.W.  
Telephone - - - - MJ 4688

# Mullard

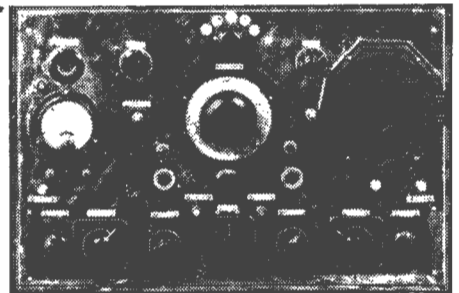

For the latest Signal Tracer described in this issue, Mullard valves are specially recommended. Types required are: 2—6K7G, 1—6B6G, 1—6E5, 1—6V6G, 1—76 and 1—80.



## FIDELITY AMPLIFIER

(Continued from page 13)

caption to the wiring diagram were found to give equal voltages (resistors R10, R11, R12). But in the amplifier shown in the photograph the use of the additional resistor was eliminated by using selected "250,000-ohm" resistors for R10 and R11. By using a so-called ¼-meg. resistor at R10 that was somewhat low and another ¼-meg. at R11 that was somewhat high it was possible to obtain an exact balance. But unless one has quite a selection of resistors the additional resistor R12 is the simplest way of obtaining a balance.

## Degenerative Feedback

Although degenerative feedback is not generally used with triode push-pull class A amplifiers, it was decided to incorporate some feedback into this amplifier to see what benefits would be obtained. The results have been quite satisfactory. It was possible to use about 10 db of feedback with the circuit, shown in the main diagram. Hum, tube noises and distortion within the feedback loop were reduced by the amount that would be expected with this amount of degeneration.

However, a considerable amount of difficulty was experienced in determining a feedback circuit that could be used with a circuit arrangement of

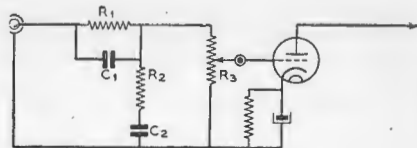

Equaliser circuit for high-frequency compensation and bass boost.

R1—500,000 ohms, ½ watt; R2—100,000 ohms, ½ watt; R3—500,000-ohm potentiometer; C1—.0005-mfd.; C2—.003-mfd.

this type. At first it was thought that it would be possible to use a dual cathode tube for the phase inverter. But no dual cathode tube (which would allow the use of the feedback to the cathode of the first section of the phase inverter) was available which would deliver sufficient peak voltage output to excite the grids of the 2A3's. So it became necessary to return the feedback energy ahead of the phase inverter. Feedback was at first attempted in the cathode of the 6J5 first amplifier. This proved unsatisfactory; there was too much phase shift throughout the amplifier and output transformer and instability resulted.

### Input Voltage Required

The feedback circuit that did prove satisfactory is the one shown in the amplifier circuit diagram. Voltage is returned from a high-impedance tap on the output transformer to the decoupling condenser in the 6J5 plate feed circuit. If a sufficiently high impedance tap is available on the output transformer it will be possible to use 10 db of feedback with this circuit with perfect stability. With this amount of degenerative feedback in the amplifier the amount of input voltage required on the grid of the 6J5 (about ¾ volt peak) is a little more than three times that required without feedback—for full output from the 2A3's. With this amount of feedback in the amplifier it is substantially flat in response, within 2 db, from 20 to 20,000 cycles and the waveform is perfect over this range. The response is down about 3 db at 16 cycles, but the waveform is still very good.

### Phasing the Feedback

Naturally, as is the case with all feedback circuits, the voltage that is returned must be of the proper phase for degeneration. But we have the advantage in determining the proper polarity that it is a go or no go proposition. If the polarity is incorrect a violent oscillation will be set up in the amplifier. In this particular circuit arrangement it will then be necessary to ground the other end of the output transformer secondary winding, and then take the feedback voltage from the end of the winding which was previously grounded. If



# WHAT ARE

# Metallized

# RESISTORS?





**This Type BT Resistor** is an example of the homogeneous "Metallized" resistance material bonded to the outer surface of a sturdy glass tube and enclosed in a protective covering.

**Voltages up to 100,000 or 100 watts (and greater)** are made possible in the new Type MV High Voltage Resistors by a spiraling of "Metallized" resistance element on a ceramic base.

**In IRC Type MP High Frequency Power Resistors**, the "Metallized" element is applied solidly over ceramic surface. Excellent characteristics at ultra-high frequencies of more than 75 megacycles.

"Metallized" Resistors differ from conventional units in that a homogeneous film of high resistance material is applied and bonded at high temperatures to insulating bases of various types. The result of this process is a resistance element of predetermined resistance value and accuracy. This process, time-tested throughout years, has been utilized and perfected for seven distinctive types of resistors each one internationally known for its exceptional quality.

As an outstanding example, the IRC type BT insulated resistors, comprising the unique "Metallized" filament element and specially developed insulating phenolic covering, have humidity characteristics hitherto unobtainable. More than 10 cycles of alternate two-hour immersions in 100deg.C. and 0deg.C. salt solution followed by two-hour loadings at normal rating result in an average change in resistance value of less than 10%. The inherent characteristics of "Metallized" Resistors are stability, low noise level, uniformity, non-ageing, low voltage, and temperature coefficient and freedom from major humidity effects. No other type of resistance material holds such an outstanding record of success. None holds such broad possibilities for future development.

SOLE AGENTS FOR AUSTRALIA: **Wm. J. McLELLAN & CO.** PHONE BW 2385

BRADBURY HOUSE, 55 YORK STREET, SYDNEY

this procedure would be inconvenient (due to a tapped voice coil output transformer) the two primary leads that go to the plates of the 6A3's or 2A3's should be reversed.

### Power Supply

A pair of 2A3's, 6A3's, 6B4G's, or 6A5G's, are rated at a plate voltage of 300 to 325 volts and a plate current of 80 ma. The 2A3 filaments require a 2½-volt supply at about 5 amperes, while the other three types require a 6.3-volt supply at about 2 amperes. From this data it can be seen that that any small b.c.l.-type power transformer capable of about 100 ma. drain with 350 to 375 volts each side of centre on the high voltage winding will be capable of handling the amplifier. If the transformer is a 2½-volt one 2A3's can be used, with a 53 phase inverter and a 56 or triode 57 as the first amplifier. Or a small 6.3-volt filament transformer may be used to supply the first amplifier and the phase inverter while running the 2A3 filaments from the power transformer.

Of the three amplifiers so far constructed, all have operated identically with the exception of the power output and the extreme low frequency response. The one with the largest output transformer went lowest in frequency—as would naturally be expected—and the one with the highest plate supply voltage delivered the greatest power output. The three tested had actual plate supply voltages of 330 volts—power output 7 watts, 365 volts—power output 9 watts, and 400 volts—power output 11 watts. It will be noted that these power output figures are slightly lower than would be expected from reference to the published tube characteristics. This discrepancy is due to the fact that the power output was actually measured at the voice coil winding of the output transformer so that the insertion loss in the transformer was subtracted from the actual power output at the plates of the valves. Published valve data gives the power output at the plates of the valves, not at the secondary of the output transformer.

### Pick-up Equalisation Circuits

Since phonograph records are not flat in frequency response, that is, they are not cut either constant amplitude or constant velocity throughout their range, it is necessary to equalise the phonograph pickup if substantially flat frequency response is desired. Records are cut constant amplitude up to a crossover frequency (from 200 to 1000 cycles, depending upon the manufacturer and upon the date when the record was recorded) and substantially constant velocity above that point. Since a crystal pick-up has a voltage output dependent

### Motor Speed

Even the best of amplifiers will be spoiled if the turntable speed is not exactly 78 revolutions per minute. A regular check should be made, preferably with a stroboscopic speed tester.

These are available from our Back Number Department at 6d. each, post free.

upon the amplitude of displacement, its response will be satisfactory on the low frequencies but it will have to have an equaliser which will build up the high frequency response. A magnetic pick-up, in which the output voltage is dependent upon the velocity of displacement, will have to be equalised so that its low frequency

response is built up. The point at which this equalisation should begin to take place is dependent upon the crossover point used in making the recording.

The input condenser and resistor R1-C1 in the main circuit diagram serves to equalise the high frequency response of the conventional crystal pick-up, using 750 cycles as the average crossover frequency. The additional small circuit diagram is for bass boost when using a crystal pick-up, with high frequency compensation, or this input circuit can be used with a magnetic pick-up to obtain the low frequency equalisation required. When using a magnetic pick-up the small condenser C1 may be removed if too much record scratch is apparent.

“University”

## SUPERTESTER

★  
The very latest in Valve and Circuit Testers



★  
Write for free test equipment catalogue

### RADIO EQUIPMENT PTY. LTD.

E. S. & A. BANK BUILDINGS, BROADWAY

Telephone: M 6391 and M 6392

Telegrams: RAQUIP, Sydney

Leading Distributors in all States

J. H. MAGRATH, Melbourne  
HEALINGS PTY. LTD., Melbourne

HEALINGS PTY. LTD., Melbourne  
HOMECRAFT PTY. LTD., Brisbane  
FOX & MACGILLYCUDDY LTD., Sydney

# ★ TEST BENCH ARRANGEMENT ★

This article from Mr. Brown, winner of our recent Battery Circuit Contest, gives a rough idea of a practical layout for a test bench to speed-up service work

I AM enclosing photographs taken some little time ago of my service bench.

I have an A.W.A. signal generator with a Stromberg-Carlson as standby and check. The meter above the generator is an output meter, and a 10-inch permagnetic Amplion speaker is behind the grille.

The panel immediately to the left is a Palec universal checker with Palec valve tester on the right-hand side.

Immediately below the generator is the main switch panel. Three loose terminals on the left-hand side are for

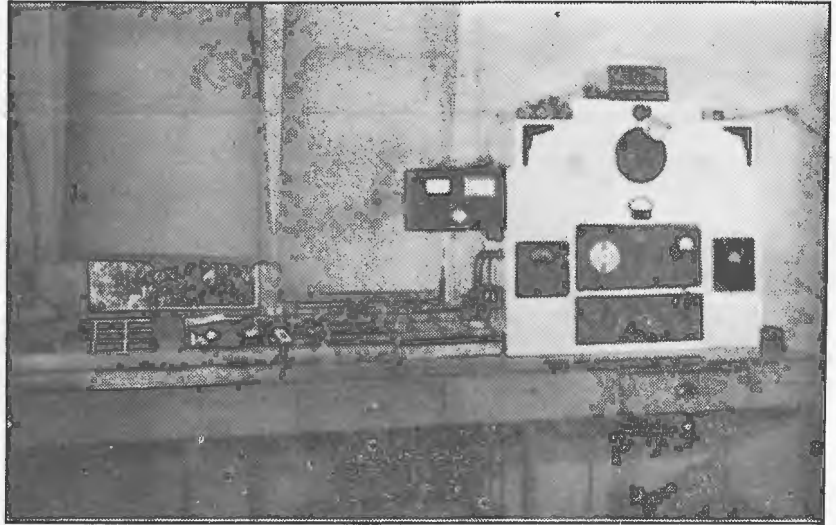

A photograph of the test bench arrangement as used by Mr. Brown at Taree.

By —

**R. Brown**  
82 Victoria Street, Taree

loose speaker leads, and below same is a male plug, as used in newest A.W.A. products.

Then, working from left, we have the A.C. switch of rectifier for the output meter and switch for the meter itself; then one 4-pin and one 5-pin socket (5-pin wired for centre-tap), and have some 30 cables which adapt these sockets to almost every commercial set on the market. Immediately above we have the field switch, in steps, to give 750; 1,000, 1,500, 2,000, 2,500 and 7,500 ohms. Then we have an externally-mounted 4-pin sprung socket with a toggle switch alongside for those A.C. models which link field to speaker input and earth the fourth pin.

Below this we have the speaker load switch, 5,000 to 20,000 ohms, all centre tapped. All plugs and terminals are controlled by the field and load switches.

Then we have the generator output switch. First position being in constant dummy (i.e., broadcast or short-wave alignment without change). Second position gives a .5 mfd. condenser for I.F. alignment with toggle above, so that when instability is noticed through A.V.C., etc., on the converter, the grid cap can be removed and bias return is then completed by the toggle just mentioned. Third position brings in an outside antennae.

The board is completed by two terminals which bring out the generator leads after switching.

To left and low down beside the board is the battery terminal board, and the three meters above are, from left, amp. meter in circuit of board below constantly. Small middle meter is a milliammeter also in circuit constantly, so that high drain or leaky coupling condensers are apparent as soon as the receiver is switched on.

The third meter is 0-1 milliammeter used for grid current check only. This may sound unnecessary, but it frequently happens that all meters are in use at one time.

The third meter is 0-1 milliammeter

We have sundry other items, such as vibrator testers, etc., under way, but am afraid they will not be finished now. Also have meter for line voltage check.

## ALL-WAVE ALL-WORLD DX CLUB

### Application for Membership



The Secretary,  
All-Wave All-World DX Club,  
117 Reservoir Street, Sydney, N.S.W.  
Dear Sir,

I am very interested in dxing, and am keen to join your Club.

Name .....

Address .....

(Please print both plainly)

My set is a .....

I enclose herewith the Life Membership fee of 3/6 (Postal Notes or Money Order), for which I will receive, post free, a Club Badge and a Membership Certificate showing my Official Club Number.

(Signed) .....

(Readers who do not want to mutilate their copies can write out the details required.)



## CONTEMPT FOR TOKYO PROPAGANDA

Axis propaganda, and particularly Japanese propaganda broadcasts, have been so inaccurate and psychologically misplaced that they have had no material effect upon the Australian people. This is apart from the work of rumour-mongers whose irresponsibility serves as a virtual fifth column for the enemy. These conclusions have been reached after a close review for several months by the Department of Information listening post. The Australian propaganda outlook is not to be defensive and the Japanese themselves are to be put on the defensive in the field of propaganda. The Minister for Information (Senator Ashley) has announced that this is to be done by broadcasts in English inside Australia and broadcasts in Japanese to Japan and Japanese-occupied territories giving the truth about the "gangster code" of Japanese diplomacy and militarism in its attempted world domination. Plans devised some time ago will be put into operation to "give the Lord How-Haw's of Tokyo something real to think and worry about." In this plan all the facilities of the Department will be employed and, in addition, the co-operation of the Press and broadcasting stations will be enlisted to give Australians a clear understanding of the true Japanese mentality, and to arouse Australians more fully to the offensive spirit. "Meanwhile," states the Minister, "those people who do listen to Japanese broadcasts can afford to treat them with the contempt that lying and exaggerated propaganda deserves, but those who continue to try and use Japanese broadcasts on which to base disturbing rumours should be dealt with ruthlessly by those to whom they pass on their rumours. The Australian people can always take the truth and our campaign to expose the enemy as he really is will be based on truth. There will be no need to exaggerate or caricature it."

### USE A GOOD AERIAL

Even the best of sets will be improved by the use of an efficient aerial. Many modern sets will give a certain amount of satisfaction with a piece of wire strung up around the picture rail, but for the most reliable reception, with clean reproduction, an outside aerial should be used.



Wireless alone can  
meet the exacting  
needs of communication  
for Mobile Units...

**INSTANT \* CONSTANT  
CERTAIN**

AUSTRALIAN-MADE

**RADIOTRON**

RADIO VALVES

\* STANDARD TO ARMY TRANSMITTERS & RECEIVERS

# MOLECULES, ATOMS & ELECTRONS

THE story of radio is the story of the electron, which can be regarded as a tiny charge of electricity. Once it was thought that the smallest thing imaginable was the atom, but we now know that it is not indivisible; that, in fact, it consists of a group of even smaller things. These are known as protons and electrons.

It is very difficult for the human mind to grasp the significance of very small dimensions, just as hard as it is for it to grapple with colossal measurements such as billions of miles. However, perhaps a few similes will help.

### Atoms and Molecules

Anything at all—solid, liquid, or gas—is comprised of molecules, which in turn are made up of atoms. A grain of sand, for example, is made up of molecules, and if it could be magnified billions upon billions of times, it might look like a huge mountain of tennis balls, each ball being a molecule, consisting of a combination of atoms. Yet an atom is an assembly of even more diminutive things—of protons and electrons.

In the centre there is a nucleus, or core, consisting of protons, which carry positive charges of electricity, and electrons, which are tiny negative charges. The protons predominate, so the nature of the nucleus is positive.

Comparatively widely separated from the nucleus, and revolving round it as the planets do round the sun, are more electrons. These are more or less free agents, and when something happens to cause one or more of them to leave the nucleus, electrical activity becomes evident.

Normally an atom is neutral, and the total number of electrons equals that of the protons. It is only when the balance is upset that the atom as a whole becomes charged positively or negatively. If electrons leave an atom, it becomes positively charged because the protons then outnumber the electrons. If new electrons are gained by the atom, it becomes negatively charged, because the electrons are then in the majority.

### How Different Elements Are Made Up

The simplest atom is that of hydrogen, which has one proton in the nucleus and a single electron revolving

⊖ ELECTRONS ⊕ PROTONS

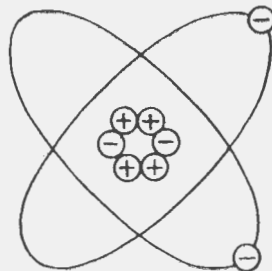

FIG. 1

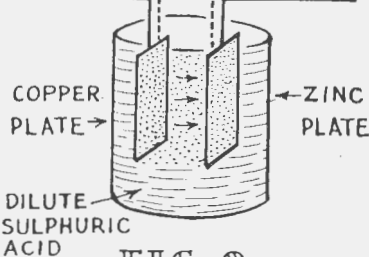
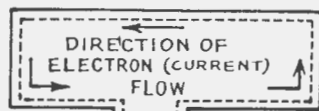

FIG. 2

ing round it. Next comes helium, the second lightest atom, which has four protons and two electrons for a core, and another two electrons as satellites, as shown in Fig. 1.

There are 92 elements in all, and these in combination with one another give thousands of different compounds. For example, two atoms of hydrogen will combine with one of oxygen to give a molecule of water.

For the present, though, we are more interested in the electron, and the way in which different substances behave as carriers of electricity.

### Conductors and Insulators

With some materials it is an easy matter to persuade electrons to leave

Unobtainable in most places, but we can supply 1A7GT, 1A5GT, 1P5GT, 2A3, ...A3, 6L77G, 6L6G, 6N7, KT66, EK2P valves, and dozens of other types. Also hard-to-obtain odd type Valves, Transformers, Condensers, Dial Glasses, etc., both new and used. Write to us to-day for anything in Radio. DENHAM'S RADIO SERVICE, Queensland's Premier Radio Distributors, Box 145, P.O., Maryborough, Queensland.

SAVE MONEY  
WITH A  
**SUBSCRIPTION!**  
Order Yours To-Day

Make sure you get every issue as soon as it is published. Place an order with your newsagent or send direct to us for a subscription.

IT SAVES YOU TIME!  
IT SAVES YOU MONEY!

We guarantee that every subscriber has his copy posted the same day it comes off the press.

**SPECIAL RATES**

- ★ 6 issues ... 5/3
- ★ 12 issues ... 10/6
- ★ 24 issues ... 20/-

**POST FREE**

Enclosed please find remittance for 10/6 in payment for an annual subscription

to the "Australasian Radio World," commencing with the ..... issue.

NAME .....

STREET and NUMBER .....

CITY ..... STATE .....

**THE AUSTRALASIAN RADIO WORLD**  
117 RESERVOIR STREET, SYDNEY

their parent atoms; such substances are known as conductors. The metals copper, silver, and gold are good examples.

For instance, if the terminals of a battery are joined by a length of copper wire, then, under the influence of the electric field that is set up, the electrons within the conductor will drift from atom to atom towards the positive pole of the battery. This drift constitutes an electric current.

As electrons enter the conductor at one end, others leave in equal numbers at the opposite end, so that the conductor itself neither gains nor loses any electricity. When the circuit is broken, the electrons simply stop moving and remain where they are.

The strength of the current is represented by the number of electrons passing a given point in one second, and this depends on the strength of the electric field causing the electron flow and on the material forming the conductor. For instance, if a rubber strap were used in place of the wire, there would be no current, or if there were it would be infinitesimal. Substances of this nature include porcelain, glass and mica, and all are known as insulators.

To summarise, then, we know that all solids, liquids, and gases are made up of molecules. These in turn can be split up into atoms, which can again be sub-divided into protons and electrons. Normally all atoms are neutral, but when they gain or lose electrons they become negatively or positively charged, as the case may be, and there is electrical activity. Electrons in motion constitute an electric current.

#### Direction of Current Flow

To a beginner, the direction in which current really flows is sometimes difficult to understand. This is because early research workers, not knowing the real nature of electricity, arbitrarily labelled the direction of current flow as being from positive to negative. Actually, electrons always flow in an external circuit in the opposite way, i.e., from negative to positive, and this is the direction of current flow.

#### How Electricity Is Generated

There are many ways of generating electricity, but only the simplest of them will be considered now.

If a plate of zinc and another of copper are immersed in a dilute solution of sulphuric acid, what is known as a primary cell is formed. When the two plates are connected by a copper wire, a current will flow through it.

The acid attacks the copper, robbing its atoms of some of their electrons, which then pass to the zinc

plate. The copper plate, to make up its electron deficiency, borrows some from the connecting wire, which in turn takes some from the zinc. Thus there is a constant flow of electrons from the copper to zinc within the solution, and from zinc to copper through the connecting wire. This current flow which takes place in a simple electric cell is illustrated in Fig. 2.

The secondary cell, or accumulator as it is more commonly known, works a little differently. Here it is necessary to apply electricity in the first place in order to get it back later. In other words, an accumulator is merely a reservoir for electrical energy. It depends for its action on a rather complicated chemical change, which need not be explained here. Sufficient to say that, unlike a primary cell, an accumulator is rechargeable and, also, a heavier current can be safely taken from it than from a dry cell.

#### The Dry Cell

Battery-operated radios usually derive their power from primary cells, or dry batteries as they are commonly called.

A dry cell is not really dry — if it were it wouldn't work, as the moisture contained in the active paste within the cell is essential to its operation. This is why all dry batteries should be kept in a cool spot in order to obtain the longest service from them.

Fig. 3 shows the internal construction of a dry cell. The outer case is of zinc, which forms the negative pole. Next, comes a lining of the active material, which is generally a paste of sal-ammoniac and plaster-of-Paris or gelatine.

In the centre of the cell is a rod of carbon (the positive pole) and this is separated from the sal-ammoniac by a layer of manganese dioxide, which prevents a chemical action taking place that would impede the efficient working of the cell.

When fresh, the voltage of a cell of this type is a little over  $1\frac{1}{2}$  volts. By connecting two such cells so that the positive terminal of one is joined to the negative terminal of the other, the voltage between the two free terminals would be double that of a single cell. With three cells so connected, the total voltage would be three times that of one and so on. This is illustrated in Fig. 4, which also shows the theoretical symbol used in radio diagrams to represent a battery of any kind. The short heavy stroke denotes the negative terminal, and the thin long one the positive.

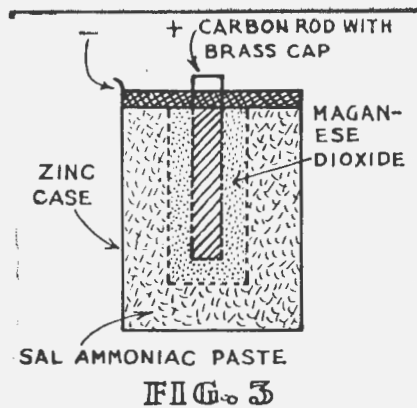

FIG. 3

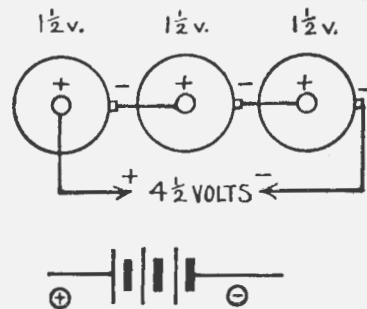

FIG. 4

"B" battery units are made up from dozens of these small cells linked in series. A 45-volt B battery consists of 30 such cells, and a 108-volt unit of 72.

#### Alternating Current

The current generated by any kind of battery flows in one direction only, and so is called direct current. In some areas in Australia and New Zealand direct current (D.C. for short) is also supplied for domestic use, but generally alternating current is provided.

This type of current will be explained more fully in a later issue, but briefly it is so named because it reverses its direction many times a second.

Next Month: Volts, Amperes, and Ohms.

A full range of all types of new and used Radio Test Equipment, including Oscilloscopes, Oscillators, Multimeters, V.T.V. Meters, Valve Testers, odd Meters, etc. We trade in and buy all types of Test Equipment. DENHAM'S RADIO SERVICE, Box 145, Maryborough, Queensland.

# Shortwave Review

CONDUCTED BY

L. J. KEAST

## NOTES FROM MY DIARY

When my identification card arrives it should bear my address as: 23 Honiton Avenue, W. Carlingford. I chose this locality for many reasons, and, despite warnings from my short-wave friends that this was the worst district in or around Sydney for cross modulation, etc., etc., I relied on the good offices of my car radio, and here I am. I figure that when I get settled this little bit of the world will compare favourably with Queensland and New Zealand for my little hobby.

So far, a very modest areal, about 25 feet long by as many feet high, of the inverted "L" type, suffices, but maybe one of these days there will be a busy bee, and the sky and the acreage of the property will be the limit.

So, kind friends, please address loggings and notes to me here.

The past month has been most interesting for the number of "off-the-band" signals that have appeared. It would be unwise to list them all, as so many are only tests, and doubtless we will discover pretty soon the channel that has been chosen. The fact that so many are anxious to find the best avenues for contact with Australia assures us of some more, and perhaps better, continuity.

### What's In a Name?

German and Italian stations broadcasting "news" are labelled by one American short-wave magazine as "The Liars' Club," and the same paper gives the Japanese the delightful appellation of "The Dagger-in-the-backs."

### Los Angeles

My reference to Los Angeles Press Wireless in March issue was timely, as long before the edition had reached Queensland, the "Malanda S.W. Tiger," friend Perkins, had logged them and, with commendable thoughtfulness, air-mailed them to me.

Another who happens on the new or unusual is that doyen of the wireless, Dr. Gaden, and if he sent a letter by ordinary mail I would expect it to contain an invoice.

I am grateful for his information re KEQ, Honolulu.

Dr. Gaden, in referring to a verification from All India Radio regarding a report on VUD-3, 19.62m, mentions their signature tune is played on a violin and 12 sitars. A sitar is an Indian stringed instrument.

## HELP WANTED

★

Mr. Perkins, of Malanda, says: "Here's one that has me completely buffaloed. Their call is **UKK** and they operate on approximately 50.5 metres. Heard on March 12 at 7.25 a.m. (6.25 a.m. A.S.T.), testing on high power, playing such records as Tom Jones and Orchestra in 'In the Shadows'; Jeanette MacDonald singing 'Sweet Mystery of Life,' and 'If I Should Fall in Love Again' played by an orchestra.

London now gives news in no fewer than twenty-seven languages and, with nearly forty outlets, they doubtless reach the four corners of the globe.

One of the best signals on the air in the evenings is **XGRS**, Shanghai, 11,675kc, 25.77m, the news read by David Lester at 8.45 p.m. being very easy to copy.

Roy Hallett reminds me that London has a technical session for beginners at 11.30 p.m. on each alternate Tuesday. The next will be on April 7. He has also sent me full programme schedules of the All India Radio stations, but pressure on space makes it impossible to print it in this issue.

## THE OHM

If anybody wants to know what an ohm is, the usual answer is to say that it is the unit of resistance; that it is the amount of resistance through which a current of an ampere will be forced by a pressure of one volt. Which, after all, is what most radio men want to know when they ask.

But actually the ohm is a unit of resistance, and if you really want to make yourself up a resistance of one ohm you can do so without an ohmmeter or using Ohm's Law in any way.

An ohm of resistance should be equal to the resistance offered by a column of mercury 106 centimetres long, with a cross-section area of a square millimetre, at the temperature of melting ice.

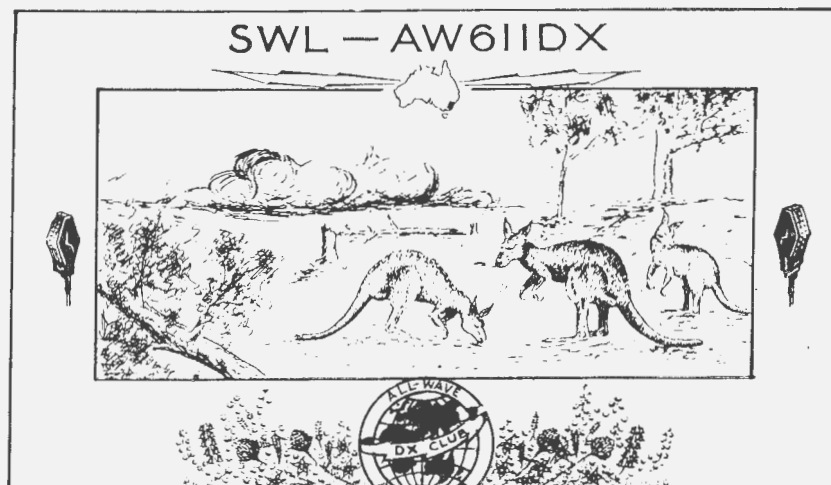

JACK HORN, of 23 Kier Avenue, Hurlstone Park, is a keen member of our DX Club. He has produced postcards for himself as shown above. This was done by getting a friend to do the drawing and then having a negative made from it by Kodak.

## NEW STATIONS

**GRK**, London, 7185kc, 41.75m: Heard in early evening and at 2 a.m.

**GRD**, London, 15,440kc, 19.42m: Another B.B.C. transmitter; first mentioned by Mr. Hugh Perkins. Excellent signal by 9.30 p.m.

**GRM**, London, 7250kc, 41.38m: And still they come. This one is evidently for the African service as it is heard from 1.30 a.m. to 2.15 a.m.

**VLQ-4**, Sydney, 7220kc, 41.55m: Commenced, I think, on March 23, in Transmission 5. Excellent signal at night.

**Indian Freedom Station** 9380kc, 31.90m: Mr. Cushen, of N.Z., sends particulars of this new one. "Heard from 2 to 2.30 a.m. At 2 a.m. News in Hindustani; at 2.15 a.m. announces 'This is Ada Zindabal . . . on 31.9m, and now you hear the News in English, which is given daily at 8.45 p.m. Indian Standard Time.' Station signs at 2.30 a.m." Mr. Cushen says this station is Jap operated for sure.

**KJE-8**, Los Angeles, 9390kc, 31.94m: Mr. Perkins advises hearing this Press Wireless station on March 7 at 11.50 a.m. They were transmitting a test musical programme.

**KJE-9**, Los Angeles, 10,750kc, 27.91m: This one opens at 1 a.m. and is another of Press Wireless Inc., Los Angeles, U.S.A. (Note in both instances I have mentioned Australian Standard Time.—Ed.).

**KTG-3**, Los Angeles, 6920kc, 43.35m: Mr. Byard, of Launceston, heard this one closing at 12.04 a.m. on February 28.

**DXR**, Berlin, 11,760kc, 25.51m: Being heard at 7 a.m. and 5 p.m., according to reports. Seems a favourite frequency, having been used by various countries at intervals.

**Location and Call-sign Unknown**, 9695kc, 30.84m: Heard from 12.30 a.m. to 12.53m. This is an anti-British station using very bad English and purporting to be in Penang, I think. Said at 12.53, when closing, that they were on 28.50m also, but no sign there.

**CR6RA**, Loanda Angola, 9470kc, 31.68m: We have all become familiar with the Portuguese East African station, **CR7BE**, situated in Lourenco Marques. Well, here is a Portuguese **West African**. Heard on Mon., Tues., Wed. and Thurs. from 6.30 a.m. to 7.30 a.m. Signal weak. Dr. Gaden was the first to notify us of this fine catch. (Loanda, or Sao Paulo de Loanda, with a population of 15,000, is a city of Angola, Portuguese West Africa, and capital of the district of the same name.)

**Rome**, 11,945kc, 25.12m: Simply announcing as "This is Rome calling," or, for variation, "You are listening to the Italian Broadcasting Service," a new transmitter has been added to the already formidable array of E.I.A.R. Same programme as **2RO-4**, heard around 5 a.m.

**XGEI**, Kuoming, Free China: Mr. Perkins submits this one as operating on approximately 18.65m. Signal at 11 p.m. was R6-7. Conducting a test transmission, records were played, "When I Grow Too Old to Dream," sung by Nelson Eddy; "Underneath the Spreading Chestnut Tree"; "Whistle While You Work" and "On the Sentimental Side," by Roy Smeck and His Serenaders. By 11.23 p.m. (10.23 A.S.T.) station faded out. At one portion of the programme the announcer said **XGEI** was on the air every Monday evening at 11 p.m.

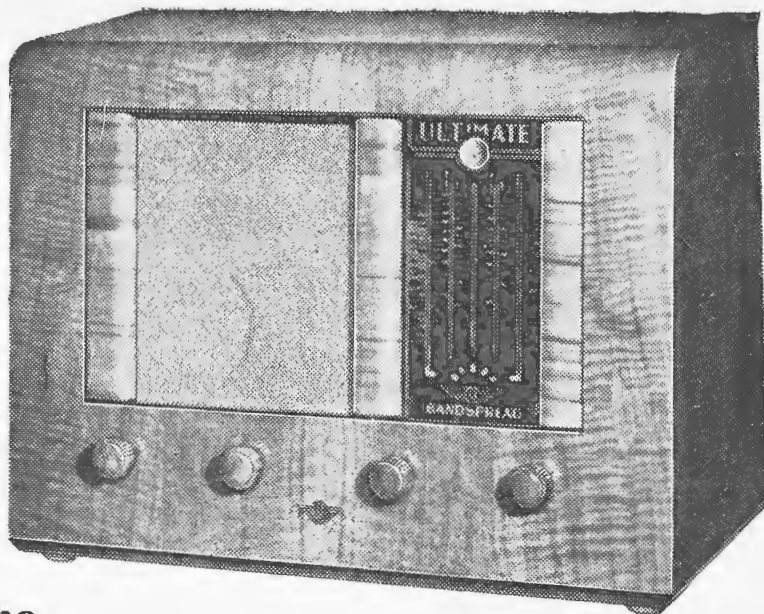

## The New 'ULTIMATE' 7-VALVE A.C. MULTI WAVE Mantel MODEL

Featuring Full Bandsread Short-wave Tuning, Anti-Drift Devices, Automatic Volume Control, Electric Eye, Spinner Tuning, etc., in addition to the improvements that have made "ULTIMATE" outstanding in performance. Special Low Volume Bass Compensation Device gives volume, tone and performance equal to most average Console Models. Specially suited for tropical climates and outback conditions, where reception is usually difficult. Can be fully depended on even under the most adverse conditions — super-plus performance is assured by "ULTIMATE" reputation. Special 8-inch Rola Reproducer. Classic cabinet of beautifully-matched, piano-finished veneers. The only set of its kind obtainable on the Australian market. Investigate the "ULTIMATE" before you make a decision — there is not a better set made; Also obtainable in A.C. Consol, Portable Mantel and Radiogram Models. Comprehensive illustrated literature post free on request.

Cut out this Coupon and post to-day.

GEORGE BROWN & CO. PTY. LTD., 267 Clarence Street, Sydney.

Please send me particulars of "ULTIMATE" Full Bandsread Receivers as advertised in "Australasian Radio World."

NAME .....

ADDRESS ..... R.W

# ULTIMATE

*Champion Radio*

Sole Australian Concessionaires:

GEORGE BROWN & CO. PTY. LTD., 267 Clarence St., Sydney

Victorian Distributors: J. H. MAGRATH PTY. LTD., 208 Little Lonsdale St., Melbourne

# The MONTHLY'S LOGGINGS

ALL TIMES ARE AUSTRALIAN EASTERN STANDARD TIME

Further pressure on space makes it imperative to only record changes or items of outstanding interest. Enemy stations are only briefly referred to.

## AUSTRALIA

- VLQ-8**, Sydney ..... 17,800kc, 16.85m  
Good, to British Isles (Gaden).
- VLQ-3**, Sydney ..... 15,315kc, 19.59m  
Patchy at 3 p.m. (Gaden).
- VLG-6**, Melbourne ..... 15,230kc, 19.69m  
Splendid at 5 p.m. in programme for England (Gaden).
- VLG-7**, Melbourne ..... 15,160kc, 19.79m  
100 per cent. in all its sessions (Gaden).
- VLG-3**, Melbourne ..... 11,710kc, 25.62m  
R max. at 4 p.m.
- VLQ-2**, Sydney ..... 11,870kc, 25.27m  
R max. at 3 p.m., but at 8.45 p.m. may be max. or zero.
- VLQ**, Sydney ..... 9615kc, 31.21m  
R max. at 6.30 p.m.
- VLW**, Wanneroo ..... 9615kc, 31.21m  
Opens at 9 p.m. with B.B.C. News (Perkins).
- VLR**, Melbourne ..... 9580kc, 31.32m  
Programme for England at 5 p.m., excellent (Gaden).
- VLQ-9**, Sydney ..... 7250kc, 41.38m  
R max. at 8.45 p.m.
- VLQ-4**, Sydney ..... 7220kc, 41.55m  
Trans. No. 5. Excellent signal at 9.30 p.m.

## OCEANIA

- Fiji:**
- VPD-2**, Suva ..... 15,160kc, 19.79m  
Schedule: 2 p.m. to 2.30 p.m.  
French session. Excellent strength.

## AFRICA

- Algeria:**
- TPZ**, Algiers ..... 12,120kc, 24.76m  
Heard in afternoons around 5.45.
- TPZ-2**, Algiers ..... 8960kc, 33.48m  
Excellent signal at 5.15 p.m. Gives News in French at 6 p.m.; closes 6.20 p.m.
- Belgian Congo:**
- OPM**, Leopoldville ..... 10,140kc, 29.59m  
Being heard weakly. Asking for reports. Closes at 5.45 a.m. with Belgian National Anthem.
- Egypt:**
- Radio Cairo**, Cairo ..... 5980kc, 50.17m  
Music till 6 a.m. News in English till 6.15 a.m., when same News is given in French. Closes at 6.30 a.m. R5 at 5.55 a.m. (Perkins).
- Ethiopia:**
- , Addis Ababa ..... 9625kc, 31.17m  
From just after midnight till 1.30 a.m.
- French Equatorial Africa:**
- FZI**, Brazzaville ..... 11,965kc, 25.06m  
News in English at 5.45 a.m.  
Heard concluding News in English at 2 p.m. Sunday (Hallett). Heard at 4 p.m. in Free French programme.—Ed.
- Morocco:**
- CNR**, Rabat ..... 8035kc, 37.34m  
4 a.m. to 10 a.m. Best at 5.30.
- Portuguese East Africa:**
- Mozambique:**
- CR7BE**, Lourenco Marques ..... 9840kc, 30.48m  
R6 at 7.35 a.m. (Byard).
- Portuguese West Africa:**
- CR6RA**, Laanda Angola ..... 9470kc, 31.68m  
Monday, Tuesday, Wednesday and Thursday, 5.30 a.m. and 6.30 a.m.

R6 signal but sandwiched between morse and **TAP** at 6.30 a.m. (Perkins).

## Senegal:

- FGR**, Dakar ..... 9410kc, 31.83m  
Heard around 5.15 a.m.

## Transvaal:

- ZRH**, Johannesburg ..... 6007kc, 49.95m  
Schedule: 1.30 a.m. to 7 a.m. News 5.30.  
News in Afrikaans at 5.45 a.m. B.B.C. News at 6.45.

## AMERICA

### Central:

#### Costa Rica:

- TIEMC**, San Jose ..... 11,900kc, 25.21m  
May just be heard after **XGOY** leaves the air.

- TIJMT**, San Jose ..... 11,900kc, 25.21m  
"Radio America Latina." Address: Apartado 849, San Jose.  
Heard well at 9.30 a.m. (Gaden).

#### Nicaragua:

- YNRS**, Managua ..... 8585kc, 34.95m  
"Radio Nicaraguense." Heard about 11 p.m.

#### Panama:

- HP5A**, Panama City ..... 11,700kc, 25.64m  
Good at 4 p.m. (Ferguson).

### North:

#### KGEI, San Francisco

"This is the United States of America broadcasting from the Fairmount Hotel in a round-the-world service." Transmitting on the . . . Various bands are mentioned, to suit the particular hour. Apart from News, some splendid talks are given and some excellent sponsored sessions such as Rudy Vallee and company. Roy Hallett reminds me of "Kraft Musicale" at 11 p.m. on Saturdays and "Time Marches On," Sundays at 4.30 p.m.

15,330kc, 19.57m: News 11 a.m. and 1 p.m. Poor at 10 a.m. but good at 2 p.m. (Gaden).

13,690kc, 21.91m: Opens with News at noon, 1 p.m. and 2.20 p.m. R4 at 2 p.m. (Byard).

7250kc, 41.38m: Opens at 4 p.m. with News. Also News at 5, 6, 7, 9.30, 10.30 p.m., 12.30 a.m. and 1.45 a.m. Excellent at 7 p.m.

6860kc, 43.73m: Opens at 6 with News. News also at 7, 9.30, 10.30 p.m., 12.30 a.m. and 1.45 a.m. News in Chinese at 9.45 p.m.

- WGEA**, Schenectady ..... 15,330kc, 19.57m  
Listen to "March of Time," 7 a.m. to 7.30 a.m. Sundays. Closes at 8.30 a.m. with fair signal.

- WCBX**, New York ..... 15,270kc, 19.64m  
Some nice reception in mornings and still going at 2 p.m. Call was **WCBX**, not **WCRC**. Announcements at 8.30 a.m. (Gaden).

- WLWO**, Cincinnati ..... 15,250kc, 19.67m  
Has long News period at 3 p.m. Announcer says on 19.70m (Hallett). (Also News at 4.15.—Ed.)

- WBOS**, Boston ..... 15,210kc, 19.72m  
News at midnight and 1 a.m.

- KRCA**, San Francisco ..... 9480kc, 31.65m  
Operates from 3.15 p.m. News 4, 5, 6, 7 and 9.30 p.m.

- WRCA**, New York ..... 15,145kc, 19.81m  
This was called a few times and **not WNBI**. Nice signal in a.m. Probably closed about 9.30 a.m. (Gaden).

- KKQ**, Bolinas ..... 11,950kc, 25.11m  
Heard at 4 p.m. when News from Fairmount Hotel is given.

- WBOS**, Boston ..... 11,870kc, 25.27m  
Good at 9 a.m. in News. "Command Performance" at 9.15 a.m. on Mondays (Hallett).

- WBOS** ..... 25.26m  
Heard well at 9-9.30 a.m. in English (Gaden).

- WCRC**, New York ..... 11,830kc, 25.36m  
Irregular, but heard occasionally about 5 a.m.

- WRUL**, Boston ..... 11,790kc, 25.45m  
Excellent signal every morning. News by Volney Hurd, "Christian Science Monitor," at 7 a.m. Special session for Australia on Tuesdays, Thursdays and Saturdays at 7.15 a.m. Closes at 8.25 a.m.

- WRUL**, Boston ..... 11,730kc, 25.58m  
Good up till 9.45 a.m. in English, but not as good as **WLWO** (Gaden). Opens 8.35 a.m.

- WLWO**, Cincinnati ..... 11,710kc, 25.62m  
Opens nicely at 8.30 a.m., closes 9.45 a.m. (Gaden). Opens again on 31.28 at 10 a.m.—Ed.

- KJE-9**, Los Angeles ..... 10,750kc, 27.90m  
Opens about 1 a.m. (Perkins).

- WRUW**, Boston ..... 9700kc, 30.93m  
Opens at 6.50 a.m.

- WRCA**, New York ..... 9670kc, 31.02m  
8 a.m. to 7 p.m. News 4 p.m. and 6.45 p.m.

- WLWO**, Cincinnati ..... 9590kc, 31.28m  
News at 10 a.m. O.K. (Gaden).

- WGEO**, Schenectady ..... 9530kc, 31.48m  
Only fair in mornings.

- KJE-8**, Los Angeles ..... 9390kc, 31.94m  
Heard transmitting test programme with R7 signal at midnight (Perkins).

- KEQ**, Honolulu ..... 7370kc, 40.70m  
Irregularly heard around 10 p.m. talking to U.S.A.

- KTG-3**, Los Angeles ..... 6920kc, 43.35m  
Heard closing on February 28 at 12.04 a.m. Gave location and frequency; said would return to air in one hour on 1750kc (Byard).

### Mexico:

- XEQQ**, Mexico City ..... 9680kc, 30.99m  
Fair just after midnight. Best at 3 p.m.

- XEWV**, Mexico City ..... 9503kc, 31.57m  
Good in afternoon and at 11 p.m.

### South:

#### Brazil:

- PRE-9**, Fortaleza ..... 6105kc, 49.14m  
Reported being heard around about 6 a.m.

- PRA-8**, Pernambuco ..... 6010kc, 49.92m  
Heard at 5.30 a.m.

#### Chile:

- CB-1180**, Santiago ..... 11,975kc, 25.05m  
Heard of good strength at 2.30 p.m. in languages, etc. (Gaden). Splendid at 9.30 p.m.

### Ecuador:

- HCJB**, Quito ..... 12,460kc, 24.08m  
Heard at terrific strength on March 9 at 9 a.m. in Spanish. On March 23 at 9.25 a.m., heard Russian. At 9.30 a.m., "You have been listening, etc., to a broadcast in the Russian language for Argentine from **HCJB**, Quito, the capital of Ecuador, in South America." Then English session—religious talks and music till 10 a.m. At 10 a.m. takes relay of News from **WBOS** (Gaden). (Note.—Times will now be 8.30 to 9.15 a.m., and I think this is only a Monday session.—Ed.)

### Peru:

- OAX4J**, Lima ..... 9340kc, 32.12m  
Nightly at 11 p.m., Sundays at 2 p.m.

## THE EAST

### China:

- XGOX**, Chungking ..... 15,200kc, 19.74m  
Special session for England from 7.30 p.m. till about 8 p.m. Heard calling **KRCA** at 9 a.m. (Gaden).

**FFZ, Shanghai** ..... 12,068kc, 24.86m  
Gives News in Russian at 8.30 p.m. Better signal lately.

**XIRS, Shanghai** ..... 11,980kc, 25.02m  
Consistently good nightly.

**XGOY, Chungking** ..... 11,925kc, 25.16m  
Australian session from 8.15 p.m. (Ferguson).

**XMHA, Shanghai** ..... 11,855kc, 25.3m  
Announces on air at 9 a.m., but cannot hear him (Gaden). This Jap-controlled hear him (Gaden). This Jap-controlled station, "Call of the Orient," gives ads. every fifteen minutes (O'Brien). (Very difficult to hear when the German is going full blast on **DJP**.—Ed.)

**XGRS, Shanghai** ..... 11,675kc, 25.7m  
Gets badly mauled some nights, but is O.K. at 8.15 a.m. in "Daily Dozen." News at 8.45 a.m. (Gaden, Hallett). (Very good signal at 8.30 p.m. on April 4 and News heard well at 8.45.—Ed.)

**XGOA, Chungking** ..... 9720kc, 30.86m  
English News at midnight.

**XGOI, Shanghai** ..... 9665kc, 31.04m  
At 10.10 p.m., announcement: "This is **XGOI**, the Voice of Shanghai." English News 10.13 p.m., Dutch 10.35, French 10.45 (Perkins).

**JTHK, Hongkong** ..... 9525kc, 31.49m  
Heard nightly. Under Jap control (Perkins).

**XGOY, Chungking** ..... 5950kc, 50.42m  
News at 11.30 p.m. Calls U.S.A. at 1 a.m. (Cushen). Good at 6 a.m.

**Portuguese China:**

**CR8AA, Macao** ..... 6250kc, 48.00m  
R5 at 10.15 p.m. (Byard).

**Dutch East Indies:**

**YDC, Bandoeng** ..... 15,150kc, 19.81m  
Heard going off the air on March 7 with the words, "This is Radio Bandoeng closing down. God save the Queen! Good-bye everyone until better times come" (Ferguson).

**Caroline Islands:**

..... 11,740kc, 25.55m  
This Jap-controlled station, according to one of our contemporaries, is located in Palao, Caroline Islands, and uses 10 k.w. of power, hence excellent signal.

..... 9565kc, 31.37m  
Also said to be in Caroline Islands.

**French Indo-China:**

**Radio Saigon** ..... 11,780kc, 25.47m  
Back on the old love.—Ed. News 8.15 and 9.15 p.m. (Cushen).

**India:**

**VUD-3, Delhi** ..... 15,290kc, 19.62m  
News gives News at 6 p.m. Heard well at 6.30 p.m. (Gaden). According to reports, is on air at 9 a.m., but doubtful if able to hear in Sydney.—Ed.

**VUD-4, Delhi** ..... 11,830kc, 25.36m  
In view of terrific interest in the East, News 10.30 p.m.

**VUD-2, Delhi** ..... 9590kc, 31.28m  
Probably a better signal than **VUD-4**. News 10.30 p.m. and 1 a.m.

**Indian Freedom Station** ..... 9380kc, 31.98m  
1 to 1.30 a.m. (Cushen). (See "New Stations.")

**VUD-2, Delhi** ..... 6130kc, 48.94m  
Opens up at 11.15 p.m. News heard here also at 1.50 a.m.

**Japan:**

**JLU-4, Tokyo** ..... 17,790kc, 16.86m  
Can be heard at 9 a.m.

**JZK, Tokyo** ..... 15,160kc, 19.79m

**JZJ, Tokyo** ..... 11,800kc, 25.42m  
One of the loudest stations on the air.

**JZI, Tokyo** ..... 9530kc, 31.46m  
Gives News at 4.30 p.m.

**JVW, Tokyo** ..... 7257kc, 41.34m  
Announced on March 29, "As from April 1, **JVW** will be discontinued, and programme will be heard on **JZK**, 19.79m."

# THE YEARS AHEAD

Who the future may hold for Australia no one can say. That victory will eventually be ours no one can deny, but in the meantime the way may be fraught with great hardship and peril . . . . .

During these troublous times, therefore, it is the duty of every citizen, every business, to "carry on" . . . a slogan that John Martin Pty. Ltd. is determined to observe to the letter as long as it is humanly possible to do so. The public can, therefore, rely on a continuation of that value and service that has so firmly established the name and reputation of "The Friendly Wholesale House."

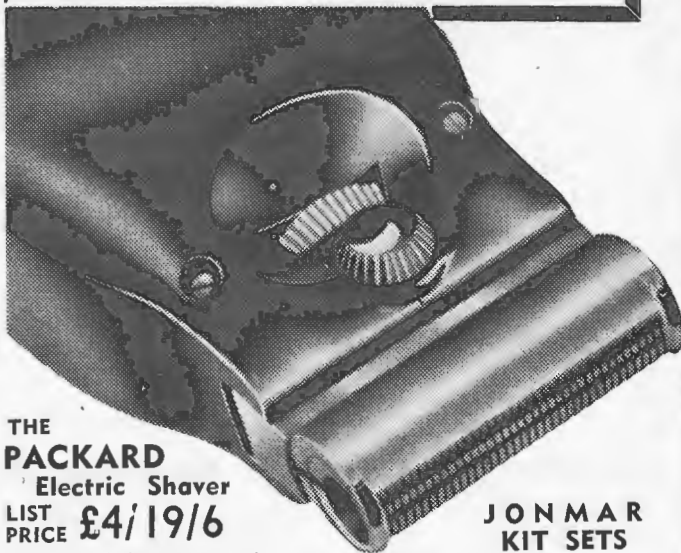

**THE PACKARD**  
Electric Shaver  
LIST PRICE £4/19/6

**JONMAR KIT SETS**

Now that blades are so hard to get, buy a **PACKARD** Electric Shaver. As safe to use as a telephone, it gives quick, clean shaves in half the time. The ultimate in shaving luxury, more than a million Packards have already been sold. And the price, including step-down transformer or special portable six-volt battery, is only £4/19/6. Order to-day while stocks are still available.

You save time, money and disappointment by using Australia's finest — the **JONMAR** Kitset. All components, and only the best branded types are used, are carefully tested before packing, and every Kitset is fully complete. You'll find a Jonmar Kitset takes all the "bugs" out of construction — and the prices are the lowest in the State, too! Note: John Martin's technical experts are always glad to advise you on any constructional problem.

**JOHN MARTIN** PTY LTD  
RADIO & ELECTRICAL SUPPLIES

116-118 CLARENCE STREET, SYDNEY

**JLG-4** ..... 15,105kc, 19.86m  
Announcements and News at 8.55 a.m.  
Heard again at 12.10 p.m. in News for U.S.A.

..... 31.35m  
Undoubtedly the old **KZRM**. News at 4.30 p.m.

**Manchuria:**

**MTCY**, Hsinking ..... 11,775kc, 25.48m  
Heard at 4.15 p.m.

**MTCY**, Hsinking ..... 9545kc, 31.43m  
News at 7 a.m.

**MTCY**, Hsinking ..... 6125kc, 48.98m  
Heard nightly.

**Philippines:**

**KZRC**, Cebu ..... 6100kc, 49.18m  
The only Philippine station left under old regime.

**KZRH**, Manila ..... 9640kc, 31.12m  
Now back on air under Japs. News at 9.30 p.m. (Cushen).

**Secret Philippine Station** ..... 9643kc, 31.11m  
"The Voice of Freedom, broadcasting from somewhere in the Philippines," opens with News nightly at 8.30 p.m. in parallel with 48.94m, and the latter is better signal (Gaden). Have heard them very faintly at 7.30 a.m. (O'Brien).

**Thai:**

**HSP-5**, Bangkok ..... 11,715kc, 25.61m  
English at 9.45 p.m. (Cushen).

**GREAT BRITAIN**

"This is London calling."

**GRQ** ..... 18,030kc, 16.64m

**GRP** ..... 17,890kc, 16.77m

**GSV** ..... 17,810kc, 16.84m

**GSG** ..... 17,790kc, 16.86m  
At 9 p.m. the above stations are O.K.  
**GSG** the best (Gaden).

**GRD** ..... 15,440kc, 19.42m  
At 7.05 p.m. found four London transmitters on the 19m band and this one the best (Gaden). Excellent station (Perkins).

**GRE**, London ..... 15,375kc, 19.51m  
Tuesdays and Fridays from 8.30 to 8.45 p.m. and at 11.30 p.m. on Wednesdays and Saturdays. Not as good as 19.42m at 8.30 p.m., but better than **GSG** and that is saying something (Gaden). Announcements at 7.30 p.m.

**GSF** ..... 15,140kc, 19.82m  
Excellent transmitter at 9 p.m. Good in South American programme at 7.45 a.m.

**GRV** ..... 12,040kc, 24.92m  
As good as any on the air at 5 p.m. (Gaden). News in English for Europe at 6 p.m. (Hallett). Heard at 8.45 a.m. in foreign languages (Perkins). (R9 at 10 a.m.—Ed.)

**GSD** ..... 11,750kc, 25.53m  
Probably the most consistent of the B.B.C. transmitters and one of the earliest of the after-lunch stations.

**GRX** ..... 9690kc, 30.96m  
French from 3.20 to 3.40 a.m., German at 3.45 a.m.

**GSC** ..... 9580kc, 31.32m  
Quite nice at 2.30 p.m. (Gaden).

**GRJ** ..... 7320kc, 40.98m  
Splendid at 5.45 a.m. (Gaden).

**GRM** ..... 7250kc, 41.38m  
African service 1.30 a.m. to 2.15 a.m. (Byard).

**GRK** ..... 7185kc, 41.75m  
Another London transmitter. Heard in early evening, also about 2 a.m.

**GRS** ..... 7065kc, 42.49m  
Heard at 5.45 p.m.

**GRN** ..... 6194kc, 48.43m  
R8 at 6.20 a.m. (Byard).

**GRW** ..... 6145kc, 48.82m  
R-8 at 6.30 a.m. (Byard).

**EUROPE**

**Bohemia:**

**DHE4A**, Prague ..... 11,840kc, 25.34m  
Heard at 6.30 a.m. Can be identified by old Czechoslovakian nine-note signal. No English.

**France:**

**Radio Vichy**, Vichy ..... 11,880kc, 25.25m  
Heard opening at 5.45 p.m. Also good at 8.30 a.m. (Hallett).

**Radio Vichy**, Vichy ..... 9520kc, 31.51m  
Heard with good signal at 5 p.m. (Hallett).

**Paris Mondial**, Vichy or Paris, 6200kc, 48.39m  
Heard at 5 a.m. Good signal.

**Germany:**

**DJR**, Berlin ..... 15,340kc, 19.56m  
Listen to "Anzac Tattoo" on Saturdays at 10.15 p.m.

..... Berlin ..... 15,310kc, 19.60m  
"German People's Transmitter." Midnight to 12.30 a.m. Announcement will be on 32m band at 4 a.m. to 5.35 a.m.

**DJB**, Berlin ..... 15,220kc, 19.74m  
News at 3.30 p.m. (Hallett).

..... Berlin ..... 12,775kc, 23.48m  
R5 at 12.30 a.m. Gave announcement in English as "This is Berlin calling," and then gave News in Hindustani (Byard).

..... Berlin ..... 9880kc, 30.36m  
Sudeten German station. 3 to 3.45 a.m.

**DJW**, Berlin ..... 9650kc, 31.09m  
"Ghost Voice" can be heard nightly in German between 11 and midnight.

**DXZ**, Berlin ..... 9570kc, 31.35m  
News and talk at 4.30 a.m.

**DXM**, Berlin ..... 7270kc, 41.27m  
News at 2.30 a.m., 4.30 a.m. and 5.30 a.m.

**DXX**, Berlin ..... 6140kc, 48.86m  
News in English at 6.30 a.m. Very nice signal (Gaden).

**DWX**, Berlin ..... 6130kc, 48.95m  
This new German gives English News at 4.30 a.m.

**Holland:**

**PCJ-2**, Huizen ..... 15,220kc, 19.71m  
This German-controlled station announces at 9.45 p.m., "Here is Holland calling." News follows and again at 10.45 p.m.—Ed. Appears to be free of whirring noise (Hallett).

**PCV**, Amsterdam ..... 18,070kc, 16.6m  
In parallel with **PCJ-2**.

**Italy:**

**Rome:**

**2RO-6** ..... 15,300kc, 19.61m

Programme for North America closes at 3.50 a.m. Good in News at 8.20 a.m. and terrific signal in News at 5.20 p.m. (Hallett).

**2RO-4** ..... 11,810kc, 25.40m  
News session at 3 p.m. comes in well (Hallett).

**2RO-?** ..... 10,320kc, 29.07m  
Also good signal at 3.40 a.m.

**2RO-18** ..... 9765kc, 30.74m  
Good signal at 3.35 a.m.

**2RO-18**, Rome ..... 9760kc, 30.74m  
Very good at 2.30 p.m. (Gaden).

**2RO-3** ..... 9630kc, 31.15m  
News in English for Australia at 5.20 p.m. Excellent signal (Hallett).

**Portugal:**

**CSW-6**, Lisbon ..... 11,040kc, 27.17m  
Talk in Portuguese from 3.30 to 3.45 a.m. Station closes, but heard again at 5 a.m.

**CS2WD**, Lisbon ..... 6200kc, 48.38m  
Heard as early as 9.30 p.m. All announcements in Portuguese, and closes with Portuguese National Anthem at 11 p.m. (Byard). (This is not a new station, as Mr. Byard suggests, but is an old-timer who has been silent for ages.—Ed.)

**Russia:**

Transmission from either Moscow or Kuibyshev.

..... 15,230kc, 19.69m  
News at 7.30 a.m. and 9.10 a.m. R6 at 9 a.m. (Byard). Programme for U.S.A. 7.15 to 7.40 a.m. News at 10.20 p.m. Good.—Ed.

..... Kuibyshev ..... 15,180kc, 19.76m  
Good from 11 p.m. till midnight.

..... Sverdlovsk ..... 12,060kc, 24.88m  
English from 11 p.m. to midnight.

..... Kuibyshev ..... 10,075kc, 29.78m  
News at 11.30 p.m.

..... Moscow ..... 9585kc, 31.30m  
English at 10 p.m.

**RV-96**, Moscow ..... 9520kc, 31.51m  
Talk in Russian at 3 a.m.  
..... Kuibyshev ..... 8050kc, 37.27m  
English at 6 a.m.

**RW-96**, Moscow ..... 6061kc, 49.5m  
English at 10 p.m. but much better signal on 31.30m.

**Siberia:**

..... Khabarovsk ..... 9566kc, 31.36m  
R6 at 8.45 p.m. (Byard).

**Spain:**

**Radio Malaga**, Malaga ..... 7210kc, 41.61m  
R5 at 7 a.m. (Byard). (I have a note of a Spanish station—call-sign unknown—

**NOTICE TO DX CLUB MEMBERS**

Members of the All-Wave All-World DX Club are advised that they should make a point of replenishing their stock of stationery immediately, as all paper prices have risen, and we expect that it will be necessary to increase prices by at least 25%.

Already it has been found necessary to abandon the log-sheets and club stickers. However, while stocks last, the following stationery is available at the old prices, as shown.

**REPORT FORMS.**—Save time and make sure of supplying all the information required by using these official forms, which identify you with an established DX organisation.  
Price ..... 1/6 for 50, post free

**NOTEPAPER.**—Headed Club notepaper for members' correspondence is also available.  
Price ..... 1/6 for 50 sheets, post free

**ALL-WAVE ALL-WORLD DX CLUB**, 119 Reservoir Street, Sydney



on 7195kc, 41.70m, heard between 5 and 9 a.m.—Ed.)

**EAJ22**, Oviedo ..... 7140kc, 42.02m  
R5 at 7 a.m. (Byard).

**Radio Mediterraneo**, Valencia, 70.35kc, 42.66m  
Opens at 6 a.m. with march. Slogan, "Voz Espana." (See "New Stations.")

**Switzerland:**

**HER-3**, Schwarzenburg ..... 6165kc, 48.66m  
Still heard of a morning with a musical programme, but no English.

**Vatican City:**

**HVJ** ..... 15,120kc, 19.84m  
Time of opening seems to vary, but generally around 4.30 p.m. and in Italian.

**HVJ** ..... 11,740kc, 25.55m  
Prisoners-of-war announced at 5 p.m.

**HVJ** ..... 9660kc, 31.06m  
Information re English prisoners-of-war at 3.20 a.m.

**HVJ** ..... 6005kc, 49.96m  
Talk at 5.15 a.m.

**Scandinavia:**

**Sweden:**

**SBP**, Stockholm ..... 11,710kc, 25.63m  
Listen on Sundays at 9.45 p.m.

**The new Telephone Numbers for  
A. G. HULL**

publisher of the

**"AUSTRALASIAN RADIO WORLD"**

are

**M 4078**

(two lines)

**M 4079**



**SBU**, Motala ..... 9530kc, 31.46m  
Think I heard this station around 4 and 5 p.m. (Hallett).

**MISCELLANEOUS**

**Canada:**

**CBFY**, Montreal ..... 11,705kc, 25.63m  
Heard at good strength about 10.30 p.m.

**CFRX**, Toronto ..... 6070kc, 49.42m  
Opens around 9.30 p.m.

**CJCX**, Sydney (Nova Scotia) ..... 6010kc, 49.92m

Was R3, opening at 8.35 p.m. (Byard).  
Excellent here at 8.45 p.m. Buckley's Cough advertisement at 9 p.m., followed by News (Cushen).

**West Indies:**

**COCY**, Havana ..... 11,740kc, 25.55m  
Good at 3 p.m., fair at 7 a.m.—Ed.

**COK**, Havana ..... 11,620kc, 25.82m  
Good, morning, afternoon and night. English spoken frequently.

**COCQ**, Havana ..... 8850kc, 33.9m  
R4 at 11.55 p.m. (Byard). Can be heard well from 10 p.m. and also good at 7 a.m.—Ed.

**COHI**, Havana ..... 6455kc, 46.48m  
R4 at 10.15 p.m. (Byard).

**COCQ**, Havana ..... 6375kc, 47.06m  
Fair from 9.40 p.m.

**Turkey:**

**TAP**, Ankara ..... 9465kc, 31.70m  
Still heard with R8 signal at 6 a.m. (Perkins).

**Location Unknown:**

..... 9695kc, 30.84m  
An anti-British station heard from 12.30 a.m. to 12.53 a.m. (See "New Stations.")

**European Revolutionary Station**

..... 9640kc, 31.12m  
Invariably announce they are on 31.20m.  
Heard every morning from 4 a.m.



**FOR BEST RESULTS**

**—SENSITIVITY—**

**—SELECTIVITY—**

**RELIABILITY—**

**USE ONLY MULLARD**

THE CHOICE OF BRITAIN'S  
BETTER RADIO MANUFACTURERS!  
**AND AUSTRALIA'S TOO!**

**Mullard** THE MASTER  
**RADIOVALVE**

Mullard-Australia Pty. Ltd., 367-371 Kent Street, Sydney, N.S.W.

Telephone: MJ 4688



# SPEEDY QUERY SERVICE

Conducted under the personal supervision of A. G. HULL

**T.H.H. (Albert Park, Vic.)** has a set which whistles on the stations at the low frequency end of the dial.

A.—This is nearly always caused by feedback from the audio end to the aerial or oscillator circuits. Keep the padder condensers well away from the audio end of the set and make sure that the aerial lead-in does not run close to the output valve. Put a small condenser, even if only .001 mfds., across the speaker to by-pass any r.f. which gets through to the audio end.

\*

**J.C.K. (Marrickville)** has a one-valve set which is not giving results up to expectations.

A.—These little sets need to be working at maximum efficiency in order to give satisfaction. You haven't got a hope unless you can get the reaction working smoothly. Try the effect of varying the length of aerial, or fitting a small mica condenser, say, .0001 mfds., in the aerial lead-in to lower the loading. It is quite normal to find that reaction is easier at the higher frequencies, but the difference should not be as much as you seem to be troubled with.

\*

**C.M.C. (Parramatta)** has a set which appears to need laboratory service.

A.—Sorry, but we cannot possibly undertake any laboratory service at the present time. Being unable to obtain suitable staff, we are forced to suspend this service. We can only suggest that you get a local serviceman to help you. The circuit is quite straight-forward and should present no difficulty to any repair man who is experienced with modern sets. Take along the original circuit so that he can look it over if in doubt.

\*

**G.F.W. (Lindfield)** asks about inverse-feedback for amplifiers with triodes.

A.—We have not done any practical experimenting in this direction, but, by a strange coincidence, we came across an article on the subject in the latest issue of the American "Radio." We were so impressed with this article that we reprinted it in this issue. No doubt you will read this article and find it of interest. Apart from the harmonic distortion, the use of feedback should ensure a flat frequency response.

**B.H. (Chatswood)** enquires about the ability of a single tuning circuit under modern conditions.

A.—In your location you should be able to get each and every local station, without undue overlap. If you use a large aerial and try to get the volume level down to a whisper you may run into a little background, but by using the right length of aerial and keeping a fair bit of reaction on, you should be able to obtain good enough results. A leaky-grid detector may prove more sensitive, but for best selectivity use an anode-bend detector with a screen-grid tube. Unfortunately this type of detector may tend to make the reaction control fierce, and to avoid this you may find a choke-coupled audio circuit is preferable to the normal type of resistance-capacity coupling. For the output valve you will use the most sensitive of pentodes or beam power valves.

\*

**L.B. (Manly)** is in doubt about a gramophone motor.

A.—We can only suggest that you make a practical test by borrowing another motor and then making a substitution. We don't know of any sure way of testing a motor for wogginess, the slowing up on heavy passages not being easy to see, even with a stroboscopic type of speed tester.

\*

**H.G. (Maroubra)** enquires about crystal pick-ups with sapphire needles.

A.—These pick-ups are listed in the United States, but so far as we know, they are not available on the local market. The claimed advantages are not so much that the needle lasts indefinitely, but that the needle pressure is much lower than with ordinary types of pick-ups, and the transient response and overall frequency response are both excellent.

\*

**T.L. (Carlton)** has converted an old set in order to get improved quality of reproduction by taking out the i.f. stage and using the one i.f. transformer to couple the converter valve in to the second detector.

A.—The scheme is a good one and usually makes a great improvement in the reproduction from the local stations,

although cutting down the sensitivity a lot. In your particular case, however, you seem to have run up against a bit of a snag in the matter of the converter valve. Those old-style autodynes were very critical about their loading and most of them would work only when feeding into a special type of intermediate transformer. Apparently that is where your trouble lies, as the converter seems to be operating in the normal way when feeding into the original transformer. There is also the thought that you may have had 175 k.c. intermediates in the original job, and the new i.f. is of the 465 type, as is usual in modern sets. It would not be expected to give proper results with a 175 k.c. type of oscillator coil. If you decide to push ahead with the scheme we feel sure the best plan will be to change over to a 2A7 type converter valve, with a new coil kit to suit the new i.f. transformer which you have on hand.

\*

**T.K. (Bondi)** asks whether it is possible to use two 6V6G type output valves in parallel on each side of a push-pull amplifier, to use four output valves in all, to get double the power output.

A.—Yes, this scheme is quite O.K. You will need a speaker transformer of half the normal loading and capable of carrying double the normal current. Power transformer will need to be able to supply the extra current. Field energising will have to be watched on account of the extra current, too. Results should be O.K. at double power output, but you will have to be doubly careful about keeping the outfit free from parasitic oscillations. Grid stoppers, and plate stoppers to isolate each pair of valves would be desirable.

\*

**W.S. (Five Dock)** is interested in "ham" radio.

A.—So far as we know there has been no official announcement about the status of the radio "ham" transmitter after the war, but we would not be at all surprised if every encouragement is given, and ham radio becomes recognised as a worthwhile hobby and pastime, as well as a field for scientific experimenting. There will be thousands of trained Morse operators and others with a grounding in radio theory, and it is expected that a great many of these will turn to ham radio when peace returns. So far as we know there is nothing to stop you going ahead and getting your operator's ticket straight away, although, of course, you won't be allowed to operate a station while the war is on.



**LIKE-A-FLASH** Overhead Cutting Head and Cutting Gear £5/5/-  
**MAKE YOUR OWN RECORDINGS.** Cutting head and overhead cutting unit complete, £5/5/-  
 Plain Records, 2/11, 3/11, 4/11, 5/11. Cutting Needles, 2/-  
 Aluminium discs, 1/-, 1/6.

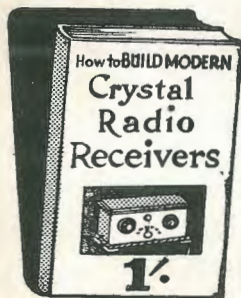

**NOW READY** 1/2 posted

Also How to Build 1 and 2-Valve Battery Sets, 1/-  
 Now ready  
 All About Aerials, 1/-  
 Radio Dictionary, 1/-  
 Outline of Wireless, 1/-  
 4-in-1 Metal and Bakelite Pocket Screw-driver Sets, 2/-



No. 1.—Adjustable Morse Code Key, with long or short tapper arms, splendidly made and finished. Strong reliable

heavy plated fittings mounted on bakelite moulded base, 12/6.  
 P.M.G. Type Sounders 35/-

No. 2.—P.M.G. Type adjustable Morse Code Key, strong and reliable; will last a lifetime  
 Heavy plated fittings on thick solid wooden base. Perfect action.

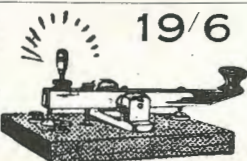

19/6

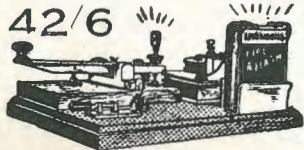

42/6

No. 3.—Set comprising No. 2 Morse Code Key P.M.G. Type, with light. Professional De Luxe Buzzer Battery. Throw-over Switch for buzzer or light. Use as required. Mounted on baseboard. Complete.

The Superhet Manual, by Camm, 10/6.  
 The Wireless Constructor's Encyclopaedia, by Camm. Nearly 400 pages. Cloth bound. Profusely illustrated. 7/6.  
 Everyman's Wireless Book, by Camm. A splendid edition. 8/6.  
 Wireless Terms Explained, by Decibel. 5/6.  
 An Elementary Wireless Course for Beginners, by Reyner, 6/6. A most outstanding edition.

# LEVENSON'S WIRELESS

Wholesale, Retail.

Games, Hobbies, Novelties, and Slot Machine Specialists.

226c PITT STREET, SYDNEY

Everything from A to Z in Radio at Sane Profit Prices.  
 'Phones: M 2525 and M 2526-7. Goods forwarded C.O.D. Post or Rail.  
 (C.O.D. Mail within N.S.W. only. Not Interstate). We welcome  
 Prepaid Telegrams and Long-Distance 'Phone Calls.

Wholesale, Retail.

## SPECIAL! SPECIAL!

Cosmocord Crystal Pickup  
 British manufacture

List Price

84/-

Now 49/6

Special price to traders, lots of 6 or more.



**COSMOCORD CRYSTAL TYPE**  
 BRITISH BUILT AND DESIGNED  
 GRAMOPHONE PICK-UP DE  
 LUXE, with volume control  
 built in as illustrated, 59/6.

**AMPLION** British built Gramo-  
 Radio Pick-up with volume control.  
 Moulded bakelite tone arm.  
 List Price 37/6 Now 32/6.  
 Dealers write for wholesale price.

**COLLARO** Spring Gramophone  
 Motor and Turntable, 30/-



Reconditioned Hygrade 'phones, 20/-, 21/-

Headphones—13/6, 15/-, 17/6, 21/-  
 Ericsson's Professional 4,000-ohm 'phones, 47/6.

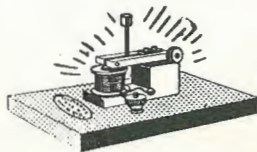

Highest-pitch Buzzer, finger-tip adjustment for professional or amateur use, 11/3.

**VALVES AT SANE PROFIT PRICES. ALL GUARANTEED.**  
 New 227 Valves, 5/9; used, 3/6.  
 New 4XP, 5/-; S215, 5/-; MH4, 2/6. 38, 78, used 5/6.  
 Raytheon B.H. Rectifier, new, 15/-; DU10, 5/-; 2A6, 35, used, 5/6.  
 Used 224, 5/6. 610RC, 610XP, new, 6/6. Used 42, 5/6.  
 New 41MRC, ML4, 3/-.  
 44SU Rectifier, 5/-.  
 PM22, new, 7/6.  
 Used 1C6, 6A7, 6A8, 6B7, 6U7, 6F6, 6F7, 6L7, 6/6.  
 Used 57, 58, 59, 6/6; 201A, 3/6; A409, 6/6; A615, E406; E452, 6/6.  
 Used PM6, PM5B, A609, 6/6.  
 6J7, 6J8, AL2, EK2, 2B7, 226, 5/6.  
 New PM12, PM2A, 18/-.  
 Let's know your valve wants.

Radiokes Straight-vision Illuminated Dials, 5/-  
 Circular Stop Light type, 4/-

Strong Bench Vyce, 6/9.

Pilot single-drum DIALS. Were 27/6, but now 3/6.  
 4-Gang British-built, Bath-tub Condensers. With cover and trimmers. 49/6. Now 10/6.  
 Insulated Lining-up Tools. Two sizes. 2/- and 2/3.

Pick-up Heads. Fit and suit all tone arms and gramophones. For operating gramophone 19/6, 22/6



## MICROPHONES

Batteryless hand-holding type, 30/-  
 Others, 15/-, 17/-, 21/-, 30/- and 45/-



High-pitched "Stay Put" adjustable Tone Buzzer, 4/3.  
 Adjustable Buzzers in Bakelite cases, 4/6, 5/6.  
 Special price to traders. Write for lists.

Just arrived! British-made Gramophone Pick up Needles. Will play 10 records. 100 in tin, 2/6.

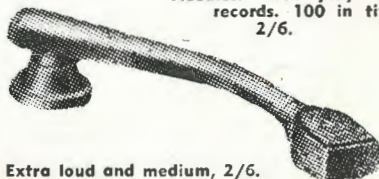

Extra loud and medium, 2/6.

Collara Highest Definition Pickup. New needle holder. Sturdy, compact, well made, with Volume Control. 50/-

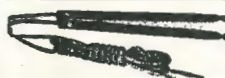

SET TESTING LEADS WITH SILK FLEX and METAL TIP ENDS. 3/9 value. NOW 2/6

Police Patrol Multi-Strand Rubber-covered Aerial. Needs no separate lead - in. 50ft., 3/3; 100ft., 6/6.

Man-o-war Heavy Duty Insulated Aerial, multi-strand wires, 50ft., 6/6; 100ft., 13/-



27/6

No. 5.—Outfit comprises the P.M.G. No. 2 Morse Code Key, with adjustable buzzer and battery all mounted on a stained baseboard, ready for immediate operation. Battery included.

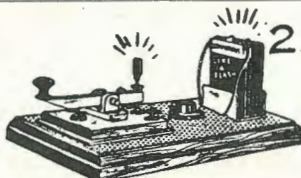

22/6

No. 6.—A real good little outfit which incorporates the No. 1 adjustable Morse Code Key, in moulded bakelite base, with a smart little adjustable buzzer all complete to operate. Junior model, 13/6.

**TECHNICIANS — Just arrived**  
 The Second Edition of the  
**RADIO**

**LABORATORY HANDBOOK**

by M. G. SCROGGIE,

B.Sc., A.M.I.R.E.

The finest text book of its kind ever published.

PRICE, 21/-

The Book of Practical Radio, by Scott Taggart, 8/6.

The Wireless Service Manual, by "The Wireless World," 8/11.

The Australian Official Radio Service Manual, 12/6. Circuit book of all standard 1940 and 1941 receivers.

Nq 621.38405 AUS



# AT THE IN THE FORCES RADIO IS VITAL!

## More and More TRAINED RADIO MEN Are Needed in Australia . . .

This is a war, not only of fighting men, but of machines, and the output of factories. The destiny of our Empire lies as much in the skilled hands of our craftsmen as it does in the efforts of our fighting men. YOU can play a vital, worthy part by embarking on a sound course of technical training NOW.

### YOU CAN START RIGHT AWAY

Of the many industries, crying out for skilled men, none is more important to the nation than Radio. We offer you the opportunity to enter Radio either in industry, or in the fighting forces.

### COSTS LITTLE

Think of this—for a few pence per day—actually less than many fellows spend on tobacco—you can prepare yourself for a man-sized job in Radio.

### TRAIN AT HOME OR AT OUR BENCHES

The Australian Radio College offers ambitious men a sound proven course in Radio Engineering! Sound because it is the result of many years' successful operation; proven because hundreds of ex-students owe their present jobs and success to the College. You can learn with equal facility in your own home (by means of our correspondence course) or attend night classes at the modernly-equipped College workshops.

### PREVIOUS KNOWLEDGE UNNECESSARY

You don't need a knowledge of Radio or Electricity. We'll give you all you need of both—you'll start at the beginning, building up knowledge just as carefully and systematically as you would lay brick after brick in its place when building a wall. You get the knowledge you want presented in a manner that makes it easy to learn FAST.

### SEND FOR FREE BOOK

First thing to do if you want to secure the facts about Radio is to send in for "Careers in Radio and Television," a lavishly-illustrated book published by the College and available to approved enquirers. Send in coupon for your copy now. It's free and post free!

"... I am writing to let you know that I, who took your service engineering course, am now in camp with the 1st Corps, HQ Sigs. of the 2nd A.I.F. I am in as a radio maintenance man and instrument (radio) mechanic. Because of the training I received from you I am able to take my place as engineer in a wireless station or mobile van radio station. Because of the training I have had I am able to pass tests set by the instructors where many fail, and it will probably mean two or three stripes for me as N.C.O. in charge of full transmitting equipment.  
— C.T.S., Melbourne.

"When I think of the trouble you and the staff of the College have taken to fit me for my work and to find me the position here, I feel deeply grateful and proud to have been a student of the Australian Radio College."  
— R.R., Bowral, N.S.W.

"I would like to thank you for my Certificate, which I received quite safely. I would also like to thank you and the staff for your sincere co-operation while and since doing my course. I have also just received a position in the control room of one of our national stations, and like this work very much."  
— H.L., Hobart, Tas.

**AUSTRALIAN RADIO COLLEGE Pty. Ltd.**  
CORNER CITY ROAD AND BROADWAY, SYDNEY      Phones: M 6391 and M 6392

To Mr. L. B. GRAHAM, Principal, Australian Radio College Pty. Ltd., Broadway, Sydney.

Dear Sir,—I am interested in getting into the Radio and Communications industry. Please send me, without obligation on my part, the free book, "Careers in Radio and Television."

NAME .....  
ADDRESS ..... ARW20

