

**THE
AUSTRALASIAN**

PRICE, 1/-

Registered at the G.P.O.
Sydney, for
transmission
by post as a periodical.

Radio World

VOL. 5 NO. 2

JULY 1940

**TIP TOP 3/4 SUPER
MANTEL SET
BUILD IT YOURSELF**

**TWO VALVE SUPER
PORTABLE BATTERY
RECEIVER**

**A RADIO RECEIVER
IN A MATCHBOX.
TINY CRYSTAL SET**

**AMPLIFIER
CHAMPIONSHIP
HEAT RESULTS**

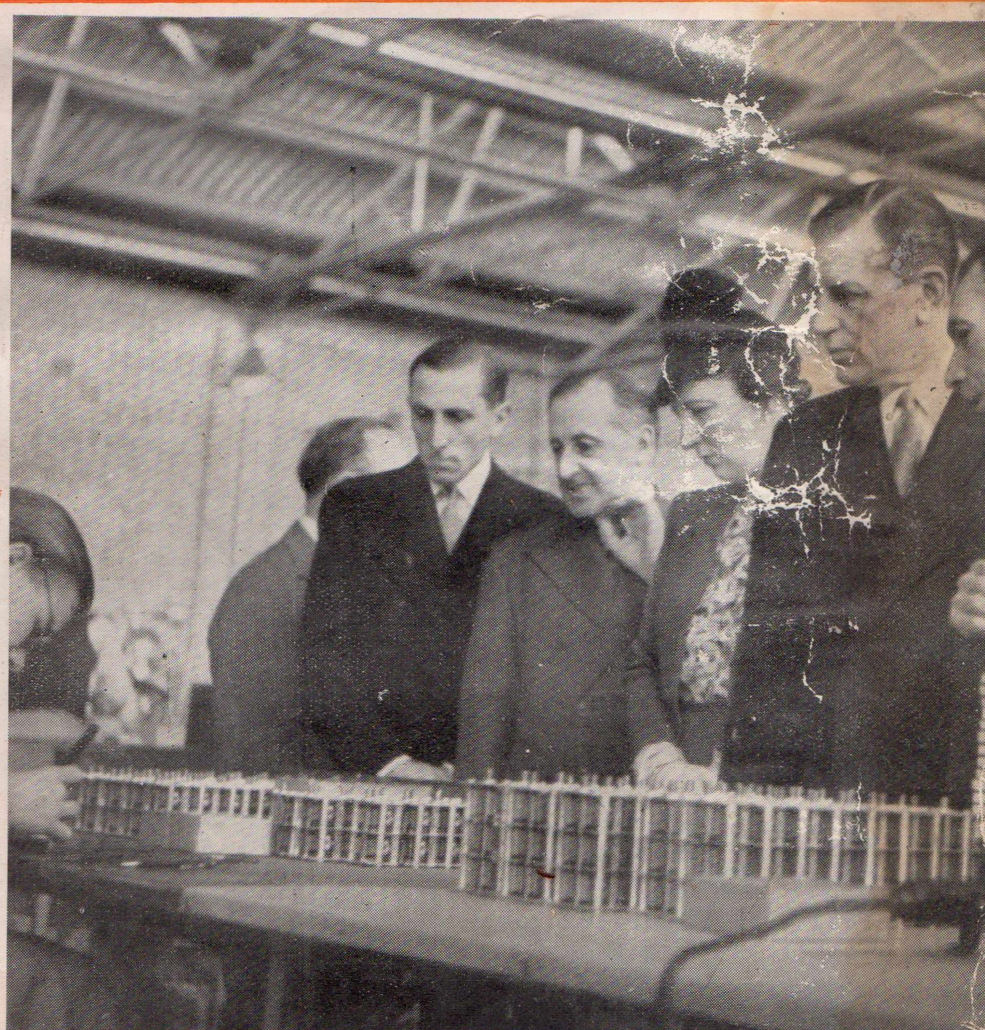

His Excellency the Governor and Lady Wakehurst Visit S.T.C. Factory. (See page 3)

BUILD THE "RADIO WORLD"

ALL-WAVE SERVICE OSCILLATOR using the

CALSTAN ALL-WAVE Oscillator Foundation Kit

AS SPECIFIED BY THE DESIGNER

THE CALSTAN ALL-WAVE OSCILLATOR FOUNDATION KIT
COMPRISES—

One special Calstan all-wave oscillator foundation kit, comprising ready-drilled steel crackle-finished cabinet, 7½" x 6½" x 10," all-wave oscillator unit (comprising five-band coil assembly and attenuator mounted in steel box, with modulation choke and condenser gang bolted in position), tuning knob and celluloid indicator, scale for front of cabinet printed on heavy art paper. PRICES: £7/17/6 Complete Kit; £4/17/6 Foundation Kit. Coil Kit only, including gang condenser and cover, £3/7/6.

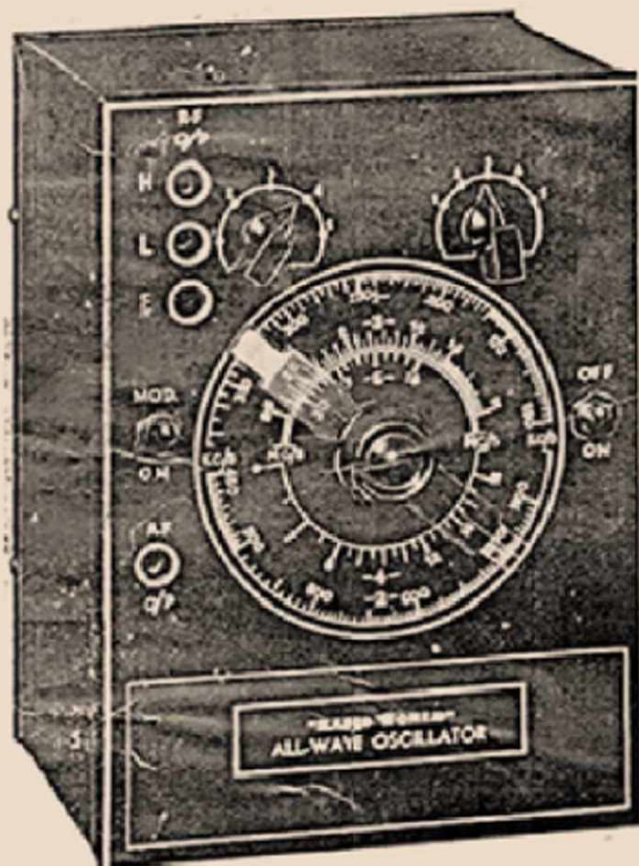

MAIN FEATURES INCLUDE:

- Continuous coverage from 150 k.c. to 30 m.c. in five bands.
- Coils, band switch and attenuator are wired and sealed in a compact steel case, modulation choke and condenser gang being mounted externally.
- ONLY FOUR COLOUR-CODED LEADS to connect Foundation Unit into circuit.
- Band coverage is accurately pre-adjusted to track with five-band direct-reading scale.
- Electron-coupled r.f. oscillator circuit ensures high frequency stability.

The Calstan Oscillator

The CALSTAN OSCILLATOR is also an instrument of outstanding quality; all wording etched on non-ferrous metal; leather carrying handle, rubber feet. Pilot light and black instrument knobs on each model. Five inch dial reads direct in k.c.'s, m.c.'s (top half) and corresponding metres (bottom half); smooth planetary movement—adjustable for slip. Two attenuators on both models.

SPECIFICATIONS: Model 306, Battery-operated, with minimised battery drain ("B" battery-drain approximately 5 m.a., at 67.5v.; "A" Battery 4.5v., drain approx. 120 m.a., including Pilot). Band spread 150 k.c.'s to 16 m.c.'s on fundamentals without breaks; above 16 m.c.'s by using 2nd harmonics. R.F. signal modulated at will. High degree of stability and accuracy particularly over 175 and 465 k.c.'s channels. Model 307 A.C. Mains operated. Feed back prevented by line filters, thus maintaining good attenuation. Band spread 150 k.c.'s to 25 m.c.'s on fundamentals without breaks.

Both models available with or without built-in output meter.
OUTPUT METER: 3 inch round type. Special Alnico magnet gives approx. 100 per cent. increase over old style. Ranges 2, 5, 10, 50, 250. Provision for measuring A.C. Volts. All necessary cards and instructions supplied.

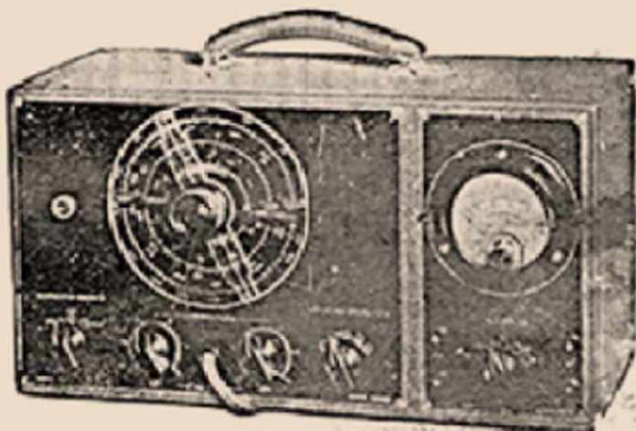

An Oscillator within the reach of every experienced set-builder or serviceman.

306 Battery Operated	£10 10
307a (illustrated) ditto, with output meter	15 25 0
307 Mains Operated	10 17 6
307a ditto, with output meter	16 2 6
Output Meter as used on both models:	5 10 0

(All prices subject to sales tax)

SLADE'S RADIO PTY. LTD.

LANG STREET, CROYDON... Phones UJ5381-82

Makers of High Grade Radio & Electrical Testing Equipment

Distributors: N.S.W.: Radio Equipment Pty. Ltd., Martin de Lounay Ltd., Block & Gerber Ltd., United Radio Distributors, John Martin Ltd., Electric Service Co., Newcastle. QUEENSLAND: Chandlers Pty. Ltd.; A. E. Harold, 123 Charlotte Street. SOUTH AUSTRALIA: Radio Wholesalers Ltd., Adelaide. WEST AUSTRALIA: Norman J. Burnell & Co., 13 Queen Street, Perth. VICTORIA: Australian General Electric Ltd., Melbourne; Arthur J. Veall Pty. Ltd., Melbourne; Hartley's Ltd., Flinders Street, Melbourne. TASMANIA: Oatley's Garage, Oatlands. NEW ZEALAND: Turnbull and Jones, all branches.

The Australasian
RADIO WORLD

Incorporating the
ALL-WAVE ALL-WORLD DX NEWS

Vol. 5.

JULY, 1940.

No. 2.

CONTENTS:

CONSTRUCTIONAL—

"Tip-Top Three-Four Superhet"	5
Standard A.C. Power Unit	19
Two Novel Circuits From America	25

GENERAL TECHNICAL—

Battery Chargers	11
Using An R.F. Oscillator	15
Rola Introduces "Kappa" Cones	35

AMPLIFIER SECTION—

Amplifier Championship	22
------------------------------	----

SHORT-WAVE SECTION—

Review	28
The Month's Loggings	30

JUNIOR TECHNICAL—

Hints and Tips	37
Building a Galvanometer	38

TRADE NOTES—

W. G. Watson Release 1940 Test Equipment	40
Meter Repairs	40
Free Resistor De-coder	40
Bargain Lines at Murdock's Radio Sale	42

SPEEDY QUERY SERVICE—

Answers to Readers' Problems	41
------------------------------------	----

The "Australasian Radio World" is published monthly by A. G. Hull. Editorial Offices: 117 Reservoir Street, Sydney, N.S.W. Telephone FL 2842.

Advertisers please note that copy should reach office of publication by 14th of month preceding that specified for insertion.

Subscription rates: 1/- per copy, 10/6 per year (12 issues), post free to Australia and New Zealand.

OUR FRONT COVER

On June 6 His Excellency the Governor, accompanied by Lady Wakehurst and attended by Mr. Peter Lubbock, made a tour of inspection of the S.T.C. Sydney factory. In the picture (from left to right) are: Mr. R. S. Beckwith (S.T.C. director), Mr. Peter Lubbock, Mr. H. C. Trenam (managing director of the S.T.C.), Lady Wakehurst, His Excellency the Governor, and Mr. S. D. McPhee (S.T.C. works manager) are seen watching the assembly of condenser gangs for S.T.C. Radio Receivers.

AMPLION
DIPHONIC SPEAKERS
give you PERFECTED
Sound Reproduction

The superb reproduction of the AMPLION Diphonic System is a result of the scientific Filter Type Dividing Networks, coupled to special speakers of unequalled response. Suitable for Fine Radio, Phono-Radio or small Auditoriums, with outputs from 10 to 15 watts—the finest theatre quality sound is now available to all.

*You've Never Heard
Sound Like It!*

Crisp brilliance of higher tones and perfect balance to 10,000 cycles is given, with resounding depth of low notes. Uniform response over wider frequency range than hitherto possible. Range from 400 to higher than 10,000 c/s. covered by 8P90 Cine Permags., and resonance-free "lows," with absence of bass modulation to lower than 40 c/s.!

Type A Kit, with 12E22 12" Special De Luxe Electro. 8P90 Cine Permags. Output transformer and two special Diphonic Inductances. Price £10/10/-

Type AP Kit, as above, with 12P64 Permags. instead of 12E22. Price £13/4/-

Amplion Diphonic Condensers for above—
33 mfd. 30/- 20 mfd. 17/9

Write now for
"Diphonic
Data"

Amplion Diphonic Speakers are also available completely wired in walnut veneer cabinets of proper acoustic design. 42" x 24" x 15." Prices on application.

DEMONSTRATIONS AT DISTRIBUTORS

AMPLION (A/sia) PTY. LTD.

382 KENT ST., SYDNEY



Martin de Launay's SERVICE stimulates business

You can take it for a positive fact that the products we sell are the very best you can get.

But you'll have to see for yourself just how pleasingly moderate are our prices and how quick our service.

If you have not yet found out that you can make your money go farther and that you can get faster service, send your next radio or electrical order to us.

Electric Coffee Percolators are also included in our comprehensive range of Electrical and Radio Supplies.

MARTIN de LAUNAY PTY. LTD.

CR. DRUITT AND CLARENCE STREETS, SYDNEY.

Phone: M 2691 (5 lines)

Also at WOLLONGONG and NEWCASTLE.

EDITORIAL . . .

Life has been brighter this month.

The office has assumed a new air of happiness. The reason—our new mantel model, "Tip Top", has been playing in the office, as you'll notice by the photograph at the top of the opposite page.

We've heard a lot about the need for auxiliary receivers in the home, and we've always made a point of having two or three sets available. But we never thought that one could prove such a boon in the office.

With extraordinary performance, considering its simplicity and low cost, "Tip Top" has been providing a background of soft music which has changed the whole atmosphere of the working day.

It makes us feel sure that this little set is bound to find favour with our readers, too. You'll be bound to find a good use for it.

Not so bright, however, is the paper position.

Every month it becomes harder and harder to obtain supplies of the kind of smooth-finish paper which we have used in the past, and, of course, costs have risen considerably.

We feel sure that our readers appreciate decent paper and clean printing, so our problem at the moment is to know how to give you all you want without using too much paper.

The solution rests with you.

If you can spare a moment we'd greatly appreciate it if you will give us an idea of what type of reading matter suits you best.

For example, there is the short-wave section.

In one way it is difficult to justify its inclusion in a paper with a policy of "100% Technical Radio", and yet we feel that it is the most accurate and authentic guide of its kind, and that it serves a valuable purpose to the keen radio man. Do you appreciate it, or would you rather have more articles about battery set design?

Let us know how you feel about such matters and we'll do what we can to fulfil your requirements.

In conclusion we would like to again draw your attention to the Amplifier Championship.

This contest is proving a wonderful success in spite of the difficult times through which we are passing. Our greatest care in regard to the Amplifier Championship is that there must be many readers who would find the auditions of boundless interest, yet have not managed to find sufficient energy to fill in the application form for a seat reservation. Of course many have done so, and already more than a hundred have been along to the first three heats, but there must be hundreds more who don't know what they are missing. Action is called for.

A. G. HULL

TIP-TOP 3/4 SUPERHET

An inexpensive four valve superhet, broadcast receiver. Designed as a mantel set, this receiver is housed in an attractive leatherette cabinet measuring 12½" x 6¾" x 7¾".



A LOT of thought has gone into the design of simple little circuits for mantel models, and some good performers have been brought out from time to time.

Some designers, however, seem to let their enthusiasm for a small number of valves run away with them, so that by the time they finish the job they have a set which uses more components and costs more to build than a bigger set using more valves.

We feel that it is a good scheme to aim at a simple set to be built at low cost, and in such a case the use of only four valves can be justified.

In response to numerous requests from readers we decided to see what we could do in the way of a contribution to the design of small sets, and so we started to look over some of the recent designs which have ap-



Soft music while you work, with "Tip-Top" in the office.

peared in our back numbers and in other publications.

First of these was the Companionette, which was detailed in our February issue. This little job used a 6F7 as r.f. stage and leaky-grid detector to make a two-valve and rectifier job which proved quite a good performer, within its limitations.

The design has been copied both far

and near, which is always a good sign.

Some experimenting with this job in some of the more difficult locations, however, gave us the impression that a t.r.f. set with only two tuned circuits does not have sufficient inherent selectivity to make it a safe recommendation for general use.

Next circuit to receive consideration was the "Comet" dual-waver, which was described in our issue of May, 1938.

We were quite unable to fault this set as a performer, and it is not surprising that its design has been used as a basis for several commercial receiver models in the 3/4 valve class.

But, from our point of view, the "Comet" was too complex to be put up as an ideal in small sets.

Using automatic volume control and dual-wave tuning, it was nearly as expensive to build as an ordinary 4/5 valve model.

An Ideal Starting Point.

But we immediately realised that the circuit was an ideal starting point from which to evolve a really attractive, simple and cheap set.

Here is the result—Tip-top, a straight broadcast mantel model using as few components as any superhet ever described, costing an absolute minimum and definitely guaranteed to give better performance than any 3/4 set described in Australia for some time past.

Nothing has been skimmed or omitted, and there are the full four stages of amplification of the conventional 4/5 set, yet only four valves are used in all.

(Continued on page 7)

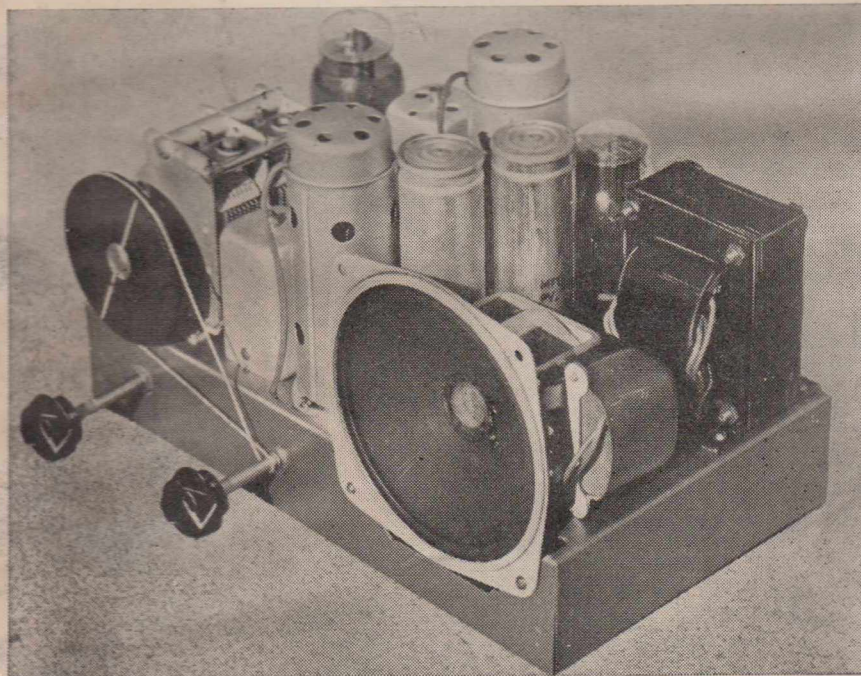

A front view of the finished receiver. Special midget power transformer is behind the speaker.

RADIOKES

The Name to Know in Radio!

You need the RADIOKES Trolitul Coil Kit for the "Tip-Top"

Technically far superior to any other coils and I.F.'s, RADIOKES Trolitul components will do a particularly good job for you in midget sets. Compact in size, without loss of sensitivity and selectivity, the new RADIOKES Coil Kit for the "Tip-Top" will give you the highest standard of results obtainable!

RADIOKES Coil Kit, Type CK1007 £1'10/3
 RADIOKES Dial, Type DWD-4 8/0

THE "TWO-VALVE SUPER"

RADIOKES have produced a special Trolitul Coil Kit and I.F. for this set. Specify RADIOKES if you wish to obtain performance equal to that given by the original "Two-Valver Super."

Radiokes Intermediate Transformer

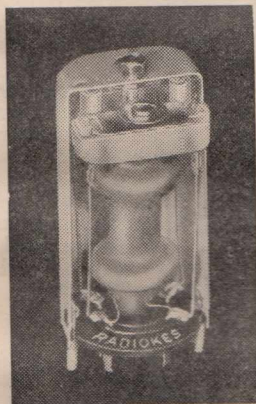

One-piece mechanically sound Trolitul formers and base—the highest standard I.F.'s available. A special feature is the round base suitable for round or square cans.

Type	List Price
A.I.F. (Air Core) ..	7/6
I.I.F. (Iron Core) ..	11/-
P.I.F. (Perm.)	13/9

RADIOKES Coil Unit Type CK-1108, comprising Dual-wave Unit Type DWU-1 £1'7/6
 SPECIAL RADIOKES Trolitul I.F. Type P.I.F.S. 15/-

£2'2/6

Radiokes Dual-Wave Coil



Litz-wound windings, lugs already tinned, short-wave range 16 to 50 metres, B.C. range 1500 to 550 k.c.
 Type List Price
 D.W.C. 14/-

RADIOKES "H" TYPE COILS WILL TRACK WITH RADIOKES "H" TYPE DIALS ONLY

NEW RADIOKES DUAL-WAVE DIAL

Designed for portables and small sets, this dial shows the stations clearly marked in green and gold. Dual-wave range is 13.7 to 50 metres, Broadcast 1600 to 550 k.c., moulded Trolitul drum gives frictionless operation. Available with round escutcheon; face 3ins. diameter. Perfect tracking with RADIOKES Coils.
 Type List Price
 DWD-4 8/-

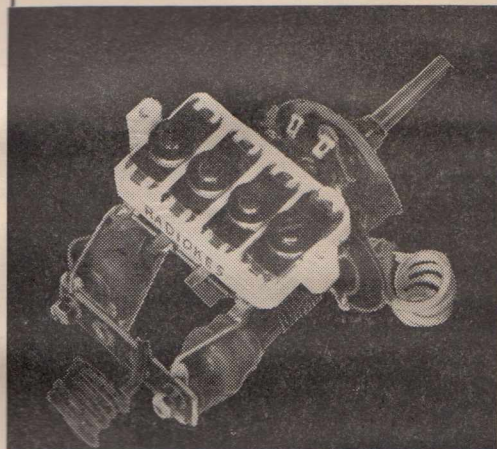
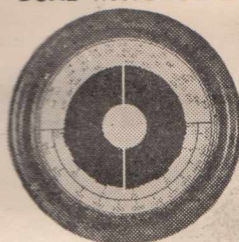

RADIOKES 13.7 to 50 metres DUAL-WAVE UNIT

Highly selective unit with exceptionally wide range. To match "H" type gang condenser; incorporates 4-in-1 padder. Solidly mounted with coils.
 Type DWU-1 List Price 27/6

RADIOKES 4-IN-1 PADDER

Supersedes 4 single padders. Trolitul construction featuring non-warping bridge.
 Type D.T.T. List Price 5/-



Radiokes Broadcast Coil Trolitul rigid construction, available in air core and permeability types.
 Type B.A.C. Aer., R.F. or Osc. List Price 6/6

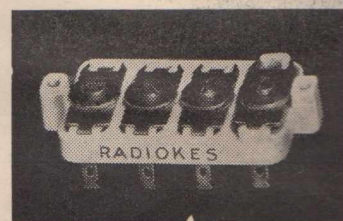

RADIO SUPPLIERS PTY. LTD.,
 Sole Agents for Radiokes Products,
 Wingello House, Angel Place,
 Sydney.

Phone: B 4586

Please add my name to your mailing list for illustrated folders showing latest Radiokes releases.

NAME

ADDRESS

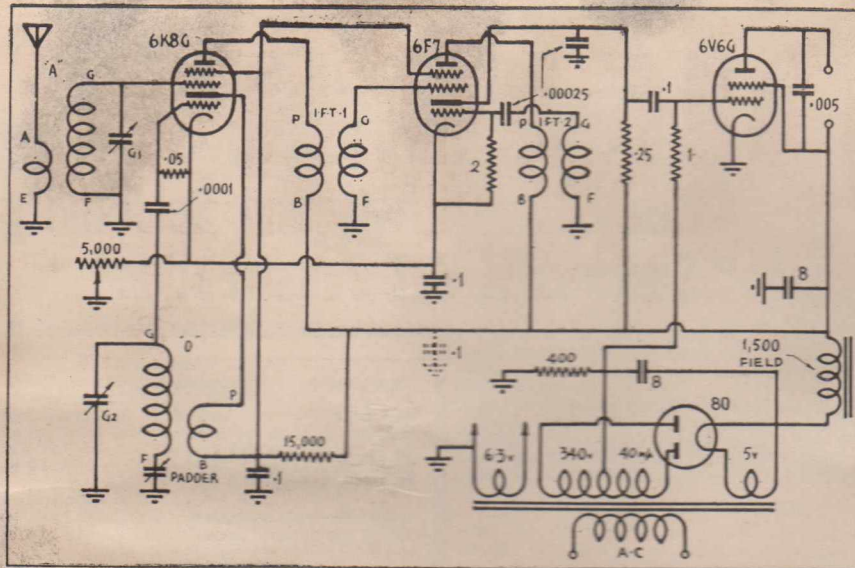

LEFT: Circuit of the "Tip-Top." When wiring the receiver, compare with the picture diagram on page 9.

those who have tried to build some of the midgets which need the gang condenser fitted upside down, with the coils tucked amongst the underside wiring, and with sensitive components, such as the padder, mounted in a position where feed-back is almost certain to cause instability.

Our layout follows conventional design, and it will readily accommodate the standard components available from our advertisers.

The layout allows simple point-to-point wiring, with adequate space for the components to be fitted within the base. Every soldered joint is accessible with an ordinary soldering iron, and each and every component can be fitted or removed individually, thereby greatly facilitating the proper adjusting and testing of the finished

SOUNDPROOF WINDOWS

Fourteen soundproof windows are being installed by Amalgamated Wireless in the aircraft assembly demonstration building, in course of erection at Fishermen's Bend, Melbourne.

chassis. The value of the provision of ample room for the layout is revealed when we mention that we assembled and wired the original set in and had it in operation within three hours of unpacking the components. Such speedy wiring would be impossible with one of the "Jugglers' Specials."

(Continued on page 9)

TIP-TOP

(continued)

There is the usual intermediate amplification, also the usual audio amplification, with ample drive for full power output and tone from the output valve, yet no difficulty with hum.

The high tension current drain has been cut back to a minimum, so that one of the small power transformers can be used without any sign of overloading or overheating.

In a nutshell, it is a set which can be built for well under a tenner, and yet be depended upon to give complete satisfaction in every way.

The Circuit.

The centre of focus in the circuit design is the use of the 6F7 pentode-triode as an intermediate amplifier and leaky grid detector.

This valve serves these purposes to perfection and is in no way experimental or freakish. It has been featured for years in many prominent brands of receivers such as Airzone and Kriesler, and has always given good service. It is quite reason-

ably priced, too, which is a point to watch when considering multi-purpose valves, as some of them cost about as much as the two ordinary valves replaced.

The converter valve is a 6K8G, which has been found by us to be easily the most satisfactory converter valve for all-round use, being a particularly easy oscillator and not at all critical to various types and styles of coils, layouts, etc.

The output valve is the 6V6G beam power valve, which is deservedly popular. In this particular set we bias it back a little to keep the current drain low, but it is still capable of fully driving the small speaker used with a set of this type.

The Layout.

A layout has been designed to permit the set to be built on to a small chassis so that it can be fitted in a neat mantel model cabinet. Great care has been taken, however, to avoid the pitfall of making the base so small that it takes a juggler to get the components into position. We have heard altogether too much from

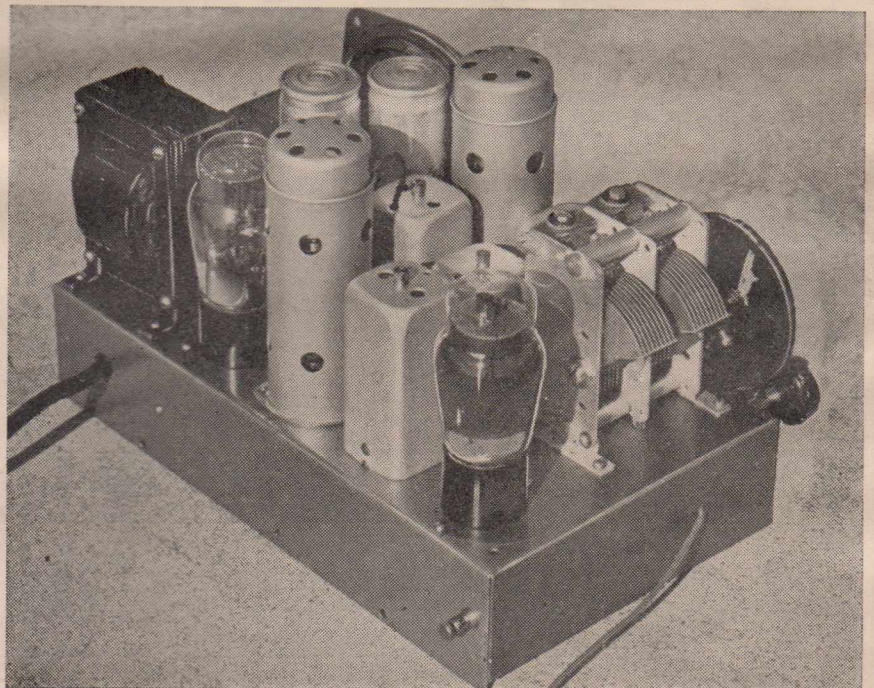

R.C.S.

TROLITUL COILS AND COMPONENTS give you

- Keener Sensitivity and Selectivity
- Successful Set Construction!

R.C.S. POTENTIOMETERS AND RHEOSTATS

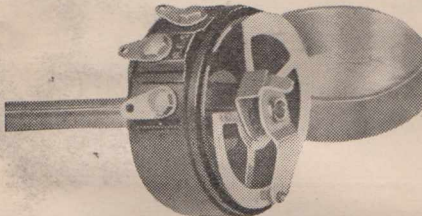

The R.C.S. Volume Controls are the result of improved and new methods of manufacture, together with alterations in design and final testing. Noiseless, they are constructed so as to cut off all volume.

	Cat. No.	Retail Price
6 ohm Rheostat	.25 Amp. PT40	5/-
10 " "	.25 Amp. PT38	5/-
20 " "	.25 Amp. PT39	5/-
30 " "	.25 Amp. PT34	5/-
400 " Potentiom.	50 M/A PT46	5/-
1000 " "	35 M/A PT47	5/-
2500 " "	30 M/A PT49	5/-
5000 " "	30 M/A PT51	5/-
10000 " "	20 M/A PT52	5/-
15000 " "	20 M/A PT53	6/6
20000 " "	15 M/A PT54	6/9

R.C.S. RADIO FREQUENCY CHOKES

TROLITUL TAPERED PIE-WOUND R.F. CHOKES

These chokes are wound on a Trolitul former, the legs and mounting screw being moulded into the former. The windings are spaced pies, tapering to the top. Owing to its very high insulation and construction, this choke is ideal for short-wave receivers.

They are made in the following sizes:—

R.F. CHOKES, Pie-Wound	Pies	M.H.	Price
RF82	3	1.7	4/6
RF83	4	2.5	4/6
RF84	5	4.0	4/6
RF85	6	7.0	4/6

STANDARD R.F. CHOKES

RF81 and RF86 are single pie-wound on a solid Trolitul core, which has the necessary solder lugs mounted in. The design of this choke eliminates the need of bakelite side dies.

RF26 Choke is for vibrator work. RF15 for filtering from the mains.

RF CHOKES—STANDARD

RF86—Cotton H.C.	1/-
RF81—Silk H.C.	1/9
RF26—Vibrator Low Tension Choke	4/3
RF15—Line Filter 2.3 M.H. .75 amp. (2 chokes, 1 former)	11/-

Obtainable from your local dealer

R.C.S. RADIO PTY. LTD.

50 GLEBE ST., GLEBE. 'Phone MW 2405

R.C.S. "H" TYPE COILS WILL TRACK ONLY WITH R.C.S. "H" TYPE DIALS—NO OTHER MAKE

FOR THE "TIP-TOP"

R.C.S. Trolitul coils and I.F.'s because of their extremely good sensitivity combined with small size, are the outstanding coil kits for midgets, mantels and portables. For best results with the "Tip-Top" specify Coil Kit code K151. Price £1/10/3 R.C.S. Dial, as illustrated below, code DA4. Price 8/-

FOR THE "TWO-VALVER SUPER"

The "Two-valve Super" requires the very best coils and I.F. to be had. To obtain the required sensitivity, specify R.C.S. Trolitul Coil Kit and the special Trolitul intermediate. Coil Unit, Code K152. Price £1/7/6 Special Trolitul I.F. Code IS31 15/-

JUST RELEASED!

NEW R.C.S. DIALS

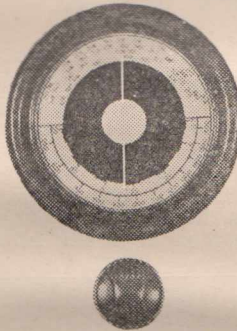

New Dual-wave Dial for Portables, etc. Face 3in. diam., finished in green and gold, stations clearly marked, metal parts plated. Moulded Trolitul drum, no friction. Range. B.C. and 13.7 to 50 metres. Code, DA-4. Price 8/-

For some time we have felt that we should provide dials for use with coils of our manufacture, thus assuring perfect tracking. Both types are single glass Dual Wave, the type DA-2 having been designed especially for use with our Five Band Communications Receiver coil kit, and the "H" type condenser. Type DA-1 is a standard Dual Wave dial for use with R.C.S. Coils and the "F" type condenser.

DA-1. Standard D/W Dial. Retail Price, 22/6.
DA-2. Communications Dial. Retail Price, 22/6.
DA-3. 13.7 to 50 metre D/W Dial. Retail Price, 22/6.

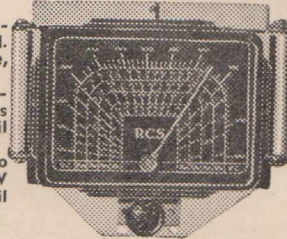

Type DA-3.

R.C.S. DUAL WAVE UNITS

Type DW24, as illustrated, consists of Aerial, R.F. and Oscillator Coils, Wave Change Switch, the necessary B/C and S/W Trimmers and Padder mounted on a rigid steel base, wired up ready to assemble in a set utilising 465 k.c. and an R.F. Stage. The bands are S/W 16 to 50 metres, and B/C 1500 to 550 k.c.

	Retail Price
DW24 for A.C. operation	£3 7 6
DW25 for battery operation	£3 7 6

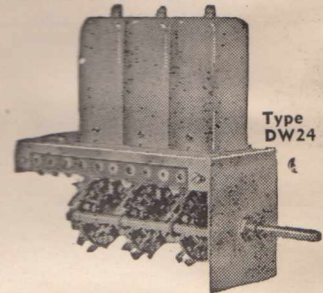

R.C.S. TROLITUL INTERMEDIATE TRANSFORMERS

The new R.C.S. Trolitul I.F.'s are extremely stable, due to new methods of construction made possible by the use of Trolitul formers and base. No loose wires to shift and alter frequency. Positively the best I.F.'s yet produced.

Cat. No.	Retail Price
Air Core, 465 k.c.	
IF107. 1st I.F.	7/6
IF108. 2nd I.F.	7/6
Iron Core, 465 k.c.	
IF109. 1st I.F.	11/-
IF110. 2nd I.F.	11/-
Air Core, 175 k.c.	
IE68. 1st I.F.	7/6
IE69. 2nd I.F.	7/6

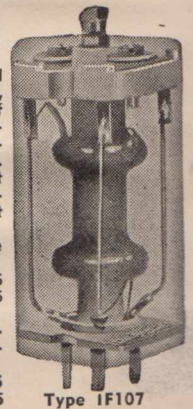

Type IF107

R.C.S. TROLITUL DUAL WAVE COILS

These coils have the B/C and S/W Trimmers incorporated. The Oscillator coil also contains the S/W Padder. S/W 16 to 50 metres, B/C 1500 to 550 k.c.

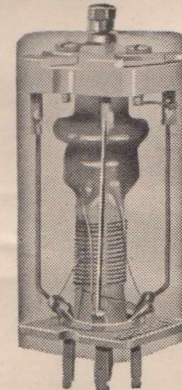

Type G19.

Cat. No.	Retail Price
G19. Aerial Air Core	14/-
G20. R.F. Air Core	14/-
G21. Osc. Air Core	14/-

BATTERY CHARGERS

The construction, maintenance and care of battery chargers is discussed in detail in this article. Garage managers, servicemen, etc., will find this instructive article a great help with their charging problems.

ONE of the big steps in the development of electricity was the introduction of the accumulator, a device for storing electrical energy.

Think for example what a wonderful thing it was to the motor car industry when self-starters were introduced. Their operation is completely dependent on the car "battery," as the group of accumulator cells is known.

While the car is going along the generator is charging up the accumulator with energy. When it is required to re-start the engine this energy is withdrawn from the accumulator to power the starter motor, which turns over the engine in the same way that it had to be "swung" with the crank handle in the days before self-starters.

We mention the analogy of the starter system of the car, as it is easy to understand and yet gives a fair insight to the fundamental purpose of the accumulator—to store electrical energy.

Accumulators are remarkably efficient and deliver up practically all the energy put into them; in other words if you put 10 amperes of current into a battery for a period of 1

hour you can expect to get about ten amperes from it for a period of one hour, or one ampere for ten hours and so on.

Direct Current Only.

Accumulators can only handle direct current, and so it becomes necessary to use a rectifier in order to charge the accumulator from a source of alternating current power supply, which is the usual power supply in the suburbs and most of the country towns.

This rectifier unit is known as a battery charger, and there are several different brands on the market, and several models in each brand.

It is also quite within the scope of the average radio man to build up one of these units.

Philips Chargers.

In the Philips range there are two types of chargers which are popular with radio dealers and radio enthusiasts.

The first lists at £4/17/6, and is rated to charge a six or twelve volt battery at a rate of 1.3 amperes, a throw of a switch being necessary to change from 6 to 12 volts.

The second type of Philips charger

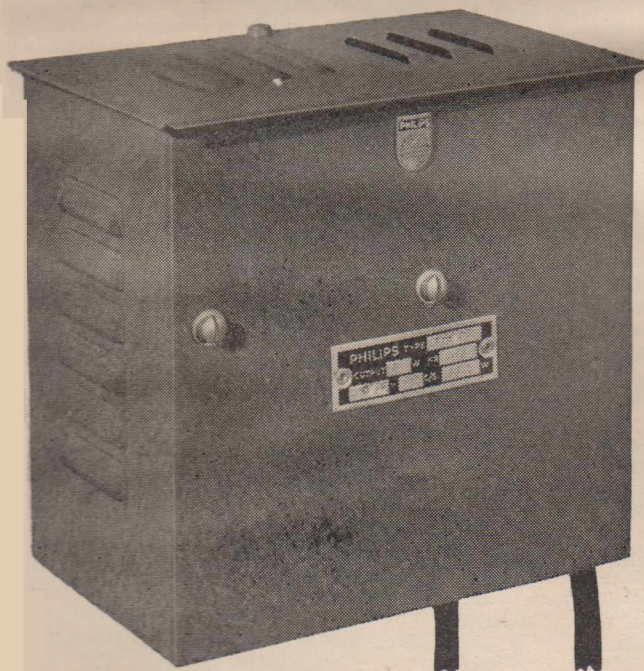

Philips charger type 1378 is designed for the home garage. Just plug in at night when garaging your car, to ensure an easy start next morning.

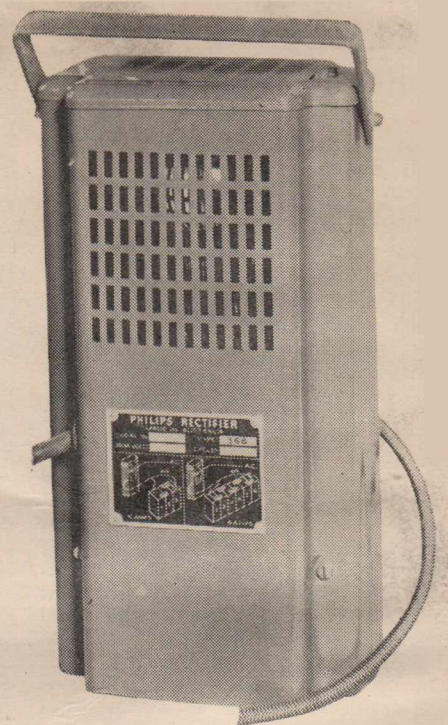

ABOVE: Philips Charger Type 368.

is known as type 368, and lists at £9/10/0. It is capable of charging six-volt accumulators at 6 amperes or 12 volt accumulators at 4 amperes.

Making a Charger.

Essentially a battery charger is simply a rectifier with a suitable step-down transformer to provide a suitable input voltage. A resistance is usually fitted to allow some control over the charging rate, but this can be overcome in a home-made charger by providing a step-down transformer with tapings.

For the home-made charger there are several types of suitable rectifier valves available.

In the Tungar range there is the 12X825, listing at 30/-. It will handle a current of up to 2 amperes, and needs a filament supply of 2 volts at 12 amperes.

A heavier Tungar bulb which is available is the type 189048, listing at 49/6. This bulb will handle 6 amperes and takes 2.2 volts at 18 amperes for the filament.

Philips Bulbs,

In the Philips range there are two bulbs which are ideally suited for home made chargers, the first being the bulb which is used in the Philips 1.3 ampere charger. Known as type 328 it lists at 19/-. For the filament it takes 1.8 volts at 2.8 amperes.

The other Philips bulb is type 367, listing at 36/-. It will handle up to 6 amperes and takes 1.8 volts at 8 amperes for the filament.

(Continued on page 12)

THE CARE OF BATTERIES

Your radio or car battery can give you years of service, if it is properly cared for. Correct care for a battery consists of seeing that the drain is not excessive, that the electrolyte is kept at the right level by the addition of distilled water, and that as soon as the accumulator is run down it is properly re-charged.

BEFORE starting to charge, sufficient pure distilled water should be added to each cell to cover the plates $\frac{1}{2}$ inch deep.

Acids should not be added, except according to the battery manufacturer's specific instructions.

Poor battery connections cause arcing and sparking and are even more dangerous than naked flames. Do not change battery connections without turning off the charger.

Violent "gassing" and a rise in temperature of the electrolyte are two indications of too high a charging current. The temperature of the electrolyte should not exceed 110 deg. F. The remedy for a high temperature

is to reduce the charging current immediately.

BOSS CHARGERS

(continued)

afford the heavier outlay for the metal rectifier models.

Other Boss Lines.

Other lines manufactured by the Boss Electrical Manufacturing Company include arc welding plants, spot welders, heavy duty power transformers, motor generator sets, and home lighting plants.

Complete information on all Boss lines is obtainable free on request from The Boss Electrical Manufacturing Company, 776-8 Parramatta Road, Lewisham, Sydney, N.S.W.

As the charging of a group of batteries progresses, the reduction being due to the rise in battery voltage. An adjustment of current after the first hour is generally sufficient unless there is considerable variation in the alternating supply voltage. Toward the end of the charging, a reduction in current is desirable, as there is considerable "gassing" of the electrolyte, and it is therefore necessary to keep the charging current at a lower rate.

Clyde heavy duty radio battery of the plug-in type.



When charging overnight the current should be adjusted a trifle lower, to insure batteries against damage.

The best method to determine the condition of a full charge of lead batteries is to use a hydrometer.

A battery charge is complete when, with current flowing at normal rate, all the cells are "gassing" (bubbling) freely and evenly and the specific gravity has remained constant for a period of five hours. (The specific gravity is indicated by a hydrometer).

The specific gravity of a good auto-
(Continued on page 18)



"MORE POWER TO YOU"

CLYDE BATTERIES

UNCONDITIONALLY GUARANTEED

CAR . . . RADIO
HOME LIGHTING

PRODUCT OF THE CLYDE ENGINEERING CO. LTD.
Obtainable from garages everywhere

WRITE NOW FOR YOUR
COPY OF LATEST PRICE LIST
ILLUSTRATING AND DESCRIBING
COMPLETE RANGE
OF CLYDE RADIO AND CAR
BATTERIES.

The Clyde Engineering
Co. Ltd.

SYDNEY, MELBOURNE, BRISBANE,
ADELAIDE

ONCE MORE
TO THE FORE
PATON!

WITH THESE TWO OUTSTANDING TESTING LINES

Paton Electrical equipment is remarkably simple, quiet, and accurate to operate from the start.

Providing an outstanding range that enables every experimenter and serviceman to secure an instrument for every radio and electrical check-up requirement.

Paton is undoubtedly the leader in its field, equal in all respects to the world's best.

Put any thoughts of expense right out of your mind! Paton equipment is reasonably priced, and is easy to purchase. You can't afford to be without the many advantages Paton equipment offers you.

Phone or call on your nearest distributor right away and make enquiries—it will pay you handsomely!

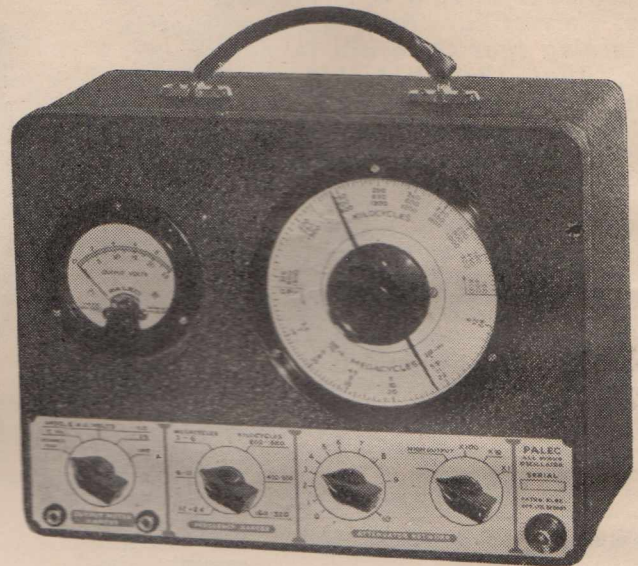

NEW "G" SERIES - - - ALL-WAVE OSCILLATOR

The new "G" series of modulated Oscillators with improved circuit design is outstanding for the variety of models available and the adaption of several important features hitherto exclusive to expensive standard Signal Generator design.

6 Models — Prices range from

£12/5/0 TO £18/12/6

MODEL "M" SERIES MULTIMETERS

Have a solid cast aluminium case measuring 8in. x 6in. x 2½in. . . . used to house all four types. The basis of each instrument is the new "PALEC" Model "K400" rectangular moving coil Meter, which gives excellent accuracy and legibility on a scale ¾in. in length. RANGES:—Volts, 10-50-250-100v. Current, 1-10-50-250 M.A.'s D.G. Resistance is three ranges from a quarter of an ohm to 15 megohms.

FOUR MODELS FROM £4/19/6 TO £9/5/6

All prices subject to slight alteration without notice

DON'T DELAY . . . SEND NOW FOR FREE DETAILED CATALOGUE OF THE PATON EQUIPMENT THAT INTERESTS YOU TO—
Obtainable from all leading distributors

PATON  *Electrical*

PATON ELECTRICAL PTY. LTD., 90 VICTORIA STREET, ASHFIELD. PHONES: UA 1960...1982

USING AN OSCILLATOR

In response to many requests we are giving this article which tells in detail the way in which an oscillator should be used.

The article is based on a booklet entitled "Twelve Uses for an R.F. Oscillator," which was issued by the old Slade-Paton Company many years ago, but it has been revised to bring it up-to-date, although the original fundamentals hold good to-day, just as they did years ago.

THE advancement of radio design and engineering has brought with it an increasing need, not only for test equipment, but for detailed information as to the application of same in the field of set building and servicing.

There are few, in this comparatively new industry of radio, who are in the fortunate position of having had a thorough technical training, consequently there may be some, particularly in the country, who perhaps will welcome the information contained in this article.

The article, which we hope will be one of a series, is to help the service man to gain an appreciation and a knowledge of the correct procedure in the use of a modern oscillator or signal generator, in conjunction with a multi-range rectifier type output meter.

This combination—the oscillator and output meter—if intelligently and systematically operated, will prove one of the most valuable and versatile pieces of testing apparatus that the service workshop can be equipped with.

Experience will show that it is well nigh impossible to perform a 100%

across the speaker's input transformer.

Meter leads equipped with small alligator clips can be used to clip on to the respective socket legs, when the servicing is done with the chassis on the bench. If it is desired to connect up the output meter while the set is still in the cabinet, some method of connecting the meter leads to the speaker plug or power valve will need to be devised.

The writer uses a couple of lengths of spring copper wire, spaghetti covered, which have an eyelet at one end, that can be slipped tightly over the pins, and enable the meter leads to be connected up to same.

In lieu of this, two lengths of rubber flex can be bared for half an inch or so and tightly wound round the pins, taking care they do not short to chassis.

In the case of the speaker input transformer, the correct pins on the speaker cord will need to be identified with an ohm-meter. The average resistance of the input transformer will be about 300 ohms, so that its pins can easily be identified as the field coil will be found to be much higher.

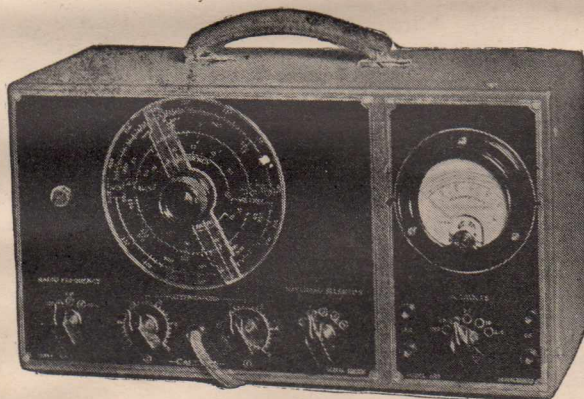

Calstan oscillator, model 306A, battery-operated, with output meter.

test job without some form of controlled signal generation. This applies not only in the case of aligning and tracking, but also in the process of bringing a set's performance back to its original standard.

The Output Meter.

The usual method of hook-up is

Dummy Antenna.

The use of dummy antenna for coupling the R.F. oscillator to a receiver's input is advantageous, as the set will then operate under more normal conditions.

The dummy antenna has similar characteristics to the average aerial, and as they are simple of construc-

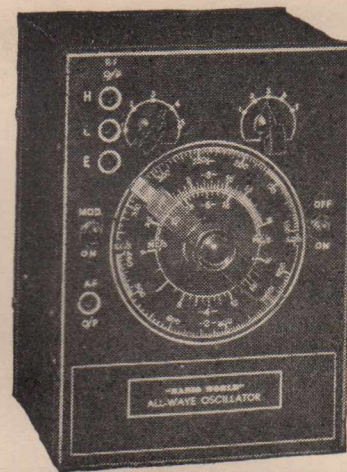

The "Radio World" all-wave oscillator described in January, 1940, issue of "Radio World."

tion, the use of one is advised.

The dummy antenna is nothing more than a coil, a resistance, and a mica condenser.

The coil can be thirty turns of number thirty-two B. & S. enamel wire on a one and a quarter inch former, the resistance twenty-five ohms and the condenser .0002 M.F., all being in series.

The circuit arrangement is shown graphically in Fig. 4. This device is inserted between oscillator output and aerial terminals of receiver, and is used on all tests where the oscillator feeds the receiver through the regular antenna input.

Aligning T.R.F. Receivers.

A T.R.F. receiver fitted with a gang condenser not of the slotted and plate type cannot be made to track perfectly over the entire band, unless a variable trimmer, as one of the operating controls is incorporated, otherwise exact alignment can only be achieved at one point on the dial. This is due to the effect of the antenna capacitance and inductance on the first R.F. circuit.

It remains then for the service man confronted with this type of set (minus variable trimmers) to decide as to which point on the dial the aligning adjustment should be made for best results.

A lot will depend on the locality. If interference from one particular station is the problem, line up at this frequency. Usually, however, the trimmers are peaked at three or four points along the dial, and a mean adjustment then arrived at. Should the set have a variable trimmer manually operated, then this trimmer should be turned half way out of mesh, and the aligning done midway along the dial.

Tracking Process.

The process of tracking can then be gone on with, as follows:—Dis-

(Continued on page 16)

connect the antenna from the radio set, replacing with shielded lead from the oscillator (usually marked R.F. output). The other lead from the oscillator goes to the earth terminal on which the ground wire is left attached.

The output meter is then connected as previously described. Switch on both oscillator and set. Adjust oscillator dial to the required frequency. Tune in the set to the signal, selecting the range of the output meter so that about high scale deflection is shown at peak.

Adjusting the Condensers.

The adjustment of the various compensating condensers on the side of the gang can then be gone on with.

As the screwdriver (preferably a bone or ivory one) brings each section of the gang into line, the output meter will show increase. As it approaches maximum deflection, reduce the oscillator attenuator. Carefully adjust each trimmer so that a fraction of a turn either way will cause the needle to drop.

Receivers having a slotted plate condenser can be made to track over the entire scale, by carefully bending the segments of the end plates until correct alignment is attained in each of the individual sections (usually five or six).

Adjustment should be made at such oscillation frequencies that in each case, when the receiver is tuned to the oscillator frequency, the split segment is about half way in mesh with the stator plate.

The process, when first attempted, may prove somewhat tedious. A little practice will soon remedy this. Well matched coils and a good make of condenser will simplify matters.

Neutralising T.R.F. Receivers.

In the old Neutrodyne, many of which are still in operation, neutralisation may be made with the oscillator at the high frequency end of the dial. The filament circuit of each R.F. valve in turn is broken by inserting a piece of paper between valve pin and socket contact.

The neutralising condenser should then be adjusted until the output meter shows minimum deflection.

Connect up output meter and clip the R.F. output wire of the modulated oscillator to the grid of the valve ahead of the second detector, the other clip connecting to chassis.

Turn on set and oscillator and adjust the oscillator dial to the required frequency. Select the output meter to show about half scale deflection and then proceed to tune the transformer feeding the second detector.

Adjust the grid circuit of this intermediate transformer first, and then carefully the plate circuit. When the point for greatest needle deflection has been arrived at you can then proceed to repeat the operation on the percentage stage.

Due to body capacity effects in the intermediate transformers, it is highly advisable to use insulated screwdrivers of bone or ivory. Even so,

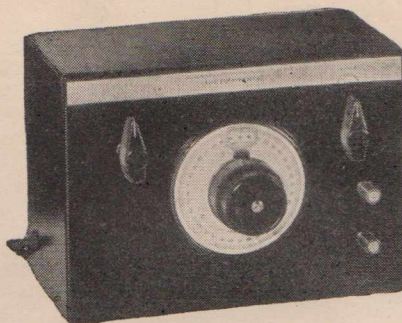

The University A.C. or battery oscillator is available from Radio Equipment Pty. Ltd., completely wired or in kit form.

it is as well to remove the driver after the condenser has been turned just a bit (when finally peaking), and note the response on the output meter. The final critical adjustment may need to be made in this manner.

Note.—If the superheterodyne has a separate oscillator valve, this should be pulled out while the above adjustments are being made.

Intermediate Line-up With A.V.C.

Adjustment of the intermediate circuits and the padding in the superheterodyne equipped with automatic volume control offers quite a problem. It is customary to adjust for greatest volume with the aid of an output meter. But this method is not dependable in a circuit where the gain is affected by the strength of the signal.

There are several methods by which the adjustments can be made in spite of the A.V.C. The simplest perhaps is to kill the automatic volume control, so that the output meter method can be used just as if no A.V.C. were built into the circuit. To kill the A.V.C. it usually suffices to short circuit a condenser, the condenser that is connected from the junction of the various individual resistors and the single resistor which goes to the diode. Another method is to have a socket adaptor which will enable a very sensitive meter to be inserted between the diode pin and its resistor, from which the automatic biasing voltage is attained. The current through this resistor will be small—about 50 to 100 microamps, depending on the size of the resistor—so that naturally a very sensitive meter would be required to get a good deflection.

Perhaps the simplest way is to attenuate the incoming signal from the test oscillator to such a degree that the R.F. voltage is not strong enough to bring the A.V.C. into operation.

For good deflection it will be necessary to select a low range on the

output meter. A sharp, definite peak will indicate the absence of A.V.C. influence.

Aligning For Flat Top.

Some manufacturers design their intermediate stages so that its tuning curve is flat-topped in order that the band-pass effect minimises the suppression of sideband frequencies.

For "flat top" resonance the modulated oscillator must be set a few kilocycles off resonance, that is, if the intermediate frequency is fundamentally 175 K.C. the oscillator is set at 172.3 kilocycles and one of the intermediate circuits is peaked at this frequency.

The oscillator is then set to 177.8 K.C. to which the other remaining intermediate is aligned. The output meter should show no appreciable change when the test oscillator frequency is shifted from the former to the latter.

To Align A Superheterodyne.

Many service men are rather diffident of attempting the adjustment of the oscillator circuit of a superheterodyne, which follows the lining up of the intermediates, yet there is nothing difficult about it.

The method of procedure is as follows:—Connect up the output meter and couple the modulated oscillator to the aerial and earth terminals of set. Switch on, then:—

- (1) Open out padder.
- (2) Adjust modulated oscillator to, say, 1,450 K.C., and tune in the set (at the high frequency end of dial) for maximum deflection, as shown on the output meter.

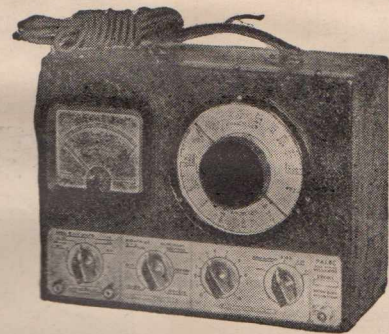

New "G" Series all-wave oscillator by Paton Electrical Pty. Ltd.

- (3) Peak the oscillator section of the gang condenser.
- (4) Follow by peaking the other (R.F.) sections of the gang.
- (5) Turn modulated oscillator to 600 K.C. and tune set to this frequency.
- (6) Carefully adjust padder for maximum deflection.
- (7) Turn back modulated oscillator and set to 1,450 K.C.

(Continued on page 17)

USING AN R.F. OSCILLATOR

(continued)

(8) Make a final critical re-adjustment of the oscillator trimmer.

The object of tracking and padding is to obtain a fixed relationship between oscillator and R.F. circuit; in other words, the oscillator is made to tune to a frequency equal to the R.F. circuit, plus the amount of the intermediate frequency, at all positions on the band.

A check should be made to see if this relationship is holding at each end of the dial after the final adjustment No. 8 has been made.

To do this go back with oscillator and set to 600 K.C., tuning carefully to this point. Now note the effect on the output meter of a fraction of a turn of the oscillator trimmer. It should drop sharply if turned slightly either way, indicating that perfect tracking has been attained.

An increase in the output meter means that the whole procedure should be gone over again, as one adjustment slightly affects the other.

Note.—Never adjust any trimmers at 600 K.C. after they have been set for 1,450 K.C.

Noises and Loose Connections.

Noises in a receiver are often due

to a bad contact somewhere in the circuit.

The oscillator provides a ready means of locating same.

Couple the oscillator to the input of set, switch on, and apply a strong modulated signal of a frequency within the broadcast band.

When the audio note is heard, go over wires and components, moving and shaking same while listening for evidence of the faulty contact in the otherwise steady note coming from the speaker.

Should the source of the trouble be rather elusive and difficult to find, the oscillator should be used in such a way as to be able to locate the particular stage in which the fault lies.

The method of procedure is to work from the audio stage towards the R.F. end, stage by stage. You may start by coupling the oscillator to the grid of the second detector and with the preceding tube pulled out, shake and jar the chassis. If the note in the speaker remains steady, try the next stage, repeating the process, until the offending circuit is identified.

Faulty Valves.

Intermittent noises may sometimes be due to a valve in which the elements inside the bulk have become loose. A gentle tap on each valve as you work along should not be overlooked.

To Determine Overall Gain.

Sensitivity tests may be made at various frequencies, as the R.F. output attenuator is an accurately, controllable instrument, and the operator will find it possible to make notes on the responsive receivers, in terms of the setting of the attenuator.

This means that if the setting of the R.F. output control necessary to give a certain output from the receiver is recorded, these values may be used for comparison of the sensitivity of the same receiver, or one of the same type, at a future date.

Accumulation of data of this type is of great value to the service man, for its use makes it possible to ascertain the condition of the receiver, as it is received from the customer, in comparison with the condition when it was returned to same.

To Check Valve Efficiency.

The oscillator and output meter supply a very effective method of checking the efficiency of a valve. Apply a signal from the oscillator to the antenna and ground terminals, and tune in on output meter on a range which will give about half scale deflection.

Now, without altering the volume control, go through the set from one end to the other, replacing valves one

(Continued on page 18)

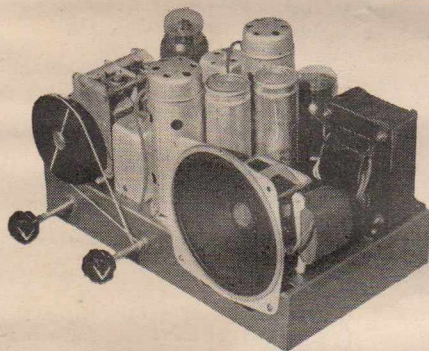

Tip Top Values on all Parts for the "TIP TOP" from RADIO EQUIPMENT Pty. Ltd.

Pardon the pun, but we just couldn't resist it. Put it down to enthusiasm, for if there's one thing we possess in plenty up here at Radio Equipment, it's enthusiasm—enthusiasm to do a good job . . . for YOU—enthusiasm to supply "Tip-Top" parts of first-grade quality at prices that are real surprises!

Why not TRY what we have to offer? After all, a quotation costs nothing, and if you've never tried us, you don't know what really snappy service IS!

THE FAMOUS "UNIVERSITY" OSCILLATORS AS USED BY THE EDITOR

Here it is, the original "University" oscillator used by Mr. Hull in his article on oscillators in this issue. You can obtain it in four forms:—

1. A.C. operated kit of parts.
2. A.C. operated completely wired and calibrated.
3. Battery operated kit of parts.

4. Battery operated, completed wired and calibrated.

This is a really first-class testing unit, ideal for aligning all types of broadcast and short-wave receivers. Prices from as low as £5/14/6, plus tax. Terms available.

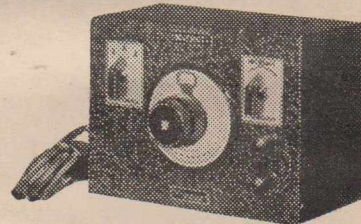

Radio Equipment Pty. Ltd.

The Radio Kit Specialists,
BROADWAY, SYDNEY.
Phones: M 6391 and M 7392. Telegrams: RAQUIP, SYDNEY.
Dear Sirs,

Please send me without obligation on my part your free Radio Buying Guide. Also quote for.....
NAME
ADDRESS R.W.4

RADIO BUYING GUIDE

If you are a genuine purchaser of radio parts, kits or test equipment, we will mail you, post free, a copy of our splendid up-to-date Buying Guide. Send coupon for your copy to Radio Equipment Pty. Ltd., Broadway, Sydney. We are distributors for "University," "Calstan" and "Palec" test equipment, R.C.S., Radiokes and all quality branded lines.

USING AN R.F. OSCILLATOR

(continued)

by one, and noting the increase, if any, the new valve will show on the output meter.

Stage Analysis.

When the radio man has a set to service, the usual procedure is to bring out an analyser, and systematically to seek the trouble by plugging in from valve to valve.

This method, in most cases, will enable the operator to quickly locate the trouble. Nevertheless, there are times when the analyser will fail, in that it will show every valve and circuit apparently in order and yet the fault still persists.

Here the modulated oscillator will prove invaluable, as stage to stage analysis can be quickly made and the trouble definitely localised.

The method of making stage analysis is to apply the output of the service oscillator to the circuit preceding that of the output and noting the response on the output meter. Work back towards the aerial, noting the amplification of each stage until the faulty stage is identified.

It remains then to be seen as to whether the fault is in the primary or secondary circuits of offending stage. After this test is made by touching the R.F. output cord on to the grid, which will be the secondary side, or the plate of preceding valve which is the primary, the search is then narrowed, and the trouble should be quickly run to earth.

Selectivity Tests.

The modulated oscillator and output meter can supply a rough but very effective indication of a receiver's selectivity, which can be used to advantage in many ways.

The practice of making a selective test on all receivers, both before and after servicing, has much to commend it, as against the rule of thumb method of checking against a station.

The principle of the test consists of applying a signal from the oscillator to show at resonance a certain standard reading on the output meter.

The oscillator dial is then shifted 10 K.C. This will drop the output meter needle. The attenuator of oscillator is then advanced until the meter reads as at resonance.

The amount of this advance as shown on the graded dial of the attenuator will indicate the receiver's selectivity.

The greater the amount of advance the sharper the tuning, and vice versa.

This 10 K.C. of resonance test should be made both above and below the original setting.

The operation should be carried out at both ends of the dial, at, say, 600 K.C. and 1,450 K.C.

CARE OF BATTERIES

(continued)

mobile battery, fully charged, is between 1.275 and 1.300. The voltage, while charging as above, is between 2.5 and 2.7 volts per cell when fully charged. The voltage of the battery falls to 2.25 or 2.35 volts per cell as soon as the charging is completed.

Measuring the voltage of a battery when idle, that is, when the battery

is neither charging or discharging, gives no indication of the condition of the battery's charge.

Do not change connections between batteries unless A.C. switch is off.

Always turn control switch off before removing or adding batteries to charging line.

Keep rectifier bulb screwed well into socket. Keep contacts inside of bulb socket clean; sandpaper them occasionally.

The Best Tip for Best Results!

Insist on **RAYMART**
CRAFT A CREED

SHORTWAVE AND
ULTRA SHORTWAVE
GEAR

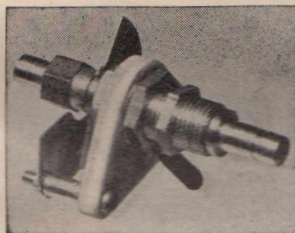

RAYMART LOW-LOSS TRIMMER
CONDENSERS

New range of low capacity condensers, with all Raymart constructional features. Available in these capacities and types—

MC7DX—double-spaced, 7 mmfd., max.	9/-
MC15X—single-spaced, 15 mmfd., max.	7/6
MC15DX—double-spaced, 15 mmfd., max.	9/-
MC40X—single-spaced, 40 mmfd., max.	9/-
MC100X—single-spaced, 100 mmfd., max.	10/-

Write for descriptive leaflet.

Designed and constructed by an English Company specialising in the production of high quality short-wave gear, RAYMART equipment has won world-wide recognition for its standard of efficiency and the quality of results obtained by its use. "The Friendly Wholesale House" recommends RAYMART equipment without qualification. Write for catalogue showing complete range of RAYMART shortwave and ultra short-wave gear — NOW!

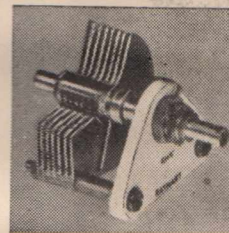

RAYMART CERAMIC
MICROVARIABLES

The use of RMX Dielectric ensures greatest efficiency at high frequencies; construction is all-brass ball-bearing drive, ball-race electrically shorted out to ensure freedom from noise. Designed for ganging, available in capacities from 15 to 250 mmfd.

Use the "World's Finest Sound Reproducers" for the ultimate in high fidelity reproduction and efficient performance. For the "Tip-Top" specify K5 25/-

**Rola
Collaro**
MAGNETIC
PICKUP

Use a Collaro Pickup on your entry for the "Amplifier Championship." Special design gives minimum tracking error and record wear and extended frequency range without noticeable distortion. Attractive metal finished arm with separate arm-rest. Price 37/6

JONMAR KITSETS are available for all "Radio World" sets. Complete to the last lug and screw. Only matched components are used, and JONMAR Kitsets are compiled by experts. Same-day dispatch service. Write for parts list and quotations for any "Radio World" Kits and everything radio and electrical.

Telegrams: "Jonmar," Sydney.

Telephone: BW 3109 (2 lines)

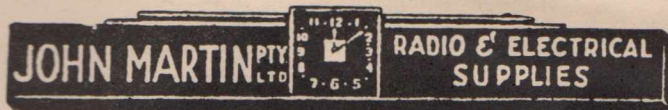

116-118 CLARENCE STREET, SYDNEY

Standard A.C. Power Unit

How to build a standard a.c. power unit suitable for all sets, described in the Radio World, requiring a separate power unit. Standard parts are used throughout.

WHEN describing the "World Standard" and "De Luxe Fidelity 8" receivers and the "Big Boy" and "Baby Grand" amplifiers we did not go into detail in regard to the power supply unit, simply recommending the use of a separate power unit, as the easiest and neatest way of building up these jobs.

Whilst we went to some lengths to describe a suitable power unit for general experimenting, we did not actually describe the circuit, wiring and construction of a standard type of power unit. Apparently this is causing some misunderstanding and so we hasten to give these details of a power unit which uses only stock components and is completely suitable for use with any of the above circuits.

The "Fundamental" power supply unit, which we suggested as being a wonderful handy unit for any ex-

RIGHT: This photograph shows neat design. Power socket can be seen below power-transformer.

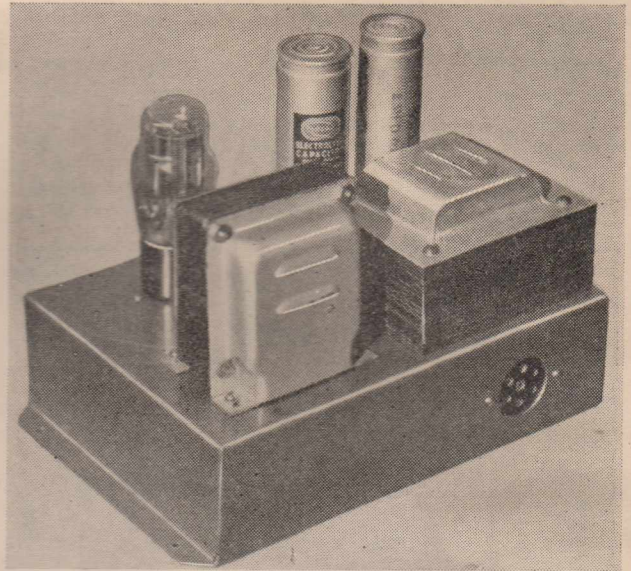

PARTS LIST.

Standard A.C. Power Unit.

- 1—Base 7" x 9½" x 2½" (Acorn, Arcadian)
- 1—Power transformer, 385v. @ 150 m.a., with 6.3v. filament windings (R.C.S., Radiokes)
- 1—Choke, 150 m.a. (Radiokes, R.C.S.)
- 2—Electrolytic condensers (T.C.C., Solar)
- 1—4-pin socket
- 1—6-pin socket
- 3yds. power flex
- 1 yd. hook-up wire
- 1—type 80 valve (Radiotron, KenRad, Philips, Mullard, Brimar)
- 1—Rubber Grommet

perimeter's bench, differed from this one in so far as it had separate transformers for filaments and high tension, with tapped primaries for each so that a certain amount of adjustment could be made to both filament and high tension voltages, and with these adjustments independent of each other.

This "Standard" unit uses standard type transformer and apart from the usual tapped primary for different supply voltages, cannot have the voltages adjusted.

The Transformer.

The main transformer has a secondary rated to supply 385 volts at 125 milliamps, or at 150 milliamps if a reserve of power is preferred. Filament windings are provided for 5 volts at 3 amps, for a rectifier, and two 6.3 volt windings for the other valve heaters.

The primary of the transformer has the usual tappings for 200, 220 and 240 volts.

Photograph at left shows close-up of power unit. Components are well spaced, to reduce possibility of hum.

Transformers to these specifications are a stock line and readily available from any of our advertisers.

The Choke.

The filter choke is also a stock line. We suggest one with a nominal rating of 150 milliamps, as if the current actually handled is less than this, there is no harm done, and on the other hand there is increased effective inductance and a more efficient smoothing of the hum.

The heavier choke also has an advantage in having a lower internal resistance, so that heavy demands

(Continued on page 20)

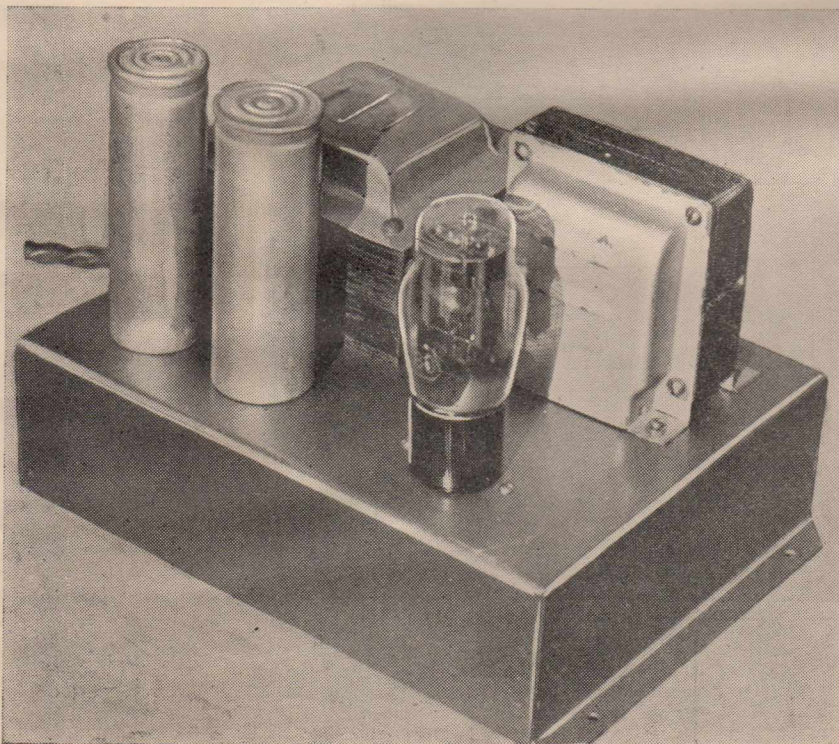

RIGHT: This picture diagram shows the simple layout and wiring.

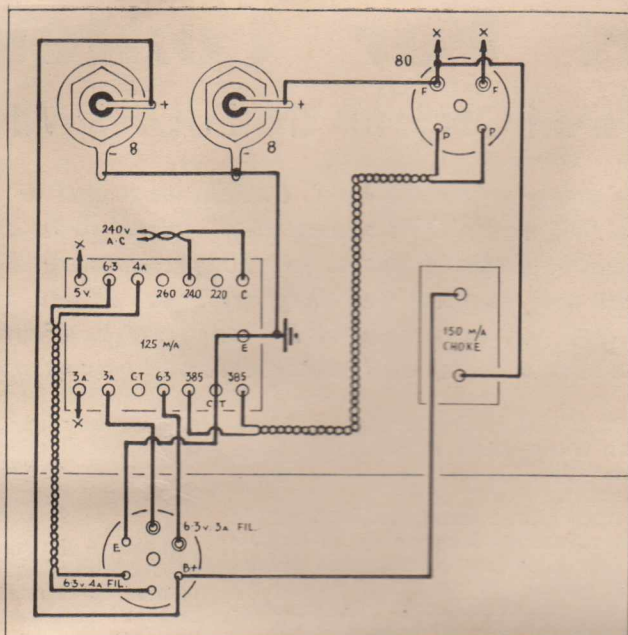

dinary rectifier. The actual increase in voltage will depend upon the actual current drain, and should be taken into account in the design of the equipment which is plugged into the power unit. For all normal requirements we recommend the old reliable type 80,

The Wiring,

The wiring up of the power unit is a very simple task, and should only take a few minutes to do. Great care should be taken, however, especially with regard to the power input, which is the most dangerous part,

The power supply cable should be a three-wire circular flex, with the third wire earthed to the metal work of the base.

A rubber grummett should be fitted to the hole where the power flex goes through the base, so that the rough edges of the metal cannot cut through the insulation of the flex, which might mean a serious short-circuit,

Still another precaution with the power flex is to tie a knot in it on the inside of the base, so that any pull on the flex will be taken by the knot and there will be no chance of the wires being pulled from their terminals,

The Outlet.

The most convenient form of outlet is the six-pin socket, as shown in the diagrams.

This is quite shock-proof under normal conditions and the whole unit, so long as it is not turned upside down, is safe.

The connections to the six-pin socket, as shown in our diagrams are easy to remember as they are fairly logical. The two heater pins take the main heater supply, the P takes the high tension, the cathode pin is earthed and the alternative heater supply takes the two pins opposite the main heaters.

RIGHT: A photograph from underneath the power unit. Study this together with the circuit and the diagram above.

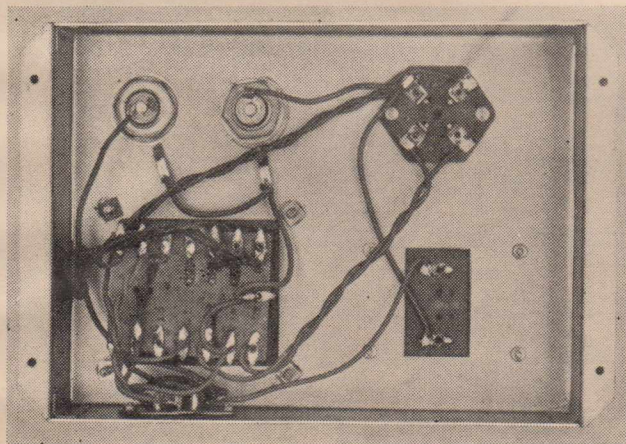

The finest thing that can be said about any resistance unit is — that it is made by

IRC
Initiative — Resourcefulness — Cooperation
to advance the interests
of the industry

IRC INSULATED Metallized RESISTORS

Sole Agents for Australia:
WM. J. McLELLAN & CO.
BRADBURY HOUSE
55 YORK STREET — SYDNEY

Keen Start For Contest . . .

AMPLIFIER CHAMPIONSHIP IN FULL SWING

The Amplifier Championship being organised by A. G. Hull on behalf of "Australasian Radio World" is now in full swing. On Tuesday evenings, amplifier enthusiasts gather at the Australian Radio College to listen to the preliminary heats, and select the finalists. All seats are reserved, but they are free. If you would like come along some Tuesday night you have only to fill out the application form, and post it immediately. You'll be welcome and you'll meet a fine gang of radio men.

The first audition for the Amplifier Championship was held on Tuesday, June 11, and as we expected it proved an interesting affair.

The Judges.

Some thirty odd enthusiasts turned up to provide the audience and seven of the official judges were present. These were Messrs. Parramore and Erman of the Recorded Music Society, Hardridge of R.C.A.-Photophone, Page of E.T.C. Industries, Head of Amplion and Graham of the Australian Radio College.

The Competitors.

Five competitors were heard. No. 1 was an entry by L. G. Hirst, the amplifier being a direct-coupled job

with a 2A6 driving a single 2A3 output triode, with a "Garrard" magnetic pick-up, and an old Amplion speaker.

At a glance these specifications did not reveal anything likely to be outstanding, but as soon as the official test record had run a few revolutions it was apparent that the job was capable of turning out mighty fine quality, and lots of it at that.

Similar to "Big Boy".

No. 2 was a push-pull 6L6G job, somewhat after the style of "Big Boy," and again the audience was treated to some fine reproduction, but this competitors choice of recordings did not appear to suit those present,

and a rowdy jazz number played with much gusto failed to give the right impression to judges and audience alike.

Loud Volume Level.

Again in the case of No. 3 the choice of recordings and the rather loud volume level maintained appeared to frighten rather than impress those present.

The amplifier was a push-pull 2A3 job with high-grade audio transformer coupling and a 12" Jensen auditorium speaker. The entrant was A. R. Taylor of Cammeray.

Competitor No. 4 was Colin F. Cameron of Maroubra Bay, who brought along an amplifier with a 57 driving a phase-changer, and a pair of 6L6G beam power outputs.

This amplifier gave reproduction of a very high standard, with a reasonably wide range of frequencies handled, and no trace of undesirable resonances or distortion, and we were a little surprised that its performance was not appreciated by the audience.

Excellent Recordings.

No. 5 was an entrant from John Crawford of Punchbowl, and consisted of a pair of 6B5 output valves driven through a phase-changer by a 6C6. With a Rola G12 in an infinite baffle this outfit turned out some fine quality, especially with some Telefunken recordings which appeared to have been recorded in a big hall and had an echo background effect which is seldom handled on ordinary recordings.

A Re-hearing.

By the time the five competitors had played through the official test record and given ten minutes of their own selections the judges went into a huddle, but would not pronounce a verdict until they had heard the No. 1, 4 and 5 competitors a second time, each playing the reverse side of the test record only, and one after the other as quickly as possible.

The Result.

After this test the public vote was taken and resulted in an overwhelming victory for No. 5.

The official judges, however, in the

LIST OF PRIZES

Goods to the value of 3 guineas, by W. J. McLellan & Co. (I.R.C. Resistors);

Goods to the value of 4 guineas by Ducon Condenser Pty. Ltd.

Mullard Valves to the value of 5 guineas, by Mullard-Australia Pty. Ltd.

Packard Lectro-Shaver, valued at £5, by John Martin Pty. Ltd.

Philips Valves to the value of 5 guineas, donated by Philips Lamps (A/sia.) Pty. Ltd.

Test Meter, valued at £6, by Radio Equipment Company Pty. Ltd.

Goods to the value of £18/16/-, by Amplion (Australasia) Pty. Ltd.

Brimar Valves to the value of 5 guineas, by Standard Telephones & Cables Pty. Ltd.

Five-band Communications type tuner kit, valued at £13/12/6. by R.C.S. Radio Pty. Ltd.

Rola G12 Speaker, valued at £8/12/-, by Rola (Aust.) Pty. Ltd.

Meter valued at 2 guineas, by Paton Electrical Pty. Ltd.

And

Cheque for ten guineas, Championship Cup and Blue Ribbon, by the proprietor of the "Australasian Radio World."

meantime had reached a unanimous verdict in favour of No. 1.

This was rather remarkable, as No. 1 received only one vote in the audience ballot.

The Second Audition.

The second audition was held on Tuesday night, June 18, when the elements were at their worst. Steady rain and a bitter wind proved too much for several competitors and only three turned up.

The Competitors.

No. 1 was an entry from Leslie Tanner of Canley Vale, and consisted of a 6C6 as triode, driving a single 42 pentode.

Naturally this small valve was not able to deliver up any great amount of volume without a certain amount of distortion being introduced. It gave excellent results, but could not hold its own with the more powerful ones present.

Complete With Guitar Players.

No. 2 was entered by H. T. Davis of Como West, who brought along not only an elaborate amplifier, but also three electric guitars complete with players. He first played the official record and then the guitar players gave a demonstration. This was a little unexpected, but as there did not appear to be anything in the rules against such a procedure it was welcomed and proved an interesting diversion.

The amplifier consisted of several stages, ending with a pair of 2A3 triodes in push-pull. A heavy bi-fonic baffle box was used with a Jensen "M" type speaker, but without an exponential flare, which Mr. Davis

later explained as being fitted under normal conditions.

Two Pick-ups at Once.

Naturally the performance of this amplifier was good, but appeared to be slightly down at the blow end, and it was also doubtful whether it was heard at its best with twin pick-ups running one behind the other on the same groove. To the average listener this "trick" might have been impressive, but to the many trained ears

present it did not represent true realism or fidelity, and so it was left to competitor No. 3 to walk away with the unanimous verdict of both official judges and public audience.

The Winner.

Competitor No. 3 was A. E. Hughes, of Marrickville, with a pair of 6A3 output valves with resistance-coupled phase-changer, crystal pick-up and a Rola K12 speaker. This outfit gave

(Continued on page 24)

APPLICATION FOR SEAT RESERVATIONS

To The Organiser,
Amplifier Championship,
117 Reservoir Street, Sydney.

Please reserve me.....seats for one of the auditions of the judging heats of the Amplifier Championship.

I enclose a 2d. stamp for postage.

NAME

ADDRESS

THIS APPLICATION MUST BE IN THE HANDS OF THE ORGANISER BEFORE JULY 30

You still have time
to use a



CRYSTAL PICKUP
for your entry in the
Amplifier Championship

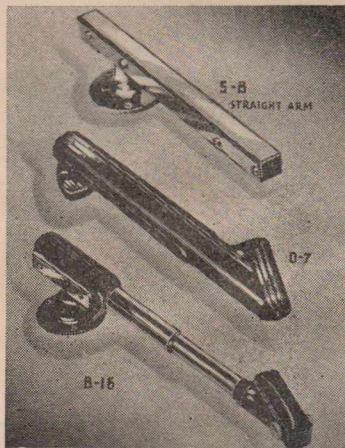

Piezo Astatic Crystal Pickups give brilliant lifelike reproduction with full bass and extended frequency range free from distortion. Needle weight of 2 3/4 ozs. eliminates record wear and tracking error is slight. Favoured known for their all-round efficiency and general dependability, Piezo Astatic and Brush Microphones give ideal frequency response without pronounced peaks.

PIEZO ASTATIC CRYSTAL PICKUPS—

Model S/8, Straight Arm	Model O-7	£2 15 0
or Bent Arm	Model B10	£7 7 0
Model S/12, Straight Arm	Model B16	£10 10 0

PIEZO ASTATIC CRYSTAL MICROPHONES—

Model D104	Model JT30	£8 10 0
Model D104HS, with Hand Switch		£9 10 0
Models DN-50, DN-HZ		£9 12 0

BRUSH MICROPHONES—
Model AP £13 15 0

AVAILABLE AT ALL LEADING RADIO STORES

Factory Reps.:

E.T.C. INDUSTRIES - - Sydney and Melbourne

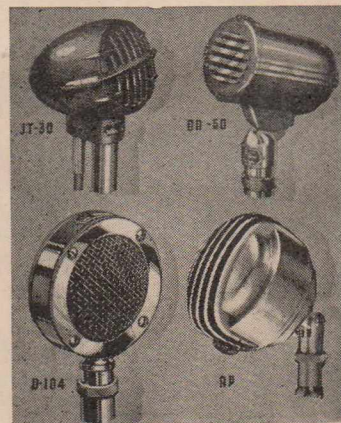

AMPLIFIER CHAMPIONSHIP

(continued)

just the results you would expect from a carefully designed amplifier of this type and such associated equipment, and although not startling, it was clean quality and quite satisfying.

The judges, however, expressed the opinion pretty freely that the standard of performance at the second audition was not as good as at the first.

Third Heat.

The third heat of the contest was held on Tuesday, June 25, and just showed how much we depend on the pointing of the finger of fate.

On the previous Tuesday, nine were sent for, and only three turned up. For the third heat, nine were again sent for, and this time they all turned up, bringing enough gear to stock a radio shop.

The large number of competitors present made it a long evening, and the hall wasn't cleared until 11.30 p.m.

Third Heat Competitors.

No. 1 in the third heat was an entrant who came all the way from Wollongong to bring an amplifier consisting of double push-pull 2A3, with phase-splitting valve, and high-grade English audio transformers. A large auditorium speaker was used, but was fitted in a hastily constructed baffle, and in our opinion there must have been something wrong in the design or construction of this unit, as it failed to give the desired effect and spoil that would undoubtedly have been a mighty fine amplifier.

No. 2 was the reigning champion, H. J. Carter, who was the Champion of Champions at the 1934 contest. On this occasion, however, Mr. Carter was not at his best. Perhaps he had

not had sufficient time to get his new amplifier going at its best, and results were not up to expectations, although not by any means poor, of course.

The job used a pair of 6L6G beam power valves in the output, driving a Jensen "M" type auditorium speaker, and driven by a resistance network, with paraphase phase-splitting, and what appeared, at a glance, to be a feedback.

The third competitor was Mr. Weelands of Ashfield, who brought along an amplifier using a pair of 50-type triodes in the final stage. One of these valves was working pretty close to its limit, and, as the amplifier warmed up to the work, the plate of the valve got redder and redder. At the finish it had practically the whole plate red hot.

A feature of this set up was the speaker, an old Jensen D8 with a home-made suspension system for the cone, consisting of a large cardboard spider across the face of the speaker. This speaker was fitted in a baffle box built to the specifications contained in our May issue, and yet it gave an entirely different effect to the baffle used by competitor No. 1, who worked from the same description, made a few minor deviations due to being unable to obtain the correct materials, and apparently completely upset the performance by so doing.

The fourth Competitor.

Fourth on the list was Mr. Barron from Granville West, who had a pair of 6L6G in a "Standard" circuit, with one of the old Saxon high-fidelity speakers.

Mr. Barron demonstrated his amplifier on both records and radio reproduction, and revealed a particularly clean high note response, and, although the lows sounded a little

weak, this did not appear to effect the official judges' opinion that it was the best amplifier present.

No. 5 was entered by H. Reid of Undercliffe, and consisted of a pair of 2A3 output valves, with resistance coupling from a pair of 6J7, with a 6J7 phase-splitter. One of the fine English "Hartley-Turner" speakers was used, and enthusiasts present were keenly interested to hear this speaker in operation, but it appeared to be unsuited by the acoustic box to which it was fitted, or for some other reason a fairly solid resonance appeared in the bass.

Mr. Reid thought that this might be a form of microphonic feedback, and the whole platform and floor appeared to resonate with the lows as put out. It seems that it is quite possible that this was a cause.

A Champion's Son.

Next competitor was Champion Carter's young son, a lad with ambition to follow in his father's footsteps. His amplifier, which we mentioned in last issue as being powered from an accumulator, was actually powered by a.c. for the contest.

No. 7 was an entry from a Mr. Gambling, of Chatswood, and consisted of a pair of 2A3 valves driven by the two sections of a 53, driven from a phase-changer.

The amplifier gave a good account of itself, and frankly, the writer was very surprised that it did not get a better reception from the judges and the audience.

No. 8 was a direct-coupled push-pull job, which was handled by P. A. Reed of Coogee. Mr. Reed explained that the amplifier needed to be warmed up before being stabilised and he brought along the necessary meters and test equipment to do this. However, when it came to performance the amplifier did not reveal anything startling, and

(Continued on page 42)

MAKE SURE OF MAXIMUM EFFICIENCY AND LONGEST LIFE
ADOPT AS YOUR STANDARD

Mullard

M A S T E R

RADIOVALVES

MULLARD-AUSTRALIA PTY. LTD. 367-371 KENT STREET, SYDNEY. Telephone: MJ4688

CHOOSE MULLARD FOR THAT PRIZE-WINNING AMPLIFIER!

Chosen the valves for that prize-winning amplifier yet? If not, you'll be interested to know that MULLARD offer an exceptionally wide range of output valves, in both American and Continental types.

There's a MULLARD valve for every purpose . . . over 300 types are listed in the 1940 MULLARD VALVE CHARACTERISTICS BOOK.

WRITE NOW

. (mentioning "Radio World") to the address given below, for your FREE copy of this valuable publication. (Please enclose a 1d. stamp for postage).

TWO NOVEL CIRCUITS

(continued)

those with one or more big receivers.

Little Tommy can listen to the thriller on it when Dad comes home tired.

Sister can use it to hear her favorite crooner when the rest of the family want to listen to war news—and so on.

Construction.

First step in the construction is to

get a good matchbox, and reinforce the drawer box with a layer of cardboard or thin wood. These will be glued into place and after the glue has set two holes are drilled at each end to take eyelets or some similar handy form of terminals for the aerial and earth connections and the two headphone leads.

For the coil a piece of stiff paper or cardboard is folded to fit into the box, about $\frac{1}{2}$ " x 1" x $1\frac{3}{8}$," and the winding consists of 70 turns of No. 32 gauge enamelled wire.

When using this kind of wire it is wise to remember that the enamel is

an insulator and any connections to the coil can only be made after the enamel has been scraped from the copper wire. This means that both

PARTS LIST. Two-Valve Super.

- 1—Base to suit.
- 1—250,000w. potentiometer (I.R.C.).
- 1—10,000w. potentiometer (I.R.C.).
- 1—2-gang condenser (Stromberg-Carlson).
- 1—dual-wave coil unit (R.C.S. and Radiokes)
- 1—I.F. with reaction (Radiokes, R.C.S.).
- 1—pair headphones (S.T.C.).
- CONDENSERS:
- 2—.00025 mfd. mica (E.T.C., T.C.C.).
- 1—.001 mfd. mica (E.T.C., T.C.C.).
- 6—.1 mfd. tubular (E.T.C., T.C.C.).
- 1—padder condenser (Radiokes, R.C.S.)
- RESISTORS:
- 1—10,000w. $\frac{1}{2}$ -watt carbon (I.R.C.).
- 1—20,000w. $\frac{1}{2}$ -watt carbon (I.R.C.).
- 2—50,000w. $\frac{1}{2}$ -watt carbon (I.R.C.).
- 2—75,000w. $\frac{1}{2}$ -watt carbon (I.R.C.).
- 1—250,000w. $\frac{1}{2}$ -watt carbon (I.R.C.).
- 1—2 megohm $\frac{1}{2}$ -watt carbon (I.R.C.).
- SOCKETS:
- 2—octal.
- VALVES:
- 2—1A7G's (Philips, Ken Rad, Brimar, Mullard, Radiotron)
- BATTERIES:
- 3—45v. "B" batteries (Eveready PR56)
- 1— $1\frac{1}{2}$ v. "A" battery (Eveready PR8).

ends will have to be scraped and also a strip of enamel from down the middle of the coil will be scraped away to allow the slider to make effective contact.

The slider consists of a small piece of spring brass or springy "tin." This slider is mounted in the lid of the box, so that as the drawer is pushed in or pulled out the effective inductance of the coil left in circuit is varied, thereby giving us the required tuning.

A small mica condenser should be fitted across the headphones to serve as an r.f. by-pass. In some cases it will be found that the set will work quite well without this condenser, but it is good practice to fit it.

Further details about this set can be obtained from the "Handy Man's Home Manual," which is on sale at Levenson's Radio, or direct from Mr. Lewis.

"Super Two-Valver"

THERE being only 24 hours in each day, and quite a few of the 24 being wasted in sleep, we haven't been able to try out a circuit from the latest issue of the American technical journal, "Radiocraft."

The circuit, which covers a novel design for a two-valve dual-wave battery-operated superhet for headphone work, seems to be just the kind of thing which would appeal to local readers. We feel sure that a number of enthusiasts will want to try out this circuit immediately, and so, instead of waiting until we get a chance to test it out, we are giving the details so that those who want to ex-

Watchword of.....

INVINCIBLE RADIO

THE KIT SPECIALISTS

WE'LL SAY IT IS—

"TIP TOP"

JUST what is needed, a three-four mantel model, as simple as the simplest, yet with just that last ounce of range and power. Straightforward layout makes for easy assembly.

YOU can build one for yourself in a few hours from our specially-selected kit of guaranteed components.

WRITE NOW for our special set-builders' price. It will show you that you can readily afford the luxury of owning one of these fine little sets.

REMEMBER we are kit specialists, we have had years of experience with amateur set-builders, and our fullest co-operation, advice and assistance goes with every kit we supply.

DON'T WASTE TIME—WRITE TO US FIRST FOR A QUOTATION.
Reply by return mail guaranteed.

Invincible Radio & Electrical Pty. Ltd.

SHOWROOMS: 102 CLARENCE ST., SYDNEY.
NORM COHEN, Manager. 'PHONE: BW 4115.

periment can get straight on with the job without any delay.

With the original set the headphones used were of the crystal type, having a high impedance. Headphones of this type are available in the "Brush" brand from the Sydney distributors, E.T.C. Industries Ltd., but the price is £6 a pair, which we feel sure is going to be a little on the high side for the man who likes to experiment with simple circuits.

There doesn't appear to be any reason why ordinary headphones should not be used, even if they don't give quite the same degree of efficiency.

An Interesting Experiment.

An interesting experiment to try would be to use a power transformer or audio transformer as a step-down ratio output transformer to get a better impedance match.

An ordinary output transformer as used with a dynamic speaker might



A photograph of the "Super Two" removed from the cabinet. The midget batteries can be seen below the set.

also be tried. Even if it is not of the correct ratio for maximum efficiency, it might help a bit.

The Arrangement.

The circuit arrangement provides for two 1A7G pentagrid converters, the first used in the ordinary way, and the second with its triode unit as detector and its pentode portion as audio amplifier and output.

Naturally the circuit is a shade more complicated than typical circuits for "blooper" twos, but should be far more efficient.

The New 1.4 Volt Valve has Simplified Country Radio!

- ★ No Accumulator
- ★ No Recharging
- ★ Fewer "B" Batteries



If you want to enjoy Country radio at its best—buy one of the new 1.4-volt models available this year. Utilising the amazing new 1.4-volt valve and equipped throughout with dependable Eveready Radio Batteries—a combination that is unbeatable for simplicity and economy—it has **NO ACCUMULATOR**, and thus no recharging problem. In addition it requires only **TWO "B" Batteries** instead of three, so that operating costs are reduced by **ONE-THIRD**.

Practically every set manufacturer in Australia is turning to 1.4-volt radio as the answer to the Country listener's demand for a more convenient, more economical type of set. Ask your dealer to demonstrate next time you are in town.



R57-1531



EVEREADY (AUSTRALIA) PTY. LTD., SYDNEY, N.S.W.

Shortwave Review

CONDUCTED BY

L. J. KEAST

Daylight Reception at its Best ★ **Stations in Frequency Order** ★ **Stations in "Countries" Form** ★ **Australian Mail at Radio Saigon** ★ **N.I.R.O.M. will Q.S.L.** ★ **Full List of Month's Loggings**

CONDITIONS over the last month can only be described in the one word, "patchy."

The unusually warm weather experienced during the week-end of June 15 upset reception, as stations generally putting in a fine signal from 6 a.m. to 9 a.m., were very, very poor. However, when we have a thunderstorm in the middle of winter, I guess the short waves figure they have a right to play up.

Daylight Reception Now At Its Best.

But we can't complain; daylight reception is now at its best and with the short period of "dead spot" from about 11 a.m. till 1 p.m. and sometimes not as long as this, the principal cities can be heard at terrific strength, and, what is more important, with almost incredible clarity, right throughout the day. From 6 p.m. till 9.30 p.m., with the exception of stations north of Australia, there is a lull, but quite often at this hour London and Europe commence to trickle through.

Choice of Stations.

As the night wears on, and definitely by midnight, the choice of stations is very great.

Listeners at present have a good opportunity of hearing the Cubans and South Americans, as from just after mid-day till closing, which varies from 2 to 4 p.m., they are excelling themselves.

Reference to observers' and listeners' reports will give a good idea of just what is coming through.

It has been decided to print most, all if space permits, reports that are received, rather than have readers wade through a list of countries to find out just what stations are being heard.

Stations in Frequency Order.

We will also print each alternate month a list of stations in frequency order. This should enable a listener to look up at once any station he is hearing and of which he is doubtful. The list referred to commences with August issue.

Stations in "Countries" Form.

September issue will carry the stations in "Countries" form. I would appreciate opinions as to how the new system appeals.

Since I have been conducting these pages, I have been compelled to chronicle the loss of some of our well-known and regular transmitters. Un-

fortunately there are still more to be added to the already formidable list.

This month records "Paris Mondial."

Admittedly, we still hear "This is Paris Mondial, the French Government Short Wave Station," but is it?

I venture to suggest that when I heard them on Saturday, June 15, at

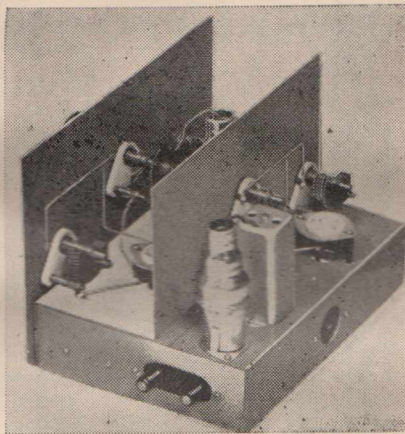

The Jones' Super-Gainer Two, a two-valve shortwave superhet, using a 6F7 and a 79. Full details will be found in July, 1937, issue of "Radio World." Obtainable from this office, price 6d.

2.15 p.m. on 31.51 metres, it was NOT our usual announcer, and am inclined to believe the speaker was NOT a Frenchman.

I have heard London say on several occasions, "A Paris radio message says—," but this most likely refers to a broadcast band.

I do not know whether Berlin has reduced their power of a night, but lately London is heard much earlier, whereas the reverse was the rule, at my location anyway.

Call sign of Moscow station on 11,900kc., 25.21m., is RIG.

Radio Saigon puts over a Letter Bag session every Tuesday at 8.55 p.m.

Radio Saigon Gets Mail from Australia.

Judging by names and addresses called last Tuesday, their mail from Australia and New Zealand is of fair proportions.

Talking of letters bags, TAP, Ankara (9465kc., 31.70m.), acknowledges letters from listeners on Sunday

mornings, following their English talk at 6.50.

As is usual in winter time, WBOS (31.35m.) are responsible for the hum that is heard on KZRM (31.35m.) from 8.30 p.m. onwards.

N.I.R.O.M. Will QSL.

N.I.R.O.M., Batavia, now send a QSL card in addition to a station booklet when verifying correct reports.

JZK, Tokyo (15,160kc., 19.79m.), in addition to a special session for Hawaii in English and Japanese from 5 to 6 p.m., also conduct a special hour for the Near East from 1 a.m. to 2 a.m. English, Arabic, Hindustan, Burmese and Japanese are used.

★

Java.

The N.I.R.O.M. (Batavia) seem to be on the air much longer than as previously. In fact, I was told that several of their transmitters are continuously on the air.

We have a more than ordinary interest in the Dutch East Indies at present, and I do wish that one of their many news sessions could be put over in English.

If you want to hear a signal tune to YDA (61.22m.) from 9 o'clock onwards.

Mr. S. I. Nelson (Cairns, Q.) advises that TAQ, Ankara (19.74m.), is back on the air again and gives news in English at 10.15 p.m. Perhaps this is the reason for the hum on top of DJB at 10 o'clock.

★

Verification Received.

I have received a very dignified QSL card (black script on pink cardboard) from KZRC, "The Voice of Cebu," "Cebu City, Philippines. It is a verification of my report of March 27. The owners are H. E. Heacock Co., and the card is signed by our old friend, Harry Fenton, as manager.

Mr. Fenton will be remembered as the news commentator some time ago on KZRM.

Station particulars are: 6100kc., 49.18m., 1000 watts, also long wave (1200kc.), 1000 watts.

No time schedule is given, but I understand it to be: 2 p.m. to 3 p.m., 7 p.m. to 1 a.m.

★

Hints On Sending For Verifications.

When sending reports to foreign countries, it is well to spell the date out, as, say for example, May 1st. If written as 1/5/40, it would be taken in some countries, particularly America, as January 5, '40.

YOU DON'T SEE THE BUTCHER for APPENDICITIS

Certainly not. You want the best specialist in town, and in a hurry. In much the same way the radio serviceman who knows refuses to replace worn-out valves in a sick radio with "bargain" valves of unknown make. Expert radio technicians the world over know that the best are no dearer . . . that Brimar British-made valves as used in the radio equipment of the "Queen Mary" and "Queen Elizabeth" are the best possible selection for any radio.

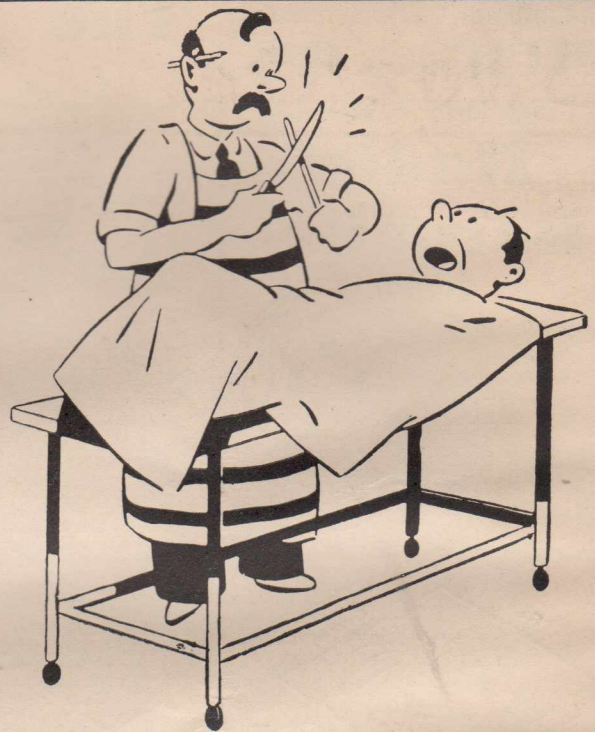

BRIMAR

BRITISH MADE VALVES

- * Because of their definitely non-microphonic properties, BRIMAR valves are especially suitable for portable radios.
- * Your nearest BRIMAR Distributor has ample stocks and can assure you prompt delivery.

BRIMAR DISTRIBUTORS

New South Wales: Standard Telephones & Cables Pty. Ltd., 252-274 Botany Road, Alexandria.
Standard Telephones & Cables Pty. Ltd., 71 Magellan Street, Lismore.
S.T.C. Radio Sales and Service, 389 Hunter Street, Newcastle.

Queensland: Trackson Bros. Pty. Ltd., 157-9 Elizabeth St., Brisbane.
Victoria: Noyes Bros. (Melbourne) Ltd., 597-603 Lonsdale St., Melbourne.
Standard Telephones & Cables Pty. Ltd., Bourke Street, Melbourne.
Western Australia: M. J. Bateman Ltd., Milligan Street, Perth.

Tasmania: W. & G. Genders Pty. Ltd., 69 Liverpool Street, Hobart, and 53 Cameron Street, Launceston.
South Australia: Radio Wholesalers Ltd., 31 Rundle Street, Adelaide.
New Zealand: Standard Telephones & Cables Pty. Ltd., Trojan House, Manners Street, Wellington.

Hams.

Although American amateurs are forbidden to "talk" to foreign stations, there appears to be plenty on the air that can still be heard. Here is a "bag" from Dr. Gaden:

10 metres: W6-DGE, RDI, PKT, GOQ, SIM, DLW, QLD; W5BB; W7-GMB, W4HRF, K6SHZ, K6TCF.

20 metres: Plenty of W's, KA's and K6's—too common to list. CO2GY, frequently heard, as also KF6JET, KF6JG, K4GMT, K7GMM, KC6HFS (gave 14,330kc.), .KC6GK (gave 14,325kc.) KC6OKS, KG6MU, KG6-PMV.

Listeners will see there is quite a lot of sport to be had from the above loggings, as they cover a very wide range and take in a fair amount of territory that is in the limelight at the moment, such as Canton Is., Baker, Howland and Enderbury Is. Jarvis Is. (KG6) is also listed.

Dr. Gaden regrets that his know-

ledge of Spanish prevented him from deciphering a very strong signal in a talk between a K4 and a "ham" in Buenos Aires. The K4 was R Max., Q5, and the B.A. R6, Q5.

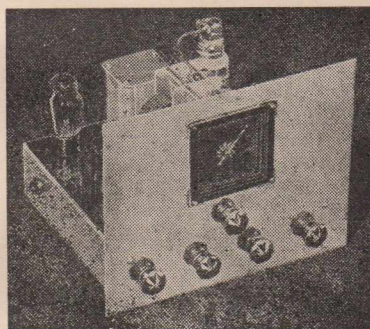

The Empire A.C. All-wave Three. Tunes continuously from 12.5 to 600 metres. Full description in issue of Dec., 1937.

A New Cuban.

Inadvertently, the following par was omitted from last issue:—

COCSO, 11.75mc., 25.92m., Havana: 10.30 a.m. to 2.30 p.m. Reported by Dr. Gaden as weak on opening, but at good strength when closing.

Receiving advice from U.S.A. on this new station, I mentioned it in a letter to Dr. Gaden, and sure enough he logged it. The station promised that those sending reports which were verified would be rewarded by view cards and booklets. Address: Senor Batista, P.O. 625.

In reporting it, Dr. Gaden said he heard some remarks about call sign COK.

The explanation, according to an American mail just to hand, is that they were operating first under the call sign COCSO, but latterly under COK. It is quite probable the station is now off the air, as it was used for the elections.

MURDOCH'S

Specially Reduced

Radio Bargains

12/6
MICRO-
PHONES
7/11

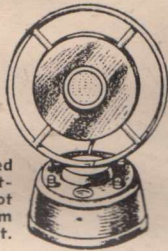

ACE Spring Suspended Microphone, with built-in transformer and pilot light. Great fun from your radio with this unit.

English price, 12/6.

SPECIAL, 7/11.

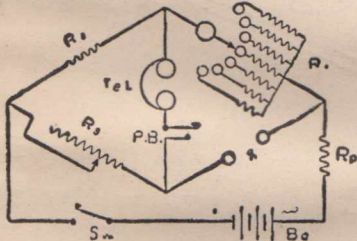

SHALLCROSS (U.S.A.) WHEATSTONE BRIDGE RESISTANCE KIT

Usly. £10/15/-, For **£3/15/-** Unassembled kit of all necessary resistances, each of extreme accuracy to plus or minus 1%. Measuring Range, 1 to 10 megohm. Kit is comprised of 40 Shallcross (U.S.A.) non-inductive wire-wound resistors on slotted Isolantite formers.

Usly. £5, For **30/-** Capacity Bridge Unassembled Kit, of all necessary resistances to assemble a Wheatstone Bridge for accurate measurement of condensers. Range, 10 mmf. to .05 mf.

Usly. £7/10/-, For **50/-** Shallcross (U.S.A.) Meter Kit, specially prepared for Weston Meters 0 to 1 M.A. Giving voltage and current range of extreme accuracy to plus or minus 1%. Kit comprises 1 watt, non-inductive slot wound in Isolantite formers.

VALVE SPECIALS

F215 Philips 2½ volt A.C. Valve. English base, cathode side connection. Usually 15/-. NOW 2/-
PM26—Mullard 6 volt Pentode, English base, for A.C. or battery. Usually 16/6. NOW 2/-
English Sockets for 1/3.

Usly. 10/6 for

6/9

Jackson English Condensers .0001 and .0015. All brass, silent.



We Pay Freight. Kindly write to Desk C52

MURDOCH'S PARK STREET

The Month's Loggings

ALL TIMES ARE AUSTRALIAN EASTERN STANDARD.

Official Observer Arthur T. Cushen (Invercargill, N.Z.) writes:—

HCJB, Ecuador (24.08m.), proud of their new 10,000 watt transmitter, have forwarded a souvenir booklet. They are most anxious for reports from Australia.

YSP El Salvador (10,400kc., 28.85m.) is being heard well all over N.Z. around 3 p.m. Signals at times are very good.

HP5A heard closing with good signals at 2 p.m.

COK Havana (11.6mc., 25.92m.) a new station, was heard last month at good signal strength, but, owing to bad modulation and interference has only been identified, as the call was hard to pick. The address is Box 625, Havana. All verified reports will be acknowledged by free coloured photos of Cuba. (See special note elsewhere.—Ed.)

Although signals are weaker, **COHI** (6.46 mc.) is still being heard at 10.30 p.m.

CFRX (6.07mc., 49.42m.) was heard on one occasion closing at 2.30 p.m. Station is in Toronto, Canada, and is operated by the Rodger Radio Corp. Reports are asked for and they will QSL with a beautiful postcard.

CJRO (6.147mc., 48.78m.), Winnipeg, can be heard with irregular signals closing at 4.30 p.m.

WLWO (25.27m.) and **WCAB** (49.50m.) are both very good.

Radio Maroc III. logged at 6.30 a.m. with fair signal.

CNP Casablanca (34.13m.) can also be heard with fair signals around 6.30 p.m.

FFZ Shanghai (24.83m.), good but lot of interference.

TAP Ankara (31.70m.), very good at 7.10 a.m. on Sundays in Letter Bag session.

EQC Iran (30.99m.) can be heard around 1 a.m., but is interfered with by **VLQ-5**.

YUA Belgrade (49.18m.), fair signals in English at 7.30 a.m.

"Radio Experimental," Bucharest, Rumania (32.46m.) heard with weak signals at 6 a.m.

"British" Freedom Station (on 11.96mc., 25.13m.) at 6.30 a.m. Signal good. This can be heard again at 7.30.—Ed.)

STOP PRESS

KGEI, Treasure Island, San Francisco, is now on 9670kc., 31.02m., from 3 p.m. to 6 p.m. and 10 p.m. to 3 a.m., but from 9.30 a.m. to 2.15 p.m. on 15,330kc., 19.56m., as usual.

Re **Mozambique**. A letter to hand states they have changed to 30.88m., the station being **CR7BE, which was on 9.64mc., and was then badly interfered with.** The change was made on March 25. They ask for reports.

Official Observer **W. M. Chapman** (Sydney) sends along a list of his loggings, together with comments:—

13 metres: Very little value.
16 metres: **TPB** faint; others poor.
19 metres: **GSF** good forenoon and afternoon. **GSI** good early evening and a.m. **WGEA** fair a.m. and p.m. **KGEI** good early afternoon. **OAX4R** fair after 7 a.m. Sunday. **2R06** good signal a.m. and afternoon. **2R014** good p.m. **RV96** quite a strong signal 1 p.m.
20 metres: Station on 20.58m. May be German or French. French spoken in early forenoon.

24 metres: **HCJB** still going strong, p.m.
25 metres: **GSD** strong afternoon and a.m. **GSE** fair a.m. **WRUL** still good a.m. **WPIT** fair a.m. **WCBX** fair a.m. **Radio Saigon** strong p.m. **RNE** strong 7 a.m. **HP5A** good 10 p.m. **PRF5 Brazil**, good 8.30 a.m. Sunday. **CB1180** fair 9.30 p.m. **VUD-4** strong p.m. **MTCY** fair a.m. **JZJ** fair a.m. and p.m. **JYW-3** good p.m. **XGOY** good p.m. **XMHA**

fair p.m. **2R04** strong a.m. **IQY** strong a.m. **Radio Maroc** strong 7 a.m.

27 metres: **PLP** fair p.m. **CSW-5** good a.m. early.

29 metres: **PMN** fair p.m.

30 metres: **TGWA** fair Sunday afternoons. **ZHP** good p.m. **JIE-3** fair late p.m. **CR7BE** fair a.m.

31 metres: **GSB** good a.m. and afternoon. **GSC** very good a.m. **KGEI** good afternoon.

TIPG good 10 p.m. **KZRM** good p.m., but some interference. (Probably **WBOS**.—Ed.)

KZRH very good p.m. **ZBW** only fair p.m. **VUD-2** strong p.m. **2R03** good a.m. and afternoons. **2R09** good a.m. **TAP** good a.m.

RAN good a.m.

41 metres: **GSW** fair afternoon. **2R011** fair 7.30 a.m. **EAJ-9** fair 7 a.m.

44 metres: **PMH** strong p.m.

49 metres: **VQ7LO** good 5 a.m.

Mr. Chapman has a verification from Delhi advising correct call sign of station on the old **VUM** wavelength is **VUD-4**, and wavelength is 25.28 metres. (Since this advice they have moved to 11,830kc., 25.36m., evidently to get away from **WLWO**, who strangely enough interfere with Delhi on 31.28m.—Ed.)

Official Observer **Wm. Bantow** (Edithvale, Vic.) received a letter from Delhi also regarding **VUD-4**. (See remarks under Mr. Chapman's report.—Ed.) He also sends a long list of loggings:—

North America: **WLWO** (25.27m.) strong at 9.30 p.m. (bad heterodyne). 31.28 fair 10 a.m., strong later. **WCAB** (31.28) fair 10 a.m. **WRCA** (31.02) fair 10 a.m. **KGEI** strong 10 p.m.

Australia: **VLR-3**, strong 9.30 a.m. **VLW-3** strong 9.30 a.m., fair 8 p.m. **VLR** strong at night. **VLW-2** strong at 10.45 p.m. **VLQ-5** strong 5 p.m. 11 p.m., fades badly. **VLQ** strong 5 p.m.

The East: **KZRH** (31.12) fairly strong (CW interference). **KZRM** strong 9.30 p.m. **KZRF** (48.86) fair 9 p.m. **KZRC Cebu** strong 8.45 p.m. (QRM). **JZK** strong 8.45 p.m. **JZJ** strong 10.30 p.m., also at 6.15 a.m. **JYW-3** strong 9.30 p.m. **ZBW-3** strong 10.30 p.m. **VUD-4** fair 10 p.m. **VUD-2** strong 10.15 p.m. **ZHP** strong 10 p.m. **ZHJ Penang** (49.3m.) strong 10.15 p.m. **Radio Saigon** strong 10 p.m. (interfered by CW some times). **XGOY** (25.21m.) strong nightly. **FFZ** (24.8m.) strong 10.45 p.m. **XPSA** (42.8) fairly strong 9.30 p.m. **XGOZ** (11.920kc., 25.17m.) strong at 8.30 p.m. At 9.15 p.m. gave calls as **XGOX** and **XGOV**. **YDC**, **YDX** and **PMH** strong. **PLP** and **PMN** only fair. **XYZ Rangoon** (49.94m.) strong at 12.45 a.m. **CSW-7** (30.8) fairly strong at 8.30 a.m. **TAP** (31.70) strong 6.45 to 7.30 a.m. **YUA Belgrade** (49.18) fair at 7 a.m. **RV-96** (31.5m.) strong with English at 6 a.m. and 8 a.m. **RV-96** (25.77m.) fairly strong in English at 8 a.m. **2R0-3** (31.13m.) strong with English 7.45 a.m.

Changes of Schedule

London now gives news at 11 p.m., instead of 11.15.

FG8AA (49.00m.), Noumea, is now heard daily, except Sundays, from 5.30 to 6.30 p.m. When closing down, the Marseillaise is played, followed now by "God Save the King."

Europeans in Wonderful Form.

Dr. Keith B. Gaden (Tharmogindah, Q.) Here is what Dr. Gaden says about his loggings: "From daylight to dark the Europeans are in wonderful form, and the U.S.A. and S. Americans are well on the improve. From 2 p.m. I found ten worthwhile signals

between **XEW** (31.58m.) and **COCQ** (33.98m.), all of which sounded like Cubans or S.A.'s.

TGWA (30.98m.) is very nice and clear at 2 p.m., much better than **XEQQ** alongside.

TG-2 Guatemala, at R7, Q5, gave its call sign in plain English.

At 2.45 p.m. heard a very powerful South American on approximately 31.77m. (This was probably **HCODA Guyaquil, Ecuador**, 9445 kc., 31.77m.—Ed.).

REPORTS WELCOMED

With the international situation as it now stands, it is becoming increasingly difficult to keep track of European stations, which more than ever are taking advantage of the short-wave prerogative of changing schedule without notice; therefore reports will be welcomed.

Even a few words may enable us to identify the "stranger," of which there seems to be many at the moment.

At 5.30 **WLWO** (49.5m.), "The Nation's Station" closes with a very strong signal.

FXSAA opens up nicely at 5.30. (This Noumean station which was heard only on Wednesdays and Saturdays, is now on the air daily except Sunday.—Ed.).

At 6 p.m. what I take to be **COCH** was coming through at great volume, and what I think was **COCW** came in at good strength at 9.40 p.m.

Moscow gives a very fine signal at 2.30 p.m. on 25.75m., but no English was heard. (**Moscow**, on 19.76, gives a talk in English at 10.15 a.m., followed by news in English; reception for the last week has been excellent.—Ed.).

H12G Trujillo (9.29mc., 32.29m.) opens at 2.30 p.m. with chimes, then a vocal hymn, followed by lady speaker. Quality of signal is poor.

Amongst the morning stations heard, the following are worthy of mention:—

YUG Belgrade (19.68m.) is very good at noon.

Martinique (30.92m.) opens up at 8.30 a.m. Session is in French, and is generally gone by 10, although the other day it was quite O.K. at this hour.

An Interesting Item.

Heard a most interesting item on June 12 from **YUC** (31.56m.) at 9 a.m. Whilst the quality was poor, I was able to learn that a representative of the N.B.C. was to give a talk. All the N.B.C. stations re-broadcast it, and **WRCA** (31.02), who are very good at this time, put over an R8, Q5 signal. The talk, which was certainly worth hearing, dealt with the Yugoslav reaction to Italy's entry into the War.

Other morning stations are: **PSH** Brazil (29.35m.) good at 9 a.m., weakens by 10. **PYA-2 Rio de Janiero** (32.59) poor at 8 a.m., fair at 9.

PRF5 (25.3) was not heard as **DJP** (25.32) is very strong. Just above **PYA-2**, same strength, is **HCZET** Guyaquil (32.64m.). They were heard at 8 a.m.

To-day (June 15), at 9.5 a.m. on 29m., were chimes very similar to that of **ORK**. Quality was poor. At 10 a.m. the two Chilean stations, **CB-1180** (25.12m.) and **CB-1190** (25.19m.) were noted and an Asiatic on approximately 25.18m. (This is probably **XGOV**, "The Voice of China."—Ed.).

CSW-7 (30.8) was still on, but only fair; **HJFK** (30.83) good and clear.

Just above **GRX** at only fair quality what was most likely **LRA-1** (30.96m.).

(Continued on page 32)

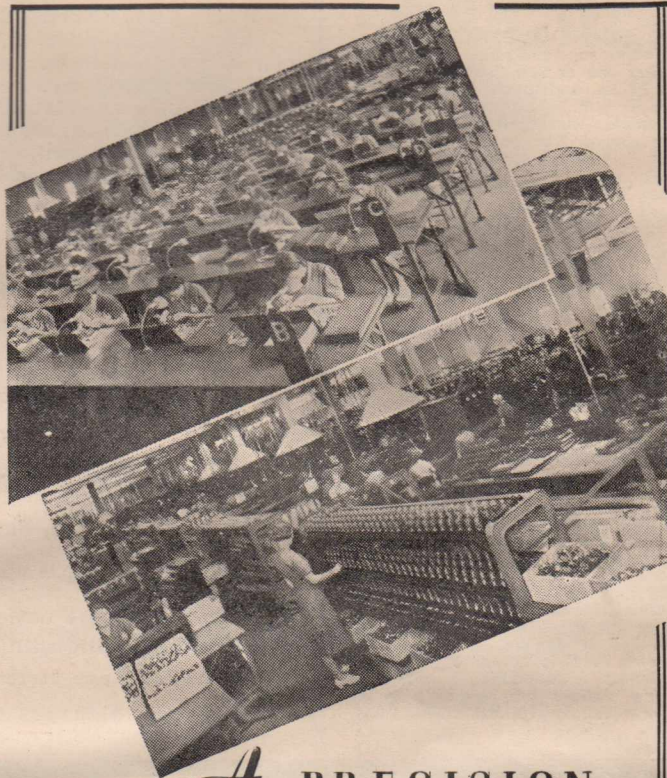

A PRECISION INDUSTRY of national importance

Backed by the complete resources of
Amalgamated Wireless
the manufacturers of Radiotron Valves
produce one million radio valves annually
at the Company's Ashfield Works
—Australia's assurance of adequate
supplies of Valves for Radio purposes.

For improved tone—reliability and
lasting satisfaction always ensure
that your broadcast receiver is
fitted with Radiotron Valves.

AMALGAMATED WIRELESS VALVE CO. PTY. LTD.
47 YORK STREET, SYDNEY, N.S.W.

LOGGINGS (continued)

Would especially draw your attention to **WBOS** (31.35m.) in their News Flashes at 3.35 p.m., which are excellent and, as events have turned out, accurate.

* * *
Mr. S. I. Nelson (AW577-DX), Cairns, Queensland, sends an interesting report and advises hearing one or two "strangers." The first was on 26.2m. and sounded like Spanish closing at 5.30 p.m. (This may have been **TG5JG Guatemala**, who operate on 26.22m., but who are supposed to go off the air at 1.30.—Ed.).

The second is on 24.15m. and sounded like Russian. This closed at 5.45 p.m. (It is quite possible it may have been Moscow; they have sprung many surprises lately as regards frequencies. They are likely to bob up anywhere.—Ed.).

Several New German Transmitters.

Mr. Nelson says he heard several new German transmitters on Hitler's birthday. (The two mentioned, viz., **DXD** (28.5m.) and **DZB** (29.86m.) are used for transmissions to America. According to my records the schedule is 9 to 10 a.m. and 6 a.m. to 1.45 p.m., respectively.—Ed.).

I used to hear regularly **CXA7 Montevideo** (26.13m.) at 10 p.m., but have not logged them lately. (I think they can be heard round about mid-day.—Ed.).

Some of the best Central and South Americans are: **TIPG, HP5A, COCH, COCO, HP5J, CB1180, HJFK**. The two Mexicans, **XEWV** and **XEQQ**, put in loud signals at Cairns in the afternoon.

Another mystery station is on 32.5m. in the mornings. It is interfered with by C.W. and is still on the air at 8 a.m. (This is very likely **PYA-2 Rio de Janeiro**, 32.59m.—Ed.).

The 49 metre band is never of entertainment level here. Occasionally it brightens up and a few stations are heard. I have logged the new Manila station, **KZRC**, "The

Voice of Cebu," although very weak here. I have just finished listening to **COCO**. They gave an English session from 10 to 10.15 p.m. (Sunday). The Russian on 25.77m. was on

WITH THE REPORTERS.

With the exception of Tasmania, South Australia and West Australia, reports have reached us from all over Australia and both islands in New Zealand.

Those who have helped in the compilation of the month's loggings are:—

Official Observers:

Arthur T. Cushen, Invercargill, N.Z.

W. M. Chapman, Kingsford, Sydney.

Wm. Bantow, Edithvale, Victoria.

and
 Dr. Keith Gaden, Tharmogindah, Queensland.

Mr. S. I. Nelson, Cairns, Queensland.

Mr. Alf. Deppeler, Edmonton, Queensland.

Mr. V. W. Curran, Bathurst, N.S.W.

Mr. N. E. Gandy, Wellington, N.Z.

Sincere thanks are tendered.

the air around 2.30 p.m. in parallel with **RNE** (25m.).

(Thank you, Mr. Nelson, glad to welcome

you to the DX Club, and will look forward to further reports.—Ed.).

Mr. V. W. Curran (Bathurst, N.S.W.) advises having received some nice verifications during last month or so. Here is the list: **Vatican City, WPIT, WRCA, HS8PJ, XYZ, HP59, Addis-Ababa, WRUL, HP5G**. The foregoing were in form of QSL cards, while from the following he received letters of confirmation of reports: **WLWO, MTCY, VQ7LO, COHI, CR7BE, XPSA** and **HP5G**. (A little mail anyone would be proud of.—Ed.).

Mr. Curran refers to hearing **COCH** (31.82m.) at 3.25 p.m. on Sunday, when, apart from usual Cuban type of programme, a lottery was drawn. He could hear the marbles in the barrel while it was rolled out; I should say rolled round. Figures were called out and checked. The station closed at 6 p.m.

Morning stations are referred to as follows:—**SUX**, Cairo, (38.15m.) 6 to 6.30.

Radio Maroc (25.13m.), 7 a.m. **LRX** (31.06m.) from 8.23 to 9 a.m., **R7** to **R5**. **WRCA** (31.03m.) 8.10 to 8.23.

Others logged were: **Delhi** (31.28) at 11 p.m.; **COCX** (32.61) 11 p.m.; **COCO** (34.48m) 10.15 p.m.; **ZBW-3** (31.49m.), and all Manila stations. **YSP** (28.85) opened at 11 p.m. **WLWO** (31.28m.), **KZRC** (49.1m.), **XYZ** (49.94m.), closes at 1 a.m.; **R9**; **XTC** (32.28) opens at 11 p.m.

Mr. Curran also refers to the seldom heard **HIIN Trujillo** (12.490kc., 24.02m.) as opening at 11 p.m. occasionally. **Radio Tananarive** opens at 1.30 a.m., **NOT** 1 a.m. as reported.

Mr. Curran concludes by saying he received a nice long letter from Station **HP5G Panama City** (25.47m.), signed by G. Williams, and asking for reports from Australia. As reception improves, he proposes to put on a special DX programme. Further particulars later. (Geo. Williams, of **HOA** and **HP5G Panama City**, is the man who sent the famous signal in 1918 announcing the surrender of the German High Sea Fleet in Scapa Flow. He has spent much of his life in radio work

QUALITY • PERFORMANCE • VALUE

ALL-WAVE ALL-WORLD DX CLUB

Application for Membership

The Secretary,
All-Wave All-World DX Club,
117 Reservoir Street,
Sydney, N.S.W.
Dear Sir,

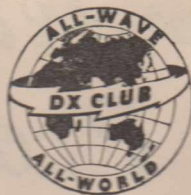

I am very interested in dxing, and am keen to join your Club.
The details you require are given below:

Name.....

Address.....

[Please print
both plainly.]

My set is a.....

(Give make or type,
number of valves,
and state whether
battery or mains
operated).

I enclose herewith the Life Membership fee of 3/6 [Postal Notes
or Money Order], for which I will receive, post free, a Club badge and
a Membership Certificate showing my Official Club Number.

(Signed).....

(Note: Readers who do not want to mutilate their copies of the "Radio World" by
cutting out this form can write out the details required).

WAR NEWS AROUND THE CLOCK !

The two-page list of world short-wave stations in last month's issue was compiled by the Shortwave Editor of "Radio World," using an Ultimate All-Wave Eight. And now . . .

The 1940-41 Ultimates are here !

With every model packed with new EXCLUSIVE features such as light ray tuning and photo process dial with selective illumination, these latest releases fully maintain the Ultimate tradition of exceptional all-round performance combined with unbeatable reliability.

Features :

- **LIGHT RAY TUNING:** Similar to the well-known ULTIMATE Loggings Pointer in operation, but more conspicuous, more attractive and more efficient.
- **BAND COVERAGE:** Broadcast Band: 1600 to 550 kilocycles (including projected extension of Broadcast Frequencies from 1500 to 1600 kilocycles; Medium Wave Band: 40 to 123 metres; Short Wave Band: 16 to 50 metres).
- **PERFORMANCE:** Particular attention has been given to Short Wave Reception on account of War activities. A high gain stage of Radio Frequency amplification is used on all three wave bands and Short Wave programmes are particularly free from "surge."
- **WIDE RANGE OF MODELS:** The 1940-41 range of Ultimates includes the following models: Six-valve D/W mantel, 8-valve All-Wave (console and mantel), 10-valve All-Wave console, 5- and 7-valve D/W vibrator models, 5-valve D/W portable.

RUSH COUPON BELOW FOR FREE DETAILS

GEORGE BROWN & CO. PTY. LTD.,
267 Clarence Street, Sydney.

Please send me without obligation particulars of the 1940/41 ULTIMATE Receivers.

NAME

ADDRESS

and has a vast store of information available. He was due to put over a special DX programme on Monday, June 3 between noon and 1 p.m. Listeners should keep a look out for him. He wants reports, and address is: Box 34, Panama City, Panama, Central America. Station HOA mentioned is on long waves, 2.34mc.—Ed.).

Mr. Alf. Deppeler (AW535-DX), Edmonton, via Cairns, Q., sends a great list of loggings secured on two receivers, a 4-valve t.r.f. and a 7-valve all-wave vibrator.

GST, GSJ and GSH are classed as erratic, some nights being good. (Just as I commenced to write these notes (9.35 p.m., June 27), I turned on the receiver and to my surprise I found all the three London transmitters on 13 metres audible, GSJ being surprisingly good. The signal was infinitely better than ZHP Singapore, and every word of the B.B.C. news could be heard.—Ed.).

New Station?

Official Observer Wm. Bantow (AW353-DX), Edithvale, Victoria, advises as having heard Szechwan, on 11,920kc., 25.17m., with a strong signal at 8.30 p.m. At 9.15 p.m. they gave call sign as ZGOX and XGOV.

(This station is also heard as "The Voice of China" at 7.30 a.m. with news in English.—Ed.).

GSG (16.86) very scratchy around 9.30 p.m. GSB, GSF and GSD are classed as good, GSF even being heard some nights at 9.30. GRX, GSW and GSA are classed as weak. (The interval signal on foreign broadcasts is actually a metronome.—Ed.).

GST (25.29) good at 10.30 a.m. VLR strong at 6.30 p.m. and most of the night. VLW-3 very strong in early morning and late afternoons. VLW very good nightly. VPD-2 Suva, good at 8.30 p.m.; FK8AA (49m.) fair 6.20 p.m.; 2RO-3 (31.13) good between 4 and 5 p.m. 2RO-20 (16.87m.) heard at 1.30 p.m. on Sunday in special broadcast to U.S.A. 2RO-4 (25.40m.) good at 8.15 a.m.

Mr. Deppeler finds most of the German transmitters O.K., particularly DJL (19.85m.) at 3.15 p.m.

YDC, PLP, YZK, JYW-3, KZRM, ZBW, KZRH and YDX are all classed as good to very good.

RW96 (19.76) very loud in afternoon. (Incidentally, this is one of the loudest stations on the air at 8.30 a.m., when news in English is given.—Ed.).

WNBI, WPIT, EAQ, TAP, COCQ and RNE good.

(Thanks, Mr. Deppeler, hope to hear from you again.—Ed.).

Mr. N. E. Gandy (Wellington, N.Z.) sends another fine list of loggings, and it would appear most of the stations received in Australia are being heard across the Tasman.

Best reception times are 5.30 to 8 a.m., 10.30 a.m. to 1 p.m., 2.30 p.m. to 5 p.m. After that, things are patchy. The difference in time helps N.Z., as they get an hour and a half with CFRX (25.60) on Sunday afternoons, 3 to 4.30 p.m. (5 to 6.30 p.m. London, Rome, America and the East all give fine signals, while the South Americans, as well as Central America, are all given good reports.

TiPG Costa Rica (31.19m.) is specially mentioned, as also is OAX4J Peru (32.12m.).

Manila is being heard well, KZRM and KZIB having choice of place.

Regret that pressure of space prevents list being given in full.

(Always glad to hear from the North Island. Please write again, Mr. Gandy.—Ed.).

Rola leads the way to Progress

with **BRILLIANT NEW MODELS**

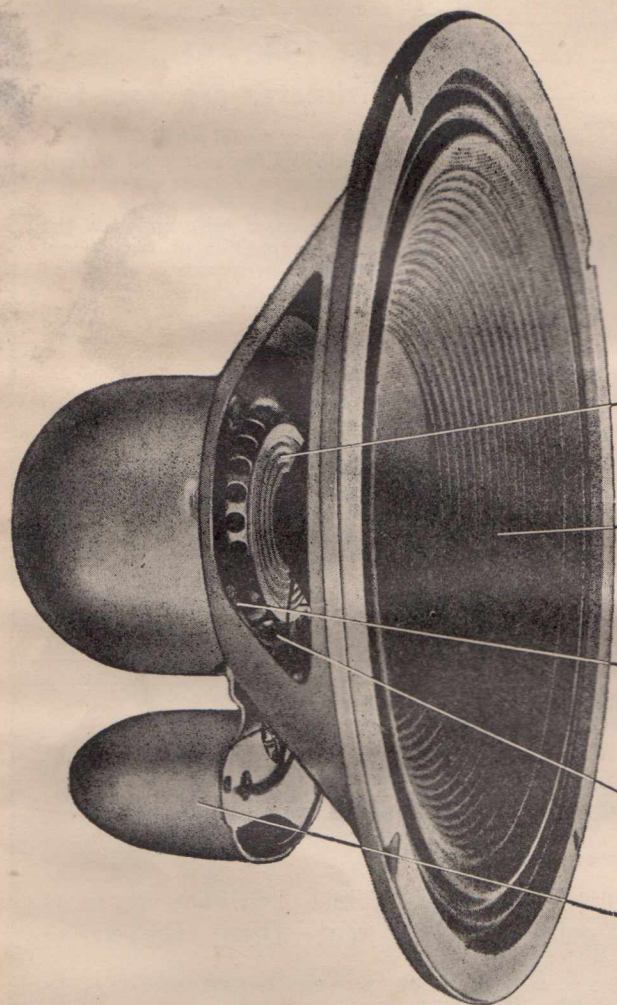

Every model in the extensive Rola range has been improved out of all recognition by far reaching developments, affecting every aspect of speaker performance.

Enormously increased efficiency—the equal of doubled power output, crisper reproduction over an extended range and superior power handling ability bring a new conception of speaker performance.

Prices are maintained at their previous low level, offering you the most generous values ever crowded into loud speakers.

Here are some of the developments that have been responsible for these outstanding results:

★ **PERMAFLEX SPIDER.**

A new resilient material of low mass allowing perfectly linear excursion of the voice coil. Permafex Spiders prevent harmful back pressure building up, yet perfect dust-proofing is preserved.

★ **KAPPA CONES.**

Lighter and tougher material provides greater rigidity without any increase in mass, enabling Rola speakers to combine high efficiency with high power handling ability.

★ **IMPROVED MAGNETIC CIRCUIT**

A much greater proportion of total flux is concentrated in the airgap resulting in far greater efficiency and crisper reproduction.

★ **PERMACENTRIC CONSTRUCTION.**

Rivetting ensures that the continuous magnetic path of low carbon steel is unbroken. Diaphragm cannot move from its central position.

★ **ISOCORE TRANSFORMER**

Breakdowns due to electrolysis cannot take place with speakers equipped with Isocore transformers, a feature pioneered by Rola.

These new Rolas are far in advance of anything you have seen or heard. They represent the very best value your money can buy anywhere in the world. Your distributor can arrange a demonstration. If you are a manufacturer, send direct for a sample.

Rola Co. (Aust.) Pty. Ltd.

**THE BOULEVARD, RICHMOND, E.1, VICTORIA. J 5351.
116 CLARENCE STREET, SYDNEY, N.S.W. B 5867.**

Rola Introduces New 'Kappa' Cones

This article deals with the latest releases from the Rola Co. It discloses the many improvements to be embodied in the 1940-41 season Rola speakers.

ROLA Company (Aust.) Pty. Ltd. announce that every speaker in their wide range of models has been improved by a series of developments. Efficiency, tonal qualities and power handling ability of all speakers have been affected by improved design.

To bring about these changes a

BELOW: Natural lighting is a feature of the new Rola factory, shown in this photograph.

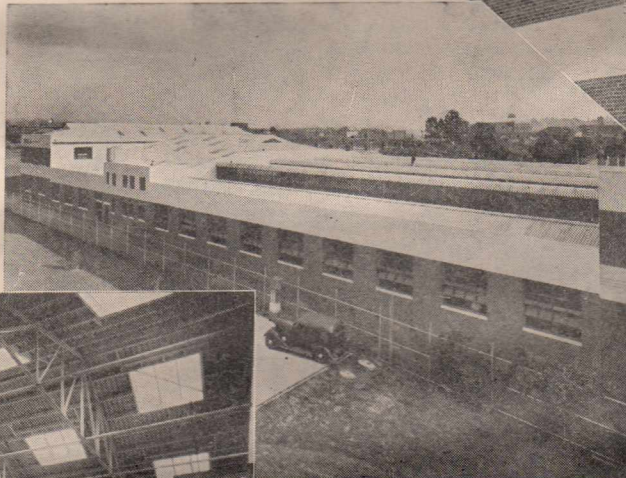

RIGHT: Threequarter front view of the Rola factory recently completed at Richmond, Melbourne.



LEFT: This photograph will give some idea of the size of the factory.

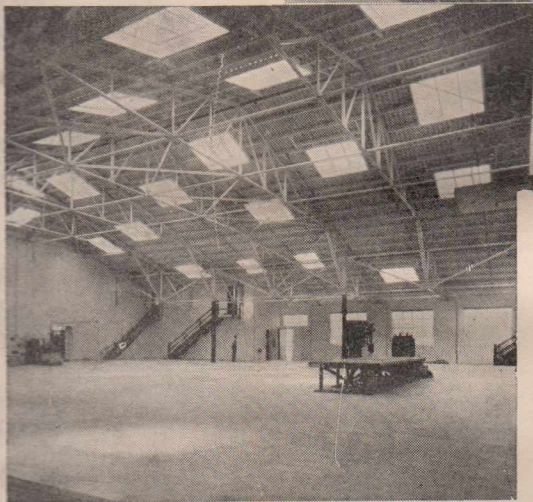

new spider, known as "Permafex," and a new "Kappa" cone have been adopted. In addition, changes have been made to the magnetic circuit. Despite these improvements, there has been no increase in the cost of the speakers, which retain their characteristic names and type numbers.

Increased Efficiency.

The most easily recognised of the improvements is the increase in efficiency. In many models, this increase in sound output for a given input is

as great as 3 d.b., which is equivalent to doubling the power output of the receiver or amplifier. The increased efficiency is so great that the new 10/21 is as efficient as the old 10/42, while the 42oz. speakers have been brought to a performance level that has never previously been achieved in speakers with a 1in. voice coil. This increase applies equally to electro-

dynamic and permanent magnet speakers—for example, the new K8 is from 2½ to 3 d.b. up on the old K8. This is a remarkable achievement, because Rola speakers have always been noted for their high efficiency. Although the increased efficiency will be of interest to all users of speakers, it will be particularly appreciated by designers of battery receivers where low output has in the past restricted the performance of battery receivers. When it is con-

sidered that the improved performance of many of Rola's speakers is the equivalent of doubled power output, some concept of the value of these developments will be realised.

At the same time, the new speakers will assist designers of power amplifier installations where increased power output will be obtained without any increase in the output from the amplifier. This means that fewer speakers will be needed in an installation to achieve the same result.

Improvement in Response.

The response has been improved over the entire musical scale. Every frequency and combination of frequencies is cleanly reproduced. Undue

accent is not placed on any section of the frequency spectrum; bass is smooth and round, while middles and top are pleasantly free from peaks and spurious frequencies resulting in the preservation of the essential character of speech and music. An improvement in transient response brings about cleaner and crisper reproduction. This is particularly noticeable in the reproduction of speech and percussion instruments where clean and sharp reproduction is essential if a high degree of fidelity is to be maintained.

Power Handling Ability.

The power handling ability of a speaker must always be considered in relation to the range of frequencies that the speaker is called upon to handle. For example, a speaker may deliver 20 watts if it is not called upon to handle any notes below 200 cycles, but this output would be substantially reduced if it is called upon

(Continued on page 36)

Rola 'Kappa' Cones

(continued)

to deal with frequencies below 100 cycles. For this reason, the rated power handling ability of a speaker in watts has no real significance unless full operating conditions are known. It is clear therefore that the low frequency response of any speaker cannot be brought up indiscriminately without impairing the "undistorted" power output of the speaker. It is not uncommon to find that speakers with very high power rating have an unsatisfactory lower note response.

However, one of the virtues of the new Rola developments is that the same amount of power may be fed into the speaker as in the past and in view of the improved response of the speakers, greater sound output has been obtained over the extended range.

Improvements in Detail.

In detail, the improvements comprise a new cone, a new spider and an improved magnetic circuit. The spider is a particularly noteworthy evolution from the moulded paper type of spider which it has now replaced. It is more resilient than any previously developed spider and permits of true linearity of voice coil

movement. This latter factor is responsible for the new Rola speakers preserving tonal fidelity even during large cone excursions.

"Permafex" spiders are made of a meshed material which allows free movement of air, but prevents the infiltration of dust, grit or sand. The properties of this new spider to "breathe" prevents back pressure building up in the dustproofed enclosure behind the spider. Unless these provisions are made a serious loss in efficiency results.

"Kappa" Cones.

"Kappa" is Rola's name for an entirely new material developed in Rola's laboratory for Australian conditions. This new material combines lightness and toughness with the correct ratio of stiffness and mass to make an ideal speaker cone. Its properties enable a more accurate control of manufacturing tolerances and more uniformity in the finished product. Kappa cones contribute largely to the ability of Rola speakers to handle large power outputs over an extended frequency range.

Improvements to the Magnetic Circuit.

Because of well-studied design of all Rola speakers, the amount of flux available in the airgap has been increased, without any alteration in the voice coil clearance. The concentration of more flux in the airgap brings

about higher efficiency and improved transient response.

Particular attention has been taken to ensure that a continuous low reluctance path is provided in the magnetic circuit. This results in a higher concentration of useful flux at the point where it is required—in the airgap. This is achieved by rivetting the magnet shell and front pole plate to the cone housing in one immovable assembly.

Rola speakers continue to use "Iso-core" transformers—available with all models. This type of transformer which was introduced by Rola over two years ago has revolutionised the servicing of speakers by preventing breakdown due to electrolysis.

Another factor contributing to the high degree of reliability achieved by Rola speakers is the method of assembly known as "Permacentric" construction. By adopting this patented method of assembly, all antiquated centring devices are abolished and the diaphragm is permanently suspended in a central position.

This method of construction, in conjunction with "Permafex" spiders, has made possible dustproofing, which is now a feature of all speakers in Rola's extensive range.

Stocks of the new models are now available from all Rola distributors. Manufacturers requiring samples can obtain them direct from the Rola Company.

VELCO TEST EQUIPMENT

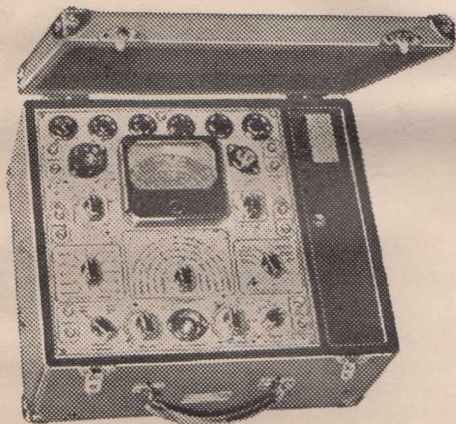

Saves Time And Money For You

Test Equipment is not a luxury—it is a necessity. Every service call involves time, and time is money. That is why the live dealer uses modern equipment . . . it reduces the time on the job and allows a bigger profit per call.

MODEL 223A MULTI-TESTER

Illustrated is the Velco-Calstan Model 233A Multi-tester, a combined Tube Checker and Multimeter, in an attractive leatherette carrying case—designed for both counter and service use. Read its many outstanding features.

- New type meter with all ranges easily readable.
- New style, permanently etched and finger-proof panel.
- Can be operated from either 6-volt accumulator or A.C. supply.
- Tests every valve on the Australian market, including new 1.4-volt series.
- Tests Electrolytic, paper and mica condensers.

- Measures A.C. volts up to 1250. Output volts up to 1250. D.C. volts up to 1250. D.C. milliamps up to 250. Ohms from $\frac{1}{2}$ ohm to 10 meg.
- Unconditionally guaranteed for 12 months.

Price **£17/17/0** or on Easy Terms

£4/17/0 Deposit and 40/- per month

490 ELIZABETH STREET, MELBOURNE, C1
Box 2135T Phone: F 3145 (6 lines)

Five other branches Melbourne, Prahran
Camberwell and Moonee Ponds

VEALLS

HINTS and TIPS

by Nicholas G. Walters

Jewel Light Substitute.

Use ordinary glass marbles (coloured) in place of the jewel, but the panel must be of some material other than metal.

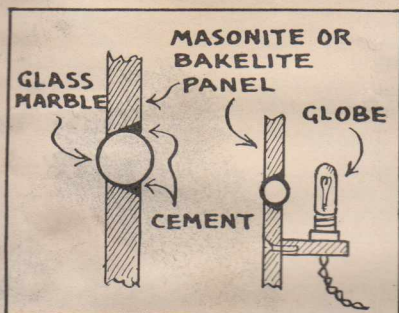

A hole about $\frac{1}{4}$ " in diameter is drilled in the panel, then enlarged with a counter-sink bit to accommodate the marble. The counter-sink bit leaves the hole slightly conical in shape allowing the marble to fit in on only one side.

The marble is then cemented in place with ordinary household cement or glue. An ordinary dial light is then mounted at the back of the marble.



A Handy Valve Lifter.

Experimenters who are always plugging valves in and out of their sockets can save much wear and tear on the valves and practically eliminate loose valve bases by making a handy little valve lifter as seen in the sketch.

It should be made of thin steel or other stiff metal.

It is shaped like a wide-tined fork,

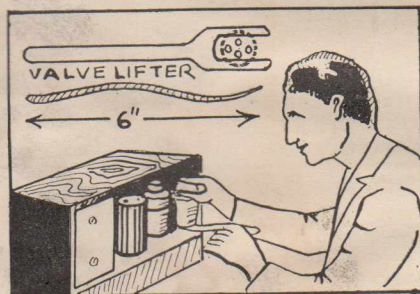

the space between the curved tines being slightly wider than the space between opposite valve pins.



Stopping Transformer Hum.

A simple and effective method of

quietening a noisy transformer or choke lamination is to drive a small

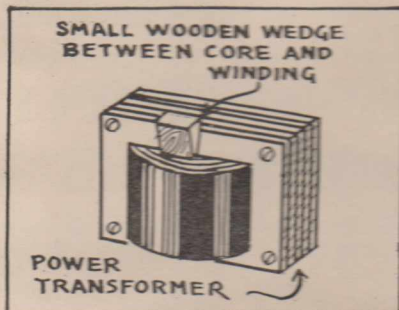

wooden wedge between the core of the transformer and the winding.

The wedge should be lightly hammered in till all signs of the singing lamination has stopped.



Better Band Spread.

Instead of purchasing a special band spread condenser or removing some of the plates of your present condenser, one can obtain quite good band spread by connecting a fixed mica condenser in series, usually about 100 mfd. with the stator plates.

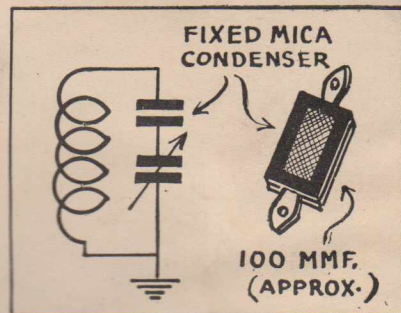

Thus any variable condenser can be used, even a 350 mfd. unit.

Doublet Lightning Arrestor.

This novel gadget uses 2 discarded spark plugs which should be thoroughly cleaned, eliminating all traces of carbon and corrosion. These are then placed into the two ends of "T" joint

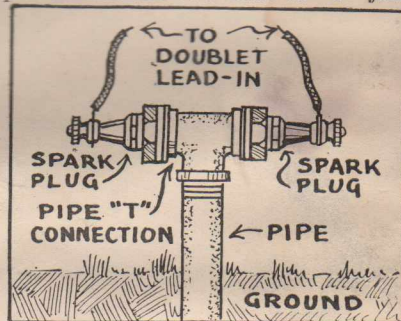

pipe connector which in turn is screwed into the ground pipe.

In my particular case a ground pipe five feet long proved to be sufficient. The details can clearly be seen in the sketch.

Have Your "RADIO WORLD" Posted To You Direct

Readers who want to take the "Radio World" on a subscription basis and have their copies posted to them direct each month are invited to complete the coupon below (annual sub., 10/6). New readers are advised that all back numbers in Volumes 1, 2 and 3 are still available, price 9d., post free, for all copies up to and including the December, 1938, issue, and 1/-, post free, for subsequent numbers.

Enclosed please find remittance for 10/6 in payment for an annual subscription to the "Australasian Radio World," commencing with the.....issue.

Name

Street and No.

City State

THE AUSTRALASIAN RADIO WORLD
117 Reservoir Street, Sydney.



The **JUNIOR**
TECHNICAL
SECTION

HOW TO BUILD A SIMPLE GALVANOMETER

THE galvanometer is one of the earliest instruments used for the detection and measurement of small electric currents. It still has many important applications to-day, both in the fields of science and commerce.

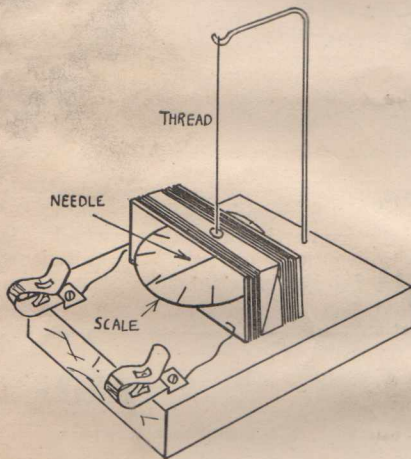

The needle is hung at the centre, and must be carefully balanced.

An electrical pyrometer for measuring the heat developed in furnaces is one such application of the galvanometer.

As is well known, the heated junction of two dissimilar metals will generate thermo-electricity. The pyrometer, therefore, consists of a "thermo-couple" connected to a galvanometer whose scale is calibrated in degrees of heat. As the temperature of the thermo-couple is increased, so is its electrical output.

Extremely Sensitive.

Simple as it is, our little galvanometer is extremely sensitive and will introduce us to some fascinating electrical experiments.

Material required:—1 empty matchbox (cover only used); 1 small sewing needle; 15 ft. of 40-gauge enamel-

led copper wire; 6 ins. of stiff 16-gauge brass or copper wire; 2 terminals; 1 wood block 2½" x 2½" x ½"; 2 woodscrews; white cardboard; glue and a fine silk thread or hair.

Construction.

Wind the coil first.

Punch two needle holes in the matchbox cover as close as possible to the edge of one open end.

Loop the end of the 40-gauge wire through these holes, leaving a couple of inches as a connecting lead.

Now neatly wind right around the cover one layer of wire ⅛" wide, cross over, leaving a space of ⅛" and wind another ⅛" layer, finishing the winding in the same manner as it was started.

Centrally between layers make an ⅛" hole; the neatest and cleanest hole is made with a red-hot knitting needle. Give the coil a coat of duco or shellac.

Allow to set and then with a razor-blade cut away the unused length of matchbox cover.

Now glue the coil to the wood block, mount the terminals and solder the wire ends to them.

Magnetising the Needle.

The sewing needle may require cutting so that it will fit lengthwise inside the coil with a little to spare, after which it is magnetised by rubbing it on a permanent magnet or headphone polepiece, etc.

Make the suspension bracket from the stiff copper or brass wire and mount in position as shown, attach needle to thread, pass thread through hole in coil and suspend from bracket. The needle should hang level and the thread should not touch the edges of the hole.

The Scale.

Now we make a circular scale with, say, twelve radical markings, and glue it horizontally in position inside the coil just below the needle. Our little galvanometer is now ready for use.

Experiments.

If a really fine thread or, better still, a human hair has been chosen for the needle suspension, we will immediately notice that the needle will always take up a position pointing north and south.

The galvanometer should be placed so that the needle lies at right angles to the coil, small currents through which will tend to pull the needle away from its normal compass position.

Our home-made wet cell if connected up will immediately make the galvo. needle swing violently and then come to rest at maximum reading, but this is "cracking nuts with a steam press."

Another Kind of Wet Cell.

Here is another kind of wet cell which won't light a torch bulb and won't ring a bell, but our little galvo. certainly proves that an electric current is flowing.

The cell this time consists of an iron and a copper wire pressed into a potato, orange or lemon!

Such experiments with galvanic action are legion—any two dissimilar metals if placed in an acid solution will set up a current flow.

Did you know that we can make a storage (accumulator) cell in the space of five minutes or so? Of course we can—here it is: Two small strips of lead in a vaseline or face-cream jar containing dilute sulphuric acid!

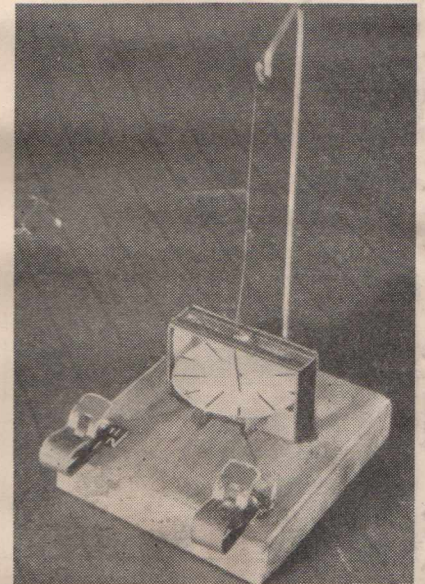

Photograph of original model.

This cell should first be charged by connecting it to a battery of two or more wet or dry cells. That our elaborate (?) accumulator takes a charge in a minute or two is soon

proved by connecting it to our galvanometer.

As a matter of fact our little accumulator if charged sufficiently will light a torch bulb.

Induction.

If a magnetic field is made to cut

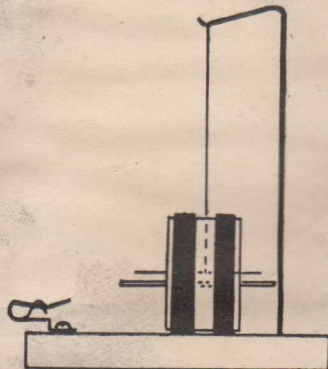

Another diagram showing a side view.

a coil of wire, an electric current will flow through the coil. The magnetic field may be provided by a permanent magnet or another coil through which a pulsating current flows.

This simple law provides us with an almost endless number of experiments with the galvanometer and we get a better idea of the workings of electric motors, generators, transformers—in fact, anything electrical which may have a coil of wire in its make-up.

For these induction experiments make up two coils or hanks of wire

J. T. QUERIES

P.P., Bankstown:—

As far as we know, there are no regulations forbidding a wired telegraph between houses. However, wires must not pass over or under power lines, telephone lines or public highways.

M.J.McV., Parramatta:—

(1) The wire ring should be of iron as thick as possible. It should touch the glass all round. A light tap may hasten the cracking.

(2) Not all of our readers are experts with tools. This is why the early articles are devoted to workshop practice. There are several working models on our waiting list. A.S., Artarmon:—

As far as possible it is the J.T. policy to avoid any tinkering with mains supply. Thanks for the suggestion just the same.

D.R.T., Burra North:—

(1) M.V. is the abbreviation of "mercury vapour."

(2) The A.R.R.L. handbook shows the revised symbols which are now to be used.

(3) About 25/-.

(4) A good meter with jewelled movement should stand up to continued needle oscillation.

consisting of, say, fifty turns 3" in diameter; the wire should be of about 20-gauge and insulated of course.

(1) Connect the ends of one coil to the galvanometer. Connect one end of the other coil to one terminal of a battery. Lay the coils one on top of the other and flick the remaining coil end on the free battery terminal. At each flick the galvanometer needle moves, indicating a flow of current. See how far it is possible to separate the coils and still observe movement of the needle.

(2) Connect one coil by long leads to the galvanometer. Now quickly wave a permanent magnet pendulum-

fashion across the coil. Again the needle indicates pulses of electric current.

(3) Repeat experiment (1). This time, however, slide the coils side by side over an empty tin. Note how the inductive effect is intensified by the addition of this iron core.

And so on.

The above ideas will indicate many paths which we may explore.

You can be sure this little galvanometer is well worth the trouble taken with its construction.

Let me know how you get on with it.

Be guided by EXPERIENCE

MARCONI SCHOOL GRADUATES HOLD THE LEADING
POSITIONS IN AUSTRALIAN RADIO TO-DAY — WHY
NOT CONSULT THE SCHOOL ABOUT YOUR OWN FUTURE?



Marconi School graduates are in charge of Aeradio stations at principal airports in Australia.

Marconi School graduates are engaged in a large proportion of the 120 broadcast stations in Australia.

Marconi School graduates are radio officers in over 150 ships of the Australian Mercantile Marine.

Marconi School graduates staff A.W.A. Beam Wireless stations in the world's longest and fastest radio-telegraph service.

Marconi School graduates operate A.W.A. coastal radio stations in Australia maintaining communication with ships at sea and with Pacific Island stations.

Marconi School Graduates operate A.W.A. Radio Stations in the Mandated Territory of New Guinea, Papua and Fiji.

Marconi School special Preparatory Courses are available for R.A.N., Army and R.A.A.F. applicants.

Marconi School training takes you step by step from elementary electricity to advanced radio engineering.

WHETHER YOU REQUIRE ONLY SOME KNOWLEDGE OF MORSE FOR DEFENCE PURPOSES OR A COMPLETE RADIO ENGINEERING TRAINING, WE HAVE THE COURSE YOU NEED!

MORSE CODE INSTRUCTION

7/6 per week or £1 monthly — Day or Evening classes



MARCONI SCHOOL OF WIRELESS

CONDUCTED BY AMALGAMATED WIRELESS (A/SIA) LTD.

47 YORK STREET - - - - - SYDNEY

TRADE NOTES

W. G. Watson Release 1940 Test Equipment

MESSRS. W. G. WATSON & Co. Pty. Ltd., of Sydney, sole Australian representatives for Triplett, Delta and Ranger-Examiner test equipment, advise that at the moment they are holding good stocks of the instruments described briefly below. However, due to the rigorous import restrictions at present in force, deliveries on the lines mentioned at the prices quoted cannot be guaranteed indefinitely.

Delta D1503 Multi-Tester: A triple-purpose instrument of unusually high flexibility, combining the functions of valve-tester, set analyser, and condenser tester. Price £16/10/-.

Delta 1200D Volt-Ohm-Milliammeter: This latest addition to the Delta range is push-button operated, and incorporates the Triplett twin instrument with a sensitivity of 2,000 ohms per volt on the D.C. scales. Price £8/-/-.

TIP-TOP (continued)

ture diagram of the wiring. Likewise it will help if the coils are mounted with the terminals the same way, so that the wiring diagram will be easier to follow.

Don't assemble the dial, gang or speaker until the rest of the wiring has been completed, as these items may be damaged while the chassis is upside down on the bench.

Wiring.

First step with the wiring is to connect up the heaters of the 6K8G, 6F7 and 6V6G, and then apply the 6.3-volt transformer winding to this circuit.

Next the 340-volt leads (red flex) can be taken to the plates of the 80 socket, and the two 5-volt leads to its filament.

The 5-volt leads will be known by their green spaghetti covering, whilst the 6-volt winding has yellow spaghetti.

The black flex lead is the centre-tap of the high tension, and runs to the can of the first electrolytic condenser, which is mounted in the base with the insulation washers provided with it.

The a.c. power supply goes in to the two yellow flex leads, and, although it is possible to join the main power flex to these leads and then cover up each joint with insulation tape and then wraps the two lots of tape together, it is neater to mount a little two-point terminal strip, and

Triplett Model 1220-A Free Point Tester: This unit, used in conjunction with any multi-meter, provides a complete set analyser. Price, £4/5/-.

Ranger Examiner Model 557 Direct Reading Signal Generator: Covers five frequency bands from 110 to 20,000 k.c. on fundamentals, with guaranteed accuracy of 1% from 110 to 3000 k.c., 2% for higher frequencies. Completely shielded, provides both modulated and unmodulated signals. Price £7/17/6.

Ranger-Examiner Model 735 D.C. Pocket Volt-Ohm-Milliammeter: Is pocket-size multi-meter in black moulded case. Any of following ranges can be chosen by selector switch: 15-150-750 volts (1000 ohms per volt); 1.5-15-150 m.a.; 0.5-1000 low ohms; 0-100,000 high ohms at 1½ volts. External batteries can be used for higher resistance measurements. Uses Triplett D'Arsonval type precision instrument with readings accurate to within two per cent. Price £4/10/-.

"Radio World" readers interested in the above lines can obtain a free 14-page catalogue illustrating and describing them by writing Messrs. W. G. Watson and Co. Pty. Ltd., 279 Clarence St., Sydney.

solder the power leads to the transformer leads at these terminals. In either case it is well to remember that these two wires are the most dangerous in the set, and they are capable of delivering a serious shock if grasped by mistake. A knot should be tied in the power flex so that it is not possible for a pull on the flex to put a strain on the terminals or joints.

Leads about four inches long should be soldered to the insulated terminals of the gang condenser before it is mounted, and run through to the underside of the base.

Meter Repairs.

READERS with burnt-out meters, or with movements they would like converted, are advised to get in touch with the Precise Electrical and Instrument Co., of 173 Liverpool Road, Ashfield, N.S.W. This firm has specialised in the design and repair of meters and test equipment during the past few years.

Charges are reasonable, and original accuracy is guaranteed.

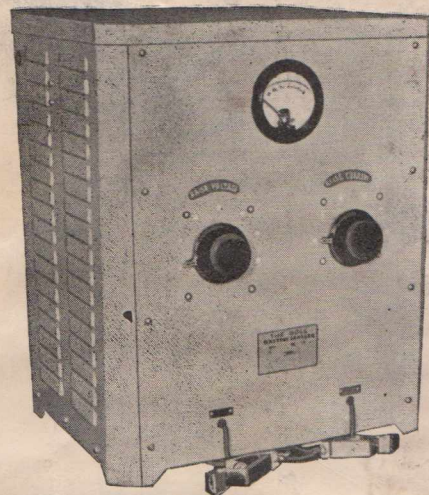

ABOVE: The Boss battery charger, described elsewhere in this issue.

FREE RESISTOR DE-CODER

Every reader should make a point of applying to Martin De Launay's for one of their nifty colour-code indicators for resistors.

These little gadgets are worth their weight in gold when you have a resistor on hand and you don't know its resistance. They are made up of celluloid, with three rotating dials carrying the colours for dot body and tip. By setting each dial according to the coding of the resistor, the rated resistance is shown clearly in figures. To obtain one of these handy rotary colour-code indicators you have only to write to Martin De Launay Pty. Ltd., mentioning that you are a reader of "Radio World."

Their address is C/r Druiitt and Clarence Streets, Sydney.

When the wiring has been completed, all loose pieces of solder should be swept out of the base and it should be carefully re-checked against the wiring diagram.

Testing.

With the valves in position and the speaker connected, the power can be switched on and the set tested with a short aerial.

Swinging the dial should bring in a few stations and, selecting 2SM or some station at the bottom of the dial, the trimmer on the aerial section of the gang can be set for best results. Then swing the dial to the other end, say on to 2FC, and set the padder for best results, at the same time rocking the dial to and fro to make sure that the station is being tuned in properly.

Further information on the alignment procedure can be gleaned from the article on oscillators in this issue.

An article in next month's issue which should be of interest to builders of this set is the one about the development of this set, as given in Headache Corner.

SPEEDY QUERY SERVICE

Conducted under the personal supervision of A. G. HULL.



prices. Write to any of our advertisers and they will be delighted to help you in this matter

* * *

J.S.V. (Brisbane) has in mind to build a big amplifier.

A.—Big Class A valves such as the Mullard D060 and similar types in Osram and Marconi brands are capable of delivering wonderful reproduction but we doubt if you will find them easy to pick up at bargain prices. From what we have been able to gather they are not available from junk stores, and they retail at quite big prices when available from the distributors. You may have quite a job to get any at all, in fact. We notice that the only big Mullard regularly listed is the D026.

* * *

J.T. (Drummoynne) writes: "I have just completed an amplifier using 6A3's in the output, and find it a very fine job. The tube line-up is a 6C6 pentode driver, 6C5 phase-changer, driving the push-pull 6A3's with a K12 speaker, but so far cannot say that I think it is better than an amplifier which my brother has which uses 6L6G in push-pull with the same sort of circuit. His amplifier seems to have more range of frequencies than my own, but I put it down that his amplifier has a greater output. His is about 10 watts, while mine is only 7 watts."

A.—While we agree to a certain extent with what you say, we feel that you would find your amplifier greatly improved if you gave it a bit more juice; in other words, get up to an effective 300 volts on the plates of the 6A3, with about 75 volts bias; in other words a real 375 volts of high tension measured from the plates to ground. These valves only start to step out when you load them up with plenty of high tension.

W.L.W. (Sydney) is keen to get a transmitting licence.

A.—There is nothing to stop you going ahead and getting your Amateur Operator's Ticket, but we doubt if there is the slightest chance of any amateur stations being licensed until the war is cleared up. Of course this war can't last for ever and in the meantime it is quite a rare chance to pick up transmitting gear cheaply. We would mention that we feel that it would be most unwise to actually start to assemble a transmitter at present, but you could make a point of picking up any cheap high voltage transformers, condensers, valves and so on.

* * *

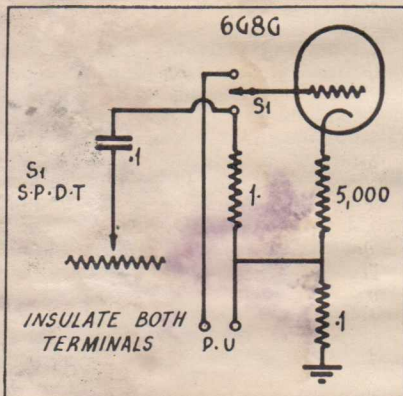

In response to many inquiries, we publish the circuit above, which shows how to connect a pickup to the "World Standard."

D.S. (Artarmon) wants a simple crystal circuit to work without a tuning condenser.

A.—The circuit for a crystal set which appears in this issue should be quite O.K. for your purpose. The efficiency of a crystal set is not likely to be high unless the tuning circuit has a nice balance of capacity and inductance, but if you only want to hear one or two of the stronger stations it should be quite possible to use the circuit in this issue, using full-sized components and a large coil.

K.T. (Lindfield) enquires about the Amplifier Championship.

* * *

A.—We all feel that we want the Amplifier Championship to be completely representative and if there are any outstanding amplifiers available we are not going to refuse to hear them just because they are a bit late with their entry. By all means see your friend and try to get him to rush through an entry. The job sounds most interesting and if the performance is anything like you claim it should stand a good chance. So far there have been many good amplifiers, but nothing really stunning.

S.K. (St. Albans) complains of late delivery.

A.—We do not come out before the first of the month, as is the case with some magazines. We prefer to come out a fortnight away from other similar magazines, and so we go on sale around the middle of the month, our direct subscribers having their copies posted out about the eighth to the tenth of each month. Everything is as up-to-date as can be at the time we go to press so it really doesn't mean a thing. Probably it would be a good idea for us to move the date forward a month and have the September issue on sale in August. Glad to know that you got such good results with the circuit.

* * *

A.N. (Petersham) brings up the subject of the original direct-coupled amplifiers of 1929 vintage.

A.—There were several different versions of direct-coupled amplifiers and quite a bit of difference in the resistor values and the circuit arrangements. We handled a large number of them at that time, mostly with 45 and E443 type output valves and in our own experience we didn't have any great amount of difficulty with the matter of the valve being overloaded whilst warming up. Even in those days when an indirectly heated valve took a couple of minutes to warm up it wasn't really serious. With modern quick heaters it shouldn't be a problem at all. We always held that if the plate current was doubled the drop in the main bias resistor would be doubled so that effective plate voltage would be reduced to only a hundred volts or so and the plate wattage ratings would never be imperilled. Several enthusiasts who were present at the first heat of the Amplifier Championship and heard the direct-coupled job have decided to do a little experimenting in this direction. If anything comes of it we will deal with these experiments in later issues.

* * *

W.B. (Hobart, Tas.) wants to put through a subscription for only six months.

A.—We prefer to have annual subscriptions, and we list out the order form that way, but actually there is no reason why you can't have a six months period if you feel that it would suit you better. Send along 5/3 and see whether we turn it down.

* * *

L. K. (Rozelle) wants details of a set which is compact, yet simple to build.

A.—You seem to be lucky as this issue contains a description of a receiver which should be ideally suited for your purpose. You can rest assured that it will bring you in all the local stations at full strength, separate them even in the worst locations and yet it won't cost you a great deal and it is quite simple to build. We don't handle kits of parts ourselves and we can't give you any

Serviceman's Technical Books

	Price.	Postage.
Automatic Control , by J. F. Rider	6/-	4d.
D.C. Voltage Distrib.—Radio Receivers , by J. F. Rider	6/-	4d.
Resonance and Alignment , by J. F. Rider	6/-	4d.
A.C. Currents—Radio Receivers , by J. F. Rider	6/-	4d.
The Oscillator at Work , by J. F. Rider	12/-	8d.
Servicing by Signal Tracing , by J. F. Rider	16/-	9d.
Cathode Ray Tube at Work	19/6	9d.

McGill's Agency

C8113-4

183-185 ELIZABETH STREET,
MELBOURNE, C.1

SPEEDY QUERY SERVICE

(continued)

Then we like to see the K12 running with something between 12 and 20 watts energising in the field, even if it is higher than the makers' rating it seems to take it in practice, with a considerable improvement in the matter of handling power.

There should be no advantage in using an audio transformer, as the phase-changer should be able to handle the job, but if you feel like it a little experimenting should be interesting and instructive.

Fifteen-foot leads to the speaker are quite O.K. in practice, but keep to heavy power flex so as to have low resistance.

There are two ratings on the 6A3, one for 60 bias and 40 mills, and the other 40 bias and 60 mills. We like about 300 on the plate with about 50 mills, and 75 bias.

Everybody seems keen about the power unit mentioned by Mr. Carter in his Amplifier Championship entry, but so far we don't know anything about it beyond what he wrote on his entry form. Naturally we hope to be able to let you have full details later.

H.V. (Cooma) sends a circuit for approval. It has a pair of 6L6G in the output, with a phase-changer driven from the audio output of a diode detector.

A.—As requested, we have glanced over your circuit, and here are one or two points which appear doubtful to us. The first is in the matter of the input of the phase-changer. This is between grid and earth, and would mean that there would be no gain in this valve, a very different matter from the way we used the phase-changer in our "World Standard" and "Big Boy." We get the full amplification of the valve by arranging an input which is between cathode and grid, and not earthed. We doubt if you could get sufficient audio output from the diode to drive the output valves without some audio gain.

...Using a 12" speaker a 750 ohm field would give you suitable energising and voltage drop, but we doubt if it would provide sufficient filtering to stop hum trouble. Really a choke and extra filter condenser should be used. Speaker transformer should be 5,000 ohm plate-to-plate load.

Whether you use separate bases or not is purely a matter of convenience, and is not affected by the circuit design.

A.B. (Queenstown Tas.) has built the "Big Boy" amplifier noted the necessary alterations to the socket wiring of the 6G8G, yet still fails to get enough punch. He asks whether it is capable of giving proper results, and says that he has heard that resistance-coupled amplifiers are hard to get going properly.

A.—We hasten to assure you that "Big Boy" is a splendid amplifier, and capable of fully loading a K12 speaker.

The socket connections in the picture diagram were wrong as mentioned in our June issue on page 39, but otherwise everything was O.K. and failure to obtain complete satisfaction should be impossible. Perhaps you have earthed one side of the volume control or pick-up lead, or the shielding of the pick-up leads. It is essential to keep the whole input above earth potential. Both input terminals must be insulated.

If hum is a trouble, one side of the 6G8G heater should be earthed, but it should not affect the power output or general performance.

We have seen at least a dozen examples of "Big Boy" and, without exception, the builders have been thrilled with results. We strongly advise you to persevere with the job until you get it going properly.

If all else fails we can only suggest you put it on a boat for Sydney and we will soon put it into proper condition, without charge.

Y.F. (Newcastle) wants a circuit designed for an amplifier.

A.—Before starting to design an amplifier it is essential to know that type of signal input which is going to be fed to it. There is a vast difference between the signal from a microphone and some types of crystal pickups. The required gain varies accordingly. It is possible to feed a crystal pick-up straight into an output valve, without any amplification at all. On the other hand some microphones have such a low signal that two stages of pre-amplifier are needed ahead of a high-gain three-stage amplifier proper.

M.S.F. (Maroubra) enquires about the designing of a special circuit.

A.—No, we cannot undertake to design a special circuit to suit your requirements, but if you care to list us out the stuff you have on hand and the kind of circuit you have in mind we feel sure that we will be able to find you a circuit in a back number. We have big stocks of practically every number and many of them contain really fine circuits. They are available at 6d. and 9d. each, post free.

AMPLIFIER CHAMPIONSHIP

(continued)

did not appear to appeal to the audience.

Minor Trouble.

Competitor No. 9 was Mr. Elsworth of Allawah, but he had more than his share of bad luck. In transit one of the speaker leads was pulled off the plug, and even after this difficulty had been overcome there was trouble with hum and microphonic hum.

The actual reproduction of the amplifier, which had a pair of 2A3's driven from a 6V6G as triode, was definitely good, and we feel sure that it would be well worth while for this man to re-enter his amplifier and come up again. Without breakdown or hum trouble it should stand a good chance of being well in the running.

The Result.

Official judges present were Messrs. Allen, Head, Page and Erman, and they were unanimous in awarding their verdict in favour of competitor No. 4.

Counting of the public ballot, however, favoured No. 3.

The voting was as follows—No. 1, 2 votes; No. 2, nil; No. 3, 14; No. 4, 2 votes; No. 5, 6 votes; No. 6, nil; No. 7, 1 vote; No. 8, 2 votes; and No. 9, 4 votes.

And so ended the third heat, with plenty of discussion among competi-

tors, judges and the audience after the hearing had ended.

General opinion seemed to be that several competitors were completely misled in using unsuitable or incorrectly built box baffles. Insufficient attention had been paid to the lining of the box and the elimination of cabinet resonances, especially in the case of one or two which were built from rather light timber.

Several of the audience were heard to express the opinion that they were amazed that several amplifiers could sound quite distortionless and yet give entirely different type of reproduction.

Further Heats.

Further heats are being arranged for the month of July, and some seats are available for those who are sufficiently interested to come along. Early application for reservations should be made. These are quite free but a stamp should be enclosed with the application.

BARGAIN LINES AT MURDOCH'S RADIO SALE

Among dozens of keenly-priced radio lines included in Murdoch's latest sale are the following bargains, that should be of real interest to "Radio World" readers.

First is a selection of two-gang double-spaced midget condensers, available in capacities of 30 and 40 mmfd. per section. Of highest quality English make, these condensers sturdily built throughout, and are provided with Isolantite bases. They are priced at 13/6 each. A single-spaced type is also available at the same price, capacity 100 mmfd. per section, together with a 30 mmfd. double-spaced single-gang type at 7/6 each.

Flush mounting nickel-plated meters of English make, priced at 9/6 each, are available in scale readings of 0-20, 50, 100 and 250 m.a., and 0-3, 10, and 16 volts.

The next line selected for review is a well-built electric soldering iron rated at 75 watts, 240 volts, fitted with an oven bit that can be extended or retracted to provide a useful degree of temperature control. It has been tested and passed, this iron is specially priced at 12/11, including flex and plug.

A line with a strong wartime appeal is a neat Morse-code outfit listing at 19/6 complete. It comprises a key and high note buzzer mounted on a steel chassis, together with a torch bulb holder. Sending is thus either aural or visual, or both. The buzzer is of the adjustable note type, while both tension and gap are adjustable in the key.

Readers are asked to note that packing and postage on all these lines and those advertised by Murdoch's elsewhere in this issue, are free.

METER REPAIRS

We are specialists in the design, manufacture and repair of meters and test equipment of all types.

PRECISE ELECTRICAL AND INSTRUMENT CO.

ELECTRICAL ENGINEERS AND INSTRUMENT MANUFACTURERS
173 Liverpool Rd., Ashfield, N.S.W.
Phone: UA 1540

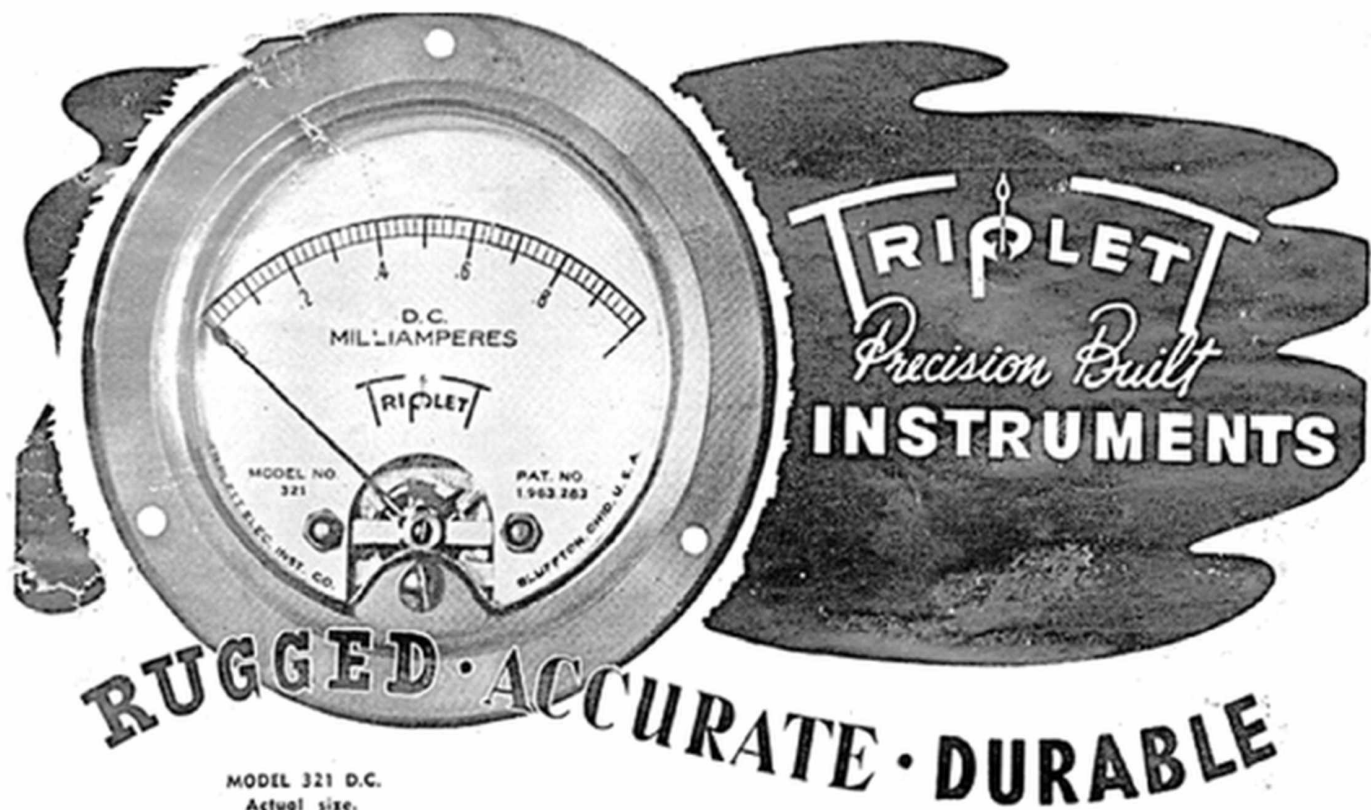

MODEL 321 D.C.
Actual size.

... built in many types and sizes !

Triplet instruments have established a new standard of quality in the field. Precision accuracy at low cost, simplicity with extreme ruggedness and bridge type construction are features that evidence the most approved engineering practice.

Magnets of laminated construction have exact lamination exactly gauged after hardening, thus assuring accuracy of scale characteristics. This is one reason accuracy of scale when not hand-adjusted can be as low as 1%. Triplet's exclusive method of maintaining absolute uniform pole piece accuracy supplants the more expensive milled soft iron type, and is far superior to those formed of soft iron. Cast magnets of cobalt and other alloys are used in some of the larger and more sensitive Triplet instruments and relays. D.C. instruments of the D'Arsonval type with an extremely light moving coil and reinforced parts. A.C. instruments are the movable iron repulsion type; are air damped and have light moving parts. Both A.C. and D.C. have selected sapphire jewel bearings and highly polished pivots. White enamelled metal dials and moulded zero adjusters. Accuracy within 1%, except rectifier type instruments, which carry a 5% tolerance. Instruments supplied with pointer stops.

TWIN INSTRUMENTS

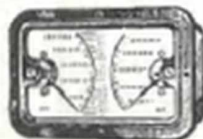

Twin Instrument.

THE TWIN is furnished in any combination of A.C. or D.C. instruments in the special rectangular moulded case that requires a minimum of space. Permits simultaneous readings on both instruments when connected in the same or separate circuits. Instrument scales are side by side, making possible two distinct readings at a glance. Used to balance loads in three-wire circuits; detect line fluctuations when load readings are taken; measure antenna and modulation current; determine filament plate voltages and similar applications.

THERMO AMMETER High Frequency Accuracy 2%

Triplet Thermo Ammeters correspond in size, etc., to corresponding D.C. models. All have moulded cases. Have external couples which withstand 50% overload connected to meter with 2-foot leads. Couples are easily replaced when necessary. Internal couples to order. External couples only, for any model. LIST PRICE 50/-

The Model 321, 3-inch dial, illustrated above, is available in 5- and 2-inch dials, designated Models 521 and 221.

Typical "321" ranges are:					
0.1	Milliamperes	33/3	0.250 Milliamperes	27/6	
0.10	"	27/6	0.500	"	27/6
0.50	"	27/6	0.1000	"	27/6
0.100	"	27/6			



529-D.C. 539-A.C.



Thermo Ammeter

W.G. WATSON & CO. PTY. LTD.

Head Office: 279 CLARENCE STREET, SYDNEY. Newcastle Branch: KING & BOLTON STREETS, NEWCASTLE.
Branches at Melbourne, Adelaide, Hobart, Launceston and Perth

TO THE £4 A WEEK MAN

who would like to be making **£500** a year

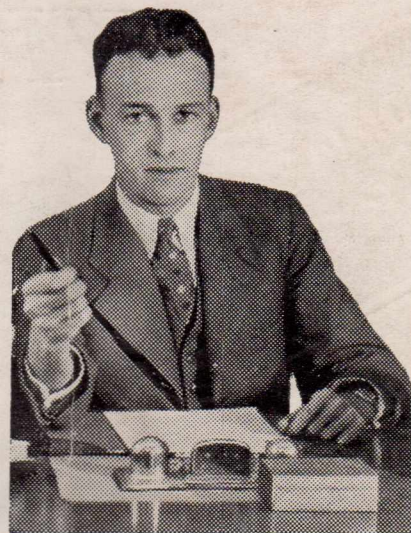
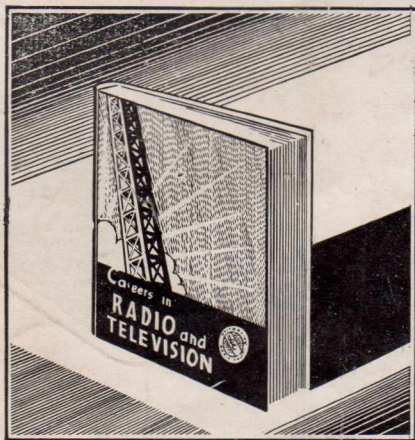

Men who can't face up to present conditions, who adopt a defeatist attitude, who are satisfied with their present job, come what may, will NOT be interested in this advertisement. But the man of action, who is set on striking out for himself, in doubling his income and opportunities, no matter how seemingly "tough" the going may be, will here find much food for thought.

This is a message to the man who knows he is capable of earning a good deal more than he earns now, but who feels he lacks the confidence and experience to get and secure a position of importance. It is also addressed to young men, perhaps not long from school, who are looking for an industry which will provide them with a profitable and interesting career NOW and in the years to come. This is the day of the specialist; unskilled labour is uncontented; Radio engineering seeks specialists in all branches. Now, more than ever before, Radio is crying out for skilled men—in peace or war, Radio booms!

Whether you possess certain Radio or electrical knowledge, or whether you know nothing of these subjects, the Australian Radio College can quickly put you on the right track. We haven't been in business for many years without acquiring a know-

ledge of what Radio demands and how we can speedily impart the knowledge that will fit you for a man-sized job.

STRIKING LETTERS.

Here are a few letters we have received from grateful students. These are not just another "batch of testimonials," but genuine unsolicited letters, typical of the hundreds which may be inspected at our head office.

A student writes:—"Before turning to Radio professionally, I had, in recent months, found it impossible to obtain employment in the line for which I was qualified. Thanks to your aid, I was placed within two weeks of my examination."

Another states:—"There must be a shortage of trained men all right. I get offers ever so often since I successfully passed through your course. My most recent was the offer of a branch manager-ship."

Here's a man, now in business for himself, who says:—"I sold six sets last week; employ two men, and have just bought a new delivery van, all in my spare time whilst training and after."

L. B. GRAHAME,

Principal, Australian Radio College. The Australian Radio College is not a cold-blooded institution run along orthodox lines—rather, it is a warm, friendly, co-operative organisation, personally conducted by the principal.

A.R.C. TRAINING COSTS LITTLE—YOU CAN TRAIN AT HOME.

For a few pence each day—less than many fellows spend on tobacco—you can train yourself in your spare time at home, for a good pay position in Radio. Think what this can mean to you—success, home of your own, good bank account, your own car, etc., and SECURITY.

IMPORTANT.

Technical experts agree that A.R.C. training is sound—it must be, for it's a sober fact that we have placed hundreds of men in first-class jobs—doubling and trebling their previous salaries. If we have done this for others, there is no reason why we cannot do it for you! If you are prepared to devote PART of your SPARE time to serious study, A.R.C. can fit you for a man-sized job.

AUSTRALIAN RADIO COLLEGE

BROADWAY (opp. Grace Bros.),
SYDNEY. Telephone: M 6391-2.

"Careers in Radio" is a book every ambitious man should read. Published by The Australian Radio College Pty. Ltd., it is available to you free. The coupon is for your convenience.

SEND FOR FREE BOOKLET



MAIL COUPON NOW

To MR. L. B. GRAHAM,
The Australian Radio College Pty. Ltd.
Broadway (opp. Grace Bros.), Sydney.
Telephones: M 6391-M 6392.

Sir,
Please send me your book, "Careers In Radio & Television." It is understood I am under no obligation in making this request.

NAME

ADDRESS A.R.W.3