

THE
AUSTRALASIAN

PRICE, 1/-

Radio World

VOL. 4 NO. 2

JUNE 10, 1939

Registered at the G.P.O.
Second Class Postage paid
by post as a periodical.

● PORTABLE VALVE TESTER:
HOME-MADE MICROPHONE

● 'RADIO WORLD' ECONOMY
FIDELITY AMPLIFIER

● 1939 COMPANIONETTE:
ASTRA DUAL-WAVE SIX

● WORLD S.W. NEWS:
HOURLY TUNING GUIDE



The Home of Rola: See p.

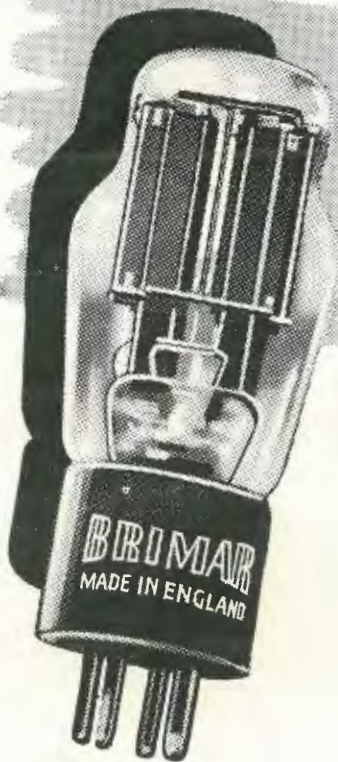

BRIMAR VALVES BRING A NEW ERA FOR PORTABLE RADIOS!

HOME BUILT PORTABLE RECEIVERS AT LAST MADE PRACTICABLE BY THE INTRODUCTION OF 1.4 VOLT VALVES!

Up till recently the construction of home-built portables was something to be avoided . . . cumbersome accumulators had to be installed and kept upright in case the acid spilled. Then again, fumes from the acid played havoc with the fittings and the interiors of the portable cabinets. Heavy batteries were also necessary, which made the so-called portable a very hefty proposition to carry about.

With the introduction of the Brimar 1.4 Volt Valves comes a new era in portable radio history. These valves eliminate the use of accumulators! . . . and reduce by one-third the weight of batteries!



As finely built as a watch

This composite picture showing the many intricate parts required in the construction of a Brimar Valve indicates how essential is the need for reliability in the modern valve. The assembly of these parts to make the complete valve is the task of skilled operatives, hundreds of whom are engaged in the giant Brimar British Valve factory where valves are produced for use in every part of the world.



BRIMAR VALVES INSTALLED IN "QUEEN MARY" & "QUEEN ELIZABETH"

The safety of thousands of passengers carried on these mammoth liners costing £12,000,000 is dependent upon radio communication. It is significant that Brimar Valves are used in the radio installations of these ships.

No matter which circuit you construct you will find that you, too, can rely on Brimar Valves to give the best in range and tone.

BRIMAR VALVES

BRIMAR DISTRIBUTORS LISTED BELOW:

N.S.W.: Standard Telephones & Cables Pty., Ltd., 258-274 Botany Road, Alexandria. QUEENSLAND: Trackson Bros. Pty., Ltd., 157-9 Elizabeth Street, Brisbane. SOUTH AUSTRALIA: Radio Wholesalers Ltd., 31 Rundle Street, Adelaide. WESTERN AUSTRALIA: M. J. Bateman, Ltd., 12 Milligan Street, Perth. VICTORIA: Noyes Bros. (Melb.) Ltd., 597-603 Lonsdale Street, Melbourne. TASMANIA: W. & G. Genders Pty. Ltd., 69 Liverpool Street, Hobart; 53 Cameron Street, Launceston, also at Burnie. NEW ZEALAND: Standard Telephones & Cables Pty. Ltd., P.O. Box 638 Wellington, P.O. Box 1897 Auckland; P.O. Box 983 Christchurch.

Hear the World on TINY TIM!

Using only a three-foot aerial and midget batteries, this amazing little receiver will pull in stations all over the world at fine headphone strength. Covers five bands (including broadcast) by switching, uses latest 1.4-volt valves.

WRITE FOR OUR QUOTATION NOW.

"The Ultra DX Three."

Designed specially for u.h.f. DX reception, the "Ultra DX Three" described in this issue is destined to become widely popular among amateurs and shortwave enthusiasts throughout New Zealand and Australia. Our kit of parts comprises only the highest quality components, designed specially for u.h.f. work.

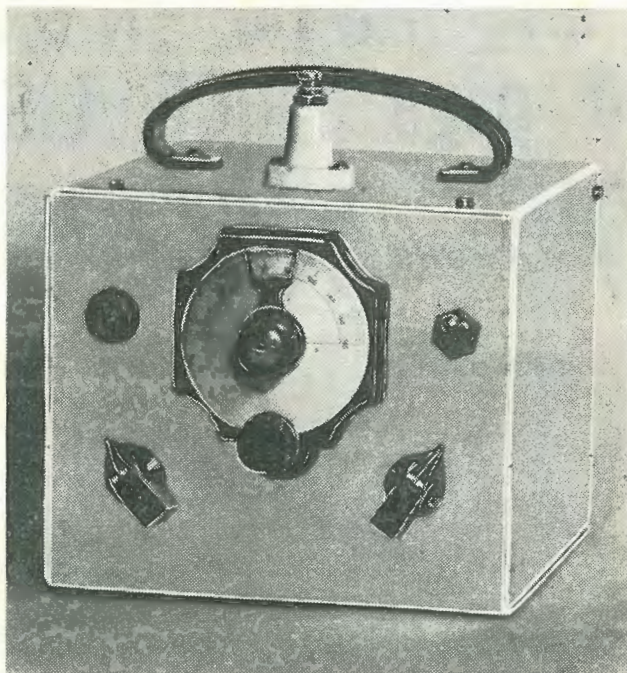

Build the "Astra Dual-Wave Six."

No finer 5/6 a.c. superhet than the "Astra Dual-Wave Six" described in this issue has ever been featured in any magazine. Its sensitivity and selectivity will amaze you, while both volume and quality are as good as from receivers costing several times the price. Write for our free quotation.

"1939 Companionette Three."

One of the cheapest a.c. kits we have ever supplied to builders, the "1939 Companionette" nevertheless gives a magnificent performance out of all proportion to its low cost. Write for details of our special kit of parts.

Hammond Transmitting Condensers.

	Nett Price
Type 8810—Split Stator 100mmfd. per Section 3000-volt	39/-
Type 8805—Split Stator 50mmfd. per Section 3000-volt	35/-
Type 7710—Split Stator 100mmfd. per Section 1500-volt	22/6
Type 7705—Split Stator	

50mmfd. per Section 1500-volt	19/6
Type 7710—Single 100 mmfd. 1500-volt	19/-
Type 7105—Single 50 mmfd. 1500-volt	17/6

Astatic Microphones.

Model T3—Wide range crystal, response 40 to 10,000 cycles	£6 17 6
Model D104—The Hams' Favourite	£6 5 0
Taylor Transmitting Tubes.	
Type T20 and TZ20	23/-
Type T40 and TZ40	32/6
Type T55	62/6
Type 866	15/6

Book Your Order NOW!

A limited number of U.T.C. modulation transformers and Meissner tuning units are available ex shipment due approximately June 10. (U.T.C. and MEISSNER are prohibited lines under Government Import Regulations for second half of 1939!).

Mikes For Amateurs.

Now—a high-grade dynamic microphone for amateur or P.A. work. Frequency response 50 to 9000 cycles £5/5/-
ASTATIC, acorn model, T-3,

crystal mike. Quality reproduction, ideal for dance band or studio work £6/10/-
ASTATIC, model D-104—the "hams" favourite £5/10/-
SHURE, model 70 SW, crystal, with modern desk stand £6/10/-

Headphones.

FROST, definitely the most popular 'phones in N.Z. 15/-
MICRO, high-grade English 'phones, used extensively in British Government departments 18/6
British Post Office pattern, heavy brass morse keys. Here's the key you have tried hard to procure 52/6

"Univex" Home Movies.

"UNIVEX" home movie cameras, projectors and photographic supplies.

Make a living record of those holiday hours, week-end trips, etc. "Univex" offers for the first time quality movie equipment at prices you can afford to pay—take the new "Univex" cine B camera with you everywhere you go; it costs only £4/17/6 and uses 8 mm. film at 5/6 per roll.

"Univex" is backed by 100 per cent. after-sales service. Write for catalogue now.

FEAR'S

FOR EVERYTHING IN RADIO

AN ADVERTISEMENT OF

F. J. W. FEAR & CO., "The Radio Pioneers."
Temporary Address: Commercial Travellers'
Building, 109 Customhouse Quay, Wellington.

GET THIS NEW 80 page PRICE LIST *FREE and POST FREE*



WILL SAVE YOU £'s

Containing the latest and best prices on electrical and radio supplies, this price list is yours for the asking. Every trader needs it as a guide to better buying.

**PIN THIS COUPON TO YOUR LETTERHEAD
AND POST TO-DAY.**

MARTIN DE LAUNAY PTY. LTD.

Clarence & Drutt Sts., Sydney (M 4268)
(and at Newcastle & Wollongong).

Please send me your new 80-page price list post-haste.

The Australasian RADIO WORLD

Incorporating the
ALL-WAVE ALL-WORLD DX NEWS

Managing Editor:
A. EARL READ, B.Sc.

Vol. 4. JUNE, 1939. No. 2.

CONTENTS:

The "Astra Dual-Wave Six"	3
The "Ultra DX Three"	6
New Ever Ready Batteries For 1.4-Volt Portables	8
Fight For Amateur Bands	10
Simple Portable Aerial	11
This Thing Called "Q"	12
More About The 1939 Companionette Three ...	15
A Portable Valve Checker	17
More Sets From Back Numbers	21
A.O.C.P. Questions And Answers	22
Experimenters—Get Down To Ultra Shorts ...	24
Installing An Extension Speaker	26
A Test-Bench Multi-Vibrator	28
Making A Reiss Microphone	31
Leaves From A Serviceman's Diary (3)	32
The Economy Fidelity Amplifier	33
What's New In Radio	36
Shortwave Review	41
Hourly Tuning Guide	46

The "Australasian Radio World" is published monthly by Read Publications Editorial offices, 214 George Street, Sydney, N.S.W. Telephone BW 6577. Cable address: "Repress," Sydney. Advertisers please note that copy should reach office of publication by 14th of month preceding that specified for insertion. (12 issues), post free to Australia and New Zealand. Subscription rates: 1/- per copy, 10/6 per year

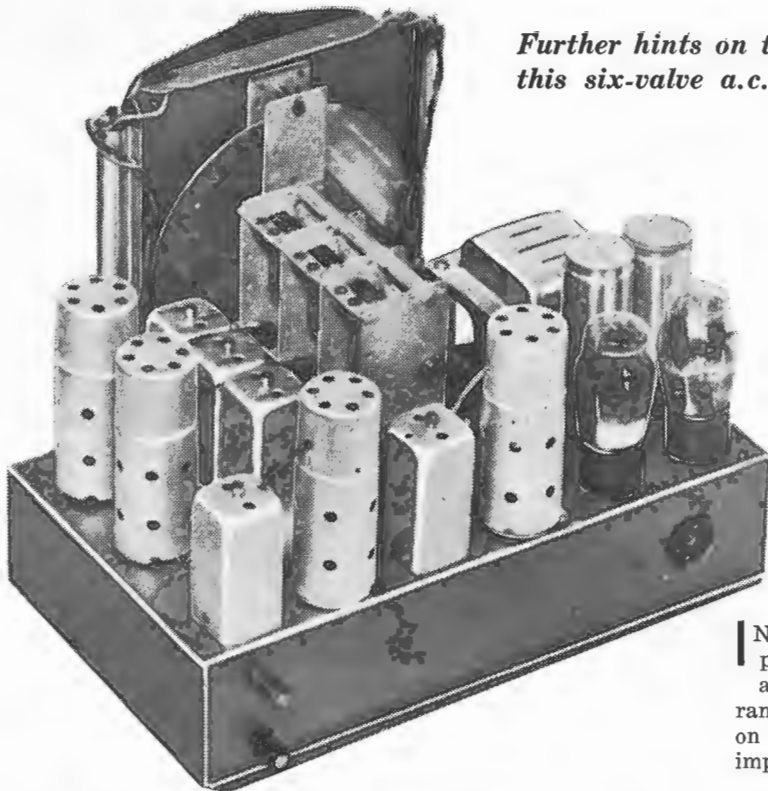

Further hints on the assembly, wiring, and alignment of this six-valve a.c. dual-wave superhet are given in the article below.

More About The Astra Dual-wave Six

IN building the "Astra Dual-wave Six," the first parts to mount are the valve and speaker sockets and power transformer. These should all be arranged so that the lugs face in the directions shown on the under-chassis wiring diagram below. An important point to remember when mounting the

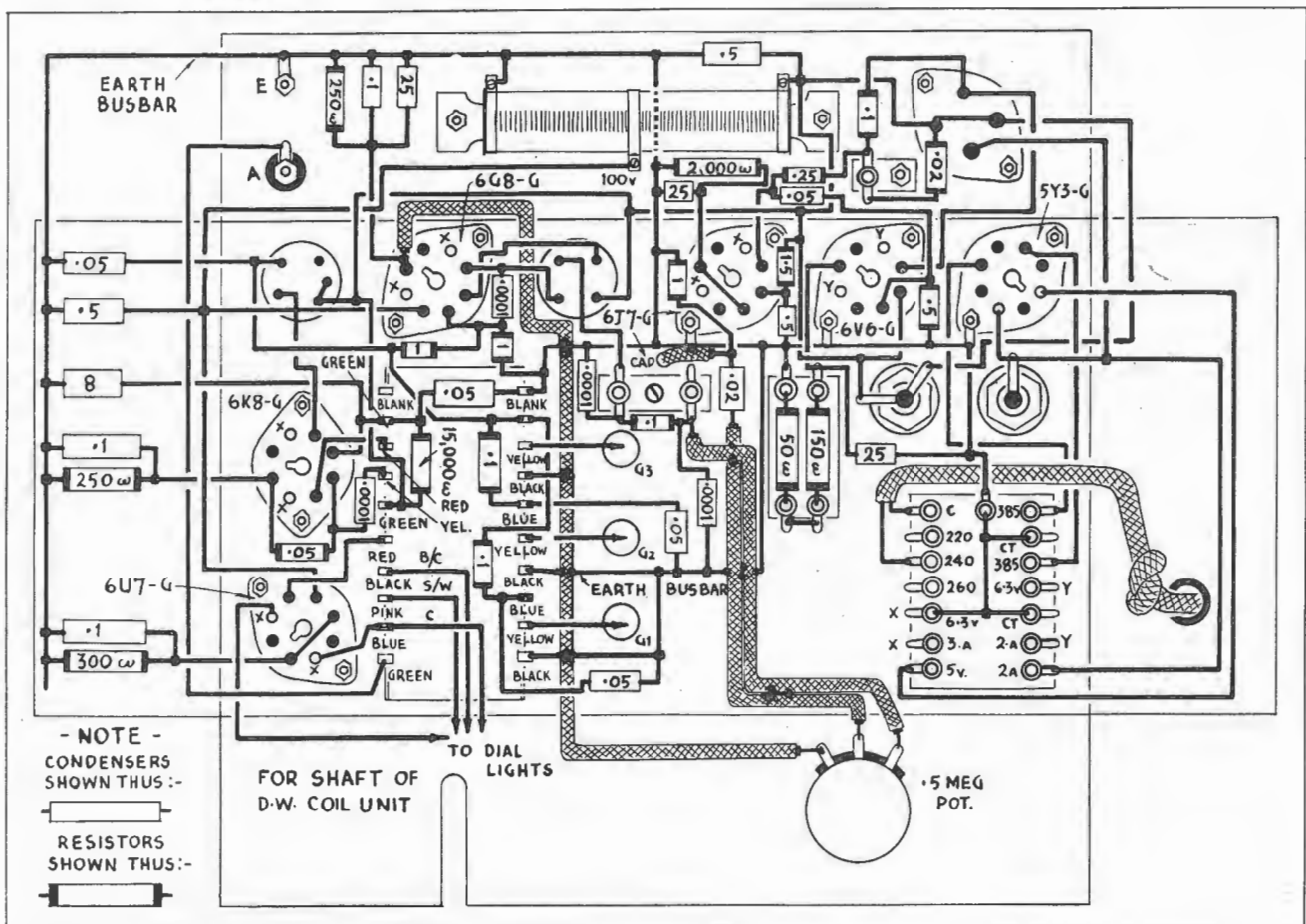

Change In "Radio World" Publication Date New Scheme Will Give Commonwealth-Wide Distribution By First Of Month.

Readers are advised that the next issue of "Radio World," to be published on July 15, will be the July-August issue. The following issue, published on August 15, will be the September issue, and this arrangement will then be maintained subsequently. In this way, by publishing each issue a fortnight or so before its actual date of publication, readers throughout the Commonwealth should receive their copies on the first of the month of issue, while subscribers whose copies are mailed direct should receive the magazine a few days earlier.

This plan is being adopted in response to enquiries from inter-state readers, asking if some new arrangement could be adopted whereby they could receive their copies earlier than a fortnight or so after date of publication, which for the past ten issues has been the tenth of the month. From now on readers will still continue to receive the "Radio World" on approximately the same date of the month as in the past, but from the September issue onward, the "Radio World" will be distributed throughout the Commonwealth by date of publication.

valve sockets is to include valve shield bases where required.

Next, the heater wiring can be put in. There are two 6.3-volt windings

on the power transformer. That with the higher current rating supplies the first four valves, while the other supplies the 6V6G heater. The

"5v. 2a." lugs connect to the filament lugs of the 5Y3G rectifier socket, and the "385v." lugs to the plate lugs. Now mount the two wet electrolytics,

RAYMART

CRAFT A CREED

New TRANSMITTING CONDENSERS —

give you PERFORMANCE PLUS!

Plus what? Plus the knowledge that in the new RAYMART range of Transmitting Condensers you have the latest development in this type of Condenser, combined with precision construction and outstanding features, assuring best results. Write "The Friendly Wholesale House" for leaflet containing full descriptive matter. RAYMART Components are used in the "Ultra DX Three" featured in this issue. As well, they are regularly specified EXCLUSIVELY for "Radio World" receivers.

These are exclusive RAYMART Transmitting Condenser advantages:

- Triangulated frame, giving extremely rigid construction and so maintaining capacities constant.
- RMX Insulators with insulators and main frame out of the field of the condensers.
- Collector brushes with corona shield, eliminating carriage of RF through the bearings.
- Long front bearing, giving absolute freedom from slackness and perfectly smooth action.
- Ball-bearing rear end.
- Maximum possible flash - over clearance everywhere.
- On the 10,000-volt peak model all plates have rounded and buffed edges.

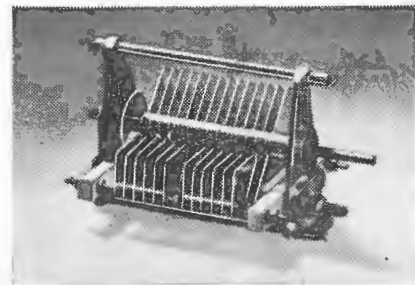
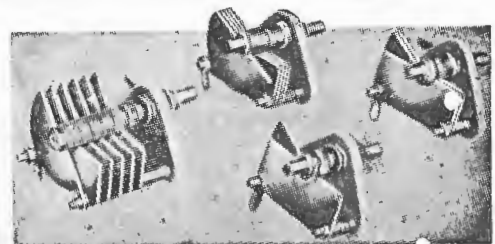

Raymart Condenser Type TCD 100X

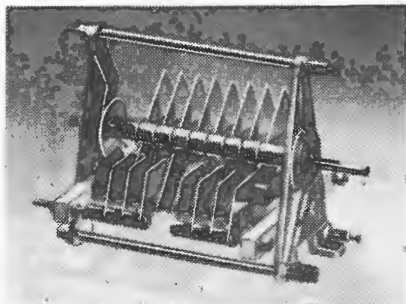

Raymart Condenser Type TX 40X

CERAMIC SHORTWAVE MICRO-VARIABLES. The range of RAYMART micro-variables employ their exclusive new material, "RMX" for greatest efficiency at highest frequencies. Ball races are electrically shorted, ensuring freedom from noise.

	List Price		List Price
VC15X 15mmfd.	6/9	VC160X 160mmfd.	9/9
VC40X 40mmfd.	7/6	VC250X 250mmfd.	
VC100X 100mmfd.	7/9	(.00025 mfd.)	10/6
NC15 (Transmitting) Neutralising	15mmfd., spacing .07in.		8/-
TC40 (Transmitting) Tuning,	40mmfd., spacing .07in.		9/6

Telegrams: "Jonmar," Sydney.
Telephone: BW 3109 (2 lines).

"The Friendly Wholesale House"



116-118 CLARENCE STREET, SYDNEY.

and complete the wiring of the smoothing filter and speaker socket.

Further Components To Mount.

The condenser gang, aerial and earth terminals, volume control and i.f. transformers are now mounted in place. Before mounting the gang, however, solder an eight-inch length of flexible push-back to each of the fixed plates lugs underneath it. These leads pass through the chassis and are soldered later to the appropriate lugs on the dual-wave coil unit.

Next, commencing at the plate lug of the 6K8G mixer, wire the first i.f. transformer, pentode section of the 6G8G, second i.f. transformer, and so on until the speaker socket is reached. As shown in the under-chassis photograph, the three leads to the volume control are covered with shielding braid, which is earthed at several points along its route. Now carefully check the wiring put in so far before proceeding further.

The voltage divider can now be mounted on the rear wall of the chassis, and wired into the circuit.

Mounting And Wiring The Dual-Wave Unit.

Next comes one of the most important tasks of all—the mounting and wiring of the dual-wave unit. To some set-builders this is the most difficult part of building a set of this type, but with the Radiokes DUA-3 unit specified not the slightest anxiety need be felt on this score, because this unit is simplicity itself to mount and wire. The colour coding as indicated on the wiring diagram and pamphlet accompanying each kit is particularly simple to follow, and obviates all danger of wrong connections.

The final step in the wiring is to mount the tuning dial and connect up the dial lights to the wave-change switch.

Complete Check Advisable.

At this stage, a complete and thorough check of the entire receiver, from aerial terminal to speaker socket, is strongly advised. While this means forcibly restraining a strong inclination to get the receiver "on the air" as soon as possible, twenty minutes or so spent in tracing out wiring could easily save possible damage to valves or components, due to a minor error.

With everything checked and passed, the grid clips and control knobs can be fitted, valves plugged in and

(Continued on page 7)

SPECIFY RADIOKES

FOR THE "ASTRA DUAL-WAVE SIX," "1939 COMPANIONETTE THREE" AND "ECONOMY FIDELITY AMPLIFIER," DESCRIBED THIS MONTH, READERS SHOULD SPECIFY RADIOKES COIL KITS AND COMPONENTS AS USED AND RECOMMENDED BY THE DESIGNER.

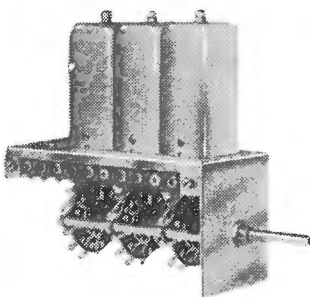

RADIOKES specialise in supplying matched and aligned coil kits:
Dual Wave Air Unit with Trol. R.F. Stage and 2-Iron Core Trol. I.F.'s. £4/7/6.

DUAL WAVE UNIT

B/C 1500 to 550 k.c. S/W 16 to 50 Metres.
Aerial, R.F., and Oscillator 460 k.c. A.C.
Cat. No. DAU-3. Retail Price .. £3/3/-
Aerial, R.F., and Oscillator 460 k.c. battery.
Cat. No. DAU-3B. Retail Price .. £3/3/-

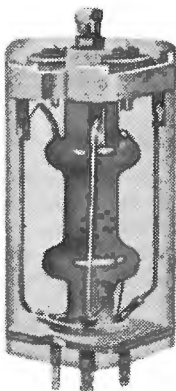

RADIOKES INTERMEDIATE TRANSFORMERS

The new Radiokes Trolitul I.F.'s are extremely stable, due to new method of construction, made possible by use of Trolitul 'formers and base. No loose wires to shift and alter frequency. Positively the best I.F.'s produced.

Air Core, 1st, 465 K.C., sq. can, 3in.x1 1/2in.	Type	Price
	I.F.A.	7/6
	I.F.I.	10/6
Air Core, 2nd, 465 K.C., sq. can, 3in.x1 1/2in.		
Iron Core, 1st, 465 K.C., sq. can, 3in.x1 1/2in.		
Iron Core, 2nd, 465 K.C., sq. can, 3in.x1 1/2in.		

RADIOKES BROADCAST COILS

Air Core Aerial Coils.		
Air Core R.F. Coils.		
Air Core Osc. Coils, 465 K.C.		
Iron Core Aerial Coils.		
Iron Core R.F. Coils.		
Iron Core Osc. Coils, 465 K.C.		
Permeability Tuned Aerial Coils.		
Permeability R.F. Coils.		
Permeability Tuned Osc. Coils, 465 K.C.		
Type		List Price
A.C.B. Air Core		6/6

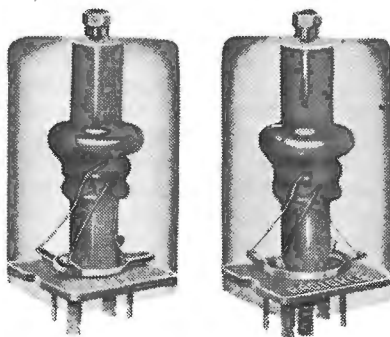

MAIL THIS COUPON NOW!

Radio Suppliers Pty. Ltd.,
Wingello House, Angel Place,
Sydney.

Please add my name to your mailing list for free technical literature and new free service.

Name.....
Address.....
State.....

Distributors:

BLOCH & GERBER Ltd.

46 YORK STREET, SYDNEY.

Telephone MA 6291 (10 lines)

It's free!

1939
FOXRADIO
CATALOGUE

Every radio technician in Australia should have a copy of the newly-released 1939 FOXRADIO Catalogue.

Comprising 68 pages and printed on high grade paper, it is packed from cover to cover with hundreds of new radio and electrical lines. All types of equipment, components, new coil kits, accessories... all are included in one of the most comprehensive catalogues ever published. For ready reference, every item is listed in alphabetical order.

Fill in and post the coupon below and your copy will be sent to you free and post free by return mail.

Messrs. Fox & MacGillycuddy
Ltd. (In Liq.),
57 York Street,
SYDNEY.

Please send me free copy of your new 68-page 1939 Foxradio Catalogue.

Name.....
Address.....

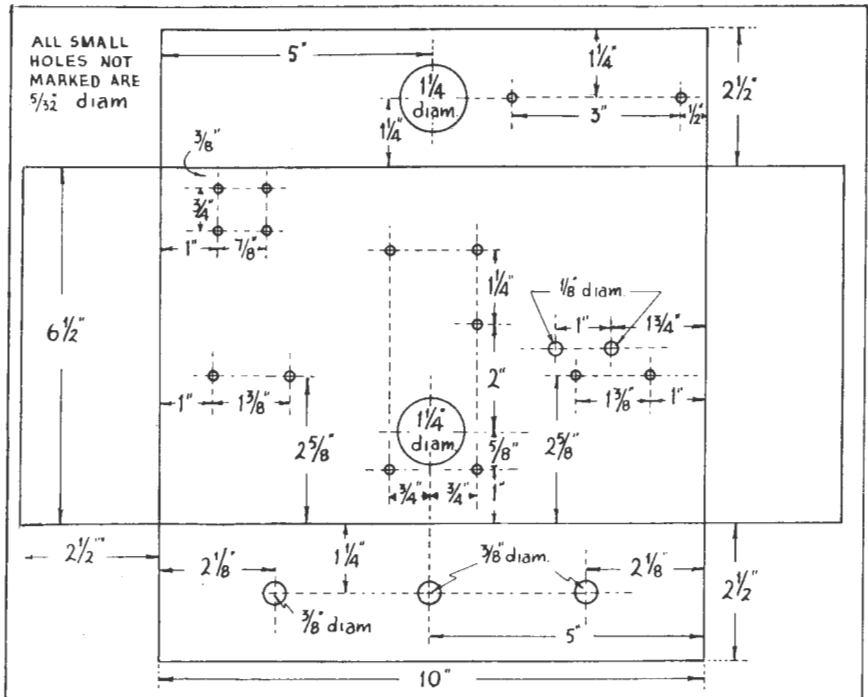

Dimensions for preparing the aluminium chassis are given in this sketch.

“ULTRA DX THREE” Chassis And Panel Data

WHILE the receiver described last month is a particularly easy set to build and get going, due attention must be paid to the layout of the chassis, panels and component parts.

The chassis itself is 10" by 6 1/2" wide and 2 1/2" deep, while the front panel is 10 1/4" by 7 3/4". Both are of 16-gauge aluminium.

The two partitions, which run longitudinally down the chassis from the front panel are 6" long x 5" high, and with a 1/2" flange on two sides for mounting on the chassis and front panel for rigidity.

The final two partitions are 3 1/2" wide by 5" high and are also provided with 1/2" flanges for mounting on chassis and adjoining partitions. These two partitions which run parallel with and about 2 7/8" inches from front panel have the two tuning controls mounted on them.

The whole of the aluminium is scrubbed with steel wool and finished with three coats of clear Duco or Dulux. (Keep in mind, of course, that where the chassis and partitions meet, a small area of the aluminium will have to be scraped to allow of good contact).

Layout Details.

Looking at the front panel, on the

left is the tuning control for the r.f. stage, and then to its right is the detector tuning control, while the three controls underneath are the regeneration, on/off switch and volume, with the headphone plug situated in the centre of the panel.

Underneath the chassis is mounted the audio choke in the detector plate lead, and associated by-pass condensers.

The 8 mfd. decoupling condenser is of particular importance. Nothing of lower value is of any use, to prevent tunable hum appearing when the detector is at its most sensitive point.

All wiring should be as rigid as possible with a common earth run-

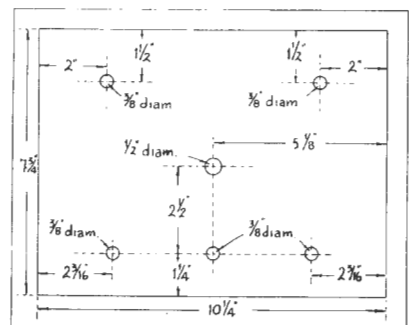

Front panel dimensions are shown above.

ning the entire length of the chassis. Finally, all components should be mounted as closely as possible to sockets. This holds true, more particularly with regard to the detector and r.f. stage sockets.

The photos appearing in last month's issue show this particularly well.

The "Astra Dual-Wave Six."

(Continued from page 5)

valve shields placed in position, speaker plugged in and aerial and

Foolproof Radio-

Clyde 'Plugg-in' Radio Batteries eliminate the possibility of wrong connections or short circuits and improves reception from every Battery-operated Radio Set.

CLYDE 'PLUGG-IN' RADIO BATTERIES

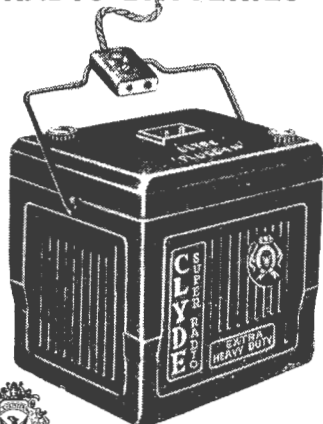

THE CLYDE ENGINEERING CO. LTD.
61-65 Wentworth Avenue, Sydney
Branches in all States

earth leads connected. Now switch on. When the heaters have warmed up, a faint hum should be heard coming from the speaker. Advance the volume and rotate the tuning control until a station is picked up.

Alignment Instructions.

The set is now ready for alignment, which should be carried out in the following manner. A service oscillator is of considerable assistance at this stage, but, if none is available, satisfactory alignment by ear can be obtained if the following instructions are carried out carefully.

Tune in a station towards the high frequency end of the band—on approximately 1400kc.

Now adjust the r.f. and aerial trimmers for the broadcast band in turn, setting each for maximum volume. During the alignment process, be careful to keep the volume well down, so that slight differences in output can be most readily noted.

Adjusting The Padder.

Next, swing the dial to a station near the other end of the band, say, 2FC, and adjust the padder. While doing this, rock the dial backwards and forwards over the station until the point is found at which volume is at maximum.

The i.f. trimmers can now be adjusted, working forward from the trimmer across the secondary of the second transformer towards the front of the set. Before these trimmers are touched, however, mark their positions so that they can be returned to their original settings if necessary.

Lastly, it will be found that if correctly built and aligned, the "Astra Dual-Wave Six" gives an exceptionally fine performance. Sensitivity, selectivity, volume and tone are all above criticism.

N.S.W. Five-Metre Achievement.

Latest news of activity on five metres in N.S.W. is that the first two-way contact between VK2LZ (Wentworth Falls) and VK2VU (Singleton) took place on Sunday, June 4, at 7.30 p.m., Sydney time. The communication was by c.w. and the signal strength of VK2VU was Q5, R5 at VK2LZ.

"A.R.W." congratulates Messrs. Bischoff (VK2LZ) and Partridge (VK2VU) on this step forward in the establishment of the 56 m.c. relay chain, which is one of the aims of the u.h.f. section of the W.I.A. (N.S.W. division).

INSIST ON R.C.S. 1939 TROLITUL COIL KITS

for the receivers described in this month's issue, and make sure of getting highest possible gain and selectivity, coupled with perfect tracking over all wavebands. All 1939 RCS coils are wound on Trolitul, and have the highest "Q" yet attained in Australia. As well, new methods of manufacture give an exceptionally high degree of precision and uniformity that is your guarantee of peak performance. Don't use inferior substitutes . . . INSIST ON RCS.

"Astra Dual-Wave Six."

The RCS unit for this new set comprises our new 1939 type Trolitul High "Q" coil unit, which contains necessary B/C and S/W trimmers together with three-section wave-change switch and padder mounted on a rigid steel bracket. Order Cat. No. K105. Retail price £3/3/-. The two I.F.'s are iron-core for better quality, selectivity and stability. Order Cat. No. IF109-10. Retail Price £1/1/-.

"1939 Companionette Three."

For the "1939 Companionette Three" we have specially designed a kit of coils on our new Trolitul formers, providing exceptionally high gain, with excellent selectivity. They are the highest-gain T.R.F. coils made. Order Cat. No. K106. Retail Price 11/6.

Other RCS Components.

Among other components included in the new, extensive RCS range for 1939 are Trolitul dual-wave coils, midget variable condensers, plug-in coils, r.f. chokes, potentiometers and rheostats, etc., etc.

ASK YOUR DEALER FOR FREE PAMPHLET DESCRIBING LATEST RCS PRODUCTS, OR WRITE DIRECT TO:

**R.C.S. RADIO
PTY. LTD.**

50 Glebe Street, Glebe,
SYDNEY.

Phone MW 2405.



One of the new RCA "Pick-Me-Up" portable radios being carried through the San Francisco Exposition grounds by Miss Kate Holliday, hostess of the music-room in the RCA exhibit.

Special Ever Ready Batteries For 1.4-Volt Portables

New "A" and "B" units are compact, light and efficient.

THE advent early this year of the new 1.4-volt valves has already resulted in the release by Australian radio manufacturers of special receivers giving excellent all-round performance with remarkably low "A" and "B" current drains.

In addition to 1.4-volt receivers for ordinary domestic use, considerable interest is also being taken in dry-cell operated portables. Anticipating the new trend, the Eveready Company has released two new dry batteries specially designed for 1.4-volt portables—a 1.5-volt "A" battery and a 45-volt "B" unit. Approximate dimensions and characteristics of both are given below.

The "A" battery (type number PR8) is a 1.4-volt wax top dry battery fitted with screw terminals. Overall height, including terminals, is $4\frac{5}{8}$ " length $5\frac{1}{8}$ " and width $2\frac{1}{8}$ ". Weight is 3lb. 1oz. Approximate service life is as follows:—

Initial Drain.	Approx. Useful Life.
200 m.a.	300 hours
250 "	220 "
300 "	170 "

It should be noted particularly that these figures are approximate only. They are based on a minimum useful voltage of one volt, though very good results have been obtained from 1.4-

volt valve receivers, using an "A" voltage of only .8 volt.

The "B" battery (type number PR45) is a 45-volt unit provided with Fahrenstock clips (tappings, minus and 45 volts). Height, including terminals, is approximately $5\frac{7}{8}$ " length $4\frac{1}{2}$ " and width $2\frac{3}{4}$ ". Weight is approximately 2lb. 10oz.

The following figures, which give an indication of the useful service life that can be expected from the PR45 unit, are based on normal usage of up to eight hours per day, and are approximate only.

Initial Drain.	Useful Service Life.
5 mills.	380 hours
6 "	310 "
7 "	260 "
8 "	220 "
9 "	200 "

Thus, the figures quoted above show that, for example, a typical four-valve receiver drawing 250 m.a. "A" current and 8 mills. of "B" current would give approximately 220 hours of operation before battery replacements were required. As well, a further attractive feature is that both "A" and "B" batteries would run down together. Finally, complete battery equipment, comprising two PR45 units and one PR8, would weigh only

8lbs. 5 ozs., making possible the manufacture of compact, powerful portables weighing under 20lbs., complete with batteries.

The Front Cover.

This month's front cover photograph shows a portion of the facade of the Rola Company factory in Melbourne — the largest of its kind in the Southern Hemisphere.

Over 200 persons are regularly employed in this up-to-date factory, which was specially designed and built for the manufacture of high quality loud speakers.

Rola Company (Aust.) Pty. Ltd. is a unit of the world-wide Rola organisation, and, it is claimed, produces at least 85% of the speaker requirements in Australia and New Zealand.

Popular!



Wherever you go this year — whatever you plan to do outdoors — add to the enjoyment of yourself and your friends by taking one of the wonderful new 1.4 volt portable radios along. Designed on entirely NEW lines and incorporating the recently introduced 1.4 volt valve, it is lighter, more compact, more effective and more economical than any other type of portable radio you've ever seen. Operates entirely on dry batteries — the smoothest and most dependable source of power for portable sets — and costs as little as 1d. PER HOUR to run! Requiring no power-point, no earth, and no outside aerial, you can carry and use it anywhere. Many well-known makes, many smartly-designed models available for you to choose from. See them to-day at any good radio store, or if you have any difficulty, write direct to Box 37, Mascot, N.S.W., for complete details of latest types.

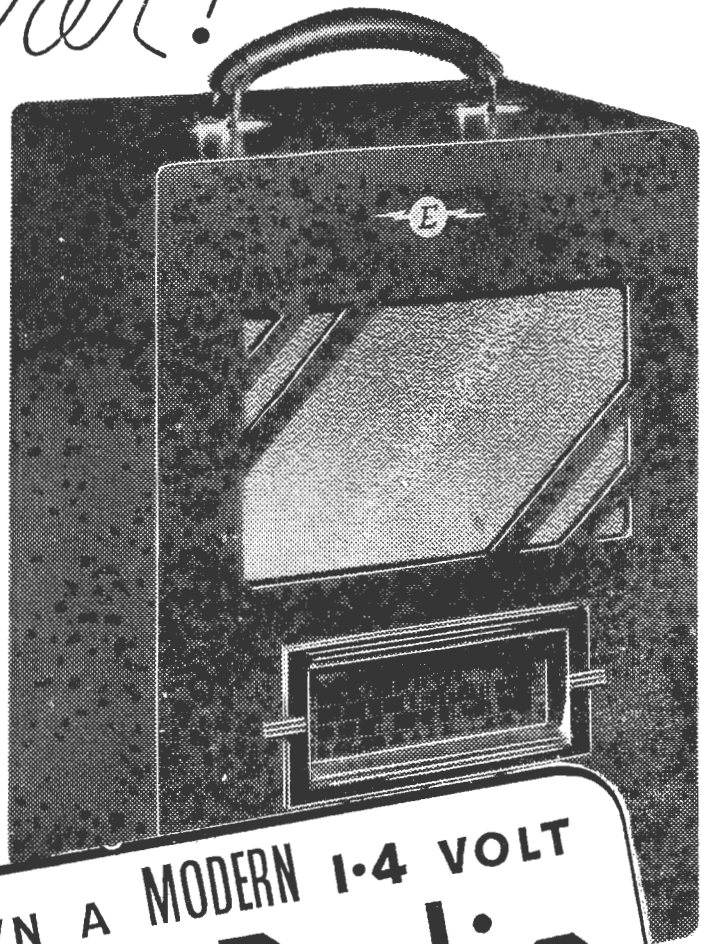

WHEN YOU OWN A MODERN 1.4 VOLT
Portable Radio

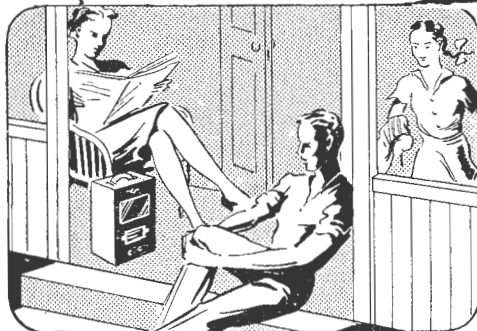

Bush picnics and outings are made ten times more enjoyable when someone has a 1.4 volt portable radio to provide music and entertainment. Easily carried because it is so light and compact — always ready to entertain you and your friends.

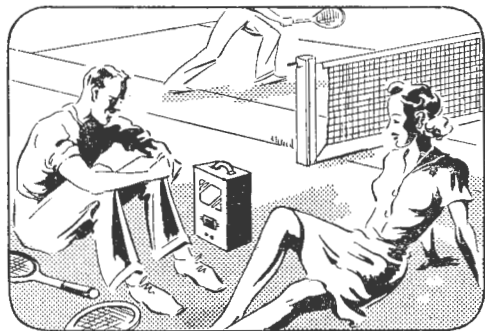

EQUIPPED WITH **EVER READY** RADIO BATTERIES

A15

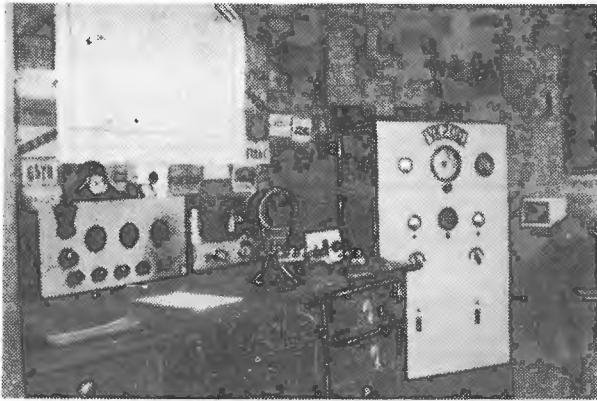

Left: A general view of amateur station VK-20Q. On the right is shown 20Q's rotating directional antenna system, designed to give highest efficiency in limited space.

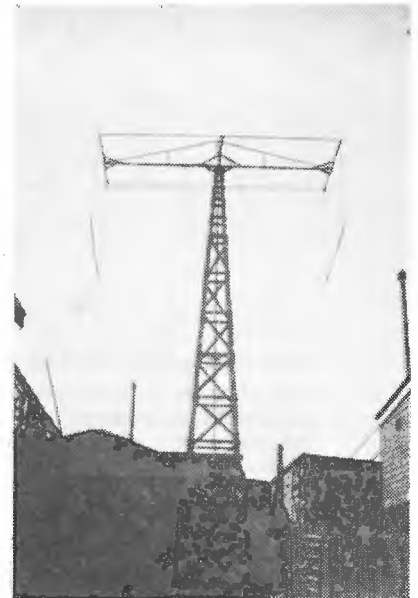

2A3's in push-pull. The microphone is a home-made crystal, constructed from a crystal pick-up. The receiver is a seven-valve super using 6-volt valves.

Rotating Antenna:

The directional antenna system should be of special interest to those who require an efficient antenna in a very limited space. It is a half-wave link-coupled doublet, with the director spaced one-tenth of a wave. The method of rotation is by means of a pipe down the centre connected with sprocket wheels and chains to the shack. This in turn connects with a pointer which moves across the face of a map on the wall in accordance to the direction of radiation of the aerial. The tower was entirely constructed by the operator, and, as will be observed from the photograph, the space available for masts and wires is very limited.

VK20Q in three years of operation has worked 60 countries on 'phone, 90 countries on c.w. and 'phone and 32 zones.

Waverley Radio Club Notes.

By F.A.B.

ALTHOUGH nothing has been heard of the above club in these pages for some time, interest, both in "Radio World" and the club, has not lagged. Since the last notes appeared, several happenings of importance have taken place.

The club's dinner was held on February 28 and was, as usual, a huge

Fight For Amateur Bands

Anticipated at Rome Convention In 1942
★ Lakemba Radio Club Notes And News.

By W.J.P.

AT a recent meeting of the Lakemba Radio Club, the following members were elected to hold office for the ensuing year:— President, E. Hodgkins, 2EH; vice-president, V. Bennett, 2VA; hon. secretary, R. Anthony, 2AEC; hon. treasurer, H. Aekling, 2PX; publicity manager, W. Phelps, 2DL; QSL manager, R. Thurston, 2AV; librarian, B. Clarke, 2IC; W.I.A. delegate, R. Anthony, 2AEC. The committee of management consists of Messrs. Warren, 2QX; Pinnell, 2ZR; and O'Donnell, 2OD. The technical committee comprises Messrs. Bennett, 2VA; Connelly; Flood, 2BN; Hall, 2AGH; Choules, 2HB; Martin; Hayes, 2AJL, and O'Donnell, 2OD. Social committee: Messrs. Clarke, 2IC; Coie, 2ACS, and Phelps, 2DL. Auditors: Messrs. Wells, 2AME, and Hayes, 2AJL.

At the meeting of the above club held on Tuesday, May 23, Mr. F. Carruthers (VK2PF) was in attendance as representative of the W.I.A. He discussed the possibility of amateurs losing their bands after the Convention at Rome in 1942, pointing out that at the last International Convention three countries had strongly voted for the cancellations of the amateur frequencies. These three countries later indicated by their policy that they apparently do

not favour the formation of international friendship. Australia and the U.S.A. on this occasion strongly rejected any proposed interference with amateur privileges.

It was pointed out that owing to the natural expansion of commercial interests, it was to be expected that some pressure would be placed on the amateur, and it was up to the amateurs to support those men who will fight in their interests. The experimenter was regarded by many commercial interests as "just playing with radio."

Experimenters, he continued, should support the W.I.A. as far as possible. The support should not only be moral but financial as well. He was not backing the Institute against radio clubs, he stated, as both have their useful purpose.

★

Details Of VK20Q.

The experimental station shown on this page is owned and operated by Mr. H. Capsey, VK20Q. The transmitter consists of a 6L6G crystal or e.c. oscillator, 807 buffer-doublet and an 809 in the final, with an input of 25 watts.

The modulation system consists of a 57 (triode), 56, 56, driving two

success. It was the twentieth anniversary, and already plans are in hand to make the twenty-first dinner the biggest on record.

Two field days have been held. The first, on the five-metre band, was held in the vicinity of Avalon, and the second, on 40 metres, was held at National Park on Sunday, June 4. The last one was particularly successful. A transmitter operating under the club's sign, 2BV, was powered by a 1000-volt generator driven by friction from the back wheel of a motor car. Several contacts were made during the day, a report of Q5, R5 being received from Orange. VK2AFZ and VK2TN also had transmitters working successfully on the field, and contacted each other several times during the day!

The membership of the Club is steadily increasing and now that morse practice classes are in full swing, a splendid opportunity is available for aspiring "hams." Lectures on a variety of subjects are regularly given, care being taken to cater for those not yet versed in the technicalities of radio.

A further field day is to be held at National Park in the near future, and anyone interested by obtain further particulars by 'phoning me (FW 5887) at practically any time during the week-end.

In conclusion I would like to extend a warm welcome to anyone interested in radio to visit the club-rooms at rear of "Almont," 13 Macpherson St., Waverley, on any Tuesday night. I can assure them that an interesting evening will be the result.

A Simple Portable Aerial.

A simple aerial-earth unit for a portable set can be constructed as follows:—

A cheap 6ft. steel rule of the concave-convex cup type is obtained,

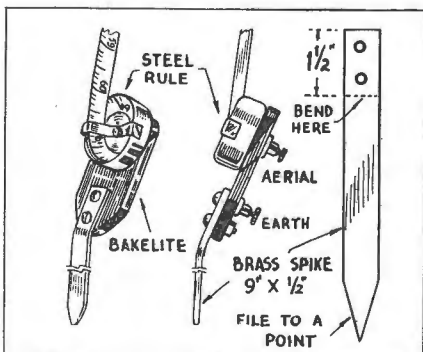

and the rivet passing through the centre drilled out and replaced by an old type terminal. This in turn is passed through a hole drilled in a piece of bakelite about 4" long and 2" wide (see sketch).

Now take a strip of brass 9" long and 1/2" wide. This is bent and bolted to the bakelite as shown in the sketch. A terminal is also provided. In use,

the pointed end of the brass strip is pushed into the ground, which should be dampened if it is dry, and the rule extended. The aerial and earth leads are taken to "A" and "E," respectively, on the set.

If the rule is tilted slightly backwards, it will remain rigid in anything but a strong wind.—J. Smaile, Adelaide, S.A.

Matchless in Performance

ROLA 6-8, 6-11, 6-15

Permanent Magnet Reproducers



A series of six-inch sound reproducers of extraordinary efficiency

Many features new to compact speakers, and indeed, new to loud speaker construction, are embodied in this series, which attains the highest degree of efficiency ever achieved in small speakers.

The magnetic structure, diaphragm, acoustic filter, and transformer have been the subject of considerable research, and far reaching improvements have been effected.

The magnets are built from higher grade steel than has ever been available before for use with compact speakers. To concentrate the maximum amount of flux in the air gap, dimensions of the magnet have been completely revised. Although somewhat unconventional, the new shape has an added advantage of allowing heavier magnets to be used without adding to the bulk of the speaker. Oval shaped magnets permit more compact placement of chassis components round the speaker. The new compact isocore transformer possesses all the qualities that make the original isocore such an outstanding success.

These speakers represent the greatest value that has ever been offered in 6-inch models. The series is moderately priced as follows:—

6-8 27/- 6-11 31/- 6-15 35/-

Write for further details.

Rola Co. (Aust.) Pty. Ltd.

The Boulevard and Park Avenue
Richmond, E.I. Victoria . J 5351
116 Clarence Street . . . Sydney
N.S.W. B 5867

This Thing Called "Q"

The concluding instalment of this article for amateur transmitters discusses ways of obtaining the optimum practical value of "Q".

By "ENGINEER"

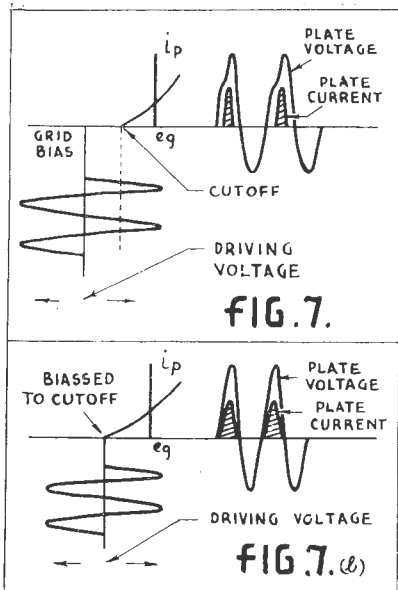

FOR c.w. working it is possible to increase the plate voltage without harm, for there are no modulation peaks to contend with.

The harmonics generated in the final stage of a transmitter are influenced to some extent by the grid bias. With short duration flicks, the plate current—that is, the current from the power supply—begins to flow when there is considerable voltage across the plate tank (see Fig. 7). There is a sharp break in the regular swing of the current, and a decided bend can be seen in the wave form at the point "P." All departure from the even swing represents r.f. distortion, and distortion means harmonic radiation.

On the other hand, if the amplifier is biased only to cut-off (low level modulation—linear final stage), the flick is extended over each alternate complete half cycle (Fig. 7b), and the distortion is less pronounced.

Higher "Q" For Class "C."

By such reasoning, it is apparent that the Class "C" final stage requires a higher Q in its tank circuit than is the case in Class "B" (linear) stages.

Another factor governing the Q, particularly where 'phone is used, is that high Q circuits require more time, both to build up and to lose their energy, than tanks which do not store so much. If the magnitude of the flicks is varied, either by plate modulation, varying the plate voltage, or grid modulation varying the

bias on one grid or more, or varying the magnitude of the grid flicks by modulating some earlier stage, high Q circuits are not able to follow the modulation at high audio frequencies.

One may modulate a good 80% at, say, 200 c.p.s., with a certain audio input, but at 10,000 c.p.s. the same audio input voltage may only modulate, say, 20%, simply because the final tank does not respond quickly enough.

Best Value A Compromise.

So, the ham, or any transmitter designer for that matter—is placed, as it were, 'twixt Satan and the briny deep—if his final tank has a high Q factor he chops his highs, and reduces the readability of his 'phone, and if he makes his Q low, he may have the authorities on his tail for radiating out of the band—for the ham bands are not in exact harmonic relation.

We decided that a final Class "C" stage required more Q to keep its harmonics down than a Class "B" stage. Here, then, is a definite argument for low level modulation. So much has been written around the subject of high and low level modulation that the writer may say no more than just this: There are many arguments for high level modulation.

By experience it has been found that values between ten and fifteen are satisfactory for Q when modulation is used, and that values up to forty may be used quite well for exclusive c.w. working.

W6CUH has done much work on final amplifiers, and sets twelve as a satisfactory all round Q for final stages. He has been successful in attaining efficiencies as high as 95%! It is obvious, then, that very little was lost in the plate tank, and very little could have been radiated as

harmonics. It is a slight digression, but it is of interest to study, briefly, his method of work.

Firstly, he tunes his final with normal, or even lower than normal, plate voltage. He tunes his grid, and then he neutralises roughly. Then he switches on his plate supply and tunes his plate tank. After careful neutralisation, he re-tunes his plate tank, and increases both drive and bias, until he can drive the plate current back to some ridiculously low value. Then he tunes his aerial, and the plate current may rise to its normal limit.

When he reduces his aerial coupling, he effectively increases the shunt resistance on his final tank, thereby increasing its Q, and at the same time reducing plate current. He knows that the maximum voltage that the valve will stand is set by the insulation in the valve itself, and he begins to increase the plate voltage until the plate current is up to normal.

Then he reduces the aerial coupling still further, and repeats until he knows that the valve just won't stand many more volts without arcing over somewhere.

He increases the voltage across his tank circuit without increasing the loss in the valve. The power output is increased, and the losses are reduced, actually, and the efficiency soars.

Standard Values For 'Phone And C.W.

If we standardise on the two values of 12 for 'phone and 40 for c.w., it is not very difficult to design an actual tank coil for any specific stage. By winding the coil with ¼-inch O.D. copper tubing, and reducing lead losses by shunning such stuff as copper braid and connecting the ends of the coil directly to the

tank condenser, the coil loss becomes practically negligible compared with the useful loss to the aerial and the wasteful loss in the valve. The Q factor then becomes simply $R_2/\omega L$, from which—

$$\omega L = \frac{R_2}{Q}$$

Now, R_2 represents the cause of all the losses in the valve, the coil and the aerial, all of which energy comes from the power supply. The resistance imposed on the power supply is simply the ratio of plate volts to plate current— E_p/I_p , which may be found from the valve manufacturers' data. Also, ωL , or $2\pi fL$, may be expressed in terms of micro henries per metre of wavelength.

The chart below has been devised to enable quick computation of L/Δ (Δ denotes wavelength) in terms of R_2 , for both values of Q (12 and 40).

Where push-pull finals are used, both plate currents are measured in parallel, and the resulting value of R_2 is only one-quarter of what it should be. Simple multiplication of L/Δ by four brings the correct result.

When one multiplies L/Δ by the wavelength, one has the required inductance in microhenries.

A Practical Formula.

Microhenries may be useful units for writers of textbooks and technical articles, but they do not mean very much to the ham or practical man until they are translated into number of turns. The A.R.R.L. has a fairly accurate and rather neat formula for number of turns—

$$n = \frac{\sqrt{3A + 9B}}{0.2A^2} L$$

- Where A = Diam. of coil in inches.
 B = Length of winding in inches.
 L = Inductance in microhenries.

All of the above is general, and applies to any final tank. One could have any plate voltage and plate current, any diameter and length of coil, and the data above would still apply. Actually that is the only reason why we use symbols like I_p , E_p , A and B. If we can find a sort of symbolic answer for any case, it should be easy to apply the formulae and mathematical operations to a particular set of conditions, and put ourselves in a position to predict the action of that specific coil.

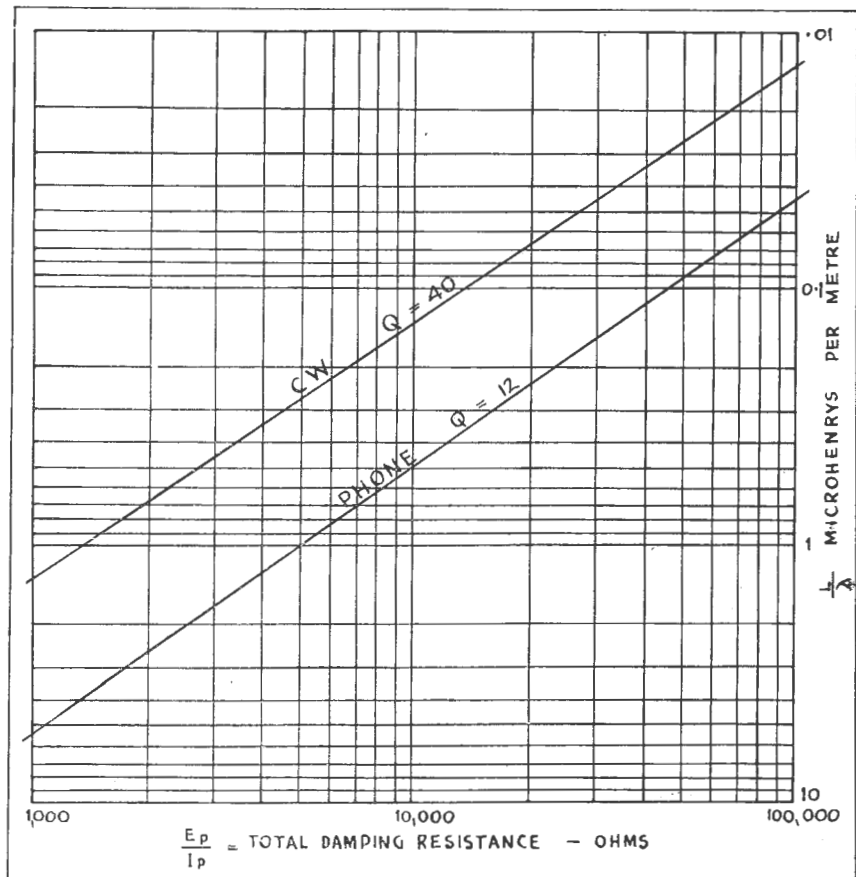

MURDOCH'S

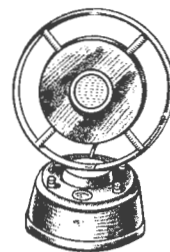

"ACE"
Microphone
and base.

7/11

(Eng. Price,
12/11)

Perfectly made, with built-in transformer and warning pilot lamp. The ultimate aim of every radio enthusiast is to have and use a microphone. One is now within range of the week's pocket money. English price, 12/6. Murdoch's price, 7/11.

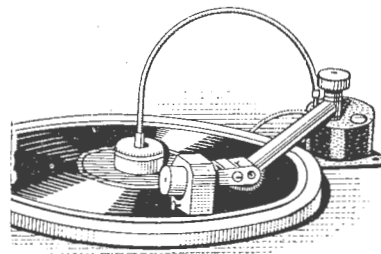

Simplex Recording Units
£6/15/-

Unimpeachable mechanical perfection, smooth, flexible transmission and perfect fibre gears, clutch and variable weight cutting head. Ball bearing suspension. High impedance can be used without matching transformer; removal of balance weight allows use as a pick-up for play back.



DIALS
22/6

Lissen Hi-Q decimal dials. England's best. Heavy metal. Used for ultra short waves. Perfect control.

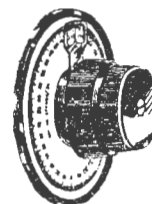

UTILITY DIALS
11/9

Micro-drive, two-speed English dial. Perfectly made.

Micro drive, 600 to 1 ratio Indigraph dials. Additional micro drive attached. Special value, 15/6.

Illustration shows English make vernier dials. New, improved model in black bakelite. Murdoch's special value, 10/6.



We pay freight. Kindly write to Desk "C52"

MURDOCH'S LTD.
Park & George Sts., Sydney.

BROWN PUBLIC ADDRESS PROJECTION UNIT GIVES GREATEST COVERAGE AT LOWEST COST.

FITTED WITH Sin. ROLA REPRODUCER.

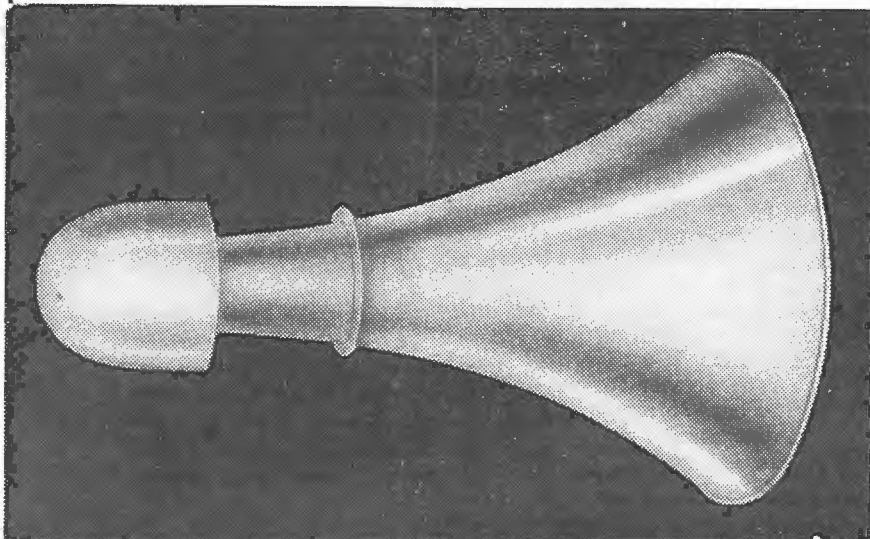

FEATURES

- Small throat opening and acoustic transformer effect of baffle plate provides maximum air loading of vibrating diaphragm. ● Proper focussing allows minimum wastage.
- Unit delivers up to 5 times effective power available from same speaker unit used with flat or box baffle. ● Reduces feedback. ● Allows more amplifier gain to be used.
- Allows wanted areas to be covered more efficiently with given amount of power.

SPECIFICATIONS

Overall length of assembly is 35½ inches, the horn having a mouth diameter of 23¾ inches. The flare of the horn is demountable for transport purposes, and the throat and loud-speaker housing may be placed inside the flare. Capacity ranges from 5 watts (Rola 8/21) to 14 watts (8/42). Can be used on electro-dynamic and permanent magnet reproducers. Units are of specially spun 16 gauge aluminium throughout with heavy rolled bead to reinforce the bell-mouth opening. Finished in standard iridescent Rola grey.

WRITE NOW FOR FREE DESCRIPTIVE PAMPHLET.

Geo. BROWN AND CO.
PTY. LTD.

267 CLARENCE STREET, SYDNEY.

Queensland Distributor: A. E. Harrold. Tasmanian Distributor: W. & G. Genders. Western Australian: Atkins (W.A.) Ltd. South Australian: R. C. Woollard. New Zealand Distributors: Swan Electric Co., Auckland.

We are Sole Australian Agents for Ultimate Radio

Alan H. Graham, Shortwave Editor "Radio World," reports exceptionally fine DX performance from latest all-wave Ultimate. (See test report in April issue). WRITE FOR FREE CATALOGUE.

A Practical Example.

Consider the 809 final stage of the transmitter discussed in the April issue. It has a tapped coil and split stator condenser, and the total loading, represented by E_p/I_p , only damps on one half of the coil. The coil itself acts as an auto transformer, and the load imposed on the whole coil is 2, or 4 times as high. Now, $E_p = 700$, and $I_p = 120$ milliamps., or 0.12 ampere, making $R = E/I$ equal to 5833.3 ohms. From the chart (Fig. 8) we find that the corresponding L/Δ value is 0.232. At 20 metres, the inductance, L , becomes 4.64 microhenries, and the actual coil must be made 4 x 4.64, or 18.56 microhenries.

If the coil is made three and a half inches diameter, and, say, four inches in length, the coil may have—

$$\sqrt{\frac{(3 \times 3.75 + 9 \times 4) \times 18.56}{0.2 \times 3.75^2}} = 17.6 \text{ turns.}$$

If it is wound with one-eighth inch (outside) diameter copper tube, or 10 s.w.g. wire, the coil loss will be small. If seventeen turns are used, the extra bit of inductance will be found in the leads to the condenser.

Further reduction of the number of turns will yield a higher value of Q , but it is not necessary, since the value of forty is quite high enough for most c.w. working, and the total coil loss would tend to increase, even though the actual resistance of the coil is reduced, because the circulating current would increase.

Any other final tank circuit may be treated in just the same manner, and the coils may be relied upon to do their work efficiently.

It is often found that final tank coils are prone to heat up while the transmitter is on the air. It certainly indicates that the circulating current is high, and that the valve is flicking the tank in good style, but far from being a good sign, it is also an indication of coil loss, incurring a drop in over-all efficiency. It only happens when the constructor, enthused with a "high C" final complex, has reduced the size of his coil too much.

For those fellows, this article has been written, and here's hoping that more and more hams waste less and less in their coils, and as harmonic radiation. You should know better now, anyway.

The Brimar 6AG6-G high gain output pentode and latest improved Rola 6" speaker form an excellent combination in this compact mid-get, which gives an exceptionally fine performance.

More About The 1939 Companionette Three

Further hints on the assembly, wiring and operation are given below.

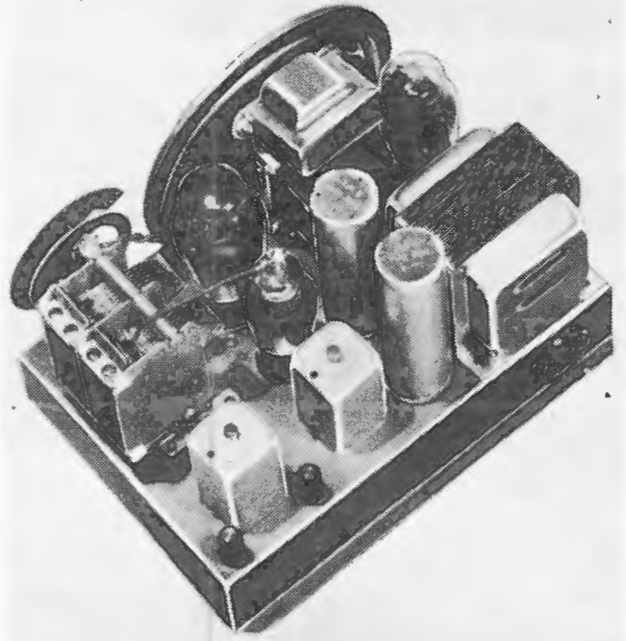

THE many readers who are evidently planning to build the "1939 Companionette Three" will find below a diagram showing the complete under-chassis wiring. The Radiokes coils used are provided with numbered lugs, these numbers being shown on the diagram, while under-socket connections of the 6F7 and 6AG6-G were given in the circuit diagram last month.

Several minor points raised by a reader might be of assistance to other prospective builders. The first is that if iron-cored coils are used, the reaction winding cannot be inserted inside the former, as this is not hollow

as with the air-cored type. A simple way out of this difficulty is to drill two small holes in the base of the former, through which the reaction winding can be taken. Thus instead of this winding being inside the former, two or three turns are put on outside, below the grid winding.

The second point is that a 120-ohm bias resistor is shown on the circuit, while a 150-ohm is specified in the list of parts. Actually, this was done because 150 ohms is the nearest universally obtainable standard value, and it is quite permissible to use it.

A final point is that the grid stopping resistor for the 6AG6-G can be

anything from 1,000 to 10,000 ohms. This resistor has no effect on the audio voltages applied to the grid of the output valve, but it is invaluable as a preventive against parasitics, generally evidenced by a harshness in the upper register.

Aligning And Operating The "Companionette."

After the wiring has been thoroughly checked by reference to the circuit and under-chassis wiring diagrams, the valves can be plugged in, aerial and earth connected and the power switched on. While doing this,

(Continued on page 48)

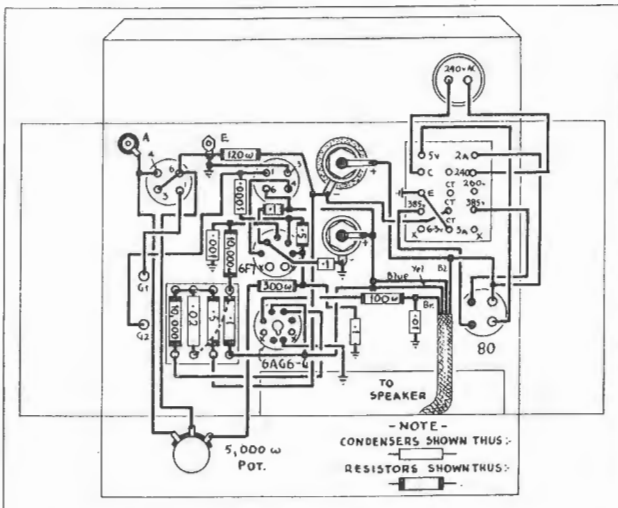

The diagram above shows the complete under-chassis wiring of the "Companionette." Dimensions for preparing

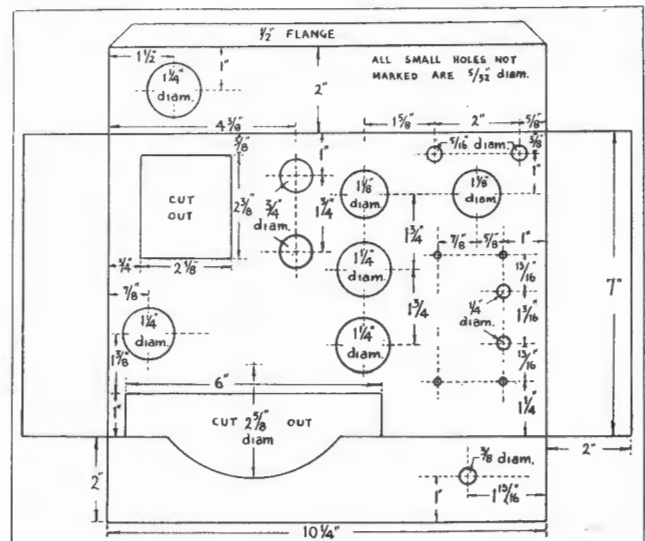

the 18-gauge sprayed steel chassis are shown on the right.

Leaves From A Serviceman's Diary . . . (3)

A further selection of common receiver faults, with probable causes and cures, are discussed below . . .

By "SERVICEMAN"



The Palec Model "M5" volt-ohm-milliammeter with analyser selector unit forms a particularly compact test unit for portable or workshop use.

IN addition to the most common receiver faults listed in this and previous issues, there is also the matter of what might be termed "mechanical examination."

In many cases, complaints of noisy operation, crackling, fading, etc., have been traced to loose components. While the radio set is out of the cabinet it should be inspected for loose coil cans, valve shields, valve sockets and bases, nuts and bolts, etc.

Defective soldered joints or dry joints often give rise to erratic operation. Suspected connections should be tested by giving the wire a gentle pull with a pair of insulated long-nosed pliers while the radio is operating. The earlier type of tubular condensers were serious offenders in this regard. Care should be exercised not to disarrange the wiring of the set, in particular on the r.f. side, as it is possible to throw many sets hopelessly out of balance by such procedure.

With the receiver operating normally it should be possible to knock or bump it without causing any resultant crackling noise in the loud speaker. The serviceman should, of course, use some tact about bumping the set in the presence of the client, as many owners fail to appreciate this part of the servicing, especially if the set is an expensive one!

"Trouble Shooting" — Common Causes Of Set Failure, With Suggested Cures.

(Continued from last month)

COMPLAINT: Weak reception.

DEFECTS AND REPAIR PROCEDURE:

(1) **Aerial Off Terminal, Broken Or Shorting To Chassis.**

(2) **Weak Valve.**

Test each valve in a tester and replace faulty one.

(3) **Open-Circuited Resistor.**

Test as before. Certain resistors although broken down will permit the set to still operate.

(4) **Open-Circuited Aerial Coil.**

Several cases have been encountered where the aerial coil is o/c, apparently through the building up of a heavy electrical charge on the antenna. Test for continuity, making sure that there is no condenser in series.

(5) **No Field Excitation, Or O/c. Field.**
See 5, "Distorted Reception."

(6) **O/c. Speaker Voice Coil.**

Certain speakers will emit sounds from the transformer laminations even though the voice coil is o/c. Test the voice coil with meter with one lead of the transformer removed.

(7) **Leaky By-Pass Condenser.**

Test voltages at various points, or apply a higher voltage across suspected condenser.

Other Defects.

Broken connections, portion of tuning coil shorting or o/c., set out of alignment, low line voltage, faulty wave change switch.

COMPLAINT: Hum in set.

DEFECTS AND REPAIR PROCEDURE:—

(1) **Faulty Electrolytic.**

Apply "electrolytic test" if suitable meter available, or connect another condenser across the one suspected of being defective.

(2) **Loose Laminations On Power Transformers.**

This will be in evidence more in the form of a mechanical buzz rather than an actual hum. Tighten the nuts and bolts binding the transformer, or tap the core gently with a hammer.

(3) **Open Circuit Grid Connection.**

Check for loose grid cap, broken connection on grid return of coil, or open circuit grid resistor.

(4) **Faulty Valve.**

Test valves, in particular for "internal short," or tap each sharply to try and locate the faulty one.

(5) **Modulation Hum.**

This is evident in the form of a hum when a carrier is tuned in, but disappears off stations. It may be due: (i) To the electro-static shield connection being broken. If the break cannot be located, or the transformer has no such shield, then try a .01 mfd. condenser of high voltage rating from one plate of the rectifier to earth. Many of the earlier types of a.c. sets were subject to modulation hum, but a cure was

(Continued on page 40)



The completed valve checker, which is built into a black leatherette-covered carrying case measuring 11" x 13½" x 6," including lid. It will check all types of valves commonly used in Australia.

A Portable Valve Checker

This modern emission type valve checker will test efficiently both Continental and American type valves Designed and described by

The Technical Dept., Radio Equipment Pty. Ltd.

THE vast number of valves used in present-day radio construction makes some means of rapid testing of valve condition an essential part of a modern service kit.

Broadly speaking, there are two main faults which may be found in valves, firstly, lack of emission and, secondly, shorts between elements. A valve tester then must of necessity test these two faults.

The valve tester, the construction of which is described in this article, is capable of testing very efficiently any valve, regardless of type, for the above faults.

The wiring of the valve tester is naturally somewhat complicated, but little difficulty should be experienced if it is taken by stages, each section being completed as far as possible before another section is commenced, and for the purpose of simplicity, the explanation of wiring will be given in definite stages. One thing is very important. Each stage of the wiring must be thoroughly checked before proceeding with the next as it is almost impossible to check the finished instrument.

The tester is supplied completely assembled on an engraved metal panel; together with the necessary

wiring components and calibration charts covering the testing positions for Philips, Mullard, and American type valves.

Before commencing to wire the instrument, it will be necessary to remove the panels carrying the neon short indicator and the power transformer to facilitate working.

The first stage in the wiring is the connecting up of the seven valve sockets. Each pin is numbered; the numbers being shown on the wiring diagram. Numbers 3 and 4 are the filament or heater pins in each case and the sockets excepting the V and P bases are assembled so that these two pins face the bottom of the instrument.

To commence, connect the No. 3's of each of the sockets, together and follow suit with the 4's, 5's, 6's, 7's, 1's and 2's in that order, these numbers are those shown on the diagram, not those shown on the valve sockets. It should be noted that on the P base there are two number 5 connections; these should be connected together, as should No. 3 and the unmarked connection of the octal base.

The next step in wiring is connecting up the sockets to the element selector switch. One connection of

this switch, between it and the circuit selector, is already made and this should be used as a marker for other connections.

The switch consists of three banks. All the connections of the top bank are linked together, and every alternate connection of the middle bank is soldered to the connection of the bottom bank immediately below it. With the tester upside down, that is, in the wiring position, and with the valve sockets towards you, the first pair to be connected together will be the ones immediately on the left hand side of the connection which is already made. Every alternate pair are then soldered together all the way round the switch, making six pairs in all.

To connect up the sockets to the switch, the following steps should be followed, care being exercised to make sure they are done correctly.

- (1) Connect No. 4 on the V base to the top bank of the switch.
- (2) Connect No. 5 on the V base to the first soldered pair on the left hand side of the marker connection.
- (3) Connect No. 2 on the V base to the second soldered pair on left hand side of the marker connection.

(4) Connect No. 1 on the V base to the third soldered pair on the left hand side of the marker connection.

(5) Connect the pin jack which forms the cap connection to the fourth soldered pair on the left of the marker connection, and connect the two pin jacks or cap connections together.

(6) Connect No. 7 on the octal base to the fifth left hand side pair.

(7) Connect No. 6 on the octal base to the last remaining soldered pair of the element selector switch.

The remaining connection from the sockets is one from No. 3 to the centre arm of the filament selector switch. The centre arm on all these switches is the one coming from underneath the wafer. Leads of about 9in. in length should be attached to each soldering lug of the meter, and a lead 6in. long attached to the centre arm of the voltage adjustment switch. The other ends of these leads are left unconnected for the time being.

The lugs of the power transformer should now be tinned, and the bracket holding this unit screwed back into

position. The primary winding should be wired to the rotary switch which forms the line adjustment, and to the toggle switch giving the 200-230 and 230-260 positions.

To connect to the line adjustment switch, turn the instrument with the valve sockets facing away from you, and connect the first fixed contact on the left hand side of the moving arm to the lowest (excepting the one marked 30) voltage tap on the primary. The next fixed contact to the left then connects to the next highest tap and so on until all the taps are connected. If any connections on the switch are left over (there should be two or three, depending on the number of taps on the primary) they should be connected together and to the 260 tapping.

The two terminals (one at each end) of the toggle switch should be connected together. The other right hand end one connects to the tap marked 30 on the primary of the transformer. The other end one on the left hand connects to the end of the primary marked C.

The next switch to be connected is the filament voltage selector, the centre arm of which was connected when wiring the sockets. The first fixed connection on the right hand side of the centre arm (valve sockets away from you) connects to the 1.5 V. tapping, the next on the right to 2 V. and so on up to the 30 volts tapping of the secondary. It is very important that the above operations be carried out correctly and a thorough check should be made before continuing.

The next step is to wire the rectifier socket. The filaments are connected to the 5 V. winding in the centre of the transformer. The plates are connected together and to the closest lug on the first 20 volt winding.

The two 20 V. windings are connected in series, usually by connecting the two centre lugs together. If, however, the transformer windings are reversed a different connection will be necessary, the second connection being the inner lug on the first winding connected to the outside lug on the second winding. The earth connection from the join between these windings should be left unconnected until the voltage from these windings can be tested.

When the tester is completed and plugged into the mains, the voltage between the outside lugs of these windings should be measured and should read approximately 40 V. If no A.C. voltmeter is available, the outside lugs may be shorted across with a piece of wire for an instant; a spark should be obtained. If no indication is obtained with either test, the connections are the wrong way round.

The components necessary should now be assembled on the panel carrying the neon short indicator. The ends of each component should be soldered to the eyelets provided. It will be noted that the resistances labelled A, B and C have a considerable amount of unused wire, do not cut this off, as it may be needed in the final calibration of the meter. The two end eyelets widely spaced from the others connect to the power flex, and the order shown in the diagram should be followed. The leads to the neon tube should be connected before the panel is reassembled.

The circuit selector switch should now be wired. This switch consists of two banks, each bank having two moving arms, one moving arm of the

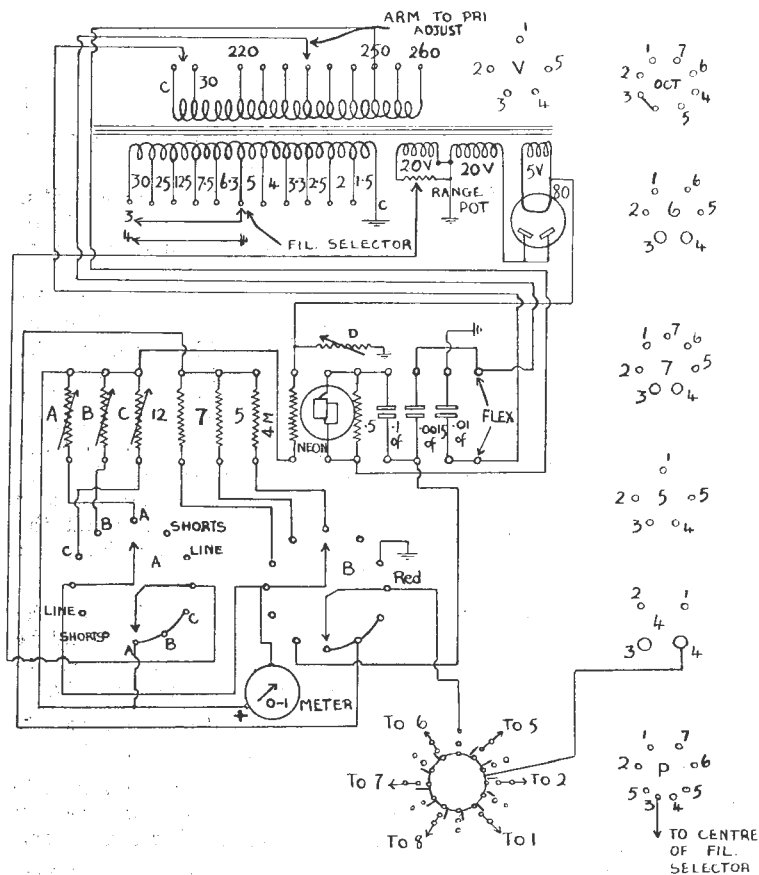

The circuit of the valve checker, the assembly of which is described in the accompanying article,

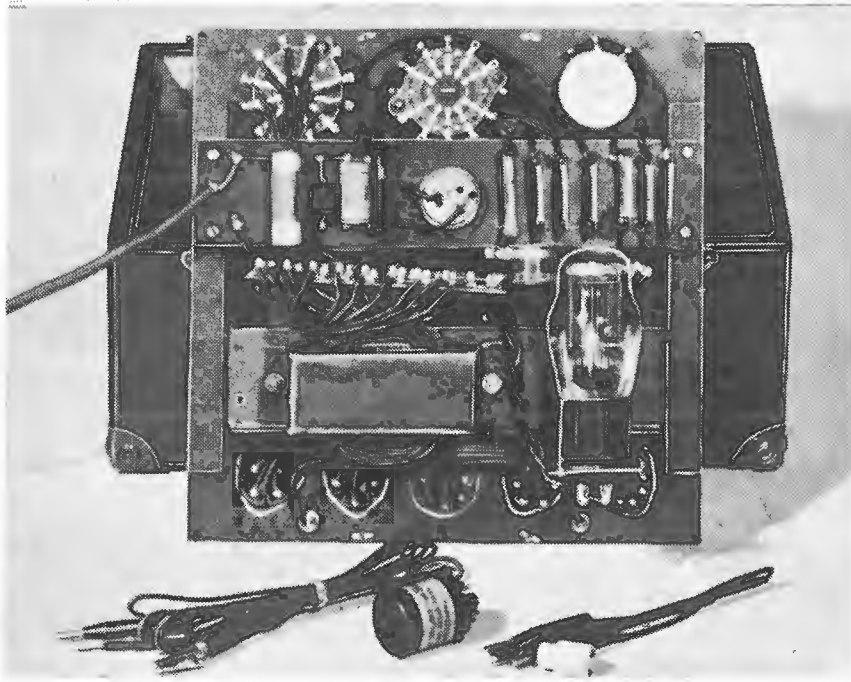

A view of the sub-panel assembly, taken after completion of the wiring. The accessories shown in the foreground are supplied with the kit of parts.

bottom bank, being already connected, can be used as a marker terminal for wiring this switch. With the instrument in the wiring position, and the valve sockets away from you, the two moving arms on the left side should be connected together. The first three fixed contacts towards the left of the marker contact on the bottom wafer should be connected together, as should the three directly above on the top wafer. The panel carrying the neon short indicator must now be re-

assembled. Having made the fore-mentioned connections to the circuit selector switch correctly, it is quite a simple matter to wire in rotation the remaining fixed contacts to the panel as shown in the diagram. The switch shown at the right of the diagram is the bottom wafer. The single remaining centre arm of this switch, i.e., the one immediately above the original marker connection, should be connected to the centre arm of the "Range" potentiometer. The connec-

tion shown as earth should be left blank for the time being. The meter should be connected, the negative side going to the two centre arms which are connected together, the positive going to the common side of the resistors A.B.C., etc.

The remaining connections of the panel, excepting those to the power transformer, should be made before proceeding further with the wiring. The adjustable resistor shown connected to earth should be left off for the time being.

Very little now remains to be done in the actual wiring of the instrument. All those points shown as earth, excepting the one on the tap of the 20 V. windings, should be joined together by insulated wire and should terminate in the connection on the power transformer marked E; they should not be connected to the frame in any way. There are seven earth points including E. on the transformer.

The two connections of the toggle switch which are joined together should be connected to the same side of the mains as the .01 condenser, the lead from the 250 V. tapping on the primary should be connected to the side of the neon lamp opposite to the .1 mfd. condenser, and the final connections are made by connecting one side of the rectifier filament to the intersection of the 4000 and 5000 ohm resistors and connecting the power cord. The tester should be carefully looked over and shaken to make sure no beads of solder are left in to cause damage.

**Make sure of
maximum efficiency
and longest life—**

**ADOPT AS YOUR
STANDARD—**

Mullard

M A S T E R

RADIOVALVES

MULLARD (AUST.) PTY. LTD., 63-67 WILLIAM STREET, SYDNEY. 'PHONE: FL 5188 (3 lines)

The tester may now be connected to the mains and the tests on the 20 V. windings previously explained carried out. When these windings are correctly made, disconnect from the mains, join the tap on the windings to E on the transformer and plug in the rectifier.

The sliding contact on the resistor marked D in the circuit should be moved to a position giving $1/3$ to $1/2$ of the total available resistance. This position with a line voltage of 240 will allow the needle to swing to the arrow on the scale with the voltage adjusting switch about halfway and with the toggle switch in the 230 to 260 position. The correct setting will naturally depend on local conditions and may be varied accordingly, care being taken to withdraw the plug from the mains before making any alteration and that the slider is making good contact before the tester is switched on again. A bad connection in this position will damage the meter.

The filament voltages should now be checked by plugging an A.C. voltmeter into the filament holes of each socket in turn and rotating the fila-

ment selector switch between 1.5 V. to 30 V. If no A.C. meter is available, the same test up to 6.3 V. may be carried out with a 6.3 V. dial lamp, and if five lamps are available they may be connected in series and the test carried up to 30 volts. It may be judged from the increasing brilliance of the lamps whether the connections are correct or not.

The resistances, A, B and C, are adjusted to approximately their correct position, but may need some slight adjustment. Adjust the line voltage of the tester, take several valves known to be good which can be tested on position A, adjust the filament voltage and plug in a valve. After testing for shorts, set all controls according to the charts and note the percentage reading of the scale. When several good valves have been tested, the average percentage should be found and should be approximately 95%. If it is under this mark turns should be added to resistor A; if over 95%, turns should be taken off. One turn will make a considerable difference; do not take off or add more than one at a time. When position A is correctly adjusted, the performance should be repeated with B and C.

The tester may also be used with a vibrator unit to work from a 6 V. "A" battery. This unit changes 6 V D.C. to 240 V. A.C., making circuit alteration unnecessary, the tester plugging into the unit instead of the A.C. mains.

VK2ME, 3ME And 6ME — Schedules For July, 1939.

The following transmission schedules will be observed by shortwave stations VK2ME, VK3ME and VK6ME during July.

VK2ME (31.28m., 9590kc.)	
Sydney Time. G.M.T.	
Sundays:	3-5 p.m. 0500-0700
	7.30-11.30 p.m. 0930-1330
Mondays:	2.30-4.30 a.m. 1630-1830
VK3ME (31.5m., 9510kc.)	
Melbourne Time. G.M.T.	
Nightly	
Monday to 7 p.m.-10 p.m.	0900-1200
Saturday (inclusive)	
VK6ME, Perth (31.28m., 9590kc.)	
Perth Time. G.M.T.	
Nightly	
Monday to 7 p.m.-9 p.m.	1100-1300
Saturday (inclusive)	

RADIO EQUIPMENT PTY. LTD. . . .

Specialising in high quality Test Equipment and Servicemen's needs

When you think of quality test equipment, think of Radio Equipment Pty. Ltd. We are distributors for "Palec," "Calstan" and English "AVO" test equipment. You can build your own testing gear from our specially designed kits of parts. If you are interested in test equipment write for FREE illustrated Test Equipment Buying Guide.

Contents of Buying Guide

- How to build an A.C. operated Oscillator.
- How to make a Universal Test Speaker.
- How to build a Modern Tube Checker.
- How to build and use a D.C. Multimeter.
- English "AVO" Test Equipment.
- "Calstan" Test Equipment.
- "Palec" Test Equipment.

RADIO EQUIPMENT PTY. LTD.

E.S. & A. BANK BUILDINGS, BROADWAY
(Opp. GRACE BROS.), SYDNEY.

Phones: M 6391 and M 6392.



The new and startling D.C. Multimeter—you can build it yourself or purchase it completely wired and tested.

Ranges—0-10, 0-50, 0-250, 0-1,000 volts.

0-1, 0-10, 0-50, 0-250 m.a.

0-500, 0-50,000 ohms with internal battery;

0-1.5 megohms with external 45-volt battery.

The meter is provided with two A.C. voltage scales to facilitate conversion for A.C. voltage ranges at low additional cost.

PRICE—COMPLETE KIT OF PARTS £4/ 8/6, plus tax.

BUILT AND TESTED £4/18/6, plus tax.

POSTAGE EXTRA

TERMS AVAILABLE

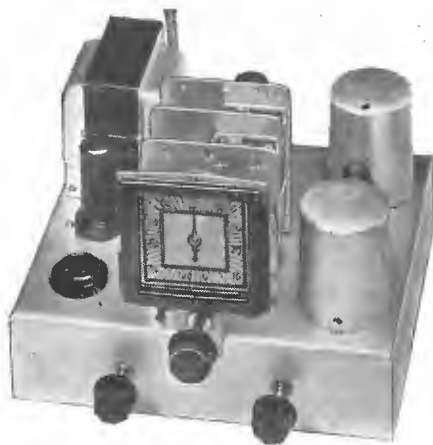

Excellent performance and low cost are the main features of this four-valve a.c. t.r.f. receiver, which uses metal valves throughout. Complete details of its assembly appear in the June, 1936, issue of "Radio World."



Right: The "Atlas All-Waver," which may be built as a one, two or three-valve receiver. It covers both the shortwave and broadcast bands, giving excellent world-wide reception. A full description appears in the September, October and November, 1938, issues of "Radio World."

More Sets From Back Numbers



Though little bigger than a box camera, the "All-Wave All-World Two" will in good locations bring in London on the short waves at good speaker strength. It was fully described in the May, 1936, issue of "Radio World."

Shown on this page is a further selection of receivers that have been described in past issues of "Radio World." As explained last month, these back numbers are available at the following specially reduced prices during the next few months.

All copies in Volumes 1, 2 and 3, up to and including the December, 1938, issue, are priced at 9d. each, post free, for single copies. Any six copies up to the date mentioned are available at 4/-. post free, and any twelve for 7/6, post free.

Inquiries are invited from readers in regard to special types of receivers, transmitters, amplifiers, etc., that may have been described in back numbers. If the required information has been published in "Radio World," full details, with date of issue, will be sent by return mail (a stamped addressed envelope must accompany all enquiries).

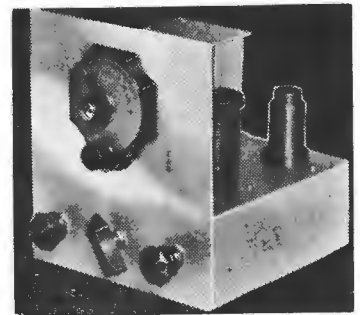

"The Eaglet All-Wave Two" uses a 6J7 as detector and a 6C5 triode output valve. Fully described in the June, 1937, issue.

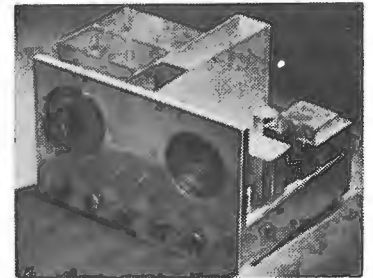

Full constructional details of the "Amateur Communications Eight" appear in the June and July, 1937, issues.



Beginners in radio will find plenty of enjoyment, besides gaining some useful practical experience, in building the "Simplex Crystal Set" illustrated alongside. See the July, 1936, issue for full constructional details.

All-wave all-world coverage from 12 to 600 metres with a standard two-gang condenser is possible with the "A.C. Empire" illustrated on the right. Also shown is the special combination power pack and amplifier with built-in speaker designed for this receiver. See December, 1937, and January, 1938, issues of "Radio World" for full details.

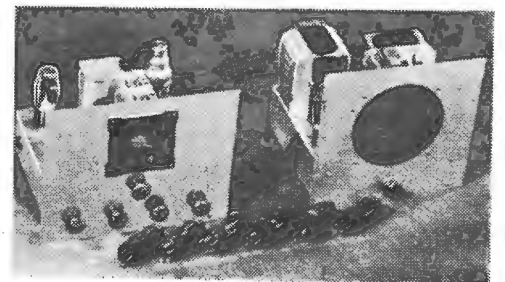

A.O.C.P. Questions & Answers

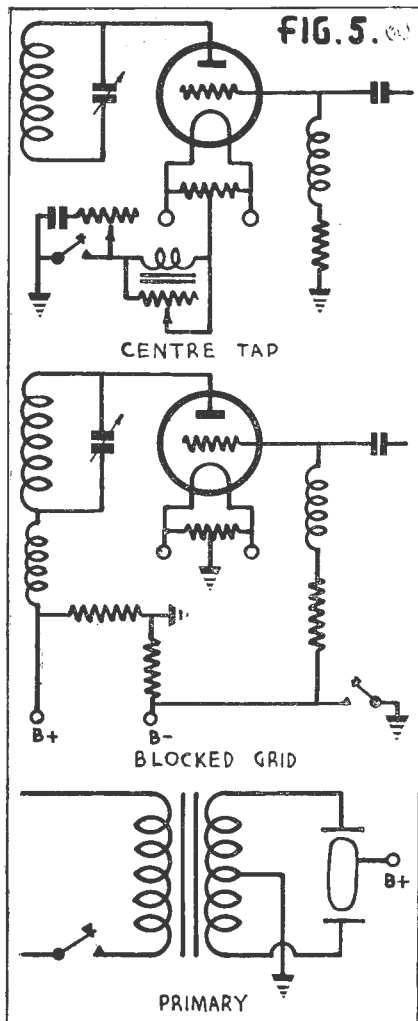

Experimenters studying for their amateur tickets will find these model answers to questions in the A.O.C.P. examination paper for October, 1938, a useful guide.

By "EXAMINER"

1 (c): What precautions should be taken in the erection of this type of line to ensure efficiency under operating conditions?

Ans.: It is necessary that the wires be kept taut and evenly-spaced throughout the length of the line. Sharp bends are to be avoided when it becomes necessary to run the line around corners. It is necessary to use a good grade of insulation.

Question 2 (a): How does the mercury-vapour rectifier differ from the high vacuum thermionic rectifier?

Ans.: The mercury-vapour rectifier differs from the high vacuum rectifier in that with the high vacuum type, the conduction is by means of the electronic stream from cathode to plate, whereas the mercury vapour type has a small quantity of mercury introduced into the tube after being evacuated. When the cathode reaches its correct operating temperature, the mercury vaporises and is broken down into positive and negative ions during the portion of the cycle the rectifier is passing current. Due to the positive ions, the resistance of the cathode plate current is lowered, increasing the efficiency of the rectifier, due to the lower voltage drop.

2 (b): What precautions should be taken in the design of a filter to be used in conjunction with such a rectifier?

Ans.: The output of a full-wave rectifier pulsates at 100 times per second when connected to a 50-cycle a.c. line supply. This output is connected to a filter whose purpose is to smooth out the pulsations into direct current.

It is advisable to use a filter with the output of the rectifier feeding directly into a choke with an inductance of a fairly high value. This will ensure that the peak current load on the rectifier will be less and also cause an improvement in the voltage regulation.

The remaining filter should be composed of a suitable value of inductance combined with capacity to smooth the pulsations to the value required. A 25-30 henry choke with

two 8 mfd. condensers will be found to keep the ripple voltage to a low value.

A bleeder resistor should be connected across the output of the filter to keep the voltage regulation more uniform. The bleeder resistance should draw approximately 10% of the full load current.

Question 3: It is desired to use a 50-watt 110-volt lamp on a 230-volt supply. What series resistance would be necessary to avoid overloading the lamp?

Ans.: From the formula—

$$I = \frac{W}{E}$$

$$I = \frac{50}{110} = \frac{5}{11} \text{ amps.}$$

The 50-watt 110-volt lamp requires a current of $\frac{5}{11}$ ampere.

The given supply voltage is 230 volts, and it is necessary to have a voltage drop of 120 volts across the resistor, when passing a current of $\frac{5}{11}$ ampere.

From Ohm's Law:—

$$R = \frac{E}{I}$$

$$R = \frac{120 \times 11}{5}$$

$$= 264 \text{ ohms.}$$

Question 4: Enumerate three causes of frequency instability in a crystal-controlled oscillator stage of a transmitter, and explain how each may be reduced to a minimum.

Ans.: Frequency instability in a crystal-controlled oscillator stage may be caused by:—

(1) Operating the oscillator with too high a plate voltage, causing excessive current through the crystal, generating heat and causing frequency drift. The plate voltage should be reduced until the crystal current reaches a safe value.

(2) Excessive loading, making it

Question 1 (a): Explain what is meant by a non-resonant matched-impedance line.

Ans.: A non-resonant matched-impedance line is a transmission line which is terminated in an impedance equal to its surge impedance.

1 (b): What determines the characteristic impedance of such a line?

Ans.: The characteristic or surge impedance is determined by the distributed inductance and capacity of the line, and may be found from the following formula:—

$$Z = 276 \log_{10} \frac{B}{A}$$

Where Z=Impedance of line.

A=Radius of wire.

B=Distance between centres of the two wires.

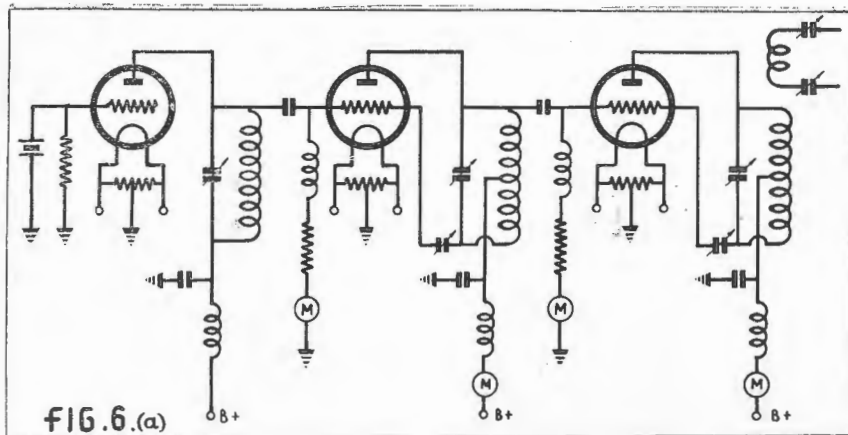

Ans.: See Fig. 6 (a).

6 (b): Explain, step by step, how such a transmitter should be neutralised.

Ans.: The correct filament voltages are applied to all valves. Plate voltage is applied to the oscillator valve and its grid circuit adjusted for maximum output as shown on the buffer grid meter.

The buffer stage is then neutralised by adjusting its neutralising condenser until there is no deflection in grid current reading when its plate circuit is tuned through resonance. It will be necessary to slightly re-tune the oscillator plate circuit when the neutralising condenser is varied.

After the buffer tube is neutralised, its plate voltage is applied, and the plate circuit tuned to resonance. The final amplifier grid meter will then show a reading. The amplifier neutralising condenser and plate circuit are varied until there is no deflection on the amplifier grid meter. Plate voltage then may be applied to the final amplifier, and its plate circuit tuned to resonance.

The aerial coupling between the amplifier plate coil and load should be adjusted until correct plate current is drawn, keeping the plate circuit always in resonance.

difficult for the oscillation to continue. The loading should be reduced to a point where it is found that stability is present.

(3) If the plate tuning circuit is adjusted so that there is maximum power output, a slight variation in loading or circuit constants may cause the oscillations to cease.

It is necessary to detune the oscillator tank condenser to a point where slightly less output is indicated.

Question 5 (a): Give drawing of three methods of "keying" a transmitter.

Ans.: See Fig. 5.

5 (b): When "keying" in the buffer stage, what precaution should be taken in respect of the stages following?

Ans.: It is necessary to apply sufficient fixed bias to the grids of the following stages, to either cut the plate current to zero or to a sufficiently low value so as not to exceed the rated plate dissipation value of the valves.

Question 6 (a): Draw a full schematic circuit of a three-stage transmitter using triode valves and excluding power supply.

A REALLY FIRST-CLASS OSCILLATOR

for as low as £10-10-0

(Within the reach of every Experimenter, Set-builder or Service-man)
It's a CALSTAN, of course!



IT'S a really high-grade job; all wording etched on non-ferrous metal; leather carrying handle, rubber feet. Pilot light and black instrument knobs on each model. Five inch dial reads direct in Kc/s, Mc/s (top half) and corresponding metres (bottom half); smooth planetary movement—adjustable for slip. Two attenuators on both models.

SPECIFICATIONS: Model 306, Battery-operated, with minimised battery drain ("B" battery drain approximately 5 ma., at 67.5 V.; "A" battery 4.5 V., drain approx. 120 ma., including Pilot).

Band spread 150 Kc/s to 16 Mc/s on fundamentals without breaks; above 16 Mc/s by using 2nd harmonics. R.F. signal modulated at will. High degree of stability and accuracy particularly over 175 and 465 Kc/s channels. Model 307 A.C. Mains operated. Feed back prevented by line filters, thus maintaining good attenuation. Bands spread 150 Kc/s to 25 Mc/s on fundamentals without breaks. Both models available with or without built-in output meter.

OUTPUT METER: 3 inch round type. Special Alnico magnet gives approx. 300 per cent. increase over old style. Ranges: 2, 5, 10, 50, 250. Provision for measuring A.C. Volts. All necessary cards and instructions supplied.

Distributors:

N.S.W.: Australian Radio College Ltd., Martin de Launay Ltd., Bloch & Gerber Ltd., United Radio Distributors, John Martin Ltd., Electric Service Co., Newcastle. QUEENSLAND: J. B. Chandler & Co. SOUTH AUSTRALIA: Radio Wholesalers Ltd., Adelaide. WEST AUSTRALIA: Norman L. Burnell & Co., 13 Queen Street, Perth. VICTORIA: Australian General Electric Ltd., Melbourne; Arthur J. Veall Pty. Ltd.; Hartleys Ltd., Flinders Street, Melbourne. TASMANIA: Noyes Bros. (Melbourne) Ltd., Launceston. NEW ZEALAND: New Zealand Electrical Equipment Co. Stocks also available from Turnbull and Jones, all branches.

306 Battery Operated	£10 10 0
306a (illustrated) ditto with output meter	15 15 0
307 Mains Operated	10 17 6
307a ditto with output meter	16 2 6
Output Meter as used on both models	5 10 0

(All prices subject to sales tax)

Terms arranged. Trade-ins accepted.

SLADE'S RADIO PTY. LTD.

Croydon, N.S.W. Phones: UJ 5381, 5382

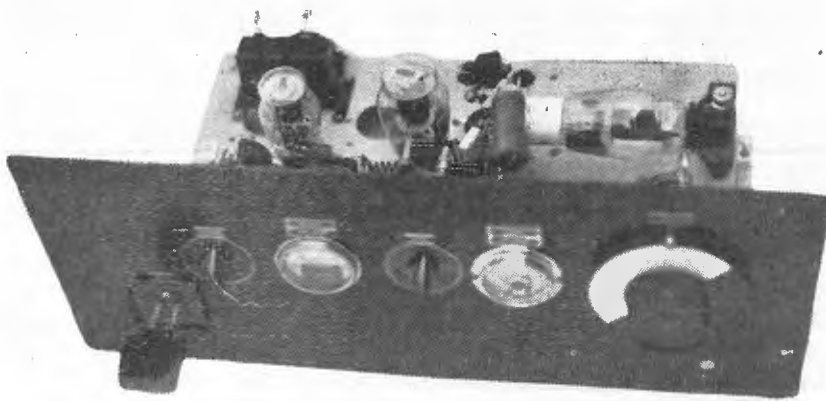

A panel view of the 56 m.c. crystal exciter unit now in use at VK2NO. Left to right: Plug-in 40-metre crystal, oscillator control, oscillator plate meter, quadrupler control, 807 plate meter, 807 doubler control.

Experimenters! . Get Down To Ultra Shorts

In this concluding instalment the author discusses the design of receivers, transmitters, and aerials for use on the ultra high frequencies.

By Don B. KNOCK Radio Editor, "The Bulletin"

THERE is no reason to be afraid of tackling experimental work with crystal control and appropriate receivers on 5 metres. Before 2.5 is even considered, there is plenty of spadework to be done on 5 metres. That can be done by wholehearted co-operation and the sinking of petty differences which have at times unfortunately characterised work in recent years on 5 metres, around Sydney in particular.

If one man does better than another in the way of successful results, the thing to do is to try to emulate his work and go one better, in a spirit of good fellowship.

The receiver now in use at VK2NO needs to be seen and heard to be believed. A station such as VK2LZ 60-odd miles away in the Blue Mountains, is so powerful that i.f. gain needs to be shut right down for comfort. It is not essential to possess a complicated self-contained superhet in order to make the most of 5 metres. A superhet converter can be hitched ahead of any receiver with sufficient r.f. amplification as the i.f. channel, with excellent results. Such converters are now in use by many in N.S.W.

With the transmitter and receiver taken care of, the next, and very important question is that of suitable aerial systems. Much useful work can be done with a plain half-wave

vertical radiator, fed in any of the accepted fashions, but to realise the full benefits of aerial possibilities, some form of directive high-gain array is desirable, and in this field there is no end of scope. Most of the high-gain arrays possible are readily applicable to 5 metres, for the reason that they are reasonably compact.

A Tried-And-Proved Array.

At the writer's station, almost every known type of vertically polarised array has been tried in the last six years, the one in use at present being the two-section W8JK. This has useful features, as it is readily erected at a fair height, being only 2 feet across the top by 17 feet in length, excluding end matching stub.

It is a good all-round system for general communication, but like all-directive arrays, must be rotatable. Being bi-directional, rotation through 180 degrees is necessary.

A recent high-gain array introduced by Kraus, W8JK, is to be tried in the near future. This is the "square-corner" reflector type in which a single half-wave element is used, backed by what is virtually a parabolic reflector curtain.

Estimated gain in the direction of the open sides of the reflector is 18 db., which is exceptionally high and

useful gain at 56 m.c. This means that a low-powered station can put out a signal approximating one of several hundred watts from a plain radiator. This array is for one direction only, and thus must be rotated through 360 degrees for all-round coverage. It seems to be the best aerial proposition to date.

In considering ways and means of stabilised signals on 56 m.c., probably the best line of approach is the superhet converter for use with an existing receiver. If the experimenter already has a good amateur band superhet with reasonable good gain in the vicinity of 46 metres, this can be used as the i.f. channel, second detector and audio portion of an effective 56 m.c. superhet.

With a converter designed for the purpose, the receiver can be tuned to any convenient intermediate frequency, and excellent results obtained. If the amateur band superhet has a b.f.o. (and if it hasn't it isn't worthy of the name), then the combination fits one for c.w. reception on 56 m.c. I go so far as to say that provision for c.w. reception on 56 m.c. is essential, if the best results are to be expected.

With the b.f.o. in operation, weak carriers can be located that would otherwise be passed over, and many more QSO's obtained than might otherwise be the case.

A word or two about converters. It is possible to get results of a kind by making up what may be styled a converter by simply using a mixer-oscillator alone. No matter what the conversion gain of the particular valve used, results anywhere near equal to those obtainable with a converter using an effective tuned r.f. stage ahead of the mixer cannot be expected. The difference is that of chalk and cheese.

Furthermore, there is no need to adopt the apparently easier way out of things by using separate tuning controls on mixer and oscillator. If a valve of the 6J8G type is used, tracking for single dial control over 56,000 to 60,000 k.c. is no problem at all, and any mythical reasons why other valves should be used in preference disappear with the tuned r.f. stage ahead. An ideal r.f. valve is the 1851, and in the single-ended series there is the 1852, an equally suitable valve.

It has been said that first consideration must be the depth of the pocket in tackling modern methods of reception at 56 m.c. That is a fallacy. The experimenter is not likely to use makeshifts for his regular work on other bands, and expect to get the best of results. That applies very much more so to ultra-shorts. It is imperative to do the job properly if anything more than mediocre communication over fairly distances is wanted.

A case in point is that of VK2VU

in Singleton, N.S.W. Recently, the writer made up a superhet converter for 2VU, consisting of an 1851 r.f. stage ahead of a 6J8G, with built-in power supply. That converter is used with a good amateur band superhet tuned to 46 metres. The result is that the c.w. signal on 56 m.c. from VK2LZ over 100 miles distant is received at R9, with speech at R8. Having tried plain mixer-oscillator input with previous 5-metre superhet designs, the writer claims that little, if anything, would be heard over that 100-mile path without the r.f. amplifier. Similar converters have been made and are in use at stations VK-2EM and VK2NS with equal results.

The superhet receiver in use at VK-2NO gives a performance of such outstanding nature that the writer is willing at any time to challenge anybody sponsoring makeshift creations to a station-for-station logging contest, in any location that might be chosen.

A great deal could be said on the subject of transmitters and aerial arrays, but space does not permit here. Sufficient to say that there is a wealth of material to deal with in these directions. To those experimenters in the Sydney district interested in 56 m.c. work and u-s-w communication in general, I suggest that the monthly meetings of the newly-constituted u-h-f section of the W.I.A. N.S.W. Division be attended.

Apart from general discussions of

interest, lectures will be given regularly, and these, instead of being informal as in the past, will be enhanced by screen projection. Those concerned with this section are not of the dabbler type, with a mere passing interest in 56 m.c. development. They comprise those who have stuck at the job and are able, by an accumulation of a wealth of practical information, to pass their ideas on to others.

Most of the matters to be discussed in the immediate future will deal with tried and proven facts, not suggestions.

Ultra-High-Frequency Section: Inaugural Meeting Of N.S.W. Division, W.I.A.

FIRST meeting of the newly-formed U.H.F. section of W.I.A., N.S.W. Division, was held at the Y.M.C.A., Pitt Street, Sydney, on the evening of June 1, 1939. At a recent council meeting of the division, Mr. Don B. Knock (VK2NO) was asked to accept the presidency of the proposed U.H.F. section, and the chair was taken by him on this evening. Secretary C. Horne (VK2AIK) was assisted by Mr. W. McGowan (VK-2MQ), who had been appointed to the assistant secretaryship of the section.

Attendance numbered twenty-two,

(Continued on page 30).

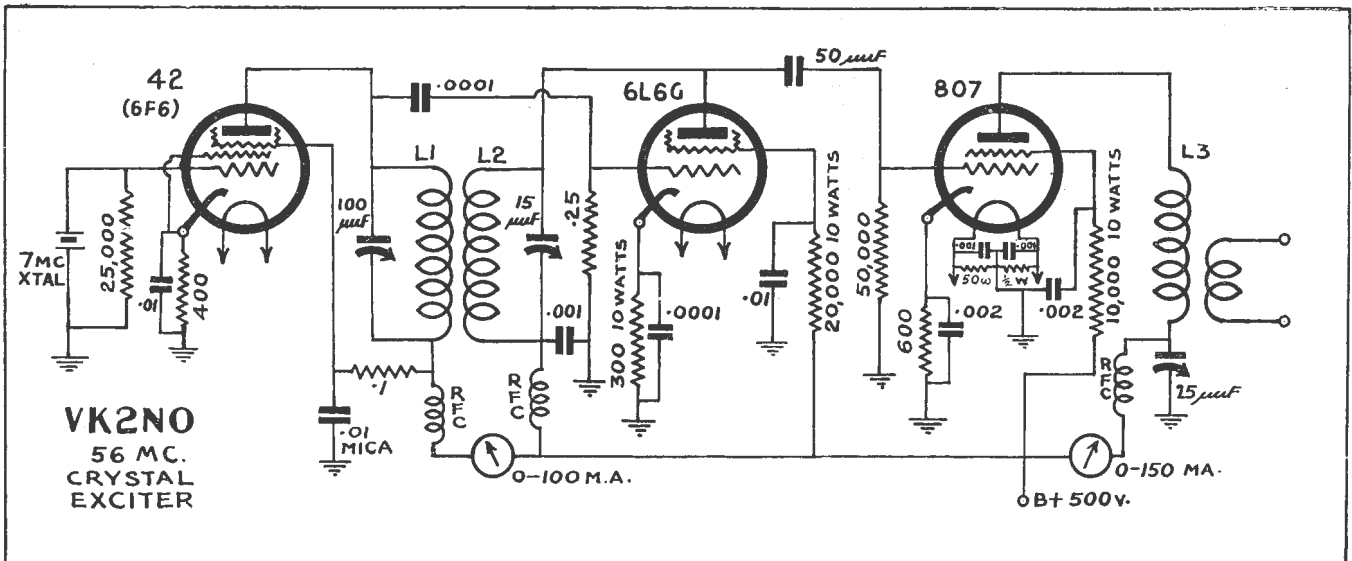

The circuit diagram, with values, of the crystal-controlled exciter unit designed by VK2NO for 5 metres, using a 40-metre crystal. Having an output of approximately 20 watts, this unit itself comprises a useful medium-power transmitter.

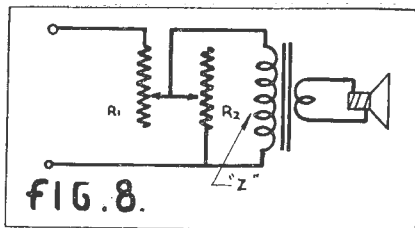
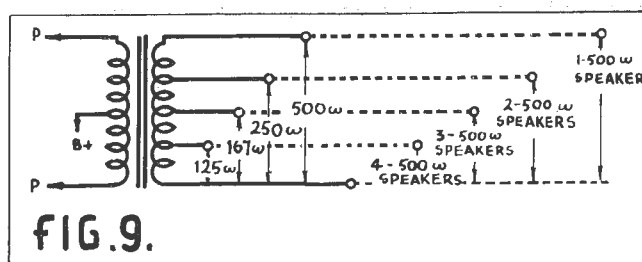

Fig. 8 (left): Controlling the volume of loud speakers by ganged potentiometers. Fig. 9 (right): Indicating how multiple speakers, each with an impedance of 500 ohms, are connected to the output transformer.



Installing An Extension Speaker

Independent volume control of extension speakers, and multiple installations, are discussed in this concluding instalment. . . . Contributed by

The Rola Company (Aust.) Ltd.

INDEPENDENT volume control of extension and or main speaker may be used as shown in Figure 8.

Resistors R1, the series element, and R2, in parallel with speaker input, are two potentiometers ganged together and connected so that when resistance in one is decreased, resistance in the other is increased.

Resistor R2 should have a value of at least five times the impedance "Z" of the speaker whose volume is being controlled. Resistor R1 has a value equal to the combination of R2 and

$$Z, \text{ i.e., } \frac{R2 \text{ plus } Z}{5}$$

Z input is 500 ohms, then R2 will be:—

$$500 \times 5 = 2,500 \text{ ohms}$$

$$R1 = \frac{2500 + 500}{5} = 600 \text{ ohms}$$

As the potentiometer R2 is connected in parallel with speaker input, some power will naturally be consumed by it. Although not serious, this may be reduced by increasing the ratio of R2 to Z input from 5 to some greater value, say, 10. Resistor R2 would then be:—

$$500 \times 10 = 5000 \text{ ohms}$$

while R1 would be:—

$$\frac{5000 + 500}{10} = 550 \text{ ohms.}$$

In this case, the power consumed by R2 would be one half that consumed by the previous example where the ratio of R2 to Z was 5.

Multiple Speaker Extensions.

In public address or factory call systems, it is sometimes necessary to have more than one extension speaker. On systems of this type, the amplifier is generally equipped with an output impedance of 500 ohms. The input impedance of each speaker is simply $ZL \times N$ where ZL is the line impedance and N is the number of extensions, the extensions being connected in parallel across the line.

Most public address systems are portable and are used for various types of work, such as sports meetings, lectures, etc. Now, on some jobs, it may only be necessary to use one speaker, while on others two,

three, four and sometimes more than four speakers will be required. As it would not be practical to change the input impedance of each speaker every time more speakers were required to be connected, it has been adopted as standard practice to equip all speakers with 500-ohm inputs.

The output transformer is then designed to have a 500-ohm output tapped 250, 167, 125 and 100 ohms. This allows for the use of one speaker only being connected to the 500-ohm tap. If two speakers are required, they are connected in parallel across the 250-ohm tap and so on, for three, four and five speakers.

Extension Speaker Cabinets Or Baffles.

The diaphragm of a loud-speaker acts as a piston throughout most of the musical frequency spectrum, up to approximately 1,500 cycles per second. Beyond that point frequency radiation is by "cone breakup." As the diaphragm moves forward it compresses the air in front of it and creates a partial vacuum behind itself.

The compressed air must go somewhere, and if there is no obstruction, moves round and fills the partial vacuum at the rear of the cone. This movement has most noticeable effects on the lower frequencies, which are practically cancelled by the process. By employing a baffle to increase the effective distance between front and rear of the vibrating

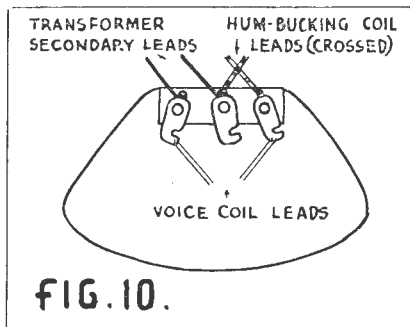

Fig. 10: Standard connections on voice coil terminal strip on most Rola electro-dynamic speakers.

diaphragm, the relative phases of the waves are shifted sufficiently so that the wave from the front of the cone is in phase with the wave from the back of the cone, thereby preventing cancellation.

The baffle must be large enough to make the shortest distance from the front to the back of the diaphragm not less than $\frac{1}{4}$ -wavelength of the lowest frequency to be reproduced.

The wavelength is determined by dividing the velocity of sound, which is approximately 1,120 feet per second, by the frequency.

Example: Supposing the lowest frequency it is desired to reproduce is 100 cycles per second, the wavelength will be $\frac{1,120}{100} = 11.2$ feet.

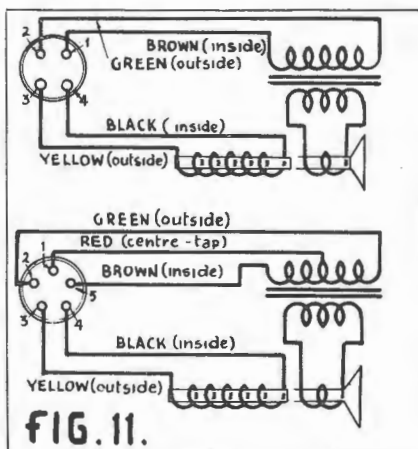

Fig. 11: Showing the standard color connections for electro-dynamic speakers. On permanent magnet speakers, the field coil is completely omitted.

The shortest distance then from the front centre to the back centre of the required baffle will then have to be $\frac{11.2}{4}$, that is, 2.8 feet approxi-

mately. Thus a baffle 2 feet 10 inches square will be required.

In the case of radio receivers the cabinet is used as a baffle.

Lists.

Two lists accompany this article, one setting out the parts required for one extension speaker, using the Rola 8-20 in conjunction with the 500-ohm line method, as described in Figure 7, with independent volume

LIST OF PARTS FOR EXTENSION SPEAKER.

- 1 — 8-20 P.M. Speaker, 500 ohms input (Rola).
- 1 — Output Transformer, 500 tap 250 ohms.
- 1 — Marquis switch type M.A.W.
- 1 — Isocore Transformer, for existing speaker, 500 ohms.
- 1 — ganged Volume Control—5,000 ohms, 550 ohms.
- Wire (50 yard coil, bell).

control incorporated. The second list gives suitable Rola speakers with comments on each.

Further information on this subject can be obtained direct from the Rola Company, who have given considerable attention to the subject and will only be too happy to assist readers.

Recommendations For Permanent Magnet Extension Speakers.

(Rola Types Listed).

12-INCH MODELS:

Suitable where highest quality music and speech desired. Must be used with baffle at least 4 feet square (or equivalent in cabinet) to get best results.

12-42, 72/-; 12-21, 50/-; 12-20, 44/-.

10-INCH MODELS:

Suitable for high quality reproduction of music and speech. Baffle at least 4 feet square (or equivalent).

10-42, 65/-; 10-21, 46/-.

8-INCH MODELS:

For general purposes gives good reproduction of music and speech. Baffle 3 feet square (or equivalent).

8-42, 61/-; 8-21, 42/6; 8-20, 38/-; 8-14, 34/-.

6-INCH MODELS:

Where good bass reproduction is not essential. Requires baffle 2 feet square.

6-14, 34/-; 6-6, 27/-.



do you like listening too?

Everyone likes listening when there's something that pleases the ear. If your radio is dull and lacks sparkle, worn valves may be the cause. Make listening the pleasure it should be . . .

Revalve with



THE WORLD'S
STANDARD
RADIO VALVES

Specify . . . **RADIOTRONS** for the "Astra Dual-Wave Six" and "1939 Companionette" described in this issue.

Building And Calibrating

A Test-Bench Multi-Vibrator

Servicemen and experimenters will find many uses for this 50-10,000 c.p.s. audio oscillator, which is both simple and cheap to build and calibrate.

Designed and described by "ENGINEER".

SOME men still prefer to squint at the sun, rather than consult a clock to find the hour of the day. Some radio servicemen still prefer their ears and some particular broadcast programme to test the "tone" of equipment, when they could check it more accurately with an audio frequency oscillator and an output meter or oscillograph. However, they are in the minority. Most radio workers would use audio testing apparatus—if they could afford it. A beat frequency oscillator cannot

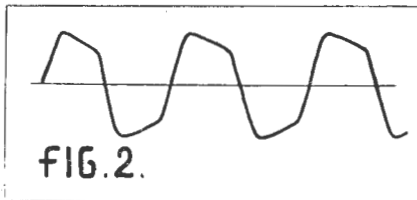

carry a guarantee below about fifty pounds—apparently a prohibitive price.

However, the construction and works of a "B.F.O." usually justify the price. There are two radio frequency oscillators of extreme stability, very well screened from each other. Their outputs are mixed in a special device which combines them without coupling the oscillating circuits in any way. The mixed R.F. signals are fed to a special detector so devised that the signal output from it has a frequency equal to the difference of the radio frequencies and as little harmonic content as possible.

The resulting audio signal has to be amplified without distortion, and the power supplies must have sufficient smoothing to keep the hum level well below the tolerable limit for a good receiver. In addition to all that, provision must be made for frequency and output calibration. In all, it is a difficult job in design and production, and cannot be jobbed out like a cheap test oscillator for receiver aligning.

You ask—"Why is all this necessary to produce alternating voltages with frequencies between 20 and 10,000 cycles per second?" The query itself introduces a clue to its answer. 20 to 10,000 is a ratio of 1/500. The ratio of capacity to cover the range would be

$$\frac{1}{500 \times 500} = \frac{1}{250,000}$$

If the minimum capacity (including stray capacity across wiring sockets, valves, etc.) were .00003 microfarad at 10,000 c./s., the maximum capacity at 20 c./s. would have to be .00003 x 250,000 = 7.5 microfarads. Have you ever seen an 8-micro-

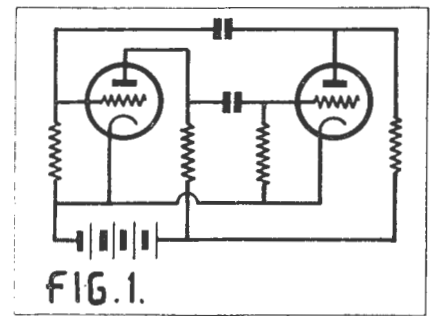

farad variable condenser?

By taking the difference of two radio frequencies, the difficulty is overcome. If one oscillator is tuned permanently to 100 k.c./sec., and the other has an adjustable frequency between 100 and 110 k.c./s., the entire range from 0 to 10 k.c./s. (10,000 c./s.) may be covered with a

capacity ratio of $\frac{1}{1.21}$. Unfortunately,

the economic situation upsets one's good intentions, and the average serviceman has to rely on his own aural judgment.

Although a continuously variable frequency, controlled by one knob, is

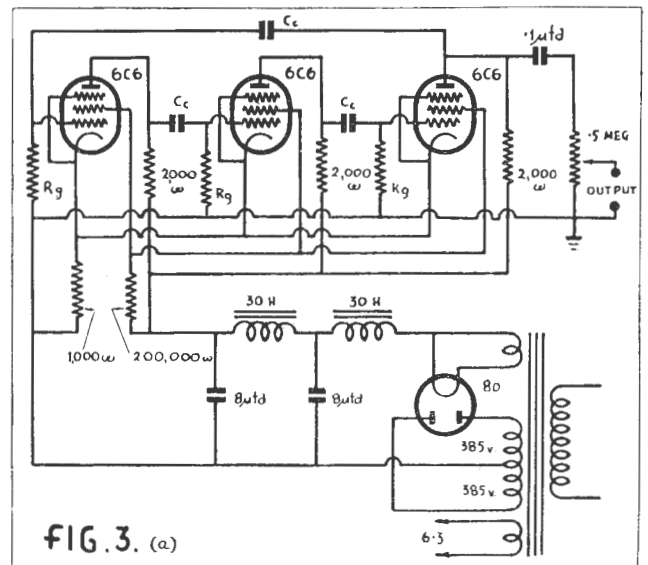

a decided advantage, a stepped control, like a wave-change switch, may be used, with some small variable selector to pick any frequency between the steps. It is quite possible to make up an ordinary Hartley or Colpitts oscillator in this way, but audio frequency coils are difficult to wind and adjust and, in any case, it is only possible to cover band ratios of about 1/3 with the variable condensers available.

Resistance-Tuned Oscillators.

When two resistance-coupled stages are connected as in Figure 1, the circuit will oscillate. Each stage inverts the voltage, so that the output of each plate is in phase with the input required at each grid. The frequency at which the oscillation occurs depends upon the valves, the plate load and grid leak resistances, the coupling capacities, and the stray capacities between plate and earth and grid and earth.

The output wave form is much like that shown in Fig. 2—laden with harmonics, and entirely unsuited for audio testing. It may be mentioned

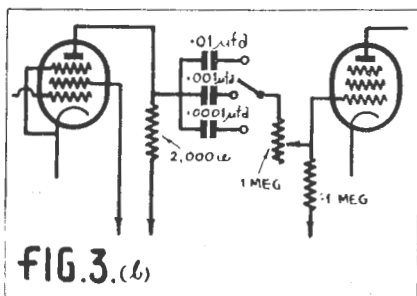

FIG. 3. (b)

in passing that this circuit is used as an harmonic generator, and it is often called the multi-vibrator in recognition of its harmonic fertility.

By introducing a third stage (Fig. 3), the oscillation is stabilised, and the waveform becomes much more pure. Each stage changes the phase by 120°, so that by the time an impulse has traversed the circuit, it is turned through 120 × 3 = 360°, that is to say, it is back in the same direction as it started.

Most of the phase shift occurs in the coupling condenser and grid leak, and it varies with the frequency. Consequently, there is only one frequency where the signal is in phase after going around the three stages, and the frequency of oscillation is stable. The simple relation $F = 1/\sqrt{3} \times 2\pi R_g C$ determines the fre-

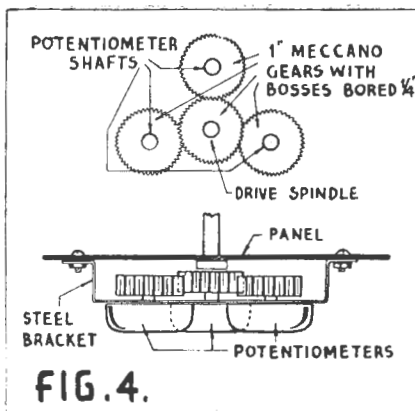

FIG. 4.

quency, where R_g is the grid resistance (megohms) and C is the coupling capacity (microfarads).

The gain of each stage has to be so adjusted that the signal, after one trip around the circuit, has just the same magnitude as it had when it started. The gain per stage is thus the cube root of one, which is one. The voltage across the grid leak is about 2/3 of the alternating (signal) voltage at the plate, and thus the plate load must be made to give a gain of about 1.5 from grid to plate.

In practice it is higher than this, and the circuit adjusts its own gain by biasing its cathodes and tending to cut off the plate current. A 6C6, which should just oscillate with a plate load resistance of 1360 ohms, is given 2,000 ohms.

Instead of varying the capacity to adjust the frequency, the continuous variation is accomplished by a 3-gang bank of 1-megohm potentiometers, covering frequency bands of 10-100, 100-1000, 1000-10,000 c/s., in three bands. The condensers must be .01, .001 and .0001 mfd. for the three respective bands, and an ordinary 3 × 3 bank from a wave-change switch is used to connect them.

The potentiometers are ganged as shown in Figure 4, with Mecanno 1" gear wheels. The wiring presents no difficulty, and no special precautions need to be taken about the placing of leads. The power supply is very well smoothed with a choke input filter.

Originally, the circuit is due to the work of Dr. Van der Pol, who used to generate a three phase alternating voltage of $\frac{1}{360}$ c/s.—that is, one cycle every ten minutes!

Applications.

Before the oscillator can be used to its best advantage it must be calibrated. We must find just which frequency is which, and mark it on the scale. Figure 5 shows a fairly simple method of finding some of the lower frequencies. It is an idea borrowed from the converters of superhet receivers.

The speaker has two input voltages—one from the oscillator through an amplifier, and the other from the 50 cycles per sec. mains. When the oscillator is set to 50 c.p.s., just a dull hum will be heard, but if it is detuned either way, the sound will seem to come and go in beats "wah—wah—wah"—and the quicker the beats the further off tune must the oscillator be. The scheme is to tune the oscillator right down to "zero beat" where the beats have slowed down and stopped.

The corresponding point on the scale should be marked, and the oscillator may be tuned to an octave above 50 c.p.s.—i.e., 100 c.p.s.—where the next zero-beat is registered. A musical fifth above that again is 150 c.p.s., where the next zero beat is recorded.

At intervals of 50 c.p.s. all the way up, the frequencies may be marked, but the musical pitch intervals between them become smaller with the increase of frequency.

At frequencies above about 1000 c/s., the 50 c/s. intervals become so close to each other that it is scarcely possible to pick them. For the range from 1,000-10,000 c/s. it is better to pick musical octaves above the 50 c/s. intervals in the 100-1,000 c/s. range. An octave is always a frequency ratio of 1/2, so that the octave above, say, 800 c/s. is 1,600 c/s.; above 1,000 c/s.—2,000 c/s. and so on.

The oscillator finds its first use in checking up on speakers. The speaker

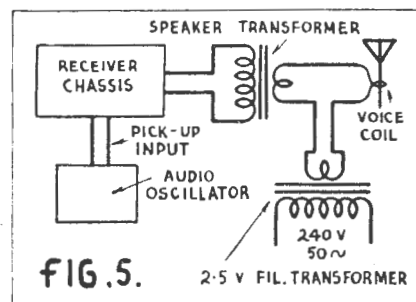

FIG. 5.

should be used always with the valve for which it was intended, and in most amplifiers and receivers, it is wise to connect the output of the oscillator directly to the pick-up terminals. As each frequency band is swept through, one may hear the various peaks and hollows in characteristic.

The effect of a tone control can be gauged by sweeping the oscillator through its top range with the control in and out.

If an output meter is connected across the speaker, some idea of frequency response can be had by plotting a graph of decibels output against frequency of input.

To check the severity of high note cutting due to high Q i.f. coils, the audio oscillator may be used to supply a modulating signal for a signal generator or test oscillator. If your test oscillator does not provide for external modulation, it is not difficult to disconnect the grid of the audio oscillator belonging to the test oscillator, and connect instead the audio oscillator described in this article.

For adjustments in the modulating side of a transmitter, the audio oscillator may be used with satisfaction. It is much easier to read the rise in aerial current when the modulating signal is a steady, pure tone.

Another use for any audio oscillator is for supplying a signal for an a.c. bridge, for measurement of inductance, capacitance and resistance.

Many other uses will present themselves to readers. The instrument is much less expensive than any B.F.O., and it is smaller, lighter and more compact. It is not a standard of frequency by any account, but it is an exceptionally useful audio oscillator. Try it.

Get Down To Ultra-Shorts.

(Continued from page 25)

including licensed experimenters and listeners, comprising the following:— Messrs. W. M. Moore (VK2HZ), M. Meyers (VK2VN), M. Lusby (VK2WN), F. Carruthers (VK2PF), N. Gough (VK2NG), H. Ackling (VK2PX), R. Treharne (VK2IQ), R. Flood (VK2BN), J. Davey (VK2YE), J. Fraser (VK2AFJ), E. Dickson (VK2AFM), A. Joscelyne (VK2AJO), S. Weston (VK2AJH). From Taree, N.S.W., came Messrs. B. Eagling (VK2AEY), E. Fallowfield (VK2AKI) and P. Potts. Sydney U.H.F. listeners were Messrs. R. Rutherford

and C. Bambury. Others present were K. Woodhouse, F. Burke (Waverley Radio Club) and C. Wilson.

The president opened the proceedings with appropriate remarks on the value and future status of ultra-high-frequency experiments along modern lines, with regard particularly to the 56 m.c. band. With the object of ensuring that Sydney area should have available consistent transmissions from a number of stations, volunteers were called for the commencement of a station roster to provide the definite presence nightly of at least one station on the air. Stations scheduled for duty for the following month are as follows:—

Mondays: VK2HZ, 56,000 kc. c.w. only, from 8 to 9 p.m.

Tuesdays: VK2VN, 56,080 kc., c.w. only, from 8 to 9 p.m.

Wednesdays: VK2NO, 56,040 kc., 30 minutes phone and 30 minutes c.w., 8 to 9 p.m.

Thursdays: VK2AJH, 58,320 kc., phone and c.w., 8 to 9 p.m.

Fridays: VK2MQ, 56,240 kc., c.w. only, 8 to 9 p.m.

Saturdays: VK2IQ, 56,190 kc., phone and c.w., 8 to 9 p.m.

Sunday nights: Open for general contacts and discussions.

In the daytime on Saturdays and Sundays, transmission will be on the air from several stations, mainly between the hours of noon and 1 p.m., for the benefit of distant stations and observers, for the reason that experience shows that conditions for possible long-distance communication are most likely to be favourable around this period.

An important benefit to the U.H.F. section is the presentation by Mr. R. Rutherford of an epidiascope for the projection of illustrations, diagrams, etc., to enhance lectures. Mr. Rutherford was appointed U.H.F. listener representative for the section. Vice-presidents appointed by nomination are Messrs. W. M. Moore (VK2HZ) and R. Treharne (VK2IQ). It was decided that meeting nights will be the first Thursday in each month. A technical committee was appointed, consisting of Messrs. Lusby (VK2WN), R. Treharne (VK2IQ), with the president as ex officio member. Matters discussed during the evening were:—

That all stations after completing a telephony contact with other stations should sign off with the station call-sign on c.w. This is considered

essential as a possible means of identification at distant positions. Where identification may be rendered difficult on speech for various reasons, a c.w. carrier can often be heard at a low signal level, and if keyed would be readily identified.

The need for comprehensive lectures was stressed, and it is anticipated that no difficulty will be encountered in this respect, both in the securing of visiting lecturers of technical standing, and from the ranks of members.

A chain of relay stations is one of the objectives of the section. This will provide more interest for outlying country 56 m.c. experimenters and will lay the foundation of what may eventually be a valuable and more or less secret channel of communication should the need arise. Activities will include mobile, portable and field day tests. Aircraft co-operation was offered by Mr. P. Potts, of Taree, whose flying activities are done in the Newcastle, N.S.W., district.

One important matter for future consideration is the possibility of a special marine test, involving the co-operation of VK and ZL experimenters, provided that arrangements can be made to erect on board a trans-Tasman vessel 56 m.c. equipment with bi-directional radiating system. Such a test would be of great interest to Australian and New Zealand experimenters and world-wide amateur radio circles in general.

It is possible that arrangements will be made for membership in the section for those who are not in a position to become W.I.A. members, although it is desirable that, where possible, membership should be taken up with the Institute in the interests of the unity of experimental radio affairs in Australia.

Ross Treharne (VK2IQ) announced on behalf of the Zero Beat Radio Club, a 56 m.c. field day to be held in Centennial Park, Sydney, on Sunday, June 25. This will include a hunt for a hidden transmitter, and provides interesting scope for the application of D.F. equipment.

Many active experimenters expressed their regret at not being able to attend this inaugural meeting, these including J. Cowan (VK2ZC), E. Treharne (VK2AFQ), A. Sutton (VK2EM), N. Macnaughton (VK2ZH), R. Hart (VK2HO), C. Bischoff (VK2LZ) and W. Peell (VK2WJ).

—D.B.K.



The completed microphone is mounted on a portable electric lamp standard. High sensitivity, low cost, and attractive appearance are outstanding features.

Making A Reiss Microphone

Odds and ends lying around the workshop can be used to make this simple but efficient microphone.

By L. WILSON

bakelite, 2 carbon pole pieces, a mica diaphragm, ½oz. of carbon granules, 1 sheet of gauze and 14 3/32" bolts 5/8" long with counter-sunk heads.

The first thing to do is to cut a rectangular hole in each of the three bakelite frames (numbered 1, 2 and 3 in Fig. 2). The size of these holes will be 2 3/4" x 1 3/4". The best thing to cut these with is a fret saw, after drilling four holes as shown in Fig. 1 (a).

When all three holes have been cut, place the frames together in a vice and, using a very sharp drill, drill fourteen 3/32" holes to accommodate the mounting bolts. When this has been completed, counter-sink the holes in frame No. 1. Next, take frame No. 4 and place one of the other frames on it, making sure that all the sides are flush. Now take a pencil and trace the exact size of the rectangular hole on the bakelite block No. 4 (see Figs. 1 and 2).

The next thing to do is to cut the slots for the carbon rods. Follow carefully the dimensions in Fig. 1 (c), making sure that the slots are well within the rectangle you have just drawn in pencil.

The filling hole comes next, and is shown clearly in Figs. 1 (b) and 1 (c). To drill this hole a 1/8" bit is required. Drill from the inside at an angle of about 45 degrees. It is important to commence drilling from the inside to ensure a smooth surface for the granules. Also, care must be taken when nearing the outside edge.

Take one of the other frames again and place it on No. 4 as before, once again making sure that the edges are

true, and carefully mark the position of all the mounting holes. When this has been done, each of these

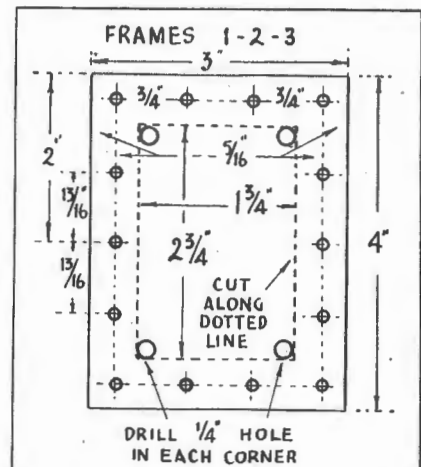
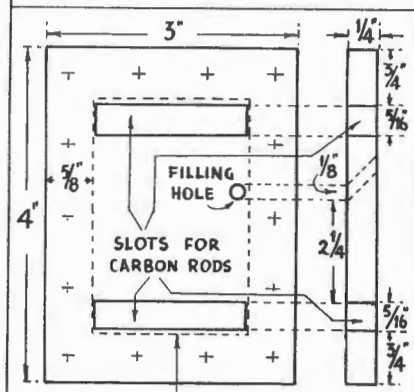

FIG. 1. (a)



RECTANGLE DRAWN IN PENCIL
FIG. 1. (b) (c)

A MATEUR transmitters and public address technicians will find many uses for this compact little "mike." Now that home recording has become so popular many set-builders will be looking round for a microphone, one that will give good quality reproduction, yet one that is simple and cheap to build.

The Reiss or transverse current microphone described here is so simple and easy to make that it is within the reach of everybody. The materials needed consist of 4 pieces of

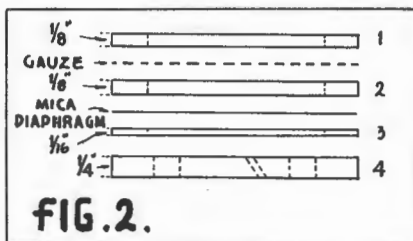
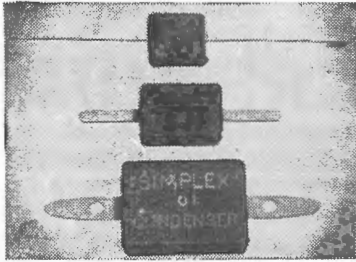

FIG. 2.

COMPACT EFFICIENCY



TO obtain ideal performance and to provide compactness without sacrificing efficiency, Simplex have made a detailed study of mica condenser requirements. To date, Simplex types S/M and P/T fulfil every possible radio need for mica condensers. Over two million of them are now in use, proof positive that they are superior in design and in actual operation. Notable features include:—

- High resistance to moisture.
- 1000 volt A.C. & D.C. test.
- Triple-strength contacts
- High accuracy of calibration.

Type S/M, available in capacities from .000005 microfarads to .01 microfarads.

Type P/T (Pigtails) measuring only $\frac{5}{8}$ " x $\frac{3}{8}$ "—capacity range .000005 microfarads to .001 microfarads.

(All Simplex condensers are subjected to a test of at least 1000 volts A.C. and D.C.)

SIMPLEX Condensers

"FAVoured BY FAMOUS FACTORIES"

Manufactured by Simplex Products Pty. Ltd., 716 Parramatta Road, Petersham, N.S.W.

'Phone LM 5615.

AGENTS IN ALL STATES.

points must be drilled and tapped to take the $\frac{3}{32}$ " mounting bolts. Great care must be exercised here or the job will be ruined. If you are not familiar with the method of drilling and tapping, I would advise you to get someone who is to do the job for you.

The carbon pole pieces can be made from a carbon rod taken from an old $1\frac{1}{2}$ v. "A" cell. Cut off two pieces $1\frac{3}{4}$ " long and carefully file these until they just fit in the slots made for them in No. 4. When finished they should be rectangular, and measure $1\frac{3}{4}$ " x $\frac{1}{8}$ " x $\frac{1}{4}$ ". At this stage, drill and tap each of these in the centre to take a small bolt—these become the terminals of the "mike." Once again it would be as well to let an experienced person do the drilling and tapping of the rods.

These rods can now be firmly glued in position. Use a very strong adhesive for this purpose, making sure to fill in all cracks, etc. so that no granules can escape.

The mica diaphragm measures $3\frac{1}{8}$ " x $2\frac{1}{2}$ " and is glued firmly over the hole in frame No. 3, leaving an equal margin all round. It is essential that the diaphragm should be flat and not sag in the centre.

When the diaphragm and the carbon rods are quite dry, the "mike" can be assembled in the order shown in Fig. 2 and the mounting bolts tightened up evenly all round.

The microphone is now ready for filling. The easiest way to do this is to make a paper funnel, place it in the filling hole and pour the granules through it. Tap the "mike" from time to time while filling to ensure an even distribution of the granules. When filling is completed, plug the hole with a small piece of cork, and the "mike" is ready to go on the air.

For excitation, this microphone requires 15 volts, the current taken by it varying between 25 and 30 m.a. The impedance of the microphone is of the order of 600 ohms, and requires a transformer with a primary-to-secondary ratio of about 20 or 25 to 1. An improvised transformer that gives very good results can be made up by winding 250 to 300 turns of any convenient gauge wire over the secondary of an ordinary audio transformer.

The microphone will give better results if suspended by a spring from each corner in some sort of frame. In the original a piece of $1\frac{1}{8}$ " hoop iron was bent to form a rect-

angle 6 " x $4\frac{3}{8}$ " and the "mike" was suspended by coil springs on each corner. This was mounted on a bracket made from another piece of hoop iron 14 " long. If a $\frac{7}{8}$ " hole is drilled in the centre of this bracket and an electric light flex adaptor screwed firmly in it, a professional touch can be added to the "mike" in the following manner.

Buy a cheap table lamp of the goose-neck variety and remove the shade and the bulb. Now insert the adaptor on the mike stand in place of the bulb. You may find that any attempt to bend the stand over will cause the mike to overbalance; in that case, a stiff rod of some description will have to be forced up the centre of the flexible shaft to keep it upright.

The photograph shows that the "mike" has a cover over it. This was made from a piece of perforated zinc hinged at the bottom and secured by a nut and bolt at the top. Details of the shape and construction can be gathered from the photograph.

I have used this "mike" for making announcements at dances held every month in a local hall, and the results have been very satisfactory. Even when held two or three inches away from the announcer, there is no objectionable blasting as is the case with some Reiss "mikes."

Stopping Battery Shorts.

A neat and safe way of holding "B" battery leads to minimise risk of shorting is to stretch around the battery an elastic band with small cuts

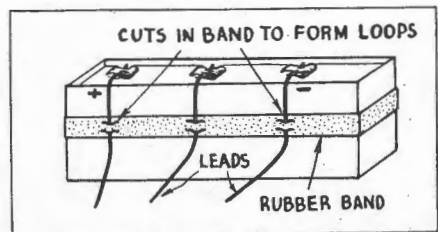

made in it to take the leads. (See sketch). Some difficulty was experienced with the band, as it was found to perish very quickly. This was overcome by rubbing soft soap into it occasionally.

Another idea which was very successful was to cut a strip from an old motor car or motor-cycle tube. The rubber band obtained in this manner is much stronger than a bought one.

This idea is very useful when used with a portable set.—J. Aiken, Nowra, N.S.W.

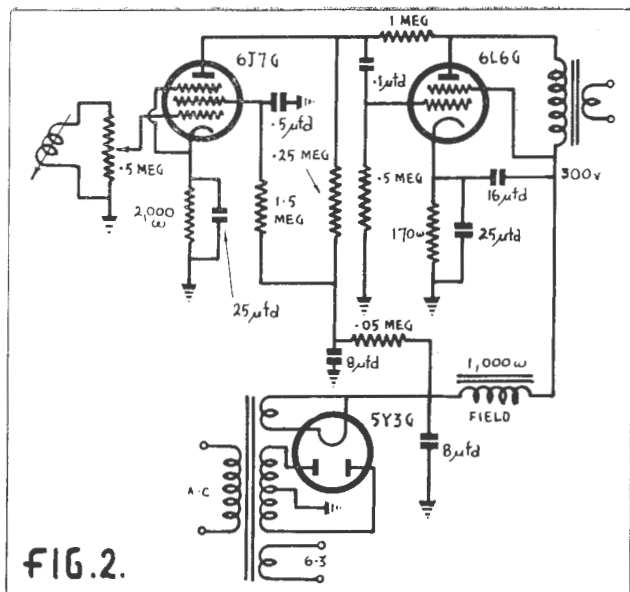

Economical to build, this amplifier nevertheless gives a performance comparable in output and quality with that obtainable from 2A3's in push-pull.

The Economy Fidelity Amplifier

Designed and described by "TETRODE"

WHEN the "Radio World" was very young, a series of articles was published on "This Pentode Business," showing how and why it was desirable to use triode valves in output stages, and that pentode valves of the 6C6, 6J7 class made excellent resistance coupled amplifying stages for swinging the output triode.

For the benefit of readers who are unable to refer to the original articles ("R.W.," Nov., Dec., 1936, and Jan., 1937), it may be wise to point out the chief objection to the pentode and tetrode class of output valves. It is that the very high plate impedances result in distortion at high audio frequencies, high note accentuation, poor transient response, and an over-stressed bass resonance in the speaker.

In "Radiotronics" for August last is an article on triode and pentode (or tetrode) output stages, showing that the reason for the high plate resistance of pentodes is easily seen from their construction. It seems that in a triode the plate is not very well screened from the cathode, and that a change of plate voltage is "felt" at the cathode, and results in a considerable change in plate current.

How Inverse Feedback Works.

It was pointed out that the screen grid of a tetrode or pentode tends to

screen the plate from the cathode, and changes of plate voltage result in only slight variations of current. By feeding a portion of the plate voltage variations back to the control grid, it may be seen that the pentode and tetrode valves are made to behave as triodes, in both gain and plate resistance. Figure 1 was drawn to demonstrate just how feedback can be made to convert pentode characteristics to those of a triode.

One well might ask "Why then, should we use pentodes with feedback, when a triode may give the same gain and distortion without?" The answer is to be found after we examine the advantages of pentodes more thoroughly. In addition to their higher gain, pentodes have higher power efficiency than triodes. The efficiency of a power valve is just the ratio of power output to total power consumption.

The most complete assessment of efficiency should include the power consumption of the heater or filament, but it is more usual to neglect such loss, and to calculate the power consumption on the basis of plate volts to plate amperes.

The 2A3, for instance, requires 250 + 45 volts (-45 volts bias) at a current of 60 m.a. or .06 amp. The power consumption is found to be 295 x .06 or 18 watts for 3.5 watts output. The efficiency is thus 3.5/18, or

0.194, usually written as 19.4%.

6L6 Has Much Higher Efficiency.

In comparison, the 6L6, with a plate voltage of 250, screen voltage of 250 and a bias of -13.5v., draws 78m.a. plate current, and 7.2m.a. screen current—a power consumption of 263.5 (.078 + .0072) or 22 watts for 6.5 watts output. The efficiency is 29.5%—a very considerable improvement, and a means of using cheaper power supply equipment for equivalent power output, or greater power output from the same power supply.

This "power output" or "maximum power" is a quantity fixed by the structure of the valve, the ability of its cathode to emit electrons, the voltages applied to the electrodes, and the resistance of the load in the plate circuit. When a valve is supposed to be operating under class "A" conditions, the distortion builds up alarmingly if grid current flows, so that the grid bias limits the grid swing.

If one tries to increase the possible grid swing by increasing the bias, the plate current tends to be cut off before the actual negative grid peaks are reached, and the distortion is increased again. The rated bias for any particular plate and screen voltages is thus fixed, and with it the maximum grid swing which deter-

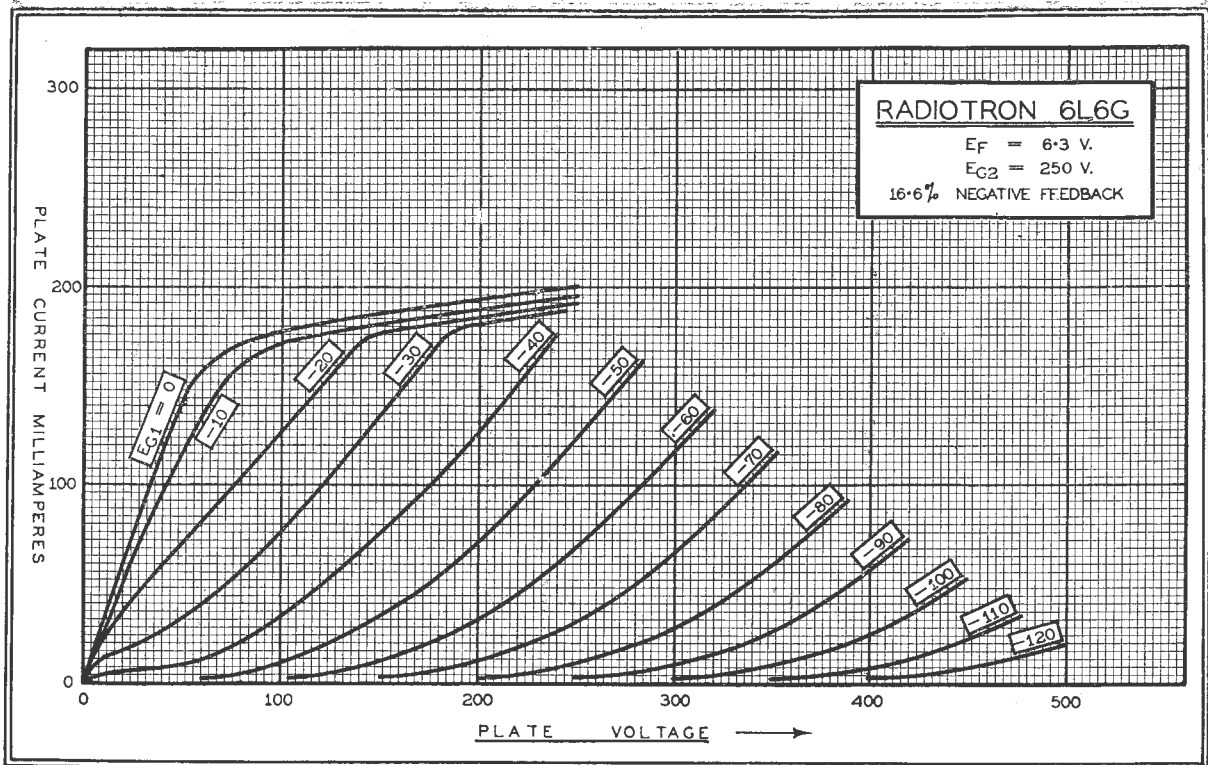

Fig. 1: Plate voltage-plate current curves for the 6L6G with 16.6% negative feedback at full output.

mines in turn the power output.

All feedback circuits are designed to reduce the effective gain of some stage prior to the output stage, either by reducing the effective load resistance of a valve, by using two grids with opposing voltages, or by introducing some output-controlled attenuating device. The actual grid swing and gain of the final stage, measured from grid to output load, remain unaltered, and so also does the power output and efficiency.

Thus the pentode or tetrode, with feedback can give triode quality with pentode or tetrode efficiency, with pentode or tetrode bias and, unfortunately, triode gain.

Modified Series Feedback Circuit.

In the Economy Fidelity Amplifier there are several novel features.

The feedback circuit is an R.C.A. development of the original Australian "series feedback" circuit which has become so popular.

In the series feedback circuit, it was customary to use two resistors across the output transformer primary as a potential divider to portion off the voltage to be fed back through the plate load resistance of the previous stage—a 6C6 or 6J7G. If one can imagine our increasing the resistance of the divider across the

speaker, one can understand what has been done to the old circuit.

As the resistance is increased, so it becomes more and more the plate load of the 6J7, until finally, there is no need for the extra series load, and the two legs of the divider became "parallel" loads of the 6J7. The cost of the amplifier has been cut by one part, and as well it has been made possible to decouple the first stage.

The decoupling system of Fig. 2 may seem rather unusual. Instead of connecting the 50,000-ohm decoupling resistor to the output side of the speaker field, it has been fed from the input side—the rectifier filament. The reason is that the voltage is considerably higher at that point, and the combination of the 50,000-ohm resistor and an 8 mfd. condenser give quite sufficient smoothing with the very small current of 0.7m.a. taken by plate and screen of the 6J7G.

6L6G Plate De-Coupling Arrangement.

The decoupling of the plate of the 6L6G possibly deserves some justification. By returning the 16mfd. output filter condenser to the 6L6G cathode, the audio frequency component of the plate current does not flow through the 170-ohm bias resistance, and, therefore, none of it is fed back

to the grid circuit. Where the bias resistor is small, in the normal circuit, the cathode by-pass condenser should be proportionately large. In this circuit the 25mfd. condenser is only included to reduce the residual hum, due, probably, to some heater-cathode leakage, possibly electronic.

Otherwise, the circuit is quite normal. The regular 0.25 plate, 1.5 megohm screen loads are used, and the 6J7 normal bias resistance of 2,000 ohms is employed. The 0.5 megohm grid resistance is the maximum permissible for a 6L6G, and the 0.1mfd. coupling condenser is there to keep the gain constant down to about 20 c.p.s.

The feedback resistance of 1 megohm from 6L6 plate to 6J7 plate, gives a feedback factor of 16%, and reduces the effective plate resistance to 1,000 ohms. The gain and distortion are reduced by a ratio of 2.6/1, and the distortion is found to be within 4% at all frequencies down to the main bass resonance of the speaker.

A speaker field of 1,000 ohms resistance is chosen, and it is excited with about 8 watts of power, and used exclusively to filter the current to the 6L6G. The output transformer has a primary wound to reflect a nominal load resistance of 2,500 ohms, the optimum for a 6L6G under

the conditions applied in this amplifier.

A list of the parts required to build the amplifier appears on this page, while next month complete constructional details will be given.

7-WATT FIDELITY AMPLIFIER. List of Parts.

- 1 steel chassis
- 1 power transformer, 385v., C.T. 385v., 6.3v. 80 mill.
- 3 octal sockets
- 1 4-pin wafer socket
- 1 small knob
- 1 500,000 ohm potentiometer (I.R.C.)

FIXED RESISTORS:

- 1 .05 meg. 1-watt carbon (I.R.C.)
- 1 .5 meg. 1-watt carbon (I.R.C.)
- 1 .25 meg. 1-watt carbon (I.R.C.)
- 1 1 meg. 1-watt carbon (I.R.C.)
- 1 1.5 meg. 1-watt carbon (I.R.C.)
- 1 2,000 ohm wirewound (I.R.C.)
- 1 170 ohm wirewound (I.R.C.)

FIXED CONDENSERS:

- 1 .1 mfd. tubular (T.C.C.)
- 1 .5 mfd. tubular (T.C.C.)
- 2 25 mfd. tubular (T.C.C.)
- 2 8 mfd. electrolytics (T.C.C.)
- 1 16 mfd. electrolytics (T.C.C.)

VALVES:

- 1 6J7G, 1 6L6G, 1 5Y3G

SPEAKER:

- 1 12 inch speaker to match single output pentode, 1,000 ohm field (Rola K-12)

MISCELLANEOUS:

- 4 Dalton spring terminals, 2 red, 2 black; 2 doz. $\frac{3}{16}$ in. x $\frac{1}{8}$ in. nuts and bolts; hook-up wire; 1 yard tinned copper wire; 2 yards power flex and plug; 1 rubber grommet.

Amateur Review.

Amateurs And S.W.L.'s.

A reference by Observer Johns, of New Zealand, in last month's notes to the low percentage of verifications received from amateurs, even when return postage is included, once again raises this ever-recurring question.

It seems that the more conscientious type of dxer must suffer for the sins of those who merely send a card saying, "I heard you, please QSL," and forget to enclose return postage. Such a method cannot but tend to create the impression that S.W.L.'s are more interested in collecting cards than in giving amateurs reports of some value. Until this idea is dispelled, the present unfortunate position will continue.

So, for the umpteenth time, dxers, make your reports of real value, and always enclose return postage—after all, most of the amateurs are just as hard up as you are, and why should they spend many pounds monthly for postage to QSL S.W.L.'s (and that's no exaggeration) when they can use that same money to purchase much-needed equipment?—S.W. Editor.

Worth waiting for!



The 'PALEC' RANGE of all-wave Oscillators

THE "PALEC" G TYPE ALL WAVE
OSCILLATOR—OUTPUT METER.

The new "G" series modulated oscillator is outstanding and unique, particularly in respect of (1) the wide choice of models available, and (2) the adaption to the popular price service oscillator of several important features hitherto exclusive to Standard Signal Generator design. These are indicated in the specifications:—

SPECIFICATIONS:

FREQUENCY RANGE: 160 KC to 24 MC in 6 bands as follows:—160-320, 400-800, 800-1600 kilocycles, and 3-6, 6-12 and 12-24 megacycles.

ACCURACY: The frequency accuracy on all six direct reading bands is exceptional; 0.5% may be expected with a guarantee of 1%.

ATTENUATOR: Low impedance (45 ohms) four-step pad attenuator, continuously variable in conjunction with perfect attenuation and accuracy of repeat readings.

R-F AMPLIFIER: A special R-F Amplifier stage is employed, resulting in maximum frequency stability and greatly improved amplitude level on all bands.

MODULATION: 400-cycle modulation at a mean value of 30%—can be switched in or out.

TUBE STAGES: R-F Oscillator—R-F Amplifier—A-F Modulator—Rectifier.

BATTERY VALVES: On the battery model, 1.4-V. tubes are used with a drain of 6 M.A. on the B and 200 M.A. on the A battery (batteries enclosed).

DUMMY ANTENNA: An external standard I.R.E. Dummy Antenna is supplied.

OUTPUT METER: The built-in Output Meter, when supplied, consists of our large square type meter with three ranges—10, 25 and 100 volts A.C.

MODELS.

Model GA: A.C. operated	£11 15 0
Model GAO: A.C. operated, with built-in Output Meter	£15 15 0
Model GAV: A.C.-Vibrator, dual operation from power supply or 6-volt accumulator	£13 15 0
Model GAVO: A.C.-Vibrator with Output Meter	£17 15 0
Model GB: Battery operated	£11 15 0
Model GBO: Battery operated, with Output Meter	£15 15 0

NOTE.—All prices are trade and subject to tax.

PATON ELECTRICAL PTY. LTD.

90 Victoria Street, Ashfield N.S.W. UA1960 & UA1982

What's New In Radio

New Season Kit-Set From John Martin Pty. Ltd.

Messrs. John Martin Pty. Ltd., of 116 Clarence St., Sydney, advise that for a limited period only their latest New Season 4/5 a.c. dual-wave pre-tested kit-set will be supplied complete with valves and Rola speaker at the special price of £10/10/-.

For an up-to-date receiver using only highest grade parts throughout, and giving a performance comparable with that of most 4/5 sets on the market, this represents exceptional value, and readers who are interested are advised to write immediately for full details.

Complete assembly instructions, including circuit and under-chassis wiring diagrams, are supplied with each kit.



Four New Palec Multi-Meters.

A range of four Palec multi-meters that will appeal strongly to all servicemen and experimenters because of their compactness, high quality and flexibility, has just been released by Paton Electrical Pty. Ltd., of Sydney.

A rectangular, black crystalline-finished cast aluminium case measuring 8" x 6" x 2½" has been used to house all four models. The basis

of each instrument is the new Palec Model K400 square type moving coil meter, which has a case size of 4" x 4½" and a scale length of 3¼." Excellent scale legibility is an outstanding feature of all four multi-meters.

Model M4 multi-meter, which is very reasonably priced at £4/15/-, is designed for d.c. only, and has a sensitivity of 1,000 ohms per volt. Voltage, current and resistance ranges are as follows:—0-10-50-250-1,000 volts D.C., 0-1-10-50-250 m.a., and 0.125-1.5 megohms.

Model MCA multi-meter is the a.c./d.c. version incorporating a metal rectifier for a.c. measurements. This model lists at £6/17/-. It should be noted that anyone purchasing the Model MCD described above can have it converted to the Model MCA at any time for the difference between the list prices of the two instruments, i.e., £2/2/-.

The remaining two models are listed as MXD and MHA. These have the same ranges as the MCD and MCA, but are both provided with a meter movement having a sensitivity of 10,000 ohms per volt.

New Palec Meter Catalogue.

A two-colour art folder listing and illustrating the complete range of Palec meters is available free on request from Paton Electrical Pty. Ltd., of 90 Victoria St., Ashfield, N.S.W. In the moving iron type there are a.c./d.c. voltmeters and ammeters, and in the moving coil type, d.c. ammeters, milliammeters and microammeters, d.c. voltmeters at 100, 1,000 and 10,000 ohms per volt, and r.f. (thermo) ammeters.



Home-Recording Unit From Veall's.

A leaflet giving full data on the Velco Precision-Built Home

A monthly review of latest releases in sets, kit-sets and components

Recorder Unit is to hand from Messrs. A. J. Veall Pty. Ltd., of Melbourne.

It is claimed that this unit embodies many features previously only obtainable in highly-priced commercial recorders. These include silver steel tracking bar, machine cut gears, flexible drive and adjustable cutting head. The feed screw has 96 grooves per inch and gives approximately 3½ minutes of playing time on a 10-inch record. The Diora cutting head supplied has a frequency response extending from 16 to 5,000 cycles, and is fitted with a special needle clamp.

The Velco Home Recorder can be purchased separately, and as well is available complete with a Dual type 45-U two-speed motor for £11/11/-. Prices are also given on accessories such as blanks, cutting and play-back needles, while instructions for use are also included.

Copies of this pamphlet are available free on request from Vealls, Box 2135, G.P.O., Melbourne, Vic.



In Latest "Radiotronics."

Permissible tolerances in regard to rated voltages for valves are discussed in an article entitled "Significance of Maximum Ratings," appearing in the latest issue of "Radiotronics" (Technical Bulletin No. 98), published by A.W. Valve Co. Pty. Ltd., while applications of the two new Radiotron gaseous voltage regulators, types VR105-30 and VR150-30, are reviewed in a further article, which quotes practical examples.

Characteristics are also given of two new additions to the 1.4-volt series of valves—types 1G4-G and 1G6-G. The 1G4-G is a general purpose triode with a .05 ampere filament. Maximum recommended plate voltage is 90 volts, bias -6 volts, amplification factor 8.8, plate resistance



Modern cabinet styling, coupled with outstanding performance, will undoubtedly ensure excellent sales for this latest Mullard release.



10,700 ohms, plate current 2.3 milliamperes.

The 1G6-G is a class "B" twin amplifier with a .1 ampere filament. In a typical class "B" operation, values for the two units are as follows:— Plate voltage 90 volts, zero bias, zero signal d.c. plate current, 2 mills., maximum signal d.c. plate current 14 mills., effective load resistance, plate-to-plate, 12,000 ohms, approximate power output, 675 milliwatts.

Technical data sheets accompanying this latest issue of "Radiotronics" cover types 1A5-G, 1A7-G, 1C5-G, 1H5-G and VR105-30.

★

1939 Foxradio Catalogue.

Many hundreds of radio and electrical lines are included in the new 68-page 1939 Foxradio Catalogue of radio and electrical accessories, issued early this month by Fox & MacGillycuddy Ltd., 57 York St., Sydney.

For ready reference, all components are arranged alphabetically. All types of radio components and equipment that servicemen or experimenters could possibly want have been included. Particular attention has been paid to the wide variety of coils and coil kits of nationally-known makes that this firm handles.

"Radio World" readers can obtain copies of this catalogue free and post free by writing the address given above.

Foxradio Kits Of Parts For "Radio World" Receivers.

Messrs. Fox & MacGillycuddy advise that, as in the past, special kits of parts have been prepared for the receivers described in this month's issue. Quotations for kits or components are available on request.

★

"Stocktaking Specials" In Test Equipment.

Messrs. W. G. Watson & Co. Pty. Ltd., Clarence St., Sydney, advise that until June 24, substantial price reductions will obtain on their current stocks of Triplett, Ranger and Delta test equipment. These "stocktaking specials" are offered subject to prior sales, and until June 24 only, when the usual prices will be restored. An amended price list is available free on request from the above address.

★

New Mullard Mantel Model.

A striking cabinet design, coupled with very fine performance, form a happy combination in the lately-released Mullard Model 43 a.c. broadcast mantel superhet illustrated above. The modern cabinet styling carried out in moulded bakelite strikes a new note in mantel receiver design, and alone should ensure excellent sales for this receiver.

This receiver was submitted to "Radio World" for test just before this issue went to press, and so there was no opportunity to make any test other than a brief run over the dial. Even this, however, was enough to show that the receiver possesses excellent sensitivity for a four-valve model, while quality of reproduction is exceptionally good, being actually superior to that obtainable from many console receivers.

★

Test Equipment Kits Of Parts From Radio Equipment Pty. Ltd.

Although a comparatively new name in the radio trade, Radio Equipment Pty. Ltd. is a firm rich in radio engineering experience, as it is associated with the Australian Radio College. Radio Equipment Pty. Ltd. intends to specialise in test equipment and servicemen's supplies. Several instruments have already been designed, and are available in kit form for those wishing to build their own. Building instructions and circuits are given with each kit of parts. The instruments can also be obtained completely wired and tested.

Four of the most interesting units comprise a simple and inexpensive a.c.-operated oscillator, a universal test speaker combined with a sensi-

DON'T GAMBLE!



Insist On....

... The following components as chosen by the designer for the receivers described every month in "Radio World."

I.R.C. RESISTORS.

I.R.C. metallised and power wire-wound resistors give unequalled dependability under the most severe conditions. We manufacture an unequalled range of values and wattages in both types. Write for details.

I.R.C. VOLUME CONTROLS.

Service records show that most volume control troubles arise at one point—the sliding contact between the centre terminal and rotor arm. The I.R.C. "C.S." control removes this trouble once and for all by replacing the "collector ring" with a positive, noiseless, silver-plated spiral, rigidly attached at each end.

BIRNBACH INSULATORS AND U.H.F. AERIALS.

Birnbach stand-off and feed-through insulators are always specified where perfect insulation is of vital importance. Write for details of the special low-cost high-gain Birnbach 5-metre aerial.

T.C.C. CONDENSERS.

T.C.C. Silver ceramic midgets are specified exclusively by "Radio World" for all applications where highest efficiency is of paramount importance—sure proof of their superiority. Also insist on T.C.C. flat mica types, and wet electrolytics for the "1939 Companionette" and the "Astra Dual Wave Six."

W. J. McLELLAN & Co.

Bradbury House

55 York St., Sydney

tive vacuum tube voltmeter, and two inexpensive d.c. multimeters.

The a.c. oscillator is extremely simple and easy to construct, and is quite efficient for aligning or servicing receivers. It provides a signal modulated at 50 cycles per second at any of the commonly-used frequencies in the intermediate broadcast or short-wave bands. The three frequency bands covered by the instrument are approximately as follows:—I.f. band, 160 to 480 kc.; broadcast band, 520 to 1550kc.; short-wave band, 6 to 16.5 megacycles.

The universal test speaker is aptly named, for it can be used with practically any type of receiver to provide any desired load impedance or field resistance within reasonable limits, and will operate with sets provided with 4, 5 or 6-pin speaker sockets, or with terminal connections for the speaker.

The speaker itself is an 8-inch electro-dynamic type, the field of

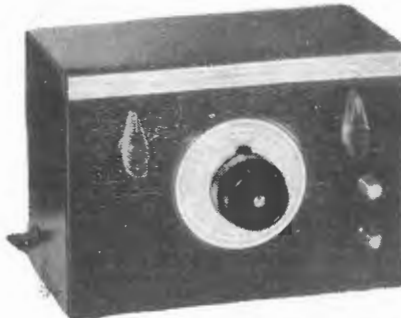

This a.c. all-wave oscillator is available in kit form from Radio Equipment Pty. Ltd.

which is energised from a built-in power unit operating from a.c. mains. This power supply also operates the vacuum tube voltmeter.

A dummy field providing resistances between 600 and 7,500 ohms is built in and a specially tapped transformer is used to provide a wide range of input impedance for either single or push-pull output valves. An ingenious matching arrangement enables the speaker to be used with any type of receiver regardless of the system of speaker connections used.

The built-in three-range vacuum tube voltmeter can be used in conjunction with an external 0-1 m.a. meter, as an output meter, for measuring a.v.c. voltage in a receiver or for any other application where a highly sensitive a.c. or d.c. voltmeter is required.

The two d.c. multimeters are designed along standard lines, both having a sensitivity of 1,000 ohms per volt on the voltage scales. The instrument has four ranges of volts up to 1250, four ranges of m.a. up to 100 and two ranges for resistance measurements up to 100,000 ohms.

The second instrument employs a new square type meter and is fitted with four voltage ranges up to 1000, four current ranges up to 250 m.a., two resistance ranges up to 50,000 ohms, using internal batteries and a third resistance range up to 1.5 megohms, in conjunction with an external 45-volt "B" battery. The scale of this particular meter is provided with two special A.C. ranges to facilitate conversion to an a.c.-d.c. unit with a minimum of trouble and expense.

Lastly, the valve checker described elsewhere in this issue is another unit of the Radio Equipment range.

Readers writing Radio Equipment Pty. Ltd. can obtain circuit and assembly data on any of the above instruments free on request.



New High-Efficiency Rola Speakers: Three Six-Inch Models.

A new high level of efficiency has been attained by a series of three six-inch speakers released by Rola. In these, almost every component has been re-designed. New magnet steel, different magnet dimensions, improved diaphragm and a compact isocore transformer have been incorporated, the nett result being a range of exceptionally high efficiency.

The magnets are built of the highest grade steel that has ever been used in commercial loud-speaker construction. Furthermore, to provide a more effective concentration of flux than was possible with conventionally-shaped magnets, entirely new dimensions have been adopted.

In addition to raising the efficiency of the new six-inch speakers, these new magnets allow of more compact placement of chassis components around the speaker.

In improving the diaphragm suspension, Rola has removed all sources of potential trouble in this section, and simultaneously have provided a most effective means of cone suspen-

The selection of components for set-builders from Murdoch's Ltd., referred to in the review below.

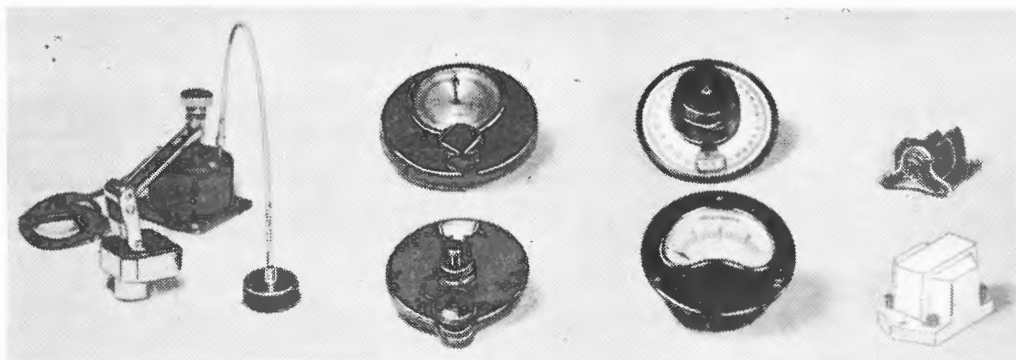

sion incorporating a special system of dustproofing.

All three speakers are fitted with the new compact isocore transformer, which possess the outstanding qualities that made the original Rola isocore a striking success. It will be remembered that this type of transformer removes the basic cause of electrolysis. The new transformer is housed in a handsome streamlined case which is fitted so that it does not project beyond the rim of the speaker—another factor making for compact receiver design.

The three speakers are priced:—6-8, 27/-; 6-11, 31/-; and 6-15, 35/-, retail. Further details can be obtained from the Rola Company (Aust.) Pty. Ltd., 116 Clarence St., Sydney, N.S.W.

★

English And Continental Components For Set-Builders.

Among a selection of English and Continental components of interest to set-builders, inspected recently at Murdoch's Ltd., of Sydney, are those illustrated in the above photograph.

On the extreme left is the Simplex recording head, complete with arm and traversing gear. This unit incorporates a very ingenious method of flexible drive taken direct from the centre of the turntable, and transmitted to the head by fibre gears. A clutch allows for full control. The weight of the cutting head is adjustable, a novel feature being that when the weight is removed the head can be used as a pick-up for playing-back purposes.

The two dials next to this unit comprise the Indigraph (in the foreground), a vernier dial that has been

on the market for over twelve years and is still the choice of many experimenters. The latest model illustrated has several minor improvements, bringing it right up-to-date. If desired, this dial can be supplied with an additional 600 to 1 microgear drive for very fine tuning.

In the background is the Lissen "Hi Q" decimal reading ultra slow-motion dial. Provided with a velvet-smooth drive, free from back lash, it can be accurately read to within a fraction of a division. This dial, which is stamped from heavy gauge steel, has provision for mounting midget condensers directly to it.

The third dial on the right is the popular Utility micro drive two-speed model.

The meter shown is the Franklin $4\frac{1}{2}$ " moving iron instrument which, although calibrated for d.c., can be used as well on a.c. A particularly comprehensive range is available—1, 3, 6 and 10 amperes; 20, 50, 100, 150 and 200 milliamperes; and 3, 6, 10, 16 and 30 volts.

The midget variable condenser (right rear) is an English Premier, with transparent trolitul insulation, ball bearings, and extended shaft for ganging. A complete range of capacities from 15 to 250 mmfd. is available in the single-spaced type, with 15 to 40 mmfd. double-spaced models.

The audio transformer with ivory bakelite case is a 3-1 Lissen "High Q." A useful application for this little transformer is in battery sets converted for pick-up operation. Connected between the driver valve and output pentode, it gives that extra lift necessary for full audio output.

Further information regarding these and other latest imported com-

ponents is available free on request from the Radio Department, Murdoch's Ltd., George St., Sydney.

★

New Radiotron Lecture Service.

The first of a new series of lectures arranged by Amalgamated Wireless Valve Co. Pty. Ltd. was delivered on the evening of April 24 last, by Mr. N. Williams, of the company's Valve Application Section.

This series of lectures has been arranged in the interests of all sections of the radio industry, and is particularly intended for radio technicians. In addition, as each lecture is delivered it is also to be made available in printed form to those interested in the trade throughout Australia.

The entire field of radio servicing is to be covered, and each paper will be devoted to one phase of the subject, without any attempt at generalisation. The first paper is entitled "A Review of Radio Receivers—Part 1, High Frequency Section." In this is discussed the high frequency section of typical receivers, with particular attention to those aspects which concern the firm of engineers.

The following sub-heads will give readers an excellent indication of the contents of this eight-page pamphlet:—Aerials, Aerial Coils, R.F. And Oscillator Coils, R.F. Amplifier, Frequency Changes, Intermediate Frequency Amplifiers, Detectors, Volume Control, Automatic Volume Control, Push-button Tuning, Complete Tuner.

"Radio World" readers in the trade interested in obtaining copies of these lectures, free of charge, are invited to write Amalgamated Wireless Valve Co. Pty. Ltd., Box 2516BE, Sydney.



*In-built
Quality*

Every Radiotron valve undergoes extensive tests before it is sealed in its carton — sealed for your protection. It will repay you to . . .

Revalue with



THE WORLD'S
STANDARD
RADIO VALVES

Specify . . . RADIOTRONS for the "Astra Dual-Wave Six" and "1939 Companionette" described in this issue.

New "G" Series Palec All-Wave Oscillators.

Despite the fact that the Model "D" Palec all-wave oscillator released last year was one of the finest instruments of its type available to Australian servicemen, the new Palec "G" type model now in production represents the most notable advance in oscillator design ever made by Paton Electrical Pty. Ltd. Actually, this new oscillator could be marketed as a signal generator, as the frequency on all six direct-reading bands is guaranteed accurate within one per cent., while 0.5% can be expected from the average stock model.

There are no less than six models available in this new "G" series, the model GA being a.c. operated; GAO, a.c. operated, with built-in output meter; GAV, a.c./vibrator (dual operation from power supply or 6-volt accumulator), GAVO, a.c./vibrator with output meter; GB, battery-operated; GBO, battery-operated with output meter.

Frequency range of all models is from 160 k.c. to 24 m.c., in six bands, as follows:—160 to 320, 400 to 800, 800 to 1600 k.c., and 3 to 6, 6 to 12, and 12 to 24 megacycles.

An outstanding feature of all models is the special attenuator provided. A low impedance (45 ohms) pad attenuator, it is continuously variable, providing excellent attenuation with high accuracy of repeat readings.

Maximum frequency stability and greatly improved amplitude level on amplifier stage. Provision is made all bands is ensured by a special r.f. for optional 400-cycle modulation at a mean value of 30%. An external standard I.R.E. dummy antenna is supplied with every model.

In the models including built-in output meters, a large square type meter is provided with three ranges—10, 25 and 100 volts a.c. On the battery models, 1.4v. valves are used with a "B" drain of 6 mills. and an "A" drain of 200 m.a. (batteries are enclosed).

A detailed review of this new series of oscillators will appear in next month's "Radio World." In the meantime, readers desiring further information can obtain it free on request by writing Paton Electrical Pty. Ltd., 90 Victoria St., Ashfield, N.S.W.

New Mullard Midget Valves.

Two midget Mullard valves that will find wide application in deaf aid equipment and midget battery portables, comprise the types DA3 and DAS1. The former is only $\frac{5}{8}$ " in diameter with a length of $2\frac{5}{8}$ ", while the latter has the same diameter, with an overall length of $2\frac{3}{8}$ ". Special wafer type sockets are available for both.

Both are provided with 2-volt filaments, drawing approximately .06 ampere. The DA3 is a triode drawing 1.8 m.a. plate current with plate and control grid voltages of 40 and -2.8 volts, respectively. Amplification factor is 4.7, and plate resistance 7,600 ohms.

The DAS1 is a tetrode that with plate and screen voltages of 120 and 60, respectively, and a grid voltage of -2.7, draws a plate current of only 1.5 mills. Plate resistance is .5 megohms.

Complete data on these two new midget valves are available from Mullard (Aust.) Pty. Ltd., 63-67 William Street, Sydney.

Leaves From A Serviceman's Diary.

(Continued from page 16)

readily effected by fitting such a condenser. (ii) Faulty power wiring is often the cause of severe humming noises and other troubles of this nature. Special reference will be given to this form of trouble in a later issue.

(6) Faulty By-Pass Condenser Across Detector Cathode.

Test condenser off load for short circuit, or on load for a constant voltage across it.

(7) Faulty Coupling Condenser In Audio Stage.

Severe hum accompanied by distortion is in evidence when this condenser breaks down. Its complete breakdown will be indicated by a positive potential on the grid of the following audio valve.

(8) Shorted Bias Resistance.

Test this resistance for a short to frame, or a breakdown in the condenser across it.

(9) Filament Connection To Earth Open Circuit.

Make sure that the filaments (or filament centre tap) are earthed in the case of indirectly-heated valves, or according to circuit requirements.

Shortwave Review

CONDUCTED BY
ALAN H. GRAHAM

Highlights Of The Month.

Some very strong signals on the 11-metre band. The new transmitter on this band, W4XA, putting in a strong steady signal from about 9 a.m. till 3 p.m. Also W6XKG, W9XA and W8XNU.

The terrific QRM on the 20-metre band on Sundays. Logging of overseas amateurs on the low frequency section of this band requires a good deal of patience, and not a little luck, so persistent is the QRM from VK's. Despite this, some interesting loggings of European hams were possible. Close on 50 countries are listed in the Calls Heard section.

FK8AA, Noumea, New Caledonia, on the air between 6 and 7 p.m. early in June. A good steady signal—signing with the Marseillaise—49.0m.

The special DX programme over "The Voice of Guatemala," TGWA, on 30.96 metres, on Sunday afternoon, June 4. The programme was dedicated to the Quixote Radio Club of Sta. Barbara, California, and provided several hours of really entertaining music. Prizes of Guatemalan coffee were offered for reports.

Radio Saigon testing on several frequencies. Reception on 49.1 metres was excellent.

A number of unusual South American stations. On 25 metres, ZP-14, Paraguay, 25.5m.; COCE, Habana, 25.4m.; CB-1180, Chile, 25.0m. On 31 metres, CXA-8, Uruguay, 31.1m. COCE is very strong.

HS6PJ on 31 and 15 metres on Thursday nights at 11 p.m.

The Chinese stations, XGOY, 25.2m., and XGOX, 16.7m. Good strong signals—Chinese music and news in English.

The excellent reception of Moscow during its English sessions was a feature of the month—on 19.76, 31.51, 19.95 and 49.75 metres. The 19.76 metre channel provided the best reception.

SBO, 49.4m., and SBP, 25.63m., Swedish stations, heard between 5 and 8 a.m.

The excellent programme from W6-XBE on 31 metres; station opens at 10 p.m. Very loud.

★

Ultra High Frequency Notes.

Once again the U.H.F. bands are offering some interesting DX. This is particularly the case with the 25-27 m.c. channel (11-metre band), on which some fine signals have been

Good Reception On 11 Metres ★ Many South American Stations Audible ★ Latest News Of Overseas Stations ★ Reports From Observers ★ Full List Of Amateur Band Loggings ★ Hourly Tuning Guide.

audible of late. A feature of reception has been that signals have been audible from about 9 a.m. till as late as 3 p.m. Despite the fact that QRM often mars reception to a consider-

able degree, not much difficulty should be experienced in identifying the louder stations. At the present moment these include W6XKG, W8-XNU and W4XA.

Of course, W6XKG are well known to dxers interested in U.H.F. reception, but the other stations have not been reported very often. As a matter of fact W9XA is a fairly recent arrival on 11 metres, having moved from 9.49 metres in about March. They now operate on 2615kc., 11.48m., which is the same channel as W9XUI occupy, which explains the QRM on W4XA's signal. W4XA are located in Nashville, Tenn., and are owned and operated by the National Life and Accident Insurance Co.; reports on reception and criticisms of programme material are very much appreciated. The actual schedule of W4XA is not known, but they are on the air till as late as 2.45 p.m., at which time their signals have been as good as QSA4, R7-8.

W8XNU are on 2550kc., 11.56m., the same frequency as W6XKG, so that QRM is almost always present on their signals. They relay WSAI, and their QRA is C/- Crosley Corporation, Cincinnati. They have been heard best around 10 or 11 a.m.

As the weeks pass, more and more experimental stations are carrying out fairly regular transmissions on the U.H.F. bands. The tendency at present seems to be to get down as low as possible, and many of the stations are working below 9 metres. As the majority of these stations use very low power, their reception in Australia seems unlikely, but freak conditions may bring their signals through occasionally.

New stations reported on the 31.6 m.c., 9.49m. band are W6XDA, Los Angeles, relaying KNX; and W1-0XIK and W10XIM, experimental transmitters of the Gulf Research and Development Co., location unknown.

On 11 metres mention is being made of a station W2CUP, which relays WOR on 25700kc. Whether this

Official Shortwave Observers.

N.S.W.: V. D. Kemmis (AW-301DX), "Brampton Hall," 49 Kurraha Road, Neutral Bay, Sydney; A. R. Payten (AW352-DX), High Street, Coff's Harbour; H. C. Craig (AW313DX), 29 Roe St., Bondi North; J. C. Taylor (AW454DX), 131 Lansdowne St., Hurstville.

SOUTH AUSTRALIA: J. C. Linehan (AW323DX), 181 South Terrace, Adelaide; A. E. Bruce (AW171DX), C/- 54 Currie Street, Adelaide; R. S. Coggins, 8 Glen Rowan Road, Woodville.

QUEENSLAND: J. K. Sorensen (AW316DX), "Fairholme," Station Road, Gympie; E. Neill (AW64DX), 26 Canning Street, Nth. Ipswich.

WEST AUSTRALIA: G. O. La Roche (AW155DX), 62 Gladstone Avenue, South Perth; W. H. Pepin (AW402DX), Seventh Avenue, Maylands; C. J. Anderson (AW417DX), Dumbleyung.

NORTH-WEST AUSTRALIA: E. Dignam (AW507DX), Mt. Bruce Station, Roebourne.

TASMANIA: H. A. Callander (AW304DX), 1 Franklin Street, West Hobart.

VICTORIA: J. Ferrier (AW-129DX), "Winniburn," Coleraine; K. A. Crowley (AW368-DX), 188 Chapel St., Prahran, S.I.

NEW ZEALAND: H. I. Johns (AW407DX), Mount Pleasant Avenue, Nelson, N.Z.; Colin Keen, Ashburton, N.Z.

transmitter has replaced W2XJI (26300kc.) or not is as yet unknown. The call-letters of the 11-metre station relaying WMCA are variously given as W2XGU and W2XQO. At all events, QRA is definitely Knickerbocker Broadcasting Co., WMCA Building, New York City.



Latest News Of Overseas Stations.

Afghanistan.

Although we have no knowledge of any readers logging this country, there are two stations, located at Kabaul and Herat, respectively, operating regularly. YAA at Kabaul are on 4195kc., 71m.; and YAH, Herat, on 5170kc., 58.2m. These usually contact each other around 11.30 p.m. QRA is Mr. Said, Ministere de P.T.T., Kabaul.

Alaska.

K7XFS, Fairbanks, is reported to be on the air irregularly between 4 a.m. and noon, broadcasting weather reports. At present K7XFS are on 8090kc., 37.0m.

Canada.

A few details are to hand regarding several new Canadian transmitters.

CFVP, Calgary, on 6130kc., 48.94m. Reported with English news session around 3 p.m.

CIH, Halifax government station, reported on 7910 and 9850kc., 37.9 and 30.4m., testing with CER, Ottawa, on the same frequencies.

China.

Further details are available regarding the Chungking stations, XGOY and XGOX. XGOY, now on 11900kc., 25.21m., transmit a news session in English for Australian listeners at 9.20 p.m. daily; other English sessions are given at 10.45 p.m. and 12.50 and 9 a.m. XGOX on 17800kc., 16.85m., are on the air daily from noon till 2 p.m., with an English news session at 12.15 p.m.

Cuba.

Our West Indies representative (whose QRA, incidentally, is Senor R. F. Rubio, Box 51, Habana) sends latest dope on the Cuban stations.

COCQ, Habana, are now on 8840 kc., 33.5m., with a power of 5kw.

The new station, COCE, Habana, is on 12230kc., 24.5m., using the slogan "La Voz del Transporte."

COX, of the Cultural Department of the Cuban Army, is testing almost daily from 7 to 9 a.m. on 6390kc., 46.9m. Reports should be sent to Cuerpo de Senales, Ciudad Militar,

Habana; as this is an official department, no coupon is required.

England.

Several new transmitters are now being used in the B.B.C. transmissions. These are GRZ, 21640kc., 13.86m.; GRY, 9600kc., 31.25m., and GRX, 9680kc., 30.93m.

Haiti.

HH3W are now operating on 9775 kc., 30.6m. Programmes consist almost entirely of Cuban music. Reports to Box A-117, Port-au-Prince, Haiti. (Rubio).

Iraq.

Further details regarding YI5KG, Baghdad. This lkw. station operates daily, from 12.30 to 2 a.m., on 7200 kc., 14.6m. Transmissions are begun and concluded with the Iraq National Anthem, and are made up mainly of readings from the Koran, news in Arabic and recorded music (Eastern). A 400w. transmitter relays these programmes on 6900kc., 43.4m. Also it is believed that another station, HNF, also in Baghdad, relays YI5KG on 9830kc., 30.52m.

It is reported that the Baghdad BCB transmitter will be relayed on 14200kc., 21.0m. Power will be only 80w.

Japan.

A number of new transmitters are now carrying the regular programmes of the Japanese Broadcasting Corporation. These are JLG-3, 11705kc., 25.63m.; JLT-2, 9645kc., 31.1m.; JLU-3, 15135kc., 19.82m.; and JXW-3, 11710kc., 26.6m.

Kenya.

Early morning dxers should look out for VQ4MSR on 6350kc., 47.3m. This station is often heard from 5 to 5.30 a.m.

Mexico.

The latest Mexican s.w. transmitter is XEQQ, Mexico City, which relays XEQ on 6080kc., 49.34m. Schedule is unknown, but XEQQ might be heard around 3 p.m.

New Zealand.

4ZB is stated to be on 4300kc., 69.9 m., from 10 p.m. to 4 a.m.

Norway.

Latest schedule available for the Norwegian stations:—LLG, 9610kc., 31.2m., 6-8 a.m., 11 a.m.-noon, 2-3 p.m.; LKV, 15170kc., 19.78m., 9.40 p.m.-1 a.m.; LKQ, 11735kc., 25.56m., 1-4 a.m., 5-9.40 p.m. A station on 10715kc., 28m., believed to be located in Jeloy, has been testing from noon-1 p.m. and from 2-3 p.m.

Paraguay.

ZP-14, Villarica, has been heard recently on 11720kc., 25.6m., around 9 a.m. Slight QRM from TPA-4, on 11715kc., is troublesome at times.

Siam.

A new station is HS4PJ on 6130kc., 48.94m. Heard weakly around 11 p.m. Reports to same QRA as HS8PJ.

ALL-WAVE ALL-WORLD DX CLUB

Application for Membership

The Secretary,
All-Wave All-World DX Club,
214 George Street,
Sydney, N.S.W.

Dear Sir,



I am very interested in dxing, and am keen to join your Club.
The details you require are given below:

Name.....

Address.....

[Please print both plainly.].....

My set is a.....

[Give make or type, number of valves, and state whether battery or mains operated.].....

I enclose herewith the Life Membership fee of 3/6 [Postal Notes or Money Order], for which I will receive, post free, a Club badge and a Membership Certificate showing my Official Club Number.

(Signed).....

[Note: Readers who do not want to mutilate their copies of the "Radio World" by cutting out this form can write out the details required.]

South Africa.

ZNB, Mafeking, Bechuanaland, from 4-5.30 a.m. on 5903kc., 50.84m.

Australia.

The new A.B.C. station in Perth, call VLW, will be on the air in about three months. Allocated frequencies are 6130, 9560 and 11830kc., 48.94, 31.38 and 25.36m.

★

Reports From Observers.

Mr. G. O. La Roche (South Perth, West Australia):

Although best reception on the broadcast bands is in the evening, reception at this time is falling off below 25 metres, as only the stronger London and Berlin stations are to be heard. On 13 metres GSJ and GSH are best; 16, metres, the usual London and Berlin transmitters; 19 metres, London, Berlin, PCJ-2, RW-96 and RKI; 25 metres, XGOY, XMHA; 31 metres, JDY, ZHP, VUD-2 and W6XBE.

Actually, almost all this month has been spent on 20 metres, where conditions have been pretty fair. Best reception has been after midnight (Perth time) when the Europeans have been coming in nicely, mostly G's. At other times, early morning and evening, the band is dominated by W's. Best 20 metre loggings include: FN7MU and FN1C, French India; SU1WM and SU8MA, Egypt; SP1QM, Poland; LA6N, Norway; HB-9DA, Switzerland; and GI2FW, Ireland.

Mr. W. H. Pepin (Maylands, West Australia):

DX conditions over here continue to vary a good deal from day to day—possibly as a result of the appearance of more sunspots. The month's most interesting loggings are:—

14.15 metres: KAX and PLE are heard regularly, calling Bangkok or Tokyo; also HS6PJ, 15.77 metres, who put in an excellent signal on Monday nights (11 p.m., E.S.T.). It was announced that HS4PJ were now operating on 49 metres.

19 metres: JVE, 19.1 metres, have been phoning Bandoeng and Bangkok fairly regularly during the mornings. The usual London, Berlin, Rome, Tokyo and DEI transmitters are heard throughout the day. The Russian stations, RW-96 and RKI, are very good during the mornings in an English session; also around 5 p.m., E.S.T.

20 metres: During recent weeks a new Cuban station has been noted on approx. 20.5 metres. This station comes on the air at 10.30 a.m., E.S.T., with the same number as COCQ. No announcements in English have been heard.

21 metres: An unknown station in the middle of the 14mc. band, calling

XKA. This may be XOB-1, which was heard on this frequency some time ago.

22 metres: SPW putting in a good signal.

31 metres: Much as in previous months. W6XBE good.

32-34 metres: Several Cuban stations have been heard around 10 a.m., E.S.T.

49 metres: Saigon has been putting in a particularly strong signal for about the past six weeks.

Best 20 metre amateur loggings include:—KA, VS2AL, VS6BE, XZ-2DM and CO.

Mr. R. S. Coggins (Woodville South, South Australia).

Conditions have been quite good, especially on the broadcast bands. The Hong Kong stations, ZBW-2 and ZBW-3, operating on 49.2 and 31.4 metres, respectively, have been logged at good strength around midnight.

From 7 p.m. till midnight the 13, 16 and 31 metre bands are best; whilst 19 and 25 metres provided excellent reception during the afternoons.

W6XBE, in San Francisco, put over a programme of excellent quality from 10 p.m., E.S.T., on 31.48 metres. Signals are very strong. Another American heard at good strength is W2XE on 13.94 metres.

On 19 metres YDC, Java, are very loud; PCJ-2, on 19.7 metres, are very strong opening at 5 p.m., E.S.T., but fade out rapidly. Moscow are fair in the mornings.

The 20-metre amateur band has been fairly good, though rather erratic. Best results are obtained between 4.30 and 6.30 p.m., E.S.T., and in the early mornings. Best loggings include: SP1KM, Poland; HA2P, Hungary; CT1TS and CT1JS, Portugal; K4FCV, Porto Rico; J5QL, Japan; CE3AC, Chile; and YV5AK, Venezuela.

Mr. J. Ferrier (Coleraine, Victoria).

There is not much to report this month, as U.H.F. conditions have not been too good. Below 8 metres only one signal was heard, and that was so weak that it was difficult to determine whether there was modulation on the carrier.

The 10-metre amateur band has been very good at times, and some nice dx has been logged, including the following stations: CO7AK and CO2CR, Cuba; VS2AK, Malaya; ZS-5T and ZS5AW, South Africa.

At present I am building a rotary beam antenna, and hope to secure improved results when it is completed.

An interesting phenomenon was noted on several occasions this month—a distinct echo on all ZL signals; evidently they were coming here on the long route as well as direct.

Portable Cases For Every Purpose



For the past eight years this Company has specialised in the design and manufacture of test equipment cases, midget cabinets for mantel radios, and carrying cases for portable receivers and public address amplifiers. Extensive stocks, unequalled anywhere else in Australia, are maintained of specially-chosen timbers, covering cloths and plated fittings.

We can supply one case—or one thousand.

AN UNSOLICITED TESTIMONIAL.

Western Manufacturing Co.,
SYDNEY.

Dear Sir,—This is just to let you know of my appreciation of the fine, accurate cabinet you made to my specifications. I am pleased beyond apprehension at your product, and honestly can say it is absolutely flawless in all respects—most particularly as regards the sizes. These were not 1/32nd" out, and I was very dependent on their accuracy for assembly purposes.—Yours faithfully,

Kenneth C. Nicoll.
152 Glen Eva Road,
ELSTERNWICK.

COMPANIONETTE CABINET.

The midget cabinet used for the "1939 Companionette" described this month was designed and built by us specially for this receiver.

Write For Special Quote.

**WESTERN
Manufacturing Co.**
18 Third Avenue,
Five Dock, Sydney.
'Phone - - - U 3444

Mr. J. C. Linehan (Adelaide, South Australia).

The most interesting station being heard at present is **Radio Saigon**. They are on 49.1 metres in the evenings till 11.45 p.m., E.S.T., when they close announcing that they will be on the air again in one hour's time on 31.19 metres. Reports on their transmissions on both wavelengths are requested. QRA is Box 412, Saigon.

W6XBE, on 31 metres, put in a splendid signal from 10 p.m., E.S.T. At 11.30 p.m. they acknowledge reports.

On the U.H.F. bands the only station at good strength is **W6XKG**.

The 20-metre amateur band has definitely improved recently. Quite a number of South Africans are to be heard here at 10 p.m., E.S.T. **FN1C**, in French India, is one of the loudest signals on the band. **PK6OM** and **VK-4NK**, Papua, are the best of the other stations logged.

10 metres is rather patchy, but on occasions some good signals break through. Best loggings recently include: **YV5AQ**, **PK2WI** and **T12RC**.

Mr. C. Anderson (Dumbleyung, West Australia).

My report this month is very scrappy, as I have been away on holidays most of the time. Best broadcast band loggings:—25 metres: **XGOY**, **XMHA**, **XGRV** and **Radio Boy-Landry**, Saigon. 31-34 metres: **COBC**, **LRX**, **W6XBE**, **W3XAL**, **COCH**, **COBZ**, **COBX** and **COCQ**. 49 metres: **ZHJ**, Saigon and **YDA**.

On Sunday, May 28, at 11 p.m., E.S.T., a Spanish-speaking station was heard on 31.1 metres (approx.). A number of calls separated by chimes were given. I wonder if this would be **CXA-8**. (Very probably.—S.W. Ed.)

Best 20-metre loggings are: **HB-9DO**, Switzerland; **VE5OT**, Canada; **F8RV**, France; and **G2AV**, England. There has been nothing of note on 10 metres, only the usual **ZL's** and **PK's**.

Mr. H. I. Johns (Nelson, New Zealand).

Reception has again been good this month, it being quite noticeable that stations heard last winter are again becoming audible. Conditions on all bands from 19 to 49 metres were quite satisfactory. 19 metres provides good daylight reception; 25 metres is best after noon, and 31 and 49 metres from about 3 p.m.

The amateur bands are also good. 10 metres provides a good number of **W's** and **K6's**; and 40 metres quite a lot of South Americans, although identification of these is rather difficult. On 20 metres best loggings for the month were **LU8AB**, Argentine; **CO2EG**, Cuba; **PK6XX**, New Guinea;

F8NT, France; and **VE5VO**, Canada.

Following are details of the most interesting broadcast stations logged:—

On 49 metres the Americans, **W8-XAL**, **W8XK**, **W9XF** and **W2XE**, around 3.30 p.m. Incidentally, **W8XK** still verifies correct reports.

Also on 49 metres the irregular Japanese station, **JZH** (49.22m.), heard at 8.45 p.m.

OAX1A, 47.33m., can be heard from 2.30 p.m. Signals are not very strong, but station can be identified by signature tune ("Good Night Song," by Ted Lewis), at 3.30 p.m.

Three Gautemalan transmitters have been putting in good signals.

DX Club Requirements.

All-Wave All-World DX Club members are advised that the following DX requirements are obtainable from Club headquarters, 214 George Street, Sydney.

REPORT FORMS.—Save time and make sure of supplying all the information required by using these official forms, which identify you with an established DX organisation.

Price . . . 1/6 for 50, post free.

NOTEPAPER.—Headed Club notepaper for members' correspondence is also available. Price, 1/6 for 50 sheets, post free.

DX CLUB STICKERS.—Enlarged two-colour replicas of the Club badge, in the form of gummed stickers, designed for attaching to envelopes, **QSL** cards, etc. Price, 5 dozen for 1/6, post free.

DX CLUB LOG SHEETS.—Designed by the Shortwave Editor, these headed and ruled log sheets are indispensable to dxers who wish to keep a simply-prepared and accurate list of loggings. Price, 3 dozen for 1/6, post free.

These are **TGWA**, 30.96m.; **TGWB**, 46.2m.; and **TG-2**, 48.4m. These are heard on Sunday afternoon between 3.30 and 6 p.m.

Quite a number of South American stations have been noted between 30 and 34 metres. These include the Cubans, **COBZ** (33.12m.), **COCH** (31.8 m.), **COCQ** (33.5m.), **OAX4J**, Peru 32.15m.); **CXA-8**, Uruguay (31.12m.); **LRX**, Argentine (31.06m.), and **XE-WW**, Mexico (31.58). All these stations are heard around 3 p.m., usually remaining on the air later on Sundays.

XGOY, Chungking, on 25.2m., are heard from 6.30 p.m.; at first signals are weak, but they rapidly increase in strength. A verification from **XMHA** states that they are now on 25.19m.

On 25 metres the best stations for the month were **HP5A**, Panama, heard from 10 p.m. with announcements in English; and **CB-1180**, 25.04m., heard from 12.30-2.30 p.m., closing with a bugle call.

Just below the 25-metre band, **HCJB**, 24.8m., and **HIN**, 24m., are heard nightly. **HCJB** were transmitting special test programmes for Australia and New Zealand from 9.30 p.m. during May. **HIN** are very strong, with a news session in Spanish at 10.15 p.m.

SPW, 22m., Warsaw, can be heard from 9.30 a.m. till 12.30 p.m.

VUD-3, 19.79m., Delhi, puts in a good signal around 1 p.m. The programme consists of native music.

On the first Sunday of each month at 4 p.m. **HBO**, 26.31m., and **HBJ**, 20.64m., transmit a special programme for Australia and New Zealand.

One of the best early morning signals is from **CWS-2**, 27.17m.

Other loggings include: **Radio Saigon** (49); **TPB** and **JLG** (41); **PCJ**, **TAP**, Moscow, **VLR** (31); **EAQ** (30); **RNE**, **W8XK** (25); **JZH** (20); **PCJ-2** on Tuesday nights (19); and **W3XL** (16).

N.B. All above times are Australian E.S.T.

Mr. A. R. Payten (Coff's Harbour, New South Wales).

I have been unable to do much dxing this month owing to pressure of business. Any listening has been almost entirely on the amateur bands, 10 and 20 metres, where conditions have been good. On 10 metres **W's** and **ZL's** are coming in well; on 20 metres, apart from the usual large number of **W's**, a good number of Europeans have been noted, mostly **G's**.

Best loggings are:—**LA6N**, Norway; **F8XT**, **F8UE** and **F8RV**, France; and **G3XI**, **G6JL**, **G2TQ**, **G5JO**, **G6WT**, **G3DH** and **G6WU**, England.

Mr. V. D. Kemmis (Neutral Bay, New South Wales):

I have been unable to forward reports for a few months because of pressure of business. However, I have spent some time in the last few weeks on the 20 metre band, and have found conditions there very patchy; a few Europeans can be heard around 6-7 a.m. and again between 4.30 and 6 p.m.; also one or two South Americans in the late afternoon and evening.

I have not included any broadcast

station calls this month, as I have not heard anything of note.

Best 20 metre loggings: YV1AQ and YV5AK, Venezuela; VP1BA, British Honduras; VP6NY and VP6YB, Barbados; HA1K, Hungary; GI-2CC, Ireland; K4FAY and K4LH, Porto Rico; and K6ILT (portable), Guam.

Mr. J. C. Taylor (Hurstville, New South Wales):

Conditions this last month have been rather disappointing on the 20-metre band—not to be compared with last year. On 20 metres the band is full of W's; Europeans are hard to log on account of QRM from VK's. Asiatic and South American stations have been surprisingly scarce. Best loggings are: K4ERJ, Porto Rico; YV1AQ and YV5AK, Venezuela; GM-5JB, Scotland; HI7G, Dominican Republic; CE1AH, Chile; OA4AW, Peru; and a few VE's.

Verifications just to hand from G4-AS, CT1ZA and LA1F.

Senor Ricardo F. Rubio (Habana, Cuba):

Senor Rubio once more forwards the latest information regarding West Indies stations (see under Cuba and Haiti in Overseas Stations section).

He also reports that 20-metre conditions are very good in his locality. Countries heard include LU, VP7, VP9, PY, VPI, CE, HK, TI, HI, G, TG, HH, ZS, YV and XE. A new amateur on 20 metres (14090kc.) is VP1WB, Belize, British Honduras.

Verifications recently to hand: XGAP, Hanoi II, ZNB, RNE, VPD-2, PDK; and K6GAS, PK1RI, KA1BH, YV5ACG, YV5ACH, TG9BA and SU-1AX.

★

Amateur Review.

First of all we must apologise for the omission, owing to lack of space, of the usual list of Calls Heard from last month's issue.

Splendid DX On 20 Metres.

Conditions on the 20-metre band have been exceptionally good of late. Right throughout the day there is always something doing, but the best reception appears to be between 4 and 7 p.m.; during this period the European stations are coming in fine style, although often badly QRM'd by VK's.

On the other hand, 10 metres has been patchy. Of course, there are W's, K6's and ZL's on the band, but not much in the way of really interesting DX is reported. Only Observer Ferrier mentions loggings of note.

Non-QSL-ing Hams.

Beginning with this issue, we are publishing a list of overseas amateur stations that do not QSL SWL re-

ports. At this stage we would like to make it quite clear that this is not intended as a black list—it is intended to prevent readers from spending money on postage and reply coupons in cases where there is very little prospect of a reply being received. After all, a number of amateurs have stated that they are not in a position to QSL to SWL's under any circumstances, and it is our intention to bring the calls of these stations under the notice of dx-ers.

Incidentally, if any reader has received a card from any of the stations listed below, please drop the S.W. Editor a note to that effect, so that the call may be omitted from future lists.

It is understood that the following European stations will not QSL:—

Belgium: ON4AU, ON4NW.
France: F3GI, F3NF, F8QD, F8-RR, F8ZF, F8KW, F8NG.
England: G2OT, G2PU, G5BJ, G5-ML, G5HS, G5SY, G6LK, G6DL, G8-MX.
Scotland: M6RG, GM8MN.
Irish Free State: E16G.
Holland: PAOZB.
Portugal: CT1PR.

★

Calls Heard.

In order to save space, the calls listed below are grouped according to the States in which they were heard. Observers in the various

States were:—

For 10 metres:—New South Wales: Payten; Victoria: Ferrier and the S.W. Editor; South Australia: Linehan.

For 20 metres:—New South Wales: Payten, Kemmis, Taylor; Victoria: the S.W. Editor; South Australia: Linehan, Coggins; West Australia: La Roche, Pepin, Anderson.

10 Metres.

South Africa.

ZS5T, ZS5AW (Vic.).

South And Central America.

Venezuela: YV5AQ (S.A.).
Costa Rica: TI2FS (S.A.).
Cuba: CO7AK, CO2CR (Vic.).

Asia And The Pacific.

D.E.I.: PK2WI (S.A.).
New Guinea: PK6XX (Vic.).
Malaya: VS2AK (Vic.).
Hawaii: K6BT, K6ECS (N.S.W.), K6NBX, K6OTH (S.A.), K6PIT, K6-PLZ, K6OQE (Vic.).

New Zealand.

ZL1MR, ZL1GI, ZL2BE, ZL3IF, ZL4KJ, ZL4GN (N.S.W.), ZL1GZ, ZL1KJ, ZL3AH, ZL3AY, ZL4BK (S.A.), ZL1GI, ZL1NG, ZL1HY, ZL-1MR, ZL2UG, ZL3IF, ZL4BK, ZL4GN (Vic.).

United States.

W4QA, W4FLS, W4EGV, W5FUA, W5HCQ, W6POZ, W6PBD, W6IXT, W6MOU, W6NKF, W6QMJ, W6NDC,

(Continued on page 47)

Have Your "RADIO WORLD" Posted To You Direct

Readers who want to take the "Radio World" on a subscription basis and have their copies posted to them direct each month are invited to complete the coupon below (annual sub. 10/6). New readers are advised that all back numbers in Volumes 1, 2 and 3 are still available, price 9d. post free for all copies up to and including the December, 1938, issue, and 1/- post free for subsequent numbers.

Enclosed please find remittance for 10/6, in payment for an annual subscription to the "Australasian Radio World," commencing with the.....issue.

Name.....

Street and No.....

City..... State.....

Country.....

Note.—N.Z. Subscribers can remit by Money Order or Postal Note.

THE AUSTRALASIAN RADIO WORLD,
214 George Street, Sydney,
N.S.W., Australia.

HOURLY TUNING GUIDE

When and Where To Search

Compiled by ALAN H. GRAHAM.

In order to assist beginners and less experienced dxers, it is intended to publish monthly a special tuning guide, setting out at what times to listen for the more easily logged stations. It should be noted that the guide is not intended to cover all stations audible; for full details as to when and where to look for the best catches are given elsewhere. Moreover, the fact that a station is shown as being on the air at a particular time is no guarantee that reception must follow as a matter of course.

All times are given in Australian Eastern Standard Time.

Key to abbreviations used: S, Sundays only; M, Mondays only; T, Tuesdays only; W, Wednesdays only; Th, Thursdays only; Sat, Saturdays only.

Midnight-1 a.m.	48.7 VIO	
	49.75 RW-96	
13.91 W2XE	49.9 COCO	
13.93 GSJ	58.3 PMY	
13.97 GSH	60.5 VUD-2	
16.81 DJH	61.1 VUM-2	
16.84 GSV	61.4 VUB-2	
16.84 TPB-3	61.9 VUC-2	
16.86 GSG	70.2 RV-15	
16.88 PHI (S)		1-2 a.m.
16.89 DJE		13.93 GSJ
19.63 DJQ		13.97 GSH
19.68 TPA-2		16.81 DJH
19.71 PCJ (Th, S)		16.84 GSV
		16.86 GSG
19.72 W8XK		16.89 DJE
19.74 DJB		19.61 2RO-6
19.79 JZK		19.63 DJQ
19.8 YDC		19.68 TPA-2
19.82 GSF		19.71 PCJ-2 (Th)
19.82 JLU-3		19.72 W8XK
25.21 XGOY		19.74 DJB
25.4 2RO-4		19.8 YDC
25.42 JZJ		19.82 GSF
27.27 PLP		19.83 W1XAL
28.48 JIB		19.84 HVJ
29.24 PMN		19.85 DJL
30.02 COBC		25.0 RNE
30.6 COCM		25.21 XGOY
30.96 ZHP		25.4 2RO-4
31.25 GRY		27.27 PLP
31.28 VK2ME (M)		28.48 JIB
		29.24 PMN
31.28 VUD-2		31.25 GRY
31.35 KZRM		31.28 VUD-2
31.45 DJN		31.45 DJN
31.48 W6XBE		31.48 W6XBE
31.49 ZBW-3		31.51 RW-96
31.51 RW-96		48.7 VIO
31.55 HS8PJ (F)		49.75 RW-96
		49.9 COCO
31.58 XEWV		58.3 PMY
31.8 COCH		60.5 VUD-2
32.59 COBX		61.1 VUM-2
32.95 COCA		61.4 VUB-2
33.32 COBZ		61.9 VUC-2
33.5 COCQ		70.2 RV-15
42.98 XPSA		

2-3 a.m.	13.93 GSJ	25.53 GSD
	13.97 GSH	25.7 IQY
	16.84 GSV	30.52 IRF
	16.86 GSG	31.01 DJX
	16.89 DJE (M)	31.02 2RO-9
	19.61 2RO-6	31.13 2RO-3
	19.72 W8XK	31.25 GRY
	19.74 DJB (M)	31.32 GSC
	19.82 GSF	31.51 RW-96
	19.85 DJL	31.7 TAP
	25.0 RNE	41.21 TPB
	25.4 2RO-4	48.88 CR7AA
	25.49 DJD	49.31 VQ7LO
	31.01 DJX	49.59 GSA
	31.25 GRY	49.75 RW-96
	31.28 VUD-2	49.83 DJC
	31.51 RW-96	
	31.7 TAP	5-6 a.m.
	49.31 VQ7LO	16.86 GSG
	49.75 RW-96	19.56 W2XAD
	49.83 DJC	19.61 GSP
	60.5 VUD-2	19.61 2RO-6
	61.1 VUM-2	19.65 W2XE
	61.4 VUB-2	19.67 W1XAL
	61.9 VUC-2	19.79 JZK
		19.85 DJL
		22.0 SPW
		24.52 TFF
		25.0 RNE
		25.25 W8XK
		25.4 2RO-4
		25.49 DJD
		25.53 GSD
		25.63 SBP
		25.63 JLG-3
		25.7 IQY
		26.31 HBO (M)
		27.17 CSW-2
		30.52 IRF
		31.01 DJX
		31.02 2RO-9
		31.13 2RO-3
		31.25 GRY
		31.28 W3XAU
		31.28 PCJ (M, W)
		31.32 GSC
		31.51 RW-96
		31.7 TAP
		41.21 TPB
		41.32 EHZ
		44.94 HBQ (M)
		47.3 VQ4MSR
		49.59 GSA
		49.75 RW-96
		49.83 DJC
		6-7 a.m.
		16.86 GSG
		19.56 W2XAD
		19.61 GSP
		19.61 2RO-6
		19.67 W1XAL
		19.79 JZK
		19.85 DJL
		22.0 SPW
		25.0 RNE
		25.25 W8XK
		25.36 W2XE
		25.45 W1XAL

25.49 DJD	25.36 W2XE
25.53 GSD	25.42 DJZ
25.63 JLG-3	25.45 W1XAL
25.63 SBP	25.49 DJD
27.17 CSW-2	25.53 GSD
30.52 IRF	25.63 JLG-3
31.01 DJX	30.31 CSW
31.02 2RO-9	31.02 W3XAL
31.25 GRY	31.02 2RO-9
31.28 PCJ (M, W)	31.06 LRX
	31.09 CS2WA (S, F)
31.28 W3XAU	31.1 JLT-2
31.32 GSC	31.13 2RO-3
31.35 W1XK	31.28 W3XAU
31.48 W2XAF	31.32 GSC
31.51 RW-96	31.35 W1XK
31.7 TAP	31.45 DJN
41.21 TPB	31.48 W2XAF
41.32 EHZ	31.55 GSB
41.8 CR6AA	41.21 TPB
47.2 ICC	49.59 GSA
49.75 RW-96	
49.83 DJC	
	9-10 a.m.
	11.48 W4XA
	11.56 W6XKG
	16.87 W3XL
	16.89 DJE
	19.56 DJR
	19.74 DJB
	19.74 DJB
	19.74 DJB
	19.8 YDC
	19.82 GSF
	19.85 DJL
	25.0 RNE
	25.21 XGOY
	25.24 TPA-3
	25.25 W8XK
	25.25 W8XK
	25.29 GSE
	25.4 2RO-4
	25.42 JZJ
	25.42 DJZ
	25.45 W1XAL
	25.49 DJD
	25.53 GSD
	25.61 TPA-4
	30.31 CSW
	30.52 IRF
	31.02 W3XAL
	31.02 2RO-9
	31.06 LRX
	31.09 W2XE
	31.09 CS2WA (S, F)
	31.13 2RO-3
	31.28 W3XAU
	31.32 GSC
	31.35 W1XK
	31.48 W2XAF
	31.51 RW-96
	31.55 GSB
	31.7 TAP
	41.21 TPB
	49.46 SBO
	49.59 GSA
	49.83 DJC
	8-9 a.m.
	16.87 W3XL
	16.87 JZL
	16.89 DJE
	19.56 W2XAD
	19.56 DJR
	19.61 2RO-6
	19.61 GSP
	19.63 DJQ
	19.74 DJR
	19.76 GSO
	19.82 GSF
	25.21 XGOY
	25.25 W8XK
	11.48 W4XA
	11.56 W6XKG
	16.87 W3XL
	16.89 DJE
	19.56 DJR
	19.57 W6XBE
	19.61 2RO-6
	19.63 DJQ
	19.75 DJB
	19.76 RW-96
	19.8 YDC
	19.95 RKI
	25.24 TPA-3
	25.25 W8XK

25.29 GSE	1-2 p.m.	31.45 DJN	31.33 KZRM	25.42 JZJ	19.71 PCJ-2
25.4 2RO-4	11.48 W4XA	31.55 GSB	31.45 VPD-2	25.57 Saigon	19.74 DJB
25.42 DJZ	11.56 W6XKG	49.5 W8XAL	31.49 ZBW-3	25.6 JXW-3	19.79 JZK
25.49 DJD	16.85 XGOX		31.55 VK3ME	27.27 PLP	19.8 YDC
25.53 GSD	19.56 DJR	5-6 p.m.	(ex. S)	28.14 JVN	19.82 JLU-3
25.61 TPA-4	19.63 DJQ	13.99 DJS	44.64 PMH	29.24 PMN	19.82 GSF
29.15 DZC	19.74 DJB	16.81 DJH	70.2 RV-15	30.02 COBC	19.85 DJL
30.52 IRF	25.24 TPA-3	16.89 DJE		30.23 JDY	25.21 XGOY
31.02 W3XAL	25.25 W8XK	19.63 DJQ	9-10 p.m.	30.96 ZHP	25.4 2RO-4
31.09 W2XE	25.42 DJZ	19.66 GSI		31.25 GRY	25.42 JZJ
31.13 2RO-3	25.49 DJD	19.71 PCJ-2 (T)	13.93 GSJ	31.28 VK6ME	25.7 IQY
31.25 RAN	25.53 GSD	19.74 DJB	13.97 GSH	(ex. S).	26.31 XGRV
31.38 DJA	25.57 W1XAL	19.76 RW-96	13.99 DJS	31.28 VK2ME	27.27 PLP
31.41 W2XAD	25.61 TPA-4	19.83 TPB-6	16.81 DJH	(S).	29.24 PMN
31.45 DJN	31.02 W3XAL	25.0 RNE	16.84 2RO-8	31.28 VUD	30.02 COBC
31.48 W2XAF	31.09 W2XE	25.24 TPA-3	16.84 GSV	31.33 KZRM	30.52 IRF
31.55 GSB	31.32 GSC	25.53 GSD	16.86 GSG	31.35 W1XK	30.6 COCM
	31.35 W1XK	26.31 HBO (M)	16.88 PHI (S)	31.48 W6XBE	30.96 ZHP
	31.38 DJA	31.28 VK2ME (S)	16.89 DJE	31.49 ZBW-3	31.25 GRY
11 a.m.-noon.	31.45 DJN		19.47 RW-96	31.58 KZIB	31.28 VK2ME (S).
11.48 W4XA	31.48 W2XAF	31.45 DJN	19.63 DJQ	31.8 COCH	
11.56 W9XKG	31.55 GSB	31.55 GSB	19.68 TPA-2	32.59 COBX	31.28 VUD
16.87 W3XL			19.71 PCJ-2 (S)	33.32 COBZ	31.33 KZRM
16.87 JZL	2-3 p.m.	6-7 p.m.	19.74 DJB	33.5 COCQ	31.45 DJN
16.89 DJE	25.53 GSD	13.99 DJS	19.8 YDC	42.98 XPSA	31.48 W6XBE
19.56 DJR	31.02 W3XAL	16.81 DJH	19.82 GSF	44.64 PMH	31.49 ZBW-3
19.57 W6XBE	31.32 GSC	16.89 DJE	25.0 RNE	46.8 TIPG	31.51 HS6PJ (Th).
19.61 2RO-6	31.35 W1XK	19.63 DJQ	25.21 XGOY	48.4 TG-2 (S)	
19.63 DJQ	31.48 W2XAF	19.71 PCJ-2 (T)	25.4 2RO-4	48.7 VIO	31.58 KZIB
19.74 DJB	31.55 GSB	19.74 DJB	25.57 Saigon	49.05 Saigon	31.8 COCH
19.76 RW-96	49.65 W4XB	19.76 RW-96	25.6 JXW-3	49.5 W8XAL	32.59 COBX
19.95 RKI		19.83 TPB-6	27.27 PLP	49.96 HP5K	33.32 COBZ
25.24 TPA-3	3-4 p.m.	25.0 RNE	28.14 JVN	58.3 PMY	33.5 COCQ
25.25 W8XK	13.99 DJS	25.24 TPA-3	29.24 PMN	70.2 RV-15	42.98 XPSA
25.26 W8XK	16.81 DJH	28.14 JVN	30.23 JDY	11 p.m.-midnight.	44.64 PMH
25.29 GSE	16.89 DJE	31.28 VK2ME (S).	30.96 ZHP	13.91 W2XE	48.4 TG-2 (S)
25.4 2RO-4	19.63 DJQ		31.25 GRY	13.93 W8XK	48.7 VPB
25.42 DJZ	19.66 GSI	7-8 p.m.	31.28 VK2ME (S).	13.97 GSH	48.93 XEXA
25.49 DJD	19.76 RW-96	13.99 DJS	31.28 VK6ME (ex. S).	15.77 HS6PJ	48.94 HS4PJ
25.53 GSD	19.79 JZK	16.81 DJH	31.33 KZRM	16.81 DJH	49.05 Saigon
25.61 TPA-4	19.85 DJL	16.84 2RO-8	31.45 VPD-2	16.84 2RO-8	49.5 W8XAL
30.52 IRF	25.0 RNE	16.89 DJE	31.49 ZBW-3	16.84 TPB-3	49.6 XETW
31.02 W3XAL	25.53 GSD	19.47 RW-96	31.55 VK3ME (ex. S)	16.84 GSV	49.9 COCO
31.09 W2XE	31.02 W3XAL	19.63 DJQ	42.98 XPSA	16.86 GSG	49.96 HP5K
31.13 2RO-3	31.28 W3XAU	19.74 DJB	44.64 PMH	16.88 PHI	58.3 PMY
31.25 RAN	31.28 VK2ME (S).	20.28 JQA	48.7 Colombo	16.89 DJE	60.5 VUD-2
31.38 DJA	31.35 W1XK	25.4 2RO-4	49.05 Saigon	19.63 DJQ	61.1 VUM-2
31.41 W2XAD	31.45 DJN	25.57 Saigon	49.5 W8XAL	19.68 TPA-2	61.4 VUB-2
31.45 DJN	31.48 W2XAF	25.6 JXW-3	58.3 PMY		61.9 VUC-2
31.48 W2XAF	31.55 GSB	28.14 JVN	70.2 RV-15		70.2 RV-15
31.55 GSB	32.15 OAX4J	31.33 KZRM			
	48.62 W2XE	31.49 ZBW-3			
	48.83 W8XK	31.55 VK3ME (ex. S)			
	49.5 W8XAL				
Noon-1 p.m.	4-5 p.m.	8-9 p.m.	10-11 p.m.		
11.48 W4XA	13.99 DJS	13.99 DJS	13.93 W8XK		
11.56 W6XKG	16.81 DJH	16.81 DJH	13.93 GSJ		
16.85 XGOX	16.89 DJE	16.89 DJE	13.97 GSH		
16.87 W3XL	19.63 DJQ	16.84 2RO-8	13.99 DJS		
19.56 DJR	19.66 GSI	16.89 DJE	16.81 DJH		
19.57 W6XBE	19.74 DJB	19.47 RW-96	16.84 2RO-8		
19.63 DJQ	19.76 RW-96	19.63 DJQ	16.84 GSV		
19.74 DJB	19.79 JZK	19.68 TPA-2	16.86 GSG		
25.24 TPA-3	19.83 TPB-6	19.74 DJB	16.88 PHI		
25.25 W8XK	19.85 DJL	19.8 YDC	16.89 DJE		
25.42 DJZ	25.0 RNE	25.4 2RO-4	19.63 DJQ		
25.49 DJD	25.24 TPA-3	25.57 Saigon	19.68 TPA-2		
25.53 GSD	25.53 GSD	25.7 IQY	19.71 PCJ-2		
25.57 W1XAL	25.6 JXW-3	27.27 PLP	19.74 DJB		
25.61 TPA-4	31.28 W3XAU (M, W, Th, Sat).	28.14 JVN	19.79 JZK		
31.02 W3XAL	31.28 VK2ME (S)	29.24 PMN	19.8 YDC		
31.09 W2XE		30.96 ZHP	19.82 GSF		
31.32 GSC		31.28 VK2ME (S).	25.21 XGOY		
31.38 DJA			25.4 2RO-4		
31.45 DJN					
31.48 W2XAF					
31.55 GSB					

Shortwave Review.

(Continued from page 45)

W6MRF, W6LAJ, W9BHP (N.S.W.), W4EZK, W4EYH, W4EDD, W6PBD, W6LIP, W8OUZ, W9ZHS (S.A.), W2-IYX, W3CBT, W4FUM, W4NT, W4-FPB, W4FGF, W6BKY, W6NXQ, W6POZ, W6NKF, W6LLA (Vic.).

20 Metres.

Europe.

Portugal: CT1TS, CT1JS (S.A.), CT1PM (Vic.).

Poland: SP1QM (W.A.), SP1KM (S.A.).

Switzerland: HB9DA, HB9DO (W.A.).

Holland: PAOEH, PAOMZ (N.S.W.), PAOWS (W.A.), PAONN, PAOEO (S.A.).

Belgium: ON4DI, ON4MZ, ON4OU

(N.S.W.), ON4FE (S.A.), ON4AU (Vic.).

Norway: LA8C, LA6N (N.S.W.), LA1G (S.A.), LA6N (W.A.).

Hungary: HA1K (N.S.W.), HA2P (S.A.).

France: F3DI, F8NT, F8UE, F8VP, F8XT, F8LX, F8RV, F8TU (N.S.W.), F3LQ, F8PZ (S.A.), F8RV, F8LX, F8NT, F8XT, F8BP, F8QD (Vic.), F3SA, F8QD, F8BA, F8NT, F8RV (W.A.).

Ireland: GI2CC (N.S.W.), GI2FW (W.A.).

Wales: GW3AX, GW3KY (N.S.W.), GW3KY (W.A.).

Scotland: GM5JB, GM2UU (N.S.W.).

England: G2PU, G2KX, G2QV, G3XI, G3DH, G5JO, G5BJ, G5WO, G6WU, G6WT, G6JL, G6VX, G6LK, G6ZI, G8IL, G8MG (N.S.W.), G2PU, G2XU, G2BJ, G2DV, G5HH, G6PD, G8OO (S.A.), G2TR, G2HK, G2AV, G2PU, G5BJ, G6FS, G8IL (Vic.), G2AV, G2IS, G2TG, G3QK, G3MK, G5BJ, G5ML, G5XD, G5TH, G5ZT, G5BK, G6XR, G6MJ, G6PD, G6TM, G6DT, G6LG, G6DL, G6WT, G6VX, G6NL, G6CP, G6WB, G6PY, G6GQ, G8LT, G8NK, G8KT, G8OF, G8MA, G8TY (W.A.).

Africa.

Egypt: SU1WM (S.A.), SU1WM, SU8MA (W.A.).

South Africa: ZS6AF (W.A.), ZS-5Q (Vic.).

Asia.

Ceylon: VS7RA (N.S.W.).

China: XU8RM (N.S.W.), XU8RB (S.A.), XU8AM, XU8RM (W.A.).

Malaya: VS2AO (N.S.W.), VS2AL (W.A.).

India: VU2CQ, VU2FU (N.S.W.), VU2LJ, VU2FA (W.A.).

French India: FN1C (S.A.), FN1C, FN7MV (W.A.).

Burma: XZ2DM (N.S.W.), XZ2JB XZ2DX (W.A.).

Hong Kong: VS6AB (S.A.), VS6BE (W.A.).

Japan: J5QL (S.A.).

Pacific.

Guam: K6ILT (N.S.W.).

Papua: VK4NK (S.A., Vic.).

New Zealand: ZL2BE (N.S.W.), ZL4GY (S.A.).

Philippines: KA1AP, KA1CH, KA-1CS, KA1HS, KA1JM, KA1ME, KA-3KK (N.S.W.), KA1ME, KA1CW, KA1HS, KA4LH, KA7HB (W.A.), KA1HS (Vic.).

D.E.I.: PK1VY, PK4KS (N.S.W.), PK1VM, PK2AY, PK4KS (W.A.), PK1PK, PK4KS (S.A.).

New Guinea: PK6XX (N.S.W., W.A.).

Hawaii: K6BPR, K6BNR, K6CMC, K6GQF, K6KGA, K6KRG, K6LEJ, K6LED, K6MVA, K6MZD, K6OTH, K6OQM (N.S.W.), K6OQE, K6PRZ (S.A.), K6KGA, K6OEW (W.A.), K6IAE, K6MVA, K6KGA (Vic.).

South America.

Ecuador: HC1FG, HC1JW, HC2CC (N.S.W.).

Colombian Republic: HK3CC (Vic.).

Argentine: LU4BC (N.S.W.).

Peru: OA4AW, OA4AI (N.S.W.).

Chile: CE1AH, CE1AG (N.S.W.), CE3AC (S.A.).

Venezuela: YV1AQ, YV5AK (N.S.W.), YV1AQ (W.A.), YV5AK (S.A.), YV1AP (Vic.).

North And Central America.

Canada: VE3HI, VE4ADV, VE5EC, VE5EF, VE5GQ, VE5JF, VE5OT, VE-5VP, VE5VO (N.S.W.), VE5OT (W.A.), VE3ACK, VE5AHO (S.A.), VE3AG, VE3AHN, VE3ADX, VE-4WJ (Vic.).

Mexico: XE1GK, XE1FY, XE2N, XE2JK (N.S.W.), XE1CX, XE1HB, XE2CN, XE2FC (Vic.).

Guatemala: TG5JG (Vic.).

Costa Rica: T12AV, T12JC, T12RC (N.S.W.).

British Honduras: VP1BA (N.S.W.).

Canal Zone: K5AY (S.A.).

West Indies.

Bermuda: VP9G (Vic.).

Barbados: VP6NY, VP6YB (N.S.W.).

Cuba: CO7CX, CO7AS, CO8AR, CO-8JK (N.S.W.), CO2RR, CO6OM (W.A.), CO2WM, CO2AM, CO2JJ, CO2RH (Vic.).

Dominican Republic: HI7G (N.S.W., S.A., Vic.).

Porto Rico: K4EJB, K4LH, K4FAY (N.S.W.), K4FAY (W.A.), K4FCV (S.A.), KAEJF (Vic.).



SWL Card Exchangers' Section.

The following overseas SWL's guarantee 100% QSL:—

Ricardo Murakami, 1014 Gulick Ave., Honolulu, Hawaii.

Luc D'Helft-Lafero, Sulferbergstraat 8, Bruges, Belgium.

Len Harbin, Chaguanas, Trinidad, B.W.I.

John Wadesworth, 41 Samuel Rd., Barnsley, Yorkshire, England.

F. X. C. N. Sequeira, 12 The Bund, Room 200, Shanghai, China.

Walter Birks, 2a Hawthorn Ave., Gainsborough, Lincs., England.

Robert Martin, 24 Rue Lacreteille, Paris 15e, France.

Sergio Gonzalez, Calle 21 No. 552, Vedado, Habana, Cuba.

C. D. La Huliniere, 1 St. John's Terrace, Guernsey, Channel Islands.

R. B. Oxrieder, 11th Engineers, Corozal, Canal Zone.

Frank Williamson, 58 Hope Street, Leigh, Lancs., England.

Adodhia Parshad Saigal, 2 Battery Lane, Delhi, India.

Bob Hoynes, 41 Vassall Rd., Brixton SW9, London, England.

"1939 Companionette Three."

(Continued from page 15)

carefully watch the rectifier for any signs of sparking or of a blue glow, either of which denotes a serious overload due to a short circuit somewhere. If either occurs, switch off immediately and re-check the wiring.

With the set operating correctly, it can be aligned before it is mounted in the cabinet. To do this, set both trimmers on top of the gang a couple of turns or so out, and tune in a station somewhere near the centre of the band. Next, carefully adjust the aerial trimmer for loudest response.

With the set operating satisfactorily, automatic reaction can be added as described last month. The amount of feedback required is adjusted by varying the coupling between the feedback winding and the grid winding of the aerial coil. This adjustment should be made while the set is tuned in to the highest wavelength station it is desired to receive. Adjust the coupling on this station until a "swish" is heard as the station is tuned in. Because the amount of feedback gradually decreases as the capacity of the condenser gang is decreased, this means that the set will not break into oscillation at any part of the band.

While the fitting of automatic reaction as described is optional, it is well worth while including, as it makes a striking improvement to both gain and selectivity.

Short Aerial Is Best In City

Locations:

The "Companionette" is highly sensitive, so that in metropolitan areas only a few feet of aerial wire are needed to give more than ample volume from all locals—in fact, in such locations a short aerial is definitely advisable. In country locations, however, with a good outside aerial and an effective earth, excellent interstate reception can be expected.

As a guide to the capabilities of the "Companionette," readers will be interested to know that 5CL, Adelaide, was tuned in at night at fair speaker strength in a Sydney suburban location, using a 60-foot aerial with a 30-foot flat top, 30 feet high.

Finally, it will be found that the tonal quality given by this little receiver is actually superior to that obtainable from many commercial consoles, while volume is far more than ample for domestic requirements.

KITS AT SPECIAL PRICES

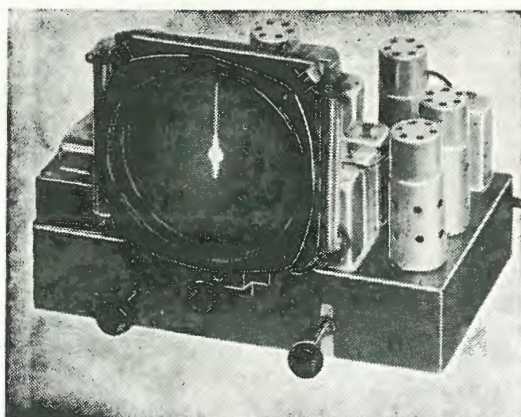

ASTRA £15-10-0

DUAL-WAVE SIX THE COMPLETE KIT.

Read the description of the Astra Dual-Wave Six published elsewhere in this issue, then rush your order to Vealls. For only £15/10/- Vealls will supply the complete parts to build this amazing 5/6 A.C. superhet and . . . will pay freight to your nearest railway station.

TWO KITS FOR COUNTRY LISTENERS

THE MELODIOUS PUSH PULL THREE **10 Gns.**

This amazing 3-valve receiver gives real seven-valve output, yet for only £10/10/- Vealls will supply everything necessary to build the complete receiver, including R.C.A. or Kenrad valves, Ever-Ready or Diamond batteries and Magnavox speaker. Particularly economical and reliable. Write for full constructional details, post free. Learn how easily you may build this astounding Battery 3.

WRITE FOR FULL DETAILS.

THE MELODIOUS 1.4V. FOUR **10 Gns.**

Using the new 1.4 volt valves and operating direct from dry cells only, this four-valve super. is just the set for those in the country where accumulator recharging presents a problem. For only £10/10/- Vealls will supply the complete kit, including valves, batteries and Magnavox speaker. Write for full details. Remember — no accum. to charge and yet this 4-valve super. costs only one halfpenny per hour to operate.

CONSTRUCTIONAL DETAILS FREE.

SOUND EQUIPMENT

Vealls are amplifier experts and will gladly give you "sound" advice. Tell us your problems or write for our complete Amplifier Catalogue, giving full details of all types of sound equipment and accessories. A complete range of amplifiers from 7 watt to 30/40 watt A.C. or battery operated.

WRITE FOR FREE CATALOGUE.

VEALLS

Letters to Box 2135, G.P.O., Melbourne.

490 Elizabeth St., 168 and 243 Swanston St., Melbourne CI; 299 Chapel St., Prahran; 3-5 Riversdale Rd., Camberwell; 97-99 Puckle St., Moonee Ponds. F 3145 (6 lines).



THE VELCO HOME-RECORDER.

Built to the exacting specifications of Vealls' sound technicians — particularly well-made, true and accurate records every time. Write for full details. Price, £8, or with "Dual" two-speed motor, £11/11/-.

No
621.38405
AUS

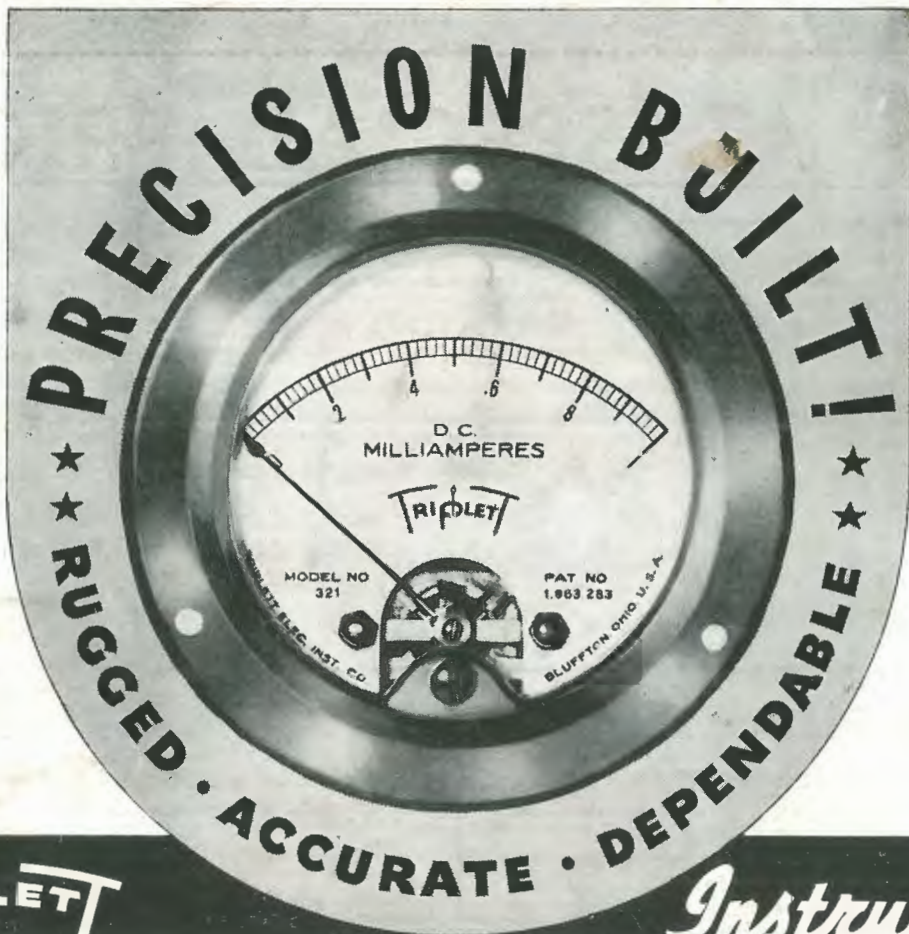

TRIPLET *Instruments*

... built in many types and sizes!

Triplet instruments have established a new standard of quality in the field. Precision accuracy at low cost, simplicity with extreme ruggedness and bridge type construction are features that evidence the most approved engineering practice.

Magnets of laminated construction have each lamination exactly gauged after hardening, thus assuring accurate scale characteristics. This is one reason accuracy of scales when not hand made can be as low as 1%. Triplet's exclusive method of maintaining absolute uniform pole piece accuracy supplants the more expensive milled soft iron type, and is far superior to those formed of soft iron. Cast magnets of cobalt and other alloys are used in some of the larger and more sensitive Triplet instruments and relays.

D.C. instruments are the D'Arsonval type with an extra light moving coil and reinforced parts. A.C. instruments are the movable iron repulsion type; are air damped and have light moving parts. Both A.C. and D.C. have selected sapphire jewel bearings and highly polished pivots. White enamelled metal dials and moulded zero adjusters. Accuracy within 1%, except rectifier type instruments, which carry a 5% guarantee. Instruments supplied with pointer stops.

THERMO AMMETER
High Frequency Accuracy 2%

Triplet Thermo Ammeters correspond in size, etc., to corresponding D.C. models. All have moulded cases. Have external couples which withstand 50% overload connected to meter with 2-foot leads. Couples are easily replaced when necessary. Internal couples to order. External couples only, for any model. LIST PRICE 50/-

The Model 321, 3-inch dial, illustrated above, is available in 5- and 2-inch dials, designated Models 521 and 221.

Typical "321" ranges are:

0.1 Milliampères	33/3	0.250 Milliampères	27/6
0.10 "	27/6	0.500 "	27/6
0.50 "	27/6	0.1000 "	27/6
0.100 "	27/6		

TWIN INSTRUMENTS

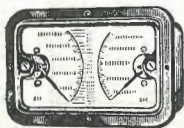

Twin Instrument.

THE TWIN is furnished in any combination of A.C. or D.C. instruments in the special rectangular moulded case that requires a minimum of space. Permits simultaneous readings on both instruments when connected in the same or separate circuits. Instrument scales are side by side, making possible two distinct readings at a glance. Used to balance loads in three-wire circuits; detect line fluctuations when load readings are taken; measure antenna and modulation current; determine filament plate voltages and similar applications.

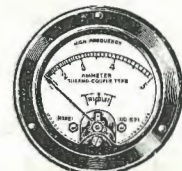

529-D.C. 539-A.C. Thermo Ammeter

W. G. WATSON & CO. PTY. LTD.

Head Office: 279 CLARENCE STREET, SYDNEY.

Newcastle Branch: KING & BOLTON STREETS, NEWCASTLE.

Branches at Melbourne, Adelaide, Hobart, Launceston and Perth.