

January 2002
Volume 70 No 1



Amateur Radio

2001
Index

**A home brew
dish and the
weather**

'The rig this way is a Collins KWM-2...
or if you catch me on 40 or 80 metres,
I'll be running the Collins S-lines'

Ian McLean, VK3JQ

'Shares the Passion'

- 1st VK phone contact with ISS
- VLF SWR and Watt Meters
- Measuring Q with the Simple Q Meter



Australian
Amateur Radio

Callbook 2002

Every shack should have one

Now also
on
searchable
CD

**The "Call Book 2002" is available from
your State Division
Order now to get the member discount**

VK1 Division

GPO Box 600, Canberra ACT 2601

VK2 Division

109 Wigram St, Parramatta NSW
(PO Box 432, Harris Park, 2150)
(Office hours Mon-Fri 1100-1400)
Phone 02 9689 2417

<http://www.ozemail.com.au/~vk2wi>

Freecall 1800 817 644

e-mail: vk2wi@ozemail.com.au

VK3 Division

40G Victory Boulevard
Ashburton VIC 3147
(Office hours Tue 10.00 - 2.30)
Phone 03 9885 9261

<http://www.wiavic.org.au>

Fax 03 9885 9298

e-mail: wiavic@wiavic.org.au

VK4 Division Queensland

PO Box 199, Wavell Heights, Old. 4012
Phone 07 3221 9377 Fax 07 3266 4929
e-mail: office@wiaq.powerup.com.au

VK5 Division (and VK8)

(GPO Box 1234 Adelaide SA 5001)
Phone 0403 368 066

[:http://www.sant.wia.org.au](http://www.sant.wia.org.au)

email: peter.reichelt@bigpond.com

VK6 Division

PO Box 10 West Perth WA 6872
Phone 08 9351 8873

Web: <http://www.vk6wia.org>

e-mail: vk6wia@inet.net.au

VK7 Division

PO Box 371 Hobart TAS 7001
Phone 03 6234 3553 (BH)

<http://www.tased.edu.au/tasonline/vk7wia>
email: batesjw@netspace.net.au

COMMERCIAL RESELLERS

Please contact June Fox (WIA Federal) on 03 9528 5962



Amateur Radio

Volume 70
Number 1
January 2002

The Journal of the Wireless
Institute of Australia
ISSN 0002-6859

Editorial

Editor: Colwyn Low VK5UE
edarmag@chariot.net.au

Technical Editor: Peter Gibson VK3AZL

Publications Committee Members

Ron Fisher VK3OM
Don Jackson VK3DBB
Evan Jaman VK3ANI
Bill Rice VK3ABP
Gil Sones VK3AUI
Bill Roper VK3BR

Advertising

Mrs June Fox,
Tel: (03) 9528 5962

Hamads

"Hamads" Newsletters Unlimited
PO Box 431, Monbulk Vic 3793
Fax: 03 9756 7031

e-mail: newsletters@ozemail.com.au

Office

10/229 Balaclava Road
Caulfield, Victoria
Telephone (03) 9528 5962
Facsimile (03) 9523 8191

Business Hours 9:30am to 3:00pm weekdays

Postal

The Editor AR
34 Hawker Crescent
Elizabeth East
South Australia 5112
Email edarmag@chariot.net.au

Production

Newsletters Unlimited 03 9756 7797

Printer

Streamline Press, Melbourne (03) 9417 2766

Postal Service

IMS (03) 9291 5888

Production Deadlines

Advertising booking and articles for
publication 10th of preceding month.

Hamads and advertising material deadline
18th day of preceding month

The contents of Amateur Radio are Copyright
Wireless Institute of Australia © 2001

Note:

December cover photograph of Brenda
Edmonds presenting Bill Rice with his Life
Membership Certificate was taken by Peter
Gibson VK3ALS.

General

A home brew dish and the weather	7
Sharing the passion	9
<i>Ian McLean, VK3JQ</i>	
1 st VK phone contact with ISS	11
<i>Jim Linton VK3PC</i>	
WIA Awards Coordinators	14
Amateur Radio Index 2001	17
Classification of emissions: Episode two	21
<i>Henry Andersson VK8HA</i>	
Perspective on recruiting and training (Opinion)	55
<i>Nell Trainor VK3IJ</i>	

Technical

VHF SWR and Watt meters	4
<i>Paul Clutter VK2SPC</i>	
Measuring Q with the Simple Q Meter	12
<i>Lindsay Lawless VK3ANJ</i>	
WBR Receiver (Technical Abstracts)	24
<i>Gil Sones VK3AUI</i>	
Digital Meter Supply (Technical Abstracts)	51
<i>Gil Sones VK3AUI</i>	

Columns

Advertisers' Index	55	How's DX?	46
ALARA	22	Intruder Watch	45
AMSAT	34	Opinion	55
Beyond Our Shores	38	Over To You	6, 56
Contests	40	Repeater Link	13
Club News	23, 37	Silent Keys	12, 26, 27, 50
WIA Division News		Spotlight on SWLING	33
VK2 Notes	31	Technical Abstracts	24, 51
VK4 Notes	31	VHF/UHF - An Expanding World	48
VK1 Notes	32	What to do in 2002	2, 7, 10
Editor's Comment	2	WIA Comment	3
Hamads	54	WIA Division Directory	30
Ham Shack Computers	15	WIA Federal Directory	2
HF Predictions	52	WIA News	7

Our cover this month

January cover is of Norm Rosensweig, VK5ZAH (right) and Rob Gurr VK5RG
with Norm's homebrew UHF antenna. See article on page 7. Photograph taken
by Max Riley VK2ARZ.

Contributions to Amateur Radio

Amateur Radio is a forum for WIA members' amateur radio experiments, experiences opinions and news. Manuscripts with drawings and/or photos are always welcome and will be considered for publication. Articles on disc or email are especially welcome. The WIA cannot be responsible for loss or damage to any material. A pamphlet, How to write for Amateur Radio is available from the Federal Office on receipt of a stamped self-addressed envelope.

Back Issues

Back issues are available directly from the WIA Federal Office (until stocks are exhausted), at \$4.00 each (including postage within Australia) to members.

Photostat copies

When back issues are no longer available, photocopies of articles are available to members at \$2.50 each (plus an additional \$2 for each additional issue in which the article appears).

Disclaimer

The opinions expressed in this publication do not necessarily reflect the official view of the WIA and the WIA cannot be held responsible for incorrect information published.

Amateur Radio Service

A radiocommunication service for the purpose of self-training, intercommunication and technical investigation carried out by amateurs; that is, by duly authorised persons interested in radio technique solely with a personal aim and without pecuniary interest.

Wireless Institute of Australia

The world's first and oldest
National Radio Society
Founded 1910

Representing

The Australian Amateur Radio Service

Member of the

International Amateur Radio Union

Registered Federal Office of the WIA

10/229 Balaclava Road
Caulfield North Vic 3161

Tel: (03) 9526 5962 Fax (03) 9523 6191
<http://www.wia.org.au>

All mail to

PO Box 2175 Caulfield Junction VIC 3161

Business hours: 9.30am-3pm weekdays

Federal Secretary

Peter Naish VK2BPN

Federal Office staff

June Fox Bookkeeper
Rita Trebilco VK3IF Examinations Officer

Council

President	Ernest Hocking	VK1LK
VK1 Federal Councillor	Gilbert Hughes	VK1GH
VK2 Federal Councillor	Barry White	VK2AAB
VK3 Federal Councillor	Jim Linton	VK3PC
VK4 Federal Councillor	David Jones	VK4OF
VK5 Federal Councillor	David Box	VK5OV
VK6 Federal Councillor	Will McGhie	VK6JU
VK7 Federal Councillor	Phil Corby	VK7ZAX

Executive

Brenda Edmonds VK3KT
David Pilley VK2AYD
Don Wilchefscki VK4BY

Federal Coordinators

AMSAT	Graham Ratcliff	VK5AGR
ARDF	Jack Bramham	VK3WWW
Awards	Mai Johnson	VK6LC
Contests	Ian Godell	VK3VP
Education	Brenda Edmonds	VK3KT
FTAC	John Martin	VK3KWA
Historian	John Edmonds	VK3AFU
IARU	Grant Willis	VK5ZWI
Intruder Watch	Harry Andersson	VK8HA
International Travel Host	John Miller	VK3DJM
ITU Conference and study group	Gilbert Hughes	VK1GH
QSL Manager (vks, vxo)	Neil Panfold	VK6NE
Videotape	VK2 Division	
Web	Joia Burford	VK5UJ

ACA Liaison Team

Ernie Hocking VK1LK
Gilbert Hughes VK1GH
Keith Malcolm VK1ZKM
Peter Naish VK2BPN
Canberra Liaison Officer Richard Jenkins VK1RJ

Editor's Comment

Colwyn Low VK5UE
edarmag@chariot.net.au

Looking ahead

Best wishes to all our readers for the New Year. I hope we will all be able to have a satisfying year in terms of activities and outcomes.

I have a number of projects in hand but not in progress at present, an amplifier for my 1296 transverter, a power meter based on an AD8307 logarithmic chip (It has capability from nanowatt to a 100 watt.) and a SWR bridge for 144 and 430 MHz. The problem seems to be getting started. I hope you can all make some time to expand your Amateur activities this year.

This year will see further pressure on our society's volunteers. There is a continuing need to present the Amateur point of view to the ACA. There are the continuing problems with LIPDs and how we negotiate a "Win-Win" solution. Unfortunately we are secondary users of the 70 cm band and cannot demand our preferred solution. I must admit I am quite surprised how many crane controllers could be subject to malfunction due to our legitimate operations. I would have thought safety would have the ACA looking more constructively at this aspect. Anyway read Will McGhie's Repeater Link column for a more in depth discussion.

Neil Trainor VK3IJ has written to me on the whole question of exams. See 'Opinion' on page 55. I think he has raised some very good ideas. There is a need to ensure that those who operate with us know sufficient to operate safely, without causing interference to other operators and neighbours and

have sufficient knowledge of the principles of the equipment we use, to look after it and operate it efficiently. When you think about it a number of us only had to learn about AM and Morse to get a licence. What we learnt to operate with SSB, FM, Packet, ATV etc. was all learnt "on the job", some of it "Monkey see, Monkey do".

The other area we need to consider seriously is who is going to do the work? You are all aware that the finances of the WIA are stretched. AR Magazine takes a large part of the WIA Federal income to produce. However without AR there is no common link for all VK Amateurs. Unfortunately some Amateurs are unable to afford the full subscription and do not receive a copy of AR. As the number of Australian Magazines which appeal to Amateurs declines, the loss of AR would be serious. Subscription to any other magazine would be much more than the present cost of AR. I would like to think AR does provide a reasonable coverage of things Amateur in Australia. However it can only be as good as the people who voluntarily write and submit articles for publication, at their own cost I should add. Without the voluntary involvement of WIA members Amateur radio in Australia would have been steamrolled by the authorities a long time ago. It is a pity that some 60% of the Australian Amateur population do not feel the WIA is worthy of their support.

Best Wishes for 2002. May all your plans become reality, may all your projects work.

73 Colwyn VK5UE

What to do in 2002

There are a number of Ham Fests and Electronic shows throughout the year. Three are advertised this month; then there is Urunga still to come.

There are contests to take part in, seriously or just to have a few hours to help the serious operators make a few more contacts. This also lets you check how well your station is performing.

There are **Field Days**. Take the portable/mobile gear into the back garden and set it up to work off batteries. Then pack it ALL up into a vehicle. A check list helps. This should cover tools and instruments used to set the station up. Nothing worse than driving 50km without the mic or the key or the coaxial plug adaptor needed to make it all workable.

AR Matters

Since last month's edition and my request for your views on the future options for AR I have received a huge response by letter and email. The response has clearly demonstrated the WIA and its members are a force to be recognised. I will shortly start the exercise of analysing this correspondence to quantify the views expressed. My initial analysis has identified that there are many views of what is and is not acceptable for the future. As such, no matter which approach we adopt, I know that some of you will not agree with the direction taken. In defence of any decision I would ask you to be conscious of the very real financial restrictions that we face at the moment and be assured that the choice will be one with the best interests of amateur radio at heart.

Among the suggestions are a number of new ideas that were not in my article last month. These include providing AR in an electronic form on the web on a subscription basis. I am personally in favour of this approach as a result of my own experience as a member of the IEEE. Providing journals on line has a number of advantages including the ability to search for articles across a wide time frame. If you are interested in seeing the way in which such a web based delivery of AR would work then I would urge you to visit the IEEE web at www.ieee.org, www.computer.org, or alternately have a look at the ARRL offering at www.arrl.org.

Federal Coordinators

Recently there have been a number of changes among the various Federal coordinators. On the awards scene Mal Johnson has taken over from John Kelleher. Mal has a number of exciting ideas that he will be publishing over the next few months in AR and on the web. The hand over has been quite a lengthy one and I sure that we will all bear with Mal while he tries to catch up on the back log of awards that are due.

On the WRC preparation front Keith Malcolm has agreed to take up the baton from Gilbert Hughes (although Gilbert

continues his involvement as the VK1 Federal councillor). Keith will be working with David Wardlaw to ensure that amateur interests are well represented at the ACA in the preparatory efforts that lead up to WRC in 2003.

We also welcome Henry Andersson who has picked up the role of Federal Intruder Watch Coordinator.

I am sure that you will all join me in saying thank you to all past coordinators and welcome to the newcomers. Finding volunteers to undertake these Federal coordination roles is never easy and often their work goes unnoticed. There are of course endless lists of tasks that need to be handled at Federal level and we are always looking for volunteers to assist in this area. At the moment I am looking for someone to help out with the collation of the material needed to make up the reference section of the annual Callbook as well as someone to assist with publicity and marketing issues. If you feel that you have the skills or time to assist then I would be delighted to hear from you.

The New Year

Next year promises to be another interesting one. On the horizon there are a number of events and issues that I am looking forward to including:

- **The 2002 Federal Convention and AGM.** There is much that we need to discuss. One of the subjects that a number of members have written to me about is the current structure of the WIA. This is a difficult issue for a number of reasons. If you have strong views on this or any other matter now is the time to lobby your local Division.
- **The results of the Productivity Commission Review.** No matter what the results of the review I am sure that we as amateurs will need to make changes to reflect the changes to the Radio Communications Act that result from the review. I hope that whatever the outcome we can act together to make Amateur Radio a more exiting option for newcomers to the hobby.
- **Foundation Licence.** The council has

already agreed that we need to investigate the matter of the foundation licence. This matter is closely linked to the matter of the Productivity Commission review and the devolution of examinations from the ACA. When the time comes to discuss the nature of such a licence, we the WIA, must be prepared to be able to put forward specific proposals for the way that the licence would be structured in terms of entry and operating privileges. If we are to be able to attract more recruits to the hobby then it is imperative that we get the structure of the foundation licence right. We need your views on this issue in order to progress this item. Even better if you have time, ideas and expertise available please get in touch.

- **Recruitment.** We need to spend time next year looking carefully at how we can recruit more amateurs. Looking forward in time to when the WIA has secured the management of examinations from the ACA and achieved a new entry level foundation licence we need to be in a position to sell amateur radio to a wide range of groups if these efforts are not be wasted. Next year I will aim to establish a recruitment group whose purpose is to work out the best way that we can raise the profile of amateur radio and help others aware of the vibrant hobby that we all know it to be.
- **Publications.** As noted earlier I would like to use next year as an opportunity to revise the current Callbook and reference material. There are a number of exciting things that we could do to make both the Callbook and the associated reference material much more attractive to members and non-members. If you feel that you have the skills to assist please make contact with me to discuss how we can improve these publications for the future.

Lets make 2002 the start of the new future of amateur radio here in Australia
Best wishes and 73s de

Ernie Hocking VK1LK
WIA Federal President

VHF SWR and Watt meters

Paul Clutter VK2SPC
52 Keats Avenue
Bateau Bay NSW 2261

Here is a VHF SWR meter built using a main line conductor and sampling strip lines enclosed in a suitable container. The design is based on an article in the RSGB VHF-UHF Manual, Third Edition 1976, edited by D S Evans G3RPE and George Jessop G6JP.

The main line conductor is best in the form of a tube, as this is more readily available and can be any diameter and length. This line is mounted between suitable sockets, SO239, by soldering flat pieces in the ends of the tubing (see Fig 1).

The characteristic impedance should be the same as the coax, the transmitter, and the antenna. The impedance is determined by the diameter of the tubing, and the space between it and the inside of the container box (see Fig 2). The SWR meter line uses a 3/4 inch OD copper tube for the centre conductor.

Next, the sampling strip lines are added to pick up RF, both forward and reverse, to give SWR. The strip lines have an impedance determined by their width, and the distance from the box upon which they are mounted, plus the terminating resistors (see Fig 2).

The impedance of the main line is given by the formula for a round centre conductor in a square outer section (see Fig 2).

$Z_o = 138 \log_{10}(1.178xD/d)$
When $d = 0.75$ inch and $D = 1.5$ inches,
 $Z_o = 51.336$ ohms.
The impedance of the sampling strip lines is given by the formula:

$Z_o = 230 \log_{10}(4xH/W)$
When $W = 0.375$ inch and $H = 0.156$ (5/32) inch, $Z_o = 50.945$ ohms. (This formula is for a strip line located over an infinite plane when the ratio H/W has a value between 0.1 and 1.0.)

Assuming that the left hand SO239 socket is the input from the transmitter, and the right hand socket goes to the antenna, the diode end of the strip line will be on the left end and will read the forward RF power. The other strip line will have its diode on the same end as the right hand antenna socket and give the reverse RF reading (see Figs 1 and 3). The terminating resistors will be connected on the opposite ends to those which have the diodes.

The distances of the strip lines from the main line conductor are not critical, but should be equal in mechanical and electrical values to keep the ratio of forward and reverse power equal. This can be tested by taking a forward reading, with left input, then reversing the connections with the same power to the right input and noting the result. It should be the same. Remember to connect a 50 ohm impedance device (dummy load or antenna) to the outputs when making the comparison tests.

Other components in the meter are shown in the circuit diagram, Fig 3. The sensitivity is such as to provide FSD on a 50 microampere meter with a carrier power of two or more watts. The upper limit is set by the dissipation of the terminating resistors which are one watt (2×100 ohm in parallel = 50 ohm) and, since the forward line is dissipating power about 32 dB down on the incident transmitted power, the maximum should not exceed about 500 watts - who has that much power on two metres?

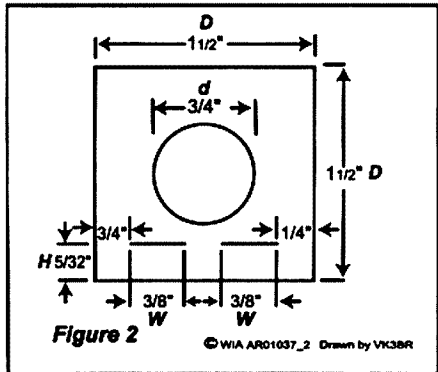

Figure 2. End view of inner conductor of SWR meter and location of strip lines, 4 1/2 inches long and parallel, and 5/32 inch above inside of box.

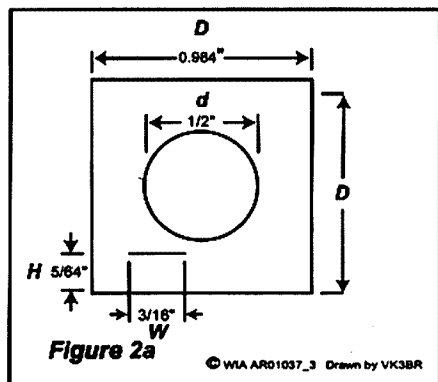

Figure 2A. End view of inner conductor of watt meter and location of strip line parallel and 5/64 inch above inside of box. Length not critical.

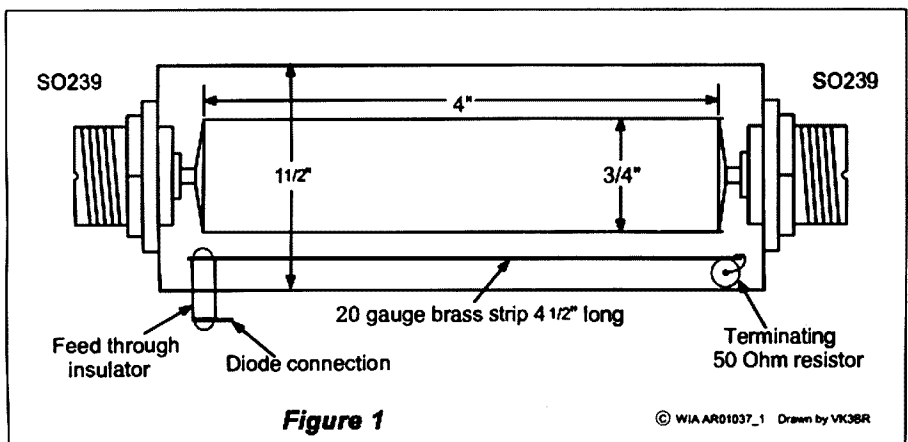

Figure 1. Main line inner conductor with side view of strip line.

As for the frequency range, the sensitivity will fall linearly with decrease in frequency from the two metre band because the coupling lines are short. Increasing frequency will deteriorate the impedance matching as the coaxial 'step' changes between the connection of the SO239 socket and the main line conductor, and also as components become increasingly reactive.

When a coaxial cable, or a similar device having characteristic impedance, is interrupted by connection to a plug, socket, or other device, a discontinuity of the dimensions, which maintain the impedance, is created. This can range from a nil effect to something quite disruptive to the performance expected from the device.

Fig 6 shows the change in dimensions of two coaxial lines which have the same impedance and it is the length "a" which could have an optimum value depending on the difference in dimensions of the two conductors. This is the case where the ends of the main line conductor (3/4" tube) are fastened to the spigots of the SO239 sockets. Unfortunately, there is no simple arithmetical formula relating the step-length to these parameters but it is a function of the characteristic impedance and of the ratio, D/d, of the inner conductors (see Fig 6). My own feeling is to make the main line conductor as long as can be easily soldered in between the SO239 sockets thus keeping the length "a" as short as possible.

Wattmeter

The wattmeter uses a reduced-diameter main line conductor of 1/2 inch OD and therefore requires a reduced size box of about one inch square to house both it and the strip line. Only one stripline is needed (see Figs 2a, 4, 5, 7, and 8). The construction is similar to the SWR meter but requires only one strip line. The wattmeter circuit diagram, Fig 4, shows two switchable preset pots to change the scale from 10 watts to 100 watts FSD. It will require adjusting with another accurate wattmeter.

From the formulas and size examples, one can calculate any main line conductor size and its box dimension to get 50 ohm impedance and the suitable strip line to match. The impedance of the main line is given by the formula for

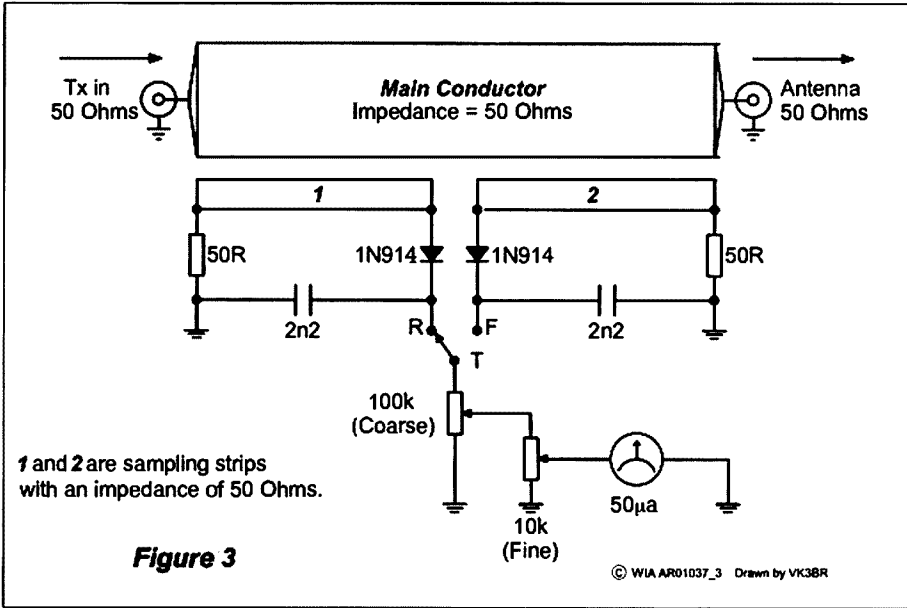

Fig 3 - VHF SWR meter circuit diagram.

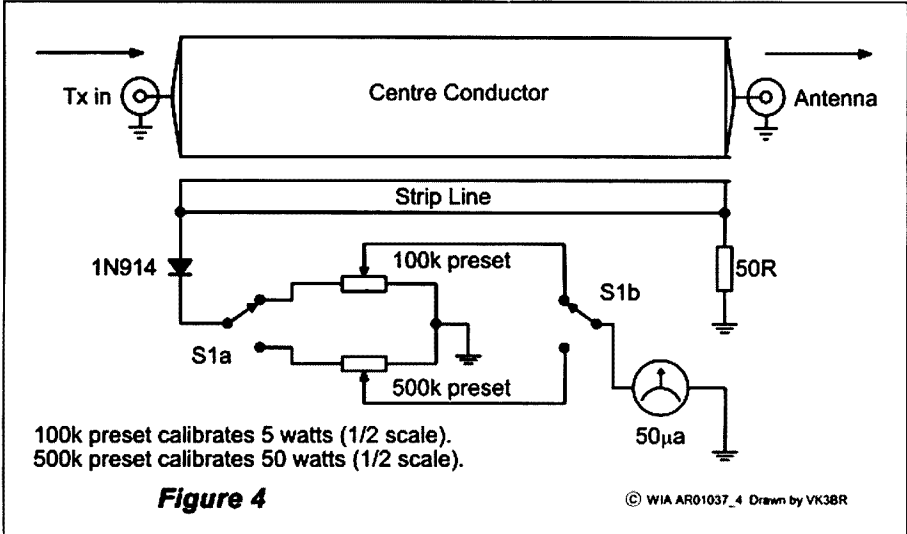

Fig 4 - Watt meter circuit diagram.

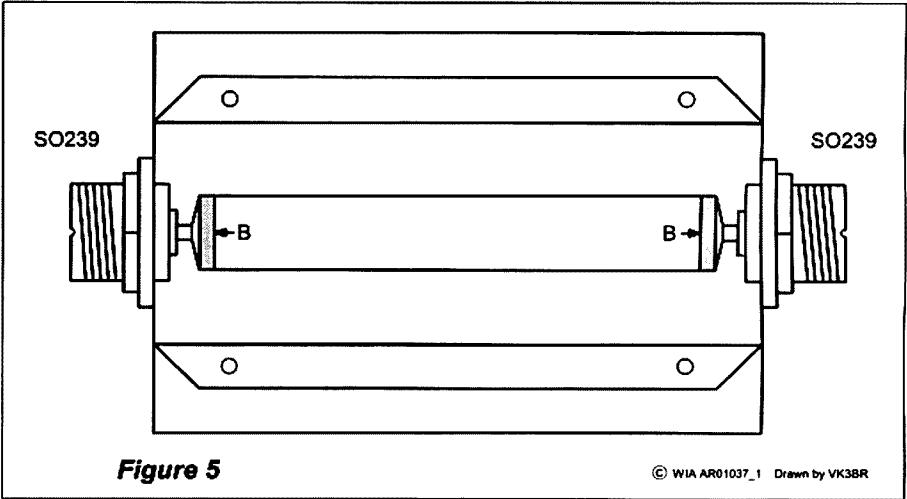
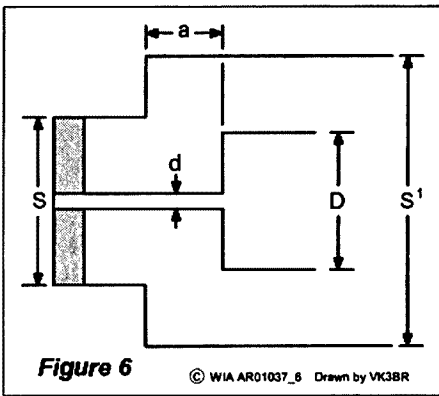

Figure 5

Fig 5 - View of centre conductor (1/2 inch diameter) between SO239 sockets (length not critical). End pieces (B) cut from 20 gauge brass and soldered in slots. Screw fastenings of square box over centre conductor and SO239 sockets not shown.



a round centre conductor in a square outer section (see Fig 2A).

$$Z_o = 138 \log (1.178 D/d)$$

When $d = 0.5$ inch and $D = 0.984$ inches, $Z_o = 50.38$ Ohms.

The impedance of the sampling strip line is given by the formula:

$$Z_o = 230 \log (4 H/W)$$

When $W = 0.187$ inch and $H = 0.078$ (5/64) inches, $Z_o = 51.083$ Ohms. (This formula is for a strip line located over an infinite plane when the ratio H/W has a value between 0.1 and 1.0.)

Finally, Tables 1 and 2 are included to enable conversion of a linear reading meter into SWR figures for 0 to 50 FSD and 0 to 100 FSD meters.

ar

Table 1 - 50 meter divisions with forward set to full scale.

Reflected Meter Reading	Reflection Coefficient	SWR Coefficient
0.5	0.01	1.02
1	0.02	1.041
2	0.04	1.083
3	0.06	1.128
4	0.08	1.174
5	0.1	1.222
6	0.12	1.273
7	0.14	1.326
8	0.16	1.381
9	0.18	1.439
10	0.2	1.5
15	0.3	1.857
20	0.4	2.333
25	0.5	3

Figure 6. Step discontinuity. The characteristic impedance Z_o is given by $138 \log_{10} S/d$ which is also $138 \log_{10} S/D$. The optimum step length a is a function of $Z_o, D/d$.

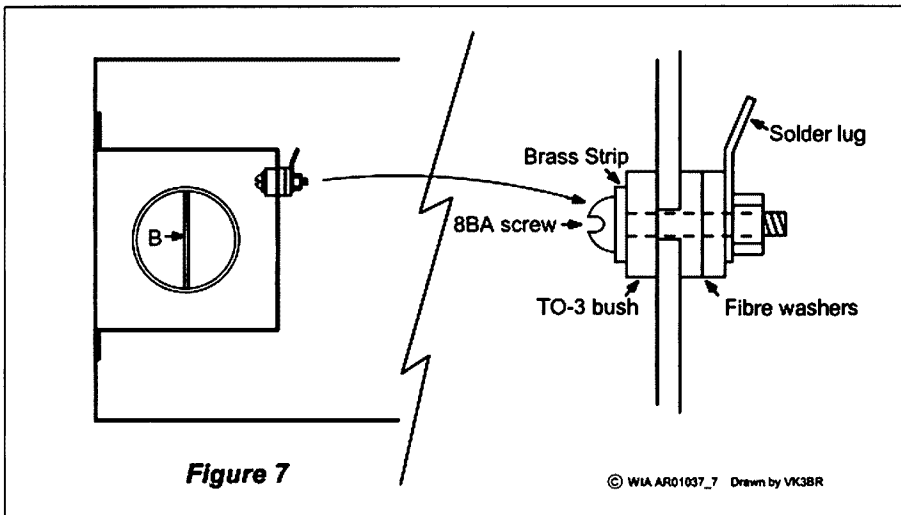

Figure 7

Table 2 - 100 meter divisions with forward set to full scale.

Reflected Meter Reading	Reflection Coefficient	SWR Coefficient
0.5	0.005	1.01
1	0.01	1.02
2	0.02	1.04
3	0.03	1.062
4	0.04	1.083
5	0.05	1.105
6	0.06	1.128
7	0.07	1.151
8	0.08	1.174
9	0.09	1.198
10	0.1	1.222
15	0.15	1.353
20	0.2	1.5
25	0.25	1.667

Figure 7. End view of centre conductor without SO239 and square box, including end view of strip line sampling conductor. Detail of TO3 bush and fibre washers holding strip and solder lug - DOUBLE SIZE.

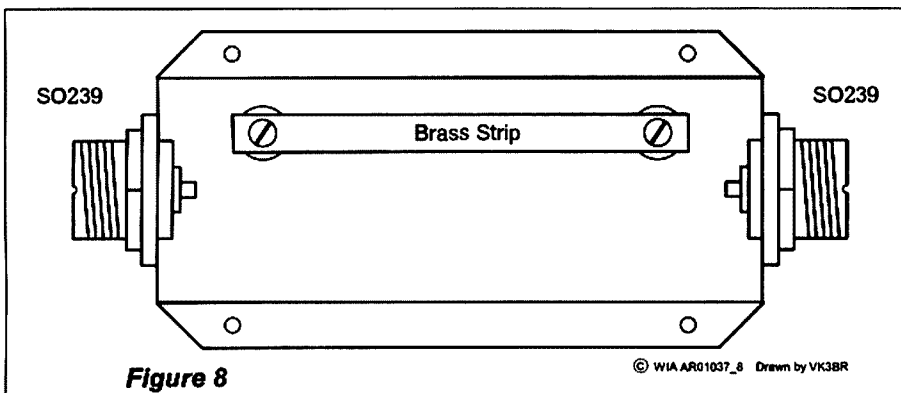

Figure 8

Figure 8. Inside view of box showing strip line mounting, without centre conductor, offset from centre line of box. Diode (refer Fig 4) is connected to left end of strip when Tx input is at left hand SO239 socket. The right hand end of the strip is connected to the 50 ohm terminating resistor.

Over to you

Bare bones transceiver

Hello fellow constructors...

I have had difficulty assembling the bare bones transceiver due to space limitations in the vicinity of the PA transistor. I have now determined that the capacitors C11 and C14 have been reversed on the parts layout diagrams. The output coupling capacitor is nearly twice the diameter of the other cap. If these capacitors are reversed in position on the parts layout the problem is solved.

Max Riley VK2ARZ.

VK5BA solved this by leaving the legs on the PA transistor long. Ed

A home brew dish and the weather

Norm Rosenzweig VK5ZAH

Having an interest in the Weather, or rather the approaching weather, a group of us have built satellite dishes to receive 1691MHz weather fax images from the GMS5 geostationary weather satellite. The actual skeleton of the dish was designed and prefabricated for me by Peter Wegener, one of those agrimechanical geniuses. The dish is 1.5 metres in diameter and made out of 12mm round steel rod. The rods are brought together to a centre hub consisting of a steel plate 200mm square, this is attached to a piece of 40mm water pipe. The dish was then covered with a taut layer of bird netting.

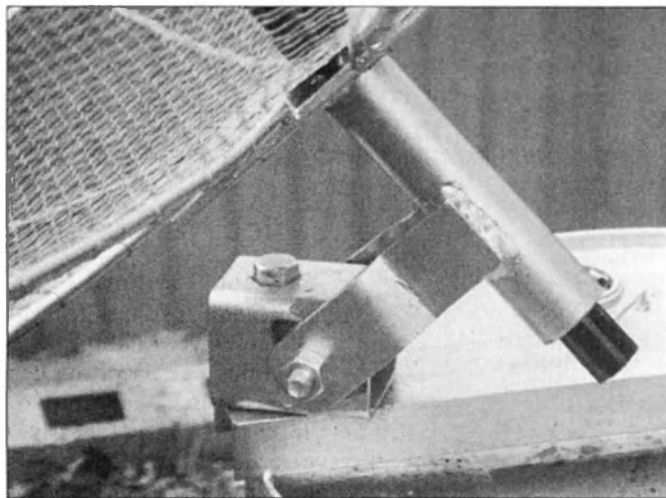

The dish has a very narrow beam and the satellite is a long way away (37000 km) and some form of alignment of the azimuth and elevation is a must, one advantage the satellite is geostationary (always in the same spot) but still some provision must be made to adjust the azimuth and elevation to align the dish to the satellite, to be 5deg out in either x or y you can miss the signal altogether, all this requires a solid base for the dish to be mounted on. We have used a 44 gallon drum filled with water for this purpose, the drum had contained plastic resin originally and its hoped the drum is lined with enough plastic to prevent rust, however if it rust out a new drum would be quite easy to replace.

Note the black bar going through the center on the center pipe, this is a piece of plastic pipe painted black to avoid UV breakdown, this is the plastic pipe that supports the feed horn.

What to do in 2002

**The Federal Convention
is not far off**

Now is the time to write to your Federal Councillor with your suggestions to make things work better.

This is a photo of the feed horn as used

The original design was to use 2x 125mm x 175mm coffee cans soldered together to form a horn 125mm x 350mm long, however I do not drink coffee. So cans would have meant buying tins of coffee and tipping out the contents.

I opted instead to get a one-piece tube bent up by the local plumbing shop out of galvanized iron. This also removes the need to paint and rust proof the coffee cans. One end of the tube was blanked off and the other has 4 L brackets soldered to it. These mount the horn to the bottom which is made of a perspex disk 170mm x 6mm and this then supports the feed horn and keeps it water proof, snail proof and spider proof.

Going across the top of the horn is a bunch of coax cables going between the shack and the tower. The black metal box contains the antenna and preamp circuit.

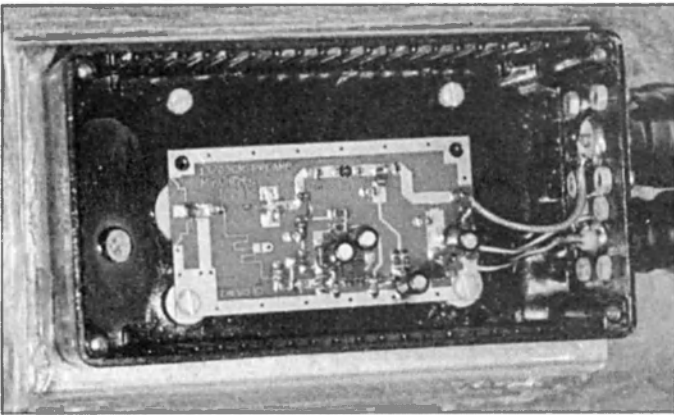
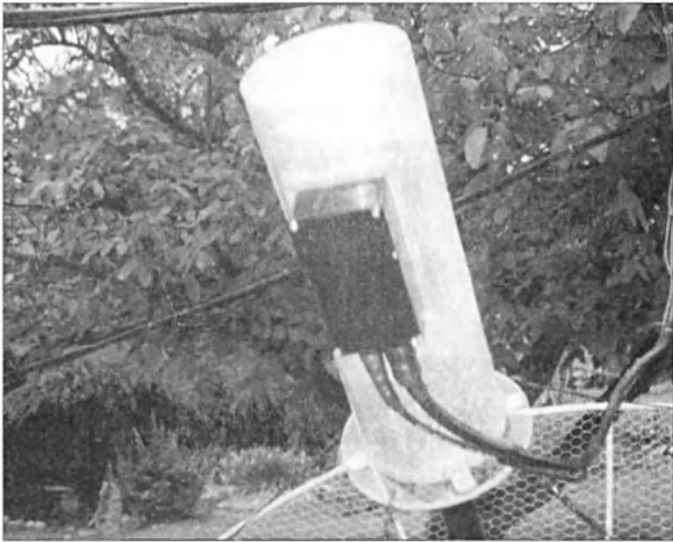

Inside that black metal box

The preamp is a Mini-Kits EME103 1150-2500MHz SMD Pre-amplifier, the preamp is a dual stage preamp that has a MGF1302 front end followed with an ERA-1 MMIC amp. The preamp is said to have 27.5db gain with a typical noise figure of 2db and requires between 10 and 15 volts. Near the left hand edge of the preamp board just visible is a part of a PTFE disk as seen under the board, this is the bush that allows the antenna to pass between the preamp and the horn, the antenna consists of a piece of bronze welding rod 38mm long and is attached direct to the input of the preamp.

The signal from the dish/preamp passes to the shack at 1691Mhz and is fed into an Icom R100 scanning receiver the audio in turn goes to the computer for processing.

This is a sample of the weather pics being received:

This one is 12 hours before the start of the Classic Adelaide Car Rally on the 27th of Oct 2001

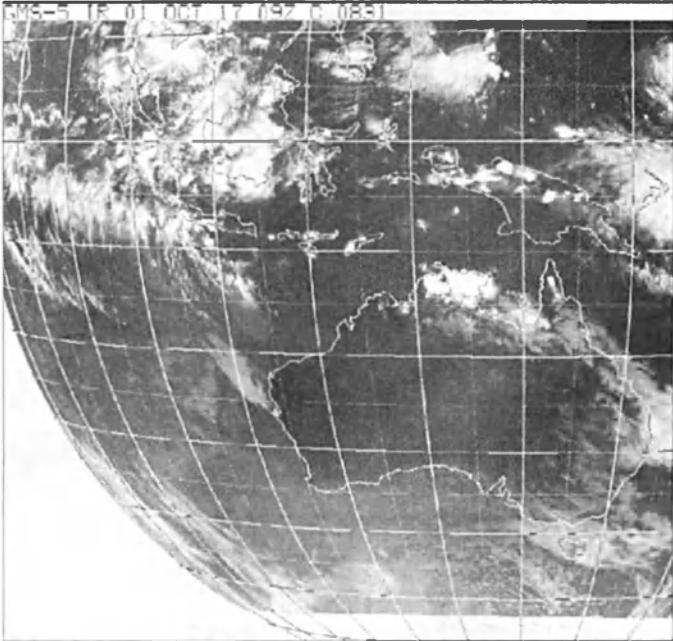

VK3GH *HAMFEST* VK3GHA

Sunday 25th February
10am to 2pm
Healesville Memorial Hall
Maroondah Highway, Healesville (Melways 278 C1)

Sales
of pre-loved
Ham equipment,
components &
computer gear

For further information:
Gavin VK3TLN 5968 8482
Carol 5962 6098

Bring your family—you can also visit Healesville's famous tourist spots

Sharing the passion

Ian McLean, VK3JQ

"The rig this way is a Collins KWM-2..." or if you catch me on 40 or 80 metres, I'll be running the Collins S-lines.

Why Collins?

Well, it's a passion. Apart from their nostalgic value, they are aesthetically pleasing, they are a pleasure to use and like all things Collins they are engineered to last and bulletproof!

My passion for Collins grew from an early age, seeing an advertisement for a 75S-3 in an ARRL handbook of the 60s. I wanted one!

My first Collins was a 75S-1 purchased from VK3AQI in 1991. 10 years on and the collection has grown to include the 75S-3, 32S-1/3, 51S-1 and the infamous KWM-2/2A.

You just have to love this gear. They look like real radios and better yet, they set the standard of performance for many years. Heathkit heaped tons of flattery on the S-line by producing as close a copy as they could. The Japanese didn't do it until rigs like the TS-930S came along. By a strange coincidence the FT-101 is identical in size and colour to the Collins S-line.

And remember when you could lift the bonnet of the old Holden and actually see the engine, well Collins rigs are like that. Lift the lid and you can see the radio in all its valve powered glory.

Even after nearly 40 years, the Collins S-Line is perfectly capable of handling today's crowded bands. Though not digital, the PTOs (VFOs) have remained linear and on frequency. It's easy to set the frequency to within a hundred cycles or so. What makes a really nice rig to join in with the boat anchor crowd is a KWM-2 paired up with a 75S-3 receiver. The 75S-3 is much less expensive than the KWM-2's companion 312B-5 external PTO and station console and using separate receiver will give you some very useful features - like dual receive, transceive, transceive in different band segments, receiver with a notch filter and a 200 cycle CW filter, etc. And, if all this wasn't enough, the KWM-2 sounds really nice on the air and its receiver's audio is quite pleasant to my ears.

The Military seem to prefer this older

equipment and they remain in service even today. The KWM-2A has seen service in both the Vietnam War and the Gulf war, it is equipment that has stood the test of time. It has proved robust, reliable and easy to operate.

It was the visions of Arthur Collins and the engineers of the Collins Radio Company that made it all possible.



Mr Arthur Collins

The Collins Radio Company

Early amateur radio operators were mainly hobbyists, but there was a sense of discovery during the infancy of radio that provided something more. Radio was the new thing, comparable to what computers mean to technological whizzes in the 1980s. And like the computer hobbyists of today who are writing their own programs and building their own equipment, amateur radio operators in the 1920s were contributing to the knowledge of practical aspects of radio art.

One person caught up in the excitement of radio was Arthur Andrew Collins.

The Collins Radio Company was founded in 1933 by Arthur Collins. Collins, an electronics genius and

pioneer, showed interest in radio communications at a very early age. In fact, he obtained his amateur radio operator's license in 1923 at the age of 14. He began experimenting with various radio frequencies and constructing radios.

One year later, at the age of 15, Arthur Collins gained national attention when he was able to establish radio contact with the Macmillan expedition during its scientific expedition to Greenland. A U.S. Naval radio station was to have received daily reports from the expedition, but was unable to do so because of atmospheric conditions. Collins, using a radio he had built, got through to the expedition and was the only person to do so.

He talked by code with the people on the expedition, copied down the incoming messages and took them to the Cedar Rapids telegraph office, where the scientific finds that the team had uncovered each day were relayed to Washington.

When the depression hit with full force in 1931, 23-year-old Collins turned his hobby into a vocation. "I picked what I was interested in," he told Forbes magazine years later, "and looked for a way to make a living."

In 1931 Collins set up a manufacturing shop in the basement of his home to make amateur radios. It was the first time such radio transmitting apparatus, of any power output, was available for purchase as an assembled and working unit. In fact, components were hard to come by; they varied widely in characteristics, and there was little, if any, pattern to their construction. Most hams had their radio equipment scattered around a room, usually in a basement or attic where the sight of tubes and wires wouldn't clutter up living areas of a home. Their equipment was strictly functional, almost to the point of inefficiency.

Collins' ham gear was designed to eliminate the clutter by packaging the equipment in neat units. The concept

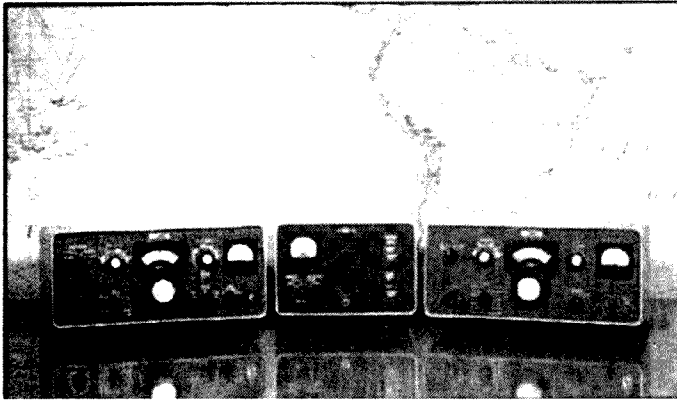

A basic Collins S-line station consisting of a 32S-1, 312B-4 and 75S-1

wealth of data.

The CCA is a non-profit, all volunteer organization and are the largest collectors organization in Amateur Radio today. Their goals are to promote the care and use of Collins Amateur Radio equipment, preserve the history and lore of

Sidman, PA 15955

Books on Collins, *The pocket guide to Collins Amateur Radio Equipment 1946 to 1980* (The book is now Out-of-Print — Over 3,000 copies sold! Limited copies may be available from:

Antique Electronics Supply, Surplus Sales of Nebraska or The Electric Radio Bookstore.) and *A Pictorial History of Collins Amateur Radio Equipment* by Jay Miller, KK5IM, send \$39.95 (cheque or money order) plus \$6.00 shipping and handling (via airmail), to Trinity Graphics Systems, 5402 Morningside Avenue, Dallas, Texas, 75206

Visit Jay's website at <http://www.kk5im.com/index.html> for more information.

In conclusion

I have noticed that there must be a fair number of Collins enthusiasts in Australia, judging by the times I have rung the number on a "For Sale" notice, only to find I am about the seventh caller and the seller wishes he had more Collins to sell. If you want it, you have to be quick, because it will be gone if you hesitate.

If you get the chance to use this gear, I am sure you will catch the bug too.

ar

proved that correctly engineered construction not only stabilized the circuitry but also made its behaviour predictable. Collins designed circuits, fabricated chassis, mounted and wired in components, tested, packed and shipped each unit. Because the gear was precisely engineered and well-built with the best parts available, it gave years of trouble-free service. A later article in the New York Times quoted a ham as saying, "Collins brought us up from the cellar and put us into the living room." The industrial philosophy of Collins products "quality" was established at the very start.

Collins and provide an information archive.

CCA membership is US\$20 (USA and Canada), US\$25 (All others). To renew or join, send payment to:

The Collins Collectors Association

PO Box 10459

Phoenix, AZ 85064-0459

Their web page is <http://www.collinsradio.org/>

The CRA exists to preserve Collins Amateur Radio equipment by promoting and encouraging its restoration and on air use. The CRA publishes the Collins journal and sponsors the QTH.NET mail list: Collins@qth.net and the CRA website at www.collinsra.com.

The Collins Journal is published bimonthly. Subscription rates by first class mailing is US\$20 (USA), US\$25 (Canada) and US\$30 (overseas), payable to:

David Knepper or *The Collins Journal*,

PO Box 34,

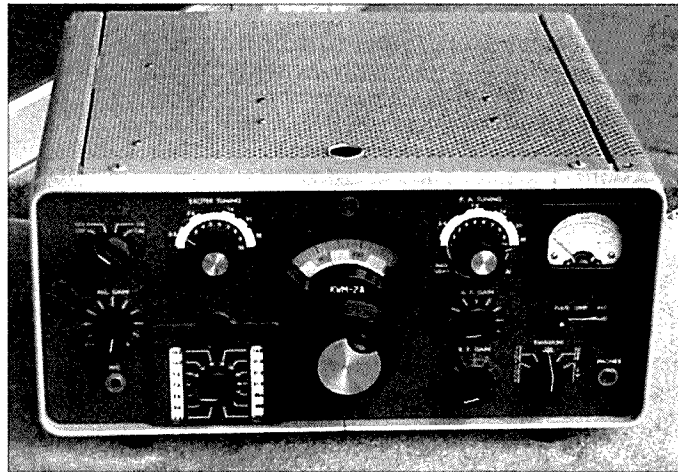

Collins KMW2A

Catching the Collins bug

So where can you find more information on Collins equipment? You will find most of the information is available on the Internet.

To get you started, you can visit my website at <http://www.angelfire.com/de/vk3kcm> and follow the numerous Collins links.

The two main sources of information that I can recommend are the Collins Collectors Association (CCA) and the Collins Radio Association (CRA). Both are American based and provide a

What to do in 2002

JOTA
is October 19th – 20th 200

Be part of WICEN

WICEN is not just for the few. If you live in eastern Australia you are very aware that natural disasters are not programmed—they just happen.

However plans to respond are in

place and WICEN is part of this response. Many WICEN groups have been activated in response to the December–January Bush Fires. Should you be a part of WICEN ?

1st VK phone contact with ISS

By Jim Linton VK3PC

Some of us are truly fortunate to do something memorable as part of our hobby amateur radio, and such an achievement has been made by Trevor Smith VK3TI who scored an inaugural voice contact with the International Space Station.

While the Expedition 3 crew had pre-arranged contacts with mostly schools in the United States, Canada and Hawaii, very little normal amateur radio activity had occurred until recently due mainly to the enormous work program of the crews.

On 19 October 2001, at around 23:00UTC, Trevor VK3TI was trying to transfer some digital frames through the space station's packet system. He was in fact engaging in a regular check of its TNC to see if its default "NOCALL" had been changed to callsign of RZ3DZR-1.

As Trevor explains it has been his practice over many, many months to switch to voice if by half way through a pass of the space station he doesn't receive a response frame. He has called NA1SS many times without a reply.

But that changed on 19 October last he said. "To my utter astonishment I heard an American voice come back to me and say, 'would you mind repeating that call'. I responded and added my name.

"Commander Frank Culbertson KD5OPQ replied 'this is Frank aboard the ISS', and I then told him he was 5 x 9. Frank he replied that he was having a little trouble receiving me. This is understandable, as the orbit pass was about 75% completed.

"We exchanged a few more words of a general nature and then he disappeared into the noise and I could hear him working a VK2."

Trevor VK3TI said as far as QSOs go it wasn't the greatest, and with hindsight he has thought of a million things he could have asked the astronaut.

"Personally it was a very special occasion to achieve probably the first CQ response from Commander Gulbertson. As you can imagine there have been hams sitting over their sets worldwide

since this occurred and many are rewarded with a contact," he said.

During the contact with NA1SS he was running his rig switched to low power and nothing special in the way of an antenna.

The equipment was an Icom 207-H feeding a 1 metre long mobile duoband mounted about 5-metres above the roofline. The transmit power from the ISS is only 1.5 watts from a hand-held with a specially constructed headset. The antenna systems on board the craft are to be dramatically improved soon.

The Amateur Radio on the International Space Station (ARISS) initial ham equipment was launched in September 2000 aboard the Space Shuttle Atlantis. In the future new antennas will cover HF, VHF, UHF and 2.4 gigahertz. Its callsigns include: US, NA1SS, and Russian, RS0ISS and RZ3DZR.

Trevor VK3TI taperecorded his QSO with NA1SS. On a local net he was so excited that it took a while for others on the net to understand him, but it was congratulations all around once they learn of the what he had in his log book.

He then sent an email report of the contact to ARISS/AMSAT advising them, as up to this time there had been no QSOs reported since the ISS Expedition 3 crew arrived.

Apart from Tony Hutchison VK5ZAI, the ARISS coordinator in Australia who has conducted several telebridges for schools in North America. An almost equally excited Tony replied within the hour that he had no knowledge of any other VK making voice contact with the space station.

Tony VK5ZAI monitors the ISS frequency 24 hours a day and to his knowledge the VK3TI contact is the first to result from a general CQ call.

Tony felt at that time the same

situation existed worldwide. Since then Frank has been very busy on air, especially over the JOTA weekend and thrilled many members of the scouting and ham radio movement worldwide. Among the facts Trevor VK3TI has learnt about the space station is that the normal crew sleep times are 22:00 to 06:00UTC, and that Frank goes to bed late for a six hour sleep. The crew has Saturday and Sunday (UTC time) off duty.

The location of the radio equipment aboard the ship is in an area not normally used, so a crewmember has to make definite decision to be on air.

Was it luck that Trevor VK3TI made the contact after putting out a voice call to the space station on hundreds of previous occasions without success? It was more likely to have been a reward for perservance!

And if you want to give it a try yourself:

International Space Station/ARISS:
Worldwide downlink for voice and packet, 145.80 MHz

Worldwide packet uplink, 145.99 MHz

Voice uplink IARU Region 2 & 3, 144.49 MHz, Region 1 145.200MHz.

Before attempting packet radio contact it is advisable to first check the ARISS webpage for operational details <http://ariss.gsfc.nasa.gov/>

Once new antennas are installed during a space walk by the Expedition 4 crew early 2002, there are plans to create two ham stations, one for VHF/UHF and the other HF.

ARISS using excellent education material prepared by NASA is also planning more school contacts including with those with students in Australia, but that is story for another writer later.

ar

Measuring Q with the Simple Q Meter

Lindsay Lawless VK3ANJ

A useful task for the Simple Q Meter described in the Feb. 0 1 AR is the comparison of the quality of coils intended for inclusion in aerial coupling units. The transfer efficiency of an aerial coupling unit is $\{1 - (Q_o / Q_u)\}$ where Q_o is the loaded Q and Q_u the unloaded Q.

The loaded Q of an L section coupler for example is $\sqrt{N - 1}$ where N is the ratio of load to source resistance, thus the transfer efficiency of a coupler coupling a load of 500 ohms to a 50 ohm TX would be 0.97 if the coil Q was 100; ie that coupler would consume 3 watts of every 100 watts input.

To make Q measurement simpler I have modified the original circuit to that of a Mk 2 version shown at Fig. 1. The recommended measurement procedure is as follows;

- (a) With S1 in position a and the subject coil disconnected, adjust the RF input to read 10 on the 50 microammeter,
- (b) Connect the subject coil between SO1 and SO2 and change S1 to position b,
- (c) Adjust the system for resonance as indicated by a maximum on the meter,
- (d) The meter reading is the apparent Q (Q_a) of the coil,

(e) $Q_a = X / (4.5 + R_c)$ where R_c is the coil loss resistance.

The procedure to (e) is sufficient for comparing coil quality; to ESTIMATE the actual coil Q calculate $R_c = (X / Q_a) - 4.5$ and $Q = X / R_c$.

The justification for the above is provided by the Thevenin equivalent circuit at Fig. 1 (b) V_{in} is the open circuit volts at SO1 which is $V_a * (R_b / R_b + R_a)$

ar

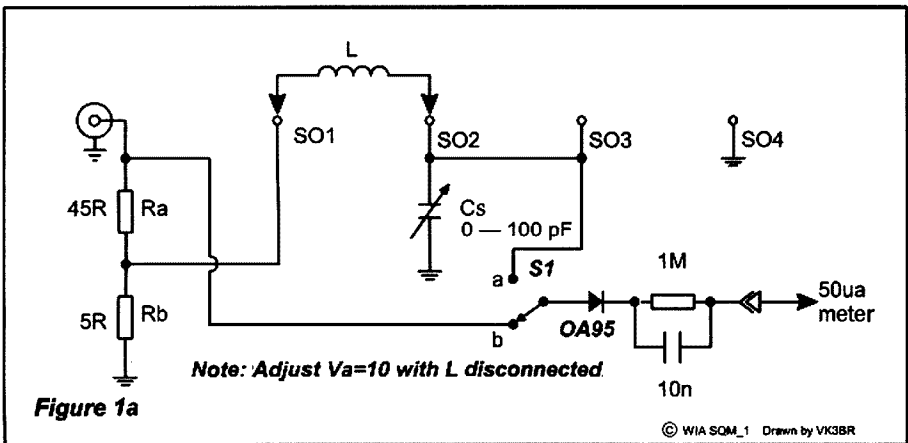

Figure 1a

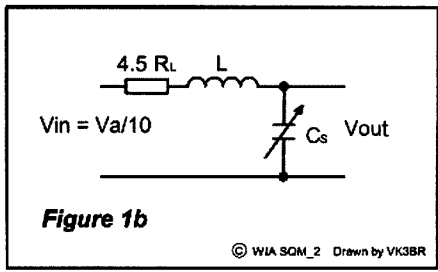

Figure 1b

Silent Key

Rex White VK2AIK

Rex White passed away at home on Friday 23rd November 2001. He had been a "Ham" operator since the 1970s as VK2AIK, from his home at Lawson NSW.

Rex was born in New Zealand on 6 June 1937. Like myself, he started school as the horror that was World War II peaked and finished.

He entered Radio College in Auckland and studied successfully for his New Zealand First Class

Commercial Radio Operator's Certificate of Proficiency. With his new licence he went to sea with Union Steamship Company on New Zealand coastal runs. By the 1960s he was on Trans Tasman routes to Sydney and Melbourne. Into the 1970s he remained on the Australian coast with Union Bulk Ships, making his home in Sydney with wife Beat.

I first met Rex when he was "sparks" on the M.V. Riadon when she was in Hobart in the early 1970s. He took out

his amateur call VK2AIK, at first for his Petersham address, although later they moved to Lawson. We had many a yarn on CW over those years, his telegraphy of course, being a delight to copy. He soon became a 2 metre enthusiast when located in the Blue Mountains.

Daphne, my wife, and I will retain fond memories of Rex and send our love to Beat, his XYL.

Jules VK5JO

LIPDs

The Front Line

If you had said to me several years ago that a radio service was to be introduced onto part of the 70 cm band and placed in the segment occupied by the inputs of some of our 70 cm repeaters I would not have believed such a technically incorrect decision could be made. Voice repeaters are usually located on high hills, masts or buildings with the intention of picking up the weakest signals and usually have high gain omnidirectional aerials. The power levels used by LIPDs are low but the free space attenuation shows that if there is little topography in the way LIPDs can radiate many kilometres. And they do.

As far as I know amateurs were never consulted about LIPDs and in particular where to place them in the 70 cm band, and this is the crucial point. Why place LIPDs on repeater inputs? Off all the places on the 70 cm band, this is where LIPDs would cause the most problems.

What I find alarming is that the original regulations relating to LIPDs, as written by the ACA, seem now to be ignored by the ACA. It also has been suggested that the LIPD regulation could be re-written by the ACA to simply overcome these difficulties in dealing with amateur complaints, even to the point of re-allocating that segment of the 70 cm band so amateurs no longer have access. This, if it be true, is simply not fair.

The ACA have said amateurs by their nature can use their technological knowledge to solve the LIPD problem. I take this to mean use CTCSS decoding on repeater inputs. This would restrict LIPD interference but place the burden on us amateurs to hopefully solve a problem not of our making. It would require modifying all 70 cm repeater receivers in the LIPD band and restricting access to those amateurs who do not have CTCSS encode. This option is not favoured by many amateurs, but we may well be forced into this if we do

not wish to change the band plan and move out of the LIPD segment.

There is an increasing feeling that the ACA have little time for amateur problems and if the problem persists or is just too hard then a heavy hand is to be applied. Amateurs understand the ACA have much to do and most of it far more important than administering a hobby activity. Coupled with this is the reduction in staff numbers and the constantly changing technology requiring attention to technologies that are becoming increasingly complex as well.

But surely we do have rights and should expect fair treatment from the ACA and not just accept what ever is dished out to us

These are my thoughts and not necessarily the thoughts of the WIA. There is some opinion that speaking out about issues like LIPDs, and in the process criticising the ACA, may only result in a bad outcome to amateur radio in Australia. Don't stick your head out least you get it chopped off. Perhaps, but it is judgement call and just where to stick up your hand and complain should be a collective call, but it has to start somewhere, and this is coming from those who have to deal with LIPD interference.

One VK6 amateur, Rob VK6JRC, has been intimately involved with LIPD interference to 70 cm repeaters and I asked him to put together a summary of his efforts to track down LIPDs that were causing interference. This is the front line effect to some of our 70 cm repeaters and the time effort and money needed to be expended to try and resolve LIPD interference.

Thanks Rob for this summary.

LIPDs in Perth

This is a time line for 70cm interference issues we have had to my knowledge here in Perth to date so far.

August 1999 - Crane Controller at

Midland Brick, Midland. Device was found to be a remote controlled overhead crane controller in the factory. The controller was causing the VK6RTH repeater to retransmit telemetry signals for long periods (hours). ACA investigated a complaint made by WARG and the controller was QSY'ed to another frequency within the 70cm LIPD band.

August 2000 - Crane Controller at a Kewdale steel factory. Device was found to be a remote controlled overhead crane controller in the factory. The controller was causing the VK6RVP repeater to retransmit telemetry signals for long periods (hours). ACA investigated a complaint made by WARG and the controller was QSY'ed to another frequency within the 70cm LIPD band.

October 2001 - Device believed to be a Crane Controller at a Canning Vale Steel factory. The device was causing the repeater to retransmit telemetry signals for long periods (hours). A complaint was made to the ACA, who advised of their new policy in relation to LIPD's;

"The ACA's policy on this matter is quite clear. If amateurs choose to operate their repeater receivers in the 433.05-434.79 MHz band, they must accept whatever level of interference arises from LIPD's. This message has been conveyed to the WIA both in correspondence and at meetings. Amateurs, by the very nature of their hobby are well placed to undertake technical measures to resolve problems associated with the operation of LIPD's.

Please note in the correspondence between Spectrum Planning Team and the WIA, that "the ACA intends to make this relationship unambiguous in the relevant regulatory provisions" and "this may involve amendment to the existing Radiocommunications Licence Conditions (Amateur Licence) Determination".

ACA was advised that no one could be sure what was causing the

WIA Awards Coordinators

The Federal Directors have decided to appoint Mai Johnson VK6LC Awards Co ordinator following the resignation of John Kelleher VK3DP. John served the WIA and the Australian Amateur community well for some 10 years. He made sure the awards system worked well and processed applications for Australian Awards expeditiously. His files of all other Amateur Awards were very extensive and his regular contribution to Amateur Radio magazine was much appreciated. We wish John well in his retirement and we hope that Mai will enjoy his new position. This is another voluntary job within the Amateur Community which is required, if we in Australia are to play our part in the world wide Amateur Community. Thank you Mai for accepting the position.



John VK3DP (left) and Mai VK6LC

Repeater Link

continued

interference until it was investigated and inspected. The device continued to transmit, but eventually QSY'ed to elsewhere in the 70cm LIPD band. The ACA did eventually visit, but could find no QRM on the repeater input frequency. (They were a couple of weeks too late)

As of December 2001, there are three 70cm repeaters operating in the Perth metropolitan area. All three repeaters currently suffer from interference (to varying degrees) on the input frequencies. One repeater (VK6RVP) has been shutdown at this stage as the QRM (a telemetry signal) appears to go 24 hours a day. Efforts will be made to track down the sources of these signals and notify the ACA. What will come from this is anyone's guess.

The Report Card:

Well, interference in three out of three Perth 70cm repeaters, certainly indicates that the interference potential of these class licenced devices is much higher than that "marketed" by the ACA. The ACA have failed dismally and deserve

an "F" for their efforts. They now seem to be "acknowledging" their failures by refusing to investigate and QSY these devices.

This is despite the Class Licence LCD for LIPD's specifically stating, "It is recognised that interference arising from the operation of a LIPD is still possible, although under less likely circumstances. As an aid to interference resolution in those circumstances, it is a condition of the operation of a device under this Class Licence that the device not cause interference to other radiocommunications devices; as well, a device will not be afforded protection from interference caused by other radio communications services (see paragraph 4 (1) (b) and Note 1 after section 4 of this Class Licence).

Should interference occur, the onus is on the user of a LIPD to take measures to resolve that interference, for example, by re-tuning or ceasing to operate the LIPD. Some LIPDs are designed so that they are able to be re-tuned, to assist the

user in avoiding interference locally."

Paragraph 4(1)(B) reads:

(b) the transmitter's operation must not cause interference to the operation of radio communications services.

Note 1 after Paragraph 4 reads:

A low interference potential device will not be afforded protection from interference caused by other radiocommunications devices. A low interference potential device operated under this Class Licence is generally not expected to suffer interference. However, an individual low interference potential device may experience, from other radiocommunications devices, interference arising from the particular circumstances of the device's operation.

Hmmmm, seems like the roles have been reversed for AR operators.

Regards, Rob, VK6JRC

For further reading, December 2001 QST magazine on page 9 has an article about the introduction of LIPDs in the United States and the intention of the ARRL to fight their introduction.

ar

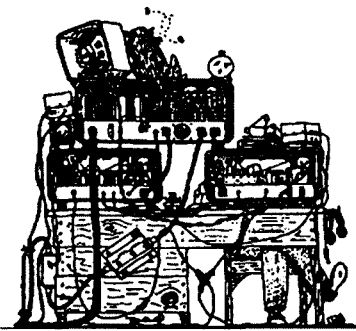

Part 10 "Cleaning Windows"

Some readers might think that this topic is rather dull and silly – please think again! It the most important regular "tweaking" activity that you will ever do easily to make your Ham Shack Computer run like clockwork, and minimise errors - read on.

Many PC users feel that they just want to "do things" with their computer, and not bother to learn the basic tasks of correctly operating or maintaining it. However, RA's are "tweakers" by nature, and the following tips for Win 95/98 users will give their Ham Shack Computer a breath of fresh air.

1. **Cleaning floppies.** Collect all those floppies around the shack. If the data is not required, re-format them from My Computer, select Format. Now you have a nice collection of "new disks" ready for further use.
2. **Backup log and data files.** Use your new stack of salvaged floppies to backup files and programs that might be needed for your Ham Shack.
3. **Uninstall obsolete programs.** Unused programs will slow down your computer. Remove these from Control Panel, Add/Remove Programs then choose the ones to uninstall.
4. **Clear out the rubbish.** Windows stores many temporary files, and Internet files. Run Disk Cleanup from Start, Programs, Accessories, and then System Tools.
5. **Run ScanDisk.** From the same directory above, run ScanDisk to check all your drives for errors, and to fix any errors.
6. **Speed up program loading.** In Win 98, a small program called walign.exe organises programs on your hard drive to speed up loading. Go to Start, Run, and type in walign, the click Run.
7. **Defragment hard drives.** With use your hard drive gets rather untidy with clusters of data all over the place. This slows down access to programs and data. Using the same Accessories directory as ScanDisk, select Disk Defragmentation. If you've not tried this before, it might take several hours to complete. Watch the evening movie on telly while your computer fully completes this task.
8. **Check applications.** You might have more programs running than you think. Using the Windows System Information Utility, go to Start, Programs, Accessories, System, Tools, and System Configuration Utility. You can now decide which programs will start automatically when your PC is switched on. Don't disable programs that you will need.
9. **Memory management.** Windows uses a "swap file" to store temporary data while you work on the PC. To speed things up, setup a permanent swap file by right clicking on My Computer, Properties, Performance, Virtual Memory. Now select "Let me specify my own virtual memory settings" A good amount to enter would be about 2.5 times the amount of RAM in your PC. Once done, reboot and run Disk Defragmenter again. Note there is now less hard drive activity.
10. **Update to 32 bit FAT.** FAT means File Allocation Table. It's like the index to a good book – only it manages the file placement on your PC. Check this by clicking My Computer, right click on C:\drive then click Properties. If you have FAT32, you can see this under the General tab. If not, go to Start, Programs, Accessories, System Tools, and follow the directions. If the converter is not listed, go to Control Panel, Add/Remove Programs then Windows Setup to install Drive Converter.
11. **Faster setting.** If you have more than 32 MB of RAM, programs can be speeded up by operating your PC as a Network Server. Right click My Computer, Properties, Performance then File System. The "Typical Role" should be changed to "Network Server" – even if you are not connected to a network!
12. **Registry backup.** In case of disasters, backup your Windows Registry. Just click Start, then Run and type in the command Scanregw and hit OK to backup the registry.
13. **TweakUI.** A very powerful Microsoft advanced user program on the Windows 98 CD-ROM in the ... \tools \reskit \powertoy directory. Right click on the tweakui.inf file – then select install. Place a TweakUI shortcut on your desktop and run. Move through all the options and read all the fine details before any changes are made. For good example, to get rid of the Windows splash screen and speed up the opening of Windows, uncheck the tick in the Boot menu option in TweakUI. On restart, your computer will load Windows faster without the boring Win 95/98 opening splash screen. TweakUI offers dozens of useful options to help streamline the operations of your computer. Once tried, TweakUI will become one of your essential tools for PC maintenance. If you load and try new software, only to decide that it's no longer needed – but you cannot clear the software from the Add/Remove list

- try TweakUI to cleanup the list once and for all. You can also Rebuild Icons, Repair System Files and prevent uninstalled disk drives from being displayed.

14. Finally. Having worked nice and slowly through steps 1-13, reboot your computer and run ScanDisk first then Disk Defragmenter once again. This will ensure that all the settings are enabled, and the data clusters on your hard drive have been placed in a contiguous order. The general speed of your computer will be much faster - which is why we started this lengthy process in the first place!
15. Clean the glass on your monitor with Window cleaner, and polish with a soft cloth.
16. Remove the keyboard and clean the keys, and between the keys, with a soft dampened cloth like "Super Wipes" and one drip of washing up liquid.
17. The inside of your computer can be cleaned by gently using a 10mm paintbrush, and a vacuum cleaner to suck out dust and "doggy hairs".
18. Gold plated contacts on RAM chips and other boards can be cleaned with a common plastic pencil eraser.
19. Floppy and CD-ROM drives can very easily removed from the case, and are cleaned with a 10mm paintbrush and the household vacuum cleaner. Be very careful with the read/write head on the floppy drive. The optical laser head on the CD-ROM is cleaned with a photographic lens tissue.
20. Internal/external Zip and LS120 drives are more difficult to clean. Try the vacuum cleaner trick with a small funnel attached to concentrate the sucking action to remove dust.
21. If you are lucky enough to have a standby, no-break power supply (EG: on a BBS or Internet node for example). Run your favourite program on your computer, then switch off the power input to the

supply. Your computer should run properly for at least 60 seconds. Switch the power to the supply back on and the operation should be restored. If the power supply cannot sustain 60 seconds, check the battery is fully charged, or replace the battery with a new one (DSE S3321). Some standby power supplies have software control through a spare comport. CheckUPS is one example where the software can be programmed to close down your computer. A nice touch in the case of sustained power failure. This is a cost-

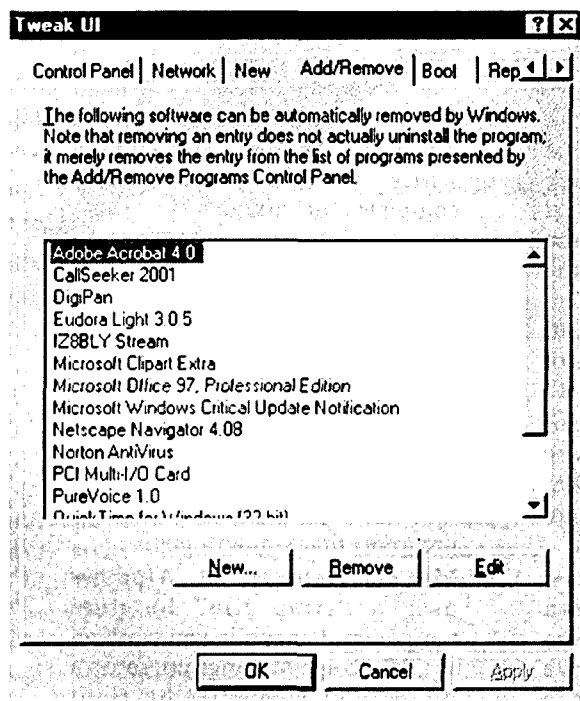

effective option, and will protect the valuable data on your hard drive too!

22. Power Surge Suppressors are highly recommended to prevent any "nasties" zapping your PC switch-mode power supply. They are being bought as part of the common multi-plug boards at your local emporium. Some of the more expensive varieties offer EMC protection and are worth looking at.
23. Shack RF grounding. Like your other Ham Shack equipment, ground the case of your computer to your main station signal earth. If you don't have a station earthing system - THEN FIT ONE NOW!

24. To install a convenient PC common earthing terminal, drill a 5.0-mm hole in the rear panel of the PC chassis. Fit a 5.0-mm x 20-mm long stainless steel bolt through the hole. Use serrated washers and secure with two lock nuts. Then use two plain washers followed by a wing nut. Coaxial cable braid can be connected to the terminal and station earth.

Review

If you have had the courage and conviction to work through ALL of the last 24 points carefully, you should end up with a fine Ham Shack Computer. In addition, you'll have learned a lot in the process. On the other hand, if you dismiss these topics because you may think they are too complex, then start reading this article again until you feel confident to do it all on your own. It will take a full weekend of spare time but the rewards will impress you time and time again.

Ham Tip No. 10.

Thinking about buying a new shack transceiver? Choose one WITH computer control. You will be thrilled to see your new acquisition being operated from your Ham Shack Computer - AND the resale value will be higher!

In the future, transceivers will be fully programmable just like a computer. Software controlled radios are slowly emerging but

are far too expensive at the moment and are only currently being adopted by the military. But the manufacturers are thinking and development is improving slowly driven by consumer market forces. Perhaps we will eventually be able to "plug-and-play", and buy "plug-ins" to do just what we want to do with our Ham Shack Computer. One can only dream - Hi.

Ham Shack Computers, No: 11 "Multi-Modes" features a range of software for CW, RTTY, PSK31, and much more...

(1) Ham Shack Computers Web Site:
<http://www2.tpg.com.au/users/vk6pg>
73s de Alan, VK6PG

ar

Amateur Radio Index 2001

Category	Title	Author	Issue	Page	Category	Title	Author	Issue	Page
Administration					2000 Results				
	160 metre Band Plan FTAC Notes	John Martin VK3KWA	December	42		CQWW DX CW Contest Results	Ian Godsil VK3VP	December	39
	Amateur Licences 5 year renewals		December	7		CQWW DX SSB Contest Results	Ian Godsil VK3VP	December	38
	EMR Compliance Self-Assessment Trial ACA		January	3		IOTA 2000 Contest Results		June	36
	How Basic is a Basic Licence ?	Brenda Edmonds VK3KT	October	51		John Moyle Field Day 2000 results		April	38
	Internet repeater Linking Permission from ACA		March	3		Novice Contest 2001		November	36
	The Federal WIA Convention 2001		June	4		NZART Memorial Contest Results	Win Gilbert ZL2GI	December	39
	The Productivity Commission Radio Communications Act	Ernest Hocking VK1LK	November	3		QRP Day Contest Results		September	41
	Update of WIA Exam Services	Brenda Edmonds VK3KT	June	17		RD 2000 Results Correction	Alex Petkovic VK6APK	March	48
	WIA Exam Service Invigilators	WIA	November	9		RD Contest 2000 Results		February	42
	WIA Makes A Submission To The Productivity Commission	Jim Linton VK3PC	November	21		Results 2001 Inaugural VK/trans Tasman Contest		July	42
	World Conference 2003		April	38		Ross Hull Contest 2000-2001 Results		June	45
Awards					Sangster Shield Contest Results				
	CIS Award	John Kelleher VK3DP	March	37		The 2000 Oceania DX Contest Results		September	41
	JARL 21st Century Dream Award	John Kelleher VK3DP	February	40		VK/Trans Tasman Contest Complete results		June	39/41
	New Zealand IARU Region 3 Award	John Kelleher VK3DP	March	37		Waitakere Sprints 2001		August	43
	Northern Ireland Six Counties Award	John Kelleher VK3DP	June	33	Contests				
	Papua New Guinea-Bird of Paradise Award	John Kelleher VK3DP	June	33		2001 Trans Tasman Competition Rules		April	36
	PSK 31 Award	John Kelleher VK3DP	April	43		ALARA Contest 2001		May	38
	Puerto Rico: Zone 8 Award	John Kelleher VK3DP	June	33		Asia Pacific Sprint 2001		May	37
	Thailand :The Siam Award	John Kelleher VK3DP	June	33		CQ/RJ WW RTTY Contest		August	43
	VK DXCC Listing February 2001	John Kelleher VK3DP	February	41		FM Fun Day		September	41
	VRZA Award	John Kelleher VK3DP	April	43		Harry Angle Memorial Sprint 2001 Rules		April	36
	WAZ Applications	Paul K5TR	March	24		Helvetia DX Contest 2001		March	34
	Yugoslavia. Worked all Yugoslavia Award	John Kelleher VK3DP	March	37		IARU HF Championships		July	42
	Zone 29 Award	John Kelleher VK3DP	April	43		Jack Files Contest 2001		June	45
Book Review						Japan International DX Contest 2001		March	34
	Ham Radio Planning for the Future	Peter Kloppenburg VK1CPK	November	12		John Moyle Field Day 2001 Rules		February	45
	Radio Projects for the Amateur Volume 2		August	36		Keyman's Club of Japan		July	42
Competitions						New Contest Site		August	44
	10th World ARDF Championships Nanking China October 2000	Jack Bramham VK3WWW	March	43		Novice Contest 2001		May	37
	ARDF Competitions	Jack Bramham VK3WWW	October	24		Oceania DX Contest 2001		September	41
Conferences						Pacific 160 metres Contest 2001		May	37
	NZART 75th Jubilee Conference June 2001		May	35		QRP Day 2001 Contest		May	36
Contest Results						Remembrance Day Contest		August	14
	Pacific 160 Metres Contest 2001		November	37		Remembrance Day 2001 Contest		June	37
	10 metres SWL Contest 2001		November	38		Ross Hull VHF-UHF 2001-2002 Contest	John Martin VK3KWA	December	40
	ALARA Contest 2000 Results		February	34		RSGB Islands on the Air Contests		July	42
	ALARA Contest Results	Christine Taylor VK5CTY	March	20		Scandinavian Activity contest		August	42
	ANARTS WW RTTY Contest Results 2000		January	41		Spring VHF/UHF Field Day 2001	John Martin VK3KWA	October	42
	ARI International DX Contest May 2000 Results		February	42		Summer VHF-UHF Field Day Rules	John Martin VK3KWA	December	41
	Commonwealth Contest 2001		November	37		Waitakere Sprint 2001		June	36
	CQ WW DX CW Contest 1999 Results		January	41		Worked All Europe DX Contest Rules		July	41
	CQ WW RTTY WPX Contest 2001		November	37	Conventions				
	CQ WW WPX SSB Contest		May	36		GippsTech-Aust. Tech. Symposium for VHF, UHF, Microwave	Chris Morley VK3KME	April	50

Amateur Radio Index 2001

Category	Title	Author	Issue	Page	Category	Title	Author	Issue	Page
	GippsTech 2001		June	11		New Zealand Walking Party Tracked with PCsat	Bill Magnusson VK3JT	December	33
	South East Radio Group Convention 2001		May	22		Nikola Tesla. The first Amateur and real Inventor of Radio	John Wagner W8AHB	April	13
	Urunga 2001	B. J. Slarke VK2ZCQ	November	23		Packet Radio Information Sources	Steve Blanche VK2KFJ	July	10
	Urunga Radio Convention April 2001	Brian Slarke VK2ZCQ	March	42		PCsat Launched	Bill Magnusson VK3JT	November	34
DXpeditions						QSL Collection is a Winner	Ken Matchett VK3TL	November	48
	St Mary's Island, AS096 IOTA May 2001	Sri VU2SBJ	November	16		QSLs from Museums	Ken Matchett VK3TL	September	18
	Whale Island Expedition	Frank May ZL1FMA	October	55		QSLs from the WIA Collection	Ken Matchett VK3TL	December	13
Equip. Review						QUIZ - How much do you know about your WIA?	Peter Parker VK3YE	April	20
	Prostel1 2051B Rotator	Martin Luther VK5GN	August	15		Radio Amateurs Old Timers Club: Can you help?	Alan Doble VK3AMD	July	44
	Rotor-EZ Review	Alan Gibbs VK6PG	November	44		Ramblings of a Crystal Set Constructor	John Hodgkinson VK2BHO	October	16
Fun Days						RD Post Script	Ian Godsil VK3VP	September	43
	International Lighthouse/Lightship Weekend	Kevin VK2CE	March	27		Remembrance Day Contest Address	Ian Godsil VK3VP	September	44
	MDRC Radio on Rails Fun Day Rules		March	22		See you in Palermo		July	14
General						Six monthly update of amateur satellites		July	37
	A Home Brew Reference Library	Peter Stuart VK2BEU	December	16		Submorse	Fred Smith VK2BN	December	14
	A Simple and Efficient Computer Logging Program	Ian Alexander VK3DDL	November	18		Sunspot Numbers (October)		December	23
	ACARS. Aircraft Communications and Reporting System	Steve Blanche VK2KFJ	March	35		Sweet Retirement. A Poem	Sheila Spargo	May	47
	Adam Lution	David Pilley VK3AYD	February	13		The Australian Amateur Radio FAQ	Peter Parker VK3YE	November	51
	Amateur Radio in the Australian Alps	Stephen Warrillow VK3JNH	April	17		The Grey Line Phenomenon	Robin Harwood VK7RH	February	47
	Amateur Radio Old Timers Club		May	22		The Rise and Fall and Rise of GRIES	Rod Green VK3AYQ	April	22
	Amateur Radio Publicity Bulletin February 2001		July	36		The Ultimate Antenna Mast	Dave Smith VK2DAL	May	17
	An Introduction to IRLP	Peter Parker VK3YE	August	45		The Urunga Convention 2001		February	17
	Antenna masts that don't annoy the neighbours	Don Jackson VK3DBB	December	35		The Very PC WIA	Peter Ellis VK1KEP	December	36
	BASS IRLP Group formed		November	35		The Water Tower	Chris VK5CTY & VK5UE	September	22
	BBC World Service drops Australia and North America	Robin Harwood VK7RH	July	43		The Way it is.	Russ White VK3MWR	March	21
	Classification of Emissions	H. Andersson VK8HA	December	23		UHF, VHF, Microwave Propagation & the Great Australian Bight	Wally Howse VK6KZ	March	4
	CW and the Horses	From D. Pilley VK3ADY	November	50		V15RAS Special Event Station	Godfrey Williams VK5BGW	October	9
	Digital Modes	Ex QST Jan 2001	February	23		VK1RGI Refurbishment	Paul Elliott VK1TEE	June	12
	Digital TV? How Good?	Repeater Link	August	19		VK5BAR Proctor BBS		February	18
	Evolution of a Satellite Earth-Station	Bill Magnusson VK3JT	June	18		Why Call CQ	LB Cebik W4RNL	December	47
	GippsTech in Pix	Ron Fisher VK3OM	October	27		WICEN Activation — a recent incident	John Alcom VK2JWA	March	44
	GMDSS Safety Compromised at the Peril of Seafarers?	Ian Godsil VK3VP	November	14		WICEN Northern Rivers Emergency Radio Operator Training		May	41
	Grid Square Standings 12th July 2001	Guy Fletcher VK2KU	September	47		Workshop and Operating Hints and Tips	Peter Parker VK3YE	June	22
	History of Packet Radio in Australia	Steve Blanche VK2KFJ	May	11		World Trade Centre	Ernie Hocking VK1LK	October	15
	How IRLP Works	David Cameron VE7LTD	August	46		World War 2 Clandestine Communications, Part 1	Malcolm Haskard VK5BA	January	17
	How You Can make The WIA Work For You	Bruce Jones VK4EHT	March	34		World War 2 Clandestine Communications, Part 2	Malcolm Haskard VK5BA	February	9
	Interesting Telegraphy Internet Sites	Stephen Smith VK2SPS	July	50		World War 2 Clandestine Communications, Part 3	Malcolm Haskard VK5BA	March	12
	International Lighthouse/Lightship Weekend	Kevin VK2CE	August	27		You, too, can write a story or column for AR		July	16
	Introducing the President	Ernie Hocking VK1LK	June	3	ILLW				
	Introduction to Automatic Packet/Position Reporting System	Bob Bruninga WB4APR	June	49		A Tale of Three Men in Search of a "House"	Carl Schlink VK3EMF	November	24
	Is there a future for the WIA?	Martin Luther VK5GN	May	9	Operational				
	JOTA Survival Guide	Stephen Watson VK4SGW	September	17		6 Monthly Update of Operational AR Satellites	Bill Magnusson VK3JT	January	36
	Love and Amateur Radio	Peter Ellis VK1KEP	April	9		DXCC Listings WEF July 4 2001	John Kelleher VK3DP	August	40
	LPDs UHF Radio Amateur Problems in the Netherlands	David Pilley VK3AYD	March	11		IARU Region 3 Monitoring Systems	B I Manohar VU2UR	November	39

Amateur Radio Index 2001

Category	Title	Author	Issue	Page	Category	Title	Author	Issue	Page
Ionospheric Update	February 2001	Evan Jaman VK3ANI	February	56	People	Bill Rice Life Member WIA	Jim Linton VK3PC	September	25
Ionospheric Update	May	Evan Jarman VK2ANI	May	42	Brenda VK3KT. First Woman Director of WIA		July	15	
Solar Cycle Conditions to Jan 2001		Evan Jarman VK3ANI	March	51	David McAulay VK3EW	John Kelleher VK3DP	February	40	
Sunspot Numbers to June 2001			August	20	Elizabeth VE7YL		July	15	
Sunspot Numbers to May 2001			July	27	Frank Bradon ex VK5FB		March	23	
Ultra Wide Band Problems	Beyond Our Shores		August	17	Ruth IT9ESZ		July	16	
OTU					Senior Operator Alf VK2UC		October	8	
Amplifier Information	David Downie VK2EZD	August	56	The Path to Winning the Ross Hull Contest	Jim Linton VK3PC	September	20		
Bearings	Les Hawkins VK4DA	February	55	Women: A global presence in Amateur radio		July	15		
Compulsory Membership	David Burnett VK5AXW	May	51	Recognition					
Compulsory Membership	Peter Parker VK3YE	July	56	Federal Awards GA Taylor to Neil Penfold VK6NC		May	25		
Computers	Ric Havyatt VK2PH	August	56	Federal Awards Ron Wilkinson Achievement Award		May	25		
Contests	David Pilley VK2AYD	January	55	Peter Alexander VK2PA Award 2000 Winner Barry VK2BJ		April	47		
Contests	Bemd W von Bojan DJ7YE	May	56	The A.R. Magazine Higginbotham Award — Bill Rice VK3ABP		April	25		
Contests	Ian Barton VK5AIB	August	56	The A.R. Magazine Technical Award—Godfrey Williams VK5GW		April	25		
Contests	Martin Luther VK5GN	January	55	Review					
Did Tesla Really Invent Radio?	Rex Newsome VK4LR	November	55	From Wireless to the Web	Peter Jensen VK2AQJ	January	13		
Diesel Engine Interference	Rodney Champness VK3UG	January	56	Ham Log 4 A Station log keeping program	Robin Gandevin VK2VN	January	6		
Entry Hurdles	Charles Gnaccarini VK3BRZ	December	56	Satellites					
Expert on Tripe	Alan Madigan VK2OA	March	56	Update InstantTrack Version 1.51 Released	Bill Magnusaon VK3JL	October	33		
Future Directions for the WIA	Ken Fuller VK4KF	April	56	Silent Key					
Hams, Exams and TimTams	Ian Jackson VK3BUF	October	56	Alan Mills EA7BA ex GW3NMF	Ron VK7RN	January	32		
Invisible Antennas	Brian Clarke VK2GCE	July	56	Arthur John Brown VK2IK	John VK4MX, Charles VK2DH	May	7		
Membership	John Stevens VK4AFS	September	56	Arthur John Brown VK2IK	John Lego VK3BU1	April	8		
Morse	Neville Chivers VK2YO	June	55	Arthur Lock VK3AUL (1911-2000)	Merv Collins VK3AFO	February	22		
Morse and Mazdaism	Fred Smith VK2EN/ACP	February	55	David Brian VK3ADD	Clint Jeffrey VK3CSJ	February	36		
Morse still more efficient	G.W. Lynton VK2AGL	February	55	Edgar Olds VK2BY	Kevin Olds VK1OK	February	20		
MXHNY	Allan Madigan VK2OA	December	56	Eric Nissen VK4XN	Alan Shawsmith VK4SS	September	33		
National QSL and WIA	John Loftus VK4EMM	June	56	Fred Hammond VH3HC	David Pilley VK3AYD	March	16		
Post This	Malcolm Sinclair VK2BMS	August	56	Fred Stirk VK2ABC	C.G. Harvey VK1AU	December	44		
QSL Exchanges	Trevor Mitchell VK3PP	February	55	Geoff Chapman VK2AIT	Ted Miles VK2FLB	November	49		
RD Contest spoilt by bad manners	Ian Barton VK5AIB	July	49	George Stanley Schulze (1920-2001) VK2GX		December	51		
Re: WIA into the 21st Century Report No 1	Peter Parker VK3YE	May	51	George Welch VK2UN	Bill Galvin VK4AK	April	33		
Re AM Transmission	Antony Rogers VK3JIA	August	55	Howard O. Lorenzen W7BI	Jim Davis VK7OW	February	22		
Re AM Transmission August AR p 55	Ian Huser VK5QV	September	56	James George Cowan VK2ZC	Bill Hall VK2XT	April	41		
Re: To Morse or not to Morse? Is that the Question	Ian Coots VK3YIC	March	56	L Harvey Utber VK3AHU	Drew Diamond	November	49		
Reform	Mike Patterson VK4MIK	August	56	Les Bell VK4LZ	Les Daniels VK2AXZ	February	51		
Reform	Michael Gell VK5ZLC	June	55	Les Osborne VK3AAO	Ray Wales VK3RW	February	26		
Reforms the easy Way	Lindsay Lawless VK3ANJ	May	51	Miss Betty Geisel VK5YL	Christine Taylor VK5CTY	January	33		
Response to the pro-Morse brigade	Ian Gray VK2IGS	May	51	Roger Malcolm Bingham VK4HD	Alan Shawsmith VK4SS	June	26		
Response to "Hams, Exams and Tim Tams"	James Robertson VK5ASE	November	56	Ron Dunne VK3MEH	Heather Dunne	January	31		
Response to "Hams, Exams and Tim Tams"	Ken Fuller VK4KF	November	56	Roy Rayner VK2DO		July	6		
Support WIA Contests	Peter Parker VK3YE	June	47	Special Events					
The other side of the coin	Harry Gifford VK2GIF	March	56	Commonwealth Games	Kevin G0TOG	November	55		
The Struggle of Mazda and Ahrihan	Fred Smith VK2BN/ACP	May	56	International Museums Weekend 2002	Harry M1BYT	December	40		
The WIA into the 21st Century Report No 1 March 2001	Martin Luther VK5GN	April	56	V15RAS: Special Event Station	Bill Paul VK2EXX	April	25		
Use IT or Lose	Ian Godsil VK3VP	January	56						
Why I am an Amateur	Phil Grigg VK2APG	September	56						
Why is Morse necessary for HF licensing	Geoff Skinner VK4XUK	January	56						
WIA Members: Loyal and Bold	John Hinsch VK5ARL	June	47						
WIA Reform or No Reform	Ron Vette VK4AJV	August	56						

Amateur Radio Index 2001

Category	Title	Author	Issue	Page	Category	Title	Author	Issue	Page
Technical Aerials					Technical				
	A Helix Antenna for 2 metre Satellite Use.	Tony Hutchison VK5ZAI	November	19		Directional Feedback Amplifiers	Gil Sones VK3AUI	November	26
	A W2PV 4 element Yagi for 6 metres	Drew Diamond VK3XU	January	8		DOX Control of Yaesu FT847	Gil Sones VK3AUI	January	27
	Correction to Phased Verticals for 10m Mobile Use	Kim Rhodes VK6TQ	January	7		Flying Solo Cable Tester	Gil Sones VK3AUI	April	25
	Invisible Antennas	Ron Homes VK5VH	April	15		Grounding	Gil Sones VK3AUI	August	26
	Let's go WARCing	Bill Day VK3SWD	December	15		Inrush Timer	Gil Sones VK3AUI	March	27
	Multi-Octave Bidirectional Wire Antennas	Robert Zavrel W7SX	July	12		Low Impedance Parallel Square Conductor Transmission Lines	Gil Sones VK3AUI	April	24
	Noise Reducing Antenna	Gil Sones VK3AUI	December	24		Modification of DS4825 8m 1/2 Wave Vertical for 50.110MHz	Peter Blundstone V7KPB	October	35
	Taming the Quad Antenna	Godfrey Williams VK5BGW	December	17		Multivibrator Overtone Crystal Oscillator	Gil Sones VK3AUI	June	26
	The DL6WU Yagi: A VHFers classic	Ian Cowan VK1BG	November	7		Noise Blanking for the High Q LF loop antenna. Correction	Lloyd Butler	September	26
	The Repair of the Hi-Gain 18AVT Antenna	Barry White VK2AAB	February	20		Optoisolated Icom CI-V Bus Interface	Gil Sones VK3AUI	May	25
	UA3IAR Switchable Quad for 20 metres	Jim Mackison VK5MB	July	17		Oscilloscope Calibrator	Gil Sones VK3AUI	April	24
Technical Microwave						Power Plug Paddle	Gil Sones VK3AUI	October	25
	Microwave Primer Part 8 Getting RF to the Antenna	David Minchin VK5KK	January	46		Preamp Supply Current Limiter	Gil Sones VK3AUI	May	24
	Microwave Primer Part 9 Antenna for 10GHz	David Minchin VK5KK	February	50		Pseudo Stereo CW Reception	Gil Sones VK3AUI	May	24
	Microwave Primer Part 10 24GHz and 47GHz	David Minchin VK5KK	March	50		Remote ATU	Gil Sones VK3AUI	July	25
	Microwave Primer Part 11 Spread Spectrum WAN	David Minchin VK5KK	April	46		Resonant Trap Baluns	Gil Sones VK3AUI	February	25
	Microwave Primer Part 12 Transverter IF TCVRs	David Minchin VK5KK	May	46		RFI Tracker	Gil Sones VK3AUI	August	25
	Microwave Primer Part 13 Transverter IF Frequencies	David Minchin VK5KK	June	51		Short Forty Antenna	Gil Sones VK3AUI	November	27
	Microwave Primer Part 14 Transverter Local Oscillators	David Minchin VK5KK	July	48		Simple Morse Practice generator	Gil Sones VK3AUI	January	27
	Microwave Primer Part 15 Portable Microwave Station	David Minchin VK5KK	August	50		Simple Reg Radio	Gil Sones VK3AUI	January	26
	Microwave Primer Part 16 Packaging a Microwave Station	David Minchin VK5KK	September	48		Skeleton Sleeve Fed Monopole	Gil Sones VK3AUI	March	25
	Microwave Primer Part 17 Packaging the Portable Station	David Minchin VK5KK	October	50		Stealth Antenna Tuning	Gil Sones VK3AUI	September	26
	Microwave Primer Part 18 ATV and Microwaves	David Minchin VK5KK	November	46		Super Regen Receiver	Gil Sones VK3AUI	February	24
	Microwave Primer Part 19 Basic ATV above 1200MHz	David Mitchin VK5KK	December	50		SWR Bridge Sensor	Gil Sones VK3AUI	July	26
Technical Rx						SWR Bridge Sensor Correction	Gil Sones VK3AUI	September	26
	A Receiving Converter for 432 MHz	Drew Diamond VK3XU	October	4		The Fox Finder	Gil Sones VK3AUI	July	24
	Correction to A Single Sideband Modulator for the LF Band	Lloyd Butler VK5BR	February	16		The Parasol	Gil Sones VK3AUI	June	24
	The DC 2000: An Experimental HF Direct Conversion RX	Peter Parker VK3YE	October	17		The Whistling Whip	Gil Sones VK3AUI	February	26
Technical TV						Digi Box	Gil Sones VK3AUI	November	40
	New Ways to Improve SSTV	Friedrich Becker VK4BDQ	December	22	Technical				
Technical TX						A 10MHz Reference Oscillator	Keith Gooley VK5OQ	August	8
	A Low Frequency Beacon transmitter	Richard Rogers VK7RO	February	14		A Meterless Capacity Meter	Neville Chivers VK2YO	November	9
Technical. Abstracts						A Morse Code ID for Home Station or Repeater	Peter Cossins VK3BFG	September	10
	160 Metre Inverted L Antenna	Gil Sones VK3AUI	June	25		A PSK31 Tuning Aid	Don Urbytes W8LGV	July	7
	A better PL259	Gil Sones VK3AUI	March	26		A Simple Q Meter	Lindsay Lawless VK3ANJ	February	19
	Active Door Loop Receive Antenna	Gil Sones VK3AUI	October	25		A X1000 Probe for High Voltage Measurements	Drew Diamond VK3XU	December	4
	Assembly Using Tube Cutter	Gil Sones VK3AUI	September	26		An Antenna Coupler for the FT 817	Peter Parker VK3YE	September	7
	CAT Interface	Gil Sones VK3AUI	May	25		An Electronic Keyer Paddle from the "Scrap Box"	Drew Diamond VK3XU	July	4
	Cloud Warmer NVIS Antenna	Gil Sones VK3AUI	October	26		An RF-Actuated CW Monitor and Practice Oscillator	Drew Diamond VK3XU	May	4
						Australia's New Electromagnetic Radiation Requirements	Peter Parker VK3YE	February	4
						Bare Bones: 80m QRP	Malcolm Haskard VK5BA	April	3
						Charlie's Toys DC-DC Converter	Charlie Sims VK2ABF	May	19
						CTCSS Encoder Board	Eric van der Weyer VK2KUR	March	8
						Energy in Radio Waves	Lindsay Lawless VK3ANJ	February	21
						Hints and Tips for using SMT	Luke Enriquez VK3EM	September	12
						Internet Linking of Repeaters	Brad Phillips ZS5BP	November	13
						Making Holes in Sheet-metal	Drew Diamond VK3XU	April	10
						Maths in Amateur Radio, Dec 2000. Correction	Lindsay Lawless VK3ANJ	April	27
						More Crystal Sets (Novice Notes)	Peter Parker VK3YE	May	14

Classification of emissions: Episode two

Henry ANDERSSON VK8HA, FedIWCOORD
VK8HA@OCTA4.NET.AU

Section II— Classification

#3 The class of emission is a set of characteristics conforming to #4 below.

#4 Emissions shall be classified and symbolized according to their basic characteristics as given in Sub-Section IIA and any optional additional characteristics as provided for in Sub-Section IIB.

#5 The basic characteristics (see Sub-Section IIA) are:

- 1) first symbol-type of modulation of the main carrier.
- 2) second symbol-nature of signal (s) modulating the main carrier.
- 3) third symbol-type of information to be transmitted.

Modulation used only for short periods and for incidental purposes (such as, in many cases, for identification or calling) may be ignored provided that the necessary bandwidth as indicated is thereby increased

Sub-section IIA-Basic characteristics

#6 1) First symbol-type of modulation of the main carrier.

1.1) Emission of an unmodulated carrier N

1.2) Emission in which the main carrier is amplitude-modulated (including cases where sub-carriers are angle-modulated

1.2.1) Double-sideband A

1.2.2) Single-sideband, full carrier H

1.2.3) Single-sideband, reduced or variable level carrier R

1.2.4) Single-sideband, suppressed carrier J

1.2.5) Independent sidebands B

1.2.6) Vestigial sideband C

1.3) Emissions in which the main carrier is angle-modulated.

1.3.1) Frequency modulation

1.3.2) Phase modulation

1.4) Emission in which the main

carrier is amplitude and angle-modulated either simultaneously or in a pre-established sequence D

1.5) Emission of pulses

1.5.1) Sequence of unmodulated pulses P

1.5.2) A number of pulses

1.5.2.1) modulated in amplitude K

1.5.2.2) modulated in width/duration L

1.5.2.3) modulated in position/phase M

1.5.2.4) in which the carrier is angle modulated during the angle-period of the pulse Q

1.5.2.5) which is a combination of the foregoing or is produced by other means V

Episode Three will be in next issue of AR.

Cheers and all the best from Henry in Humpty Doo.

VK8HA-FED.IW CO-ORD.

Amateur Radio Index 2001

Category Title	Author	Issue	Page	Category Title	Author	Issue	Page
Noise blanking for the High Q LF Loop Antenna	Lloyd Butler VK5BR	August	4	The Active Loop Converter at LF	Lloyd Butler VK5BR	January	4
Proctor Bulletin Board Service —A voice for the Far Outback	Rob Gurr VK5RG	January	21	The Outback 813 Amplifier	Steve Page VK6BGN/AA6SN	December	8
PSK31. The Easy Way. Part 2	Alan Gibbs VK6PG	June	8	The Simple Z Match Simplified	Lloyd Butler VK5BR	June	6
Recycling a Mobile Phone Hands-Free Microphone/Earpiece	Steve Mahoney VK5AIM	October	14	Transforming the New Car	Richard Cortis VK2XRS	October	10
Rewinding Power Transformers for 13.8V	Drew Diamond VK3XU	September	4	Use of Ferrite Cores In RF Broadband Transformers	Ron Saunders VK2WB	November	4
Tesla Coils	Will McGhie VK6UU	March	46	Technical Notes			
The "Good Enough"	Peter Parker VK3YE	January	14	Microphone and Loudspeaker Sensitivity	Lindsay Lawless VK3ANJ	November	27



EASTERN AND MOUNTAIN DISTRICT RADIO CLUB INC.

WHITE ELEPHANT SALE

Sunday 24 March 2002

Great Ryrie Primary School
Great Ryrie Street Heathmont
Doors open at 10:30 AM
Entry \$5.00 per head

Happy New Year to everyone!

I hope the festive season was good to you and yours and that you are all ready to enjoy the coming year. If you are planning an overseas trip remember to include Palermo in June to share the International YL Meet. If you are planning your trip around Australia don't forget to be in Murray Bridge for the long weekend at the beginning of October for the ALARAMEET 2002.

These will both be memorable occasions for YLs and for OMs. For more information go to the websites (or ask someone else to do it for you) at

Web site: <http://www.qsl.net/y12002>

Or

buscemi@skyol.it

or, for the ALARAMEET

<http://alarammeet2002.8m.com>

A very special award

Marilyn VK3DMS has been interested in stamps for a long time but the first world stamp exhibition she visited was in Melbourne in 1968. As a consequence of that event she became a serious collector and exhibitor. One of these days she would like to be as good as the collectors exhibited in Melbourne. She is especially interested in thematic collections. In a thematic display the collection often tells the geography or history of a topic through stamps.

Marilyn's first exhibition theme was minerals but when she took up amateur radio she started her "Radiomania" collection. She tells the history of radio, the people and the inventions and all the many aspects of telecommunications, through stamps and postal material from all round the world.

At the Melbourne Ausipex one of the awards was for the Top Lady Thematic Exhibitor. This was won by Mary Ann Owens, an American exhibitor. The prize was a beautiful opal necklace donated by a Melbourne jeweller.

Since the first competition display in 1991 Marilyn has exhibited many many times in many parts of the world, building and improving the collection all the time. She has won numerous prizes and medals although; up to now, the elusive Gold medal has eluded her.

This year her "Radiomania" collection has been to Calcutta and Brussels and, most recently to Brisbane for "Stampex 2001".

In Brisbane Marilyn was adjudged as "Top Lady Thematic Exhibitor" and was awarded the original opal necklace, donated back by Mary Ann Owens for the same category. To say Marilyn was thrilled is inadequate. She was quite "blown away" by the coincidence and by the necklace.

In her own words: "When I am much older and decrepit, I will donate it back again for some other lucky lady!"

I think we can say Marilyn has equalled those people she admired so much 17 years ago. Well Done!!

Visitors

Late month I reported the visit to Australia of Maxie DJ4YL and her sister, Marile. This month Rosemary ZL1WRO and her OM Ralph ZL4AG where in Adelaide. They have family in Melbourne and Sydney but spent a week in Adelaide between the two groups. They did not have much opportunity to meet too many VK5s but enjoyed a lunch in the city and a tour of the country, including our shack in the bush, with my OM Geoff and myself which also included a visit with Jean VK5TSX and her OM Rod VK5SX in their caravan at Mannum.

They say they will go back to ZL singing the praises of our state. As they did not get to see Murray Bridge perhaps

they will be back next year for the ALARAMEET.

Club activities

Pat VK3OZ told us on the Monday Net about the recent Fox Hunt and Picnic run by the radio club they attend. Judging from the number of participants in the foxhunt – with three foxes there were plenty of signals to chase – and the number of cars involved, it was a great success. The Picnic the next weekend was a fitting end to the year's activity.

In VK5 the YL members of AHARS and other members of ALARA ran the usual pie and pasty and drink stall at the "Buy and Sell" there was no dearth of customers and many friends to greet. The annual photo of the VK "thrives" does not show all the ladies present.

If you look closely you may be able to see the opal necklace around Marilyn's neck.

The ALARA Contest Results

The full results should be in the February Contest column but there is no doubt that it was a very successful contest. Everyone seems to have liked the new date and longer hours. This is reflected in the almost doubling of the logs submitted. HOWEVER not everyone did remember to send in their logs. Please remember next year!

Gwen VK3DYL was again the overall winner with a score of 786 and Bev VK4NBC was to top scorer in the Novice section, with Bev ZL1OS again the top ZL YL. These girls work hard to make those contacts. Well Done!

The biggest thrill for ALARA, though, is that we have a winner this year (Pat VL3OZ) for the Florence McKenzie Trophy for the top scorer on CW. Now that the speed requirements have been lowered for CW there are fewer people using the code in contests. It is increasingly difficult for anyone to make



The ALARA Buy and Sell: Meg VK5YG, Marilyn VK3DMS, Christine VK5CTY, Tina VK5TMC, Shirley

enough contacts to win this trophy nowadays.

Thank you for your perseverance, Pat, and thanks to those who gave her CW contacts.

ALARA is very proud to recognise the first VKYL amateur, Florence McKenzie (VK2GA) and to keep her memory fresh by this trophy donated by the VK4 amateurs.

Congratulations and thanks, Pat.

From the Contest Manager:

"Almost every log received had a favourable comment about the change of date. Four logs were received by email this year. I hope more will use the facility next year as it helps to get the logs in on time. It was great to see a club station again this year, the Townsville ARC, who

used their special event callsign VI4FLG.

With all the positive feedback about the changes, the ALARA Contest for 2002 will be the last full weekend of August 24/25th

Please spread the word around about the friendly contest and please be there yourselves."

ar

Club News

Adelaide Hills Amateur Radio Society

The last official meeting for the year was a great success. Members, asked to bring something along that they find most useful brought an amazing range of items.

As is usual. They were asked to tell everyone why they found these things useful to have so it was an evening of variety.

One of the oldest items on display was the original Z match made by Phil VK5NN, which he accompanied by one of the latest automatic tuning devices. Although the new one is great he still finds the original one better on some bands.

We were shown the latest multimeter (Linden VK5SWR) alongside one that was possibly 20 years old but had the virtue that it had an inbuilt VHF capability (Hans VK5YX). Both universally useful.

Jim VK5JST talked about and demonstrated breadboarding from the resistor hung by a string from the ceiling with everything else attached (until the weight of just one more component caused the 'cat's cradle' to collapse with bangs and smoke) to the latest white boards with the inbuilt connections. This presentation won the prize for the evening.

One most interesting demonstration was the portable radio set-up shown by Steve VK5AIM. This is what he and his XYL take when they go down to the beach on a hot night.

It consists of a case to carry the radio itself which converts to a stand on which the radio sits when in use, a vertical aerial which can be jammed into the sand and the power supply.

The power supply can just be a 12-volt battery or, if they go to the beach early enough, a small solar array that can produce enough energy to contact the world. As you can imagine many of the beach strollers stop to ask what the rig is all about and to learn something about amateur radio. What good publicity, especially when a contact is in progress!!

In December AHARS will have it's Christmas Dinner and in January there will be a more informal meeting as the school used during the year is unavailable in school holidays.

Once normal meetings start on the third Thursday in February visitors to VK5 are welcome.

ar

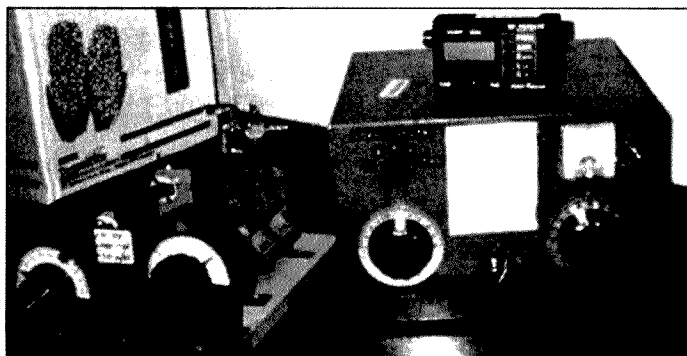

The two antenna tuning units

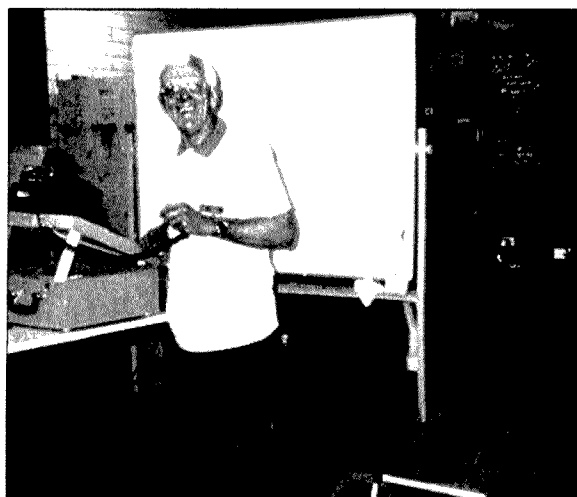

Steve VK5AIM

coming in
February

Amateur
Radio

● Harry Angle Sprint Results
● ALARA Contest Results

WBR Receiver

The WBR receiver is a regenerative receiver which uses a coupling method reminiscent of a wheatstone bridge. Dan Wissell N1BYT described the receiver in QST August 2001. The receiver uses a circuit reminiscent of a wheatstone bridge type of circuit to couple the antenna to the receiver oscillator and infinite impedance detector. This design is claimed to minimise antenna radiation, frequency pulling,

microphonics, and hand capacitance effects which can make regenerative receivers difficult.

The circuit is given in Fig 1. The bridge is formed by L1 which is centre tapped and the capacitors C5 and C6. The tuned circuit comprises L1 and capacitors C7 and C8 and the capacitance of diode D1. The antenna is coupled to the bridge at the midpoint of Z1 which is a one inch length of 20 gauge

wire connecting the centre point of L1 to ground. The antenna is connected via R3 a 1 kohm linear pot which is used as a signal level control and hence the volume control. The oscillator signal is more than 40 dB down at the connection point to Z1 from that at the ends of L1. This is good antenna isolation which will minimise the effect of the antenna on operation and also reduce oscillator radiation.

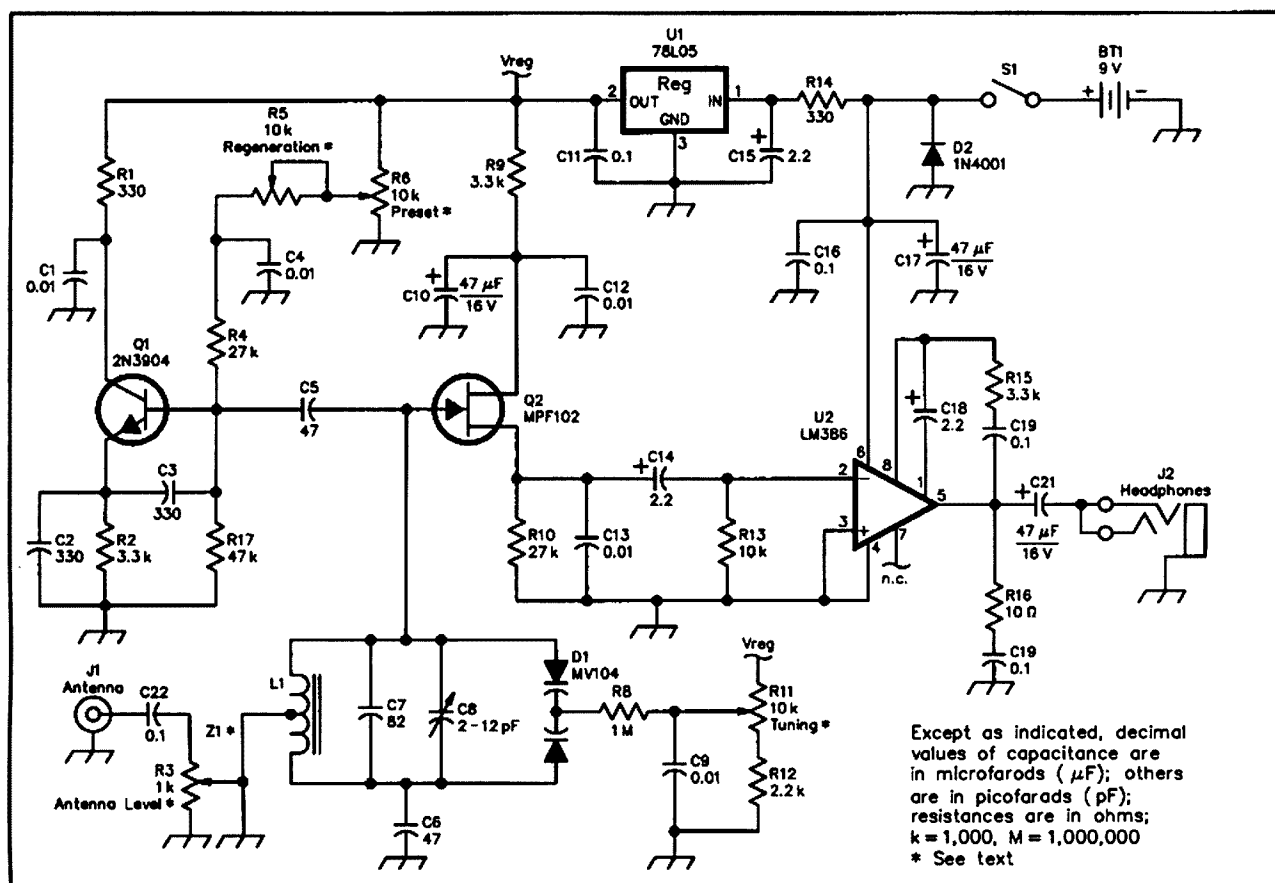

Figure 1—Schematic of the WBR receiver. Unless otherwise specified, resistors are 1/4-W 5% tolerance carbon composition.

- C2, C3—330 pF, 5% NPO
- C5, C8—47 pF, 5% NPO
- C7—82 pF, 5% NPO
- C8—2-12 pF NPO
- C1, C4, C9, C12, C13, C18, C22—0.01 μF
- C11, C16, C20—0.1 μF
- C10, C17, C21—47- μF , 16-V electrolytic
- D1—MV104
- D2—1N4001
- J2—Three-conductor phone jack, 1/8 inch.
- L1—Approximately 3.7 μH : 28 turns of #22, center tapped, on T-68-8 core (yellow).

- Q1—2N3819
- Q2—MPF102
- R1, R14—330 Ω
- R2, R9, R15—3.3 k Ω
- R3—1 k Ω linear-taper potentiometer. Panel mount.
- R4, R10—27 k Ω
- R5—10 k Ω linear-taper potentiometer. Panel mount.
- R6—10 k Ω linear-taper potentiometer. Panel or PWB mount.
- R7—47 k Ω
- R8—1 M Ω
- R11—10 k Ω , 10-turn potentiometer. Digi-Key # 3590S-1-103-ND.
- R12—2.2 k Ω
- R13—10 k Ω
- R16—10 Ω
- S1—SPST
- U1—78L05
- U2—LM386

Fig 1 WBR Receiver Circuit Diagram.

L1 is wound on a yellow T-68-6 toroid core. The inductance is approximately 3.7 microhenry from a centre tapped winding of 26 turns of 22 gauge wire. The tuned circuit covers the 7 MHz band.

The tuning control is R11 which is a ten turn 10 kohm potentiometer. This provides a variable tuning voltage to the variable capacitance diode D1.

Q1 is configured as a Colpitts oscillator. Oscillation is controlled by varying the base voltage. The regeneration controls are R6 which is a 10 k preset potentiometer and R5 which is a panel mounted 10 k regeneration control. R6 is preset to give a useful range of adjustment for R5.

Q2 is configured as an infinite impedance detector.

A regulated supply is used for the oscillator, detector, and the tuning diode. this is provided by the three terminal regulator U1.

An LM386 is used as the audio amplifier. This is adequate for headphone reception when used on the forty metre band with a dipole antenna.

Components are relatively non critical. The capacitors below a value of 330 pF are all NPO ceramic. The 0.01 and 0.1 mF capacitors are all small ceramics. The original was built using "dead bug" or ugly construction on a piece of printed circuit copper clad laminate. High value resistors or bypass

capacitors were used as standoffs. Looking at the circuit there are not many points where a standoff is required.

Operation is from a 9 volt battery which should last a fair time. This avoids any problems with other power supplies.

Operation on other bands would be possible by varying tuned circuit components and also capacitors C5 and C6. However this will require some appreciation of how the receiver works.

As with all regenerative some experimentation with control settings is required to achieve best performance.



Callbook

This year's callbook is a shortened version containing only the VK call signs and little peripheral information. Its price reflects its shortened format by being considerably less at \$15.00 (plus postage and handling).

Callbook on CD Rom.

This year WIA is offering the 2002 Callbook as an Acrobat file on a CD Rom, also for \$15.00 (plus postage and handling)

The advantages of CD Rom is that the files are searchable by callsign address, surname, postcode or even suburb, virtually whatever you want.

The attached search program, Acrobat Reader, is the world's most popular reader of files and is completely cross-platform compatible, it works on all computers.

We have included readable, searchable and printable files of the 2001 information regarding

Examiners

WIA Divisional Information

Wicen

ACA information

Operating information

Radio and TV Broadcast Stations

Internet Addresses of Interest

Affiliated Clubs

Travellers nets

Operating —special interest groups

Repeaters and Beacons

Useful forms.

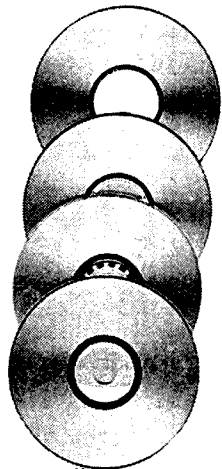

**Order through your local Division
contact details on page 30**

Ask about the price of the Book and the CD if bought together.

Silent Key

Ronald M^cDouall Stuart VK2ASJ

20/10/1921 — 9/7/2001

Ron carried a physical disability from his birth on 20 October 1921. His condition was described at that time as congenital spastic paralysis. These days we would probably say Palsy. His disability was entirely physical. Being highly intelligent he led a very positive and useful life, contributing effectively to community affairs.

Ron developed an interest in radio in his very early years. When we had probably the only radio in the street and neighbours used to come and listen to the tests. Those years the sound of bat hitting ball was produced by tapping a pencil on the table and the shout of *Rickety Kate* meant a wicket had fallen. His interest intensified when we obtained (what was then upmarket) an AWA Fisk Radiola. It had shortwave and Ron concentrated on picking up anything (local or overseas) and learning to read Morse code.

The Shortwave came in handy during

PLANE IN DISTRESS OVER NEWCASTLE

Its petrol supply running low, a Douglas aircraft carrying 26 passengers circled round Newcastle for some time last night firing flares and signalling for landing lights. Through the efforts of the Volunteer Air Observers' Corps, it was brought safely to an emergency landing

The plane was on its way from Queensland to Sydney. It was first seen sending out signals over Cardiff by Mr. G. A. McDonald, a member of the VAOC. Though he was not rostered for duty at the time—shortly before 8 pm—he rang the control post at Newcastle.

When the controller on duty at Newcastle headquarters of the VAOC (Mr. J. H. Pragnell) received the message, he telephoned through to a nearby air station, and gave advice of the plane's plight. He also telephoned to Mr. R. Stuart, who has previously been instrumental in saving a

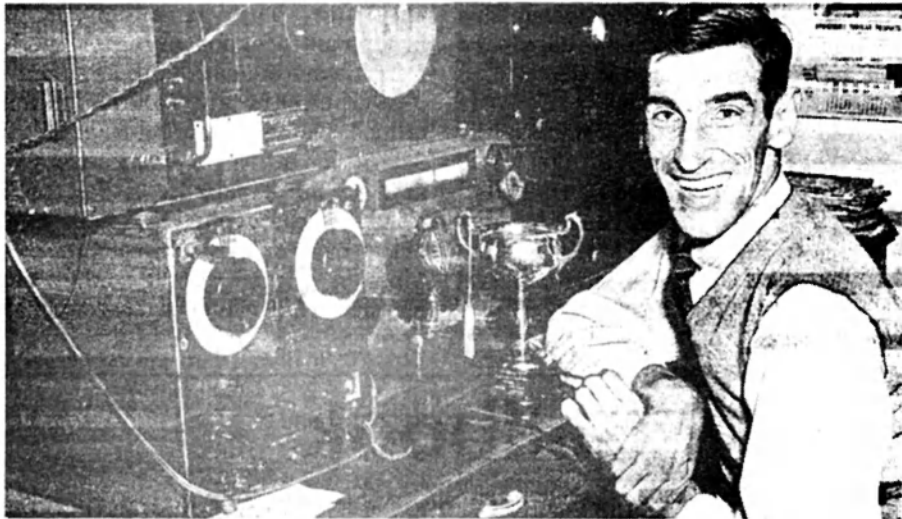

Keen observer: Ron McDouall Stuart, chief observer at the Stockton post, used his short-wave radio to help several aircraft in distress.

the war years when he took on a post with the volunteer air observer corp and was able to play a major role in saving a plane that had lost its course.

Post War Ron pursued his interest in

radio. He sat for the exam and became the proud operator of station VK2ASJ. Naturally because of his physical handicap, he could not repair and maintain his receivers and transmitters and was dependent on his amateur radio mates for help; and help they did! If he was missed on a sked or wasn't on air for a couple of days, the phone would ring and the hams would arrive. His uncontrollable hand movements prevented the use of a standard Morse key. Harold Whyte VK2AHA (SK) made up a foot key and Ron was able slowly, but quite effectively, to tap out messages.

Only last year Ron received from the New South Wales Division, a certificate congratulating him on 50 years membership of the Wireless Institute of Australia and dedication to amateur radio. He was the first to acknowledge that these years of membership were only possible because of help from his fellow hams. Ron was very proud of his amateur radio associations and when anyone inadvertently and somewhat unwisely said that he was a CB operator, he smartly corrected them, pointing out that amateur radio operators had to sit for an examination and fulfil the government regulations. Ron's other interests included all sports, but mainly cricket. He was also church secretary at one time and their publicity officer for 26 years.

Liberator and a Douglas, picked up a message on his short-wave set from the plane, indicating that petrol was low and that it must land immediately.

The air station was advised again, a flare path was laid down, and the Douglas "homed in" with searchlights.

In the meantime, the plane had been circling over the district. At one stage the pilot dropped a flare on the aerodrome at District Park, but decided, because of its size, against risking a landing.

This morning, with petrol tanks filled, the plane resumed its interrupted flight to Sydney.

RONALD McDOUALL STUART

20/10/1921 - 9/7/01



Ode to Ron Stuart

My friend, Patron of Stockton Cricket Club, Life Member and a Great Blake.

*Playing for Stockton will never be the same
Without you Ronny at our games.
To walk out and play in front of you
All players knew only the best would do.
Through the good and the bad you always stuck fast
To the boys from Stockton you just showed your class.
You could get a five or score a ton
Then to look at you and see a smile and a clap
And not forgetting the tipping of that famous floppy hat.
We loved you mate,
You made playing for Stockton so great
So, at a day's end
When you walk from Lynn
Take some time and let this sink in,
Show some respect and tip your hats
To where he would sit
Because we loved you Ronny Stuart
And that's it!*

John Allanson 13/7/01

Silent Keys

Les Kinch VK2BBD JP

It is with sadness that I inform you of the passing of Les Kinch ex VK2BBD. At his home in Phoenix Arizona USA on 3rd December 2001.

Les was born on Christmas Day 1926, served in the Merchant Navy and later in the Army for 21 years as a Communications Specialist. He arrived in Australia in 1968 when he was allocated the call VK2BBD

Les was a longstanding member of the Manly Warringah Radio Society, until he moved to county NSW, where he was instrumental in the starting of the Ex Manly Warringah Radio Society Net (3.590 Mhz 0630 EST) in 1983. Les was a pioneer in the use of computers in ham radio. He later moved to the UK in 1995, then Arizona USA in 1998.

Les is survived by his wife Alice, a son and daughter.

VK2KJB

Fred Stirk VK2ABC

Frederick James Stirk ex VK2ABC passed away on 15th September 2001 aged 86 years. Fred had a lifelong involvement with Radio. Gaining his Amateur Operators Licence at age 16 as VK2XV, he operated briefly as VK4XV and later VK2ABC. Early working years were radio related, first with retail outlets and then with radio Stations, 2GB, 2KA and 2WL.

In World War 2 in the RAAF he served in North Queensland and New Guinea, with the rank of Flying Officer.

Several proficiency awards and certificates were gained and Fred became a member of the Australian Institute of Radio Engineers.

Many enjoyable hours were spent contacting amateurs locally and overseas. Coloured pins on a map in his radio room denoted worldwide contacts and his treasured collection of QSL cards numbered thousands.

Frequent certificates were gained in annual WIA competitions, often 1st place. Fred also wrote some articles for "Amateur Radio". Fred's final award was a certificate of congratulations, presented at the WIA Headquarters in April 2000. The citation read "For 68 years membership of the WIA and dedication to Amateur Radio".

Ada Stirk

(QTHR for VK2ABC in 2000 Callbook)

Ron lived at home in Dunbar Street, Stockton until he entered the hostel section of Wescott Nursing Home on 31st January 1997. Even though Ron had a heart condition, his death was sudden and unexpected. Representatives at the funeral were some family members of

the late Harold Whyte VK2AHA together with Bill Hall VK2XT, Merv Hardy VK2DA, Norm Stanley VK2BNS and Ron's second op; Darryl Boyce.

W M'D Stuart
98 Dunbar Street
Stockton 2295

SCOOOP PURCHASE!



**All-mode operation on the HF, 6m, 2m,
and 70cm bands with full satellite capability...**

Yaesu FT-847 'Earth Station'

Ready for action on SSB, CW, AM, FM and digital modes, the FT-847's compact size makes it ideal for a variety of portable/mobile applications as well as for serious base station operation. You get a solid 100W output on the HF and 6m bands, 50W output on both 2m and 70cm, dual fan cooling and a rugged diecast chassis. Plus, the ultra-quiet HEMT receive pre-amp on 2m and 70cm contributes to the FT-847's amazing sensitivity figures. Advanced Digital Signal Processing (DSP) circuitry enhances received signal/noise ratio for easier copy of signals under marginal conditions through the use of 16 selectable noise reduction algorithms, while the Bandpass and Auto-notch filters aid the IF based Shift and Noise Blanker circuits in reducing interference on crowded bands.

The FT-847 is ready for satellite operation, with crossband full duplex operation, normal and inverted VFO tracking of the satellite uplink/downlink, as well as 12 special satellite memories with alphanumeric tags. Also provided is a low-noise Direct Digital Synthesiser (DDS) that provides tuning steps as small as 0.1Hz, plus there's an adjustable DSP bandpass filter as narrow as 25Hz for exceptional weak-signal CW performance. You can also install optional Collins' mechanical filters in both the transmit and receive chain for enhanced SSB operation, as well as a 500Hz Collins' filter in the receiver side for CW. An effective speech processor with adjustable frequency shift voice tailoring is also provided to add punch to your SSB transmissions. The FT-847 is ready for data modes, with a rear panel Data In/Out socket and a packet socket for 1200/9600 baud VHF/UHF operation. Other features include extended receive operation (36-76, 108-174, and 420-512MHz), a high-speed computer control interface, 10-key keypad for band/frequency entry, and a shuttle-jog tuning ring for fast QSY. Also Included are encode/decode CTCSS and DCS

operation, selectable channelised steps for FM operation, FM narrow/wide modes for 29MHz use, and a large LCD screen with adjustable backlighting.

Each transceiver is supplied with a hand-mic, DC power lead and a comprehensive instruction manual. Call us for a copy of Yaesu's 6 page colour brochure to learn more about this incredible value 'Earth Station' transceiver.

D 3425

2 Year Warranty

YAESU

\$2995

SCOOOP PURCHASE!

SAVE \$44!

Offer expires 28/2/02

DICK SMITH
ELECTRONICS

That's where you go!

SOLID PERFORMANCE!

VX-5R 6m/2m/70cm Deluxe Handheld

Tiny, yet incredibly rugged, the VX-5R provides 6m, 2m and 70cm amateur band operation with 5W output as standard (4.5W on 70cm), made possible by a unique PA design, super high-capacity 7.2V 1100mA/H Lithium-ion battery, and a diecast metal case. Plus, ultra-wide VHF and UHF as well as medium-wave* and shortwave reception facilities are provided.

Another really useful feature is the large backlit dot-matrix LCD screen that can be configured to suit your operating needs. You can choose large frequency digits, dual line displays (VFO 'A' and 'B' frequencies, VFO 'A' frequency and battery voltage and even VFO 'A' frequency as well as other data such as recent Tx/Rx times or transceiver internal temperature), or even 8-digit alpha-numeric memory labels. All this in a diecast aluminium enclosure just 58W x 87H x 28D mm (w/o knobs or antenna)!

Other features include:

- Tx: 50-54, 144-148, 430-450MHz
- Rx: 0.5-1.8MHz, 1.8-16MHz, 48-729MHz, 800-999MHz (cellular blocked)
- Full feature keypad, CTCSS encode/decode, Digital Code Squelch
- Comprehensive menu system
- Over 200 regular memories, plus 10 pairs of 'Band limit' memories
- Fast battery charging from the supplied AC adaptor
- 5 battery saving systems, plus Tx/Rx usage monitor.
- Spectra-Scope™ for monitoring adjacent channel activity
- Comes with FNB-58LI 1100mA/H Lithium-Ion battery, flexible antenna and AC adaptor/charger

D 3670

*10kHz steps only.

2 Year Warranty

YAESU

\$599

All Yaesu products listed are priced in Australian dollars, and are not stocked in Dick Smith Electronics stores outside Australia. Check our web site www.dse.com.au for further ordering information.

Offer expires 28/2/2002.

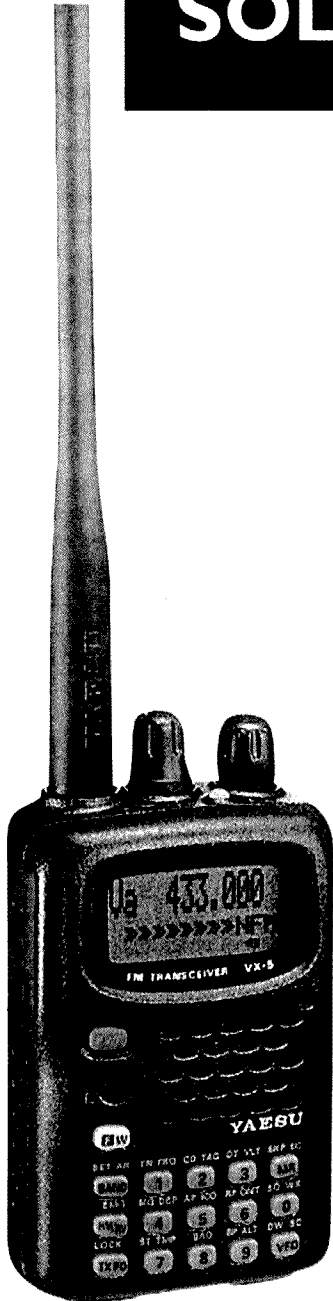

VX-5R pictured showing large frequency digits

PHONE FAX AND MAIL ORDERS

PHONE: Within Australia: 1300 366 644
(Local call charge)

FAX: (02) 9642 9155 within Australia and
(+612) 9642 9155 from outside Australia

MAIL: DICK SMITH ELECTRONICS, Direct Link, Reply Paid 500,
PO Box 500, Regents Park DC NSW 2143 (No stamp required)

Excludes packaging and postage. All major credit cards accepted. 14 Day Money Back Guaranteed if NOT completely satisfied. (Software, books, contracted phones, ADMS packages excluded)



Visit our web site at
<http://www.dse.com.au>

DICK SMITH

ELECTRONICS

That's where you go!

Yaesu transceivers and accessories stocked in selected Australian stores only. Other Australian stores can place orders on a deposit-paid basis. Offers expire 28/2/2002. All prices shown are in Australian dollars and are inclusive of GST.



Division Directory

The Amateur Radio Service exists for the purpose of self training, intercommunication and technical investigation. It is carried out by amateurs who are duly authorised people interested in radio technique solely with a personal aim and without pecuniary interest.

The Wireless Institute of Australia represents the interests of all radio amateurs throughout Australia. National representation is handled by the executive office under council direction. There is one councillor for each of the seven Divisions. This directory lists all the Divisional offices, broadcast schedules and subscription rates. All enquiries should be directed to your local Division.

Broadcast schedules All frequencies MHz. All times are local.

VK1 Division Australian Capital Territory,
GPO Box 600, Canberra ACT 2601
President Gilbert Hughes
Secretary Peter Kloppenburg
Treasurer Linden S Orr

VK1GH
VK1CPK
VK1LSO

VK2 Division New South Wales
109 Wigram St, Parramatta NSW
(PO Box 432, Harris Park, 2150)
(Office hours Mon-Fri 1100-1400)
Phone 02 9689 2417
Web: <http://www.ozemail.com.au/~vk2wi>
Freecall 1800 817 644
e-mail: vk2wi@ozemail.com.au
Fax 02 9633 1525

President Terry Davies
Secretary Pat Leeper
Treasurer Chris Minahan

VK2KDK
VK2JPA
VK2EJ

VK3 Division Victoria
40G Victory Boulevard Ashburton VIC 3147
(Office hours Tue 10.00 -2.30)
Phone 03 9885 9261
Web: <http://www.wiavic.org.au>
Fax 03 9885 9298
e-mail: wiavic@wiavic.org.au

President Jim Linton
Secretary John Brown
Treasurer Barry Wilton

VK3PC
VK3JJB
VK3XV

VK4 Division Queensland
PO Box 199, Wavell Heights, Qld. 4012
Phone 07 3221 9377
e-mail: office@wiaq.powerup.com.au
Fax 07 3266 4929
Web: <http://www.wia.org.au/vk4>

President Bill Riis
Secretary Bruce Jones
Treasurer Bill McDermott
Office Mgr John Stevens

VK4YCU
VK4EHT
VK4AZM
VK4AFS

VK5 Division South Australia and Northern Territory
(GPO Box 1234 Adelaide SA 5001)
Phone 0403 368 066
web: <http://www.sant.wia.org.au>
email: peter.reichert@bigpond.com

President David Minchin
Secretary Peter Reichelt
Treasurer Trevor Quick

VK5KK
VK5APR
VK5ATQ

VK6 Division Western Australia
PO Box 10 West Perth WA 6872
Phone 08 9351 8873
Web: <http://www.vk6wia.org>
e-mail: vk6wia@inet.net.au

President Neil Penfold
Secretary Christine Bastin
Treasurer Bruce Hedland-Thomas

VK6NE
VK6ZLZ
VK6OO

VK7 Division Tasmania
PO Box 371 Hobart TAS 7001
Phone 03 6234 3553 (BH)
Web: <http://www.tased.edu.au/tasonline/vk7wia>
also through <http://www.wis.org.au/vk7>
email: batesjw@netspace.net.au

President Phil Corby
Secretary John Bates
Treasurer John Bates

VK7ZAX
VK7RT
VK7RT

VK1WI: 3.590 LSB, 146.950 FM each Thursday evening from 8.00pm local time. The broadcast text is available on packet, on Internet [aus.radio.amateur.misc](http://www.ozemail.com.au/~vk2wi) news group, and on the VK1 Home Page <http://www.vk1.wia.ampr.org>

Annual Membership Fees. Full \$77.00 Pensioner or student \$70.00. Without *Amateur Radio* \$48.00

From VK2WI 1.845, 3.595, 7.146*, 10.125, 14.160, 24.950, 28.320, 29.120, 52.120, 52.525, 144.150, 147.000, 438.525, 1281.750 (* morning only) with relays to some of 18.120, 21.170, 584.750 ATV sound. Many country regions relay on 2 m or 70 cm repeaters. Sunday at 1000 and 1930. Highlights included in VK2AWX Newcastle news, Monday 1930 on 3.593 plus 10 m, 2 m, 70 cm, 23 cm. The broadcast text is available on the Internet newsgroup [aus.radio.amateur.misc](http://www.ozemail.com.au/~vk2wi), and on packet radio.

Annual Membership Fees. Full \$78.00 Pensioner or student \$61.00. Without *Amateur Radio* \$47.00

VK3BWI broadcasts on the 1st Sunday of the month at 20.00hrs Primary frequencies, 3.615 DSB, 7.085 LSB, and FM(R)s VK3RML 146.700, VK3RMM 147.250, VK3RWG 147.225, and 70 cm FM(R)s VK3ROU 438.225, and VK3RMU 438.075. Major news under call VK3ZWI on Victorian packet BBS and WIA VIC Web Site.

Annual Membership Fees. Full \$78.00 Pensioner or student \$61.00. Without *Amateur Radio* \$47.00

VK4WIA broadcasts on 1.825 MHz SSB, 3.605 MHz SSB, 7.118 MHz SSB, 10.135 MHz SSB, 14.342 MHz SSB, 21.175 MHz SSB, 28.400 MHz SSB, 29.660 MHz FM (rptr), 147.000 MHz, and 438.525 MHz (in the Brisbane region, and on regional VHF/UHF repeaters) at 0900 hrs K every Sunday morning. QNEWS is repeated Monday evenings, at 19.30 hrs K, on 3.605 MHz SSB and 147.000 MHz FM. On Sunday evenings, at 18.45 hrs K on 3.605SSB and 147.000 FM, a repeat of the previous week's edition of QNEWS is broadcast. Broadcast news in text form on packet is available under WIAQ@VKNET. QNEWS Text and real audio files available from the web site

Annual Membership Fees. Full \$83.00 Pensioner or student \$71.00. Without *Amateur Radio* \$52.00

VK5WI: 1827 kHz AM, 3.550 MHz LSB, 7.095 AM, 14.175 USB, 28.470 USB, 53.100 FM, 147.000 FM Adelaide, 146.800 FM Mildura, 146.900 FM South East, 146.925 FM Central North, 438.475 FM Adelaide North, ATV Ch 35 579.250 Adelaide. (NT) 3.555 USB, 7.065 USB, 10.125 USB, 146.700 FM, 0900 hrs Sunday. The repeat of the broadcast occurs Monday Nights at 1930hrs on 3585kHz and 146.675 MHz FM. The broadcast is available in 'Realaudio' format from the website at www.sant.wia.org.au Broadcast Page area.

Annual Membership Fees. Full \$82.00 Pensioner or student \$68.00. Without *Amateur Radio* \$54.00

VK6WIA: 146.700 FM(R) Perth at 0930hrs Sunday relayed on 1.865, 3.564, 7.075, 10.125, 14.116, 14.175, 21.185, 29.120 FM, 50.150 and 438.525 MHz. Country relays 3.582, 147.200 (R) Cataby, 147.350 (R) Busselton, 146.900 (R) Mt William (Bunbury), 147.000 (R) Katanning and 147.250 (R) Mt Saddleback. Broadcast repeated on 146.700 at 1900 hrs Sunday relayed on 1.865, 3.564 and 438.525 MHz : country relays on 146.900, 147.000, 147.200, 147.250 and 147.350 MHz..Also in "Real Audio" format from the VK6 WIA website

Annual Membership Fees. Full \$67.00 Pensioner or student \$61.00. Without *Amateur Radio* \$36.00

VK7WI: 146.700 MHz FM (VK7RHT) at 0930 hrs Sunday relayed on 147.000 (VK7RAA), 146.725 (VK7RNE), 146.625 (VK7RMD), 3.570, 7.090, 14.130, 52.100, 144.150 (Hobart), repeated Tues 3.590 at 1930 hrs.

Annual Membership Fees. Full \$85.00 Pensioner or student \$72.00. Without *Amateur Radio* \$52.00

VK8 Northern Territory (part of the VK5 Division and relays broadcasts from VK5 as shown, received on 14 or 28 MHz).

VK2 Notes

By Pat Leeper VK2JPA

By the time you read this, the office will have re-opened for business on January 8th 2002. We hope you had an enjoyable holiday season with lots of goodies in your stockings, as well as a recharge for those who have to go back to work.

The Annual General Meeting of the VK2 Division will take place on 13th April 2002, with nominations and agenda items due by 2nd March. Members will be notified by post in the middle of January, just in case they don't pick up on it elsewhere.

Hornsby and District Radio Club, which runs the morse beacon VK2RCW, has requested the Division to take it over as rising costs make it impossible for Hornsby to maintain it. The Council agreed to take the beacon to the Dural site, but it will have to have a call-sign change to VK2RSY along with the other beacons operating from Dural. The move will be made before the licence is due

for renewal in February, but no date can be given as yet.

We welcomed eight new members to the VK2 Division at the last Council meeting on 7th December.

Dural fared reasonably well in the storms of early December with no damage to the building but the trees suffered with broken branches, one of which partly demolished the old brick barbecue. Until we get permission from Hornsby Council to remove those branches caught up and to lop some of the trees to make them safe, the area under the trees will be roped off.

The Conference of Clubs was held on 8th December with a smaller than usual attendance. This must be put down to the change of date caused by the federal election as it brought the event too close to the Christmas season. Those attending had a rewarding time with the various

discussions brought up by attendees. One important matter brought up was the suggestion that a Voluntary Workers insurance scheme be set up similar to the Affiliated Clubs Public Liability scheme. The Division will need to know how many clubs are interested before we go ahead, and a mailing will be going out to the clubs to see what numbers we can come up with.

The next Conference of Clubs will be held on 11th May 2002.

The VK2 Librarian, Aub VK2AXT, has a project dear to his heart that he needs some help with. He has an AVO Mark 4 valve tester that he wants to set up in the library area so members can come in and test their valves. But it doesn't work and he needs a circuit diagram. Anyone out there help with this?

That's all for this month, see you next time.

VK4 Notes—Qnews

By Alistair Elrick VK4MV

Young Gun

6 year old home-brew?

No not stale beer laying in the corner of the Sunshine Coast Amateur Radio Club rooms, it's the youngest member of SCARC, Joel Falknau who won the junior home brew award for building his own PSK31 kit at the ripe old age of 6! In his presentation to club members up to 70 years his senior, his main claim to fame was "I only burnt my finger once" Hopefully he will become the third generation amateur in the Falknau family.

Cairns 'AR Club

The Cairns club has their 2 and 70 metre repeaters up and running on Mt. Yarrabah, SE of Cairns. Both repeaters are working well and the club is looking for reports. The 2-metre repeater is linked into the IRLP network with

stations from all over Australia and, of course, some International ones heard as well.

Ipswich

Word into the Q recently from Robert Bryce to say the Ipswich Clubs repeater is undergoing tests and they'd like reception reports of their 146.900 MHz repeater. Thanks to the generosity of commercial radio giant, RIVER 949, the Ipswich 146.9 repeater now sits high atop the Rivers Tower at Mt. Kobby.

As an aside Mike VK4XT from Dalby says RIVER 949 is heard at excellent strength out there so no doubt Mike will be trying for the Ipswich Repeater!

Wanted returned.

In the early hours of Sunday 25th thieves broke into the remote transmitter site of Radio 4BH in Brisbane. What was stolen you ask? 22 Satellite dishes being stored

there for Radio TAB. These dishes earmarked as replacements for the racing radio's network from Ceduna in VK5 to Townsville in Far North VK4. So if you're at your local pub and a shifty looking character whispers "wanna buy a hot dish"... LET ME KNOW!! Email: 4tabadmin @ 4tab.com.au or telephone Graham Kemp, Acting General Manager, on (07) 3360 1008.

P.S. only the dishes were stolen! Mounting mechanics were left behind.

Radio Scouting JOTA/JOTI

We had another exciting and successful Jamboree on The Air this year with plenty of overseas contacts being made by Scouts and Guides. It seems that radio contacts were a little higher than previous years.

On behalf of the Youth Members and Leaders of Scouts Australia -

Queensland Branch I would like to thank the Radio Operators that supported and assisted Scout Groups and Districts to participate in JOTA this year. Your support and expertise is greatly appreciated by all participants.

To date - I have just on 950 participants, although we have sold over 1200 badges with more orders coming thick and fast. We were able to allocate 24 Scout callsigns to Scout Groups this year, which is about the same as last year. Townsville, Mackay, Rockhampton, Sunshine Coast and Maryborough all had huge events.

There were plenty of small operations on the Gold Coast and Brisbane. Our biggest success story for the weekend was the JOTA & JOTI Base at Baden

Powell Scout Park in Samford, Brisbane with over 200 participants to the weekend camp - VK4SAA made plenty of contacts throughout the weekend with the help of 8 dedicated operators. Lots of Australian and overseas contacts were made and the participants were very interested in talking to Scouts and Guides on the radio. We were visited by the WIAQ with Secretary Bruce Jones seeing our set up on Saturday afternoon and he was able to join in the action, manning a radio for a couple of hours.

While I still have some administrative duties to tidy up for this year's JOTA - Date for next year - the 45th World Scout Jamboree On The Air will be on Saturday and Sunday 19th & 20th October 2002.

During the "off season" more PR & promotions will be happening though Scouts and I am very interested in talking to Amateur Clubs during the New Year.

In January the Australian Rover Moot will be happening on the Sunshine Coast and plans are under way for an Amateur Radio Station to be set up!

Stay tuned to the Q for more as it comes to hand. Again, thank you to those Operators who helped for JOTA 2001 - now onwards to JOTA 2002!

73s from Alistair

VK1 Notes

Forward Bias

The scheduled Trash & Treasure sale on November 24, 2001 was very successful. The Farrer compound was chukka full of stalls with something for almost everyone. Almost 50 visitors came to have a look and they were not disappointed. Items for sale included solid state transceivers, antenna couplers (ATU), aluminum chassis, circulators, directional couplers, dummy loads, transistors, integrated circuits (including voltage regulators), VHF and UHF Yagis, 12 volt power supplies, studio microphones, and a whole lot more, at ridiculously low prices. All stallholders agreed that another T & T should be held soon. Maybe April is a good time to hold one, when there is still a bit of sunshine in the air.

Classes for aspirant radio amateurs will start again in the first week of February. On offer will be Novice theory, Regulations, and Morse code at 5 and 10 words per minute. Classes for AOCF theory will be available if at least five applicants sign up for that course. Cost will be minimal; enough to cover basics,

and the purchase of textbooks. For those wanting a copy of the updated, but abridged, Amateur Regulations manual send an email to pkloppen@austarmetro.com.au. A course information evening will be held on February 1, 2002. You can also call Gilbert Hughes on 6254 3266 for details.

Marconi Day on 12 December was also very successful. The Division, through Gilbert Hughes (VK1GH), and staff of the Computer Sciences and Engineering School of the University of Canberra put up an antenna farm on top of Building 11, comprising vertical antennas for 10, 15, and 20 metres. The hamshack, right underneath the roof-covered ground mat, was equipped with modern transceivers and operated by Reginald Moger (VK1MV) and William Rawlings (VK1WR); both professional telegraphists. They used a special callsign issued for the occasion (VI1GM). Contacts were made with New Zealanders, Canadians, and U.K. amateurs. Satellite communications, using the School's 4-metre dish antenna, were conducted by Peter Ellis (VK1KEP),

who made a significant number of contacts with 70-cm uplink and 2-metre downlink equipment. For visitors to the open day, there were many things to see and hear. Equipment on show was Lasers with long-range distance measurement setups, antique radios from 1914 and 1923 - still working -, and a speech by Peter Jensen (VK2AQJ) about Marconi and his discoveries. The Gallery was hung with metre-square photographs of the various antenna systems that Marconi used in his propagation experiments in 1901, at Poldhu in the U.K.

Don't forget folks, the Annual General Meeting on February 24, 2002 will be preceded by a BBQ starting at 6:00 pm, in the compound of the Parks and Garden Depot in Longerenong St, Farrer.

The next Trash & Treasure sale will be held on Sunday, April 21, 2002 starting at 12:00 midday, also at the compound.

The next general meeting will be held on January 28, 2002 again at the Scout hall in Longerenong St. Farrer at 7.30 for 8.00 pm. Cheers.

The Voice of Afghanistan

The Afghani situation continues to be the focus of shortwave listeners. As I reported in the November 2001 column, the Americans mounted a psychological warfare unit called "Operation Solo", operating from a EC-130 aircraft flying at high altitude in a figure eight pattern. They were reportedly operating several AM and FM senders, after the Taliban transmitting centres in Kabul were taken out in bombing raids. This operation also was easily heard on 8700 kHz USB and was listed as an official frequency, although very few Afghans possessed receivers equipped with SSB. It could easily have been a Taliban point to point channel for command and control. However we quickly deduced that the SSB transmissions were not coming from an aircraft but from a fixed location, probably from an adjacent CIS nation, such as Turkmenistan.

The Northern Alliance army was supported by heavy American aerial firepower, which decimated the Taliban forces. Thousands of troops defected and surrendered cities such as Kabul, Herat, Mazar-el-sharif although fierce fighting raged around Kandahar and Kunduz. So complete was the downfall that the UN had to hastily organise a roundtable conference in Germany where the various factions could hammer out an interim government. A tentative agreement was reached just as this month's column was being written and a new interim administration in Kabul is to take over from December 22. The agreement also provided for UN troops to be stationed within Afghanistan.

The Northern Alliance quickly got transmitters on in Kabul, Herat and Mazar-el-sharif but these were low powered and not easily heard outside these cities.. It is unclear if the interim government will be able to commence broadcasting on shortwave as reports are that all the shortwave transmitting capabilities were completely decimated as a result of the American air raids.

Also at the end of November, a mysterious station emerged signing itself

as the "Voice of Afghanistan". This station is on 9950 kHz from 1330 to 1430 UTC with 15 minutes of Pashtoo and 15 minutes of Dari (Persian) with these being repeated in the second half-hour. What was interesting was that this station eventually identified itself as coming from London! The principal backer is *Said Jalal Karim*, who is an Afghan entrepreneur currently operating from there. Yet there is considerable speculation that it may be a front for either the American or British intelligence services as monitors detected a subtle anti-Northern Alliance bias, probably backing one of the other factions.

The station comes in well, being much stronger than the Psyops station on 8700 kHz. The sender is apparently at Samara within Russia, rated at 250 kW, although the studios are in London. So confident were the backers of this operation that they even held a press conference to announce the commencement of the station. The station's postal address is: Afghan Broadcasting Company, 21 Worship Street, London, UK EC2 2DW. It even has an email address of: afgbc9950@hotmail.com They have already replied to some reception reports via email. According to the station's backer, they are hoping to double their operational hours to 2 hours daily as from January 1st and commence as early as 1230.

The 8700 kHz operation may have gone by now due to the altered situation on the ground although the hunt continues for the al-Khayeeda terrorist cells. I have noticed that the signal does vary in signal strength.

Now the focus has turned to the perennial crisis between the Israelis and the Palestinians, following several nasty suicide bombings. Over the past 18 months, relations between the sides rapidly deteriorated following the appointment of Ariel Sharon as Israel's Prime Minister. In the first week of December, Israel had had enough and the Israeli Defence Forces were

unleashed to try and force the Palestinians to back down. I have noticed an escalation of the MOSSAD spy numbers signals. Stations such as "Charlie India Oscar" or "Victor Tango Oscar" or derivatives of that are easily heard throughout the HF spectrum, usually on USB with reduced carrier.

The morning news from Jerusalem in English is on daily at 0500 UTC

On 17545 khz directed to Australia and is immediately followed by French, This is a direct relay from one of the domestic networks.

These domestic networks are also easily heard via their shortwave relays.

They are of course in Hebrew and are on

0430-0600 15640
0500-1900 15760
0800-1900 17535
1700-0430 11585
1900-0500 9345
1900-1950 15640
1900-2300 9390
2100-2215 15640
2300-0600 7545.

Also Israel broadcasts in Arabic via shortwave on the following channels and again is a relay of their domestic service. It is carried 0400-2215 on 5915 9815 and 12145 kHz. The Palestinian Authority was given a MW channel plus several FM frequencies but no HF allocations. This has not prevented them from using shortwave frequencies from other sympathetic Arab neighbours.

As some of you may be aware, I recently moved into a retirement complex and now have a very temporary antenna sitting along the curtain rail for about 8 meters and only two meters high. Don't knock it as it does work although not as good if it is outside and much higher. This will happen shortly. Alas my transmitting days could be over as it is virtually impossible to operate except perhaps on low power via the local repeater. This is frustrating but I am determined to listen in.

Well that is all for now. Don't forget you can email me at vk7rh@wia.org.au.

73 de VK7RH

Six-monthly update of operational amateur radio satellites

This information is compiled from many sources including personal observations of my own and my friends. The information is as current as I can obtain at the time of writing. It relies heavily on the day-to-day happenings on the AMSAT-NA email bulletin board and by listening to and operating the satellites themselves.

AO-40

Launched: November 16, 2000 aboard an Ariane 5 launcher from Kourou, French Guiana.

Status: Currently, the U/L-1 to S-2 passband is active.

Uplink U-band 435.550-435.800 MHz CW/SSB

L1-band 1269.250-1269.500 MHz CW/SSB

L2-band 1268.325-1268.575 MHz CW/SSB

Downlink S2-band 2401.225-2401.475 MHz CW/SSB

AO-40 will be experiencing eclipses and other problems associated with sun-angle right through until April 2002. Some of these will render communications impossible and therefore the control stations may switch off all transponder operations on odd occasions. These periods will be kept to a minimum and as the sun-angle improves active periods will become longer.

There still remain a number of very important operations yet to take place in the commissioning of AO-40. The two most important for the long-term viability of AO-40 are, the unfurling of the solar cell panels and the switch to 3-axis stabilisation (permanent earth-pointing attitude). As a precursor to carrying out these operations, the control stations are using the eclipse time to manipulate the attitude of AO-40. It will be made to drift from its present value through 180,0 and back again to 0,0 during the eclipse period. In doing

so it will pass through periods of very poor squint angles and during those periods the transponders may as well be turned off. When this critical period is over and full power is again available, it will be time to continue the tests on the 3-axis stabilisation system. If it all works properly the solar cells will be unfurled to allow for continuous operation.

There is no firm timetable for these events but they are expected to be undertaken soon after the eclipse period ends in April 2002. The unfurling of the solar array is a "one-off" operation. It cannot be reversed. If successful it will then allow the deployment of the HF antenna which until that time will remain coiled up inside the space-frame behind the solar array panels. Once the HF antenna is deployed, the 10 and 15 metre receivers can then be turned on and tested. They can be linked to the S-band or K-band downlinks.

The latest news on AO-40 happenings is always available on the AMSAT-NA bulletin board. Please be patient. These are delicate, critical operations and the control stations are doing their best to give us a bird which is in the best possible condition for as long into the future as possible. In the meantime, reports are coming to hand daily of excellent operating conditions on mode U/L-S. Strong signals and wide footprints are the order of the day despite the less than optimum squint angles. If all goes well with the 3-axis stabilisation and the solar array unfurling we should have a truly marvellous communication satellite with narrow and wide angle camera operations, RUDAK digital mailbox, 24GHz and laser experimental comms packages and perhaps even two HF uplinks on 21 MHz and 28 MHz. Enough to keep us all happy for some time to come.

The AMSAT group in Australia

The National Co-ordinator of AMSAT-VK is Graham Ratcliff VK5AGR. No formal application is necessary for membership and no membership fees apply. Graham maintains an email mailing list for breaking news and such things as software releases. Members use the AMSAT-Australia HF net as a forum.

AMSAT-Australia HF net

The net meets formally on the second Sunday evening of the month. In winter (end of March until the end of October) the net meets on 3.685 MHz at 1000UTC with early check-ins at 0945UTC. In summer (end of October until end of March) the net meets on 7.068 MHz at 0900UTC with early check-ins at 0845UTC. All communication regarding AMSAT-Australia matters can be addressed to:

AMSAT-VK,
GPO Box 2141,
Adelaide, SA. 5001.

Graham's email address is:
vk5agr@amsat.org

International Space Station (ISS)

Worldwide packet uplink: 145.990 MHz

Region 1 voice uplink: 145.200 MHz

Region 2/3 voice uplink: 144.490 MHz

Worldwide downlink: 145.800 MHz

TNC callsign: NO CALL

The initial amateur radio station equipment was delivered to the ISS in September 2000 aboard shuttle Atlantis. ARISS (the organisation) is made up of delegates from major national Amateur Radio bodies, including AMSAT. The ISS packet station is normally available for UI packets. It is therefore possible to digipeat your position packets through it using APRS or Ulview (type) software. The mailbox and keyboard

are currently disabled. You are advised to visit the packet section of the ARISS web page before attempting to first work ISS on packet. The ISS crew members are very busy. They have a demanding daily schedule. The daily crew schedule (which gives an idea when crew members have free time and may be available for Amateur Radio operations) can be found at: <http://spaceflight.nasa.gov/station/timelines/2001/may/index.html>. When the crew members are operating the amateur radio station, they will use the following callsigns:

U.S. callsign: NA1SS
 Russian callsigns: RS0ISS, RZ3DZR

RS-12

Uplink 145.910 to 145.950 MHz CW/SSB
 Downlink 29.410 to 29.450 MHz CW/SSB
 Beacon 29.408 MHz

Launched: February 5, 1991 aboard a Russian Cosmos C launcher. Status: RS-12 was re-activated in mode-A on January 1, 2001. The latest information on RS-12 and RS-13 can be found on the AC5DK RS-12/13 Satellite Operators page at: <http://www.qsl.net/ac5dk/rs1213/rs1213.html>.

RS-15

Uplink 145.858 to 145.898 MHz CW/SSB
 Downlink 29.354 to 29.394 MHz CW/SSB
 Beacon 29.352 MHz (intermittent)

SSB meeting frequency 29.380 MHz (unofficial)
 Launched: December 26, 1994 from the Baikonur Cosmodrome. Status: Semi-operational, mode-A, using a 2-metre uplink and a 10-metre downlink. Dave, WB6LLO, has operating information for RS-15 on his web site. In addition to satellite data, antenna information for mode-A operation is also featured. The WB6LLO web site URL is: <http://home.san.rr.com/doguimont/uploads>.

AO-10

Uplink 435.030 to 435.180 MHz CW/LSB
 Downlink 145.975 to 145.825 MHz CW/USB
 Beacon 145.810 MHz (unmodulated carrier)

Launched: June 16, 1983 by an Ariane launcher from Kourou, French Guiana.

Status: Semi-operational, mode-B. AO-10 has been locked into a 70-cm uplink and a 2-metre downlink for several years. AO-10 has been undergoing something of a 're-discovery' since the launch of AO-40 which has attracted a lot more interest in the high orbit birds. Hardly a day goes by without reports of good international contacts being made. Remember however to listen to the beacon regularly during an operating session and cease transmission if the beacon is FM-ing. This is standard procedure on AO-10. Stacey Mills maintains a web site for AO-10.

Visit <http://www.cstone.net/~w4sm/AO-10.html> for the latest information.

UO-14

Uplink 145.975 MHz FM
 Downlink 435.070 MHz FM

Launched: January 22, 1990 by an Ariane launcher from Kourou, French Guiana.
 Status: Operational, mode J

FO-20

Uplink 145.90 to 146.00 MHz CW/LSB
 Downlink 435.80 to 435.90 MHz CW/USB

Launched: February 07, 1990 by an H1 launcher from the Tanegashima Space Center in Japan. Status: Operational. FO-20 is in mode JA.

FO-29

Launched: August 17, 1996, by an H-2 launcher from the Tanegashima Space Center in Japan.

Status: Operational
 Voice/CW Mode JA

Uplink 145.90 to 146.00 MHz CW/LSB
 Downlink 435.80 to 435.90 MHz CW/USB

Digital Mode JD

Uplink 145.850 145.870 145.910 MHz FM
 Downlink 435.910 MHz 1200-baud BPSK or 9600-baud FSK

Callsign 8J1JCS

Digital talker 435.910 MHz

FO-29 has been switched into mode JA for the latter part of 2001. No further scheduling was available at the time of writing.

PCSat

Uplink/downlink 145.830 MHz 1200 baud AX-25 AFSK
 via PCSAT-1

Uplink 435.250 MHz 9600 baud via PCSAT-2

APRS Downlink 144.390 MHz (Region 2)

Launched: September 30, 2001 aboard an Athena-1 rocket from the Kodiak Alaska Launch Complex.

Status: Operational but experiencing difficulties due to long solar eclipses. At the time of writing, PCSat is in trouble due to long eclipse periods each day. For some unknown reason it seems to be resetting itself to high power mode towards the end of almost every period of eclipse. This situation is potentially critical and could result in premature battery failure. The satellite may not survive until the sun-angles improve but in an endeavor to recover it, a number of control stations have been set up around the globe. These stations are resetting PCSat when it is observed to be switched back into high power mode. It is hoped that in this way it can be coaxed along to survive the eclipse period but time will tell. In the meantime digipeating and most other operations have been turned off to conserve battery power. You can watch the telemetry yourself to see first hand what is the situation. Each telemetry string consists of a number of fields separated by commas. Towards the end of each telemetry string is a series of 8 digits which are usually either all 1s (,11111111,) indicating high power mode or 00111111, indicating low power mode, the first two digits being the critical ones. On the last two passes which I monitored prior to submitting this column, the reset had been successful for a couple of orbits without intervention but some garbage characters have been noticed in the TLM string on the last pass and this is NOT a good sign. Keep your fingers crossed. Bob Bruninga was anxious to keep the bird operational so it could be activated during the Marconi-day celebrations.

TIUNGSAT-1

Uplink 145.850 or 145.925 MHz
9600-baud FSK
Downlink 437.325 MHz
38400-baud FSK
Broadcast callsign MYSAT3-11
BBS MYSAT3-12
Launched: September 26, 2000 aboard a converted Soviet ballistic missile from the Baikonur Cosmodrome.
Status: Operational at 38k4-baud FSK. The power budget will not allow continuous operation. It may be turned off when it comes into range. Ground station software is therefore needed to allow operators to command the satellite transmitter to switch on. Data recovery rates are very high on Tiungsat-1. The dynamic efficiency sits around 100% for most of each pass. Downloads of well over 2 megabytes and nudging 3 megabytes per pass are common. Tiungsat-1 is a prime example of just how well a digital satellite can perform. The latest round of high resolution images contained a number from our neck-of-the-woods.

UO-22

Uplink 145.900 or 145.975 MHz
FM 9600-baud FSK
Downlink 435.120 MHz FM
Broadcast Callsign UOSAT5-11
BBS UOSAT5-12
Launched: July 17, 1991 by an Ariane launcher from Kourou, French Guiana.
Status: Operational. More than 10 years on and once again the "old reliable" UO-22 is being called upon to carry more than its allotted load. KO-23 is unlikely to return to service and KO-25 is suffering from very poor download efficiencies.

Together with the normal packet radio "satgate" traffic, UO-22 appears to be coping very well. The store-and-forward BBS is always busy and download efficiency runs around 100% for most of each pass. My station automatically checks out UO-22 each day. It keeps my computer clock accurate and updates my tracking programs with fresh keplerian elements every few days.

What would we do without good old UO-22? A big thank you to Chris and the team at UoS who somehow magically keep her in 'apple-pie' order.

UO-11

Downlink 145.825 MHz FM
(1200-baud AFSK)
Mode-S Beacon 2401.500 MHz
Launched: March 1, 1984 by a Delta-Thor rocket from Vandenberg Air Force Base in California.
Status: Operational and still performing its educational functions perfectly after almost 17 years in space. Signals from this old-timer are still sufficient for even modest receiving stations to extract useful data from its telemetry broadcasts. This satellite is worth the effort, even if only for old times sake. It gives a glimpse of the forward thinking that went into its design at Surrey University in 1983 during the early, heady days of the amateur/academic organisation that preceded SSTL. More information on OSCAR-11 is available at G3CWV, Clive Wallis' very informative site, <http://www.users.zetnet.co.uk/clivew/>. Oscar-11's reliable 2.4 GHz beacon is still being used as a 'yard-stick' for testing state-of-the-art microwave downlink systems being setup for AO-40 ground stations. This aging satellite is thus linking two eras in Amateur Radio Satellite technology.

AO-16

Uplink 145.90 145.92 145.94 145.96 MHz FM
(using 1200-baud Manchester FSK)
Downlink 437.025 MHz SSB
(RC-BPSK 1200-baud PSK)
Mode-S Beacon 2401.1428 MHz
Broadcast Callsign: PACSAT-11
BBS PACSAT-12
Launched: January 22, 1990 by an Ariane launcher from Kourou, French Guiana.
Status: Semi-operational, the digipeater command is on and is in use mainly by APRS stations for automated position reporting.

IO-26

Uplink 145.875 145.900 145.925 145.950 MHz FM
(1200-baud)
Downlink 435.822 MHz SSB
Broadcast Callsign ITMSAT-11
BBS ITMSAT-12
Launched: September 26, 1993 by an Ariane launcher from Kourou, French Guiana.

Status: Semi-operational, the digipeater function is on and open for APRS/Ulview users.

KO-25

Uplink 145.980 MHz FM
(9600-baud FSK)
Downlink 436.500 MHz FM
Broadcast Callsign HL02-11
BBS HL02-12
Launched: September 26, 1993 by an Ariane launcher from Kourou, French Guiana.
Status: Semi-operational with very low downlink efficiency. I have been trying to download the same file since October 2001 with very little (if anything) being downloaded each pass. I have seen no explanation of why this is so. Keep the fingers crossed on this one.

UO-36

Uplink 145.960 MHz
(9600-baud FSK)
Downlink 437.025 MHz 437.400 MHz
(38k4-baud FSK)
Broadcast Callsign UO121-11
BBS UO121-12
Launched: April 21, 1999 by a Russian launcher from the Baikonur Cosmodrome.
Status: Unknown, with very little activity heard for some months now but it's still on the 'active' list. Hopefully this excellent bird will be recovered from whatever ails it at present. Its often stunning picture quality was the best of any of the imaging birds. Like Tiungsat-1, it too requires the ground station to have the ability to turn on the satellite transmitter when it comes into range. The same software does the job for both satellites.

Starshine3 and Sapphire

Both these satellites were launched in cluster with PCsat. They are both reported as having beacons in the 2-metre amateur radio band. So far, I have heard neither, but early reports indicated activity from both these birds. Starshine3 is designed to be visible to the un-aided eye when in sunlight and the project is directed towards school children all over the world, many of whom were involved in aspects of its construction (mirror polishing etc.). It is a 1 metre sphere, covered in small circular mirrors which reflect the

sunlight as Starshine rotates. Despite many attempts to see this satellite, neither I nor any of my satellite-watching friends have been successful to date. We'd really like to hear from anyone who has actually seen Starshine3.

That concludes the list of operational amateur radio satellites at the end of 2001. You will notice one or two missing from last year's list. Like all good things, amateur radio satellites do come to an end. Sadly some never even see the

'light-of-day' so to speak despite the best of efforts by their designer/builders. We do owe these people a debt of gratitude and we would all be the losers were it not for their tireless efforts. Bob and the team at the US Naval Academy recently spent a 36-hour, sleepless period trying to recover PCsat from the eclipses. That is not all that unusual. The AO-40 control team has been doing such things off and on for the first year of AO-40's life. New plans are always on the drawing board, new satellites are always

being dreamed-up. Watch the AMSAT bulletin board at www.amsat.org for the latest information. Come and take part. Contribute your ideas. The planners are out there watching and you can bet they will pick up any ideas worthy of inclusion. Watch this space in 2002 for news of "Project-JJ".

I hope you have all survived the ever-more-hectic festive season and are ready for the fray in 2002....

Bill, VK3JT
ar

Club News

Central Coast Amateur Radio Club Field Day

The Central Coast Amateur Radio Club Hosts the Southern

Hemisphere's Largest Amateur Radio and Communications Show

On Sunday 24th February 2002 the Central Coast is host to the largest gathering of Radio Amateurs, Radio Communications Enthusiasts, Computer and Electronic Hobbyists in the Southern Hemisphere. More than 2000 people from 40 clubs and organisation from all over Australia and the Pacific will converge on Wyong Racecourse to display and trade the latest radio communications equipment. Exhibits and operating displays will show and demonstrate:

- All facets of Amateur Radio
- CB Radio
- Shortwave Listening and Scanning
- Packet Radio - Computerised Communications
- Television and Multimedia

transmission and reception demonstrations

- Interesting technical lectures, seminars and workshops
- Electronic construction
- Exhibits of Vintage and Historical Radio collecting and restoration
- Volunteer Emergency Communications
- Satellite Reception
- Hobby computing
- Internet communications
- Radio Fox Hunting
- Truckloads of pre-loved equipment at give away prices in the flea market and disposals areas.
- See all major Radio and electronics equipment suppliers together under one roof with many dealers showing the latest offerings and great bargains

Throughout the day there will be several seminar sessions and workshops

on topical subjects, with presentations from experts and equipment suppliers, including talks on the latest technology.

Plenty of off street parking is available within Wyong Racecourse grounds. Tea, coffee and biscuits will be available from 8.30 am to 3.00 p.m. at no charge in the Dining Room. Hot and cold food can also be purchased within Wyong Racecourse.

Anyone with an interest in radio communications or electronics can contact the event organisers, The Central Coast Amateur Radio Club, by phoning 02 43402500 for more information. There is an extensive and informative web site covering the Field Day at www.ccarc.org.au.

Gates to the Racecourse will be open to the public from 8.30am Entrance fee: Adults \$10.00, Seniors Card, pensioner concession, students \$5.00, Children under 12 free.

The Central Coast Amateur Radio Club presents

Central Coast Field Day

for

RADIO AMATEURS AND ENTHUSIASTS, COMPUTER AND ELECTRONIC HOBBYISTS

Sunday 24th February, 2002

Gates Open 8.30 am

DON'T MISS THE BIGGEST FIELD DAY AND HAMFEST IN THE SOUTHERN HEMISPHERE

For further information write to The CCARC, PO Box 346, Woy Woy, 2256 NSW
Phone 02 4340 2500, Web www.ccarc.org.au, Email vk2afy@hotmail.com

Beyond Our Shores

David A. Pilley VK2AYD
davpil@midcoast.com.au

This month most of the reports are from QNEWS, which is broadcast from VK4 every Sunday and Monday.

Interesting Statistics

USKA (Swiss Union of Short Wave Amateurs) recently printed a breakdown in their magazine "Old Man", of Radio Amateurs around the world. The total was shown as 2,986,722 with Japan heading the list with 1,296,056. The growth seemed to be more in the third world countries. The breakdown also showed the percentage of Amateurs who were members of their respective national societies. Iceland topped the list at 95% but then there are not too many Amateurs there! Finland was high with 87%. Australia was shown as 30%. There was also a breakdown showing the Amateur population compared with the national population and you can imagine, Japan topped out again with 10.3%. Australia was 0.84%. It also went on to show Amateurs per 100 km², but that's not a fair analysis for VK.

(from Hans VK4/HE9RFF)

Russia sees RED on Non-CW Licences

The Russian Federation supports the retention of mandatory Morse code licence tests for the Amateur Service according to a packet bulletin from VK3ZWI.

The Russian Federation also advocates the retention of ITU RR S25.3 that prohibits third party traffic out of concern of commercialisation of the Amateur Service, and it does not fully agree with a proposed change to S19 intended to give more flexibility in the formation of amateur call-signs.

(QNEWS 20/10)

New York City Television Seeks New Home

November: Seven weeks after a terrorist attack caused the collapse of the World Trade Centre, hundreds of thousands of homes in the New York City area remain unable to receive more than four television stations.

Because the main antennas atop the north tower came down, all the local stations, except Channels 2 and 41, which had backup antennas on the Empire State Building, had lost a significant part of their audiences.

WNBC-TV channel 4 which in the late 1940's was the first to broadcast from the Empire State Building made a triumphant return when it flipped the switch on its new Empire located transmitter.

The Empire State Building was the home to almost all New York City television broadcasters before the World Trade Centre was built.

(ARNewsline(tm) from various published news reports.)

W1AW

Maxim Memorial Station W1AW has made some hardware changes to its 40-metre bulletin/code practice transmitter and now is seeking signal reports.

Reports should note location, time of reception, mode, signal strength and quality. Use of the standard RST system is acceptable.

Mail reports on a postcard to W1AW 40-metre reports, 225 Main St, Newington, CT 06111. E-mail reports may be sent to w1aw@arrl.org.

W1AW's schedule calls for Morse practice Tuesdays through Fridays, 14:00Z and Morse practice/bulletins Mondays through Fridays 21:00-23:00Z, both on 7047.5 kHz. The weekday digital transmission begins at 23:00Z on 7095 kHz. A phone bulletin is transmitted daily at 01.45Z on 7290 kHz.

The complete W1AW operating schedule is on the ARRL Web site: <http://www.arrl.org/w1aw.html>.

Final Frontier

SpaceDaily reports a new survey by the Teal Group has identified some 600 active satellites in Earth orbit or in deep space. The survey factored in all satellites launched since 1980, and, after a process of elimination, arrived at an estimate of 600 to 610 for satellites that remain active today. (We'll soon have a super reflector up there!)

(AMSAT-NA via ARNewsLine)

ISS DXCC?

The International Space Station Expedition 4, crew of Commander Yuri Onufrienko, Flight Engineers Dan Bursch, KC5PNU and Carl Walz, KC5TIE, were launched aboard the shuttle Endeavour November 29. In addition to a new crew, new Amateur Radio antennas are manifested aboard the shuttle for transport to the ISS. The new antennas will be installed around the perimeter of the Service Module, allowing future operation from HF to microwave frequencies. The HF antenna is made up of a flexible tape that will work on 10-metres—and possibly 15 and 20 metres.

The ISS is on orbit at an average altitude of 395 kilometres above Earth.

For more information about the ISS, visit NASA's Human Space Flight Web site, <http://spaceflight.nasa.gov/>.

(NASA via AMSAT News service)

Emergency Comms

Watching CNN News on TV, my ears pricked up when the announcer said the only communications from many of the islands struck by Hurricane Michelle was by amateur radio.

Hurricane Michelle, boasting winds of up to 216 km/h, swept across Cuba and the Bahamas November 3-5. The Hurricane Watch Net and W4EHW at the National Hurricane Centre in Miami teamed up to provide forecasters with real-time surface reports. Amateur radio also was used for the first time to communicate directly with a hurricane hunter aircraft as it was in the eye of a hurricane over land.

A few months back astronauts on the ISS were asked by school students how they would communicate should the power fail and they responded "By Amateur Radio". Perhaps that's the reason why most astronauts are radio amateurs!

Is your hand-held charged-jic?

(arrl letter)

Afghanistan

I wonder how many readers have at last had a QSO with that most wanted DXCC country?

ARRL approves Afghanistan operation

for DXCC: The ARRL DXCC Desk reports it has received acceptable documentation for YA5T in Afghanistan and has approved it for DXCC credit. Afghanistan is among the top 10 "most wanted" countries. The license, which authorizes operation on all bands—including 6 metres—was issued by the Islamic Republic of Afghanistan government that's still recognized by the United Nations. YA5T will be operated by Peter Casier, ON6TT, as well as by Mats Persson, SM7PKK, Robert Kasca, S53R, and Mark Demeuleneere, ON4WW. All work for the UN World Food Program. YA5T will be on the air as their schedules permit. The DXCC documentation is for contacts made on or after November 20, 2001. No other call signs or operations have been approved. For more information, visit the YA5T Web site managed by Bruce Richards, WD4NGB <http://www.qsl.net/ya5t/>.

(ARRL Nov 30 N/L)

G3AQC's signal spans the Atlantic on 73 kHz!

Low-frequency experimenter Lawrence "Laurie" Mayhead, G3AQC, has added another LF accomplishment to his list—transatlantic reception of his 73 kHz

signal. Word of the LF exploit came just weeks before the centennial of the historic transatlantic transmission of December 12, 1901, when Guglielmo Marconi, in Newfoundland, received the letter "S" transmitted from England.

Laurie, operating on 72.401 kHz was received in the U.S. by John Andrews, W1TAG.

He was using dual-frequency CW (known as DFCQ) featuring elements that are 2 minutes long. Andrew detected his signal using ARGO DSP software.

Figured by grid squares, the distance between G3AQC and W1TAG was 3275 miles (5270 km).

Andrews said he lives in a residential area that's not known for being especially "quiet," so he's puzzled that he's apparently the only US station to hear the 73-kHz transmissions from the UK.

Last February, Mayhead and Larry Kayser, VA3LK, in Ontario, completed a transatlantic Amateur Radio contact on 136 kHz. The UK's 73-kHz band is a 2.8 kHz sliver of spectrum, from 71.6 to 74.4 kHz.

The ARRL has petitioned the FCC to create two low-frequency Amateur Radio

allocations—at 136 kHz and at 160-190 kHz. FCC action is anticipated in 2002.

(ARRL Nov 30 N/L)

On the lighter side

Two letters in the December RSGB RadCom caught my eye.

G3GTF had noticed that in a picture on the cover of the September RadCom, 80% of the people featured were wearing spectacles. (The picture was of a group of Amateurs taking part in a Morse Campaign, all with telegraphy keys at their fingertips). G3GTF is a Morse aficionado and also wears spectacles.

Question: Is Morse bad for the eyesight?!

The next letter was from G0LYY. was not surprised at the lack of success the experiments using trees as antennas had produced. He fell to wondering how many experiments had been done with the traditional 'wet string'? (It's very easily portable).

Questions: Does a length of wet string stay wet with RF running through it?

Does it work better in rain or sunshine?

So what have you been experimenting with lately...?

Wishing you happy hamming in 2002.

AVO Mk 4 circuit diagram wanted

The VK2 Librarian, Aub VK2AXT, has a project dear to his heart that he needs some help with. He has an AVO Mark 4 valve tester that he wants to set up in the library area so members can come in and test their valves. But it doesn't work and he needs a circuit diagram. Anyone out there help with this?

Contact Aub via the divisional office.

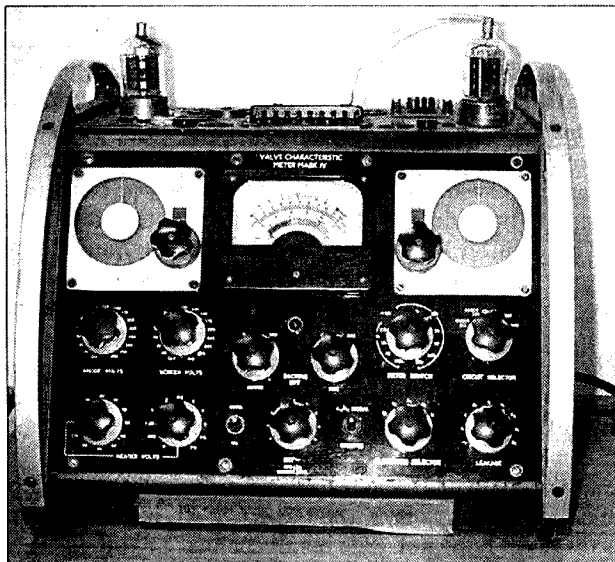

Calibrating

Tune: Home on the Range

Oh give me an ohm, where the amperes roam,
Where the volts and the decibels play.
Where the rocks that you see,
Are all called BC3,
With their frequencies put there to stay.

Chorus:

Ohm, ohm in my cage,
It was there that I first learned to pray,
When each LD2 was blown neatly through,
And the quartz was all cloudy all day.

discovered b Colin Consiglio - SWL
WIA - L30371 on <http://www.bliley.net/XTAL/History.html>

Contests

Ian Godsil VK3VP
contests@wia.org.au

Contest Calendar January-March 2002

Jan	5-6	ARRL RTTY Roundup		
Jan	12-13	Summer VHF Field Day		(Dec 01)
Jan	11-13	Japan Intl DX Contest 160m-40m	(CW)	(Dec 01)
Jan	20	HA DX Contest	(CW)	
Jan	25-27	CQ 160 Metres Contest	(CW)	
Jan	26-27	REF Contest		
Feb	2-3	Ten-Ten Intl. QSO Party	(SSB)	
Feb	9-10	WW RTTY WPX Contest	(RTTY)	
Feb	9	Asia-Pacific Sprint	(CW)	
Feb	9-10	PACC Contest	(CW/SSB)	
Feb	16-17	ARRL Intl. DX Contest	(CW)	
Feb	22-24	CQ 160 Metres Contest	(SSB)	
Feb	23-24	REF DX Contest	(SSB)	
Feb	23-24	RSGB 7MHz DX Contest	(CW)	
Feb	24	High Speed Club CW Contests		
Mar	2/3	ARRL Intl. DX Contest	(SSB)	
Mar	9/10	RSGB Commonwealth Contest		(Jan 02)
Mar	9/10	WWL DX Contest	(CW/SSB)	
Mar	16/17	John Moyle Field Day		
Mar	16/17	Bermuda Contest	(CW/SSB)	
Mar	16/17	DARC SSTV Contest		
Mar	16/17	Russian DX Contest	(CW/SSB)	
Mar	23/24	CQ WW WPX Contest	(SSB)	

A VERY HAPPY NEW YEAR to you all and I hope that it will be a pleasant one with not too many worries.

Please notice that I write "pleasant" and not "good", for the simple reason that very few of us are not caught up in some way with the stresses and strains of our community — notably increased working hours for those who have jobs and increased costs for all of us. There isn't a Club or specific-interest group today that is not desperate for a dollar, and that includes the WIA and your local Radio Club.

If things continue as they have been last year, there will be clubs that will close for lack of continued support.

Future of VK Contests

Whilst this column cannot proffer solutions to the economic ills of Society, I do wonder if something like this may happen to our local contests.

Those of you who seriously support our VK contests will know that there has been falling participation in several events over some years and some contests have now gone. I am pleased to report that this does NOT apply to the revamped Oceania DX Contest, of which I hope to have details in a few months.

The smaller events also need your support — the Ross Hull and VHF Field Day this month; John Moyle F/D in March; VK-Tasman in June. I have made a separate list of this year's events and I ask you all to put these dates into your diaries NOW, with a note to take part.

The RD will always be the "popular" contest, but even it seems to show signs of falling participation in some sections. Is this so? I hope not. (See results below to form your own opinion.)

Sometimes things become static, so perhaps you can think of ways to spark

up our VK contests. If so, PLEASE let me have your ideas, preferably in writing via e-mail to the address above, or by postal mail to 57 Nepean Highway, Aspendale, 3195. I can think of a few things, but there must be other ways that you can see to improve things — changes to rules, scoring systems, etc.

As with the future of the WIA, if we don't ALL work together the activities will disappear. This would not only be a shame, but also show us in Australia as running contrary to the trends in New Zealand, America and Europe, where contest participation is increasing each year.

I really look forward to any serious contributions from you. Meanwhile, good luck in the VHF contests this month.

73, Ian Godsil VK3VP

Australian Contests 2002

(Dates to be finally confirmed, but should be correct. Please note these and aim to participate this year.)

to 13	Jan	Ross Hull VHF	20	July	Pacific 160 Metres
12/13	Jan	VHF Field Day	17/18	Aug	RD
16/17	March	John Moyle Field Day	24/25	Aug	Alara
25	April	Harry Angel Sprint	5/6	Oct	Oceania DX
1	June	VK/Tasman	12/13	Oct	Oceania DX
8	June	QRP Day	9	Nov	VHF Field Day
15/16	June	Novice	26	Dec	Ross Hull VHF

65th Commonwealth Contest 2002 Rules

NOTE RULE CHANGES

1. **START TIME** will be 1000 UTC on 9th March 2002 and **FINISH** is 1000 UTC on 10th March 2002
2. In Restricted Section the requirement of at least 4 hours operation after 0001 on the second day is removed.
3. Ducie Island, VP6, is added to the call area list.
4. As this is the Golden Jubilee year for HM The Queen, a special certificate will be awarded to any entrant making contact with more than 50 band-call areas.

RULES

The Commonwealth Contest promotes contacts between stations in the Commonwealth and Mandated Territories. See table for qualifying Call Areas. A more relaxed contest environment which gives you the opportunity to work some choice DX. These rules should be read in conjunction with RSGB General Rules in the RSGB Contesting Guide 2002.

Date: 9/10 March 2002
Time: 1000 to 1000
Bands: All HF (no WARC)
MODE: CW

EXCHANGE: RST + Serial number

1. **Eligible entrants:** UK entrants must be members of RSGB. Overseas-Licensed Radio Amateurs within the Commonwealth or British Mandated Territories. Single-operator. Entrants may not receive any assistance during the contest, including the use of spotting nets, packet clusters or other assistance in finding new bonuses. 'Headquarters stations', GB or other UK special event call signs and maritime or aeronautical mobile are not eligible. Entries from 'Commonwealth Society Headquarters stations' are welcome and will be scored and shown separately in the results.
2. **Sections:** (a) Open, no limit on operating time. (b) Restricted, operation is limited to 12 hours. Off periods must be clearly marked and a minimum of 60 minutes in length.
3. **Frequencies:** Entrants should operate in the lower 30kHz of each band, except when contacting Novice stations operating above 21030 and 28030kHz.
4. **Scoring:** Contacts may be made with any station using a Commonwealth Call Area prefix except those within the entrants own Call Area. Note that for this contest, the

entire UK counts as ONE call area, and therefore UK stations may not work each other for points. Each contact scores 5 points, with a bonus of 20 points for each of the first three contacts with each Commonwealth Call Area, on each band.

5. **"Headquarters" Stations:** A number of Commonwealth Society HQ stations are expected to be active during the contest and will send 'HQ' after their serial number, to identify themselves. Every HQ station counts as an additional call area and entrants may contact their own HQ station for points and bonuses.

Entries from Headquarters stations are welcome and will be scored and shown separately in the results.

6. **Logs:** Separate logs and lists of bonuses claimed are required for each band. Entries must be accompanied by a summary sheet indicating the section entered and the scores claimed on each band.
7. **Address for logs:** RSGB HF Contests Committee, c/o S.V.KNOWLES G3UFY, 77 Bensham Manor Road, Thornton Heath, Surrey, CR7 7AF, UK
8. **Closing Date for Logs:** Logs must be postmarked no later than 7 April, 2002.
9. **Awards:**

- (a) **Open-The Senior Rose Bowl** will be awarded to the overall leader. The Col. Thomas Rose Bowl will be awarded to the highest-placed UK station. Certificates of Merit will be awarded to the leading three entrants overall and to the leading stations in each Call Area.
- (b) **Restricted-The Junior Rose Bowl** will be awarded to the leading station. Certificates of Merit will be awarded to the leading three entrants overall and to the leading stations in each Call Area.
- (c) A Commonwealth Medal will be awarded to the entrant in either section who in the opinion of the HF Contest Committee has most improved his or her score, or contributed significantly to the contest over the years.
- (d) A Special Golden Jubilee Certificate will be awarded to every entrant in either section who makes contact with more than 50 Band-Call Areas in the 2002 contest. For example; VP9 worked on 3 different bands counts as 3 Band-Call Areas. Entrants are asked to note their claimed Band-Call Area total on the Summary Sheet.

Commonwealth Call Areas List

(Revised 14 November 2002)

3B6 Agalega and St. Brandon
3B8 Mauritius
3B9 Rodriguez Island
3D2 Fiji
3D2 Rotuma
3D2 Conway Reef
3DA Swaziland
4S Sri Lanka
5B Cyprus
5H Tanzania
5N Nigeria
5W Western Samoa
5X Uganda
5Z Kenya
6Y Jamaica
7P Lesotho
7Q Malawi
8P Barbados
8Q Maldives Islands
8R Guyana
9G Ghana
9H Malta
9J Zambia
9L Sierra Leone
9M0 Spratly Island
9M2 W. Malaysia
9M6/8 E. Malaysia
9V Singapore
9Y Trinidad and Tobago
A2 Botswana
A3 Kingdom of Tonga
AP Pakistan
C2 Nauru
C5 Gambia
C6 Bahamas
C9 Mozambique
CY0 Sable Island
CY9 St. Paul Island
G,GB,GD,GI,GJ,GM,GU,GW United Kingdom (all one area)
H44 Solomon Islands
H40 Tamotu
J3 Grenada
J6 St. Lucia
J7 Dominica
J8 Saint Vincent
P2 Papua New Guinea
S2 Bangladesh
S7 Seychelles
T2 Tuvalu
T30 W. Kiribati
T31 C. Kiribati
T32 E. Kiribati
T33 Banaba
TJ Camerouns
V2 Antigua, Barbuda
V3 Belize
V4 St. Kitts Nevis
V5 Namibia

V8 Brunei
VE1 Nova Scotia
VE2 Quebec
VE3 Ontario
VE4 Manitoba
VE5 Saskatchewan
VE6 Alberta
VE7 British Columbia
VE8 North West Territories
VE9 New Brunswick
VK0 Heard Island
VK0 Macquarie Island
VK1 Australian Capital Terr
VK2 New South Wales
VK3 Victoria
VK4 Queensland
VK5 South Australia
VK6 Western Australia
VK7 Tasmania
VK8 Northern Territory
VK9C Cocos (Keeling) Island
VK9L Lord Howe Island
VK9M Mellish Reef
VK9N Norfolk Island
VK9W Willis Island
VK9X Christmas Island
VO1 Newfoundland
VO2 Labrador
VP2E Anguilla
VP2M Montserrat
VP2V British Virgin Islands
VP5 Turks and Caicos Islands
VP6 Pitcairn Island
VP6 Ducie Island
VP8 Antarctica
VP8 Falkland Islands
VP8 South Georgia
VP8 South Sandwich
VP8 South Shetland
VP8 South Orkney
VP9 Bermuda
VQ9 Chagos
VU India
VU4 Andaman and Nicobar
VU7 Laccadives
VY0 Nunavut
VY1 Yukon
VY2 Prince Edward Island
YJ Vanuatu
Z2 Zimbabwe
ZB2 Gibraltar
ZC4 Cyprus (UK Bases):
ZD7 St. Helena
ZD8 Ascension Island
ZD9 Tristan de Cunha/ Gough Isl.
ZF Cayman Islands
ZK1 North Cook Islands
ZK1 South Cook Islands
ZK2 Niue
ZK3 Tokelau Islands
ZL0 ZL New Zealand Reciprocal

ZL1 New Zealand-Area 1
ZL2 New Zealand-Area 2
ZL3 New Zealand-Area 3
ZL4 New Zealand-Area 4
ZL6 New Zealand
ZL7 Chatham Island
ZL8 Kermadec Island
ZL9 Auckland and Campbell Isl.
ZS1 Western Cape Province
ZS2 Eastern Cape Province
ZS4 Free State Province
ZS5 Kwa-Zulu Natal Province
ZS6 Gauteng Province
ZS8 Marion Island
ZS0 South Africa
GB5CC RSGB HQ Station
Other Commonwealth HQ stations count as separate Call Areas

Results Remembrance Day Contest 2001

from Alek Petkovic VK6APK Contest Manager

VK2 Division Wins!

Congratulations to the VK2 Division for a well deserved win in the 2001 RD Contest. A good effort in the HF section and a big upturn in activity in the VHF section means that the trophy is theirs. Hopefully, this convincing win will inspire further increases in VHF activity in years to come.

I am very pleased to say that the submitted logs were of a very high standard. The message seems to have got through to participants, that VHF and HF logs should be kept separate. This has made the task of calculating the results much easier than in previous years.

Here now are the results for the contest.

Divisional Scores

Table 1 shows the placing of each division along with their overall Improvement Factors.

Table 1: Divisional Ladder

1st	VK2	3.431
2nd	VK1	1.946
3rd	VK5/b	1.228
4th	VK4	0.865
5th	VK7	0.596
6th	VK6	0.584
7th	VK3	0.421

The total scores in both HF and VHF are shown in Table 2.

Table 2: Divisional Scores

Div'n	HF	VHF
VK1	879	395

VK2	3466	398
VK3	2286	2174
VK4	2692	1297
VK5/8	2657	2638
VK6	1486	2751
VK7	1124	597

For those who wish to know how the final score for each division is calculated, I have included the following live example of how it is done. I will use the VK3 Division's figures in the calculations.

First is the calculation of Benchmarks for VK3 for 2000 RD Contest.

2000 Benchmarks (As published in 1999 Results)

HF 2886
 VHF 10903
 2000 Scores. (As published in 2000 Results)

HF 4754
 VHF 8758

Formula:

$$2001 \text{ Benchmark} = (0.25 \times 2000 \text{ Score}) + (0.75 \times 2000 \text{ Benchmark})$$

Calculations:

HF
 $2001 \text{ Benchmark} = (0.25 \times 4754) + (0.75 \times 2886)$

$$2001 \text{ Benchmark} = 1188.5 + 2164.5$$

$$2001 \text{ Benchmark} = 3353$$

VHF
 $2001 \text{ Benchmark} = (0.25 \times 8758) + (0.75 \times 8717)$

$$2001 \text{ Benchmark} = 2189.5 + 6537.75$$

$$2001 \text{ Benchmark} = 8727$$

Those 2 benchmark figures are the scores the division needs to beat to register a positive improvement factor in each section of the contest.

Now to calculate the final score, let's use the points that the VK3 division scored in HF and VHF this year.

Formula:

$$\text{Improvement Factor} = \frac{2001 \text{ Points}}{\text{divided by } 2001 \text{ Benchmark}}$$

Calculations:

HF
 $2286 / 3852 = 0.593$

VHF
 $2174 / 8727 = 0.249$

The two improvement factors are now averaged to give the division's final result.

Formula:

$$\text{Overall Score} = (\text{HF Improvement} + \text{VHF Improvement}) / 2$$

Calculation:

$$\text{Overall Score} = (0.593 + 0.249) / 2$$

$$\text{Overall Score} = 0.842 / 2$$

$$\text{Overall Score} = 0.421$$

Here now, are the Benchmark figures for the year 2002.

Table 3: 2002 Benchmarks

Div'n	HF	VHF
VK1	730	213
VK2	4386	148
VK3	3461	7089
VK4	3711	1239
VK5/8	3694	1760
VK6	2374	4066
VK7	1662	918

Individual Scores

The individual scores for entrants are listed below. Certificate winners are denoted by an asterisk (*) and the top Australian scores in each section by a hash (#). Certificates will be issued to the top operators in each division. Where a multi operator

station holds the top score, a certificate will also be issued to the top scoring single operator in that section. Where a single operator station holds top place, only that station will receive a certificate.

VK1		BDT	129
HF Phone		APP	105
DE	121*	VG	102
ZX	105	HV	96
CEE	97	BOR	85
EY	35	EM	65
HF CW		IBT	60
AU	200*	SS	53
ENG	194	ASU	51
HF Open		BQS	50
VP	127*	EMU	48
VHF Phone		SRC	44
ZX	90*	AGF	43
VP	87	CNI	30
RG	45	BJK	26
HS	44	XT	25
7RG	44	IGS	20
SAA	42	WIR	20
EY	36	CF	11
DE	7	BUI	4
VK2			
HF Phone		HF CW	
DCL	247*	OI	202*#
JBC	241*	BHO	180
GWK	176	PS	130
JAH	106	QF	104
		AZR	70
		RJ	54
		PH	48

HF Open		KQB	53
AYD	437*	ABP	50
BO	380	AMW	40
WL	24	GIL	33
VHF Phone		BCZ	24
HRW	102*	EX	20
BDT	86	DCP	16
SRC	71	KK	16
LCD	66	DY	14
XIE	35	AAJ	11
YHN	30	HF CW	
BOR	8	BKU	194*
VK3		MV	90
HF Phone		AMD	52
OM	219*	AAM	40
AHY	158	SV	28
KTO	131	HF Open	
ADW	128	VP	118*
GH	96	YE	104
HV	87	VB	86
XQ	85	VHF Phone	
BVW	82	DBQ	352*#
DKT	66	XQ	195
DS	65	JK	185
DET	63	HXR	170
JK	60	GH	142
WB	57	KTO	155

XJU	112
DYL	100
HAY	99
NOV	84
EST	68
CRP	65
VP	64
ZWI	64
KK	54
KKJ	54
TFE	49
BGS	36
XH	33
EX	30
YE	22
BVW	17
DCP	10
VB	10
AMW	3
KQB	1
VK4	
<i>HF Phone</i>	
DO	387*#
BAY	234
FNQ	218
FJ	202
GQ	179
RC	154
FLG	85
AWL	76
ZJ	73
ZA	65
KJD	60
BTW	59
KKN	49
ACW	45
EQ	43
DZ	37
ACB	24
PJ	18
FXL	17
ADY	16
EV	13
<i>HF CW</i>	
BUI	176*
XW	98
IW	16
<i>HF Open</i>	
LT	272*
GZ	76
<i>VHF Phone</i>	
3CE	261*
AML	240
AR	209
ZBV	171
3YID	117
RC	61
OE	60
ZA	53
EV	51

FLG	23
PJ	19
ADY	18
ZJ	8
BAY	6
VK5/8	
<i>HF Phone</i>	
BP	171*
KBJ	141*
KMC	132
XY	114
WO	112
ASN	79
BQ	76
ADD	74
RV	50
FD	46
NN	41
TW	35
TY	30
AIM	22
PC	21
CTY	12
MX	9
JGM	8
UE	6
<i>HF CW</i>	
UM	188*
HO	92
BGL	84
NJ	80
8HA	58
AU	52
BS	34
<i>HF OPEN</i>	
BRC	627*#
ATU	240*
ET	23
<i>VHF Phone</i>	
BRC	333*
KBJ	258*
AR	250
ZHT	224
XVS	221
ZBK	203
PC	188
HCP	162
XY	157
ZKK	139
KLD	121
ATQ	58
FD	48
UE	46
AVQ	44
ET	36
RV	36
EMI	35
JGM	28
MX	22
AIM	18

KMC	11
VK6	
<i>HF Phone</i>	
LC	230*
CSW	227
BH	123
JP	108
KHD	72
KH	57
ADI	48
OE	33
APK	30
GL	26
SAR	25
PX	21
AD	13
BDO	8
<i>HF CW</i>	
AFW	168*
AJ	120
HD	40
HK	26
AF	22
<i>HF Open</i>	
AR	51*
RZ	38
<i>VHF Phone</i>	
KTN	271*
ANC	218
JIP	206
ZBP	206
AD	162
HU	161
SAA	160
BDO	145
AR	143
CSW	139
SAR	138
JP	120
ZLT	120
HAO	119
WT	63
YF	62
EH	61
HGR	49
RO	47

APK	36
SMH	23
RZ	25
KH	23
HK	20
KHD	20
MM	14
VK7	
<i>HF Phone</i>	
JGD	200*
CK	196
RN	141
RR	140
KTW	100
KH	90
KC	70
NDO	53
JAB	27
NGC	22
RM	20
PP	19
LUV	16
BM	15
KBE	15
<i>VHF Phone</i>	
JGD	155*
HSE	139
EB	78
NDO	68
RM	50
KTW	46
FB	27
PP	18
RR	16
SWL Section	
Peter Kenyon 319*#	
Andrew Robertson 119	
Overseas Section	
<i>HF Phone</i>	
P29KFS	159*
ZL3TX	40
<i>HF Open</i>	
P29IO	216*
ZL2ALJ	209
ZL2AJB	68

I received lots of comments with the logs this year. From these comments it is obvious that although participation is down on last year, the spirit of the RD Contest is still very strong and that it will live on for many years

ar

Note:

Contest Co ordinator Ian Godsfil has now been allocated email address:

contests@wia.org.au,

Intruder Watch

Henry, VK8HA
your WIA Federal Intruder Watch Co-ordinator
and also VK8-Co-ord.

International Amateur Radio Union. Region 3

Monitoring systems news

The situation in Region 3 continues to be bothered by the several harmonics from DPR-Korea, the various other VFTs on many bands, the other regular broadcasters (except VoSharia, which has gone off 7085 kHz now) and the reduced activity of the jumping jammers on the 40 m band frequencies. The spurious "Christian Voice" radio signals on 21420 kHz frequently reported by VK8HA from Darwin area, gets highlighted this month, as it was heard as far away as in New Zealand too. The Monitoring Coordinators are contacting the concerned broadcaster for solving this problem.

There are reports of the occasional bursts from data transmitting stations on the different frequencies of the 20 m

band and there are regular feed back from the different monitors.

The occasional loggings of the non amateur beacons on 28 MHz band are becoming frequent due to the improving conditions due to the solar activity.

The detailed reports received from the individual Societies of Region 3, may be seen for the voluminous data they have logged and compiled for the intruder watch programmes.

OM Martin VE3OAT, the Region 2 Coordinator has given a paragraph on the Mutant Beacons, which are the non amateur beacons found on the 28 MHz band also. Apart from this, he has highlighted the others like the 7039 Russian Beacons; the NON (carriers) on 14000 and 14001; the harmonic of DPR

Korea on 14250 and the 10th harmonic of Radio Majagual on 14301 kHz., heard in Region 2.

OM Ron G4GKO, has reorganized his web page, which contains lots of European loggings of these intrusions, which will be of reference value to others.

For the latest info from Region 1, pse visit the web site: <http://myweb.tiscali.co.uk/rdnronald>

And for info from Region 2, www.echelon.ca/iarumsr2

Sorry, the report from JARL was not received till 31 Oct 2001 and I had to send the report without it.

Compiled by:
B.L.Manohar "ARASU" VU2UR.
Regional coordinator.

VK8 Intruder Watch Report for Sept 2001

VK8HA QTH is 50 km south east of Darwin on the Arnhem Highway near the Adelaide River Crossing.
Address: Box 619, Humpty Doo, NT.0836. vk8ha@octa4.net.au

Freq	Date	Time	Mode	Bearing	Country	Ident/Remarks	Freq	Date	Time	Mode	Bearing	Country	Ident/Remarks
03560	0509	1030	A3e		N.Korea	Pyongyang B/Cast S9 Start 1010	14050	1809	1300	?	350		UI Multi Channel modulated noise
03560	1509	1940	A3e		N.Korea	Pyongyang B/Cast In French	14185	2509	0745	F	333		No QSB . 0750 changed txor
07070	1509	1950	A3e			UI B/Cast And Jammer							Beam/log as sig dropped from over
14320	0209	1200	Pkt			UI Packet making mess of S.E.A.N.E.T.							S9 To S7 ..VK8 11mile?
14320	1309	0630	F1?			UI F1	14180	2509	0745	Pkt	330-300		Not very active now..only short bursts of xmissions..then nil for long periods
14025	0309	1215	M7b	330		11mile?.S9 steady. CI at 1236	18105	0809	1220	A3E		China	B/cast Yunnan 3rd harm.only S1
14005	0409	1250	F1b	330		S9 Daily	24890	0809	1230	A3E			2 B/Cast Stations . No ID as S1 only
14040	0409	1255	Pkt	---		Daily	24890-24890-24990						
14040	1309	0620	Pkt	320	Chinese?	Daily..	24990	Dly	24hrs			VK8	OHR northeast of VK8HA approx 50km Being at rear of their ant. low sig at VK8HA
14057	0409	1253	NON	345		Daily.some CW,pkt As Usual CW= 201 id 8s5vu Qsa 2 Carrier. SSB Japanese/American Voice Radio Check.testing 4 3 2 1 How copy							
14001	0809	1230	NON	---		Carrier. SSB Japanese/American Voice Radio Check.testing 4 3 2 1 How copy							
14001	0909	1215	SSB	350	Chinese	And Digital							
14116	1309	0620	Pkt	---		UI Pkt							
14414	1309	0630	F	---		UI Multichannel							
14427	1309	0630	F1b	---		UI							
14178	1309	0630	SSB	330	Indones	Fonepatch.s9 / S2..usb							
14120	1309	0630	SSB	---	Indones	Indon Crims on LSB							
14100	1309	0630	SSB	---	Indones	Indon Crims on USB							
14080	1309	0630	SSB	---	Indones	Indon Crims on USB							
14075	1309	0630	SSB	---	Indones	Indon Crims on USB							
14115	1309	0650	SSB	215	Indones	Indon Crims on LSB People Smugglers?							
14120	1309	0650	SSB	215	at sea	Same as above.moved here when jammed							
14180	1209	1530	Pkt	330		Strong Stn in 330 Degs Afghanistan?							
14180	1209	2200	Pkt	300		Weaker Stn in 300 Degs Lybia? Still going after the 11-09-2001 disaster	5099						
14301	1509	0800	Bip	350		Bip bip with odd Chinese Packet bursts	14057	1609	1205	F1	350		Back again after two weeks off air.(cl 0509)
14057	1609	1205	F1	350		Back again after two weeks off air.(cl 0509)	14005	1809	1215	F1b	020		UI
14005	1809	1215	F1b	020		UI	14015	1809	1250	F1	020		UI sounds same as 14005
14015	1809	1250	F1	020		UI sounds same as 14005	14127	1809	1250	F1	330		UI Multi Channel..cl 1254
14127	1809	1250	F1	330		UI Multi Channel..cl 1254	14123	1809	1250	F1	330		UI Multi Channel CI at 1254
14123	1809	1250	F1	330		UI Multi Channel CI at 1254							

Will check with radio inspector when WIA Fed IW co-ordinator has been appointed. VK8HA is on the books. 28MHz band is full of Chinese CB and other intruders.

DX is also getting stronger
All the best from VK8-land and Henry In Humpty Doo
vk8ha@octa4.net.au

VK4 Summary for September 2001

VK4 Co-ordinator, Tom Walker, VK4BTW. QTHR
13 Bothwell St., Toowoomba, Qld. 4350 Australia

Freq	Date	Utc	Emm	Details
3.560	0209	1020	A3E	N.Korean B/C stn. may be at Kojang. (34 loggings)
14.067	1209	0510	WBD	Continuous "bubbling" sound, some long pauses.(8 loggs.)
21.420	0809	2145	A3E	H-3 of N.Korea B/C stn. On 7.140 Mhz. (27 loggings)

Also many single frequency reports of Indonesian and Vietnamese pirate stns. on 7MHz and 28 MHz bands. Single freqs. of multi-channel wide band data stns. in 14 MHz band. The inconsistency of these makes regular reporting difficult.

How's DX?

Ross Christie, VK3WAC
19 Browns Road, Montrose 3765, Vic.
Email Vk3wac@aol.com

Something old, something new... and a humble achievement

For those who have missed the news, P5 North Korea has been put on the air by Ed, 4L4FN who works for the UN World Food Program. Ed has been requesting official authorisation to operate an amateur radio station in P5 but had always been unsuccessful until now. However, persistence does pay off, and a recent concerted effort on Ed's behalf has resulted in him gaining 'verbal permission' to operate. He is currently awaiting the official documentation from the authorities but has wasted no time in getting on the air as P5/4L4FN. He expects official documentation (which is required for recognition by DXCC) by late December. So if you hear him give him a call and worry about the official status later. Currently he is operating SSB only (though I have heard that he is expecting a paddle key in the post shortly, good man!) and is using only simple antennas so don't expect big signals from him. His preferred haunts are 20m (around 14205kHz) and 10m (around 28575kHz) split 15 – 35 kHz up. Because Ed has an official job that consumes more than 12 hours of his day his on air appearances will naturally be restricted (this is not a DXpedition) and the best time to catch him is between 1400 – 1500 and 2200 – 2300 UTC. He will be leaving P5 for a short holiday home over the Christmas period and expects to be back around mid January when he will be bringing some equipment for the digital modes. If you are looking for P5 (and who isn't?) then get in there and do battle, good luck!

From one rare DXCC entity to a completely new one. Bill Moore, NC1L, the DXCC Manager has announced that Ducie Island (a part of the Pitcairn Island group and located at lat. 24 39'57" south and long 124 48'21" west) has been accepted as a new entity. Ducie Island was nominated for IARU recognition by PIARA (Pitcairn Amateur Radio

Association) in March 2001. PIARA applied to IARU Region 3 and after due consideration by IARU members worldwide Ducie Island was granted recognition on November 16, 2001. As such, under DXCC rules, Ducie Island has become a separate 'political entity' and qualifies as the 335th entity. DXCC recognition is effective from 0000 UTC 16 Nov 2001. QSL cards for contacts will be accepted by DXCC beginning 1 June 2001, however QSOs dated 16 Nov 2001 and later will count. Please note, this island has been activated as IOTA OC-182 but these contacts will not be recognised for DXCC purposes. So as to get this 'new one' into as many logs as possible, as soon as possible, a DXpedition had been planned but had to be cancelled due to severe storms in the area. Apparently the team had to abandon attempts to land on the island because there was a real danger to life and limb. However, some of the equipment destined for the DXpedition has been donated to PIARA who hopefully will use it to mount another attempt to activate Ducie Island.

Another note from Bill, NC1L concerns an application to DXCC for recognition of the XU7AAR (Cambodia) operation that took place in late 1999. Processing had been on hold awaiting supporting official documentation but now the paperwork has come through and it has now been accepted for DXCC credit. So if you have had this one rejected in the past it can now be claimed in your next submission and will be accepted.

So much for the new and exotic, now for my more humble achievement. I managed to grab a couple of Belgian stations who were using the special OQ prefix issued to celebrate the birth of H.R.H Princess Elisabeth who arrived on the 25th of October 2001. As I write this, the postman has just delivered a letter from Rene, OQ5GI, containing a

commemorative QSL card featuring the happy royal couple with their new addition and a Belgian flag sticker. The OQ calls will be on air until the end of the year. A special award is on offer for those who work 5 stations during the qualifying period. The award manager is Egbert, ON4CAS/N1TOI

Not much on offer this month in the way of DX but then I suppose the weather is turning a lot cooler in the northern hemisphere and planning, rather than operating, will be occupying the Dxpeditors. Never mind, don't give up but get on the bands and have a listen, if you hear anything exciting then drop me line so I'll know what I missed.

The DX

3D2, ROTUMA. Tony, 3D2AG, will be active from Rotuma until the 10th of January 2002. He has been heard often the last few weeks on 10 and 20 metres, CW and SSB, beginning around 0130 UTC. QSL direct to 3D2AG (address in the callbook). [TNX 3D2AG and OPDX]

9L, SIERRA LEONE. Zbyszek (Zbig), SP7BTB, will be operating as 9L1BTB from Sierra Leone until mid 2002. Currently he is in Freetown working for the United Nations. He is a prolific operator and plans to be on 40, 20, 17, 15 and 12 metres SSB. QSL via SP7CDG. [TNX SP7BTB and OPDX]

OA, PERU. Rene, DL2JRM and Daniel, DL5SE will be activating San Lorenzo Island (SA-052) on the 3rd until the 13th of January 2002. The pair have applied to the authorities for the special call signs 4T4I (David) and 4T4X (Daniel). QSL via their home calls. [TNX VA3RJ and 425 DX News]

P5, NORTH KOREA. Ed, 4L4FN, is operating from this eagerly sought DXCC entity. He is mostly active on 20 and 10 metres, around 14205 and 28575 kHz, SSB only (at the moment). Official status is still a bit grey as he only has 'verbal' permission at the moment, but official

documentation is on its way to satisfy DXCC. Those on the 'net' can visit <http://www.amsatnet.com> for news and details of his current operating times. QSL via Bruce Paige KK5DO, PO Box 310, Alief, TX 77411, USA. [TNX KK5DO and 425 DX News]

TM, FRANCE. Patrick, F6OIE, has been issued with the special call TM0A. The call will be on air during the period of the 19th of Jan until the 1st of Feb 2002. QSL via F6OIE. [TNX F5NQL and 425 DX News]

Special Events

The special call TM4AMD will be on air from France between the 26th of December until the 13th of January. The call is to publicise the 24th Rally Arras-Madrid-Dakar (used to be called the Paris-Dakar rally). QSL via F6IGF direct or bureau. Further details can be had from <http://perso.wanadoo.fr/ara62> [TNX F5PSI and 425 DX News]

OX, GREENLAND. Rene, OX3HX is currently active as OX1AWG. This special call is for the Arctic Winter Games that run from 17th until the 24th of March 2002. QSL via OX3HX. [TNX PA3GVI and 425 DX News]

Round up

If you like working stations based in the Antarctic then keep an ear out for the following who will all be stationed down there for the coming months; CE9NKR, CE9MFJ, EM1HO, EM1KCC, KC4/N3SIG, KC4AAA, KC4USA and VK0KMT.

Anton, ZS4AGA is a newly licenced amateur radio operator. He is currently stationed at the SANAE Base on Princess Martha Coast (AN-16). Anton will be there until February 2002 and plans to operate the bases amateur radio station ZS7ANT. [TNX DL5EBE and 425 DX News]

R1, ANTARCTICA. Oleg, UA1PBA will be operating as R1ANF from the Russian Antarctic Base "Bellingshausen" (AN-010) beginning around mid December. QSL via RK1PWA. [TNX DL5EBE and 425 DX News]

HF0, POLAND (ANTARCTICA). Mirosław Stefanski, SP7JKW will be operating as HF0POL from the Polish base 'Henryk Arctowski' on King George Island, South Shetlands (AN-010). He will be there from the 1st of Jan until the 31st of Dec 2002. Mirosław plans to be

on CW, RTTY and PSK31 (maybe with some SSB thrown in for good measure) on all bands including WARC. QSL via SQ5TA either direct to Artur Tabaszewski, ul. Wiejska 100, 26-606 Radom, Poland or via the bureau. [TNX SP2FAP, SQ5TA and 425 DX News]

VP8, South Orkneys. Mike, GM0HCQ (VP8CMH/mm) had expected to operate as VP8SIG from Signy Island in the South Orkneys on the 18th and 19th of Nov. However storms and strong winds prevented a safe landing. His next visit to the island will be sometime in late January. He is now sailing to King Edward Point, South Georgia (AN-007) and he thinks he will be able to operate as VP8SGK as and when his spare time allows. More information about the ship and details of the trip can be found at the British Antarctic Survey web site at <http://www.antarctica.ac.uk/diaries/es/> especially information specifically related to Mikes ship the RRS "Ernest Shackleton". [TNX DL5EBE and K8AJS and 425 DX News]

YA, AFGHANISTAN. A report from The Daily DX says that the foreign ministry of the Islamic Republic of Afghanistan (Northern Alliance) issued the call YA5T to Peter, ON6TT, Matts, SM7PKK and Robert, S53R. It permits operation on all bands and modes. Hopefully this is just the beginning of the road to an active amateur radio presence from Afghanistan.

QRP DXCC AWARD. A QRP DXCC Award certificate is to be issued for working 100 different DXCC entities on the DXCC List, while operating at genuine QRP powers, e.g. 5 watts or less. Applications for the award will be accepted from the 2nd of January 2002, however valid contacts may have been made at any time since 15 November 1945. The award is not endorseable and is separate and distinct from the traditional DXCC award program. Certificates will be dated but not numbered. QSL cards will not be required for verification but applicants must certify the authenticity of log entries and information. Further details and application forms etc can be found at the following website <http://www.arrl.org/awards/dxcc/qrp/index.html> [TNX NC1L and 425 DX News]

5A, LIBYA. Abubaker, 5A1A, says that there have been many pirate stations active from Libya over the past few

months. He sends a list of the only government authorised stations active at the moment, these are;

5A1ASC Assaker Club station. QSL via DK4HB direct or via Bureau.

5A1A Abubaker Alzway. He will be using his existing direct QSL information until he goes to Germany in the next few weeks.

5A1TA Tark Abu Kris. QSL via EA3GIP direct or via the Bureau.

5A1HA Haytm Hashim. QSL via DJ9ZB direct or via the Bureau.

The Australian 80 metre DX window is to be expanded to 3776 - 3800 kHz. The WIA approached the ACA with a proposal to creating a shared arrangement with the current commercial users of this piece of spectrum. The ACA, after negotiations with the WIA and the commercial users, has decided to re-allocate this part of the band to amateurs on a primary basis beginning on the 1st of Jan 2004. The commercial users are to migrate to their newly allocated channels, in the land mobile service adjacent to our new amateur band, by the end of Dec 2003. [TNX OPDX]

Sources

This month our thanks go to the following people and organisations for the information and news in this months DX Notes; 3D2AG, SP7BTB, VA3RJ, KK5DO, F5NQL, F5PSI, PA3GVI, DL5EBE, SP2FAP, SQ5TA, K8AJS, NC1L, 5A1A, The Daily DX, 425 DX News and OPDX.

ar

VK2 Division Annual General Meeting

The Annual General Meeting of the VK2 Division will take place on

13th April 2002,

with nominations and agenda items due by
2nd March.

Members will be further notified by post in the middle of January.

Pat Leeper VK2JPA
Divisional Secretary

VHF-UHF

AN EXPANDING WORLD

David K Minchin VK5KK

Postal 10 Harvey Cres, Salisbury Heights, SA, 5109

E-mail: tecknolt@arcom.com.au

Web page: <http://members.ozemail.com.au/~tecknolt>

Fax: +61 8 82924501 NEW FAX NUMBER

Phone: 0403 368 066 AH ONLY

All times are in UTC.

6 Metres

Norm VK3DUT reports ... I thought I'd pass on some brief notes of some exciting openings we've had in this corner of OZ (QF32ve) for this equinox.

5/10/01 JAs from 0200z, 12/10/01 JAs 0114z, 14/10/01 from 0843z, heaps JAs and at 0900x BD4EBC (China - new one for me), last JA at 1204z, Had JAs in on several other days but on 28/10/01 1255z (late here) OE2UKL, OE3MWS, OE3WBA and OE1WWA JN67/68, at 1305z (brief opening), there was an Aurora running at the time but I don't know that it played a part, however the VK8RAS/b was in at the same time and this may have provided the link. 49.750 + - and 48.250 also very strong at the time. Also heard but missed DL7AV, apparently he also heard me but it all happened too quickly!

8/11/01, 0510z, VU2LO 5X6 ML88, 0538z, A45XR 5x3, LL93, 12/11/0, 0725z, HZIMD 5X7 LL34

13/11/01, N6XQ, 0015z, dm12, also heard XE1kk/b XE2UZL/b and KL7NO very weakly, then from 0744z - 0810z, OH1XT 5X5 KP01uk (15,517km), ES1AJ, OH7PI, OH7KM, ES2QN, OH6KSL, OH3BHL, OH5LK, OH2TP, ES2KM, OH4OH, ES1CW, ES1WN, ES4EQ, ES1II, ES3BR, ES4EQ sigs bet. S2 -s9! The VK8RAS/b was there again as was 48.239.4/6 (multi carriers) 49.750 + - 45.250 (not from ZL) also heard DL and ON weakly on cw. 14/11/01 Similar conditions building with vk8ras/b etc in but my Antenna rotator stuck! I did hear and was heard by OH1XT but much QSB and stuck about 15 deg off OH!!! (I heard my 5x5 report but not sure if he got mine.

19/11/01, 2137z KL7CDG 5X3 BP51, 2158Z, KL7FZ 5X2 (Alaska at last!)

20/11/01 from 2232z - 0018z, W5OZI, W7XU/0, N0QJM, N0VSB, K0UB, N5WS, NOLAN, AA5XE, W6JKV/5, W9JN (EN54dn, 15,246km), W0SD, KM0T, KA0J, VE7XF AT 2314Z, W7USB, N7AU.

All up 8 new ones for me, some of these rather unexpected but very exciting and I don't believe it's all over yet.

Many other nights where various indicators heard very strong but no contacts made but I liken it a bit to fishing - "you never know what's out there"! BTW, I use 100 W to a 'H' frame with 4x5's at 55 ft. My location is approx 60m ASL with very average takeoff in any direction (rising ground to West/NW. I also operate on 2 m&70 cm with regular contacts to VK1, 2 on aircraft enhancement etc and heard/worked various VK2's 3's 4's 5's and 7's during the recent meteors showers. Norm VK3DUT

VK 6 metre Beacon's in disarray?

Just how useful are our beacons for overseas DX on 6 metres? While we still have restrictions on the use of 50 - 52 MHz in some areas, VK still has three Beacon sub bands

John Kirk VE3XT has helped get atleast 20 North American beacons going and has contributed the following looking back into VK from North America. "The advent of 6 metre transceivers with scan capability has changed the listening habits of DX'ers. From a North-American perspective, I can tell you that there are literally THOUSANDS of hams scanning 50.000 to 50.100 for any sign of beacons. There are, at best, a few dozen who remember to check the Aussie 52 MHz beacon block, because doing so would GREATLY increase the scan cycle time, and for most North Americans would mean listening to a great deal of TV crud that ends up in the 51-52 MHz.

North Americans are nowhere near as adept as Aussies in spotting openings based on reception of TV carriers. They probably wouldn't want to, for the same

reasons as above - increased scan cycle time.

You can see where this is going, can't you? If we accept that 6 metres is an international DX band (as opposed to a "work your neighbouring grid square" band), and that the purpose of our beacons is to alert overseas operators to openings that might otherwise get missed, shouldn't we place those beacons on frequencies that are actually monitored?

I think we'll all work more DX if we turn up the heat on efforts to move them (VK 6 metre beacons) down the band. I personally prefer the 50.000 to 50.080 block, again because of my knowledge of the scanning habits of overseas operators, but it is conceivable that we could modify their behavior to include up to 50.3XX if they were rewarded with more DX contacts. I've checked the 50.000 to 50.080 block, and there are still some frequencies available that would give us worldwide clear frequencies, but they are going fast! Good beacons are going to be even more important as the sunspot cycle fizzles, and we have to go back to making our contacts the hard way - 5 hop E etc.

When you look at how the rest of the world has set up beacons we are largely back in the sixties with our lot except for a few good useful beacons set up by dedicated 6 metre operators. Putting a beacon on below 50.1 MHz might cause pain in populated areas but we plenty of country sites are available. Time to fix up our act?

Experimental 2 metre Beacon in VK3

Chas VK3BRZ reports ... Lee VK3PK and I have placed an experimental PSK31 beacon in operation on 144.500 MHz. Currently the beacon sends its callsign, latitude/longitude, 6-character grid square, power, antenna type and height

above sea level. The ident sequence repeats at 1-minute intervals with a CW ident every 4th cycle. There is some APRS-format data at the start of the ident cycle

At this stage the beacon is temporary. We expect to keep it in operation over the summer DX period, say to the end of March, after which we will review its usefulness and/or future development. Its callsign is VK3QM. The equipment consists of a Kenwood TR-751A delivering about 12 W to a Halo antenna mounted on the roof of my work QTH in Geelong. This is a 2-storey building on an elevated site not far out of the city centre. It has a great take-off in every direction including VK7, except to the west, where the nearby Barabool Hills obscure it a bit.

Its short-term stability over any one-hour period is within 50Hz or so, but over a day will depend on the ambient temperature. Reports are welcome ... Chas VK3BRZ

2 metre Sporadic Es

John VK5NJ reports.. Tuesday morning 3-12-2001. It started out with loading up a new 80 m dipole, open wire feeder, roller inductor ATU on 6 metres! It loaded up ok so I put out a few CQ cw calls. I worked VK4JH Joe he was 559 at 2348Z. A bit later I worked Joe again on SSB but lots of QSB. I worked VK4FNQ John, on 50.150 MHz. John suggested listening on 2 m he was now hearing our 144.550 beacon, we went to 144.100 @0024 I couldn't believe my ears & eyes our SSB reports VK4FNQ was 57! My 2 m antenna is a Diamond X300 collinear vertical 11 metre above the ground. John was also hearing our 146.900 FM repeater also.73 from John VK5NJ.

JAs smash world 75GHz record

On 16 November 2001, at 1310 Japanese standard time, JA1ELV/2, located in PM95JL, worked JA1KVN/1 in QM06BF, on 75 GHz SSB for a new world record of 151 kilometres, just 6 km more than that set up earlier this year by Will, W0EOM and Bob, KF6KVG.

JA1ELV/P was heard at RS45 while he copied JA1KVN/1 at RS43. JA1ELV/1 had 3 mW output to a 50 cm dish and was located at just under 2000 metres ASL on the side of Mt. Fuji. JA1KVN/1 had 1 mW output to an 80 cm dish and

was located 296 metres ASL on the slopes of Mt. Tsukuba.

The low relative humidity (around 42%) and fine weather obviously helped a lot! ... from Peter Day G3PHO. I believe Peter is coming to VK in 2002 so I'll keep you posted

New North American DX records on 241GHz and 322GHz.

At 01:45z on Dec 15th, 2001 a QSO was made between W2SZ/4 (op: WA1ZMS) and WA4RTS/4 on the 322GHz band over a whopping distance of 0.5 km. Both stations were located in FM07ji.

At 02:35Z on Dec 15th, 2001 a QSO was made between W2SZ/4 (op: WA1ZMS) located at 37-21-13N 79-10-15W (FM07ji) and WA4RTS/4 located at 37-21-49N 79-10-19W (FM07ji) on 241GHz over a distance of 1.1 km. This is a North American first for the band and a new NA record at the same time.

Both of the about QSO's were made using MCW and wideband FM IF receivers. Power output on 322 GHz is estimated to be just a few microwatts, while on 241GHz the power is a measured 0.75mW.

The stations are constructed of 80.6 GHz free running Gunn oscillators driving GaAs diode triplers (Univ of Virginia design) to give output on the 241 GHz band. The triplers have a tiny amount of 4th harmonic output, which was used for the 322 GHz QSO. Both stations use homebrew 6-inch parabolic dishes with hyperbolic sub-reflectors. ...Brain WA1ZMS

Microwave Primer Part Twenty:

Where do you get what you need!

Maybe this part should have been first, not towards the end of the series! All the way along I have given a few clues as to different designs and where to go looking for some bits. The truth is it does take a little time to find something's but a surprising amount of parts and assemblies are available locally. This part should help you start looking, like it or not the Internet is going to be your best tool for this.

We have already discussed the various designs around. By now you should have some idea on where you want to

start. If you want to find some of the designs I have been talking about then the following website is your FIRST stop! All Dubus articles archived since 1982! <http://www.qsl.net/ok1cdj/dubus> Another place to start from is on my website

<http://members.ozemail.com.au/~tecknolt/linksto.htm> This will get you to some better pages with better links, etc.

Another place to start is WA1MBA's Microwave reflector; visit <http://mbs.valinet.com/mailman/listinfo/microwave> to subscribe.

Printed Circuit boards form the basis of most projects. FR4 Glass fibre is used for most applications up to 2 GHz with Teflon Glass fibreboards from there up. While PC board can be sourced locally or on the Internet, the etching of the board is a bit of an art with the tolerance required for filters and etc frequency dependant striplines. Luckily a few amateurs are well set up to do PCBs. For years Norm VK5ZAH has done PCBs for the Equipment Supplies projects including Teflon up to 10 GHz. Norm has a very good library of artwork for some of the overseas designs. He can be contacted at nrosie@mail.mdt.net.au

Semiconductors like Gasfets and Hemt's can be sourced locally but mostly only in quantity buys. MMICs are available through a few sources in Australia. MMICs are perhaps the most common "building block" part of any project. The Internet has a few sources overseas but sometimes just buying for yourself can be a bit expensive when you have to buy ten times as much as you need. Doing searches on Ebay is a good starting point, after a while you will find a few of the regular traders who handle surplus "new" stuff. Perhaps the best option is to get help from another amateur or group that is already sourcing bits. The Equipment Supplies still has a reasonable stock of parts, email me or maybe I can give you a few names to try in your neighbourhood!

Another one is SHF Microwave Parts Co at www.shfmicro.com. Or just use a good search engine on the Internet and plug in a few part numbers and see what you get ... usually a lot of junk but a few gems rise to the surface!

The easiest way is to build a kit; after all some one else has already done part of the work by finding all the bits! Not too many kit vendors exist globally who handle microwave designs. Locally the

"Hey, Old Timer..."



If you have been licensed for more than 25 years you are invited to join the

Radio Amateurs Old Timers Club Australia

or if you have been licensed for less than 25 but more than ten years, you are invited to become an Associate Member of the RAOTC.

In either case a \$2.50 joining fee plus \$8.00 for one year or \$15.00 for two years gets you two interesting OTN Journals a year plus good fellowship.

Write to

RAOTC,
3/237 Bluff Road
Sandringham VIC 3191

or call Arthur VK3VQ on 03 9598 4262 or Allan VK3AMD on 03 9570 4610, for an application form.

For All Your Requirements

AUTHORISED DEALER
ICOM

KENWOOD

AMATEUR COMMERCIAL
MARINE COMMUNICATIONS



14 Mary Street
Hazelmere

Western Australia 6055

Telephone: (08) 9274 1118

Facsimile: (08) 9250 3734

E-mail: tower@con.net.au

www: <http://www.tower.visionimage.com.au>

Silent keys

Brian Edward Toomath VK4BET
Ted Miles VK2FLB

Equipment Supplies Committee (WIA SA) produced 1,000's of kits up until recently but currently only trades on a restricted basis until we can find someone keen enough to run this side!

Mark VK5EME has a good selection of kits for amplifiers, ATV and transverters up to 1296 MHz have a look at www.minikits.com.au. Overseas perhaps the best known is Down East Microwave in the USA. The current exchange rate does not help VK amateurs much but the kits are first rate. Down East can be found at www.downeastmicrowave.com.

Ok that's all the new stuff but what about surplus stuff? Locally it varies from state to state. VK5 has been one of the luckier areas with the Defence and associated industry here being a significant part of the economy. While not as good as there were, scrap yards usually turn up hardware like waveguide, dishes, coax, microwave transmitters and etc. Half of it (atleast!) is junk but it is like prospecting, just keep digging. Auctions are another source but do your homework otherwise you will go home with some expensive

trash rather than trinkets! Dishes are easy to source, thanks to Pay TV.

If all else fails ask around. Drop me an email and I will try and help.

In closing

Welcome to 2002. We still have 420 - 450 MHz although this year will be this bands most challenging time. Various alternative bandplans have been floating around, sort of Plan B, Plan C and Plan D stuff depending on what happens where. Stay close to your local WIA Division to keep abreast of the issues and have some input.

Doug VK3UM has sent in the following.. I have just been advised that DUBUS will cost the same as last year (\$45-00) Please forward subs in the normal manner (\$45) as below and if you know of anyone else please let them know as well. I will make the cut off the first week in February 2002 so PLEASE try and remember! Doug McArthur, 'TIKALUNA, 26 Old Murrindindi Rd. Glenburn Vic 3717

I'll leave you with this thought .. "In any contest between power and patience, bet on patience!"

73. David VK5KK

ar

Sunspot numbers

Monthly average count Oct 2001: 149.8

Smoothed Sunspot Number Apr 2001: 107.6

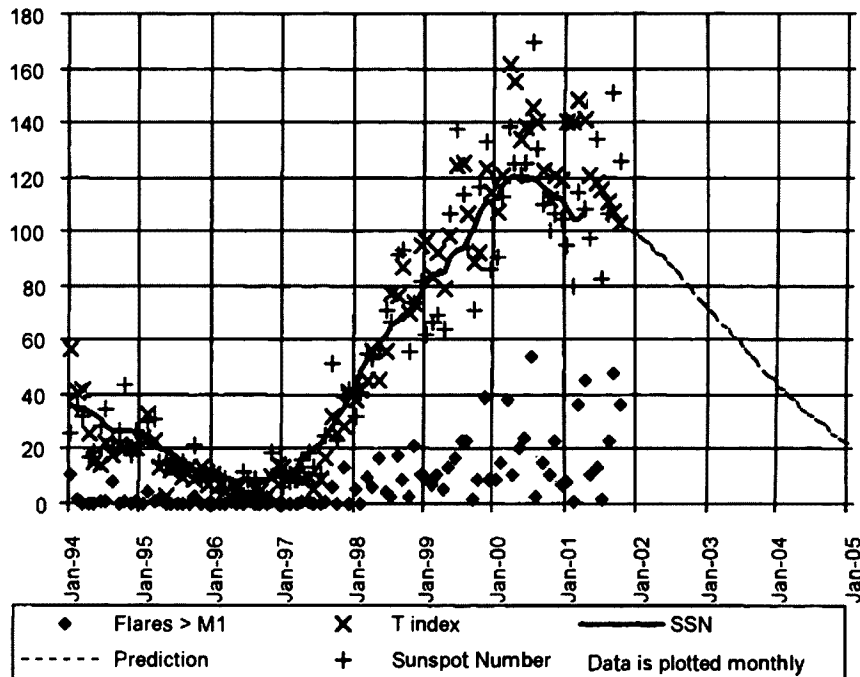

Data provided by the Ionospheric Prediction Service

Digital Meter Supply

The digital meter supply is a simple means of providing a floating isolated supply to power a digital meter module. These require a floating supply and at least in the USA are appearing as surplus at attractive prices at hamfests and such. A suitable floating power supply was described in QST September 2001 by Mike Bryce WB8VGE.

The circuit which provides two floating supplies generates each supply using an OP Amp operating as an oscillator to drive a switching transistor with the primary of a small audio

transformer as its collector load. The centre tapped secondary drives a rectifier circuit which feeds the supply to the meter via a simple Zener diode shunt regulator. The power input to the circuit is passed through a three terminal regulator to stabilise the circuit. A limiting resistor is placed in series with the collector supply to each switching transistor.

The circuit is shown in Fig 2. The components are all relatively non critical. The transformers are 200 ohm Centre Tapped primary with an 8 ohm

secondary. Similar transformers are readily available and were used as output transformers in transistor radios. Provision is made in the circuit for supply from two sources via steering diodes D1 and D2. This may not be required but the diodes do protect from reverse polarity. The current drawn by the circuit with both supplies is 140 mA. The frequency of operation is around 2.5 kHz.

The circuit would also be suited to a variety of applications where floating or negative supplies are needed.

ar

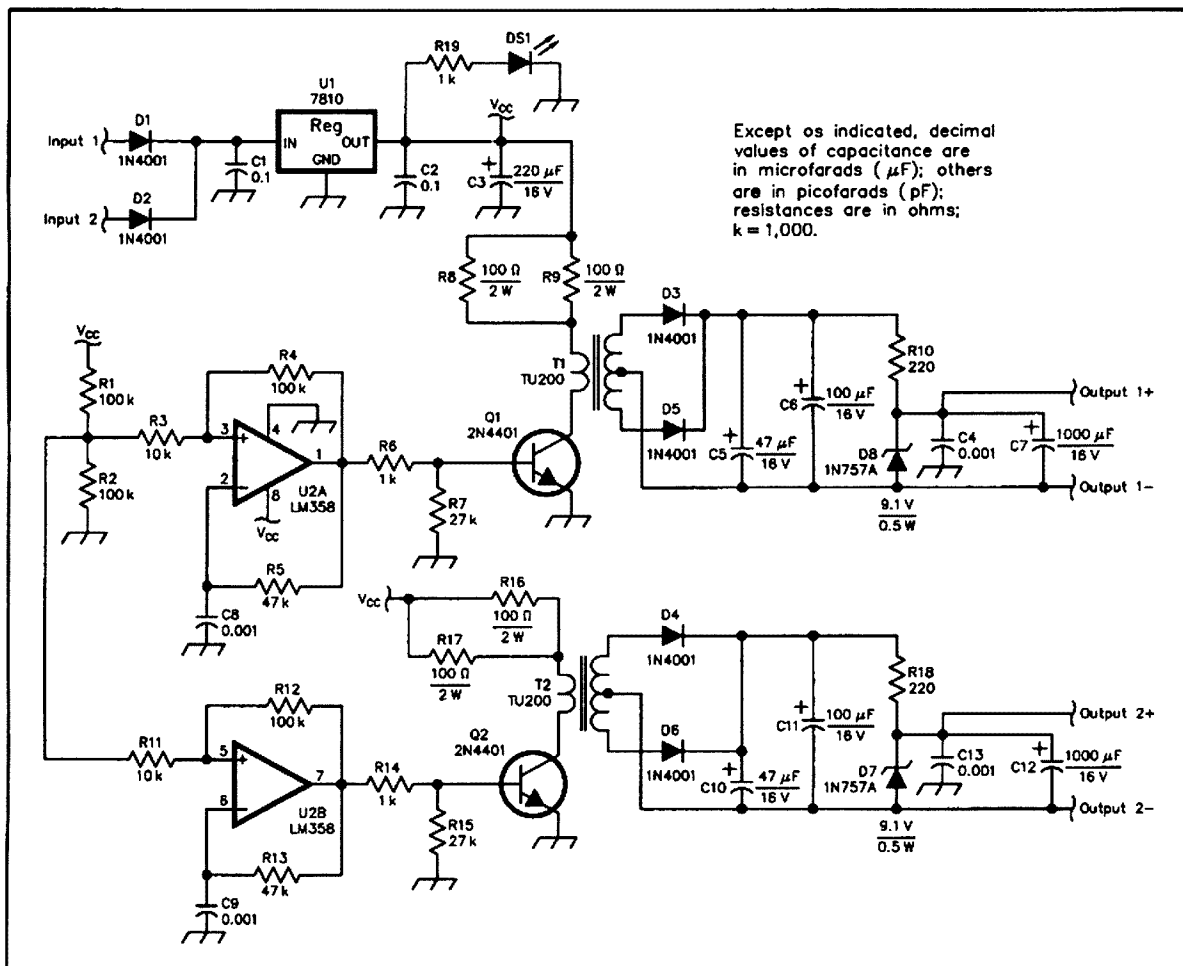

Figure 1—Schematic diagram of the digital meter supply. Part numbers in parentheses are from Mouser Electronics, tel 800-346-6873.

C1, C2—0.1 μF ceramic.
C3—220 μF electrolytic, 18 V (140-XRL-16V220).
C4, C8, C9, C13—0.001 μF ceramic.
C5, C10—47 μF electrolytic, 16 V (140-XRL-16V47).
C6, C11—100 μF , 16 V.
C7, C12—1000 μF , 16 V (140HTRL18V1000).

D1-D6—1N4001 (625-1N4001).
D7, D8—1N757A (610-1N757A).
DS1—Red LED.
Q1, Q2—2N4401 (610-2N4401).
R1, R2—100 k Ω , 1/4 W.
R3, R11—10 k Ω , 1/4 W.
R4, R12—100 k Ω .
R5, R13—47 k Ω , 1/4 W.
R6, R14, R19—1 k Ω , 1/4 W.
R7, R15—27 k Ω , 1/4 W.

R8, R9, R16, R17—100 Ω , 2 W (282-15-100).
R10, R18—220 Ω , 1/4 W.
T1, T2—Transformer, 200 Ω pri/8 Ω sec (42TU200).
U1—7810 voltage regulator (511-L78M10CDT).
U2—LM358 (511-LM358N).
Heat sink (532-576802B31).

Fig 2. Digital Meter Supply.

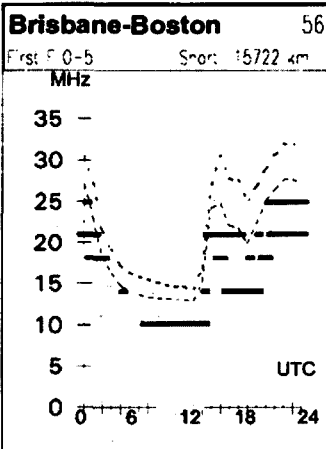
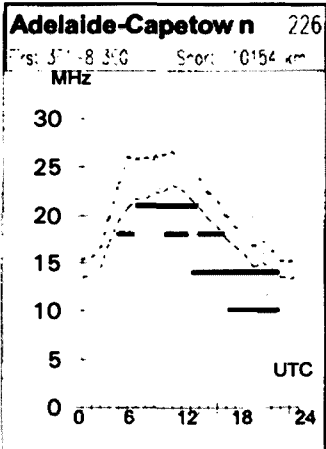

January 2002
 T index: 106

Legend

UD
 F-MUF
 E-MUF
 OWF
 ALF
 10%-50
 50%-90
 90%-10

Frequency scale
 Time scale

HF Predictions

by **Evan Jarman VK3ANI**
 34 Alandale Court Blackburn Vic 3130

These graphs show the predicted diurnal variation of key frequencies for the nominated circuits. These frequencies as identified in the legend are:-

- Upper Decile (F-layer)
- F-layer Maximum Usable Frequency
- E-layer Maximum Usable Frequency
- Optimum Working Frequency (F-layer)
- Absorption Limiting Frequency (D region)

Shown hourly are the highest frequency amateur bands in ranges between these key frequencies, when usable. The path, propagation mode and Australian terminal bearing are also given for each circuit.

These predictions were made with the Ionospheric Prediction Service program: ASAPS Version 4

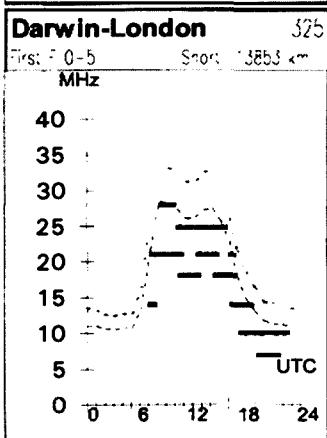
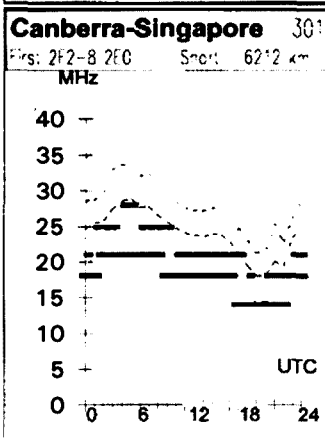
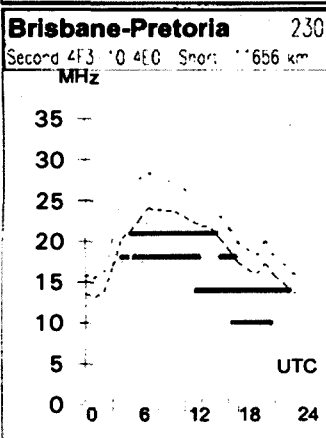
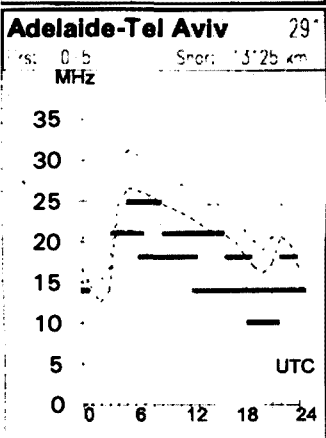
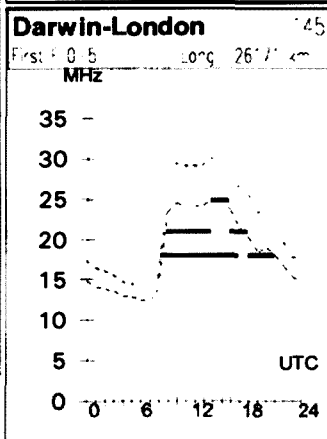
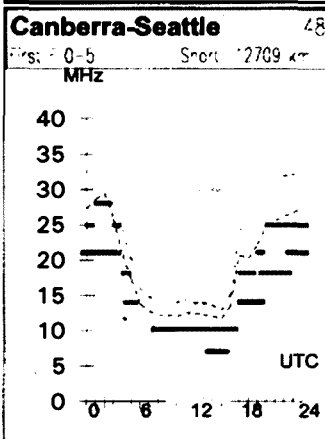
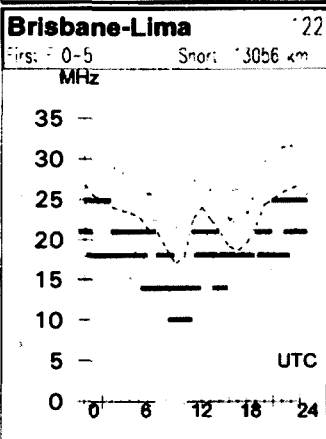
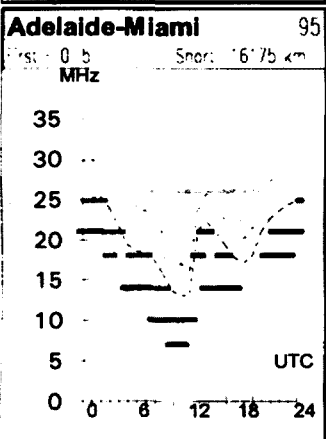
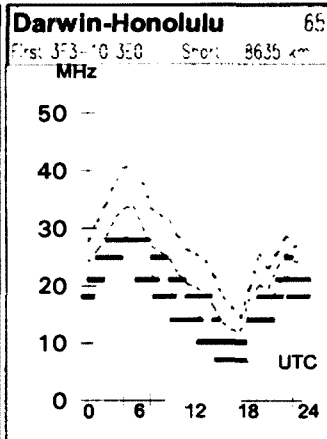
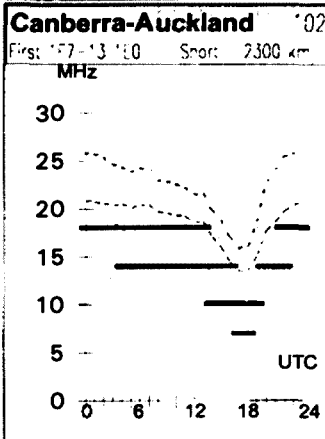
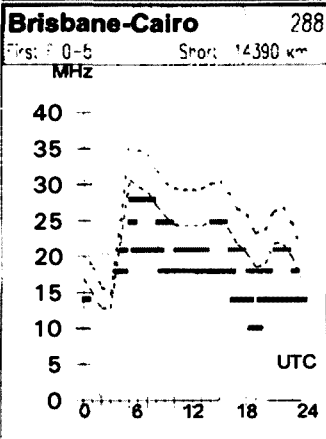
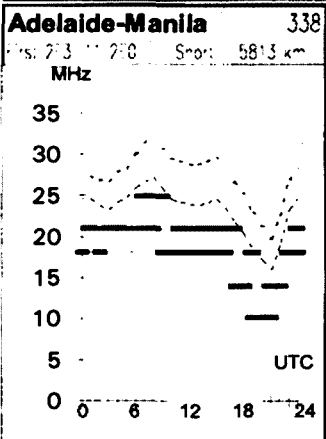

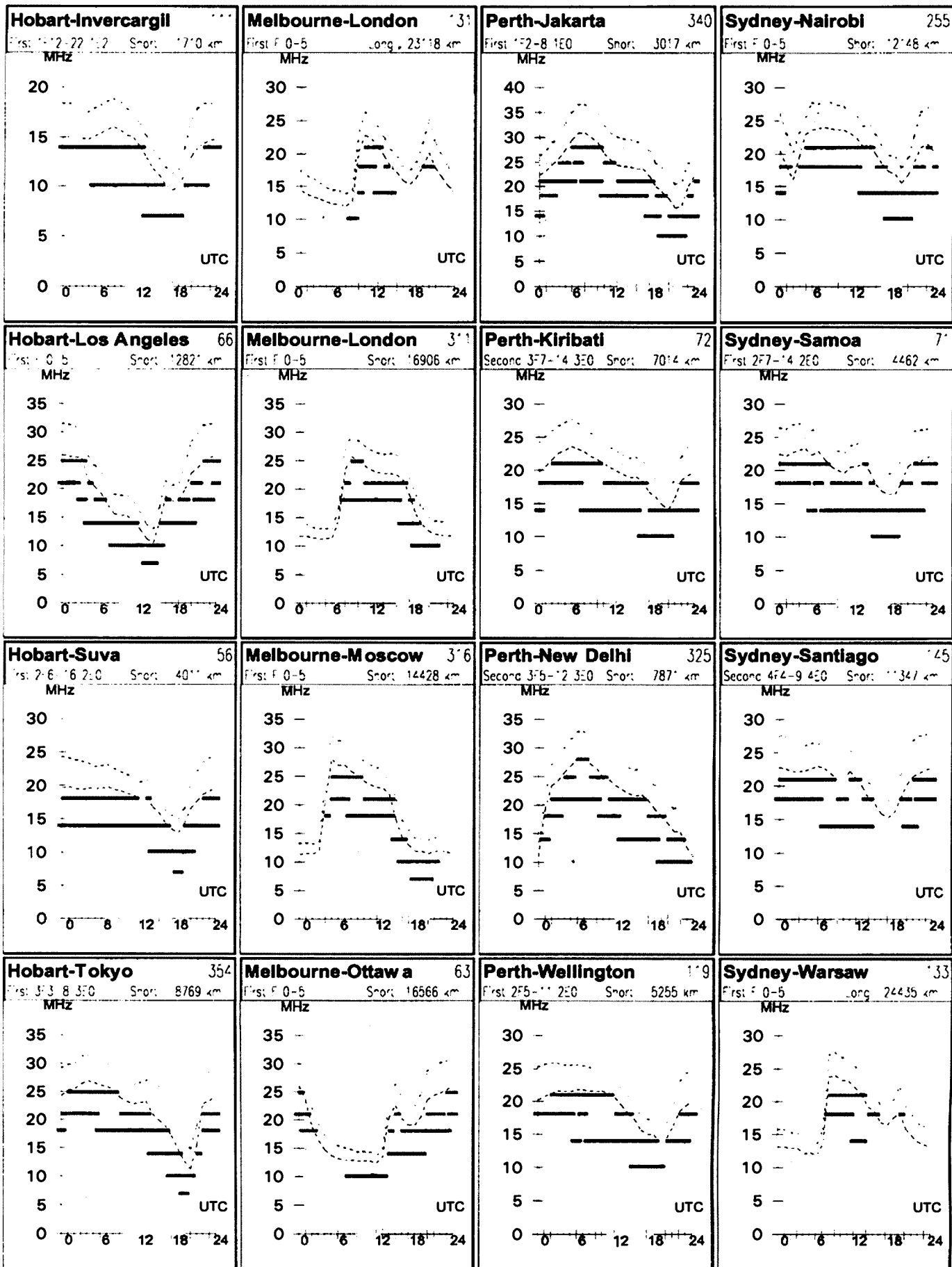

HAMADS

microphone \$40. **YAESU DIPLEXER AD-3 VHF/UHF** \$95. **TERLIN OB8-500 HF MOBILE ANTENNAS** (2 only) \$300 each. Please contact: John Abbott, VK4SKY, QTHR, Phone 0417 410 503 or emailvk4sky@wvia.org.au or PO Box 1166, Coolangatta, 4225, Queensland

WANTED QLD

• **WWII NO 19** tcvr and power amp or part sets also **3 Mark II**, and **A Mark III suitcase tcvr, S-phone 13 Mark IV** as well as **MCR 1** with coil units. Ray VK4FH PO Box 5263, Daisy Hill, Qld 4127 Phone 07 3299 3819, fax 07 3299 3821

WANTED TAS

• **US ARMY VHF FM** transistor power amplifiers **model AM-4306/GRC**. Require several units for parts, any condition! Treveor Briggs VK7TB, 9 Norfolk St, Perth Tas 7300. Phone 03 6398 2118

WANTED COCOS ISLANDS

• For Cocos Island Resident Amateur: Solid State **HF Transceiver/ Kenwood TS-130S or TS-140S, TS-440S, or ICOM, Yaesu equivalent**. If transceiver not working, please detail faults comprehensively. Help me get back on air, I can organise collection of equipment. Andy VK9CC QTHR, vk9cc@wvia.org.au, Phone 0415 735 408

TRADE ADS

PSK-31, SSTV, RTTY SOUNDBOARD INTERFACES

Fully isolated, ready to plug in. <http://www.G3LIV.CO.UK>, johnny@melvin.com, G3LIV QTHR.

ELECTRONIC VALVES

If you are looking for valves you can contact, Gamini Liyadipitiya at email: gamini@ee.unsw.edu.au Small negotiated fee — first come first served.

AMIDON FERROMAGNETIC CORES:

For all RF applications. Send business size SASE for data/price to RJ & US Imports, PO Box 431, Kiama NSW 2533 (no enquiries at office please. 14 Boanyo Ave Kiama). www.cyberelectric.net.au/~rjandusimports.

Agencies at: Active Electronics Tas, Truscotts Electronic World, Melbourne: Tower Communications, Perth: Haven Electronics, Nowra.

HF, VHF, UHF ANTENNAS & ACCESSORIES

Alum towers, guys etc. Diamond VSWR/PWR meters. HD copper ant wire & insulators. TX tubes & pwr transistors. Quality coax cables & connectors. Free advice & catalogue. ATN Antennas Ph 03 5492 2224 Fax 03 5492 2666, email atnant@ruralnet.net.au

Email your hamad

Then we just cut and paste.
You proof it, you retain control.

<http://www.hamsearch.com>
a not-for-profit site that is a search engine for hams

- Hamads may be submitted by email or on the form on the reverse of your current Amateur Radio address flysheet. Please print carefully, especially where case or numerals are critical.
- Please submit separate forms for For Sale and Wanted items, and be sure to include your name, address and telephone number (including STD code) if you do not use the flysheet.
- Eight lines (forty words) per issue free to all WIA members, ninth and tenth lines for name and address. Commercial rates apply for non-members.
- Deceased estates Hamads will be published in full, even if the ad is not fully radio equipment.
- WIA policy recommends that the serial number of all equipment for sale should be included.
- QTHR means the address is correct in the current WIA Call Book.
- Ordinary Hamads from members who are deemed to be in general electronics retail and wholesale distributive trades should be certified as referring only to private articles not being re-sold for merchandising purposes.
- Commercial advertising (Trade Hamads) are pre-payable at \$25.00 for four lines (twenty words), plus \$2.25 per line (or part thereof), with a minimum charge of \$25.00. Cheques are to be made out to: WIA Hamads.
- Copy should be typed or in block letters, and be received by the deadlines shown on page 1 of each issue of Amateur Radio, at:

Email: newsletters@ozemail.com.au Fax: 03 9756 7031

Postal: Newsletters Unlimited, PO Box 431, Monbulk Vic 3793

Please send your Hamad by ONE method only (email preferred)

FOR SALE NSW

- **ALINCO DX70** 100 watt HF and 6m as new condition, hardly uses. New price \$1700, sell \$900. David VK2BDT QTHR Phone 02 4821 5036
- **GELOSO:** tuning dial scale, lens and escutcheon only, showing frequencies 10 through 80m, bandspread. As new. Brian, VK2GCE, Phone 02 9545 2650 or [preferred] brianclarke@telstra.easymail.com.au
- **WARBIRD DISPLAYS:** Rxs, TxS, modulators, racks, mounts, remotes, some complete **COMMAND setups** as used in WWII operations. Brian, VK2GCE, 02 Phone 9545 2650 or [preferred] brianclarke@telstra.easymail.com.au
- **CROs TEK 585A and 547**, with single, dual and quad channel plug-ins. Manuals also available. All items in excellent working order. Brian VK2GCE, Phone 02 9545 2650 or [preferred] brianclarke@telstra.easymail.com.au
- **YAESU F107M** SN OH060302, owner's manual, **YAESU YM-38** mic, **EMOTATOR 1102 MXX**, **CHIRNSIDE CE-35LX TRIBANDER** 5 element antenna, **SKYTRIM TELESCOPIC TILTING MAST** 10.5m, all leads and plugs, world globe map flat, \$1000 one lot. Lyle VK2IG QTHR Phone 02 9878 3380

FOR SALE VIC

- **DIAMOND 5X200 SWR AND POWER METER** \$100. **BENCER CW PADDLE** and **KENT ELECTRONIC KEYS** \$100. All in excellent condition. VK3AAC Phone 03 5127 3905
- **ICOM FL-54 CW FILTER 250HZ BW**, suits IC-730, IC-740 etc. \$45 inc postage in VK. Chas VK3BRZ Phone 03 5282 3167

FOR SALE SA

- **ICOM IC-730 HF TCVR** SN 13814403 \$350. **YAESU 20A POWER FP700** \$100. **KENWOOD TH 205A FM H/H** SN 8010244 \$150. **TRAPPED DIPOLE HF ANT. A24-8D**

\$75. **ALINCO ROTATOR EMR 400**. New bearings \$100. **ANT TUNER AT130** \$100. **KENWOOD LF 30A FILTER** \$20. **KENWOOD HF MOBILE ANT. SET MA5** \$100. **CHIRNSIDE HF VERT. ANT. CE5SS** \$100. **DSE 2M ANT. D4211** \$30. **WELZ ANT. SW. CH20A** \$20. **SIEMENS POWER 240V FILTER** \$15. Cables, connectors, etc. \$50. Sell the lot, \$1000 ono. Ted VK5KEW Phone 08 8552 3885

• **RADIO AMATEUR'S HANDBOOKS** (aka ARRL Handbooks) 1957, 1961, 1963, 1967, 1977, 1978, 1983, 1985x2, and one ARRL Antenna Book, 1956. \$10 each. Will ship COD anywhere in VK. Hank VK5JAZ, Phone mobile (08) 0403-285-940 or Email vk5jaz@hotmail.com

• **FAX/ MODEM 33600BPS**, metal case with AC power adaptor and telephone cable, \$10. Will ship COD anywhere in VK. Hank VK5JAZ, Phone mobile (08) 0403-285-940 or Email vk5jaz@hotmail.com

WANTED SA

• **DICK SMITH ELECTRONICS 6M AND 2M ALL-MODE LINEAR AMPLIFIERS** - one of each - kits preferred but already constructed amps considered. Peter VK5ZPG phone 08 8556 2608, email pwhellum@adam.com.au

FOR SALE QLD

• Shack Clearance. All Must Go: New in box **KENWOOD PS-52** Heavy duty power supply \$450. **KENWOOD TL-922** HF linear amplifier with EIMAC 3-500Z tubes. \$1850. **YAESU FT-757 GX** HF Transceiver WITH **FC757AT AUTOMATIC ATU**, Scanning Yaesu hand microphone \$950. **YAESU YD-148** golf ball style desk microphone, new in box \$95. **ELECTRO-VOICE 600E** dynamic hand microphone \$95. CPI (USA) amplified hand microphone \$55. **REALISTIC PRO-2022 AC/DC** base scanner receiver \$150. **AWA UHF FM** complete repeater \$250. **ICOM AH-7000 DISCONE ANTENNA** new in box \$250. **ICOM MH-98** scanning DTMF hand microphone new \$75. **NEW YAESU YE-7A** black hand

Perspective on recruiting and training

Amateur examinations

Recently a very good friend of mine gave me a printout of the New Zealand Amateur Radio Transmitters question bank which is published on the Internet (with answers) and is available to students. What a marvellous idea this is! The bank contains 600 questions, which include 130 covering Regulation knowledge. The rest covers Theory requirements. If a student gains a high pass rate he or she can qualify for a "full" call. If a somewhat lower pass is achieved that sets them up for a Novice licence. A morse code test is also required but that may well disappear in the near future.

I have been involved in question formulation and theory classes for several years. Here in Australia the question bank is not generally available to the amateur body. Not only do the students in New Zealand know exactly what is required of them, but also the people helping to train them know the exact scope that their lessons or tutoring should cover. This approach has many things in its favour. It means that one exam covers both regulations and theory for both Novice and Full Call aspirants. In the near future it may be the only exam required.

Overall it could mean cheaper access to our community, because there would be only one exam fee to be paid and clubs or others could run shorter and therefore cheaper courses. All the books available here contain a lot of material, which is not examinable, and do not include many items that are covered in our question banks. I find the two books by Graeme Scott VK2KE by far the best available. Many of the courses available here are far too long. If the nomenclature in the NZ Regulations bank was amended to fit local conditions we could

use the whole Question Bank here. If a similar system to this ever becomes a possibility here in Australia I would be delighted to give time and energy to help bring it about. I have heard that the USA has a similar system and that their membership is growing.

What should be in exams?

One of the most important reasons for having Amateur Radio is for people to communicate with one another. My main reason for being an Amateur Radio operator is to enable me to help more people to qualify for the theory requirements. Quite a few of the people who come into this service want to be able to use the radio mainly as a means of developing new friends here and around the world.

They don't need the equivalent of a university degree course foisted on them. If they have a basic understanding of: -

- (a) how a radio receiver works
- (b) how a transmitter works and
- (c) how antennas work

They are well on the way to their necessary level of understanding. Add to that a thorough understanding of how interference to other services can be caused and eliminated (or at least reduced to an acceptable level) and they are nearly there.

I see no reason to extend the requirements to include more about current technological developments. If operators have an understanding of the matters referred to above and desire to investigate other methods of communication other than voice or morse they can probably learn more about that from the information booklets accompanying the new equipment than

we can ever afford to concern ourselves with teaching them.

This is the way things have been going up to now in most cases. We basically need to get them on air saying "Hello" to each other and the rest is relatively unimportant. The ACA at present requires a pass in a Regulations exam. It may be more legally binding for them to accept a signature on a form which states something like "I have read and understood the Regulations concerning Amateur Radio and agree to abide by them". The Morse exam looks like becoming a thing of the past in the near future. I look forward to the time when the path towards an Amateur licence is much more simplified, just as it is in New Zealand.

Who do we recruit ?

A lot of talk about getting new members for the Amateur fraternity centres around getting young people to join. We may be putting too much emphasis on this age group. They have computer games and the Internet to interest them. They may not have too much spare money to invest in somewhat expensive courses and exams to say nothing of buying often costly equipment.

Let's retain an interest in them by all means but there is another group of people who merit closer scrutiny. Many people in their 50's are retiring earlier than was common a few years ago and are often looking for a new interest. Some have had a desire to become radio amateurs for a long time, but circumstances and their jobs have kept them from doing anything about it. I have three in a class of five who are more or less in this category. Their interest and ability to apply themselves is exceptional. We overlook them at our peril.

ADVERTISERS INDEX

Dick Smith.....	28, 29, OBC
Icom.....	IBC
Tower Communications	50
WIA Call Book.....	25, IFC

TRADE PRACTICES ACT

It is impossible for us to ensure that the advertisements submitted for publication comply with the Trade Practices Act 1974. Therefore, advertisers and advertising agents will appreciate the absolute need for themselves to ensure that the provisions of the Act are strictly complied with.

VICTORIAN CONSUMER AFFAIRS ACT

All advertisers are advised that advertisements containing only a PO Box number as the address cannot be accepted without the addition of the business address of the box-holder or seller of the goods.

Note 1 Views expressed in letters and Opinion pages are those of the authors and do not necessarily represent the policy of the WIA.
2. Some of the letters may be shortened to allow more letters to be published.

Internet Repeater Linking

Peter Parker's article on Repeater Linking using the Internet was very welcome but disappointingly contains a few inaccuracies and some omissions. No mention was made of the pioneering work done in VK6; in fact the first repeater to be linked LEGALLY in Australia was VK6RTH in Perth. I know because it was I who obtained permission from the ACA to do it!

I like to think (says he modestly) that I also encouraged our VK2 colleagues to legally link some of their repeaters. IRLP is a great system but it bothers me that in order to make it attractive some find it necessary to make adverse and inaccurate judgements about Iphone.

Much is made of the computer operating system used. A side issue in my view, I used Windows 98 in my system with very few crashes and of course Iphone could operate under Linux if preferred.

A stated advantage of IRLP is that you can't get in through a computer, in my view (living in the Sinai in Egypt) that is a decided DISADVANTAGE. What about the amateurs that find themselves without HF or VHF facilities in nursing homes or hospitals, as well as people like me working away from VK?

With Iphone I have been able from Egypt to check into the WA Repeater Group Net just as I would from Perth. Much is made of non-amateurs getting to air via Iphone, in all the time I was linking I have never heard a non-amateur access an Australian repeater via the net. Safeguards were in place. On HF how do we know if the operator the other is licensed and what about the gateways and all that CB QRM that is broadcast on our repeaters? IRLP may be more secure but it's harder for amateurs to access too! I know this may appeal to the more puritanical of our brethren.

A typical Iphone link up often used eight or more radios, to say that IRLP is better from that point of view is wrong too.

For all that, using the Internet to link repeaters is a great idea, it is cheap and very effective, a great resource for amateurs as communicators to utilise. How else could I speak to an amateur in

the UK using his handheld on his local repeater whilst fishing on some English riverbank or a US amateur driving down the freeway in LA?

Alan Taylor VK6BN
Sinai, Egypt

Internet not part of Amateur Radio

I wish to take issue with David Pilley and any others that claim that the use of Internet linking is part of the evolution of Amateur Radio. It is NOT. It is the coupling of Amateur Radio to commercial communications systems, for the use of which a charge is made. This takes the operation outside the realm of Amateur Radio and into some kind of hybrid system.

Had they wanted to adopt the same kind of convoluted thinking, Amateur Radio operators could many years ago have made a similar kind of connection. However, they saw Amateur Radio as self-sustaining, running independently of commercial interests, and prevailing in situations in which commercial systems, despite their massive financial backing, frequently failed. The great appeal of Amateur Radio lay in showing what could be achieved with low-cost and often home-built equipment. Amateurs knew that their stations could never attain the sophistication of the multi-million dollar commercial enterprises, but they proved that they could maintain viable and useful communications under all kinds of difficult or adverse conditions.

What the technocrats of today are trying to sell us is the guaranteed operation and certain performance of a world-wide commercial network, to which Amateur Radio stations can connect as extremely peripheral appendages. The network can be used just as well without the involvement of Amateur Radio at all! While some artificial restrictions have been placed, by regulatory requirements, on indiscriminate connection to these systems, there is no technical reason why anybody could not use them.

If more and more Amateur Radio operators resort to the use of this linking, the skills and independence, which we have developed in the past, will gradually be lost. With that the

fascination with extending our frontiers which has held the interest of generations of communicators for the best part of 100 years. I do not speak as an opponent of computers. I hold a diploma in Information Technology, and make considerable use of the Internet. But let us leave our repeaters, which are the main target of Internet linking, to the use for which they were designed - the enhancement of mobile and local communications.

Stan Ellis, VK2DDL

Cardiac Pacemakers and Amateur Radio

My wife has just recently had a cardiac pacemaker implanted, and in the list of dos and don'ts there is very little reference to Amateur Radio frequencies and operation as being of any risk to the successful functions of these devices. ACA have been very supportive in my enquires to them concerning this matter, and have sent on a comprehensive report on EMR and public health. This deals mainly with digital telephones and cell antenna installations, but still no definite mention of Amateur Radio frequencies other than to make sure that one's amateur radio station and antenna system falls within the compliance requirements of the EMR regulations being introduced in the near future. There has also been discussion on risks associated with close proximity to mobile antenna systems on HF VHF and UHF and also with hand held units and relationship of the antennae to areas of the head, but none of these situations apply at this QTH.

I wonder just how many amateur operators would be in this situation, that of being personally involved with cardiac pacemakers either on their own person or with close members of the family. I would like Amateurs who are familiar with the situation and who have particular knowledge and other information especially with regard to the safety of all concerned to contact me. I would be pleased to hear further from anyone on this matter, and my QTH is as per current call book, and Email address is vk4bf@telstra.easymail.com.au

Ron Tulloch VK4BF

▶ YAESU SUPER DEAL!



Yaesu FT-1000MP Mark V Deluxe HF Base Station

Yaesu is proud to enter a new chapter in the history books with the new premier-class MARK-V FT-1000MP. Offering new features such as 200W PEP RF output, a Class-A RF power amplifier, interlocked Digital Bandwidth Tracking, a variable RF front-end preselector filter and improved control layouts, the MARK-V represents the highest overall performance ever offered in a Yaesu HF transceiver.

Whether your interest is in ragchewing or contest operation, the MARK-V's outstanding hybrid analogue/DSP receiver IF chain incorporating a new 10 pole Collins SSB filter and the use of Enhanced Digital Signal Processing (EDSP) with improved front panel access provides dramatic improvements in readability under tough conditions. For ease of use, the new MARK-V uses an external FP-29 power supply which can be mounted next to the transceiver, or under your operating desk. Yaesu's IF-based EDSP system provides noise-reduction protocols, audio enhancement with equalisation programs for Tx and Rx use and an automatic notch filter which identifies and eliminates multiple interfering carriers.

The MARK-V FT-1000MP also features selectable receiver front-ends, High-stability Reference Oscillator, an internal high-power auto antenna tuner, two main antenna sockets, selectable tuning steps as small as 0.625Hz, dual-mode noise blankers, 500Hz and 6kHz IF filters, an RS-232C computer interface, plus easy digital mode interfacing. With so many new and improved features, why not ask for a copy of the 8 page colour brochure today to learn more about this amazing new transceiver.

D 3450

2 Year Warranty

\$5990

SAVE \$500!

YAESU

On display at selected PowerHouse stores only. Please call for details.
All Yaesu products are priced in Australian dollars, and are not stocked
in Dick Smith Electronics stores outside Australia.

Offer expires 28/2/2002.

DICK SMITH
ELECTRONICS

That's where you go!

Be the predator, not the prey

IC-756PROII (HF/6m) Amateur Transceiver



ICOM raises the bar of excellence with the world's most powerful DSP technology in amateur radio history with the IC-756PROII. From the box to heavy contest action, in a matter of seconds. Imagine the fun and excitement of creating your own filter width and shape while on the air, rag chewing, or in the middle of a pile-up!!

Features include

- Sharp & soft, IF filter shape
- No optional filters to buy
- 41 selectable IF Filter bandwidths
- Choice of 3 filters per mode
- Improved 3rd IMD & wide dynamic range
- Triple band stacking register
- Built-in Antenna Tuner
- Two levels of receiver pre-amp
- Three levels of attenuator
- Dual watch on same band
- IF DSP
- 13.8V DC operation
- 5 to 100W SSB,CW,FM,RTTY (including RTTY decoder)
- 4 to 40W AM
- Dual Antenna Sockets
- Real Time Spectrum Scope
- One-touch record/play
- Digital voice memory
- Extended 1/4 tuning step & BPF functions for SSB-D mode
- 32 bit floating point DSP and 24 bit AD/DA converter
- SSB / CW synchronous tuning
- 8 Display types
- 7 Font Types
- Memory Keyer
- 4.9 inch color TFT LCD

ICOM
Clearly Ahead

Find your nearest ICOM dealer at
www.icom.net.au
or (03) 9387 0666

VIC Strictly Ham (03) 9729 7656, Harris Communications (03) 9347 6264
NSW Amateur Transceiver Radio Centre (02) 9896 2545 QLD Kyle Communications
(07) 3857 4400 WA Tower Communications (08) 9274 1118 SA ICS (08) 8447 3688

February 2002

Volume 70 No 2



Amateur Radio



**The ultimate
home brew**

- ★ **"Tone-a-Volt" Audible Voltage and Component Tester**
- ★ **Neville Mattick VK2QF gives *66 Tips for 6***
- ★ **A Field Day or Emergency Portable Mast for VHF & UHF Antennas**

The DISCONE: good broadband antenna for VHF and UHF, cheap and easy to build



Australian
Amateur Radio

Callbook **Every**
2002 **shack**
should
have one



**The "Call Book 2002" is available from
your State Division
Order now to get the member discount**

VK1 Division

GPO Box 600, Canberra ACT 2601

VK2 Division

109 Wigram St, Parramatta NSW
(PO Box 432, Harris Park, 2150)
(Office hours Mon-Fri 1100-1400)
Phone 02 9689 2417
<http://www.ozemail.com.au/~vk2wi>
Freecall 1800 817 644
e-mail: vk2wi@ozemail.com.au

VK3 Division

40G Victory Boulevard
Ashburton VIC 3147
(Office hours Tue 10.00 - 2.30)
Phone 03 9885 9261
<http://www.wiavic.org.au>
Fax 03 9885 9298
e-mail: wiavic@wiavic.org.au

VK4 Division Queensland
PO Box 199, Wavell Heights, Old. 4012
Phone 07 3221 9377 Fax 07 3266 4929
e-mail: office@wiaq.powerup.com.au

VK5 Division (and VK8)

(GPO Box 1234 Adelaide SA 5001)
Phone 0403 368 066
: <http://www.sant.wia.org.au>
email: peter.reichelt@bigpond.com

VK6 Division

PO Box 10 West Perth WA 6872
Phone 08 9351 8873
Web: <http://www.vk6wia.org>
e-mail: vk6wia@inet.net.au

VK7 Division

PO Box 371 Hobart TAS 7001
Phone 03 6234 3553 (BH)
<http://www.tased.edu.au/tasonline/vk7wia>
email: batesjw@netspace.net.au

COMMERCIAL RESELLERS

Please contact June Fox (WIA Federal) on 03 9528 5962



Amateur Radio

Volume 70
Number 2
February 2002

The Journal of the Wireless
Institute of Australia

ISSN 0002-6859

Editorial

Editor: Colwyn Low VK5UE
edarmag@chariot.net.au

Technical Editor: Peter Gibson VK3AZL

Publications Committee Members

Ron Fisher VK3OM
Don Jackson VK3DBB
Evan Jarman VK3ANI
Bill Rice VK3ABP
Gil Sones VK3AUI
Bill Roper VK3BR

Advertising

Mrs June Fox,
Tel: (03) 9528 5962

Hamads

"Hamads" Newsletters Unlimited
PO Box 431, Monbulk Vic 3793
Fax: 03 9756 7031

e-mail: newsletters@ozemail.com.au

Office

10/229 Balaclava Road
Caulfield, Victoria
Telephone (03) 9528 5962
Facsimile (03) 9523 8191

Business Hours 9:30am to 3:00pm weekdays

Postal

The Editor AR
34 Hawker Crescent
Elizabeth East
South Australia 5112
Email edarmag@chariot.net.au

Production

Newsletters Unlimited 03 9756 7797

Printer

Streamline Press, Melbourne (03) 9417 2766

Postal Service

IMS (03) 9291 5888

Production Deadlines

Advertising booking and articles for
publication 10th of preceding month.

Hamads and advertising material deadline
18th day of preceding month

The contents of Amateur Radio are Copyright
Wireless Institute of Australia © 2002

General

66 Tips for 6	8
<i>Neville Mattick VK2QF</i>	
LANGKAWI AS-058. A Holiday Solree	13
<i>Johnny Melvin G3LIV</i>	
Ve haft vays of making you TOCK	16
<i>Mike Krochmal VK3KRO</i>	
The new UK Foundation Licence	18
<i>David A Pilley VK2AYD</i>	
Classification of emissions: Episode three	46
<i>Henry Andersson VK8HA</i>	
What happens	40
<i>Colwyn Low VK5UE</i>	

Technical

"Tone-a-Volt" audible voltage and component tester	4
<i>Drew Diamond VK3XU</i>	
The DISCONE—a good broadband antenna	9
<i>Mike Todd VK6JMA</i>	
A Field Day or Emergency Portable Mast for VHF & UHF Antennas	11
<i>Keith Gooley VK5OO</i>	
Portable Two Element Triband Yagi (Technical Abstracts)	25
<i>Gil Sones VK3AUI</i>	
Sardine Sender Updated (Technical Abstracts)	26
<i>Gil Sones VK3AUI</i>	
Determining Transistor and Diode Leads with a Multimeter (Technical Abstracts)	26
<i>Gil Sones VK3AUI</i>	

Columns

Advertisers' Index	55	Ham Shack Computers	47
ALARA	20	HF Predictions	52
AMSAT	35	How's DX?	38
Beyond Our Shores	23	Intruder Watch	32
Education Notes	24	Over To You	56
Contests	41	Repeater Link	33
Club News	21	Silent Keys	10, 31
WIA Division News		Spotlight on SWLing	22
VK1 Notes	30	Technical Abstracts	25
VK2 Notes	30	VHF/UHF - An Expanding World	49
VK4 Notes	30	WIA Comment	3
VK6 Notes	31	WIA Division Directory	IBC
Editor's Comment	2	WIA Federal Directory	2
Hamads	54		

Our cover this month

The station shown here is homebrewed except for the microphones and the clock. It is a tribute to the Amateur spirit and in particular to George Hodgson VK2OH who built it. Long Live Homebrew!

Contributions to Amateur Radio

Amateur Radio is a forum for WIA members' amateur radio experiments, experiences opinions and news. Manuscripts with drawings and or photos are always welcome and will be considered for publication. Articles on disc or email are especially welcome. The WIA cannot be responsible for loss or damage to any material. A pamphlet, How to write for Amateur Radio is available from the Federal Office on receipt of a stamped self-addressed envelope.

Back Issues

Back issues are available directly from the WIA Federal Office (until stocks are exhausted), at \$4.00 each (including postage within Australia) to members.

Photostat copies

When back issues are no longer available, photocopies of articles are available to members at \$2.50 each (plus an additional \$2 for each additional issue in which the article appears).

Disclaimer

The opinions expressed in this publication do not necessarily reflect the official view of the WIA and the WIA cannot be held responsible for incorrect information published.

Amateur Radio Service

A radiocommunication service for the purpose of self-training, intercommunication and technical investigation carried out by amateurs; that is, by duly authorised persons interested in radio technique solely with a personal aim and without pecuniary interest.

Wireless Institute of Australia

The world's first and oldest
National Radio Society
Founded 1910

Representing

The Australian Amateur Radio Service

Member of the
International Amateur Radio Union

Registered Federal Office of the WIA

10/229 Balaclava Road
Caulfield North Vic 3161

Tel: (03) 9528 5962 Fax (03) 9523 8191

<http://www.wia.org.au>

All mail to

PO Box 2175 Caulfield Junction VIC 3161

Business hours: 9.30am-3pm weekdays

Federal Secretary

Peter Naish VK2BPN

Federal Office staff

June Fox Bookkeeper
Rita Trebilco VK3IF Examinations Officer

Council

President	Ernest Hocking	VK1LK
VK1 Federal Councillor	Gilbert Hughes	VK1GH
VK2 Federal Councillor	Barry White	VK2AAB
VK3 Federal Councillor	Jim Linton	VK3PC
VK4 Federal Councillor	David Jones	VK4OF
VK5 Federal Councillor	David Box	VK5OV
VK6 Federal Councillor	Will McGhie	VK6UU
VK7 Federal Councillor	Phil Corby	VK7ZAX

Executive

Brenda Edmonds
David Pilley
Don Wilschelski

VK3KT
VK2AYD
VK4BY

Federal Coordinators

AMSAT	Graham Ratcliff	VK5AGR
ARDF	Jack Bramham	VK3WWW
Awards	Mai Johnson	VK6LC
Contests	Ian Godsil	VK3VP
Education	Brenda Edmonds	VK3KT
FTAC	John Martin	VK3KWA
Historian	John Edmonds	VK3AFU
IARU	Grant Willis	VK5ZWI
Intruder Watch	Harry Anderson	VK8HA
International Travel Host	John Miller	VK3DJM
ITU Conference and study group	Gilbert Hughes	VK1GH
QSL Manager (VKs, VKs)	Neil Penfold	VK6NE
Videotapes	VK2 Division	
Web	Joe Burford	VK5UJ

ACA Liaison Team

Ernie Hocking VK1LK
Gilbert Hughes VK1GH
Kelth Malcolm VK1ZKM
Peter Naish VK2BPN
Canberra Liaison Officer Richard Jenkins VK1RJ

Editor's Comment

Gremlins!

This month has been a bit of a hassle. More things than usual went wrong. None of them big but added together they just made things difficult and wearing. However we have a magazine so I have to write the Editorial.

The month of January has seen a lot of activity on the future of AR. The possibilities range from none to continue as is. One major factor will be cost. Others much more important to the continuation of the WIA is "Do we need AR" and "Can we continue as a viable organisation without it". You the members will have to make the final decision so please discuss it with your friends, at your Radio club and with your Divisional officers, in particular your Federal Councillor. Surveys have been arranged in VK3 and VK6.

In the December issue, page 7, I published a letter on three year licence payments. The letter put forward one Ham's story with one ACA officer and named the officer. The ACA has now informed the WIA that the method of approach was incorrect and we should not have named the particular officer. While the information was correct when obtained, there was a pending fee alteration which had not been passed to all officers. We wish to acknowledge the helpfulness of the officer in dealing with the inquiry. However the ACA therefore have requested

1. Unless it has been explicitly agreed beforehand, please do not refer people in Amateur Radio and elsewhere to specific officers within the ACA. Please use the ACA's nation-wide local rate number (1300 850 115) for enquires, except where there is an agreed contact officer for a particular issue. Amateur enquires will normally be handled by the

local ACA office, unless they are of policy or national significance, in which case they will be dealt with by the Customer Services Coordination Team.

2. Please check fees, changes of policy, etc with the Manager, Customer Services Coordination (ie Gill) if at all possible before going to print. We would probably have been able to tell the author about the forthcoming fee changes, whereas someone in a Regional Office may not have access to the same level of information.

Exams. Please note, the WIA exam service reopens 1st March and VK2DQ Ron Bertrand's Internet course is on the web at <http://www.radioelectronicschool.com>

Apology

We apologise to Ted Miles VK2FLB our notice of his passing was premature and he has informed me that our notice was incorrect. Ted had advised us of the passing of George Stanly Schulze VK2GX and some how his name was associated with the SK list. Ted, we are very sorry and we hope you continue to enjoy a health and fulfilling life.

Seanet 2002

Perth is hosting the *Seanet Convention* on the 1st, 2nd & 3rd November this year with the backing and assistance of the "Northern Corridor Radio Group". They have a Web site up and running the site is — www.qls.net/seanet2002

Well I survived the UHF Summer Field Day as a grid hopper. Had a good time. Now will have to get the HF gear ready for the John Moyle Field Day. Look in the Contest Column for the Australian 2002 Contests.

Enjoy your Amateur Radio activities in whatever field they lie.

73 Colwyn VK5UE

PLAN AHEAD

John Moyle Field Day March 16 & 17

See page 42 for details

"Another quiet month at WIA Federal"

As a youngster I well remember watching Laurel and Hardy and trying to understand their throwaway line about "Another fine mess that you've gotten me into". I was reminded of this as I sat down to put pen to paper to relate the activities at Federal WIA since my last report. It does seem that every way we turn at the moment that another issue crops up to challenge us. At least in sitting down to write this report it does make me realise that amateur radio is still a very vibrant hobby - if it was not then I suspect we would not be presented with quite as many challenges.

In the last few weeks correspondence has mostly been focused on the issues of the future of AR, debate on the possible structure of the WIA and the question of allocation of the recently released AA call signs for VK0 and VK9. In addition the subjects of the launch of the Foundation licence in the UK, inappropriate band usage on 40m band, the ongoing debate on the 70cm band plan, beginning to plan for the 2002 convention which will be held in Melbourne, and lastly but by no means least trying to get someone to volunteer to pick up the task of the editor for the reference material from the call book. To stay within the space our editor Colwyn allocates me I will concentrate on the major issues

I will start with the launch of the Foundation licence in the UK. We were all very aware of the launch date but I suspect many of us were surprised at the extent of the take up of the new licence in its first days. As I have earlier alluded to, the WIA must have a clear position on the form that we would like to see such a licence take here in Australia. Given the success of the UK model perhaps we should take heed of their approach. I know that David Pilley has put together an article in this issue of AR describing what was done. It's worth the read. I am still looking for volunteers who can help in putting together the

WIA position so that we can be ready to finalise our position at the Federal convention and go to the ACA and DoCITA with our case.

Progress on AR

Last month I made reference to collating the results of member correspondence over the future of AR. In reviewing the correspondence I quickly realised that I could not use the responses as the basis of any realistic statistical treatment of member views. However I can summarise the main results. These include responses from over 100 members when I include the survey results from the VK6 web page - well done to all in the VK6 Divisional council who took part in this survey initiative. This level of response is very favourable in view of the current membership numbers:

- There was a strong positive response to publishing AR on the web (at least 40 positive replies, and only 5 against). There remains a concern that not all members have Internet access. On the positive side a number of members pointed out that accessibility software often made electronic articles more available to those with impaired vision.
- There was strong support for reducing AR to 6 issues per year (59 positive replies)
- There was strong support for publishing AR more widely. There was no distinction made between the WIA publishing AR directly or achieving this in conjunction with a commercial organisation although the need to retain full editorial control was identified as a concern.
- There were 4 replies suggesting that we might look at a joint publication with NZART
- There was a strong overall indication that most people were

concerned over increasing costs. A number of responses indicated that we should look carefully at cost reduction measures as a means to increase membership. One response noted that it was better to get something rather than nothing from members. As a pensioner he made it clear that the only reason for non-renewal of membership was the high cost as a proportion of his pension.

- A number of replies pointed out the importance of AR as the Institute's House journal,
- A small number of responses identified the importance of AR as a vehicle for the publication of construction articles, but surprisingly there was no response from the contest or DX community - it appears that they have already made the transition to the web as a way of managing their activities.

At this stage I have received a number of quotations from suppliers of potential solutions. I am now in the process of documenting these costed options so that I can present them to council in the near future.

WIA structure issues.

At last year's convention there was some discussion of Martin Luther's paper on the future structure of the WIA. At that convention no specific conclusion was reached and although there has been some continued discussion we are not really any further forward. I know that a number of us are continuing to investigate options. At least one member is trying to rewrite the current WIA articles of association in an attempt to reach a position which better meets members requirements. The debate has I believe also been taking place various at Divisional meetings. I intend to make myself available during the forthcoming

Continued on page 7

"Tone-a-Volt" audible voltage and component tester

Drew Diamond, VK3XU
45 Gatters Rd.,
Wonga Park, 3115.

Multimeters are marvelous. For a modest price, we can buy a little digital meter, which will measure all the usual electrical quantities. And for a little extra cost, you can have an instrument that does capacitance, inductance, and even frequency, but these devices all assume that the user can see the meter. There are applications, in continuity testing for example, where it may be operationally awkward, or slow, to have to watch a multimeter's display, when all that may be required is a response to a go/no-go test.

A few years ago, Tandy offered a neat little talking multimeter, which was of great utility, particularly to vision-impaired enthusiasts. Unfortunately, that instrument is no longer marketed. Details of a homemade audible tester are therefore offered. There are just two

modes of operation; Ohms (resistance) and Volts. When the probe leads are applied to a short-circuit, a tone of about 500 Hz is emitted. Tone frequency descends as resistance increases, so that a P-N diode junction for instance, produces about 450 Hz, and at 10

Megohms the output burbles at about 50 Hz. When measuring potential, tone frequency rises with voltage. For example, a forward biased silicon junction (about 0.6 V) produces about 200 Hz, 1.5 V gives 350 Hz, 5 V; 500 Hz, 12 V about 800 Hz, and 18 V yields about 1000 Hz.

The Ohms (or "buzz") mode may find use in checking the goodness and continuity of wire connections (and give a much quicker response than an ordinary visual display), in looking for shorts, opens and P-N junctions in circuitry (again, quicker than a meter) and so on. Capacitors, when first connected will cause a gliding tone or squawk that dies

away at a rate according to the size and quality of the capacitor. In the Volts mode, the user may check for the presence, polarity and approximate value of voltages (in battery checking for instance), which should make the device of particular use to vision-impaired persons.

Circuit

An ordinary NE-555 timer chip is wired as an astable relaxation oscillator. Trigger point may be altered (and therefore the frequency) by varying the voltage applied to the discharge pin 7, thus making the '555 behave as a voltage controlled oscillator. When the voltage (with respect to ground pin 1) equals, or is less than about +6 V, the chip stops oscillating. As the positive voltage is raised beyond 6 V, the circuit will oscillate at an increasingly higher frequency, as noted above. In order to make the '555 respond to dc levels just over 0 V; a positive bias voltage must be applied for voltage measurements. The necessary bias is supplied by the voltage divider comprised of the 10 k - 10 k trimpot - 22 k resistor string. The slider of the trimpot is set for about +6 V. Now, input voltage, applied via the probes will add to the standing bias voltage, and thus cause the '555 to oscillate.

In the resistance (Ohms) mode, S1 configures the input such that the +9 V supply rail is made available as input voltage. When a resistance, or short-circuit is placed across the probes, the '555 oscillates. The input circuit switch S1 is wired so that a positive potential in the Volts mode shall cause a tone

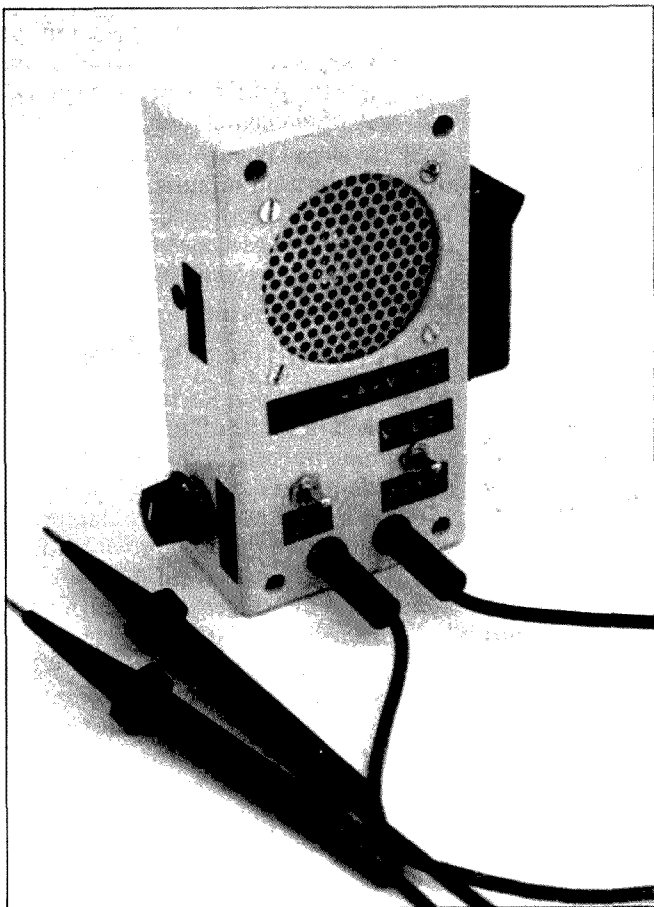
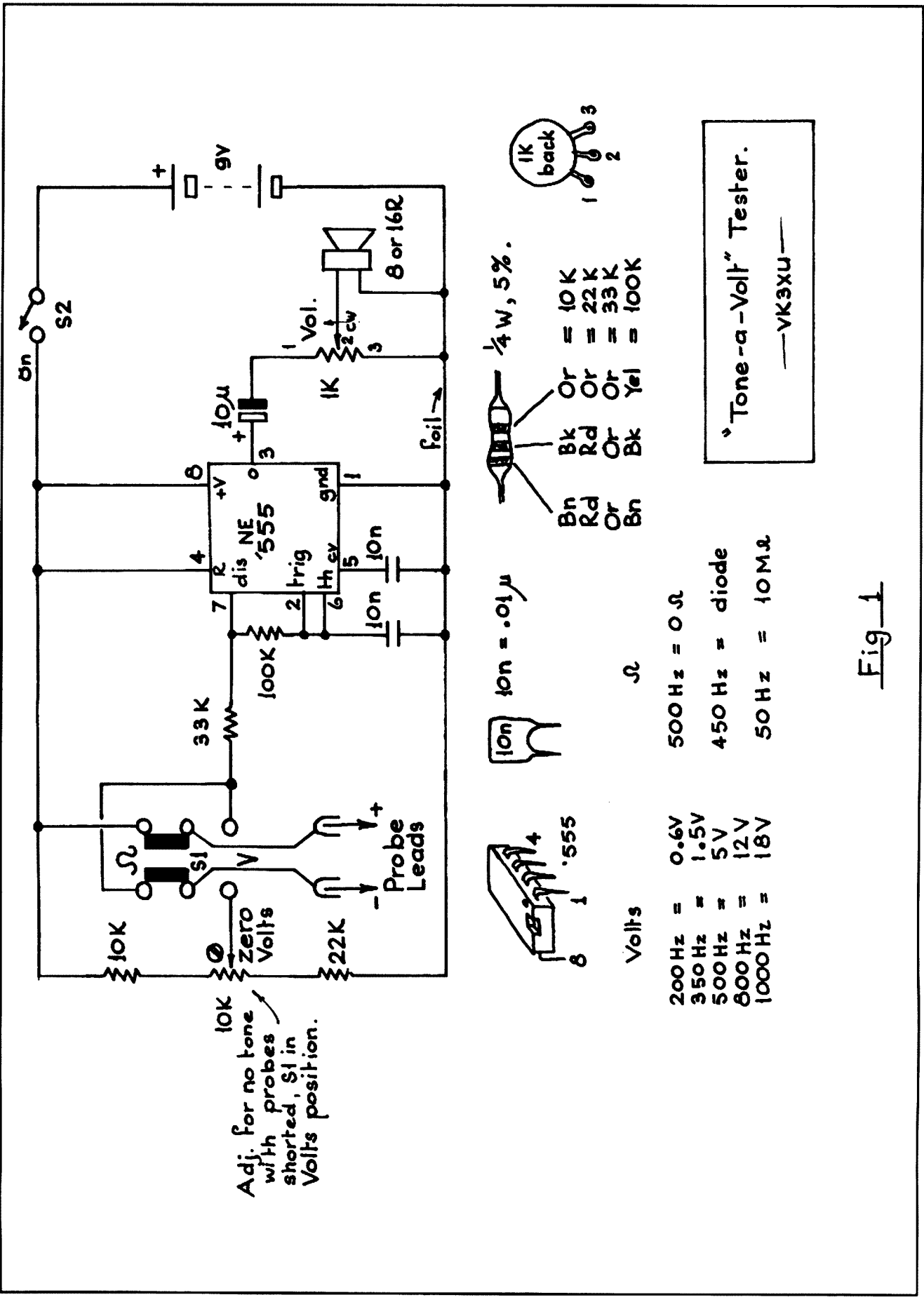

Photo 1. "Tone-a-Volt" tester



Adj. for no tone with probes shorted, S1 in Volts position.



10n = .01 μ

Bn	Or
Rd	Or
Or	Or
Bn	Yel

1/4W, 5%.

= 10 K
= 22 K
= 33 K
= 100K

Volts

200 Hz = 0.6V
 350 Hz = 1.5V
 500 Hz = 5V
 600 Hz = 12V
 1000 Hz = 18V

500 Hz = 0 Ω
 450 Hz = diode
 50 Hz = 10M Ω

'Tone-a-Volt' Tester.
 —VK3XU—

Fig 1

Figure 1

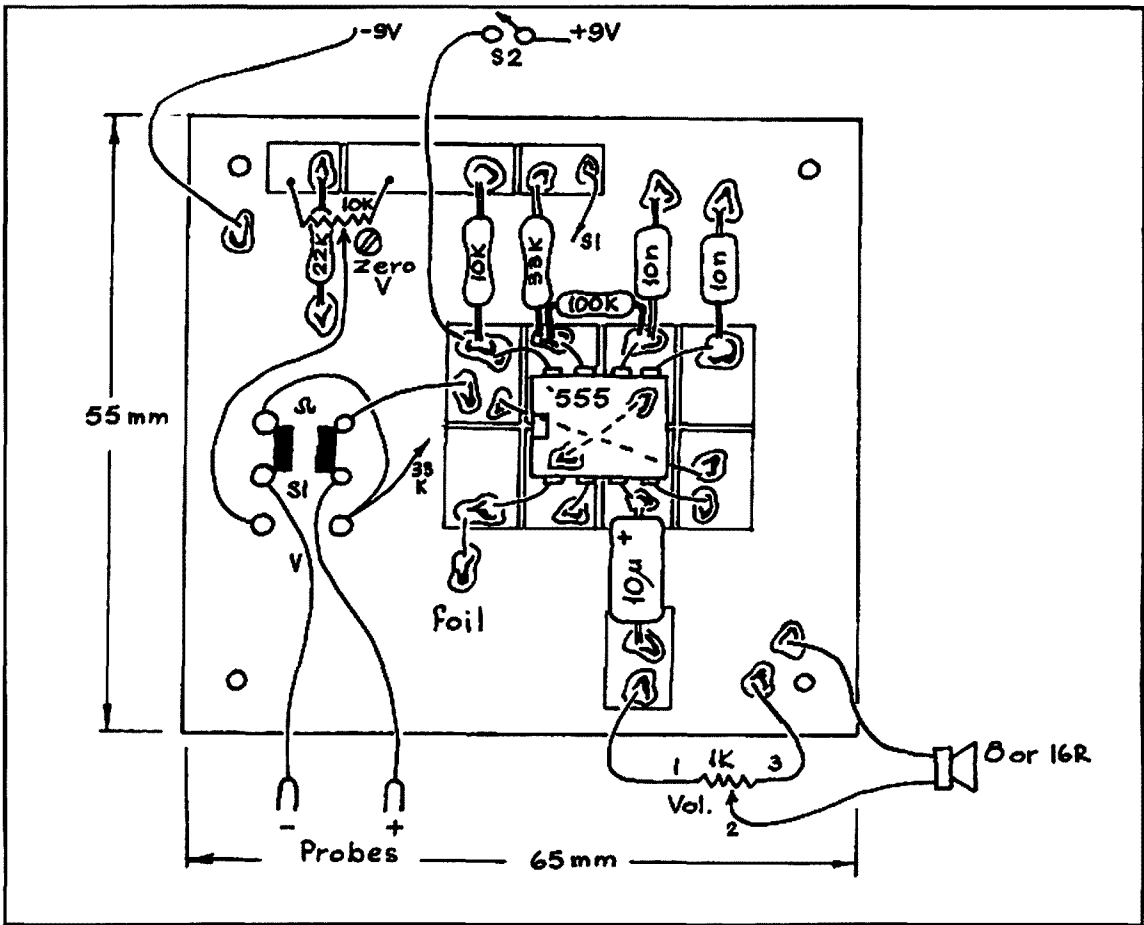

Figure 2

response, and when switched to Ohms, the 'positive' lead presents a positive potential to the device under test. So, if the P element of a transistor or diode junction is connected to the positive test lead, and the N element to the negative lead, the tester will beep.

Construction

A plain circuit board measuring 55 x 65 mm accommodates most of the components. A suggested 'paddyboard' (see Ref 2) layout is shown in Fig. 2. However, construction method is not at all critical, so that just about any wiring style that you prefer- even 'dead-bug', should work satisfactorily. It is recommended that the '555 chip should be fitted into a suitable 8-pin I.C. socket and soldered with tinned wires (about 0.6 mm) to an 8-land substrate, which in turn may be super-glued upon your circuit board.

The case shown is a 'Jiffy' box measuring 130 x 68 x 44 mm, and is available from the usual electronics suppliers. An internal view of the

prototype is shown in Photo 2. Leave sufficient hook-up wire lead lengths so that the front cover may be fully opened for access. An external holder for the 9 V 'transistor' battery is strongly recommended, particularly if you are making this tester for a blind mate. A pair of ordinary banana sockets, spaced 0.75" should be provided for connection of the probes.

Operation

Give the wiring, soldering and parts placement a thorough visual inspection. Install a fresh (preferably alkaline- for lowest internal resistance) 9 V 'transistor' battery and switch on. Turn the 1 k vol. pot to about half travel. With switch S1 in the Ohms position, short the test probes together. You should hear a tone of about 500 Hz. Grip each probe tip with your body as the 'circuit'. You should be able to vary the tone by squeezing and relaxing your grip upon the probe tips, thus proving correct operation of the Ohms function.

Switch S1 to Volts. Short the probes and adjust the 10 k 'zero Volts' trim-pot so that the '555 just ceases oscillating- thus setting the circuit for best sensitivity. Test by connecting the probes to various sources of voltage. For example, a 1.5 V cell, then 6 V, 9V and 12 V batteries if available. Or you could connect the probes to a variable voltage dc power supply. Some typical Voltage : Frequency figures are shown on the schematic diagram in Fig. 1.

Diodes and transistor junctions may be checked by connecting the probe leads one way, then the other- a 450 Hz tone should be heard when the diode is conducting, silence for the reverse direction. For transistors, also check for leakage by connecting between collector and emitter, base open. For a good NPN, with the positive lead on the collector, negative on the base, a sweaty finger applied between the base and collector should turn the transistor on and cause a buzz.

Capacitors as small as 5 nF (0.005 µF) may be checked. In ohms mode, connect

the capacitor to the probe leads- you should hear a click or a squawk, then silence, depending upon capacitance. Larger caps will cause a correspondingly longer squawk. A good low-leakage electrolytic, when correctly polarized, should eventually cease clicking when fully charged-although caps which have been out of use for some time may need 'forming', but should eventually settle to about 5 or so clicks per second, indicating very low leakage.

Parts

All of the components specified are available from our familiar electronics vendors, including Altronics, Dick Smith Electronics, Electronics World and Jaycar. My 'Jiffy' box is a Jaycar HB6023. The 1 k vol. pot may be a miniature or ordinary sized part, depending on space available. Miniature switches are suggested for S1 and S2. The speaker may be a small transistor radio type, 8 or 16 ohms.

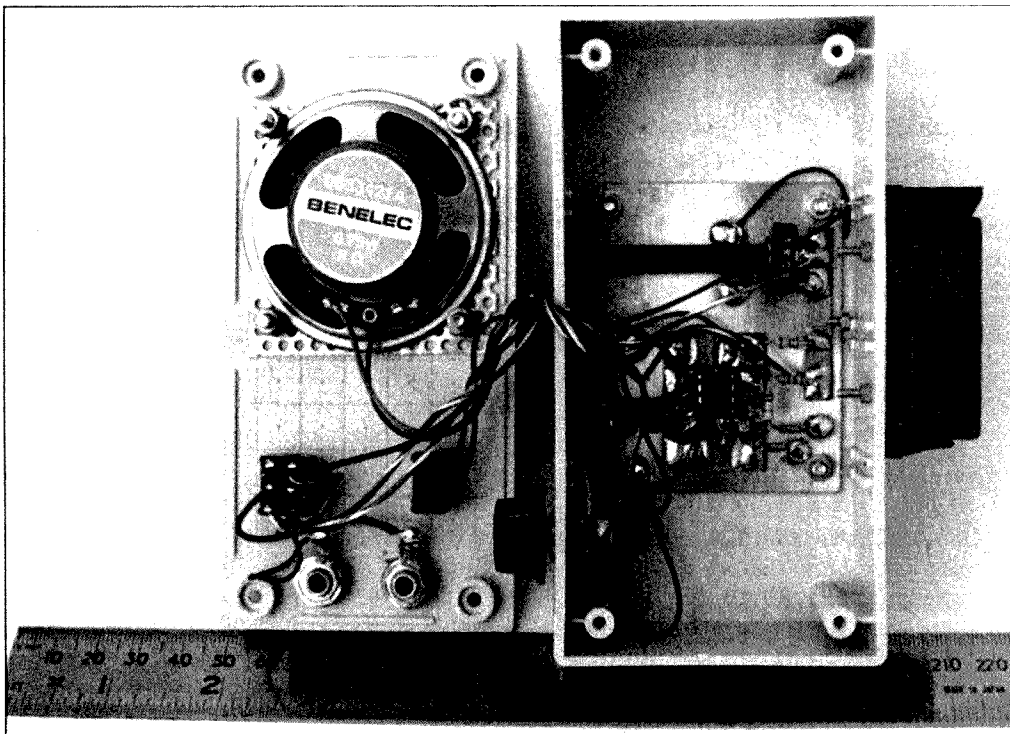

Photo 2. Internal view

References and Further Reading:

1. Conversations with Dave Buck, VK3AAD.
2. "Paddyboard" Circuit Construction; Diamond, AR, Feb. '95.

3. I.C. Timer Cookbook; W. Jung, Sams Publications.
4. Engineer's Notebook, F. Mimms, Archer Publications.
5. 555 Timer and Applications; M. Sharma. BPB Publications.

ar

WIA Comment

Continued from page 3

Wyong field day to discuss this matter with anyone who can spare the time. I would like to be able to put some time aside at the 2002 WIA AGM to have some further discussion of this matter with the Divisional councillors. In order to make this a success I would ask that you make your views known to me as well as taking the time to lobby your local Divisional Federal councillor. They need to know your thoughts if they are to represent your views in the National debate.

AA call signs for VK0 and VK9

As a result of the ACA decision to release the AA series of call signs there has been some debate on what the WIA policy is

or needs to be. The discussion of this issue has identified a significant management issue for the Federal organisation - namely the need to record and advertise WIA policy on such matters. I have identified this as a major issue for all of in the Federal WIA. If we are to be better informed and better able to improve matters it is imperative that we can easily gain access to WIA policy. For me it has been as an ongoing battle to ensure that I can comment on matters of concern to amateurs safe in the knowledge that I am aware of current policy. I have identified that we need to have a catalogue of WIA policy that is readily available to all members. The sort of thing that I currently envisage is a searchable area on the WIA web page where members can gain access to

current policy. For members without direct web access I would propose that their local council or club arrange to perform the search, print the results and send on the results of the inquiry.

I will draw this month's column to a close noting that I need to get back to preparing for the forthcoming International Radio Communication Advisory Committee (IRAC) meeting. As I noted last year this is a great opportunity for amateurs to have a voice nationally to ensure that the interest of both amateurs and all Australians are met in the preparation for the World Radio Conference in 2003.

73s and I look forward to meeting as many of you as possible at the Wyong field day.

Ernie Hocking VK1LK

66 Tips for 6

- Learn CW
- Anything is possible on Six metres
- Maximum distances are worked from every location some time every cycle
- Listen a lot, transmit a little
- Use a CW filter or narrow band for phone
- Avoid 50.110 for everything but DX that is determined to work you there
- Never rag chew on the call frequency, if called there qsy next over
- QSY at LEAST 50 to 100 kHz up the band for SSB, there is plenty of space above 50.15 for casual contacts
- Study the lists of worldwide indicators published on the Internet as a guide to propagation in your area
- Every location is different, be content with your results, not what someone else may have worked
- Choose a transceiver with a good noise blanker
- Minimise noise of all kinds as much as possible
- Fax machines are notorious sources of noise
- Cover all the PCs possible with toroids on each lead
- Use quality headphones for every session
- Connect only with N style connectors
- Low loss coax of at least 16 to 20mm outside diameter
- Seal all connections with bitumen seal to exclude water
- Be utterly familiar with your transceiver
- Use a low noise (modest gain 8dB) pre-amp in the receive line as close as possible to the antenna
- Use computer analysis (K6STI's YO is a good start) to optimise the yagi antenna
- Peak a maximum gain antenna for 50.110
- Use a fast reliable rotator
- Select a high front to back ratio to exclude noise and QRM
- Get that antenna as high as possible
- Work DX when the band is open, even if you have worked Japan or

Mexico before, there is a strong likelihood that many operators at the other end will need your prefix or country for a new one

- Remember we all had to start somewhere, one DXCC, grid, whatever is your fancy
- Record every QSO either on a quality tape deck or digitally
- Incorporate a silence relay to stop the tape when transmitting for a clean recording
- QSL everybody who wants one promptly
- Send your wanted QSL's within several days of the QSO, strike whilst the iron is hot usually results in confirming that contact
- Make sure your envelope contains return postage
- Will the return envelope be large enough to hold an average QSL card
- Always use self seal envelopes, active DX stations and QSL managers hate sealing hundreds of envelopes with tape or glue
- Is the return envelope Air Mail marked? Some postal systems do not automatically use Air for return post
- Ignore bad childish behaviour on the band, tune away and call CQ just to show them what they are missing by landing some rare DX
- Regularly check that your transmission is going where you want by having a clean signal
- Look for the in obvious paths for propagation
- Just because it hasn't happened on a particular path, doesn't mean it won't
- There are many more paths, modes and countries waiting to be a Six Metre first for someone
- Watch for unusual indicators in the 30 to 50MHz sub band then listen/call
- Simplify your logging with a computer log book as you QSO
- Have the PC online during the peak windows watching the various logging sites
- Share your results with a quick post
- After the opening submit the log extract to an email system or place

Neville Mattick VK2QF (ex 4W/VK2QF)

it online to help others understand the openings

- Be patient (very)
- White noise isn't so bad, especially when it's interrupted with someone from the other side of the world
- Let others have the frequency as soon as possible
- Keep your QSO's brief
- Don't exchange more than needed to validate the QSO, grids can be read on the web or QSL card
- Use standard phonetics
- Slow and steady morse around 20 words per minute with plenty of word space works best
- Contesting is an excellent method to practice DX QSOing technique
- Be prepared for strange call signs during openings, contesting is a way to have an open mind for prefixes that are totally different from the ones in across town QSOs
- Equinoxes provide (F2, TEP and combinations with Es) the majority of propagation on Six
- Solstice propagation (mostly via Sporadic E) has powerful potential to give rewards
- Help DXers with whatever they want, no station out on the island means no QSO!
- Donate old gear, any sort can put another country on the air
- It's only a hobby
- Remember your family, friends and work come first
- Tune the band frequently during openings and well away from the call frequency, many people never operate near there due to QRM
- Have a second rig or receiver scanning on an MUF or omni antenna
- Set one rig's antenna to scan in the opposite direction to the other looking for openings
- Scan all indicators in one mode to gain an idea of their strength and relevance to openings
- Set the scan frequencies in a descending order in memory channels, like a spectrum sweep to predict the MUF
- Have FUN!

The DISCONE

— a good broadband antenna for VHF and UHF, relatively cheap and easy to build

Mike Todd VK6JMA
(vk6jma@email.com)

From "Amateur Radio Companion CD-ROM"

The discone is a vertically polarised broadband antenna which exhibits a SWR of 1.5:1 or better over a wide range of frequencies. Below its design frequency, the SWR rises sharply but within its range of resonant frequencies the antenna has an impedance of close to 50 ohms. The discone is used mainly at VHF and UHF frequencies, as the size becomes too cumbersome for HF.

The discone antenna consists of a disc-like top section and a cone-like bottom as shown in the picture to the right. The top section is composed of 6 - 8 radials. The cone-like skirt consists of an equal number of radials. Generally 6 radials give good performance for receiving equipment such as scanners, but 8 radials are more commonly used for transmitting.

Dimension "L" is equal to $\frac{1}{4}$ wavelength of the lowest design frequency in free space. The disc is 0.7 of $\frac{1}{4}$ wavelength in diameter, making each of the disc radials $0.35 \times \frac{1}{4}\lambda$ in length. The disc diameter is calculated:

$$\text{diam} = \frac{1}{4} \times \frac{300}{f} \times 0.7$$

where f is the lowest design frequency in MHz.

Half of this value is, of course, the radial length.

The cone radials are wavelength long and the base of the cone is $\frac{1}{4}$ wavelength in diameter, meaning that the cone radials slope down at 60° from horizontal.

An easy (rough-and-ready, but it works) method of construction.

For 144 MHz and above #12 (2mm) steel wire is usually strong enough (except for standing up to birds, hailstones and other heavy objects which may fall from the sky).

Referring to Figure 2:

1. Decide on the lowest frequency of operation for your discone. A discone with a bottom frequency of

144 MHz will give good performance on 430 MHz (70cm) and 1240 MHz (23cm) bands.

2. Make two circles of wire, about 3cm in diameter with a small tag. Use about 12cm of wire for the circles, this gives enough excess for a 2-3cm tag. The tag will be used for attaching the feedline.
3. Cut the radials for the disc at 0.35 of $\frac{1}{4}$ wavelength + 1-2cm for your chosen base frequency.
4. Cut the radials for the cone at $\frac{1}{4}$ wavelength + 1-2cm long. The extra 1-2cm is for wrapping and soldering to the centre ring.
5. Taking one circle, make a 'hook' in the end of each radial. Put the hook around the edge of the ring and pinch closed with pliers. This prevents the radials falling off before they are soldered in place.
6. Attach the rest of the radials, evenly spaced around the ring.
7. Repeat steps 5 and 6 for the cone. Don't worry about the slope at this stage, it is easier to set the slope with the antenna assembled.
8. The disc needs to be insulated from the cone. To achieve this you will need 5 wooden spacers. Two of them must be sized to fit inside the ring; the other three must be larger by 1-2cm (diameter). Each disc must have a hole drilled through the centre for a retaining bolt, as shown in the Figure 3. These can be made using a holesaw in practically any wood.
9. Assemble the antenna upside-down, placing the bolt through the top (large) spacer. Add a small spacer then position the disc section with the ring fitting around the small spacer. Add another large spacer then the other small spacer. Position the cone section with the ring fitting around the small spacer. Finally add the remaining large spacer. (Figure 3)

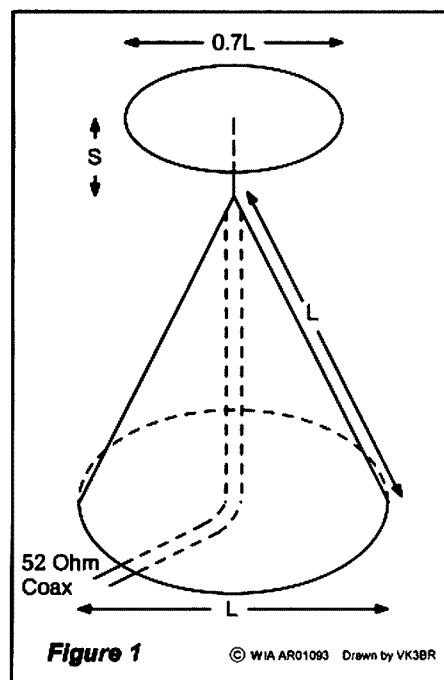

Figure 1. Basic Discone parameters

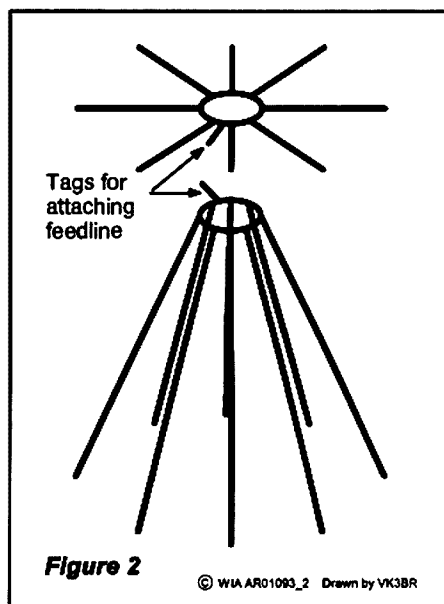

Figure 2. Skeleton Discone construction

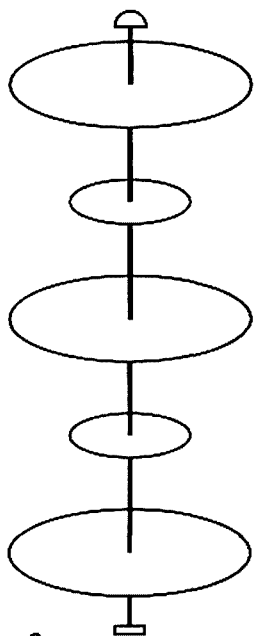

Figure 3

© WIA AR 1093 3 Drawn by VK3BR

Figure 3. Construction of the joining hardware

10. To attach the antenna to a boom to set the slope of the cone radials, you will need a small L-shaped bracket with a hole drilled through the small end of the 'L'. This goes on the bottom of the assembly before adding the nut and tightening. Attach the long end of the 'L' to the boom using a clamp.

11. Turn the antenna up the right way and bend the cone radials down at 60° from horizontal. A 60° slope means that the end of the radial is half the radial's length out from the boom.

For example, if the lowest design frequency is 144 MHz, the wavelength is 2.083m, $1/4\lambda$ is 0.521m. This means the cone radials are 52cm long and the ends should be 26cm out from the boom.

12. The coaxial cable (50 ohm) can be run up along the boom and attached to the tags on the rings, the centre conductor attached to the disc and the braid attaches to the cone.

13. To protect it from the weather you can cut slots in the lid from a spray-

can and fit it over the top like a cap, then use tape to fix it in place.

Because the discone has a wide bandwidth, precise measurements to the n^{th} degree are not critical. It is relatively simple to design and construct, and inexpensive to model using wire before constructing a more robust antenna out of tubing or other material.

Alignment and adjustment

Before putting it up on your roof, mast or whatever, you can check the SWR and frequency of your discone and adjust it by changing the angle of the cone radials or trimming the radial lengths, but you can generally be fairly sure that it will perform well enough by working to the measurements.

Summary

There is nothing fancy about this design which I simplified from some of the more complex construction methods I have seen and it works well, giving a good signal on 2 metres.

ar

Silent Key

Geoff West VK2BT

It is with great regret that The Manly-Warringah Radio Society records the passing of Geoff West VK2BT. He was 76. Born at the time when shortwave broadcasting was just beginning, throughout his life Geoff maintained an interest in amateur radio. His workshop was an Aladdin's Cave, reflecting the extraordinary era of radio development through which he had lived.

In 1941, during World War II, he raised his age from 16 to 18 and joined the Merchant Navy. After the Japanese attack on Pearl Harbour (Dec. 7th, 1941) Geoff was on a ship that was sent from Australia to Pearl Harbour to assist the Americans in the evacuation of women and children to the United States. Fires were still burning when his ship arrived and there was anxiety about the fact that no one knew the whereabouts of the Japanese fleet. Geoff did a second trip from Pearl Harbour to the US and continued to serve in the Merchant Navy for a few years after the cessation of hostilities.

In 1950 Geoff met his future wife Betty. She was then a bus conductress aboard

the 190 bus route, a well-known trek to the people of the Barrenjoey Peninsula north of Sydney. In the space of three months Betty and Geoff were married, a marriage that during its 51 years brought them four boys and a girl and the blessing of grandchildren.

In 1994 he gained his first call as VK2MOF which spurred him on to learn CW and get a full call. For anyone of his age that was no mean achievement but Geoff had a particularly strong characteristic – tenaciousness. In this case it paid off handsomely and he became the proud owner of the full call VK2ADW. Later, in 1998, he changed this to VK2BT thus becoming a member of the elite of call holders – those with two letters after the digit.

Geoff sometimes said that his only regret was that he didn't become a ham earlier. He equated being a ham with holding a call but Geoff had always been a ham and a first class one at that. When he built something he built it properly. With the Merchant Service he worked in the engine room and it was within

that environment that he developed his superb craftsmanship. Witnesses to this are the excellent QRP transceivers and hand keys that he built, two of those keys now in permanent use by the Society.

Geoff spent his working life in the hardware trade, acquiring a formidable expertise in plumbing and plumbing parts. Despite the ups and downs of the economy he was never out of work and until his late sixties he enjoyed excellent health. He and Betty retired to the Central Coast where he joined the Westlakes Amateur Radio Club.

Then, in 1992, Geoff had a quadruple bypass after which he took things more quietly. In order to be close to a hospital and family, he and Betty moved back to Sydney and settled in Narrabeen, which was when he joined the Manly-Warringah Radio Society. It was rare for him to miss a Society meeting and at 1630 every day he was a regular on Westlakes' 40-metre 'Footloose' net (7070 kHz).

To Betty and family the Society offers its deepest sympathy. Geoff will be sadly missed.

Bob Hawksley VK2GRY

A Field Day or Emergency Portable Mast for VHF & UHF Antennas

Keith Gooley VK50Q

If you start doing any field day or emergency portable operating on VHF or UHF, you soon find the need for a small lightweight mast that can be carried to the hilltop site and quickly erected. The mast provides support for 2 m, 70 cm and higher beams giving a useful gain increase over the basic vertical antennas used on these bands. Other desirable attributes of such a mast are that it should allow easy rotation of the beams but should provide a means of locking the antennas in the desired direction. Otherwise it is certain that a breeze will spring up in these exposed places and will always want to turn the beams to a direction other than that desired.

I went on a couple of field excursions and soon discovered that such a mast was required. While thinking over the problem of how to make it, I hit upon the idea of using the not-often-used

projector stand. It was no good cannibalising the stand and making a dedicated support for the mast as I sometimes use the stand for a slide projector or very occasionally dust off the old 8 mm projector look at 8 mm movies. No, they are not all on VHS tapes. So I need to keep the projector stand in a form that it can be used for its original purpose but at the same time provide support for a short mast.

The photographs and diagram give the general idea. Materials and dimensions are basically as a result of

what I had on hand and can be adapted to whatever you have. A 30 mm hole was cut in the centre of the tilting tray of the projector stand with a hole saw. The bolt that clamps the tray in the selected position is removed when the stand is required for mast support duty. This allows a 1.8 m length of 25 mm OD aluminium tube to be slid down the centre support tube of the projector stand and rest on the rivet that goes across the tube at the bottom. This rivet holds the bracket that anchors the leg stays to the centre tube.

So, now we have the aluminium mast section supported in the projector stand with the tray free to flop up and down. I found it very useful to hold the tray horizontal to act as a support for small transceivers and even a gel battery. After a false start or two, I came up with the



Photo 1

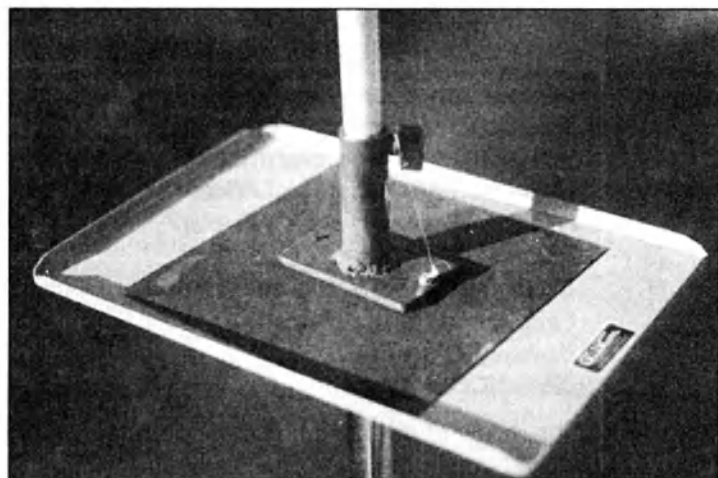

Photo 2

method shown in the photographs. A 100 mm section of pipe that is a loose fit over the aluminium mast is welded to a piece of 5 mm steel bar about 120 by 65 mm. Onto this flange is screwed a larger, thinner plate just smaller than the tray. When the mast is passed through this assembly and the plate rests on the tray, the tray is held horizontal. The mast can be prevented from turning by a thumbscrew in a threaded hole in the section of pipe. The pipe-flange assembly can't turn on the tray due to the turned up lip around the edge of the tray.

A broom handle was filed down at one end to make it a push fit into the top of the aluminium mast giving more height. Being of non-conducting material, a vertically polarised 2 m Yagi can be mounted on the mast without interfering with the pattern of the antenna. A vertical slot was cut in the top of the aluminium mast and a screw put into the broom handle so that with the broom handle fitted to the mast, the screw in

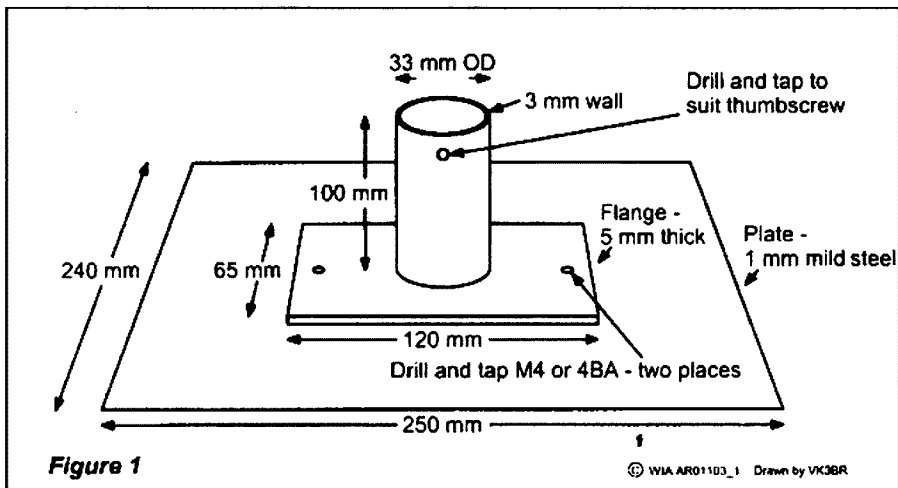

Figure 1

the slot prevents the broom handle turning in the aluminium tube.

Conclusion

This is a simple lightweight mast to be used for supporting small VHF and UHF

beam antennas in a field-portable or emergency situation. It uses an existing commercial projector stand as the basic support without any detrimental effect on the projector stand's original use.

ar

Federal WIA Convention

Appointment to Federal Positions

The WIA Federal Convention and Annual General Meeting of the WIA will be held in Melbourne on 17, 18 & 19 May 2002



At this meeting, a number of positions will be filled. Nominations from interested persons must be received by the Federal Secretary at the registered office of WIA Federal in Melbourne no later than close of business on 5th April 2002.

The positions are **President**
Directors (3 positions to be filled)
Company Secretary

Editor "Amateur Radio" magazine
Publications Committee (5 positions)
WIA/ACA Liaison Committee (3 positions)
IARU Region III Liaison Officer
ITU Conference & Study Group
Federal Web Page Coordinator
Chairman Federal Technical Advisory Committee
Federal Education Coordinator
Federal Historian
AMSAT Coordinator

Intruder Watch Coordinator
Federal Contest Coordinator
Federal Awards Manager
Federal WICEN Coordinator
International Travel Host
ARDF Coordinator
Federal QSL Manager
VK9/VK0 QSL Bureau
QSL Collection Curator
Videotape Coordinator

Nominations received direct will be considered but preference is likely to be given to Divisional nominees

Peter J. Naish VK2BPN
Federal Secretary

LANGKAWI AS-058

A Holiday Soiree

Johnny Melvin G3LIV.

johnny@melvin.com www.g3liv.co.uk

During the winter months of 1997 thoughts turned to holidays and where I could play radio at the same time. 1995 had seen two weeks in Cyprus with a TS 50 and a quarterwave vertical for 20 m and great fun it was, just grab your *CEPT, ask the hotel if its OK and away you go. Yes it really is as easy as that.



John and Nerio

However thoughts on the Far East and places outside the CEPT license area seemed to draw my interest. I had in 1994 holidayed in Thailand, Penang, and Bali but without a radio. This time I thought I'd go for it. Would it be Singapore, Thailand or Malaysia? A check with the XYL on dates and June was decided on, mention of taking a rig (I have a FT900CAT) brought a favourable comment. So off I started in late December with letters to the authorities in 9V1 - 9M2 - and the Radio Amateur Society of Thailand (no license authority listed in RSGB info)

As I had not read any magazine articles on obtaining a licence for the far east, various phone calls were made in the UK, however not a lot of information was gained from this avenue, until I managed to get hold of Ray G3NOM, he was a great help from day one. Although I had not settled on which countries to visit, a quick look at the wanted island list in the IOTA Directory led me to Langkawi AS-058 in Malaysia and Phuket AS-053 in Thailand. This was where Ray really excelled; he had a spare copy of the Malaysian license application form here

in the UK. This was posted to me and now the hunt started. I should state here that the application form did arrive from the Malaysian authorities but not until some time in Feb taking about 8 weeks or so. My advice is if you are even only thinking about going out but have not decided on dates then get your request in

for you application paperwork. By the way it costs 1 Ringet which is about 25cents USA. I have been informed that it is possible to present the paper work personally at the centre and have it dealt with in a couple of days. See address later.

I should at this juncture explain where Langkawi is situated. Langkawi comprises a group of 99 tropical islands lying off the northwestern coast of Peninsular Malaysia, the main island is known as Pulau Langkawi. For the more informed the exact position of the group is 05.5-06.5N 99-100E for IOTA it is AS 058 Perlis/Kedah State Group. It is located north of the Island of Pinang and south of the island of Phuket in Thailand. This group of islands is blessed with an intriguing heritage of fabulous myths and legends of ogres and gigantic birds, warriors and fairy princesses, battles and romance. With a geological history dating back 500 million odd years, the islands contain unique rock formations that stir the imagination and baffle the mind.

Now back to the main plot.

Requirements to accompany the application were,

Application Form, Full equipment information, Serial Numbers, Power, Modes, Bands.

Copy of current UK license or country of residence. Copy of main Passport pages.

Completion of Wireless Security Declaration signed.

2 Character references (Now you find out who your friends are)

Sketch of antennas to be used.

All this has now to be bundled up and sent to the authorities in KL.

Was this the first step by Malaysian officials I asked myself, to discourage the faint hearted? However Geordies are made of sterner stuff. (Geordies is the local term for the inhabitants of Newcastle upon Tyne, my QTH.) At this point enter Ray G3NOM once again, who informs me that he is going on the 9M0C expedition to Layang Layang and would I like him to deal with my application while in KL en route. Not one to look a gift horse (nothing personnel Ray) in the mouth his offer was immediately accepted and all posted to his UK address. (He's now moved to Bangkok full time).

This was now late Jan 98 and the weeks are going by at an alarming rate. Reply from 9V1 Singapore " We regret to inform you that we do not issue a license to foreigners to operate amateur station while they are in Singapore for a short period, one must be resident for a minimum of three months before making an application ". I had inquired in my letter if it was permissible to land at customs with a rig in the bag. However this was not answered. So rule out Singapore.

Now a letter from Thida the General Secretary, of the Thailand Radio Society in Bangkok. This was not good news, pointing out much like Singapore that a minimum period must be completed before a license would be issued, however it would seem that you also

need a separate piece of paper to give you permission as to where you may transmit from. Thida also indicated that it was not in ones best interest to have equipment in your ownership without declaring it to customs. I am told you can leave it with them and recollect when leaving the country. I decided not to put this to the test.

At this time an email from G3NOM to let me know that the Malaysian license was OK and I could plan ahead at least for 9M2/G3LIV from Langkawi AS-058. Now I had a problem, I was to land at KL have 4 days to get over the near 24hrs travelling from Newcastle, then on to Langkawi for 10 days. No problem so far, however how do I get to land in Phuket, Thailand with a FT900 in my flight bag and no license and I had also decided to break the trip home from Thailand by stopping for 6 days in Dubai. As I had made no enquires regarding amateur radio there I did not know the lie of the land. If you understand what I mean.

White knight to rescue, by this I mean again G3NOM, who happens to be the holder of the HB9DX FT900 owned by the RSGB IOTA bunch. Would I like to collect it in KL take it to Langkawi have my 10 days on the island and just return it, and go on my way to Phuket, what an excellent idea. This was agreed and because Ray was in UK again the IOTA rig was temporarily located with Zainal 9M2ZA in KL. After a bit of email shuffling all was arranged for the pick up. Now enter hiccup, in the heat of all the moving between London/Bangkok/ KL/ and the Spratly 9MOC location Ray had left the receipt for my successful application for 9M2 license in his Bangkok flat and he was in UK.

My original hope had been that some weeks before I was to fly out the license would be posted from the authorities to my home QTH, so I emailed their centre that was handling the license explaining that the receipt was in Bangkok and I had noway of getting it to confirm the receipt number and could they indicate that the license would be dispatched in due course. Three weeks no reply, I then faxed a copy of the email with an urgent heading, but still no reply and I was leaving in 5 days!!!. Ray during this period stayed quite calm (indicating his

vast experience in these matters) and pointed out to me that he never really expected a reply, and in a very cool manner suggested that I just called at the centre and picked it up. So that was the decision as I left UK, but I thought I should pick up the paperwork before I got a taxi to Zainal for the rig. Taxi dropped me at the centre, I said who I was to the young lady behind the counter, expecting a list of questions, when all she said was " Yes, Mr Melvin, license for Langkawi, have a nice holiday" and handed me a buff envelope.

I was back on the pavement in less than 5 mins with my Licence. I hopped into a very cheap taxi and returned to my hotel.



John Melvin G3LIV

Totally forgetting I had intended to purchase (yes purchase) a number of application forms to be located with the RSGB so as to shorten the waiting period for pilgrims that may follow in my footsteps. The cost of the form is only about 15 pence each, about 25 cents USA.

A quick phone call to 9M2ZA and off we went in a taxi to pick up the Yaesu FT900AT and other bits and pieces. His home was found with no problems and very nice it is with a mass of jungle type greenery around it and a mast, I think he said about 20m if required with a Tri bander on top. Whilst his XYL was on other business she had left a plate of banana fritters, which went down very well. As I mentioned Zainal and I had exchanged some emails and one surprise

that ensued only 10 days before I left was that there was no power supply located with the rig. I had a switch mode so took that with me. Keith GM4YXI had been using the rig the previous month and had left 25m of coax with a PL259 on one end. As the antennas I was taking needed a double ended PL259 cable it was necessary for me to carry the tools etc to add the plug. In the spell I had in 5B4 I had devised a 20m quarter wave ground plane, which broke down into 28 inch lengths, this fitted diagonally in my suit case. I had also made a dual band 20/17 m dipole. Whilst making this I had no luck getting standard figure 8 cable to work as the elements, alar the antenna hand books, However as soon as I made the dual dipole out of 300 ohm black ladder type feeder it worked as I had expected and I could switch between

either band with under 2.1 SWR across both bands with just the one coax feed. This became my main antenna at Langkawi, as to the GP; the roofs on the hotels seem to be standard sloping tiled as in UK, not flat as in Spain etc. So because of the heavy rainfall in the wet season the roofs tend to extend over the balconies, in my case by about 2 m this did not allow me to erect the vertical from either balcony during my stay.

I had written to the hotel prior to arriving and mentioned my requirements. You know the standard ones. A room in the upper floors with access to the roof, as well as 20m palm trees about 10 m from my balcony and 15m apart, in the clear with a member of the staff who is trained as a steeplejack or even Jill. However to my surprise they had located me in a suite of rooms with two balconies at no extra charge. There were trees outside, which allowed me to locate the dipole in a flat top position. However it was found after some playing around that I was doing better when it was situated in a more inverted V formation.

Operating in this area of the world seems totally different to my previous experiences. In my location there was virtually no propagation during the day. The bands 20/17/15 m did not start to be useable until around 2200 local time; this is 8hrs ahead of UTC. 80 and 40m were just a blur of static and were not seriously investigated. While I was in 5B4 I just had to drop the key and within

minutes I would have the pack calling. However now it seemed to be different. Conditions were on the whole pretty poor for the duration of the stay. I was to be there 10 nights. First one was unpacking and the usual lets get a meal and a sit down. 3 of the next few days had electrical storms all late evening to early morning and it would have been a waste of time to even fire the rig up. It was also noted that the mains voltage was obviously down over UK standards and my PSU would only power the FT900 to about 60 watts before closing down. Therefore most of the operating was after 2200 with the band been open for say 45mins when I would have a good run of QSOs. Then the band would just die with only one or two stations audible, then after an hour or so come to life again. Lots of CQs did not seem to attract a lot of interest and this from 9M2 in AS-058. However over the period of operation some 800 contacts were made, my key speed went up as did my direct logging into the book, sorry no room for a computer. Wife had insisted that I had at least one extra pair of socks and underpants in my case. It was a tight call. Most stations were in mid Europe, some Gs and the odd W but lots of JAs and the like. Interesting enough a W6 or 7 would call with a good signal and I thought that OK now for a W pileup but no luck there would be 2 or 3 then no more, yet I was getting good reports. Only 3 VK stations were worked VK2BJ VK7BC VK8XC.

I had a number of QSOs with John GM4DKO/DU3 he is working out there for 18 months and over the days I could hear him calling CQ and not getting many takers. It made ME feel better Hi. The first G to be worked was G3JDT followed by G3LVP but Gs counted for only about 2% of contacts. Plenty of the U area with quite a lot of signals with less than T9 notes. I must comment on the JA stations that are a pleasure to work, and conduct themselves like gentlemen. It was nice to be called by a KH2 and an XE both all time new ones for me. Pity they don't count for my G DXCC. One evening was lost, I admit to going to an Island about 40 miles off the mainland where a dive platform is located, to try my hand at snorkelling. I did manage OK and the view was spectacular however the sea was rough and after an hour of bobbing up and down, I just wanted to be buried at sea.

Never again.

Last night of the 10 was pickup time so no operating, we were leaving at 0330 for the return flight to KL, as my arrival there was in the middle of the rush hour and I could not make it to Zainals to return the rig he had agreed to come to the airport. Thanks again Zainal. The QSL cards are now under production and ALL contacts will be sent a card. .

According to local folklore, Langkawi derived its name from the eagle or "Lang, short for "helang". In old Malay "Kawi" denotes "reddish brown," hence Langkawi means "reddish brown eagle". Situated near Kuah Jetty in Langkawi there is a giant statue of this eagle, now I mean GIANT with a wingspan of 23m and a height of 14m without the base, which is an additional 6m. The feathered version can regularly be seen souring over the island. This is the main theme of the QSL card.

We were now off to Phuket in Thailand, no rig, nice island, my room was over a sea water lagoon which was crying out for an antenna. But no license !!!!!. I had a few weeks prior worked Nerio HS0/IK4MRH on 15m SSB and had arranged to meet him while on the island. A call to him, resulted in him picking us up, and heading for the hills where his home is situated, very nice it is to. Nerio is a big very friendly Italian gentleman. The jungle comes up to his back wall. There is a nice 17m tower with a 4 el on the top. He runs a TS850, which looks quite old, but it turns out that the problem is condensation on the metalwork, which rusts very quickly. On thing that was obvious was the hand engraved customs numbers spread right across the top of the front panel? This is a requirement it would seem. He was running a Linear until quite recently but it would appear that he had left it in by mistake on 40 where he has a bit of TVI but this time it was been picked up by the audio amp in the local mosque. The authorities were at his QTH the next day. Linear now in bedroom wardrobe. Better safe I think is the motto. Nerio mentioned that there were only approx only 100 HF licenses in Thailand, not sure how firm that info is, but I don't hear many. The visit was another welcoming side to amateur radio. Thank you Newry, your coffee was fine by the way.

Well that about covers the 9M2 jaunt. Would I do it again ? Of course I would

its unbelievable the thrill when the world wants YOU an ordinary G. One point I would like to, raise for the future is the FT900 in 9M2, it is still in its original Yaesu cardboard packing, could we who are interested in IOTA raise the cash needed and have it fitted into some kind of photographers type case, this also to include switch mode PSU. This would really simplify its portability and help I'm sure the one man DX-expedition . I would donate if the IOTA committee got a fund going.

I am OK in the Callbook over the last 16years if I can be of any help to you then please give me a call 0191 2843028.

As a postscript to this original trip I have made a trip to Penang AS 015. Operation took place 4th May to 24th May 1999. So if you worked me, you will get a QSL card 100%. Remember me saying I did intend to pick up some application forms for future years. Well I needed one myself again this year.

So no one to blame but myself.

Address for Malaysian Amateur Licence

Surahanjaya Komunikas dan Multimedia Malaysia.

Malaysian Communications and Multimedia Commission,
Aras 11 Menara Dato-Onn,
Putra World Trade Centre,
45, Jalan Ismail,
50480,
Kuala Lumpur.

Tel: +60 3 294-2121.

Fax: +60 3 294 0908.

www.cnc.gov.my.

Application Fee RM60 per application.

License will usually be allocated for 3 months. It would seem that receipt for the Fee indicates permission to transmit. I am told it is now possible to down load the application form from the web page (November 2001)

One final final, thank you Ray G3NOM with out whose help this trip would not have been possible. Thanks to Yaesu for sponsoring my QSL cards and supplying the logs, may their valued input to IOTA continue.

Good luck and give it a try its great fun.

73s de Johnny Melvin G3LIV.

*CEPT... European Conference of Postal and Telecommunications Administrations.

Recommendation T/R 61-01. Means that in Europe or indeed the USA, we have no need to apply for temporary license. Just hold a valid license for our country of residence and permission is automatic.

ar

Ve haff vays of making you **TOCK!**



An encounter with an intercontinental clock and an incontinent battery

Having been born in Germany, I just could not resist the title. Here's how I fixed a sticky problem in a clock:

Mike Krochmal VK3KRO
PO Box 112, Ormond, Vic 3204
kroch@autoscan.com.au
www.autoscan.com.au/~autoscan

The problem:

Having bought a lovely old Kenwood clock from what I thought to be a reputable source (for what would otherwise have been a high but not totally unreasonable price), I was dismayed to find when I unpacked it that

the battery terminals were in an advanced state of corrosion (see Photo 1). To add to the problem, this clock's battery compartment is an integral component of its mechanism, as it often is in the clock drives, as these days they can be obtained as an individual item. This meant that I could not just toss out

the old battery compartment and replace it with a new one. It's also important to remember that battery contacts must be springy (to maintain good contact with the battery at all times) and should be made

of a low-resistance material. This rules out some simple replacement solutions. To make things worse, the battery contacts in this compartment needed to fit down a narrow slot, and I did not want to drill into the plastic of the original compartment in the process of fitting new contacts. It seems that this particular style of battery compartment was quite common at the time, and so the following is a description of how I fixed the problem, written in the hope that it may assist others in a similar situation. In my experience, batteries in clocks are seldom checked for health unless the clock actually stops – by which time it is often too late.

The cause:

It has always been a mystery to me how to best get rid of the muck left behind when a primary cell leaks. The stuff seems to be neither necessarily acid nor alkaline, so I have never had much luck with neutralisation by the application of the opposite (lemon juice or vinegar as acids, or soda bicarb as alkaline). Ordinarily, if you do this, you would see some fizzing as the acid and alkali neutralise each other, and produce water and gas. I've had no such luck with the stuff that comes out of batteries. I did speak about this with a very helpful man at Union Carbide many years ago. He suggested that the leakage can be either or both (alkaline and acidic), depending on the battery chemistry and circumstances, and the best strategy is to dilute (with lots and lots of water) rather than neutralise. He also

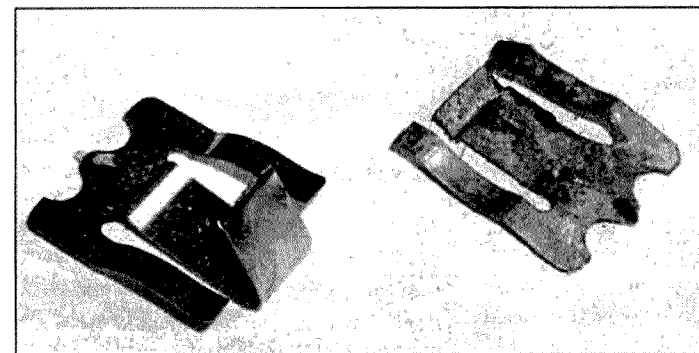

Photo 1. Corroded battery clips

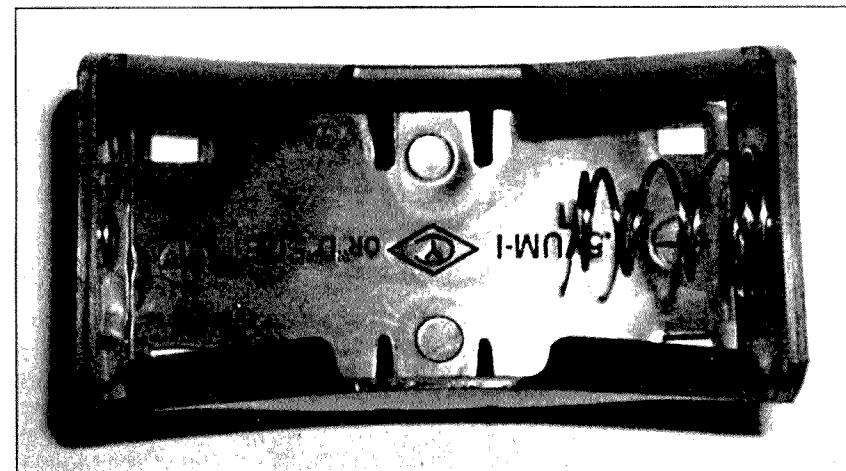

Photo 2. New battery clip, prior to disassembly

mentioned that the brown stain, which is often seen, is the result of the electrolytes attacking the end-seal cap of the battery, and that this could often be eradicated by use of a proprietary rust and stain remover.

Over the years, I have accumulated a fairly sizeable collection of articles about batteries. However, they all seem to want to talk about performance. None of them discusses leakage and how to remedy it. The same goes for the Internet – there is an amazing lack of information on this subject. The search for good information continues.

The solution:

The clip used in the clock is of a type seen fairly commonly. In this case, one "D"-cell was used, but my remedy can be used equally effectively for other cell sizes and numbers. I purchased a single "D"-cell battery clip at one of our major electronic component suppliers (see Photo 2), and used a soldering iron to melt the metal contacts out of the plastic housing. This was quite a simple, if smelly, operation. The next step was to make some plates to hold these contacts in the existing battery holder. I happened to have some mm brass sheet to hand, and I used a pair of tinsnips to cut two pieces, which would just fit, down the slots of the battery compartment. It helps to run a file over the edges, and round the corners, in order to avoid cut fingers from the sharp edges. I measured the location where the centre of the battery would end up, and in this location I drilled a 9/64 (3.5 mm) hole in each brass piece. For each side, I then inserted a 1/8 inch (3 mm) rivet through the brass piece and into the contact scavenged from the new holder (see Photo 3). In the case of the positive contact (as can be seen in the photo), I had to place the finished assembly into a vice and flatten it, as the head of the rivet was a bit too high and made insertion of the battery difficult. As it was, I had to force the new contacts down the grooves a little bit, but in this case everything worked out fine. However, care should be taken not to apply too much force during this operation, in order to avoid cracking the plastic battery housing, which is being repaired. It may be necessary to file down the rivet head on the outside of the brass piece to reduce the amount of mechanical interference.

The result:

Voila! A fully functional battery housing! (See Photo 4) With the expenditure of just a couple of dollars and an hours' worth of work, the little aeroplane on the "second hand" of my good old 24-hour movement Kenwood hamclock is

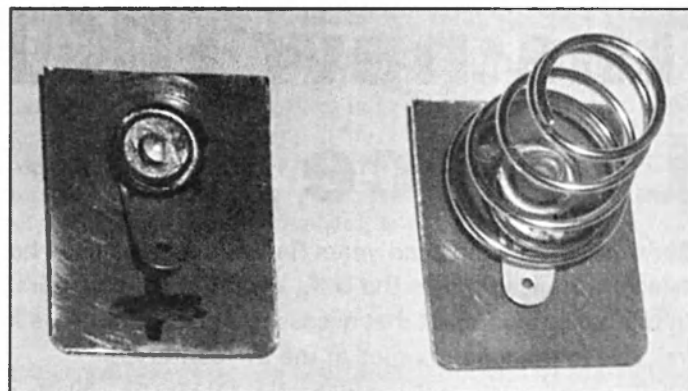

Photo 3. Brass plate assemblies, with new contacts

once again merrily going round and round. Keeps good time, too!

Thanks (I think) go to Peter, VK3YE, for dobbing me in for this article.

ar

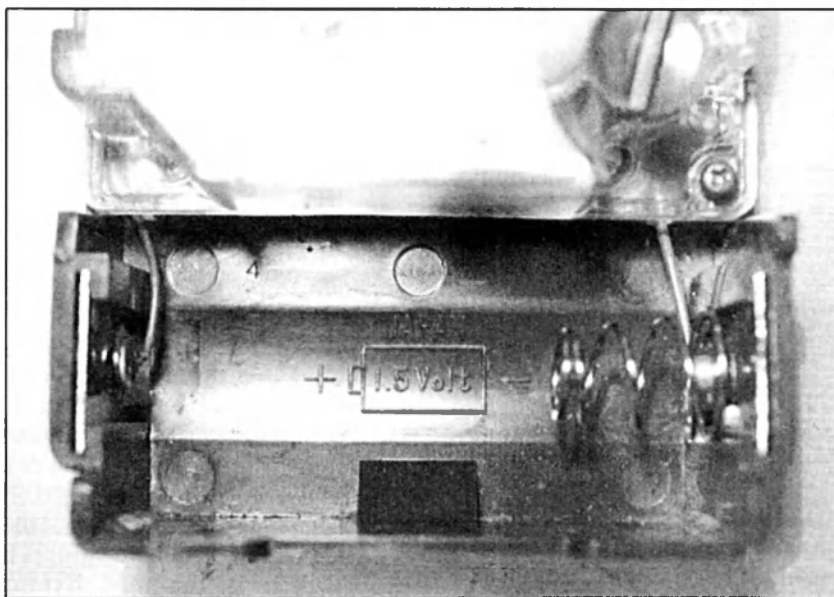

Photo 4. New contacts in situ

VK3GH HAMFEST VK3GHA

Sunday 25th February

10am to 2pm

Healesville Memorial Hall

Maroondah Highway, Healesville (Melways 278 C1)

For further information:

Gavin VK3TLN 5968 8482

Carol 5962 6098

Bring your family—you can also visit Healesville's famous tourist spots

Sales
of pre-loved
Ham equipment,
components &
computer gear

The new UK Foundation Licence

By David A. Pilley VK2AYD
davpil@midcoast.com.au

For more than a hundred years Radio Amateurs have been in the forefront of developments in telecommunications. In the U.K., the RSGB, in collaboration with the Radio Authority (RA), have agreed that it is in the national interest that access to amateur radio be improved so that Radio Amateurs can continue to play a key role in the technologies of the 21st century.

'Radio is once again at the cutting edge of progress', David Hendon, CEO Radiocommunications Agency (RA), 2000.

In such a future amateur radio offers:

- A great potential for innovation in radio communications;
- A way of drawing people into a technical activity that can result in them pursuing a career in engineering, so enhancing the technical skills of the country;
- A source of emergency communication skills at times when conventional communication links are strained or out of action;
- A contribution to international friendship; and
- A rewarding and challenging leisure activity which is open to all ages.

The decline in the numbers taking the traditional UK radio amateur examination underlined the need to take action. With the expected relaxation in the Morse Code requirement for HF access it was decided that the time was right for a much more radical review of the amateur radio examination system. As Richard Horton, G3XWH, commented at the time, "It is easier to obtain a pilot's licence for a light aircraft than an amateur radio licence". Indeed

it was possible to obtain a UK amateur licence without ever having listened on a short wave receiver!

It was decided that any new licence had to be focused on the need for a person to show they would be a safe and competent operator. This implied practical 'on the air' experience being a part of the new licence and more attention to training rather than being able to answer questions in a traditional examination.

Last September the first stage of the new licence was announced. It is envisaged that there will be three levels, Foundation, Intermediate and Full and that through self and formal training a radio amateur will progress from Foundation to Full. Some transitional arrangements have been put in place, upgrading the M5 licence to Full, rationalising the current Novice Licence and improving the privileges recognising the probability of the Morse code requirement being dropped.

But it is the new licence, the "Foundation Licence" which has attracted the attention.

This licence provides access to most of the amateur bands (all HF except for the 10m band) and restricts licencees to a maximum power of 10 watts output. Transmitting equipment has to be commercially manufactured, or be a

properly designed and constructed commercial kit. There are few other restrictions.

The intention is that the Foundation Licence course will be the route into amateur radio. The course can be given by any Full Licence radio amateur and involves a little radio theory, some safety and EMC practice. About 12 hours of the course is envisaged and it can be taken over a weekend. The innovations come in the practical side, candidates have to make both HF and VHF live QSOs on air as part of the course. They have to show they can tune up an ATU and set up an HF transceiver correctly as well as use the correct operating procedure. And they have to take a Morse assessment.

Why Morse?

The RSGB and the RA believe that Morse is a highly relevant mode for radio amateurs, especially for QRP and spectrum efficiency. The Morse Assessment is a short practical appreciation course. Candidates have to copy and send a short (20-30 letter) piece of text which is sent slowly to them. They have a crib sheet and can write it down in dots and dashes if they wish. However they do have to copy the text correctly. But repeats are given until they do! Finally candidates have to answer



Three of the first holders of the Morse Assessment completion certificates



The first class at Colchester with the course instructors

20 questions on the course content, and get 15 right. The results are given to the candidates immediately at the end of the course and they are given the documentation to apply for their new licence right away.

Many Class B (VHF only) licencees have taken the opportunity to acquire this new licence to open up their operating capabilities on HF. All that was necessary for them, was to take the Morse Assessment and by 7th November over 40 Class B Radio Amateurs had taken the test at the RSGB H.Q.

According to the RSGB January "RadCom", at the first pilot run weekend course at Colchester, England, fifteen candidates ranging in age from 11 upwards, passed and now have the new "M3xxx" call. (Have you worked one yet? - First M3-VK QSO?)

As Bob Whelan, G3PJT, President of the RSGB points out, "We are engaged

in a strategy to reposition amateur radio as a relevant, exciting, demanding and socially valuable technological pastime. Amateur radio's biggest enemy is apathy. We intend to use the new Foundation Licence to rejuvenate clubs, to spearhead a schools educational programme, and with our new demonstration vehicle, GB4FUN, to improve radically the public appreciation of amateur radio."

The RSGB has produced a booklet called "Foundation Licence Now!" by Alan Betts, G0HIQ, which is available from the RSGB bookshop. More information can be obtained from the RSGB web site at www.rsgb.org and look out for a new dedicated website for Foundation Licence. The RSGB has complete packages of material for all aspects of the course. The procedures have been tested in a 3 month pilot. It all seemed to work. The examination

questions are computer generated and will in the longer term be available to authorised amateurs via a website. No delays in taking the examination at the end of the course and re-sits are allowed.

And they have kept the cost down, the target course cost is £10 per candidate. The book is only £3.99.

As a post script, the RSGB advised that at January 7, 600 new M3 Foundation Licences had been issued. On January 1 the RSGB organised a QSO party and it was estimated about 100 M3 stations were active.

But the most telling fact is that there is a new mood afoot. Positive comments from clubs and individuals calling into help. Over 80 clubs and 40 schools are raring to get started. The challenge is to turn this enthusiasm into new amateur activity and a life long interest in the greatest of all pastimes.

ar

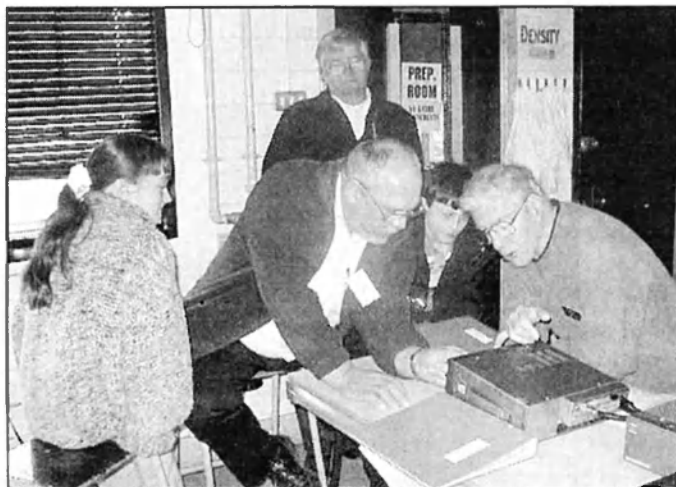

A hands-on demonstration of amateur radio in action as part of the Foundation course. Students listening to HF.

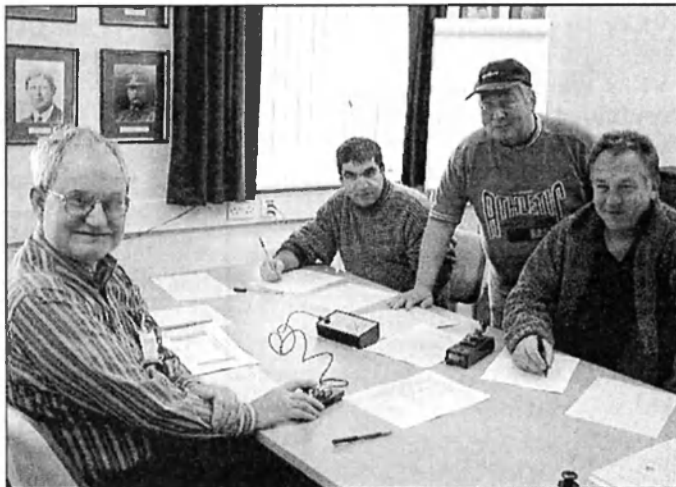

Bob Whelan G3PJT, President of RSGB (left) at the first pilot Foundation Licence Morse Assessment session at RSGB HQ.

Bass Amateur Radio IRLP Group, Rosebud, Victoria

HAMFEST

Saturday, 30 March
10am to 2pm

Boneo Cricket Club Grounds,
Cnr Boneo Rd and Limestone Rd, Boneo

Booking of trestles and further info:
Graham VK3JBO 03 5982 0315

More details in March AR

New WIA Members

The WIA bids a warm welcome to the following new members who were entered into the WIA Membership Register during the month of DECEMBER.

VK2BRY	MR R YEATS
VK2UW	MR W WRIGHT
VK3ALX	MR T ALEXANDER
VK3FDX	MR P WOLF
VK3HZ	MR D SMITH
VK3JNK	MR D MADISON
VK3PA	MR A GREENING
VK3TUA	MR A BOYD
VK4AKI	MR K JONES
VK4BRV	MR R R VIJMSA
VK4CE	MR J R SEMPLE
VK4EZ	MR R D SIVYER
VK4JL	MR J E TUCKER
VK4KIN	MR J ELLIOT
VK4LNZ	MR B L SHOOBERT
VK4YKR	MR P A GREGORY
VK7CS	MR A SZOPKO
VK7NJD	MR J DOOLAN

ALARA

Christine Taylor VK5CTY
VK5CTY@VK5TTY or geencee@picknowl.com.au

What a strange new year it was...

This Festive season has illustrated to us all what a diverse country we have. The terrible bushfires (following a pretty terrible storm) in VK2 have reminded us all how easily our beautiful bushland can become a fearsome place to be. Our sympathy goes out to everyone who has suffered the loss of a home or who has courageously helped to save many more homes (yes, we have a number of YL members who are also volunteer firefighters of whom we are justly proud).

At the same time as these fires, the VK4s were enduring a drought and longing for rain, while the VK3s and VK5s were complaining about the continued cold weather after a mild but wet winter.

As members of ALARA and participants in the Monday night nets we hear about the weather from one end of the country to the other, each week.

Why not join us? All YLs are welcome, not only members. If you do not have a licence but your OM does, he can call into the net and then pass the mike over to you while he stays in the shack to make it legal. It is interesting to hear what people across the country are doing and to "meet" their families in the process.

We use 3.580+/- from 1000 Zulu once we move into Daylight Saving, and 1030 Zulu under winter times.

News of members

Poppy VK6YF and Sally VK4SHE have both settled into their new homes but neither of them has yet got suitable aerials in the air so we miss them from out nets.

Both Poppy and Bev VK6DE have braved the new world of computers so we soon will be able to add them to our email lists. There is a lot to learn and many new friends to meet when you sit at your keyboard but computers can also be terrible time-wasters, so be warned.

Our hobbies often overlap

We all know about Marilyn VK3DMS and her "Radiomania" stamps and how well she has done in competitions, but in researching the genealogy of my family there has been an overlap into things related to radio.

I have known for many years that my OM's grandfather was an operator on the Overland Telegraph as was his brother but I was astonished to discover recently that one of my own ancestors was also involved in the telegraph.

She was the schoolmistress for the Mount Pleasant area (in the Adelaide Hills area) when the telegraph was connected to the town. She must have

known Morse Code because she was the person who received and sent the first messages in Mount Pleasant in 1862. It was less of a surprise to read that some of my ancestors had bred horses used in building the telegraph lines. I should think there were many people involved in horse breeding in those days.

Luncheons

Do remember that at least three states have regular luncheons each month. All of them welcome interstate visitors, with or without warning!

In VK3 and VK5 the luncheons are on the second Friday of the month and in VK6 they are held on the last Thursday of the month.

In VK3 the lunches are at the "Vista Café" in Little Collins Street, starting at 1130 or thereabouts. In VK5 they are "Bertie's Pancake Kitchen" downstairs of the Southern Cross arcade in King William Street and start at 1200.

In VK6 the luncheon is in the "Park Hotel" in North Perth at 1200.

All the venues are easy to find so please come along.

In VK6 there is usually a table nearby for the OM's, while in VK5 there is a luncheon at the Blackwood RSL of members of AHARS which a number of ALARA OMs attend on the same day.

Don't forget the two YL meets in 2002

If you are in Europe in June, there is an International YL Meet in Palermo. If you are touring Australia please add Murray Bridge to your itinerary at the beginning of October.

Both meetings will be great fun for the YLs and the OMs so make sure you don't miss them.

Look back in this column or in the ALARA Newsletter for more information about both gatherings if you think there is any chance you will be there.

ar

Amateur Radio Companion CD-ROM

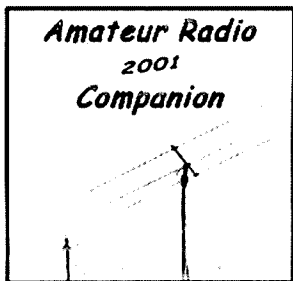

Full of programs and information for both the experienced operator and the aspiring Ham!

Theory, Antennas, Morse Code, Technical data and much more!

Only A\$22.95 or NZ\$29.95 inc p&h

Enquiries welcome

Michael Todd Computers & Communications

15 Conifer Street, Maddington
Western Australia 6109

Ph: 0407-089-308 (Aust) or
+61-407-089-308 (int.)

Email: toddcomp@bigpond.com
WWW: <http://www.arcompanion.com>

Summerland Amateur Radio Club

Chris Meagher VK2LCD Publicity Officer SARC

December 12 marked the centenary of Marconi's first transatlantic morse transmission and the local ABC asked if the club could help with some old radios to add to the ABC's small collection, for a small display.

Our industrious members went much further and transformed the foyer of the Lismore studios into an extensive exhibition of AM radios, amateur equipment and historical information on Marconi.

There were frequent on-air 'promos' which mentioned the club and the display, and on the day, crowds poured in to what was originally envisaged as a small group for morning tea. Martin Corben, local ABC manager, and his staff did a marvelous job escorting groups on mini-tours of the studios, thus relieving pressure on the foyer which was near bursting point!



Close up of the centenary cake before being cut, sorry there's no 'after' picture! Photo: Ian Gray

Adelaide Hills Amateur Radio Society

As usual the December meeting was celebrated with a Christmas dinner. Just under 60 members and families were there to enjoy a most pleasant evening. The food was great and the company was equally enjoyable.

The usual venue for meetings is unavailable to the club during school holidays so the January meeting will be a barbecue at the home of a member; however, in February we will be back at the Blackwood High School on the third Thursday of the month.

If you are in Adelaide on that day, please come along at 7.30 or get in touch with either Geoff VK5TY or Alby VK5TAW for more information. You can be sure the lecture and the company will be interesting.

ar



Alf Webb, VK2UC cuts the cake, under watchful eye of Martin Corben, ABC manager. Photo: Chris Meagher

The highlight of the event was the cutting of the centenary cake, most expertly carried out by SARC member and Australia's oldest active ham, Alf Webb VK2UC. This was done in the studio packed with excited onlookers, who sang a chorus of "Happy Birthday dear Radio" live to air. The scene was quite extraordinary and one presenter Fiona Wyllie won't forget!

Fiona also interviewed Alf and other club members about amateur radio and it seemed that the hams had indeed stolen the show from Marconi! In the afternoon, school groups visited and learned about the operations of a modern radio studio. The most popular exhibit was a working spark transmitter and many put their fist to the key for the first time.

Thanks to John, VK2JWA for organizing the show and providing gear, Ken VK2AFH, Ian VK2IGS, Leith VK2EA, for radios and historical information from their collections. By the end of the week, over a thousand people had been to see the display, and many thousands more heard about the club and amateur radio via press, radio and TV.

ar



Visitors at the display. Photo: Chris Meagher

Spotlight on SWLing

By Robin L. Harwood VK7RH

Firstly I must apologise for the December column not appearing but I know it was sent but the fault may be at this end when I was looking up in my files I got a warning that there were hidden macros embedded in the text. It may not have come out at the editorial desk.

Much of the copy in December was an update on the situation in Afghanistan, including the scoop that I may have been the first person in the World to hear the Psychological Warfare Unit, even beating the prestigious BBC Monitoring Service. However the situation has vastly changed since then. American forces have supported the Afghan factions in overthrowing the Taliban regime and capturing many al-Khayeda terrorists yet Osama Bin Laden has so far eluded capture.

Since the fall of the Taliban regime and the liberation of the major cities, there has been a rush of donor nations eager to restore the damaged radio and television infrastructure. However shortwave broadcasts are yet to resume although the Psyops broadcasts are still continuing. They are still on 8700 kHz USB, probably until the Radio Free Afghanistan operation commences very soon. It was recently approved by the US Congress and signed into law by President Bush and senders will be sent to Kuwait from another location.

Passport 2002 now available

This is undoubtedly the best short-wave guide available and Larry Magne and his crew has done an excellent job. This 592-

page book not only contains the latest news from the various short-wave broadcasters as well as the very popular receiver review. Also it is good to see photos of various individuals who I know through email contacts. The frequency section is an invaluable aid to identification of the various short-wave broadcasters.

The price to Australia is \$26 US and I know these were ordered in bulk by several sources and have already been delivered. I do not know if they will commercially available locally. More details on Passport 2002 are at <http://www.passband.com>.

I have moved

Late in October, I moved into a retirement village in Norwood. This has severely curtailed my on-air activities yet I have obtained permission to erect antennas. I am using a very temporary antenna along the curtain rail in my main room and it works but not as well as an outside one. I am hoping to have an outside trap dipole up by now. However HF transmitting is out. I must admit being interested in the comments in the December "AR" of remote operation via the Internet of ham stations. This would be a boon to people in my particular situation. I did have several links to remote receiving locations but have lost these. I seem to remember that the demand to operate these receivers was so high that you could only access the rigs for 30 seconds at a time. Is there anybody with updated links to these remote receivers?

On the 31st of December, Radio Norway International ceased to exist, although Norway did not exit shortwave broadcasting. Apparently they now relay domestic programming in the first half-hour until Radio Denmark comes on in the second half-hour. The closure of the external service was caused by a budgetary blowout and as the Danes had signed a contract to utilise the senders within Norway till 2003, they had no choice but to continue with relaying

domestic programming.

Our Time and Frequency station, VNG also may be closing on the 30th of June, according to information from overseas monitors. It is also a budgetary decision.

The broadcast that never made it! December 12th was the centenary of the Marconi's transatlantic communications between Poldhu in Cornwall

and St. Johns in Newfoundland. Several events were held throughout the World to commemorate this historic occasion. However the Canadian Broadcasting Corporation, after a huge investment and 18 months planning, had to jettison their special broadcasts because technicians had walked out on strike a few days beforehand as a result of an industrial dispute.

Another non-event was a historic re-enactment of Marconi's achievement with a proposed spark gap transmission from Poldhu to Newfoundland. This was supposed to be on 1700 kHz and many listeners both in the UK, Europe and Newfoundland made the effort but nothing was heard. Apparently they ended up using a mobile phone which picked up the sound of a spark gap and fed it by landline to a Defence Forces Station where the signal was sent by SSB on a much higher frequency to St. Johns where it was supposed to be received on a modern receiver. However they could not hear it allegedly because the background noise from the crowd. Nobody heard the special transmission either at other locations, which makes one wonder if the re-enactment went ahead at all. All was not lost as a Ontario (Canada) ham received special permission to send a spark gap transmission on 3560 kHz at night and the 20 kHz wide signal was heard in the north east United States and Canada.

I now have an email address exclusively for this column, being vk7rh@wia.org.au. Plead note that my postal address is now 20/177 Penquite Road, Norwood TAS 7250. 73 de VK7RH

ar

Silent Keys

The WIA regrets to announce the recent passing of:-

G (GEOFF) WEST VK2BT
M W (MARTIN) SAUNDERS
VK3AMV
W G H DANIEL VK3NX
E G (EDWARD) HAFNER VK4AEW
K J (KEVIN) HORAN VK5IT
F (FRED) REID VK7SD

Beyond our Shores

David A. Pilley VK2AYD
davpil@midcoast.cpm.au

QSLs

According to the ARRL QSL Manager, N1FOC, since the anthrax scare, there has been a big slowing down of QSL cards passing through the bureau. In 2000 they handled 1,868,895 cards mostly for distribution inside the USA. I've heard a few rumours how some hams are handling QSL cards with the scare still active. One Amateur told me he put all QSL cards received from overseas in the microwave before opening!

ARRL Study Panel recommends eliminating Novice Bands

On the basis of nearly 5000 survey responses, the ARRL Novice Spectrum Study Committee has recommended that the ARRL petition the FCC to eliminate the Novice CW sub-bands and allow Novice and Technician with Element 1 credit licensees to operate CW on the General 80, 40, 15 and 10-metre CW allocations at up to 200 W output. The panel suggested setting aside portions of those bands for "slow CW operation" to aid new CW operators in enhancing their skills. The committee recommended refarming the current Novice/Tech Plus sub-bands in part to allow expansion of the phone allocations on 80, 40 and 15 metres.

The committee, chaired by ARRL International Affairs Vice President Rod Stafford, W6ROD, has been studying the status and usage of the Novice/Technician Plus HF bands with an eye toward determining what changes to usage of that spectrum might be needed now that the FCC no longer issues new Novice licenses.

The survey offered possible refarming options for each of the bands involved—including no change at all. Generally speaking, the predefined options proposed retaining Extra class CW sub-bands on the affected bands, setting aside expanded CW reserves for all license classes except Technicians lacking Element 1 credit, and dividing the remaining spectrum into expanded

phone segments for General, Advanced and Extra class operators. A guiding principle was that no class of licensees would lose any privileges as a result of refarming.

The committee recommended expanding the phone bands in accordance with the most popular of the survey choices offered—three for 80, 40 and 15 metres and two for 10 metres. Here's a summary:

- On 80 metre, nearly 40% of those responding opted for a plan that would extend the US phone allocation to 3700 kHz, with Extras permitted on the entire sub-band, and with Advanced and General class sub-bands starting at 3725 and 3800 kHz respectively.
- On 40 metre, nearly half of the respondents picked the plan to extend the primary US phone allocation to 7125 kHz, with Extra and Advanced licensees allowed on the entire segment and Generals from 7175 kHz and up.
- On 15 metre, again, nearly half of those responding wanted the US phone allocation extended to 21,175 kHz, with Extras permitted on the entire allocation, and Advanced and General sub-bands beginning at 21,200 and 21,250 kHz respectively.
- On 10 metre—where Novice and Tech Plus licensees already may operate CW, RTTY and data from 28,100 to 28,300 kHz, nearly 55% of the respondents favored a plan to retain the US phone allocation from 28,300 to 29,700 kHz and to extend CW access to Novice/Tech Plus operators to 28,000 kHz, an additional 100 kHz. The current Tech Plus 28,300 to 28,500 kHz phone segment would be retained.

The committee's report says that if the ARRL Board adopts the plan, the League should include any request to the FCC to implement the changes within an omnibus filing encompassing other issues, rather than as a separate petition. Consideration of any necessary ARRL Band Plan changes would follow ultimate FCC approval.

(ARRL Dec Newsletter)

All-ham crew settling in aboard ISS

For the first time, there's an all-ham crew aboard the International Space Station. The Expedition 4 crew of Commander Yuri Onufrienko, RK3DUO, and flight engineers Dan Bursch, KD5PNU, and Carl Walz, KC5TIE, is settling into the ISS quarters that will be its home for the next six months. Amateur Radio on the International Space Station school contacts already are tentatively set for January and February.

The new Amateur Radio antennas carried into space for the ISS have been stowed for the time being. Current plans call for them to be installed around the perimeter of the Service Module by the Expedition 6 crew. The new antennas will allow future operation from HF to microwave frequencies, once additional ham gear is brought aboard the ISS.

(ARRL Dec Newsletter)

"Santa Ham" special event a thrill for the younger set

Did you speak to Santa?

Several hams with young children report their kids have enjoyed the thrill of their lives talking with Santa via ham radio. The W6S "Santa's Workshop" special event operation by ARRL member Mickey Hicks, WO6T, in Bakersfield, California, now is in its 30th year of helping to make the season special for youngsters.

"Hats off to WO6T!" enthused Peter Schipelliti, W1DAD, of Atkinson, New Hampshire, who says he bumped into the W6S Santa's Workshop station while he was tuning around on 20 metre the evening of December 19. He awoke daughter, Geena—at age 6 already a seasoned Kid's Day veteran—so she could talk to Santa.

"She had a great time, especially when Santa recited our address and said that he would be coming next week," Schipelliti said. "Santa reinforced some basic values and reminded her that she should share her toys and continue to be good."

Mickey Hicks, 71, says he started his Santa's Workshop as a one-night effort, but he soon realized he needed to expand it. The annual W6S special event now runs for 10 days each Christmas

Education Notes

Brenda M Edmonds VK3KT
WIA Federal Education Co-ordinator

Examination review

By now readers will be aware that the *WIA Exam Service* is undergoing a review of its processes and procedures. An Audit of the Service was carried out by agents of the ACA late last year. The report recently to hand makes recommendations as to improvements needed.

The major concern of the ACA was whether or not sufficient processes were in place to prevent any fraud or to identify and deal with any fraud that does occur. The WIA is mindful of the fact that the level of suspected fraud is very low, but has been concerned for some time that suspicions have been hard to follow up, difficult to prove and impossible to prosecute. The WIA has neither the financial resources nor the sufficiently trained staff to take action against the few unorthodox practitioners who see the exams as a source of personal gain.

The good news is that the audit has recommended that the ACA take the responsibility for investigation of any complaints of suspected fraud and, if necessary, follow through up to the stage of prosecution.

The review is also allowing the WIA Exam Service to tidy its lists of accredited examiners. Many of those listed have retired from or lost interest in examining, but have not notified us of their decisions. This causes confusion and bother if their names are given to persons enquiring about exams. It is

hoped that those responding to the invitation to be re-registered as accredited will be those whose interest is still high.

The examination manuals are also under review; to be replaced by a simplified set of instructions to those involved in examinations and checklists for all aspects of the event. The persons administering the exams will be known as "invigilators" rather than examiners, as the "Examiner" is in reality the ACA, with the WIA acting as its agent. ("Invigilator" simply means "person supervising an examination".)

The system is being reorganised around existing clubs. Each club will provide a group of invigilators, with a Group Leader to do the management of arranging the event, the ordering of papers, the invigilation and the return of materials to WIA Exam Service. Of course some allowance must be made for areas remote from existing clubs, and the present system of "remote" examinations will continue with minor modifications.

We do not expect that these modifications will make the

administration of examinations any more difficult or stressful for the invigilators. In fact, it should be easier as the procedures will be spelt out in more detail. It will require a little more attention to detail, and more careful forward planning of the times and dates of events.

I must stress that, while we have leant heavily on the need to address possible fraud and so maintain the integrity and reputation of the WIA Exam Service, our experience over the years has been that the incidence of suspected fraud has been very low. The audit agreed with this view, and expressed some satisfaction with the ways in which any incidents had been handled. We have complete confidence in the vast majority of our current examiners, and do not wish to imply criticism of them by this review.

There will inevitably be some period of adjustment needed as the new procedures are implemented. We ask for your patience and tolerance for this time, in the hope that we will end up with a better, more manageable system that serves everyone more satisfactorily.

Beyone Our Shores continued

season and occupies 7 to 10 hours of his day, including preparation.

"It's not scripted," he said. "I ad lib all the time." He said he spreads his effort out among several bands too—and notes that 17 metre has been great this year. Hicks estimates that he speaks with 400 to 500 youngsters each holiday season, and sometimes they include children of the youngsters he'd met years earlier.

A ham for 41 years and a long-time Amateur Radio instructor, Hicks says his Santa's Workshop has been a great ham radio recruiting tool. One of his most memorable experiences was when a young girl he'd once spoken with on the air as Santa came by with her ham ticket in hand to thank him in person for

getting her interested. "I had tears in my eyes, of course," he said.

Santa had a Web cam <<http://www.wo6t.com>>so the kids could see Santa in operation.

Do we have a volunteer to be the VK/ZL Santa next year?

(*ARRL Dec Newsletter*)

CANADA

The RAC Board of Directors has elected of Charles Leggatt, VE3CFL of Toronto, as the Canadian Radio Amateur of the Year for 2001.

Charles served in the Royal Corps of Signals, 1941-1945, and moved to Canada in 1953. He worked as an assistant chief engineer with a U.S. company, which worked on the Avro

Arrow project. After that project was scrubbed in the 1960s Charles sold insurance and trained salespeople. He is also a sailor and writer.

Charles' contributions to amateur radio are many and earned this award for his tireless work in providing instruction and training so others may become radio amateurs. Because of his work over the past 12 years some 200 persons have become licensed radio amateurs.

Should we have a "Radio Amateur of the Year?"

(*RAC via qnews*)

If you have an interesting story or know of a forthcoming event overseas, please email or snail mail me. VK2AYD QTHR or davpil@midcoast.com.au

Portable Two Element Triband Yagi

A portable two element triband yagi came as a result of the portable operating experiences of Markus Hansen VE7CA. Markus published the design in QST November 2001.

The antenna uses wire elements and a hairpin match to achieve a match on 20,15, and 10 metres. The elements are strung between wooden spreaders. The

feedpoint to form a simple choke balun.

Dimensions given favour the bottom end of each band. To adjust the antenna set it up paying attention to the lengths and spacings. Then on 15 metres adjust the hairpin match for lowest SWR in the chosen portion of the band. Then check 10 metres and 20 metres SWR's. Adjust the lengths of the 10 and 20 metre driven

elements for best performance on 10 and 20 metres. Remember the result is a compromise and the aim is to get an acceptable result on all three bands. Markus VE7CA was able to achieve an SWR under 1.3 : 1 in the CW segments of all three bands. He also had under 2:1 in the bottom of the SSB segments.

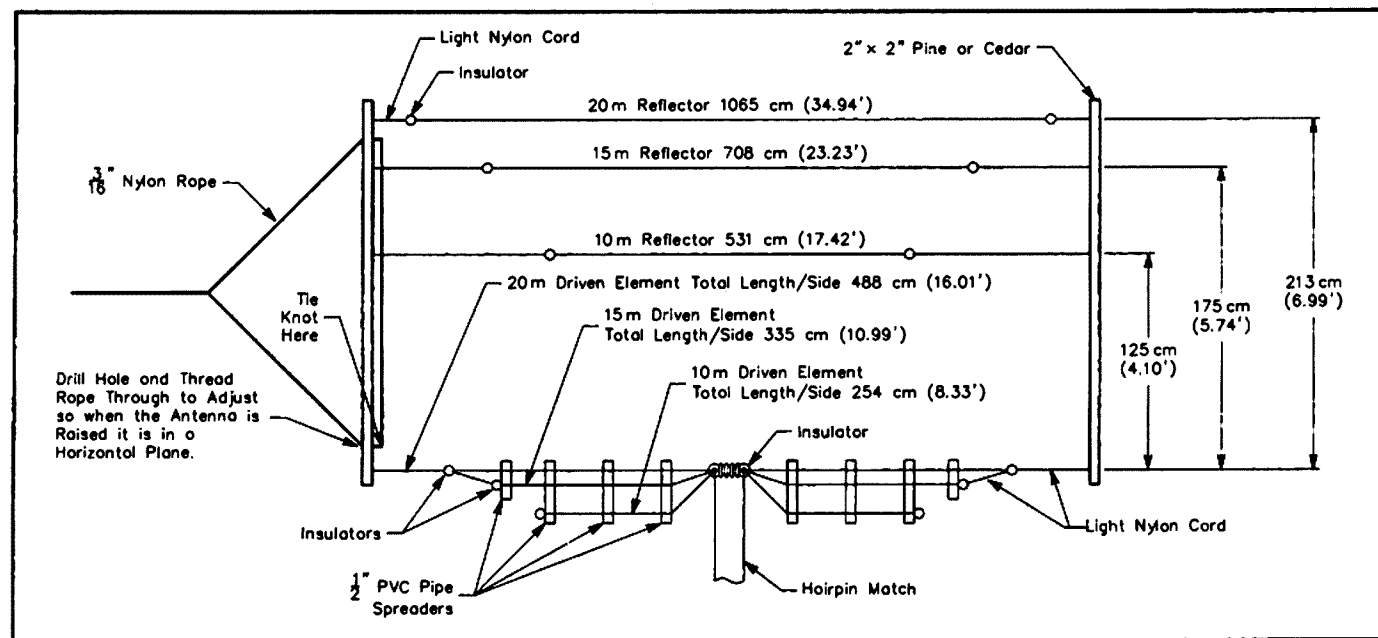

Fig 1. 2 Element Wire Triband Yagi.

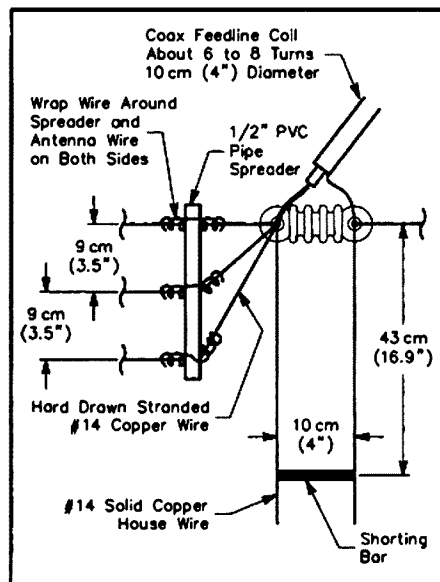

Fig 2. Feed Point of Triband Wire Yagi.

spreaders used were 2 x 2 inch pine 2.13 metres long and local timber could be used. The size and timber type is not critical but it should be light and strong enough. While the size specified is not common locally in Victoria there are alternatives available. Have a look around at your timber merchant.

The antenna is a two element beam. The driven elements have a common feedpoint and a hairpin match is used. The reflectors are strung separately. The antenna is shown in Fig 1.. The feedpoint and hairpin match are shown in Fig 2.. The feedline used was 25 metres of RG58 which is a compromise between antenna height, station position, and weight and of course loss. The feedline is coiled up for 6 to 8 turns on a 100mm diameter close to the

This is an awkward spot!

Club publicity officers,
Help us fill corners like this by using it to publicise your coming event.
Send us your details

Technical Abstracts

Sardine Sender Updated

The Sardine Sender was a popular homebrew QRP rig published in QST October 1978 by Doug DeMaw W1FB. The name came from the use of a sardine tine as the chassis base for the rig. The connectors were mounted on the side walls of the sardine tin with the circuit board on top. The parts were mainly from Radio Shack which we know as Tandy.

An updated version appeared in QST November 2001 from Erik Westgard NY9D. The parts are mostly still available. The crystal used was a 3.579545 MHz colour burst crystal but other crystals can be used.

The main difficulty which had to be overcome was a source of suitable RFCs. This was overcome by modifying Radio Shack 100 microhenry chokes part number 273-102 to provide the required inductors.

The circuit board looks like a perforated prototype board but strip board or plain perforated board could be used. The size is set by the size of the sardine tin mounting base.

The circuit is given in Fig 3. There are relatively few critical components and most were sourced from Radio Shack or Tandy. Some small parts such as resistors and capacitors came

from miscellaneous grab bag assortments sold by Tandy. All picofarad value capacitors should be NPO ceramic for preference. The higher value capacitors other than electrolytics could be monolithic ceramic types.

The 2N3053 transistor should be fitted with a heat sink. The coil data is given in Table 1. All coils are based on a 100 microhenry RFC Radio Shack (Tandy) part number 273-102.

Table 1. Coil Data Using Radio Shack 273-102 100 microhenry RFCs.

L1	100 microhenry unmodified RFC
L2 - L4	10 microhenry choke. Unwind to 15 turns close wound near the centre of the choke.
L5	12 microhenry choke. Unwind all but 16 turns. Gives 11.8 microhenry.
L6	8.9 microhenry choke. Unwind all but 14 turns for 8.9 microhenry.
T1	Broadband impedance matching transformer. Unwind to 15 turns to give 10.6 microhenry. Save wire and use it to over wind a 2 turn secondary winding.

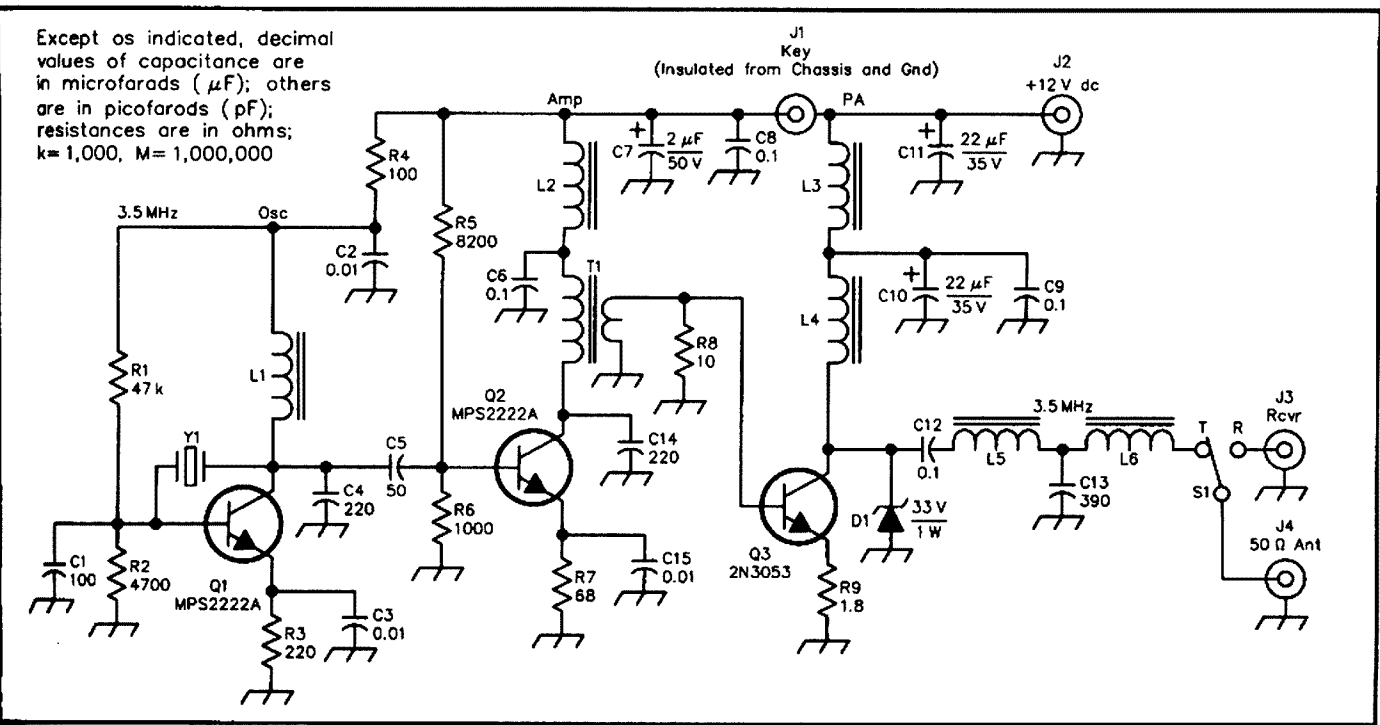

Fig 3. Updated W1FB Sardine Sender Transmitter.

SEANET 2002

PLAN AHEAD

Perth, November 1ST, 2ND, 3RD

Supported by the Northern Corridor Radio Group. Web site www.qsl.net/seanet2002 for all the news.
 Contacts vk6adi@wn.com.au OR vk6xc@qsl.net

Determining Transistor and Diode Leads with a Multimeter

An old but useful technique was presented in the Hints and Kinks column of Bob Schetgen KU7G in QST September 2001 by Bert Kelley AA4FB.

The technique is to use a multimeter on the Ohms range to identify transistor leads. Many multimeters have a diode check function which provides a suitable range. However you can use any suitable Ohms range which uses a current low enough not to damage the device under test. A small signal transistor cannot handle the current that a power transistor can handle.

A transistor can be represented as a pair of diodes. See Fig 4. By conducting a series of tests you can identify the base

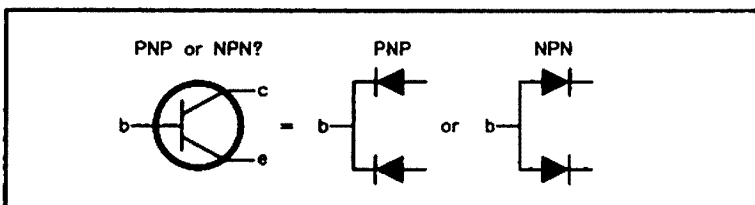

Fig 4. Bipolar Transistor Appears to an Ohmmeter as a Pair of Diodes.

lead common to both diodes. The meter polarity will tell you if the transistor is PNP or NPN. Just look at the diagram and your tests. Watch out for some meters which have test probes which are reversed polarity on the Ohms range. Another meter will reveal this. The collector to emitter test should be high

resistance in each direction. The other tests are like all diodes high resistance one way and low resistance the other.

You can often do the test on transistors still in circuit but watch out for the influence of other components. Best result is achieved out of circuit.

URUNGA FIELD DAY

Easter Saturday & Sunday, March 30 & 31 2002
Senior Citizens Hall, Bowra St

quizzes

novelties

lucky door prizes

Trade tables

Tea and Coffee available

Fox Hunts and raffles



The second Urunga Radio Convention 1950.

PROGRAM

Saturday 30th March

10-11 am 80 m Mobile Foxhunt

11.30-Noon 2m Pedestrian

Noon -1.30pm Lunch

1.00-1.30 80 m Novice

2-3 pm 2 m Mobile multi Tx

3.30-4 pm Talk-in m 146.500

6.00 pm Meal Booking required

Sunday 31st March Easter

9-9.30am Scramble

10-10.30 am 80 m Novice 40 m Fun type event

11-Noon 2 m mobile multi Tx

Noon -1 pm Lunch

1.30-2 pm 2m Pedestrian

2.30-3 pm Talk-In 2m fun event

4.pm Presentations

More information from:

Brian VK2ZCQ 02 6655 1115,
Arnold VK2ADA

Registration

One day OM \$10, YL \$6, Family \$16

Two Day OM \$12, YL \$8, Family \$20

WIA DXCC standings (January 31, 2002)

Callsign	Countries	Callsign	Countries	Callsign	Countries	Callsign	Countries
Honour Roll (325) Phone		General listing - Phone		General listing - Phone		Honour Roll (325) Open	
VK3EW	334/340	VK6LC	253/254	ZS6IR	102/104	VK7BC	334/343
VK5MS	333/387	VK2HV	253/000	KB2NEK	102/103	VK4LC	333/380
VK4LC	333/380	VK2PU	243/247	C21NJ	102/000	VK5WO	333/369
VK5WO	333/365	VK6YF	238/241	VK2FZR	102/000	VK6HD	333/360
VK6LK	333/358	VK8KTC	231/233	JH3OHO	101/103	VK3QI	333/348
VK6HD	333/358	VK6APW	228/229	VK3EJM	101/103	VK4UA	331/347
VK3QI	333/347	VK3ETM	226/227	VK3KTO	101/102	VK2AVZ	329/340
VK3AKK	333/346	VK8AM	225/000	VK1PRG	101/000	VK3AKK	327/388
VK3DYL	333/339	VK3SM	222/242	ON4BCM	100/000	VK4AAR	327/331
VK2FGI	333/339	VK5BO	217/222	Honour Roll (325) CW		General listing - Open	
VK3SX	333/338	VK3DD	213/217	VK6HD	333/354	VK3UY	324/330
VK4UA	331/345	VK4IL	212/000	VK3QI	333/345	VK3JI	322/351
VK1ZL	331/337	VK4XJ	204/216	VK5WO	326/342	VK6AMK	322/341
VK4OH	330/337	VK3DVT	201/204	General listing - CW		VK4LV	320/319
VK2AVZ	329/340	VK2CA	201/000	VK3KS	307/335	VK4DV	313/328
VK3CSR	329/338	VK6BH	200/000	VK4LV	297/300	VK4ICU	311/313
VK2DEJ	329/335	VK3EFT	198/201	VK4ICU	291/000	VK6RO	310/316
VK6NE	328/344	PY2DBU	195/197	VK3JI	274/299	VK4DP	309/323
VK3YJ	326/332	VK2FHN	190/000	VK3AKK	270/275	VK3DP	305/309
VK4AAR	325/329	VK7JAB	186/000	VK4KU	251/000	VK4BG	293/312
General listing - Phone		G0VXX	184/000	VK7BC	246/255	VK7TS	285/286
VK7BC	324/329	VK2FHN	173/000	VK6MK	246/249	VK3CYL	282/288
EA3AKN	323/331	WA1MKS	171/000	VK3DP	245/247	VK3CIM	282/286
VK3AMK	321/340	VK6APH	168/169	VK2CWS	244/246	VK2UK	269/273
VK5EE	321/327	VK4CHB	167/168	VK4DA	237/239	VK5BO	264/302
VK6VS	319/323	VK2BQS	164/167	VK3DQ	234/261	VK6ANC	261/265
VK5FV	319/322	LU5DSE	161/000	VK3CIM	233/234	TF5BW	260/264
VK4LV	313/307	VK4ARB	159/160	VK4DP	205/216	VK6LC	258/256
VK6AJW	312/317	VK4IT	154/155	VK7TS	204/000	PY2DVU	254/259
VK3JI	310/325	VK4BP	154/000	VK7RO	201/204	VK6MK	253/256
VK6APK	310/315	VK2GSN	152/000	VK5GZ	197/199	VK2HV	253/000
VK5WV	306/328	VK7LUV	148/000	VK6PY	190/194	VK2CWS	250/252
VK6PY	306/312	VK2SPS	141/143	VK6HW	179/182	VK5UO	248/250
VK4SJ	306/307	VK8LC	136/000	VK5UO	165/166	VK3DQ	246/275
VK6RO	304/310	VK3DQ	133/147	VK5BO	159/184	VK6APW	239/240
VK6ABS	304/000	VK2LEE	130/132	VK4XJ	150/163	VK2ETM	238/240
VK4ICU	303/305	TI2YLL	127/000	WA5VGI	146/148	VK4DA	237/239
VK3IR	302/308	VK4VIS	126/128	VK4UA	143/145	VK8AM	236/000
VK1TX	300/000	YC8EMH	126/127	VK4AAR	142/144	VK4XJ	233/249
VK6DY	294/301	VK2IRP	125/101	VK8AM	138/000	WA5VGI	216/218
VK4DP	293/305	TG8NE	125/000	N0TM	135/000	VK5GZ	204/206
VK2WU	291/296	VK2EJK	124/000	VK7DQ	131/132	VK2EFT	202/205
VK4BG	286/302	SM6PRX	121/126	VK2BQS	124/126	VK2FHN	193/000
VK4EJ	286/288	HL4YD	118/119	VK2TB	123/125	VK2BQS	181/184
VK3CYL	282/288	VK2MH	116/118	VK7CQ	120/122	VK4CHB	177/179
VK4BAY	275/278	VK7WD	115/116	DK6AP	120/000	VK6APH	171/172
VK3DP	274/277	VK5GZ	113/115	SP1AFU	112/113	9A4KA	168/000
VK4TS	270/271	VK6NV	111/113	K5QNM	110/113	SM6PRX	162/169
VK2UK	268/273	JA8XDM	111/000	VK5BWW	110/113	VK3VB	153/165
VK3GI	263/267	C21DJ	109/000	VK6NV	109/110	ON9MCR	129/140
VK4AO	263/000	VK3MRG	108/000	OK1FED	109/000	VK4EZ	129/138
VK3VQ	259/276	JE9EMA	108/000	VK2FYM	106/108	YB8GH	127/129
VK3UY	259/261	VK5UO	107/110	VK4CXQ	106/000	VK3OZ	126/127
VK6ANC	258/262	HC2HYB	106/107	UR5BSJ	106/000	VK7CQ	123/125
VK5IE	258/261	VK4LW	105/000	VK3DG	102/000	VK3MRG	109/000
VK3CIM	253/257	JN6MIC	103/104	SM6PRX	101/102	VK2AJE	100/000



WIA Callbook

This year's callbook is a shortened version containing only the VK call signs and little peripheral information. Its price reflects its shortened format by being considerably less at \$15.00 (plus postage and handling).

Callbook on CD Rom.

This year WIA is offering the 2002 Callbook as an Acrobat file on a CD Rom, also for \$15.00 (plus postage and handling)

The advantages of CD Rom is that the files are searchable by callsign address, surname, postcode or even suburb, virtually whatever you want.

The attached search program, Acrobat Reader, is the world's most popular reader of files and is completely cross-platform compatible, it works on all computers.

We have included readable, searchable and printable files of the 2001 information regarding

Examiners

WIA Divisional Information

Wicen

ACA information

Operating information

Radio and TV Broadcast Stations

Internet Addresses of Interest

Affiliated Clubs

Travellers nets

Operating —special interest groups

Repeaters and Beacons

Useful forms.

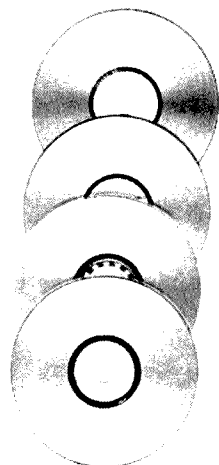

**Order through your local Division
contact details on inside back cover**

Ask about the price of the Book and the CD if bought together.



EASTERN AND MOUNTAIN DISTRICT RADIO CLUB INC.

SUNDAY 24 MARCH 2002

ELEPHANT SALE

Selling space: \$15.00 per table
(inc. entry for one person). For Bookings call
Peter VK3DI on 9720 8874 or email
petermac@alphalink.com.au by 10 March

Great Ryrie Primary School

Great Ryrie Street Heathmont

Doors open at 10:30 AM

Entry \$5.00 per head

www.emdrc.com.au



Division News

VK1 Notes

Forward Bias

Feel like stretching your wings and do something different and interesting this year? Why not join the Division's committee? There are eight places on offer. Once you are elected to the committee, you get to know more about the things that happen at the various levels in the world of Amateur Radio. Many of the activities that happen at national and international levels have their origin at club or divisional committees. This year will be particularly interesting as the ACA will be responding to WIA initiated proposals in response to the changing

circumstances in which Amateur Radio finds itself. Some of these proposals include changes to band plans, a new type of licence, and new rules for the WIA examination service. All of these changes provide opportunities for implementation of the changes, and to guide the Club or Division seamlessly toward greater enjoyment of the hobby. Nomination forms for a position on the committee are available before the AGM. Just send your address to pkloppen@austarmetro.com.au

Don't forget folks, the Annual General

Peter Kloppenburg VK1CPK
Meeting (AGM) on February 24, 2002 will be preceded by a BBQ starting at 6:00 pm, in the compound of the Parks and Garden Depot in Longerenong St, Farrer. The callbooks for 2002 have arrived. Pickup your copy at any of the General Meetings and pay only \$12.50 when personally collected.

The next Trash & Treasure sale will be held on Sunday, April 21, 2002 starting at 12:00 midday, also at the compound.

The AGM will be held on February 24, 2002, at the Scout Hall in Longerenong St. Farrer at 7.30 for 8.00 pm. Cheers.

VK2 Notes

By Pat Leeper VK2JPA

The Annual General Meeting of the VK2 Division will take place on 13th April 2002, with nominations and agenda items due by 2nd March. Members will be notified by post in the middle of January, just in case they don't pick up on it elsewhere.

The main interest over the holiday period was, of course, in the large number of bushfires threatening

property and life along the NSW coast and in the Blue Mountains. At time of writing this column, I have not heard of any amateurs directly affected adversely by the fires. I hope this remains so.

To the many amateurs involved, either as firefighters, communications, or just general dogsbodies behind the scenes, you have our grateful thanks for your

efforts that together, saved so many homes from the flames.

It has been a quiet time otherwise for the Division over the break, with the next event to be the Trash and Treasure on the last Sunday in January. Then comes the Field Day!

See you there...

That's all for this month.

VK4 Notes

Sunshine Coast Interference

Interference on 146.425 MHz appears to be a digital type transmission. It does not sound like 1200-baud packet, too short. But just like packet, it starts, goes for a time, and then goes quiet for a while. It seems to drift from 146.420 to almost 146.500. It appears to come from the Wilkes Knob area. Maybe the portable traffic lights supposedly on 160.000 MHz? If you have the ability to scan the spectrum, then maybe identification of freq. and owner of the transmission could be made. Results please to Bill VK4XZ

Use-by-date!

You've heard VK4BTW Tom mention

that "Use-by-Date" as applied to the observer members of the Intruder Watch, well it has finally applied to his position as VK4 Co-ordinator and VK4BTW has advised the WIAQ Council and others that he will be resigning that position at the end of June 2002. Until that date Tom will be on the job as usual unless the position is filled earlier. Tom offers all assistance needed to get started with IARUMS.

Townsville Ladies get a gong in the ALARA Contest

The Ladies of Amateur Radio group in Townsville say they are excited! With good reason too, as the special event station VI4FLG that they operated

during the 21st ALARA Contest has received a certificate for "Top VK Club Station".

The certificate will be suitably framed and displayed at the TARCinc Club Station and copies of the certificate will be presented to all ladies who operated the winning station.

John Moyle for the TARCinc

The Townsville Amateur Radio Club will be active during the 2002 John Moyle Field Day from a tributary of the mighty Burdekin River.

The Club Station VK4WIT will be located at Fletcher Creek Camping Grounds, Gregory Developmental Highway (Lynd Highway), Fletcher

Creek, Shire of Dalrymple. Position 19deg 48min 50sec South, 146deg 03min 17sec East. It's 130km by road from Cluden Walkabout via Flinders Highway and Gregory Developmental Road or, 180km by road from Thuringowa Central via Herveys Range Road and Gregory Developmental Road. The Grid QH30ae UTM 55K 0401000 7808829 at an altitude of 270 metres.

Duration from p.m. Friday March 15th until lunch Sunday March 17th. Club Station and Singalong under the big TARC tarps, TARCvan in attendance.

ABC Publicity Broadcast

Still in Townsville, VK4PS gave the good oil on Marconi and Amateur Radio over the local ABC Radio Station 4QN. Interviewer Michael Clark had Alan provide the history of the first radio message plus a discussion on Amateur Radio's involvement with the State Emergency Service, the educational program of the local Amateur Radio Club and the enthusiasm that licensees have in their experimentation.

VK4 Distance Record

A new Queensland distance record on 24.048.1 GHz USB was established on the morning of Tuesday 8th of January over a 72.8-km path. Location 1: Wellington Point, VK3ZQB + VK4ZHL portable. Location 2: Caloundra, VK3XPD + VK5DK portable. Signals strengths up to 5x5 after initial optimisation with typical daytime QSB. The visiting team is continuing with local propagation experiments. The challenges of building and operating microwave amateur radio equipment are wonderfully rewarding in many ways!

VK6 Notes

Notice of the Annual General Meeting for 2002

It is hereby notified that the Annual General Meeting of the Wireless Institute of Australia (Western Australian Division Incorporated) will start at 10am on Saturday 20th April 2002.

The venue for this year's AGM event will be the Board Room at CWA House 1174 Hay Street West Perth and the agenda will be:

1. Consideration of the Council's annual report
2. Consideration of the financial report
3. Consideration of other reports
4. Election of office-bearers (President, Vice President and seven other Councillors)
5. Election of two Auditors
6. Appointment of a Patron
7. General business which has been duly notified.

Notices of Motion for the AGM must be received by the Secretary not less than 42 days prior to the meeting (ie by the

8th March 2002), and must be signed by at least three members.

The Secretary's postal address is WIA WA Div. PO Box 10 West Perth WA 6872.

Nominations of candidates for election to Council must be received by the Secretary, in writing, not less than 42 days prior to the meeting (ie by the 8th March 2002), with an intimation that the candidate is willing to act.

A candidate may submit a statement, not exceeding 200 words, outlining his or her experience and case for election. Each nomination shall be signed by two members proposing the candidate. Candidates must possess a current amateur licence.

Any financial member who is entitled to vote may appoint a proxy, who must also be a financial member who is entitled to vote, to speak and vote on his or her behalf. Written notice of such proxy must be received by the Secretary prior to the meeting, and be in the following form:

I (*full name*), a member of the Institute, hereby appoint (*full name*), also a member of the Institute, to act for me as my proxy, and in my name do all things which I myself being present could do at the meeting of the Institute held on the 20th April 2002.

Signed:

Witness:

Date:

Lunch will be provided in the form of sandwiches, cakes, biscuits, coffee and juice.

Council trust there are sufficient amateurs who care enough to come along to the AGM and would like to see a quorum by 10am. Lunch will be at 12 midday and then there could be 2 hours of discussion on amateur radio "The AR topic's that interest me", plus "Any Questions". Will VK6UU might bring his Tesla Coil along for a demonstration, in case you missed it last year.

Silent Key

Bill Bower VK7AV

It is with regret that I learnt today that Bill Bower ex VK7AV passed away after a long battle with Alzheimer's. Bill was in Special Care at Peacehaven. Rae, his widow just lives a few doors away from me at 5/177 Penquite Road and I used

to see her daily as she walked across to special care to see Bill.

Bill or "Ace" as he was known was onetime Divisional Secretary and Northern Branch Secretary and he got his call after graduating from CB. He was

for many years the Launceston Registrar of Births, Deaths and Marriages, or as he called it, the Office of Hatch, Match and Despatch.

Vale Ace VK7AV

Robin L. Harwood
20/177 Panquite Road
Norwood TAS 7250

Intruder Watch

Thanks to all who sent in observations for this report.

The 14 MHz Indon CRIMS and others below 14.1 have decreased more than somewhat thanks to the Amateurs who have 'occupied' the frequencies. There are some 'nasty' indon crims especially on 14.1. Do not be deterred, as this seems to be the only way we can get them off our bands. Thanks to the Amateur who played the 'Talliban Hitparade' that really upset the Al Qaida followers..!!!!..

The 'JOEY' mob do not seem to be able to change frequency or USB to LSB, maybe they are XTAL locked on 14.100!

One Intruder not heard for some time is QUANG ZOU, not far from Hong Kong. The broadcast on 18085 starting before 0820 and they did close transmission at 1127 when they were heard in Humpty Doo. They give ID and time pips at 0900. If you remember, they used to relay Hong Kong on 28 MHz a few years ago!!

The U.N.T.A.E.T. VHFFONELINKS on the 144MHz Amateur band is being sorted out. We will keep you informed on the progress.

Keep up the good work please and remember if we do not, there will be no bands for our new generations of radio amateurs..

GL de Henry, VK8HA in Humpty Doo, email:vk8ha@octa4.net.au

FREQ	DATE	TIME	EMM	DEGS	RST	DETAILS	FREQ	DATE	TIME	EMM	DEGS	RST	DETAILS
14100	DY	ALL	USB	330	S9+	Indon CB Crims on USB and LSB..Chinese Packet fqs below 14.1	14250	DY	—	A3E	—	—	PyongYang B/cast.H5 of 2.850MHz lowmod level NON at times
14110	DY	1210	CW	320	S2	Daily Pips.Now moved to 14315.CWFigs also at 2330	14279	3011	0600	F7	330	S2	UI
14116	DY	—	F7B	—	—	Hels.type.4 channel 500Hz space.short runs	18085	1811	0820	A3E	—	S9	B/cast from QuangZou China near HongKong.ID + time pips at 0900
14120	1811	1152	PKT	345	S9	Chinese Packet	21420	—	—	A3E	—	—	H3 of PyongYang on 7.140
14120	DY	—	F7B	—	—	4 channel data 500Hz space	28000	DY	any	CB	—	—	Chinese CB. Some stns up to S9+. They took 'A HIDING' during the CW Contest!
14300	1811	1130	R7	330	S9	UI .same tx as sending Daily Pips?	<p>The 24890 + CODAR - OHR near Humpty Doo is still going strong. Not very strong at VK8HA QTH back of their antennas! Thank GOD for that, otherwise that would be the end of 24 Megs for me!!</p> <p>That is all for now. de Henry VK8HA</p>						
14175	—	—	R7B	—	—	'Sawmill' type .4 kHz wide w/timing tick							
14190	—	—	R7B?	—	—	Twin data channel 250Hz space							
14219	—	—	F1B	—	—	RTTY 500Hz shift 75 Bd..contin.for 30 mins +							
14175	3011	0600	F7	330	S7	UI Sawmill							

International Amateur Radio Union. Region 3

Monitoring Systems Newsletter, December 2001.

Compiled by:
B.L.Manohar "ARASU" VU2UR.
Regional Coordinator.

A hearty welcome to the Pitcairn Island Amateur Radio Association (PIARA) to the Monitoring Systems Group of Region 3. We wish to hear PIARA nominating one of their active amateurs for Monitoring Systems work, so that Region 3, has the advantage of having the observations from the area, so close to Region 2.

Reports from Australia and New Zealand say about the signals from Quang Zou transmitter from Mainland China on 18085 kHz. And the Indian sub continent experiences the 3rd harmonic signals from Yunnan B/S on 18105 kHz. The number of Indonesian pirate operations is continuing unabated on various frequencies in the 40 and 20

metre bands. The data transmitting stations occupying about 4 kHz bandwidth are also reported from VK/ZL area. The harmonics of DPR-Korea is still continuing on various frequencies of the 20mb, especially the 5th harmonic from 2850 kHz on 14250 kHz, daily, in the VK region.

News from Region 1: The Voice of Broad Masses from Eritrea is reported by DARC and SRAL on 7100 kHz. Complaints by DARC through German Authorities were ignored and the station continues. The MS Coordinator of VERON, reported reception of CB like traffic from Brazil in the slot 24890 to 24990 kHz.

News from Region 2: The single letter beacons from Russia, A, C, F, M, S were reported, with a word of caution that A beacon might have been the improperly keyed K beacon. The 10th Harmonic of Radio Majagual, Colombia is going strong on 14301 kHz. CB type operators on 24 and 28 MHz bands from Brazil and Argentina taxi cabs etc.,

For the latest info from Region 1, please visit the web site: <http://myweb.tiscali.co.uk/rdnronald> and for info from Region 2 www.echelon.ca/iarumr2

Note: As JARL report has not arrived, this newsletter goes without it. Sorry.

Wish you all a merry Christmas and happy New Year 2002.

Repeater Link

Will McGhie VK6UU
21 Waterloo Cr Lesmurdie 6076
will2@iinet.net.au
VK6UU@VK6BBR

LIPD Web site

I received an E-mail from Rob VK6JRC telling of a web site established by Rob to inform amateurs of the continuing problems with LIPD interference in the 70cm band. In conjunction with the West Australian Repeater Group Rob sent the following information.

WARG wishes to highlight this issue to all amateur radio operators and bring about a change to the current 'ACA policy. WARG does not believe that knee jerk reactions such as changing the 70cm band plan to utilise possibly 5.4MHz, 6MHz, combined with the current 5MHz repeater splits is in the best interests of amateurs.

In doing so, a website has been established to provide information and a forum for discussions.

The website can be found at: <http://www.perthhost.com/lipd>

We would welcome your input via our Message Board. Given that similar issues

have now also come about in the United States, with the ARRL set to take up the fight with the FCC over changes to Part 15 rules, which would allow commercial manufacturers to unleash their products in the 425MHz-435MHz band, we would also welcome input from any overseas amateurs. (See <http://www.arrl.org/news/bandthreat/>)

*Regards,
Rob VK6JRC*

IRLP Information

Yet another E-mail, this time from Ron VK3ECV in relation to IRLP linked repeater sites around the World and an information sheet of most of the IRLP nodes. Below is part of Ron's E-mail and the attached Information sheet.

On the VK-IRLP mailing list, we have been discussing ways in which we can promote the growing VK IRLP network and new technologies available for us to use.

What is being proposed is a list of current (and pending) VK IRLP Nodes, and new International Nodes to be published each month.

There are currently 21 in VK servicing all capitals except Canberra (pending) & Brisbane and Hobart. A number of country cities / towns are also serviced.

I've attached a file that has a list of most the nodes just for your info. A full list is available at <http://www.irlp.net> on the status page.

Ron Perry, VK3ECV, Mildura.

It is unlikely that I will have the time for an article for March as I will be in Melbourne for a part of February and then driving back to Perth, yes during the hottest time of year.

I hope to put together an article on Digital still Cameras with a few tips on what amateur radio operator should look for as soon as possible and hopefully include a few digital photographs and just what you can do with digital photography.

VK IRLP Nodes

Nods	Callsign	City	State	Node	Callsign	City	State	Node	Callsign	City	State
100	VE7RHS	Vancouver	BC	301	WA6SUP	Sacramento	CA	451	KD4Z	Orlando	FL
260	VE3PGC	Cornwall	ON	436	W9DXN	Dixon	IL	128	VE6MPR	Banff	AB
419	N4XQM	Atlanta	GA	112	VE7KU	Port Alberni	BC	321	W7AOR	Las Vegas	NV
101	VE7URG	Vancouver	BC	302	WA6LCN	Marinwood	CA	453	K4KSA	Tampa Bay	FL
261	VE3EI	Cornwall	ON	436	W1CDO	Seattle	WA	129	VE6WRT	Calgary	AB
420	N4GLB	Upstate	SC	115	VE7REE	Penticton	BC	322	KH6GMP	Kailua Kona	HI
102	VE7RNA	Chemainus	BC	303	KB6THO	Pasadena	CA	455	W4DOC	Atlanta	GA
262	VE3NUU	Monkland	ON	437	W8HDU	Lima	OH	130	VE6TRC	Ft. McMurray	AB
421	W2ISB	Liverpool	NY	116	VE7RAP	Comox	BC	323	KB7LVC	Boise	ID
103	VE7VIC	Victoria	BC	304	WA6JFK	Los Angeles	CA	456	NE1H	Atlanta	GA
265	VA3MME	Omeme	ON	438	W9BCC	Wausau	WI	131	VE6RJZ	Canmore	AB
423	NJ2FM	Hopatcong	NJ	117	VE7RIA	Victoria	BC	324	KB7RSI	Las Vegas	NV
104	VE7RMT	Victoria	BC	306	AC7DE	Helena	MT	457	WB2WPA	Naples	FL
268	VE3DJD	Burlington	ON	439	KC7ZWG	West Tacoma	WA	133	VE5CMR	Saskatoon	SK
426	WR2ROC	Rochester	NY	120	VE6RPT	Calgary	AB	325	N7BFS	Spokane	WA
106	VE7RVN	Vernon	BC	307	WA6TWF	Santa Ana	CA	459	WA1ZVZ	Branford	CT
270	VE3ORX	Orangeville	ON	440	KC8NCE	Grand Haven	MI	134	VE5RAD	Nth Battleford	SK
426	KD4RAA	Raleigh	NC	122	VE6TE	Red Deer	AB	326	KH7R	Henderson	NV
106	VA7OKN	Vernon	BC	308	WR6AVM	Honolulu	HI	460	KD4BBM	Miami	FL
276	VE3KAR	Kingston	ON	444	KB3HF	St. Peters	MO	135	VE5SKN	Saskatoon	SK
427	KD4RAA	Raleigh	NC	123	VE6ZV	Calgary	AB	327	K7SDC	Castle Dale	UT
107	VE7MFS	Coquitlam	BC	313	K7QJI	Fruitland	ID	466	WR3S	Nashville	TN
280	VA3CWS	Richmond Hill	ON	445	N8DNX	Stutsmanville	MI	136	VE5CC	Saskatoon	SK
428	W9ADS	Champaign	IL	124	VE6SBR	Edmonton	AB	328	WX7Y	Castle Dale	UT
108	VE7TSI	Kamloops	BC	316	WA6RQD	Oceanside	CA	476	N3IO	Philadelphia	PA
281	VA3SCR	Innisfil	ON	446	WB8NXP	Southfield	MI	137	VE5IOU	Prince Albert	SK
430	N3APP	Erie	PA	126	VE7FFF	Pr George	BC	329	W7AOR	Las Vegas	NV
109	VA7MAR	Mackenzie	BC	316	WA6RQD	Oceanside	CA	478	KA3VMA	Drexel Hill	PA
290	VA3RVU	Brampton	ON	448	K1IMD	East Long Is	NY	138	VE5MLR	Meadow Lk	SK
432	W1QWT	Scituate	MA	126	SARA	Province W	AB	330	N7CK	San Manuel	AZ
110	VE7RGF	Grand Forks	BC	317	WD6AWP	Huntington B	CA	510	G4CUI	Sheffield	SY
300	AH6LE	Mt. Angel	OR	450	N4NEQ	Atlanta	GA	139	VE7RJZ	Invermere	BC
433	K9WZ	Plymouth	IN	127	VA6IRL	Lethbridge	AB	331	KA7STK	St. George	UT
111	VE7BHI	Port Alberni	BC	320	AH6CP	Honolulu	HI	512	M1ERS	Sheffield	SY

140	VA7RDX	Vanderhoof	BC	621	VK2TTA	Wahroonga	NSW	399	WY0X	Centennial	CO
333	NV7RM	Reno	NV	201	VE9ARZ	Fredericton	NB	710	J73CS	Roseau	—
513	G4BVV	Malby	SY	365	KE6PCV	Los Angeles	CA	219	VE3OAK	Oakville	ON
145	VE6PRR	Peace River	AB	622	VK2RIC	Lismore	NSW	400	WA3KOK	Washington	DC
335	NOPSR	Denver	CO	202	VE3ULR	Toronto	ON	750	9Y4AT	Valsayn	Trinidad
514	G0FUO	Mexborough	SY	366	KD7EFG	Murray	UT	221	VE3TST	Stittsville	ON
150	VY1RW	Whitehorse	YT	625	VK2JPJ	Paddington	NSW	402	KA2JZO	Bordentown	NJ
337	AB7TJ	Minden	NV	203	VE1CRA	Charlottet'n	PEI	888	KC4USV	McMurdo Strn	—
515	GB3US	Sheffield	SY	368	N7LZM	Kennewick	WA	230	VO1KEN	St. Johns	NF
151	VY1RHJ	Haines Jtn	YT	626	VK2WAG	Wagga	NSW	403	N2LKV	Stony Point	NY
340	KB8JXX	Anchorage	AK	204	VE3EV	Ottawa	ON	232	VO1BWP	Corner Brook	NF
520	G4NJI	Rotherham	SY	369	N6SEX	Sacramento	CA	404	N2CKH	Lakewood	NJ
155	VE5WVM	Regina	SK	630	VK3RGL	Melbourne	VIC	REFLECTORS			
341	KD6GDB	Santa Monica	CA	205	VE1NSG	Halifax	NS	235	VO1HHR	Grand Falls	NF
521	G8UVE	Burnley	LA	371	WA4HND	Grand Junct	CO	405	N2BJ	New Lenox	IL
157	VE5SCR	Swift Current	SK	631	VK3HEG	Ballarat	VIC	900	REF0	Vancouver	BC
342	KD6LVP	Beaverton	OR	206	VE1WRC	Amherst	NS	240	VE3SUE	London	ON
540	G0XEL	Manchester	—	373	NH6HF	Lihue	HI	406	W1IMD	Portland	ME
160	VE8YK	Yellowknife	NT	632	VK3WRM	Merbein	VIC	910	REF1	Toronto	ON
344	AH6GR	Maui	HI	207	VE1KK	NewGlasgow	NS	241	VE3RBM	Kitchener	ON
600	VK2RBM	Sydney	NSW	376	N6JVH	Los Angeles	CA	408	W2CNY	Syracuse	NY
162	VE8NWT	Yellowknife	NT	633	VK3RPU	Arthur's Seat	VIC	920	REF2	Denver	CO
350	K6JSI	San Diego	CA	208	VE1WN	Greenwood	NS	242	VE3SY	Petersburg	ON
601	VK2RMP	Wollongong	NSW	378	WR6HMB	Half Moon	CA	409	KB2FAF	Cortland	NY
165	VE4UMR	Winnipeg	MB	639	VK3JED	IRLP-Exp	VIC	921	REF921	Raleigh	NC
352	WB6EGR	Burbank	CA	209	VE3BIP	Belleville	ON	245	VE3RAK	Toronto	ON
602	VK2RMB	Terry Hills	NSW	380	AH6JA	Hilo	HI	410	KF3DY	Wellsboro	PA
170	VE4SRR	Swan River	MB	640	VK4RGC	Gold Coast	QLD	930	REF3	Saskatoon	SK
353	K6JXY	San Marcos	CA	210	VE3ADT	Toronto	ON	246	VE3MUS	Huntsville	ON
603	VK2RMR	Mt. Riverview	NSW	381	KG6EAO	Kapaa	HI	412	KF6SWL	Omaha	NE
175	VE4FFR	Flin Flon	MB	648	VK4RCA	Cairns	QLD	931	REF931	Fredericton	NB
354	W6DXX	Palm Springs	CA	211	VE1WY	Lindsay	ON	250	VE3DPL	Norwich	ON
604	VK2RTZ	Newcastle	NSW	382	KC7GHT	Phoenix	AZ	413	WA2ZPX	Middletown	NY
180	VE6MHU	Medicine Hat	AB	650	VK5UJ	Adelaide	SA	940	REF4	Yellowknife	NT
355	VE6RGP	San Diego	CA	213	VE3YYS	Ottawa	ON	255	VE2BRR	Montreal	QC
605	VK2RCZ	Sydney	NSW	384	K6IXA	Atwater	CA	414	WJ2W	Terre Haute	IN
185	VE6COM	Lethbridge	AB	670	VK7AX	Ulverstone	TAS	950	REF5	Sydney	NSW
357	N7HQZ	Ferndale	CA	214	VE3XTX	Owen Sound	ON	256	VE2TPE	Baie-Comeau	QC
606	VK2RAG	Gosford	NSW	385	W7FDF	Tucson	AZ	415	N5IUF	Dall/Ft Worth	TX
186	VE6KJM	Airdrie	AB	680	VK8RTE	Darwin	NT	257	VE2RJS	Montreal	QC
361	K6UB	Saratoga	CA	215	VE1BAS	Orleans	ON	416	WB5TUF	Houston	TX
610	VK6RNC	Perth	W.A.	387	K6KCP	Sacramento	CA	238 Nodes & Refs			
190	VE6LT	Red Deer	AB	690	ZL3TMB	Christchurch	NZ	Compiled: 19/11/01			
362	KU6V	Fremont	CA	216	VE3IRL	Toronto	ON	258	VA2RLP	Baie-Comeau	QC
620	VK6RFM	Fremantle	W.A.	395	WB6ARE	Cedar Park	TX	418	N4MSE	Dallas	TX
200	VA3LU	Thunder Bay	ON	700	J73D	Roseau	Dominica				
363	KG6EVO	Tahoe City	CA	217	VA3BBB	Windsor	ON				

Don't miss the biggest field day and hamfest in the southern hemisphere

The Central Coast Amateur Radio Club presents

Central Coast Field Day

for

RADIO AMATEURS AND ENTHUSIASTS, COMPUTER AND ELECTRONIC HOBBYISTS

Sunday 24th February, 2002

Gates Open 8.30 am

For further information write to The CCARC, PO Box 346, Woy Woy, 2256 NSW
Phone 02 4340 2500, Web www.ccarc.org.au, Email vk2afy@hotmail.com

How to Win Friends and Influence People

Cryptic title – eh? And nothing to do with Dale Carnegie. Read on.

Over a couple of weeks or so I've been exchanging e-mails with Peter VK5ZGP. Like many of us, Peter has been part of the Oscar scene for several satellite generations. We talked mainly of the changes that have taken place in the last few years. One particular aspect is the trend away from voice communication and towards more and more digital comms. Happily AO-40 has addressed this situation and a lot of folk have re-discovered the pleasure of chatting via amateur radio satellite to friends old and new all over the world. Peter's main source of enjoyment comes from rag-chewing on the birds and one of his observations in particular made me sit up and take notice. That was the lack of (or difficulty in finding) comprehensive information on really basic, down-to-earth operating practices for total newcomers. It's true that each satellite has its own set of specialised requirements. To cope with that, the only answer – and this applies to all operators, old and new-is to get as much information as you can and read, read,

read. But there are some common rules that don't change from bird to bird and these rules are the ones we are going to talk about here. "How do I get started?", "How do I make sure I do the right thing and not make a fool of myself in front of other operators?" This sort of thing was behind my writing the "Beginner's Series" that appeared in AR back in 1989. In fact I had been asked only last year to consider updating the series. I got as far as dusting off the old 5.25" floppies (remember them?) and seeking help from my friend Alan vk3asb who had a computer that could read them and copy them onto 3.5" diskettes. However, on reading the articles through it became obvious that so much had changed that nothing short of a complete re-write would do. With the end-of-year fast approaching, the plans were shelved for the time being. Anyway, as they say in the classics, Peter wasn't just playing with the idea and he put his pen where most folks just exercise their mouths and ... presto! He came up with a set of suggestions for all those newcomers out there. The emphasis is on the voice-comms birds and the suggestions confront one of the most perplexing of all things that new satellite operators have to cope with, what to do about Doppler shift. The suggestions are based on Peter's own operating experience and the things he found perplexing when he too was a beginner. The list is comprehensive and I'll deal with it over a month or three. I must thank Peter for the considerable amount of work he has put in to compiling what is to follow. I have done very little editing, mainly to fit into the confines of the monthly column. The words are his and I think you'll agree he's done a fine job. Over to Peter.

"After a break of some 8 years, I decided to fire up the old Oscar 10 and 13 equipment and, knowing full well that Oscar 13 has been long gone, got the shock of my life at the grandmother of them all, AO-10, still operating rather wonderfully well, considering her age

and disabilities! Over the past month I have chalked up so many contacts it makes my previous efforts some years ago look rather dismal. However, the reason for this note is that I have recently worked several Australian amateurs who are very obviously new to satellite operations and have, it appears very little practical knowledge of the basic operating principles involved. The most common mistake most seem to make is to use their receivers to tune the other party, thus causing the first party to retune, causing the other party to again retune, and up/down we all go!"

"When using so-called 'easy satellites', RS-12/13, RS-15 (which is sporadic in its operation), and in fact, just about all voice comms satellites, always work on the principle of trying to stay on the one receive frequency. As the bird appears over your particular horizon, you should already have your favourite frequency picked out; and in the case of RS-12/13, FO-29 etc, that would normally be somewhere near the centre of the transponder's band-pass."

"The Doppler shift associated with low earth orbit (LEO) satellites can make things very interesting and unless we all stick to a single plan of attack, we all end up chasing each other across the passband, dropping off the end, usually well before the satellite pass is over. The following tips are meant as a guideline only, but the basic principle is to maintain a reasonably constant receive frequency".

"I'll use RS-12/13 as an example; it has a transponder that is non-inverting (ie. USB in and USB out-and, of course, USB is the normal method of operation at these frequencies). It's transponder has a pass band of 40 kHz. Here's an outline of a procedure that I have found to work well".

1. A few minutes before the bird is due to appear, set your transmitter up on your favourite uplink frequency and for most people this is the centre of the uplink pass band, 145.930 MHz (the pass band is 40

The AMSAT group in Australia.

The National Co-ordinator of AMSAT-VK is Graham Ratcliff VK5AGR. No formal application is necessary for membership and no membership fees apply. Graham maintains an email mailing list for breaking news and such things as software releases. Members use the AMSAT-Australia HF net as a forum.

AMSAT-Australia HF net.

The net meets formally on the second Sunday evening of the month. In winter (end of March until the end of October) the net meets on 3.685 MHz at 1000utc with early check-ins at 0945utc. In summer (end of October until end of March) the net meets on 7.068 MHz at 0900utc with early check-ins at 0845utc. All communication regarding AMSAT-Australia matters can be addressed to:

AMSAT-VK,
GPO Box 2141,
Adelaide, SA, 5001.
Graham's email address is:
vk5agr@amat.org

kHz wide, covering 145.910 to 145.950 MHz)-and have it set in CW mode, with your key attached. (more on this later!)

2. A few seconds before the bird appears over your radio horizon you should be able to receive the beacon on 29.408 MHz +/- Doppler shift; if you note the beacon's frequency, it should give you some idea of the current Doppler shift, allowing an approximation for your transmitter frequency.
3. As the bird does actually appear over your horizon, have a quick tune over its pass band, tuning from 29.410 to 29.450. If you hear no other amateurs calling CQ, quickly set your receiver to the mid pass band frequency of 29.430 MHz and don't touch it for the rest of the pass.
4. Assuming you don't hear anyone calling CQ, set your receiver to 29.430, USB.
5. Make sure your 2m transmitting antenna is pointed in the right direction (all the better if you have a computer driven rotator system!) and, remembering the approximate Doppler shift as heard when listening on the beacon frequency, key your transmitter (CW) at the centre frequency (145.930 +/- Doppler) and slowly move your transmitter frequency until you hear your own signal coming back to you on 10 metres. *Do not move your receive frequency at this or any other time.*
6. Switch your transmitter to USB and start calling CQ; the usual method is simply 'CQ satellite' or even 'CQ RS-12/13' if you like. The most important thing to remember is *not to move your receiver to keep your own voice fully resolved. Use your transmitter VFO to keep your own signal in the same receive position.* Yes, I know, it's a little strange, but you'll get used to it, I promise!
7. As the bird flies across the sky, its Doppler rate will change according to it's position relative to your station, the worse-case scenario would be one that passes directly over the top of your station, where Doppler is not present for that brief period when it's directly overhead-but that ain't for long!

8. Remember, this is full duplex communications! However, pause once in a while to listen, but **DON'T TOUCH YOUR RECEIVE FREQUENCY!** If someone is tuning across the band, they will hear you if you both share the same 'RF shadow' from the bird. If someone is about, you'll quite often hear a carrier slowly zeroing in on your set received frequency; then, with some luck, the caller will then switch to USB and he should be right on frequency, or, at the very least, pretty close to it. However, keep your receiver where it is and keep talking to him, letting him hear your signal and allowing him to tune you in correctly. Again, remember it's full duplex and it's best to have a set of headphones connected to your receiver otherwise the audio feedback is going to be something rather fierce! (and it's good manners to wear them for that very reason!) Headphones also make it easy for you to *adjust your own tx frequency to stay on that one receive frequency!*
9. As the QSO progresses, and with luck it can be for upward of 10 minutes or so-don't be in a hurry, satellite communications is one of the last areas to be hit by the 'quick and the gone'-you know the types, a quick exchange of call signs, handles, QTHs, signal reports and QSL details-'a sort of 'wham, bam, thank-you ma'am type of thing-in satellite comms, we like to have a good old yarn! *However, above all else, remain on the one receive frequency; use your transmitter VFO to keep your own voice resolved at that frequency.* The other amateur should be doing exactly the same. That way, you both stay together, at the same frequency.
10. If you do start chasing the other person's transmission, think twice about following them up or down the band-with RS-12/13's narrow pass band of only 40 kHz, and starting in the centre of the band, it won't take long before you both drop off the edge of the civilised world as we now it, and, as they said in the old days, 'Beyond this point there be dragons!'

Next month I'll include Peter's observations regarding operating through FO-29 and in the following month's column, his suggestions regarding AO-10 which is experiencing something of a revival since the advent of AO-40 has given a lot of newcomers their first experience of a high-orbit, wide-footprint, long pass-time satellite. Thanks a million Peter.

AO-40 News from the Control Stations via the AMSAT-BB

Attitude Management Through Current Eclipse Period

Stacey Mills W4SM reports that the attitude change is progressing smoothly and so far the transponders have been turned on for at least part of every orbit. It was expected that when solar sensor lock was regained in the latter half of January 2002, it would be possible to raise the ALAT back to 0 after which Command stations would then chase the Sun slowly toward 0/0, getting there in April as planned. Controllers were hoping to keep the transponders on for at least part of each orbit, right after perigee throughout this period, but there may be times when this is not possible. At the time of writing, this was the latest information from Stacey:

"We had predicted that the solar sensors would again begin functioning on Orbit 549, and we have preliminary indications on Orbit 548 that they are about to lock again. Once we have precisely determined ALON/ALAT and the sun sensors are functional, we will start magnetorquing to hold ALON against the mystery effect, first slowly raising ALAT to 0 and then progressively advancing ALON from about 300 back towards 360 (0). As noted earlier, it will take until mid April to get back to 0/0, as the sun must first move out of the way".

More Pictures from the SCOPE Team

Yoshi, JA6XKQ, and the JAMSAT team (along with the RUDAK and SCOPE teams) reported via JAMSAT that they had released several new pictures from the SCOPE cameras on AO-40. RUDAK command station member Jim White, WD0E, captured the latest pix on December 12th. One of the pictures is

the first photo from Camera-A. The pictures are available at: <http://www.jamsat.or.jp/scope/011215/>

AO-40 Operating News

Many reports are coming in of excellent conditions on the mode U/L-S transponder on AO-40. Not a day goes by on the bulletin board without accounts of good DX contacts being made. It seems many operators are well on their way to DXCC on AO-40. The availability of cheap 2.4 GHz downconverters and small ex-TV dishes has made this a popular mode, even for newcomers to microwaves. There is plenty of material available on the web regarding modifying these downconverters so why not join in? There are lots of stations in North America and Europe looking for contacts into VK and the Southern Hemisphere generally. Hopefully the move to 3-axis stabilisation will improve squint angles all round and lead to an even greater upsurge in DX activity on the bird.

PCsat News

PCsat survives the Rigors of Marconi Day

Bob Bruninga WA4APR was a worried man when he rang Richard VK3JFK. He needed help from someone in the Southern Hemisphere who could send commands up to PCsat. The satellite was experiencing rather long eclipses and the batteries were going to give up unless something was done quickly. Something was causing it to switch into high power mode and the Northern Hemisphere control stations were not able to get it to switch back to low power again. The batteries were being drained almost flat. Richard rang me and between us we were able to accommodate Bob's requirements. Bob sent me some telemetry display software and some control station software and away we went. For some days, with Richard monitoring, I was able to do the switching each time the satellite came into view. Bob was preparing to travel to Newfoundland for the US Navy's Marconi-Day celebrations. He delayed his departure until the last moment and was (just) able to upload suitable celebratory messages to the satellite. We were all worried that PCsat would not survive the extra load imposed by these messages but as it turned out-it did. The

satellite ran perfectly during the period of the celebrations and only required a reset command once in that time. It has since been returned to normal APRS digipeating service and I have only had to reset it once since. Bob and his team are to be congratulated on turning such a simple satellite into such a success story. PCsat will undoubtedly set a pattern of APRS-style operation for future amateur radio satellites. (I can hardly wait!

GPS Tests on PCsat.

Bob WA4APR reported that the GPS experiment was turned on for several orbits on 9th January when the satellite first came into full sunshine again after the long eclipse session. The limited battery budget had not allowed these whole-orbit tests to be made earlier. The GPS remained on for a full orbit and battery volts remained above 15.6 or 1.3 volts per cell. Bob decided to risk leaving it turned on WORLDWIDE for a few more orbits to see what happened. The telltale TELEMETRY values are 00011111 where the 3rd 0 means the GPS is turned on. Further evidence is to watch for the \$GPGGA sentences every 30 sec from W3ADO-1 on 145.827 MHz, 1200 baud and MITEL data packets every 30 sec from PCSAT-11 on 144.390 MHz, 9600 baud.

Bologna Moon-Bounce Effort Thwarted by Dish-feed Problem

The Italian amateurs don't do things by halves - so-as part of their celebrations for Marconi-Day, 23cm EME transmissions were planned using a 32 metre diameter Radio-Astronomy dish near Bologna in northern Italy. This was reminiscent of the Algonquin (Canada) tests of some years ago. These types of tests are always of interest to satellite buffs for they offer an unusual opportunity to test one's UHF/Microwave gear under extreme circumstances. I recall meeting with some success during the Algonquin EME tests when Peter Ormrod VK3CPO and I camped out for two nights using quite rudimentary gear. This time I spent some time building a 1.2 GHz feed for my dish and on the day of the test (Marconi-Day), I worked out all the necessary directions and times, lined up the dish on the Moon and listened, as the Moon slowly set, for

the whole of the mutual window with Bologna. Sadly ... not a sausage! I had even calculated the Doppler shift due to the relative motion of the Moon which was at various times, moving closer to Bologna and at first closer to and then further away from Milawa (all at differing rates). I wanted to be sure I was tuning in the right spot. I was reasonably confident of at least hearing the station and (due more to their 32m dish than to any effort of mine), to perhaps even make a contact. It was mid afternoon our time when the EME window opened to Bologna and with the Sun high in the sky I could hear 3-4 dB of solar noise. That should have been more than enough sensitivity to allow me to at very least hear the Bologna signals. So what went wrong? Did I get the times wrong? Was the tracking program in error? Did I mess up the UT time difference? There was no mention on the Amsat-BB of the tests being abandoned and when I made an inquiry I was informed that the signals had come in loud and clear in the USA. Things looked black. It was "back to the drawing board" but I still couldn't find anything wrong. The next day I received an e-mail from Domenico, I8CVS who was part of the team. He informed me that they had trouble with their dish feed device for some time after their moonrise (which was when the VK window opened). They did not resolve the problem until after the mutual window with VK had closed ... that is to say ... the Moon had set here. So there it was. I was frantically tuning around and checking the aiming of the dish and all the while there was feverish activity at the other end to resolve a problem. It appears the problem had also disappointed a couple of regular VK EMEers who had scheds, so I wasn't the only one. Still ... I was relieved to know that my gear was probably good enough to do the job but sadly it just wasn't to be on the day.

ar



RD Contest:
Interesting that 304 of
NSW 398 VHF points
came from members
on SARC

How's DX

Ross Christie, VK3WAC
19 Browns Road, Montrose 3765, Vic.
Email vk3wac@aol.com

How about Antarctica?

Propagation on the amateur bands has picked up at last and it seems that conditions are now beginning to reflect those expected at the peak of the sunspot cycle. Late evenings are especially good into Europe from my QTH on 15 and 20 metres, and 10 metres has proved very lively in the late afternoon and early evenings. The 6 metre band is still very quiet at my location and even though I have had my IC746 scanning over the calling frequencies no DX has been heard, only a few local stations. My antenna setup for 6m is very basic, a colinear vertical and a simple dipole, but surely I would have heard the better equipped local working the DX if it was around?

The DX

3W, VIETNAM. Karl, W9XK is currently QRV as 3W2XK from Saigon and will be there until early April. He spends a bit of time around 14260-14270 kHz, 21370-21400kHz and 28500 kHz. QSL via W9XK. [TNX Daily DX]

5N, NIGERIA. Frank, 5N1BHF, has been busy on the 12 metre band, around 24940 kHz actually. He can be heard as early as 1000z and sometimes as late as 1615z. When not on 12 metres he can often be found on 20 metres on 14195 kHz usually after 0500z. QSL via OE6LAG. Another Nigerian station, 5N0NHD, has also often been heard on 24899 kHz CW but after 0700z. QSL via JH8BKL. [TNX OPDX]

5R, MADAGASCAR. Solofo, 5R8ET and Albert, 5R8GZ are both QRV on 12 metres. Solofo can often be found on 24947 kHz SSB after 1600z, QSL is via K1WY. Also, Albert is active on 24902 kHz CW or on 24966 kHz SSB usually between 1215 and 1530z. QSL is via G3SWH. [TNX OPDX]

7X, ALGERIA. Mirek, SP5IXI (VK3DXI, 9V1XE and 9M8DX) has been working in Algeria since June 2001. He says that his request for an amateur radio licence has been granted and he has asked for the callsign 7X0DX but is still awaiting confirmation of this. Mirek

There are a few Dxpeditions planned for this month, probably the most notable is that to Ducie Island. This new DXCC entity will be in great demand from the DXCC hunters and those of us in VK who wish to add this new one to the list should be in a better position than most. Due to our relatively close proximity some judicious planning should see us able to pick a band and time that will enable us to put in a decent signal to the DXpedition operators. This should offset to a fair degree the 'Californian Kilowatts' who will be running up their power bills to log this new one for themselves.

Those not into pile-ups might want to have a go at working some stations in

Antarctica. Mondays at 1700z (0400 local) on 21275kHz sees the Antarctica Net on the air. The milder weather in this region during the summer in the southern hemisphere sees the supply ships visiting with equipment and stores for the coming winter. They also bring a crew change that often includes new amateur operators. Naturally they will be keen to find out what conditions are like from the bottom (top?) of the world on the various bands. Admittedly the net is active a bit early in the day for normal 8 - 5 workers, but who said life was meant to be easy?

Whatever your interest, get on the bands and have a listen around and I am sure you will find something that will pique your interest!

to M0BLF either direct or via the bureau. [TNX VA3RJ and The Daily DX]

DL (GERMAN ANTARCTIC BASE). Dominik, DL5EBE says that a YL operator, Mechita, may soon be QRV for a short period of time as DP0GVN from the German Antarctic Base "Georg von Neumayer". Amateur operator Sepp, who was active from here a number of years ago as DP0LEX, is also a member of the current team based at the new "Kohnen Station" which is located about 500 km south of Neumayer Base. Dominik is not sure what kind of HF equipment is installed at the base but hopefully it will be able to QSY onto the amateur bands. He hopes to join the Antarctic net which runs every Monday on 21275 kHz around 1700z. [TNX The Daily DX]

GJ, JERSEY. Martin Atherton, G3ZAY and Dominic Smith, M0BLF will be active from the Isle of Jersey (EU-013) as GJ6UW from the 15th until the 17th of February. Their plans are to operate on all bands 160 - 10 metres CW and SSB from a site in the north of the island. QSL

to M0BLF either direct or via the bureau. [TNX VA3RJ and The Daily DX]

HC, EQUADOR. Rick Dorsch, NE8Z will be travelling around Equador during the period 1st to 16th of Feb. He plans to be on 80 - 10 metres CW and SSB. He will be using the call HC1MD followed by a region identifier. HC1MD from Tumbaco, HC1MD/HC1 from Pichincha Volcano, HC1MD/HC3 from Loja, HC1MD/HC4 from Sua, HC1MD/HC4/p from IOTA SA-056 (with 100 watts and a dipole) and HC1MD/HC5 from Cuenca. QSL via K8LJG, John Kroll, 3528 Craig Drive, Flint, Michigan 48506, USA. Award chasers may be interested in having a look at the HC/HD DX Award "Equatorial Line Diploma" at <http://www.octavia.com/qs/awards.htm> [TNX NE8Z and 425 DX News]

HF0 (POLISH ANTARCTIC BASE). Mirosław Stefanski, SP7JKW is heading off to Antarctica and will be active as HF0POL from the Polish base "Henryk Arctowski" on King George Island, South Shetlands (AN-010). He will be there from the 1st of Jan until the 31st of Dec 2002. He hopes to be able to operate CW, RTTY and PSK-31 and perhaps some SSB on all HF bands including WARC. Listen for him on the weekly Antarctic net on 21275 kHz at 1700z

Mondays. QSL via SQ5TA either direct to Artur Tabaszewski, ul. Wiejska 100, 26-606 Radom, Poland or via the bureau. [TNX SP2FAP and SQ5TA and 425 DX News]

J3, GRENADA. Bill, VE3EBN plans to be active during February and March as J37LR from the island of Grenada. He will be active using CW and SSB on all bands 10 - 40 metres. His equipment consists of an ICOM 706MKII running 100 watts into a mini quad and a half size G5RV. QSL via VE3EBN either direct or via the bureau. [TNX VE3EBN and The Daily DX]

P43, ARUBA. Martin, VE3MR will be on the air from Aruba in the southern Caribbean, until April 2002 as P43MR. QSL direct to VE3MR, address in QRZ callbook. [TNX VE3MR and The Daily DX]

V51, NAMIBIA. Two amateur operators, DL2SL and SP6IXF, will be active from Namibia in Feb and March 2002. The pair will be operating from 'Farm Heimat' which is approx. 130km west of the capital. They will be on air signing V51/DL2SL and V51/SP6IXF between beginning on the 15th of Feb through until the 8th of March. Operations are planned for all HF bands and 6 metres using a TS-450, TS-50 and IC-706MKII, antennas will include a 3 element Delta on 40 and 80 metres, a TH3, slopers for the WARC bands and a 4-element yagi on 6 metres. They will also have some wire (some?) available to erect some 160m beverage antennas. [TNX DL2SL and The Daily DX]

ZL5 (ANTARCTIC). Chris, KC4/N3SIG says he might get a chance to operate as ZL5CP from near the New Zealand Antarctic Base "Scott" on Ross Island (AN-011), Antarctica. If he is successful he will operate around 14.243 MHz. QSL via AI3D. [TNX N3SIG and 425 DX News]

IOTA Activity

TI9, COCOS ISLAND. The TI9M DXpedition to Cocos Island (NA-012) has now been scheduled for the 17th of Feb until the 4th of March. So far, 14 operators have confirmed their participation, but the group is sure to reach a total of 15. They group will operate four stations feeding verticals for 160, 80 and 40m, 5-band Cubical Quads for 20/17/15/12/10m, dipoles for 30m and a 6-element Yagi for 6m. They have supplied a list of suggested frequencies, these are: 1825, 3502, 7002, 10102,

14022, 18072, 21022, 24892, 28022 and 50102 kHz CW, 1845, 3795, 7080, 14195, 18145, 21295, 24945, 28495 and 50145 kHz SSB and 7035, 14080, 21080 and 28080 kHz RTTY. QSL direct to Grupo Isla del Coco, Apartado 220-6100, Ciudad Colon, Costa Rica. Please note, IRCs are not valid in Costa Rica.

XE, MEXICO. Ken, G3OCA and Les, G4CWD will be travelling to Mexico to activate a few rare IOTA entities. They will be departing the UK on the 2nd of March heading for the QTH of XE2MX that is serving as their DXpedition headquarters. If they get the chance they plan to operate from most of the following IOTA groups: NA-162, NA-163, NA-164, NA-165 and NA-167. Dates and times will depend on local conditions. A special callsign has been applied for and will be used from all locations. Ken and Les will leave Mexico on the 24th of March. QSL via G3OCA either direct or via the RSGB bureau. Any queries regarding the operation should be sent to ken@g3oca.fsnet.co.uk [TNX 425 DX News and The Daily DX]

Special Events

OX, GREENLAND. Rene, OX3HX is currently active as OX1AWG. This is the special call for the Arctic Winter Games that are being held over the period the 17th until the 24th of March. If you manage a QSO then QSL via OX3HX. [TNX PA3GVI and 425 DX News]

HL17, SOUTH KOREA. Lee, DS1BHE says that the Korean Amateur Radio League (KARL) will be operating a special event station, callsign HL17FWC, to celebrate the 17th FIFA World Cup competition being staged in Korea and Japan. The station will be active from the 1st of Jan until the 30th of May (just before the games begin?) Korean Hams will also change their callsigns during the period of the games (31st of May - 30th of June) to the following: HL1ABC will become HL17ABC, DS1ABC becomes DS17ABC/1, 6K2ABC becomes 6K17ABC/2. Club stations e.g. DS0AB, 6K0AB, 6L0AB, 6M0AB, D70AB, D80AB etc will change their 0 (zeros) to 17. Also, ten special calls DT#FWC (DT0, DT through to DT9) will be aired to honour the ten Korean cities hosting the games. Planning for a special award is underway by KARL officials, details will be released later. [TNX OPDX and 425 DX News]

DXpeditions

VP6TC, DUCIE ISLAND. Tom Christian, VP6TC (PIARA president) says that planning is now complete for the Pitcairn Island Amateur Radio Association's second attempt to mount a DXpedition to Ducie Island (OC-182). The group will leave Mangareva (French Polynesia) on the 12th of March and will use a VP6 callsign (to be announced at the beginning of operations). Plans are for the group to be operational ASAP upon arriving on the island. The operators will be VP6TC, VP6DB, VP6AZ, VP6MW, VP6BK/JA1BK, JA3USA, JF1IST, K9AJ, and K5VT. The DXpedition has assigned two main frequencies that will be active 24 hours a day, 21020 kHz for CW and 21295 kHz for SSB. Other frequencies include 28495 kHz and 14195 kHz for SSB and 14020 kHz for CW, but activity is also planned for the 160 - 6 metres. RTTY will also get a run as well. Tom says that the low bands and WARC are more likely to be activated in the last days of the DXpedition as the aim is to get his new DXCC entity into as many logs as possible. The team will have 2-element beams for 10 and 15 metres, a 4 Square for 20 metres and wire and vertical antennas for the other bands. There will be a 6 metre beacon set up on 50.110 Mhz to allow propagation into the region to be checked. QSL for HF QSO's is via VE3HO, Garth Hamilton, P.O. Box 1156, Fonthill, Ontario L0S 1E0, Canada and for 6 metre QSO's via JA1BK, Kan Mizoguchi, 5-3 Sakuragaoka 4 Chome, Tama-City, Tokyo 206-0013, Japan. Logs will be available on line for checking at <http://www.big.or.jp/~ham/dx.html>. Donations to help fund the DXpedition will be gratefully accepted and can be sent to either VE3HO or JA1BK. [TNX K5NX, VE3HO and 425 DX News]

XR0X, SAN FELIX. Massimo Mucci, I8NHJ will be one of the 13 operators who are conducting a DXpedition to San Felix Island (SA-013), between the 12th and the 30th of March 2002. The expedition is being planned and led by Carlos, NP4IW/CE3AQI and carried out in conjunction with Cordell Expeditions. All the required documentation has been acquired and all is in order. Other members of the team include Alan K5AB, Doug N6TQS, Dick K5AND, John N7CQQ, Franz DJ9ZB, Ricardo CE0YWS, Michael N6MZ, Joseph KO4RR, Willy HB9AHL,

Robert KK6EK and Charles W6KK. QSL via N7CQQ. For further information visit the DXpedition website <http://www.cordell.org/SFX>

5U, NIGER. Paolo, I2UIY reports that the planned DXpedition to Niger will take place on the 3rd to the 18th of February. Seven operators will manning three stations on all bands 160-6 metres running SSB, CW, RTTY and PSK31. More information is available at <http://www.qsl.net/niger-2002>. [TNX I2UIY and 425 DX News]

S9, SAO TOME. A group of Norwegian and Swedish operators LA6FJA, LA7THA, LA5QKA, LA5UF, LA6EIA, LA7WCA, LC3EAT, LC6ZBT, SM5COP and SM5IMO will be active from Sao Tome (AF-023) from the 4th until the 10th of Feb. They have applied for the call S9LA and have been given oral confirmation that it will be issued to them for their operation. The group plans to have at least two stations on the air 24 hours a day with a schedule to operate on 160-6 metres CW, SSB, RTTY, PSK31 and may be SSTV. They will have amplifiers, a wide range of antennas and will place an emphasis on the low and WARC bands, digital modes and 6

metres. The Pilots for the operation are Trond, LA9VDA for North & South America and low bands (e-mail to la9vda@online.no), Tor, LA3WAA for Europe, Africa and 6 metres (e-mail torpet@online.no) and Teru, JM2HBO for Japan, Asia and Oceania (e-mail teru@k-net.or.jp). QSL via LA2N, Sore Sunnmore Gruppa av NRRL v/ Otto Norhagen, NO-6143 Fiskaabygd, Norway. [TNX LA6FJA and 425 DX News]

P5, NORTH KOREA. Toma, YU1AB reports that Hrane, YT1AD and Voja, YU7AV visited North Korea on the 16th of Dec on a business trip. While there they had organised an appointment with the North Korean Ministry of Telecommunications where they requested permission to operate from P5. They took amateur radio equipment with them in the hope they would be allowed to operate during their stay but unfortunately they did not receive authorisation to activate an amateur radio station on this visit. However, after discussions they have obtained "written permission" to conduct a DXpedition beginning on the 5th of March 2002. During the DXpedition activities Hrane and Voja will help train 20 local amateur operators. Further details will be released in due course. For many years North Korea has been on the very rare list, perhaps we are seeing preparations being made that will see P5 return to the amateur bands on a more permanent basis? [TNX YU1AB and 425 DX News]

Round up

Canadian amateur radio operators will be allowed to replace their ordinary prefix with a special event prefix to the

celebrate the 100th anniversary of Marconi's first transatlantic transmission. VX will replace VE, VG for VA, XJ for VO and XK for VY. These changes are authorised for the period between the 12th of Dec 2001 until the 12th of Feb 2002. [TNX OPDX Bulletin and 425 DX News]

ANTARCTICA NET. Every Monday on 21275 kHz at around 1700z a traffic net operation is held on this frequency. DXers have a chance, after the regular traffic has been sent, to work stations from Antarctica. The net has a number of regulars including ZS7/ZS4AGA, R1ANF as well as VP8CMH/mm. Because it is summer in the southern hemisphere there are a number of supply ships and extra personnel visiting the various international research stations and bases this has brought an increase in the 'local' amateur population. The 'Antarctica Net' expect some new 'check-ins' over the next few weeks, hopefully they will include KC4/N3SIG from Mc Murdo Base, R1ANF who is expected at Bellingshausen Base, YL Mechita who might be active from DPOGVN from the Neumyer Base and the possible activation of the new German base "Kohnen Station". [TNX The Daily DX and OPDX]

Sources

This month our thanks go to SP5IXI, VA3RJ, NE8Z, SP2FAP, SQ5TA, VE3EBN, VE3MR, DL2SL, N3SIG, PA3GVI, K5NX, VE3HO, I2UIY, LA6FJA, YU1AB, The Daily DX, 425 DX News and OPDX for their kind permission to include the above information in DX Notes.

ar

For All Your Requirements

AUTHORISED DEALER

ICOM

KENWOOD

AMATEUR COMMERCIAL
MARINE COMMUNICATIONS

 Tower
Communications

14 Mary Street
Hazelmere
Western Australia 6055
Telephone: (08) 9274 1118
Facsimile: (08) 9250 3734

E-mail: tower@con.net.au

www: <http://www.tower.visionimage.com.au>

What happens?

Colwyn Low VK5UE

On Australia Day evening I decided to try out my multi band dipole on 40 metres. Could only read one AX signal and every thing else too weak to read. Tried the 132 ft. wire and gained a few 'S' points but no more signals. So closed up and decided dipole needs attention. Sunday 27th evening turn the 101 on and on 40 metres can read a signal from Puerto Rica. When I go back to the spot there is VEZZT

calling CQ I reply and get 5/5. I never fail to be surprised what you can work when you are on the right band with the best aerial at the right time. That is one of the things I like about Amateur Radio the unexpected. My home station is a bit underpowered and the aerial systems are marginal. That is why getting to Canada is good for 5UE.

ar

Contest Calendar February - May 2002

Feb	2-3	Ten-Ten Intl. QSO Party	(SSB)	
Feb	9-10	WW RTTY WPX Contest	(RTTY)	
Feb	9	Asia-Pacific Sprint	(CW)	
Feb	9-10	PACC Contest	(CW/SSB)	
Feb	16-17	ARRL Intl. DX Contest	(CW)	
Feb	22-24	CQ 160 Metres Contest	(SSB)	
Feb	23-24	REF DX Contest	(SSB)	
Feb	23-24	RSGB 7MHz DX Contest	(CW)	
Feb	24	High Speed Club CW Contests		
Mar	2/3	ARRL Intl. DX Contest	(SSB)	
Mar	9/10	RSGB Commonwealth Contest		(Jan 02)
Mar	9/10	WWL DX Contest	(CW/SSB)	
Mar	16/17	John Moyle Field Day	(CW/SSB/FM)	(Feb 02)
Mar	16/17	Bermuda Contest	(CW/SSB)	
Mar	16/17	DARC SSTV Contest		
Mar	16/17	Russian DX Contest	(CW/SSB)	(Feb 02)
Mar	23/24	CQ WW WPX Contest	(SSB)	(Feb 02)
Apr	6/7	SP DX Contest	(CW/SSB)	
Apr	6/7	EA RTTY Contest		
Apr	12-14	Japan Intl. DX Contest High Bands	(CW)	
Apr	13	PSK31 Rumble		
Apr	13/14	Holyland DX Contest	(CW/SSB)	
Apr	20/21	YU DX Contest	(CW/SSB)	
Apr	25	Harry Angel Sprint		
apr	27/28	Helvetia DX Contest	(CW/SSB)	

Greetings to all readers and contestants. This month it is time to think of the John Moyle Field Day again and I am happy to present both the results for last year and the rules for this year.

This is a good experience for many operators, both those who get out in the paddocks somewhere and those who do it from home. As you can see by the scores, quite high numbers are achieved by both single and multi-operators.

Going out with your gear, even if it just in the car, is quite a different way of approaching a contest situation. Yes, it can be cramped working from a car, but not impossible, especially for a limited time like the six-hours section. A table and a second battery can help here quite markedly, as can a covering over your table. Please consider this very seriously, as your contribution will make for a more interesting and active event.

I hope that you will try to better your score of last year. This will certainly be my aim, but as we shall be moving house about that time it may be a little difficult this year. BUT, don't let things like that stand in your way!!

As you will see from the results, our congratulations this

year go to VK4SK for being the winner of the President's Cup for 2001. Well done and thank you.

Good contesting and 73 de Ian VK3VP

Result CQ-M DX Contest 2001

First place in Oceania Section Single Operator All Bands QRP Section:

VK3VP/QRP Ian

Results John Moyle Field Day 2001

from Eric Fittock VK4NEF Contest Manager

Comments from 2001 JMFD

Our first John Moyle. Bad weather on Friday (wind, dust, rain) made installation difficult and curtailed some portable operators. VK3SWD

It was fun to participate and also to remember John with respect.

I "grew up" radiowise using his designs and know-how. VK3WB 75+

Enjoyed the contest but would be good to see more VHF/ UHF SSB activity. VK3KTO

Activity was well down and we were very disappointed at the lack of promotion of the contest. Indeed, because of the alterations to the timing of the distribution of AR magazine,

many members did not even have the contest rules in time for the event. VK4WIZ

Power lead for the 6m gear was left at home, no 6m contacts. Callsign withheld to protect the innocent.

Stn.	Category	Mode	Band	Points	Place	
<i>Portable, Six Hour</i>						
VK5SR	Multi-op	All Mode	All Band	1024	*	1
VK3CNE	Multi-op	All Mode	All Band	582	*	2
VK3APC	Multi-op	All Mode	All Band	578	*	3
VK2BOR	Multi-op	All Mode	All Band	510		
VK4WIZ	Multi-op	All Mode	HF	366	*	1
VK2LE	Single	All Mode	All Band	128	*	1
VK2DVZ	Single	Phone	All Band	134	*	1
VK5AIM	Single	Phone	All Band	66	*	2
VK5UE	Single	Phone	All Band	58		
VK3YE	Single	All Mode	HF	96	1	
VK4SK	Single	CW	HF	88	**	1
VK4BAF	Single	Phone	HF	160	*	1
VK3AUC	Single	Phone	HF	32		
<i>Portable, 24 Hour</i>						
VK4WIS	Multi-op	All Mode	All Band	4894	*	1
VK3ER	Multi-op	All Mode	All Band	4096	*	2
VK2HZ	Multi-op	All Mode	All Band	2088	*	3
VK3SWD	Multi-op	All Mode	All Band	1608		
VK4CHB	Multi-op	All Mode	All Band	1490		
VK4BAR	Multi-op	All Mode	All Band	1086		
VK3GH	Multi-op	All Mode	All Band	956		
VK2IBT	Multi-op	All Mode	All Band	336		
VK4IZ	Multi-op	All Mode	HF	1742	*	1
VK4QD	Multi-op	All Mode	HF	1056	*	2
VK5BAR	Multi-op	All Mode	HF	596	*	3
VK5GRC	Multi-op	All Mode	HF	424		
VK4WIT	Multi-op	All Mode	HF	314		
VK4EV	Single	All Mode	HF	134	*	1
VK4JM	Single	Phone	All Band	672	*	1
VK3WB	Single	Phone	All Band	140		
VK7JGD	Single	Phone	HF	156	*	1
VK5AR	Single	Phone	V-UHF	1728	*	1
VK4IS	Single	Phone	V-UHF	832		
<i>Home, 24 Hour</i>						
VK4FJ	Home	All Mode	All Band	188	*	1
VK2CZ	Home	All Mode	All Band	181	*	2
VK4GWC	Home	All Mode	All Band	140	*	3
VK3VP/QRP	Home	All Mode	All Band	92		
VK5ADD	Home	All Mode	All Band	83		
ZL2AOI	Home	All Mode	All Band	83	*	1
VK4DO	Home	All Mode	All Band	72		
VK3KQB	Home	All Mode	All Band	70		
VK2GCE	Home	All Mode	All Band	43		
VK3JSS	Home	All Mode	All Band	41		
VK5RG	Home	All Mode	All Band	40		
VK2QV	Home	All Mode	All Band	40		
VK3PP	Home	All Mode	All Band	36		
VK4ASM	Home	All Mode	All Band	36		
VK4PJ	Home	All Mode	All Band	34		
<i>Home, 6 Hour</i>						
VK3KTO	Home	All Mode	All Band	81	*	1

** = Presidents Cup winner VK4SK

John Moyle Field Day Contest 2002

Presented by Eric Fittock VK4NEF

16 – 17 March, 2002

0100 UTC Sat - 0059 Sun

Well, once again those who enjoy a weekend in the bush should be planning for this year's John Moyle Field Day. The rules are the same as last year.

If anyone wishes to contact me privately to discuss rules etc, my home phone number is 07 3390 5664, and my address is as shown in the Log Submission section below. I wish all entrants good luck, and look forward to hearing you on air during the contest!

Overview

1. The aim is to encourage and provide familiarisation with portable operation, and provide training for emergency situations. The rules are therefore designed to encourage field operation.
2. The contest takes place on the 3rd full weekend in March each year, and runs from 0100 UTC Saturday to 0059 UTC Sunday, 16-17 March 2002.
3. The contest is open to all VK, ZL and P2 stations. Other stations are welcome to participate, but can only claim points for contacts with VK, ZL and P2 stations.
4. Single operator portable entries shall consist of ONE choice from each of the following (e.g. 6 hour, portable, phone, VHF/UHF):
 - a. 24 or 6 hour;
 - b. Phone, CW, or All mode;
 - c. HF, VHF/UHF or All Band.
5. Multi-operator portable entries shall be All mode, and consist of ONE choice from each of the following:
 - a. 24 or 6 hour;
 - b. HF, VHF/UHF or All Band.
6. Home and SWL entries may be either 24 hour or 6 hours, All mode, All band.

Scoring

7. Portable HF stations shall score 2 points per QSO.
8. Portable stations shall score the following on 6m:
 - a. 0-49 km, 2 points per QSO;
 - b. 50-99 km, 10 points per QSO;
 - c. 100-149 km 20 points per QSO;
 - d. 150-199 km 30 points per QSO;
 - e. 200-499 km 50 points per QSO;
 - f. 500 km and greater, 2 points per QSO.
9. Portable stations shall score the following on 144MHz and higher:
 - a. 0 to 49 km, 2 points per QSO;
 - b. 50 to 99 km, 10 points per QSO;
 - c. 100 to 149 km, 20 points per QSO;
 - d. 150 km and greater, 30 points per QSO.
10. For each VHF/UHF QSO where more than 2 points is claimed, either the latitude and longitude of the station contacted or other satisfactory proof of distance must be supplied.

11. Home stations shall score:
 - a. Two points per QSO with each portable station.
 - b. One point per QSO with other home stations.

Log Submission

12. Logs must be accompanied by a summary sheet showing: callsign, name, mailing address, section entered, number of contacts, claimed score, location of the station during the contest, and equipment used, and a signed declaration stating "I hereby declare that this station was operated in accordance with the rules and spirit of the contest". For multi-operator stations, the names and callsigns (legible) of all operators must be listed.
13. Logs must be postmarked no later than 27 April 2002, and forwarded to: "John Moyle Contest Manager, 108 Queensport Road, Murarrie Qld 4172, Australia". An ASCII text copy on a MS-DOS floppy disc would be most helpful. Alternatively, logs may be e-mailed to: esr@powerup.com.au Logs sent by disc or e-mail must include a summary sheet and declaration, but the operators name (legible) is acceptable in lieu of a signature.

Certificates and Trophy

14. At the discretion of the Contest Manager, certificates will be awarded to the winners of each portable section. Additional certificates may be awarded where operation merits it. Note that entrants in a 24 hour section are ineligible for awards in a 6 hour section.
15. The Australian portable station, CW section, with the highest CW score will be awarded the President's Cup, a perpetual trophy held at the Executive Office, and will receive an individually inscribed wall plaque as permanent recognition.

Disqualification

16. General WIA contest disqualification criteria, as published in Amateur Radio from time to time, applies to entries in this contest. Logs which are illegible or excessively untidy are also liable to be disqualified.

Definitions

17. A portable station comprises field equipment operating from a power source, e.g. batteries, portable generator, solar power, wind power, independent of any permanent facilities
18. All equipment comprising the portable station must be located within an 800m diameter circle.
19. A single operator station is where one person performs all operating, logging, and spotting functions.
20. A single operator may only use a callsign of which he/she is the official holder. A single operator may not use a callsign belonging to any group, club or organisation for which he/she is a sponsor except as part of a multioperator entry.

21. A multioperator station is where more than one person operates, checks for duplicates, keeps the log, performs spotting, etc.
22. A multioperator station may use only one callsign during the contest.
23. Multioperator stations may only use one transmitter on each band at any one time, regardless of the mode in use.
24. Multioperator stations must use a separate log for each band.
25. A station operated by a club, group, or organisation will be considered to be multioperator by default.
26. None of the portable field equipment may be erected on the site earlier than 28 hours before the beginning of the contest.
27. Single operator stations may receive moderate assistance prior to and during the contest, except for operating, logging and spotting. The practice of clubs or groups providing massive logistic support to a single operator is, however, totally against the spirit of the contest. Offenders will be disqualified, and at the discretion of the manager, may be banned from further participation in the contest for a period of up to 3 years.
28. Phone includes SSB, AM and FM.
29. CW includes CW, RTTY, and packet.
30. It is not expected that any other modes will be used in the contest, but if they are, they shall be classed as CW.
31. All amateur bands may be used except 10, 18 and 24 MHz. VHF/UHF means all amateur bands above 30 MHz. Note: On 6 m, the region below 50.150 has been declared a contest free zone, and contest CQ's and exchanges may only take place above this frequency. Stations violating this rule will be disqualified.
32. Cross-band, cross-mode and contacts made via repeaters are not permitted for contest credit. However, repeaters may be used to arrange a contact on another frequency where a repeater is not used for the contact.
33. Stations may make repeat contacts and claim full points for each one. For this purpose, the contest is divided into eight consecutive three-hour blocks: 01-0359. 04-0659. 07-0959. 10-1259. 13-1559. 16-1859. 19-2159. 22-0059 UTC. If you work a station at 0359 UTC a repeat contact may be made after the start of a new block providing, they are not consecutive or are separated by five minutes, since the previous valid contact with that station on the same band and mode.
34. Stations must exchange ciphers comprising RS(T) plus a 3 digit number commencing at 001 and incrementing by one for each contact.
35. Portable stations shall add the letter "P" to their own cipher, eg. 59001P.
36. Multioperator stations are to commence each band with 001.
37. Receiving stations must record the ciphers sent by both stations being logged. QSO points will be on the same basis as for Home Stations, unless the receiving station is portable.
38. The practice of commencing operation and later selecting the most profitable operational period within the allocated contest times is not in the spirit of the contest, and shall result in disqualification. The period of operation commences with the first contact on any band or mode, and finishes either 6 or 24 hours later.

World-wide WPX Contest

SSB: 23 - 24 March

CW: 25 - 26 May

0000z Sat - 2359z Sun

OBJECT: to work as many stations world-wide as possible.

BANDS: 160 - 10m (no WARC).

CATEGORIES: single operator single or all-bands; unrestricted power, low power (max. 100W o/p), QRPp (max. 5W o/p); multi-operator single or multi-tx, all bands only. Single operator stations are where one person performs all operating, logging and spotting functions. **NOTE:** single operators may only work 36 out of total 48 hours' operation. Off periods must be at least one hour and clearly marked in log. No time limits apply to multi-operator stations. Multi-multi stations must have all txs located within a 500m diameter circle or within property limits of licensee's address, whichever is greater. All antennae must be physically connected by wires to station txs and rxs.

EXCHANGE: RS(T) plus three-digit number starting at 001, continuing to four digits if necessary. Multi-tx stations must use separate numbers for each band.

SCORE: three points (20/15/10m) or six points (160/80/40m)

for contacts with stations on different WAC continents and one point (20/15/10m) or two points (160/80/40m) for contacts with stations within same WAC boundary. QSOs with stations in same country are permitted for multiplier credit, but have zero points value.

MULTIPLIER is total number of prefixes worked on all bands (each prefix counted once only regardless of the number of different bands on which it is worked).

FINAL SCORE is total QSO points X total multipliers.

LOGS must show times in UTC, breaks and prefix multipliers first time worked. Logs should be checked for duplicates, correct points and multipliers. They should be accompanied by a sorted alphanumeric list of prefix multipliers and a summary sheet showing call, name, address, category, power, scoring information and a signed declaration that all contest rules and radio regulations have been observed.

SEND LOGS by disk. CT's *.bin file or *.all file; N6TR's *.dat file; NA's *.qdf file or *.dbf files are preferred. ASCII file

containing all information is acceptable. Disk files must be in chronological order for single operator and multi-single stations and chronological order by bands for multi-multi stations. Please label disks and name your files with call used (eg VK3JS.BIN or VK3JS.DAT). Disks will be required from top-scoring stations. Send by 5 May (SSB) or 7 July (CW) to: WPX Contest, 76 N Broadway, Hicksville, NY 11801, USA. Indicate SSB or CW on

envelope. Logs may be sent via e-mail to: <n8bjq@erinet.com>

To be eligible for AWARDS, single operator stations must show at least 12 hours' operation and multi-operators 24 hours' operation. Single band entries showing points for more than one band will be judged multi-bands unless otherwise specified.

Russian DX Contest

16/17 March

1200 Sat - 1200z Sun,

BANDS: 160 - 10 m (no WARC).

SECTIONS: Single Operator; CW, Phone, Mixed; single or all bands.

MODES: CW, SSB Mixed.

EXCHANGE RS(T) plus serial number starting with 001. Russian stations will send serial number plus two-letter Oblast code (max 88 + 3 on each band).

SCORE: 10 points per Russian QSO, five points for QSOs with stations on another continent, three points for stations in the same continent and two points with your own country. Continents as per WAC.

FINAL SCORE is total QSO points by number of DXCC countries and Russian Oblasts worked on each band.

SEND LOGS and summary sheets postmarked by 11 April 2002 to: Contest Committee SRR, PO Box 59, 105122 Moscow, Russia.

Oblast designators are:

AB AD AL AM AO AR BA BO BR BU CB CK CN CT CU DA EA EW GA HA HK HM IR IV JA JN KA KB KC KE KG KI KJ KK KL KM KN KO KP KR KS KT KU LO LP MA MD MG MO MR MU NN NO NS NV OB OM OR PE PK PM PS RA RO SA SL ST SM SO SP SR SV TA TB TL TM TN TO TU TV UD UL UO VL VG VO VR YA.

ar

21ST ALARA Contest Results

25/26th August, 2001

Gwen VK3DYL	786	Top score overall, Top score VK YL, Top phone score, Top VK3 Alara member	John VK3MGZ	109	
Bev VK4NBC	412	Top VK Novice, Top VK4 Alara member	Jacqueline ZL1JAQ	106	
Bev ZL1OS	381	Top DX YL, Top ZL Alara member	Townsville ARC	93	Top VK Club station (using special callsign V14FLG)
Susan VK7LUV	311	Top VK7 Alara member	Margaret VK4AOE	91	
Alex ZL1BVK	311	Top ZL OM	Biny ZL2AZY	85	
Pat VK3OZ	298	Top VK YL CW (Florence McKenzie Trophy - 55 pts)	Alwyn ZL1CCJ	85	
Bex VK6DE	298	Top VK6 Alara member	Justin VK7KTW	80	
Elizabeth VE7YL	257	Top VE Alara member	Bron VK3DYF	76	
John VK5NJ	246	Top VK OM	Evelyn VK4EQ	48	Top VK YL non-member
Christine VK5CTY	235	Top VK5 Alara member	Elva ZL1BIZ	41	
Noel VK3FGN	179		Jenny VK5ANW	36	
Alan VK7JAB	171		Mavis VK3KS	33	
Dot VK2DB	169	Top VK2 Alara member	John VK2JJS	30	
Robyn VK3WX	164		Chris VK2LCD	30	
Meg VK5YG	162		Summary:		
Marilyn VK3DMS	124	CHECK LOG	VK Alara members	14	(Includes 1 check log)
Celia ZL1ALK	110		DX Alara members	6	
			VK YL non-member	1	
			VK OMs	7	
			DX OMs	2	
			Club Stations	1	
			Total logs	31	

Harry Angel Sprint 2001 Results

from Trent VK4TI

This sprint contest, open to all Amateur Stations and SWLs honours the late Harry Angel VK4HA. Harry who passed away at the age of 106 in 1998 was at the time Australia's oldest living Radio Amateur. Harry served in the Middle East and other areas during the First World War. The Sprint is unique as it lasts for 106 minutes, Harry's age, in place of the customary 60 minutes.

What a great turnout! The average logs showed a score of 31 points compared with last year's average of 24. Well done fellows.

VK2AYD David jumped to top spot breaking the VK5 stranglehold on the event. David's efficient use of both modes made the difference.

VK5NJ was right up there again managing to be only just pipped by one point using his new horizontal loop! Strewth, his first contact was K9DX so it figures he might have thought "I've got this one in the bag.."

Harry Angel regular Mick VK4ABV was top VK4 competing in the mixed mode category.

Top phone score was former winner Kevin operating the club callsign VK5SR.

This is now the third year of the test and the results still show that interest is high.

Thank you again for your participation and thank you to everyone for supporting VK4 contesting

Trent VK4TI

Certificates will be despatched by the first week of January. If you do not receive yours, contact me direct on email vk4ti@radiomag.com or phone 0408 497550

Comments from the Logs:

VK5XE Ian Northeast—

Thanks for the contest it was a bit of a lonely affair after the first 45 minutes but had fun and not much QRM

VK3VP Ian—

Not a huge number of CW signals but good to hear some (Better check that antenna Ian after 5NJ's results)

VK4GZ Ron—

There appeared more activity this year. The number of CW operators was up and it was pleasing to see the ZLs involved.

VK4TI—

I lost my own log!

Callsign	Category	Score
VK5NJ	C	62
VK2KM	C	34
VK5XE	C	34
VK3VP	C	28
VK8AM	C	16
VK2AYD	M Trophy	63
ZL2AJB	M	39
VK4ABV	M	36
VK4GZ	M	35
VK5UE	M	6
VK5SR	P	45
VK4AJS	P	32
VK2JAH	P	22
VK7JGD	P	21
VK4JM	P	20
VK2KST	P	19
VK3ABP	P	12
VK2MQX	P	4

ar

Classification of Emissions: Episode 3

Henry ANDERSSON VK8HA, FedIWCOORD
VK8HA@OCTA4.NET.AU

- | | | |
|--|---|---|
| <p>1.6) Cases not covered above, in which an emission consists of the main carrier modulated, either simultaneously or in a pre-established sequence, in a combination of two or more of the following modes: amplitude, angle, pulse W</p> <p>1.7) Cases not otherwise covered X</p> <p>2) Second symbol - nature of signal(s) modulating the main carrier</p> <p>2.1) No modulating signal 0</p> <p>2.2) A single channel containing quantized or digital information without the use of a modulating sub-carrier 3 1</p> <p>2.3) A single channel containing quantized or digital information</p> | <p>with the use of a modulating sub-carrier 3 2</p> <p>2.4) A single channel containing analogue information 3</p> <p>2.5) Two or more channels containing quantized or digital information 7</p> <p>2.6) Two or more channels containing analogue information 8</p> <p>2.7) Composite system with one or more channels containing quantized or digital information together with one or more channels containing analogue information 9</p> <p>2.8) Cases not otherwise covered x</p> <p>3) Third symbol - type of</p> | <p>information to be transmitted 4</p> <p>3.1) No information transmitted N</p> <p>3.2) Telegraphy - for aural reception A</p> <p>3.3) Telegraphy - for automatic reception B</p> <p>3.4) Facsimile C</p> <p>3.5) Data transmission, telemetry, telecommand D</p> <p>3.6) Telephony (including sound broadcasting) E</p> <p>3.7) Television (video) f</p> <p>3.8) Combination of the above W</p> <p>3.9) Cases not otherwise covered X</p> <p>Happy 2k2 and see u nxt month de Henry vk8ha VK8HA@OCTA4.NET.AU</p> |
|--|---|---|

ar

Part 11 "Digital Modes"

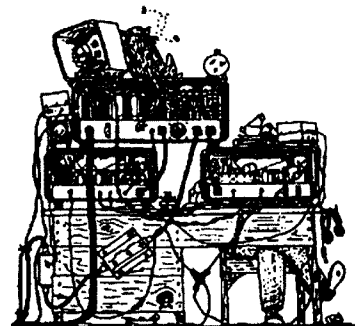

Amateur Radio Magazines from around the world regularly quote Internet addresses, digital circuits and devices, and computer software offering enhanced AR operation. However, if you are not "into" the Internet, or short on computer knowledge, then most of these references tend to be ignored. Making a start in the digital world is the hard part, but once started, your enjoyment of the hobby will be much enhanced.

Digital Roundup

Aside of the fact that all the new digital modes require the use of a computer in your Ham Shack, they can be divided into two key groups.

1. Fuzzy Modes like Morse Code, RTTY, PSK31(1), PSK63F, PSK125F MFSK8, MFSK16, MFSK31, Hellschreiber, SSTV etc. These are keyboard-to-keyboard modes used for chatting, contests, and DXing mainly on the HF bands. They are called "Fuzzy Modes" because there is no error correction and rely on operator interpretation to fill in gaps and errors during a QSO.

2. Correction modes are those with interactive data verification to minimise errors, and they include VHF/HF Packet, PSK63F, Amtor, Pactor, Pactor II, Clover, MT631K etc. Newer modes include HSCW (High Speed CW) and WSJT by Joe Taylor, K1JT.(2)

G3FDU(3) studied some of these new modes (see adjacent Fig. 1) including data from ZL1BPU(4) who devised MFSK16 implemented by IZ8BLY in his program - Stream(5). G4JNT also argued (6) about the poor spectrum usages of FSK on HF packet. He mentions ...the concern of beginners in datacomms these days of incompatible modes coming on the bands all using sound cards and simple interfacing hardware.

It is now easy for DSP software writers to come up with yet another modulation and coding system...

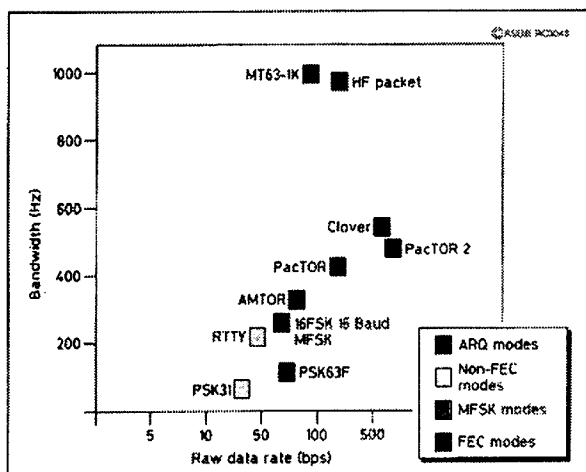

Fig 1: Relative speeds and bandwidths of data modes. Source: BARTG

What Now?

The writer has been using various forms of digital communications for many years - since the early days of RTTY using surplus mechanical teleprinting equipment. Over the last 10 or so years, with the help of personal computers, much of the readily available software packages from the Internet have been extensively tried and tested.

Most of the newer packages are mainly used for amateur experimentation, and it's safe to suggest that a high percentage of these packages have faults, bugs, and other problems when operating in a Windows® environment. There is a huge amount of "rubbish" available for download on the Internet. However, assertive software writers have produced some excellent software that has settled down to become very popular

worldwide. RTTY and PSK31 would have to be the trendsetters these days on the HF bands. For VHF/UHF packet enthusiasts, WinPack (7) is excellent. However, to save and retrieve archived files, WinPack also needs WinMail (8) to complete the installation. Some popular AR software packages need further work to be done before they are released into the public domain. Very few can be said to be totally reliable, easy to install (or uninstall), set up and operate in an active AR station.

Getting Started

Example 1. Assume that you own an old faithful Kenwood TS520S, and a multi-band vertical antenna in a small garden or hanging from the back porch. In addition, the family have donated a Pentium 1, 75MHz computer with an 850Mb hard drive, 16bit SoundBlaster audio card, a CD-ROM and say 16Mb of memory. This will do fine to get started on PSK31 using DigiPan software. All you need to add in terms of hardware is a simple interface box to connect the input and output tones between the transceiver and the soundcard (1).

Example 2. If you are active on VHF FM, why not try packet radio messaging with WinPack (7). All that's needed is a low cost interface modem (BayCom) and the same computer described in example 1 above. Packet radio offers worldwide contact with no network fees like trying to access the Internet. Ask your local colleagues or club members about packet radio, and watch a demonstration in a friend's Ham Shack.

Example 3. You are the proud owner of a new Icom IC756PRO feeding a nice new Vectra linear feeding a multi-band log periodic antenna at 90 feet. Contesting is your passion on CW/RTTY and you are a computer whiz. Exactly the same interface is required (1) suggested in example 1. Adding YPlog, Rotor E-Z, HamScope, DigiPan and MMTTY you will be able to do everything described in this Ham Shack Computers series and much more with ease – ALL with the same old recycled Pentium 1/75 computer above. Very nice indeed! Add the FM packet system from example 2 above, and you'll be spot-watching the international packet DX Cluster nodes and operating HF all at the same time!

Fancy Stuff

Many AR operators seem to have a shack full of gear, which they like to show off to visitors. However, when it comes to the crunch, most of the gear is non operational, or even connected together!

Obviously, these operators need to rethink their direction, connect the HF, VHF/UHF systems to their respective antennas etc, and interface the key components to a single computer management system. Simple free software is now available to operate these fancy new modes suggested in this article. From now on, the sky is the limit with many hours ahead experimenting with different software packages until you decide on the ones that suit your personal desires the best.

One reader in Melbourne explained to the writer saying he had lost interest in Amateur Radio until he had read "PSK31-The Easy Way"(1). After, hooking up the interface, loading DigiPan and setting the soundcard input and output levels, worldwide PSK31 contacts came thick and fast. He said that his interest was now restored, and the fun came back into his hobby. Many others have responded in the same way, so if you are pondering about these newfangled digital modes, the time has never been better to upgrade your station and join in the fun. If you are in difficulties, try sending a message to the writer, you might be surprised by the results! (9).

Getting Serious

Running digital modes from a modern transceiver has its problems too. For example, PSK31 runs in the SSB/USB mode with a Varicode tone modulated signal accurately adjusted to keep the SSB intermodulation products well below -25dB. The RX passband is limited to the usual 300-4,000Hz, and variable IF passband adjustment is needed to improve reception especially during busy contests. Ideally, the transceiver should have a special narrow band PSK filter but this is not easy when there are no spare filter options in the transceiver. Adding external audio DSP hardware (a Timewave DSP9 etc) will improve the random noise problems by a good 10dB or more allowing "noise floor" reception of weak PSK stations. RTTY contest enthusiasts will find MMTTY options to manipulate the DSP settings for their sound cards. In addition, readers will be impressed with DigiPan used as a spectrum scope for any mode. Once tried, this will become an essential tool in your digital arsenal.

Future Trends

Weak Signal Communications (WSC) can be applied to any AR application especially VHF/UHF/SHF, EME and transcontinental long haul HF, and satellite work. Meteor scatter (MS) followers now use WSJT (2) software on 2M VHF to win distance records with MS and other means of signal refraction. WSJT (designated FSK441) is the favourite in high speed meteor scatter (HSMS) using "pings" reflected from the underdense ionisation trails of random meteors at about 100Km in height.

FSK441 uses FSK at 441Hz. Four distinct tones are used, namely 882, 1323, 1764, and 2205Hz. Each encoded character uses three tone intervals and therefore requires 3/441 seconds (approx 2.3mS) for its transmission. FSK441 accommodates a potential "alphabet" of 48 characters. These characters are sent repeatedly amounting to pure single-frequency carriers, and their pings are easily recognised by the software and the human ear, and converts noise floor S0 and S1 pings into solid copy!

Whilst FSK441 is currently used for MS and EME work, other applications include VHF/UHF communications interstate by bouncing signals at HSCW from airliners flying the regular routes between Australian capital cities. It's

even possible to span the Pacific using the same technique. At least, the airline schedules are more regular than the Perseids!

The future is very bright indeed, and there is plenty of room for research, development, and experimentation by today's average RA. Long haul VHF/UHF Dxing becomes a reality once local and national/international beacons start using automated PSK/WSJT, in addition to conventional CW for identification. Some circles suggest Slow Speed CW (SSCW) can resolve signals some -10dB below the noise floor.

For beginners, all this might seem overwhelming. But once you bravely make a small start and gain confidence, then the dividends will outweigh the effort and personal enjoyment follows. Digital Modes is a vast topic that would fill huge textbook let alone two pages in this magazine. Talk to your club mates, ask their advice, watch a demonstration, and have a go yourself.

Ham Tip No. 11

Listen between 14.065 and 14.095 Mhz any time of day. Strange "warbling" signals can be heard even when the SSB and CW segments seem closed. These are the wonderful digital modes at work.

Next month, Ham Shack Computers, No: 12 *Computer Phobia* is real basic stuff for those readers who are afraid to even try using a computer, thus preventing them from enjoying the delights of modern Amateur Radio. A thought-provoking article for readers prepared to be honest and admit the real underpinning truth to themselves!

References

- (1) *PSK31-The Easy Way*. AR March 2000 and June 2001 by VK6PG.
- (2) *WSJT Hitting WS VHF MS by Storm*. CQ Magazine Oct 2001 by N6CL.
<http://pulsar.princeton.edu/~joe/k1jt>
- (3) *Recent Keyboard Modes Compared*. In *Mercury*, the RSARS Journal, March 2001 by G3FDU.
- (4) <http://www.qsl.net/z11bpu>
- (5) <http://.IZ8BLY.syonline.it>
- (6) *Data: Modes Compared*. RSGB RadCom. October 2001 by G4JNT.
- (7) Roger Barker, G4IDE. WinPack at <http://peaksys.co.uk>
- (8) Mike Marriott, G4OPC.
- (9) Ham Shack Computers Web Site: <http://www2.tpg.com.au/users/vk6pg>

David K Minchin VK5KK

Postal: 10 Harvey Cres, Salisbury Heights, SA, 5109

E-mail: tecknolt@arcom.com.au

Web page: <http://members.ozemail.com.au/~tecknolt>

Fax +61 8 82924601 NEW FAX NUMBER

Phone 0403368066 AH ONLY

All times are in UTC.

That old "Chestnut" Calling Frequencies!

Soapbox time! Once upon a time we didn't have calling frequencies. Before the days of stable VFOs almost everyone was crystal locked to a favourite frequency arrived at by good luck more than good management. Some operators had more than one crystal but most had their pet frequencies. Who can remember, "Calling CQ and tuning from the band edge up, what say someone please!"

Then around 1972-1975 it all changed. AM disappeared quicker than the dinosaurs did 65 million years before. Suddenly everyone had a VFO. As everyone migrated from their Pet frequencies under the notion that we had to squash together in 100kHz or less it left a dilemma, where do we "park" the VFO? Enter calling frequencies! 52.050 & 144.100 MHz were arrived at as they loosely straddled the CW and SSB segments. AM had by now been relegated to the wasteland beyond 0.2.

Ever since then countless attempts have been made to police calling frequencies but with varying success. If the band is wide open with rare DX the notion of a band plan even existing usually goes out the window ... of course, people will bend the rules on the calling frequency! You can bet that the only place you will raise activity is where everyone else's receiver is parked, the calling frequency! If you QSY off the calling frequency all those others with their VFOs parked won't be able to hear you so better stay there and make a noise. Catch 22 isn't it. Its not the Calling Frequency at fault, it's the thinking behind it.

Lets put an old idea back into the scene but in a different way, let's talk about "Centres of Activity". Those who were fortunate enough to take part in last years Leonids Meteor activity would have experienced what it is like to have 80 plus stations spread between 144.095 and 144.120 MHz with 80% of the activity on 144.1 MHz. I heard many try and do the right thing by QSYing up and down the band but 80% of the contacts to be had were on 144.1MHz. That notch in the VFO optic coupler or the Gear drive is pretty deep!

I'll use 144 MHz as my example but it

equally applies to 50 MHz and perhaps less to 432 MHz and above. Imagine, during the Leonids, if we had all been a bit better organized prior and nominated not one frequency but 5 or 10 "Centres of activity" say 10 kHz apart. On each of the "centres of activity" there would be some knowledge of who would be there or what geographical location could be worked (eg. country area).

Just how you divide things up is open to comment. Maybe we do it this way. Lets, for the exercise, call 144.100 to 144.250 our segment where VKs & ZLs want to work each other. North/South contacts are on Odd tens (144.11, 144.13, 144.15) and East/West are on even tens (144.12, 144.14, 144.16 and so on). That means that in built up areas if everyone is working in one direction only you have 20 kHz separation, not perfect better than being on top of each other! You can still move plus or minus 5 kHz to pick up a secondary contact if you are out of an area and QRM isn't a problem. You can then carve up frequencies to more geographical areas starting from the end of circuits and working back.

How these centres of activity are allocated and used then takes a more local focus. Eg. VK6 Albany/Perth could be nominated 144.160 MHz, VK7 could be 144.190 MHz and VK4 could be 144.130MHz. Specific country areas then have subsets of these. The centre of activity can also be made mode specific, eg. WSJT is centred on 144.140 MHz or Liaison for Upper UHF/Microwave contacts is centred on 144.250 MHz. As the band opens or additional stations come on they slide up and down. If one area is particularly active then this could spill over to another, it doesn't really matter. If you want to work VK6 you know where to

look, plus or minus a bit and it isn't on the same frequency as the ham down the road working a country station in a different direction.

If the band opens to one or more areas you then have multiple centres of activity. If you live at a cross road such as VK2, 3 & 5 where you listen will then depend on where you point your antenna and what you want to work! Its no different to how a trunking two way radio system works but perhaps not as regimented as the local Radio Control Model Aero club with coloured pegs for assigning unique frequencies to avert co-channel interference (read expensive prangs!).

Ah yes, but how do you keep up with all the activity. How can you listen on the potential 10 or 15 frequencies? Tune or scan around! Most sets being used now have scanning facilities than can set up to run through frequencies, a lot use the facility for looking at beacons so what's the difference? And chances are you are only going to have 3 or 4 centres to cover from any one given area. Hey they did it in the old days, remember ... tuning from the band edge up! Lets flatten out that big spike on the calling frequencies!

6 Metres

John Martin, VK3KWA reports.. VHF-UHF records have been updated with two new 6-metre records.

National Digital Mode record: VK3AMK to JL4GTO, 03/01/99, distance 8234.0 km.

VK3 State Long Path record: VK3OT to LU7DZ, 20/04/91, distance 28319.8 km.

The following files (Word 97 RTF format) are available on request: VHF Records 2002-1 (13 kb) - List of current VHF-UHF records. VHF Records History (68 kb) - List of all VHF-UHF records

since 1947. VHF Record Claims (10 kb) - Terms and conditions for VHF-UHF record claims, and a claim form... John VK3KWA

Steve VK3OT reports 31/12/2001 -band is still open to Europe since 0700Z and also Middle East A45, JY9, HZ1, 4X/4Z OD5 5B4/ZC4, F, DL, SP, 9A, OK/OM, I, S5, YU, SV, UK9 UA0, mni VK2/3 area QF02/12/21/22/32 also ZL3 to ME/5B4. Sporadic Es to VK6 / VK8 at same time. Last DX heard calling at 1100Z was JY9NX calling ... Steve VK3OT

2002 Summer Field Day

Barry VK3BJM reports ... Almost ancient history now, but my notes from last weekend's field day are as follows:

Mt Moliagul would be a really, really good spot, except for the existing RF installations. These apparently include a 2m packet repeater and a 70cm voice repeater. Certainly something up there was desensing my 2m receiver - 5x9 signals would drop to 5x0.5 - though I managed to survive all that, and didn't lose any contacts as a result. The high points were ...

[1] Working 3 VK5 portable stations all through the 24 hours; propagation to the SW/Mt Gambier area really ramped up into Saturday evening/Sunday morning. Would have been interesting trying 23cm to VK5AR/p. The Adelaide beacon was audible for the whole contest, too. I thought I'd lost it just after sundown on Saturday, but it turned out that the frequency of the beacon dropped 300Hz, which took it out of range of my narrow CW filter...The levels of the 2 VK5 beacons to my location was noticeably different to that of stations only 100km or so further south of me, on several occasions during the contest.

[2] General level of activity on 23cm - plenty of contacts on that band. Being the first contact to Darryl VK3XDQ, @ Welshmans Reef, on 23cm via his rhombic! Activating QF13 on 23cm to several stations.

[3] Plenty of stations on air in the SW of the country, both home and portable (and mobile!).

Not so high points:

[1] Propagation to the NE was not so flash. Heard nothing all Saturday and Sunday morning AEP produced signals that were less

than startling. Heard Gordon, VK2ZAB and Guy, VK2KU, calling towards Bendigo numerous times, but could not make myself heard. It was good to make it as far as Murrumbateman and Canberra.

[2] No contacts on 2.4GHz, despite many attempts with Charlie, VK3FMD, and every suggestion from the signals observed on 23cm that we would have a chance. Nothing was heard in either direction. Much head scratching has ensued - from my end I'm endeavouring to pep up the RX, the TX and the dish size... Leave nothing to chance, I reckon. ...Barry, VK3BJM

Andrew Davis VK1DA reports ... Chris VK1DO and Andrew VK1DA operated VK1ACA from Red Hill, a low ridge at the south end of the main Canberra city area. Our site was several metres away from blackened grass and trees, the result of recent bushfires, which swept up the Red Hill ridge.

Saturday night: no VK3 signals heard, several locals and one near Sydney, 7 contacts in all, 4 on 144 and 3 on 432. We packed up the station at 10pm and went home to sleep. Sunday morning from 2004 to 2300 UTC: 20 contacts; 14 on 144, 3 on 432 and 3 on 1296. 5 VK3s on 144, all others except 2KU, 2ZAB, 2KRE, were local (Canberra/Queanbeyan/Bungendore).

The 1296 transverter producing very weak signals and the Bird (with 5 W slug) indicated no output. Some major component failure seems likely. The 432 rig also failed to produce reliable output; SWR sensing was cutting power back substantially and this affected transmission quality too. Suspected connector damage but internal inspection of radio revealed no obvious problem.

There were a number of local QRM sources at our site, including birdies from telemetry gear at the adjacent water reservoir and some repetitive noise. Most operation on 144 required the noise blanker engaged and a cavity filter in line. Without the filter the receiver was noticeably desensed. There are a number of pager transmitters on the nearby Isaacs Ridge .. Andrew VK1DA.

2 Metres and above

This morning Thursday 10 January 2002 we had some propagation between

Hobart and the Sydney area. The weather map shows a strong ridge extending north from south of Tasmania, and passing exactly through both Hobart and Sydney. Contacts were made on 144MHz SSB between Rex VK7MO (at home), Guy VK2KU and Gordon VK2ZAB.

9 Jan 2002 at 2145UTC - VK2ZAB-VK7MO (41)

9 Jan 2002 at 2146UTC - VK2KU-VK7MO (52,41)

Rex was continuously audible in the Blue Mountains until about 2215 UTC at 52.

VK7MO was running 200 W into 1x6 elements. I immediately telephoned Peter VK7KPB (50 W, 1x12) on Flinders Island, but we did not succeed in completing a contact. I could tell Peter was there but could not copy anything. Peter copied occasional words from me...Guy VK2KU

Where is all the activity??? Joe VK5UJ reports at 13:00 UTC 16/01/2002 the following beacons heard VK6REP 5x7, VK5RSE 5x9+40 and VK3RGL 4x1. CQ on 144.1 & 144.2 only taker was another local. At 20:00 UTC 16/01/2002, VK6REP 5x2, VK5RSE 5x9+40 & VK3RGL 5x5. Another CQ on 144.1 & 144.2 no takers! Equipment, no preamp, Kenwood TR751a 25 W and ATN yagi ...Cheers, Joe VK5UJ.

WSJT

Rex VK7MO reports .. In summary the conclusions of consultation on standardizing WSJT procedures in the VK region are:

1. Use North American Defaults
2. Use the Focus Frequency of 144.230 as far as possible
3. Do not use single tones on the Focus Frequency
4. On the Focus Frequency modify the North American defaults manually to avoid confusion - example below
CQ VK7MO VK7MO TXing
VK7MO 2626 VK2FZ 26
VK2FZ TXing
VK2FZ R16R16 VK7MO R16
VK7MO Txing
VK2FZ RRR VK2FZ Txing
VK7MO 73 VK7MO Txing

Essentially this means that a Txing station always identifies on the Focus Frequency

5. Allow for QSYing if a station is suffering interference or wishes to

use single tones for a difficult contact

6. Use the channel format to QSY eg CQ 333 means listening Channel 3 or 144.330

7. Use frequencies of 144.330, 144.340, 144.350, 144.360, 144.370, 144.380 and 144.390 to QSY

Thanks to all who made input to this process.... Rex VK7MO

Beacon Report

Don VK6HK reports.. All those interested in the VK6 - East Bight path...Wal VK6KZ reports in a visit to Augusta that all three VK6RSW transmitters continue to be operational. However some frequency drift has occurred which it was not possible to correct on this occasion. The current nominal key down carrier frequencies (all FSK) are:-

2m: 144.561 MHz

70cm: 432.563 MHz

23cm: 1296.554 MHz

The beacons feed gain antennas to the east and north from Augusta, which is in the extreme SW corner of VK6, near Cape Leeuwin. In the near future it is intended to replace the present 144 MHz transmitter and increase power from 10 to 50 W.... Don VK6HK

Microwave Primer Part 21 Epilogue

This is the last in the current series. Thanks go out to the numerous contributors to the Primer, soon to be published on various media. A few have asked along the way, how the various designators, eg. K band and X band, etc came into existence. The following is the best I could come up with...

Microwave band designators go back to WWII, where they were supposed to confuse the enemy as to which frequency radar was being used. Today's designators still resemble the original WWII scheme below (Source 5th ED, Reference Data for Radio Engineers/Howard. W. Sams).

L band: .39 to 1.55 GHz,

S band: 1.55 to 5.2 GHz,

X band: 5.2 to 10.9 GHz

K band: 10.9 to 36.0 GHz

During the 1960's there was a move to rename the microwave bands. You may sometimes see reference to A band or B band, etc on equipment from this era. The scheme never caught on except for

C-band, which fits in between S band and X band. Also at this time K band was been split up into Ka, Ku etc.

Now, due to popular demand (thanks for all the e-mails of support recently) I now introduce the replacement "Microwave Round-up" segment!

47 GHz SSB QSO in France on 31 Dec 2001

For the last day of the year 2001, Dominique, F5AXP and Jean-Marie, F6ETU braved the cold, -3 C, and the storm on Mount Tauch (JN12IV). For my part (Michel, F6BVA), weather wise it was no better than going on the slopes of Mount Ventoux in grid JN24PD at 1400m (about 4300 ft) a violent mistral with the temperature at -8°C/18 F. The WX was quite changeable between the morning and the afternoon QSOs. We noted that aluminium boxes were completely frozen!

However, we did make a superb QSO on 47 GHz and we were at 250 km/152 miles. SSB signals were profoundly affected by signal/QSB at levels between 51 -56. In this period of little activity, this merits some lines on the reflector (French Hyper)!!

This QSB did not involve parabola movements as our tripods are stable and the mechanical apparatus was designed to avoid slippage. For my part (F6BVA), I have always stated that QSOs at distances, with or without wind, have multiple causes of QSB. For this QSO of 31 Dec, the trajectory followed very close to the coastal fringe of the Mediterranean. This is a very unstable zone, the hygrometry is very difficult to master in this zone. The force of the northern wind amplifies this phenomenon. There was as well on our path, and this in spite of the wind, a very large unstable mist that diffused and dispersed the signal. But to be more specific, all the contacts made by me in past at more than 150 km on 47 GHz have always been affected by QSB, even those on beautiful days with nice, warm temperatures.

Antennas: F6BVA uses a parabolic antenna of 80 cm (32 inches) in dia, F5AXP uses a 1.2 metre offset

Equipment: The 24 GHz equipment is the basic DB6NT units with amplifiers by G3ACE. On 47.1 GHz the mixer is by DB6NT with about 100 microwatts output. The local oscillators are operated on 12 VDC on both 24 and 47 GHz

It was Michel who had the worst

weather environment on Mt Ventoux and who had to wait for some time before trying a QSO on 47 GHz at 300 km/180 miles which, unfortunately, was not made.

Dominique will send me (W3HMS) pix when the film is finished and processed. ... For Dominique, Jean-Marie, and Michel by John, W3HMS. Translator and Editor.

New Microwave records for VK2 & VK4

Doug VK4OE reports ...during the last week 8-microwave Distance Records were broken. On 8-1-2002 a new VK4 record on 24 GHz was established between Kings Beach, Caloundra and Wellington Point, Brisbane. Previous record was 30km; the new record is 73.8 km.

On 12-1-2002 UTC, just after a weather change line passed through SE Queensland/N'thn NSW in the evening after a memorably hot day, a new VK4 and VK2 record was made on 10 gigs between Byron Bay, NSW and Hervey Bay, QLD. Previous record was 327.8 km; the new record is 380.7 km. On the same night a new VK4 and VK2 record was established on 5.7 gigs over the same path between Byron Bay and Hervey Bay. Previous record was 246km, new record is now 380.7km.

Also on the same night a new VK4 and VK2 record was made on 3.4 Gigs over the same path between Byron Bay and Hervey Bay. Previous record was 246.5 km and new record is 380.7 km. Amateurs on this joint DX operation were: -VK3ZQB Russell, VK3XPD Alan, VK5DK Colin &VK4ZHL Errol. Doug VK4OE

In closing

A reminder that the Year 2002 VHF Communications Magazine renewals are now due. Cut-off date is 28/2/2002. Same price as last year, A\$55-00 posted to my QTHR at the top of the column. All cheques to be made out to "WIA SA & NT Divn Inc". For those who watch Heyburn's Tropo propagation site note the following alternative address http://www.globalserve.net/~hepburnw/tropo_austr.html

I'll leave you with this thought.. "It is by logic that we prove, but by intuition that we discover"

73 David VK5KK

ar

HF Predictions

by Evan Jarman VK3ANI
34 Alandale Court Blackburn Vic 3130

These graphs show the predicted diurnal variation of key frequencies for the nominated circuits.
These frequencies as identified in the legend are:-

- Upper Decile (F-layer)
- F-layer Maximum Usable Frequency
- E-layer Maximum Usable Frequency
- Optimum Working Frequency (F-layer)
- Absorption Limiting Frequency (D region)

Shown hourly are the highest frequency amateur bands in ranges between these key frequencies, when usable. The path, propagation mode and Australian terminal bearing are also given for each circuit.
These predictions were made with the Ionospheric Prediction Service program: ASAPS Version 4

February 2002
T index: 107

Legend
UD
F-MUF
OWF
ALF
10%-50
50%-90
90%-10
Frequency scale
Time scale

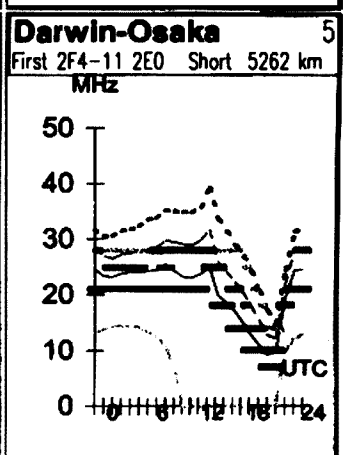
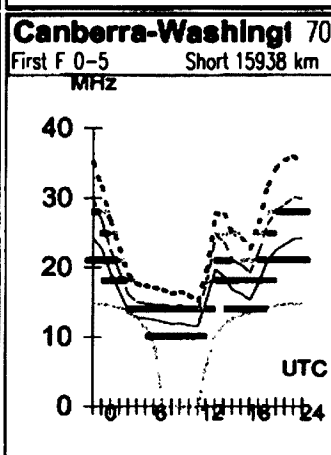
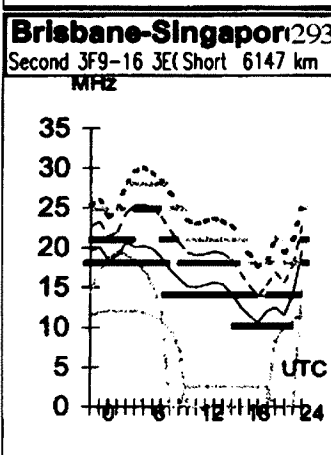
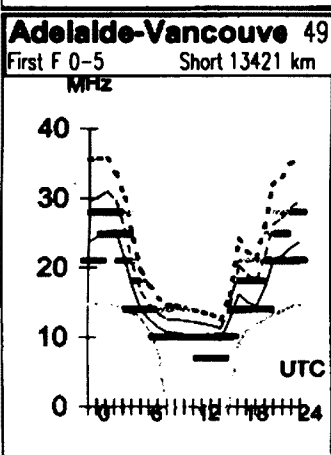
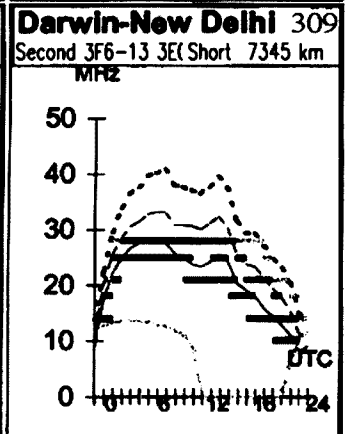
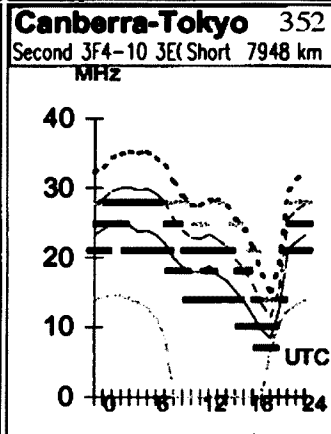
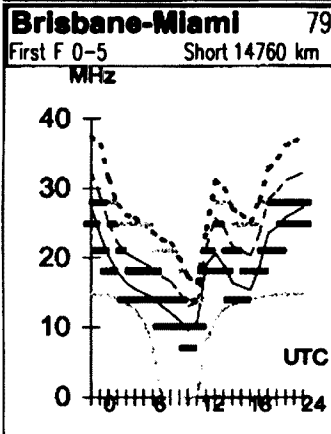
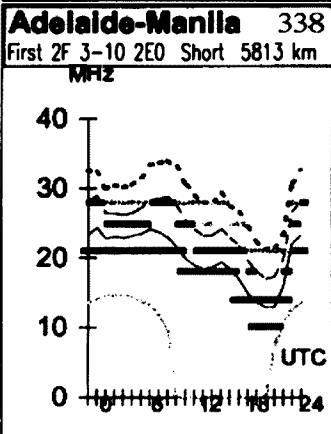
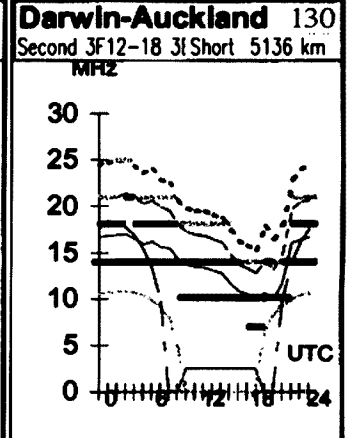
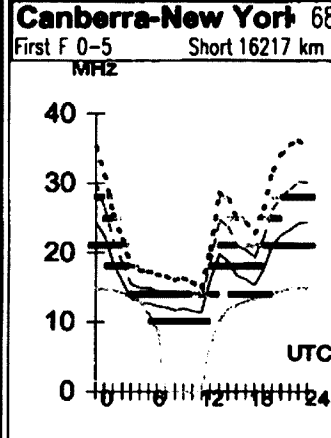
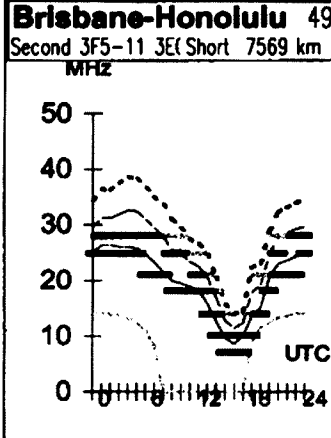
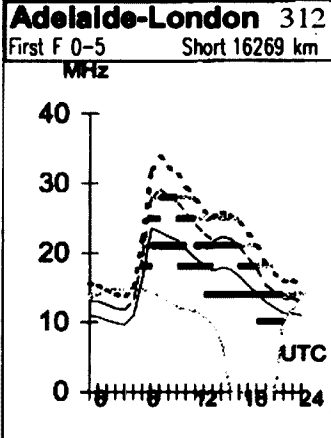
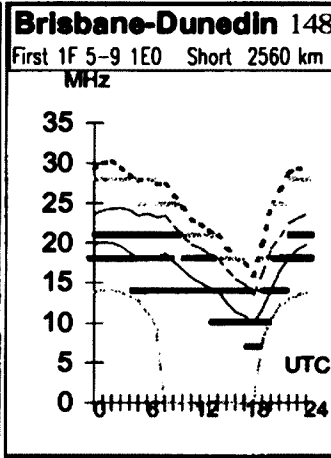
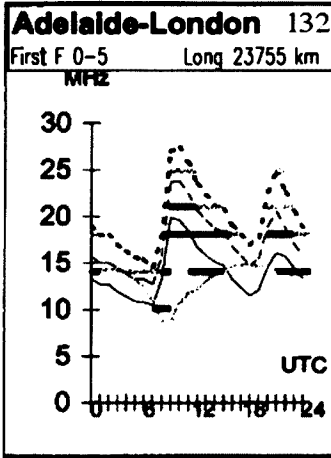

Hobart-Cairo 278
First F 0-5 Short 14263 km

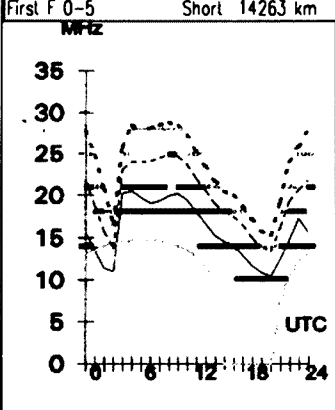

Melbourne-Moscow 316
First F 0-5 Short 1428 km

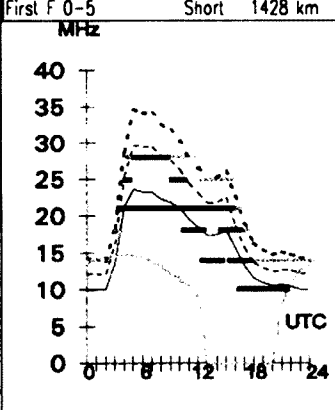

Perth-Dakar 259
First F 0-5 Short 14918 km

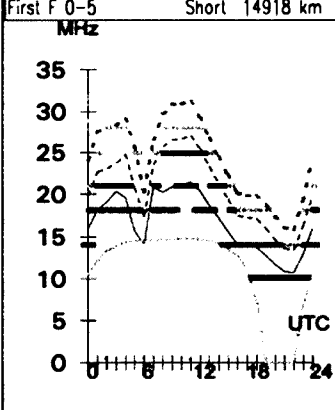

Sydney-Barbados 119
First F 0-5 Short 16155 km

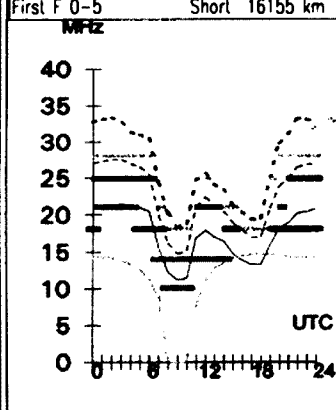

Hobart-Cape Town 220
Second 4F5-13 4E0 Short 10026 km

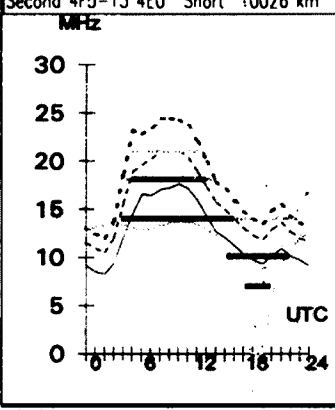

Melbourne-Ottawa 63
First F 0-5 Short 16566 km

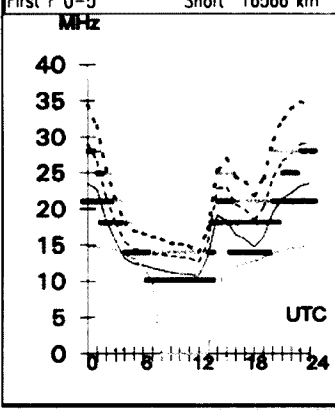

Perth-Johannesburg 248
First 3F4-9 3E0 Short 8315 km

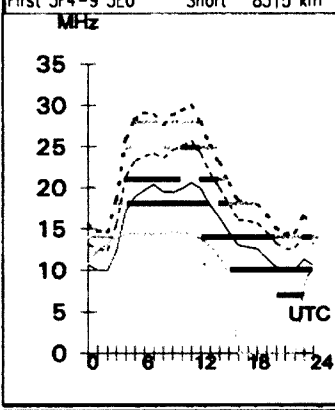

Sydney-London 139
First F 0-5 Long 23032 km

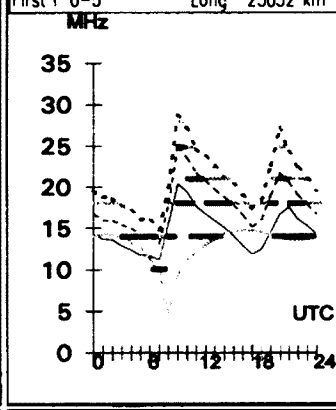

Hobart-Chicago 72
First F 0-5 Short 15576 km

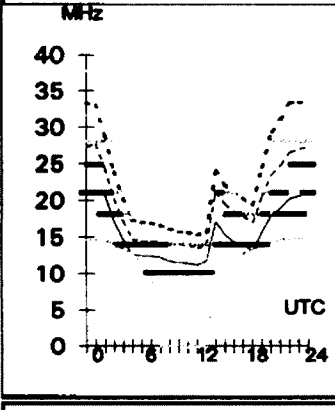

Melbourne-Seattle 50
First F 0-5 Short 13178 km

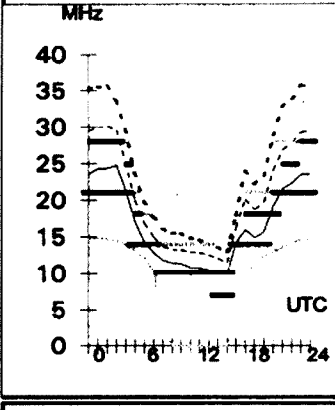

Perth-Montevideo 187
First F 0-5 Short 12536 km

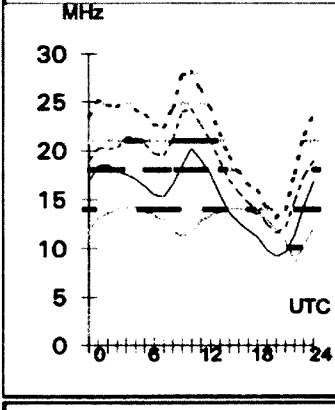

Sydney-London 319
First F 0-5 Short 16992 km

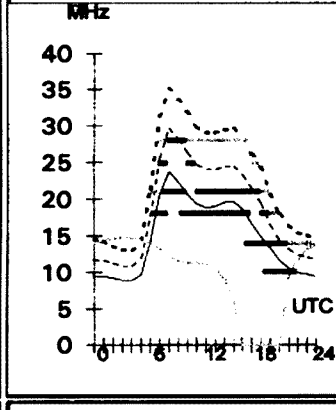

Hobart-Santiago 149
Second 4F5-8 4E0 Short 10688 km

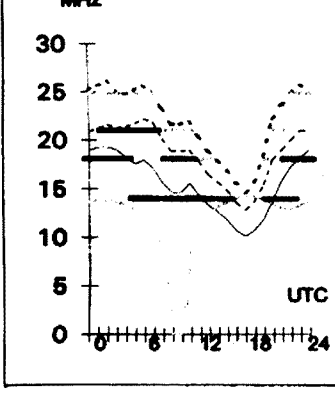

Melbourne-Sofia 296
First F 0-5 Short 15132 km

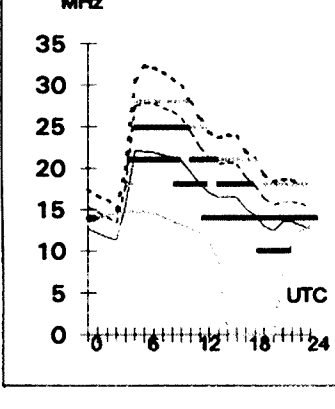

Perth-Tel Aviv 302
Second 4F4-8 4E0 Short 11091 km

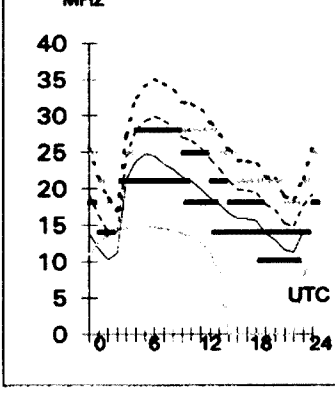

Sydney-Warsaw 133
First F 0-5 Long 24435 km

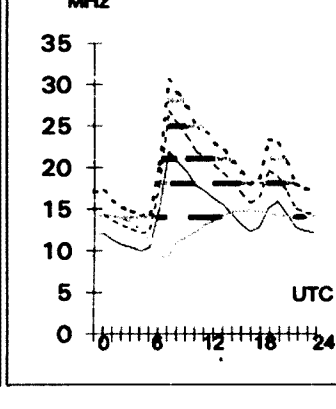

HAMADS

FOR SALE QLD

• **Uniden 2020** transceiver. 12 V or 240 V PS. Separate 2nd VFO. Provision for xtals. Spare finals. Instruction book and diagrams \$250 only. VK4PJ QTHR phbrown@powerup.com.au

WANTED QLD

• **Kenwood remote VFO-820** also **Kenwood transverter 502**, for use on Kenwood TS 820 transceiver. Contact Aub VK4HBA QTHR, email aub@ozemail.com.au, or Phone 3410 0004

• **2625 and 6082 valves.** VK4NS QTHR, email vk4ns599@ozemail.com.au

• **ICOM CW Filter FL-100.** Modem or soundcard interface plus software for PSK31, RTTY, CW, FACTOR, WEATHERFAX. Intended for marine communication/navigation. C.P. Gerhardt VK4CPG, PO Box 196, Hervey Bay Qld 4655, email kris.gerhardt@bigpond.com

FOR SALE SA

• **Icom IC-761** all band Tx general coverage Rx SN02112 \$1000. **Kenwood SW-2000** HF SWR/power meter SN 4040058 \$80. **Welz SP45M** VHF SWR/power meter SN 454505 \$40. **Tet HB-33SP** three element triband antenna \$100. VK5AX QTHR

• **60ft butt section tower** for sale, good condition includes base plate and guy wires dismantled. \$1200.00 ono. Stuart D Cameron VK5ADE, email scameron@bigpond.net.au

WANTED SA

• **Wanted URGENTLY parts for an early model Astor TV** an ESJ model series A and or B preferably one of each part numbers CHOKE L151 & L237 for an old set of great personal value. Prepared to buy a complete chassis that contained ALL parts but would prefer just the nominated chokes. Please advise. I would be prepared to pay postage from any part of VK. VK5ZLC, QTHR. Phone 08 8294 6906

FOR SALE WA

WANTED WA

• **NEC VERSA 2730MT laptop Battery pack** or pinouts for same, dead or alive NIMH or Li-Ion also **"PortBar 2700"** (docking adaptor). Bob VK6KW QTHR, email daybreak.campfarm@bigpond.com Phone 08 9319 1644

• **Icom IC-751A** SSB/CW/FM/AM 1.8 - 30MHz 100w transceiver, including WARC bands and general coverage receive from 100kHz to 30MHz. Complete with **IC-HM12** microphone, dual 500Hz CW filters and manual. Excellent condition. \$750. **CDE Ham-M heavy duty rotator**, with controller, lots of rotator cable and manual. Good condition. \$250. Triangular lower mast section and cast iron base of **Hills 57' Teletower**. \$100. Six **"Power Rod"** fibreglass fishing rod blanks - 9' 4" long. Suit 21/24/28MHz 2-element delta loop antenna or similar. \$100 the lot. Steve Ireland, VK6VZ. Phone: (08) 9298 9330 or email: sire@iinet.net.au

FOR SALE TAS

• **Deceased estate VK7FD. PS 55** power supply coupled to **Icom IC735** Xcvr. **Yaesu FT-290R** 2 metre Xcvr. **Kenwood TS-130** Xcvr. **Yaesu FT-200** Xcvr. **Yaesu FT-840** Xcvr coupled to **FC-700 ATU**, **Yaesu FT-411E** 2 metre hand held. **Uniden Bearcat scanner**. 1 20ft 3 leg tower. **Icom IC-735**. Boxes available for most of the gear. All gear well kept. Deidre Reid Phone 03 6431 5173

- Hamads may be submitted by email or on the form on the reverse of your current Amateur Radio address flysheet. Please print carefully, especially where case or numerals are critical.
- Please submit separate forms for For Sale and Wanted items, and be sure to include your name, address and telephone number (including STD code) if you do not use the flysheet.
- Eight lines (forty words) per issue free to all WIA members, ninth and tenth lines for name and address. Commercial rates apply for non-members.
- Deceased estates Hamads will be published in full, even if the ad is not fully radio equipment.
- WIA policy recommends that the serial number of all equipment for sale should be included.
- QTHR means the address is correct in the current WIA Call Book.
- Ordinary Hamads from members who are deemed to be in general electronics retail and wholesale distributive trades should be certified as referring only to private articles not being re-sold for merchandising purposes.
- Commercial advertising (Trade Hamads) are pre-payable at \$25.00 for four lines (twenty words), plus \$2.25 per line (or part thereof), with a minimum charge of \$25.00. Cheques are to be made out to: WIA Hamads.
- Copy should be typed or in block letters, and be received by the deadlines shown on page 1 of each issue of Amateur Radio, at:

Email: newsletters@ozemail.com.au Fax: 03 9756 7031

Postal: Newsletters Unlimited, PO Box 431, Monbulk Vic 3793

Please send your Hamad by ONE method only (email preferred)

FOR SALE NSW

• **Port Macquarie QTH.** 3 el TET and Tower, sea glimpses, 3BR Brick Veneer, plus TS-570 & PS. \$220,000. Ian Dalrymple VK2XU. Phone 02 6584 9922

• **WW2 transmitter type 88**, N - X bands, s/ n MRS40, in heavy 19 in. rack cabinet. Mains power transformer & 2 valves missing. \$50 ONO. **WW2 aircraft generator-alternator** 28 V & 100 A @ 1200-1400 Hz, 1200 W \$50 ONO. Suit electric car? Both buyer collect, I can't lift! **Stingray 2** (converted CB), 10 m SSB 24 ch transceiver, vgc. \$40. **Katsumi** Electronic keyer, includes paddle & 6 V dc or 240 V ac power supply, \$30. **Daiwa RF Modal RF550** speech processor, 13.8 V dc or 230 V ac, \$50. Keith VK2AXN QTHR, Sydney. Phone 02 9489 0304.

• **Running a ham radio course?** Call us for books to use with your course or studies. We have Novice Theory Handbook, Study Guide for the Novice, and AOCIP theory and AOCIP Study Guide. A total of 4 books which in effect provide a complete self-study program for anyone wanting to get their ham licence, or anyone running a course and needing economically priced and concise texts. All books written and published by an Australian ham who is a retired TAFE teacher with 15 years of experience with radio classes. Scotty, VK2KE. Email enquiries welcome to scott@albury.net.au, mail to PO Box 385 Albury NSW 2640 or FAX on Phone 02 6021 8813.

• **Deceased estate. KENWOOD TS 2000.** All band. Used 1 week. Sn 30400058 \$3200. **YAESU FT-920** HF Xcvr, as new. sn 71090482 \$1200. **ICOM IC-255A** 2 m mobile 25 W sn 04868 \$150. Ron VK2GUB Phone 02 9484 4226

WANTED NSW

• **Antenna tuner** Emtron EAT-300 or EAT-300A. Roger VK2ARF QTHR Fax/Phone 02 9440 1212

• **Yaesu FT-690** 6 metre portable transceiver. Bob VK2CAN. Phone 02 9416 3727

• Urgently require operator's **Instruction book for REALISTIC brand DX-394** HF comms receiver. Willing to pay all photocopy expenses etc. Arthur VK2DKF, Phone 02 4739 8695 or email aforster@bigpond.com.au

FOR SALE VIC

• **Deceased estate: Daiwa** 2 metre linear amp and PSU \$280 ono. **HF linear amp** 400 W and PSU, price negotiable. **Trio** portable oscilloscope. \$50. **CVS 450** UHF power amplifier \$50. **Leader** grid-dip meter \$60. **O-tech** audio generator \$30. **Icom IC-751A** HF transceiver and **Icom IC PS-30** power supply \$950 ono. Apply VK3DFE QTHR, Phone 03 9807 3995

• Spare **3/500 tube** for linear amplifier. What offers? Alf Chandler VK3LC, 1/09 Grande Classic Residences, 1 Brewer Road, Brighton East 3187.

• **Yaesu FT 757-GX** xcvr. Gen Cov Rx. GC with mic, books etc \$475. **Yaesu FC-700** AT inbuilt SWR/PWR meter plus dummy load \$100. **FT-690R II** 6 m multi mode xcvr EC \$125. Dick Smith **Powermaster 20 A** P/S \$100. **Phillips 828** with 4/2m channels. Book etc \$5. **Shure 444D** Desk mic. \$100. Ron VK3OM QTHR 03 5944 3019.

• **TOWER**, four galvanised triangular commercially made sections, each 1830 long, 250 side 32 diam. pipe, 26 kg. Built-in ladder. Base plate 380x380x11 with mounting bolts. Also two **Hills** 4 section telescopic tubing masts. Any offers? John VK3GF QTHR johnc@anson.com.au Phone 03 5562 5545

• **Yaesu YO-100** monitor scope Serial no. 6J2 13359 Japanese manual only \$50 VK3FIM Phone 03 9802 9475

• **Yaesu FRG7** Rx, unmarked \$150. **Daiwa RF-440** speech processor \$40. **Goldring cardioid** 50k 20052 microphone \$10. 2 element 15 metre Yagi \$50. Mike VK3KTO. Phone 03 5998 7590

MISCELLANEOUS

• The WIA QSL Collection (now Federal) requires QSLs. All types welcome, especially rare DX pictorial cards, special issue. Please contact the Hon Curator, Ken Matchett VK3TL, 4 Sunrise Hill Road, Montrose Vic 3765, tel. (03) 9728 5350

STOLEN EQUIPMENT

• Below is a list of equipment that was stolen from my vehicle, while I was working at the Dandenong basketball centre on the 18/1/2002, between 7 and 10 PM: **Kenwood TS 790a** Serial #51200137, all mode Triband Radio, fitted with 23cm (UT 10) module serial number 51000035 and **TSU 5** tone unit; **Garmin GPS 2 Plus** serial number 40639025; **Kenwood DPC-M727** Portable CD/MP3 player serial #10900136. Frank VK3ZNF, Phone 0409 459 468

• The ACA recently had the theft of equipment from its Adelaide office that may be offered to amateurs. If any amateur is offered this equipment or has information could they please contact their local ACA office or the nearest police station.

The stolen items:

- Nikon Digital Camera CoolPix950 s/n 408855
- Icom UHF H/Held ICU16 s/n 5167
- Opelelectronic 3000 Frequency Counter s/n 3
- AOR-8000 Scanning Receiver s/n 41248
- Garmin GPS Receiver s/n 40445710

<http://www.hamsearch.com>
a not-for-profit site that is a search engine for hams

TRADE ADS

PSK-31, SSTV, RTTY SOUNDBOARD INTERFACES

Fully isolated, ready to plug in.
<http://www.G3LIV.CO.UK>,
johnny@melvin.com, G3LIV QTHR.

AMIDON FERROMAGNETIC CORES:

For all RF applications. Send business size SASE for data/price to RJ & US Imports, PO Box 431, Kiama NSW 2533 (no enquiries at office please. 14 Boanyo Ave Kiama). www.cyberelectric.net.au/~rjandusimports.

Agencies at: Active Electronics Tas; Truscotts Electronic World, Melbourne; TTS Systems, Tyabb; Tower Communications, Perth; Haven Electronics, Nowra.

HF, VHF, UHF ANTENNAS & ACCESSORIES

Alum towers, guys etc. Diamond VSWR/PWR meters. HD copper ant wire & insulators. TX tubes & pwr transistors. Quality coax cables & connectors. Free advice & catalogue.
ATN Antennas Ph 03 5492 2224 Fax 03 5492 2666, email atnant@ruralnet.net.au

Email your hamad

Then we just cut and paste.
You proof it, you retain control.

"Hey, Old Timer..."



If you have been licensed for more than 25 years you are invited to join the

Radio Amateurs Old Timers Club Australia

or if you have been licensed for less than 25 but more than ten years, you are invited to become an Associate Member of the RAOTC.

In either case a \$2.50 joining fee plus \$8.00 for one year or \$15.00 for two years gets you two interesting OTN Journals a year plus good fellowship.

Write to

RAOTC,
3/237 Bluff Road
Sandringham VIC 3191

or call Arthur VK3VQ on 03 9598 4262 or Allan VK3AMD on 03 9570 4610, for an application form.

Un-Silent Key

We are pleased to advise that contrary to the report in January AR, Ted Miles VK2FLB is alive and well! *Amateur Radio* apologises for any embarrassment or distress caused by this error.

PLEASE BE KIND TO OSCAR

Meet Mr Oscar Goldenboy, our Hamad typist

Oscar is not an expert in your field — he thinks Megahertz is what happens when he stubs his toe on a rock.

To help Oscar, please write your hamad legibly, using both capitals and lower case, and use legitimate abbreviations.

This will reduce the chance of errors being published, which inconveniences everyone.

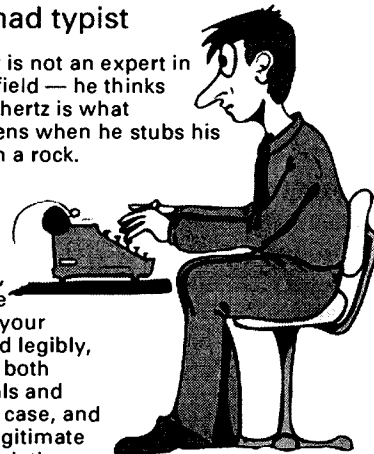

Sunspot Numbers

Monthly average count Dec 2001: 131.8

Smoothed Sunspot Number Jun 2001: 109.8

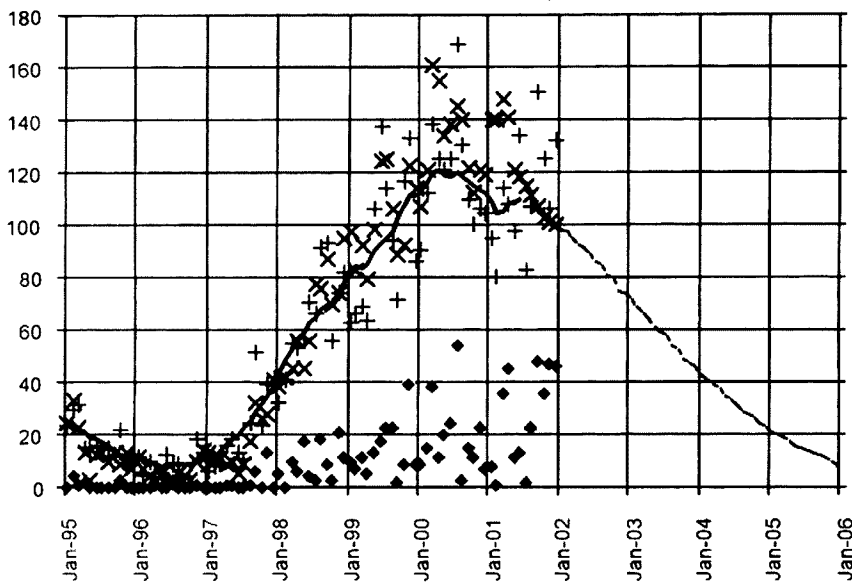

◆ Flares > M1 ✕ T index — SSN
 - - - - - Prediction + Sunspot Number Plots are made monthly

Data provided by the Ionospheric Prediction Service

ADVERTISERS INDEX

- Icom.....IBC
- Michael Todd Computers.....:20
- Tower Communications:40
- WIA Call Book.....:IFC

TRADE PRACTICES ACT

It is impossible for us to ensure that the advertisements submitted for publication comply with the Trade Practices Act 1974. Therefore, advertisers and advertising agents will appreciate the absolute need for themselves to ensure that the provisions of the Act are strictly complied with.

VICTORIAN CONSUMER AFFAIRS ACT

All advertisers are advised that advertisements containing only a PO Box number as the address cannot be accepted without the addition of the business address of the box-holder or seller of the goods.

Over To You

CRTB

It brought back great memories to read the article by Allan Madigan in the December issue. I too have always maintained that my time in, the Chief Telegraph Office Sydney was great part of my education. I also worked in the Telegraph Offices in Melbourne Hobart and finished my career in Perth.

On the subject of "Cutting em up" the one he didn't mention was the Lottery results sent daily by morse to West Maitland (now known as Maitland). When you called up West Maitland and said "Sli (shall I go ahead) Lottery", he would say "Ga Cut Em Up".

This meant the following abbreviations: 1 sent as A, 2 as U, 3 as V, 5 as E, 7 as B, 8 as D, 9 as N, 0 as T

This involved intense concentration and at the Sydney end you were relieved after 15 minutes but the receiving Postal Clerks had no breaks.

When morse was removed from West Maitland and they went on to Teleprinters - after a week the Editor of the Mercury, insisted that the Lottery Press be taken on morse. This was done for quite a while.

Frank Spruhan of CRTB fame is buried in a small country cemetery in Mid North Coast of NSW and on the bottom of his headstone is C R T B .

73s to any former Telegraphist colleagues.

Ken Knox VK6ZO

Don't lower the standard

I just cannot believe that any forward thinking or sensible person would contemplate denigrating our hobby by lowering the standard of entry.

Surely it is bad enough that we have reduced the morse barrier somewhat and our technical standard is at a low level already. If we get any lower we will undoubtedly not retain the reciprocal levels which we enjoy presently with the major countries.

It seems that this matter is driven by a need to increase WIA membership, and

as a WIA member I most strongly support an increase in membership. However to my mind there is only one efficacious way to do that. Yes, by that I mean compulsory membership. OK, don't throw the magazine away yet.

Firstly. Most Sporting and Hobby groups in this country are required to affiliate with either a State or Federal body. We don't have that compulsion, but we rely on our WIA to do the work to maintain both our status and standards with the Federal Government. It is only those few who subscribe to the Institute who provide the funds (most unfairly) to enable this to happen. I can only suppose that the fees levied by our association are indicative of the numbers of members it has. Surely then, if we had compulsory membership the fees could be reduced drastically. Other government departments have provision in their licensing procedures to ensure memberships are retained so why can't that apply equally to us

Finally, to lower the standard, to allow the CB fraternity on to our frequencies would in no way guarantee an increase of WIA members. Doubtless it would increase our amateur numbers but I believe that there is sufficient increase in our numbers world wide to justify retaining standards as they are without losing our present privileges.

I share fully the sentiments of Chas VK3BRZ (AR Dec 2001). If this occurs, I will be leaving the Institute.

Bill McCarthy VK4WMC

Internet and Amateur Radio

I disagree with Stan Ellis, VK2DDL, whose comments in AR January 2002 are obviously well intentioned, but he is really off the mark in today's society.

One of the problems we face in the promotion of the hobby of Amateur Radio, is the fact that most of those "technical types" who previously would pursue studies in obtaining the AOCP or LOACP etc, are now obtaining their "kicks" from the Internet.

Let's face it, amateur radio (the hobby) as we know it today is on the downslide, especially here in VK.

When I was eight (in 1949 !!), I was introduced to MF and short wave radio from a friend who helped me build my first crystal set. I had great delight in being able to listen to local MF stations, and later I was able to receive some overseas stations. That interest has continued all my life, and I have had the privilege to have achieved the technical qualifications required, and held an Amateur Radio licence (AOCP) for over 30 years.

Comparing today as to how I started in a radio hobby all those years ago, I only have to look no further than my immediate family. My four year old grandson already has a (healthy ??) interest in computers. He can move the mouse, log on to various programs such as "Bob the Builder" and "Train Simulator". I guess in time he may show an interest in radio, but all of my friends state that none of their children have any interest in anything else EXCEPT their computer, and the Internet.

I am a computer technician (semi retired!), in my travels to businesses and private homes, I often come across a computer which has broken down, and where the owner is a teenager. If you want to see real distress, remove his / her computer and Internet access for a few days. Mention amateur radio, and you get a blank look. Any thought of radio at all refers to the music (!) played on the commercial FM band.

If the Internet can be used as a means to inspire an interest of Amateur Radio in our younger generation to our declining hobby, then I am all for it.

We shut our doors and ears to the CB boom in the late 70s and early 80s with disastrous results. Amateur Radio lost out then, and it is now happening again.

Our destiny is in our own hands, but we achieve little with negative attitudes.

Vy 73 Bruce Bathols VK3UV

Note 1 Views expressed in letters are those of the authors and do not necessarily represent the policy of the WIA.
2. Some of the letters may be shortened to allow more letters to be published.



Division Directory

The Amateur Radio Service exists for the purpose of self training, intercommunication and technical investigation. It is carried out by amateurs who are duly authorised people interested in radio technique solely with a personal aim and without pecuniary interest.

The Wireless Institute of Australia represents the interests of all radio amateurs throughout Australia. National representation is handled by the executive office under council direction. There is one councillor for each of the seven Divisions. This directory lists all the Divisional offices, broadcast schedules and subscription rates. All enquiries should be directed to your local Division.

Broadcast schedules All frequencies MHz. All times are local.

VK1 Division Australian Capital Territory,

GPO Box 600, Canberra ACT 2601

President Gilbert Hughes

Secretary Peter Kloppenburg

Treasurer Linden S Orr

VK1GH

VK1CPK

VK1LSO

VK1WI: 3.590 LSB, 146.950 FM each Thursday evening from 8.00pm local time. The broadcast text is available on packet, on Internet [aus.radio.amateur.misc](http://www.amsat.org/aus.radio.amateur.misc) news group, and on the VK1 Home Page <http://www.vk1.wia.ampr.org>

Annual Membership Fees. Full \$77.00 Pensioner or student \$70.00. Without *Amateur Radio* \$48.00

VK2 Division New South Wales

109 Wigram St, Parramatta NSW

(PO Box 432, Harris Park, 2150)

(Office hours Mon-Fri 1100-1400)

Phone 02 9689 2417

Web: <http://www.ozemail.com.au/~vk2wi>

Freecall 1800 817 644

e-mail: vk2wi@ozemail.com.au

Fax 02 9633 1525

President Terry Davies

Secretary Pat Leeper

Treasurer Chris Minahan

VK2KDK

VK2JPA

VK2EJ

From VK2WI 1.845, 3.595, 7.146*, 10.125, 14.160, 24.950, 28.320, 29.120, 52.120, 52.525, 144.150, 147.000, 438.525, 1281.750 (* morning only) with relays to some of 18.120, 21.170, 584.750 ATV sound. Many country regions relay on 2 m or 70 cm repeaters. Sunday at 1000 and 1930. Highlights included in VK2AWX Newcastle news, Monday 1930 on 3.593 plus 10 m, 2 m, 70 cm, 23 cm. The broadcast text is available on the Internet newsgroup [aus.radio.amateur.misc](http://www.amsat.org/aus.radio.amateur.misc), and on packet radio.

Annual Membership Fees. Full \$78.00 Pensioner or student \$61.00. Without *Amateur Radio* \$47.00

VK3 Division Victoria

40G Victory Boulevard Ashburton VIC 3147

(Office hours Tue 10.00 -2.30)

Phone 03 9885 9261

Web: <http://www.wiavic.org.au>

Fax 03 9885 9298

e-mail: wiavic@wiavic.org.au

President Jim Linton

Secretary John Brown

Treasurer Barry Wilton

VK3PC

VK3JJB

VK3XV

VK3BWI broadcasts on the 1st Sunday of the month at 20.00hrs Primary frequencies, 3.615 DSB, 7.085 LSB, and FM(R)s VK3RML 146.700, VK3RMM 147.250, VK3RWG 147.225, and 70 cm FM(R)s VK3ROU 438.225, and VK3RNU 438.075. Major news under call VK3ZWI on Victorian packet BBS and WIA VIC Web Site.

Annual Membership Fees. Full \$78.00 Pensioner or student \$61.00. Without *Amateur Radio* \$47.00

VK4 Division Queensland

PO Box 199, Wavell Heights, Qld. 4012

Phone 07 3221 9377

e-mail: office@wiaq.powerup.com.au

Fax 07 3266 4929

Web: <http://www.wia.org.au/vk4>

President Bill Riis

Secretary Bruce Jones

Treasurer Bill McDermott

Office Mgr John Stevens

VK4YCU

VK4EHT

VK4AZM

VK4AFS

VK4WIA broadcasts on 1.825 MHz SSB, 3.605 MHz SSB, 7.118 MHz SSB, 10.135 MHz SSB, 14.342 MHz SSB, 21.175 MHz SSB, 28.400 MHz SSB, 29.660 MHz FM (rpr), 147.000 MHz, and 438.525 MHz (in the Brisbane region, and on regional VHF/UHF repeaters) at 0900 hrs K every Sunday morning. QNEWS is repeated Monday evenings, at 19.30 hrs K, on 3.605 MHz SSB and 147.000 MHz FM. On Sunday evenings, at 18.45 hrs K on 3.605MHz SSB and 147.000 FM, a repeat of the previous week's edition of QNEWS is broadcast. Broadcast news in text form on packet is available under WIAQ@VKNET. QNEWS Text and real audio files available from the web site

Annual Membership Fees. Full \$83.00 Pensioner or student \$71.00. Without *Amateur Radio* \$52.00

VK5 Division South Australia and Northern Territory

(GPO Box 1234 Adelaide SA 5001)

Phone 0403 368 066

web:<http://www.sant.wia.org.au>

email: peter.reichelt@bigpond.com

President David Minchin

Secretary Peter Reichelt

Treasurer Trevor Quick

VK5KK

VK5APR

VK5ATQ

VK5WI: 1827 kHz AM, 3.550 MHz LSB, 7.095 AM, 14.175 USB, 28.470 USB, 53.100 FM, 147.000 FM Adelaide, 146.800 FM Mildura, 146.900 FM South East, 146.925 FM Central North, 438.475 FM Adelaide North, ATV Ch 35 579.250 Adelaide. (NT) 3.555 USB, 7.065 USB, 10.125 USB, 146.700 FM, 0900 hrs Sunday. The repeat of the broadcast occurs Monday Nights at 1930hrs on 3585kHz and 146.675 MHz FM. The broadcast is available in 'Realaudio' format from the website at www.sant.wia.org.au Broadcast Page area.

Annual Membership Fees. Full \$82.00 Pensioner or student \$68.00. Without *Amateur Radio* \$54.00

VK6 Division Western Australia

PO Box 10 West Perth WA 6872

Phone 08 9351 8873

Web: <http://www.vk6wia.org>

e-mail: vk6wia@iinet.net.au

President Neil Penfold

Secretary Christine Bastin

Treasurer Bruce Hedland-Thomas

VK6NE

VK6ZLZ

VK6QO

VK6WIA: 146.700 FM(R) Perth at 0930hrs Sunday relayed on 1.865, 3.564, 7.075, 10.125, 14.116, 14.175, 21.185, 29.120 FM, 50.150 and 438.525 MHz, Country relays 3.582, 147.200 (R) Catoby, 147.350 (R) Busselton, 146.900 (R) Mt William (Bunbury), 147.000 (R) Katanning and 147.250 (R) Mt Saddleback. Broadcast repeated on 146.700 at 1900 hrs Sunday relayed on 1.865, 3.564 and 438.525 MHz : country relays on 146.900,147.000, 147.200, 147.250 and 147.350 MHz..Also in "Real Audio" format from the VK6 WIA website

Annual Membership Fees. Full \$67.00 Pensioner or student \$61.00. Without *Amateur Radio* \$36.00

VK7 Division Tasmania

PO Box 371 Hobart TAS 7001

Phone 03 6234 3553 (BH)

Web: <http://www.tased.edu.au/tasonline/vk7wia>

also through <http://www.wis.org.au/vk7>

email: batesjw@netspace.net.au

President Phil Corby

Secretary John Bates

Treasurer John Bates

VK7ZAX

VK7RT

VK7RT

VK7WI: 146.700 MHz FM (VK7RHT) at 0930 hrs Sunday relayed on 147.000 (VK7RAA), 146.725 (VK7RNE), 146.625 (VK7RMD), 3.570, 7.090, 14.130, 52.100, 144.150 (Hobart), repeated Tues 3.590 at 1930 hrs.

Annual Membership Fees. Full \$85.00 Pensioner or student \$72.00. Without *Amateur Radio* \$52.00

VK8 Northern Territory (part of the VK5 Division and relays broadcasts from VK5 as shown, received on 14 or 28 MHz).

Be the predator, not the prey

IC-756PROII (HF/6m)

Amateur Transceiver



ICOM raises the bar of excellence with the world's most powerful DSP technology in amateur radio history with the IC-756PROII. From the box to heavy contest action, in a matter of seconds. Imagine the fun and excitement of creating your own filter width and shape while on the air, rag chowing, or in the middle of a pile-up!!

Features include

- Sharp & soft, IF filter shape
- No optional filters to buy
- 41 selectable IF Filter bandwidths
- Choice of 3 filters per mode
- Improved 3rd IMD & wide dynamic range
- Triple band stacking register
- Built-in Antenna Tuner
- Two levels of receiver pre-amp
- Three levels of attenuator
- Dual watch on same band
- IF DSP
- 13.8V DC operation
- 5 to 100W SSB,CW,FM,RTTY (including RTTY decoder)
- 4 to 40W AM
- Dual Antenna Sockets
- Real Time Spectrum Scope
- One-touch record/play
- Digital voice memory
- Extended 1/4 tuning step & BPF functions for SSB-D mode
- 32 bit floating point DSP and 24 bit AD/DA converter
- SSB / CW synchronous tuning
- 8 Display types
- 7 Font Types
- Memory Keyer
- 4.9 inch color TFT LCD

ICOM
Clearly Ahead

find your nearest ICOM dealer at

www.icom.net.au

or (03) 9387 0666

March 2002
Volume 70 No 3



Amateur Radio

Fox-hunting Fun for Families at Field Days

★ **The Double Tuned
Crystal Set Tuner**

★ **"Tone-a-Tune"
Audible SWR Bridge**

★ **Charlie's Grid Dip
Meter**





Australian
Amateur Radio

Callbook 2002

Every shack should have one



Now also
on
searchable
CD

**The "Call Book 2002" is available from
your State Division
Order now to get the member discount**

VK1 Division

GPO Box 600, Canberra ACT 2601

VK2 Division

109 Wigram St, Parramatta NSW
(PO Box 432, Harris Park, 2150)
(Office hours Mon-Fri 1100-1400)
Phone 02 9689 2417
<http://www.ozemail.com.au/~vk2wi>
Freecall 1800 817 644
e-mail: vk2wi@ozemail.com.au

VK3 Division

40G Victory Boulevard
Ashburton VIC 3147
(Office hours Tue 10.00 - 2.30)
Phone 03 9885 9261
<http://www.wiavic.org.au>
Fax 03 9885 9298
e-mail: wiavic@wiavic.org.au

VK4 Division Queensland
PO Box 199, Wavell Heights, Old. 4012
Phone 07 3221 9377 Fax 07 3266 4929
e-mail: office@wiaq.powerup.com.au

VK5 Division (and VK8)

(GPO Box 1234 Adelaide SA 5001)
Phone 0403 368 066
:<http://www.sant.wia.org.au>
email: peter.reichelt@bigpond.com

VK6 Division

PO Box 10 West Perth WA 6872
Phone 08 9351 8873
Web: <http://www.vk6wia.org>
e-mail: vk6wia@iinet.net.au

VK7 Division

PO Box 371 Hobart TAS 7001
Phone 03 6234 3553 (BH)
<http://www.tased.edu.au/tasonline/vk7wia>
email: batesjw@netspace.net.au

COMMERCIAL RESELLERS

Please contact June Fox (WIA Federal) on 03 9528 5962



Amateur Radio

The Journal of the Wireless
Institute of Australia

ISSN 0002-6859

Editorial

Editor: Colwyn Low VK5UE
edarmag@chariot.net.au

Technical Editor: Peter Gibson VK3AZL

Publications Committee Members

Ron Fisher VK3OM
Don Jackson VK3DBB
Evan Jarman VK3ANI
Bill Rice VK3ABP
Gil Sones VK3AUI
Bill Roper VK3BR

Advertising

Mrs June Fox,
Tel: (03) 9528 5962

Hamads

"Hamads" Newsletters Unlimited
PO Box 431, Monbulk Vic 3793
Fax: 03 9756 7031
e-mail: newsletters@ozemail.com.au

Office

10/229 Balaclava Road
Caulfield, Victoria
Telephone (03) 9528 5962
Facsimile (03) 9523 8191

Business Hours 9:30am to 3:00pm weekdays

Postal

The Editor AR
34 Hawker Crescent
Elizabeth East
South Australia 5112
Email edarmag@chariot.net.au

Production

Newsletters Unlimited 03 9756 7797

Printer

Streamline Press, Melbourne (03) 9417 2766

Postal Service

IMS (03) 9291 5888

Production Deadlines

Advertising booking and articles for
publication 10th of preceding month.

Hamads and advertising material deadline
18th day of preceding month

The contents of Amateur Radio are Copyright
Wireless Institute of Australia © 2002

Our cover this month

Urunga Field Day 2001: 80m
Junior Fox Hunts, won by Reese
Austin on Saturday, Carl Winkler
on Sunday

General

Episode Four of Types of Emissions	7
True Confessions of a Bin Raider	12
John Kirk VK2PV/VE6XT	
Morse sending made easy	13
Neville Mattick VK2QF (ex 4W/VK2QF)	
Computers in the shack as a log book	14
Neville Mattick VK2QF (ex 4W/VK2QF)	
Seanet	15
Early Experiments: Developing Radio Communication for the Flying Doctor Service	16
Rodney Champness VK3UG	
The Manual CW Decoder	20
Steve Page, VK6BGN	
WICEN helps the community	25

Technical

"Tone-a tune" audible SWR bridge	4
Drew Diamond VK3XU	
The Double-tuned Crystal Set Tuner	8
Felix Scerri VK4FUQ	
Charlie's Toys: No 1 Grid Dip Meter	10
Charlie Sims VK2ABF	
Finding a break in multicore cable (Technical Abstracts)	26
Gil Sones VK3AUI	
Soldering Litz wire (Technical Abstracts)	26
Gil Sones VK3AUI	
Battery saver timer (Technical Abstracts)	27
Gil Sones VK3AUI	
Depth stops for drilling (Technical Abstracts)	27
Gil Sones VK3AUI	
Monel wire for corrosion free antenna (Technical Abstracts)	28
Gil Sones VK3AUI	

Columns

Advertisers' Index	55	Hamads	54
ALARA	22	Ham Shack Computers	39
AMSAT	34	HF Predictions	52
Beyond Our Shores	37	How's DX?	44
Contests	41	Over To You	56
Club News	23	Silent Keys	24, 32, 33, 38, 43, 47
WIA Division News		Spotlight on SWLing	51
VK1 Notes	30	Technical Abstracts	26
VK2 Notes	33	VHF/UHF - An Expanding World	48
VK3 Notes	32	WIA Comment	3
VK4 Notes	30	WIA Division Directory	IBC
VK7 Notes	31	WIA Federal Directory	2
Editor's Comment	2		

Contributions to Amateur Radio

Amateur Radio is a forum for WIA members' amateur radio experiments, experiences opinions and news. Manuscripts with drawings and/or photos are always welcome and will be considered for publication. Articles on disc or email are especially welcome. The WIA cannot be responsible for loss or damage to any material. A pamphlet, How to write for Amateur Radio is available from the Federal Office on receipt of a stamped self-addressed envelope.

Back Issues

Back issues are available directly from the WIA Federal Office (until stocks are exhausted), at \$4.00 each (including postage within Australia) to members.

Photostat copies

When back issues are no longer available, photocopies of articles are available to members at \$2.50 each (plus an additional \$2 for each additional issue in which the article appears).

Disclaimer

The opinions expressed in this publication do not necessarily reflect the official view of the WIA and the WIA cannot be held responsible for incorrect information published.

Amateur Radio Service

A radiocommunication service for the purpose of self-training, intercommunication and technical investigation carried out by amateurs; that is, by duly authorised persons interested in radio technique solely with a personal aim and without pecuniary interest.

Wireless Institute of Australia

The world's first and oldest
National Radio Society
Founded 1910

Representing

The Australian Amateur Radio Service

Member of the
International Amateur Radio Union

Registered Federal Office of the WIA
10/229 Balaclava Road
Caulfield North Vic 3161
Tel: (03) 9528 5962 Fax (03) 9523 8191
<http://www.wia.org.au>

All mail to
PO Box 2175 Caulfield Junction VIC 3161
Business hours: 9.30am-3pm weekdays

Federal Secretary

Peter Naish VK2BPN

Federal Office staff

June Fox Bookkeeper
Rita Trebilco VK3IF Examinations Officer

Council

President	Ernest Hocking	VK1LK
VK1 Federal Councillor	Gilbert Hughes	VK1GH
VK2 Federal Councillor	Barry White	VK2AAB
VK3 Federal Councillor	Jim Linton	VK3PC
VK4 Federal Councillor	David Jones	VK4OF
VK5 Federal Councillor	David Box	VK5OV
VK6 Federal Councillor	Will McGhie	VK6UU
VK7 Federal Councillor	Phil Corby	VK7ZAX

Executive

Brenda Edmonds VK3KT
David Pilley VK2AYD
Don Wilschefsik VK4BY

Federal Coordinators

AMSAT	Graham Ratcliff	VK5AGR
ARDF	Jack Bramham	VK3WWW
Awards	Mai Johnson	VK6LC
Contests	Ian Godsill	VK3VP
Education	Brenda Edmonds	VK3KT
FTAC	John Martin	VK3KWA
Historian	John Edmonds	VK3AFU
IARU	Grant Willis	VK5ZWI
Intruder Watch	Harry Andersson	VK8HA
International Travel Host	John Miller	VK3DJM
ITU Conference and study group	Gilbert Hughes	VK1GH
QSL Manager (vks, vko)	Neil Penfold	VK6NE
Videotapes	VK2 Division	
Web	Joe Burford	VK5UJ

ACA Liaison Team

Ernie Hocking VK1LK
Gilbert Hughes VK1GH
Keith Malcolm VK1ZKM
Peter Naish VK2BPN
Canberra Liaison Officer Richard Jenkins VK1RJ

Editor's Comment

Colwyn Low VK5UE
edarmag@chariot.net.au

AR must change, but how?

Most of you will have heard about the survey being conducted by WIA Federal on the future form of AR Magazine. This has come about because of the proportion of the WIA Federal Budget, which is taken up by the publication of AR Magazine. Unfortunately if we want a magazine some cost is involved and the present magazine is being produced at the lowest possible cost for a reasonable quality magazine.

Any variation in paper quality to give sharper photographs and diagrams for example will cause a significant cost increase not only for paper but it would also require a change of printing press also at higher cost.

The Editor receives an Honorarium for the time he has to devote to preparing the magazine, a 365 day a year job, but all the other WIA members involved in producing AR are volunteers. Removing the Honorarium would make little difference to the cost of producing the magazine but the time involved requires some recognition by the members.

Now the content of the magazine is also provided free. There are no payments to authors, more volunteers. If we want specific topics covered we have to find volunteers to write the articles. There is no money to commission material. Some material from overseas is brought to the Editor's attention but in all honesty there is little that can be published in AR without modification for local conditions eg in technical construction articles, local suppliers of components. Who is going to find time to research this unless they have done the searching to build it themselves? Usually they have little inclination to write the local version. Occasionally this happens: we are presently preparing an article which originally appeared in *Electron*. This is one of the Dutch AR Society Journals but only because we had a member who was fluent in Dutch and was willing to do the translation.

My feeling from the lack of feedback is that AR is OK, could be

better, could be much worse. I publish mainly simple technical articles because the older membership is not into big projects. I'm not sure what the younger group do, but maybe they are much more IT literate and they exchange information on the net within special interest groups. None of this is polished for publication in a "formal" magazine.

So I will continue to put the magazine together from what members submit for inclusion. I will use articles from overseas AR Society Journals when they are passed to me.

Show us what you are doing!

I'm told the recent Hamfests at Wyong and Healesville went well. Unfortunately the only photo I have seen of Wyong shows mainly the backs of attendees. So if there are any good, clear, bright faced photos of people and equipment at a recent event out there, either hard copy photographs or 3megapixel digital, I would like to use one on an AR Cover with a report on the event. The John Moyle Field Day should also have provided photographic opportunities, however four element beams at sixty feet have all been seen before.

I am hoping to run a multi band FD station 1.8MHz to 1.296GHz. When your station is an FT101E and some ex commercial VHF Xcvrs and a kit built transverter for 1.296GHz it takes a bit of packing and power reticulation planning and of course when you have done all that you still have to select the aerials and how and where you will mount them. Are you also going to get out there on FD and have some fun? The other side of it is that it is an exercise in preparedness for emergency communications.

73 Colwyn VK5UE

Amateur Radio: linking the nation again

Amateur Radio Operators are often found among the ranks of early pioneers in Australia. While many people are aware of the exploits of people like Traeger there are many more whose names and endeavours are only known to the amateur radio community.

When I talk to non-amateurs I can take pride in identifying the role that amateurs had to play in shaping many of today's modern communications methods. Experimentation is after all one of the prime reasons for the existence of the amateur radio licence. This is not to say that experimentation is all about building esoteric circuits and getting them to operate on air. This was brought home to me today as I took part in efforts to bring the Internet Radio Linking Project (IRLP) to the last Australian territory, namely the ACT.

After some trials and tribulations the task was completed on Sunday 17 February, an important day for amateur radio in Australia for a number of reasons. Firstly it is a metaphor for the way amateur radio can bring people together, both within Australia and the world. Secondly it reinstates the value of self-education in amateur radio. Much of the implementation required that amateurs learn a wide range of new skills. Finally it was personally significant, making me realise that amateur radio is an evolving hobby. One of the first contacts was with the owner of an IRLP node in the North of England to a UK station licenced under the new foundation licence arrangements. I look forward to the release of the Productivity Commission report in early March 2002, hoping that the need for a foundation licence has been recognised, and that the report recommends the required changes to the legislation to permit its introduction. We need the enthusiasm of new members who will propel amateur radio into the future.

Legal Operations

For some months the WIA has been working with the ACA to reach agreement on a public statement of an interpretation of the ways in which IRLP

can be legally operated in Australia under the terms of the current Licence Conditions Determination (LCD). I hope that this work can be finalised in the near future so that all amateur operators can be aware of how to correctly build such installations. This work has been spurred on by a concern that some amateurs have been operating in a manner which might well be illegal. At this stage whilst the ACA has indicated that it is happy with the authentication and operating principles of IRLP they have yet to commit to other Internet linking mechanisms such as iLink and winLink. The WIA cautions all amateurs against operating in a manner which is in violation of their licence.

AR

I released a draft of the AR discussion paper in late February to the members of the Federal council and executive. Some of you may well have received copies already - if not have a chat with your local Divisional council in order to obtain a copy. At this stage we are not considering any new options other than those already identified in earlier reports on progress. The main variation that has been introduced in the options paper is to consider a hybrid approach with both news stand and web based delivery of AR as a way of meeting the range of stated member preferences. Adopting this approach can be viewed as a way of meeting all members' delivery needs as well as serving as a means of putting amateur radio in front of the public. For some time now we have asked the question "How can we attract new members?" The response often entails the use of a marketing campaign to present the details of what amateur radio is about to the General Public. Placing AR on the newsstands is a great way of achieving this while at the same time placing its future on a sound financial footing.

The decision of where we go from here is to a large extent dependent on Federal Council and the advice that I receive from them. If you want to help to

influence the decision you should make your representations to your local Divisional council members. After an initial review I hope that we will be able to publish the options paper to all members so that they can see the details of the options being examined and more importantly participate in the debate.

Examinations

There has been a considerable amount of discussion in the last few weeks about the recent changes to the amateur examination invigilation scheme. Whilst I am sure that some of you may be unhappy with the current scheme there are two factors that I would ask you to consider. These changes are to a large extent only the first changes of a two stage process. Last year we indicated to the ACA in our response to an open tender invitation that the WIA would be happy to take on the full responsibility for administering all amateur examinations in Australia. For us to be able to do this we need to demonstrate impartiality in the way that the examinations are administered. If, as hoped, the ACA do in fact devolve full responsibility for the management of amateur examinations to us then the recently announced changes will need to be further refined. The experience that we have gained in this first round of change will I hope make it much easier for us to develop a system that both meets the ACA's requirements for impartiality as well as meeting the needs of the instructors and invigilators. I am keenly aware of the efforts of the many individuals who give freely of their time in order to ensure that new amateurs can receive the instruction, coaching, and easily accessible, supervised examinations that they need to gain their certificates of competence in order to become licenced operators. Thank you for all of your efforts.

73s and I hope next month to be able to report on discussions held at the Wyong field day

"Tone-a-Tune"

Audible SWR Bridge

Drew Diamond, VK3XU
45 Gatters Rd.,
Wonga Park, 3115.

In radio transmitting work, an instrument that finds frequent use is our trusty SWR bridge. Generally, the indication given to the user is a visual one, by means of a moving coil meter or meters, or LED bar graphs- which is fine for persons with good eyesight. And if you have poor, or no eyesight- what to do? Offered here are details of a handy little bridge, which gives an audible indication of relative SWR.

After calibration in the (F)orward direction, the bridge is switched to read (R)everse, where a lower frequency tone will be heard. When adjusting an antenna coupler for instance, the user simply adjusts the coupler controls for lowest tone (or silence, for SWR of 1).

Unlike "strip-line" type bridges, the transformer pattern (Ref 3) has substantially flat sensitivity from 1.8 MHz to at least 50 MHz (but not 144 MHz), and may be used at power levels from as low as 1 W (QRP) to the legal CW limit of 120 W.

Circuit

Transformer T1 (see Fig 1) is formed by passing a short length of RG-58 coax cable through a toroidal core, which has 12, turns wound upon it. The coil, which responds mainly to the current component of the electro-magnetic field flowing along the coax sample, is terminated with a 54 ohm resistance, comprised of two 27 ohm resistors connected in series. The junction of the 27 ohm resistors is connected to a series voltage divider comprised of a 4.7 k

resistor and 500 ohm trim pot, at which a portion of the electric (voltage) component of the field is injected. When RF energy is flowing along the coax, and the (Ant)enna connector is terminated in a purely resistive load of 50 ohms, the voltage induced in the transformer winding will aid the electric field sample at one end of the winding, and exactly oppose (or cancel) the voltage obtained at the other end. Now, if the terminating impedance deviates from 50 ohms resistive, there will be proportionately less cancellation, resulting in a net voltage available for detection on the (R)eflected side of the coil winding. Germanium diodes detect the voltages thus obtained at each end of

the coil winding, and their resultant relative dc values are established upon the slider of the dual-gang sensitivity pot. (F)orward and (R)eflected readings are selected with switch S2.

To provide an audible reading, an ordinary NE-555 timer chip is wired as an astable oscillator. Trigger point may be altered (and therefore the frequency) by varying the voltage applied to the discharge pin 7, thus making the '555 behave as a voltage controlled oscillator. When the voltage (with respect to ground pin 1) equals, or is less than about +6 V, the chip stops oscillating. As the positive voltage is raised beyond 6 V, the circuit will oscillate at an increasingly higher frequency, as noted above. In order to make the '555 respond to dc levels just over 0 V, a positive bias voltage must be applied. The necessary bias is supplied by the voltage divider comprised of the 10 k - 10 k trimpot - 22 k resistor string. The slider of the trimpot is set for about +6 V. Now, input voltage, resulting from the dc signal from each SWR bridge diode will add to the standing bias voltage, and thus cause the '555 to oscillate. The frequency of oscillation will rise in proportion to the degree of mis-match (higher SWR) when the dc level from the (R)eflection diode is selected by S2.

Note that the SWR bridge "ground" PC foil and the NE-555's "ground" foil (-9 V rail) are electrically separate with regard to dc.

Construction

A plain circuit board measuring 55 x 40 accommodates the SWR bridge components, and a separate plain circuit board measuring 55 X 65 mm contains most of the components for the

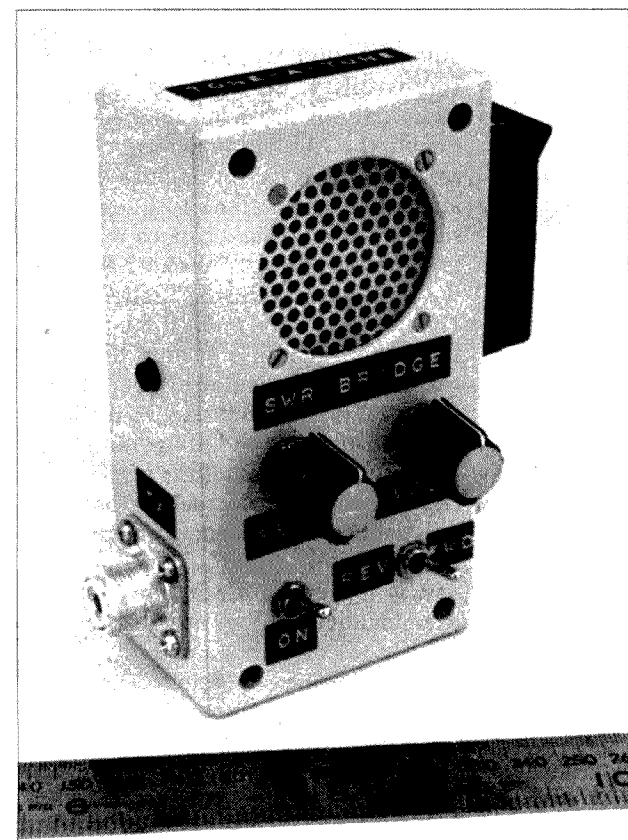

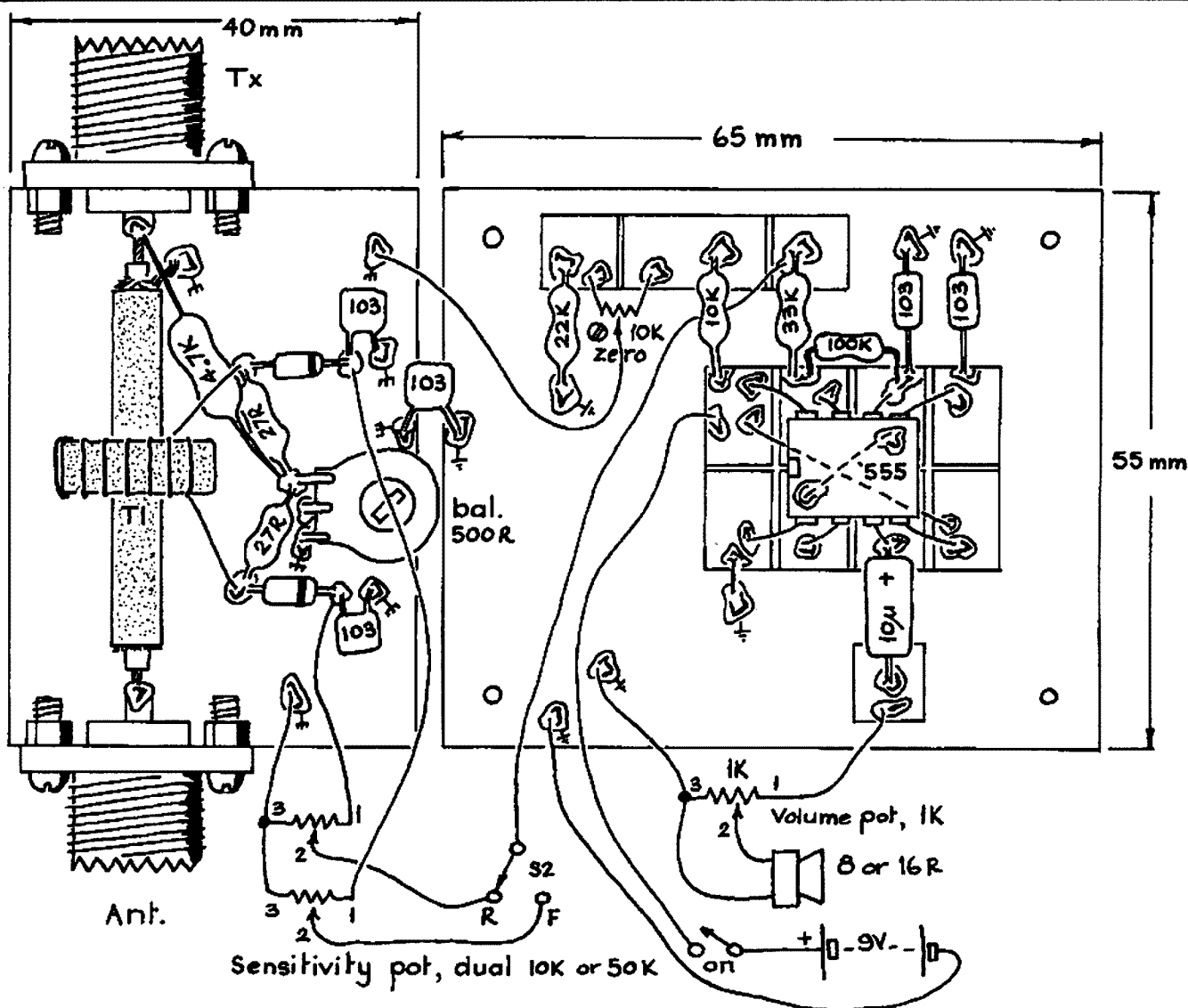

Fig 2

oscillator. For the device to work properly, the arrangement of the SWR bridge components should be duplicated as closely as practicable. A suggested 'paddyboard' (see Ref 2) layout is shown in Fig. 2. The RG-58 coax jacket is a snug fit through the hole of the toroidal core. Note that the braid is connected to foil at one end only. It is recommended that the '555 chip be fitted into a suitable 8-pin I.C. socket and soldered with tinned wires (about 0.6 mm) to an 8-land substrate, which in turn may be super-glued upon your circuit board.

The case shown is a 'jiffy' box

measuring 130 x 68 x 44 mm, and is available from the usual electronics suppliers. An internal view of the prototype is shown in Photo 2. Leave sufficient hook-up wire lead lengths so that the front cover may be fully opened for access. An external holder for the battery is recommended.

Operation

Give the wiring, soldering and parts placement a thorough visual inspection. Install a fresh (preferably alkaline- for lowest internal resistance) 9 V 'transistor' battery. Set all pots and trim pots to about half travel. Switch on. You

may hear a tone, or buzz. Vary the zero trim pot through its range, then set it at the point where oscillation just ceases, thus establishing best sensitivity for the oscillator. Using coax cables, connect the TX connector to the transmitter's output, and connect a low SWR, suitably rated 50 ohm dummy load to the Ant connector. Key the transmitter on and apply a CW tuning signal to the bridge. In one of the positions of S2 you should hear a tone. You should be able to vary the tone frequency by changing the setting of the sens(itivity) pot. One setting of S2 will yield a high tone, the other a low one. The low setting turns

out to be the (R)eflected position of S2. With S2 in the (F)orward position, adjust the sens pot for a tone of about 300 Hz. Switch S2 to (R)eflected, and carefully adjust the 500 R bal pot for lowest tone or silence, indicating SWR = 1.

In use, a tuning signal is applied with S2 set to (F), and the sens pot is adjusted for a tone of about 300 Hz. S2 is then flicked to (R), where a lower tone (or silence) should be heard. When adjusting an antenna coupler for instance, the coupler's controls are adjusted, as required, to bring the (R) tone down to as low a frequency as possible, and preferably to zero (silence).

Parts

Most of the components specified are available from our familiar electronics vendors, including Altronics, Dick Smith Electronics, Electronic World and Jaycar. My 'jiffy' box is a Jaycar HB6023. The 1 k vol pot and dual 10 k (or 50 k) sens pot should be miniature types, and miniature switches are also suggested for S1 and S2. The speaker may be a small transistor radio type, 8 or 16 ohms. See Hamads in Amateur Radio for your local Amidon core supplier.

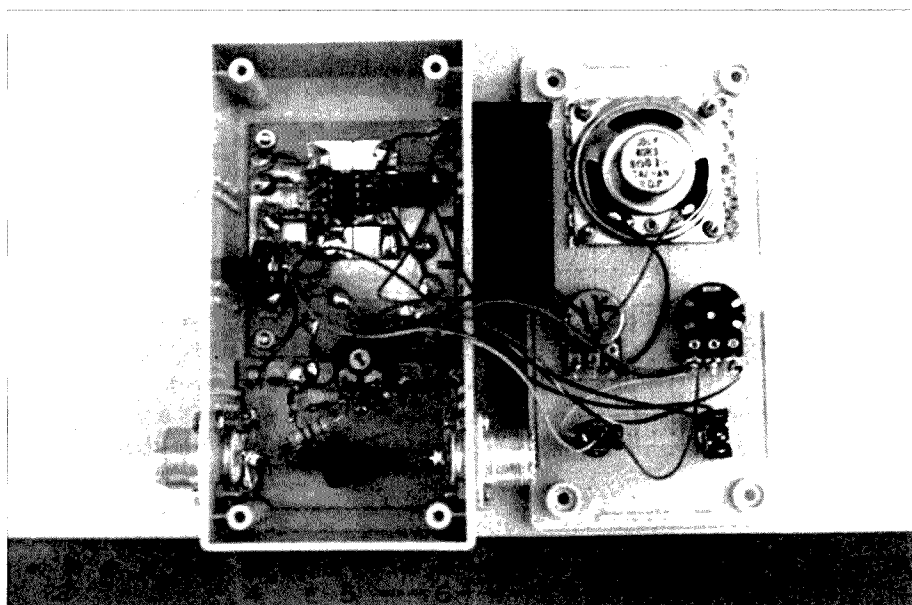

References and Further Reading:

1. Conversations with Dave Buck, VK3AAD.
2. "Paddyboard" Circuit Construction; Diamond, AR, Feb. '95.
3. "A Twin-meter SWR Bridge"; Diamond, AR May '99.
4. I.C. Timer Cookbook; W. Jung. Sams Publications.
5. Engineer's Notebook, F. Mims. Archer Publications.
6. 555 Timer and Applications; M. Sharma. BPB Publications.

ar

Episode Four of Types of Emission

SUB-SECTION IIB - Optional characteristics for the classification of emission

#7 The optional characteristics should be added for a more complete description.

These are:

Fourth symbol - Details of signal (s)

Fifth symbol - Nature of multiplexing

Where the fourth or fifth symbol is used it shall be indicated as below,

Where the fourth or the fifth symbol is not used this should be indicated by a dash where each symbol would otherwise appear.

1) Fourth symbol - Details of signal (s)

- 1.1) Two-condition code with elements of differing numbers and/or durations

A

- 1.2) Two-condition code with elements of the same number and duration without -error correction

B

- 1.3) Two-condition code with elements of the same number and duration and error-correction

C

- 1.4) Four-condition code in which each condition represents a signal element (or one or more bits)

D

- 1.5) Multi-condition code in which each condition represents a signal element (of one or more bits)

E

- 1.6) Multi-condition code in which each condition or combination of conditions represents a character

F

- 1.7) Sound of broadcasting quality (monophonic)

G

- 1.8) Sound of broadcasting quality (stereophonic or quadraphonic)

H

- 1.9) Sound of commercial quality (excluding categories given in #1.10) and 1.11)

J

- 1.10) Sound of commercial quality with the use of frequency inversion or band-splitting

K

- 1.11) Sound of commercial quality with separate frequency-modulated signals to control the level of demodulated signal

L

- 1.12) Monochrome

M

- 1.13) Colour

N

- 1.14) Combination of the above

W

- 1.15) Cases not otherwise covered

X

Cheers from Henry
VK8HA@OCTA4.NET.AU

The Double Tuned Crystal Set Tuner

Felix Scerri VK4FUQ
9 Garbutt Street
Ingham Qld 4850

Crystal Sets have undergone a bit of a revival in recent years. This is something I am quite happy about. I built my first crystal set back in my childhood and have built a few more since then. There is something magical about a radio receiver that doesn't use any batteries! The article describes what I call my reference standard crystal set. It is a beauty. It uses two tuned circuits in a novel configuration to provide high selectivity prior to the diode detector.

The unit is primarily designed as a tuner but it will also feed high impedance headphones or a crystal earpiece directly.

As will be seen from the circuit, the set is still very simple and straightforward. I built mine true breadboard style on a piece of pine board using strips of double sided tape to secure the two tuning coils and other components. The main tuning capacitor was glued with a few dabs of a high strength adhesive. I used an old tuning gang salvaged from an old valve receiver for the main tuning and a modern miniature variable capacitor for the preselector tuning.

Winding the Coils

I wound the coils on short lengths of ordinary ferrite rod material. I used about fifty turns for the main tuning coil and about twice as many for the preselector coil. This is necessary because of the lower maximum capacitance of the miniature tuning capacitor compared to the main tuning capacitor. The connected long wire antenna also has an effect. In all likelihood the exact number of turns will have to be determined by experiment. That's half the fun!

I used quite thin wire salvaged from an old valve receiver IF transformer to wind the coils. Despite what one might think this gave very efficient coils. Using substantially thicker wire was not as efficient. The wire used could be 0.315mm enamelled copper winding wire close wound on ferrite rods. In my model I spaced my coils about two inches apart, once again, in individual versions, this will have to be determined by actual experiment. Also remember to

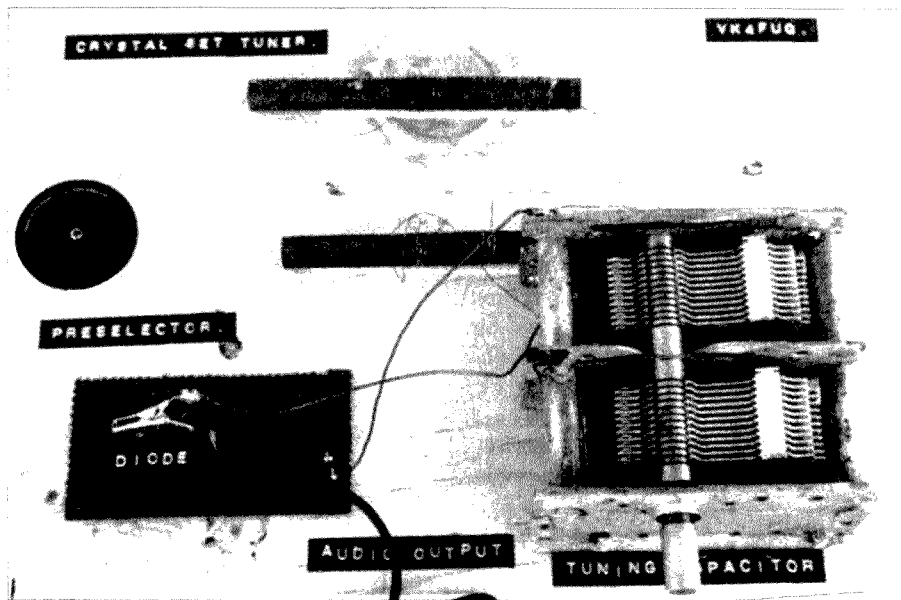

Photo 1. Double Tuned Crystal Set.

observe the winding phasing. A hint - superglue type adhesives make coil winding easy.

The Detector

When it comes to diode detectors I am reminded of an old television advertisement from the 1970's for a certain engine oil. One could alter it slightly and say, "Diodes ain't Diodes". In all honesty any germanium diode will work in a crystal set but some types are definitely better than others. I favour the use of gold bonded diodes such as the OA47. The 1N60 is acceptable, as is any germanium diode. Many things can affect diode performance, such as the level of signal injection, and diode termination. In the end, the lesson is, use whatever diode works best.

Using The Set

Depending on location an external antenna and earth will be required. As I am over seventy miles from our local transmitters, at this location, they are definitely required. As was stated earlier this design is primarily intended to feed an amplifier and speakers as it is in my case. As the audio output level is a little low for a line level input I use an outboard one transistor preamp to raise the level. Once again magnetic high impedance headphones or a crystal earpiece can be directly connected. If using a crystal earpiece firstly connect a ten kohm resistor across the output of the detector diode. This is very important. The diode requires a resistive termination to function properly.

If using a preamp arrange the circuit to provide this. On my preamp the input

level control serves this purpose. In use both tuning capacitors need to be peaked to the same frequency. The main tuning will be somewhat broad, the preselector tuning, sharper.

That's it, the best part, the audio quality has to be heard to be believed.

Parts List

L1 80-100 turns 0.315mm enamelled copper wire close wound on ferrite rod depending on local conditions.

L2 50 turns 0.315 mm enamelled copper wire close wound on ferrite rod.

VC1 Miniature Variable Capacitor, Max 260pF.

VC2 450 pF variable Capacitor from old valve receiver.

D1 OA47 Germanium Diode.

C1 0.002 mF ceramic capacitor.

R1 10 kohm metal film resistor, if needed for diode termination.

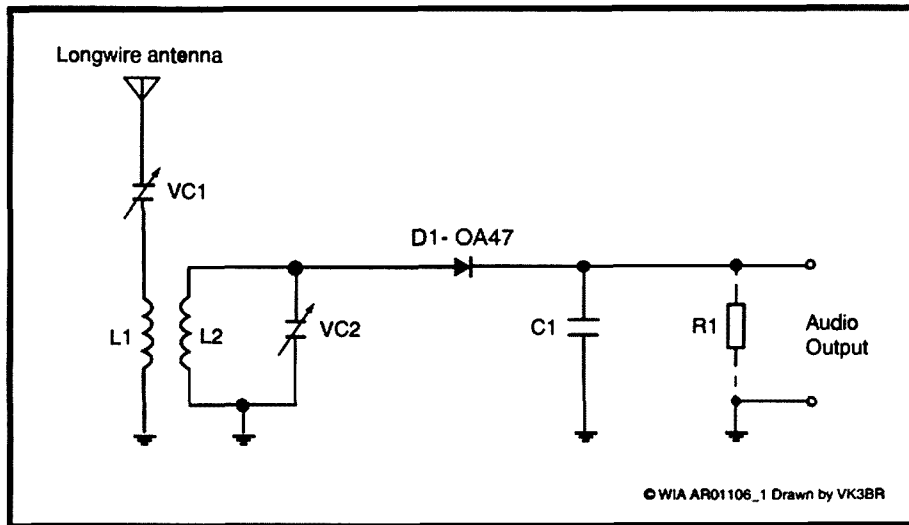

Figure 1. Double Tuned Crystal Set Circuit.

ar

Federal WIA Convention

Appointment to Federal Positions

The WIA Federal Convention and Annual General Meeting of the WIA will be held in Melbourne on **17, 18 & 19 May 2002**

At this meeting, a number of positions will be filled. Nominations from interested persons must be received by the Federal Secretary at the registered office of WIA Federal in Melbourne no later than close of business on 5th April 2002.

The positions are

President
Directors (3 positions to be filled)
Company Secretary

Editor "Amateur Radio" magazine
Publications Committee (5 positions)
WIA/ACA Liaison Committee (3 positions)
IARU Region III Liaison Officer
ITU Conference & Study Group
Federal Web Page Coordinator
Chairman Federal Technical Advisory Committee
Federal Education Coordinator
Federal Historian
AMSAT Coordinator

Intruder Watch Coordinator
Federal Contest Coordinator
Federal Awards Manager
Federal WICEN Coordinator
International Travel Host
ARDF Coordinator
Federal QSL Manager
VK9/VK0 QSL Bureau
QSL Collection Curator
Videotape Coordinator

Nominations received direct will be considered but preference is likely to be given to Divisional nominees

Peter J. Naish VK2BPN
Federal Secretary

Unlikely Projects

Charlie's Toys No 1. Grid Dip Meter

Charlie Sims VK2ABF QTHR
Email: chasims@ozemail.com.au
Fax: (by arrangement only) 02 96359937
Voice line: 02 96359937
M/Hd: QF56LE

How it just grew

My need for a reliable G.D.Meter arose when I purchased two ex-taxi phone boards for \$2 each. The objective was to have a couple of two metre receivers to continuously monitor the packet net.

My Pkt address is VK2ABF@VK2GJB. Heck, does one realise that a video monitor consumes about 250 watts by itself. What price the power bill! Hi!

Now, my commercial GDO is quite twitchy at 144 MHz, when it's able to get up that far, that is; in fact I'd had enough of solid state GDOs. The old vacuum tube version seemed to be the answer.

Which tube then?

The old 955 acorn tube, if not gassy, suffers from surplus lead length, leaving very little for the hairpin inductor thus

requiring an extension link to get into typical 2 m circuitry. Not a likely choice really, maybe the triode of a 6U8 or 6BL8 ex TV tuner vintage may suffice.

My friend, who sold me the boards suggested a 5718 with pigtail leads—said it was good to 700 MHz. He also drew me up a butterfly variable capacitor to go with it. I liked the tube, but needed more coverage than a small segment of the band. A small butterfly wouldn't give enough coverage, I thought. Among my treasures was a wide spaced "condenser" of about 70 pf capacitance. Unlikely, but just wait and see! Because

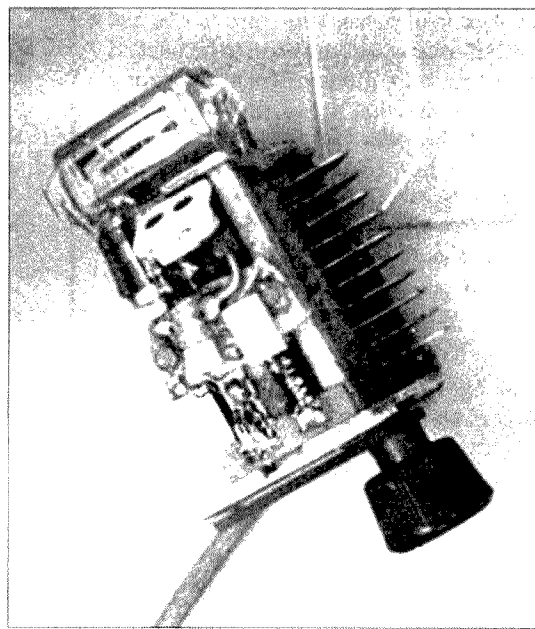

Photo 1

the stator plates had central side mounts, I was able to saw the two halves on alternate sides of the mounts, —what butchery! Also the three central stator plates were removed- using the same abrasive saw. (Wire with grit stuck on.) Hardware stores have them for about \$10. The remaining stator plates became three only per segment, bringing the "C" for the circuit to about 25-30pf. The saw cut gaps were restored using pieces of toothpick dipped in Araldite. (TM.) See fig. 1.

Construction in brief

Now, legs to the two segments were provided -terminated by a 300 ohm TV socket at the corner of the instrument- not like most GDOs which have the hairpin outlet fair in the end of a biggish (in proportion) box. The longest leg was made much fatter to make it think it was part of the rear stator segment. Hairpins were made in random fashion with the most likely ones selected for service. Photo 1 shows the circuitry.

The valve (type 5718) and other tuned circuit components were tucked in to ensure the shortest lead length. In the second photograph you can see how snugly the valve tucks into the capacitor. You can also read the type No., and just have a gander at those nice short leads! However, the edge-view meter (cheap) sits in line of sight, just below the inductor socket. Many of the components can be seen in both photographs. Coils are identified by

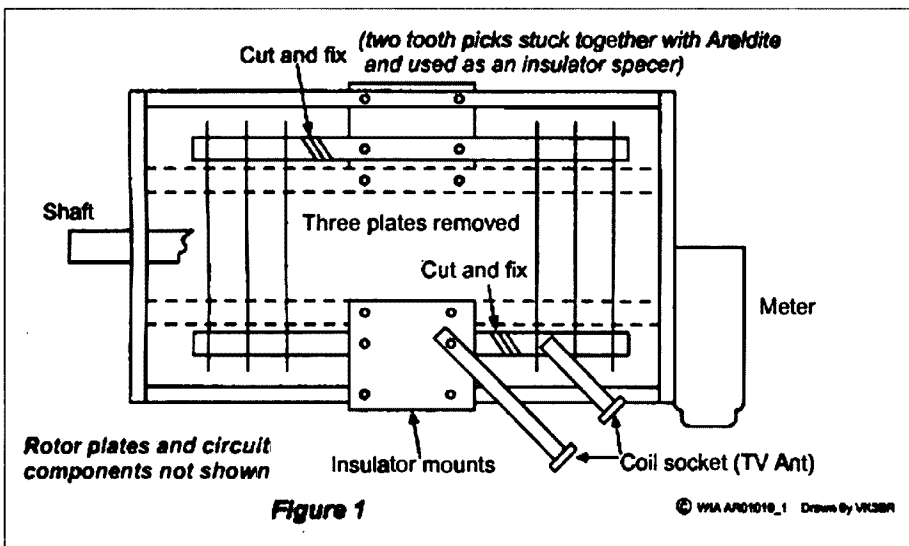

Figure 1

threading different coloured shrink tube over them and heating to taste. A cigarette lighter was adequate for this. On the other end of the variable capacitor I stuck a 180 degree protractor, a knob on the spindle with flat cursor tipped with a scrap of centrally scribed perspex. Attached is a copy of my calibration Tables 1 and 2, but your's will be different. The calibration listing is given to illustrate how 40 m. and the local oscillator appropriate to it can be just covered by capacitor chosen.

Feeding the beast

To power up this monster I used a dog-blanket transformer, 240V-25V ac. This was boosted with a string (about 5 X tantalums and 1N4007s) of voltage improver. This gave about 75V, which was short of requirements. However, by reducing the grid leak resistor, I obtained a good needle swing for all ranges. 6.3 volts ac for the heater came from half of a half- burnt-out 12V plug pack tucked inside the dog-box without the cover along with the voltage multiplier, all insulated with scrunched up paper and held steady with double-sided sticky tape and Araldite(TM.) and the lid put on quickly.

This item actually works, and works very well, but who needs a GDO anyway?

Well, the challenge was there, and the alternative was to toss out all those

precious treasures that I had kept for years.

The Circuit

Any GDO circuit will do, they are all the same, aren't they?

Feedback.

Not the electrical kind, but any helpful suggestions would be appreciated. Unlikely?

Does any contributor expect his project to be duplicated by another enthusiast? I think not, but why not test the water? Hopefully, some readers will read this more than once.

Editor's Note. When you're stuck, are you stuck? The junk box does have its uses.

ar

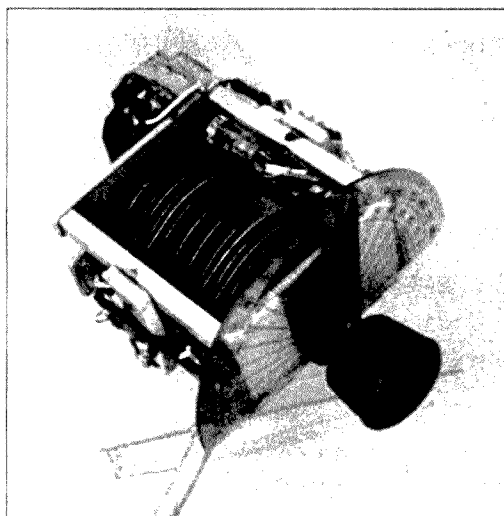

Photo 2

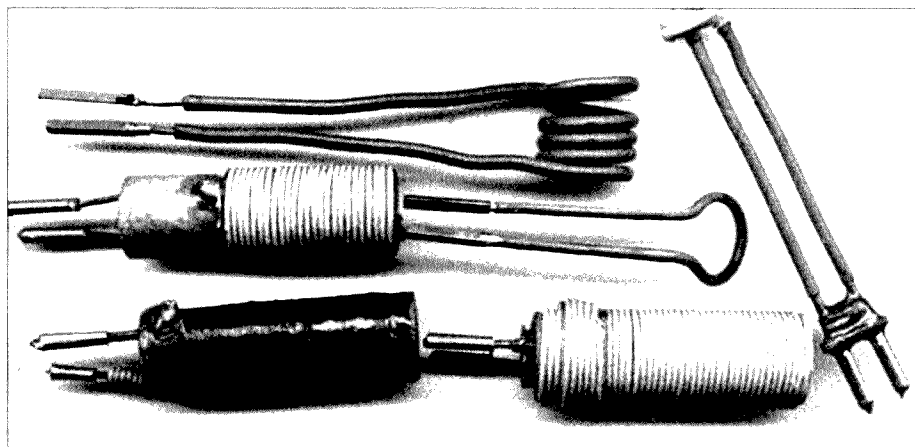

Photo 3

Calibrations

Charlie's Grid Dip Meter for determining frequency of tuned circuits

Large Dark Coil	4.75 - 6.0 MHz
Large Light Coil	9.00 - 12.0 MHz
Small Light Coil	14.00 - 20.0 MHz
Top Coil	53.00 - 75.0 MHz

Table 1 (See photo 3)

2 metre calibration

Degree	MHz	Degree	MHz
0	130	130	144
36	134	135	145
42	135	146	146
52	136	155	147
64	137	164	148
		180	150

Table 2

Club News

New IRLP Node in Melbourne

Melbourne's first IRLP Node on the 70cm band is up and running via the Arthur's Seat repeater on a frequency of 439.725 MHz.

The node is operated by members of the Bass amateur Radio IRLP Group.

We invite all amateurs to try the IRLP. Our operators will be only too happy to demonstrate IRLP.

For further information you can contact our group by phone, 03 5982 0315, or write to the Secretary at PO Box 368, Rosebud Vic 3939

True Confessions of a Bin Raider

John Kirk VK2PV/VE6XT,
Ph. (02) 9245-6372, Fax (02) 9492-2639,
E-mail: john_kirk@brambles.com.au

'Dumpster Diving' for Fun and Profit

Drew Diamond's excellent article on rewinding power transformers (AR, Sept 2001) prompted me to share the results of my recent experience with that annual Aussie ritual euphemistically called "Council Cleanup". This is wherein dozens, if not hundreds of perfectly serviceable transformers suitable for amateur projects are delivered to the curbside to await the opportunistic electronic experimenter.

Invariably, they are disguised as dead microwave ovens, but don't be fooled – every one is the cornerstone of a decent high current, low voltage power supply. If we had our druthers, we'd accept only carcasses of the behemoth of the microwave kingdom, the 1.0 or even 1.1 kW "nuker", though even their littler cousins provide good practice material and gifts for friends too proud to dumpster-dive].

Inspired by a QEX article of a few years ago (Build a High Voltage Power Supply at Low Cost, Henderson, Jan 1998 QEX, 47), my first "dive" resulted in a few pearls to play with.

By application of Drew's formula: $\text{Watts} = (5.58 \times \text{core area})^2$ we find the pig iron within to be in reality around 500 watts. Clearly, microwave ovens are spec'd out in "marketing watts", a unit of measure akin to "peak audio power", which has severed all ties with the laws of physics that govern us mere mortals. Nonetheless, this transformer shows real potential in amateur applications, even for those of us with current-hungry vhf "bricks". Dimensions compare

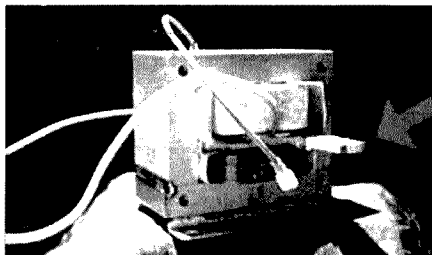

Magnetic shunt #1 about to part company with the transformer. Shunt #2 still in place

favourably with the unit in my store-bought 35-amp power supply, confirming that we're probably onto a good thing.

Because these transformers have welded laminations (presumably to cut down the chatter amongst those loose 'E's and 'I's), our approach has to be a little different than Drew's. The secondary and primary are not wound "over/under", as we are accustomed to seeing with control transformers but rather side by side, with a generous gap in between. This enables us, with a little care, to remove the existing high voltage winding with precision surgical instruments such as hacksaw and wood chisel. Don't use the good chisels – this is rough service!

Remember: small gauge wire = secondary = discard. Large gauge = primary = keep. This will seem obvious to the grey-bearded "hollow-state" generation, but somewhat counter-intuitive to those of us that earned our stripes releasing the imprisoned smoke from within silicon fuses.

Also on board will be a heavily insulated 3.15-volt filament winding. Count the turns as you peel this off to confirm the "turns per volt" ratio, but I've yet to see one that wasn't a fortuitous 1 turn per volt, making the math coming up dead easy.

Another peculiarity of microwave transformers is the presence of one or more magnetic shunts. What the %^&* is a magnetic shunt? I still don't really know, but they were described to me as a deliberate attempt to make the

transformer suck wind under heavy load. I agonized over this after reading Henderson's article, but in practice, they're easy to deal with – look for 1 to 2 small lamination blocks that look like they could be convinced to vacate, and apply appropriate blunt trauma with a block of wood and hammer.

The carcass that remains will have a generous winding window. That, combined with the 1 turn per volt ratio, makes rewinding a snap. Because we'll be drawing the entire length of wire "through the keyhole" with every turn, you'll want to precut a suitable length, rather than work with the whole roll. Both from an availability standpoint and ease of winding, it may be preferable to parallel 2 or more smaller gauge windings to achieve the desired "oomph". Since we've generally got lots of real estate to play with, it might be worth considering doubling up the secondary turns, enabling us to go to the more efficient 2-diode bridge configuration.

There you have it! Before we return the patient to the curbside, we would probably consider scavenging the AC power cord, fuse block, control PC board and possibly some sheet metal, but in reality, there's not much else to interest us here. A true stealth artist, working under cover of darkness, could have the patient back at the neighbour's rubbish pile before they even missed it, albeit several kilos lighter!



Morse sending made easy

Neville Mattick VK2QF (ex 4W/VK2QF)

It wasn't until three years ago that Morse sending became a problem to me. It has been explained by the discovery of a rare genetic disorder that causes reduced fine hand control. Now I know why my handwriting is nearly illegible and has been always. What a problem, Morse sending is garbage and frustrating with aches and pains both in the wrist and ears from all the mistakes.

Suddenly a link on the UKSMG (UK Six Metre Group) announcements page directed me to the home of Steve K1EL and his micro controller (or PIC) CW generators.

These amazing little devices are the Radio Amateur's answer to all aspects of Morse generation. They make programmed EPROM's redundant for fixed ID on say repeaters or the home station. A range of models is available. My first was the K10, a standalone keyer with paddle input and many features. This worked well with its four volatile memories, but the operation of a paddle was still a chore.

Along came the K20, this is paradise! The K20 is a standalone PIC built on a small circuit board with the following amazing features:

- Built-In PS/2 AT Keyboard Interface
- Iambic CW Paddle Interface
- PTT Output: Open Collector (low true)
- Adjustable lead in and tail delays
- Key Output: Open Collector (low true)
- Adjustable Speed 5-99 WPM
- Adjustable Dit/Dah Weighting
- Adjustable Character Spacing
- Built-In Sidetone Generator
- On Board Speaker
- Sidetone with adjustable frequency
- 12 Message memories
- No crystals or oscillators
- Operating Voltage: 8-18 Vdc
- On board regulated 5 volt supply
- Current Draw: <5 mA less keyboard
- Embedded commands in messages
- Iambic A, B, and "Bug" keyer modes
- Built in CW practice modes
- Autospace
- First Dit/Dah adjustable correction
- HSCW Output Capability

Several of these units have been made and all worked flawlessly straight off the workbench. All that is required to

control the K20 is a standard PC keyboard with a PS/2 or mini din plug.

The twelve function keys on the keyboard provide memory functions that are written to the EPROM as they are saved along with a host of user preset functions. These are available each time the keyer is turned on, so no need to program anything after the initial setup!

One of the most useful functions is the beacon feature that enables a message to be programmed in and have it repeat with a preset delay or speed variation. As a result of the intermittent power experienced in my recent East Timor activities Steve K1EL incorporated a

'persistent beacon' feature that has the keyer resume the message in 'Function button one' whenever powered on or until the Escape key is pressed. The full manual is available for download at the Internet address below.

To contact the designer via mail:
Steven T. Elliott K1EL, 43 Meadowcrest Drive, Bedford, NH 03110, USA

Email: K1EL@aol.com or on the Internet <http://members.aol.com/k1el/>

Enjoy the new dimension of precision (yes it has to be heard to be appreciated) Morse!

ar

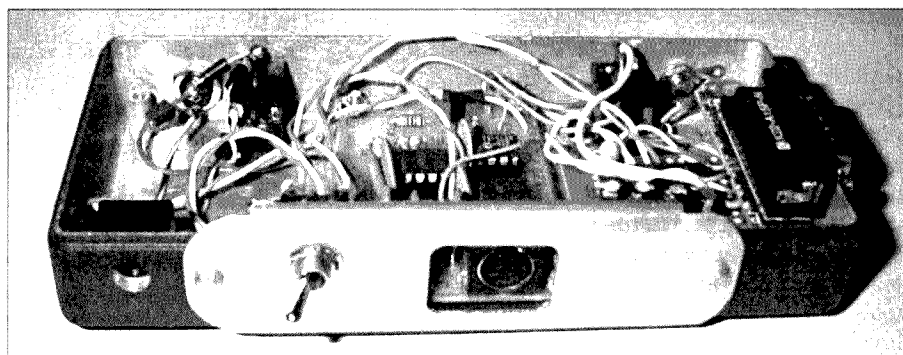
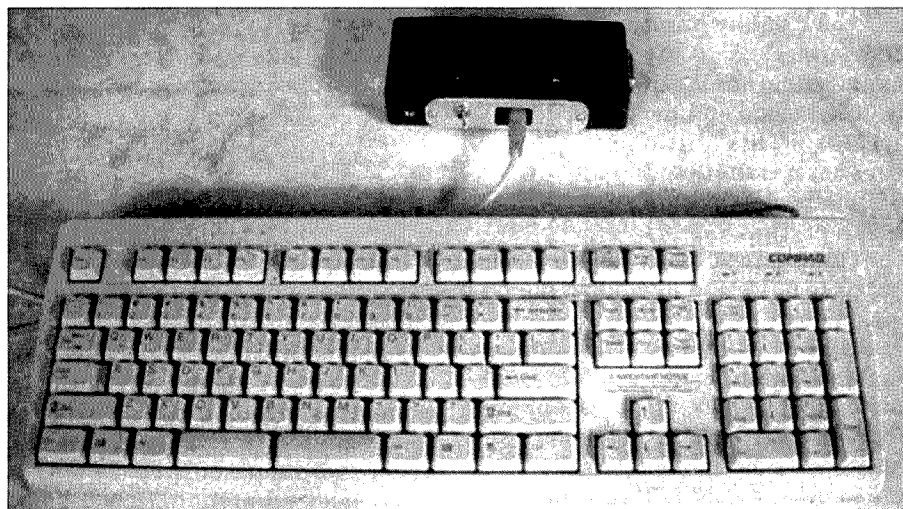

Computers in the shack as a logbook!

Neville Mattick VK2QF [ex 4W/VK2QF]

The shack is a natural place to integrate technology, especially if that technology simplifies using your station [or at least that is the hope!].

Computers are almost universal these days and are a great tool in the shack. Most rigs can be connected to the conventional personal computer [PC] with a simple cable to a free serial port. Nearly all common brands of amateur transceiver have a serial port [just like that on the PC] somewhere on the rear panel. Add a cable and even a basic computer then some magic in the form of software [code or programming that the computer runs] and presto, a new dimension to the hobby and computers! My experience has been with Kenwood and the TS570s. This little transceiver is an HF and Six metre unit with a receiver that covers continuously from 30kHz to 60MHz.

Kenwood provide a specific 'Remote Control Program' or RCP for short. This file is named RCP2911.ZIP and is available from numerous sites on the Internet such as the Kenwood .com FTP server at ftp://216.133.235.165/Amateur/RCPsoftware/TS570DRCP2/Rcp2911.zip.

It requires a little configuration to use, which is covered by the owner's manual. If your transceiver doesn't support remote or computer control there is still a number of programs available to access the rig via a computer.

Contesting is a part of the hobby that I enjoy. I only compete in CW for one reason and one reason only, that is to maintain strong CW capability for low level or weak signal DX work on Six metres [my main AR passion!]. Some

people call this 'cheating' but a QSO is a QSO and is valid for DXCC submission, I estimate the efficiency of Morse to be 3 times that of a phone contact under weak [read normal] conditions on Six metres. The evening of October the 31st 2000 was a good test,

the making. Under the design of Tom N1MM, Terry AB5K and Thomas PA3CEF is N1MM Free Logger. This program is available via the Internet from <http://groups.yahoo.com/group/N1MMLogger>

This is a screen shot of N1MM Free Logger on my PC. The minimum PC needed to run the program properly is a Pentium II 266 or better. This shot shows the two VFO frequencies in the 'band scope' either side of the screen, at the top is the log, with the entry box in the middle. At the lower centre is the 'Info' window which gives band and score summaries for the time on one band and recent multipliers for example.

The program provides many ways for the user to adjust the way it connects to the rig and all the basic variables involved in contesting. CW generation with N1MM Free Logger is a snap, all from the keyboard with a range of configurable preset or macro commands for calling CQ, exchanging and signing off for example. PSK, DX spotting, phone contesting recording and RTTY are also supported! Kenwood, Icom and some Yaesu rigs are easy to connect with N1MM Free Logger. A comprehensive manual is available for download along with the latest versions of the program.

The manual explains for example how the rig is keyed using either the Serial [sometimes called the mouse port] or Parallel [printer] port. A simple interface is made with a transistor to isolate and drive the rig's keying line.

The beauty of all this is that N1MM Free Logger exports your work into a

promise showed for an European opening, 48MHz video and then just under two hours of propagation. 60 QSOs later all around 16,500 km, 9 countries and 5 new entities worked, most were threshold CW contacts, but importantly in the log.

Now having contacts is ok but what about all that log keeping, scoring and submission to the contest manager!

That used to be a tiresome nightmare, typing in say 500 plus QSOs then checking for invalid (or 'dupe') contacts, scoring the multipliers, completing a cover sheet and finally mailing it all off! Too much!

To the rescue are the software authors, many logging programs already support contests or similar and a new one is in

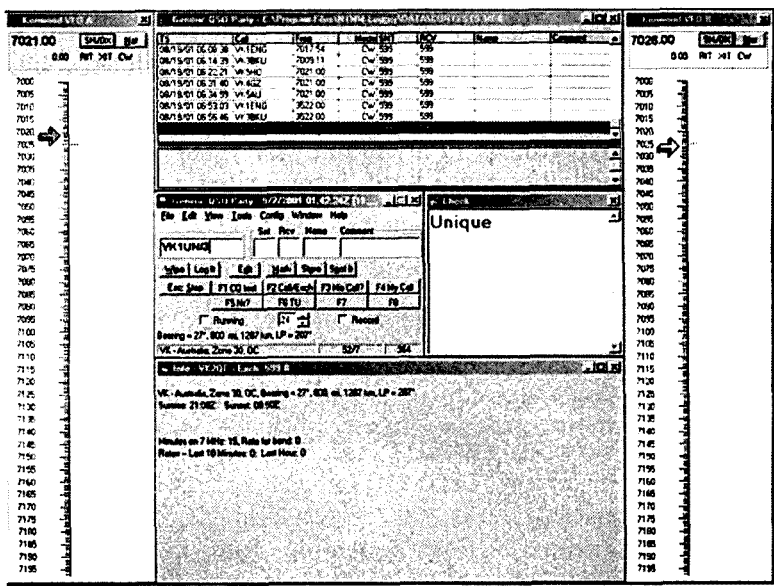

range of formats so that other programs can read the data. Cabrillo is one such format and is universally accepted for contest logs, enabling the manager to score and check the log for errors and dupes. ADIF [or Amateur Data Interchange Format] is also supported both for import and export. Data in the program is stored in an MS Access database format. A

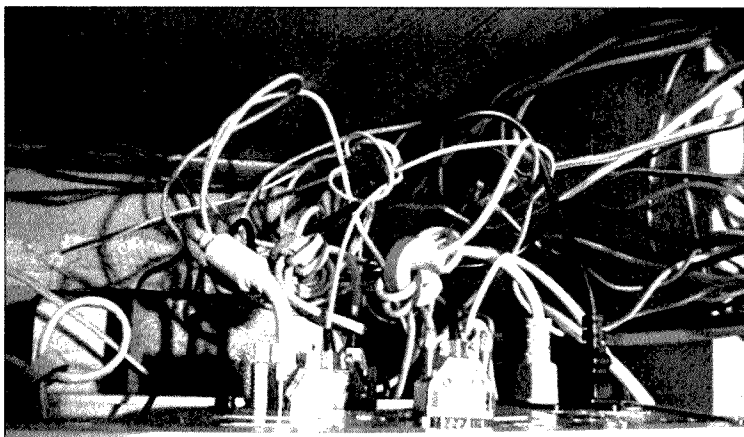

database can hold many contests individually or these maybe combined into one running or DX logbook. MS Access can also open the files N1MM Free Logger creates, enabling export in a wide range of formats also!

General DX logging is supported and the next essential step of 'E-QSL' is being developed. This can't happen too soon for my liking. The bane of a good session on air is all those cards that arrive. Amateur Radio must move to a fully electronic and verified QSL system, this could have the upload of the last day's QSOs to a web server and the other

station is immediately able to verify the contact, that will be such an effort saver!

One downside of the computer is noise, both broadband and spots or spuri! The last thing needed during a DX session is rubbish on the DX's frequency. Some computers are poorly shielded so it's important to look for a casing that seals well at the joints. All those cables going to and fro are a major cause of noise leakage. One solution is to salvage the toroids from old PC power supplies, cut off the windings and ravel as many PC lead turns through them right at the rear of the box.

This latest PC is very quiet on all but one or two minor spots fortunately after filtering the leads. All these toroids also help to keep stray RF out of the beast as well. Interconnection of PCs has never been easier, in the left of photo 2 is a 100MHz network cable to a hub, and from there it is served by a local proxy machine connected to the Internet. All this makes watching DX spotting sites a snap

whilst on air. Adding a network to just two PCs doesn't require a hub, only a single crossover Cat5 cable, but for the \$150 or so it cost's to connect two PCs via 100MHz network cards and a hub, it is well worth it.

Integrating the PC with Amateur Radio is just a natural extension of our hobby and now that more Internet links are made to interface net surfers with aspects of what we take for granted can only be a good thing.

ar

SEANet

The South East Asia Amateur Radio Network (SEANET) was established to 1964 on 20m (14.320 MHz plus or minus QRM). The objective of this Net is to promote fellowship among hams and to relay emergency, medical, urgent or priority traffic. This on-the-air meeting which has taken place without fail daily at 1200 UTC has strengthened unity and co-operation among Hams around the world, especially those within the region. The net also provides Hams a facility for testing their equipment and propagation condition on the 20m band.

The first convention or eyeball QSO of SEANet took place on the island of Penang, Malaysia, in December 1971 when about 30 amateurs met. Present at that historic meeting were the first Net Controller Paddy Gunasekera 4S7PB of Sri Lanka and stalwarts 'Big John' van Leader 9M2IR, 9V1OQ, HS1AIR, Ebbey Lucas 9V1QG of Singapore and Eshee Razak 9M2FK of Malaysia. The second was held in

Bankok in 1972. Recent Seanel conferences were held in Pattaya, Thailand in 2000 and Kota Kinabalu, Malaysia in 2001. This year in Perth will be the 30th Conference.

SEANET has no permanent Secretariat as such, the devoted net controllers work out a schedule among themselves to run the net. It is through the net controllers that the net has been useful in many ways, such as passing the DX news. Dx-

peditions, handling emergency and medical traffic, all amid assigning frequencies for stations wishing to work each other, although SEANET is not a DX net. Members of this 38 year old network can take credit for many actual life saving communications activities, such as, answering distress calls from yachts and handling traffic for medical emergencies and special medicines.

ar

SEANET 2002

**PERTH,
November 1ST, 2ND, 3RD**

Supported by the Northern Corridor Radio Group. Web site www.qsl.net/seanet2002 for all the news. Contacts vk6adi@wn.com.au OR vk6xc@qsl.net

Early Experiments

Developing Radio Communications for the Flying Doctor Service

Rodney Champness VK3UG
6 Mundoona Court
Mooroopna Vic 3629

When the 20th century was only just a teenager an exceptional man came onto the scene in the outback of Australia. He wanted people in the outback to enjoy many of the facilities that we take for granted in the more populated areas of Australia.

City dwellers and those in more populated rural areas had reasonable roads (lousy by today's standard), telephones, a postal service, an embryonic wireless (radio to us) entertainment service (if listening to shipping stations transmitting Morse code is entertainment!), railways, reasonable medical services, schools, churches and even motor cars.

What did the people in the outback have? They had space, glorious space, loneliness, hard work, no roads (but a few 4WD standard tracks, in some places), no telephone, certainly no radio, no railways, no medical facilities, few cars, no churches and no educational facilities. The people of the outback sure had it all!

Who was this person that had such forward innovative views, who wanted to change life for the better in the outback? It was the Reverend John Flynn (Flynn of the Inland), a minister in the

Presbyterian Church. He felt a great compassion for these lonely outback people and strove to find ways to make their lives just that bit better. What did he see as the critical needs of the people in the outback? He could see that the most important necessity was medical facilities - doctors, nurses and hospitals. A number of hospitals were built in strategic locations. The resident staffing was two nurses. Yes, that was fine, but how would people several hundred kilometres away access these facilities quickly enough that the person needing the attention didn't die on the way to hospital. Several hundreds of kilometres over rough bush tracks would take days often in sweltering heat. It doesn't bear thinking about.

In 1917 Rev John Flynn read a letter from Clifford Peel which convinced him aircraft would provide the swift transport sick and injured people needed to access medical facilities.

Aircraft were still very much string and chewing gum machines, but within a few years he could see them being the means of providing the necessary swift transport. He even approached the government of the day after WW1 finished suggesting that the military could use their aircraft and pilots to perform these duties instead of idly sitting around telling bigger and bigger fibs about their exploits during the war. The government was not interested. It was suffering from myopia as most have since.

Wireless for the Outback

The means to call out the "flying doctor" was still exercising Flynn's mind. Telephones were not an economical or practical method of summoning aid. The lines were extremely costly to install and of very doubtful reliability. What other way was there to summon aid? He wondered if the new fangled wireless could be used by people in remote areas to send for aid in an emergency. By 1919 he was convinced that the use of wireless was the means to summon aid to the sick and injured. He actively encouraged radio buffs to come up with a small, portable, inexpensive, amplitude modulated (AM), easy to use transceiver that could be used away from power sources like the mains or 32 volt lighting plants. The Wireless Institute of Australia, WIA, was approached and "Wireless Weekly" ran a competition for people to design this transceiver for the outback. Nothing came of this as no-one could see how to meet the criteria.

In those days, at the beginning of the 1920s, such a transceiver had NEVER been built and the gurus of the time said,

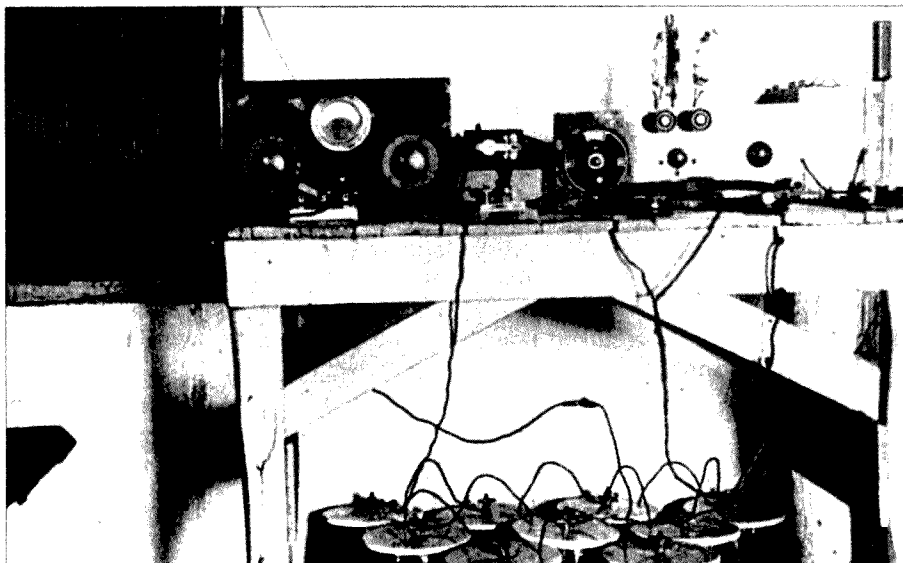

Photo 1. Hermansburg Experimental Station 1928. Installed by Alf Traeger.

"No go, not for quite a few years yet". Radio was very much in its infancy. Flynn was not the sort of man to give up on something that he believed in so strongly. He learnt all he could from books and by experimentation. He spoke with many people asking their opinions and advice. There were two who stood out from the crowd, David Wyles and Harry Kauper. Each endeavoured to persuade Flynn that what he was asking was just not practical at that stage, and to modify his requirements to suit what it was possible to achieve.

I suspect they were exasperated with Flynn. It is interesting to consider that AM broadcasting only started in Australia in late 1923. Wyles told Flynn bluntly that AM wasn't practical at this stage. Operators would have to learn Morse code. Kauper told Flynn to stop mucking around, getting advice from everyone - which was often contradictory - and get someone to help him who really knew what he was doing. Both Wyles and Kauper had put their foot in it. Flynn asked both of them to help him in various ways. Wyles arranged for help from George Towns so that experiments could be conducted in the outback in 1925. Kauper was drafted to assist as Flynn's mentor on technical matters.

In 1925 John Flynn and George Towns assembled a variety of transmitting and receiving equipment. This was to be used in radio communications experiments around the outback, throughout northern South Australia and southern Northern Territory. They received considerable assistance from Kauper who was the chief engineer at 5CL in getting their gear together. To power the equipment Flynn thought up the idea of powering the equipment from a generator attached to the running board of the vehicle. It was powered by a pulley and belt arrangement from one of the back wheels - once it was jacked up.

They tried many generators and all were too variable in their output voltage to be used on free running oscillator cum output type transmitters. The frequency shift with Morse (CW) keying or voice operation was just too much, so that the signal was more like frequency shift keying or FM voice transmission. Remember crystal controlled oscillators were only just starting to be used in transmitters at that stage (1925). Kauper

remembered testing a 600 volt generator made by a young bloke called Alf Traeger. It had proved very good and the suggestion was made to see if the generator was available, as it should be good enough for the job.

Traeger's generator was obtained and used for the trip. The trip proved that radio communications could be achieved between the outback and Adelaide. Being amateurs the 80 metre band was used at night for most of their communications. Voice and Morse code modes were used and success was achieved with both. However it was seen that whilst communications was possible, Morse code was much more practical and effective than voice. Hence voice transmissions from the proposed transceivers was ruled out of contention at that time.

It was also determined that the equipment that they had and the antenna systems they used were not at all suitable for non-technical people to use. Lastly jacking up the car wheel and running a generator from it was totally impractical. There were few cars in the outback anyway.

The Hermannsburg Experiment

In 1926 another expedition was planned by Flynn and Towns to Stuart, Alice Springs, to test another style of set. A 50 watt AM base would be installed at Stuart, a portable set at Hermannsburg Lutheran Mission and another at the Arltunga Police Station. Kauper was given the task of building the two sets. In fact there were three with the third being used as a spare.

Disaster struck not long before Towns and Flynn were to leave to conduct these further experiments in the centre of Australia. Towns became ill and had to withdraw. Flynn was now desperate, as he needed someone to go with him, otherwise the experiments would have to wait for another year. He approached Harry Kauper to see if he would be able to come. He couldn't due to work commitments at 5CL but suggested a young bloke by the name of Alf Traeger who may be interested in assisting.

Alf Traeger jumped at the chance to be involved and was given the task of getting everything ready for the trip. On arrival at Stuart the base station and 32 volt lighting plant were installed at the

hospital that Flynn had built there a few years before hand. It is now a museum named "Adelaide House" and is alongside the Flynn Memorial Church in Alice Springs. It has some of the memorabilia from that era on display.

Having installed and tested the gear at Stuart and leaving it in the care of a PMG telegraphist Flynn and Traeger set off for Hermannsburg Lutheran Mission. The vehicle was overloaded with around half a ton of batteries and radio equipment. The equipment was installed and tested. The Pastor was taught Morse code rather quickly. I suspect he was up to novice amateur radio operator standard or better within the week or so that the installation took to complete.

There were some hiccups in communicating with Stuart but communications were established on around 88 metres as authorised by the PMG not on the amateur band where earlier experiments had been conducted.

This installation was still not what Flynn needed for the outback but it did prove a number of things. It proved that non-technical people could be taught to use the new fangled wireless transmitting and receiving equipment. They could also be taught Morse well enough to enable them to send it to the base whilst hearing a voice reply.

The gear was still not suitable for the job though and much work remained to be done to develop a suitable transceiver. This came in November 1928 with the prototype "baby" pedal radio.

The Hermannsburg Station

Over the last few years I have been researching the development of HF radio communications in the outback. I have had assistance from many people who have been involved either in researching the subject or who have been involved in the early days of the flying doctor service. As a consequence of this research many of the mysteries concerning the early pedal radios have been solved.

From the information I have obtained and the tests I have conducted I have been able to determine what the Hermannsburg station is likely to have consisted of. You may care to read "Traeger - The Pedal Radio Man" by the late Rev. Fred McKay to find out a bit

Hermannsburg experimental transceiver 1926

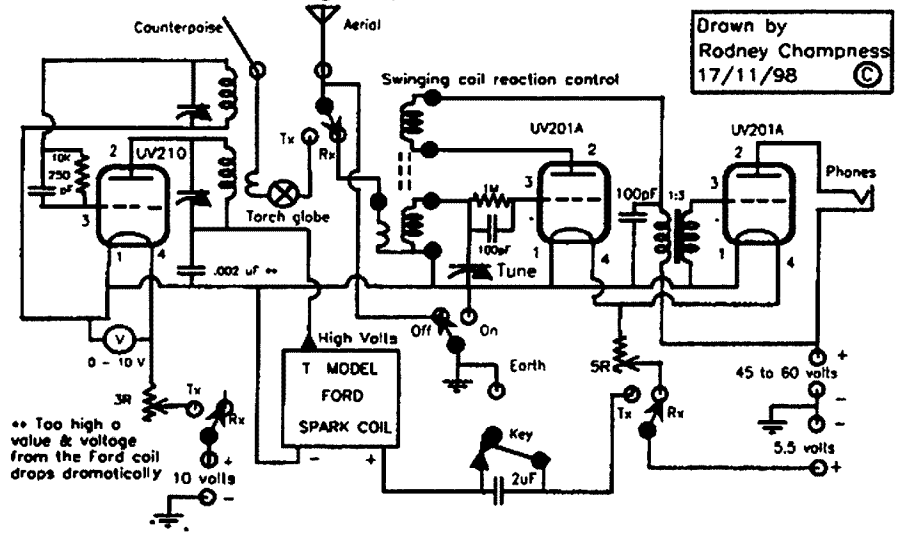

Fig 1. Hermannsburg Transceiver Circuit 1926.

more about all of what I've written so far. From other information sources I accessed what is believed to be part of the circuit of the installation. With all the snippets of information available, a complete circuit has been drawn which is similar if not the same as the original. See Fig 1.

The stations at Hermannsburg and Arltunga were powered by nine Edison primary cells. These cells used copper (oxide) as one plate and zinc as the other and caustic soda as the electrolyte. I have consulted a number of the early respected electrical handbooks endeavouring to find out the facts on the construction and general characteristics of these cells. It seems to be agreed that the cells will develop around 1.1 volts open circuit but under heavy load the voltage delivered to the circuit is around 0.65 to 0.7 volts. What constitutes a heavy load is not specified but appears to be of the order of an amp or two.

The transmitter is believed to have been powered by the nine cells in series, which provided around six volts. The transmitter valve filament would have been supplied with five volts via a rheostat from the six volt battery bank. The full six volts would have been supplied to the Ford T coil. The Ford T coil supplied jagged, raw, nasty AC for the plate of the transmitting valve. It might have been designed to give high voltage for the spark plugs in model T Fords but would also give sufficient voltage when rectified by the transmitter

valve for the transmitter oscillator cum output valve to operate effectively. The transmitting valve was probably an overloaded 201A and would have produced around three watts of radio frequency energy to the antenna.

If the voltage of the cells was 1.1 volts per cell when operating it is likely that a 210 valve was used in the transmitter with its filament fed via a rheostat to provide 7.5 volts for the filament. The Ford T coil would probably have been run off the 10 volts and the transmitter output would have been around five watts.

The signal from the transmitter was interrupted continuous wave (ICW) rather than CW. It would have been rather a broad signal covering quite a few kilohertz with a raucous tone. This type of transmission is banned from the airwaves these days. The transmission frequency would have varied with keying, as the transmitter was a single stage tuned grid tuned plate design coupled directly to the antenna.

The circuit of the transmitter was not different to any extent to the average amateur transmitter of the era. Some amateurs away from the mains did use the Ford T coil as the source of high tension voltage for their transmitters. These transmitters although not up to scratch by today's standards were streets ahead of the spark transmitters that they superseded.

The battery bank was tapped at 3.5 volts. Whether this was used to power

some of the new low voltage battery receiver valves (such as the 199A) is unknown. However it is thought that the receiver used two 201A valves whose filaments were supplied via a rheostat from the six volt battery bank. The HT was supplied by a large Burgess 45 volt dry battery.

If the battery voltage was 10 volts the tapping point would have been at 5.5 volts. This would have been an ideal spot to tap the battery for the receiver 201A valves.

One valve acted as a regenerative detector and the other as a transformer coupled audio stage. It was in reality a standard two valve amateur band receiver and similar to most two valve broadcast receivers of the era. So nothing new here.

Harry Kauper could have saved himself a lot of development time if he and the others John Flynn had coerced into helping had known of the WWI trench radio transceivers of 1917. These sets were not unlike the sets used at Hermannsburg and Arltunga except that they operated below the broadcast band whilst Kauper's design was on short wave. However, military secrets being what they are, Kauper and his friends had no access to this information.

A Test Transmitter

I built a test transmitter nominally to the design of the Hermannsburg transmitter using a 6CM7 twin triode. See Fig 2. I used the triode with the highest voltage rating (pulse) and the lowest gain to simulate the operating parameters of the 210 or the 201A. The primary of the Ford T coil was keyed and the secondary voltage was rectified in the valve. The voltage to the primary of the Ford T coil was six volts. The transmitter output was measured as three watts.

The transmitter valve only loaded the coil on each half wave hence quite high voltages were evident around the circuit and across the valve when it was not conducting. It was found that the voltage applied to the primary of the Ford T coil had to be reversed to stop flash-over across the tuning capacitor. This occurred because the voltage waveform from the coil is very asymmetrical with a much higher peak voltage in one direction compared to the other. The valve under these conditions could easily flash-over too, and literature of the era indicated this was not an uncommon

occurrence. Hence the Hermannsburg transmitter could easily have broken down and actually did several months into the tests.

A check was done to see what the signal sounded like on an 80 metre (3.5 to 3.7 MHz) receiver. It sounded terrible, a raucous buzz at the keying rate. One advantage of such a signal at those times was that it spread fairly wide in frequency, so that it was not difficult for the base station to find if it was a little off frequency.

Towards The "Baby" Transceiver

Alf Traeger was now very much involved in the development of a suitable radio transceiver for use by the non-technical people of the outback. Rev John Flynn gave him the task of developing the "baby" transceiver that would allow the outback folk to contact the "mother" station. The "mother" station (radio base station) would be placed where there were facilities such as a hospital, nurses, a doctor, an airfield and access to an aircraft at short notice. Ultimately Cloncurry in Western Queensland was selected as the location for the first flying doctor base.

Over the next two years Alf Traeger with his mentor Harry Kauper solved most of the problems that beset the development of such a revolutionary concept as a simple, easy to use, portable, rugged, light weight, low power consumption, frequency stable (transmitter), 300 mile range, cheap radio transceiver. Wow what a specification! Today this is easily achieved. At that time most military portable transceivers required several technical people, a transport vehicle, and an engine powered electrical supply to make the station operational. The Australian Army is believed to have had a set requiring such a support system and it only had a range of 30 miles.

One of the biggest hurdles that Alf Traeger had to overcome was how to supply power for the transceiver, as at most locations where such sets were to be used there were no sources of electrical power. Dry batteries were not up to the standard of today and would go flat within a few months in the humid tropics. Batteries weren't cheap and getting them to the "baby" transceivers would not be easy. The amount of energy

that the transmitter required to operate it would be too great to expect even a reasonable life from the batteries. Four series connected 45 volt batteries would have just too much leakage and would likely be flat just when they were needed.

To overcome this Alf Traeger experimented with hand wound generators and found that they could supply the high voltage necessary to power small transmitters. He observed that the Morse code note was poor and output power variable as one hand wound the generator and the other operated the Morse key. He eventually overcame this by making a pedal powered generator, which meant that two hands were free to operate the transmitter and Morse key. Now you know why the original transceivers were called pedal radios. However it was not practical to power the transmitter valve filament from another winding on the generator. The voltage may have varied sufficiently to burn the filament out. The filament was powered from two No 6 cells in series. Low voltage dry cells didn't go flat so quickly in humid locations as the high voltage ones did.

It was decided that the pedal generator was unsuitable to power the receiver high voltage requirements as the generator created radio interference and it would be tiring pedaling the whole time that a radio schedule was on. The receiver valve filaments were supplied from a 1.5 volt battery.

Kauper had been experimenting with space charge tetrode valves such as the Philips A141 for use in simple receivers. This valve only required a few volts on its plate to work effectively. A low voltage dry battery would not go flat too quickly in the humid environment of northern Australia. A receiver using two of these valves was designed and proved to work satisfactorily.

The normal tuned grid tuned plate free running oscillator cum transmitter output stage of transmitters of the era was not stable enough to be used by non-technical people in the outback. It would be a certainty that the transmitter would not remain on frequency for long and

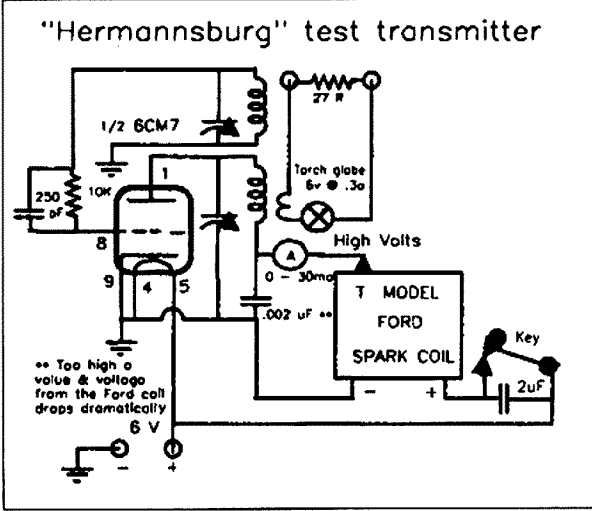

Fig 2. Hermannsburg Test Transmitter Circuit.

hence emergency calls would be missed. It was decided that the transmitter must be crystal controlled. It was a new development but Harry Kauper and Alf Traeger had successfully experimented with it on the amateur radio bands. The crystal controlled circuit that they developed for the "baby" sets was quite reliable and appears to be better than many of the circuits used by other amateurs radio operators of the era.

Alf Traeger now had the bits and pieces working and it was only a matter of putting everything together in a "coffin" style radio cabinet. He did this and in November 1928 he presented the "baby" transceiver to John Flynn. This was the set that Flynn had been waiting so long for. The outback was no longer dumb it had a voice, even if it was in Morse code.

There you have it, a precis of the beginning of the development of radio communications in the outback and specifically of the Royal Flying Doctor Service as it became officially known in 1955. Research has revealed some errors and inconsistencies in technical information in some publications and wherever possible these have been corrected. The book I am writing called "Outback Radio" covers this part of the development of radio communications in the outback plus subsequent developments in considerably more detail.

© Copyright to this article and the illustrations is held by Rodney Champness.

The Manual CW Decoder

Applying logic to CW learning

Steve Page, VK6BGN
 P.O. Box 383, Wickham, W.A. 6720

This story begins about 4 years ago when I relocated from about 400 km north of Kalgoorlie to the small iron ore town of Wickham, located in the Pilbara some 1500kms north of Perth.

One of the first things I did after I settled in was to locate the old Wickham Ham Radio Clubroom and station. The clubroom and operating station were still there along with a FT-101 HF rig and a 2 element quad for 20 metres.

One afternoon while at the club station I started looking through some of the old A.R. magazines that were of the 1980s vintage. I don't actually remember which month or year the magazine I was looking at but along with other articles for such things as RTTY reception with Basic code and a Tandy TRS-80 computer was an article about CW which caught my attention. It was not a software/hardware technique of decoding but more of a manual hand operated technique or aid for someone who I suppose is just starting out to learn the code.

Some months after I read this article I went back over to the clubroom and looked through all the old mags but couldn't locate this article again. From memory the article was a revisit to a 1930s article which first appeared in QST. Possibly it's time to revisit it again for the newer readers and even for the older readers too.

The manual hand operated decoder in Figure 1a, which again was redrawn from memory and operates in a simple fashion.

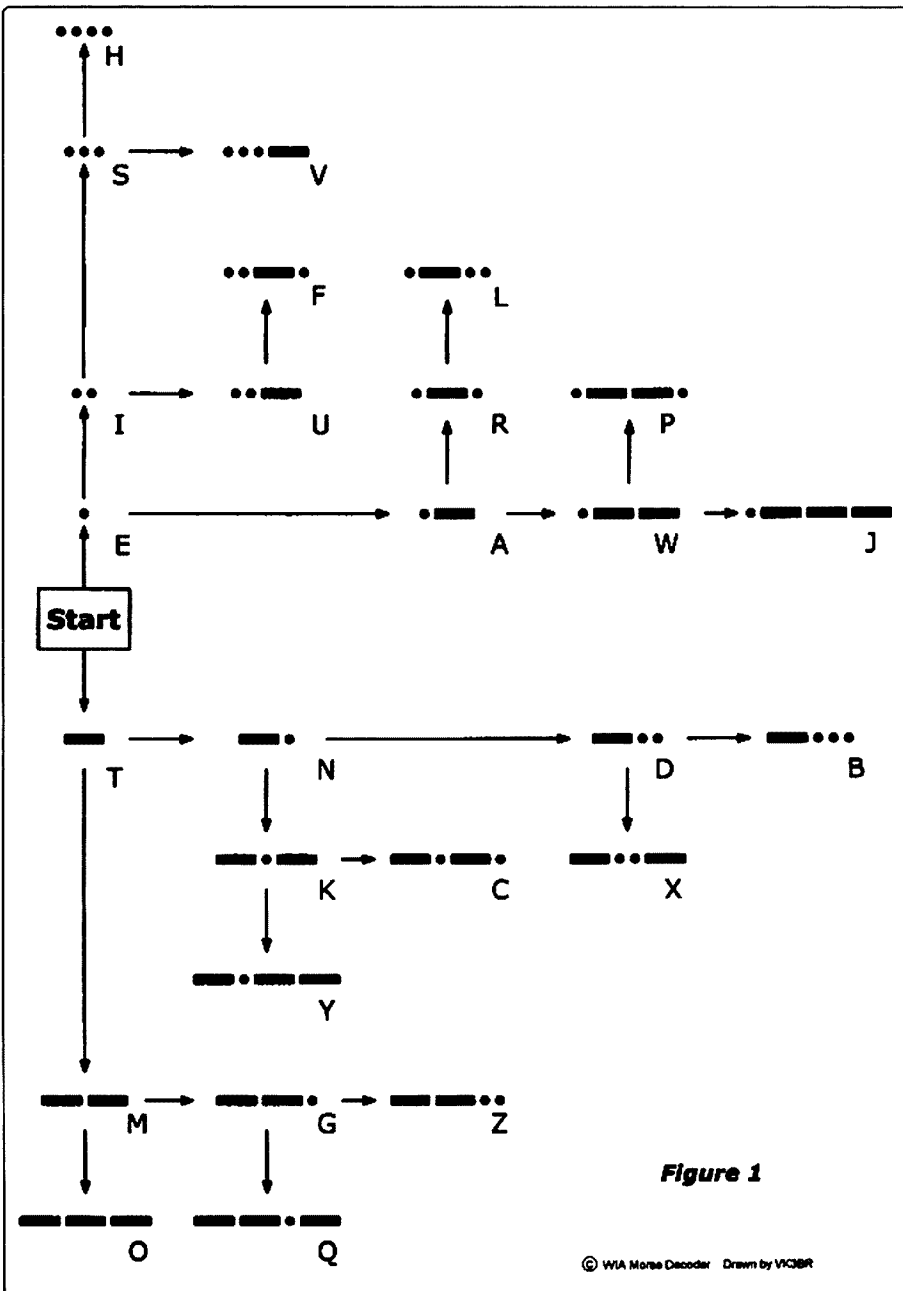

Figure 1

© WIA Morse Decoder Drawn by VK6BR

Figure 1a



**John Moyle Field Day
 March 16 & 17**

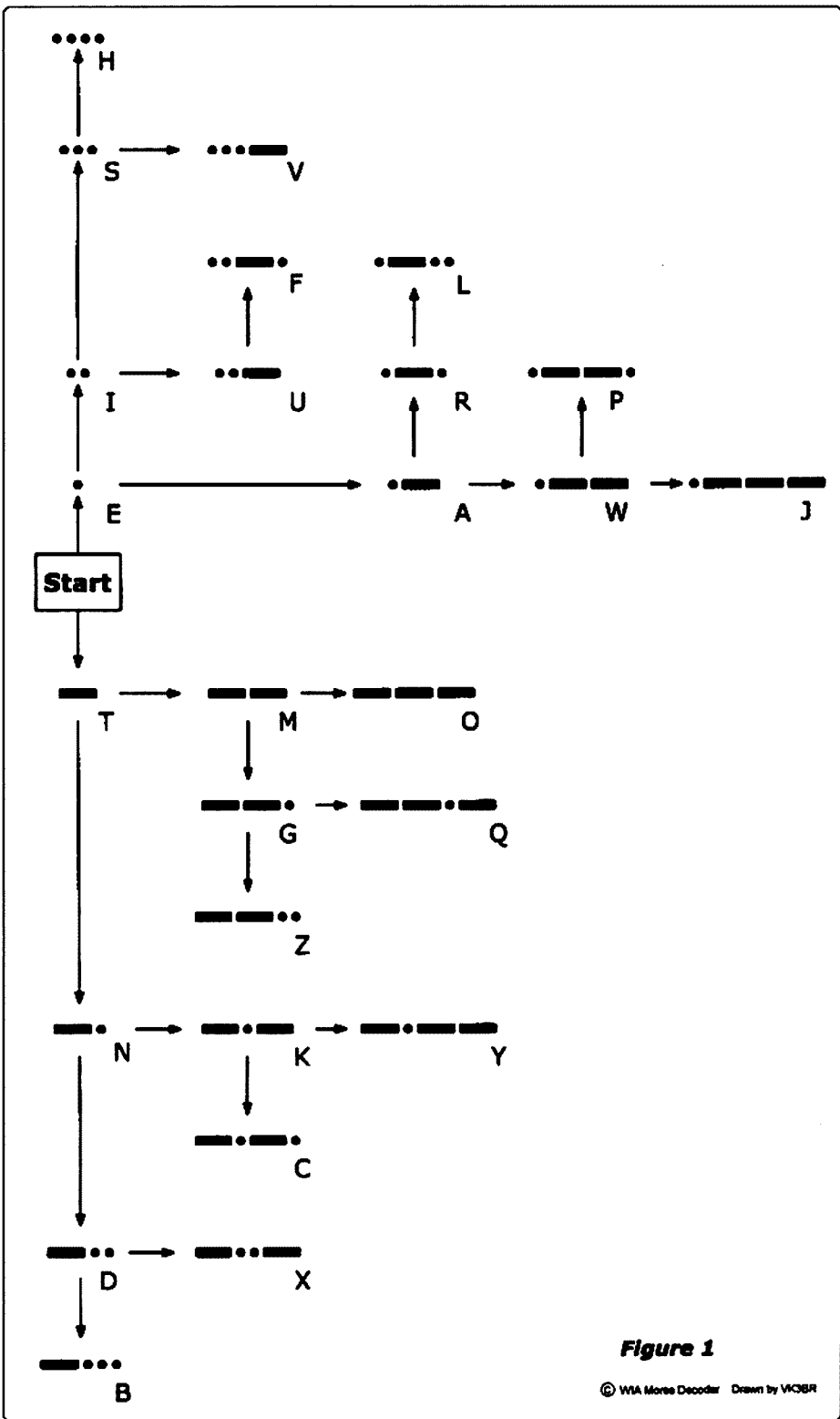

Figure 1b

Figure 1

© WIA Morse Decoder Drawn by VK3BR

The Rules

- 1) Place your finger at the centre start position.
- 2) If you hear a "dot", move your finger up.
- 3) If you hear a "dash" move your finger down.
- 4) If your first move was up, (a dot) and you hear another "dot", move up again, otherwise it's a "dash" and move right.
- 5) If you first move was down, (a dash) and you hear another "dash" move down again, otherwise it's a "dot" and move right.
- 6) If you hear a short break, then the letter is complete, quickly write the letter down with the pen or pencil in the other hand and return your finger to the start position and wait for the next letter. (I'm sure you've got the idea by now)

Obviously this is for slow code, probably somewhere in the vicinity of 5 wpm or even less. Maybe even for some one who doesn't even know the code and would just like to decipher a very slow CW message.

I haven't yet given this a try but I'm sure some where in a deep dark corner of my hard drive is an old DOS CW practice program that could be turned down to just a few words a minute. That's if I can even get a DOS prompt up on the computer monitor when using my new operating system!

Editor's Note.

This is the first time I had seen this scheme. I felt it might be easier if after the first move to dot or dash you always did the same moves for dot 'up/down' and dashes 'right'. Figure 1b shows this scheme.

'The IRLP For Kids Net'
 ...a great starting point for young people

For details see Club News on page 23

Plan ahead for an exciting year

Gosford Field Day

Did you stop to speak to Dot, VK2DB? I hope so. I hope she told you all about the ALARAMEET 2002 in Murray Bridge at the beginning of October. We do want some new faces as well as the ones we already know. It is such a great opportunity to renew friendships and to make new ones.

Ladies, you can participate, even if you don't hold a licence yourself. ALARA was founded by a group of YLs who wanted "something of their own" at the Hamfests that they went to with their OMs. Some of the foundation members did hold licences but some did not – and some have never been interested in taking up a licence yet have remained faithful members of ALARA.

Please come and have fun. We do not have serious discussion sessions, we just enjoy being together and doing things together.

Some of our interests outside amateur radio

You have heard of Marilyn's exploit with her stamps, but did you know that we have quite a number of painters in our midst. I have a lovely watercolour done by Pat VK4PT and another one done by Meg VK5YG, who recently won a prize from the Burnside Painting Group. Mary VK5AMD and Sally VK4SHE are oil painters. You have seen some of Sally's cartoons in this column over the years.

Do you remember the poems of Joy VK2EBX? She won a number of prizes for those. Deb VK5JD has won several awards for her poetry in recent years, too. In the UK Jasmin G4KFP has a novel in the pipeline and has had several short stories published.

If you listen on a Monday night (at 1000Z in Daylight Summer Time) and 1030Z Winter Time) you will hear us

discussing gardening in all its aspects. Many of us preserve fruit for the winter or make jam or pickles, sometimes exchanging recipes. It is interesting to hear how the place where you live affects what grows in your garden and when it is ripe.

We have a number of very skilled craft workers. We were all amazed and impressed by the patchwork Val VK4VR brought to the Perth ALARAMEET, and by the lovely drawings of wildflowers Ann VK4ANN had done on her way to the MEET. Maria is a member of the Embroiderer's Guild and had tried her hand at many different techniques of embroidering, as has Marjorie VK2AMJ. Shirley VK5JST teaches bobbin lace and has won many prizes for her work. Mary Rodgers is also a bobbin lace maker but has shown us several others items she has made. Tina VK5TMC works in leather, is an expert cross-stitcher and makes all sorts of interesting items out of beads. My apologies to those I have not mentioned.

Yes we have many skills and many interests. It is not hard to find someone with whom you have much in common.

USA County Hunters Award to June VK4SJ

If you want to know about DXing, ask June. She has always been interested in this aspect of amateur radio. This award has recently rewarded her hard work. June is the only Oceania YL to hold this award, and only the fifth DX YL to earn it. Well done June! It takes an enormous amount of time and dedication to "catch" all the counties.

June can be heard regularly on the 222 Net on Monday afternoon (call in on 14.222 from 0530Z). She is the regular Control for the Net and has been for most of the time since Dave ZL1AMD moved home.

The International YL Meet In Palermo

To cater for the many visitors to the area there are a number of tours involved in the planning for this event, including a 4 day tour of Sicily before the MEET starts and other shorter tours covering through to the Wednesday after the actual official gathering. It all sounds positively marvellous. If you are interested in the details or would like to register read page 10 in the ALARA Newsletter or go to the website <http://www.qsl.net/yl2002>

Two interesting contests coming up

The CLARA and Family HF Contest will be held from 1700 UTC 19th March 2002 to 1700 UTC March 20th 2002

The contest is open to all amateurs, is HF only but you may use CW and/or phone. The idea is to work as many CLARA members or YL non-members with multipliers (up to 14 are possible) for each Canadian call area and extra points for contacting family amateur stations.

It sounds like fun. The full rules are in the ALARA Newsletter.

The Thelma Souper Memorial Contest will be held on the 6th and 7th April 2002 from 0700 UTC to 1000 UTC on the Saturday and Sunday evenings. All contacts are on 80 Metres; both phone and CW may be used.

Any WARO member who has worked at least 10 stations becomes a multiplier. A bonus station, ZL6YL will operate at random times and will act as a multiplier for each night worked.

If the rules sounds complicated it is partly because there are some changes this year, but the complete details are in the ALARA Newsletter.

Why not have a listen and have a go! That is the Australian way, isn't it?

Contacts made in the Thelma Souper Contest can be used towards the WARO Award. Contact WARO for more details.

Adelaide Hills Amateur Radio Society

The January meeting took the form of a very pleasant barbecue at the home of Brian VK5SV. About 50 members and families and one interstate visitor (Lance VK4EW) were there on what turned out to be one of the few hot nights VK5 has had this summer.

Much good fellowship was enjoyed and many interesting conversations were heard.

The evening was concluded by a film show of a series of shorts so there was something for everyone. Altogether a very pleasant way to start the year.

The AGM will be held at the start of the February meeting and will be followed by a speaker. Everyone is welcome to come along on the third Thursday of each month to the Blackwood High School from 7.30. The topics and format of the meetings vary

but are always interesting and well attended.

Interstate and overseas visitors contact either Geoff VK5TY or Alby VK5TAW QTHR for further information.

You have two to choose from, for the AHARS column one has some of the ladies in it, the other has a group of OMs with the V4 second from the right.

73, Christine

Midland Amateur Radio Group

The Midland Amateur Radio Group is holding its annual Radio Convention on the 28th April 2002 at a new and brighter location, the WEERONA Secondary College Hall on the Midland Highway (road to Echuca/Shepparton) Bendigo. Approx 3.4 km from the fountain.

The usual displays and sale of new and second hand equipment will be there to suit any budget. Food and drinks will be available during the day at the tuck shop. We will be opening the doors at 10:00am until 3:00pm and the door prizes will be drawn at approx 1:00 pm.

So please make a day of it and come

and catch up with old friends and put a face to that new contact. You can also take in the tourist sites of this wonderful city. The Midland Amateur Radio Club is at present working on a number of projects for the local area. These are an ATV repeater to service the local district and a proposed 2 m FM repeater to go

into the Echuca area to fill in a bit of a hole in coverage along the Murray River so your attendance at our convention will greatly assist us in these endeavours.

Secretary, Mark Harris VK3EME, P/H (03) 54487055, Fax (03) 54405796, mharris@impulse.net.au

Bass Amateur Radio IRLP Group

Calling all young people...

Do you have your Amateur licence? Are you interested in joining the Amateur Radio family? Here is the opportunity for you to be more involved:

Every Saturday from 12 noon our group will link up on Reflector 2 and join in with 'The IRLP for Kids Net' from

America. The net is run by young operators, and goes for approximately one hour. Kids can hear and talk to each other around the world. VK3JBO Graham and VK3JED Tony will open the link up. 'The IRLP for Kids Net' can be heard via the VK3RPU Repeater.

So, senior amateurs, if you're trying

to get young people interested in the hobby, here is a great starting point.

For more information contact Graham VK3JBO on 5982 0315 or call him on VK3RPU. This is an Amateur Radio Education Initiative. It's a step in the right direction!

ALARA continued

A new award – the 33 Award has opened.

In honour of YLRL founder, Ethel Smith K4LMB a certificate will be awarded to any amateur who works 33 YL amateurs on any authorised frequency (excluding nets and repeaters), starting from Feb 13th 2002, Ethel's birthday.

Start keeping a special log and look for more information next month.

ALARAMEET 2002 in Murray Bridge

Keep the date free in your diaries and send in your registration. The details of all planned tours and gatherings are all listed in the January Newsletter and on the website

Why not make your bookings now and send your registration to Jean VK5TSX. We are looking forward to seeing you all there.

Nominations for the AGM in May

If you are interested in offering your services to ALARA in any capacity, please contact our Secretary, Margaret VK4AOE at evron@bigpond.com.au or on packet at VK4AOE@VK4YH. We can always use new blood and you can be sure it will not be an onerous task although it will be interesting.

Silent Key

Kenneth Neal Greenhalgh VK2KG

Born Parkes 27/02/09. Died Sydney 14/1/02, aged 92

Ken was one of four children, all lived into their 90s. His father was a member on the NSW Police and the family moved around NSW as he was growing up

By the time he had finished school he was living in Newcastle. He had developed a healthy interest in radio and spent his spare time constructing the current version of crystal and, as the budget allowed, tube receivers.

The latter required batteries. He became proficient at scrounging "worn out" cells and revitalizing them for the current experiment. Suitable glass jars and a supply of Sal Ammoniac was vital. He eventually obtained a battery eliminator but with no power on the house, had to rely on an obliging neighbor and a long power lead

With limited amplification available, low loss designs were important. His pride and joy was a receiver that used a sheet of glass as a baseboard. He made the drill to allow the necessary holes to be drilled in the glass.

By then, Ken had also developed an interest in birds and was an avid egg collector. He retained the ability to identify birds by their call and to describe their appearance to the end of his life.

Ken's first job was as an apprentice fitter and turner with the NSW railway. His career ended on completion of his apprenticeship, it was depression time and there was no permanent work available.

He moved in with relatives at Rooty Hill and continued with radio as a hobby

Brother Jack (VK2ADF) was able to get him a job as engineer at Lapstone Hotel; it is now a RAAF base. His amateur gear had to be put away for the next two years but while there he met Mary Speirs and married her in 1933.

He had already obtained his Operators Limited Certificate of Proficiency in Radiotelephony in 1932

Ken became the first engineer of 2KO not long after the station was licensed

in 1931 by (now) Sir Allan Fairhall (VK2KB). Initially the studios and transmitter were located in New Lampton and the original transmitter was rated at 100 watt.

Over the next few years he moved the transmitter site to Sandgate where a "T" antenna was installed and the transmitter power was boosted to 500 W. The transmitter used water cooled tubes and motor generator set was used for some of the supplies. Much of the installation was constructed by station staff.

One engineer was surprised to find fire flies in the grass one evening. On closer inspection he realized the flashes were small arcs and that the antenna had fallen down. The transmitter was obviously very tolerant and vswr detectors were still to be invented.

Transmission ran for less than 24 hrs per day, Ken cycled to and from Mayfield daily and developed a good relationship with the fishermen selling Hunter River prawns in the area.

He then moved the studios to the Civic Center area of Newcastle. In keeping with the philosophy to use the latest technology, it was decided to upgrade the studio equipment to use indirectly heated tubes. As usual, the station staff built the gear and it was decided to install it after the station closed down one evening. The cutover was finished not long before the station was due back on the air. They were horrified to find that the program was full of hum and the original equipment had to be rushed back into service. There were things to be learned about keeping signal and heater currents separate and if necessary, hum bucking could be used.

By the late 1930s, the station had outgrown the Civic studio site and was relocated to the top floors of the new CML building in Hunter Street

Again, all studio and control room equipment was built where possible. Ken was convinced that studded faders would offer high reliability and as they

were expensive, designed and built the faders to go into the new mixing consoles.

The transmitter site was also upgraded. A new transmitter building was erected to hold the brand new AWA 500 W transmitter, the "T" antenna was replaced with a 1/4 wavelength vertical and a coaxial cable was installed to link the two.

AWA were commissioned to do a field strength survey and much publicity was obtained promoting the stations technical performance

The program link from the studios was however still by overhead telephone lines. They became noisy regularly due to poor contact in the twisted joints used when a repair was necessary. The "do it yourself" solution was to get a short circuit on the far end of the line and to discharge an 8uf capacitor, charged to 300v on the line. It effectively welded any troublesome joints. There were no reports of shocked lines men

The station relied on 78 rpm records for music, the steel pick up stylus had to be changed for every disk played. In an effort to improve quality and the choice of music, the station purchased a library of "hill and dale" recordings which required pick up heads that responded to vertical rather than horizontal movement. By adjusting the damping in the heads, it was possible to optimize the response and the station used the improved performance in heavy promotion.

Ken obtained his First Class Commercial Operators Certificate of Proficiency in 1944 and was regarded as having a good fist at 60wpm

The Second World War produced a number of changes to 2KO. The most dramatic was the installation of a large axe at the transmitter site with instructions that if the Japanese invaded don't worry about tubes, destroy the transformers and chokes before escaping.

Ken put his mechanical training to

good use to design and built a coil winder able to be used to build layer wound transformers. During WW2 he and his wife produced many of the hearing aid transformers required in Australia

2KO was still running for less than 24 hrs a day. Transmitters were still temperamental devices that could not be run unattended. The current ABCB rules required that all meters were read and logged each hour. The station technical staff, including Ken worked 24 hr shifts and slept at the site.

Apart from the log keeping duties, all technical staff continued working on current projects. This could include fabricating metal chassis and panels, painting as necessary, designing, building and testing the final product. Staff included Jim Cowan, VK2ZC, Harold Whyte VK2AHA and Dave Davies. CQ and QST were required reading.

As was common in those days, there was an emergency studio was on site. On more than one occasion the transmitter tech had the honor of welcoming listeners to the station and playing records until the morning announcer arrived at the studios.

An AWA 2 kW transmitter had been installed by this time. The transmitter frequency was routinely checked from the receiving station at Middle Head. Ken received a call one evening to say that the measuring station thought they

had a problem with measuring system calibration. The normal procedure, after doing the internal calibration was to check 2KO's freq. if it was spot on, the measuring receiver calibration was regarded as being confirmed. Apparently the crystal normally used to air was very stable.

Unfortunately, it had been destroyed some weeks before and the spare crystal had been put into use. Since then, Middle Head had been looking for a problem in their gear that didn't exist.

2KO acquired one of the first wire recorders in use in the industry though portable did mean that two people could lift it. They also obtained the first cartridge machine and put it into use for commercial replay. At that time commercials were being cut to acetate disks and the control room operator had 6 turntables for commercials. The advantages offered by the cart machine were obvious.

In 1961 Ken left 2KO to become the first Chief Engineer of NBN. He had obtained his TVOCP (#18) in the first exam held in January 1957 and was responsible for the design and installation of the studio and transmitter site on Mount Sugarloaf.

The studio relied on valve equipment and transmission was in the morning and afternoon with a break in between. It was necessary to warm up the equipment for at least half an hour before

going to air, stability was a problem. So were mains transformers designed for 60hz operation.

NBN's commercial rates were similar to those of the local radio stations. The volume of commercials rose rapidly to the legal limit and confirmed that the station design and staff were well equipped to cope.

Following a change in the ownership of NBN, Ken returned to 2KO. 2UE was now part of the group and he became responsible for the design and installation of new 2UE studios, located at North Sydney. The studios were to be the first "all solid state" installation in Australia and were the base for the successful operation of 2UE for many years.

Ken retired from the group in 1969 with the intention to travel and of spending more time with ham radio

Notwithstanding failing sight, he designed and built a number of SSB transceivers. He was not able to complete a gem facetter

Ken was an Associate, Member and Fellow of the IRE/IREE and served as Chairman of the Newcastle division for a number of years. He was a member of the WIA

Ken's wife died in 1974. He is survived by 2 children, 5 grand children and 1 great grandchild.

Athol Greenhalgh VK2BCJ

ar

WICEN helps the community

Some aspects of the Red Cross Canoe Marathon December 2001 on the River Murray on the NSW Victorian border. WICEN provided communications



Gil Sones VK3AUI

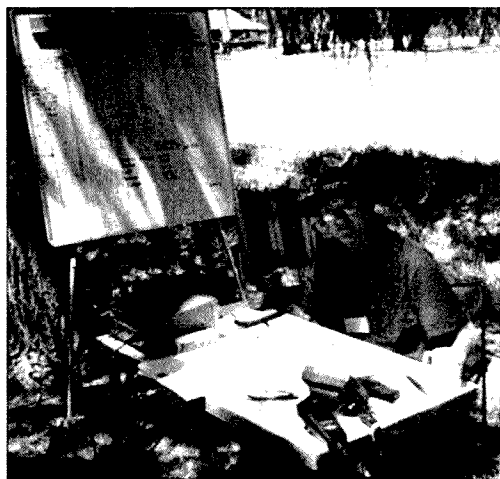

Joan McDonnell (YL of VK3UCM)

Technical Abstracts

Gil Sones VK3AUI

30 Moore Street, Box Hill South, Vic 3128

Finding a break in multicore cable

A useful tip for finding a break in multicore cable appeared in the Hints and Kinks column of Bob Schetgen KU7G in QST November 2001. The tip came from Bert Kelley AA4FB who used a capacitance meter to find the location of a broken core in a multicore cable.

Capacitance meters are readily available and are often included as one of the functions on digital multimeters. Alternatively a capacitance bridge can be built to do a particular job fairly simply.

The broken conductor is first determined with an Ohmmeter. The digital multimeter may even offer this as an audible continuity test function.

The test set up for locating a cable break is shown in Fig 1. Breaks often occur near the ends of cables due to frequent flexing of the cable. The capacity between the ends of the broken conductor and the other conductors will

vary between the ends of the cable. The capacitance at the broken end will be lower. The distance to the break can be estimated by comparing the capacitance from each end to adjacent conductors with the capacitance between unbroken conductors. You can then estimate the location of the break.

If the cable is unshielded then simply

measure capacitance between one conductor and all the others and then between the ends of the broken conductor and all the others. This may be needed for some unshielded cables.

Watch out for variable capacity caused by moving leads around. One solution may be to temporarily tape the test leads in position so they do not move about.

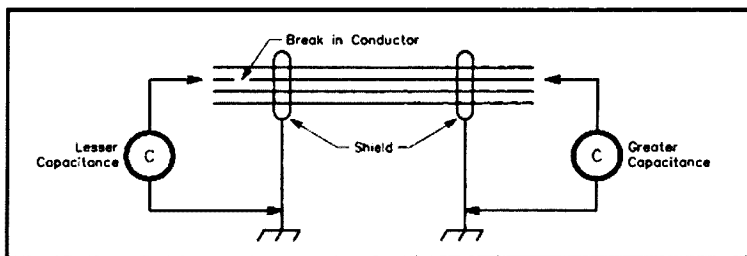

Fig 1. Test Set Up for determining position of cable break in multicore cable.

*For All Your
Requirements*

AUTHORISED DEALER

ICOM

KENWOOD

AMATEUR COMMERCIAL

MARINE COMMUNICATIONS

Tower
Communications

14 Mary Street
Hazelmere

Western Australia 6055

Telephone: (08) 9274 1118

Facsimile: (08) 9250 3734

E-mail: tower@con.net.au

www: <http://www.tower.visionimage.com.au>

Soldering Litz wire

Litz wire exhibits better Q in LF tuned circuits than solid wire of equivalent cross section. It consists of hundreds of individual lacquered strands. If the lacquer is the older non fluxing type soldering is difficult. It is difficult to remove the lacquer without damaging the fine strands.

The LF column of Dave Pick G3YXM in the November 2001 edition of Rad Com contained a method of removing the lacquer to allow the litz wire to be soldered. The method came from Mal G3KEV.

The idea is to dip the end of the Litz wire in paint stripper for a few minutes to soften and dissolve the enamel insulation. Then use a toothbrush to remove the softened and dissolved enamel insulation. The final thing is to dip the end in white spirit and wipe dry.

You could try lighter fluid or shellite. The bare copper end is then soldered.

There are a number of volatile and potentially dangerous solvents and inflammable liquids used so you should take appropriate precautions. Work in a well ventilated area and avoid inhaling the fumes. Also keep away from sources of ignition as the flash points may be low. With care and appropriate precautions you should be able to solder the Litz wire.

Battery saver timer

Many homebrew projects and helpful gadgets use a 9 Volt battery. They are only used for a short time. This results in them often being left on. The battery is then flat the next time you want to use them.

A handy auto switch off circuit appeared in the Hints and Kinks column of Bob Schetgen KU7G in QST November 2001. The circuit came from Lyle Koehler K0LR. The circuit gives two or three minutes of operation and then switches off. The only drain is the standing current drain of the CMOS IC.

The circuit is shown in Fig 2. The switch is a pushbutton which when pushed discharges the capacitor C1 which is a tantalum electrolytic. The circuit then turns on the transistor switch Q1 for 2 to 3 minutes which is set by the value of C1 and R1. The IC is a CD4093 type which contains four schmitt trigger NAND gates. The switching transistor is a PNP switching type and any near equivalent will do. All the parts were available from Radio Shack in the USA. Radio Shack is known as Tandy in Australia. Most local suppliers would have the parts.

The circuit could be built on a piece of strip board or you could build it dead bug style on a scrap of PCB laminate.

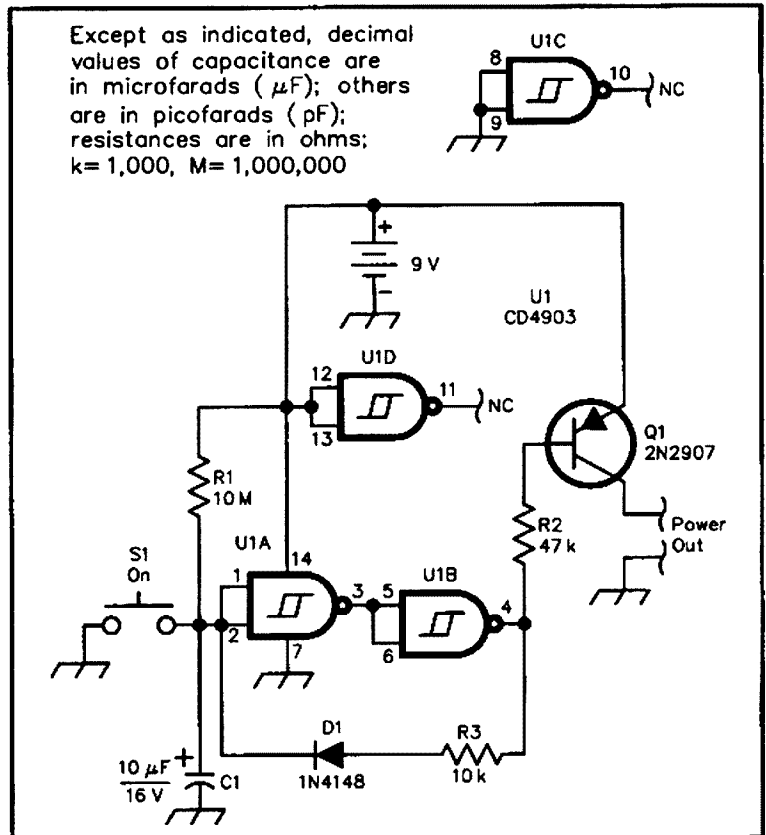

Fig 2 K0LR's Battery Saver Circuit for low power accessories.

Depth stops for drilling

Depth stops for use when drilling were discussed in the In Practice column of Ian White G3SEK in Rad Com August 2001. When drilling holes it is often desirable to control the depth that the hole is drilled. There are many ways of doing this.

The simplest is to use a drill on a stand which has a stop which can be preset. This will result in the most repeatable result and will also ensure optimum alignment of the drill. Drill stands are readily available and usable ones can be obtained at reasonable prices from most hardware suppliers.

Another way is to use the collars fitted with grub screws which can be salvaged from electrical fittings. You can find

these in old terminal blocks, plugs, sockets, switches and other electrical items. Simply fit these to the drill bit and you have a depth stop. However watch out as the surface you are drilling may be marked.

For less accuracy and repeatability you can mark the drill bit using a felt tip pen and then stop the drill at the appropriate time.

Another way is to attach a flag of masking tape to the drill bit and stop when you see the chippings being swept away. This last tip was reported as coming from the UK DIY newsgroup.

There are many tips and interesting items in Ian Whites column and on his website. His website is www.iftech.com/g3sek.

Technical Abstracts

Monel wire for corrosion free antenna

An interesting material for making an antenna which is corrosion free was discussed in the Hints and Kinks column of Bob Schetgen KU7G in QST September 2001. The idea came from Charles L Wood W2VMX.

Charles W2VMX has lived in areas suffering from salt spray and heavy industrial pollution for many years. Antennas made of copper wire suffer from corrosion and deteriorate. He found that Monel wire was available from fishing tackle distributors. It is easier to handle than stainless steel and is kink resistant. It is sold in the USA as trolling wire. Charles found that it could be soldered using rosin core tin/lead solder using a 100/150 Watt soldering iron.

The wire is sold in a variety of gauges

identified as from 15 to 200 pounds. He used 25 pound wire which is 0.018 inches diameter and 60 pound wire which is 0.028 inches diameter. Some care should be taken when wrapping or bending it as it has more spring than copper wire. It can also puncture fingers easily so proceed with care. Use pliers to bend and form it rather than bare hands.

Monel has more resistive loss than copper. Zack Lau W1VT ARRL Lab engineer calculated the loss of a 20 metre

dipole at 30 feet as 0.6 dB greater for a dipole made of 0.028 inch dia Monel than a dipole made from #12 Copper. Still this loss may be quite acceptable in an area where corrosion can rapidly reduce the efficiency of the antenna made of copper.

The Monel wire is probably available locally through fishing tackle suppliers. Some research may be in order if you suffer from corrosion. The internet would probably give some leads if your local suppliers can't help you.

URUNGA FIELD DAY

Easter Saturday & Sunday, March 30 & 31 2002
Senior Citizens Hall, Bowra St

- quizzes
- lucky door prizes
- novelties
- Trade tables
- Tea and Coffee available
- Fox Hunts and raffles



The second Urunga Radio Convention 1950

PROGRAM

Saturday 30th March

- 10-11 am 80 m Mobile Foxhunt
- 11.30-Noon 2m Pedestrian
- Noon - 1.30pm Lunch
- 1.00-1.30 80 m Novice
- 2-3 pm 2 m Mobile multi Tx
- 3.30-4 pm Talk-in m 146.500
- 6.00 pm Meal Booking required

Sunday 31st March Easter

- 9-9.30am Scramble
- 10-10.30 am 80 m Novice 40 m Fun type event
- 11-Noon 2 m mobile multi Tx
- Noon - 1 pm Lunch
- 1.30-2 pm 2m Pedestrian
- 2.30-3 pm Talk-In 2m fun event
- 4.pm Presentations

More information from:
Brian VK2ZCQ 02 6655 1115,
Arnold VK2ADA

Registration
One day OM \$10, YL \$6, Family \$16
Two Day OM \$12, YL \$8, Family \$20

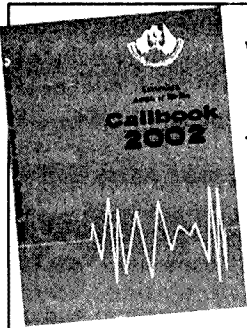

WIA Callbook

This year's callbook is a shortened version containing only the VK call signs and little peripheral information. Its price reflects its shortened format by being considerably less at \$15.00 (plus postage and handling).

Callbook on CD Rom

This year WIA is offering the 2002 Callbook as an Acrobat file on a CD Rom, also for \$15.00 (plus postage and handling)

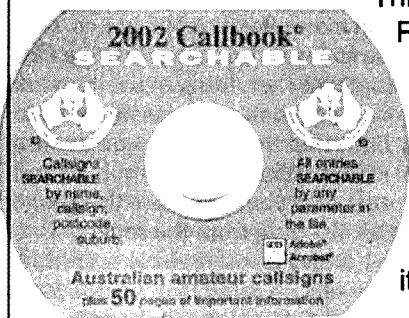

The advantages of CD Rom is that the files are searchable by callsign address, surname, postcode or even suburb.

The attached search program, Acrobat Reader, is the world's most popular reader of files and is completely cross-platform compatible, it works on all computers.

We have included readable,searchable and printable files of the 2001 information regarding

- | | |
|---------------------------------|------------------------------------|
| Examiners | Internet Addresses of Interest |
| WIA Divisional Information | Affiliated Clubs |
| Wicen | Travellers nets |
| ACA information | Operating —special interest groups |
| Operating information | Repeaters and Beacons |
| Radio and TV Broadcast Stations | Useful forms. |

Order through your local Division contact details on inside back cover

Ask about the price of the Book and the CD if bought together.

EASTERN AND MOUNTAIN DISTRICT RADIO CLUB INC.

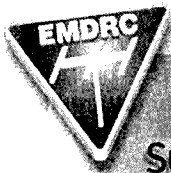

WHITE ELEPHANT SALE

SUNDAY 24 MARCH 2002

Selling space: \$15.00 per table (inc. entry for one person). For Bookings call Peter VK3DI on 9720 8874 or email petermac@alphalink.com.au by 10 March

Great Ryrie Primary School

Great Ryrie Street Heathmont

Doors open at 10:30 AM

Entry \$5.00 per head

www.emdrc.com.au

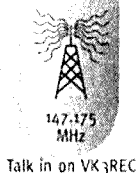

VK1 Notes

Forward Bias

Peter Kloppenburg VK1CPK

The guest speaker at the January General Meeting was D. Robert Woodman (VK1EY), a.k.a. Bob. His subject for the evening was his working life with Telecom. Although not directly associated with Amateur Radio, Telecom has always been in the business of long distance voice communications, using wires, coaxial cables, amplifiers, microphones, and headphones. All these things are used by Radio Amateurs but on a different scale. It is therefore not surprising that Bob felt at home in both environments.

His talk was peppered with jokes and anecdotes, which he had collected over the years. With great foresight, he had taken photos of every aspect of the work that he was associated with during the years. While he was talking about various subjects, he handed out manilla folders containing photos he took while on the job. This was very impressive

because the audience that evening could hear, and see, what life was like at Telecom.

One very interesting subject he spoke about was the incidence of lightning strikes on poles, buildings, and buried cables of all kinds. As Telecom has put a lot of copper in the ground all over Australia, it is not surprising that their staff has gained much experience in finding the location of a strike and, subsequently, resplicing the melted cable(s).

With the use of drawings on the whiteboard, Bob showed how to provide a good earth for a telephone exchange, a pole, or a buried cable. He even told us the value of the maximum earth resistance that was acceptable (3 ohms).

He said that any complaints that Telecom received from subscribers were acted upon straight away. Bob remembers the farmer who came in to

say that while on the phone to one of his neighbours he received an electric shock through the handset that bruised his ear and made him deaf on one side. He also said that the telephone did not work anymore after that. When Bob went to make an inspection the following day, he found that everything in the junction box on the outside pole was melted due to a lightning strike. The conclusion from all this: When there is thunder and lightning near you, don't use the phone and pull the plug from the socket.

Don't forget folks, there is a Trash & Treasure sale on Sunday, 28 April 2002 in the compound of the Parks & Garden Depot, Longerenong Street, Farrer. Sellers at 11 a.m., buyers at 12 midday.

The next General Meeting will be held on Monday, March 25, 2002. 7.30 for 8.00 pm at the Scout Hall, Longerenong St, Farrer. Cheers.

VK4 Notes

A Long Way in VK4

On the morning of 8-1-2002 a new VK4 record on 24.0481 Gigahertz was established between Kings Beach Caloundra and Wellington Point Brisbane. The previous record was 30km; the new record is 73.8 km.

Location 1: Wellington Point, VK3ZQB + VK4ZHL (all portable).

Location 2: Caloundra, VK3XPD + VK5DK (all portable).

Signal strengths up to 5x5 after initial optimisation with typical daytime QSB. The visiting team is continuing with local propagation experiments. The challenges of building and operating microwave amateur radio equipment are wonderfully rewarding in many ways!

As well on 12-1-2002 UTC a new VK4 and VK2 record was made on 10 GHz, between Byron Bay, NSW and Harvey Bay, QLD. Previous record was 327.8 km; the new record is 380.7 km.

On the same night a new VK4 and VK2 record was established on 5.7 GHz, between Byron Bay and Harvey Bay. Previous record was 246 km; the new record is now 380.7 km

This was followed on the same night with a new VK4 and VK2 record on 3.4 GHz, between once again between Byron Bay and Harvey Bay. Previous record was 246.5 km and new record is 380.7 km

The Amateurs involved in this joint DX operation were: -

VK3ZQB Russell

VK3XPD Alan

VK5DK Colin

VK4ZHL Errol

A record on 10 GHz was broken on 12-1-2002 UTC between Port Macquarie and Byron Bay, but this record was extended later that night.

Amateurs involved were VK3ZQB and VK4ZHL and VK2EI Neil in NSW.

Microwavers

Quite apart from the current interest in record breaking contacts on Microwave Bands. Quite a few Sunshine Coast Amateurs, together with a rapidly growing number of Brisbane Amateurs are pushing ahead with Networking Computers on 2.4 GHz. If you access the QDG's Web Site and go to the relevant Brismesh Link you'll REALLY be surprised at the extent of the interest in this new frontier of High-speed, Microwave Computer Networking.

Fire Away

Phil VK4HUM, who only very recently obtained his amateur radio licence, had a very quick introduction to emergency operating! Phil, visiting family in Mittagong and Sydney, linked up with some of the members of Fisher's Ghost Amateur Radio Club whilst getting into the thick of the bushfire action.

Doing a stint on radio duty at Picton Fire HQ on a Friday night, he said this is the first time ever that amateurs and civilians had been called in on a fire emergency.

Phil gave a talk at the February TARC Management Meeting on emergency communications relating to fires, as although the Townsville WICEN group have had experience running communications for cyclones, floods and searches, they have little experience with fires!

Media Watch and PR Opportunities

Ron VK4EV callback operator reports on record 59 callbacks on the VK4RBN repeater for QNEWS recently.

We'd love to hear from Bayside as to whether or not they are still handling callbacks and news on 70cm in Brisbane Sundays and on their 2-metre repeater on Monday nights.

Bruce ZS5BR of the Hiway Amateur Radio Club, City of Durban in South Africa run QNEWS every Saturday Night at 1930 hrs SAST on their local repeater 145.600 MHz which covers all of the City of Durban and Hiway areas. Bruce, we welcome you and our ZS friends to QNEWS, and hope to get regular feedback from you!

Does your repeater air QNEWS Ham News? If your local repeater makes use of all 3 segments or parts 1 and 3 only, of the WIAQ's weekly Amateur Radio news broadcast, QNEWS, please let us know.

We'd appreciate it if repeater managers would send the call sign, frequency, location, and sponsoring club/organisation of the repeater as well as the time and day QNEWS is aired to Graham VK4BB, qnews@wia.org.au each week. Or by packet to VK4BB @ VK4WIE.#BNE.QLD.AUS.OC

Another new QNEWS rebroadcaster joins the ranks, and again from ZS land. Reece reece@kingsley.co.za sent us this report. "Greetings from Cape Town, on behalf of the Oakdale Amateur Radio Club, with callsign ZS1OAK, situated in the Northern Suburbs of Cape Town. We are re-transmitting your QNEWS bulletins on our Tuesday evening Oakdale Natter-net at about 18.30h UTC, to a group of about 20 regular listeners. We transmit on the main Cape Town 145.750 MHz repeater, and your bulletin is well sent by ZR1TRD Andre.

Council News by President Ewan VK4ERM

On Tuesday 15Jan02 David VK4OF and Ewan VK4ERM had a lengthy discussion with a town-planning

consultant working for Pine Rivers Shire Council on the drafting of the new town planning acts. It is hoped the outcomes will be clear on the requirements for towers and masts and differentiate between those structures used by the Amateur Service and those of a commercial nature. David and Ewan will continue to have input to the PRSC document and expect to have the opportunity to review the appropriate sections of the drafts. If the documents are progressed expediently then they may become the model for other councils.

The Volunteer Spirit

VK4OF David as VK4 Federal Councillor notes that former VK1 Federal Councillor and member of the ACA Liaison Committee Glenn Dunstan VK1XX/VK4 and P2 has been a resident of VK4 for some time, and is now a member of this Division being based in Cairns. He has kindly offered his services as a Councillor. He is unavailable for any of the normal hack-work which generally occurs in Brisbane, but would welcome the opportunity to continue to serve the WIA and his newly adopted division. Thanks and welcome Glenn.

VK7 Notes

QRM

February is annual meeting time for our three branches around Tasmania (You will be aware that Tasmania has three WIA branches rather than affiliated Clubs). As this goes to the Editor two have so far had their meetings and I have pleasure in listing the main Executive officers in them

Southern Branch (Hobart Area)

President: Justin Miles-Clark VK7TW
Vice President: Scott Evans VK7HSE
Hon Secretary: Dale Barnes VK7DG
Asst. Secretary: Kevin Burgess VK7BK
Hon. Treasurer: Richard Rogers VK7RO

North-West Branch (Devonport/Burnie Area)

President: Bob Cropper VK7BY
Vice President: Max Freeman VK7MD

Hon. Secretary: Ron Churcher VK7RN
Hon. Treasurer: John Webster VK7KDR

The Launceston branch Executive will have to wait till next month!

Our Division annual meeting is scheduled for the 23rd March at Burnie.

Tasmanian members are very involved with the main Car Rallies The Southern members do the communications for the TARGA TASMANIA Rally in March while the North-West branch will do the same for RALLY TASMANIA on the 15th./17th February. Both Rallies traverse very difficult country radio-wise and we get quite a kick out of "getting through" when the so-called pros. can't make it.

Marconi Centenary celebrations were held in the south and the northwest on

December 12th. The north-west branch flew a kite in co-operation with the Kite Flyers of Tasmania at the site of the first Marconi transmission in the Southern Hemisphere (between Devonport and Queenscliffe) and world-wide contacts were made. Using IRLP node 670 we were in touch with the Newfoundland amateurs and greetings were exchanged between State WIA president Phil Corby and his counterpart in Newfoundland followed by greetings exchange between the Mayor of Devonport (Ald Mary Binks) and the Mayor of St Johns. Good publicity resulted in the local papers.

Cheers for now Ron VK7RN

VK3 Notes

By Jim Linton VK3PC

WIA Victoria web site: www.wiavic.org.au

email: wiavic@wiavic.org.au

Member consultation

The WIA Federal Council is expected to vote soon on the future of the WIA journal Amateur Radio. It has been undergoing a review due to a downturn in advertising revenue and a smaller print run due to a lack of growth in WIA membership.

A survey of members through the WIA Victoria website found overwhelming support for the WIA to continue to publish its own magazine, and not to insert it into another publication.

The option of having a bi-monthly printed magazine (6 issues a year) gained "acceptability" support of 62% of the 119 who responded to the survey. There was an underlying sentiment among a small number of respondents that they preferred a monthly magazine, but would accept a bi-monthly publication.

Only 22% believed that the WIA did not need to have its own printed magazine with some of those being critical of Amateur Radio magazine's style and content.

On the question of whether AR magazine should be inserted into either Radiomag or Break-In (NZART), 71%

outrightly rejected both options. An insert in Radiomag was supported by 25% of those surveyed, while only 4% nominated Break-In. Awareness of Break-In through having read a copy of the NZART journal stood at 20%. When asked if they subscribed to Radiomag or regularly bought it, 32% said yes.

Publishing AR magazine on the Internet for WIA members as an e-zine saw 49% of respondents in favour and 51% against.

The survey also gave respondents an opportunity to make comments on any question. Some were concerned about the issue of access to the Internet, and therefore the ability for members to obtain Amateur Radio if it were only an e-zine. The e-zine question result also reconfirms WIA Victoria's belief that about 50% of today's radio amateurs do not have, or do not readily have access to the Internet.

The result however could be seen as clearly identifying an existing market opportunity to publish AR magazine as an e-zine, albeit as an addition to a printed magazine, with access restricted to members. The survey found that 44% of respondents currently read ezines.

New councillors

The WIA Victoria Council is now at full strength following the appointment of three new councillors. They are Murray Price VK3JKZ, Barry Robinson VK3JBR, and Jonas Sadauskas VK3VF.

The trio join councillors Peter Mill VK3APO, John Brown VK3JJB, Barry Wilton VK3XV, Keith Proctor VK3FT and Jim Linton VK3PC.

As announced previously, Barry Wilton VK3XV has retired as Treasurer. His replacement is Jim Baxter VK3DBQ. He has been learning the requirements of the job since late last year and was formally appointed last month.

Gary Furr VK3KKJ had resigned from council effectively from the end of December 2001, but will continue in his role as Internet Project officer. Thank you Gary for your contribution as a councillor and the website has never looked so good.

IRLP providers meeting

WIA Victoria convened the first ever meeting of Internet Repeater Linking Protocol (IRLP) providers in VK3 to discuss issues surrounding the use of the Internet to link repeaters, including with those overseas with local repeaters.

WIA Victoria has been supporting the existing groups in their early stages of introducing IRLP through technical liaison, licensing and advice. The meeting on 19 February brought them together for discussion and mutual benefit.

Attending were representatives of IRLP nodes in Mildura, Ballarat, Geelong, Mornington Peninsula, and Melbourne. Three other groups that have advanced plans for setting up IRLP nodes also attended.

Within a few months it is expected that new IRLP nodes linked to 70cm repeaters will be servicing Melbourne's south, south-east and east. The first IRLP node, a joint venture between the Moorabbin and District Radio Club and the Geelong Amateur Radio Group, has been operating through the two metre repeater VK3RGL at Geelong. It will switch soon to VK3RGL 70cm.

The BASS IRLP Group has been using the Arthur's Seat 70cm repeater VK3RPU. More recently the North East Radio Group has been operating its node in Melbourne's north-east via the club's 70cm repeater VK3RMH.

The meeting heard details of each of the operating systems, their plans for the future, and the proposals for new IRLP nodes.

Those gathered agreed that an education campaign on the use of IRLP was needed, and as a starting point the WIA Victoria Voice Repeater Guidelines have now been updated to include guidelines for the use of IRLP. The revised guidelines are available on the WIA Victoria website.

In another initiative arising out of a very positive meeting is the setting up of a VK3 email list for IRLP providers to encourage the sharing of information, liaison with WIA Victoria, and coordination.

Silent Keys

The WIA regrets to announce the recent passing of:-

G W Lanyon VK2AGL
P W Campbell VK2AXJ
G (West) West VK2BT
M W (Martin) Saunders VK3AMV
A C Corrick VK3CBG
S H Williams VK3DSW
W G H Daniel VK3NX
E G (Edward) Hafner VK4AEW
S O Martin VK4MUQ
K J (Kevin) Horan VK5IT
Jp (Peter) Rodgers VK5KJT
C H (Clarrie) Castle VK5KL
(Leith) VK5LG
K J Atkins VK5MW
F (Fred) Reid VK7SD

VK2 Notes

By Pat Loeper VK2JPA

A last reminder that the Annual General Meeting of the VK2 Division will take place on 13th April at Amateur Radio House Wigram Street Parramatta, commencing at 11 am.

The Trash and Treasure on the last Sunday in January was well attended and many amateurs renewed friendships. The Home Brew Group met after the Trash and Treasure with projects to be examined and many topics to discuss.

At the beginning of the Group's meeting, Barry White VK2AAB, the VK2 Federal Councillor, made an award to Guy Fletcher VK2KU for his antenna article in Amateur Radio (picture). It is good to see a local amateur making the grade in technical writing for AR. Let's hope it stirs others to write articles for our magazine.

Next month we hope to write about the Wyong Field Day and those who attended it. Perhaps we saw you there?

That's all for this month.

ar



Silent Key

Edward Charles, "Eddie" Hornbuckle, VK3BBP

22/08/1922 - 30/1/2002

Eddie past away on the 30th January 2002 missed very much by his family and many, many friends.

He is remembered for his many qualities, love for his family and friends, integrity, ingenuity, his interest in diverse fields of technology, people and his ability to realise ideas into reality in his own, unique way.

You only have to look at his homebrew antenna mast, which is an absolute masterpiece of Australian bush inventiveness, an awe-inspiring 50 ft high. Only a small electric winch is used to raise and lower the mast. The fulcrum being about 8 ft above ground, the mast is counter balanced by 1

Deutz diesel 100 HP flywheel, 1 Garden truck engine flywheel and various blocks of concrete picked up successively by a heavy chain when the tower moves majestically skywards. It was Eddie's great pride and liked to show it off to visiting amateurs, possibly also inspiring a certain amount of fear as well as the movement tended to be a bit wobbly on the way up. However his engineering insight showed up here because firstly, the amount of balance weight picked up followed closely the first quarter of the cosine function so that there was almost perfect balance all the way when the mast was erected.

Secondly, the point where the line was attached to pull the mast down is about 2/3rds up the mast thus no great leverage was required.

I will be remember him foremost for his optimism and positive attitude, 25 years ago we sat for the exams in Sale, Victoria and the CW was really a problem for him, but he stuck to it and after his seventh try obtained his full licence!

This attitude showed up very much in his last years when he suffered much due to his illnesses, but he found great strength in the loving care of his beloved wife Elaine.

More Operating Hints from Peter Whellum VK5ZPG

Carrying on from last month, here is an account of Peter's experiences using FO-29 and AO-10:

"FO-29 is an interesting bird as it is inverting. In simple terms, if you transmit on the uplink in LSB, you will appear in the downlink as USB - the preferred method! However, inverting voice comms birds like FO-29 also have 'opposite tracking frequencies'. By that I mean that if you transmitted in at the low end of the uplink, say at the pass band 2m frequency of 145.900 MHz, LSB, you will be received at the high end of the downlink (in this case, 435.900 MHz, USB) - inverting in the full sense of the word! However, operating through these birds is relatively simple if you are lucky enough to have a 'satellite special' transceiver, e.g. the Yaesu FT-736R. Study the user manual, particularly those parts relevant to satellite operations, and in particular, inverting types! Let's look at a typical FO-29 contact (oh, and when you do make contact, take your time and have a good yarn while you're at it!):

I will assume you have your antennae

The AMSAT group in Australia

The National Co-ordinator of AMSAT-VK is Graham Ratcliff VK5AGR. No formal application is necessary for membership and no membership fees apply. Graham maintains an email mailing list for breaking news and such things as software releases. Members use the AMSAT-Australia HF net as a forum.

AMSAT-Australia HF net

The net meets formally on the second Sunday evening of the month. In winter (end of March until the end of October) the net meets on 3.685 MHz at 1000utc with early check-ins at 0945utc. In summer (end of October until end of March) the net meets on 7.068 MHz at 0900utc with early check-ins at 0845utc. All communication regarding AMSAT-Australia matters can be addressed to: AMSAT-VK, GPO Box 2141, Adelaide, SA. 5001. Graham's email address is: vk5agr@amsat.org

all set up and hopefully, computer controlled, otherwise you'll need a couple of extra hands! However, let's assume you do! A few minutes before the bird is due to appear over your radio horizon, set your transmit and receive frequencies for the centre of the transponder's pass band;

(a) Set your TX frequency to mid passband of about 145.950 MHz - CW initially;

(b) Set your Rx frequency to mid downlink pass band of about 435.850 MHz - USB

If you are using the FT-736 or similar, you could then switch to 'reverse' tracking, but I personally don't worry about the 'reverse' tracking yet - or at all for these low earth orbit types! Once you have set your transceiver up, LEAVE YOUR RX FREQUENCY AT THE CENTRE OF THE PASS BAND AND DON'T MOVE IT UNLESS YOU HAVE INTERFERENCE. If you do switch to reverse tracking, you will end up chasing each other up and down the band - you'll end up in a mess!

As the bird appears over your radio horizon:

1. Have a quick tune across the band, but make sure your FT-736R (or equivalent) is in the Reverse tracking mode - that way you will be tracking opposite in frequency - I hope you understand what I mean there! (You will be able to tune to the centre of the passband, knowing your TX frequency will be similarly tuned.)

2. If you hear no one calling, with your 736R still in the reverse mode, move to the centre of the passband as shown on the receive readout. THEN SWITCH TO TRANSMIT - CW. (ie, move the tracking switch to the TX position.)

3. Leave your Rx frequency alone! Key your transmitter with a burst and slowly tune your tx vfo until you hear your own signal coming back at you on your 70 cm receiver - and please, make sure you're wearing your headphones!

4. As you start to hear your own signal, keep tuning until you get a nice zero-beat or close to it, then switch to LSB. Start talking and USE YOUR TX VFO TO RESOLVE YOUR OWN SIGNAL - NOT YOUR RX!

5. Once you have your own signal resolved nicely (and don't you sound nice through the headphones!), give your normal satellite CQ. Remember, it is full duplex, but pause once in a while to listen in case there is a weak station. If anyone is about and hears you and wants to have a yack, you'll soon hear the familiar heterodyne as the other bloke starts to zero beat his signal onto your frequency - keep talking to help him zero in, otherwise he'll be slightly off frequency, tempting you to use your receiver to tune him in - he'll then start chasing you and away you go again, falling off the edge of the world to the place of dragons!

6. During your QSO, use your transmitter VFO to keep your received signal in the one spot - please don't use your receiver unless you find yourself with some form of interference. You will find, particularly with nearly 'over the top' passes, your fingers are almost constantly retuning your tx VFO - Doppler shift, although relatively small, is enough to quickly spoil your beautifully resolved voice coming back to you through your headphones! The other amateur will be doing the same thing as you - HOPEFULLY! If he isn't, then you are in for the ride of your life - you follow him down or up, and he follows you down or up and before long, you both end up visiting the dragons!

7. I have seen it written somewhere that someone suggested the higher frequency in use is the one that is changed, leaving the lower frequency alone. I've never worked anyone who uses that principle, but

it would work just as well as changing your tx VFO; however, most hams seem to change their tx frequency, regardless of which is higher. It certainly seems the case with RS12/13, RS15 (when it's on), FO-29 and AO-10. The main thing is to maintain at least one link constant; otherwise you will stray where dragons lurk, just waiting for the unwary ham!

8. Oh, forgot to mention polarisation! If you have the ability to switch between LHCP and RHCP, all the better, as it can assist with some of the deep QSB that you'll often experience, and that adds yet another dimension to the fun of working these wonderful birds! (If you haven't, well, it just means you have one free hand to perhaps take notes or fill in the logbook - provided you have an automatic az/el system of course!)

A quick word about the grandmother voice comms satellite of them all, dear old Oscar 10 - after all these years (launched in 1983!), with dead batteries and with, I believe, absolutely no control over her activities, she is a remarkable old lady.

At times the activity on AO-10 is fast and furious, on other occasions you can be talking to yourself, with quite decent return signals for what seems like hours - and quite often it can be in your view for 10 or more hours - and often quite workable for a good proportion of that time!

You need good antennae, good rx preamps (mounted at the mast - I hope! - unless your cable runs are short and you can get away with them in the shack) and a bit of patience - and the ability to switch polarisation of both tx and rx as the old lady seems to like to wobble a

Zeehan Primary School to talk to ISS Astronauts

Tony Hutchison VK5ZAI, Australian ARISS co-ordinator reports that a contact has been organised for students at the Zeehan Primary School in Tasmania for mid-March, around the time you will be reading this column. This will be the first time that Australian school children will have the opportunity to talk to Astronauts

on board the ISS. The contact will be made live with the aid of Bill, VK7KHZ. Tony also reports that Bordertown Primary School is also on schedule to make a similar contact later in the year. Many thanks to Tony and Bill. I hope to report the success of this event next month.

bit in her space travels! However, 5 x 9 plus signals are a regular event, so are 1 x 1, but thankfully the noise level is sufficiently high you don't bother even trying! Seriously though, it's jolly good fun; think about giving it a go. If you do, and are new to 'the game', similar working 'protocol' to working the LEOs also applies.

1. Listen to the beacon (145.810 MHz) - to give you some idea of Doppler shift and where to start transmitting.
2. She's an inverting bird, so set Rx and TX up for the centre of the band (i.e. uplink on about 435.100 MHz, initially on CW, then to LSB; downlink on about 145.900 - USB);
3. Start transmitting CW - short bursts, listening on 145.900 for your signal; remember, use your tx VFO to 'find' your own signal and then keep using it as Doppler takes hold.
4. Unless you happen to catch AO-10 at perigee, Doppler shift isn't quite as bad as it is for the LEOs. However, it is present and you must remember to change your transmitter vfo frequency to remain on the one transmitting frequency. However, this is where transceivers like the FT-736R make life so much easier! Once you have your tx and rx frequencies resolved, simply

switch to the reverse tracking position (and don't forget to tx in LSB!) and then you are free to tune up and down the band pass of the transponder (145.825 to 145.975 MHz), knowing that your tx and rx frequencies are locked together, but tracking in opposite directions. However, you will need to occasionally switch back to your tx to adjust the tx VFO to remain on frequency - but is certainly less frequent an event than working through the LEOs.

5. I've found that most hams seem to congregate around the middle of the downlink passband of 145.900 and, if the band is inactive, most seem to stay at that frequency. Good manners, however, should come into play and perhaps a suggested move up or down a few kHz would be in order.
6. Deep QSB can be 'nasty' - a bit like dropping off to visit the dragons! A bit of patience will pay off as the deep fades usually also mean a round of good to excellent signals - 5x9 copy, both ways, is often possible, even when the bird is several thousands of kilometres above the earth; a wonderful old grandmother if ever there was one! (And I suspect she suffers from

KO-25 Efficiency Improves

I have received reports indicating that the download efficiency of KO-25 has improved of late from very low performance to around 50-60%. Let's hope that this is due to some action of the control stations and not just a random event. I'll be keeping an eye on KO-25 this month to see if the situation remains the same or perhaps even improves. With only the occasional meaningless noises from KO-23, the poor efficiency of KO-25 has placed a heavy burden on UO-22, the last of the 9600 baud birds delivering full performance.

Knighthood for UoSat Pioneer

Martin Sweeting G3YJO has been knighted for his efforts in the field of education using satellite technology. From its humble beginnings at University of Surrey to the present-day "Surrey Satellite Technology" company, the entire technology-transfer program has been inspired by the leadership and vision of Martin Sweeting

StarShine-3 goes silent

Starshine-3 has been silent since January 9, 2002. The satellite has a very simple command-set. Controllers are able to turn the transmitter on or off and change the interval between packets. With just this limited amount of control, recovery of the satellite looks unlikely.

'selective deafness' on the odd occasion!).

7. A further word about 'good manners' on AO-10. Because the batteries, for all intents and purposes, simply don't exist, she relies on the sun for her power. If you hear the beacon fm-ing, or hear your return signal start to "fm", then please don't continue to transmit, your signal will quickly become unreadable and there could be others that are trying to use it at very low power settings which don't cause the fm-ing. Another very important point is to never use more power than that which is sufficient to hear your own signal clearly, taking the overall bandpass conditions into

consideration. If we all worked 400 watts PEP into the old dear when she is 'open', we're likely to make her 'pull the plug' on the lot of us. A good cross yagi system, say 10 elements on both 2m and 70 cm, with around 50 to 100 watts should get you well and truly into her passband; if you need much more, give it a rest and try something else, methinks she's trying to tell you it ain't worth trying at that particular time!

8. One final word - you will often find she is in your radio horizon for several hours at a time, giving you plenty of time to try to work through her, so take your time,

listen around the passband and you may well be surprised at what you hear! I can't wait to get on to AO-40!" Oh, and as she passes close to perigee, expect all sorts of interference from Asian taxi-drivers, who seem to be using FM gear, apparently on the 2m band - it all makes for good fun though as SSB signals can usually be heard quite clearly through the 'squiggles' of fm stations."

Thanks very much to Peter for his contributions over the last two months. I hope they will inspire some more folks to dust off the gear and get in there and have - not just a QSO - but a good old rag-chew on the birds.

Exciting Plans on the Table at AMSAT-NA

The AMSAT-NA Board of Directors has been busy looking at an exciting new proposal for a satellite.

As many of you are aware, ANSAT-NA membership is comprised of people from all walks of life, including those who earn their living designing and building satellites. A company who builds satellites - with AMSAT-NA members as senior officers - approached the Board with a proposal to build a microsatellite in conjunction with AMSAT. This microsatellite, based on a design with several receivers and high power transmitters will enable users to:

- communicate using analog voice through the satellite on several VHF uplink and UHF downlink channels simultaneously. Operation will be similar to AO-27 and UO-14 - but with handheld QRP power!

- communicate using 9600-baud digital store-and-forward data, similar to UO-22 and KO-25
- communicate using APRS 9600-baud packet data, in either a digipeat or store-and-forward mode
- repeat 1200-baud AFSK APRS packet data through the satellite's analog repeater
- experiment with PSK-31 operation (28 MHz up/70-cm down)
- uplink voice or data on 23-cm, 2-meters or 10-meters with a 70-cm downlink
- receive up to 56k-baud digital transmissions using an UHF downlink
- receive spacecraft telemetry and bulletins
- experiment with various, simple, low gain antennas

There is also room on board for one or two secondary payloads. This is quite a lot for a small satellite, but with shrinking electronic components it is possible to get so much more into a small space. The board anticipates that the satellite will be designed, constructed, and undergo all its tests in 2002-2003, and be ready for launch in late 2003. A suitable launch has not yet been defined; however, there are several opportunities that are being investigated. It is important to note that during the development of this bird, the design of the Eagle satellite project will continue. Eagle, being a larger satellite (and to be launched into GTO) will take longer to design and build. Currently, we hope that Eagle will be launched sometime in 2004, and we are still negotiating launch requirements.

New Amateur Radio Antenna System on ISS

Yep, it's finally happened. After years of makeshift antennas, first on MIR and then on ISS, the permanent amateur radio antenna system was deployed recently during a space-walk. In no small way, this can be seen to indicate that amateur radio has come of age and has been recognised as a permanent adjunct to ISS operations. Congratulations to Lou McFadin, W5DID, who constructed the antenna array in the AMSAT-NA lab in Orlando. These new antennas will provide enhanced communications with ISS.

Ground-Breaking GPS Tests on AO-40 and PCsat

Recent tests of the GPS navigation system on AO-40 were an outstanding success. The command team reported that these tests were particularly noteworthy as it was the first time ever - amateur or commercial - that the GPS satellites were used from ABOVE their orbital ring. The GPS birds are designed to broadcast their signals downwards to users on the ground. Until now it was not known for sure if they could be accessed in a meaningful way from above. Congratulations to the command team for a world-first for amateur radio.

Whilst on the subject of GPS, I reported last month that the PCsat GPS experiment had been turned on. I was fortunate to observe one of the passes over VK and it was working perfectly. My UIview program displayed the position of PCsat as it came into range and continued transmitting position packets every 30 seconds or so until LOS. I was able to follow its progress across Australia and check the track against my WiSP tracking program. As expected, the two agreed perfectly.

2002 ARDF World Championships

The Slovak Amateur Radio Association (SARA) will host the 11th World Championships of Amateur Radio Direction Finding September 2-7 in the Slovak Republic.

Participants are divided into five categories for men and four categories for women, in accordance with newly approved ARDF rules of the International Amateur Radio Union (IARU). Each country may have up to

three members per category on its team. IARU societies for each participating country should have submitted a Letter of Intent with tentative team size by January 31.

New amateur radio antennas installed in space!

On January 14, thanks to a space walk by ISS crew members Yuri Onufrienko, RK3DUO and Carl Walz, KC5TIE, the International Space Station had its first VHF-UHF antenna installed.

ARISS Board Chairman Frank Bauer, KA3HDO, who monitored the operation from earth said "It was pretty exciting to see the unfurled ISS ham antenna system permanently mounted on the outside edge of the Service Module," Bauer said. "The antenna system looked breathtaking from the videos we witnessed while supporting the EVA. It went like clockwork, everything deploying just as it was supposed to."

While crewmate Dan Bursch, KD5PNU, monitored and videotaped the space-walk—or EVA—from inside the ISS, Onufrienko and Walz first relocated a Russian cargo crane used to maneuver equipment and space-walkers. Then, they installed the flexible-tape VHF-UHF Amateur Radio antenna on a handrail at the end of the Zvezda Service Module—the crew's living quarters. The ARISS initial ham station gear—single-band hand-held transceivers for 2 metres and 70 cm—is installed in the Zarya Functional Cargo Block. NA1SS currently uses antennas that were installed to aid docking operations and EVAs. The new VHF-UHF antenna is the first one designed for and dedicated specifically to support ARISS operations.

Three antennas are for VHF-UHF, while the fourth will support HF, although no HF gear is aboard the ISS at this point. Installation of the new antenna on Zvezda paves the way for two separate ham stations aboard Space Station Alpha.

Bauer credited Lou McFadin, W5DID; Mark Steiner, K3MS; Ken Nichols, KD3VK; and Mark Clausen with providing support for the antenna installation from the NASA Goddard/ISS Ham-Goddard Control Center. He said Carolyn Conley, KD5JSO, provided antenna installation support at NASA's Johnson Space Center Mission Control Center. "Congratulations team on a job well done. We have taken our ideas, concepts and vision and transformed them into reality," he said.

The antenna installation got top billing in several high-profile media outlets covering the space walk.

On January 25 the new HF antenna was installed—although there's no HF gear aboard the ISS as yet. The antenna was put into place during a space-walk—or EVA—conducted by Expedition 4 Crew Commander, Yuri Onufrienko, RK3DUO, and astronaut Dan Bursch, KD5PNU.

The antenna is a flexible-tape design—similar to, but longer than, the VHF-UHF antenna previously. The antenna is installed at the end of the Service Module in the 2 o'clock position (6 o'clock is pointing toward Earth).

The HF antenna is a 2.5-metre (8.2-foot) long flexible tape. Bauer thinks it will definitely work on 10 metres and speculated that it might work on 15 or 20 too. Bauer added that he did not know when HF gear would be transported to the ISS or when it might be made available for use by a future crew.

This EVA lasted several hours and also involved attaching six thruster plume deflectors on the ISS as well as the ham antenna work. Installation involved not only the mechanical deployment of the antenna but routing cables, establishing the RF connection and even photographic documentation.

A paper entitled "2001: an Amateur Radio Space Odyssey on the International Space Station," which details the development of ARISS and discusses the four new ARISS antennas is available via the ARISS Web site <<http://ariss.gsfc.nasa.gov/EVAs/amsat01.pdf>>.

Taking the pill

United Kingdom

The world of medical communications research has finally caught up with the lights of Hollywood. This, as we learn of the part Australian developed tiny radio camera-in-a-capsule that patients can swallow. It is a camera that will transmit pictures to give doctors a close-up view of what is inside of you.

The new transmitting video pill is made by Given Imaging Ltd. It is called

the M2A Swallowable Imaging Capsule. It is also exceeding tiny. It is so small that it is easily swallowed by the patient. Its inventors say that it then painlessly winds its way through the digestive tract and uses wireless technology to transmit full colour pictures to a belt pack receiver worn by the patient. That unit also decodes the signal and records the information as the patient goes about his or her daily routine.

The entire system is reminiscent of the science fiction movie "Fantastic Voyage." In that film a submarine and its crew of medical specialists are miniaturised and injected into the bloodstream of a critically injured man to perform an operation to save his life while receiving instructions by two way radio.

(Science Today via arnewsline&QNEWS)

Mobile operation in Europe

The "e" Mark

Today cars and trucks are very sophisticated and many have electronic systems that require safeguarding to ensure that they do not cause interference to the braking and speed control systems.

Back in October 1995, the European Commission (EC) issued a directive (95/54/EC) with the aim of improving safety by minimising the risk of interference to essential electronic systems in vehicles. This directive did not specifically target radio communication equipment, but all fitted electronic/electrical equipment

The Directive states that all four-wheel vehicles (other than tractors and mobile machinery) with a design speed greater than 25 kph will need to meet suitable electromagnetic compatibility (EMC) standards. Equipment that meets these EMC standards is marked with an "e"

mark. The "e" mark should not be confused with the "CE" mark, which is for general equipment, and requires conformity to a number of different standards.

No new car built after October 2002 can be fitted with a radio transceiver, or any other equipment that produces radio emissions, unless that equipment has an 'e' mark fitted. This presents a number of problems, not least if a mobile radio user acquires a new car it will not be acceptable to transfer the old radio to the new vehicle unless it has the "e" mark, a fact that could cause considerable hardship to some businesses.

It is interesting to note that the British RA is currently unaware of any manufacturers who are making "e" marked equipment for the radio industry! Imagine the effects on the use of cell-phones, etc.!!

(RSGB Jan RadCom)

But there is hope. The following is a translation from January DL/QTC

With the increase in electronic equipment to control the operation of an automobile, there has been quite an outcry in Europe as to the effect Amateur Radio equipment has with the electronic system.

Car manufacturer Renault has recently advised the DARC that they give permission to install and run radio equipment in their cars. Specifications have been given for every model regarding the mounting of the radio, the position of the aerial, frequencies and power. Renault is using a guidance paper recommended and acknowledged by all major car manufactures in Europe. All specifications given have to be complied with. Non-compliance can cause a loss of warranty on the vehicle and as stated earlier a loss of insurance cover.

DL/QTC1/02 via VK4BDQ

Single letter suffix for Germany

The German Telecommunication Authority has accepted a recommendation from the German Amateur Radio Club (DARC) to use single letter suffixes. However, this will only be issued to Club stations and is expected to take affect later in the year.

DL/QTC1/02 via VK4BDQ.

New Zealand simplifies amateur licencing

New Zealand has streamlined the route to obtain an Amateur Radio license. New Zealand now offers just two license classes, Limited and General. The Novice and the Novice/Limited licenses no longer are issued, although holders may retain them and continue to operate; some also may be eligible for an almost-instant upgrade. The New Zealand Association of Radio Transmitters (NZART) administers the volunteer examination program there, and examinations are supervised by

examiners from NZART branches. Candidates get two hours to complete a 60-question test and must answer 40 questions correctly to pass. The Morse code speed to qualify for the General-grade license has been lowered to 5 WPM. The General License provides access to all Amateur Radio bands with full privileges. A Study Guide and full information on the New Zealand licensing system is available via the NZART Web site <http://www.nzart.org.nz/nzart/>.

ar

Silent Keys

Kevin McGrath, VK3EQM

Kevin McGrath, VK3EQM, became a Silent Key on the 14th January 2002 (aged 74 years) after a short hard struggle with cancer.

Kevin was a keen CW operator and his interest in radio stemmed from a long and distinguished Army career, in which he achieved the rank of Major. His tutorship and instruction ability helped many people in the East Gippsland area to obtain their Ham licence with his knowledge in both

Theory and CW.

Affectionately known as "Poppa Bear", "Grumps" and "Mate", he will be sadly missed in the East Gippsland Amateur Radio Club and to Amateur Radio in general.

The E.G.A.R.C. offers its sincere condolences to Milly, Anne, Jan, Jenny, David and families.

73 Kevin. from:
VK3RS-Ron Sutcliffe, E.G.A.R.C.
R.I.P.

Barrie Lakey VK3BL

It is with great sorrow that our esteemed Secretary passed away on January 4, after a long illness, and will be sadly missed by all members for his help, contribution and friendship over many years with our club. Our deepest sympathy goes to XYL Yvonne and family.

President, Committee and Members.
Midland Amateur Radio Club. Inc.
Bandigo, Victoria.

Part 12 - ComputerPhobia

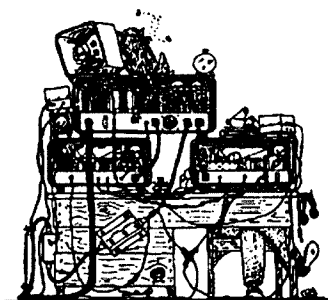

Are you frightened about using a computer? Do you think that if you use a computer, you might damage something? If you write short letters on your computer, then "click" on the Save icon, can you find them the next day? Can you install new software then run them from a desktop icon? Can you save files to floppy disks? As a reader of this series, if you have any doubt about just one of the questions above, then read on.

Many people use computers for simple things like writing letters and/or just playing games like Solitaire. The computer may have been purchased as a "package deal" where software is pre-installed, and Icons appear when the computer is switched on. All the user does is to "click" on one of the icons and the computer does the rest. If they need to move a file, or clean out and delete old files, the user is totally baffled. If anything goes wrong the user calls in "a technician". It's clear that this user has what's called "ComputerPhobia".

ComputerPhobia is common in Amateur Radio. For example, one RA has sold or given a computer to a friend with little or no knowledge about computers. Without handbooks or any form of proper instruction, the new owner is totally stumped. The new owner finds the computer far too complicated to understand, and decides to abandon it. He finds it embarrassing to ask someone for help in getting started. What are the pile of software disks for, and how do you use them?

Case Study No. 1

A RA buys a new computer from his local emporium. All the software is loaded and configured ready to go at first switch-on. Handbooks and all the software are supplied. The user studies the books in detail and tries writing letters and playing a few games. Notes are made at each step and the user's knowledge and experience rapidly grows. He asks friends how to do unusual tasks, and exercises them regularly until he acquires the processes naturally without the notes. Within a few months, the user has gained the confidence to explore new opportunities and is delighted with his new computer. He/she has reached the "fun stage" and the world of computer technology is not
Amateur Radio, March 2002

a threatening experience and ComputerPhobia has been challenged.

Case Study No. 2

An experienced RA with a 2 metre FM transceiver has been given a computer with packet radio software installed. Faced with finding a modem to connect between the computer and the transceiver, and instructions on how to use the installation is daunting, especially when the RA has little knowledge about computers. Asking an experienced RA for tips, the user follows the instructions and successfully connects to the local BBS. However, another RA visits and says that the software is "poor" and installs another package. The visitor fails to correctly configure the new software properly leaving the user without a working packet installation. Once again, seeking advice from the experienced RA, the user returns to the original software package and once again enjoys successful packet radio. The moral to this case study is NEVER INTERFERE into someone else's computer unless you are prepared to fully configure and provide instruction. In this case the visitor's software offered was inferior to what the user originally had!

Case Study No. 3

An experienced RA and a well-known DXer has an old computer. He wants to connect the computer to his rig, add software to control the station and keep an electronic logbook. The user asks an experienced RA to do this for him, and to supply the software. However, the computer is very old, slow, lacks hard drive space and spare communications ports. The visitor adds a new comport, the rig and logbook software, and provides basic instruction on its use. However, the user has little computer

knowledge, cannot save, and retrieve files and finds note taking difficult as a future reference to problem solving. The user complains that the software is too slow, want's to add packet radio, computerised CW, PSK31, RTTY etc, and asks the experienced operator to do this for him! If the computer lacks the resources to properly do the job in the first instance, then adding more software only compounds existing problems. The solution in this case is solid planning about what you want to do with your computer, and to learn the fundamentals before trying to hook everything together. Move in small steps until the goals have been achieved. Importantly; learn each step before moving forward. If you are not sure about how things work, try looking for the help files in the software, print them and do some serious bedtime reading before venturing into new ground.

Case Study No. 4

Son gives dad (a senior RA operator) a computer with no documentation or backup software and the senior operator had no experience with computers. A free CD-ROM was used to install Internet access, a new colour printer and image scanner was purchased, and the conglomerate was installed according to the enclosed booklets. With no experience, the senior RA was baffled and overwhelmed by what he saw. Losing patience with the complexity, the senior RA decided to switch off the computer. When tactfully questioned by an experienced RA, the senior operator did not wish to talk about the situation. In this most serious case of ComputerPhobia, the senior had given up learning about new technology. It will be very difficult to put him back on track.

Solutions

1. Training Programs

Most TAFE and Community Colleges offer short-courses in the basic operation of computers. Special courses are available for "seniors" at a discount, and courses may run for one day or several evenings per week.

2. Self Motivation

Self-motivation and a desire to explore new technology options drive Amateur Radio as an activity. Using a computer is no different to succeeding as a licensed Amateur Radio operator. In today's world, computers have become central to many daily activities - so why not spend a little time of your own and accept the challenge. Rewards are for the taking.

3. Learning to Learn

Many people find it difficult to learn about new things and mentally store and retrieve information gained. In fact, its common these days to find people who will not listen or question, or even accept good advice offered to them as a gesture to assisting them with problems. They turn away and ignore the gesture as being fickle and undesired. Listening is one of the great skills of life, and developing the wisdom to process and use information gained takes personal concentration.

4. AR Clubs and Societies

Organisations at all levels should be mindful that they must regularly provide lectures and seminars to help members - especially those seeking new ideas or lacking knowledge. New juniors and seniors alike is the future lifeblood of any club or society. Help your members to succeed and they return their gratitude by introducing new members. If your organisation fails to plan - then it's planning to fail!

5. Opportunity Shops

Don't be afraid to visit your local Salvation Army Opportunity Shop. The writer has found hardware, software, and unused handbooks in abundance - each at prices that will amaze the reader. For a few cents, old software handbooks give new life to your personal knowledge, and answer some of those niggling computer problems. Build a small library as a source of reference, and share this valuable resource with your club mates when they are in

difficulties with their Ham Shack Computer.

6. Club Lecture

If you are doing something new, operating a new data mode, using your computer to run your station etc, then offer your services to your club by way of a seminar demonstrating how it all works. Many clubs and societies organise meetings where the "official business" is conducted first - followed by the guest speaker. Avoid this structure vigorously because it's a typical example of planning to fail. Any AR club or society worth its salt elects a committee to handle the "official business" on another day - leaving the members meetings for members' enjoyment, junk sales, meaningful lectures and seminars etc.

7. The Spirit of Amateur Radio

If a new member, a junior or senior, or one of your club mates asks you a question, always answer clearly and offer a sketch, diagram, or a reference where they can find more information. Invite them to see your own Ham Shack in operation. Show them by demonstrating how things work, what's needed in equipment and software. If the Spirit of Amateur Radio was alive and well in the 1950's and 60's. Then why not show your colleagues that it's still thriving in the new millennium - but even better with digital modes and computers to assist us enjoy the hobby even more.

8. Write things down.

New ideas, software instructions, computer quirks, circuit diagrams, operating notes, vintage radio repairs and modifications, antenna design, computer interface diagrams and much more can be written on your Ham Shack Computer. One effective way to become proficient with your new-fangled computer is to write about your favourite Amateur Radio topic. Set the margins, columns, and font sizes to make a start on your document using your favourite word processor. Oh yes, mistakes will be made but the process of learning will rapidly follow. Proof read your work, print out a copy, and read once again. Once you are happy with the content, send a copy to your local club or society for publication. Now this is real productivity using your newfound computer skills. Even you're own Ham

Shack Computer notes can be stored in a display book ready for instant reference when needed. At least you won't have problems trying to read your own handwriting anymore, Hi

9. Club donations

With so many users upgrading computers these days, ask club members to donate unwanted computer hardware and software to "the club computer pool". Members can then access much-needed items from the pool for a small donation. Ensure that the member gets appropriate assistance and advice. Just selling a huge box of secondhand computer parts for a dollar an item is NOT THE SOLUTION. Offer help at all stages to ensure a satisfied member. Ideally, build up a Club Computer from the bits and have it available (with training) for a new member. Then stand back and see your membership slowly grow by reputation.

Ham Tip No. 12.

This *Ham Shack Computers* series has now been running for a whole year. The process of writing each "episode" has been exciting and fun for the writer too! Many "episodes" have been written at the express wishes of readers. One member wrote saying that he had given up Amateur Radio until he read *Ham Shack Computers*. The member hooked up his computer to his rig, got PSK31 running and is now planning other uses for his new computerised system!

The first 12 issues are available by contacting the writer by mail, packet, email, or by the plain old telephone system (POTS). Readers desiring copies in Word 97 format (zipped or unzipped) on disk are asked to provide a blank 100Mb Zip Disk. The latest published AR Magazine issue can always be downloaded from the Web Site listed below.

Ham Shack Computers No: 13, *Computer Viruses*, is essential reading for all active Radio Amateurs, even if you are not connected to the Internet but exchange files with other users. Failure to protect your computer from viruses is a recipe for disaster. Requested by Christine, VK6ZLZ on behalf of the WA Division, Wireless Institute of Australia.

(1) Ham Shack Computers Web Site: <http://www2.tpg.com.au/users/vk6pg>

73s de Alan, VK6PG

ar

Contest Calendar March - May 2002

Mar 2/3	ARRL Intl. DX Contest	(SSB)	
Mar 9/10	RSGB Commonwealth Contest		(Jan 02)
Mar 9/10	WWL DX Contest	(CW/SSB)	
Mar 16/17	John Moyle Field Day	(CW/SSB/FM)	(Feb 02)
Mar 16/17	Bermuda Contest	(CW/SSB)	
Mar 16/17	DARC SSTV Contest		
Mar 16/17	Russian DX Contest	(CW/SSB)	(Feb 02)
Mar 23/24	CQ WW WPX Contest	(SSB)	(Feb 02)
Apr 6/7	SP DX Contest	(CW/SSB)	
Apr 6/7	EA RTTY Contest		
Apr 12-14	Japan Intl. DX Contest High Bands	(CW)	(Dec 01)
Apr 13/14	Holyland DX Contest	(CW/SSB)	
Apr 20	TARA PSK31 Rumble		(Mar 02)
Apr 20/21	YU DX Contest	(CW/SSB)	
Apr 25	Harry Angel Sprint		(Mar 02)
Apr 27/28	Helvetia DX Contest	(CW/SSB)	
May 4/5	Danish SSTV Contest		
May 4/5	10-10 Intl. QSO Party	(CW/RTTY)	
May 4/5	ARI Intl. DX Contest	(CW/SSB/RTTY)	
May 11/12	VOLTA RTTY Contest		
May 11/12	CQ-M Intl. DX Contest	(CW/SSB/SSTV)	
May 18/19	Baltic Contest	(CW/SSB)	
May 25/26	Anatolian RTTY WW Contest		
May 25/26	CQ WW WPX Contest	(CW)	(Feb 02)

Greetings to all readers. You probably realise that lead-times for notes in magazines like this mean that articles are written some little time before you see them in print. Because of that, as I start these notes the annual Ross Hull and Summer VHF Field Day contests have just concluded and I am very much looking forward to the results – not because I expect to win, but because I tried to practise what I write and entered in areas which are not normally my operating fields.

I really enjoyed the experience, even though I was surprised at the lack of signals on two metres SSB as far as the Ross Hull was concerned. So what can I think about this? Three things come to mind – either I was listening and calling at the wrong times (even though I made a point of calling at different times), or there is much work to be done on my antenna system for those bands. Probably the answer is in both of these thoughts.

(By the time these notes appear in print my wife and I shall be about to move house, so a new QTH will be an opportunity to plan afresh for a new antenna set-up.)

However, is there something else in the form of many of us not using the capabilities of our radios? Huge numbers of operators have radios that cover every

band and mode these days. *What a shame that no use is made of them.* After all, a few regulars competing between themselves is hardly a "contest", is it?

The moral of all this is, I think, don't be afraid to get in and try something new and don't be put off if it does not go all that well the first time. Improvements can always be made if the will is there. I certainly enjoyed the experience of VHF contests and shall repeat it at some future time.

Different Modes?

If you look at the Calendar you will see that in May there will be several RTTY contests and even an SSTV section in one event. Why not aim to try something different like that this year? You may be quite surprised at your results! Look forward to hearing you.

Thinking Point

If you look at the rules for the TARA PSK31 Rumble below, you will see several references to web sites. In these days of electronic communications this is quite understandable. So it raises the question about the philosophy of columns like this.

As you know, this column has brought comments, rules and results for many years. I do feel that it is time for a change of style in my comments, but is there still a need amongst you readers for details of rules to be published? Are you able, or would you prefer, to find these on a web site yourself? Should I concentrate on just VK/ZL rules (even though these are available on web sites)? Is it time for a complete change of column format?

I would genuinely like to hear from you on this and it leads me directly to the next item below. Please e-mail me: contests@wia.org.au

New Contest Web Site

Last year, about the middle of the year I think, I mentioned that I would try to establish a web site focusing on Australian contests. Well, I did a lot reading and trying to put things together and finally it has happened!

The new site is now available with a URL (address) of www.vkham.com/contest/

I do not want it to be an elaborate site (i.e. lots of pictures and things that will take ages to view or download), but I would like it to meet your needs. Please have a look and let me know your thoughts. Certainly I would like it to be a reference for VK and ZL contests in these days of increasing use of electronic media for disseminating information.

Harry Angel Sprint

Finally, the annual Harry Angel Sprint is approaching again and details are below. Please note that at time of writing

I understand that there is no Manager appointed for this year, so I ask that logs be sent to me at WIA Federal Office.

Attention all testers

Due to security concerns, all participants in CQ-sponsored contests are asked to submit their logs electronically. Logs received though the mail at CQ offices will be held unopened until all potential health risks have been evaluated. There is no guarantee that mail will be opened. Please see the rules for all CQ contests. **73 and good contesting, Ian Godsil VK3VP**

Results CQ WW DX Contests 2001

(VK/ZLs only)

CW	VK6VZ	6,647	points
	VK2AYD	42	"
SSB	ZL6QH	13,884	"

Rules Harry Angel Memorial Sprint

1100z-1246z Tue 25 April, 2002

This is now an annual Contest to remember VK's oldest contest operator, Harry Angel. Please note the time length of the Contest-106 minutes, Harry's age when he died in 1998. It is open to all appropriately qualified HF operators.

Object is to make as many contacts as possible

Band 80 metres, using modes CW and SSB.

Categories: Single Operator (CW, Phone, Mixed) and SWL.

Frequencies: CW: 3500-3700 kHz, Phone: 3535-3700 kHz.

Contacts in DX window not permitted.

Exchange RS(T) and serial number; revert to 001 if 999 reached.

Score two points per CW QSO and one point per Phone QSO. Stations may be worked once only per mode.

Logs must show time UTC; callsign worked (both callsigns for SWLs; mode; RS(T); serial numbers sent and received for each QSO.

Send summary sheet showing name and date of Contest; name, address and callsign of entrant; category entered; points claimed and a signed declaration that the rules and spirit of the Contest were observed.

Send written logs to:

Harry Angel Sprint, WIA Federal, PO Box 2175, Caulfield Junction, 3161, by Friday, 24 May, 2002. Logs may be sent by e-mail to: contests@wia.org.au

Rules TARA PSK31 Rumble

20 April 0000z – 2400Z

Mode: PSK only. 80,40,20,15,10,6 meters. Work stations once per band.

Exchange: name; state/province/DX send dxcc prefix. Operate 1 of 6 categories.

The Club Challenge, special rules for this on web site below!

Power: Normal: 100w max. Great: 20w max. Super: 5w max.

Final score is QSOs (W + VE + JA + VK call areas + 1 point per DX incl. your own).

Multipliers count once per band.

To be valid, scores must be received via our online score submission form found at <http://www.qsl.net/wm2u/score.htm>, or e-mail Logs to wm2u@n2ty.org, by last entry date: 18 May, 2002. Logs must be available for review if requested.

Please read web rules for details on <http://www.qsl.net/wm2u/rumble.html> or <http://www.n2ty.org>. Info e-mail to Bill Eddy, ny2u@n2ty.org or Ernie Mills, wm2u@n2ty.org

ar

Spring VHF-UHF Field Day 2001: Results

Contest manager: John Martin VK3KWA

Call	Name	Locator(s)	6 m	2 m	70 cm	23 cm	12 cm	9 cm	6 cm	3 cm	TOTAL
Section A: Single Operator, 24 Hours											
VK5AIM	S. Mahony	PF94, 95	52	171	275	500	-	-	-	-	998
VK5ZUC	A. Russell	PF94	-	171	280	-	-	-	-	-	451
Section B: Single Operator, 6 Hours											
VK3WRE	R. Edgar	QF31	-	189	305	488	330	450	-	320	2082
VK3KAI	P. Freeman	QF21, 22, 31, 32	-	261	405	472	-	440	-	210	1788
VK5ADE	S. Cameron	PF94, 95	51	165	265	376	-	-	-	-	857
VK5UE	C. Low	PF94, 95	47	153	245	376	-	-	-	-	821
VK3YE	P. Parker	QF21	36	300	210	-	-	-	-	-	546
VK3PC	J. Linton	QF22	-	105	-	-	-	-	-	-	105
Section C: Multi Operator, 24 Hours											
VK3ATL	GARC (1)	QF21	-	504	670	848	-	-	-	450	1862
VK3AEF	(2)	QF03	58	417	585	376	-	-	-	-	1436
VK5BAR	AHARC (3)	PF95	-	140	80	-	-	-	-	-	240
Section D: Home Station, 24 Hours											
VK3FMD	C. Kahwagi	QF22	41	474	600	784	340	340	210	210	2999
VK3TMP	M. Pickering	QF21	38	396	455	560	-	-	-	230	1679
VK3YB	P. M. Pavey	QF21	54	297	310	424	-	-	-	-	1085
VK5AR	A. Raftery	PF95	37	117	190	288	-	-	-	-	634
VK3VB	P. H. Pavey	QF21	39	123	180	-	-	-	-	-	342

- (1) Geelong Amateur Radio Club: D. Learmonth VK3XLD, L. Sim VK3ZLS, C. Gnaccarini VK3BRZ, A. Gnaccarini (SWL).
 (2) J. Bywaters VK3AEF, B. Farmers VK3AQX.

- (3) Adelaide Hills Amateur Radio Club: D. Cavies VK5AFO, P. Hoffman VK5XPH.

Two logs were re-scored. One had counted a repeat contact which had been made too soon, and the other claimed

claimed some contacts which had been made after the expiry of the six hour operating period.

Sincere thanks to Mark Detering VK3TLW for assistance in checking the logs.

ar

Silent Key

Peter Campbell, VK2AXJ

It is with regret that I report that Peter Campbell VK2AXJ passed away on 12 February 2002, after a long illness.

Peter was born at Leeton NSW in 1932. He was educated at Leeton High School after which he moved to Sydney and undertook an apprenticeship in tool fitting. He qualified as a toolmaker and was employed by CSIRO in the Microwave Measurements Laboratory for many

years, retiring in 1991.

Peter obtained his first licence as VK2ZPB in 1961 and his unrestricted call VK2AXJ shortly thereafter. He was very active on VHF and HF in Sydney in the 1960s and was a very keen constructor and experimenter.

Upon retirement, Peter moved to the Mid South Coast of NSW and was very active as Radio Officer for the local Coastal Patrol. A competent computer

programmer, Peter did considerable work on computerizing maps of the coastal area. His programs are widely used by other branches of the Coastal Patrol. He also was a tireless worker for the Mid South Coast Club.

Peter will be sadly missed by all that knew him.

Stan Bourke VK2EL,
 Secretary Mid South Coast Amateur
 Radio Club. Inc.

How's DX?

Ross Christie, VK3WAC
19 Browns Road, Montrose 3765, Vic.
Email Vk3wac@aol.com

How to work under-the-dog-pile DX

How easy do you find working DX and DXpeditions, that is the real rare under-the-dog-pile type of DX? If you're like me you'll have a listen for a short while for any instructions being issued by the DX station then jump in with both feet. Also, if you're like me, you'll call and call mostly to no avail, continuously being drowned out by the expert DX chasers who appear to run many kilowatts to multi-element beams mounted at tens of metres above ground.

Many DX and DXpedition operators run schedules, beaming into specific areas to try to maximise the number of contacts they make, putting their rare call into as many logbooks as possible in the short time they are on air. These schedules are often based on the known 'most needed DXCC' requirements of particular areas (geographic and callsign) and gives the average operator a fairer go under more controlled and less congested conditions. Oceania (VK, ZL, P29 etc) has been largely ignored by the planners and organisers of major DXpeditions due to a number of reasons, not the least being the small population of amateur operators in the region.

Tony, VK3TZ and Allan, VK2ACA have made moves to improve our collective chances of being heard amongst the big guns. Allan has agreed to conduct a survey of VK/ZL operators with the aim of compiling a 'most needed DXCC list' for our area. This information will be made available to the various DX and DXpedition groups to try and convince them that there is a particular need for certain entities/countries in VK/ZL. We can all help Allan by visiting his site and completing the survey form at <http://www.vkham.com/Info/mostwanted.html>

or post him a letter if you don't have access to the Internet. The more people who provide input to the survey the larger the list of active VK/ZL DX operators will be, and the better the chance that we will be scheduled our own slot in DX and DXpedition operations.

IOTA chasers are also in for a bit of bad news this month. A snippet of news from The Daily DX tells of a planned DXpedition by XE2MX, XE1KK, G3OCA and G4CWD to activate some of the islands off the coast of Baja, California, Mexico being torpedoed, by (you'll never guess) Mexican amateurs! Apparently Mexican amateurs registered objections with the authorities, and unfortunately, have been successful in having the necessary licences for the operation withheld. Fred, N6AWD and Ray, N6VR had arranged for vital equipment and support to be available to the group on their arrival in Los Angeles. Alas, the group has determined to forego any further plans for activating these islands.

The recent volcanic activity in the Republic of Congo has found amateur radio playing a vital role in communications in the region. ARAC has been requested to set up emergency

HF links between Goma and Kinshasa after the failure of the telecommunications infrastructure. The IARU has submitted a proposal that could see four permanent amateur radio licences being issued. Good news for amateur DX'ers at least, but very sad for the local population who must be suffering terribly in the aftermath of the destruction caused by the volcano. It's a pity that the value of amateur radio as communications tool is under estimated until disasters such as this occur. Patrick, 9Q/F6BLQ, who is already in The Republic of Congo, suggests there might be some activity from here during the CQ WPX SSB contest at the end of March.

Another sad note is the news of Shiro Nomura, JA1CB, who became a silent key at the age of 70 years old on the 18th of Jan 2002. Junji Saito, JA7SSB, JA1AND and W9KNI have the onerous task of informing us of his passing. Although Shiro was not a keen DX'er, as an executive and chief engineer at Kenwood Radio he was responsible for many of the companies major developments. He designed the TS-900 some thirty years ago and more recently the TS-930s. Our condolences go to his wife, daughter and son.

The DX

5R, MADAGASCAR. Bruno, F5DKO, says he will be active from the 4th until the 16th of March from a variety of islands off Madagascar. He expects to be active during the first week from Madagascar's Coastal Islands West Group (AF-057), and the second week from Madagascar's Coastal Islands East Group (AF-090). QSL via IZ8CCW: Antonio Cannataro, PO Box:360, 87100

Cosenza, Italy. [TNX F5DKO and OPDX]

CE, CHILE. Marco, CE6TBN, will be active on all bands 10-40 metres SSB over the weekend of the 8th to 10th of March as CE6TBN/2. He will be operating from Damas Island (SA-086). QSL via N1IBM, Morris E. Maze III, 847 Dolan St., Lanoka Harbor, NJ 08734, USA. [TNX CE6BTN and 425 DX News]

J3, GRENADA. Bill, VE3EBN will be

active on 10-40 metres CW and SSB as J37LR from Grenada (NA-024) during February and March. QSL via VE3EBN either direct or through the bureau. [TNX VE3EBN and The Daily DX]

J6, St Lucia. Gary, KI6T will be operating on 10 - 80 metres, SSB and CW, as J68GS from St. Lucia (NA-108). Activity will take place from the 21st of March until the 2nd of April. Gary says

he will also participate in the CQ WPX SSB Contest with J6DX. QSL route for J68GS is via KI6T either direct or through the bureau. [TNX KI6T and 425 DX News]

P5, NORTH KOREA. Ed, P5/4L4LN, is back on the air again and using the new Butternut Vertical that was sent him. All reports indicate that he is getting out better and that he is on 15 metres as well now. He can often be heard on 21225kHz after 2300 UTC, also check 28580kHz. Ed makes a practice of working stations according to call areas; this is a good practice as long as people listen, and respond, to what call is being requested. [TNX OPDX]

PJ2, CURACAO. Larry, K6RO and Ron, W6UL will be operating mainly on the WARC bands and 160 metres on SSB and CW from Curacao (SA-006) between

the period 27th of February until the 5th of March. Larry intends to operate in the ARRL DX SSB Contest held over the 2nd and 3rd of March as PJ2K while Ron will be signing as PJ2/W6UL before and after the contest. QSL via KU9C. [TNX K6RO and 425 DX News]

YA, AFGHANISTAN. Nick, G4KUX has been active as G4KUX/YA on 20 metres. Nick says that he is in Afghanistan helping to install and set up an international communications network. Although reports say that there has been no documentation submitted to the ARRL regarding his YA operations (the 'work first worry later' policy is best implemented at this stage) Nick says that he has been working for the government for some time and is sure that documentation will be available soon.

Have a listen around 14198kHz after 0330 UTC. QSL via G4KUX. [TNX G4KUX/YA and OPDX]

YA0USA, AFGHANISTAN. Karl, K4YT has managed to obtain a club license, call sign YA0USA, which can be used by US government officials operating from the American Embassy in Kabul. Karl personally activated the call prior to leaving Kabul on a trip. QSL via K4YT. [TNX K4YT and The Daily DX]

ZL5, ANTARCTICA. Chris, KC4/N3SIG is presently active as ZL5CP from the New Zealand "Scott" Base located on Ross Island (AN-011). QSL via AI3D. Have a listen for Chris on the Antarctic net on Monday nights on 15 metres. [TNX DL5EBE and 425 DX News]

continued next page

The other end of the circuit SP7GIQ

Henryk Kotowski SMOJHF S05JHF

Chris SP7GIQ is 45 years old and received his licence at the age of 16. He learned contesting and building Yagi antennae at clubs near Warszawa, Poland. About ten years ago he moved to a small town of Lask, erected a few towers, built Quad antennas and started winning contests.

As of today he has:

- 10m 5 element Quad at 27 m
- 5 + 5 + 5 + 5 (stacked) Quads - top at 35 m
- 15m 4 element Quad at 27 m
- 4 + 4 (stacked) Quads at 35 m
- 20m 4 element Quad at 27 m
- 4 + 4 (stacked) Quads at 35 m
- 40m 2 element Quad
- 80 and 160m a vertical for transmitting and Beverage wires for receiving.

IC751A and a similarly ancient Alpha amplifier and a medium sized house.

e-mail:

sp7giq@pro.onet.pl

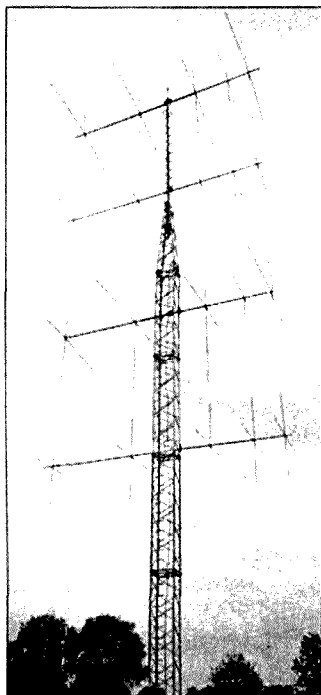

Detail of the Stacked Quads

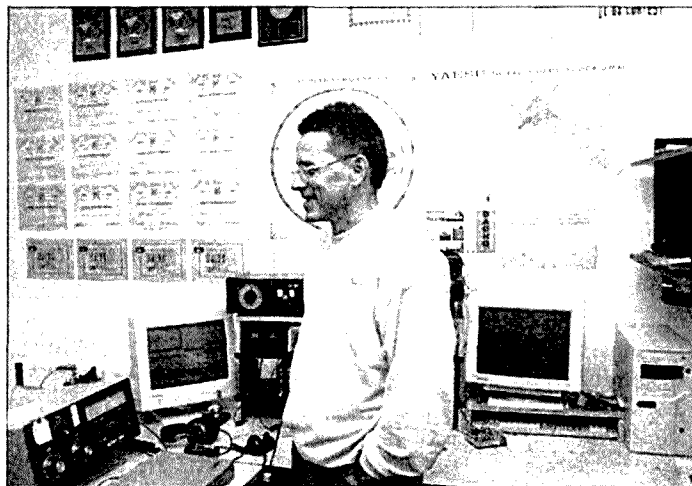

SP7GIQ in his shack

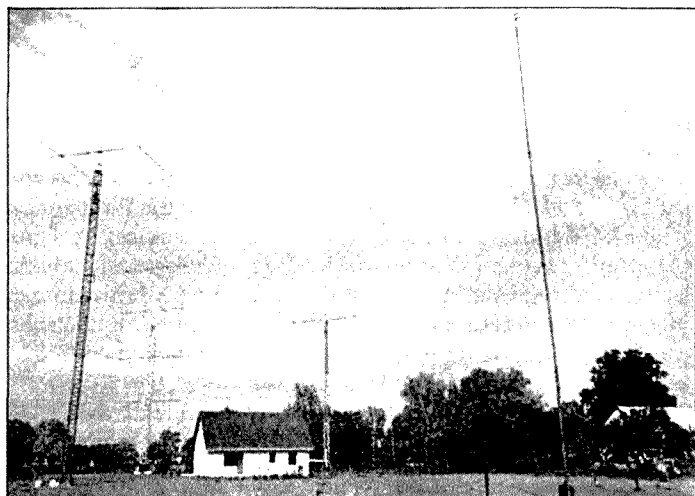

General view of the station

Special Events

ON, BELGIUM. A group of operators from the city of Bruges will be active as OP1A on all bands and modes from the 20th of Feb through until the 31st of December. The special call is to celebrate the award to the city "Bruges 2002, Cultural Capital of Europe". QSL via ON5TO, Omer Timmerman, Boterbekeweg 8, 8200 Bruges, Belgium. [TNX ON5TO and 425 DX News]

INTERNATIONAL LIGHTHOUSE/SHIP WEEKEND 2002. Mike, GM4SUC, has announced that the International Lighthouse/Lightship Weekend 2002 will take place from 0001z on Saturday the 17th of August until 2359z on Sunday the 18th of August. Last years event had 348 amateur radio stations on air from

lighthouses and lightships in 46 countries. A full list of stations that were active including their QTH and QSL information can be found at <http://vk2ce.com/illw/2001.htm> More information will be released regarding this years event later in the year.

9N, NEPAL. Charly, K4VUD / 9N1UD has sent word that all the donated equipment from US amateurs he took to Nepal a couple of years ago is still working wonders for the hams there. Many DX'ers will remember the late Father Moran, 9N0MM, and on the 14th of April they will celebrate the anniversary of Father Moran's operations. Unfortunately, due to the political fallout after the murder of the

King, and members of his family, 9N1AA and Charly have not been able to secure Father Moran's callsign, 9N0MM. This call was at one time proposed as a club callsign in Father Morans memory. However, they have not entirely given up hope of obtaining the call and still intend to establish the memorial club station in Kathmandu. [TNX OPDX]

UA, RUSSIA. Vlad, RN4LP says that the club station RW4LYL will use the special call RI4M throughout 2002, although he forgot to give the reason why. Perhaps it'll come out later (unless it's a Russian state secret!) QSL via RN4LP, Vladislav Lakeev, P.O. Box 208, Dimitrovgrad, 433512, Russia. [TNX RN4LP and 425 DX News]

DXpeditions

KH1 (Baker and Howland Islands). Operators for the KH1 (Baker & Howland) DXpedition have been selected and will comprise YT1AD as team leader, AH6HY, K1LZ, K3NA, K6NDV, KW4DA, N6TQS, RZ3AA, YU1AU, YZ7AA, Z31FU, Z32AU and Z32ZM. The group will depart Los Angeles on the 20th of April and head for Nadi, Fiji Islands. Part of the team will then embark for Tuvalu, while five operators will fly to Funafuti and operate for three days with a T2 call. The entire team will depart from Funafuti on the 26th and will arrive on Baker Island on the 29th or 30th of April. They hope to be able to operate from the island from the

30th of April until the 10th of May when they will return to Fiji then on to Los Angeles and finally to the Dayton Hamvention. The team will be comprehensively equipped having six transceivers, five amplifiers, four generators and a variety of beams, verticals and dipoles. Plans are to operate on 160 to 6 metres on CW, SSB, RTTY, PSK, SSTV, FM and Satellite. The callsign will be announced when the operation starts to prevent any pirating of the call. QSL via YT1AD (CW, RTTY, PSK and SSTV) and RZ3AA (SSB). [TNX YT1AD and 425 DX News]

H40, TEMOTU. Nick Hacko, VK1AA (VK2ICV/VK9LX) and Ranko Boca,

YT6A will be operating from Temotu between the 28th of March until the 12th of April. All previous operations have mainly concentrated on the higher HF bands so this operation will spend most of their time on 40, 80 and 160 metres and the WARC bands using CW and RTTY. Strict baggage limits (16kgs) have meant a special, and costly, deal with Solomon Airlines in order to transport a vertical antenna and amplifier to the island. To cover this extra cost donations will be gladly accepted. A website is available with more details of the operation at <http://www.qsl.net/vk1aa/temotu/> [TNX VK1AA and 425 DX News]

Round up

HP1BYS advises that permanent beacons were to be activated on the following frequencies 10108, 18105, 50012 and 144292 kHz. The callsigns allocated for the beacons are HP1RCP/B, HP1AC/B and HP1AVS/B. [TNX HP1BYS and The Daily DX]

9K, KUWAIT. Members of the Kuwait Amateur Radio Society (KARS) activated the special callsign 9K2RA/AE to celebrate the return of "His Highness the Amir of Kuwait Alshaikh Jabber Alahmad Alsabab" from a successful trip overseas for medical treatment on Tuesday 15th of January 2002. If you worked them a special QSL card is available. Note, the suffix "/AE" is the suffix letters in the Amirs callsign, 9K2AE. [TNX OPDX]

XF4, MEXICO. XE1BEF sends a report that two operations are currently being planned to take place from Socorro Island (NA-030), Revilla Gigedo in 2002. The first one is being organised by XE1KK and he will announce he dates soon. The second is planned for November by a group of operators from Europe and Mexico, including DJ9ZB and XE1BEF himself. More information on both operations will be available in due course. [TNX XE1BEF and 425 DX News]

AFGHANISTAN. Peter, SM7PKK and QRZ-DX have provided the latest news on operations from Afghanistan. Information to hand reveals that any operation using the callsign YA5T after

2 December 2001 was definitely by a pirate station. Peter has been flying in and out of Afghanistan on official business for the past few months. His pattern of movements will be similar for the next few months as well, so he says his time on air will be very sporadic. However, Peter is not the only amateur operator in the country.

- Robert, SM7PKK will be spending February and March in the country after a trip to the United Arab Emirates, A6.
- Mats, SM7PKK will be in the UAE, A6 for few couple of weeks after which he might be spending some time in YA.

- Mark, ON4WW is in Pakistan, AP and should be in YA by the end of January for at least a couple of weeks.
- Nick, G4KUX has been signing G4KUX/YA for several days now. This is his sixth trip to Afghanistan where he is involved with a major telecommunications project. He will be in YA until early February and will return to Kabul after a few weeks' break. The ARRL DXCC Desk has not received any documentation so far; reportedly Nick has a verbal authorization and expects a written permission shortly. QSL via G4KUX.

Poland: A Central European Country with a stormy history

Political changes in this region some 12 years ago resulted in a more independent governing system. The country has recently become a member of NATO. Some 40 million people live here but as many Poles live abroad scattered around the world.

Approximately 15000 licences are issued in Poland with prefixes SP, SQ, SN, 3Z. Foreign nationals visiting or settled here are given SO -prefix.

As of January 1, 2001 the CEPT agreement is effective in Poland. The national organization, PZK an IARU

member has its headquarters in Bydgoszcz nowadays, <http://www.pzkorg.pl>. During a recent IARU HF Championship PZK's "headquarters" station SNOHQ did extremely well.

A50B, BHUTAN. This callign has been assigned to the new club station for the Technical College, Polytechnic and University of Puentsholling, Bhutan. The station equipment has been set up by Ray, G3NOM/A52OM. QSL to P.O. Box 88, Thimpu, Bhutan. [TNX The Daily DX and 425 DX News]

TM2E, FRANCE. This special call was used on the 1st to the 14th of January to celebrate the adoption and introduction of the new Euro currency in France as well as eleven other European countries. QSL via F8BPN. More information on the Euro-Award can be found at <http://www.euro-award.fr.st> [TNX F8BPN and 425 DX News]

HAMAWARDS.COM. <http://www.hamawards.com/> is new website currently under development that should have been officially launched in early February by A.J. Farmer, KB3HGY. The idea of the website is to create a centralised index of awards available to

amateur radio operators. [TNX HA5CQ and 425 DX News]

KH4, MIDWAY. David Robbins, K1TTT reports that "the Midway Phoenix Company, which has been running the island's infrastructure, is vacating the island effective the 1st of March. This essentially closes down the entire island except for the Fish and Wildlife Service post. All air transport has been canceled, stores and accommodation sites are closed and all the company employees are packing to leave". This means that Phil/G3SWH and Jim/G3RTE have been forced to cancel their 30th March until the 6th of April 'W4M' operation, much to their disappointment. It also means that future visits to the island will be that much harder as the company also maintained the airport equipment and runways. [TNX AD1C, G3SWH and 425 DX News]

The correct QSL route for VP8GEO (South Georgia) is VE3GCO. [TNX The Daily DX].

Don't forget, pay a visit to Allan VK2ACA's website and complete the VK/ZL DXCC 'most needed' survey form, at <http://www.vkham.com/Info/mostwanted.html>

Sources

Thanks this month to the following for their kind permission to use the above material in DX Notes.

AD1C, G3SWH, HA5CQ, F8BPN, ON4WW, SM7PKK, SM7PKK, XE1BEF, HP1BYS, VK1AA, YT1AD, RN4LP, GM4SUC, ON5TO, DL5EBE, K4YT, G4KUX/YA, K6RO, KI6T, VE3EBN, CE6BTN, F5DKO, JA7SSB, JA1AND, W9KNI, 9Q/F6BLQ, VK3TZ, VK2ACA, QRZ-DX, 425 DX News and The Daily DX.

Selwyn Weston, VK2SY

It is with regret that I advise of the passing, on Monday 7th January 2002, of Selwyn Weston, VK2SY, at the age of 89, following a massive heart attack.

Sel was born and reared in Morpeth in N.S.W. He served in the RAAF during World War 2, where he established the communications facilities of a number of forward airfields and rose to commissioned rank.

After the war he established Weston Electronics, which pioneered the use of two-way radios in motor vehicles, was instrumental in equipping many outback stations, and produced a

number of excellent commercial units still in use today. He was also the first manager in Australia of Kenwood Electronics and one of the first to employ Dick Smith. The several businesses with which he was associated flourished because of his technical and administrative skills, his inventiveness, and, above all, because of his personal integrity.

Following his retirement he became active in the RSL, and having, in later years, acquired a knowledge of computing, he devised programs for the calculation of pensions, which he then

donated to that body.

He is survived by his wife, Kere, his two children, Max and Sandra, and his grandchildren.

Sel was a brilliant man, a good friend and an outstanding amateur. His loss will be felt by his many radio associates, both amateur and professional, and particularly by those amateurs with whom he maintained contact to within a few months of his death, in the persons of VK2PM, VK2RJ, VK2DV and VK2DDL.

Vale Sel Weston, VK2SY.

Stan Ellis VK2DDL, svellis@tsn.cc

Silent Key

VHF/UHF

AN EXPANDING WORLD

David K Minchin VK5KK

Postal: 10 Harvey Cres, Salisbury Heights, SA, 5109

E-mail: tecknolt@ozemail.com.au EMAIL ADDRESS CHANGED! Web page: <http://members.ozemail.com.au/~tecknolt>

Fax: +61 8 82924501 Phone: 0403 368 066 AH only

All times are in UTC.

50 MHz enters the Second Camel's Hump!

Like a few sunspot cycles past, it looks like this one may have two peaks, with a good start to the autumn equinox reported from several quarters.

Steve VK3OT reports ... Possibly the best EU dx I have ever experienced came in here on Feb 3rd from 0730z, a bit like that opening you guys (VK5) had in 1992. The day started with a chance QSO on SSB with ZF1DC Cayman Islands, out of the blue, worked in VK2 also by VK2BA I think. All afternoon, the VK6 beacons were strong on 066, and two up above 50.3. Later the VK6s started working ZL3.

At about 0730 right on teatime, I heard a 6 suffix down on 101 thinking it might be VK6ADI turned out to be I6BQI, he was 559 to 579 in copy. Later still on 110 I heard IK1EGC, EY8MM and a 9A all calling CQ, and later still settled down on 106 and worked around 70

144 MHz and above

Tropo reports are few and far between this month.

Phil VK5AKK reports: 30/1/2002 Worked Darrell VK6KDC this morning at 23:26 on 2m. Signal reports 5x5 and 5x7 over a distance of 2066 km from Adelaide to Manjimup (OF85). Esperance beacon still audible as I write but nothing heard from the Albany beacon this summer. Phil VK5AKK.

From VK5KK's observations, VK6REP beacon on 144.567 MHz was audible from 0900Z 29/1/2002 peaking to around 569 at 1930Z on 30/1/2002. No sign or Albany or Augusta beacons. On average, the Esperance beacon has been heard an average of 1 to 3 days per week throughout January & February 2002; this is way down on previous years.

Andrew VK6YAA, at Collie in WA reports: 3/2/2002 I have just made a contact to VK5 on FM accessing the VK5RAD repeater in Adelaide. QSO was

stations over the next 90 minutes of opening. I worked Italy, Croatia, Bosnia, Yugoslavia, Poland, Austria, France, Germany, Slovakia, Belgium, Netherlands, Slovenia, Tadzikistan. 4 new DXCC countries bring me up to 120+ worked. Total QSO's however over past 10 years is under 300 to 30 countries from Europe. ...All CW 100 watts to 9 element yagi from Grid LOC QF12ag .. 73's Steve VK3OT

Ted G4UPS reports ... thought you would be interested in these surprising QSO's with two VK4 stations today (18.2.2002). I was turning my 6m antenna from 090 degrees to beam due west to check for a possible opening across the pond when I got to due North I heard VK4ABW and just was able to turn the antenna to around 035 deg when I answered his CQ. I worked Gary at 1148 UTC 559 both ways.

I telephoned G3HBR to let him know and I moved from 110 to 105 and put

with Greg VK5THA. Signals with heavy QSB but peaking S9+20db. Andrew VK6XAA

Ron VK3AFW reports: VK5VF Adelaide 519 in Melbourne 31/1/2002 up to 2145 UTC, VK5RSE Mt Gambier good strength, VK3RRU Mildura 529 & VK3RGG Gippsland readable off back of beam. Called CQ on 144.1 beaming Adelaide and then Esperance in between use of channel by Air Craft enhancers. Nil response from the West. Trevor, VK3KEG, reports working VK5AKK last night (2m), others making the grade on 1296. Trevor was also hearing a VK6 beacon during the day yesterday. Ron VK3AFW

Barry VK3BJM reports: a quick run down on activity with the "Big Wheel" mobile 2m antenna over the weekend of the 3/4thth of February 2002. No contacts made on the trip to Maldon on Friday night - presumably because all sensible people had their radios disconnected

out a CQDX and got a most pleasant surprise when VK4CXQ answered! Worked him 559/559 both ways at 1152 UTC. I was still beaming around 035 degrees, and by the time I had phoned two other hams both the VK4 stations had faded out. It was only when I checked the DX Cluster later that learnt that VK4CXQ had been spotted at 1157 by JG3LER and at 1208 559 by HL1LTC! So VK4CXQ was certainly spreading his RF around!

The normal path for any VK from here in this restricted valley is a skewed one at 090 degrees, so a rather surprising opening, the kind that keeps us tuning around even when the band is dead! ... 73s Ted G4UPS

Ray VK4BLK reports ... we are back into the DX season here with a good opening to EU. On 17/2/2002 0947Z—1015Z worked 9G's, 2PA's & 1UT with signals up to S9.

73 RayVK4BLK

because of the electrical storms that swept through Victoria. Certainly the pocket of activity that I could see in front of (and then all around) me as I passed along the Castlemaine - Maldon road would have to be one of the most intense displays I've ever seen. There seemed to be a burst of lightning every ten seconds for a good 25 minutes.

Saturday afternoon brought a pleasant surprise - the first time I have managed to hear the Mildura 2m beacon. This was from outside my friends' home, at the foot of Mt Tarrengower, mid afternoon. It must have been warm in Mildura - the frequency was 1kHz up on the usual 144.433MHz.

Around 7pm EDST we popped up to the summit, and put out a few calls. From the lack of responses, it must have been dinnertime... The 2m beacons from Adelaide, Mt Gambier, Mildura, and Gippsland were all heard without difficulty.

On Sunday morning, I dragged myself up to the summit again. I failed to find the Mildura beacon, but Adelaide and Mt Gambier beacons could still be heard. On 144.200, I worked the following stations: 2/2/02 2134Z Rej VK2MP, 55-57 (52-54) - 499km. Lovely signal! 2137Z David VK3AUU, 52 (55) - 207km. Big

wheel to Halo! 2139Z Ron VK3AFW, 57 (no report given) *, 2142Z Gavin VK3HY, 53 (52) *, 2149Z Ian VK1BG, 41 (41) - 486km. Very fast chop on the signal from Ian. The report in brackets is the report from the contacted station. * Both Ron and Gavin were beaming NE from Melbourne when worked.

I also heard Gordon, VK2ZAB, and a subsequent phone call informed me that he had heard me, too. Signals weren't quite good enough to provide a contact - just recognizable mumbles. Still nice over a 740km path. Couldn't hear VK2ZRE, though I heard him being called. Quite a good weekend .. Barry, VK3BJM

Rogue TUBSAT Intruder on 144.100 MHz!

Those who monitored 144.100 MHz from around 22nd to the 26th of January 2002 would have no doubt heard the TUBSAT satellite "Intruder" beacon!

The choice of frequency was unfortunate for VK being our much maligned cloning frequency (calling frequency's new nick name after last months pot stir in this column!) on 2 metres. The following excerpts have been lifted from a communiqué from Norbert DF5DP, explaining some of the background.

"Today I found the phone number of Prof. Renner at Technical University

Berlin (TUB), Germany, who is the head of the TUBSAT team. I called him by phone and got the information I give below: MAROC-TUBSAT is a joint project of TUB and a Moroccan group at Rabat. This group was responsible for the choice of frequencies. They told him, that they were radio amateurs, and the frequencies were OK and coordinated. The 144.100 MHz downlink is a beacon, which was implemented to support tracking of the satellite and enable discrimination of the correct object in the NORAD data.

Prof. Renner received lots of complaints about this transmission on

144.100 MHz from radio amateurs, especially from Australia. From this he learned, that there must be something wrong with using this frequency. He immediately urged the Moroccan team to switch off this downlink then, and they did so. The command channel of the satellite is 436.075 MHz. This is an up- and downlink. The downlink is not active permanently; it only responds, when the command stations are sending any commands. There are two command stations: one in Berlin, Germany, and one in Rabat, Morocco.... Norbert, DF5DP

Microwave Round up

One of these months I had hoped to put in a small review of the Yaesu FT817 5W portable DC to 430 MHz All mode. I bought one for transverter use some time back but alas it has developed the dreaded low power output (try 150mW!) fault that has hit a few of these transceivers. Using my portable set up during the January Field day was a laugh, as a result!

As I had pensioned off or sold to other potential u-wavers some of my collection of FT290s & IC202s it took 3

transceivers to replace the FT817! In the meantime, Peter VK3KAI has been out portable with his FT817. Comments coming back from field use are promising. After 6 weeks mine still isn't back from Sydney. Hopefully I'll get it in time for the John Moyle!

Peter VK3KCG reports ... A couple of amateurs in Frankston Vic have decided that it is about time to start getting some microwave beacons up and going. A 1296 beacon is now constructed and output power will be around 6 watts. I am currently finishing off the 2400 MHz beacon and the power output should be

10 or 36 watts depending on what line up I decide on for the afterburner.

I am currently negotiating with South East Water to mount the beacons on one of their huge water storage tanks that looks over most of the countryside. Our aim is to send most of the signals in the general direction of Mt Gambier, Adelaide, Albany and Perth. Small vertical antennas that will be fed with a small amount of coupled energy will service the Melbourne community. I hope that these beacons will inspire more amateurs to build equipment for these bands. .. Peter VK3 KCG ex ZPW

National 24 GHz record out to 200.8 kilometres

Russell VK3ZQB reports ... The cool summer that prevails over southern Australia has not produced significant amounts of tropospheric propagation so far this year, but there are occasions when there is just enough to be useful. This was the case on the morning of the 26th January when I was lucky enough to work Colin VK5DK on 24 GHz. We had been watching a small duct that existed between Mount Gambier and Port Fairy that was exhibiting intense ducting on 144 MHz, 432 MHz and 1296 MHz. We had speculated that it was strong enough to make solid contacts on

10 GHz but were a little uncertain about the duct supporting 24 Ghz.

After looking at the weather maps and consulting the Hepburn tropo web site, we gambled that conditions would further improve toward the end of the influencing high-pressure cell. Then we would have a dryer northerly airflow that would be beneficial to 24 GHz. We surfaced at 6.30am DST on the morning of the 26th to a scene of dense fog, exactly what we didn't want for operating on 24 GHz. A contact with Colin on 144 MHz confirmed that he also was fogged in at Mount Gambier.

We had a contact on 1296 MHz and found that propagation conditions were better than the previous night. We decided that in spite of the fog we would travel to our selected sites and wait for the fog to lift. We were hoping that as the sun heated the air, the fog would lift and we would have a window of good propagation that might support a 24 GHz contact.

Colin went to The Bluff, a high spot west of Mount Gambier while I travelled to Mt Warrnambool near Panmure, east of Warrnambool. It was late in the morning before the fog started to lift and

we established contact on 10 GHz about 2230 UTC. The signal on 10 GHz was very strong and we decided to have a look on 24 GHz. At first, we could hear nothing but then about 2253 UTC, Colin heard my keyer very faintly.

We persisted, by 2334 UTC 25th January, the visibility had improved and we could hear each other's keyer at 5-3 with QSB. We had a contact on voice and exchanged reports setting a new national, VK3 and VK5 distance record for 24 GHz.

The fog layer seemed reluctant to lift

as was clearly visible along the coast at 2357 UTC. We thought there was a chance that propagation on 24 GHz might peak further and if it was to get any better, it would be worth moving further to the east toward Camperdown to increase the distance worked.

We watched the signal on 24 GHz for another hour but it did not get any stronger.

Deep fades with peaks of S3 were all we were going to get and conditions seemed to deteriorate as the day progressed. We did not think that

extending the record any further that day was going to be possible and so we packed up and returned to the home QTH.

I am sure that we will have more chances this summer to increase the record distance and as I write this story, the band is showing form with the Adelaide and Esperance beacons audible. So let us hope that even though the summer has been poor, that we might see some late tropo developing... Russell VK3ZQB

VK3/5 Microwave Field Operations W/E 19/1/2002

Peter VK3KAI reports ... Saturday 19 January was a relatively hot day in Victoria, temperatures reaching into the mid-30's. A small number of microwave operators thought that there might be some prospect of propagation in the evening given the weather forecast. Rob VK3EK set up his portable station in his backyard. Ralph VK3WRE and myself set up our respective stations on the local hilltop (QF31fp). Charlie VK3FMD headed into the southern Dandenong ranges whilst Trevor VK5NC headed for the Portland area (QF01).

The first contacts from QF31 were made by VK3WRE with VK3EK on 3.4GHz and 10GHz at around 1000Z. Shortly afterward, I made contact with Rob using my mobile setup on both 3.4GHz and 10GHz. Contact was made on 2m with VK5NC/3 at around 1025.

He was having some success with Charlie on the Microwave bands - I think contacts were made on 3.4, 5.7 and 10 GHz. From QF31, we could hear nothing of Trevor on any of the microwave bands. By this time an increasingly strong sea breeze was picking up from the SE that may have affected propagation to the east of the Melbourne area. Ralph and I subsequently made contacts with Charlie on 3.4, 5.7 and 10GHz SSB across a 101km obstructed path.

We believe that my contacts establish Mobile records for these bands, with VK3EK on 9cm and 3cm at about 119km and with VK3FMD on 6cm at about 101km. Equipment details at QF31: VK3WRE/p -FT817 with transverters for each band to offset fed dishes. 3.4GHz

20W output, 5.7GHz 10mW output, 10GHz 100mW output. VK3KAI/m - FT817 with transverters for each band. 3.4GHz 10mW, 5.7GHz 4W, 10GHz 100mW. Antennas were a 600mm x 425mm grid pack style dish ex-PayTV covered with "mouse mesh" using a WA5VJB triband feed and a 26dB horn for 3cm. Both of these are on a rotatable mount on the car ski bars. The mast also had lightweight Yagis for 70cm and 23cm mounted on it. The entire set up is capable of being operated mobile at up to 60km/h. True mobile operation is not recommended due to safety considerations. However the set up does allow for relatively rapid change of locations over short distances without the need to pull down and then re-erect the antennas. ..Peter VK3KAI

GippsTech 2002 Call for Papers

The Gippsland Technical Conference (GippsTech) has its focus on all topics of relevance to amateurs interested in amateur VHF, UHF and Microwave communications.

The 2002 event will be held at the Gippsland Campus of Monash University, located in Churchill. The conference location is about 2 hours drive east of Melbourne. The event will be held on the weekend of July 6 & 7.

The Organising Committee welcomes Expressions of Interest from anyone willing to make a presentation at the 2002 event.

Further details can be found at the Eastern Zone ARC website at <http://www.qsl.net/vk3bez/index.htm> or from Peter VK3KAI (QTHR).

In closing

Rex VK7MO reports .. the VK7RAE beacon on 144.474 MHz is now back on air. The VK7RAE 432 MHz beacon is still off the air.

Sadly, Clarrie Castle VK5KL became a silent key on the 21st of January 2002. Clarrie had been active on 6 metres for over 55 years, his most famous achievement was the "50 MHz World Record in 1947", one of the first reported TEP contacts on 6 metres. He remained active on 50 MHz CW up until the last equinox.

Now for a small soapbox. A few months ago a bit of comment hit the e-mail circuits about a lack of 144/432 MHz related material in this column. While a dozen or so emails supported the evolution of the content (vs. a couple that didn't) I whole heartily agree! I am sure the editor would give us more room

but the answer to WHY there isn't more is surely obvious ... I can't print it if I don't get it!

There has been a slow decline in VHF type "contacts worked" contributions for many years according to Eric and my more recent observations. This month it was just two. 50 MHz info is seasonal but on average I receive more contributions than 144/432. The converse has been with microwave and portable contributors. About 1/3 of the microwave material I get each month will fit. If I put any more in, we might just have to rename the column "RIP VHF .. 1000 plus MHz Rules"! So if you want more VHF related stuff in this column send it in ... fix the problem, don't be the problem!

I'll leave you with this thought .. "Intuition is reason in a hurry!"

73s David VK5KK
ar

The changing face of SW

A quarter of the year has rapidly slipped past. It is quite apparent that short wave, as we know it, is changing. Increasingly international broadcasters are opting out of producing their own programming and leasing their unused transmitting capacity to either religious or clandestine political organisations. The UK based firm, Merlin Communications has emerged as the major broker of selling unused transmitter capacity. Merlin was formed by the management of the BBC External service senders and recently was purchased by a British Defence contractor.

The latest broadcaster to opt out of international programming is Israel. It has announced that it wants to drop all languages on HF other than Hebrew and Arabic. A campaign has been launched to reverse this decision.

Another nation that has recently commenced selling their unused transmitting capacity is France. Test transmissions of the Libyan radio recently commenced but direction finding confirmed that these were coming from France and not Libya. Also the modulation of the known Libyan based senders is quite different compared to the French relays. However Merlin was not involved in this partnership, as far as I am led to believe.

There has been a dramatic increase of late in the number of Chinese HF senders with the majority relaying either the first or second network and are used to occupy HF channels as a form of jamming. White noise or overmodulated audio is still used against Radio Free Asia and the Taiwanese broadcasts to the mainland. Incidentally some of the overmodulated jammers come out as narrow-band FM signals on my FRG 7700.

The *Voice of America* from Washington DC has ditched its popular media program, "Communications World". The compere, Dr. Kim Andrew Elliot, has returned to the audience research unit. There are only three remaining media or DX programs remaining on shortwave; Glenn Hauser's "World of Radio" over WWCR and RFPI, "Cumbre DX", hosted by Marie Lam over the World Harvest Network and the long-running "DX Partyline" over HCJB in Ecuador. There has been a rumour that the latter may be the next one to fall.

For many decades mariners have

become used to receiving weather FAX pictures via Australian defence senders. This will change on June 30th, when these will close and re-open from a private contractor with senders at Charleville, QLD and in WA, utilising the identical channels. The same outfit will also take over the Telstra RADPHONE channels, which means that Sydney, Melbourne and Perth Radio will also go. I believe that the new operators are linked to Taupo Maritime Radio in NZ. I believe that there have been misgivings within the maritime community, particularly within south Eastern Australia, that the station is located at Charleville. The other maritime station, Penta COMMSTAT in NSW, will probably cover that region.

The Afghan crisis continues and Radio Free Afghanistan commenced at the end of February, following the passing of legislation in the US Congress. This really is a reactivation as this station operated in the early 80's under auspices of RFE/Liberty and this is where the operation will be based. Incidentally the latter station may be quickly relocated from Prague, after the Czech Government became increasingly nervous after September 11th. The studios are presently located in the centre of Prague and the authorities want to move them to a secure location away from there. The Americans are reluctant to move but may be forced to relocate elsewhere in Europe.

Despite the new station commencing, the signal on 8700 kHz continues at 1230Z. This Psychological Operations station may cease at very short notice, especially after Radio Free Afghanistan takes over. The London-based Radio Afghanistan via Samara in Russia, continues on 9950 kHz. Recent news

reports that the interim administration in Kabul is experiencing difficulties from local warlords. This could see a dramatic increase in clandestine broadcasting from nations such as Iran and the CIS nations, especially Russia.

Don't forget that Europe and the CIS nations will revert to Daylight Saving Time on the 31st of March. This is when the majority of frequency and time alterations take place. Israel also goes on to daylight saving early in April and the USA reverts on the first Sunday in April. Also those Australian states on summertime go back to Standard time on the 31st. Our Kiwi friends go back on the 15th of March.

In conclusion, may I ask correspondents using emails not to include any attachments? I recently received several that had viruses and the correspondents were completely unaware that they were there. It is a very good idea to have antivirus software as a protection. Unfortunately I recently lost over 160 emails before reading them, due to a nasty virus called Backdoor. This disabled my antivirus software before wiping out the inbox. So be alert and aware.

That is all for March, A happy Easter to all. 73 de VK7RH

ar

Amateur Radio

another membership
service from your
WIA

Adelaide-Ottawa 58

First F 0-5 Short 16901 km

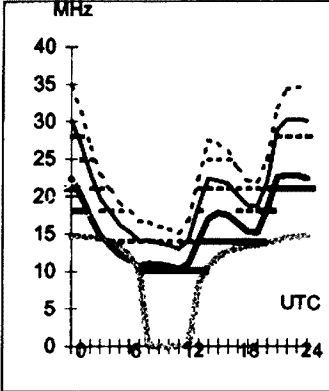

Brisbane-Auckland 123

First F 7-10 1E0 Short 2290 km

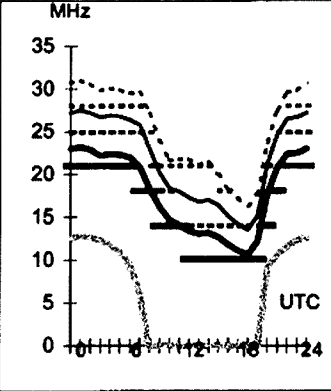

March 2002

T index: 110

Legend

UD

E-MUF

F-MUF

OWF

ALF

>10%

>50%

>90%

Time scale

HF Predictions

by Evan Jarman VK3ANI
34 Alandale Court Blackburn Vic 3130

These graphs show the predicted diurnal variation of key frequencies for the nominated circuits. These frequencies as identified in the legend are:-

- Upper Decile (F-layer)
- F-layer Maximum Usable Frequency
- E-layer Maximum Usable Frequency
- Optimum Working Frequency (F-layer)
- Absorption Limiting Frequency (D region)

Shown hourly are the highest frequency amateur bands in ranges between these key frequencies, when usable. The path, propagation mode and Australian terminal bearing are also given for each circuit. These predictions were made with the Ionospheric Prediction Service program: ASAPS Version 4

Adelaide-Singapore 311

Second 3F11-17 Short 5414 km

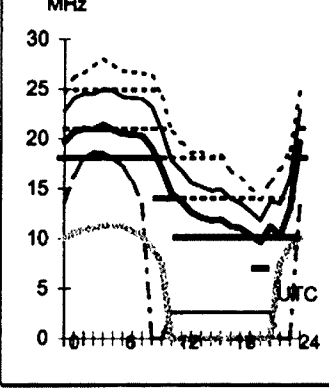

Brisbane-Los Angeles 59

Second 4F3-8 4E1 Short 11564 km

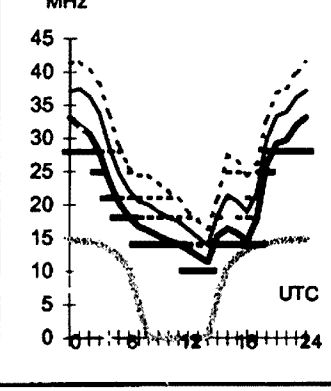

Canberra-London 136

First F 0-5 Long 23042 km

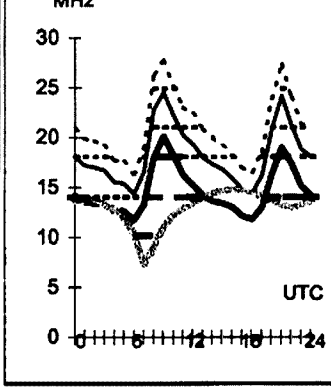

Darwin-Honolulu 65

Second 4F8-16 4I Short 8635 km

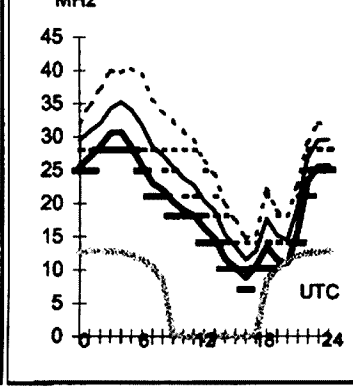

Adelaide-Tel Aviv 291

First F 0-5 Short 13125 km

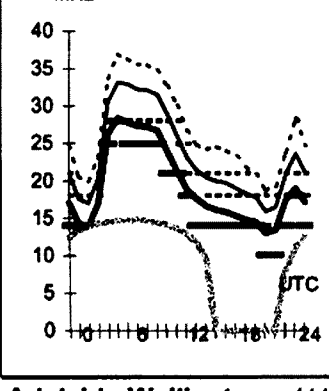

Brisbane-Manila 320

First 2F 3-9 2E0 Short 5812 km

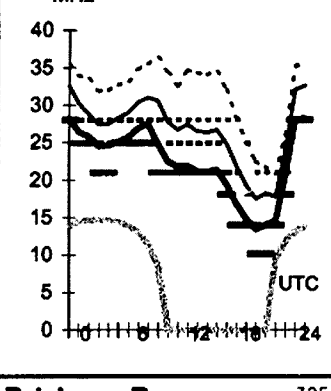

Canberra-London 316

First F 0-5 Short 16982 km

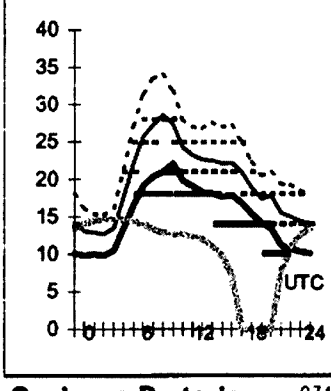

Darwin-Osaka 5

First 2F4-11 2E0 Short 5262 km

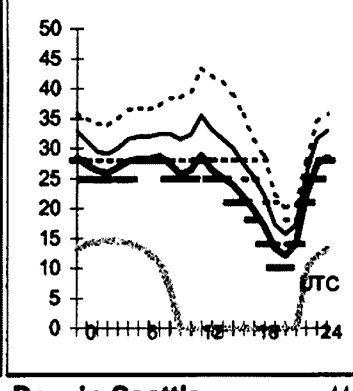

Adelaide-Wellington 114

Second 2F14-19 Short 3214 km

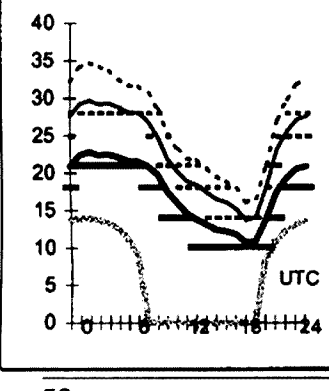

Brisbane-Rome 305

First F 0-5 Short 16108 km

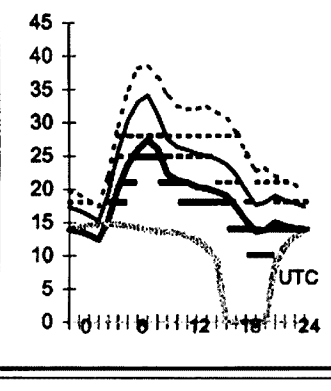

Canberra-Pretoria 231

Second 4F4-8 4E1 Short 10824 km

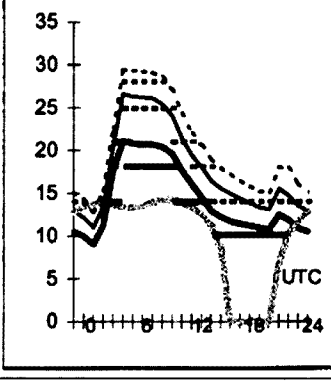

Darwin-Seattle 44

First F 0-5 Short 12282 km

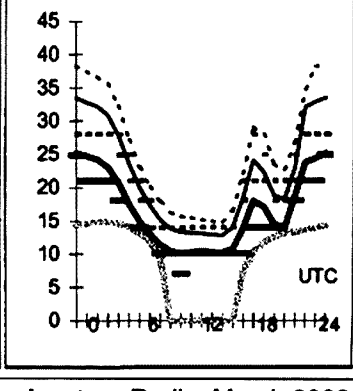

Hobart-Cairo 278 **Melbourne-Capetown** 222 **Perth-Johannesburg** 246 **Sydney-Barbados** 119

First F 0-5 Short 14263 km

Second 4F5-9 4E Short 10318 km

Second 4F9-13 4I Short 8315 km

First F 0-5 Short 16155 km

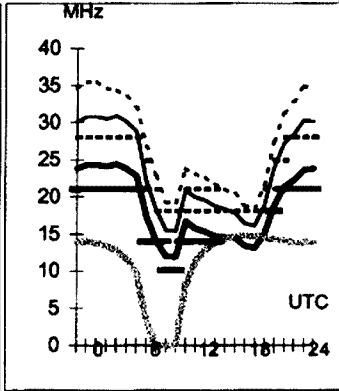
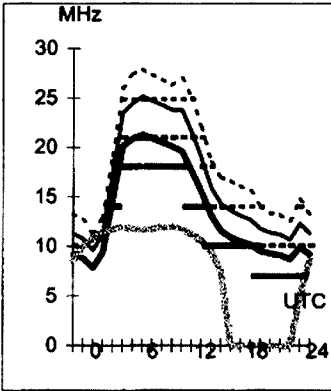
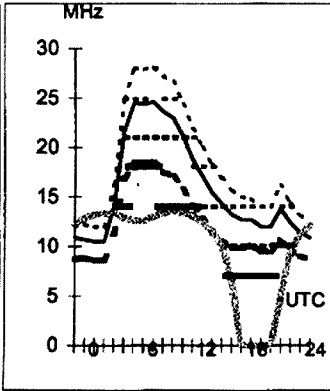
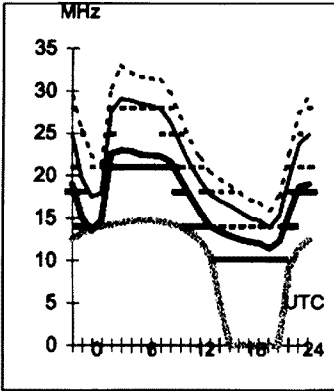

Hobart-Chicago 72 **Melbourne-Moscow** 316 **Perth-London** 133 **Sydney-Nairobi** 255

First F 0-5 Short 15576 km

First F 0-5 Short 14428 km

First F 0-5 Long 25543 km

First F 0-5 Short 12148 km

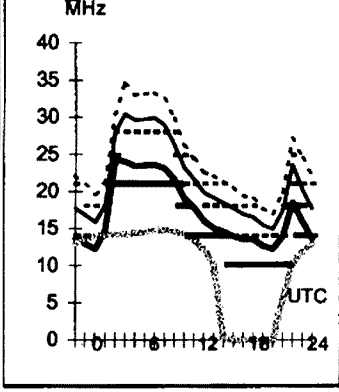
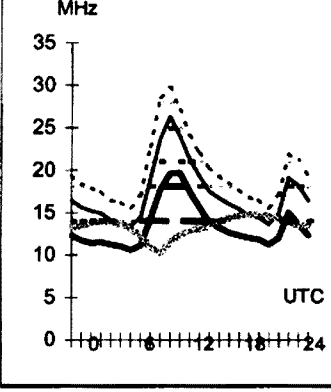
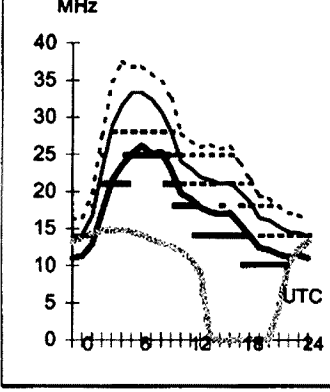
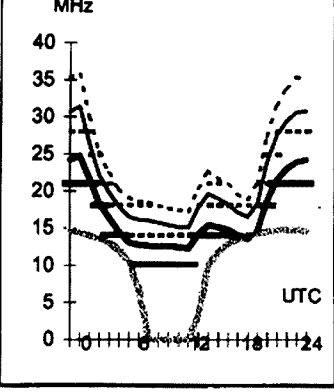

Hobart-Oslo 138 **Melbourne-Quebec** 60 **Perth-London** 313 **Sydney-Seoul** 340

First F 0-5 Long 23451 km

First F 0-5 Short 16903 km

First F 0-5 Short 14481 km

Second 4F8-14 4I Short 8325 km

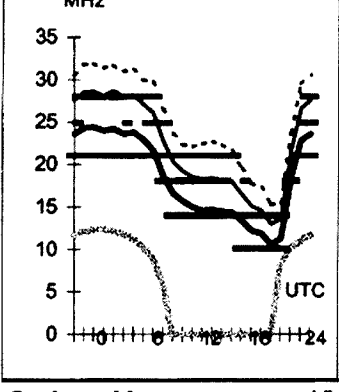
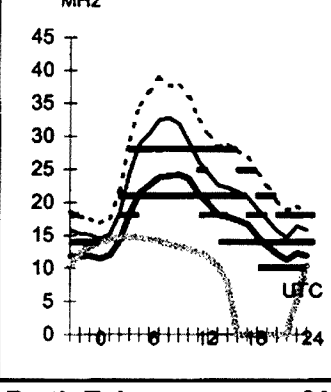
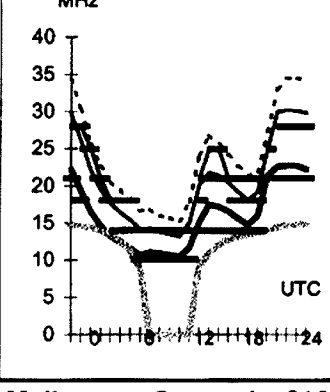
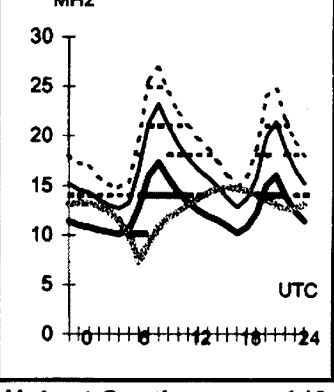

Hobart-Santiago 149 **Melbourne-Senegal** 219 **Perth-Tokyo** 20 **Sydney-Vancouver** 45

Second 4F4-7 4E Short 10688 km

First F 0-5 Short 16910 km

Second 3F4-10 3I Short 7923 km

First F 0-5 Short 12501 km

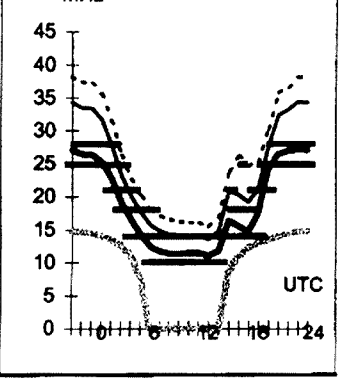
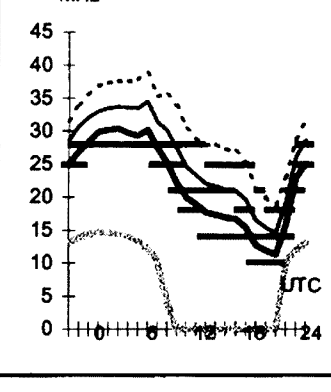
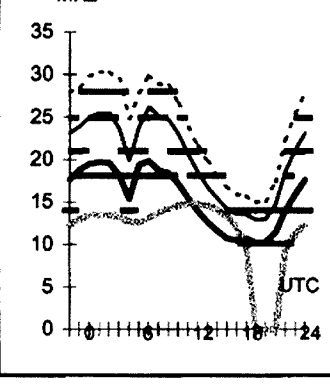
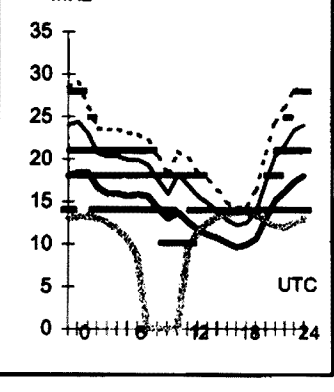

HAMADS

- Hamads may be submitted by email or on the form on the reverse of your current Amateur Radio address flysheet. Please print carefully, especially where case or numerals are critical.
- Please submit separate forms for For Sale and Wanted items, and be sure to include your name, address and telephone number (including STD code) if you do not use the flysheet.
- Eight lines (forty words) per issue free to all WIA members, ninth and tenth lines for name and address. Commercial rates apply for non-members.
- Deceased estates Hamads will be published in full, even if the ad is not fully radio equipment.
- WIA policy recommends that the serial number of all equipment for sale should be included.
- QTHR means the address is correct in the current WIA Call Book.
- Ordinary Hamads from members who are deemed to be in general electronics retail and wholesale distributive trades should be certified as referring only to private articles not being re-sold for merchandising purposes.
- Commercial advertising (Trade Hamads) are pre-payable at \$25.00 for four lines (twenty words), plus \$2.25 per line (or part thereof), with a minimum charge of \$25.00. Cheques are to be made out to: WIA Hamads.
- Copy should be typed or in block letters, and be received by the deadlines shown on page 1 of each issue of Amateur Radio, at:

Email: newsletters@ozemail.com.au **Fax:** 03 9756 7031

Postal: Newsletters Unlimited, PO Box 431, Monbulk Vic 3793

Please send your Hamad by ONE method only (email preferred)

FOR SALE NSW

- 204BA new in box \$350. TS-50 \$950. R-5000 \$500. TET tri band beam, tilt over crank up tower with rotator \$600. PS-50 and PS-430 supplies \$250 and \$225. YAESU 1000 MP \$4500. Ian VK2XU, QTHR, Phone 02 6584 9922.
- Free: RIKADENKI 6-pen chart recorder with high quality solid state DC amplifier. ALDEN solid state fax receiver ex RAAF. HEATH Impscope CRO specialised for analysing nerve impulses. All items large 1970s vintage, suit 19 inch rack or large shelving. Unused lately but good condition. You collect. Contact John vk2duw@wia.org.au

WANTED NSW

- YAESU FT-690 6 metre portable transceiver. Bob VK2CAN. Phone 02 9416 3727

FOR SALE VIC

- POWER SUPPLY 40 A variable output with 13 volt fixed over voltage protection \$200. FT-7 xcvr, goes well with 15 A power supply \$250. Prop pitch motor with supply and direction indicator \$180. 150 watt solid state broadband amp \$150. Restored VAUGHAN radio telephone less xtals \$50. Les VK3CX, Phone 03 5422 2860
- ICOM IC-745 transceiver, serial no 02053, good order except notch filter not working, complete with FM board and service manual, all WARC HF bands \$600 ono. Rodney Champness VK3UG, QTHR, Phone 03 5825 1354
- TONO 5000E SN532800 sends and receives Morse etc. Good condition \$300 or offer. MFJ Turbo packet radio controller model MFJ1270B SN01023736 \$80 ono. Ted VK3XT Phone 03 5257 3375
- REVEX power/swr meter 1.6 to 525 MHz, 2/20/200 W, new in carton \$160 (cost \$268). NIPPON antenna rotator with 50ft control cable plus 5 el 2 m yagi and 70 cm Ringo \$150 (not suitable for HF beams). Pick up only. Andy VK3UJ. QTHR, Phone 03 9723 8380.

• TOWER For Sale: 6 heavily galvanized 360 triangular sections, each 3 m long, plus base 1 m long with all guy wires bolts and fittings. Dismantled. 19 m total length. Quality heavy duty tower. Price \$400. Bill VK3JOL, Bendigo Phone 03 5439 6321, email wjcrnck@netcon.net.au

• Two only military type radio sets, model WS 38 Mk. 3, made by M.R. Pty. Ltd. Tuning Range from 7.4 to 8.8 MHz approx. Measures about 180 X 100 X 260, with cables, headsets and microphones, plus 1 instruction set, printed on aluminium sheets. Cases in good order, no antennae, cables need work. What offers? Don VK3DBB, QTHR, Phone (03) 5941 1351 A.H. only, or email to vk3dbb@ozemail.com.au

• ANTENNAS and Masts. 3 element 40 m Beam 32ft. 3 Element 20 m Beam 24ft. 2x7 Element 2 m Beams. Prop Pitch Motor with controller. 27MHz Vertical (base Station) Aircraft Antenna (base Station). 3 Element 10 m H/Duty Beam. Hard Drawn Copper Wire 2mm diameter several hundred feet. Numerous mobile antennas including multi and duo band. UHF Twin dish antenna with power divider. Numerous Towers. Les Davis VK3CX, PO Box 270, Kyneton, Victoria Phone 03 5422 2860

• ICOM 271A 2 m multimode transceiver fitted with CI-V, UX-14 computer control interfaces. ICOM 471A 70cm multimode transceiver. Both units are modified for 9600 baud terrestrial and satellite operation. Both complete in original boxes with microphones and handbooks. \$1500.00 the pair. Excellent condition. Bob VK3BNC. QTHR, Phone 03 5339 5317 or email terrill@giant.net.au

• Boatanchor, WESTON LM160B VHF base station all valve through to QQE06-40 final. Xtals for 146.5, also Weston mobile all valve, final YL1240 also Xtals for 146.5. Eminently collectable. \$50 the lot incl spare QQE06-40. QTH Sale. Max VK3VI, Phone 03 5144 2687.

WANTED VIC

- DTMF Dialler with memory. Kevin VK3HKW. QTHR, Phone 03 9836 1587
- OLD TIMER working on valve equipment needs a valve tester. Any offers? Bill VK3ZWO Phone 03 9598 6304
- JR RADIO SERVICE HANDBOOK VR series 1964. Instructions for Valve tester TMS T-36B. JOHNSON VIKING 500 transmitter and handbook (circa 1957). Rodney Champness VK3UG QTHR, Phone 03 5825 1354.
- COMMAND RECEIVER 1.5 - 3MHz. I.F. 705kHz, R25 BC454. Geoff Beauchamp L31551 Phone 03 9509 3926
- Somewhere in Australia must be the other half of my NATIONAL FRR-59A Receiver! I need the front end section to make the radio complete. Shipping happily paid from anywhere in Australia. Please contact Morris VK3DOC, Phone 03 9824 8988 or email morriso@vifp.monash.edu.au
- Mono NAGRA with power supply. Pilot tone not required. Peter, VK3FPL, qwang@tpg.com.au
- US Navy RAL receiver must be substantially complete and capable of restoration to its former glory. Wireless set No 208 QRP 2.6-3.6 MHz transmitter-receiver made by Radio Corporation Pty, Melbourne during WWII. Desperately need Tx Master Oscillator (VFO) dial, tuning capacitor and coil (L7a & C16A), or complete unit any condition. Contact Kevin Luxford VK3DAP. QTHR, Mobile 0438 003 474, NOT BEFORE noon on any day.
- In 1971 sold a 9 valve homebrew HF Rx in a hammetone case tuning 6 to 7MHz with an EDDYSTONE 898 dial. If still existing and in reasonable condition, I would like to re-purchase. Phone or SMS Grant, L30903 Mobile 0418 331 538
- CIRCUIT DIAGRAM for an ICOM IC-20 FM transceiver. Contact Ian AH Phone 03 5751 1631, or email lorian@netc.net.au.

WANTED QLD

- YAESU G5400B or equivalent rotator AZ & Elevation with computer connection. VK4ZFO. Not QTHR. N E Griffiths Phone 07 5474 4360
- VIBROPLEX Bug. Contact Bill VK4WMC QTHR, Phone 07 5541 4730
- Wanted dearly by simple mind, a random word Morse generator (non-computer). Also a paddle and/or bug and Morse teaching tapes from 20 to 30 wpm, in good and operational condition. Please reply to Ron VK4AJV, rhvette@gympie.big.net.au or phone 07 5488 0268

FOR SALE WA

- ICOM IC-751A SSB/CW/FM/AM 1.8 - 30MHz 100 W transceiver, including WARC bands and general coverage receive from 100kHz to 30MHz. Complete with IC-HM12 microphone, dual 500Hz CW filters and manual. Excellent condition. \$750. CDE Ham-M heavy duty rotator, with controller, lots of rotator cable and manual. Good condition. \$250. Triangular lower mast section and cast iron base of Hills 57' Teletower. \$100. Six 'Power Rod' fibreglass fishing rod blanks - 9' 4" long. Suit 21/24/28MHz 2-element delta loop antenna or similar. \$100 the lot. Steve Ireland, VK6VZ. Phone: 08 9298 9330 or email: sire@inet.net.au

WANTED WA

- Power transformer for YAESU YO-901 multiscope or old unit with good transformer in it. VK6ABS QTHR, Phone 08 9075 4136
- 20 pf variable air caps for Tx/Rx QRP CW, reduction drive gears. Dig into those junk boxes. All values of air caps needed for home brew station. Karl, PO Box 164, Greenbushes, 6254 WA

MISCELLANEOUS

- The WIA QSL Collection (now Federal) requires QSLs. All types welcome, especially rare DX pictorial cards, special issue. Please contact the Hon Curator, Ken Matchett VK3TL, 4 Sunrise Hill Road, Montrose Vic 3785, tel. (03) 9728 5350

<http://www.hamsearch.com>

a not-for-profit site that is a search engine for hams

New WIA Members

The WIA bids a warm welcome to the following new members who were entered into the WIA Membership Register during the month of FEBRUARY.

L21095 Mr P E Bell
L30984 Mr K E Pert
L30985 Mr E J Gilbertson
L40371 Mr A Perry
L50370 Mrs M E Rodgers
VK1KRF Mr K M Richens
VK2AAC Mr Z Novak
VK2IFT Mr J S Brown
VK2IUT Mr K R Virtue
VK2TRD Mr E Baker JP
VK2YKB Mrs K Boskos
VK2ZB Mr M Regan
VK3APM Mr P McGill
VK3AUR Mr M Wimborne
VK3BD Mr B Dodgson
VK3IS Mr D A Bickerdike
VK3JLB Mr L Billson
VK3JYD Mr H Evans
VK3MCF Mr M C Franck
VK3MED Mr D Lording
VK3QO Mr D Bellair
VK3SK Mr R E Slutzkin
VK3TRC Mr R Cook
VK3TSM Mr S Burrows
VK3VET Mr Z Filuk
VK3WEP Mr R B Weppner
VK3XXX Mr M Beacham
VK3ZHS Mr A Howes
VK4CCV Mr P Moscat
VK4CRO Mr R F Croucher
VK4CRT Mr A Meachen
VK4KAD Mr I Tinney
VK4PB Mr P C Breed
VK4UU Murrumba Comm. Group
VK5PDA Mr B J Juett
VK7DY Mr K Sulman
VK8NSB Mr S L Birkin

ADVERTISERS INDEX

Icom.....IBC
Tower Communications26
WIA Call Book.....IFC

TRADE ADS

PSK-31, SSTV, RTTY SOUNDBOARD INTERFACES

Fully isolated, ready to plug in.
<http://www.G3LIV.CO.UK>
jqhenny@melvin.com, G3LIV QTHR.

AMIDON FERROMAGNETIC CORES:

For all RF applications. Send business size SASE for data/price to RJ & US Imports, PO Box 431, Kiama NSW 2533 (no enquiries at office please. 14 Boanyo Ave Kiama). www.catchnet.com.au/~rjandusimports

Agencies at: Active Electronics Tas; Truscotts Electronic World, Melbourne; TTS Systems, Tyabb; Tower Communications, Perth; Haven Electronics, Nowra.

HF, VHF, UHF ANTENNAS & ACCESSORIES

Alum towers, guys etc. Diamond VSWR/PWR meters. HD copper ant wire & insulators. TX tubes & pwr transistors. Quality coax cables & connectors. Free advice & catalogue.
ATN Antennas Ph 03 5492 2224 Fax 03 5492 2666, email atnant@ruralnet.net.au

For Sale by Tender: CFA's HF Radio System

CFA is disposing of its surplus HF (2-12 MHz) radio equipment.

This consists of a quantity of 85 solid state PCM Hawk Xtal controlled 12V DC 100W mobile radios (no mics or other accessories available) and 3 Codan (1 kW) HF SSB base transmitters comprising a Xtal controlled exciter and valve PA. The fixed installation HF antenna system and remote operating equipment for the Codan radios is also available for sale.

The Hawk radios are held in store and the Codan radios are installed at CFA's training college. It will be the purchaser's responsibility to remove the equipment from site, as the equipment will be sold on site on an as-is, where-is basis. Limited spares are available together with handbooks and service manuals.

"Hey, Old Timer..."



If you have been licensed for more than 25 years you are invited to join the

Radio Amateurs Old Timers Club Australia

or if you have been licensed for less than 25 but more than ten years, you are invited to become an Associate Member of the RAOTC.

In either case a \$2.50 joining fee plus \$8.00 for one year or \$15.00 for two years gets you two interesting OTN Journals a year plus good fellowship.

Write to

RAOTC,
3/237 Bluff Road
Sandringham VIC 3191

or call Arthur VK3VQ on 03 9598 4262 or Allan VK3AMD on 03 9570 4610, for an application form.

Radio Amateurs Old Timers Club

March Luncheon

Speaker: Jim Karamalakis, Senior Testing Officer, Radiation Compliance Laboratories,
Australian Communications Authority

Forthcoming EMR Regulations and their Significance for Amateur Radio Operators

Bentleigh Club, Yawla Street, Bentleigh (Melways 68.B11)

Tuesday, March 12 at 12.30pm

Cost: \$27.50 Inc GST

Enquiries: Arthur Evans VK3VQ 9598 4262

TRADE PRACTICES ACT
It is impossible for us to ensure that the advertisements submitted for publication comply with the Trade Practices Act 1974. Therefore, advertisers and advertising agents will appreciate the absolute need for themselves to ensure that the provisions of the Act are strictly complied with.

VICTORIAN CONSUMER AFFAIRS ACT
All advertisers are advised that advertisements containing only a PO Box number as the address cannot be accepted without the addition of the business address of the box-holder or seller of the goods.

Over To You

VK5SIG

The Royal Australian Signals Association (S.A.) during the year 2000 operated special event station VI5RAS as a celebration of the Corps 75th birthday.

Recently a permanent licence was obtained and is the property of the above association. Within our ranks we have four qualified amateurs who will manage the station.

Actual station policy and type of activity has yet to be decided, however it will definitely not be a DX chaser, we are more interested in making radio contact with other local and interstate amateurs plus where possible contact with similar associations, societies etc. here in Australia and overseas.

Some of the proposed activities are as follows:

1. Take part in the yearly RD contest.
2. Establish a regular net.
3. Be involved with the Royal Signals Amateur Radio Association.
4. Involve serving members of 144 Sig. Sqn.
5. Be in contact with as broad a range of amateurs as possible.
6. Contribute to, and help increase activity on the amateur bands.

By the time this notice goes to print the station should be active, should you have a common interest or require more information please don't hesitate to contact myself or Brian Stevens (VK5FV).

Godfrey Williams, VK5BGW

Errata:

Division Directory

Please note: the following information was omitted from the Division Directory at the time of going to press. It will be included in the April Division Directory. We apologise for any inconvenience.

Fees

Div	F Grade	G Grade	X Grade
VK1	\$80.00	\$71.00	\$48.00
VK2	\$80.00	\$63.00	\$50.00
VK3	\$83.00	\$67.00	\$51.00
VK4	\$95.00	\$81.00	\$69.00
VK5	\$88.00	\$73.00	\$58.00
VK6	\$71.00	\$65.00	\$39.00
VK7	\$90.00	\$77.00	\$57.00

VK4 details:

President
Secretary
Treasurer
VK4AZM

Ewan McLeod VK4ERM
Bob Cummin VK4YBN
Bill McDermott

- Note 1 Views expressed in letters are those of the authors and do not necessarily represent the policy of the WIA.
2. Some of the letters may be shortened to allow more letters to be published.

Complaint about the spurious emissions from Radio Pyongyang, DPR-Korea

From:

Secretary, IARU- Region 3 HQ,
Tokyo, JAPAN.

Copy to : Chairman, IARU-Region 3.
Sir,

I had submitted a complaint in June 2000, about Radio Pyongyang, DPR-Korea, using the frequency of 3560 kHz, for regular broadcasting. This was discussed in the Directors' Meeting in August/September 2000.

I am now submitting a more serious complaint regarding the unsuppressed spurious and harmonic emissions from the same station- Radio Pyongyang.

These have been reported in the 20, 15 and 10 metre bands, from many countries.

The paragraph No. S 15.1 of the Radio Regulations as adopted by WRC-1995 details that "All stations are forbidden to carry out unnecessary transmissions or the transmission of superfluous signals.etc..."

Thus, the present complaint is about the violation of paragraph S 15.1

I have enclosed all the supporting documentation for the complaint first, and in the end, I have completed the Proforma Appendix S-10, for ready submission.

The above detailing has already been shown to the International Coordinator and his approval obtained for further processing at your end.

Kindly process at the Headquarters the above complaint and if possible, action may kindly be taken to process it through the ITU itself, as the complaint covers many frequencies simultaneously.

Thank you,

Yours faithfully,

B.L.Manohar

"Arasu" Regional MS Coordinator

Dated 05 Jan 2002..

Complaint on the unsuppressed harmonics and spurious signals from Radio Pyongyang-DPR-Korea

Apart from broadcasting regularly on 3560 kHz, an amateur frequency, (about which a complaint was filed with the R3HQ in June 2000)

Radio Pyongyang of DPR Korea has also been reported to be transmitting harmonics and spurious unsuppressed signals from its various SW transmitters on the various amateur frequency bands of 20, 15 and 10 metre bands. This has been going on for over FIVE years and has been regularly reported by the MS Organisations of the Regional National Societies, reflected through the Monthly

Reports of the Region 3 and 2.

These signals have been reported even from the countries like Argentina, USA and Canada of Region 2. While the signal strengths are QSA 3 to 4 in Region 2 Countries, they are consistently higher, in the Region 3 countries. The worst of the interference from these various harmonics/spurious emissions is suffered by the Amateur Radio Fraternity of JARL, who have been regularly reporting in huge numbers and strengths. This does not mean that countries like, China, South Korea,

Taiwan, Hong Kong and others are not suffering this interference. Unfortunately, there are no established and functional Monitoring Systems in these countries, or the neighbouring countries of DPR-Korea, to report and substantiate this Complaint.

Editors note: some 6 pages of detail followed which we do not have the space to present. Anyone wanting the full report should e-mail me or the WIA IW Convenor VK8HA, at vk8ha@octa4.net.au.



Division Directory

The Amateur Radio Service exists for the purpose of self training, intercommunication and technical investigation. It is carried out by amateurs who are duly authorised people interested in radio technique solely with a personal aim and without pecuniary interest.

The Wireless Institute of Australia represents the interests of all radio amateurs throughout Australia. National representation is handled by the executive office under council direction. There is one councillor for each of the seven Divisions. This directory lists all the Divisional offices, broadcast schedules and subscription rates. All enquiries should be directed to your local Division.

VK1 Division Australian Capital Territory,
GPO Box 600, Canberra ACT 2601
President Gilbert Hughes
Secretary Peter Kloppenburg
Treasurer Linden S Orr

VK1GH
VK1CPK
VK1LSO

VK2 Division New South Wales
109 Wigram St, Parramatta NSW
(PO Box 432, Harris Park, 2150)
(Office hours Mon-Fri 1100-1400)
Phone 02 9689 2417
Web: <http://www.ozemail.com.au/~vk2wi>
Freecall 1800 817 644

e-mail: vk2wi@ozemail.com.au
Fax 02 9633 1525

President Terry Davies VK2KDK
Secretary Pat Leeper VK2JPA
Treasurer Chris Minahan VK2EJ

VK3 Division Victoria
40G Victory Boulevard Ashburton VIC 3147
(Office hours Tue 10.00 -2.30)
Phone 03 9885 9261
Web: <http://www.wiavic.org.au>
Fax 03 9885 9298

e-mail: wiavic@wiavic.org.au

President Jim Linton VK3PC
Secretary John Brown VK3JJB
Treasurer Barry Wilton VK3XV

VK4 Division Queensland
PO Box 199, Wavell Heights, Qld. 4012
Phone 07 3221 9377
e-mail: office@wiaq.powerup.com.au
Fax 07 3266 4929
Web: <http://www.wia.org.au/vk4>

President Bill Riis VK4YCU
Secretary Bruce Jones VK4EHT
Treasurer Bill McDermott VK4AZM
Office Mgr John Stevens VK4AFS

VK5 Division South Australia and Northern Territory
(GPO Box 1234 Adelaide SA 5001)
Phone 0403 368 066
web: <http://www.sant.wia.org.au>
email: peter.reichelt@bigpond.com

President David Minchin VK5KK
Secretary Peter Reichelt VK5APR
Treasurer Trevor Quirk VK5ATQ

VK6 Division Western Australia
PO Box 10 West Perth WA 6872
Phone 08 9351 8873
Web: <http://www.vk6wia.org>
e-mail: vk6wia@inet.net.au

President Neil Penfold VK6NE
Secretary Christine Bastin VK6ZLZ
Treasurer Bruce Hedland-Thomas VK6OO

VK7 Division Tasmania
PO Box 371 Hobart TAS 7001
Phone 03 6234 3553 (BH)
Web: <http://www.tased.edu.au/tasonline/vk7wia>
also through <http://www.wis.org.au/vk7>
email: batesjw@netspace.net.au

President Phil Corby VK7ZAX
Secretary John Bates VK7RT
Treasurer John Bates VK7RT

Broadcast schedules All frequencies MHz. All times are local.

VK1WI: 3.590 LSB, 146.950 FM each Thursday evening from 8.00pm local time. The broadcast text is available on packet, on Internet aus.radio.amateur.misc news group, and on the VK1 Home Page <http://www.vk1.wia.ampr.org>

Annual Membership Fees. Full \$77.00 Pensioner or student \$70.00. Without *Amateur Radio* \$48.00

From VK2WI 1.845, 3.595, 7.146*, 10.125, 14.160, 24.950, 28.320, 29.120, 52.120, 52.525, 144.150, 147.000, 438.525, 1281.750 (* morning only) with relays to some of 18.120, 21.170, 584.750 ATV sound. Many country regions relay on 2 m or 70 cm repeaters. Sunday at 1000 and 1930. Highlights included in VK2AWX Newcastle news, Monday 1930 on 3.593 plus 10 m, 2 m, 70 cm, 23 cm. The broadcast text is available on the Internet newsgroup aus.radio.amateur.misc, and on packet radio.

Annual Membership Fees. Full \$78.00 Pensioner or student \$61.00. Without *Amateur Radio* \$47.00

VK3BWI broadcasts on the 1st Sunday of the month at 20.00hrs Primary frequencies, 3.615 DSB, 7.085 LSB, and FM(R)s VK3RML 146.700, VK3RMM 147.250, VK3RWG 147.225, and 70 cm FM(R)s VK3ROU 438.225, and VK3RMU 438.075. Major news under call VK3ZWI on Victorian packet BBS and WIA VIC Web Site.

Annual Membership Fees. Full \$78.00 Pensioner or student \$61.00. Without *Amateur Radio* \$47.00

VK4WIA broadcasts on 1.825 MHz SSB, 3.605 MHz SSB, 7.118 MHz SSB, 10.135 MHz SSB, 14.342 MHz SSB, 21.175 MHz SSB, 28.400 MHz SSB, 29.660 MHz FM (rptr), 147.000 MHz, and 438.525 MHz (in the Brisbane region, and on regional VHF/UHF repeaters) at 0900 hrs K every Sunday morning. QNEWS is repeated Monday evenings, at 19.30 hrs K, on 3.605 MHz SSB and 147.000 MHz FM. On Sunday evenings, at 18.45 hrs K on 3.605SSB and 147.000 FM, a repeat of the previous week's edition of QNEWS is broadcast. Broadcast news in text form on packet is available under WIAQ@VKNET. QNEWS Text and real audio files available from the web site

Annual Membership Fees. Full \$83.00 Pensioner or student \$71.00. Without *Amateur Radio* \$52.00

VK5WI: 1827 kHz AM, 3.550 MHz LSB, 7.095 AM, 14.175 USB, 28.470 USB, 53.100 FM, 147.000 FM Adelaide, 146.800 FM Mildura, 146.900 FM South East, 146.925 FM Central North, 438.475 FM Adelaide North, ATV Ch 35 579.250 Adelaide. (NT) 3.555 USB, 7.065 USB, 10.125 USB, 146.700 FM, 0900 hrs Sunday. The repeat of the broadcast occurs Monday Nights at 1930hrs on 3585kHz and 146.675 MHz FM. The broadcast is available in 'Realaudio' format from the website at www.sant.wia.org.au Broadcast Page area.

Annual Membership Fees. Full \$82.00 Pensioner or student \$68.00. Without *Amateur Radio* \$54.00

VK6WIA: 146.700 FM(R) Perth at 0930hrs Sunday relayed on 1.865, 3.564, 7.075, 10.125, 14.116, 14.175, 21.185, 29.120 FM, 50.150 and 438.525 MHz. Country relays 3.582, 147.200 (R) Catalby, 147.350 (R) Busselton, 146.900 (R) Mt William (Bunbury), 147.000 (R) Katanning and 147.250 (R) Mt Saddleback. Broadcast repeated on 146.700 at 1900 hrs Sunday relayed on 1.865, 3.564 and 438.525 MHz : country relays on 146.900, 147.000, 147.200, 147.250 and 147.350 MHz. Also in "Real Audio" format from the VK6 WIA website

Annual Membership Fees. Full \$67.00 Pensioner or student \$61.00. Without *Amateur Radio* \$36.00

VK7WI: 146.700 MHz FM (VK7RHT) at 0930 hrs Sunday relayed on 147.000 (VK7RAA), 146.725 (VK7RNE), 146.625 (VK7RMD), 3.570, 7.090, 14.130, 52.100, 144.150 (Hobart), repeated Tues 3.590 at 1930 hrs.

Annual Membership Fees. Full \$85.00 Pensioner or student \$72.00. Without *Amateur Radio* \$52.00

VK8 Northern Territory (part of the VK5 Division and relays broadcasts from VK5 as shown, received on 14 or 28 MHz).

Be the predator, not the prey

IC-756PROII (HF/6m)

Amateur Transceiver



ICOM raises the bar of excellence with the world's most powerful DSP technology in amateur radio history with the IC-756PROII. From the box to heavy contest action, in a matter of seconds. Imagine the fun and excitement of creating your own filter width and shape while on the air, rag chewing, or in the middle of a pile-up!!

Features include

- Sharp & soft, IF filter shape
- No optional filters to buy
- 41 selectable IF Filter bandwidths
- Choice of 3 filters per mode
- Improved 3rd IMD & wide dynamic range
- Triple band stacking register
- Built-in Antenna Tuner
- Two levels of receiver pre-amp
- Three levels of attenuator
- Dual watch on same band
- IF DSP
- 13.8V DC operation
- 5 to 100W SSB,CW,FM,RTTY (including RTTY decoder)
- 4 to 40W AM
- Dual Antenna Sockets
- Real Time Spectrum Scope
- One-touch record/play
- Digital voice memory
- Extended 1/4 tuning step & BPF functions for SSB-D mode
- 32 bit floating point DSP and 24 bit AD/DA converter
- SSB / CW synchronous tuning
- 8 Display types
- 7 Font Types
- Memory Keyer
- 4.9 inch color TFT LCD

ICOM
Clearly Ahead

find your nearest ICOM dealer at

www.icom.net.au

or (03) 9387 0666

VIC Strictly Ham (03) 9729 7656, Harris Communications (03) 9347 6264
NSW Amateur Transceiver Radio Centre (02) 9896 2545 QLD Kyle Communications
(07) 3857 4400 WA Tower Communications (08) 9274 1118 SA ICS (08) 8447 3688

April 2002

Volume 70 No 4

\$ 5.95



Amateur Radio

**Home
Brew!**

VK3AJK

designs and builds
his own mast

- ★ **An LF/VHF milliwatt/watts power meter**
- ★ **A construction report on the *WBR***
- ★ **Power and SWR meter**

ISSN 0002-6859



9 770002 685048 04



Australian
Amateur Radio

Callbook 2002

Every shack should have one



Now also
on
searchable
CD

**The "Call Book 2002" is available from
your State Division
Order now to get the member discount**

VK1 Division

GPO Box 600, Canberra ACT 2601

VK2 Division

109 Wigram St, Parramatta NSW
(PO Box 432, Harris Park, 2150)
(Office hours Mon-Fri 1100-1400)
Phone 02 9689 2417

<http://www.ozemail.com.au/~vk2wi>
Freecall 1800 817 644
e-mail: vk2wi@ozemail.com.au

VK3 Division

40G Victory Boulevard
Ashburton VIC 3147
(Office hours Tue 10.00 - 2.30)
Phone 03 9885 9261
<http://www.wiavic.org.au>
Fax 03 9885 9298
e-mail: wiavic@wiavic.org.au

VK4 Division Queensland
PO Box 199, Wavell Heights, Old. 4012
Phone 07 3221 9377 Fax 07 3266 4929
e-mail: office@wiaq.powerup.com.au

VK5 Division (and VK8)

(GPO Box 1234 Adelaide SA 5001)
Phone 0403 368 066
[:http://www.sant.wia.org.au](http://www.sant.wia.org.au)
email: peter.reichelt@bigpond.com

VK6 Division

PO Box 10 West Perth WA 6872
Phone 08 9351 8873
Web: <http://www.vk6wia.org>
e-mail: vk6wia@iinet.net.au

VK7 Division

PO Box 371 Hobart TAS 7001
Phone 03 6234 3553 (BH)
<http://www.tased.edu.au/tasonline/vk7wia>
email: batesjw@netspace.net.au

COMMERCIAL RESELLERS

Please contact June Fox (WIA Federal) on 03 9528 5962



Amateur Radio

Volume 70
Number 4
April 2002

The Journal of the Wireless
Institute of Australia
ISSN 0002-6859

Editorial

Editor: Colwyn Low VK5UE
edarmag@chariot.net.au

Technical Editor: Peter Gibson VK3AZL

Publications Committee Members

Ron Fisher	VK3OM
Don Jackson	VK3DBB
Evan Jarman	VK3ANI
Bill Rice	VK3ABP
Gil Sones	VK3AUI
Bill Roper	VK3BR

Advertising

Mrs June Fox,
Tel: (03) 9528 5962

Hamads

"Hamads" Newsletters Unlimited
PO Box 431, Monbulk Vic 3793
Fax: 03 9756 7031
e-mail: newsletters@ozemail.com.au

Office

10/229 Balaclava Road
Cauffield, Victoria
Telephone (03) 9528 5962
Facsimile (03) 9523 8191

Business Hours 9:30am to 3:00pm weekdays

Postal

The Editor AR
34 Hawker Crescent
Elizabeth East
South Australia 5112
Email edarmag@chariot.net.au

Production

Newsletters Unlimited 03 9756 7797

Printer

Streamline Press, Melbourne (03) 9417 2766

Postal Service

IMS (03) 9291 5888

Production Deadlines

Advertising booking and articles for
publication 10th of preceding month.

Hamads and advertising material deadline
18th day of preceding month

The contents of Amateur Radio are Copyright
Wireless Institute of Australia © 2002

General

What does the WIA do for Australian Amateurs?	8
<i>Ernest Hocking VK1LK</i>	
A Cradle for Portable Transceivers	10
<i>Peter Parker VK3YE</i>	
Junked crystals make a Tree-top Tester	11
<i>Steve J Mahony, VK5AIM</i>	
AMSAT-NA Chief visits VK	12
<i>By Jim Linton VK3PC</i>	
A Constructor's Report on the WBR Receiver	15
<i>Peter Parker VK3YE</i>	
Why it is Important to contribute technical articles to AR (Opinion)	40
<i>Draw Diamond, VK3XU</i>	
Gridsquare League Table Update	48

Technical

An LF-VHF Milliwatt/Watts Power Meter	4
<i>Draw Diamond, VK3XU</i>	
Another battery saver timer	14
<i>Evan Phillips VK3BIX</i>	
The P & SWR meter	17
<i>Kees Heuvelman, PA0CJH</i>	
The Miracle Whip (Technical Abstracts)	23
<i>Gil Sones VK3AUI</i>	
Antenna Tuning Unit (Technical Abstracts)	24
<i>Gil Sones VK3AUI</i>	
VFO Temperature Stabilisation (Technical Abstracts)	24
<i>Gil Sones VK3AUI</i>	

Columns

Advertisers' Index	55	Ham Shack Computers	46
ALARA	28	HF Predictions	52
AMSAT	32	How's DX?	34
Beyond Our Shores	37	Opinion	40
Contests	42	Over To You	56
Club News	25	Silent Keys	14, 27, 33, 36, 38
WIA Division News		Spotlight on SWLing	29
VK1 Notes	30	Technical Abstracts	23
VK3 Notes	30	VHF/UHF - An Expanding World	49
VK4 Notes	31	WIA Comment	3
VK5/8 Notice	33	WIA Division Directory	IBC
Editor's Comment	2	WIA Federal Directory	2
Education Notes	22	Will's Page	39
Hamads	54		

Our cover this month

An example of amateur self-training and home-brewing. The mast was constructed by Jack Spark VK3AJK of Lakes Entrance. Jack is a self-trained welder, and designed and constructed the mast without help except for the galvanising. It is one of several; the others were for amateur friends. Submitted by Lindsay Lawless VK3ANJ

Contributions to Amateur Radio

Amateur Radio is a forum for WIA members' amateur radio experiments, experiences opinions and news. Manuscripts with drawings and or photos are always welcome and will be considered for publication. Articles on disc or email are especially welcome. The WIA cannot be responsible for loss or damage to any material. A pamphlet, How to write for Amateur Radio is available from the Federal Office on receipt of a stamped self-addressed envelope.

Back Issues

Back issues are available directly from the WIA Federal Office (until stocks are exhausted), at \$4.00 each (including postage within Australia) to members.

Photostat copies

When back issues are no longer available, photocopies of articles are available to members at \$2.50 each (plus an additional \$2 for each additional issue in which the article appears).

Disclaimer

The opinions expressed in this publication do not necessarily reflect the official view of the WIA and the WIA cannot be held responsible for incorrect information published.

Amateur Radio Service

A radiocommunication service for the purpose of self-training, intercommunication and technical investigation carried out by amateurs; that is, by duly authorised persons interested in radio technique solely with a personal aim and without pecuniary interest.

Editorial Comment

Colwyn Low VK5UE
edarmag@chariot.net.au

Wireless Institute of Australia

The world's first and oldest
National Radio Society

Founded 1910

Representing

The Australian Amateur Radio Service

Member of the

International Amateur Radio Union

Registered Federal Office of the WIA

10/229 Balaclava Road
Caulfield North Vic 3161

Tel: (03) 9528 5962 Fax (03) 9523 8191
<http://www.wia.org.au>

All mail to
PO Box 2175 Caulfield Junction VIC 3181

Business hours: 9.30am-3pm weekdays

Federal Secretary

Peter Naish VK2BPN

Federal Office staff

June Fox Bookkeeper
Rita Trebilco VK3IF Examinations Officer

Council

President	Ernest Hocking	VK1LK
VK1 Federal Councillor	Gilbert Hughes	VK1GH
VK2 Federal Councillor	Barry White	VK2AAB
VK3 Federal Councillor	Jim Linton	VK3PC
VK4 Federal Councillor	David Jones	VK4OF
VK5 Federal Councillor	David Box	VK5OV
VK6 Federal Councillor	Will McGhie	VK6UU
VK7 Federal Councillor	Phil Corby	VK7ZAX

Executive

Brenda Edmonds VK3KT
David Pilley VK2AYD
Don Wilschefski VK4BY

Federal Coordinators

AMSAT	Graham Ratcliff	VK5AGR
ARDF	Jack Bramham	VK3WWW
Awards	Mal Johnson	VK6LC
Contests	Ian Godsil	VK3VP
Education	Brenda Edmonds	VK3KT
FTAC	John Martin	VK3KWA
Historian	John Edmonds	VK3AFU
IARU	Grant Willis	VK5ZWI
Intruder Watch	Harry Andersson	VK8HA
International Travel Host	John Miller	VK3DJM
ITU Conference and study group	Gilbert Hughes	VK1GH
QSL Manager (VK9, VK0)	Neil Penfold	VK6NE
Videotapes	VK2 Division	
Web	Joe Burford	VK5UJ

ACA Liaison Team

Ernie Hocking VK1LK
Gilbert Hughes VK1GH
Keith Malcolm VK1ZKM
Peter Naish VK2BPN

Canberra Liaison Officer Richard Jenkins VK1RJ

Welcome new readers

Welcome to those of you who have bought a copy of **Amateur Radio magazine**.

The magazine is the journal of the Wireless Institute of Australia, the oldest Amateur Radio Society in the world. The magazine tries to provide a variety of material to its readers each month. There is a group of technical articles and a group of general interest articles in the front of the magazine. There is a section for news from the Wireless Institutes, its State Divisions and from some Amateur Radio Clubs. The back half contains special interest group newsletters like those on DX, Contests and AMSAT. The final part of the magazine is letters from members and advertisements for the sale and purchase of amateur radio equipment.

The debate on where the Wireless Institute should be going and what the future of this magazine continues around the country. If you have been unable to find a Federal Councillor to air your views to, you can contact the President at president@wia.org.au. We aim to become a more cohesive unit and to gather more Australian Amateurs into our ranks. It is the WIA that talks to the ACA and other Government Agencies on behalf of all Amateurs. If you are not a member, you have little chance of being heard.

The WIA Federal Convention will be held in Melbourne in May. It will be an evening gathering open to all members of WIA Divisions. This should be used by members to get their views across to Federal Councillors. I hope to be able to publish a report on the Convention in June AR along with a copy of the abbreviated WIA Federal Accounts all in the interest of openness and wider communication which the present Council is endeavouring to develop.

On the real Amateur activities the DXers are having some better conditions and the VHF/UHF

enthusiasts are getting out to work longer distances. The contest operators have been out on the John Moyle Field Day in greater numbers than in the last few years and seem to have had a great time all over the country. I was alright until at 10.30pm on a dark road pointing uphill the Beetle battery decided it would not start the car...The one advantage of a 6V system car is you need two 6V batteries to run 12V radio equipment. So unload the equipment, swap over the batteries; reload the car and TG the thing started. The constructors also seem to be busy I have been sent several interesting construction projects and we are now publishing some simple VHF test gear designs which are quite adequate for Amateur use.

Internet linked Amateur Radio. Have a look at <http://www.geocities.com/gj7jhf/ilinking.html>

Describes many forms of Internet linking but note that not all are allowed in Australia due to the possible ease of access to a broadcasting radio by unauthorised people. "ilink" seems to me to be wide open to unauthorised users unless you sit on it all the time.

The Federal Awards Coordinator Mal Johnson VK6LC has now got a handle on things and next month we will present his first report on the revised system and Eqslng. LOVK and LOTW will be explained.

That is all for now. Sorry if we are a bit late, but that is because I took the time off to participate in the Field Day and a few other "Murphys".

Next month I will have to make space for a few corrections to recent articles.

This month's activity suggestion get all the outside station equipment fixed before winter sets in.

So 73 Colwyn

Exciting opportunities on the horizon...

AR Trial

As you open this month's AR many of you will wonder why this month's edition of AR has a cover price of \$5.95. In the March edition I made reference to the need to get the message about what amateur radio has to offer to a wider audience. Towards this end this I have authorised a limited trial of the publication of AR on a number of news stands throughout Australia. Whilst I am sure that not all of you will approve of this step, it is something that I believe that we have to do in order to collect factual evidence about the viability of such a option. This trial has two major

aims. Firstly is the need to gain information about the likely take up of AR should it be available on a non-member, non-subscription basis. The second aim is to raise the profile of amateur radio by making key material such as AR available to a wide audience.

There are many exciting opportunities on the horizon for Amateur Radio so we all need to work together to realise these opportunities. Firstly in order to ensure that the message about the benefits of amateur radio reach a wide audience we need to publicise the hobby. A wider publication of AR may be one approach

to meet this need. Secondly in order to gain further information on these issues we have arranged for a short survey questionnaire to be attached to this issue. This survey is also published on the WIA web page at www.wia.org.au. I would encourage anyone who reads this issue to reply to the survey. The survey is an opportunity for anyone interested in any aspect of amateur radio to have their say and help to influence the future of the WIA journal. You do not need to be an amateur radio operator to participate.

The Annual Federal Convention and AGM

The Federal Convention and AGM is only a month or so away. As I write these notes there are two main issues which will occupy the council and executive during the various meetings. The first issue is that of the structure of the WIA. This discussion has been precipitated by a motion from VK5 proposing that a group be established to carefully review the current structure and make its report available for discussion prior to the 2003 AGM. The aim is to have a decision taken at 2003 AGM with implementation taking place over a 2-year period. The need to review the structure and constitution of the Federal body has been driven by a number of topical issues which impact upon many activities and hobbies other

than just amateur radio. These include a general decline in the membership of clubs and societies as well as an increased sensitivity to spending money. If the WIA is to be relevant to its membership in the future it needs to carefully define the services that it offers to members and ensure that these services are both relevant to today's hobby as well as being cost effective.

The second major issue will be defining a clear strategy for the future. Many of the matters that have been discussed throughout the last year will reach a critical time during the forthcoming year. Amongst these I include the outcome of the Productivity Commission review, the future of the

amateur examination service, and a strategy for the future of AR itself.

This year I am trying to organise two additions to the current convention format. Firstly I am trying to determine whether it is practical to be able to provide some immediate reporting of convention activities. The second addition is to organise an open dinner on Friday 17 May close to the convention location. If this can be arranged it will be a good opportunity to meet informally with the members of the executive and council. We have been given quotations that indicate costs of around \$30 per head. If you are interested in attending can you please register this interest with me via email or directly with the Federal Office.

WIA Office bearers

One of the important activities carried out during the convention is the election of office bearers. These are not just the positions of the members of the executive but also includes the various coordination roles that we need to perform. As this issue of AR goes to press there remains a number of roles to be filled. If you have the time and interest I would urge you to make contact with

either your local councilor or myself and identify yourself as a candidate for one of the roles. Among the known vacancies are the positions of editor of AR from 2003 on. Colwyn Low VK5UE has indicated that he would like a break from this demanding task that he has performed from the January 2000 edition.

Also vacant are the positions of

Federal historian and Federal QSL collection curator. I am sure that you will join me applauding all of the current coordinators for their splendid efforts. Their efforts will stand as a model to future volunteers for these important positions. If you wish to find out more about the nature any of the positions then any member of the current WIA team would be delighted to talk to you

An LF-VHF Milliwatt/ Watts Power Meter

Draw Diamond, VK3XU,
45 Gatters Road,
Wonga Park, 3115.

It is generally accepted in the telecommunications industry that power levels shall be expressed in terms of dB referenced to some agreed level, usually 1 mW. Radio is no exception. Communications workers routinely think in terms of dB above or below 0 dBm, where, in radio work, 0 dBm represents 1 mW, usually in 50 ohms. So when a power level of say +20 dBm is required, a quick mental calculation converts this to "20 dB above 1 mW", or 100 mW. Similarly, a power level of -10 dBm is 10 dB below 1 mW, or 100 microwatts. Indeed, after a while, a mental conversion is not necessary, as it becomes customary to simply work in terms of plus or minus so many "dBm" - and leave it at that.

Furthermore, if it is remembered that 10 dB is a power gain (or loss) of ten times, and 3 dB is a power gain (or loss) of 2 (and that 6 dB is therefore a factor of 4); it is easily possible to determine, by simple arithmetic, any given power level in 1 dB steps, without having to memorise a whole chart, or consult log tables. If you are rusty about "dB" - look up "decibels" in any recent amateur radio handbook (see also Refs. 1, 2 and 3).

Use of power levels in terms of dBm (or dBW; where 0dBW = 1 W) is inextricably linked to all radio frequency power measurements. For example, the local oscillator signal into a ring-diode mixer may be specified by the maker as needing to be (typically) +6dBm, which represents a power level of 6dB 'above' 1 mW = 4 mW. Or a transverter may require a drive power of +13 dBm, which is 10 times and then twice 1 mW = 20 mW. There are many similar instances where the amateur experimenter will need to make an actual power measurement in the mW range in terms of dBm.

However, commercial mW power meters can be quite costly, even second-hand, as they are highly prized by serious experimenters. An example is the excellent Hewlett Packard series 432 power meter, which uses a bolometer as the sensing element (another problem is

obtaining a bolometer that has not been burnt-out by a careless user). Such instruments express power in terms of dBm. Where is it necessary to measure a level of say 10 W, we simply insert an appropriate amount of attenuation in front of the meter. A common value is 20 dB worth of 'power attenuator', then an ordinary 20 dB attenuator (which has only to handle 100 mW) making a total in-line of 40 dB, and therefore, for 10 W input power, 1 mW will be delivered to the meter's input, which will read 0 dBm, or 1 mW. With such an outfit, the experimenter can measure a wide range of power levels, from milliwatts to tens of watts, or even hundreds of watts if suitable attenuator(s) are available.

Here are details of a simple mW power meter that suits many amateur applications. Basic sensitivity is 100 mW to 1 mW (-10 dBm to 0 dBm). With internal switch attenuators of 10 and 20 dB, measuring range is from -10 dBm to +30 dBm (1 W). The range is extended to +40 dBm (10 W) by use of an external 10 dB 'power' attenuator. Frequency

range is within plus or minus 1 dB from less than 50 kHz to at least 150 MHz, and is quite useable to about 300 MHz.

Circuit

To obtain adequate sensitivity down to -10 dBm, a pair of ordinary BAT-46 hot-carrier diodes form the RF detector element (Fig. 1). Sensitivity is significantly improved (over a single diode or voltage-doubler) by using the diodes in a full-wave rectifier configuration, and thus driving the -ve and +ve inputs of an LM386 amplifier. In this iteration, the '386 is configured as a dc, or servo amplifier. When no dc signal is present at the input, the output

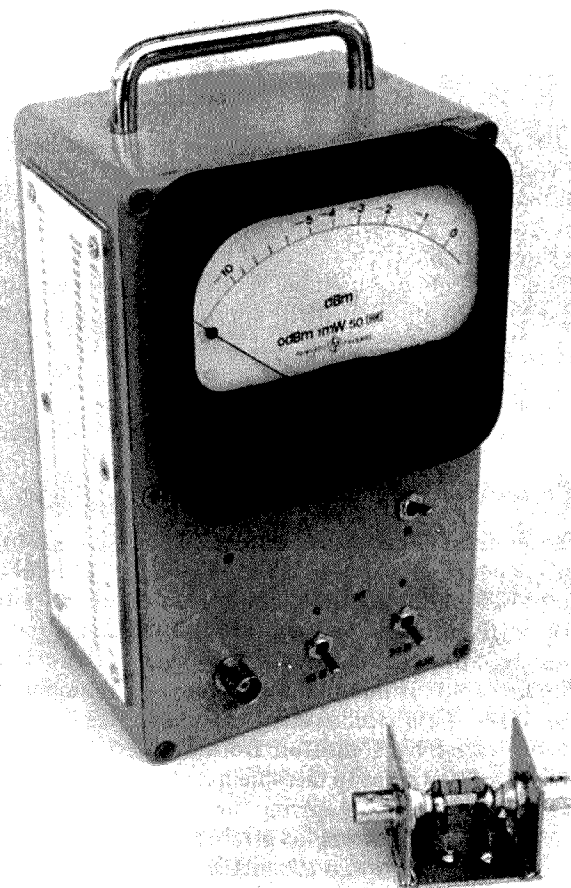

Photo 1: mW power meter and 10dB 'power' attenuator

of the '386 at pin 5 rests at about half rail; 4.5 Vdc. The 1 mA meter and calibration pot are connected in what is virtually a bridge, between pin 5, and the centre of a voltage divider, being the slider of the 500 ohm bal(ance) pot. At balance, the meter reading will be zero. Now, when a dc signal- the result of detected RF at the signal input, is applied to the '386 input, the voltage at pin 5 will move in a positive direction, thus unbalancing the bridge and proportionately driving the meter.

A useful degree of input protection, and improved insensitivity to battery voltage variation is obtained by connecting a third BAT-46 diode across the detector output as shown. Very little current is drawn from the detector by the '386, but the tiny capacitance of the diodes causes the input to look slightly reactive. The 3 dB attenuator (6 dB return loss) effectively masks this small reactance, and thus improves the overall accuracy of the instrument.

Construction

For good resolution, I have used a rather larger 1 mA meter than perhaps would be expected for such a simple instrument- but the meter size is up to you. The die-cast box for the prototype measures 120 x 185 x 80 mm. Any box, metal or plastic, which will accommodate your chosen meter should do. The 9 V 'transistor' battery and holder may be fitted inside or outside, as desired.

The components are accommodated upon a plain printed circuit, which measures 100 x 80 mm, in a meld of 'ugly' and 'paddyboard' style (for a description of 'paddyboard' style, please see Ref. 5). A suggested layout is shown in Fig. 2 and Photo 2. Only the attenuator resistors and detector components need have short lead lengths, so the remaining components may be wired up using any chosen method- including 'ugly' style.

For ease of working, the '386 should be fitted into a suitable socket, which is attached with fine tinned copper wires (about 0.6 mm) upon a segmented substrate board, which in turn is superglued to the main board. Or you could use part of an experimenter's board (upside-down), available from DSE and Jaycar. Connections for the battery holder and meter may be made with ordinary insulated hook-up wire.

An additional external 10 dB 'power'

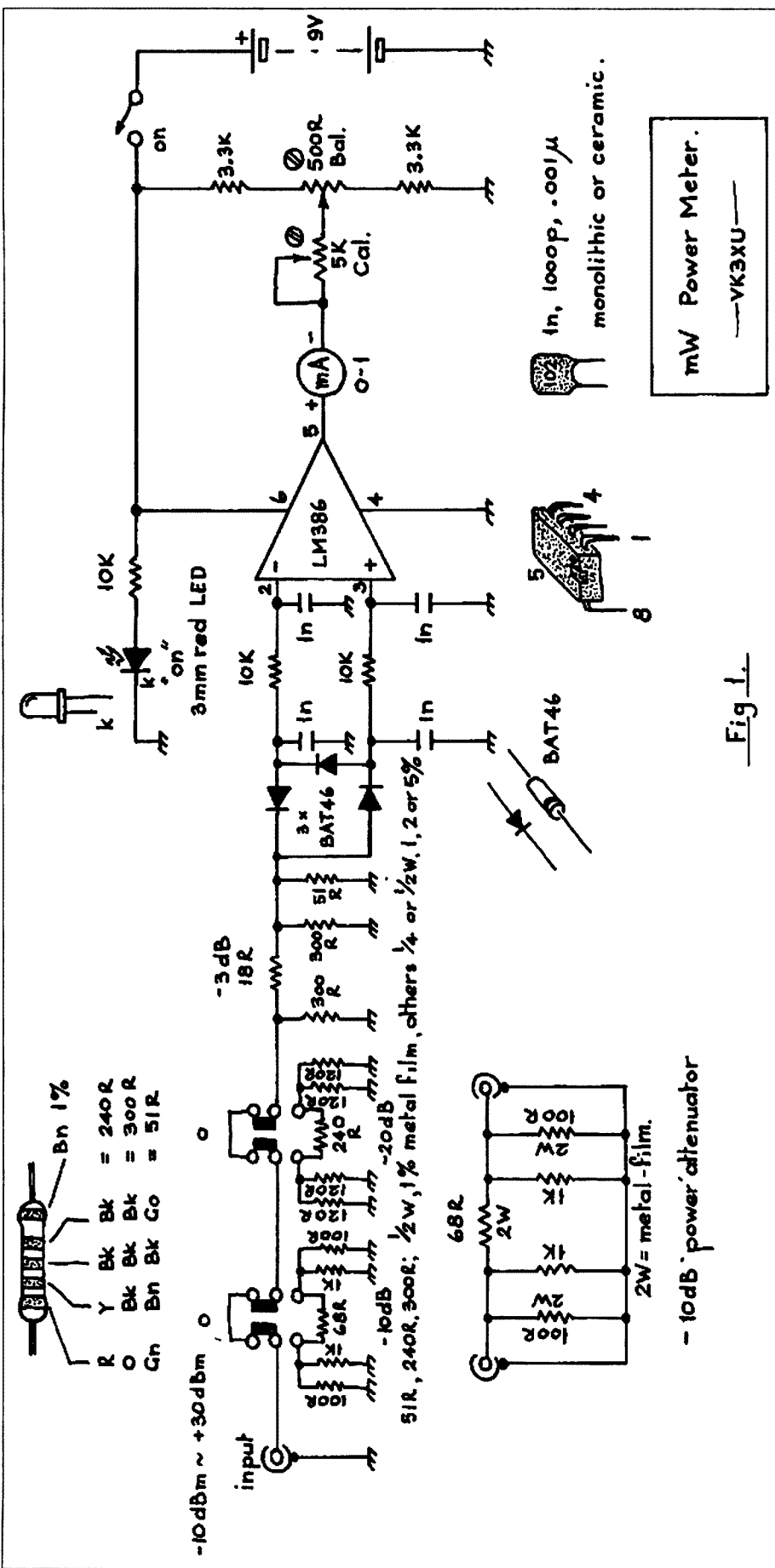

Fig 1.

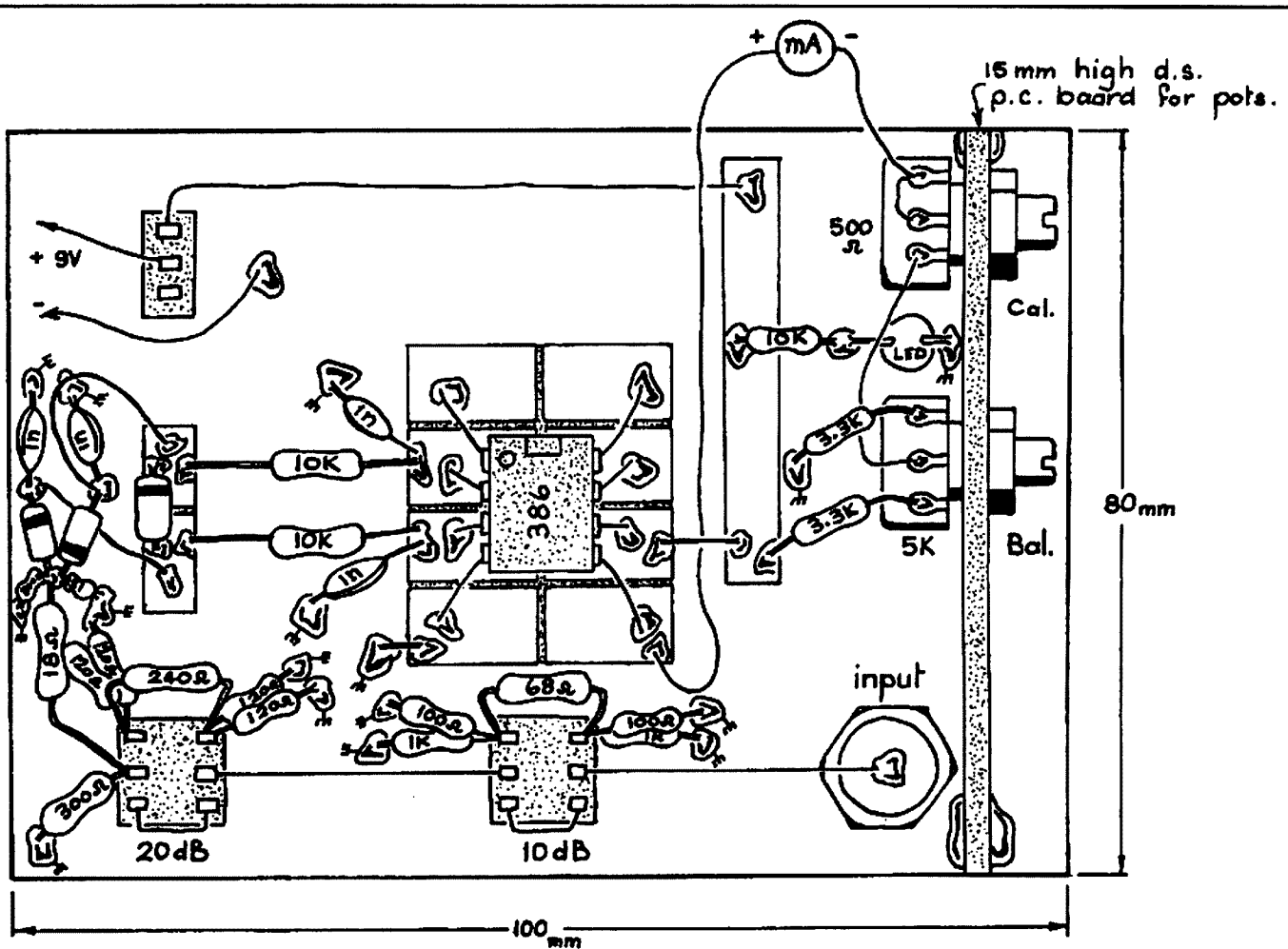

Fig 2

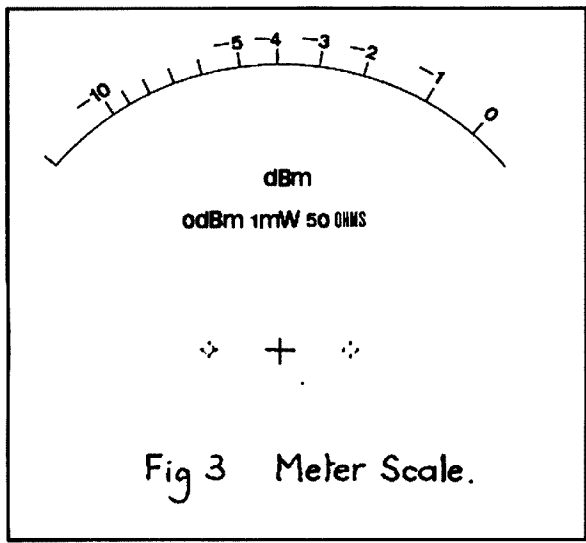

Fig 3 Meter Scale.

attenuator, which permits measurements to 10 W, is highly recommended. An example model, made from scraps of double-sided printed circuit board, is shown in Photo 1, and schematically in Fig. 1. For measurements up to 100 W, a power attenuator similar to that described in Ref. 6 is suggested.

Calibration

Before switching on, check your wiring again, and confirm that all components are correctly placed. Pay particular attention to the polarity of the diodes, and that the '386 chip is oriented correctly (wrong direction may destroy the chip). Switch on, and adjust the Bal. pot for no meter deflection. Set the Cal. pot for maximum resistance. If you have a calibrated (output) signal generator, one which can deliver a known 1 mW (0 dBm) signal; then you will know what to do. Adjust the Cal. pot so that the meter reads about 80% of full-scale for a 1 mW input signal (no attenuation switched in).

No sig gen? If you have a HF transmitter that can deliver a QRP CW signal known to be 1 W; switch in the 10 and 20 dB attenuators. With 1 W applied, adjust the Sens. pot for about 80% of fsd. If you are not sure as to the accuracy of your "1

W" input signal, I suggest use of the probe described in Ref. 7, which, when applied to the input connector, should read 7 V, representing just under 1 W in 50 ohms. With 30 dB 'in line', the meter then reads 1 mW/0 dBm.

The -10 dBm calibration point can be established by inserting a further 10 dB attenuation. If you have a 1 dB/step attenuator (such as described in Ref. 8), then the 1 dB calibrations can be found and marked. However, without a 1 dB/step attenuator, the scale of the prototype, shown in Fig. 3 may be relied upon as being sufficiently accurate for amateur work. It is suggested that the dBm: (rounded) power chart, shown in Table 1, should be copied, and affixed to the box, as shown in Photo 1.

Operation

Some sample input powers and their readings would be as follows; a 500 mW signal would require to have the 10 and 20 dB attenuators switched in and the meter would read -3 dBm (+27 dBm, or 3 dB down on 1000 mW), 50 mW would read -3 dBm with just the 20 dB attenuator in (+17 dBm), a 2 mW signal would require the 10 dB attenuator in, and the meter would read -7 dBm, ie. +3 dBm, and so on. For a 100 W (+50 dBm) signal, we would require 20 dB worth of 'power' attenuation (eg. the 10 dB power attenuator of Ref. 6, and the 10 dB described here), and the internal 10 and 20 dB attenuators switched in.

Parts

Most components, including miniature pots for the 'trim-pots', are available from our usual electronics vendors. Additionally, BAT-46 diodes (as replacement for their catalogued OA95) are available from Jaycar. 2 W metal-film resistors may be ordered from Electronic World (Ph. 03 9723 3860- will answer mail orders), or from suppliers to the TV service trade.

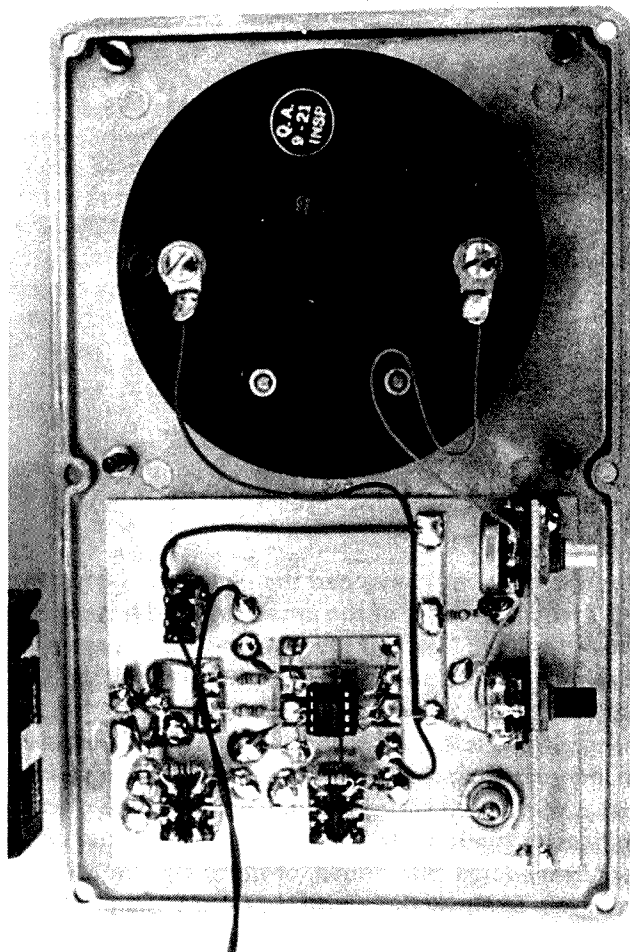

Photo 2: Internal view

References and Further Reading:

1. The VHF/UHF DX Book; I. White, G3SEK (Ed.), DIR Publishing.
2. The VHF/UHF Handbook (1997 edn); Dick Biddilph, G8DPS (Ed.); RSGB.
3. Test Equipment for the Radio Amateur, C. Smith, G4FZH (Ed.), RSGB.
4. "An RF Milliwatt Meter", R. Champness, VK3UG, Lo-Key #44 (VK QRP Club).
5. "Paddyboard" Circuit Construction" Diamond, AR, Feb. '95.
6. "A Homebrew Power Meter and Attenuator Set", Diamond, AR, Nov, 97.
7. "An RF Voltage Probe", Diamond, AR, Aug. '00.
8. "An Attenuator Set for Receiver Sensitivity Measurements"; Diamond, AR, Aug 99.

dBm	Power		dBm	Power	
30	1000	mW	9	8.0	mW
29	800	" "	8	6.3	" "
28	630	" "	7	5.0	" "
27	500	" "	6	4.0	" "
26	400	" "	5	3.15	" "
25	315	" "	4	2.5	" "
24	250	" "	3	2.0	" "
23	200	" "	2	1.6	" "
22	160	" "	1	1.25	" "
21	125	" "	0	1.0	" "
20	100	" "	-1	800	uW
19	80	" "	-2	630	" "
18	63	" "	-3	500	" "
17	50	" "	-4	400	" "
16	40	" "	-5	315	" "
15	31.5	" "	-6	250	" "
14	25	" "	-7	200	" "
13	20	" "	-8	160	" "
12	16	" "	-9	125	" "
11	12.5	" "	-10	100	" "
10	10	" "			

Table 1



What does the WIA do for Australian Amateurs?

Ernest Hocking VK1LK
President, Wireless Institute of Australia

Over the last year I have had the pleasure of corresponding with many members of the amateur radio fraternity on a range of issues. Many of these have been reported in my monthly notes column. One thing though sticks in my mind above all others in my dealing with everyone that I have corresponded with. What then is that thing? Put simply it is the incredible passion that we amateurs all have for our hobby. Whether it is the individual collections of vintage equipment, the local club that is proud to show off its handy work in the local club house, or more ambitiously the groups that strive to show the world that Australians are up there with the best and cannot be ignored. There is no denying that radio today still has all the magic that attracted people to the hobby all those years ago, when it first emerged onto an unsuspecting world.

Communication

I believe that one of the prime services that the WIA offers to its members is communications. This is not simple by stating that the WIA informs its members what is going on by virtue of publishing AR on a monthly basis. Rather I mean that it offers the opportunity for dialog with all amateurs operators. This dialog is necessary in order that many of the WIA's functions can be effectively carried out. Activities such as *direct representation* via IARU (*International Amateur Radio Union*), or *indirectly* through participation in the various *national consultative groups* can only be effective if the office holders are aware of the issues that affect the members.

AR, the house journal of the WIA itself fulfills a number of key functions. It is a key means of informing members of

what's going on within the hobby. It is not the role of AR to compete with academic journals, but by the same token it does provide an excellent vehicle through which members can communicate technical ideas relevant to the practical operations of radiocommunications. Increasing many of us rely upon the Internet and in this the WIA web page is another key part of our communication strategy. Over the next few months I expect we will be able to provide more material on the web page that is both topical as well as of a reference nature.

Another area where communications are important is in the role of the *Technical Advisory Committees*. Whilst not always visible, this nationwide group that reviews and comments on technical matters that have an impact on amateur radio operation are always hard at work. In addition to liaising on

Why then, if we are such an entrepreneurial group, do we need an organisation such as the WIA? Or put another way what does the WIA do for you the members? For me; trying to answer this question has been an interesting exercise. In order to answer the question I have divided the various activities and services up into a number of categories:

matters such as band plans in the last year they have to provide comment to various government groups on matters such as the use of vehicle borne radar to the possible interference impact of using the electricity grid to provide broadband Internet communications.

Additionally there is the *debate of matters of significance*. In today's connected world it is possible to have an almost real time debate about matters of importance. No longer can organisations state that it is too difficult to discuss matters of importance. The recent discussion on the future of AR itself is a case in point. If you have a viewpoint, then your voice can be heard. Today's WIA is keen to engage all amateurs in these discussions in order to ensure that the best interests of amateur radio are met.

Services

There are a number of vital services that we all associate with the WIA whether at a Federal or a Divisional level. The first that springs to mind is the provision of *QSL services*. However there are many more. The WIA provides a key role in the coordination of all *education matters* of relevance to gaining the amateur radio certificate of proficiency. This extends right from the setting of the syllabus through to the issue and marking of examination papers. If our recent application to the ACA is successful then I hope that in the future that we will be delegated full custody of the examination service.

Two more areas of service are in the *coordination and management of contests and awards*. The amount of work that goes on behind the scenes to ensure that overseas as well as Australian amateurs receive a prompt service has to be seen to be believed. Although all of the work is done by

Divisional services

Not all services are provided by the Federal WIA. Many are provided at local Divisional and Club levels. Here the practical side of radio is delivered. *If you have a problem* with your antenna there will always be someone to provide a hand. If you are having *difficulty obtaining planning permission* for that longed for mast, the local club or division can assist. Many of us make regular use of the various *VHF and UHF repeaters*. It is often the local WIA Division and club that provides the technical expertise, funds and enthusiasm to make it all happen. So you are not a VHF operator - well have you ever thought about who provides the

volunteers I am sure that the WIA has a key role in being accountable for ensuring that these roles are carried out to everyone's satisfaction. Another critical service is the *monitoring of illegal activity* through the intruder watchers. This dedicated group are responsible for the collection and presentation of evidence of all violations of the Australian amateur Spectrum. Without the efforts of the intruder watchers many of our frequencies would have been rendered useless a long time ago.

Summary of main WIA services

- QSL services
- Major role in amateur radio education
- Coordination of contests and awards
- Monitoring of illegal activity

range of beacons that can be used to assess HF propagation - you guessed right - probably a local WIA representative group.

The WIA does not of course provide every amateur in Australia with all of these services. However, if you are an active operator or experimenter, then I feel sure that in some way the WIA will be acting to support you. So why don't you inquire of your local club to see what the WIA can offer you, or even better what you can offer them. *By acting in unison we can ensure that amateur radio is properly represented at all levels of State, Federal, and International Government.*

How to join WIA

- Through your local amateur radio club
- Through your Division (contact details on inside back cover)
- Contact WIA Federal Office (03) 9528 5962

Why not think about joining WIA today?

Australian Made ANTENNAS

"Setting a New Standard" COM-AN-TENA

(Formerly a j and j coman)
83 Belgrave-Hallam Road
HALLAM 3803

All new 5/8 vertical 16 radials	\$145
Dual drive 26-30 5 ele yagi beam	\$305
4 ele 10-11m yagi beam	\$262
5-6-&7 ele high gain antennas 11m	\$call
3 ele delta loop 10-11m	\$320
11m 5/8 vertical/4-1/4 wave radials	\$170
Duoband 10-15 3 ele each band	\$356
Log-periodic 7 ele 13-30 MHz 7.7m boom	\$890
Tri-band 5 ele HB35C s/steel fix	\$730
3 ele 20m computer opt	\$390
3 ele 15m computer opt	\$285
M B Vert Auto switch 10-80m	\$310
40m linear loaded 2 ele beam	\$580
6m 5 ele compt opt beam	\$259
6m 7 ele compt opt beam	\$355
10 ele high performance 2m	\$135
17 ele high performance 70cm	\$119
2m vert 2-5/8 co-linear 4 rad	\$ 96

Special
DEMO 21 metre aluminium mast complete.
Tilt over telescopic.
One only \$2600
(new price \$3500)

Guyed Masts

21 metres 13 metres
Winch-up & tilt-over. Aluminium and stainless steel three-sided construction with auto-brake winches

Free Standing Masts

9.5 metres

New Baluns

1-1 to 16-1 to 3kW

03 9702 4028

Mob: 0419 542 437

Andy VK3IV

Bright ideas

A Cradle for Portable Transceivers

Use for a pair of chopping-boards

Peter Parker VK3YE
12/8 Walnut St, Carnegie Vic 3163
Email: parkerp@alphalink.com.au
Web: www.qslnet/vk3ye

Portable operation often requires that the operator dispense with the comforts of home. Where equipment is hand carried the single operator can only afford to take necessities such as rig, battery and antenna. Unless it is possible to also take a portable table, both operator and equipment must sit on the ground. A small transceiver flat on the ground is very hard to reach and makes for bad ergonomics. Microphone connections can be strained, cabinets can be scratched and dust ingress is easier. Reading the transmitted frequency or adjusting the controls is also made very difficult.



Photo Cradle in use. (Perspective funny as it is on a shed roof for better photography)

Transceivers such as the Forest Phone and some Codans overcome this by being usable with the front panel facing upwards. Having all connections emerge from the front or side and providing a squat shoebox-style case. Controls and connections on the top achieve this. More recently outdoors minded QRP constructors, mainly in North America, have started doing likewise often referring to their designs as "trail friendly radios" However even, when commercially available amateur transceivers can sit flat on their back panel, their depth usually makes them liable to tip.

817 when no table is available. It folds flat for easy carriage. When folded the bracket can replace the trusty paperback book that is necessary for convenient tabletop operation of this transceiver.

Construction should be fairly self-evident from the photograph. The bracket is A shaped and made from two small polyethylene chopping boards. The boards are attached with a metal hinge. The boards open out to a maximum angle of 90 degrees. This angle is limited by the

placement of the hinge and the overhanging ends of two bolts used to mount the hinge. The transceivers rear panel is restrained by a U or L shaped metal bracket. This is screwed onto one of the chopping boards. The placement of this bracket should allow sufficient clearance for the rear panel antenna, power and key connections. A rubber band further stabilises the rig. Total cost of all parts should be around, ten dollars.

The bracket has been used during several portable excursions. It has made operating much more comfortable and is recommended for any amateur who uses modern equipment in the field.

This project is a simple bracket to allow easier operation of the Yaesu FT-

NEW WIA MEMBERS

The WIA bids a warm welcome to the following new members who were entered into the WIA Membership Register during the month of MARCH.

L60350 MS S L KEOGH	L60425 MR D HOWARTH
L60420 MISS N P HUSK	VK2ANI MR L FURNER
L60421 MRS M J L BONDARENKO	VK2AYO MR D H WALTERS
L60422 MR A V BONDARENKO	VK2CB MR D J REYNOLDS
L60423 MR K J PESTELL	VK2EXA MR G C SARGEANT
L60424 MR C G ROBERTS	VK4SG MR S R GRANTHAM

Junked crystals make a Tree-top Tester

Steve J Mahony, VK5AIM
19 Kentish Rd, Elizabeth Downs.
South Australia 5113

In an article in AR it was mentioned that useful crystals could be obtained at junk sales. I have become a "bower bird", in collecting crystals from scrapped printed circuit boards (PCBs). It is also a name given to people who collect things to which they are attracted, or so that no one else can have them!

These printed circuit boards usually have one or more crystals on them. An inspection often reveals crystals of a useful frequency. Crystals marked with an even frequency, eg 50000MHz, 100000MHz, are the ones to look for. The little crystal oscillator modules are also worth looking for. I have one on 480000 MHz along with the necessary extra components that makes an excellent marker for 144 MHz and 432 MHz. The RSGB had an article on similar dual band marker recently.

I have found that the easy way to remove the chosen crystals is to use a small sharp blade of a small pocket knife. Just slide the blade along remove the solder pad and cut through the fine wire lead. As the holes are usually plated through, they require too much heat to unsolder. You may have to prise the crystal off the board with the same blade as they are often stuck on with double-sided tape. With a little patience useful crystals can be salvaged.

Imagine my surprise when on one PCB I found a crystal marked 14.318 MHz. Right up at the top end of the 20 metre band! No wonder computers put Sproggies on the Amateur bands. Ha Ha, I thought this crystal would make an excellent Weak Signal Source!

Either before or after finding this crystal I salvaged a nice little silver plated box. The box was about 3 inches x 3 inches x 1 inch deep. The lid was fastened with 6 BA screws into threaded bushes. I think it once contained a Filter. It was ideal for my weak signal source.

A search through various technical articles found a circuit. In no time I had

an oscillator going wired up rats nest style on the workbench. It pinned the S meter needle on the IC735.

The little box was measured up to allow for a PCB a 9 volt battery and a BNC socket. A circuit was drawn on a suitable sized piece of double-sided PCB with a resist pen and etched. It was drawn almost like the circuit to allow the components to be surface mounted. Room was allowed for an attenuator pad at the output. Not many components were required - a 2N3819 FET, a BC557 transistor and a few resistors and capacitors. A tin plate shield and divider

Somebody suggested that I buy a toy koala, place the oscillator inside ... and put it up a gumtree

for the attenuator was fitted around the PCB. A feed through capacitor for the 9V DC was provided. With the lid screwed on and a 50 ohm termination fitted to the BNC output connector not a squeak could be heard on the IC735 when it was switched on. I had to adjust the values of the attenuator pad to get a 9 reading on the IC735 S meter: corresponding to 50 microvolts. I have decided to leave the battery out after leaving the thing switched on for several months stored in the cupboard!

Together with a switched attenuator and fixed attenuators, it is interesting to compare the sensitivity, AGC action and minimum signal detection of various

receiver/transceivers. With an AC millivolt meter connected across the speaker it is surprising to see the difference. A FT-757, IC735 and the new IC-706 all behave differently. I was really surprised with the weak signal sensitivity of a simple direct conversion receiver. Anything the 3 big ones could just hear the direct conversion receiver could detect and hear!

It has been interesting to take the weak signal source around to other amateurs' shacks and see how their receivers/transceivers perform! Most enlightening at times.

I have even hidden the weak signal source in an empty drink carton with 10 feet of green hookup wire attached to a BNC connector, taken it down to a nearby park, switched it on and tossed it up into a gumtree. I then came home to listen for it on the IC735! I could hear it on the 3 element monoband beam. While not strong enough for the S meter to read, I could see the front to back ratio and side rejection of the antenna.

Somebody has suggested that I buy a toy koala, place the oscillator inside complete with green wire antenna and then put it up a gumtree

So there you are keep your eyes open for the right crystals on those junked PCBs and you could have a nice set of test oscillators.

Problem with your antenna?

Ask your local WIA club or Division for help

(For Divisional contact details inside back cover)

AMSAT-NA Chief visits VK

By Jim Linton VK3PC

The President of AMSAT-NA, Robin Haighton VE3FRH, was billed as an international amateur satellite expert in publicity for his recent talk in Melbourne. He not only lived up to that description, but showed he is a down to earth and keen active radio amateur.

Robin said the pioneering work of radio amateurs that began at the turn of the last century leading to many communication facilities we now enjoy, is being carried on today by AMSAT with innovation and the development of many ideas within small satellites.

His talk at the Moorabbin and District Radio Club attended by 90 radio amateurs included details about a new satellite project.

AMSAT-NA has just signed a contract with a US firm SpaceQuest for a Low Earth Orbit (LEO) satellite called Echo, which is due to be launched at the end of this year.

He said, "This microsatellite with 8-watts downput and very sensitive receivers will enable users to communicate using analog voice on several VHF uplink and UHF downlink channels simultaneously - but with handheld QRP power!"

Other features of Echo will be APRS packet data, and PSK-31 operation (28 MHz up/70cm down), uplink voice or data on 23cm, 2 metres or 10 metres with a 70cm downlink.

"It will be over Australia every 90 minutes with passes ranging from 10 to 20 minutes, depending how directly it passes over Australia at any one time," Robin explained.

In another project, AMSAT-NA is moving ahead with Project Eagle, which will complement AO-40, be put into a similar geosynchronous transfer orbit, and cover the 70cm band, the 2-metre, S and L bands. It is hoped to be launched in 2004.

Also on the drawing board, Germany's AMSAT-DL is in the preliminary stages of planning a mission to the planet Mars in about 2007-8. It would probably use a satellite about the size of AO-40.

AO-40 – success out of post launch failure

Using a Power Point presentation Robin provide a step by step look at the Phase 3D AO-40 satellite, the most ambitious amateur satellite project ever.

Its configuration is six-sided, with solar panels on each side, and its weight is 632kg. When the solar cells are deployed they are about 7-metres across.

Robin conceded that in his opinion "AO-40 took too long to build, it's too big in size and complexity, and we have had some failures with it."

Apart from the disappointing loss of its 2 metre trans-mitter due to internal damage to the satellite, Robin said AO-40 is working extremely well.

Its originally intended orbit would not have favoured the Southern Hemisphere, but its current orbit, the result of propulsion difficulties, is giving very good reception in Australia.

He explained how it was launched on November 16, 2001, into an almost perfect geosynchronous transfer orbit, and within a few hours telemetry was being received from its 2 metre beacon.

It was necessary to make some orbital changes and stablisation, and deployment of solar panels, before AO-40 was open for general use by radio amateurs

Robin explained that all was going well until December when the satellite's 400-newton motor was operated. During one burn attempt nothing happened, due



L-R Jim Linton VK3PC, Robin Haighton VE3FRH, Keith McCarthy VK3JNB at the MDRC

to a suspected sticking valve.

On a later burn of the motor was due to last three minutes, the motor did not shut off for a further two to three minutes, placing it in a higher apogee orbit.

On December 11, 2000, while remotely working the troublesome fuel valve, a sudden loss of signal from the satellite occurred. Robin recalled how everyone feared that AO-40 has suffered an onboard explosion, or thrown into an orbit away from earth.

"All we could do for about three days was weep," he said, "but fortunately NORAD (North American Aerospace Defence Command) found it to be in one piece, and not a thousand pieces as we had thought."

After a lot of experimentation, ZL2AOX found he could activate one of the satellite's transmitters. That was on Christmas Day 2000 (UTC) when he put up signals on 70cm and activated the S-band (2.4 GHz) transmitter on the satellite, and downlink telemetry was successfully recovered.

Robin said, "It was the happiest Christmas many radio amateurs around the world had had for many a long year."

The satellite was then painstakingly tested, and progressively brought into service, with the S-2 band transmitter opened for general use on 5 May 2001.

Found to be working fine were the 70cm and 1.2 GHz receivers, the S-2 (2.4 GHz) transmitter, the magnetorquing system (to control the satellite spin rate),

"NASA is looking on us very favourably and saying 'hey you guys did a great job for us and now what can we do for you?'"

onboard cameras, and high-gain antennas.

One of the cameras has already transmitted pictures of earth from space. In the middle of this year AMSAT plans to take a series of images of earth from the satellite, transmitted digitally via its RUDAK system.

A unique feature on AO-40 is called LEILA, which senses excessively powered SSB uplinks, gives an audible warning, and then notches out the offending signal preventing its access, and "hogging" of the transponder.

Robin encouraged radio amateurs to consider using AO-40, its orbit providing excellent coverage over many hours.

A 70cm SSB transceiver with a beam for the uplink, and a relatively cheap 2.4GHz downlink receiver and antenna

is required. A number of regular operators are using AO-40 while portable, showing it is relatively easy.

Apart from SSB telephony the satellite is also being used for digital contacts, PSK31, and some SSTV.

Giving NASA useful data

While AO-40 was being built, NASA approach AMSAT with a Global Positioning System (GPS) package and asked if it would be interested in putting it on board the satellite.

Robin said the NASA project was to try and determine the location of the satellite, when it was outside the orbit of the GPS ring of satellites.

NASA stipulated that its package needed to be tested early in the orbit life of AO-40, but none of the equipment was

radiation hardened, and not expected to last the rigors of space more than three months.

The propulsion difficulties experienced meant it was a year before AMSAT could get around to activating the NASA GPS package.

Everything worked 100% giving NASA excellent data. The outcome is that using GPS, satellite orbits can be more accurately measured, which will mean that in the future more orbit slots are now possible over the equator for geostationary satellites.

Robin said, "NASA is looking on us very favourably and saying 'hey you guys did a great job for us and now what can we do for you?' ... and discussions are ongoing and look most encouraging."

ar

Exciting opportunities on the horizon...

Continued from page 3

Productivity Commission

Late last year I reported on the Productivity Commission in their efforts to review the current Radiocommunications Act. Their efforts are mostly aimed at the larger commercial users of the Radio Frequency spectrum. Even so the needs of the amateur radio community were listened to by the Commissioners as is reflected in their draft report, which can be found on the Productivity Commission web page at www.pc.gov.au. It is pleasing to note that they have a clear recommendation

to examine the devolution of many of the current administrative arrangements conducted by the ACA to the WIA (Section 11.1, recommendation 11.1, page 248). This recommendation has the potential to have a significant impact on the WIA and the manner in which it operates. I have asked the Divisions for their comments on the draft and will attend the final round of public hearing in April to ensure that the best interests of amateur radio are represented.

Well that brings me to the end of this month's notes. I trust that all readers of this edition find something of interest to them. Once again can I please urge everyone to respond to the attached survey. The WIA needs to adapt to meet future amateur radio requirements. This is your chance to make sure that your views are heard

73s and I look forward to hearing your views.

Ernest Hocking VK1LK

Cable, Connectors, Tools



- RG58C/U Belden 8259 @ \$0.90 per metre
- RG213/U Belden 8267 @ \$4.45 per metre
- RG8/U Belden 9913 Low Loss @ \$5.15 per metre
- RG8/U Belden 9913F7 High Flex Low Loss @ \$5.55 per metre
- RG8/U - RF400 Belden 7810 Low Loss Sweep Tested to 6000MHz @ \$6.30 per metre



- RG58: B80-006 UHF connector (M) @ \$7.65 each
- RG8/213: B80-001 UHF connector (M) @ \$8.80 each
- RG213: B30-001 N connector (M) @ \$9.10 each
- RG8: B30-041 N connector (M) @ \$14.00 each

TOOLS

- Coax Cutters: C.K. @ \$40.00 each
- Strippers: ● Ideal - RG58 @ \$33.00 each
- RG8/213 @ \$53.00 each

* All prices include GST

* Minimum order value \$50 payable by Visa, Mastercard, Bankcard or Money Order

* Packing and Delivery \$15 within Australia (Outside Australia P.O.A.)



ABN: 62 088 051 030

email - sales @elektron.com.au or Phone: (03) 9761-3207
Elektron Pty Ltd, Unit 2, 14 Melrich Road, Bayswater, Victoria 3153.

Bright ideas

Another battery saver timer

Evan Phillips VK3BIX

Recently I made up a piece of test equipment of a type that would only require use for a minute or two on any occasion.

As I was concerned that the 9V battery would inevitably be destroyed by my failure to switch the unit off after use or by accidental switching on, I devised a simple circuit which only allows use for a set, short period after pressing the "ON" button.

When the unit is OFF the only current flow is through the emitter-collector junctions of the two transistors and, with no bias applied these things have resistances of heaps of megohms. I was unable to detect any current drain using a DVM and think that the battery will last virtually its shelf life in the OFF state.

When the "ON" button is pressed, the 555 timer is powered with pin 3 high, both transistors switch on and the load is supplied through the BC557. When the timed period is over 555 pin 3 goes low, and the system instantly switches off. The diode is needed to ensure a clean switch-off of the system. Note that pressing the ON button during a cycle

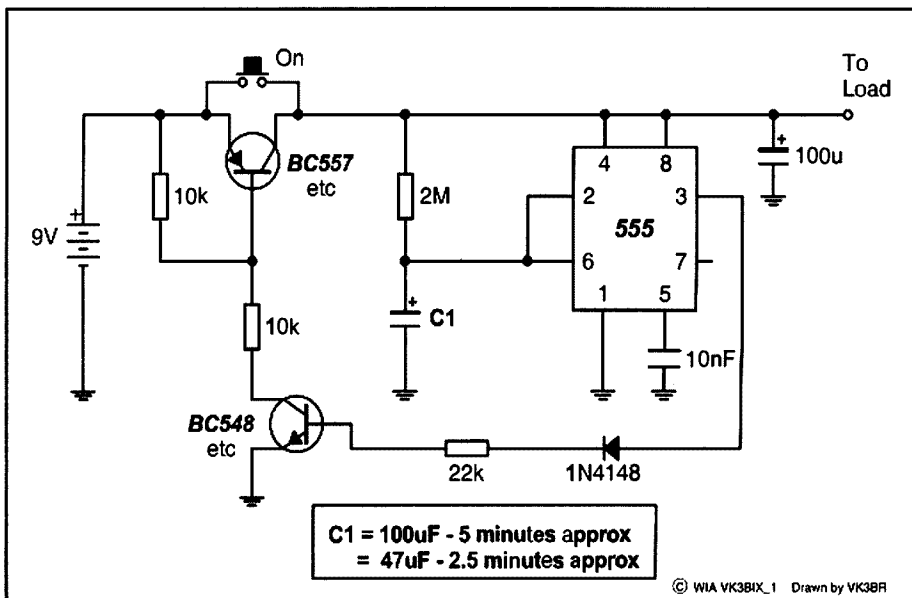

C1 = 100uF - 5 minutes approx
= 47uF - 2.5 minutes approx

© WIA VK3BIX_1 Drawn by VK3BR

will not lengthen the ON time. After switch-off, the ON button can be again pressed to repeat the cycle.

This arrangement can be used with

gadgets requiring larger batteries, with the BC557 being replaced with a higher current transistor if necessary.

ar

Silent Key

John Eastaugh VK5GY

John Eastaugh was born and raised in Southern England. He joined the Royal Air Force at an early age, served in Europe, the Middle East and Australia. While in the Middle East he obtained his Amateur Radio License by correspondence, later to qualify in Morse at a Royal Naval Base on return to England.

He left the RAF at the age of 40 and immigrated with his wife Iesje (eesha) to Adelaide where he took Managerial work with GEC. He later ran his own business in the manufacture of domestic and small business Kilns.

He retired early and built his own home at Bull Creek, Meadows. Nr Adelaide. His QTH was on a ridge at one of the highest points in the region and with a self constructed 70ft x 4 section free standing adjustable tower topped with a TH6, he was well known internationally on HF.

He was a member of the South coast Amateur Radio Club, a member of WICEN, and was a keen motorcyclist.

John and I met on local Packet some ten years ago at a time when we were both trying to discover how to use Computers with Amateur Radio. We

became close pals, able to visit each other regularly and chatted on Packet three nights weekly between 11pm and midnight.

Apart from his wife Iesje he leaves a daughter and family, son in America, and many friends in the Adelaide region. He died after a short illness at the age of 67. He will be sadly missed by all who knew him.

Derek Hague

vk5afp @ McLaren Vale. SA.

Mail: glenhardy@chariot.net.au

Packet: vk5afp@vk5tty.#adl.#sa.aus.oc

A Constructor's Report on the WBR Receiver

Peter Parker VK3YE
12/8 Walnut Street, Carnegie, 3163
Email: parkerp@a1phalink.com.au
Web- <http://www.qs1.net/vk3ye>

The WBR is a novel regenerative receiver using a bridge style method of coupling the antenna to the receiver's detector. Other features include a separate local oscillator and infinite impedance detector. The project was first described in reference 1 and is summarised in reference 2.

Changes made

The WBR pictured was constructed in August, 2001 shortly after the article became available in Australia. The following modifications were made to suit available components and the author's preferences:

- Use of BZY88 zener diodes instead of the varactor diodes specified.
- A HEF4007 biased in linear operation as the audio amplifier. (see Reference 2) instead of the LM386 to provide sufficient gain for speaker reception.
- Use of a meter movement scaled 0-10, to monitor tuning voltage and thus provide a rough indication of received frequency
- Substitution of a BC547 for the 2N3904,
- Use of a T50-2 toroid instead of the T68-6 core specified.

Results

The receiver worked first time, but sensitivity was poor. This deafness is not an isolated problem as Drew VK3XU reported similar results with his WBR.

When looking for ways to restore sensitivity, my attention was turned to Z1. This is effectively a short circuit across the antenna connection. I say effectively because it consists of just 25 millimetres of wire with the antenna tapped at the midpoint. I concluded that any receiver with a short circuit across the antenna connection is bound to be deaf and proceeded to seek alternatives.

Sensitivity increased dramatically (possibly 20dB) when the wire link was

replaced with a 0.22uH RF choke. The wiper of the RF gain control was connected to the junction of the RF choke and the centre tap of LI via a 10nF capacitor. The RF choke used was salvaged from the pi network of a 27 MHz CB radio.

After the modification, speaker reception of VK stations became possible in a quiet room. DX stations could be clearly heard on headphones and band noise was apparent when connecting the antenna. Though there was a risk that the change could give rise to frequency pulling, the receiver remained on frequency at all settings of the RF gain control.

As an experiment, the 0.22uH was replaced with a 0.65uH inductor. Overall receiver gain increased, but there was some detuning caused by adjusting the RF

Photo 1 WBR Receiver.

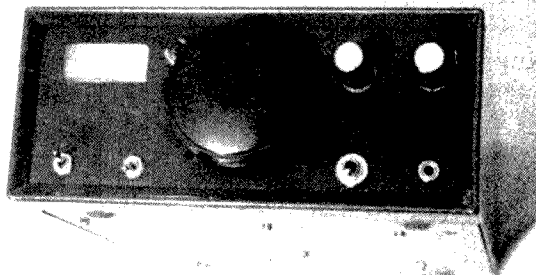

gain control. The amount of frequency pulling was approximately 500Hz, so it would be annoying if frequent adjustment of the RF gain control was required.

Another exercise was to replace the

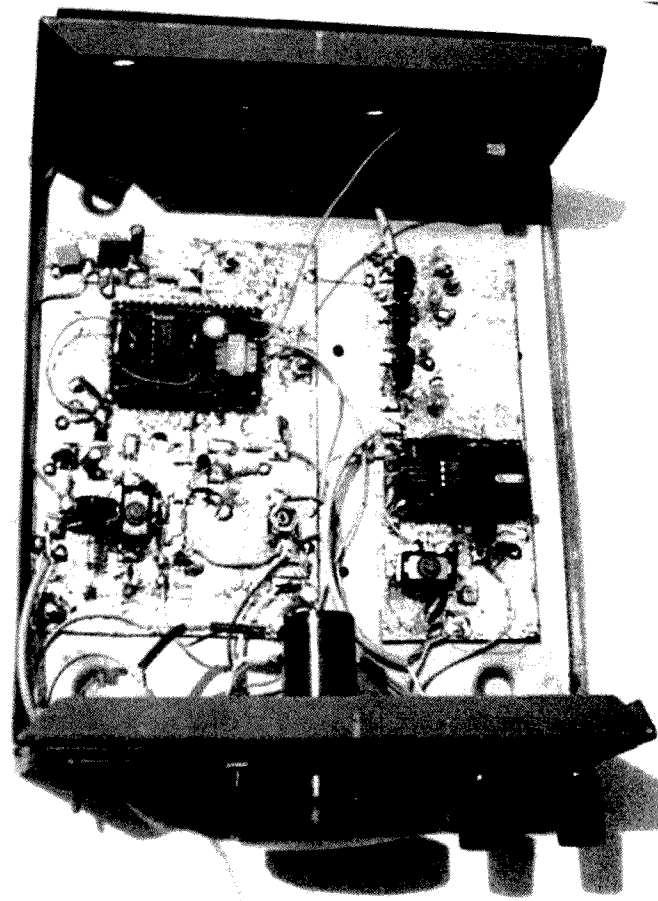

Photo 2 WBR Receiver Interior.

RF choke with a resistor. Several values between 10Ω and 100Ω were tried. As with the RF chokes, there was a trade-off between receiver gain and frequency pulling. Resistance values between 33Ω and 100Ω provided speaker reception of the louder DX signals. However values around 10Ω made for easier adjustment of the RF gain control. However this control is not essential and tends to be run 'flat out' at all times. Not using or omitting this control would make interaction less troublesome than might initially be thought.

With any of the above substitutions for ZI the completed set is a joy to use, particularly with CW and SSB signals. In operation it feels more like a direct conversion receiver than a regenerative. It breaks into oscillation smoothly with a gentle hiss, and there are no ear

shattering squeals. The regeneration is more or less a 'set and forget' adjustment and does not need to be adjusted, even when tuning across the receiver's full 7.0 – 7.2 MHz range. It is certainly one of the best regenerative receivers I have ever built.

Photo Two shows the interior of the set. The receiver proper occupies the left of the picture. It is built paddy board style, except for the audio amplifier that is mounted on a small board. On the right is an unfinished converter for eighty metres. This uses an NE602 oscillator/mixer. A local oscillator frequency of 10.7 MHz (crystal obtained from a dismantled crystal filter) provides backwards tuning of 3.5–3.7 MHz. A 4MHz pi network on the converter's input prevents IF breakthrough at 7 MHz and image reception of 17.5 MHz

broadcast signals. Otherwise the converter circuit is conventional and can be found in numerous articles.

Conclusion

The WBR is a novel design capable of excellent performance. However the circuit as published requires work to bring its sensitivity to an acceptable level. Fortunately the modifications are easy and it is possible to combine stable performance with good sensitivity.

References

1. Wissell, WBR Receiver, QST August 2001
2. Sones, Technical Abstract, AR January 2002
3. Parker, DC 2000 Receiver AR October 2001

ar

G. & C. COMMUNICATIONS

Authorised dealer for ✓ Kenwood ✓ Icom ✓ Barrett RFDS ✓ GME Electrophone ✓ Uniden ✓ RF Industries

✓ **KENWOOD TS2000** All-mode multibander HF/50/144/440
Auto antenna tuner built-in



✓ **ELECTROPHONE TX3400**
40 Channel UHF remote mount transceiver
with ten extra receive channels



✓ **ICOM IC207H**
Amateur 2m/70cm FM mobile transceiver.
Compact dual band unit with detachable
control panel (OPC-600 cable required)

Australia-wide orders welcome. Payment by credit card, cheque or money order

**19 Arleon Crescent Cranbourne 3977
Ph: 03 5996 3298 Fax: 03 5995 0184**

**Email: gcomm@netspace.net.au
www.netspace.net.au/~gcomm**

The P & SWR meter

Kees Heuvelman, PA0CJH
Breugel, Netherlands.
translated by Bill Beyer VK3BHW

The Power and Standing Wave Ratio Meter is a measuring device that indicates transmitted power to the antenna cable. The power indicated is the effective power that is radiated by the antenna, ie the output of the transmitter minus the reflected power from the antenna. Note that antenna and feeder line losses are not taken into consideration.

Power is read from a moving coil meter with a linear scale, with power ranges of 10, 20, 50, 100, 250 and 500 watt, a power level of 1 watt can be read with reasonable accuracy.

The device sports a "hold" (peak

facility) so that peak power is indicated which facilitates SSB tests. As with most SWR meters the "voltage reflection coefficient" is measured, (Rho), that is the ratio between the reflected voltage and the voltage going to the antenna

from the transmitter. In this instrument that ratio is calculated so there is no need to the usual setting up to "set" in forward mode and then switching to reverse.

Because of the ratio calculation circuitry a "hold" facility is not required, although the voltage amplitudes can vary the ratio of the voltages at certain conditions remains the same. When the voltage becomes too low for reliable readings the SWR sections is switched off to prevent false readings.

The frequency range of the device described here runs from 1.6 to 60 MHz

Block Diagram

Many designs of power and SWR meters have been published over the years. This design is based on an idea of John Grebenkemper, KI6WX, and is to be found in "ARRL Antenna Handbook" amongst others. The meter described here differs on a number of points.

The P & SWR meter starts of with a directional coupler. It is placed in the feeder between the transmitter and the antenna. The coupler generates two ac voltages; derived from the forward and reverse power, Vfwd and Vrefl. A voltage of 7.07 V equals a power of 500 W.

The voltages Vfwd and Vrefl are each applied to individual amplifiers. The amplifiers have two functions, namely voltage amplification and correction of the nonlinearity of the diodes in the coupler section. It must be possible to change the amplification because at a power level of 500 watt the output voltage of the coupler is a factor square root (500/10) higher than at 10 watt. Thus the amplification can be changed to suit 10, 25, 50, 100, 250, and 500 watt full-scale.

The correction function of the amplifiers is to compensate for diode characteristic, which comes into play especially at low power levels. For this reason, Schottky diodes are used having low forward barrier voltage.

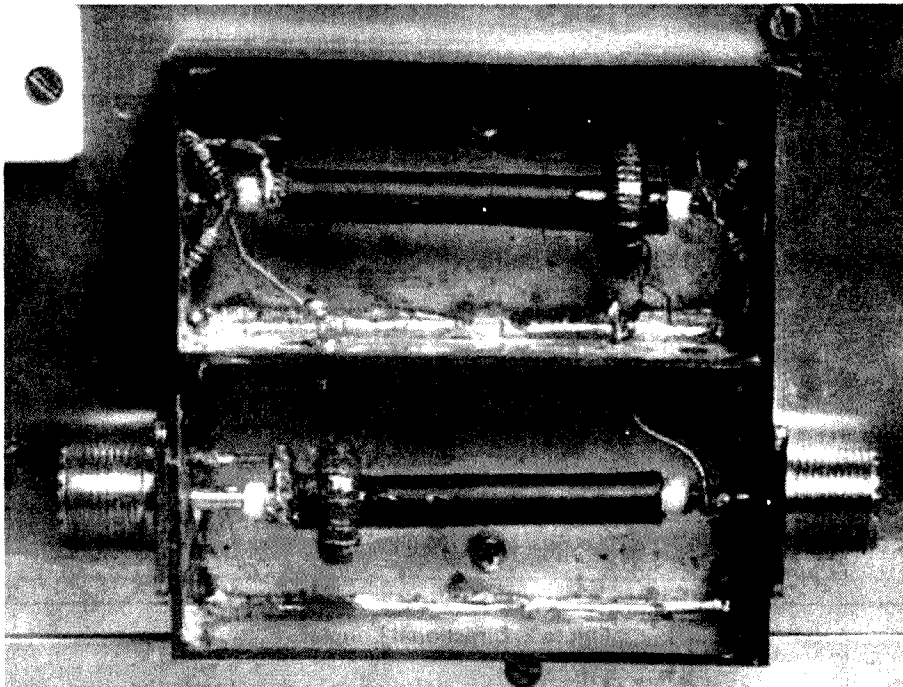

Photo 1. Inside view, directional coupler



Photo 2. View of front panel

The output voltages of the amplifiers are named V_f and V_r respectively. As power equals the square of voltage ($P=V^2/R$) the forward voltage and the reflected voltage are squared so that the outputs are the function of the power applied to the antenna. In the following blocks of the circuit the difference of the two powers, forward and reverse is determined, so that we finish up with the actual power radiated. Note that the feeder and antenna losses are not seen by the P&SWR meter.

In the last block of figure 1 the reflection coefficient ρ is determined. The Standing Wave Ratio follows from $SWR=(1+\rho)/(1-\rho)$.

When $\rho = 0$ meter deflection is also zero and the $SWR = 1$ and with total reflection $\rho=1$, and the SWR is infinite and the meter is full scale. Therefore the moving coil meter being a linear instrument needs to be corrected for meaningful SWR readings.

The scale will look as follows;

Deflection %	SWR
0	1
20	1.5
33.3	2
50	3
60	4
66.7	5
82	10
90	20
96	50
100	Infinite.

The Directional Coupler

Drawn in figure 2 is the directional coupler. The coaxial sockets TX and ANT are connected by a piece of 50-ohm coaxial cable. The braid is only earthed at Tx. A ring core T1 with 31 windings is slid over the coax. This forms a current transformer reducing current 31 times.

Fixed between points A and B is a second piece of coax terminated on either side with 50 ohms (resistors R1 and R2) and the copper braid earthed at B only. This coax also carries a ring core T2 that is exactly the same as T1, however this transformer acts as a voltage transformer, reducing the voltage at ANT (point B) 31 times. The voltages generated at points A and B are rectified by the Schottky diodes (BAT81) producing the DC voltages V_{fwd} and V_{refl} and are in turn presented to the two amplifiers mentioned above.

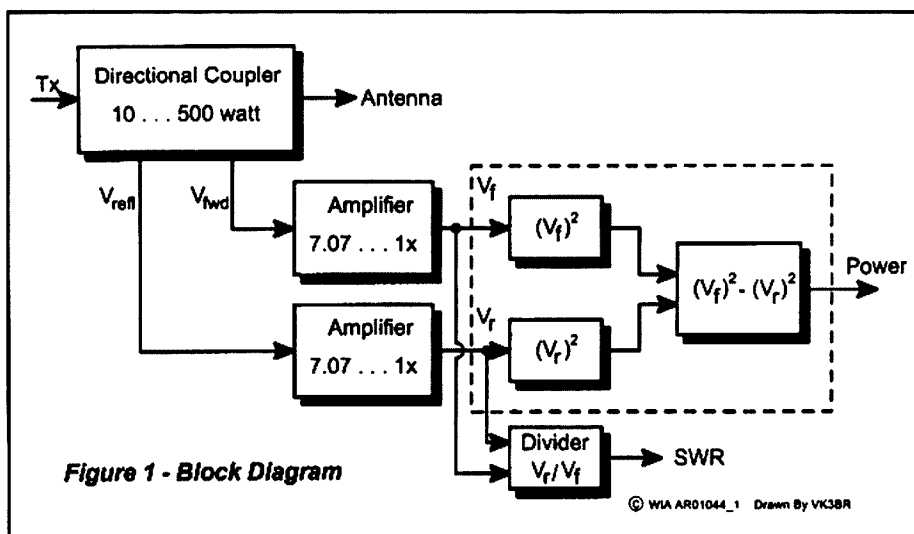

Figure 1. Block diagram

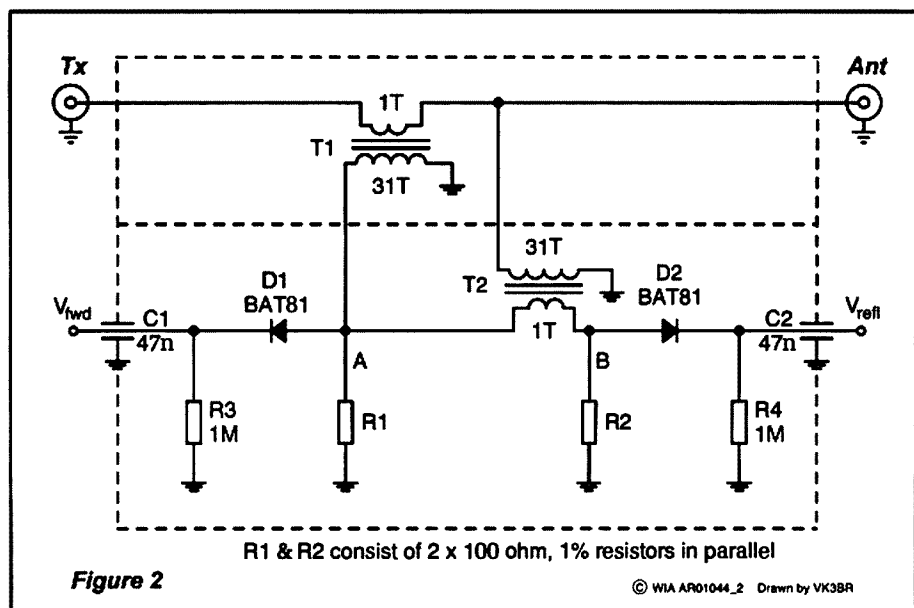

Figure 2. Directional Coupler

Construction of the directional coupler

The directional coupler is housed in a small box measuring 85 x 85 x 28 mm, constructed of double sided PCB board 1.8 mm thick soldered together at the edges. Inside a divider made of the same PCB is installed and soldered. In the upper compartment current and voltage are taken from the piece of AIRCELL 7 coax, with an OD of 7.4mm, the total length being 80 mm. AIRCELL 7 is used here as it matches nicely the inside diameter of the ring core; also the coax braid can be soldered without melting the dielectric of the coax. The coax is mounted between the two SO-239 connectors. The braid is soldered on the

left side only, do not earth the other side!

The current T1 transformer slides over the left side of the coax. It is an iron powder ring core Amidon T68-2 (red), dimensions 17.5 OD, 9.5 ID and the secondary winding consists of 31 turns of 0.2mm posyn wire. (You could use enameled wire Editor) One side of T1 goes to earth, the other side goes via a through insulator (not a feed through capacitor) to the bottom compartment to point A. This bottom piece of coax is the same as in the top compartment and mounted on two stand-off insulators. Here, the braid is earthed on the right hand side and T2 is positioned on the right end. T2 is in all respects similar to T1; this is important for the accurate functioning of the coupler.

The lower coax is terminated at either end with 50 ohm made up of two resistors of 100 ohm in parallel. Diodes D1 and D2 are connected to feed through capacitors located at the back of the enclosure. The position of T1 and T2 determine the polarity of Vfwd and Vrefl. The simplest way is to build the coupler and find the correct polarity by trial and error.

The amplifiers

The circuit of these amplifiers (Figure 4) is almost directly taken from the article written by KI6WX. (Calibrating Diode detectors, QEX Aug. 1990). Each amplifier consists of 2 op amps (TLC27L2). The gain of the first op amp amplifies is near to unity; it has compensation for the non-linearity characteristic of the diode detector in the directional coupler. The compensation circuitry consists of R3, R4 and R5. The diodes of the directional coupler and the op amps should be matched as close as possible, and should be selected for equal voltage drops at a certain current. At 1 milliampere through each diode the forward voltages should agree within a few mV.

With the second op amp the desired amplification can be selected and measured between points Mp1 and Mp2, this can be done in 6 steps varying from 7.07 to 1.0 volts relating to the power ranges from 10 to 500 watt. This is done with the selector switch "Power Range". Zero setting is done with trimmer R7.

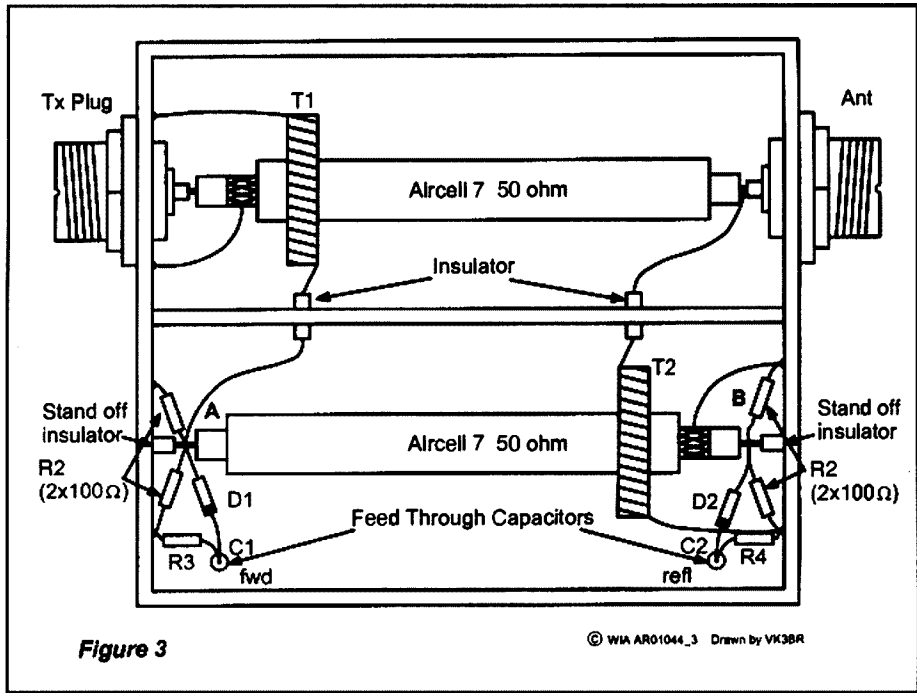

Figure 3

© WIA AR01044_3 Drawn by VK3BR

Figure 3. Directional coupler construction

This trimmer is fed with properly stabilized DC voltages of + 2.5 and -2.5 from 2 x LM336's. These are in turn supplied with 15 Vdc via adjustable current sources. Note that two of these circuits are required, one for Vfwd and one for Vrefl.

The MC1595 is a multiplier chip. When the two inputs are connected together it squares the input. The accuracy of the squaring is 2%. Motorola also manufactures the MC1495, which has an accuracy of 5%. In this circuit an error of 0.1dB and 0.2dB respectively would be incurred.

Power measurement

The circuit for power measurement (Figure 5) consists of two ICs type MC1595 and an op amp type CA3140E.

The CA3140E determines the difference of the two squares.

The switch Sk has three positions; position 1 coupled to the power (240

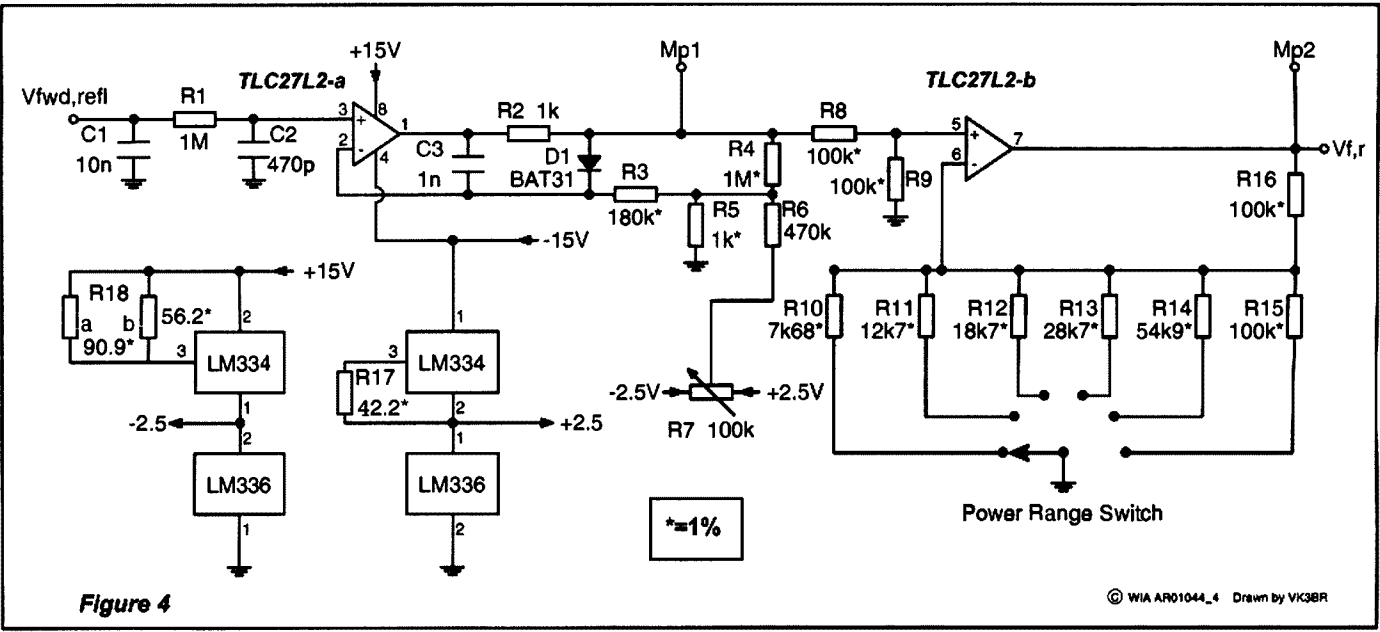

Figure 4

© WIA AR01044_4 Drawn by VK3BR

Figure 4. The amplifiers (2 required)

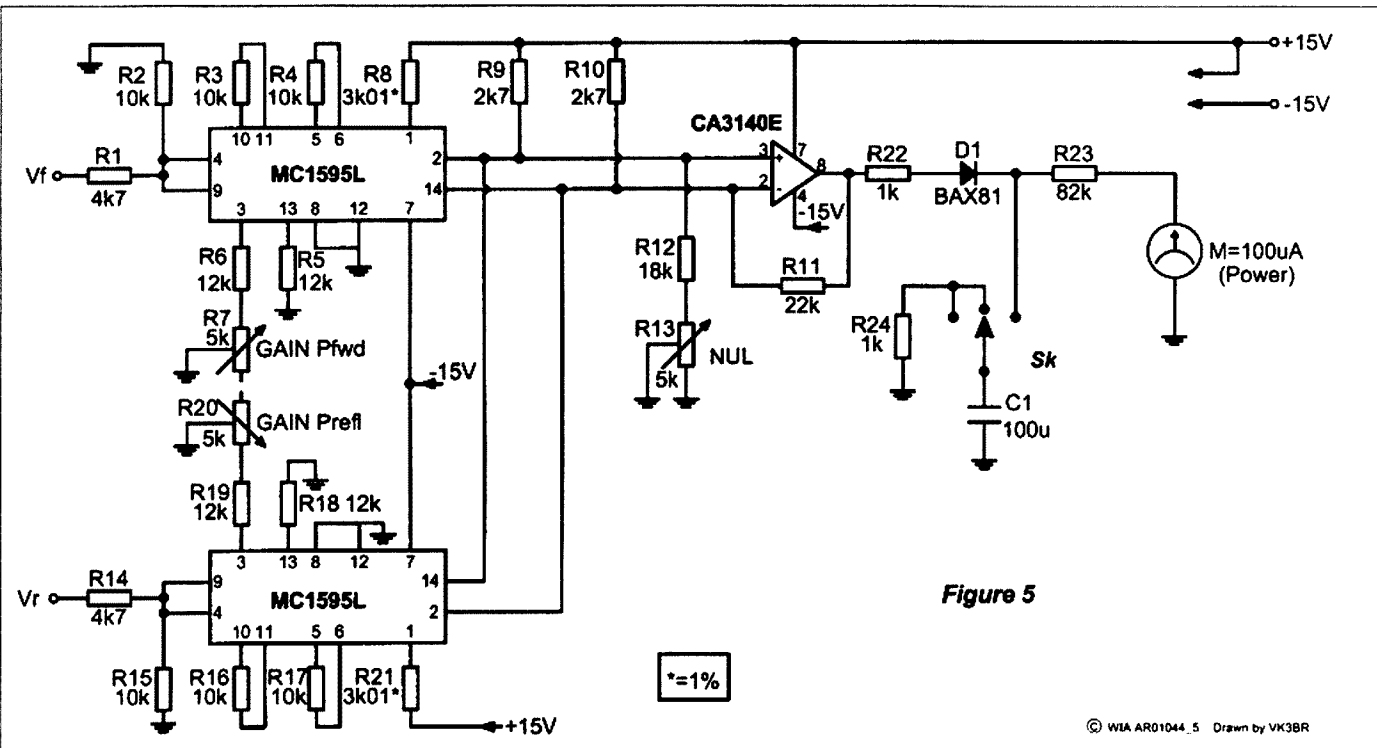

Figure 5

© WIA AR01044_5 Drawn by VK3BR

Figure 5. Power measurement

Vac) is the off position. In position 2 the meter follows rapid fluctuations, this can be used to tune the transmitter to a certain power level, usually the maximum power. Position 3 is the normal working mode, capacitor C1 is switched in to obtain peak measurement; through the diode D1, it

is charged rapidly but discharges slowly through R23 and the meter. In position 2 C1 is discharged rapidly through R24. Position 3 works satisfactory for SSB, the radiated power can be read off more or less as a constant value while speaking into the mike.

The divider

To obtain the standing wave ratio the voltage V_r needs to be divided by voltage V_f . The result is the coefficient of reflection ρ . It would be possible to also use the MC1595 by using it as the feedback element with an op amp

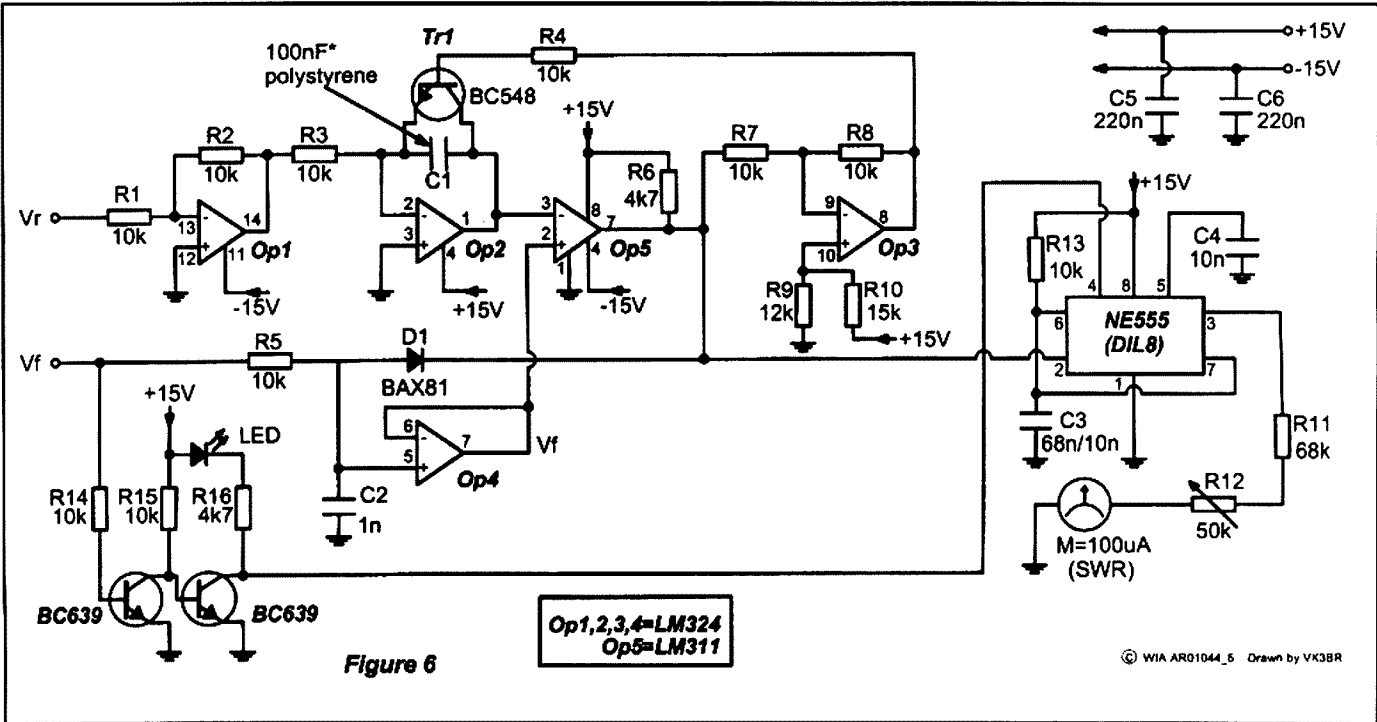

Figure 6

Op1,2,3,4=LM324
Op5=LM311

© WIA AR01044_5 Drawn by VK3BR

Figure 6. Divider circuit

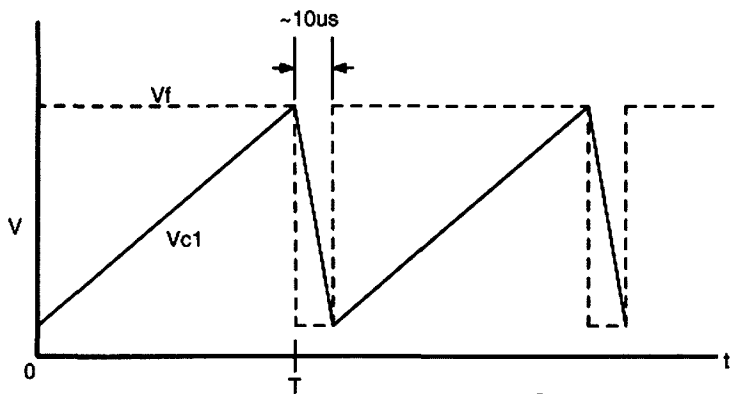

Figure 7

© WIA AR01044_7 Drawn by VK3BR

Figure 7. Timing diagram divider circuit

circuit. Experiments with this were rather disappointing; lots of fiddling required to get a satisfactory result. The stability was also a problem.

A better proposition is a voltage to frequency converter. With a V-f converter a voltage is converted by means of an integrating op amp to a frequency which is proportional to that voltage.

After some experimenting a very stable divider was designed and made with an accuracy of 1%, and no calibration is required (excepting the moving coil meter). The circuit of the divider is drawn in fig. 6.

The heart of the circuit is the integrator OP2 charging capacitor C1 with a current proportional to V_r , Tr1 discharges C1 at the instant when the voltage across C1 equals V_f ; see fig. 7 C1 can only be charged when Tr1 is not conducting. The inverter op amp OP1's gain is -1 it supplies a negative current through R3 turning the output voltage of OP2 positive. When OP2's voltage exceeds that of OP4, that is V_f , (OP4 gain being unity), the output of the OP5 comparator will swing to 0 volts. Tr1 will be turned on via OP3 and C1 will be rapidly discharged. (Time T in fig. 7). To "lock" OP5 into a stable condition the input of OP4 is pulled to 0 volts via D1. Because OP3 and OP4 are relatively slow it takes some time (ca 10 microseconds) before Tr1 stops conducting. The two op amps are not required to be fast; otherwise C1 would not be discharged completely, affecting the accuracy of the circuit. On the other hand the comparator should be accurate and fast.

With C1 completely discharged the output of OP2 returns to a proper 0 volts, and OP5 will swing the other way and C1 will be charged again. At the output of the comparator a negative going pulse is generated every time "Time T" is reached. This pulse is applied to the NE555 configured as a monostable multivibrator. The NE555 generates an output pulse of fixed duration, about 9 mseconds, delivering a pulse train with a frequency of $1/T$. The average voltage represents the frequency $1/T$.

Calculation of time T.

The current, which charges C1, is $I_c = V_r/R3$

After T sec the charge of C1 will be $Q_c1 = I_c * T$

and the voltage $V_{c1} = Q_{c1}/C1 = I_c * T / C1 = V_r * T / R3C1$

The comparator changes state when $V_{c1} = V_f$

therefore $T = (V_f/V_r) * C1 * R3$

The output frequency therefore will be $f = 1/T = (V_r/V_f) / (C1 * R3)$.

The product of C1 and R3 is 1ms, so when $V_r/V_f = 1$ then $f = 1000$ Hz. At this stage the reflection coefficient ρ is 1 and the SWR is infinite, thus the meter should show full deflection.

When V_f is 0, (no signal) the division will be undetermined and the NE555 output will be uncertain. The transistors Tr2 and Tr3 measure V_f . When V_f drops below about 10% of the maximum value Tr3 will conduct, the collector of Tr3 will go to 0 volts and the NE555 will be blocked, ie. no output. The LED will light up indicating a No-signal condition. This might be an indication to switch to a lower power range.

The supply

The P&SWR meter is supplied with +15Vdc (40 mA) and -15Vdc (25 mA). These voltages need to be stabilized with for example a LM7815 and a LM7915. The supply was built on a PCB; the amplifiers and the divider are placed on a separate PCB. The decoupling capacitors C5 and C6 (fig. 6) are also located on this PCB

Calibrating the P & SWR meter

The only requirement for setting up is an accurate, preferably digital, voltmeter.

Note: where a zero voltage input is called for, connect this input to earth to ensure a true zero voltage.

Directional coupler, fig. 2

As can be seen from the circuit, there's nothing to be calibrated. With a radiated power of 500 W the ac voltage can be calculated as follows; $V_{fwd} = \sqrt{(P * R1) / N}$.

With $P = 500$, $R1 = 50$ ohm, and $N = 31$, $V_{fwd} = 5$ Vac (effective value). After rectification by diode D1 the dc voltage is $\sqrt{2}$ times the effective value $1.414 * 5.0 = 7.07$ Vdc.

This value is used for setting up the remainder of the P&SWR-meter.

The Amplifier, fig. 4

All that needs to be done is to zero the two amplifiers. This is done with R7, and the voltmeter connected to testpoint MP2. With no input voltages applied, and the Power Range Switch set to 10 watt, (max. gain) set MP2 to zero.

Powermeter, fig. 5

Start off with the null setting of the power meter, (moving coil meter), with R13. Again make sure that no input voltages are applied and switch Sk in position 2 (fast). Now apply 7.07 Vdc to the V_{fwd} amplifier and the Power Range Switch to 500 watt. Keep the other amplifier at zero input. With R7 (GAIN Pfw) set the deflection to 100%. Next, apply 7.07Vdc to the V_{refl} amplifier and set Power output to 0% (with Gain Pref.); this should simulate that the outgoing energy equals the returning energy, total reflection and no RF radiated.

Divider, fig. 6.

When $V_{fwd} = 0$, there should not be any meter deflection and the LED should light up.

Continued on page 22

Education Notes

Brenda Edmonds VK3KT

Seeking "hooks" for new recruits

Thank you to those readers who provided some feedback on the idea of a low level entry licence. The idea seems to have quite a lot of support among the members, although thoughts on the required syllabus and the privileges to be offered seem to vary a lot.

I have been following the progress of the British Foundation Licence, but have not yet been able to examine a sample examination paper. The syllabus seems to be set about equal to our original Novice Licence, but it must be a lot simpler if it is intended to be covered in a weekend of study.

If we are to lobby for a low level entry, we must decide the purpose of the exercise. We currently have five levels of licence, although only four levels of privilege. Where is the need for another level?

As I see it, this licence will be an attempt to encourage more recruits into the hobby. We have been trying to increase recruitment for some years, and have not succeeded very well. The original Novice licence was very effective in recruiting. Our numbers rose markedly as a result of that licence being formalised just at the time when CB radio was starting to lose its initial charm, so we had large numbers of CB operators looking for a higher level of involvement. Some of these recruits

have been active enthusiastic amateurs for over twenty-five years now. But now we do not now have CB as the initial "hook" to grab the interest.

As amateurs, we have all found the hobby to be absorbing, challenging, exciting, stimulating or satisfying. How can we pass on those feelings about the hobby to another generation of amateurs? Where do we find that new generation? How do we introduce new persons into the amateur field so that they will likewise experience its attractions?

For some years now we have stressed the need for increased WIA membership, but most of our publicity material has been directed at those who are already licensed. We need to direct some of our energy to publicising amateur radio to the general public, so that persons who have never heard of us become interested and look for information, and we must make it easy for people to access the information. We need a lot of ideas from readers about how to spread the word and get ourselves some useful publicity.

The low level entry has the potential to foster recruitment, but only of those who have heard of amateur radio elsewhere. We still need to find ways to attract the interest of those who do not know about us.

There are three groups of people we should be targeting.

1. Young folk; they are heavily involved with computers and could be approached through this addiction;
2. Those nearing retirement; it is an ideal hobby for retirement, and can add much to the years of persons of limited mobility;
3. Women (my favourite hobbyhorse); we have neglected half the population for too long.

We need clever advertising directed towards these groups, and we need to increase our normal general advertising. There is a place here for every member-go out this week and talk about amateur radio to at least five non-amateurs. Follow up with anyone who shows some interest. Invite them to your shack, lend them a copy of the magazine, take them on a foxhunt, but do something to get a new person interested. If each current member introduced one new candidate, very many of our long term worries would be over.

There is no point worrying about making changes to the structure of the WIA or the future of the magazine or changes to the examination systems if we do not have enough new recruits coming in to maintain the hobby, let alone the WIA.

ar

The P & SWR meter *continued...*

Apply equal input voltages, say 5 Vdc. Set the SWR meter with R12 to maximum deflection, ie. SWR = infinite. By varying the inputs with equal voltages the indication should remain constant. Unless the input voltage drops very low and the LED should light up.

Post Scriptum

The P&SWR-meter does well under working conditions. At any instant the radiated power and the SWR can be read on the meters. Off course nothing can be done while in a QSO. On the other hand you can look for a portion of the band where the SWR is lowest, off course once you know that no further

news. It is more important that you keep an eye on the meters and if something goes astray immediate action can be taken.

I've also had some thoughts to do the whole thing digitally, however a fair amount of complexity would be involved, but for the moment this setup is probably more suitable for the general amateur.

The described P&SWR meter works well from 1.6 to 60 MHz. I am now working on and testing another version with a working range from 1.6 to 440 MHz. The construction of this is a lot more difficult off course.

Finally I would like to thank Bob,

ON9CVD (ex PA3FLU) for the interesting discussions we had and for his valuable comments regarding this article.

NB, When you look closely at the Power meter it can be seen that the meter is not linear. It was donated to me by Bernhard PA0ES. It looked OK but it is not linear, and probably belongs to the moving iron type family). However a proper moving coil meter will do the job. Kees, PA0CJH

**This article first appeared in the magazine "Electron" March 2001. "Electron" is the Dutch equivalent of "Amateur Radio" in Australia. It was written by Kees Heuvelman PA0CJH and translated by Bill Beyer VK3BHW*

ar

The Miracle Whip

Small QRP HF rigs have been appearing and have now been joined by the FT817 which gives 160 metre to 70 centimetres in a single small package. The need for a small antenna system covering as many bands as possible has produced a number of solutions. In July 2001 QST Robert Victor VA2ERY described a whip and loading/matching arrangement which could be used from 80 metres through 70 centimetres. He called this the miracle whip. A commercial version has appeared and you can see it on the web at "miracleantenna.com".

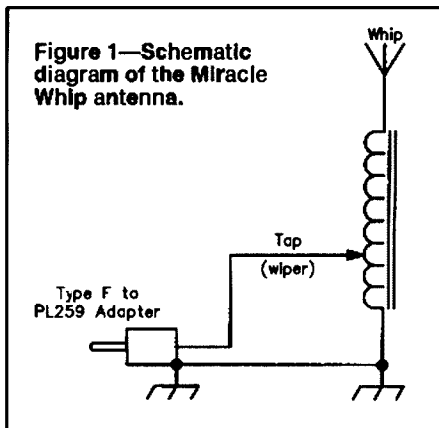

Figure 1. Miracle Whip Antenna Schematic

The antenna uses a 48 inch long telescoping whip. This can be adjusted for quarter wave resonance on the higher bands. The whip could be one sold as a replacement part or you might find one on a variety of items which have passed their useful life.

The whip mounts on a small plastic box which houses an adjustable toroidal inductor and provides a mounting for a male PL259 plug which can be plugged into the radio. The toroidal inductor acts as combined loading and matching components to resonate the whip with base loading and match it to the radio. The circuit is shown in Fig 1.

To adjust the toroidal inductor the shaft and wiper mechanism from a power rheostat are used. The resistance element which is wound on a ceramic toroid is removed and is replaced with the toroidal inductor wound on a ferrite core. The ferrite core is a Palomar F82-61. The ferrite core with the winding is glued to some insulating perforated board as a mounting. See Fig 2 and Fig 3. The toroid is wound with 60 turns of #26 enamelled copper wire. The top outer edge of the winding is sanded to remove the enamel and enable the wiper to make contact. The wiper assembly is

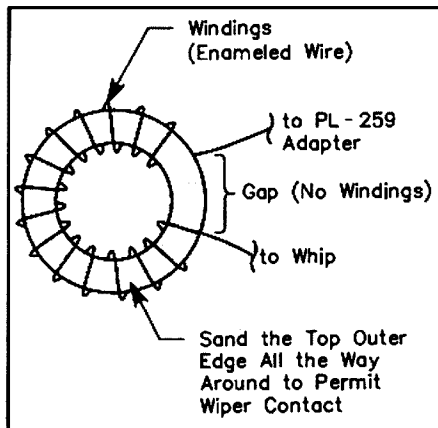

Figure 2. Winding on Ferrite Core. Use 60 turns #26 enamelled copper wire on a Palomar F82-61 ferrite core. Sand enamel on top outer edge to allow contact with wiper contact

modified so as to contact one turn at a time. See Fig 4.

The output connector is a panel mounted PL259 male plug. It is hard to find and a PL259 male to female F connector has been used. The F connector female socket is threaded and this is used with a suitable nut to hold the adaptor to the panel providing a PL259 male output. The connection to the inner of the type F connector can be by using the inner conductor of a scrap of RG59 style TV coax inner conductor. This just pushes in and is the normal pin in a type F connector. The PL259 to type F adaptor was obtained from RadioShack which is Tandy in Australia. The part number is 278-258. You may find this works in your local Tandy shop.

In operation the adjustment of the whip length and the tapping point provide a match to the radio. Adjust the tapping point to find a noise peak and then fine tune the whip length. After peaking on receive use the rigs inbuilt SWR meter to get the best adjustment. Robert VA2ERY was able to approach 1:1 on 20,15, and 10 and obtained close to

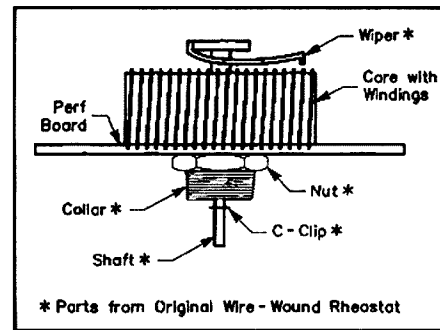

Figure 3. Modified Rheostat Assembly. Wiper and brush make contact with core winding

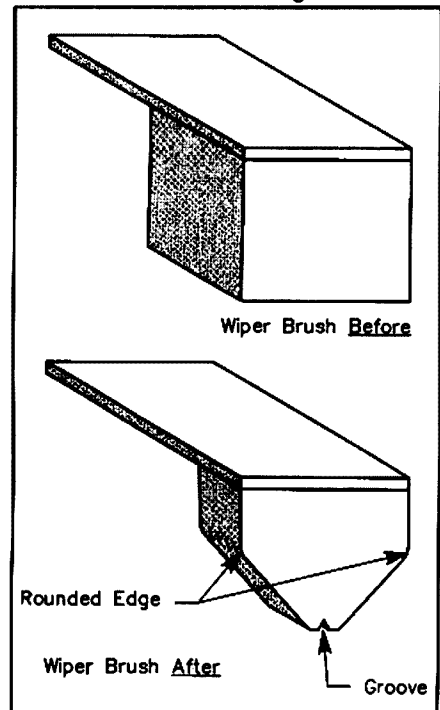

Fig 4. Wiper Modification. Wiper Brush modified by filing so as to only make contact with one turn of toroid winding at a time.

2:1 on 80 and 40. On the VHF/UHF bands the inductor shunts the feed by setting at the top turn and the antenna length adjustment peaks the antenna. The inductor has virtually no effect on the VHF/UHF bands.

Antenna Tuning Unit

A simple antenna tuning unit based on the original design of Doug DeMaw W1FB appeared in Break In Nov/Dec 2001. It was designed by Kelvin Barnsdale ZL3KB and had previously been published in HamLarks.

The design is the SPC Transmatch. The circuit is shown in Fig 5. Capacitor C1 is 200 to 300 pF maximum and C2A and C2B are ganged capacitors of similar capacity each gang. Receiving type capacitors may be OK up toward the 100 watt level. However wider spaced capacitors would be preferable.

The coil L1 consists of 24 turns of 18 gauge wire 45mm long on a 38mm form. Plastic pipe can be used for the former. Tappings are at 12 turns for 80mx, 18 turns for 40 mx, and the full coil of 24 turns for 20 mx. Coil L2 is 5 turns of 14 gauge wire 20mm long on a 20 mm diameter and is mounted at right angles to L1 on the back of the selector switch. The taps on L2 are 2 turns on 15 mx, and 3 turns on 10 mx with a full winding of 5 turns.

The capacitors are insulated from ground and so the shafts must also be insulated from ground and the operator. Slow motion drives are nice but not essential.

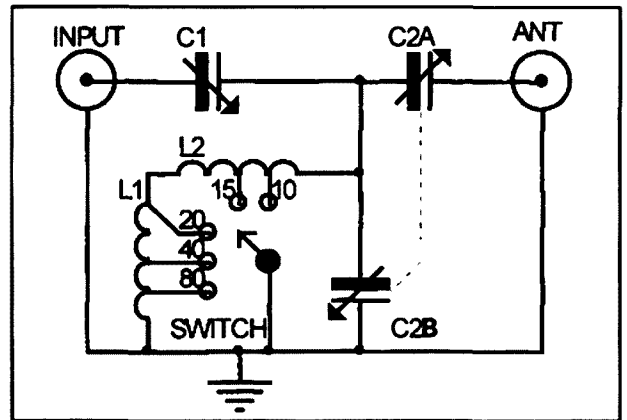

Fig 5. Antenna Tuning Unit.

VFO Temperature Stabilisation

A means of stabilising a VFO by keeping it at a constant temperature appeared in Rad Com November 2001. The idea came from R G Dancy G3JRD who used a simple controller circuit and heating pad to keep an FT101 VFO at around 26 degrees C. This was sufficient to improve stability particularly when the shack temperature was somewhat lower. This may not be needed or be a viable option in some parts of Australia.

The heater pad was made by setting 10 500 ohm 5W ceramic resistors in a bed of car exhaust repair paste. This baked hard after a short time giving a heating pad which was about 3 in x 4 in x 3/8th in thick. This was sat upon an aluminium tray raised just above the bench beneath the bottom of the FT101 transceiver. There was a gap between the top of the pad and the bottom of the transceiver.

inside the case with the sensor adjacent to the VFO and the readout outside the case. The temperature setting control was then adjusted so as to maintain a constant 26 degrees or thereabouts.

The parts are not critical and could be adapted to suit what is available. G3JRD leaves the heater on all the time and so minimises warm up drift.

ar

The paralld resistors in the pad with a combined resistance of 50 ohms were connected to the controller shown in Fig 6. The Negative Temperature Coefficient Thermistor was fastened inside the transceiver just below the VFO and above the heating pad which is beneath the transceiver case. A remote reading temperature indicator was used to monitor the temperature

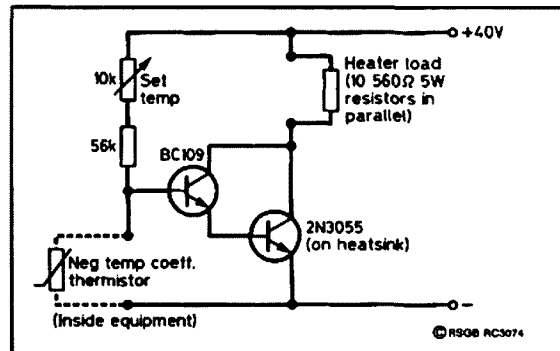

Fig 6 Temperature Controller Circuit Diagram.

For All Your Requirements

AUTHORISED DEALER

ICOM

KENWOOD

AMATEUR COMMERCIAL

VISION IMAGE COMMUNICATIONS

Tower Communications

14 Mary Street
Hazelmere
Western Australia 6055
Telephone: (08) 9274 1118
Facsimile: (08) 9250 3734
E-mail: tower@con.net.au
www: http://www.tower.visionimage.com.au

News from the Moorabbin & District Radio Club

Peter Parker VK3YE, Publicity Officer
Moorabbin & District Radio Club
parkerp@alphalink.com.au (03) 9569 6751

AMSAT Meeting a success

February's talk by AMSAT North America chief Robin Haighton, VE3FRH was a huge success attended by nearly ninety amateurs from all over Victoria and interstate.

Officially welcomed by VK3 WIA President Jim Linton VK3PC, Robin spoke for more than an hour on the Phase3D/AO40 project, in addition to future AMSAT projects now in the planning stages.

Thanks to the technical contributions of a number of club members, overhead video projection and good quality audio was provided, to ensure that we all saw and heard every detail of Robin's excellent talk.

David VK3JDA was also on hand

recording everything for ATV which will doubtless be seen fairly soon.

Audio was also being recorded by Andrew Rennie from 88.3, Southern FM, and will be featured in Andrew's popular Space in the near future.

Robin had also brought with him a number of T-shirts featuring AMSAT logos which were auctioned to an eagerly bidding audience. The funds raised, (around \$150) are to be donated to the VK arm of the AMSAT organisation. As auctioneer Robin

proved to be of no mean talent, with the whole process adding to the enjoyment of all.

The MDRC catering was also equal to the task with refreshments provided after the talk. A most entertaining and instructive evening was the official verdict of all who attended, and we thank Robin again for fitting us into his busy schedule.

Thanks also to Jim Linton for his help, and to all our amateur friends for coming along to make the night a great success.

APC News now on 7MHz

To increase the reach of APC News, a 7 MHz service was added earlier this year.

The relay, performed by Graeme VK3GRL, has attracted callbacks from around south-eastern Australia. We expect it will be popular with VK3s on the move and interstate amateurs wishing to keep up to date with the latest via a midweek bulletin.

APC News goes to air 8pm each Wednesday and can be heard on the following frequencies:

1.843 MHz AM
3.565 MHz LSB

7.065 MHz LSB
29.640 MHz FM
53.575 MHz FM
146.550 MHz FM
438.750 MHz FM

Items for inclusion in APC News can be sent to keith@lcd.net.au or parkerp@alphalink.com.au. If you wish to contact the news team on the air, try calling on 146.550 MHz or 53.900 MHz VK3RMS repeater.

Radio on Rails this month

Yes, it's on again! Two metres and seventy centimetres will again be full of signals from tram and train mobile stations during this year's Radio on Rails Fun Day on Sunday April 14.

Radio on Rails encourages amateurs to operate from trains and trams around Melbourne. Participants get to experiment with VHF/UHF portable equipment and antennas and demonstrate amateur radio to the general public. Entrants also meet other contestants, thanks to the unique 'eyeball contact' rule. Sections exist for both radio amateurs and listeners.

The rules for *Radio on Rails* appear below. The only change this year is that contacts made via internet radio links are not valid for scoring purposes. However this rule may be reviewed next year with consideration given to making Radio on Rails a national event. Both home and train/tram mobile stations may enter. Participants are invited to meet for lunch afterwards at a city venue to be arranged on the day.

continued next page

AR in the papers

Amateur radio got its best publicity so far this year with articles appearing in The Age and its sister paper, the Sydney Morning Herald.

The 600 word article was titled *Ham On the Web*. Published in the February 12 edition of the two papers, it describes how radio amateurs are using Internet Radio Linking to extend communications worldwide.

The story features well-know IRLP identity and Moorabbin District Radio Club member Tony Langdon VK3JED. It describes the worldwide capabilities of

IRLP and how it compares with I-phone. Other amateur activities mentioned include the conversion of ex-CFA equipment and tram mobile satellite communications.

Overall, the article positively portrayed modern amateur radio and is a credit to both its writer Barry Park and Tony Langdon.

MDRC Radio on Rails Fun Day Rules

Object: To make amateur radio contacts from trains and trams around Melbourne.

Date: Sunday, April 14, 2002

Time: 9am-1pm

Bands: 433.000-440.000 and 145.225-148.000 MHz only

Mode: FM voice

Sections:

- A. Transmitting Mobile (in train or tram, also includes waiting at railway stations or tram stops)
- B. Transmitting Home (includes operators at home or in a car)
- C. Listening Mobile (in train or tram, also includes waiting at railway stations or tram stops)
- D. Listening Home (includes listeners at home or in a car)

Contacts: Train or tram mobile stations may work (or hear) any station for points. Home station entrants may work (or hear) train or tram mobile stations only for points.

Repeat contacts: Repeat contacts are valid for scoring purposes provided at least one hour has elapsed between them. In most cases, stations may be worked *once per hour per band*. The exception is for contacts via crossband 2m/70cm systems, such as the VK3RMN repeater, or satellites operating in full duplex. In these cases, repeat contacts are permitted, but stations may only work each other *once per hour, irrespective of band*.

Use of repeaters, satellites and internet radio linking: Contacts on repeaters

and satellites count for scoring purposes. Because IRLP and I-Phone links are not intended for contest traffic, contacts via internet radio links do not count for scoring purposes.

Exchange: Train or tram mobile stations give their nearest railway station, tram route number or tram stop location (if waiting). Home stations give their suburb. No serial numbers are required.

Eyeball contacts: Stations in Sections A and C may claim extra points for 'eyeball contacts'. An eyeball contact is defined as one where participants can shake hands with one another on a train, tram, railway station or tram stop.

Prearrangement of eyeball contacts before the contest start time is not allowed. However, eyeball contacts may be arranged during the contest period on two metres or seventy centimetres FM only. Unlike with radio contacts, entrants cannot claim extra points for repeat eyeball contacts with the same person. Amateurs or SWLs not active in the contest cannot be claimed as eyeball contacts.

Scoring: Score 1 point per station worked (or heard) on each band. Total score is the number of radio contacts made (or stations heard) on all bands plus the number of valid eyeball contacts made.

Logs: Logs should show time, frequency, callsign and exchanges

for each contact. Eyeball contacts should also be logged. Train or tram mobile entrants should staple their used Met ticket to their log. Where this is not practical (eg ticket remains current after the contest), a signed photocopy of the ticket will be accepted in lieu.

Logs should be posted to *Radio on Rails*, MDRC, PO Box 58, Highett, Vic, 3190. Logs should be received by 10 May, 2002.

Certificates: These will be awarded to the first three placegetters in each section. Other entrants will receive participation certificates.

Results: Results will be announced in the WIA's *Amateur Radio* magazine and on APC News.

MDRC Hamfest next month

A reminder that the MDRC's Hamfest will be on Saturday May 11, starting 10am. The venue will be the same as last year-the Brentwood Secondary College in Watsons Road, Glen Waverley (Melways 71 D7). Enter off Heath Street.

Lee Moyle VK3GK has offered himself as hamfest organiser. If you'd like to book a table, contact Lee on 9705 1051 (home), or 0429 810 101 (mobile). Tables will be allocated on a first come first served so be quick.

The MDRC Hamfest has become Melbourne's most popular hamfest. Over 400 people attended last year. Don't miss it!

Adelaide Hills Amateur Radio Society

It was the AGM for AHARS in February. It was as well attended as usual. The executive, Geoff Taylor as President, Lloyd Butler, Alby Woods as Secretary and Bryan Trott as Treasurer is unchanged with Geoff Bridgeland, John Elliott and Jim Tregellis as committee members.

Following the AGM Steve VK5AIM took the floor and both entertained and informed members about rotators, their similarities and their differences.

Starting with the simplest, "Armstrong" rotator, graduating via one turned by a rope through the wall and finishing up with the best and strongest designs capable of controlling the biggest beams, Steve discussed them all.

He drew some circuits suitable for use for indicator systems and he highly recommended that a plug and socket be used in the cable from the antenna to the shack. There can be nothing so daunting as the sight of two cable ends,

each with five or six or maybe eight different coloured wires to be connected correctly. If you use a plug and socket you only have to know once which wire does what at the top and at the bottom.

Have you bought an antenna system and been told when you asked about the cable, have you been told

"Oh we just cut it off where it went through the wall". Steve has. Not very helpful.

An interesting lecture.

Bass Amateur Radio IRLP Group News

Graham VK3JBO

Like all beginners who first hear the IRLP in action it blew us away. Neil VK3TNB, Mark VK3UAE and I made further enquiries and eventually, with the help of Tony VK3JED, on Monday 27 August 2001 at the QTH of VK3JBO, Rosebud, Victoria, the Bass Amateur Radio IRLP Group was formed

Neil had purchased the IRLP board, radio, computer, router, aerials and the ADSL line. After a couple of days everything was fitted and attached and the tests began. I received a signal at my QTH (VK3JBO). The frequency was 146.475 MHz, simplex on the 2 metre band.

We approached the ACA and WIA and approval was given to use the Node on 2 metres, for identification, the node was to use Neil's call sign, VK3TNB. Contacts began around Australia and overseas. Congratulations flooded in from other nodes, operators and fellow hams. Reports on the signal were excellent.

After three months I received the phone call we were waiting for, from the WIA Vic, giving permission to use the Arthur's Seat Repeater on 70cm 439.725 MHz with negative offset. Neil and I climbed a ladder to change the antenna, then back we went inside the house to change the frequencies. Neil pressed the

mike button and announced, "This is VK3TNB testing IRLP node 633 via VK3RPU Arthur's Seat on the Mornington Peninsula Victoria...". The test signal was received perfectly and we became the first IRLP in Melbourne on the air in the 70 cm band.

Yes there were problems. First the provider line, then after six weeks on 70cm the repeater, started to break down and finally died. Guess it couldn't handle the heat! I ask all members to be patient when using the IRLP and remember to leave a 4-5 second pause between transmissions or breaks.

We cannot go any further without saying thanks to Tony VK3JED for his assistance.. Also to Neil VK3TNB for his generosity to the group. Thanks to the ACA and WIA Vic for their prompt responses, assistance and courtesy. WIA Vic has openly stated that they are very supportive of IRLP activities and experiments

Novice Operators

Good news from the ACA. Novices (limited, no Morse) can use the IRLP even though the signal may be out of band in another country due to the mode/method used. The signal may even be retransmitted on the 1.2 GHz etc. Once the signal leaves VK jurisdiction it becomes the responsibility of the country the signal is received in. Out of band use still applies under VK jurisdiction.

Members are requested not to use the reflector nodes when normal node connections can be used. (This applies to our node only). When we use the reflectors regularly we prevent other amateurs using the repeater for its intended mobile use.

Importantly, if you use a node, downlink it when you are finished. The authorities have stated strongly that the IRLP must be monitored at all times when connected.

ar

Silent Key

Gordon William Lanyon VK2AGL, 1920 to 2002.

Hams who tune the lower end of the 40 metre Band will have noticed the absence lately of one of its most active occupants VK2A6L. It seemed that at almost any time of day Gordon would be around ready for a ragchew or to offer help if there was some difficulty in establishing a QSO. There was no need to wait for his Callsign, as his 'fist' was enough.

I first met Gordon January 1940 when as R.A.A.F. recruits we started on Nr. 19 Wireless Telegraphist course at 1 School of Technical Training. Our Barracks were a condemned old building in Latrobe Street Melbourne. We slept on straw-filled palliasses on the bare wooden floor. I shared with him the nine month course the latter half of which was done at the more salubrious Point Cook Signals School. On graduation we were posted to 11 Squadron Port Moresby travelling there on the S.S. Macdui later

to be bombed and wrecked in the harbour. Gordon was first put on to Aeradio VZPY watches before becoming W/T Operator on one of the four C Class Flying Boats that had been taken over from Qantas. His aircraft became heavily involved in evacuating personnel from Samari Rabaul and other outposts.

In 1942 Gordon became WIT operator in the crew of Air Vice Marshall Jones. He held that exalted post until his discharge in December 1944 after five years service and 1746 flying hours. He rose to the rank of Flying Officer.

He then joined Qantas Empire Airways as a Radio Officer being put on to the Perth/Colombo flights. These became known as the "Double Sunrise" trips as they started before sunrise and finished the morning of the next day. Average flight time was 28 hours. There was a second leg to Karachi, another 14

hours of night flying. Aircraft used were Catalinas and Liberators. Gordon returned to routine flying with QEA late 1945.

In February 1958 he crewed in the Royal Flight of Queen Elizabeth which "lost" an engine between Cocos and Mauritius. His comment later "Radio was busy"

The RO became redundant in 1960 and Gordon became Navigator and flew as such until retiring in 1974. He returned in 1976 to fly for Papua New Guinea Airline as RO/Navigator for one more year managing a little Amateur Aeronautical Mobile with his recently acquired Callsign at the same time .I remember working him this way. In his career Gordon flew over 21,000 hours. As a Radio Amateur his loss will be greatly felt.

Cul Gordon tks. VK2BKH.

GOTA: Guides On The Air

We all know about JOTA, Jamboree of the Air. Many of us assist scouts and guides to participate but few of us have heard of GOTA until now.

Many guides do share in the fun of JOTA but in this country not many have previously used radios for GOTA. The activity is linked to Guides Thinking Day, in which VK guides do share, which is held each year in February.

After the events of September 11th the important role amateur radio can play has been recognised everywhere, but particularly in the USA and Canada, so much closer to those events.

ALARA was introduced to GOTA through an item in our January Newsletter. I was also sent an email by Norma VK2YL (ALARA'S first President), alerting me to the fact that she was organising a station at her mother's QTH (Bobbie VK2PXS) for the occasion, so I could tell the VK5s to listen for the station.

Through Faith VK5HFC who is the Guide Co-ordinator for radio activities, I did just that BUT there was a massive storm (one of a number this year) in VK2 that week. The storm completely demolished Bobbie's antenna but

fortunately did not damage her house. However, this meant that Norma was unable to participate.

I do hope some people did manage to run stations for their local guides and I hope you managed to have some contacts

However, whatever happened this year, I suggest you make a special effort to set up a station for some guides. It is great to show boys and girls what amateur radio is all about but it is even better if it is a YL station that they are using when it is a guide activity.

Think about it for next year!!

Instant power for mobile phones or laptops

There was a small article in the March 2nd issue of "New Scientist" that struck a chord. Someone has developed a thing (no, it is not yet on the market) that acts rather like the Traeger Pedal radios. There is a foot pedal about the size of a paperback which you pedal for five

minutes to give you enough stored power to run your laptop for about 20 minutes, or your mobile phone for much longer.

What a brilliant idea for those times when you find yourself with a "dead" electronic device and with no

convenient power point (or when you have left the charger at home).

It will apparently be called a Stepcharger and is said to cost \$150 (may be US dollars). Watch for it at your local electronic store.

Have you booked your accommodation yet?

Have you booked accommodation for the ALARAMEET 2002 in Murray Bridge? Have you notified Jean VK5TSX which activities you would like to share? She would like to have the Notice of Interest forms in as soon as you make up your mind. She will let us know when she needs your deposits in the next Newsletter.

It will be a fun weekend. There is very little formal business but a lot of informal talking. Registration is on the Saturday morning 5th October at the Community Centre/Boat Shed in the main street, but there will be an informal meal together on the Friday night for early arrivals.

A paddle steamer trip is organised for the Saturday afternoon with a fully catered dinner that night at the Racecourse. We will tour the Monarto Zoo in a bus, with a guide to tell us all about the animals and the open range zoo there.

A visit to Old Tailem Town has been arranged for Sunday afternoon with dinner at (Crocodile) Dundee's (there has

been a name change back to just Dundee's but the whole name is more interesting) that evening.

For those still there on the Monday a whole day bus tour has been arranged that will include a winery, a trip on a steam train (we hope) and/or a ride on the horse tram over to Granite Island at Victor Harbour. We finish up that evening at Mount Lofty looking out over the city of Adelaide.

A smaller tour has been arranged for the Tuesday, to a bush block where hopefully there will be wild kangaroos, and certainly some colourful parrots on show.

Do join us. While many of the YLs there are amateurs there will be others who are not. While most of the OMs will be amateurs there will be some who are not. Whatever your interest outside amateur radio there will be someone there that weekend who shares your interest. Do come. Do plan your holidays to include that weekend in Murray Bridge, or just come for the time itself.

Mini DXpeditions

There will be a mini YL dxpediton to Lord Howe Island VK9, in Mid September—just before the ALARAMEET. This will cover the Spring Equinox in the Southern Hemisphere so the bands should be good. Then some of those YLs will go to another Pacific Island (the name of which is secret, just now) for a further 2 weeks.

If you can't participate (or even if you can) in the ALARAMEET listen out for the VK9 stations and make some rare DX.

Palermo International YL Meet

Several VK5 girls are going to this meet. Some will be joining the tour before the meet, or the follow-on tour. It sounds most exciting and colourful. Those of us who cannot go will be with the participants in spirit and we look forward to hearing all about it.

Our very best wishes will be with everyone in Palermo towards the end of June.

Spotlight on SWLing

by Robin Laird Harwood VK7RH

49 metre surprises!

The first quarter of the year has already slipped by and personally I find that I am having less time to actually listen, since I moved into this retirement village. I do have a very temporary antenna but the performance is best after nightfall. I am still hoping for an outside aerial to improve my monitoring activities. Interestingly, it is the 49 metre allocation that is providing some surprises. Not only am I hearing the usual powerhouse signals, but also smaller regional stations. This allocation is very crowded, particularly at night with heterodynes on top of signals. The modulation on these signals can sometimes be detected using either the upper or lower sideband in conjunction with your notch filter.

For example, there is a low powered Indonesian floating around 6153 kHz hemmed in between signals on either side. It is actually located in Biak in West Papua (formerly Irian Jaya). The signal is often undermodulated and perhaps may not be carrying any programming at times, although the carrier remains on. Singapore is on 6150. Many of these regionals seemingly vary their frequencies; especially the Vietnamese further up within the marine allocation. The latter always seem to be on a different channel from day to day.

I believe that China has recently upgraded their transmitting facilities in Tibet, which they refer to as Xijang. They have been well heard on a number of HF channels including 6200 at around 1200, when they relay the Tibetan minorities program from Beijing. One monitor reports they have an English I/D. They are also have been monitored on 6130 kHz, which has also been a long time channel of Laos. I would presume that Tibet would be more stable than Laos, which is, from memory, not exactly on channel.

Kol Israel is continuing to broadcast in English on shortwave. I am currently hearing them very well on 17535 at 0500 but they go to Summer time early this

month so they will now be on at 0400 until mid- September. I do note however the French broadcast, which automatically followed, has been dropped, so perhaps some changes were made to shortwave programming.

Broadcasts to Afghanistan continue to increase with Radio Free Afghanistan commencing operations late in January. It is part of the Radio Liberty/ RFE stable and is broadcasting from Prague in the Czech Republic. This station has been using the old Parliament building, right in the heart of Prague, and the nervous Czechs do wish to relocate it elsewhere, after September 11th. The Station and their American backers want to stay put for now.

Also the Russians became extremely nervous when this station decided to commence broadcasts to Chechnya in the local language. Moscow threatened to cancel their licenses to air their programs domestically throughout the Russian Federation. One day before the Chechen programs were to commence, the organization decided to postpone the release, after consultation with the US State Department.

The 8700 USB signal is continuing but with more music than previously. Not

only are there many international stations now in Dari and Pushto, but an independent media has emerged within the country, so I expect that this SSB station could disappear at a moments notice. At present, I am hearing the VOA in Farsi or Dari on 17855 at 0230 UTC but it is unclear where it is coming from.

Recently the French started hiring out their senders, in a similar arrangement to their British and German colleagues. Libya has been heard via France now for some time and now it appears that Iran may also have started broadcasting via France. Also in an odd twist, Radio France International and Radio Taipei International recently signed an agreement to exchange airtime.

RFI currently broadcasts via Chinese transmitters to SE Asia and at deadline time, I have not heard of any reaction from Beijing to this agreement with Taiwan.

Don't forget you can email me at vk7rh@wia.org.au but please no attachments unless by prior arrangement. One SWL unwittingly sent me a virus, which was fortunately detected by my antivirus software.

Until next month, the very best of monitoring-VK7RH

Moorabbin and District Radio Club VK3APC

ENTRY ONLY
\$6.00!

HAMFEST 2002

Saturday 11 May 2002

MDRC have much pleasure in inviting you to participate in our ANNUAL HAMFEST to be held between 10.00am and 2.00pm on Saturday 11 May 2002. Snacks and hot food will be available. Talk in via VK3RML 2M repeater on 146.700 MHz and on 146.550 MHz simplex.

Enquiries: Graeme Lewis, VK3GRL. Tel AH: (03) 9702 1199

All inside and
undercover

Demonstrations of ATV
and packet radio

Sales:
new

Sales:
used

BRENTWOOD
SECONDARY COLLEGE

Watsons Road, Glen Waverley.
Melways Reference 71 D7
Enter via Heath Street

VK1 Notes

Forward Bias

Two members answered my call for a position on the Divisional Committee. Confrere Russell Manning (VK1JRM) had not been an office bearer before, but John Woolner (VK1ET) had previously been secretary to the Division. Mrs. Linden Orr (VK1LSO), who had stood in for Ernest Hocking (treasurer) when he resigned last year, also nominated again. We now have a full complement of seven members on the committee. The line up is as follows: President, Gilbert Hughes (VK1GH); Vice-President Phil Longworth (VK1ZPL); Vice-President Alan Hawes (VK1WX); Treasurer, Linden Orr (VK1LSO), Secretary, Peter Kloppenburg (VK1CPK); Committee Members, Russell Manning (VK1JRM), John Woolner (VK1ET), Richard Elliott (VK1KRE).

The position of chairman of the ACT Technical Advisory Committee (ATAC) is filled by Michael Dower (VK1ENG), who continues from last year. The QSL bureau is managed by Waldis Jirgins (VK1WJ) and Ray Reinholz (VK1PRG), outwards and inwards respectively.

As announced previously, a BBQ was held in the compound in front of the Farrer hamshack one and a half hour before the start of the AGM. This event was well attended, probably because it provided an opportunity to twiddle the knobs on the transceiver installed in the shack. Those who remained outside were overwhelmed by the sound of European DX that was coming through

Peter Kloppenburg VK1CPK

at that time of the day. German, French, and Norwegian voices calling CQ wafted through the compound, while Waldis was busy inside answering the calls on behalf of VK1WI. Surprisingly, the Hy-Gain 18-AVT vertical, on the roof, was the antenna in use and gave excellent service.

There will be another BBQ held during the Trash & Treasure sale on Sunday, April 21, 2002. Naturally, in the compound.

The next General Meeting will be held on Monday, April 22, 2002 at 7.30 for 8.00 pm in the Scout Hall, Longerenong St. Farrer. Cheers

VK3 Notes

By Jim Linton VK3PC

WIA Victoria web site: www.wiavic.org.au
email: wiavic@wiavic.org.au

AGM reminder

Members will receive a formal notice of the WIA Victoria Annual General Meeting that is to be held on Wednesday, 29 May.

There will be the traditional insert in Amateur Radio magazine that includes annual reports. Members who do not subscribe to the magazine will receive an individual mail out.

Trial Saturday opening of the office

To measure member interest in having weekend access to the WIA Victoria Office in Ashburton, a trial opening on Saturday's between 10am and midday is now underway.

During this trial, rostered Councillors will be available each Saturday to answer member and non-member enquires and discuss policies and services over a cup of tea or coffee.

On sale will be the 2002 Australian

Callbook, licence study books, logbooks, used equipment and test gear. Members who are registered with the QSL Bureau can also drop off their outwards QSL cards.

The trial opening will continue until the AGM in May, unless it is found that the patronage is below justifiable levels. Normal Tuesday opening will continue. The telephone number of the office is 9885 9261.

2002 Callbook and CD ROM

The 2002 printed Australian Radio Amateur Callbooks are available from WIA Victoria office. Member Price \$12.50, Non Member Price \$15.00.

Mass production of the CD ROM containing both the callsign listings and the reference material and information, has been delayed. At the time of writing these VK3 Notes, their availability and price details were not known.

A proto-type of the fully searchable credit card-sized CD was briefly on sale at the Wyong Field Day in February. It is understood at the time of writing these VK3 Notes, that the CD is being refined before its release for sale.

WIA Victoria Website

Monthly visits to our web site www.wiavic.org.au are now more than double those of the same period last year, indicating the increasing popularity of the site both among VK and overseas radio amateurs.

WIA Victoria members who register to access the member's section of the site also receive the additional benefit of being included on the email list to receive all the latest news about our hobby, as it happens.

If you have access to email and the Internet, and are not registered, this can be easily done online via the website.

Thanks to Gary Furr, VK3KKJ who, although resigning from his position as

VK3 Divisional Councillor is to continue the enormous behind the scenes work to maintain and upgrade the website.

Nominations for Federal Coordinator roles

The WIA Victoria Council confirmed its support for the following members and these nominations have now been advised to the Federal Secretary for election by the Federal Council at the Federal Convention, to be held next month.

ARDF Coordinator

Jack Braham, VK3WWW

Federal Contest Coordinator

Ian Godsil, VK3VP

Federal Education Coordinator

Brenda Edmonds, VK3KT

Federal WICEN Coordinator

John Weir, VK3ZRV

International Travel Host

John Miller VK3DJM

QSL Collection Curator

Ken Matchett, VK3TL

WIA Exam Service

Following a review of the WIA Exam Service, it was necessary to invite fresh applications from the clubs wishing to

provide examinations and the individual exam invigilators.

Letters of appointment have been sent to the exam team leaders and exam invigilators. A list of them will appear on the WIA Victoria website. If you are looking for an examination centre, or know someone who is, then check the website or telephone the WIA Victoria Office on 9885 9261.

We thank the clubs throughout Victoria who have undertaken to be part of the new exam service and provide examinations under the new rules.

VK4 Notes

Qnews

Townsville Tech Library grows

The TARC Technical Library has grown a bit, thanks to a generous donation from the estate of Gary Hinspeter of a large number of racked and indexed back issues of Electronics Australia, Amateur Radio Action and Silicon Chip.

Gary was a volunteer with 4TTT-FM and although not a Ham, had a fascination with technical things. The TARCinc will be sorting this very valuable donation and integrating it with the existing technical library to make a mighty resource for the region.

2.4 GHz Data

Well a lot of background work has been going by Ian VK4kJ, Keith VK4AKA and Len VK4ALF to get a reliable link running using the 2.4 GHz wlan technology. Last weekend they installed the Sunshine Coast node at their repeater site at Maleny with mixed test reports.

Further testing was done fine tuning modified cards resulting in VK4AKA making the 10 km mark, followed by VK4ALF making 39.3 km. Moving the dish a bit from the GPS positioning mark saw 5.5 Mb show up.

Gold Coast Repeater

Ken VK4KD is persevering with QNEWS broadcasts on the coast despite continued repeater problems. Most callbacks are originating on the 148.500

MHz simplex channel, such is the lack of coverage since the Gold Coast were forced into relocating from Springbrook. Thanks Ken and despite nowhere near the old 60 plus checkins, 20 in on a recent weekend simplex, is excellent.

Repeaters elsewhere

Geoff Nelson VK4ZGF in Maryborough reports 31 during a recent check in for the Qnews. Congratulations to all, a new "all time high" in the Hervey Bay, Maryborough area. Then Cairns 2 metre also a record high of 6 thanks to another Jeff, VK4MTV.

Precision 10m Beacon under test

A new beacon transmitter for the VK4RTL 10 metre Beacon is currently under test at the QTH of Don VK4MC. Don has adapted parts of a telecommunications exciter to make the 28.270MHz CW Transmitter, which includes a precision oven stabilised, crystal, harmonic filtering and a very clean and precise 5 watt output. Reception reports required, forward to the TARCinc email address

vk4wit @ wia.org.au or sp packet to tarc @ vk4rat.#nq.qld.aus.oc or call them in on a QNEWS callback or NQNET callback.

By Alistair Elrick VK4MV

Amateur Radio Hour with VK4AA report

Yes, we got Chris VK4AA / VK3CE to go on-air in Townsville, even though he had to fly up via Cut-throat Airlines, nursing a jaw which had undergone extensive dental work, plus he was very anaemic after being attacked by killer Vampire Mozzies on top of Mount Stuart (the ones that guard the VK4RAT repeater).

Alan VK4PS introduced him, Gavin VK4ZZ got gazzumped by him (pun intended), but it was all meant to be. Chris was able to tell the listeners to the 4TTT-FM Community Access Radio Program-the Amateur Radio Hour, that as of February 27 it was only two weeks to go until the next (overdue) issue of RadioMag appeared. Chris also provided an enthusiastic commentary (prompted by Alan) of things currently happening in the world of Amateur Radio and also gazed into the tooth encrusted crystal ball and told all listening some of the things that might pop up in the hobby in the near future. Be sure to read RadioMag's editorial next issue, it will be certainly interesting and there just might be a photo or two of the killer Vampire Mozzies!

Switched OFF doesn't necessarily mean switched RIGHT OFF!

"Get an in-line AC ammeter and you will be amazed to find out how much power many new gadgets consume when switched 'off'".

This topic applies not only to satellite users but also to all computer users. But since the overwhelming majority of satellite users will be regular computer users it will apply to readers of this column. The subject was brought to my attention by a submission to the AMSAT bulletin board recently. Wayne Estes W9AE was replying to a thread concerning RF feedback around the shack. His response was interesting enough and wide-reaching enough to be worthy of reprinting here.

Over to Wayne. "Get an in-line AC ammeter and you will be amazed to find out how much power many new gadgets consume when switched 'off'. For example, my Harman Kardon active speakers draw 5 watts when switched off (my retired Sony active speakers draw 20 watts when switched off!). My Dell Pentium-4 computer draws 5 watts when switched off. My NEC LCD monitor draws 5 watts in standby, only dropping to 4 watts when I turn off the front panel power switch. All this stuff is connected to a power strip that I switch off after shutting down the

computer. A few watts times 20+ hours per day (when you're not actually using the stuff) adds up to a LOT of wasted energy. The 'Energy Star' rating is totally bogus in my opinion. Infrequently used 'Energy Star' stuff often consumes far more energy in standby than it does in actual use".

Wayne goes on to sum up. "All my ham radio equipment really is off when switched off. But I haven't yet measured the off current drain of my new G-5500B rotor. It doesn't have a microprocessor but that doesn't guarantee that it's really off when switched 'off'. The power switch in many gizmos is connected to the secondary of the power transformer. The transformer stays powered up (nice and warm) even when the gizmo is switched 'off'. Obviously, all 'plug pack' transformers consume power 24 hours per day. My computer power strip also switches off the plug pack transformers for my cellphone charger and Maha AA battery charger".

Wayne's remarks are timely for all of us. I have since taken to switching off things at the mains switch when leaving

the gear for any length of time. I found that easy to do since I live in an area prone to power spikes resulting from lightning and static discharge. My gear is normally powered through the kind of in-line switching board that Wayne was referring to above and this makes it easy to "hit-the-big-switch" in reality when closing down the station. I now routinely switch everything OFF when I'm not actually using it. The benefits of doing this are (at least) three-fold. Less likelihood of RF feedback from equipment that you think is inactive but is actually turned partly on. A worthwhile saving in your power bill and a reduced risk of fire from overheated apparatus, especially plug-pack power supplies. On this last point always be sure that the plug-packs you buy are completely compliant with current electrical regulations. They should have printed on them a compliance number about 10 digits long and beginning with V in Victoria, Q in Queensland etc. Thanks for your timely warning Wayne.

Another opportunity to test your 1296 MHz receiver sensitivity

You may recall that a couple of months ago during the Marconi-day celebrations a group of amateurs in Bologna, Italy secured some time on a large radio telescope and made EME transmissions. They used enough ERP to be heard in more modest "Oscar-class" station receivers, the idea being to enable users to assess their receive capability. Several years ago there were similar regular transmissions from a group in Algonquin, Canada. These tests have been fairly infrequent in recent years and always involve a lot of footwork by a few people each time. About 18 months ago a group in northern New Jersey, USA took it upon themselves to provide a continuous EME beacon service in the 23cm amateur radio band. This is very

useful for EME-ers and Oscar-class stations wishing to test their gear at very weak signal levels. They have an informative web site at: <http://www.setileague.org/eme/index.html> that is well worth a visit. As the site name suggests, they are associated with the SETI league project. I have yet to try out this beacon service but I'm led to believe that stations with dishes of the order of 3 metres are already hearing the signals. Australia has brief mutual windows with NJ but the Moon will be low to the horizon at both ends. The frequency used is 1296 MHz and the callsign of the station beacon is W2ETI. The station is no jury-rigged hash-up. It comprises highest quality frequency measuring and power measuring

equipment. So much so in fact, that during March this year the beacon service was used by technicians at the giant Aricebo radio telescope, the world's largest instrument of its kind to calibrate their receiver weak-signal threshold. During the tests the output was progressively wound back to "peanut-power" (Not a good time to test your Oscar station!). This is an outstanding example of how amateurs can take a meaningful part in state-of-the-art professional radio astronomy. Until recently the Aricebo team had used the transmissions from the Voyager spacecraft for this purpose. Voyager is now so far away that even this huge dish cannot receive the signals reliably.

The Ultimate DX Contact?

Don't try this at home! NASA recently announced that it had successfully bridged 7.4 billion miles of space to contact the Pioneer 10 spacecraft on the 30th anniversary of its launch. Scientists beamed a message to the craft from a radio telescope in the desert east of Los Angeles. A second radio telescope in Spain received the return response 22 hours and six minutes later. The return signal was reported to be "loud and

clear". NASA last heard from the craft in July. Pioneer 10's original, 21-month mission has improbably stretched three decades. The spacecraft was launched on March 2, 1972. It passed through the asteroid belt between the orbits of Mars and Jupiter and obtained close-up images of Jupiter. In 1983, it became the first manmade object to leave the solar system when it passed the orbit of distant Pluto.

Packet Radio returns to ISS

Amsat News Service announced recently that normal packet activity has resumed aboard the International Space Station. The ISS crew upgraded the old system with a new packet module that was sent into space on an earlier mission. The old system, crippled with a dead backup battery for RAM, had been operating in a digipeat mode using the NOCALL call sign and other ROM defaults. The new module, using the callsign RS0ISS, is using a specially developed ROM set with standard ISS defaults, a new battery and an extended memory. Although the mailbox function has been activated, ground stations are

discouraged from using it. Currently, there is no computer hooked up to the packet system; also, the crew will be much too busy to respond to individual messages posted there. Frequencies will remain the same: uplink on 145.990 MHz; downlink on 145.800 MHz. The installation and checkout of the packet module resulted from a team effort between the Russian team (led by Sergei Samburov, RV3DR) and the U.S. team. During the past month, the team developed a set of crew procedures that were reviewed and approved by specialists at both Energia and NASA.

Keps beware!

I had cause for concern a few weeks ago when I seemed to be the only one who was not able to turn on Tiungsat-1. All inquiries made came up with stunned looks and responses like, "It's working OK here". After checking just about everything I could think of, I turned to the keplerian elements. Voila! The keps had not been updated since January –

but why? Further investigation revealed that the keps for Tiungsat-1 were no longer included in the "amateur-radio" set from Celestrak. I haven't found out why yet but that was the answer. All the rest of the satellites were being updated but not Tiungsat-1. Eventually of course the satellite was half-a-world away when I was trying to turn it on Oh well.

The AMSAT group in Australia

The National Co-ordinator of AMSAT-VK is Graham Ratcliff VK5AGR. No formal application is necessary for membership and no membership fees apply. Graham maintains an e-mail mailing list for breaking news and such things as software releases. Members use the AMSAT-Australia HF net as a forum.

AMSAT-Australia HF net

The net meets formally on the second Sunday evening of the month. In winter (end of March until the end of October) the net meets on 3.685 MHz at 1000UTC with early check-ins at 0945UTC. In summer (end of October until end of March) the net meets on 7.068 MHz at 0900UTC with early check-ins at 0845UTC. All communication regarding AMSAT-Australia matters can be addressed to:

AMSAT-VK,
GPO Box 2141,
Adelaide, SA.5001.

Graham's e-mail address is:
vk5agr@amsat.org

New designations for old

It was recently announced that both PCsat and Starshine-3 had been allocated "Oscar-numbers". PCsat will henceforth be known as NO-44 (Navigational-Oscar-44) and Starshine-3 was allocated NO-45. Be careful to check for these new designations in keplerian element sets that you might download.

Notice for the WIA SA and NT Division members

The Division AGM is to be held on
28th May 2002 at 8 pm.

The venue is the St John's building Arthur St Unley.

Nominations are called for the following positions:

President, Secretary, Treasurer and councillors.

Nominations close on the 28th of April 2002.

Address for nominations:

The Secretary, WIA SA, GPO Box 1234, Adelaide SA 5001

Silent Keys

The WIA regrets to announce the recent passing of:-

R K Barrington VK2DOV

H D Schmidt VK5BVM

L S (Leith) Cotton VK5LG

How's DX?

Ross Christie, VK3WAC
19 Browns Road, Montrose 3765, Vic.
Email vk3wac@aoi.com

Spoilsport QRM

DXpeditions are a great opportunity to work a 'rare' country or location that, for a variety of reasons, is not normally easily worked by the amateur population. And while we can all admit that amateur radio has many facets, with radio as the common theme, most of us cannot understand the reasoning behind the deliberate interference to a DXpedition station by another amateur radio station.

Two major DXpeditions in March, PW0T and TI9M, were both plagued by deliberate interference which made QSOs much harder than they ought to have been for a large number of operators. The 'cut and thrust' of a DX pileup is tough enough without having to put up with malicious QRM from a station or operator on the frequency who has no other intention than to disrupt the activities of others. I monitored one of the TI9M stations for a while and, happily, am convinced that the QRM was not originating from VK, strong but not from VK. PW0T also suffered from QRM but on a different band and day. While this sort of behaviour is beyond the pale, unforgivable and difficult to prevent, surely there are stations on the frequency, somewhere, that are very near to the source of QRM who can identify the culprit!

It is not only the deliberate QRM to DX stations that raise the ire of the amateur radio community. There are

also those amateurs who refuse to abide by the various band plans causing QRM, knowingly or unknowingly, to other users. Band plans are 'gentleman's agreements' and are devised to minimise interference between the various modes and users of a band. To be effective they must be adhered to by all. Those who insist they have a 'right' to work wherever they like on a band, using whatever mode they like, are simply advocating anarchy, which will benefit no one in the long run. Those who ignore these 'gentleman's agreements' can only be described as un-social, insisting that their personal right is more important than orderly sharing of a limited resource. Kindergarten kids are encouraged to share when interacting with others, perhaps 'band plan breakers' should look inwardly and ask themselves if they are being fair. The hobby of amateur radio may well need members, but operators of these types we can all do without. (And by the way;

yes, I think my chance of working TI9M was compromised by a selfish amateur operator!)

Voice from space

An unexpected station popped up on 14296kHz a few evenings ago. The space shuttle was heard while an astronaut was performing an 'extra vehicular activity' (space walk to those of us who are not up to date with the NASA jargon). I didn't catch the callsign of the operator aboard the shuttle but could plainly hear him describing to stations in Europe what was happening on the excursion. Apparently the 'maneuvering arm' was in action at the same time lending some help to the EVA astronaut on this part of their mission. I knew that shuttle crews are often active on VHF during a mission, but I have never heard of HF operations. I wonder if they QSL (or can swing the beam round to my direction? Hey perhaps that's what that arm thingy is for!!)

The DX

7X, ALGERIA. Mirek, VK2DXI (aka VK3DXI, 9V1XE) has been transferred to Algeria. He has applied for, and been granted, an amateur licence after the Ministry of Communications conducted an inspection of his equipment. Mirek is now waiting for his licence documents to arrive so he can begin operating. He hopes to be able to work as many VK stations as possible, check out his website at <http://www.7x0.sp5zcc.waw.pl> for more information. QSL via DL4DBR. [TNX Mirek, VK2DXI]

7Z, SAUDI ARABIA. Joe, W5FJG, is on a working trip to Jeddah, Saudi Arabia and has been issued the callsign 7Z1AC. He expects to be there until at

least April this year and though work commitments will take priority he says he will operate as much as he can. QSL via WA4WTG. [TNX W5FJG and The daily DX]

9Q, ZAIRE. Pat, 9Q1A, says that he will be on air as much as possible, workload permitting. He will be looking out especially for VK and ZL stations daily on about 14280 kHz +/- QRM between 17:30 and 18:00 UTC. [TNX 9Q1A and 425 DX News]

D2, ANGOLA. Joao, CT1BFL, will be active from Angola as D2U for the next two years or so. He plans to operate on all bands 10-160 metres on CW and SSB. Joao mentions that due to QRN low band activity may be a little difficult but he

will try. QSL via CT1BFL. [TNX CT1BFL and The Daily DX]

EA8, CANARY ISLANDS. Cesare, I5WEA is currently active as EA8/I5WEA from Tenerife in the Canary Islands until the 10th of April. [TNX I5WEA and The Daily DX]

ET, ETHIOPIA. Paul, W4PFM, will be stationed here for the next six months and has just been issued the callsign ET3PMW by the Ministry of Communications. He has already been active on 10 and 15 metres during the past few weeks. Have a listen around 28438 kHz after 14:30Z and on the 21270 kHz net after about 07:00Z. QSL via W7KEU. [TNX W4PFM and OPDX]

TT, CHAD. Chris, TT8DX is heading

back to Chad on the 27th of February and will be there until December. He plans to concentrate on the low bands and 6 metres. QSL via F5OGL. [TNX The Daily DX]

VK9, LORD HOWE ISLAND. Jack, VK6CTL will be operating as VK9LT from Lord Howe Island (OC-004) from

IOTA Activity

DL, GERMANY. A group of German operators, DF3UFW, DL8DZL, DK5NOA, DL2DSL, DL2DRO, DL2LCE, DM4WL and DL1DWR will be active from Usedom Island (EU-129, O-13 for the German Islands Award) over the period of the 12th until the 20th of April. Two side operations will take place when on the 14th of April when three members of the team will take a trip to Grosse Wotig

Special Events

Mike Shortland, G0EFO, is a member of the **Titanic Wireless Commemorative Group**, and has sent along some information on a special event station that is being put on air to commemorate the 90th anniversary of the sinking of the RMV TITANIC. Mike says that the station will operate from 10:30 on Saturday the 13th of April until 05:47 on Monday the 15th of April (times in UTC). The activity is also to commemorate the heroism of Jack Phillips, the Chief Wireless Telegraphist of the Titanic. His SOS calls (in Morse code) saved more than 700 lives when the liner sank in the freezing waters of the North Atlantic 90 years ago to the day on April 15th at 05:47Z. Tragically, Jack (who was only 25 years old) lost his life on that fateful night, drowning along with many others. The special callsign GB90MGY (Titanic's callsign was MGY) will be operated by the members of the Titanic Wireless Commemorative Group (20 local hams and all members of the local Guildford and District Radio Society). The station will operate from Godalming, Surrey, UK, the birthplace of Jack Phillips, where his heroic deeds are still celebrated. Activity will take place on

DXpeditions

The planned DXpedition to Mellish Reef over the period of the 12th to the 22nd of April will operate five stations and will be active on all bands from 160–6 metres (including WARC) on SSB, CW and RTTY. One of the stations will be dedicated to 6 metres with a separate

the 11th until the 22nd of April. Activity will mostly be on SSB. QSL via HB9QR, Erwin Fink, Toedistr. 7, CH-8572 Berg, Switzerland. VK and ZL via VK6CTL. [TNX VK6CTL]

VP5, NORTH CAICOS. Rodger, GM3JOB and Willie, GM4ZNC will be operating from North Caicos (NA-002)

(GIA O-35, but not an IOTA entity) while the remainder of the group will travel to Wolgaster Schlossinsel (GIA O-031, again not an IOTA entity). QSL via bureau. [TNX DL2VFR and 425 DX News]

I, ITALY. Tony, IK8VRH reports that he will be on a working trip to the islands of Ventotene (EU-045, IIA LT-

all amateur bands, CW only, from 80-10 metres (including the WARC bands). QSLs via RSGB. More information (preferred operating frequencies, times etc) can be found at <http://www.gdrs.net/titanic> [TNX 425 DX News]

The special event callsign **IR0MA** will be active to celebrate the 2755th anniversary of the founding of Rome during the period of the 1st until the 30th of April. (Although its only been a couple of centuries, perhaps we should have a similar activity for the founding of Sydney or Melbourne? Just a thought!) QSL direct only to IOMWI. [TNX The Daily DX]

The unique callsign **GB50 (Golf Bravo Fifty)** has been issued by the UK Radiocommunications Agency for a special event station to be established at **Windsor Castle** in celebration of **Queen Elizabeth's 50th anniversary of her succession to the throne**. The special event station will be active over the period of the 29th of May until the 9th of June. The station will be organised and operated by members of the Cray Valley Radio Society (CVRS) in association

operator. The team will include G4EDG, JH7OHF, JJ1LIB, JP1TRJ, K3NA, VK4DH, VK4GL, VK4WR, VK4APG and ZL4PO. The group would like to acknowledge Yaesu, The Chiltern DX Club, 5 Star DXers Association, BT Exact Technologies and PCA.AA for providing

from the 10th until the 19th of April. They will be signing as VP5/GM3JOB and VP5/GM4ZNC on all bands 160-10 metres, both SSB and CW. QSL via the respective home calls either direct or via the bureau. [TNX GM4ZNC and 425 DX News]

011) and Ponza (EU-045, IIA LT-001) from the 4th until the 21st of March and the 3rd until the 19th of April. His first activity will have finished by the time you read this but his April trip should be timely. He plans to operate as much as he can as IB0/IK8VRH during his free time. QSL via home call. [TNX IK8VRH and 425 DX News]

with Burnham Beeches Radio Society (BBRC) and also with the support of the Radio Society of Great Britain (RSGB). Activity will take place on all bands from 80–6 metres on CW, SSB, PSK31 and RTTY. The organisers hope to make as many QSOs with radio amateurs around the world as possible with an emphasis on the British Commonwealth countries. The station will be operational from 07:00–22:00 UTC daily. Several stations will be on the air simultaneously, and all will be equipped for multi-band operation. A web site is currently up and running and will be kept updated with the latest news, www.gb50.com The QSL Manager will be Owen G4DFI and an attractive commemorative card will be produced. Cards may be sent via the bureau, or direct to Owen Cross, G4DFI, 28 Garden Avenue, Bexleyheath, Kent DA7 4LF, England. Don Field, G3XTT will provide further information as it becomes available on his website including details of a special award, he will also handle all publicity. Don can be reached by e-mail at g3xtt@lineone.net [TNX G3XTT and RSGB]

equipment, support and material to help activate Mellish Reef. Visit the VK9ML website at <http://www.qsl.net/vk9ml/2002/> for further information.

C5, THE GAMBIA. Jan, PA9JJ says he is planning a 'personal' DXpedition to The Gambia. He will be operating from

Kololi between the 15th and the 29th of April. He will collect his documentation and licence (he has applied for C56JJ) upon arrival in Banjul. Plans are to concentrate 40 and 80 metres and the WARC bands mostly on SSB, with some activity on the other bands using CW. No RTTY and no 160 metre activity is envisaged. His equipment will comprise an FT100 and a multiband dipole. His trip is actually a short holiday so activity will not be 24hrs a day. Logs will be available on the web at <http://www.qsl.net/pa9jj> after the operation. QSL via PA9JJ. [TNX OPDX and 425 DX News]

Round up

P5, NORTH KOREA (P5/4L4FN Status). Bruce, KK5DO, (QSL Manager for Ed, P5/4L4FN) was overheard saying that he feels confident that all the P5/4L4FN activity will count for DXCC. However, he did stress that it is not official, yet! He also mentioned that North Korea does not officially 'issue' a license, so any 'written permission' to operate should suffice. Government officials have visited Ed's station on a few occasions and the North Korean government is fully aware of his activity. His current contract with the United Nations World Food Program comes to an end in June, however, if it is renewed he anticipates being there for another year. Ed is still active on 15 metres SSB but he is currently honing his skills on CW and RTTY and should be using these

KH1 (Baker and Howland Islands). The operators of the KH1 (Baker & Howland) DXpedition will be YT1AD, AH6HY, K1LZ, K3NA, K6NDV, KW4DA, N6TQS, RZ3AA, YU1AU, YZ7AA, Z31FU, Z32AU and Z32ZM. The group will depart from Los Angeles on the 20th of April and head for Nadi in the Fiji Islands. Part of the team will then embark for Tuvalu while five other operators will fly to Funafuti and operate on a T2 call for about three days. The entire team will then travel from Funafuti on the 26th of April and should arrive on Baker Island on the 29th or 30th of April. Operations from Baker Island will continue until the 10th of May. The

DXpedition will be very comprehensively equipped, including; 6 transceivers, 5 linear amplifiers (3 x ACOM 1000 and 2 x 400 W), 6 beams, 3 verticals, 2 dipoles, 2 beverages (320m), 2 x 5kVA and 2 x 2kVA generators, 1 km coax cable, 2 km wire, 1 km cord, 2000 litres of fuel, 120 anchors for support and 4 tents. (I bet they forget something!) Plans are to operate on all bands 160-6 metres on CW, SSB, RTTY, PSK, SSTV, FM and Satellite. The call to be used for the operation will be announced just prior to the beginning of the operation to deter pirates etc. QSL via YT1AD for CW, RTTY, PSK and SSTV contacts and via RZ3AA for SSB contacts. [TNX YT1AD and 425 DX News]

modes soon. [TNX KK5DO and OPDX]

TARA PSK31 RUMBLE. The TARA PSK31 Rumble (The Spring Wakeup), sponsored by the Troy ARA, will be on air from 00:00 until 24:00 UTC on the 20th of April. As this activity promotes the PSK31 mode it will be PSK only on 80, 40, 20, 15, 10 and 6 metres. If you want to participate then the rules are available at <http://www.qsl.net/wm2u/rumble.html> or <http://www.n2ty.org> [TNX WM2U and 425 DX News]

Chris, G0TQJ, will be heading for **Kabul Afghanistan** on the 23rd of April. He says he will be there until approx. the end of July. His equipment will be an FT-920 into a multi-band dipole. [TNX G0TQJ and The Daily DX]

WORLD AMATEUR RADIO DAY "2002" AWARD. Sylwester Jarkiewicz, SP2FAP, who is the editor and publisher of MK QTC has forwarded the following announcement from Piotr Skrzypczak, SP2JMR, the president of PZK. "The W.A.R.D. Award is designed to commemorate the World Amateur Radio Day which is celebrated annually on the 18th of April. It is issued by PZK (Polish Amateur Radio Union) and the Editor of MK QTC. The WARD Award is available for a minimum of 50 QSOs on HF bands or 10 QSOs on VHF bands. All contacts must be made on April 18th between 00:00 and 24:00 UTC. A standard application form including the list of QSOs should be sent before May 31, 2002 to Redakcja MK QTC, ul. Wielmozy 5b, 82-337 Suchacz-Zamek, Poland. The price of the WARD Award is 3 USD, 5 IRC or 5 Euro. A full color example of the award (sized 210 x

297mm) can be viewed at <http://qtc.radio.org.pl> Special prizes will be made available for the following achievements; for the highest number of digital QSO's, for the highest number of SSB QSO's and for the highest number of CW QSO's. A version of the WARD Award is also available for SWL's.

RZ9MYL is the callsign of a **YL University** club station located in **Omsk, Asiatic Russia**. There are approximately 70 YL's attending the University who make good use of the station to practice their language skills. Most of the students do not have an amateur license or SWL ticket. Yuri, UA9MAR, is an experienced operator is usually also on frequency with the operator. The University issues separate awards for having QSO's with 2, 5 and 10 YL's using the various club station callsigns (RZ9MYL, UK9MYL and UZ9MYL). Applications for the award can be made by sending an extract of your log and \$5 US to Gunter Haertling, DH6ARM, Am Kalkwerk 59, 04603 Lehnendorf, Germany. For more info and pictures of the YL operators visit <http://www.qsl.net/rz9myl/>

Sources

Quite a wide range of information this month and our thanks are extended to the following people and organisations for it all; G3XTT, IK8VRH, DL2VFR, GM4ZNC, VK6CTL, W4PFM, I5WEA, CT1BFL, 9Q1A, W5FJG, VK2DXI, YT1AD, KK5DO, G0TQJ, WM2U, RSGB, ARRL, OPDX, 425 DX News and The Daily DX.

Silent Key

**Jim Stephenson
VK2AEK**

It is with sadness we record the passing of Jim Stephenson, VK2AEK on 4th March 2002 aged 83. Jim had been an active amateur for over 50 years and was very well known and respected in Amateur circles.

Les Daniels VK2AXZ

ar

Most of the news this month has originated from the U.S.A. If you have any interesting news that you would like to share with our members, please email it to me.

The considerate operator

As the development of Radio Communications changes, so do the needs of those using new modes of transmissions to know just where to find each other on the amateur bands. The ARRL recently came up with a suggested list for *The Considerate Operator* so that

if you are interested in say QRP, SSTV or PSK31 you will know generally where to look on the amateur bands. It isn't law, or IARU implied, it is just a guide. By so using, it may help to keep the bands a little better disciplined.

Some of the frequencies they have selected are outside of our amateur band allocations here in Australia, however SWLs may like to be aware of them.

("ACDS" means Automatically Controlled Data Stations)

1.800-1.810	Digital	7.080-7.100	Data	21.070-21.100	Data
1.810	QRP CW calling	7.100-7.105	ACDS	21.090-21.100	ACDS
1.800-2.000	CW	7.171	SSTV	21.340	SSTV
1.843-2.000	SSB, STV and other wideband modes	7.285	QRP SSB calling	21.385	QRP SSB calling
1.910	SSB QRP calling	7.290	AM calling	24.920-24.925	Data
1.995-2.000	Experimental & Beacons	10.130-10.140	Data	24.925-24.930	ACDS28.060 QRP CW calling
3.500-3.510	CW DX	10.140-10.150	ACDS	28.070-28.120	Data
3.560	QRP CW calling	14.060 QRP	CW calling	28.120-28.189	ACDS
3.590	RTTY DX	14.070-14.095	Data	28.190-28.225	Beacons
3.580-3.620	Data	14.095-14.099	ACDS	28.385	QRP SSB calling6
3.620-3.635	ACDS	14.100	IBP/NCDXF beacons	28.680	SSTV
3.710	QRP & Novice	14.101-14.112	ACDS	29.000-29.200	AM
3.790-3.800	DX Window	14.230	SSTV	29.300-29.510	Satellite downlinks
3.885	AM calling	14.285	QRP SSB calling	29.520-29.580	Repeater inputs
7.040	RTTY DX & QRP CW calling	14.286	AM calling	29.600	FM simplex
		18.100-18.105	Data	29.620-29.680	Repeater outputs
		18.105-18.110	ACDS		
		21.060 QRP	CW calling		

Remember this is for Considerate Operators.

Digital voice

In January and February QST, Doug Smith, KF6DX, who is Chair of the ARRL Digital Voice Working Group, wrote an interesting article giving an update and forecast with the future use of digital voice. Most digital voice experiments and uses have been in the VHF/UHF and above frequencies so it was interesting to read that experiments had been conducted on 40 metres. Tucson Amateur Packet Radio (TAPR) is producing a digital voice coder/decoder called a "vocoder". In mid 2001 the ITU approved certain systems as standard and it is forecast that the appearance of

digital audio will soon give rise to a new crop of digital receivers. A few months ago Alinco announced a digital voice option for some of their VHF and UHF transceivers. At the Japanese Ham Fair last year both ICOM and Kenwood demonstrated 23-cm digital transceivers. The ICOM operated at 8 kbits/s in voice mode and 128 kbits/s in data mode. In contrast on HF 3 kbits/s is considered high.

Is any member in Australia experimenting with this mode?

It would be interesting to hear from them.

Packet radio in space

ARISS promises no more "nocall" on ISS packet

Since Amateur Radio gear was installed on the ISS in 2000, the packet system—crippled with a dead RAM (random access memory) backup battery—has been operating in digipeat mode using the NOCALL call sign and other TNC default settings. Earthbound users have been able to access the system nonetheless, but the lack of a call sign has been an annoyance.

ARISS advise no more NOCALL! Normal packet activity—with a real call sign—should begin soon on the

International Space Station. Amateur Radio on the International

Space Station (ARISS) Board Chairman Frank Bauer, KA3HDO, said Expedition 4 crew will install the new packet module sent up to the ISS last August, and the system should be up and running by February 25.

U.W.B. devices

Back in August last year I mentioned Ultra Wide Band Devices were under investigation in Europe and the USA.

U.W.B. is a modulation method where a low power transmitter produces a signal of extreme bandwidth. The signal may be small pulses of only 0.5ns that is radiated through wideband antennas capable of spreading over the entire spectrum. The intended output level is said to be less than 1mW but, even with this small amount of power, the energy produced during the pulse is quite high.

The ARRL reported the FCC had released a first report on these devices. Proponents have touted the technology is a means of providing high speed wireless data connections such as the

The new module, using the call sign RS0ISS, will employ a specially developed ROM programmed with standard ISS defaults, a new battery and an extended memory—up to one megabyte. The TNC also has eight-bit capability to support Russian Cyrillic typesets, and a one-minute timeout

internet as well as for such applications as object penetration imaging systems such as ground-penetrating radar, through wall imaging systems, medical and surveillance systems.

It isn't just the Radio Amateur frequencies that could be affected, concerns have also been expressed by the US Department of Defense, the airline industry and cellular telephone companies, about the potential of UWB devices to interfere with the Global Positioning System (GPS).

For now, at least, the FCC has stated communication uses of ultra-wideband will be restricted to frequencies above 3.1 GHz which was welcomed by the Defense Department as it will protect

disconnect from the PMS if no pertinent packets are heard.

The uplink is 145.99 MHz; the downlink is 145.80 MHz. For additional information, visit the ARISS Web site <<http://ariss.gsfc.nasa.gov/EVAs/amsat01.pdf>>.—ARISS (ARRL N/L 22/2)

GPS and other critical military systems from interference. However DoD plans to monitor future UWB developments as are the ARRL.

(ARRL N/L 1/3)

For the DX prefix buff

The callsign GB50 has been issued for a special event station to be run at Windsor Castle to celebrate the Golden Jubilee of HM the Queen.

The station will be active 29 May-9 June, from 0700 to 2200 UTC daily, and will be open to the general public. For further information see <www.gb50.com>

ar

Silent Key

John Ewen Gerber OBE; AFC; VK1EG

On Saturday 2 March 2002, 84 year Old Timer John became a silent key.

As a graduate of the RAAF pre-war Wireless School at Laverton, John became entitled to a 1st Class Commercial Operators certificate. 25 years later he became interested in Amateur Radio and on the basis of his Commercial Certificate became VK1EG.

A bachelor, John lived for 36 years in units where access to aerials was difficult. His amateur operations were restricted to phone and CW contacts with friends in Canberra, Victoria and South Australia.

In 1940 when John was posted to Darwin, 12 squadron personnel lived in the abandoned Vesty Meatworks and operated Wirraways (with 1082-1083 TRF radio, with plug-in coils) from Parap aerodrome.

Later, galvanised iron sheds for dormitory accommodation were erected at Parap by squadron personnel. No ceiling fans, and lights-out at 2130 (except the toilet block). If the mail was late, there would be a queue waiting outside the toilet block to read their mail.

In 1942 John did a tour with 4 Sqdn (Wirraways now with AT5-AR8 radio) doing Army Co-operation along the Kokoda trail and at Buna-Sananda. Then he became deeply involved in land air warfare policy. He had first hand operational experience as Air Liaison Officer to the 'G.O.C at Nadzab during the landings there in 1943; and attended the British Army's School of Land-Air Warfare. His O.B.E was well earned in the difficult Land-Air warfare environment.

Tours of duty as a pilot in several Dakota transport squadrons involved time in Korea, and for variety, a tour as CO of a Maritime squadron flying Lincoln aircraft.

Well known as a genealogist; aviation historian and genuine good-mate, John will be missed. His flying career started as a Corporal Air Observer in 1940 and progressed through Navigator, Advanced Navigator, Pilot and General Duties Staff Officer.

I believe a paper written by John for the Chief of the Air Staff led to RAAF acquiring long range Transport aircraft, the now famous Hercules C130 series.

Over-exposure to the midday sun during his tropical postings started the process that cost him his life.

Vale John VK1EG.

ar

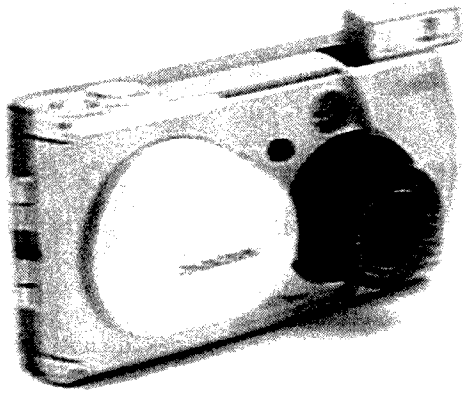

Digital Cameras

Many amateurs already own a digital still camera but for those who don't and are thinking about buying one, a few words from a digital camera owner. This is a big subject and only some simple basics are contained in this article.

Digital cameras are great. The quality exceeds your average camera in terms of the final printed snapshot. Film cameras are capable of fantastic pictures but the end result of mass developing and other factors can result in rather ordinary pictures. Film is capable of resolutions in the thousands of DPI (dots per inch) but DPI is just one of many aspects that go together to produce a good picture.

Digital cameras are now available that come close enough to equalling film DPI. A 5 megapixel digital camera equates to about 2,500 DPI. Depending on what type of film you are using the DPI is unlikely to exceed 4,000 DPI, and other factors such as the lens may mean a film camera is unable to focus an image that can take advantage of the DPI figure of film. Digital cameras not only come close to many film cameras; they can exceed them in final picture quality.

My first was a third of a megapixel camera, meaning it had 640 horizontal pixels to 480 vertical pixels. It took fairly average looking pictures in terms of resolution but did a good job on colour accuracy, gray scale tracking and gamma. The pictures were pleasing enough and many thousands of pictures were taken using the Epson 500. After a few years, and much Internet research, I bought a second hand Kodak 4800 digital camera. In fact I bid for the camera on ebay via the Internet, which was a fun experience in itself.

So for any amateur wanting to purchase a digital camera, and knowing little, a few pointers.

DPI (Megapixels)

As important as dots per inch are, there is a point at which extra DPI may be a waste. If your main use of a digital camera is to view pictures on a computer screen then a one megapixel camera does a good job. During a recent car trip from Melbourne to Perth following the coast

as much as possible all the way, all digital pictures were taken at one megapixel, the lowest resolution on my three megapixel camera. The pictures look great and print up to A4 size also looking great. The reason for choosing the one megapixel size was to be able to take lots of pictures on the available memory card. My camera contains a 128 Meg flash memory card and this allowed for 390 pictures with low JPEG compression. Digital cameras let you take pictures at no cost. Experiment away and keep the good ones and erase the bad ones.

The point is don't assume a digital camera has to have lots of pixels to take a good picture. Experience has shown a good zoom lens (3 times minimum) and lots of memory are more important.

So if you can't afford the latest digital camera with its 5 megapixel resolution, have a look at the one two and three megapixel cameras. Memory size for storing pictures is important if you are traveling, as there is nowhere to download the pictures. As a bare minimum 32 Meg of memory. This allows for almost 100 pictures at the one megapixel resolution with low jpeg compression.

Lenses

A digital camera is only as good as its lens. A close look at many digital camera lenses shows a small amount of chromatic aberration, colour fringing at the edges of the picture. This effect is slight and usually only seen if you zoom in on the edges of the picture, where there is high contrast changes like the edges of tree branches or buildings. It is worth mentioning, as you may wonder just what it is when you take a close up look at some digital photographs. Just as many film cameras suffer from the same effect but at snapshot size printing it is normally not seen, it is the digital image that allows for closer scrutiny.

ISO

Most digital cameras now come with what is the equivalent of film speed adjustment or ISO setting. In the digital world this is just camera sensitivity (more gain) It comes at the expense of increased noise in the picture, just like film. I tend to leave the ISO setting at normal and increase the iris size or longer exposure. Once you have noise in the picture it is difficult (but not impossible) to do much about it when computer editing.

Focus

All the various camera setting aside, digital cameras come with an automatic setting that works very well. In particular the automatic focus, which 99 times out of a hundred, gets the focus spot on.

Exposure

In the manual mode my particular camera can be set from a thousandths of a second up to a time exposure of 16 seconds. This time exposure allows for some rather interesting photographs to be taken. One night I set up the camera on a tripod looking down my street. The resulting photograph was a surprise, as the street came out in strong colour along with the stars in the sky.

Processing

This is where the fun is. There is almost nothing that can't be done on a computer to a digital photograph. What I aim for is simple, a pleasing photograph. Black blacks, white whites, a good colour balance with a bit of unsharp mask (sharpness). It is not possible to go on with an article on digital photography processing on the computer because it is a very lengthy subject. It took many hours of playing around and a fair bit of

Continued on page 40

Opinion

Drew Diamond, VK3XU.

Why it is important to contribute technical articles to AR

At radio club meetings, or on-air, the remark- "no-one builds any more" is sometimes heard. As a regular contributor to this esteemed journal, I enjoy a considerable correspondence with interested readers (letters that you and our editor never see), and am therefore able to form a pretty good picture as to what many of our colleagues are doing. Because builders and experimenters typically spend more of their precious time in the workshop than on-air talking about their accomplishments, it is assumed that little technical work is going on. Let me say here that there is a significant crowd of keen radio workers around this country busily building and experimenting along various lines, a number of them (as far as I know) doing some valuable new work, or refining and adapting the results of others. For instance, I know of several keen receiver builders with some very bright ideas, who are achieving good results in their field.

The problem is though, that not enough of these projects and experiments get written-up or documented. It seems that some fellows find that, when a project is satisfactorily

completed, there is little energy remaining to follow through with the necessary "paper-work"- or the urge to get on to the next exciting project is just too strong. Admittedly, there is generally about as many hours in writing a project up as in the doing of it. Never-the-less, I feel it is important that, whenever possible and appropriate, projects and experimental results should be suitably documented for publication. Let me list just six good reasons for doing so:

1. In order that other enthusiasts may have a go at building their own model, along similar lines.
2. To allow an experimenter/builder to "borrow" ideas for adaptation to some other project.
3. Keeping abreast. For various reasons, many readers have no immediate intention of actually building a described project, or directly applying experimental results, but are never-the-less very interested in the work of others, and expect to see and read such articles in their society's official journal.
4. Politics. Amateur radio still has as one of it's core functions; "technical investigations and experiments",

and it is therefore vital that our journal should regularly publish suitable material. Any government official, politician or other person or body who wishes to know what we are up to (in the Technical Dept.) has only to look in our journal, and hopefully be assured that we are indeed doing worthwhile work.

5. The traditional free exchange of ideas- so that amateur radio societies in other countries may republish in their own journal, material which is thought also to be of interest in that country (as Gil Sones does for us here in his valuable "Technical Abstracts" column).
6. Historical. All published articles become an archival document, so that any person may reasonably access information as necessary at some future time.

So, have a think about the value of the radio work that you do. If you observe that your friends find it interesting, and request further details; then it's a sure bet that many AR readers would like to see it too. Please share it around- write that article for your magazine.

ar

Digital cameras *continued*

reading on the Internet to have some skill in digital computer processing and the results are most pleasing.

Printing

Printing out digital photographs, even on cheap \$250 printers produce surprisingly good results. You have to use the correct paper to prevent the ink from spreading out, if you want the best quality but it is worth it. Some photographic development houses will print your digital photographs from a digital image. Either drop the pictures off on disk, CD or the camera memory card and pick up the finished photograph a day or two latter. Digital printing takes longer than film processing, as it is a new wait and see

venture. Many photographic developers allow you to e-mail in the photographs, which saves a trip.

Internet

If you want to learn more about digital cameras there is no better place than the Internet. There are hundreds of sites with pictures, information and reviews of all the different models of digital camera. The very camera you may be thinking of buying will be listed along with its specifications, sample pictures and opinions from people who already own the camera. Truly amazing, although it is important to use some degree of humor, intuition and judgment when reading user reviews on the Internet.

We live in a time where much is taken for granted, and for all the bad comments about the Internet the good outweighs it many times over. Researching a product like a digital camera on the Internet is incredible, so much information available, and you can even end up buying your final digital camera choice via the Internet.

One great site for looking up digital cameras is Steve's Digicams. You can even send in pictures and the best one each month wins a digital camera. Have a look at:

www.steves-digicams.com/daily_dpotd.html

ar

STRICTLY HAM

PTY LTD



★ IC-746 PRO

- Icom WORK THE WORLD performance
- The best way to get onto HF plus 6 and 2 metres
 - Multifunction hi-res display
 - Direct frequency
 - Shack or portable



★ IC-756 PRO II

- Icom's new HF+50-MHz digital
The performance king Try it to see why
- Multi-colour multi-function screen



★ TH-D7A(G)

- Dual bander
- Effortless 2m & 70cm
- BUILT IN PACKET
- 200 alphanumeric memory channels
- 6W from 13.8VDC
- Comes with NiCd battery and charger
- APRS compatible



★ TS-2000

- High performance standards
- Three distinct operation platforms,
 - 1 Traditional transceiver-full front panel,
 - 2 "Silver box" for mobile use
 - 3 The ARCP-2000 computer control
- 100 watts on HF, 6 metres and 2 metres, 50 watts on 70cm,

★ IC-706MkII G

Ultra Small:

167(W) x 58 (H) x 200 (D), 2.45kg

Detachable Control Panel/
Display (optional equipment
required for remote operation)

SSB/AM/CW/RTTY Narrow
Filter Options



★ TM-D700A

Kenwood's new TM-D700A makes the most of exciting SSTV, GPS, and APRS® (Automatic Packet/Position Reporting (rapidly gaining popularity worldwide). Extra large amber and black display. Built-in TNC offers a wide range of options, inc. simple packet operation using AX.25

Ham radio is truly entering a new era.



★ TS-50

Mount it in a vehicle, take it on a DX-pedition or use it as a permanent base station transceiver. The easy-to-use menu system adds flexibility, stable operation in any situation.

- DDS with fuzzy control
- 100 Memory channels
- Switchable AGC circuit (SLOW/FAST)
- IF shift Noise blanker (pulse)
- Dual VFOs (A & B)

Outstanding performance



14 CHURCH ST BAYSWATER VIC 3153

Phone (03) 9729 7656

email sales@strictlyham.com.au

Fax 903 9729 7422

www.strictlyham.com.au

Contests

Ian Godsil VK3VP
contests@wia.org.au

Contest Calendar April – June 2002

Apr 6/7	SP DX Contest	(CW/SSB)	
Apr 6/7	EA RTTY Contest		
Apr 12-14	Japan Intl. DX Contest High Bands	(CW)	(Dec 01)
Apr 13/14	Holyland DX Contest	(CW/SSB)	
Apr 20	TARA PSK31 Rumble		(Mar 02)
Apr 20/21	YU DX Contest	(CW/SSB)	
Apr 25	Harry Angel Sprint		(Mar 02)
Apr 27/28	Helvetia DX Contest	(CW/SSB)	
May 4/5	Danish SSTV Contest		
May 4/5	10-10 Intl. QSO Party	(CW/RTTY)	
May 4/5	ARI Intl. DX Contest	(CW/SSB/RTTY)	
May 11/12	VOLTA RTTY Contest		
May 11/12	CQ-M Intl. DX Contest	(CW/SSB/SSTV)	
May 18/19	Baltic Contest	(CW/SSB)	
May 25/26	Anatolian RTTY WW Contest		
May 25/26	CQ WW WPX Contest	(CW)	(Feb 02)
June 1	VK/trans-Tasman Contest		(May 02)
June 1/2	South American WW CW Contest		
June 8	QRP Day		(Apr 02)
June 8/9	ANARTS WW RTTY Contest		
June 8/9	Queen Elizabeth II Golden Jubilee Contest	(CW/SSB)	(Apr 02)
June 8	Asia-Pacific Sprint	(SSB)	
June 15/16	Novice Contest	(CW/SSB)	
June 22/23	SP QRP Contest	(CW)	
June 22/23	Marconi Memorial HF Contest	(CW)	

Greetings to all readers

Special Points to Note

This month your support is asked for the annual Harry Angel Sprint, on ANZAC night, 25th April. We remember Harry as VK's oldest licensed amateur at the time of his death in 1998.

All you RTTY enthusiasts will be aware of the large number of contests for this mode in the near future, especially the ANARTS World-Wide Contest in June. Please make these known to as many VKs as possible.

From Dave Lawley G4BUO, the following note for your diary—

“To celebrate the Golden Jubilee of Her Majesty Queen Elizabeth II in June, 2002, the Radio Society of Great Britain is organising a special contest to promote contact with stations in the British

Commonwealth. There will be commemorative plaques for the overall winners, certificates for the leading score from each country and for all stations contacting 50 or more Commonwealth call areas. The General Rules for RSGB HF contests do not apply to this event.”

Full details are listed below and there is a special logging program for this event called “SDJ”, written by Paul O’Kane EI5DI, the author of the logger ‘Super Duper’. This program may be downloaded from Paul’s web site: <http://www.ei5di.com>. It is a stand-alone program and if you have never tried Super Duper I would encourage you to do so through this event. Those already using SD need not download this special program, but use Type 9 category.

General

As I have indicated sometime recently, 2001 was my year for learning to use a contest logging program. As a result, I do have a favourite, but I use two others if and when situations demand. I also subscribe to a reflector for my chosen program and I was amused the other day to read that the latest version is causing an intermittent fault. The correspondent had decided not to impede his progress in whatever he was working at the time, so went on entering by hand. His comment was “writing and operating the paddles is no joke”.

I smiled to myself because now I know exactly how he felt and many of you will know also. This is an example of how quickly we can adapt to new ideas and tools available.

Twelve months ago I would have reacted quite differently from this, but now I have no hesitation in urging any of you who are interested in contests but not yet using a logging program to learn one as soon as possible.

There are those who may say that DOS-based programs are old-hat and ^&%#*(, but trying is key to it all. There are good reasons why the long-standing loggers are DOS-based, but this does not mean that you MUST run your computer

under DOS (and learn it if you are young enough to have come up through Windows only). You can still use a DOS window within Windows. Perhaps this could be food for discussion at a later time.

So if you have not gone into contest logging, please do so soon! The advantages are many, especially being able to send entries electronically – something that is now being required by

ARRL and may well become standard for most contests.

VKHAM Contest Site

I have received a few comments on the new web site and I thank all those who took the time. However, I would still like to hear a wider cross-section of opinions. Please look at: www.vkham.com/contest/
73 and good contesting, Ian Godsil VK3VP

The VK/ trans-Tasman Contest:

This exciting 80 metres Contest will be staged on the first Saturday in June.

It runs for 6 hours, in 1 hour stages, - long enough to be interesting without being arduous, and providing constant activity with stations being reworked each hour.

The main emphasis will be on contacts made between VK and ZL stations, with the scoring structured to give all stations an equal chance, regardless of their geographical location.

Bonus points can also be earned each hour, and are awarded to encourage trans-Tasman contacts and participation by VK5s, 8s and VK6s.

Phone and CW Categories will be catered for, as well as a separate Category to encourage QRP operators.

An engraved trophy will be awarded to the outright winner, with certificates for winners and placegetters in the other Categories.

This Contest is not a sprint or a marathon. It will provide 6 hours of non-stop evening entertainment that should not impinge too much on family life or sleep time.

So, make a note of the details, and give it a go!

The only thing we ask is that you take

the time to submit your log (even if you don't think you will win). This is essential to make it all worthwhile, and to ensure the on-going success of the Contest.

Rules will be published in the WIA and NZART magazines, and are available on the Contest website:

<http://home.iprimus.com.au/vktasman>

Queries and comments can be emailed to the Contest Manager on: vktasman@hotmail.com

QRP Day Contest 2002 Rules

0700z - 1100z Sat 8 June

Open to all CW operators.

Object is to work as many stations as possible.

Category: Single Operator only.

Sections: (i) VK, ZL, P29 (ii) outside the above call areas.

Mode: CW only. **Bands:** all HF bands (no WARC).

Exchange: RST plus serial number beginning at 001 and incrementing by one for each contact.

Repeat contacts on same band: In order to make greater use of available band space and time, repeat contacts with the same station will be allowed with a minimum of two (2) hours between contacts.

Special Event Station: In 2002 VK3JS will act as a Special Event Station. It will operate on all HF bands, but will submit a Checklog only. VK3JS may be worked once only for the

contest, and stations may claim 20 POINTS for the contact.

Scoring:

Stations within VK/ZL/P29 score as follows: -

VK/ZL/P29 contacts 1 point

Outside VK/ZL/P29 3 points

Stations outside VK/ZL/P29 score as follows:-

VK/ZL/P29 contacts 3 points

Outside VK/ZL/P29 1 point

Special Event Station VK3JS: 20 points

All contacts made with homebrew transmitter or transceiver score double points.

Final Score is the sum of the total QSO points. Except for the use of homebrew equipment (see above), no multipliers apply.

Certificates: Certificates will be awarded to the following:-

(i) first three placegetters in each section,

(ii) top scorer on each band (if the entrant is not already a placegetter).

General: any station claiming to operate QRP MUST NOT exceed a maximum of five watts carrier to the antenna and should add /QRP after its callsign. Logs showing contacts and points claimed, together with a full description of equipment used, should be sent to:-

Ron Everingham VK4EV,
30 Hunter Street, Everton Park,
Queensland, 4053,
no later than 5 July, 2002.

QEI Jubilee Contest Rules

from Dave Lawley G4BUO,
Contest Manager

8/9 June, 2002 1000z Sat. – 1000z Sun.

To celebrate the Golden Jubilee of Her Majesty Queen Elizabeth II in June 2002, the Radio Society of Great Britain is organising a special contest to promote contact with stations in the British Commonwealth. There will be commemorative plaques for the overall winners, certificates for the leading score from each country and for all stations contacting fifty or more Commonwealth call areas. There will also be a range of special certificates for UK Intermediate and Foundation licensees. The General Rules for RSGB HF Contests do not apply to this event.

Date: Sat. 8/Sun 9 June 2002.

Time: 1000UTC Sat - 1000UTC Sun

Bands: 3.5, 7, 14, 21 and 28MHz.

Modes: CW and SSB. IARU band plans should be observed. Contest-preferred segments should be observed; no operation to take place on 3560 - 3600, 3650 - 3700, 14060 - 14125 and 14300 - 14350kHz.

Exchange: RS (T) and serial number starting from 001.

Categories:

- Single operator unassisted. Entries may be CW only, SSB only or mixed mode.
- Single operator assisted. As (a) above but passive use of DX spotting nets and DX Cluster is allowed. Self-spotting is not allowed.
- Multi operator. As (b) above but

more than one person may operate the station. In all categories only one signal may be transmitted at a time.

Sections:

- British Commonwealth: Work any station except your own call area.
- Rest of the World: Work any station in the British Commonwealth.

Scoring: Stations within the Commonwealth may not contact their own call area for points or multipliers. Stations outside the Commonwealth may contact Commonwealth stations only. See the call area list. Note that for this contest all of G, GM, GW, GI, GJ, GU, GD counts as one call area, and therefore British Isles stations (excluding EI) may not work each other. A station may be contacted only once per band, regardless of mode. Each contact scores 5 points. **Multiplier** is the total of different Commonwealth call areas worked on each band.

Final score is the total of QSO points multiplied by the total multipliers worked.

Logs: Electronic submission of logs by disk or e-mail is encouraged, and is required from all who use a computer to log or prepare the logs. Electronic entries are preferred using recognised contest software

(eg SD, CT, NA, TR). ASCII log files are required, together with an ASCII summary file. File names must indicate the entrant's callsign eg g3xyz.log and g3xyz.sum. The entrant must ensure that the logging software produces a log file that contains all QSO data correctly scored.

Logs must show: Time, Callsign, RS (T) / serial number sent, RS (T) / serial number received, multiplier claimed, QSO points.

A **summary** indicating category and section, contacts per band / mode must be included with a declaration that the rules and licence conditions have been complied with. All QSOs (including duplicates) must be included, with non-scoring QSOs clearly marked. Single mode entrants who make contacts on the other mode should submit these separately as checklogs.

Send logs by e-mail as an attachment to: <hf.contests@rsgb.org.uk>

Postal entries should be addressed to: RSGB HF Contests Committee, c/o S V Knowles G3UFY, 77 Bensham Manor Road, Thornton Heath, Surrey CR7 7AF, UK. The closing date is 6 July, 2002.

(Customised logging software SDJ is available from EI5DI's web site: www.ei5di.com)

Awards:

- A commemorative trophy will be awarded to the UK station making the highest score in the single operator unassisted category.
- Commemorative plaques will be awarded to the first, second and third placed entrants in the British Commonwealth and Rest of the World sections for each category, and to the leader on each mode in each category.
- The leading entry from each country will be awarded a special certificate, provided that at least 100 QSOs have been logged.
- Certificates will be awarded to the three highest placed UK Intermediate licensees, and to the three highest placed UK Foundation licensees.
- A commemorative certificate will be awarded to every entrant who contacts 50 or more band call areas.

Commonwealth and Jubilee Contests Call Areas - 2002

3B6/7 Agalega and St Brandon
3B8 Mauritius
3B9 Rodriguez Island
3D2 Fiji
3D2 Rotuma
3D2 Conway Reef
3DA Swaziland
4S Sri Lanka
5B Cyprus

Commonwealth and Jubilee Contests Call Areas - 2002 *continued*

5H Tanzania
 5N Nigeria
 5W Western Samoa
 5X Uganda
 5Z Kenya
 6Y Jamaica
 7P Lesotho
 7Q Malawi
 8P Barbados
 8Q Maldives
 8R Guyana
 9G Ghana
 9H Malta
 9J Zambia
 9L Sierra Leone
 9M0 Spratly Islands
 9M2 W Malaysia
 9M6/8 E Malaysia
 9V Singapore
 9Y Trinidad & Tobago
 A2 Botswana
 A3 Kingdom of Tonga
 AP Pakistan
 C2 Nauru
 C5 Gambia
 C6 Bahamas
 C9 Mozambique
 CY0 Sable Island
 CY9 St Paul Island
 G, GD, GI, GJ, GM, GU, GW
 etc United Kingdom
 (all one area)
 H44 Solomon Islands
 H40 Temotu
 J3 Grenada
 J6 St Lucia
 J7 Dominica
 J8 St Vincent
 P2 Papua New Guinea
 S2 Bangladesh
 S7 Seychelles
 T2 Tuvalu
 T30 W Kiribati
 T31 C Kiribati
 T32 E Kiribati
 T33 Banaba
 TJ Cameroon
 V2 Antigua & Barbuda
 V3 Belize
 V4 St Kitts & Nevis
 V5 Namibia
 V8 Brunei
 VE1 Nova Scotia
 VE2 Quebec
 VE3 Ontario
 VE4 Manitoba
 VE5 Saskatchewan
 VE6 Alberta
 VE7 British Columbia

VE8 North West Territories
 VE9 New Brunswick
 VK0 Heard Island
 VK0 Macquarie Island
 VK1 Australian Capital Territory
 VK2 New South Wales
 VK3 Victoria
 VK4 Queensland
 VK5 South Australia
 VK6 Western Australia
 VK7 Tasmania
 VK8 Northern Territory
 VK9C Cocos (Keeling) Islands
 VK9L Lord Howe Island
 VK9M Mellish Reef
 VK9N Norfolk Island
 VK9W Willis Island
 VK9X Christmas Island
 VO1 Newfoundland
 VO2 Labrador
 VP2E Anguilla
 VP2M Montserrat
 VP2V British Virgin Islands
 VP5 Turks & Caicos Islands

VP6 Pitcairn Island
 VP6 Ducie Island
 VP8 Antarctica
 VP8 Falkland Islands
 VP8 South Georgia
 VP8 South Sandwich
 VP8 South Shetland
 VP8 South Orkney
 VP9 Bermuda
 VQ9 Chagos
 VU India
 VU4 Andaman & Nicobar Is
 VU7 Laccadive Islands
 VY0 Nunavut
 VY1 Yukon
 VY2 Prince Edward Island
 YJ Vanuatu
 Z2 Zimbabwe
 ZB2 Gibraltar
 ZC4 Cyprus (UK Bases)
 ZD7 St Helena
 ZD8 Ascension Island
 ZD9 Tristan da Cunha & Gough Island
 ZF Cayman Islands

ZK1 North Cook Islands
 ZK1 South Cook Islands
 ZK2 Niue
 ZK3 Tokelau
 ZL0 /ZL New Zealand Reciprocal
 ZL1 New Zealand - Area 1
 ZL2 New Zealand - Area 2
 ZL3 New Zealand - Area 3
 ZL4 New Zealand - Area 4
 ZL6 New Zealand
 ZL7 Chatham Islands
 ZL8 Kermadec Islands
 ZL9 Auckland & Campbell Island
 ZS1 Western Cape Province
 ZS2 Eastern Cape Province
 ZS4 Free State Province
 ZS5 Kwa-Zulu Natal Province
 ZS6 Gauteng Province
 ZS8 Marion Island
 ZS0 South Africa Special Event

ar

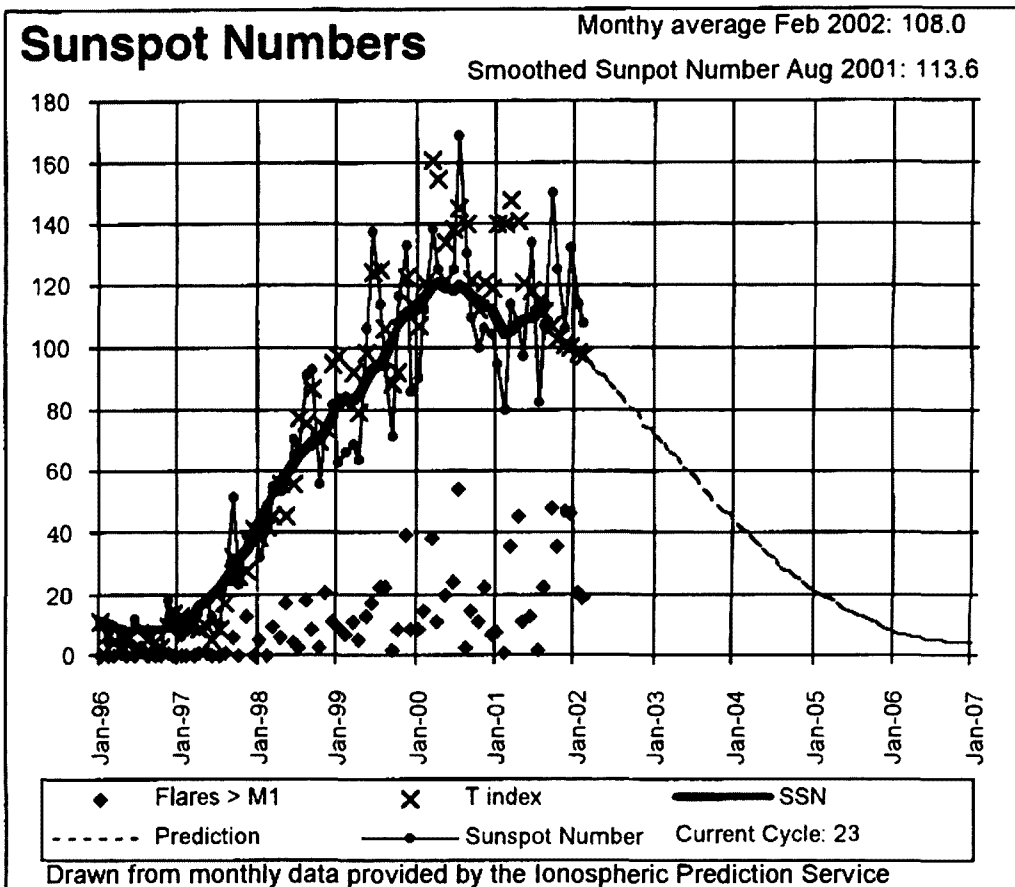

Ham Shack Computers

Alan Gibbs, VK6PG
223 Crimea Street, NORANDA WA 6062
Email: vk6pg@tpg.com.au

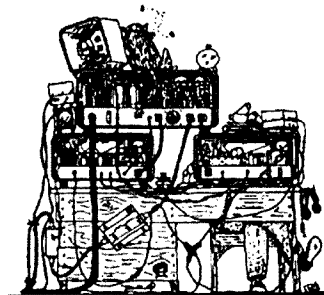

Part 13 – Computer Viruses

All computers are prone to virus attacks. The effect can be total software devastation rendering your computer useless within seconds. Even when not connected to the Internet, but you use or swap files on floppy disks, CDs or try to install new software, you are wide open to virus attacks.

As humble human beings, we take steps to vaccinate our children and promote cleanliness to avoid the possibility of catching infectious diseases. There is no guarantee that these steps will prevent disease, but we have minimised the risk.

With computers, many thousands of data files are used to effectively make the computer work properly. If just one of these files is faulty, our computer stops working until the file is repaired or replaced. But which is the faulty file?

What are computer viruses?

Viruses are computer programs written by ill-intentioned programmers, and designed to attach copies of itself to other computer files. Thereafter, whenever the infected program is run, the attached virus program is activated and attaches itself to other files and programs and so on. The process continues until your computer “crashes” and becomes unusable. Many viruses run “in the background” and are invisible to the user but can be passed on to other users by email or exchanging disks. Here, the viruses spread rapidly attacking other files until a state of collapse exists. Virus programs usually have classified targets to infect. These are broadly:

1. **Program viruses** that infect executable files that run computer programs like word processors, spreadsheets, games, and operating system files.
2. **Boot viruses** can infect disks by attaching themselves to special programs called boot records and master boot records. These records contain the programs needed to start your computer from switch-on and to open Windows.

3. **Macro viruses** are small command files that are used to perform specific operations – like automatically doing something with your favourite computer program. They are little programs that run within a major program like your word processor. There are hundreds of these little macro files that are also open to virus attacks.

Today, there are tens of thousands of viruses wandering around the world. Many viruses are known and are identified by anti-virus software writers who provide appropriate programs that will eliminate (delete) these undesirables. However, new virus programs are being written and distributed worldwide every day. Keeping your Anti-Virus software up-to-date is essential to survival.

In just one short Internet connection to collect email, the writer was “hit” with 14 separate virus files within seconds. The computer immediately failed to respond, and to resolve the problem and eliminate the viruses, the writer had to run an Anti-Virus program from protected (read only) floppy disks. It took over four hours to restore the computer back into full operation where each virus had been identified and successfully removed.

In severe cases, it becomes essential to re-format your hard drive and reload all the software from scratch. This can take more than a week of spare time and is the worst case scenario.

Virus Definitions

Because viruses are written in computer code, they can be identified by their special code characteristics. AntiVirus software companies collect these special virus characteristics and devise specific virus definitions - and the means to

delete the virus before further damage is done. These definitions are collected for each known virus and listed in a virus “look-up” file attached to an AntiVirus software package on your computer. Once your AntiVirus software identifies a “hit”, the definition file database is scanned to see if the virus is known. Once identified, the user can choose to delete the virus and/or inoculate your own computer files to clear up the problems and return to normal use.

If an unknown virus is suspected by the AntiVirus software, which appears to be damaging or attempting to change files on your computer, the AntiVirus software prevents this action from happening. The software presents the user with a warning dialogue menu suggesting an appropriate course of action.

In addition, mature AntiVirus software offers the user the option of inoculating your own files, and/or continuous operation in the background as a “safe guard that watches” every action made by your computer. Should suspicious activity be detected, the user is warned of the activity with suggested steps to be taken to resolve the situation. This is the “vaccination stage” that all computer users should be aware – and be thoroughly proficient in it's use. Remember – you may not know that you have a virus – but you could be “the carrier” just like bacteria in the human world. Don't pass on viruses to others.

Kids exchanging games on disks, AR operators trying new software, the Internet itself, ISPs and data servers, other World-Wide-Web users, BBSs, schools, Universities, TAFE Colleges, private and corporate networks (LANs), friends, relations and club members are all possible sources of potential viruses.

Lastly, YOU. It may not be intentional but you can be the guilty party without even knowing you are causing the chaos.

The Solution

The world's most widely used AntiVirus program is now produced by Symantec (2) Corporation in California USA. Symantec purchased the rights from Peter Norton (of Norton Commander and Norton Utilities fame in the 80's) some years ago. However, Symantec still use the "Peter Norton" theme in their publicity and advertising strategies. Called Norton AntiVirus for Windows, it has been released in different versions over the years. One of the best was Norton AntiVirus for Windows 95, version 2 and is still valid today provided the user has registered their copy, and the updated definition files are installed monthly from Symantec via the Internet.

command files are copied onto the first disk, and the remainder is used to store the virus definitions from the Norton database. In severe cases of a virus attack which destroys the Windows operating system itself, your first rescue disk is used to boot your computer from first switch-on. The computer is opened in DOS, and a simple dialogue box appears prompting for the next floppy. Choose the SCAN

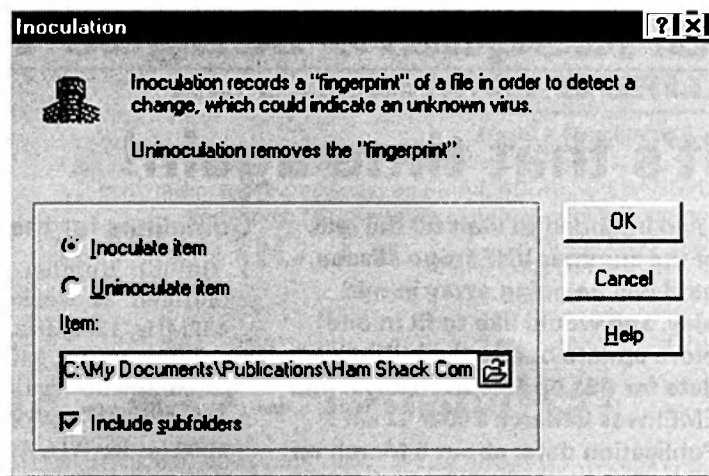

option and Norton will slowly scan all your computer files, and automatically eliminate any and all potential viruses on the way. This is the best way to "clean up" your computer, but **BE WARNED** - this process will take about **FOUR HOURS** to complete. Choose a quiet afternoon or early evening, set Norton to work in the Rescue Mode, then go and watch a long

value your own Ham Shack Computer, please take the time to protect your own (and other AR users) computer interests.

Computer viruses have become forefront in international warfare. The White House, Pentagon, military networks and satellites, Microsoft Corporation, and the financial institutions have each been under attack many times. Viruses are nothing new. Just one rampant virus could bring down the whole world's computer networks and international information exchange might collapse. It's far cheaper to fire a small stealth virus into the Internet than to hurl an attack with thousands of troops and billions of dollars in armaments.

Ham Tip No. 13. Never ever trust free AntiVirus software from any source. Spend a little time money and buy from a reputable software publisher who regularly offers updated virus definition files. You have been warned - there is no other effective solution.

Ham Shack Computers, No: 14 Packet Radio coming next month

(1) Ham Shack Computers Web Site:

<http://www2.tpg.com.au/users/vk6pg>

(2) Norton AntiVirus software:

<http://www.symantec.com.au>

(3) McAfee AntiVirus software

<http://www.mcafee.com.au>

73s de Alan, VK6PG
ar

“By acting in unison we can ensure that amateur radio is properly represented at all levels of State, Federal, and International Government.”
Ernest Hocking VK1LK, President, WIA

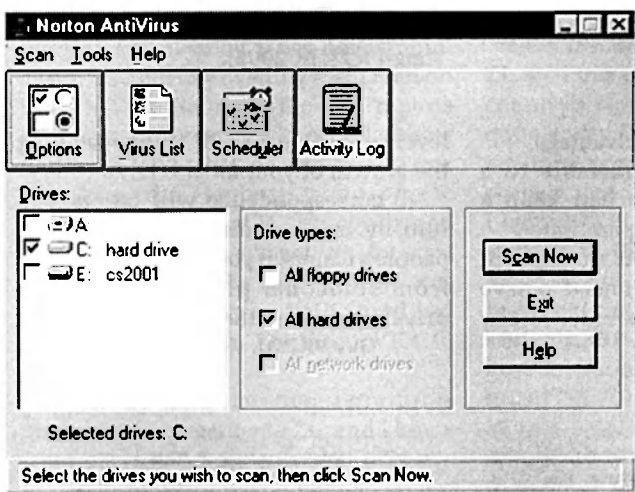

Operation is controlled from the simple interface shown above, and little knowledge of computers is needed to scan and eliminate virus problems. The Options button offers the user a myriad of choices to configure the program. EG Automatic protection enabled option allows Norton AntiVirus to run in the background from startup, and works continuously seeking possible infection. An excellent choice being to check any floppy disk offered to you by a friend. Select just the A: drive and hit the Scan Now button and the job is done.

To offer total protection using Norton AntiVirus, the recommended Rescue Disks can be made from the software. Five or more new floppy disks are required to complete the automated tasks in producing your disks. Boot and

movie on the telly! Once done, remove the floppy and reboot your computer to see if Windows has been restored. If your computer is back to normal, you will be delighted that you spent this week's pocket money on purchasing the AntiVirus software in the first place.

For our more sceptical readers who perhaps cast aside these words, all that can be said is, once "hit" with a major virus and your computer fails to function correctly, don't blame the writer of this column. Buy the software and do the job properly in the first place - you will never regret it. By all means try out other brands of AntiVirus software. McAfee (3) is another good choice, and there are many others. However, be mindful that you will need to update the definition files every month. Pinching software from a mate is not the answer. If you

Gridsquare League Table Update

It's that time again!

I had intended to wait till the end of the summer VHF tropo season, but I will be going away in mid May, and would like to fit in one more update before then. Closing date for this update (terrestrial and EME): was 2 March 2002.

Publication date: about 5 March on Web. Early updates are appreciated, late updates can not be included. Remember that any station not confirming his/her status at least once a year may be omitted from the table. A copy of the gridsquare rules is attached. Guy VK2KU, vk2ku@hermes.net.au, QTHR 2002, Phone (02) 4759 2670

Comments

If you move house to a new "region", you have to start again, though your old score still stands of course.

The intention of Rules 8 and 9 is to encourage portable operation (up to 100 km from home, or from a rare gridsquare) to overcome the limitations of a home qth, but not to an extent which

Guidelines for the Gridsquare League Table as at 26 October 2001

1. Submit number of grid squares claimed as worked on 144MHz, 432MHz, 1296MHz, 2.4GHz, 3.4GHz, 5.7GHz, 10GHz, 24GHz. No details of actual squares/stations required.
2. Starting date for contacts: 1st January 1990 (as for WIA Awards).
3. No distinction between modes (cw, ssb, fm etc.) - a square is a square.
4. EME claims to be listed separately.
5. Contacts via repeater or active satellite should not be counted.
6. Cross-band contacts should not be counted (on either band).
7. Contacts with aeronautical or maritime mobile stations should not be counted.
8. Except as allowed by Rule 9, all squares claimed must be worked from locations within a single limited "region", which can be encompassed by a circle of radius 50km.
9. A gridsquare may also be claimed by a "reverse contact" from that square to any station in your home square.
10. Entry is open to any VK, not just subscribers to the VK-VHF Reflector.
11. The Table of Standings will be posted on the VK-VHF Reflector roughly every 3 months, and may be reprinted from there in "Amateur Radio" and other magazines.
12. Updates to me at any time by email/mail (QTHR 2002).

confers an unreasonable advantage.

If you regularly go portable to a different "region", you can keep a separate tally for the /p operation.

There is no minimum number of squares to start - you don't need to have 50 squares on 2m! Please enter at any

level so that we may all enjoy watching the growth of your tally.

No correspondence will be entered into by me regarding the veracity of people's claims. If you want more details from someone, please email them privately and not through the Reflector.

Guy VK2KU, vk2ku@hermes.net.au

Gridsquare Standings at 4 March 2002

144MHz	Terrestrial	VK2TG	Bob	19	VK2KU	Guy	28	VK2DXE/p	Alan	2	VK6KZ	Wally	4	5.7GHz			
VK2ZAB	Gordon	70	VK4DFE	Chris	19	VK3BJM	Barry	28	VK3DMW	Ken	1	VK3KEG	Trevor	3	VK3FMD	Charlie	7
VK3BRZ	Chas	62	VK6KZ	Wally	19	VK3ZLS	Les	27				VK3YB	Phil	3	VK3WRE	Ralph	6
VK2KU	Guy	61	VK3TLW	Mark	18	VK2DVZ	Ross	25	1296MHz			VK2DXE/p	Alan	2	VK3KAI	Peter	5
VK2DVZ	Ross	58	VK2TK	John	17	VK3TMP	Max	25	VK2ZAB	Gordon	25	VK3BVP	Shane	2	VK6KZ	Wally	4
VK2FLR	Mike	54	VK3AL	Alan	17	VK3BDL	Mike	24	VK2KU	Guy	19	VK3CY	Des	2	VK3BJM	Barry	2
VK3TMP	Max	53	VK3YB	Phil	16	VK3CY	Des	23	VK3EK	Rob	19	VK2CZ	David	1	VK6BHT	Neil	2
VK3EK	Rob	51	VK6KZ/p	Wally	16	VK3KAI	Peter	23	VK3KWA	John	19	VK3DMW	Ken	1	VK3XLD	David	1
VK3CY	Des	50	VK3DMW	Ken	13	VK2MP	Rej	22	VK3XLD	David	18						
VK3BDL	Mike	48	VK2DXE/p	Alan	10	VK3WRE	Ralph	21	VK3BRZ	Chas	16	2.4GHz			10GHz		
VK3XLD	David	47	VK2TWO	Andrew	5	VK3CAT	Tony	14	VK3FMD	Charlie	15	VK3WRE	Ralph	8	VK6BHT	Neil	9
VK3ZLS	Les	47	VK2CZ	David	1	VK4KZR	Rod	14	VK2DVZ	Ross	13	VK3KAI	Peter	7	VK3FMD	Charlie	6
VK2MP	Rej	45				VK7MO	Rex	14	VK3BDL	Mike	12	VK3EK	Rob	4	VK6KZ	Wally	5
VK3FMD	Charlie	45	144MHz	EME		VK3KEG	Trevor	13	VK3BJM	Barry	11	VK3FMD	Charlie	4	VK3EK	Rob	4
VK2DXE	Alan	43	VK2FLR	Mike	85	VK3TLW	Mark	12	VK3KAI	Peter	11	VK6KZ	Wally	4	VK3KAI	Peter	4
VK3BJM	Barry	41	VK3CY	Des	66	VK6KZ	Wally	12	VK3TMP	Max	11	VK3BJM	Barry	3	VK2EI	Neil	2
VK3CAT	Tony	39	VK2KU	Guy	21	VK2TK	John	11	VK3WRE	Ralph	11	VK4KZR	Rod	2	VK3BJM	Barry	2
VK3KAI	Peter	39	VK3KEG	Trevor	3	VK3AL	Alan	10	VK3ZLS	Les	9	VK3TLW	Mark	1	VK3TLW	Mark	1
VK3WRE	Ralph	37	VK2DVZ	Ross	2	VK3ANP	David	10	VK4KZR	Rod	9				VK3WRE	Ralph	1
VK3KEG	Trevor	36				VK6KZ/p	Wally	8	VK7MO	Rex	9	3.4GHz			VK3XLD	David	1
VK4KZR	Rod	29	432MHz			VK2TG	Bob	7	VK2TK	John	8	VK3KAI	Peter	4			
VK2EI	Neil	28	VK2ZAB	Gordon	46	VK3KME	Chris	7	VK3TLW	Mark	8	VK6KZ	Wally	4	24GHz		
VK6HK	Don	28	VK3BRZ	Chas	45	VK3YB	Phil	6	VK3AL	Alan	7	VK3EK	Rob	3	VK6BHT	Neil	3
VK7MO	Rex	27	VK3XLD	David	43	VK2CZ	David	3	VK6KZ/p	Wally	5	VK3FMD	Charlie	3	VK2EI	Neil	2
VK4TZL	Glenn	25	VK3FMD	Charlie	34	VK2TWO	Andrew	3	VK2MP	Rej	4	VK3WRE	Ralph	1	VK6KZ	Wally	2
VK3KME	Chris	20	VK3EK	Rob	30	VK4DFE	Chris	3									

Additions, updates and requests for the guidelines to Guy VK2KU, VK2ku@hermes.net.au, or by mail (QTHR 2002). Next update of this table will be around 9 May 2002. Stations who do not confirm their status for more than 12 months may be dropped from the table.

VHF/UHF AN EXPANDING WORLD

David K Minchin VK5KK

Postal: 10 Harvey Cres, Salisbury Heights, SA, 5109

E-mail: tecknolt@ozemail.com.au EMAIL ADDRESS CHANGED!

Web page: <http://members.ozemail.com.au/~tecknolt>

Fax: +61 8 82924501

Phone: 0403 368 066 AH only

All times are in UTC.

VK2 and VK4 to ZL 144 – 432 – 1296MHz!

After a lack luster Tropo Summer period, VK2 & VK4 have had a good tropo opening to New Zealand. Doug Friend, VK4OE reports ... when looking at the weather map on the Monday evening news (18th March), the possibility of imminent trans-Tasman propagation was obvious. However, with Tuesday being a very busy day for me both at work and all evening, it was only around 11pm on Tuesday evening that I read on the VK-VHF Reflector the first reports of hearing beacons and contacts being had from VK2 to ZL on 2 m and 70 cm. Checking the Hepburn tropospheric propagation indicator site confirmed this. But, Hepburn's 'machine' forecast for Wednesday the 20th (UTC) was showing a particularly startling red and orange 'band' from Southern VK4 to Northern ZL.

From my home location, terra firma obstructs propagation to ZL, and I knew from previous experience that if I were to be successful I would have to go out portable. On Wednesday morning I learned from local VK4's that on 2 m they had been working stations in Northern ZL, even as far as the Hamilton area South-East of Auckland and the Taranaki province well South of Auckland. So during the day I arranged for Trevor VK4AFL to ring me at work if the band looked still to be promising. Sure enough, around 4:00 pm local time (0600 UTC) Trevor telephoned saying that "the bands are wide open to ZL!" After arranging to leave work early, by 5:30 pm I was setting up my portable equipment on the eastern slope of Mt Coot-tha in Brisbane.

Immediately Nick ZL1IU [RF65VQ] was 5x9 just using only 25 W to my trusty old halo antenna. A few minutes later, after elevating the 70 cm and 23 cm antennas, an easy contact on 432.1

MHz at 5 x 7 to 9 signal strength was had with Nick. We made many further short QSOs over the next three hours on 2 m and 70 cm. Several other Brisbane VK4's were present, struggling sometimes with signal strengths. This confirmed that the preferred location to be was an elevated one. During this time, Nick could also be heard working several VK2s.

Nick is located in a prime position in ZL well towards the northern tip of the country's North Island. That's actually quite a way North and West of the high amateur population Auckland area. I suspect that if I had had a beam on 2m, I would have completed contacts with stations in that area, but my intended focus was on higher frequencies. [I did have equipment available for 2.403 GHz and 10.368 GHz, but no one was available/contactable in ZL to do those tests.] On 70 cm I was using around 20 W to a 21-el yagi and on 23 cm I had around 10 W to a 55-el loop yagi ready to use.

After telephoning Vaughan ZL1TGC in Auckland, the message quickly spread that I was out portable and set up for higher bands. Soon Keith ZL1AVO telephoned to say that he was listening and calling for me on 1296.1 MHz. It was a simple case of tuning and he was there, not very strong (QSB from unworkable up to 4 x 1) but enough for us to complete the contact (0905 to 0915Z). At about 2,250 km it wasn't a new distance record, but a truly memorable contact!

The fun of listening to a weak VHF/UHF station from so far away is unbeatable and tantalizing! [All the more on microwave frequencies!!] At 0943Z ZL1AVO and I made contact again on 23 cm, this time with signals up to 5 x 2. Apparently, the path had become significantly easier as time went on, but not for me to ZL on 2 m with my

simple halo. There is a limit! Next time, I'll take a beam for 2 m as well!!

Around 8 pm (1000Z) Nick ZL1IU was heard to be working stations on 144 MHz in Hervey Bay (240km N of Brisbane) and even Yeppoon (530 km N of Brisbane) QRB around 2,600 km. John, VK4AJS in Yeppoon was hearing ZL1IU on 432.1MHz at about 5 x 1, but the QSO was not completed. That would have been a new VK4 distance record for this band...better luck next time! Some contacts were being had from Brisbane to ZL1IU on Thursday morning, but during the day the weather system moved on and we said good-bye to another one of these amazing incidents of extended VHF/UHF. 73s Doug VK4OE

Gordon VK2ZAB reports ... it has happened at last!! Stations worked by VK2ZAB on 19/03/02, 0227Z ZL1IU at Kaikohe on 2 m SSB 5/3 5/3, 0232Z ZL1IU on 70 cm SSB 5/3 5/3, 0254Z ZL2WSP at New Plymouth on 2m SSB 5/3 5/3, 0255Z ZL2WSP on 70cm SSB 5/1 5/1, 0301Z ZL2TAL on 2m SSB 5/2 5/3, 0310Z ZL2TE on 2m SSB 5/3 5/5, 0314Z ZL2VAL on 2m SSB 5/4 5/5, 0437Z ZL1TPH at Orema on 2m SSB 5/2 5/5, 0546Z ZL1TBG at Warkworth on 2m SSB 5/2 5/2, 0613Z ZL1AVZ at Auckland on 2m SSB 5/3 5/5.

Signals were generally stronger late in the day and early evening. ZL1IU got to S9. The duct formed further to the north as the evening approached and ZLs were working into VK4 at that time. At least a dozen VK stations were heard participating ... Gordon VK2ZAB.

From Port Macquarie, Neil VK2EI reports ... 18.3.02Z 2038 Gordon VK2ZAB alert Hamilton beacon audible. 5/1p at VK2EI. Both Auckland & Hamilton beacons audible with QSB all morning. No response to frequent CQs 19.3.02Z 0105 ZL2WSP Stu 5/2-5 5/

2-5. Responded to Guy VK2KU Reflector alert, 0138 ZL2TAL Ray 5/3-4 5/3 Alerted by Stu, Had to crank up his tower! 0227 ZL2TE Sid 5/2-3 5/2, 0253 ZL1IU Nick 5/1 (Not completed), 0311 ZL1IU 5/2 5/1, 0312 to 0433 Numerous contacts with ZL2WSP, 2TAL, 2TE, 1IU, 0435 ZL2VAL Alan 5/2 5/2, 0536 ZL1TPH/P Steve 5/3 5/5 Orewa, 0548 ZL1TPG Ralph 5/3 5/2 Warkworth, 0606

50 MHz Report

Ray VK4BLK at Yeppoon reports ... Latest DX report as follows 24/2 0946 DL7QY S549 R559, 28/2 0942 PA4PA 549 539, 1012 SP6GZZ 539 559 2/3 0904-1008 LZ, UR, 9A, YU, ES & CT 31 CW QSOs. 7/3 0027 D44TA 55 58, 8/3 0121 D44TD 55 55, 12/3 0616-0931 EX, UN, YT, I, G, OE, OM & S57 17 CW QSOs 16/3 0135 D44TD 54 54 ... 73 Ray VK4BLK

Bevan VK4CXQ reports ... a bit more on my activities as mentioned by Ted G4UPS in the March AR

Most activity with Europe started

EME Report

Doug VK3UM reports ... I managed to get on from 1200 -1345 UTC on the 23rd and worked (all random) RA3LE 55n 55n, S52CW 54n he disappeared after coming back?? SM2CEW 54n 56n, and SP6OPN 43n 55n. I heard HB9Q (55n) calling ZL1IU for ages (nothing heard here also) as well as OE5JFL (56n) and J11NNJ (33n). Faraday seemed consistent (about 80 degrees) with noticeable libration at about 10 degrees El when I almost fell asleep at the key. I subsequently gave it away before my moon set! I came on for moon rise at

VHF Activity!

After firing an "Exocet" at the lack of VHF contributions last month we seem to be back on track . thanks to some tropo propagation too! As suspected the bands are active. Gordon VK2ZAB reports ... I have been through my log for the 30-day period to 17/3/2002 and extracted the following list of stations worked on 2 m SSB with the distance and number of times worked (brackets) hundreds of contacts!

VK1BG 260 km (19), VK1BUC 260km (14), VK1ZQR 260km (14), VK1GL 260km (1)

VK2 KU 100 km (27), VK2BXT < 100km (16), VK2ZCV at 290 km (27),

ZL1AVZ Brian 5/8-9 5/7 Muriwai (West of Auckland), 0724 ZL1BK/P Harry 5/4 5/8 Auckland FT817 4 W to 7el beam!! 0751 ZL1IU 5/8 5/5, 0857 ZL1AKW Dave 5/5 5/3-4 Tauranga, 0909 ZL1AVZ 5/9 5/9. 1925 ZL1TPH Dave 5/2 5/1 Home station.... previously portable, 1926 ZL2TAL 5/3 5/3, 1952 ZL2WSP 5/4 5/3, 2110Z Auckland beacon 5/6 and Hamilton 5/3.

about mid Feb with EH QSOs and some YTs, OMs and a welcome EH9. Some JAs & VRs crept in and a VU2 also. 18 Feb some Gs and an OY9 (Feroe Is), GMs and GWs. 20 Feb onwards it got busy with Italy, Bulgaria, Malta Yugoslavia, Poland, Slovak, Cyprus, Germany, Slovenia and & Czech QSOs 24 Feb was busy with 78 QSOs into EU including Ukraine, Belarus, Macedonia, Croatia, Switzerland France and Austria as well as the others mentioned above. Things quietened down for the next few nights but on 28th came back with Gs, PAs, DJs,

0825 UTC on 24th and only found Toshi JA6AHB 55n 54n on. We both called for ages with no response and gave it at about 0900. Pretty quiet for an activity weekend but I guess the weather in Europe was not very good and of course it was pretty dark (early in the morning) on the other side of the pond for my moon rise!!

During the course of the month I received approval (under the new licensing conditions in VK) from our authorities (Australian Communication Authority) with respect to my high

VK2EI at 290km (28) VK2BRG at 410 km (3), VK2ZRE at 340 km (15), VK2KWM at 330 km (1), VK2MP at 240 km (16), VK2AES at 240 km (3), VK2BDT at 190 km (3) VK2FLR < 100 km (5), VK2XKE <100km (8), VK2TQP at 415 km (16) out of 30 days, VK2AAS < 100 km (2), VK2AAS/p at 198 km (6), VK2BA at 390 km (12), VK2YO at 640 km (1) VK2DVZ at 230 km (10) VK2IJM < 100 km (8), VK2ZVF <100km (1) VK2TK <100km (10) VK2JDR <100km (4), VK2TG <100km (8) VK2KEP <100km (3) VK2EM at 120 km (1), VK2YFM <100 km (1), VK2ZBD <100km (1), VK2DCJ <100km (1)

Notes: Contacts from 0730Z on reduced my power to 12 W to reduce TVI. The Auckland & Hamilton beacons audible majority of the time, no others heard. Stu advised New Plymouth beacon off air due RFI to Garage Door opener!! Total worked 11; new contacts 8 and only 1 new grid square ... Neil VK2EI

SPs, OKs, OMs, Fs and a few JAs again.

March started with EX8MLT, UK9AA then the EU countries again March 2nd had 96 QSOs with EU and RW & RU and T9 and CTs March 3 - 45 EU QSOs inc 7 SVs almost one after the other. From 3-16 conditions changed and about 50/50 Asian/ EU QSOs ending with a nice HZ1MD QSO

From mid Feb to mid March about 400 QSO were logged on 6 Metres, 90% were EUs and 10% Asia Pacific Nothing into Nth/Sth America as yet - maybe next month ... Bevan VK4CXQ

power permit for both 70 and 23 cm. This followed considerable (and detailed) measurement procedures and independent accreditation of radiation levels under the Australian Standard AS2772. The permit is for celestial experiments only and allows me 1500 watts on 70 cm and 750 watts output on 23 cm in association with the dish gain and other fixed losses. It is the first (and currently only) high power permit issued in VK under the new licensing conditions ... Doug VK3UM

VK3AJN at 530 km (13), VK3II at 725 km (20), VK3KEG at 740 km (17), VK3ANP at 540 km (2), VK3TDV/p at 380 km (2)

VK4AFL at 690 km (2), VK4DFE at 780 km (7), VK4AML at 715 km (14), VK4KK at 715km (1)

Then there was Barry VK3BJM who was contacted on several occasions between Melbourne and Sydney at all sorts of distances and sort of, maybe, partial contacts with Melbourne Stations VK3AFW and VK3FMD. In addition many of the 2 m stations were also worked on 70 cm SSB. VK4AML on 8 occasions for example ... Gordon VK2ZAB

WSJT

Rex VK7MO reports ... Joe Taylor, K1JT, has now produced a beta version of WSJT with an additional mode for tropo. It has similar objectives for weak signal tropo and EME as PUA-43, although not compatible with it, and is called JT44. It does not require the special receiver as for PUA 43 and appears to overcome the requirement for accurate timing by sending a synchronization tone in the first 15 seconds and 22 characters of information in the second 15 seconds.

John Moyle Field Day 2002

Chas VK3BRZ reports ... what a great weekend's activity the John Moyle field day turned out to be. The amount of interest in VHF/UHF SSB came as a surprise. We didn't even drag out the HF rig; such was the activity on VHF/UHF! I hope the VHF DX bug bit some of the tyros out with their clubs hard!

We (VK3ATL/p QF21CU) experienced sustained tropo ducting in all directions. The Mt. Gambier, Adelaide, Mildura,

Microwave Round up

Another reminder that the 2002 Gippsland Technical Conference (GippsTech) will be held at the Gippsland Campus of Monash University, located in Churchill, on the weekend of July 6 & 7. The conference's focus is on all topics of relevance to amateurs interested in amateur VHF, UHF and Microwave communications. The conference location is about 2 hours drive east of Melbourne. For further information have a look at <http://www.qsl.net/vk3bez/index.htm> or contact Peter VK3KAI (QTHR).

10 GHz Hotel Portable!

During a visit to Adelaide, Doug VK4OE brought with him his homebrew 144/2403/10368 transceiver. This must be the most compact 3 in one microwave unit around measuring approximately 350mm x 100mm x 300mm. Based on an IC202 (gutted and rebuilt into the case) the unit puts out 5 watts on 144MHz, about the same on 2403 MHz and 1 watt from a G3WDG transverter with a Qualcomm PA. Doug has travelled with this same unit through

It uses the same 43 character "alphabet" as PUA-43 and sends each character as a separate tone spaced 10.77 Hz apart from 1270.5 to 1755.0 Hz.

While I have not yet found anyone to work the background info suggests it will work to -20 dB compared to an SSB bandwidth of 2500 Hz in 30 second segments and to -27 dB with signal averaging over 20 minutes. Thus it should do around 30 dB better than SSB.

The beta version is available at the

following: First read the file <http://pulsar.princeton.edu/~joe/K1JT/BETA192.TXT> and then download the program at <http://pulsar.princeton.edu/~joe/K1JT/BETA192.ZIP> The new version also provides some improvements for FSK441 for meteor scatter. You can switch between JT44 and FSK441 by clicking a button. Sounds like it will be interesting to try ... Rex, VK7MO

Nimitabel and Launceston 2m beacons were audible throughout the contest period. Notable 2m contacts included VK5ARC on 2m, VK5ACY (Kangaroo Is. PF84) and VK7KPB (Flinders Is), the latter two after the end of the contest period, but nevertheless welcome additions to our logbook. VK7KPB was also worked on 70cm.

Many thanks to Barry VK3BJM for QF14 on 23cm, the first new grid I've worked for over a year, on any band. (By the way Barry, our second attempt at 23cm late Saturday evening failed due to our 23cm battery supply having died! A battery voltage monitor/alarm is currently being designed ... Chas VK3BRZ

New VK Microwave records

3.4 GHz and 5.7 GHz VK2 and VK4 records for both bands: VK3ZQB/2 and VK4ZHL/2 to VK5DK/4 and VK3XPD/4, 12/01/02, 380.9 km.

10 GHz VK2 record: VK2EI/2 to VK3ZQB/4 and VK4ZHL/4, 12/01/02, 331.3 km. This record then is supplemented by a new VK2 and VK4 record: VK3ZQB/2 and VK4ZHL/2 to VK5DK/4 and VK3XPD/4, 12/01/02, 380.9 km.

24 GHz VK1 record: VK1BUC/1 and VK3ZQB/1 to VK3XPD/2 and VK5DK/

2, 18/01/02, 51.2 km. This record was then extended later in the same day to 59.7 km. VK4 record: VK3ZQB/4 and VK4ZHL/4 to VK5DK/4 and VK3XPD/4, 08/01/02, 74.0 km. VK3, VK5 and national record: VK3ZQB/3 to VK5DK/5, 25/01/02, 200.8 km.

Mobile Records: There are two new national mobile records: 3.4 GHz: VK3KAI/M to VK3EK, 19/01/02, 124.7 km 5.7 GHz: VK3KAI/M to VK3FMD/3, 19/01/02, 103.3 km. 10 GHz: VK3KAI/M to VK3EK, 19/01/02, 124.7 km.

In closing

For something completely different have a look at some of the "Cartoon" artwork found under microscope on Integrated Circuit substrates <http://micro.magnet.fsu.edu/creatures/index.html> since the late 60's it looks like the various IC engineers have been leaving their own "personal" graphics on production ICs!

Between writing this column and the next I will be overseas. I'll leave you with this thought. "People who snore fall asleep first!"

73s David VK5KK

HF Predictions

by Evan Jarman VK3ANI

34 Alandale Court Blackburn Vic 3130

These graphs show the predicted diurnal variation of key frequencies for the nominated circuits.

These frequencies as identified in the legend are:-

- Upper Decile (F-layer)
- F-layer Maximum Usable Frequency
- E-layer Maximum Usable Frequency
- Optimum Working Frequency (F-layer)
- Absorption Limiting Frequency (D region)

Shown hourly are the highest frequency amateur bands in ranges between these key frequencies, when usable. The path, propagation mode and Australian terminal bearing are also given for each circuit.

These predictions were made with the Ionospheric Prediction Service program: ASAPS Version 4

April
2002

T index: 106

Legend
 UD
 E-MUF
 F-MUF
 OWF
 ALF
 >10%
 >50%
 >90%
 Time scale

Adelaide-Moscow 318

First F 0-5 Short 13807 km

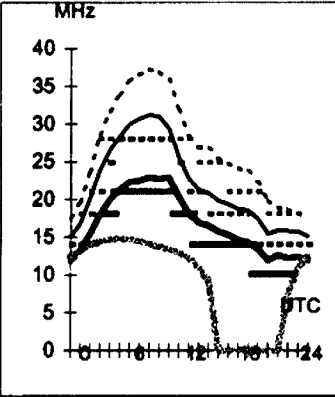

Brisbane-Berlin 321

First F 0-5 Short 15678 km

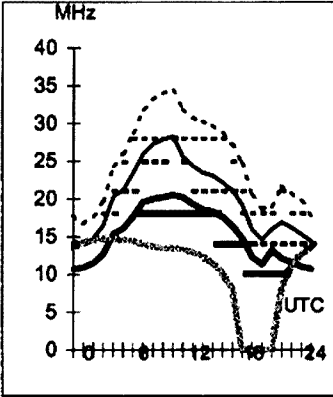

Adelaide-Osaka 357

Second 3F5-10 3I Short 7746 km

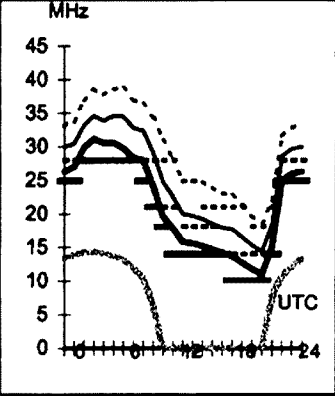

Brisbane-Cairo 288

First F 0-5 Short 14390 km

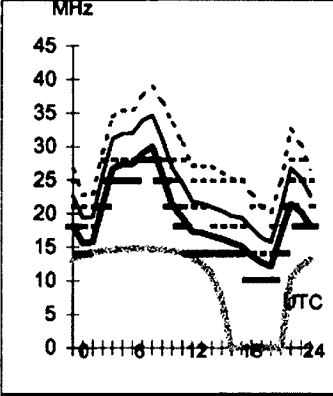

Canberra-Auckland 102

Second 2F21-24 2 Short 2300 km

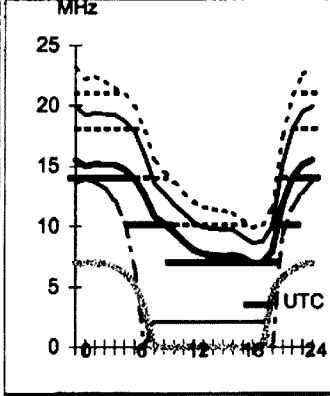

Darwin-London 145

First F 0-5 Long 26171 km

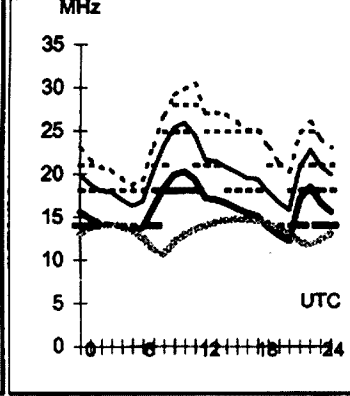

Adelaide-Pretoria 238

Second 4F5-7 4E Short 10064 km

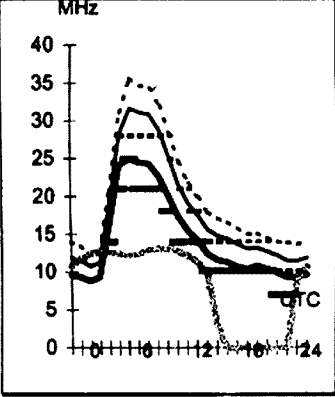

Brisbane-Noumea 70

First 1F15-19 1E Short 1472 km

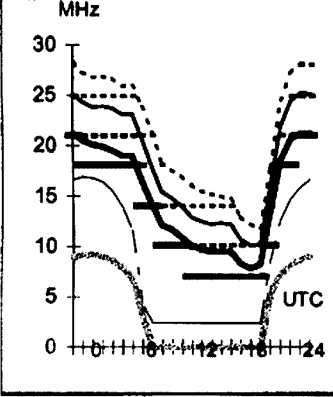

Canberra-Capetown 219

Second 4F4-6 4E Short 10778 km

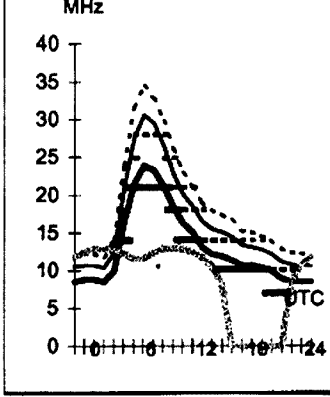

Darwin-London 325

First F 0-5 Short 13853 km

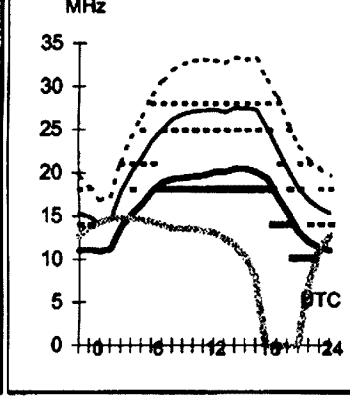

Adelaide-Seattle 51

First F 0-5 Short 13413 km

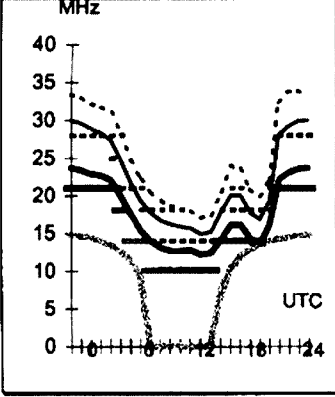

Brisbane-Singapore 293

Second 3F9-14 3I Short 6147 km

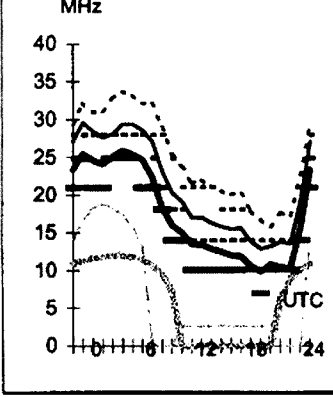

Canberra-Manila 327

Second 3F8-15 3I Short 6286 km

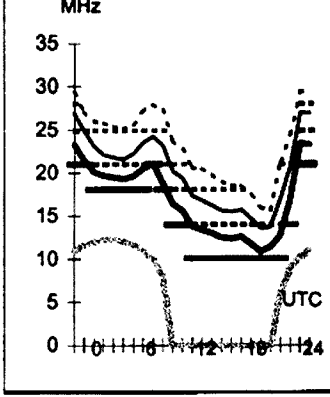

Darwin-Riyadh 295

Second 4F5-13 Short 10000 km

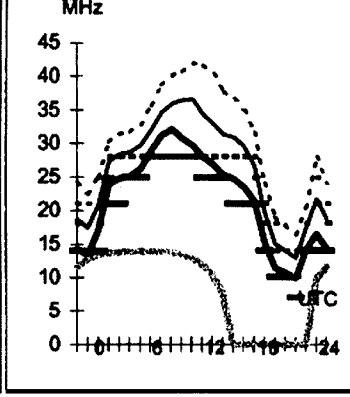

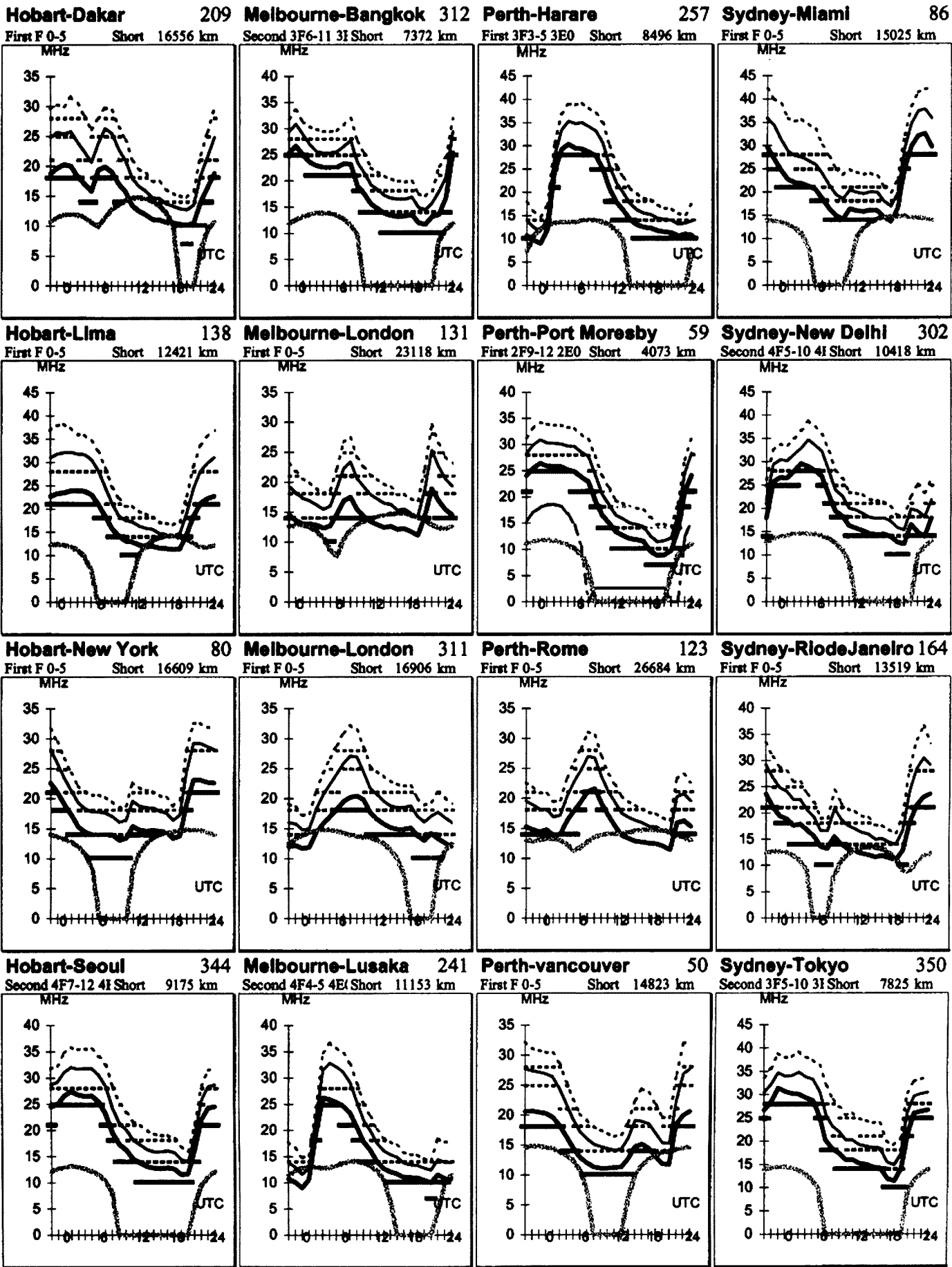

HAMADS

- Hamads may be submitted by email or on the form on the reverse of your current Amateur Radio address flysheet. Please print carefully, especially where case or numerals are critical.
- Please submit separate forms for For Sale and Wanted Items, and be sure to include your name, address and telephone number (including STD code) if you do not use the flysheet.
- Eight lines (forty words) per issue free to all WIA members, ninth and tenth lines for name and address. Commercial rates apply for non-members.
- Deceased estates Hamads will be published in full, even if the ad is not fully radio equipment.
- WIA policy recommends that the serial number of all equipment for sale should be included.
- QTHR means the address is correct in the current WIA Call Book.
- Ordinary Hamads from members who are deemed to be in general electronics retail and wholesale distributive trades should be certified as referring only to private articles not being re-sold for merchandising purposes.
- Commercial advertising (Trade Hamads) are pre-payable at \$25.00 for four lines (twenty words), plus \$2.25 per line (or part thereof), with a minimum charge of \$25.00. Cheques are to be made out to: WIA Hamads.
- Copy should be typed or in block letters, and be received by the deadlines shown on page 1 of each issue of Amateur Radio, at:

Email: newsletters@ozemail.com.au **Fax:** 03 9756 7031

Postal: Newsletters Unlimited, PO Box 431, Monbulk Vic 3793

Please send your Hamad by ONE method only (email preferred)

FOR SALE NSW

- Two power supplies "Power-Tech" 10A 13.8V \$110, and "Ferguson" 2A 13.8V cont. \$35. Contact David VK2AIF QTHR. Phone 02 6586 4980
- Lower mast winch, all associated antenna. Remove premises. Offer. No charge. Complete station, all YAESU equipment, including manuals. Ross VK2AIH. Phone 02 9521 4475
- Shortwave receiver R-390A, good overhauled cond. \$450. VK2EDD Phone 02 4982 9847
- YAESU FT-847 #86060458. Mint cond., manual. Original carton. HF/VHF/UHF. \$2500. Les VK2KLD QTHR or Phone 02 4297 2737 or 0419 295 371
- Station close down. YAESU FT-707 xcvr with WARC bands, YAESU FP-707 power supply, YAESU YM34 desk mike, SX200 Diamond swr/ power meter 1.8 to 200 MHz, EAT-300 EMTRON antenna tuner, PALOMAR tuner, YAESU FT-212RH mobile 2m xcvr, PACKRAT PK-232 MBX packet control with computer disc and all cables used twice, YAESU World Clock. Wooden Hutch 1299mm L X 750 mm H X 300mm D fitted with 13.8v power points and earthing points. All equipment mounts in this hutch. All equipment in perfect condition. Will throw in PHILIPS FM-828 good condition, FU400 COMANDER antenna rotator 400 lbs vertical loading. The lot \$1700. Charles VK2NAJ QTHR Jindabyne Phone 02 64561646
- Power supply. DICK SMITH Lab Power K3206, variable to 40 volts (-20,+20) 3 amps. Adjustable current limit. Volt & current meters. Brand new never used, \$200 ONO. VK2AS QTHR Phone 02 9416 7784
- KENWOOD TS-50 HF Amateur Transceiver with AT-50 Tuner, c/w Mic, All Cables, H/Books, Mobile Mount & Hardware etc, in Original Packing. VGC. \$1500 ONO. Peter VK2APP Phone 02 6382 6086. pcpage@draget.com.au

- YAESU 757-GX xcvr. faulty memory and tx, audio rough, receiver OK \$350. YAESU FT-707 xcvr, rough tx audio, receiver OK \$300. George VK2DJR QTHR Phone (02) 66874807. Email: gbud@dnet.aunz.com
- Estate of Peter Campbell VK2AXJ. MFJ1278 Multi Mode Data Controller, GC, \$200. CHY 8220G Universal Counter, GC, \$100. Packet Modem, BLAK PAK, GC, \$50. TNC PAC COMM Tiny2, GC, \$150. YAESU FT-26 2m HH, spare batt pack, FC, \$200. Power supply ETI Dual Rail, GC, \$50. Scanner REALISTIC Pro 2021, FC, \$100. Noise bridge OMEGA-T TE7-01, GC, \$25. Receiver KENWOOD R-2000, GC, \$350. Mic YAESU MH14, GC, \$25. YAESU FT-757GX HF, GC, \$550. YAESU Auto ATU FC-757AT, GC, \$250. ATU MFJ498 Versa Tuner, GC, \$100. Solder station WELLER WTCPN, GC, \$100. Power supply JAYTECH MP088 30A, GC, \$300. PHILIPS PRM80, UHF, not working, \$20. YAESU FT-212RH 2m, GC, \$300. YAESU FT-3000M 2m GC, mic, \$200. BWD 539A 5" Dual trace Scope, GC, \$100. Solder station UNGAR 9900, FC, \$50. VARIAC YOKOYAMA SB10 2kVA 10A, FC, \$50. FLUKE DMM 8022, GC, \$100. Antenna SCALAR 2m 5/8, HB GP, Fair only, \$20. Antenna KINGRAY. 27MHz marine, no base, fair, \$10. All Serial numbers available, major items with manuals. Stan VK2EL, QTHR Phone 02 4455 5825. email: sbourke@shoal.net.au
- WARBIRD displays: Rxs, Txs, modulators, racks, mounts, remotes, some complete Command setups as used in WWII operations. Brian, VK2GCE, 02 9545 2650 or [preferred] brianclarke@idx.com.au
- Datasheets on the following sub-miniature valves. (Alternative type numbers in brackets): JG-6111 (JRP-6111), JAN-5899 (CF-477), JAN-6021 (JRP-6021), JHS-5718, EF72 (CV-465), CV469. Will pay reasonable photocopying and mailing costs. Contact Pat Brennan VK2ABE, PO Box 158, Tamworth NSW

WANTED NSW

FOR SALE VIC

- WARBIRD displays: Rxs, Txs, modulators, racks, mounts, remotes, some complete Command and Radar setups as used in WWII operations. Bill, VK3AQB Phone 03 9337 4902 or jikajika@net2000.com.au
- KENWOOD TS-711A 2m all mode transceiver, VGC with operating manual, hand mike and service manual \$600 ONO. Damien VK3RX Phone 03 5427 3121.
- KANTRONICS KPC-3 packet communicator. New, unused, boxed. \$120. DATONG RF speech processor, wired for 8 pin Icom. \$60. Power supplies. 3.5 amp \$30. 3.5 amp metered \$35. OSKERBLOCK SWR-145 VHF 5/ 25/ 250 watt power/SWR meter \$100. KENWOOD DM-81 dip meter, as new, boxed, \$75. Ron VK3OM QTHR. Ph. 03 5944 3019.
- MILITARY Equipment. ARB receiver 150kHz -9 MHz complete perfect condition, tuning head, control box all cables and tuning shaft. No mods. Also comes with ARR-1 type UHF homing receiver with hard to get plugs and accessories. Probably most complete example operating in Oz. \$490. BC-348 N Original complete with DM 28 dyno. No holes or mods and with original wiring. Front panel refinished. Photo available. \$480. BC-342 N. perfect condx. no holes and as ground/mobile rx has original 115 AC power supply builtin in lieu of dyno. \$360. OS-4B/AP Navy radar/Oscilloscopes, new with manuals and cables 2 available, \$60 each. Collins avionic HF xcvr 618T-3. no cables or plugs. \$450. Freight extra. VK3IZ fax 03 5156 2049 email; jupeter@datafast.net.au QTHR.
- Clearance: ICOM IC-27A 2m xcvr in box + extras \$250: MFJ1278T \$300. MFJ1274T \$200. MFJ931 Artificial Ground \$95. TIMEWAVE DSP9 \$200: KENWOOD MC80 Base Mic \$100. UNIDEN HR2510 with chipswitch \$350. Tower wind-up 60ft \$400. YAESU FC-700 ATU \$120. Phone David VK3NDS Phone 0419 357 104 or email dcsimpson@optushome.com.au

WANTED VIC

- 6 metre solid state linear, anything considered. Peter VK3DU Phone 03 9379 3626
- Type 955 acorn tube for "Measurements" model 59 megacycle meter. Prefer swap something I've got, you need. Drew VK3XU QTHR. Phone 03 9722 1620
- Desperately seeking for Wireless Set No 11 - One three pin male chassis power socket (triangular pattern with two big pins) and two female plugs to suit. A Press To Tune switch (S5A) and Pull For RC switch (S6A). Rectangular black bakelite front panel 3 hole jack cover (labelled PHONES and LINE). One brass nameplate for LP PSU. One PSU case with or without power supply chassis (HP or LP unit). Clem VK3CYD Phone 03 5126 2064 clem@dcsi.net.au

FOR SALE QLD

- Transformer 3000 volts CT 250 mA multi tap 240 V Primary. Also 4500 V CT plus 3000V CT 500 mA and 1 amp. Primary 110 V and 220 V multi taps. Tropical sealed metal case. Valves 2 off EIMAC 100TH. Best offers. VK4UA Phone 07 5546 7041.
- YAESU FT-757 GX HF All mode Transceiver with scanning hand microphone, DC lead, technical manual, excellent condition \$500.00. CUSHCRAFT AV-5 Trapped HF Vertical antenna, as new with full owners manual \$350.00. ICOM HM-98 Deluxe DTMF scanning hand

microphone, new in box \$65.00. YAESU MUSEN FP-301 HD Heavy Duty Power supply for 150 watt output transceivers. 30 A plus, built in communications speaker \$395.00. KENWOOD PG-3B Noise Filter \$35. PG-2N DC Power Cable \$25.00. MB-201 Mounting Bracket \$30.00 All items new. Shure R5R Microphone Insert New \$45.00. Contact: John Abbott VK4SKY QTHR, Phone 0417 410 503, Email:johneabbott@hotmail.com

WANTED SA

• Has anyone a copy of May 1998 Amateur Radio they do not want. Will buy, pay postage. Do need it VK5BUJ. Murray, Phone 08 8738 0000 QTHR

• Wanted very urgently two chokes L151 and L237 for the restoration of an ASTOR TV model ESJ 17 inch B & W If you can supply these components PLEASE contact me at mgell@arc.com.au phone 08 8294 6906 VK5ZLC QTHR.

FOR SALE WA

• Australian Official Radio Service Manual Volumes 1 and 2 giving circuit diagrams and service information on all domestic radios produced in Australia for 1937 and 1938. In good condition. What offers? Contact John VK6JAH jah@ois.com.au

• 1.2 GHz! Yes, that's 1.2 GHz. YAESU FT-2311R mobile transceiver, 10W FM, offsets, memories etc, c/w mic & DC lead but no mounting bracket or book. Good condition and performance. Previously from deceased estate. Sensible offers please. John, VK6XJ QTHR Phone 08 9295 3333 or email jtuppen@q-net.net.au

WANTED WA

• Old general coverage valve communications receiver in any condition for a restoration project - especially HAMMARLUND SP600JX, RCA AR88, NATIONAL HRO or COLLINS 51J4. What 'boat anchor' receivers do you have gathering dust and rust in your garage? Steve Ireland, VK6VZ. Phone: 08 9298 9330 or email: sire@iinet.net.au

FOR SALE TAS

• YAESU FRG-7700 \$475. ICOM 207H (as new) \$525. UNIDEN 100 Scanner \$150. Kevin VK7YKR Phone 0417 514 802,

WANTED TAS

• ALINCO speaker-microphone unit EMS-9 or similar to suit DJ180-DJ480. Also wanted either a 50ch or 200ch memory to suit same. Other accessories also considered. Alternatively a YAESU FT-26 in going order. Rod VK7TRF QTHR. Phone 03 6227 8925, 0417 314 425.

<http://www.hamsearch.com>

a not-for-profit site that is a search engine for hams

ADVERTISERS INDEX

Com-an-tena.....	13
Elektron.....	8
G & C Communications.....	16
Icom.....	OBC
Strictly Ham.....	41
Tower Communications.....	26
WIA Call Book.....	IFC

TRADE ADS

PSK-31, SSTV, RTTY SOUNDBOARD INTERFACES

Fully isolated, ready to plug in.
<http://www.G3LIV.CO.UK>,
johnny@melvin.com, G3LIV QTHR.

AMIDON FERROMAGNETIC CORES:

For all RF applications. Send business size SASE for data/price to RJ & US Imports, PO Box 431, Kiama NSW 2533 (no enquiries at office please. 14 Boanyo Ave Kiama). www.catchnet.com.au/~rjandusimports

Agencies at: Active Electronics Tas; Truscotts Electronic World, Melbourne; TTS Systems, Tyabb; Tower Communications, Perth; Haven Electronics, Nowra.

HF, VHF, UHF ANTENNAS & ACCESSORIES

Alum towers, guys etc. Diamond VSWR/PWR meters. HD copper ant wire & insulators. TX tubes & pwr transistors. Quality coax cables & connectors. Free advice & catalogue. ATN Antennas Ph 03 5492 2224 Fax 03 5492 2666, email atnant@ruralnet.net.au

ITEMS FOR SALE TAS

2 only Microwave Link Units ex Hec, a trailer or ute required to pick these up, \$50.00 ea

1 only Icom IC-2800H service manual on CD ROM, \$30

1 only Toshiba T1900 monochrome 486SX laptop computer with 4Mb of RAM, 123Mb hard drive, very good condition \$150

1 only Toshiba TI 910 monochrome 486SX laptop computer with 4Mb of RAM, 123Mb hard drive, very good condition, \$150

1 only Toshiba T1960CS colour 486DX laptop computer with 4Mb of RAM, 123Mb hard drive, very good condition but no battery or power supply, "as is where is" \$80.00

1 only Toshiba Satellite Pro 410 Pentium laptop, CD ROM, external floppy drive, good battery, docking station and original carry bag, all in perfect condition \$800 ONO.

2 only ATN 11 element 477MHz UHF CB beam antennas with baluns, phasing harness and ATN power divider, all N connectors and mounted on spreader bar \$100 the lot.

1 only Telereader CWR-670E with manual all in good order \$50.

2 only Philips FM-900 base unit radios with digital clock and power supply, programmed for 2m \$150 each

1 only PacComm TNC-320 with manual \$100.

1 only MFJ Turbo Packet Radio Controller, model MFJ 1270B, brand new, never used \$100

1 only Icom IC-28A 2m transceiver with optional I-IM-14 DTMF microphone and tone unit also mounting bracket, manual and box, as new condition \$400. There is also a service manual available for this radio at an additional cost of \$30.00

"Hey, Old Timer..."



If you have been licensed for more than 25 years you are invited to join the

Radio Amateurs Old Timers Club Australia

or if you have been licensed for less than 25 but more than ten years, you are invited to become an Associate Member of the RAOTC.

In either case a \$2.50 joining fee plus \$8.00 for one year or \$15.00 for two years gets you two interesting OTN Journals a year plus good fellowship.

Write to

RAOTC,
3/237 Bluff Road
Sandringham VIC 3191

or call Arthur VK3VQ on 03 9598 4262 or Allan VK3AMD on 03 9570 4610, for an application form.

1 only Yaesu FT 2311R 1.2GHz mobile transceiver fitted with optional tone unit and comes with mounting bracket, manual and box mint condition \$400.

1 only Australian Military Forces A510 wireless station in very good condition and as far as I can tell is complete apart from the Morse key, whereabouts unknown \$300.

Service Manuals For Sale

1 only Kenwood TS-600.
1 only Kenwood TS-830S
1 only Kenwood RZ-1.
1 only Kenwood TM-201/D.
1 only Kenwood TW-410OA/E.
1 only Kenwood TS-850S
1 only Alinco DR-605T/E/Teirre.2.
1 only Alinco DJ-GLT/E.
1 only Alinco DJ-500T/E.
1 only Yaesu FT-470.
1 only Yaesu FT-3000M.
1 only Yaesu FT-900.
1 only Yaesu FT-ONE.

Instruction Manuals

1 only Kenwood TH-25A/TH-45A.
1 only Kenwood TH-751A/TH851A.
1 only Kenwood TS-700A.
1 only Kenwood TS-820S.
1 only Kenwood TS-180S.
1 only NEC CQ-110E HF-SSB.
1 only Yaesu FT-980.
1 only Yaesu FT-757GX
1 only Yaesu FT-ONE.
1 only Yaesu FC-301 Antenna Tuner.

All manuals are \$30.00 each regardless of type and size.

Contact David Spicer VK7ZDJ,
5A Helen St, Ulverstone, Tasmania.
Phone 03 6425 2030, 0413 219 680

TRADE PRACTICES ACT
It is impossible for us to ensure that the advertisements submitted for publication comply with the Trade Practices Act 1974. Therefore, advertisers and advertising agents will appreciate the absolute need for themselves to ensure that the provisions of the Act are strictly complied with.

VICTORIAN CONSUMER AFFAIRS ACT
All advertisers are advised that advertisements containing only a PO Box number as the address cannot be accepted without the addition of the business address of the box-holder or seller of the goods.

Mental Illness and The Amateur Code

The Amateur is Friendly...Slow patient sending when requested, friendly advice and counsel to the beginner, kindly assistance, cooperation and consideration for the interests of others; these are the marks of the amateur spirit.

Paul M. Segal *ARRL Handbook*
I would like to provide this information so that the Amateur Radio Fraternity might understand a bit about Operators who have a mental illness.

People who have mental illnesses are mostly harmless to others. They are more a danger to themselves, as they often reflect back onto themselves their many struggles trying to maintain a "normal" life, while coping with their illness. Some have repeated suicide attempts. Some of these sadly succeed.

Extreme sensitive, creativity, intelligence and the inability to cope with stress and emotional pain is very common with sufferers. Often the sufferer knows this. They then try at all cost to stay out of these situations, in case the situation triggers an episode.

Medical drugs are often used to control the person's symptoms. A "balancing act" has to be achieved by the Professionals, as the side effects of the medication can be worse than the illness. The sufferer may be turned into a mindless "blob" appearing lifeless, unmotivated, intoxicated. They may be generally very "unmoved" by events that ordinary people would relish over. If the balance of the medication is not correct the sufferer may have delusions, hallucinations-auditory-visual-smell and taste. Also the ability to concentrate for long periods of time is impossible. The simple job of adjusting an antenna tuner may take many short sessions but will be completed correctly.

Extreme depression may result, for example, if you handed a sufferer a million dollars they would just not want it. Then again they may appear overly happy about everything. Even events that are sad and traumatic to other people. They may also believe they are a "genius" in a field they have knowledge of eg delusions of being a genetic Engineer and creating, making plans, talking about engineering a plant

that will rid the world of Cancer is a good example. The discussions a sufferer will have appear to be very feasible though they will be very "over the top" for ordinary people.

Also when someone is delusional, obsessions with religion, constant praying and believing they have an ability to heal people of sickness are very common behaviours. In extreme situations the sufferer will believe he is God himself. The whole universe revolving around themselves. A very lonely place to be!

Routine in the life of someone with mental illness is very helpful. Amateur radio it is often a way of "holding on" to "the real world". The "shack" is a "castle" and, in cases of severe obsession, the gear has to be kept running near to perfection. If a piece of gear breaks down the sufferer will try and try to fix the problem to the detriment of his loved ones, family, friends and money. It may result in the person becoming "unstable" as "his world" appears to be threatened very badly. The operator may go to enormous extremes to "fix" the problem to "get back" to familiar ground.

You may encounter the operator of mental illness sounding vague and disoriented with slurred speech. A lot of these symptoms may be caused by the medication. The person is usually very aware of this and feels very "different" to others; often a "freak" and tires so hard to be "normal" like everyone else. They try very hard to "fit in", because they feel the need to be accepted by others and their peers. It can be so hard for them to just say: "Well you are a real LID for treating me that way on air" and throwing the "big switch".

Some sufferers may just give up!

How you can help?

Be honest with the operator. If the ideas presented appear above you, communicate this fact in a gentle manner. Try NOT to condemn the person and try not to ignore his efforts to be your friend/fellow operator.

People with mental illness are often very perspective and often "read between the lines" on the "thread" of a

conversation. Try and allow the person credence to their ideas, and try and respect their opinions on your ideas. Rejection is disastrous to a sufferer.

Often encouragement means SO MUCH! It may just give the person hope to face another hour, day, week, month etc.

If you find you are not "handling" their manner, maybe it's time you gently told them in a non-threatening way or "throw the big switch" and kick the dog. NOT the "Missus or kids!!"

Acceptance of their situation may be difficult at first. It is the key!

In time you will gain a true loyal friend, and you will gain a lot of patience and wisdom in learning that you have so much and so much more to give.

Thank you and 73s

Heinz VK3BEW @ VK3EEE

Email: vk3bew@iprimus.com.au for comments and feedback.

Note 1 Views expressed in the letters and opinion columns are those of the authors and do not necessarily represent the policy of the WIA.

2. Some of the letters may be shortened to allow more letters to be published.

Address letters to:

**The Editor
Amateur Radio
34 Hawker Crescent
Elizabeth East SA 5117**

or email:

edarmag@chariot.net.au

“Without the efforts of the WIA intruder watchers many of our frequencies would have been rendered useless a long time ago.”

**Ernest Hocking VK1LK
President, WIA**



Division Directory

The Amateur Radio Service exists for the purpose of self training, intercommunication and technical investigation. It is carried out by amateurs who are duly authorised people interested in radio technique solely with a personal aim and without pecuniary interest.

The Wireless Institute of Australia represents the interests of all radio amateurs throughout Australia. National representation is handled by the executive office under council direction. There is one councillor for each of the seven Divisions. This directory lists all the Divisional offices, broadcast schedules and subscription rates. All enquiries should be directed to your local Division.

Broadcast schedules All frequencies MHz. All times are local.

VK1 Division Australian Capital Territory,
GPO Box 600, Canberra ACT 2601
President Gilbert Hughes
Secretary Peter Kloppenburg
Treasurer Linden S Orr

VK1GH
VK1CPK
VK1LSO

VK2 Division New South Wales
109 Wigram St, Parramatta NSW
(PO Box 432, Harris Park, 2150)
(Office hours Mon-Fri 1100-1400)
Phone 02 9689 2417
Web: <http://www.ozemail.com.au/~vk2wi>
Freecall 1800 817 644
e-mail: vk2wi@ozemail.com.au
Fax 02 9633 1525
President Terry Davies
Secretary Pat Leeper
Treasurer Chris Minahan

VK2KDK
VK2JPA
VK2EJ

VK3 Division Victoria
40G Victory Boulevard Ashburton VIC 3147
(Office hours Tue 10.00 -2.30)
Phone 03 9885 9261
Web: <http://www.wiavic.org.au>
Fax 03 9885 9298
e-mail: wiavic@wiavic.org.au
President Jim Linton
Secretary John Brown
Treasurer Barry Wilton

VK3PC
VK3JJB
VK3XV

VK4 Division Queensland
PO Box 199, Wavell Heights, Qld. 4012
Phone 07 3221 9377
e-mail: office@wiaq.powerup.com.au
Fax 07 3266 4929
Web: <http://www.wia.org.au/vk4>
President Ewan McLeod
Secretary Bob Cummin
Treasurer Bill McDermott
Office Mgr John Stevens

VK4ERM
VK4YBN
VK4AZM
VK4AFS

VK5 Division South Australia and Northern Territory
(GPO Box 1234 Adelaide SA 5001)
Phone 0403 368 066
web: <http://www.sant.wia.org.au>
email: peter.reichelt@bigpond.com
President David Minchin
Secretary Peter Reichelt
Treasurer Trevor Quick

VK5KK
VK5APR
VK5ATQ

VK6 Division Western Australia
PO Box 10 West Perth WA 6872
Phone 08 9351 8873
Web: <http://www.vk6wia.org>
e-mail: vk6wia@inet.net.au
President Neil Penfold
Secretary Christine Bastin
Treasurer Bruce Hedland-Thomas

VK6NE
VK6ZLZ
VK6QO

VK7 Division Tasmania
PO Box 371 Hobart TAS 7001
Phone 03 6234 3553 (BH)
Web: <http://www.tased.edu.au/tasonline/vk7wia>
also through <http://www.wis.org.au/vk7>
email: batesjw@netspace.net.au
President Phil Corby
Secretary John Bates
Treasurer John Bates

VK7ZAX
VK7RT
VK7RT

VK1WI: 3.590 LSB, 146.950 FM each Thursday evening from 8.00pm local time. The broadcast text is available on packet, on Internet aus.radio.amateur.misc news group, and on the VK1 Home Page <http://www.vk1.wia.ampr.org>

Annual Membership Fees. Full \$80.00 Pensioner or student \$71.00. Without *Amateur Radio* \$48.00

From VK2WI 1.845, 3.595, 7.146*, 10.125, 14.160, 24.950, 28.320, 29.120, 52.120, 52.525, 144.150, 147.000, 438.525, 1281.750 (* morning only) with relays to some of 18.120, 21.170, 584.750 ATV sound. Many country regions relay on 2 m or 70 cm repeaters. Sunday at 1000 and 1930. Highlights included in VK2AWX Newcastle news, Monday 1930 on 3.593 plus 10 m, 2 m, 70 cm, 23 cm. The broadcast text is available on the Internet newsgroup aus.radio.amateur.misc, and on packet radio.

Annual Membership Fees. Full \$80.00 Pensioner or student \$63.00. Without *Amateur Radio* \$50.00

VK3BWI broadcasts on the 1st Sunday of the month at 20.00hrs Primary frequencies, 3.615 DSB, 7.085 LSB, and FM(R)s VK3RML 146.700, VK3RMM 147.250, VK3RWG 147.225, and 70 cm FM(R)s VK3ROU 438.225, and VK3RMMU 438.075. Major news under call VK3ZWI on Victorian packet BBS and WIA VIC Web Site.

Annual Membership Fees. Full \$83.00 Pensioner or student \$67.00. Without *Amateur Radio* \$51.00

VK4WIA broadcasts on 1.825 MHz SSB, 3.605 MHz SSB, 7.118 MHz SSB, 10.135 MHz SSB, 14.342 MHz SSB, 21.175 MHz SSB, 28.400 MHz SSB, 29.660 MHz FM (rptr), 147.000 MHz, and 438.525 MHz (in the Brisbane region, and on regional VHF/UHF repeaters) at 0900 hrs K every Sunday morning. QNEWS is repeated Monday evenings, at 19.30 hrs K, on 3.605 MHz SSB and 147.000 MHz FM. On Sunday evenings, at 18.45 hrs K on 3.605SSB and 147.000 FM, a repeat of the previous week's edition of QNEWS is broadcast. Broadcast news in text form on packet is available under WIAQ@VKNET. QNEWS Text and real audio files available from the web site

Annual Membership Fees. Full \$95.00 Pensioner or student \$81.00. Without *Amateur Radio* \$69.00

VK5WI: 1843 kHz AM, 3.550 MHz LSB, 7.095 AM, 14.175 USB, 28.470 USB, 53.100 FM, 147.000 FM Adelaide, 146.800 FM Mildura, 146.900 FM South East, 146.925 FM Central North, 438.475 FM Adelaide North, ATV Ch 35 579.250 Adelaide. (NT) 3.555 USB, 7.065 USB, 10.125 USB, 146.700 FM, 0900 hrs Sunday. The repeat of the broadcast occurs Monday Nights at 1930hrs on 3585kHz and 146.675 MHz FM. The broadcast is available in 'Realaudio' format from the website at www.sant.wia.org.au Broadcast Page area.

Annual Membership Fees. Full \$88.00 Pensioner or student \$73.00. Without *Amateur Radio* \$58.00

VK6WIA: 146.700 FM(R) Perth at 0930hrs Sunday relayed on 1.865, 3.564, 7.075, 10.125, 14.116, 14.175, 21.185, 29.120 FM, 50.150 and 438.525 MHz. Country relays 3.582, 147.200 (R) Cataby, 147.350 (R) Busselton, 146.900 (R) Mt William (Bunbury). 147.000 (R) Katanning and 147.250 (R) Mt Saddleback. Broadcast repeated on 146.700 at 1900 hrs Sunday relayed on 1.865, 3.564 and 438.525 MHz : country relays on 146.900, 147.000, 147.200, 147.250 and 147.350 MHz..Also in "Real Audio" format from the VK6 WIA website

Annual Membership Fees. Full \$71.00 Pensioner or student \$65.00. Without *Amateur Radio* \$39.00

VK7WI: 146.700 MHz FM (VK7RHT) at 0930 hrs Sunday relayed on 147.000 (VK7RAA), 146.725 (VK7RNE), 146.625 (VK7RMD), 3.570, 7.090, 14.130, 52.100, 144.150 (Hobart), repeated Tues 3.590 at 1930 hrs.

Annual Membership Fees. Full \$90.00 Pensioner or student \$77.00. Without *Amateur Radio* \$57.00

VK8 Northern Territory (part of the VK5 Division and relays broadcasts from VK5 as shown, received on 14 or 28 MHz).

Be the predator, not the prey

IC-756PROII (HF/6m) Amateur Transceiver



ICOM raises the bar of excellence with the world's most powerful DSP technology in amateur radio history with the IC-756PROII. From the box to heavy contest action, in a matter of seconds. Imagine the fun and excitement of creating your own filter width and shape while on the air, rag chewing, or in the middle of a pile-up!!

Features include

- Sharp & soft, IF filter shape
- No optional filters to buy
- 41 selectable IF Filter bandwidths
- Choice of 3 filters per mode
- Improved 3rd IMD & wide dynamic range
- Triple band stacking register
- Built-in Antenna Tuner
- Two levels of receiver pre-amp
- Three levels of attenuator
- Dual watch on same band
- IF DSP
- 13.8V DC operation
- 5 to 100W SSB,CW,FM,RTTY (including RTTY decoder)
- 4 to 40W AM
- Dual Antenna Sockets
- Real Time Spectrum Scope
- One-touch record/play
- Digital voice memory
- Extended 1/4 tuning step & BPF functions for SSB-D mode
- 32 bit floating point DSP and 24 bit AD/DA converter
- SSB / CW synchronous tuning
- 8 Display types
- 7 Font Types
- Memory Keyer
- 4.9 inch color TFT LCD

ICOM
Clearly Ahead

find your nearest ICOM dealer at

www.icom.net.au

or (03) 9387 0666



May 2002
Volume 70 No 5

Amateur Radio

\$ 5.95

**A Practicable
Superhet Receiver
for 1.8 to 2.0 MHz (and HF)**

by Drew Diamond, VK3XU

VK5GN's MAGNIFICENT *Obsession*

"at the cross roads look left and you
will see the Radio Station"



The ISS Project
School children
contact Space Station
astronauts

Bright ideas:
Cheap and Cheerful Varicap Diodes



ISSN 0002-6859



9 770002 685055 05



Australian
Amateur Radio

Callbook 2002 *Every shack should have one*



Now also
on
searchable
CD

**The "Call Book 2002" is available from
your State Division
Order now to get the member discount**

VK1 Division

GPO Box 600, Canberra ACT 2601

VK2 Division

109 Wigram St, Parramatta NSW
(PO Box 432, Harris Park, 2150)
(Office hours Mon-Fri 1100-1400)
Phone 02 9689 2417
<http://www.ozemail.com.au/~vk2wi>
Freecall 1800 817 644
e-mail: vk2wi@ozemail.com.au

VK3 Division

40G Victory Boulevard
Ashburton VIC 3147
(Office hours Tue 10.00 - 2.30)
Phone 03 9885 9261
<http://www.wiavic.org.au>
Fax 03 9885 9298
e-mail: wiavic@wiavic.org.au

VK4 Division Queensland
PO Box 199, Wavell Heights, Qld. 4012
Phone 07 3221 9377 Fax 07 3266 4929
e-mail: office@wiaq.powerup.com.au

VK5 Division (and VK8)

(GPO Box 1234 Adelaide SA 5001)
Phone 0403 368 066
: <http://www.sant.wia.org.au>
email: peter.reichelt@bigpond.com

VK6 Division

PO Box 10 West Perth WA 6872
Phone 08 9351 8873
Web: <http://www.vk6wia.org>
e-mail: vk6wia@inet.net.au

VK7 Division

PO Box 371 Hobart TAS 7001
Phone 03 6234 3553 (BH)
<http://www.tased.edu.au/tasonline/vk7wia>
email: batesjw@netspace.net.au

COMMERCIAL RESELLERS

Please contact June Fox (WIA Federal) on 03 9528 5962



Amateur Radio

Volume 70
Number 5
May 2002

The Journal of the Wireless
Institute of Australia
ISSN 0002-6859

Editorial

Editor: Colwyn Low VK5UE
edarmag@chariot.net.au

Technical Editor: Peter Gibson VK3AZL

Publications Committee Members
Ron Fisher VK3OM
Don Jackson VK3DBB
Evan Jarman VK3ANI
Bill Rice VK3ABP
Gill Sones VK3AUI
Bill Roper VK3BR

Advertising

Mrs June Fox,
Tel: (03) 9528 5962

Hamads

"Hamads" Newsletters Unlimited
PO Box 431, Monbulk Vic 3793
Fax: 03 9756 7031
e-mail: newsletters@ozemail.com.au

Office

10/229 Balaclava Road
Caulfield, Victoria
Telephone (03) 9528 5962
Facsimile (03) 9523 8191

Business Hours 9:30am to 3:00pm weekdays

Postal

The Editor AR
34 Hawker Crescent
Elizabeth East
South Australia 5112
Email edarmag@chariot.net.au

Production

Newsletters Unlimited 03 9756 7797

Printer

Streamline Press, Melbourne (03) 9417 2766

Postal Service

IMS (03) 9291 5888

Production Deadlines

Advertising booking and articles for
publication 10th of preceding month.

Hamads and advertising material deadline
18th day of preceding month

The contents of Amateur Radio are Copyright
Wireless Institute of Australia © 2002

General

Martin Luther VK5GN...a man who builds his life around amateur radio	11
Colwyn Low VK5UE	
From Z (Zeehan) to A (Astronaut) and back	18
Dick Van Beek VK7KVB	
Clandestine communication equipment: my part in its creation	22
Stephen G Hart VK5HA	
Amateur Radio Survey	29

Technical

A Practical Superhet Receiver for 1.8 to 2.0 MHz (and HF)	4
Drew Diamond, VK3XU	
Six Metre Squalo (Technical Abstracts)	14
Gill Sones VK3AUI	
Active Antenna (Technical Abstracts)	15
Gill Sones VK3AUI	
Cheap and Cheerful Varicap Diodes (Bright Ideas)	17
Jim Tregellaa VK5JST	
Shortening screws (Technical Abstracts)	21
Gill Sones VK3AUI	

Columns

Advertisers' Index	55	Editor's Comment	2
ALARA	25	Hamads	54
ARDF	47	Ham Shack Computers	51
AMSAT	35	HF Predictions	48
Awards	34	How's DX?	37
Beyond Our Shores	26	New Members	2
Bright Ideas	17	Over To You	52
Corrections	13	Silent Keys	53
Contests	40	Technical Abstracts	14, 15, 21
Club News	39	VHF/UHF - An Expanding World	44
WIA Division News		WIA Comment	3
VK7 Notes	31	WIA Division Directory	56
VK1 Notes	32	WIA Federal Directory	2
VK4 Notes	32	Will's Page	28
VK2 Notice	33		

Our cover this month

Martin Luther VK5GN with his radio station on 30 acres 50km north of Adelaide, away from complaining neighbours.

For the full story turn to page 11

Contributions to Amateur Radio

Amateur Radio is a forum for WIA members' amateur radio experiments, experiences opinions and news. Manuscripts with drawings and or photos are always welcome and will be considered for publication. Articles on disc or email are especially welcome. The WIA cannot be responsible for loss or damage to any material. A pamphlet, How to write for Amateur Radio is available from the Federal Office on receipt of a stamped self-addressed envelope.

Back Issues

Back issues are available directly from the WIA Federal Office (until stocks are exhausted), at \$4.00 each (including postage within Australia) to members.

Photostat copies

When back issues are no longer available, photocopies of articles are available to members at \$2.50 each (plus an additional \$2 for each additional issue in which the article appears).

Disclaimer

The opinions expressed in this publication do not necessarily reflect the official view of the WIA and the WIA cannot be held responsible for incorrect information published.

Amateur Radio Service

A radiocommunication service for the purpose of self-training, intercommunication and technical investigation carried out by amateurs; that is, by duly authorised persons interested in radio technique solely with a personal aim and without pecuniary interest.

Wireless Institute of Australia

The world's first and oldest
National Radio Society
Founded 1910

Representing
The Australian Amateur Radio Service

Member of the
International Amateur Radio Union

Registered Federal Office of the WIA

10/229 Balaclava Road
Caulfield North Vic 3161

Tel: (03) 9528 5962 Fax (03) 9523 8191
<http://www.wia.org.au>

All mail to
PO Box 2175 Caulfield Junction VIC 3161

Business hours: 9.30am-3pm weekdays

Federal Secretary

Peter Naish VK2BPN

Federal Office staff

June Fox Bookkeeper
Rita Trebilco VK3IF Examinations Officer

Council

President	Ernest Hocking	VK1LK
VK1 Federal Councillor	Gilbert Hughes	VK1GH
VK2 Federal Councillor	Barry White	VK2AAB
VK3 Federal Councillor	Jim Linton	VK3PC
VK4 Federal Councillor	David Jones	VK4OF
VK5 Federal Councillor	David Box	VK5OV
VK6 Federal Councillor	Will McGhie	VK6UU
VK7 Federal Councillor	Phil Corby	VK7ZAX

Executive

Brenda Edmonds
David Pilley
Don Wilschetski

VK3KT
VK2AYD
VK4BY

Federal Coordinators

AMSAT	Graham Ratcliff	VK5AGR
ARDF	Jack Bramham	VK3WWW
Awards	Mal Johnson	VK8LC
Contests	Ian Godsil	VK3VP
Education	Brenda Edmonds	VK3KT
FTAC	John Martin	VK3KWA
Historian	John Edmonds	VK3AFU
IARU	Grant Willis	VK5ZWI
Intruder Watch	Harry Andersson	VK8HA
International	John Miller	VK3DJM
Travel Host		
ITU Conference and study group	Gilbert Hughes	VK1GH
OSL Manager (VKS, VKO)	Neil Penfold	VK6NE
Videotapes	VK2 Division	
Web	Joe Burford	VK5UJ

ACA Liaison Team

Ernie Hocking	VK1LK	
Gilbert Hughes	VK1GH	
Keith Malcolm	VK1ZKM	
Peter Naish	VK2BPN	
Canberra Liaison Officer	Richard Jenkins	VK1RJ

Editorial Comment

Colwyn Low VK5UE
edarmag@chariot.net.au

WIA is for all amateurs

Welcome to all our long standing members and our new readers.

I am glad some of you have decided to purchase the magazine again. The WIA is the Amateur Radio organisation for all Australian Amateurs and so it's good to be able to spread the word to non-members, whom we also have to represent to Government bodies. Like all organisations we have a diverse range of views amongst our members and hopefully we are learning to talk, debate, argue our different points of view in a democratic way and move with the majority decision. So with the Federal Convention this month I hope that reason will prevail.

Amateurs are less numerous than they were a few decades ago and our ranks are thinning. We are becoming a group of balding grey haired old men (page 33 !!!!!). However there are things we do which excite people. Look at the article on the Zeehan Primary School talking to the International Space Station Astronauts on page 18. Certainly, some of the things we used to do can now be done more easily on the cell phone and the Internet, but there are still lots of personal challenges in building electronic equipment which will do both mundane and exotic things. There is still the thrill of getting a new mode to work with our station equipment; there is still the thrill of getting a response from a station far away. Far away, depending on the

frequency used, can be thousands of kilometres or just a few.

Excitement comes in other ways. I have been looking for a Bird Wattmeter for about a year and in April I attended the Adelaide North East Radio Clubs Bring and Buy sale. I walked round once and nothing caught my eye. Later I'm just filling in time and there it was in full view, one Bird Type 43. When I got it home I went looking for sources of the parts to customise it to my requirements. I wanted N connectors and UHF plugs so I was more than surprised to find it is still in production and everything I needed is in the Bird Electronic catalogue. The reason I mention this is that this meter is a piece of classic design and great craftsmanship. The principals used to design it are basic but the instrument will still be sought after when it becomes part of my Deceased Estate. Now all I have to do is make time to use it.

There are a few contests and activities some or all of us should be thinking of taking part in. The Queens Golden Jubilee GB50 activity, the VK/Trans Tasman Contest, the GippsTech Conference and the Remembrance Day Contest. Now is the time to check the equipment, to decide how we will participate and possibly talk a few of our friends into participating as well.

Enjoy your Amateur Radio and let others know Amateur Radio is fun!

73 Colwyn VK5UE

NEW WIA MEMBERS

The WIA bids a warm welcome to the following new members who were entered into the WIA Membership Register during the month of APRIL.

Mr H M Brown
L21096 Mr R Morgan
L21097 Mr P T Lark
VK1AI Mr G J Parkhurst
VK2MSC Mr S D Salmon
VK4BLE Mr L E Pritchard
VK4BQL Mr L G Heal
VK4CO Ms V M Meachen

VK4ZB Mr G L Szatmary
VK6YNE Mr N J Elrick
VK7KHZ Mr S Lynd
VK7KVB Mr D P Van Beek
VK7YKR Mr K G Rappell
VK7ZZB Mr K A Briggs
ZS6QW Mr S Gorgevik

End of year report

It is some 12 months now since I took over the role of WIA Federal president from Peter Naish.

Through this last year I have had a chance to participate in the operation of the WIA at first hand. Above all I have been struck by the incredible energy and passion that all amateurs have for our hobby.

However for all of the good points there always seems to be one obstacle preventing things from happening. I personally find this very intriguing. Why is it that this bunch of people, who do things that many people can only dream about and marvel at, cannot seem to attract new blood to the hobby? Is it because we are too critical of our own achievements and are worried that they might not be good enough to be let loose on the world? I am sure that none of us really believes that.

In the real world people make mistakes. The first release of a product often has a problem of some description, be it a publication with typographic errors, a business trip that does not work out as hoped, or a computer with a hardware fault. As amateur radio operators we should not be frightened or ashamed to tell people what an exciting hobby amateur radio is.

I believe that amateur radio has a great future in Australia. To make this happen, we the amateurs radio operators of Australia, need to sell our story. Over the last year I have had the opportunity to correspond with many amateurs who provide their time and expertise to others to help them pass the examinations needed to hold an amateur radio licence. I have also corresponded with many more of you who volunteer your time and experience at local, state, and national level to advance the cause of amateur radio. For all of your efforts I would like to extend a very big thank you and ask that you continue to be excellent ambassadors for amateur radio.

In this last year we have also worked hard to promote the cause of amateur

radio via the work of the Productivity Commission review and submissions made to the ACA in terms of taking on a greater role in administering the examination regime. Here the theme is one of self regulation and many of us are keen to take up the challenge and make entry into amateur radio simpler. However we need to go further. There is much that can be done to raise the profile of amateur radio in order to drive home the message that the hobby has a lot to offer. If we are to see concessions for pensioners, recognition of the benefits of amateur radio in the education system or changes to the current licence conditions then we need to increase our profile in Government.

Why is it that this bunch of people, who do things that many people can only dream about and marvel at, cannot seem to attract new blood to the hobby?

We need to get the message not just to the ACA but also to those departments that administers pensions and education. The story doesn't just stop with Government. We also need to sell our message to private industry. Amateurs are significant consumers of electronics as well as contributors to many aspects of the Australian electronics industry. As such we can and do make a valuable contribution to the Australian economy. We need to make people aware of what amateur radio has to offer.

What then can amateurs do to help to make this happen? If you have the time to contribute, or the contacts in government and industry that can help us to raise our profile then please make the effort to contact either myself or your local WIA representative and make

yourself known. Together we can make a difference.

AR matters

Hopefully by now many of you will have seen copies of AR on sale at the newsstands. I know of at least two news agents in Canberra that have copies on their shelves. Over the last few days I have even watched them sell. However we need to know what readers think of AR in its current format. Due to timing difficulties we missed getting the promised survey into the April issue. With this issue I hope we have resolved these problems and would ask as many of you as possible to respond to the survey. For those that prefer, a copy of the survey is also available on the WIA web page at www.wia.org.au.

Federal Convention and AGM.

By the time this issue of AR reaches you the WIA AGM and convention should have been held in Melbourne. This year's convention promises to be an exciting one with the many challenges raised over the last year providing a great opportunity for vigorous discussion on future strategy relating to issues as wide ranging as WIA structure, future foundation licence categories, through to setting budgets for the next 12 months. In keeping with member's requests I will try to get a summary of the results of the meeting to members as quickly as possible after the convention.

73s and I look forward to hearing your views on any amateur radio related matters

Ernest Hocking VK1LK

**SURVEY
on pages 29
and 30**

A Practicable Superhet Receiver for 1.8 to 2.0 MHz (and HF)

Drew Diamond, VK3XU,
45 Gatters Road,
WONGA PARK, 3115.

Increased interest in 160 metres has caused me to build a new receiver for 'Top-Band', which is arguably one of the most challenging in terms of performance. Consider that ground-wave signals from powerful local stations, both amateur and broadcast, will arrive at the input right along with those sought-after weak DX signals. In addition, there may be (typically) loud static crashes, impulse noise, and a host of spurs from domestic appliances. In such an environment the receiver must therefore possess the best possible signal handling attributes.

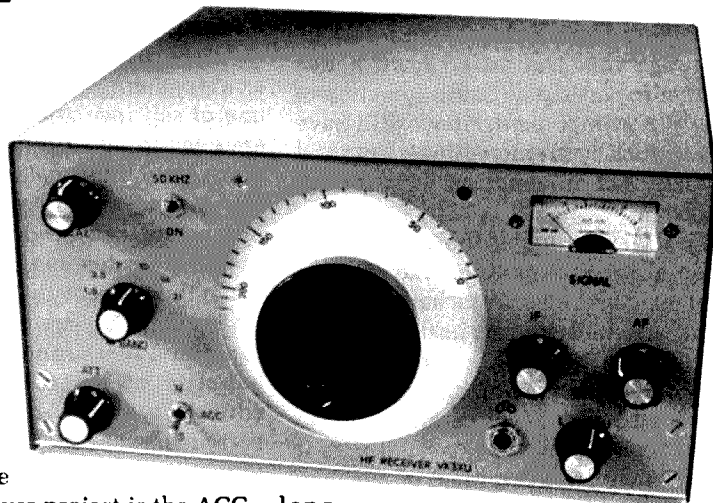

Amateur and professional publications occasionally have circuit details for receivers with impressive claimed performance. These designs generally use new, or hard-to-get esoteric parts. Australian experimenters are quite familiar with the usual story in this regard: "Yes mate, we can get those for you, minimum order; one hundred units at \$14 each, six to eight weeks delivery"-when all we need is perhaps two. The aim for this model was to produce a receiver with at least adequate, and hopefully very good performance using locally available parts.

Much of a superheterodyne receiver's ability to cope with strong (unwanted) signals derives from the first mixer, which is the stage in the set where some undesirable effects can occur if it is not done properly. After much study and experiment, it was decided to employ a switched CMOS gate mixer (Refs. 1-6), it being one of the strongest practicable circuits using conventional components. Adequate SSB and CW bandwidth is obtained with a (now) conventional crystal ladder filter at 4 MHz. The idea of a dedicated AGC-controlled IF amplifier chip has been rejected because- in my experience, these devices always seem to be difficult to buy in small quantities. So an IF amplifier which uses ordinary discrete components is employed. One of the

most troublesome aspects of a receiver project is the AGC problem- excellent AGC generally dictates quite complex electronics. Never-the-less, for this model, very satisfactory AGC is obtained with fairly simple circuitry- and no fancy parts. The basic 1.8 - 2 MHz "tunable IF" shall also form the basis of an amateur bands HF receiver by the inclusion of an internal switched frequency converter- also employing the CMOS mixer scheme (the subject of a follow-up article).

The prototype works well, has nice signal handling and AGC characteristics and is pleasant to operate. Sensitivity is 0.2 microvolts for 10 dB S + N : N. Selectivity is about 2 kHz, allowing U/LSB SSB, CW and AM (as SSB) reception. Third-order IMD dynamic range (according to the ARRL Lab. method outlined in Ref. 7) is in excess of 90 dB (my measurement was limited by phase-noise from one of the generators). Audio output varies only 6 dB for an input signal range of 10 uV to 3 mV (an effective AGC range of 50 dB, which includes the greater portion of input signal levels normally encountered). Rejection of the IF (4 MHz) is 80 dB, and image rejection (7.6 MHz) is 100 dB. There is one just audible internally-generated spur at 2.0 MHz, whose equivalent value is less than 0.1 uV. In practical terms, with a 180 foot

long inverted-L antenna connected, and the receiver at maximum gain, there have been no instances of overload or cross-modulation from (very) strong local stations, nor is the receiver at all bothered by nearby BC, TV and FM transmitters.

Circuit

Input signals are first routed through a two-resonator 1.8 - 2.0 MHz band-pass filter (see top left-hand corner, Fig. 1). The usual Butterworth circuit has been re-jigged to the pi configuration to allow the trim capacitor rotors to more conveniently connect to chassis ground, and which places the coils in series with the input, thus offering far greater attenuation to unwanted HF and VHF signals. Although seldom required, a simple pot style attenuator is fitted at the input. Sensitivity (and S : N) is substantially improved by the inclusion of a judicious amount of RF gain- about 10 dB, supplied by a single 2N3053 (or similar) bipolar transistor Q1 in a conventional ('strong') broadband class A amplifier.

The switched CMOS mixer at U1 was first outlined (I think) in Ref. 1. Hannes Coetzee applied the idea to his direct conversion receiver project in Refs. 2 and 3, and several other experimenters

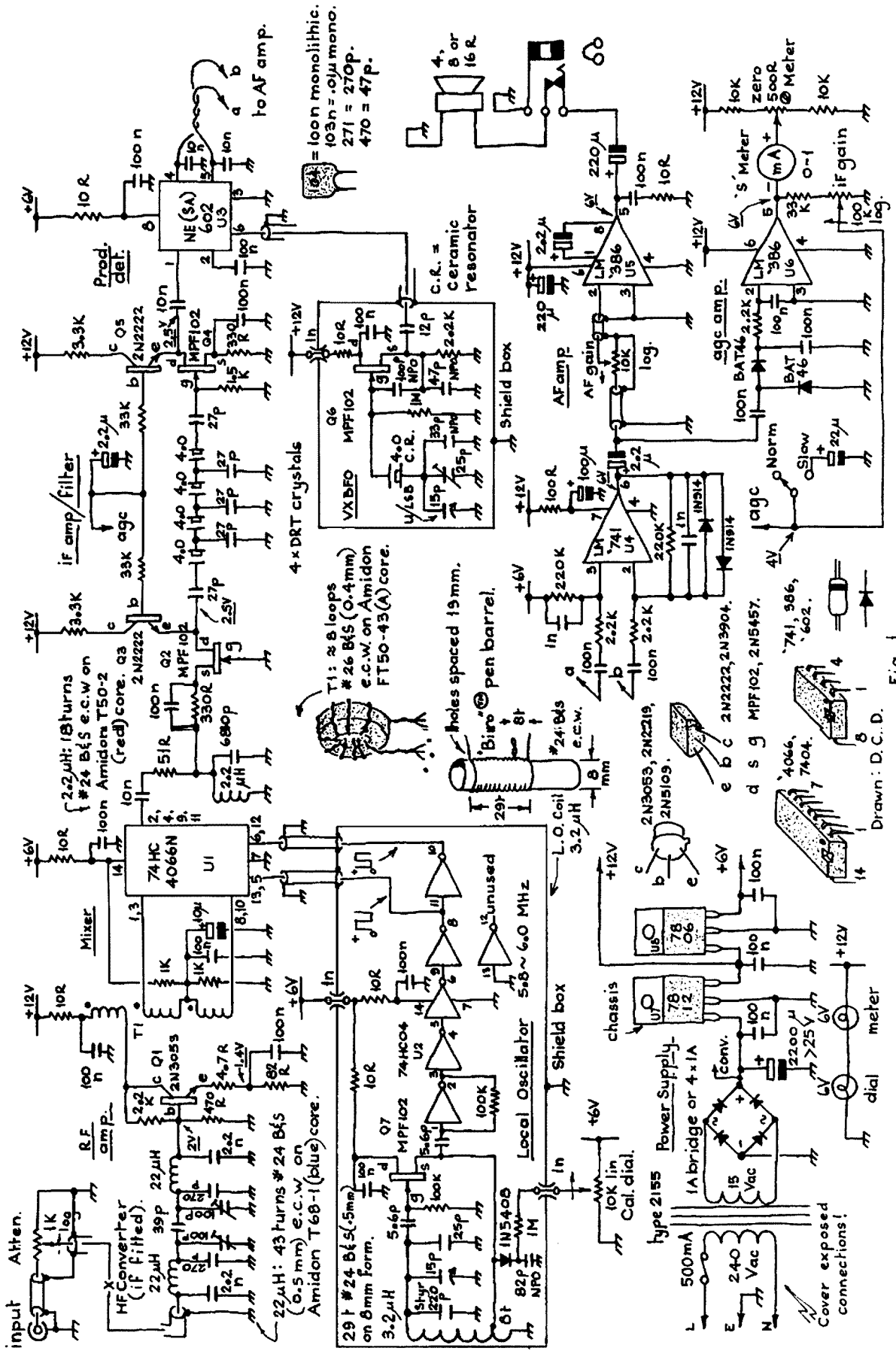

Figure 1

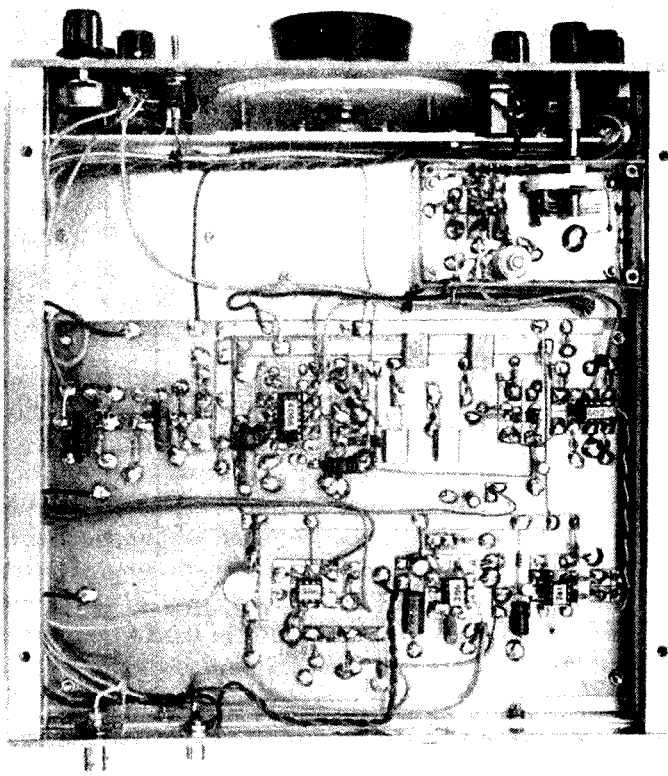

Photo 2: Below chassis; main circuit board (VXBFO box, lid removed)

have written about their success also (Refs. 4-6). According to my measurements, the CMOS mixer has significantly lower loss than a ring-diode, yet the local oscillator power requirement is greatly reduced (and hence also, the risk of internal spur production). It is an easy matter to drive the CMOS switch(es) 180 degrees out of phase from another CMOS chip, such as a 74HC04. The only drawback with the CMOS mixer appears to be its frequency response, at present (using ordinary chips) limited to about 21 MHz.

A conventional Hartley LC circuit, maintained with an MPF102 FET at Q7 supplies our local oscillator (L.O.) signal, and is adjustable from 5.8 to about 6 MHz. The first gate of the 74HC04 CMOS HEX inverter chip U2 is biased for linear operation with a 100 k resistor. The necessary 180 degree out of phase square-wave drive signals for the CMOS switch mixer are applied to each of two parallel connected gates of the '4066 chip at U1.

Ideally, the output of the CMOS mixer (as with any "commutated" type mixer) should look into 50 ohms resistive for all frequencies present at the mixer's output (not just the expected "sum and

difference" products), which job is normally done with a diplexer. After experimenting with various circuits, it was found that a quite simple diplexer, consisting of a tank comprised of a 2.2 uH coil and 680 pF capacitor, tuned to the wanted IF frequency (4 MHz), and a series 51 ohm 'dump' resistor (where all the unwanted products are dissipated) did the job rather well.

The first stage of the IF amplifier is a common-gate connected MPF102 FET at Q2, thus providing a fairly low impedance

termination for the wanted 4 MHz output from the mixer/diplexer network. The drain load of the first IF amp is comprised of the emitter-collector of a 2N2222 transistor Q3 and 3.3 k resistor in series, which provides a pretty good match into the crystal ladder filter. Note that the effective resistance of the series 2N2222 (and hence, the gain of that stage) can be varied by application of a suitable dc signal into the base of the transistor. The crystal filter looks into the gate of the second IF amplifier (another MPF102 Q4), this time in common source mode. The filter is properly terminated with a 1.5 k resistor at the gate. A second 2N2222 (Q5)/3.3 k series network is again used as drain load.

Because the product detector has only to deal with the few signals that have squeezed through the crystal filter and gain-controlled IF amplifier, we can employ a ubiquitous NE (SA) 602 at U3, it being easy to use in this application, and actually provides about 15 dB conversion (from IF to AF) gain. Variable crystal BFO (VXBFO) signal is applied to the OSC port at pin 6. A 4 MHz ceramic resonator gives a much larger frequency pull than is obtainable with

an ordinary crystal. The resonator is powered by an MPF102 at Q6, and may be varied in frequency right through the band-pass of the crystal filter, allowing upper or lower sideband reception, by placing the BFO's signal at one or the other side of the filter. Also, under crowded band conditions, it is a very handy feature in CW reception to be able to place the BFO signal somewhere near the middle of the filter's band-pass to reduce close-in QRM.

Product-detected audio is raised to 'speaker/headphone level with a conventional LM741-386 amplifier, U4-U5. AGC signal is picked off at the output of the '741 (U4), and applied to a two-diode (BAT-46) voltage doubler detector. The dc level thus obtained is applied to a second '386 at U6, used here as a dc amplifier. When no signal is present, the '386 output at pin 5 rests at about half rail; 6 Vdc. About 4 V worth of this dc signal is used as AGC voltage, and is applied simultaneously to the bases of the 2N2222 IF amp partial drain loads, Q3 and Q5. When a signal is tuned in, or an existing signal strength increases, the output dc level will drop proportionately, thus causing the IF amp gain to fall, thereby holding the output at a reasonably constant level.

A back to back pair of diodes are wired across the feedback resistor of the '741 amp U4 (it being one of the main gain blocks) in order to clip transient pulses which are too fast for the AGC loop. If desired, under some operating conditions, an additional 22 uF capacitor may be switched in to provide a longer follow-on (or Slow) AGC effect. AGC action thus obtained is (perhaps) surprisingly smooth. IF gain may be manually adjusted by use of the 100 k pot at the output of U6. The 1 mA 'S' meter is in a virtual bridge circuit, and provides a roughly logarithmic indication of signal strength, so that a 1 uV signal deflects about 0.05 mA, and a 50 uV (S9) signal gives about 0.5 mA or half-scale.

A 50 kHz calibration signal source (Fig. 2), derived from a 5 MHz crystal, is provided so that the dial may be set precisely on the 50 kHz marks. The calibrator is particularly handy when using the converter for HF access, as each converter crystal may be a little off it's nominal frequency. Furthermore, when going from USB to LSB, the effective dial calibration moves by about

STRICTLY HAM

ABN 72 059 638 407 PTY LTD



★ IC-746 PRO

- Icom **WORK THE WORLD** performance
- The best way to get onto HF plus 6 and 2 metres
 - Multifunction hi-res display
 - Direct frequency
 - Shack or portable



★ IC-756 PRO II

- Icom's new HF+50-MHz digital
The performance king Try it to see why
- Multi-colour multi-function screen

★ TH-D7A(G)

- Dual bander
- Effortless 2m & 70cm
- BUILT IN PACKET
- 200 alphanumeric memory channels
- 6W from 13.8VDC
- Comes with NiCd battery and charger
- APRS compatible



★ TS-2000

- High performance standards
- Three distinct operation platforms,
 - 1 Traditional transceiver-full front panel,
 - 2 "Silver box" for mobile use
 - 3 The ARCP-2000 computer control
- 100 watts on HF, 6 metres and 2 metres, 50 watts on 70cm,



★ IC-706MKIIG

167(W) x 58 (H) x 200 (D), 2.45kg

Detachable Control Panel/ Display (optional equipment required for remote operation)

SSB/AM/CW/RTTY Narrow Filter Options

Ultra Small



★ TM-D700A

Kenwood's new TM-D700A makes the most of exciting SSTV, GPS, and APRS® (Automatic Packet/Position Reporting System; rapidly gaining popularity world-wide).

Extra large amber and black display.

Built-in TNC offers a wide range of options, inc. simple packet operation using AX.25

Ham radio is truly entering a new era.



★ TS-50

Mount it in a vehicle, take it on a DX-pedition or use it as a permanent base station transceiver. Easy-to-use menu system adds flexibility, stable operation in any situation.

- DDS with fuzzy control
- 100 Memory channels
- Switchable AGC circuit (SLOW/FAST)
- IF shift Noise blanker (pulse)
- Dual VFOs (A & B)



Outstanding performance

It will ROTATE YOU!!
We have EMOTATOR

ALSO

- ★ KANTRONICS
- ★ DIAMOND
- ★ MFJ
- ★ MIRAGE

14 CHURCH ST BAYSWATER VIC 3153

Phone (03) 9729 7656
email sales@strictlyham.com.au

Fax (03) 9729 7422
www.strictlyham.com.au

construction. Tuning range is just over 200 kHz, so a pretty good dial will be necessary if acceptable frequency resolution is desired. My dial consists of a disc of 110 mm diameter, made from 3 mm opaque perspex, which, when calibrated with marks every 10 kHz gives quite good resolution by interpolation down to 1 kHz- good enough for most work. It is illuminated from behind with a 6 V/50 mA pea-lamp wired in series with another for the 'S' meter. A second disc, a 100 mm diameter piece of clear 3 mm perspex is a friction-fit into the front panel to act as cursor (a scribed radial line), and protect the calibration markings. An ordinary 6:1 planetary reduction drive is used to provide fine manual adjustment of L.O. frequency. An insulated flexible coupler should be interposed between the drive and capacitor spindle.

Use ordinary hook-up wire for all dc and 50 Hz connections, including power supply, 6 and 12 V supplies, AGC rail and S-meter. Note the twisted-pair connection between U3 and U4. The coax/shielded wire connections may be

done with ordinary shielded wire (it is close to 50 ohms impedance, and so serves for RF and AF connections).

The power transformer should be located in such a position that it is at least 30 mm away from any active device, as it is possible for stray flux to affect P-N junctions (believed to be Hall-effect), and cause audible hum, or 50 Hz FM of an oscillator. The transformer in the prototype is mounted upon two 30 mm long aluminium spacer rods (the transformer is visible in Photo 3, but not the spacers).

Tune-up

With the means available to you, check that the power supply, L.O. and VXBFO are working. If an oscilloscope is on-hand, observe (with X10 probe) the 5 V p-p square waveforms at pins 11 and 10 of U2. Measure the L.O. frequency with a counter (or listen for the signal on another receiver) and adjust the 25 pF beehive trim cap so that, with the 15 pF tuning cap at full mesh, the L.O. generates about 5.790 MHz. Confirm that at least 6 MHz is generated with the

tuning cap at minimum mesh. After some 10 minutes of warm-up, the signal should be quite stable. Similar for the VXBFO; observe a clean sine-wave signal at the source of Q6 of about 2 V p-p. Set the 15 pF tuning cap to mid-range, then adjust the 25 pF trim cap for 4.000 MHz. With the 15 pF variable cap, it should be possible to pull the VXBFO from about 3.995 to 4.005 MHz.

When the set is fully wired and checked for accuracy, pause and confirm that all polarised components are properly installed- pay particular attention to the I.C.'s- they must be plugged in correctly to avoid their possible destruction. When power is applied, you should hear just a soft hiss from the 'speaker with the AF and IF gain pots at maximum. Apply your finger upon a screw-driver blade to pin 2 or 3 of the '741. You should hear a buzz, indicating that the AF amp is working. Adjust the 500 ohm trim pot and zero the S-meter.

Connect an antenna to the input- a few metres of hook-up wire should do initially. Vary the VXBFO through its

GippsTech 2002 Conference

July 6 and 7

The program for the forthcoming technical conference to be held at Churchill is starting to take shape.

The conference focuses on issues relating to VHF, UHF and microwave frequencies and their uses for amateur communications. Plans are for technical sessions during the day on Saturday and Sunday morning, including a BBQ lunch on both days. A conference dinner will be held on Saturday evening. A program is planned for accompanying partners, with Pauline Corrigan once again offering to take charge.

The Conference organisers welcome further contributions to and suggestions for the program. Topics identified to date include:

- Using JT44 for tropospheric propagation. (VK2FLR)
- WSJT meteor scatter experiences. (VK7MO)
- Integration of a 1W 10GHz PA with a 650mm offset fed dish. (VK2EI)
- System integration with the Milliwave power amplifier at 24GHz. (VK2EI)
- The VK3UM 10 metre dish installation: A pictorial

presentation of the installation from start to finish including the mount, drives, tracking and feed systems. (VK3UM)

- RF Radiation: Does your Station meet the new licensing assessment requirements? Obtaining a High power permit. (VK3UM)
- Transmission line fault finding using a simple homebrew TDR. (VK3ZRX)
- The trials and tribulations of running a basic VHF-UHF station. (Bob VK2TG)

Further details can be found at the VK3BEZ web site at <http://www.qsl.net/vk3bez/>. Anyone willing to contribute further topics for the program should contact the Chair of the organising committee, Peter VK3KAI, at vk3kai@qsl.net.

Peter Freeman, School of Applied Sciences,
Monash University, Churchill, Victoria, Australia
Phone: 03 5122 6416 or 03 9902 6416
Fax: 03 5122 6738 or 3842 03 9902 6738
peter.freeman@sci.monash.edu.au

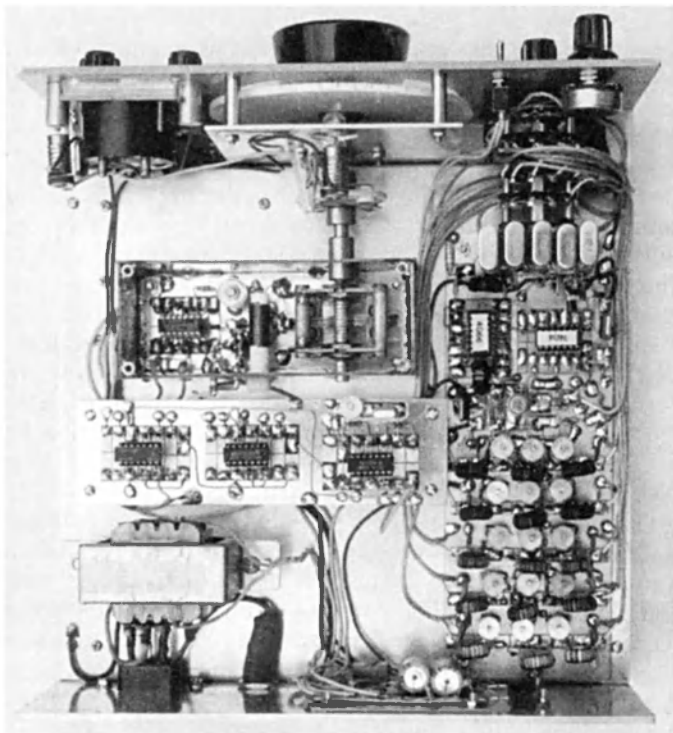

Photo 3: Above chassis; power supply, crystal calibrator, LO (lid removed) and HF converter

range, it should be possible to sweep it from one end of the crystal filter pass-band to the other, heard as a ssss-shoosh-ssss sound, which indicates that the set is 'gainy', and probably working thus far. Tune around for a signal (or spur- from a TV or PC). Carefully peak and re-peak the input filter 100 pF trim caps for best gain and flatness as the receiver is tuned between 1.8 and 2 MHz. When an SSB or CW signal is tuned in, it should sound clean, undistorted and free of hum, fuzziness or other

defects. Moderate to strong signals should cause the S-meter to deflect upwards, and strong signals shall not 'blast your ears off', indicating that the AGC circuit is working correctly.

To aid in any necessary troubleshooting, some typical key voltages are shown underlined on the circuit. In receiver work, one of the most difficult problems to trace is 'deafness'. A popular method is the 'half-split', where a known signal is introduced at a point about half way along a string of stages (such as a superhet). After first checking the vital items; supply rails, oscillators (their frequency and amplitude) and the op-amp dc levels, a suitable point in this set is at the input to the IF amp. Apply finger/screw-driver blade to the source of Q2. If the IF and AF stages are 'gainy', you should hear a buzz of signals and noise which happen to be on, or near 4 MHz. If you can do this, then the problem is probably between the RF input and mixer. Double-check the connections for the broadband transformer T1. The phasing, shown by the dots, must be correct if the mixer is to work properly. Measure the dc voltages around the RF amp Q1. Any reading which deviates greatly from that shown on the circuit would be a vital clue.

Parts

DSE, Jaycar and Altronics can supply most of the ordinary electronic components. The BAT-46 diodes (these replace OA91s) and crystals, marked 'DRT', and 100 pF trim caps were purchased from Jaycar (your filter crystals should all be of the same make). Additionally, the 4.0 MHz ceramic resonator, NE (SA) 602, Amidon cores, 1 nF feethru caps and 25 pF 'beehive' and other trim caps are available from Electronic World (03 9723 3860- will answer mail orders). For good stability, the 220 pF capacitor in the L.O. tank should be a 'styroseal' or silver mica, and the 33, 100 and 47 pF caps in the VXBFO should be NPO ceramic types. All others (including coupling and bypass) may be monolithic or ordinary ceramic types. There are no known suppliers of new variable capacitors, but these are by no means rare items. Ask your mates at the radio club- or look for caps at the next hamfest. For the 15 pF variable cap in the L.O., use one of those excellent English dual ball-bearing types, if possible. See Hamads in AR for your local Amidon supplier.

Bibliography

1. "An Ultra-Low Distortion HF Switched FET Mixer"; E. Kushnick, RF Design, Sep. '92.
2. "A Multi-Band DC Receiver"; H. Coetzee, ZS6BZP, Electronics World, Feb. '98.
3. "A Multi-Band DC Receiver"; H. Coetzee, ZS6BZP, Comms Quarterly, Fall '98.
4. "An Experimental HF Receiver" H. Hepburn, VK3AFQ, Radio Comms, Dec. '98.
5. "Sperimentare con il ricevitore a conversione diretta; A. di Giancarlo Moda, I7SWX, and W. Favaro, I2BWK, Radio Rivista, July 99.
6. "An Experimental HF Direct Conversion Receiver; P. Parker, VK3YE, AR Oct. '01.
7. ARRL Handbook, 1980 edition.
8. "Paddyboard" Circuit Construction"; Diamond, AR Feb. '95.
9. "From Circuit to Chassis"; Diamond, AR Dec. '00.

ar

*For All Your
Requirements*

AUTHORISED DEALER
ICOM

KENWOOD

AMATEUR COMMERCIAL
MARINE COMMUNICATIONS

Tower
Communications

14 Mary Street
Hazelmere
Western Australia 6055
Telephone: (08) 9274 1118
Facsimile: (08) 9250 3734

E-mail: tower@con.net.au

www: http://www.tower.visionimage.com.au

MARTIN LUTHER VK5GN

... a man who builds his life around amateur radio

Based on an interview with
Colwyn Low VK5UE

Martin came to Amateur radio in 1960. His great uncle had a shortwave radio that fascinated Martin. A very generous gift saw the old radio carried to a new home. School friends had an interest in radio and so together they got into crystal sets.

Later Martin was given a No 19 Set. (A WW2 vehicle mounted HF transceiver) for Christmas and he was firmly set on the path to Ham Radio. In 1966 he was licenced as G3VBX and operated with 10 W on 1.8 MHz AM. Everything homebrewed.

Then he moved to SSB but it took a lot of scrounging and hoarding of pocket money to get all the parts. The finished set operated on 1.8 and 3.5 MHz SSB. The final 807 was tuned by the "blue glow", as a meter was too expensive initially!

The collection of QSL cards was an important part of the activity. Today Martin counts his cards by the metre e.g. USA number 1 call area is 0.4m of cards! His log books alone take up over a metre of shelf.

Martin went to University College Bangor, North Wales and there met up with the Uni Radio Club who were UHF orientated and liked to climb Snowdonia's mountains in cold cloudy weather and work DX into Europe from Norway to Italy. They knew they were high enough when the big beams had to be pointed below horizontal to work into close in parts of the UK. The university club acquired a KW2000 and this was used to enter some HF contests. Pile-ups from the states for the GW contact on 10 metres further fired Martins enthusiasm for HF.

At this time he used his vacation jobs

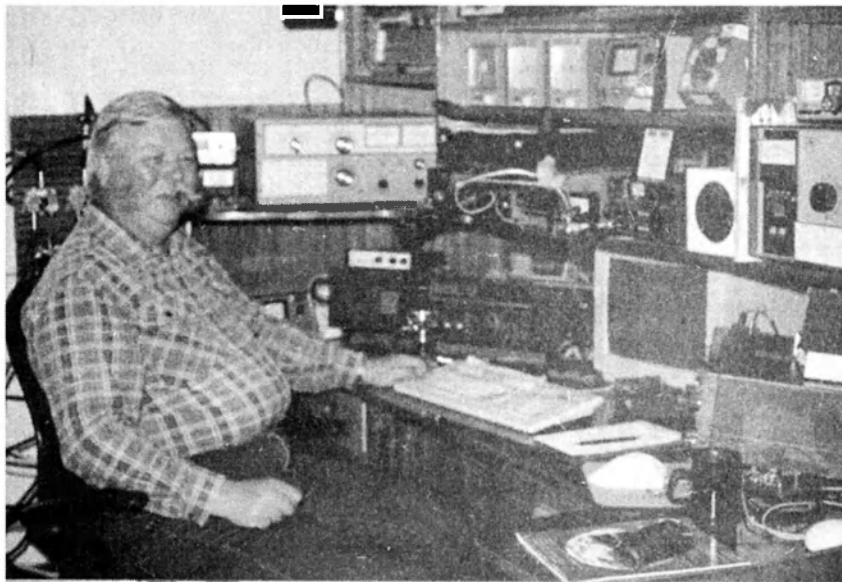

Martin Luther VK5GN at his console

to buy a FLDX400, while still using a home brew double conversion superhet receiver.

He moved to Australia in 1971 to VK4 as VK4VU. Lots more contesting from a suburban block and then portable, when he got serious and needed the best

Today the site has 5 x 70 foot towers. They carry a logperiodic for spotting and there are dedicated monobanders for 10 and 15. A 90ft vertical is dedicated to 1.8 MHz and 3.5MHz. and there are towers for VHF and UHF beams. When Martin gave me the instructions to reach VK5GN it ended up "at the cross roads look left and you will see the Radio Station". It is a radio station.

location and aerials. He used a 2 element Quad and a trap vertical initially. Later he moved to the rural fringe to a bigger block and better aerials, a four-element quad and two towers.

1984 brought the move to SA and Modbury and another suburban block again portable operation kept the interest

fired. A 30ft aluminium tower hoisted 2 element yagis on hilltops around South Australia especially fun on ten and fifteen.

Martin's personal situation allowed a move and in July 1991 he and Linda (VK5QP) purchased their current home about 50km north of Adelaide. With 30 acres set in a rural landscape on the Adelaide plains. Martin could now set up a "Serious Contest Station"

Today the site has 5 x 70 foot towers. They carry a logperiodic for spotting and there are dedicated monobanders for 10 and 15. A 90ft vertical is dedicated to 1.8 MHz and 3.5MHz. and there are towers for VHF and UHF beams. When Martin gave me the instructions to reach VK5GN it ended up "at the cross roads look left and you will see the Radio Station". It is a radio station.

Inside the shack all the feeders come to a switching panel. Care has been taken to ensure consistent matching and it is possible to switch aerials without having to rematch the transceiver. There are two

The VK5GN Radio Station



The Station hardware

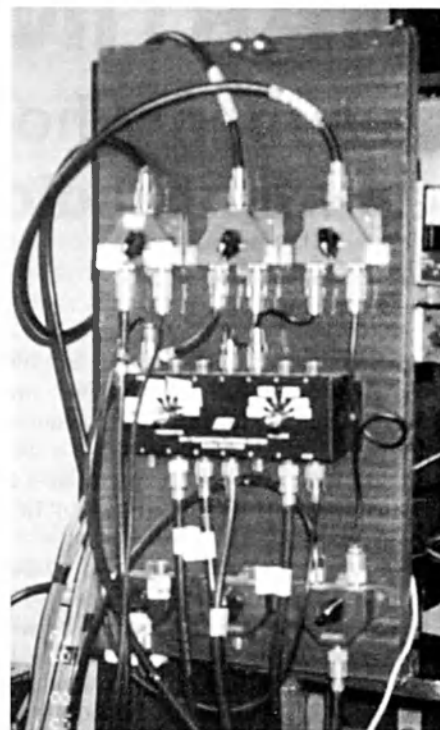

Antenna Switching Panel

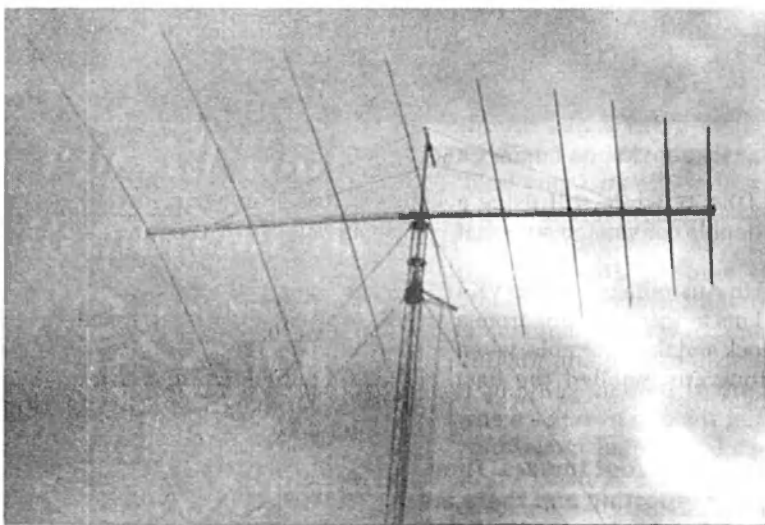

Log Periodic



The Towers



VHF and UHF Beams

transceivers and one is used for monitoring/spotting and the other is the operating unit. A computer logging system and automatic calling unit complete the basic station. Martin uses software control and the station is integrated with the computer

Like all good Amateur Stations this one continues to evolve. Martin is planning new towers for a better presence on the 20 and 40 metre bands as well as working on new microphone and audio feeds for cleanest sounding signals.

A quick look at the QSO analysis on the computer showed that between 1992 and 2001 there were 62,000 contacts on SSB, 30,000 on CW. It this total 15,000 had been contacted on four bands. Martin's QSLs come by the kilo. Martin commented on the large numbers of direct cards received. Australia is still a



rare country for many amateurs in the Northern Hemisphere.

The dedication has paid off and Martin is the holder of many world wide contesting awards. These include more than ten trophies for Continental wins as well as over one hundred winning certificates at the country level in significant contests. The most recent award was the Winners Cup for the Single Operator All Band Phone Section of the Oceania DX Contest in 2000. His score was 3.73 M points.

Although the main transceivers are now commercial Martin still builds much of his station including antennas. A Radio Amateur for over 35 years Martin is still clearly having fun and constantly learning new things.

ar

Contest plaques and the Oceania DX Contest Winners Cup

Correction

Simple Q meter

The Simple Q Meter AR January 2002 p12 had two errors in the diagrams. Fig. 1 Switch contacts S1 labels 'a' and 'b' should be reversed. Fig. 2 The resistor should be labeled $4.5 + R_c$. The attached diagrams are correct.

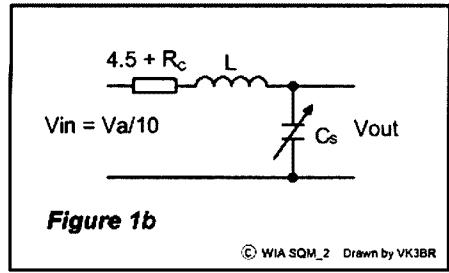
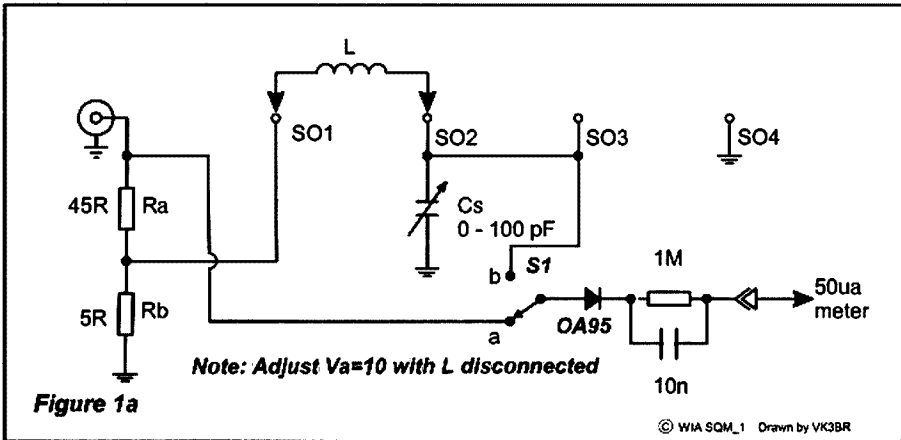



The Oxley Region Amateur Radio Club Inc

PORT MACQUARIE FIELD DAY

QUEEN'S BIRTHDAY WEEKEND 8th and 9th JUNE, 2002

Sea Scout Hall, Buller Street, Port Macquarie NSW

A family fun weekend on the beautiful mid-north coast.
Mobile and pedestrian fox hunts, professional equipment displays,
demonstrations and stacks of pre-loved gear.

Enquiries 02 6582 3557

For accommodation contact the
Visitor Information Centre
02 6581 8000

Technical Abstracts

Gil Sones VK3AUI
30 Moore Street, Box Hill South, Vic 3128

Six Metre Squalo

A Squalo is a square halo antenna. A Halo is a dipole folded into a circle and a Squalo is a dipole folded into a square. Both the halo and the squalo offer an approximately omnidirectional pattern in the horizontal plane. They can be made smaller by end capacitive loading and this is often done for use as a mobile horizontally polarised omnidirectional antenna. A design for six metres appeared in QST January 2002 built by Dick Stroud W9SR. This design was unusual in that the Squalo was constructed from the frame of a discarded folding lawn chair.

The squalo was built from the legs of the folding chair which had been discarded due to the seat and backrest becoming unreliable as the webbing deteriorated. The thin wall aluminium tubing had an

outside diameter of 0.975 inches and the right angle bends had been made by the chair manufacturer. The antenna construction is shown in Fig 1.

The two halves of the Squalo were

joined by a 12 inch length of 1 inch tubing which telescoped over the two ends. This was fastened together with screws. A teflon insulator made from teflon rod was used to join the opposite

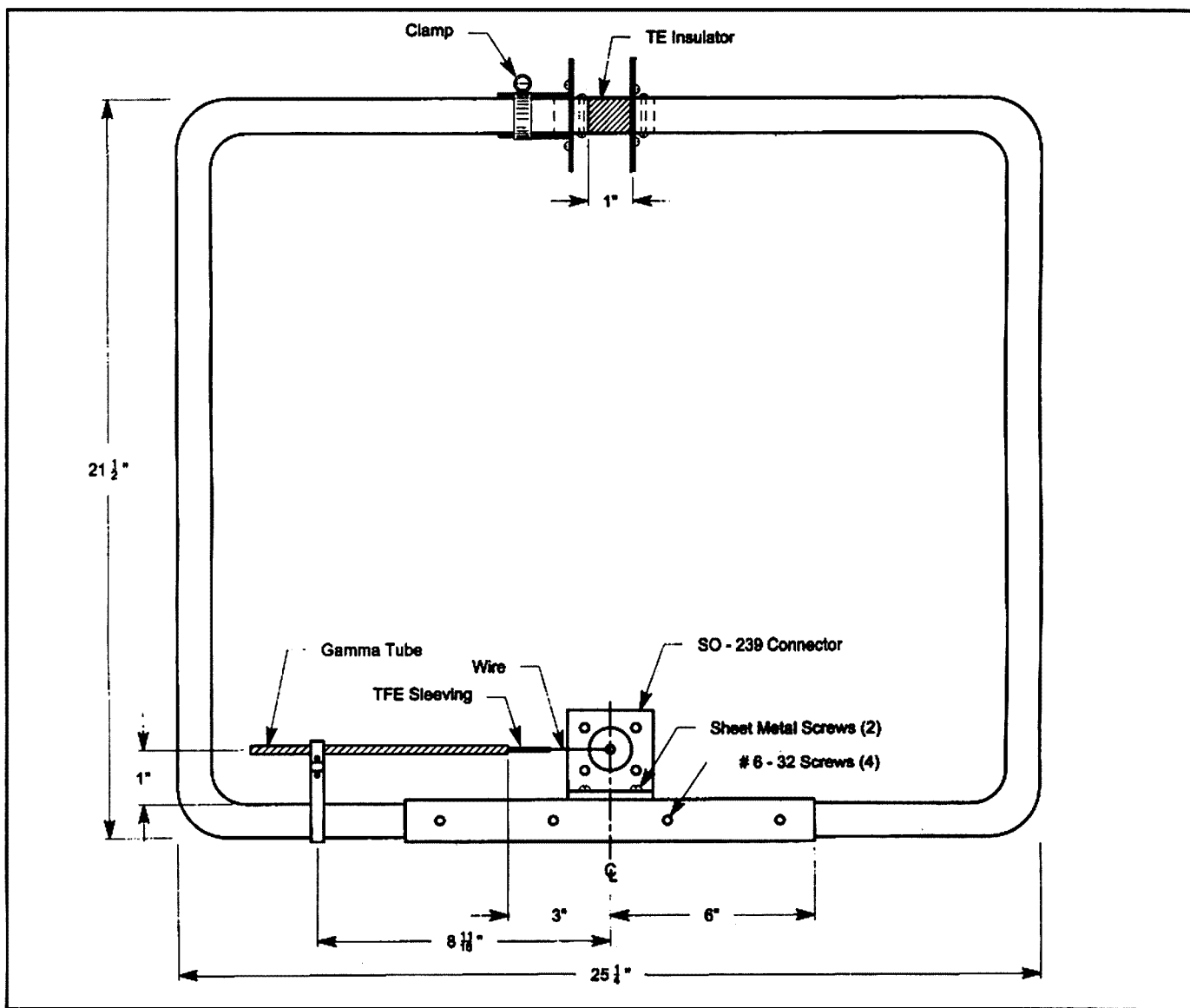

Fig 1. Squalo Antenna.

side. The two capacitor discs were 3.75 inches in diameter and had a centre hole to just clear the tubing. Small L brackets hold the discs to the tubing. One disc is fixed and the other is adjusted and clamped in position by a hose clamp which holds the L bracket in place on the tubing.

The Gamma match is made from a 7.25 inch length of 0.225 inch OD aluminium tubing. The centre element is a 9.375

inch length of 0.125 inch diameter copper wire. The centre element is insulated from the outer tube by some teflon sleeving. The adjustable clamp for the Gamma arm is made from thin aluminium sheet and is made in the form of a double clamp.

A mounting plate of 0.125 inch thick aluminium is used which was 6 inches long and 2.75 inches wide. This was fastened to the mast and the Squalo in

the middle of the element adjacent to the feed point.

The antenna is first resonated by adjusting the capacitor spacing. Then the SWR is minimised by adjusting the Gamma match. There may be some interaction and after several adjustments a low SWR should be obtained. The author obtained a 2:1 SWR bandwidth of 333 kHz.

Active Antenna

An active antenna comprises an antenna element and an amplifier combined into the one device. The antenna element can be a dipole, loop, or a monopole and is usually non resonant and small. The amplifier is combined with the antenna element hence the term active antenna. A design to cover 160 metres to 4/6 metres appeared in Rad Com October 2001 designed by Ian Braithwaite G4COL. It uses a 1 metre or thereabouts length of wire for the element and the amplifier uses standard components which should be easy to obtain.

A longer antenna length may seem attractive but it may result in signals which overload the amplifier causing severe intermodulation. The amplifier has a modest gain and must handle all signals present from below the broadcast band to VHF. The small antenna picks up a smaller signal and so helps to limit intermodulation. The amplifier amplifies the signal and allows the use of a coaxial cable to the receiver. The small antenna and amplifier can be less visually obtrusive and can even be hidden inside a non metallic roof.

The amplifier is shown in Fig 2. The FET used is a J310 type which is readily available. The output transformer is wound on a small toroid. This could be an Amidon FT37-61, or FT50-61 or alternatively a Philips type using 3C85 material no 433003037790 which is available from Farnell stock code 175-504. While the Farnell code is for the UK they do have an outlet in Australia.

The toroid T1 is wound with a quadrifilar winding of 0.2 mm diameter enamelled copper wire. Four strands of 0.2 mm enamelled copper wire approximately 300 mm long are placed

side by side and twisted together. A few twists per centimetre is adequate. The use of a small vice and a small hand drill will allow this to be done easily. The windings are then connected in series to produce one winding with three taps. The tap nearest the ground end is used for the output and this provides a 4:1 voltage stepdown.

The power feed unit RF Choke RFC1 is wound on another toroid of the same

type and consists of around 20 turns.

The resistor R2 is selected on test to give a current through the FET of 15 mA. A suitable starting value would be 47 ohms or 68 ohms and the current should be in the range of 10 to 20 mA with a target around 15 mA.

Both the antenna amplifier unit and the power feed unit were housed in small diecast boxes. Other types of small metal boxes could be used if desired.

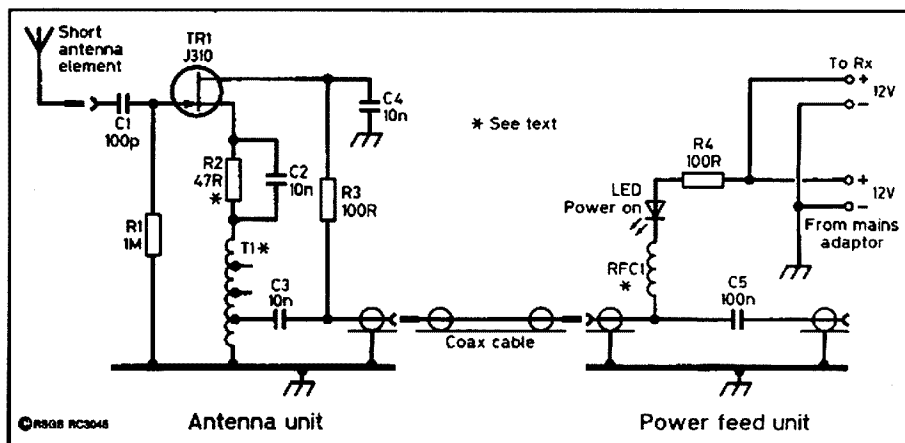

Fig 2. Active Antenna Amplifier and Power Feed Units.

Andrews Communication Systems

ESTABLISHED 1976

ACN 001 968 752

ALINCO

Made in Japan

DX-70TH



HF+ 6m 100W

ALL-MODE COMPACT TRANSCEIVER \$1499

- ★ DR-605EA FULL DUPLEX TWINBANDER \$899
- ★ DJ-G5EA FULL FEATURE H H TWINBANDER \$549
- ★ DJ-V5EA WIDE RECEIVE DUAL BANDER \$499
- ★ DR-435 UHF 35W MOBILE WITH 100ch MEMORY \$599
- ★ EDX-2 AUTOMATIC ANTENNA TUNER \$599
- ★ DJ-X2 NEW H+H SCANNER \$329
- ★ DR-135TP 2m MOBILE 50W & PACKET \$499
- ★ DJ-X2000 ALL MODE HAND-HELD SCANNER \$999

3-YEAR WARRANTY— MASSIVE RANGE
No. 1 ALINCO IMPORTER. Call us

GME ELECTROPHONE

UHF
CBs



- ★ TX-3400 REMOTE \$429
- ★ TX-3200 UHF. SCANS \$299
- ★ TX-4400 NEW UHF \$429
- ★ TX-6000 UHF H/HELD \$479

PROUDLY MADE IN AUSTRALIA
Authorised Dealer - Plenty of Stock

UHF

- 12 dBi vertical \$249
- 20 element Yagi \$249
- 6.5dBi with spring \$89

- ★ 450Ωline \$4/m
- ★ RG-213/u100m \$199
- ★ RG.213A.L.L. \$5/m
- ★ Plenty of connectors

EMOTATOR ROTATORS 747SRX

Made in Japan quality

- ★ 105TSX MEDIUM HEAVY DUTY \$799
- ★ 747SRX HEAVY DUTY \$1199
- ★ 1200 FXX SL PER HEAVY DUTY \$1999

Exclusive
Factory-
Direct
Importer



ICOM

Made in Japan



IC-706MKIIG WITH DSP \$2499
HF + 6m, + 2m + 70m TRANCEIVER

- ★ IC-756 Pro HF + 6m, colour \$Call
- ★ IC-746 Pro HF + 6m, + 2m \$3999
- ★ IC-718 100W HF SSB \$1649
- ★ IC-910H 2m + 70cm SSB \$Call
- ★ IC-207H 2m + 70cm FM \$699

IC-R3 h/held SP version \$599

- TV screen
- .05~900, 1300~2250 MHz AM/FM
- 450Ch (Regular IC-R3 \$999)



- ★ IC-R2 COMPACT SCANNER \$339
 - ★ IC-R10 ALL-MODE SCANNER \$699
 - ★ IC-R75 HF +6m RECEIVER \$1599
 - ★ IC-2800H 2m + 70cm FM \$Call
- 2 YEAR WARRANTY APPLIES

KENWOOD 1 YEAR WARRANTY Plenty Available

- ★ TS-50S HF 100W. MOBILE \$1599
- ★ TS-570SG HF + 6m. MOBILE \$2499
- ★ TS-2000 HF + 6m +2m + 70cm \$3799

MASSIVE RANGE OF USED RADIOS

SYNCR0 AUSTRALIA

TRANSCEIVERS — LINEARS — MICS — ANTENNAS — FREQUENCY COUNTERS

- SWR METER METAL CASE \$15
- 3 POSITION ANTENNA SWITCH \$15

TELESCOPES

HIGH QUALITY
BEST PRICES IN AUSTRALIA
REFRACTORS
70mm from..... \$179
Factory direct Importer — Massive range



MFJ TUNERS



MANY MORE ACCESSORIES IN STOCK

Uniden SCANNERS

Call for best prices

DIAMOND ANTENNA

FACTORY—DIRECT IMPORTER



- METERS
 - ANTENNAS
 - DIPLEXERS
- CALL

Uniden UHF CB

Please call for best prices

- GARMIN GPS from \$329
- KenwoodTK860G 25W \$799
- JAYCAR 40A &25A Power Supplies
- MAGNETIC 400/800MHz (used) \$9
- MASTEROTOR ROTATORS \$199

<http://www.andrewscom.com.au>

MORE INFO & USED RADIOS LIST ON OUR WEBSITE

CALL (02) 9636-9060 or 9688-4301 or FAX 9688-1995

SHOP 8, 41—51 BATHURST ST, GREYSTANES, NSW 2145 Near Great Western Highway

Why pay more? MAIL ORDER TO PO BOX 240, PENDLE HILL, NSW 2145

Some items indent. Prices subject to change without notice - limited stock, some items.

Cheap and Cheerful Varicap Diodes

Jim Tregellas VK5JST
14 Sheringa Drive, Morphett Vale, SA 5162
E-mail: endsodds@internode.on.net

Recently, I have been playing around with VCXOs and VCOs, and to do this, have delved into my stock of varicap diodes, types BA102, BB105, and BB212s. These old faithfuls have been soldered into and removed from many trial circuits, and now have leads so short that some are no longer usable and require replacement.

I went to the usual places, such as the Dick Smith and Jaycar catalogues, only to discover that the only varicap still sold by these organisations is the BB212 at a one off price of around \$6.00. This device is generally used for tuning AM car radios, has very large junction capacitance, and so is not too useful at HF. Hmmmm..... Well, I thought, perhaps Radio Spares have high frequency varicaps around 30picofarads.

So I dug out their 1998 catalogue and looked for conventional varicaps. Sure enough, there was the Motorola MV series with the desired characteristics. The MV1638 (30pf at -4V) sells for \$35.07 in unit quantities- Hmmmm again. Alternatively you can have BB619s or BB515s for around a dollar each but the catch here is the package. These diodes are supplied in a SOD 123 surface-mounting package, 1mm wide x 1.8mm long - for me these need to be fluorescent green, braille encoded and supplied with optional guide dog! Well, desperate times cause desperate measures, and remembering that all semi-conductor junctions have capacitance, I started looking at some of the other semiconductor devices in my junk box.

A quartz crystal oscillator was built at 10MHz, which featured low crystal drive levels and consequently very small AC voltages across any crystal series capacitance. A frequency versus capacitance law was then established for this oscillator by plugging in various values of crystal series capacitance. A number of diodes were then substituted

for the crystal series capacitance to establish how large or small their junction capacitance was. The graphs below show the winners. 1N4004s, 1N914s, and various zeners around 20-30 volts were tried, with little success. In general the junction capacitance is either too low to be useful at HF, or reverse leakage current eliminates the device. However, 1 watt high voltage zeners (70 volts and beyond) as well as high power diodes (2 and 3 amp) seem to produce good circuit Qs at 10MHz combined with negligible leakage

currents. And best of all, these devices won't disappear because they have to have this physical size in order to dissipate the quite large powers for which they have been designed. Couple this with a price of around 50 cents, and you've got a highly desirable varicap. Of course, they don't come with a 5% tolerance, but this will not deter any experimenter worthy of the name, as these devices are so cheap and readily available. One other advantage- an optional guide dog is not required.

ar

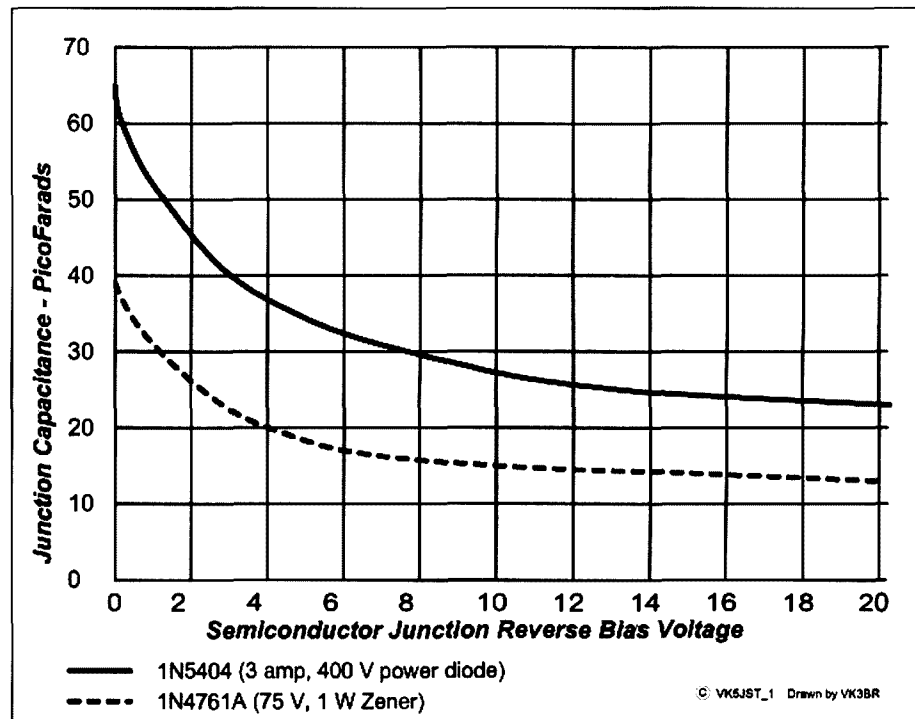

ALARAMEET 2002

<http://alarammeet2002.8m.com/>

From **Z** to **A** – and back Zeehan Astronaut

Zeehan Primary School International Space Station Contact 20/3/2002

By Dick Van Beek VK7KVB

The International Space Station (ISS) has been of great interest to most people on planet Earth and in particular to the family of an eight-year-old boy, Thomas Lynd, in a little mining town on the West Coast of Tasmania. Thomas' Dad just happened to be an amateur, Bill VK7KHZ (his real name is Shane!) Thomas and Bill had spoken to Andy Thomas aboard MIR and listened to many passes when Andy spoke to other amateurs in Australia, so when hearing contacts from the new ISS the inevitable question arose, "When are we going to speak to the ISS, Dad?"

The Zeehan Primary School Principal Neville Barnard was asked if the school would be interested in making a contact with the ISS. "Yes", was the immediate answer. An application was made to ARISS (Amateur Radio International Space Station), approved and a date and time set. This would be a history making first for Australian Amateur Radio and the ARISS.

At about this time VK5ZAI Tony Hutchinson the Australian appointed coordinator of ARISS became more involved and as our appointed mentor was of an enormous help with his advice and continuous email updates.

Grade 5/6 was the lucky class, under the guidance of teacher Miss Kathryn Weidenhofer. This class was nearly at the end of an educational project

covering Communications and Space science so the potential ISS contact would fit in really well with the school curriculum. As the contact date approached the students worked out

questions they would ask, practised correct radio procedure with the aid of an obsolete microphone Bill had given them, and listened to audio files of other schools who had already made contact



Dick VK7KVB and Bill VK7KHZ operate the station for the students

with ISS. This "training" proved to be very worthwhile on the actual contact day.

One of the conditions of the ARISS contact was that we had 2 complete working stations so the following equipment was selected.

- 1 x 4 x 4 element crossed Yagi antenna at fixed azimuth on a tripod stand with a medium duty rotator, elevation was controlled manually.
- 1 x Quadrifilar Helix circular polarisation standby antenna.



Students queue up to ask questions of astronaut Carl Walz KC5TIE



Thomas Lynd closes the Station

- 1 x Alinco DR119t VHF radio with output set at 5 watts.
- 1 x Icom 251A multi mode standby radio. (The Alinco proved to receive better at FM than the Icom.)
- 1 x Tokyo High Power HL180v amplifier.
- 2 x Dick Smith 20 amp power supplies wired in parallel.
- 1 x 210 AH lead acid battery connected to the power supplies.
- 1 x PC (main use, record the contact.)
- 1 x Speaker phone

The big day arrived. By the time I got to the Zeehan Primary School Bill was already at work. We had planned to hold the event outside in the courtyard so people could watch the ISS as it passed overhead while the students spoke to astronaut Carl Walz KC5TIE. But the weather turned sour with high winds and heavy rain so the equipment was set up in the assembly hall. The wind had blown over and damaged the crossed Yagi antenna, so Bill and I completed its installation by anchoring

the tripod antenna stand to the flat roof with G clamps. The Quadrifilar Helix antenna was mounted to the side of the building and all antennas and feeders were checked. SWR on all antennas was below 1.2:1 despite the damp. Next the antennas were tested with the Tokyo High Power amplifier in line for a few minutes with no problems. Power out of the amplifier was 120 watts. Current

No ARISS contact had been made with any Australian school to date so this would be a history making first for Australian Amateur Radio and the International Space Station.

drawn was 30 amps when the Alinco was keyed up and amplifier on. The current was shared between two identical power supplies. The power supplies we used were variable voltage types so it was easy to set the voltage on one and then adjust the other until the amp meter read about the same, in this case about 15 amps per supply. If the mains failed we would fall back on the

210 amp hour battery. We had the radio equipment and antennas ready.

We wanted to record the contact and this was done using a P266 PC that had multimedia capabilities. An electret microphone plugged into the sound card was taped to an extension speaker that was connected to the Alinco radio we would use for the contact. Bill's son Benjamin was given the job of holding the microphone a set length from each person. This set up made it easy to record both sides of the conversation.

A phone was also required to be near the station so Tony VK5ZAI could assist if necessary, also we considered it beneficial to have access the Internet in the lead up to the contact, to keep an eye on the Web page that displayed the ISS tracking software. The phone worked OK but no matter what we did we could not get the modem to work. We learned later that the school used a 4wire commander telephone system. We really wanted to get the computer next to the radio gear on the Internet but this was not to be. The school had a computer set up not



Success!

sincere appreciation to ARISS, AMSAT, NASA and WORLDCOM for their support.

With less than two minutes to go before our scheduled contact, total silence fell on the room. Two very anxious amateurs, Bill sitting with microphone in hand and myself poised with fingers on the

computer could not believe how long the last 2 minutes seemed to be.

At exactly 7:26: 32 The call went out, "NA1SS, NA1SS this is VK7KHZ Zeehan Primary School, Zeehan Tasmania do you receive OVER..."

Nothing heard, with total silence through the radio loudspeaker. Tony VK5ZAI responds around 10 seconds later through the speaker phone "Call him again I think he heard you"

"NA1SS NA1SS this is VK7KHZ..." etc.

"VK7KHZ this is NA1SS I hear you loud and clear OVER"

"NA1SS this is VK7KHZ we also hear you loud and clear, may we start our questions OVER"

"VK7KHZ you can start the questions OVER"

Following is the list of questions from the Zeehan Primary School;

1. This is Natasha Board - *How long do you stay on the ISS before returning home* OVER

2. This is Dylan Bramich - *How often do you get to talk to your family* OVER

3. This is Jamie Keogh - *What is the hardest thing about working in zero gravity* OVER

4. This is Daniel Mackrell - *What is it like to walk in space* OVER

5. This is Emma McKenzie - *What do you do in your spare time, are you able to watch TV or listen to radio* OVER
6. This is Tristan Nankervis - *What type of food do you eat in space and how is it prepared* OVER
7. This is Michael Turner - *What happens to your rubbish, is it bought back to Earth for disposal* OVER
8. This is Tahana Beamsley - *What, for you is the most anxious part of space travel, Lift-off or re-entering the earth's atmosphere* OVER
9. This is Natalie Maine - *How do you prepare your body for your return to Earth* OVER
10. This is Thomas Brooke - *What happens if something goes wrong and you have to evacuate the ISS* OVER
11. This is Melissa Campbell - *What types of Space experiments are you involved in on the ISS* OVER
12. This is Naomi Duggan - *How do you sleep in zero gravity* OVER
13. This is Ashleigh Docherty - *Why do you have to wear the Space suit only when you are outside the Space Station and at lift-off & re-entry* OVER

Station Close

"NA1SS this is Thomas Lynd... On behalf of the students of Zeehan Primary School and Grade 5/6 teacher Miss Weidenhofer I wish to say thank you for this exciting opportunity to speak with you, we wish you well and we will be watching with interest your return to Earth. This is VK7KHZ - OUT "

We were fortunate there was time to ask all 13 questions, receive answers and for Thomas to close the station. Total unedited wave file showed that the contact had been 10 minutes and 26 seconds. The grade 5/6 Zeehan Primary School students and everyone else in the hall had been given the opportunity few people in the world have, of being involved in a live contact with Carl Walz on board the ISS. The contact was hailed as an outstanding success as the room was filled with applause from the excited crowd!

For those interested pictures and a copy of the audio file can be found at: - <http://www.vk7ax.tassie.net.au/spectrum/ZeelSS.htm>.

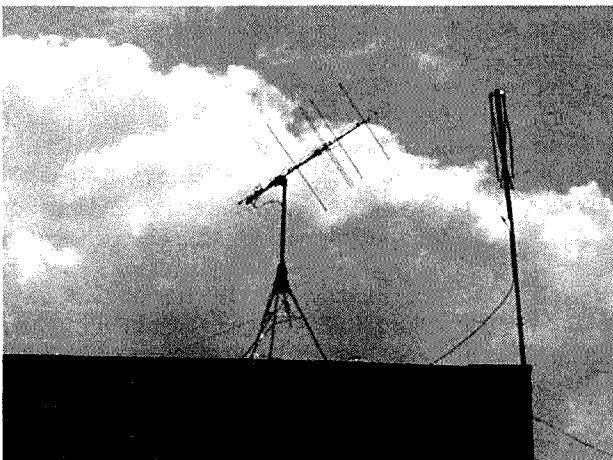

Zeehan ISS Antenna

Shortening Screws

A screw of the length required is often unavailable which leads to the use of a longer screw which needs to be shortened. This is an increasingly common problem as most hardware is packaged in what are regarded as a few common sizes. Shortening a screw can produce a result which is less than ideal when you need to use the shortened screw. In the In Practice column of Ian White G3SEK in Rad Com December 2001 a method of shortening a screw using only basic tools was

given. The method requires the use of two steel nuts. The nuts are run onto the screw with the outer nut being adjusted to the required length. The inner nut is used to lock the outer nut in position. The screw with the two nuts is now held in a vice with fibre jaws. Don't use the steel jaws as they will damage the screw head as they grip. This is shown in Fig 3a.

The unwanted length can then be removed using a small hacksaw. The face of the outer nut provides a cutting guide. Then file the end of the screw and the nut flat with a small file. The outer nut can now be removed. The nut will be a little stiff but will be removed without too much trouble. It will have raised a lip on the end of the thread in the process. See Fig 3b. Use a needle file to remove the lip which is sharp and a hazard. Clean up the start of the thread with the needle file. Now remove the second nut and if stiff screw it back on and clean up the thread some more until the nut can be removed with ease.

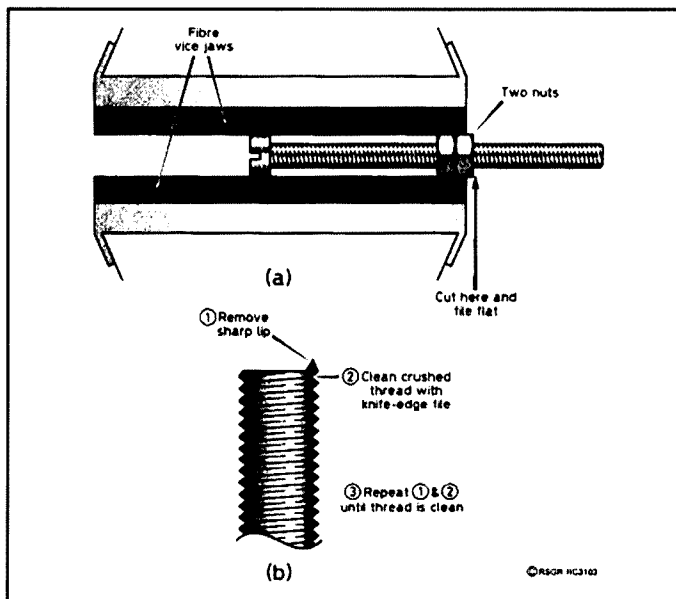

Fig 3. (a) Gripping Screw for Shortening. (b) Restoring Cut Thread with Needle File.

TTS Systems Communications Equipment

We stock the LDG Electronics Z11 QRP antenna tuner kit

This little tuner is fully automatic and covers all HF bands. It's an ideal companion for the Yaesu FT817. It's super compact, (127 x 216 x 32 mm) and weighs less than 0.5 Kg.

● Easy to assemble amateur kits

● Automatic antenna tuner Kits

LDG RT11 Remote 150 watt
LDG AT-11MP 150 watt with SWR meter.
Remote control for RT11

● Transceivers/Transverters/Receivers

TEN-TEC 2 & 6 meter transceiver kits
TEN-TEC QRP CW HF transceivers kits
TEN-TEC HF Receiver kits
TEN-TEC 2 & 6 meter transverters

* Note these kits are supplied at board level only. Other kits are complete with enclosure

● Accessory Kits

RF Dummy Load kits
TTS-450 4:1 Balun Kit
High Power 40 to 500 pf variable capacitor kits
SWR Bridge & Wattmeter kit
Active receive antenna kit *
Budget electronic keyer *
Transmatch tuning bridge *
Microphone speech processor *
Broadband preamp DC to 1Ghz *

All kits include easy to follow step by step assembly instructions. You supply the soldering iron and basic tools.

All kit products can be supplied fully assembled and tested.

■ We can supply the full range of TEN-TEC range of transceivers and HF linears (not kits). Call for details.

■ We also supply a wide range of professional grade RF connectors and cables. Check our web site or call for a free catalog.

■ Lutron 2.5 Ghz Battery operated hand held frequency counters. (0.1 Hz resolution up to 10 Mhz)

■ We now stock Amidon Iron Powder and Ferrite Cores — Call for an application guide

Phone 03 59774808

Fax 03 59774801

Email – info@ttssystems.com.au

Website - www.ttssystems.com.au

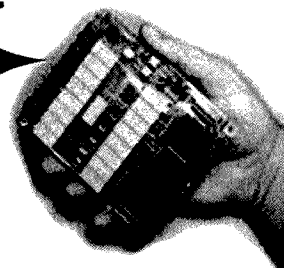

Clandestine communication equipment: my part in its creation

by Stephen G. Hart VK5HA

The recent series of articles on WW2 Clandestine Communications by Malcolm Haskard [1] brought back memories of how I was involved in the product engineering and manufacture of clandestine equipment. It all started in 1924, when aged 8 I was given a crystal set and became "hooked" on radio. In later years I became an electronics engineer and over an 18 year period, starting 1938 I worked on several clandestine projects in the United Kingdom before coming to Australia in 1956.

My first challenge, type BEF2

My first job in radio was a trouble-shooter in the production test department of Cossor Radio in North London. After a few months I moved to Philco Radio at Perivale, progressing over time from the Production Floor to the Development Laboratory. In late 1938 I produced the prototype of a small battery operated LW-MW portable receiver, which later was the BEF2, which was issued to troops and others as a means of disseminating news. The set was in a wooden cabinet with a striped Rexine material cover, and about 30 cm long, 15 x 15cm looking endwise. The compact size was made possible through employing the recently available miniature 1.4 v battery type valves. While working at Philco in 1939 I became aware of the Signals Development Organisation (SDO) headed by Colonel Schoeter and Captain Holiday, both known to me for they had been on the General Engineering staff at Philco. This organisation was the forerunner of the Inter Services Research Board (ISRB) R&D Establishment at Old Welwyn in Hertfordshire, ISRB headquarters were in Baker Street; I assume it was a division of the Special Operations Executive (SOE).

The Eureka Mk III

Having registered with the Government Appointments Board I was offered a job at the Ministry of Supply Air Defence Experimental Establishment (ADEE) at Somerford, then in May 1940 in the Radar Receiving Development Laboratory, and transferred to the Department providing Establishment and Manufacture liaison in 1941. The Superintendent of ADEE was an Australian, Dr. D H Black, and in 1942

he delegated me to the Air Ministry Telecommunications Research Establishment (TRE) Eureka Mk III project to liaise between TRE and the Cossor Company in North London. The Eureka was a very small radio transceiver beacon similar to the S-phone. I remember a visit to an army base in Salisbury Plains where a Major strapped on the belt carrying the Eureka and several bulky batteries and threw himself onto the floor very heavily several times in different postures to establish whether or not bodily injury occurred.

The Miniature receiver, type MCR 1

In 1943, as the outcome of an earlier social visit to Philco, I rejoined the company to work on a special project, the MCR1. I met Captain, later Major John Brown the designer of the MCR 1, who showed me his prototype and filled me in with the design details. My job was production development, prototyping extending through the early stages of production and testing with a continuing technical responsibility throughout the period of MCR 1 production. Figure 1 shows the MCR 1 circuit diagram. The AC/DC power unit was the responsibility of another engineer and the final packaging in the Huntley & Palmer biscuit tin was probably undertaken by ISRB themselves.

The drawing office, model shop, tool room and press shop all helped in the making of the metalwork and mouldings. It was my task to construct six prototypes and subject them to all the necessary measurements and tests in order to assess and then establish the performance parameters for the approval of Major Brown, a task that included IF and RF coils. The design of the MCR 1 was unusual in as much as it used a

single span system that gave LW-MW band coverage in a single range (100 to 1600kHz). When it came for me to put Major Brown's prototype through performance tests instability was observed on this band. The problem was passed back to the Major. A resonant IF trap in the aerial circuit was the cure.

For the first few weeks of production I spent time each day on the assembly line, taking the place in turn of each operator whose specific task I knew very well. I recall the total production as 50,000 or more than a 1,000 units per week, taking over a year to complete the task. The coil winding shop, although by no means small, was unable to cope with the very large number of coils needed per week, so Philips and Advance Co. were brought in as sub-contractors. The miniature variable antenna trimmer capacitor was made by GD Radio at Hendon. Philco Test Department designed and built several signal generators that provided rapid frequency selection enabling minimum test time, needed for the high rate of daily production.

The Airborne S-phone unit

Following upon the MCR 1, ISRB gave Philco the contract to produce the S-phone Airborne VFO Unit. The preproduction task was given to me. Liaison was with Lieutenant Hoyle who demonstrated and explained the system to me at Old Welwyn headquarters. The S-Phone was a duplex transceiver, two way communication taking place with sound proofed headset and microphone so only the operator could know what was said and received. Ground equipment in use is shown in Figure 2.

The VFO was around 20cm long and 8 x 8cm looking endwise. It used an RL 18 triode, a short lecher line tuned with

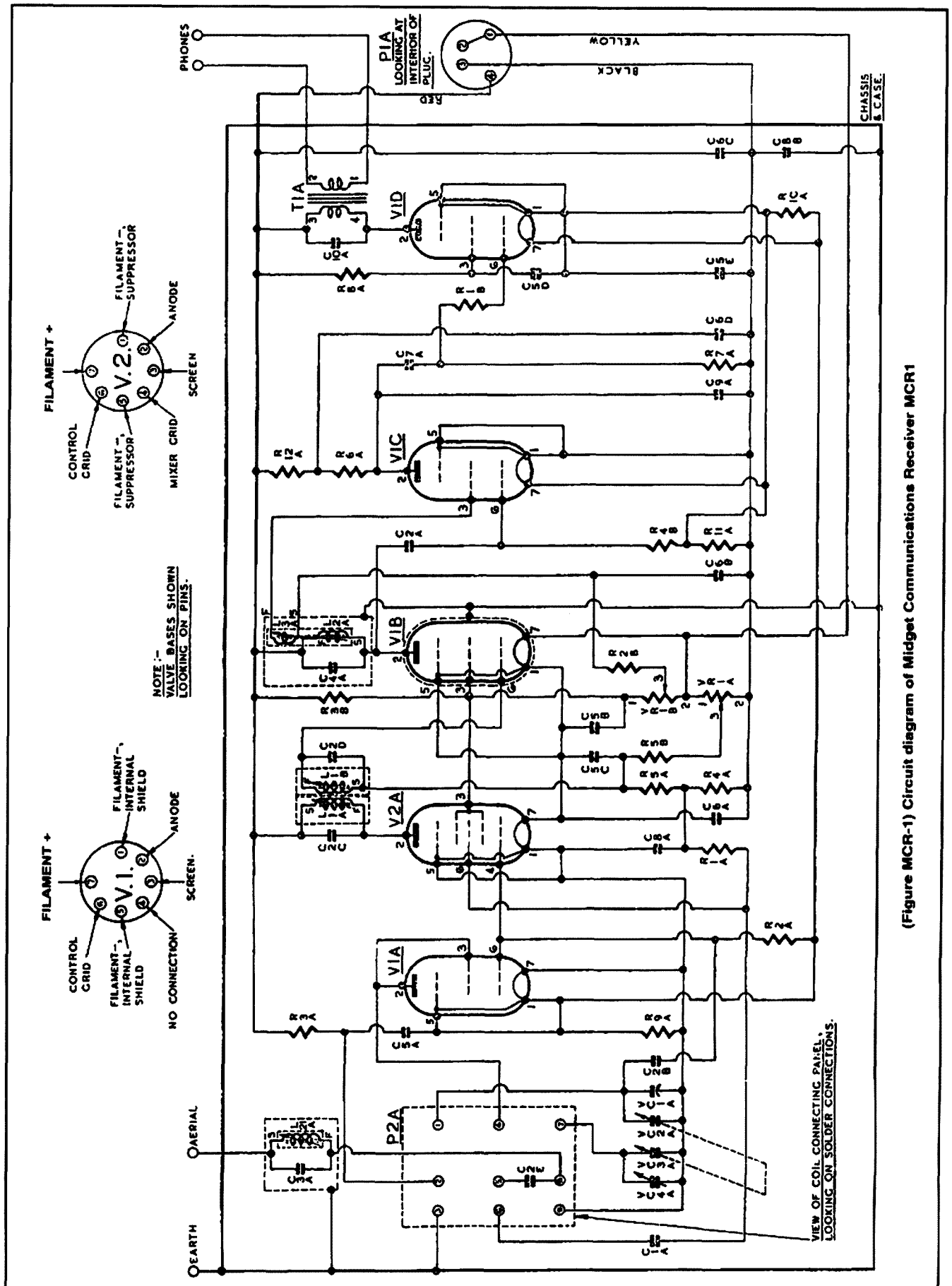

(Figure MCR-1) Circuit diagram of Midget Communications Receiver MCR1

Figure 1. Circuit and components for the Midget Communication Receiver, Type MCR1

Australian Made ANTENNAS

"Setting a New Standard" COM-AN-TENA

(Formerly a j and j coman)
83 Belgrave-Hallam Road
HALLAM 3803

All new 5/8 vertical 16 radials	\$145
Dual drive 26-30 5 ele yagi beam	\$305
4 ele 10-11m yagi beam	\$262
5-6-&7 ele high gain antennas 11m	\$call
3 ele delta loop 10-11m	\$320
11m 5/8 vertical/4-1/4 wave radials	\$170
Duoband 10-15 3 ele each band	\$356
Log-periodic 7 ele 13-30 MHz 7.7m boom	\$890
Tri-band 5 ele HB35C s/steel fix	\$730
3 ele 20m computer opt	\$390
3 ele 15m computer opt	\$285
M B Vert Auto switch 10-80m	\$310
40m linear loaded 2 ele beam	\$580
6m 5 ele compt opt beam	\$259
6m 7 ele compt opt beam	\$355
10 ele high performance 2m	\$135
17 ele high performance 70cm	\$119
2m vert 2-5/8 co-linear 4 rad	\$ 96

Special
DEMO 21 metre aluminium mast
complete. Tilt over telescopic.
One only **\$2600**
(new price \$3500)

Guyed Masts

21 metres **13 metres**
Winch-up & tilt-over. Aluminium and stainless steel
three-sided construction. Auto-brake winches

Free Standing Masts

9.5 metres
New Baluns
1-1 to 16-1 to 3kW



Our Masts
meet Australian Standards.
We supply all the computations
and data you will need for
a permit

03 9702 4028
Mob: 0419 542 437
Andy VK3IV

a variable capacitor of unusual design, rotation of one semi-circular surface perpendicular to the other. The test set up employed a ground plane antenna using a copper sheet about 60cm square upon which were mounted three quarter wave elements. The transmitter and antenna were activated by a complex looking unit I knew no more about than how to operate. It facilitated modulation and the switching of the two reflector elements which provided Left-Ahead-Right sensing to guide the approaching supplies support plane to the location of the Resistance Personnel in hiding. Accuracy I believe was around half a degree.

Other clandestine equipment

Over the period 1948 to 1956 I was with the production unit of an organisation whose task it was to design and provide communications equipment for the needs of intelligence gathering. As Works Engineer (Electronics) I was associated with the prototyping of a modernised version of the S-phone system, the setting up of the production test facility and then overseeing production testing which was carried out between a site in Buckinghamshire and a Dunstable Downs hilltop.

Following that, I was asked to give thought to the design and development of an MCR 1 follow-

on, if possible the size of a 50 Players tin. Variable inductance tuning was considered, but discarded when I came up with the concept of a two section side-by-side variable capacitor embodying drive and spiral scale. This concept resulted in the overall dimensions of the receiver, inclusive of the coil box to be less than 16cm long, 8cm wide and 4cm in depth. The main body was minus a rectangular section less than 9cm long and 4 x 4cm looking endwise, this space accommodated the plug-in coil box. Only one being needed to cover all bands. Two coil box sides comprised of longitudinal bakelite panels housing the connecting sockets. Inside the box there were two rows of miniature potcore inductors, one row for the antenna, the other for the oscillator circuit. Band selection was by changing the coil box orientation of which there were four options. The reduction drive of 22:1 and the frequency calibration were a composite part of the mechanics linking the two side-by-side capacitor sections together. The circuit was that of a basic superhet with BFO and a nominal IF of 460kHz. The valves were of the ultra miniature type, pencil thin with flying leads. The side-by-side capacitor was prototyped and manufactured by Wingrove & Rogers the "Polar" company in Liverpool, founded by Colonel Rogers (with whom I

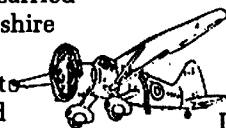

liased) and Major Wingrove. There was a companion battery pack and several hundred sets were made. It was known as the Receiver type 301. This was my final participation in what at that time, in view of the cold war, was a most necessary field.

Conclusion

I trust these memories will encourage others to share their experiences of clandestine communication equipment, including design, manufacture and operation so that the secrets of past years can be shared with equipment restored and treasured.

References

Haskard M. R. (2001), "World War II Clandestine Communications", in three parts, Amateur Radio, Volume 69, Nos. 1, 2 and 3.

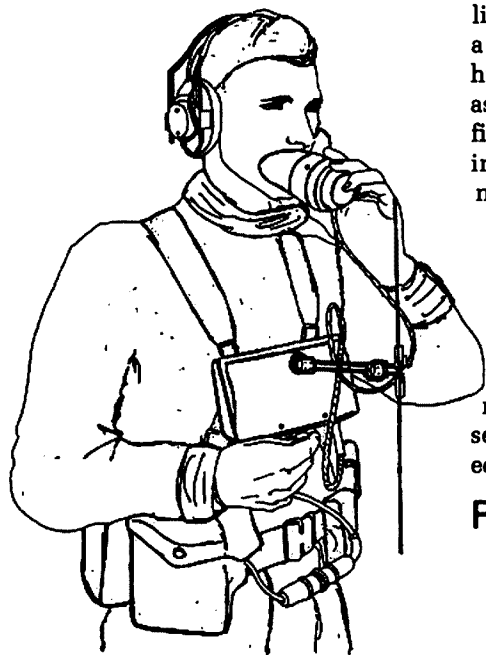

Figure 2. The S-Phone in operation, bringing in a Lysander aircraft.

ar

Gosford Field Day

As usual Dot VK2DB manned (or should that be womanned?) the ALARA stand for the Gosford Field Day and had a number of YL visitors. June VK4SJ came down from the Sunshine Coast, Val VK4VR and Anne VK4ANN came down from Maleny, Agnes VK2GWI and Karen VK2YKB visited and Linden VK1LSO decided to join ALARA on the day. Welcome and Hello to everyone.

Dot was luckier than most, she purchased a searchable CD of the WIA Callbook, which seems to have been in short supply since that Field Day. No doubt it will reappear in due course.

The 222 Net

This net is very efficiently run by June VK2SJ and is used by a number of overseas YL stations on a regular basis. We should make the most of the opportunity while the propagation is so good. The sunspot cycle will not last forever.

The Net is run each Monday on 14.222 MHz. It is suggested you call in from 530UTC that way, as other calls come in they can be told you are there so you can make contact.

Why not see how many DX YLs you can contact. There are lots of Awards to be gained this way.

I also hope a number of people entered the Thelma Souper Contest at the beginning of April. With the change in the rules to allow VK stations to be multipliers and with OMs allowed to contact both YL and OM stations there should be much more opportunity to make good scores.

The details of the rules were all in the ALARA Newsletter for January.

The 33 Award

There is a new YL award, just launched on 14th April. In honour of Ethel K4LMB, a certificate will be awarded to any licensed radio operator who works 33 different YLs on any authorised frequency, including UHF, VHF, or HF. Net or repeater contacts cannot be counted

The award will only be available during 2002.

Logs should be sent to YLRL Vice President Jeanie Parker WA6UVF, QTHR postmarked no later than 31st December 2002.



Above: Agnes VK2GWI and Nancy at the ALARA table.

Right: Anne VK4ANN and Val VK4VR taking a crossword break.

ALARAMEET 2002

October 5 and October 6, 2002.
Murray Bridge SA

The date is getting closer. Many people have booked their accommodation but we are not sure if all of those have told Jean VK5TSX, the coordinator, that they have done so.

All the details of costing will be in the April Newsletter and posted on the website. The deposits will need to be on their way soon, too, so the information

in the Newsletter should help you organise all that.

We hope a number of OMs will come along and bring their YLs. It is not necessary to be a member of ALARA to participate. It is a great weekend of good fellowship for YLs and OMs. It is normal for the local amateurs to join in, wherever the ALARAMEET is held. We hope this year will be no exception.

Another story of our Mary

Mary VK5AMD is known to many of the travellers between Adelaide and Melbourne. She monitors 2 metres continuously and enjoys all the conversations with passing amateurs. She also makes a mean cuppa, so stop and visit if you have time.

However, her latest activity has revived an interest she has had since she was a child. She has taken up painting again, and, with a little encouragement from the Tolmer Palette Painters she has put some of her paintings on show.

She has been drawing since she was a

child; she has painted in oils and is now trying her hand at water-colours.

One of her paintings will be part of the Special Effort at the ALARAMEET later this year. Perhaps she will bring several others along to show us.

If you would like to see Mary's paintings and those of other local artists the Tolmer Palette Group has opened a gallery in Bordertown which is attracting a number of passing visitors as well as the townspeople.

A YL with many talents is Mary.

Beyond Our Shores

David A. Pilley VK2AYD
davpil@midcoast.com.au

Logbook of the World will complement QSL tradition

ARRL's Logbook of the World (LOTW) electronic contact-verification program will spark "a culture change" when it's introduced later this year, predicts Project Manager Wayne Mills, N7NG.

Once LOTW is operational, participants will be able to qualify for awards such as DXCC or WAS without having to first secure verification in the form of hard-copy QSL cards. But Mills—who heads ARRL's Membership Services Department—is quick to add that LOTW will complement the conventional exchange of QSL cards, not replace it.

"We will not do away with accepting QSL cards in the traditional manner," Mills says. "We're not replacing the whole paper QSL scheme with Logbook of the World." Neither will Logbook of the World provide a means to get QSLs—electronic or otherwise. Mills said amateurs will still be able to solicit QSLs—even electronic cards—although e-QSLs still may not be used to apply for ARRL awards. Mills this week issued a separate ARRL e-QSL policy statement to clarify what is and what is not acceptable

<<http://www.arrl.org/news/stories/2002/03/07/100/>>.

Logbook of the World "is really a system to offer credits for awards—and not just our awards," Mills explained. He hopes to enlist the participation of other organizations that grant operating

awards, such as CQ and RSGB.

Central to the LOTW concept is a huge repository of constantly updated log data provided by individual DXers, contesters and DXpeditions and maintained by ARRL. Once it's up and running, Logbook of the World will be able to provide quick contact credit. Mills adds that the system will be open to all—ARRL members and nonmembers.

Registering and uploading electronic log data to LOTW will be free. The only time users will incur charges is when they wish to apply contact credits toward a particular award, such as DXCC, WAS or VUCC.

Software development for *The Logbook of the World* continues. "We're well into the software implementation phase for the logbook server," said ARRL Web/Software Development Department Manager Jon Bloom, KE3Z, who expects to begin full system testing this spring.

"The security part is the linchpin of the system," Bloom said. Both he and Mills emphasize that every effort will be made to ensure the integrity of LOTW log data. Registrants will have to positively identify themselves via off-

line, hard-copy means before being issued a secure—and free—digital signature and granted password access.

In simple terms, when a participant logs on, the Logbook system would determine if its database contains any contact "matches" with log data submitted. If so, a user could apply any credits generated to particular awards at a per-credit fee. Mills said the cost would be in line with current ARRL award fees.

In situations where an operator disputes a failure to match, Mills said, the operators involved would have to resolve the situation off-line.

Bloom and Mills believe that *Logbook of the World* will improve the integrity of the confirmation process. "It will remove some of the human factors that lead to errors," Bloom said. And, Mills added, *Logbook* will minimize opportunities to purposely "game the system" or to outright cheat—something that's not always possible to detect even with paper QSL submittals.

Mills said he hopes to announce an inauguration date for *Logbook of the World* within a few months.

(ARRL N/L 10/3)

Amateur radio in space

Over the past year I have reported quite a few of the contacts the International Space Station had conducted with schools around the globe. The March 14 contact – sponsored by the Amateur Radio on the International Space Station (ARISS) programme – was the 50th in a series of scheduled school QSOs since the first ISS crew came aboard in November 2000.

The lucky school for this contact was with the Peter Anich Oberschule für Geometer in Bolzano, Italy. It was conducted in English. During the 10-minute contact, 10 students put 18 questions to Dan Bursch, KD5PNU, on a wide variety of topics. Students asked about electrical power consumption and oxygen production aboard the ISS as

well as about ultraviolet and cosmic ray exposure.

During the contact, Bursch and his ISS crewmates, Yury Onufrienko, RK3DUO, and Carl Walz, KC5TIE, were passing over Australia, where Tony Hutchison, VK5ZAI, served as the ground station. Two-way audio was distributed via a WorldCom teleconferencing circuit.

Teacher Peter Kofler, IN3JHZ, prepared the students for the ARISS contact and handled telebridge audio at the school. ARISS mentor Gaston Bertels, ON4WF, in Brussels moderated the session.

Think of the distances involved here. It really shows amateur radio at its best and should make you feel proud to be part of this exclusive fraternity.

(ARRL N/L 16/3)

Maritime Mobile says "Thank you"

David Beane, G0TAG, this week expressed his thanks to members of the Maritime Mobile Service Net, who assisted him and his wife, Sarah, after their sailing vessel Tao went aground March 26 off Cuba.

Amateurs were able to contact Cuban authorities, who secured the vessel and later helped to refloat it. "Having got our brains back together after our nasty incident we wish to send our thanks to the guys on the Maritime Mobile Net who acted with such efficiency when we went aground on the north coast of Cuba," Beane said. "The Cubans helped

to lay out our anchors and stood by us during the night." They also arranged for a tow boat, Beane said, but as it turned out, a tow was not needed as the couple managed to get their sailboat into deeper water by themselves. Cuban fishermen then escorted the Tao into the ocean through a gap in the reef, and in port at Moa, two divers checked out the

underside for damage—all at no cost, "just a lot of smiling and waving," Beane said.

If you have any interesting amateur radio news from overseas, please share it with us.

Email davpil@midcoast.com.au or snail mail me de VK2AYD.

Morse programme

Did You Know?

...that a new Morse Teacher program is available? Developed by NZART's Morseman, it can be downloaded from the NZART web site or purchased on floppy disk from NZART Headquarters.

It runs in Windows, will take you from absolute zero to high Morse speeds, and is probably the best and most friendly Morse teaching program ever.

See: <http://www.nzart.org.nz/nzart/>

(NZART N/L 16/3)

Farewell

Many of you who pioneered SSB back in the '50s will remember B & W – Barker & Williamson, either from the early SSB transmitter 5100 or from the famous 2Q4 phase shift network that plugged into an octal base.

I used the 2Q4 in my first attempt at building a "Donald Duck" SSB transmitter, as it was known then. "It will never catch on" was the cry. I never really was successful in completely suppressing the unwanted sideband. You may be interested to learn that Jack Williamson, W3GC, passed away a few months back. He was a great inventor.

G. & C. COMMUNICATIONS

Authorised dealer for ✓ Kenwood ✓ Icom ✓ Barrett RFDS ✓ GME Electrophone ✓ Uniden ✓ RF Industries



KENWOOD TS2000



All-mode multiband HF/
50/144/440
Auto antenna tuner built-in



✓ **ELECTROPHONE TX3400**
10 Channel UHF remote mount transceiver
with ten extra receive channels



ICOM IC207H

Amateur 2m/70cm FM mobile transceiver.
Compact dual band unit with detachable
control panel (OPC-600 cable required)

Australia-wide orders welcome. Payment by credit card, cheque or money order
19 Arleon Crescent Cranbourne 3977
Ph: 03 5996 3298 Fax: 03 5995 0184

Email: gccomm@netspace.net.au
www.netspace.net.au/~gccomm

Soapbox!

I'm climbing onto a shaky soapbox for this month's column and expressing some thoughts, thoughts that are mine and not necessarily anybody else's or the WIA.

Connecting radio systems, and in particular repeaters to or via the Internet is a hotly debated topic at the moment. The WIA and others are struggling to interface this new frontier, the Internet, to amateur radio. Now the intention of this article is not to even attempt to sort out the problems real and or imagined but to look at the broader issue facing amateur radio and that is regulations. Readers of this column over the years will have detected a general dislike by me of regulations. We do need regulations, but my issue is the detailed complexity and difficulty in finding the right balance for a hobby that has at its heart experimentation.

For starters, regulations relating to amateur radio are too complex and detailed. To explain over all what I mean about over regulations, without getting into vast amounts of detail, a simple philosophical point. Amateur regulations are put together on the assumption that something unwanted might happen. Rather than assume the worst, as is the current situation, why not take the opposite position and only regulate if something undesirable starts to happen.

For example the Internet connection problem to repeaters at the moment. Clever amateurs and non amateurs design software and hardware to allow amateurs to talk through their local repeater, via the Internet, to other amateurs on the other side of the World. There are several different types of software and some allow only radio to radio contact and others for the connecting medium, the Internet, to also talk from a computer out to an amateur repeater. It is this possibility of non-amateurs gaining access to amateur repeaters that is causing all the problems.

Lets ask the question, so what? What if a non-amateur pops up from an Internet connection on your local

repeater? Now I know this is as close to treason as you can get in the eyes of many amateurs, but hear me out. As I said, amateur regulations assume the worst, and in this situation it is assumed that vast numbers of Internet idiots could and most probably would end up yelling profanities at you from your local repeater. The repeater could become clogged with the worst kind of misfits from all over the World in their thousands.

However as I have aged I have come to question what appears to be the logical outcome more and more. If we always assume the worst we amateurs could continue to isolate ourselves. Amateur radio is by its nature a solitary hobby within the hobby and is facing difficulties maintaining numbers. So lets

For starters, regulations relating to amateur radio are too complex and detailed...

speculate on a different outcome of allowing non-amateurs onto some repeaters via the Internet.

Only some repeaters would be connected to the Internet and allow non-amateurs to talk from their computers out onto a radio repeater. Remember we as amateurs decide if we want to connect a repeater to the Internet and if we want non-amateurs to have access from the Internet.

Perhaps our worst fears would not happen. Perhaps there would be a number of non amateurs popping up on some of our so designated repeaters who are interesting to talk to and perhaps also could become interested in amateur radio.

Now I hear what some of you are saying. There are no end of local, National and International regulations that stand in the way of this happening. Third party agreements, non-commercial rules, the list is a long one. However non-amateurs talking to amateurs could see the hobby of amateur radio explained to the Internet visitor, along with its content limitations. An opportunity to present amateur radio to the World could be just out there on the other side of a vast pile of regulations. If it proves to be an unworkable mess we control the off button.

Amateur radio needs a means of trying ideas like this. Written into the regulations there needs to be an experimental clause saying, "this looks like a bad idea but just incase we, the regulators, don't know all the answers, will allow a trial to be sure." It was thought that the telephone would only be useful for letting people know they had a telegram to pick up at the post office. How wrong could you be?

That's my controversial topic for the month, allowing non-amateurs via the Internet onto some of our repeaters. Yes lots of problems perhaps, but the point of this article is to say our hobby is technologically based which rapid change and we struggle with that change and declining numbers, usually by a vast number of regulations. Regulating bodies are there to regulate by creating rules, it is not their nature to deregulate or be innovative unless they are convinced it could just work. And most important to the regulator, make their job easier.

I would enjoy criticism on this topic as it could just be I'm way off the beam and need to go back to fixing a blocked sewerage pipe, which is what I was doing when I took a coffee break to write this article.

ar

Take Five — Help us to help you

As promised in the last month's AR I take pleasure in including a brief set of survey questions about the WIA and its house journal *Amateur Radio* (AR).

I would be grateful if you could take the time to respond to this survey so that the WIA can better understand how to deliver a quality service to its members, as well as all Australian amateur radio operators.

Completed forms should be returned to me directly.

A copy of this survey can also be found on the WIA web page at www.wia.org.au

All survey responses will be entered into a draw. The first three survey forms drawn will receive a free one year subscription to AR.

Many thanks in advance for your responses

73s from Ernest Hocking VK1LK

1. Are you a current member of the WIA
YES NO

2. Have you been a member of the WIA in the past (If yes, would you please indicate why you have stopped your membership)
YES NO

Comment:

3. Do you subscribe to AR
YES NO

4. Have you subscribed to AR in the past (would you please indicate why you have stopped your subscription)
YES NO

Comment:

5. Would you be interested in a subscription to AR in its current format.
YES NO

6. Would you please indicate what factors would stop you from subscribing to AR:
Print quality Technical content
Cost Other

Comment:

7. Do you believe that the WIA keeps you up to date in amateur radio matters
YES NO

Comment:

8. Do you believe that you are able to have your opinions and views heard by the WIA
YES NO

Comment:

Please return this survey to:

Ernest Hocking
WIA Federal President
PO Box 691
Dickson
ACT 2602

Continues on next page

Separate survey form along this line

9. Indicate how you think the WIA can improve its communications with Australian amateurs.

Comment:

10. Would a electronic subscription to AR be of interest to you? (email or via the World Wide Web)

YES NO

Comment:

11. Are you a currently licenced amateur radio operator?

YES NO

12. Are you an amateur radio operator who currently does not hold a licence?

YES NO

13. Are you interested in becoming an amateur radio operator?

YES NO

14. Is there any specific reason why you do not currently hold a licence?

15. Do you have easy access to the Internet?

YES NO

16. Are you a member of a local radio club?

YES NO

17. Do you currently act in any role in support of amateur radio activities?

YES NO

Role held:

18. Would you be prepared to provide time, or other assistance to the WIA to help other amateurs in the promotion of amateur radio.

YES NO

Comment:

19. Gender MALE FEMALE

20. Would you please indicate your age

under 20 21—30
31—40 41—50
51—60 61—70
Over 70

If you are a member,
and wish to tell us more about how we can help you feel free to enclose a note.

If you are not a member,
please feel free to include a note about what you see as positive steps WIA could take to better serve amateur radio in general

Only fill in the section opposite if you wish to Name _____ VK _____

be in the draw for subscriptions. Address: _____

If you wish to remain anonymous leave it blank.

VK7 Notes

QRM. Tasmanian notes

The Tasmanian Division annual meetings, held late March resulted in some changes to our executive and Council. Our Council must consist of at least two from each of the three branches – This year's members are:-

SOUTHERN BRANCH

Mike Jenner VK7FB
John Bates VK7RT.
Dale Barnes VH7DG.

NORTHERN BRANCH

Phil Corby VK7ZAX
Al Burke VK7AN
Geoff Wells VK7ZOO

NORTH WEST BRANCH

Ron Churcher VK7RN
Bob Cropper VK7BY

Mike Jenner was elected as President, John Bates as Secretary/treasurer and Phil Corby continued on as our Federal Councillor. It is disappointing that our membership has fallen slightly over this year – this is happening, it seems, in all hobby. sports clubs etc and is a serious trend in people involvement. We have to keep a tight rein on our finances – thank you, John, for your good work here.

We held the meetings in the Burnie Scout hall. An I.R.L.P. demonstration attracted a lot of attention as did a brilliant interactive video presentation put on by Hydro Tasmania and presented by their senior technician, Terry Ives, VK7ZTI on the windfarm project at Woolnorth in the far northwest of Tasmania.

At the last meeting of the Southern branch Mike Grath gave a lecture on "Communicating with light" with an interesting example of the optical technique of using L.E.D.s and readily available detectors to communicate over many kilometres. His fellow experimenter, Chris Long will soon join him in Hobart to conduct more experiments and even try for long distance records. We await with interest more news of these.

The Southern ATV group has re-activated itself and has a six metre repeater and an ATV repeater as fresh

projects. The Tasmanian beacons, 2 metre and six metres, are humming away merrily from their Kelcey Tiers location

behind Devonport but the 70 cm. Beacon is still on the sick list. Won't be long ! Cheers for now.

Ron, VK7RN



VK7 Council. Seated, L to R: Incoming State President Mike Jenner, VK7FB, Honary secretary John Bates VK7RT.

Standing, L to R: Dale Barnes, VK7DG, Phil Corby, VK7ZAX (Federal Councillor), Ron Churcher, VK7RN, Bob Cropper, VK7BY, Al Burke, VK7AN. Missing Geoff Wells, VK7ZOO.



Terry Ives, VK7ZTI a senior technician with Hydro Tasmania setting up his interactive video presentation of the windfarm project in far northwest Tasmania.also explaining the Basslink proposal for linking Tasmania to the Victorian grid.

VK1 Notes

Forward Bias

Quorum: a minimum number of members in an assembly required to be present before any business can be transacted. As most of you will know, at committee meetings a quorum is five members. But at general meetings, annual general meetings, and extraordinary meetings the quorum is 30 members. This rule is giving a few heartaches, because during the last few years membership has dwindled, and as a consequence fewer members show up at general meetings. At present, most meetings comprise between 20 and 25 members, not counting visitors. Although this number is representative of the membership, no business can be transacted without a quorum. On important issues, the Committee can only seek advice from members present at a general meeting and resolve them at the following committee meeting. Dry

stuff, but very important. At the last committee meeting it was resolved to present two special resolutions to the members at the November meeting, one of which deals with this issue by changing the quorum down from 30 to 15. The other resolution deals with notices. It will be proposed that the way in which members are advised about meetings will be done through the use of ordinary mail or via the internet, or by the use of the Divisional Website. This will save the Division hundreds of dollars when not having to advertise in the local newspapers. You will hear more about this in the months to come.

On another subject, Amateurs in the ACT and surrounding district now have access to the IRLP mode of operation. Thanks to confreres Ernest Hocking (VK1LK), Hugh Blemings (VK1YYZ),

Peter Kloppenburg VK1CPK

Alan Hawes (VK1WX), and Phil Longworth (VK1ZPL), Canberra now has an IRLP node in operation. This node, identified as 611, operates via the 70-cm Black Mountain (Telstra Tower) repeater on 438.525 MHz. The node at present is an "open" system; all you need is an UHF rig, and a means of generating DTMF tones to access it. Due to the receiver input being affected by LIPDs however, it is planned to install CTCSS sub-tones access of 123 Hz to the repeater in the near future. If you happen to be in the Canberra area, feel free to fire up and use our IRLP node, and of course, we welcome anyone who has IRLP access from their home to drop in on Node 611 and give us a call.

The next general meeting will be held at 8.00 pm on May 27, 2002 in the Scout Hall, Longerenong St, Farrer. Cheers.

VK4 Notes

Qnews

Sunshine Coast

The repeater group set out to a very wet Maleny to move the SCARC 146.850 repeater into its new resting-place. As the rain came down so did the shed from the old location and was reassembled at the new site complete with antennas. The repeater cabinet was carried up a now very slippery clay hill and installed into place and turned on many thanks to those present Wayne VK4SWC, Keith VK4AKA, Geoff VK4KEL, Joel and Len VK4ALF. Then happy that all was working well they headed down the hill but someone forgot about how slippery that hill was and the rest of them got a huge laugh.

VK4ABW attains 6m DXCC

He is so excited! and he is not Big Kev! Gary/VK4ABW of Deeragun has attained his 6 metre DXCC. That is, he has worked 101 confirmed countries on 50MHz. Gary submitted his QSL cards and award submission to the WIA Federal Awards Officer and in no time at all has received back a very nice looking certificate and a letter of

congratulations. Some wags have suggested Gary now tries for the CW DXCC for 6metres, anyway congratulations Gary and may the contacts remain fruitful!

International Museums Weekend activated in Townsville

On the weekend 15-16 June 2002 there is a worldwide Amateur Radio activity known as International Museums Weekend where working amateur radio stations are established in Museums.

Pimlico-Mundingburra Scout Group with leader Steve VK4SGW and assistance from the Townsville Amateur Radio Club will be establishing a station at the Museum of Tropical North Queensland in Townsville. The aims of the activity are to promote Amateur Radio and Radio Scouting, promote Scouting, and attract new members, and in return provide an interesting activity and publicity for the museum.

The museum responded to Steve's initial request with great enthusiasm and support for the activity and invited Steve

By Alistair Elrick VK4MV

to visit the museum to find out what would be available for the operation. Steve was totally surprised with an offer of a position in the most visible and public area, the Great Gallery, which contains a replica of the bow of HMS Pandora. The set-up team will also be able to erect an antenna on top of the 28 m roof. The museum has also offered to arrange press releases and multi-media coverage for this event.

Steve currently plans to set up a compact station with a laptop and HF radio and a Scouting display with no more than one Patrol or Six (6 - 8 boys and girls) present at any one time, in uniform, plus a couple of radio operators. Planned modes will be HF SSB and SSTV (MMSSTV software). No evening or night operation will occur due to the museum closing at night.

Find out more at the International Museums Weekend website at: www.ukradioamateur.org/imw/ or at Museum of Tropical North Queensland: www.mtq.qld.gov.au or at the Townsville Amateur Radio Club website www.vk4tub.org/tarc/

New Morse trainer available at TARC web site

Following the article found in 24th March edition of the QNEWS Workbench, some enterprising members of theTARCinc grabbed and tried out a copy of the Morseman's windows based program Morse Teacher. Its been 10 years since the Morseman introduced

his dos-based Morse training programs to the hams in Townsville and the new program has all the great features of the old one plus more. Its very easy to install and can either teach you the letters and numbers at your own pace or engage you in receive exercises from stored pieces of text. With the

Morseman's blessing Morse Teacher is now available on theTARCinc website as well as the main NZART site. To get it on the western side of the Tasman, get on the World Wide Web to: www.vk4tub.org select the TARC icon and navigate to the resources page.

73s from Allstair

VK2 Notes

by Pat Leeper VK2JPA

On Saturday 13th April, the Divisional AGM was held at Amateur Radio House in Parramatta.

There were 50 members in attendance and debate was lively at times during discussion on motions.

The election of Councillors was declared as follows: Terry Davies VK2KDK, Chris Minahan VK2EJ, Brian Kelly VK2WBK, John Turner VK2WRT, Owen Holmwood VK2AEJ, Geoff McGrorey-Clark VK2EO, and Eric Fossey VK2EFY. Eric Fossey VK2EFY later indicated that he would resign.

The Special Resolution that T. Mills VK2ZTM be made a life member was declared carried, with acclamation, after counting of those present and postal votes, with 128 votes for and 12 against : over 91 per cent in favour, more than the required 75 per cent in favour.

Voting on the other motions under consideration resulted as follows :



motion 1 - carried; motion 2 - lost; motion 3 - carried; motion 4 carried; motions 5 and 6 were withdrawn.

That's all for this month.

Photo courtesy of Eric van der Weyer VK2KUR

Cable, Connectors, Tools



- RG58C/U Belden 8259 @ \$0.90 per metre
- RG213/U Belden 8267 @ \$4.45 per metre
- RG8/U Belden 9913 Low Loss @ \$5.15 per metre
- RG8/U Belden 9913F7 High Flex Low Loss @ \$5.55 per metre
- RG8/U - RF400 Belden 7810 Low Loss Sweep Tested to 6000MHz @ \$6.30 per metre



- RG58: B80-006 UHF connector (M) @ \$7.65 each
- RG8/213: B80-001 UHF connector (M) @ \$8.80 each
- RG213: B30-001 N connector (M) @ \$9.10 each
- RG8: B30-041 N connector(M) @ \$14.00 each

TOOLS

- Coax Cutters: C.K. @ \$40.00 each
- Strippers: ● Ideal - RG58 @ \$33.00 each
- RG8/213 @ \$53.00 each

* All prices include GST

* Minimum order value \$50

payable by Visa, Mastercard, Bankcard or Money Order

* Packing and Delivery \$15 within Australia (Outside Australia P.O.A.)



ABN: 62 088 051 030

email - sales @elektron.com.au or Phone: (03) 9761-3207
Elektron Pty Ltd, Unit 2, 14 Melrich Road, Bayswater, Victoria 3153.

Awards

Malcolm K. Johnson VK6LC, Federal Awards Manager
P.O. Box 196. Cannington. WA 6987. email awards@wia.org.au

eQSLs: the way of the future?

What is the future of Electronic QSLing (eQSL) and where will we be with our Awards Program in the next few years? Hopefully the Federal Council at the next AGM will adopt a working policy and have it approved and in place for this year.

In the U.S.A. the new system will incorporate a "Master data base log book" or *Logbook of the World* (LOTW). A typical title from the ARRL, alternative award programs from various other countries will have similar QSL logbooks (LOVK) and this is also being fast tracked for this year.

In the case of major DXpeditions they will register their master log to the system and this will be available for verification, both for the QSLer and the award submission.

In future an operator will generate his/her award request on a specially formatted computer log application and email it. Updates and tallies will also be returned after fast data processing and printing.

I am sure once the dust has settled and all the systems are in place, improvements will be designed enabling software to transfer files with a common language and format.

It sounds exciting and I am sure it's all progress. For those that are not into computers the present system will continue but at a heavy cost.

My view is that while I will still pay the price for personal QSLs, electronic QSLing will save me time and money when applying for awards.

For those that just do not QSL it will give them another option with a minimum effort. This will also be a blessing for contest station operators dealing with thousands of QSLs.

As more information becomes available we will keep you up to date. It is developing fast and its implementation is not too far away.

Extract from an ARRL News Release August 2, 2001

Fast on the heels of approval of the *Logbook of the World* by the ARRL Board of Directors, software design to support the electronic contact-

verification program is continuing apace. ARRL Membership Services Manager and LOTW Project Manager, Wayne Mills, N7NG, said the ARRL hopes soon to make LOTW software modules available to vendors for incorporation into their logging programs. These modules are being developed as part of the Trusted QSL open-source project headed by Darryl Wagoner, WA1GON. What is the W.I.A. doing right now?

We have updated all 8 of the old manual awards onto computer format and (non-active) typical samples are available to view on our national web site. They have been designed and formatted in Microsoft Excel and down loads will be available in 4 formats along with application sheets. These are active intelligent auto-tallying working templates to simplify the program and make it much simpler for the applicant. The new award templates can be zipped up and emailed to me for processing. The basic rules have not changed but have been updated to suit fast and changing modes. For those that prefer the manual mode these templates are also available in hard copy.

I will be covering this subject in detail in future issues.

New DXCC ARRL ruling for 1S Spratly Islands

1S Spratly Islands Callsign operations were deleted from the ARRL DXCC country listing as from the latest publications October 1st, 2000 edition, it was agreed by ARRL 30.8.2000.

Section II. DXCC List Criteria

Special Areas: (c) The Spratly Islands, due to the nature of conflicting claims, and without recognising or refuting any claim, is

recognised as a Special Entity. Operations from this area will be accepted with the necessary permissions issued by an occupying Entity. Operations without such permissions, such as with a self-assigned (e.g. 1S Callsign, will not be recognised for DXCC credit).

The WIA Awards Program follows the ARRL Rules, and up to the time I received the new Awards Management December 2001, we had been accepting 1S operations.

We now formally advise our WIA members that this is now invalid and will no longer be accepted

The ITU assigned 1S call sign still stands, but now will never be accepted until the Spratly Islands become a one or shared government assignment. ARRL will not accept "self nominated" operations that don't have a government approval to operate from these Islands.

The Spratlies are a political hot potato and, although technically belonging to no one, are claimed by China, Philippines, Malaysia, Vietnam, Taiwan, Indonesia and others. (Not for DXCC but for their rich oil deposits)

ARRL is only accepting operations that have official permission from one of the above countries, eg. Malaysia has been there many times as 9M0, also Taiwan BV9S.

New ARRL DXCC list

This is about to be released now and is dated February 2002. I will be supplying the new complete DXCC list for AR June 2002.

The additional VP6 Ducie Island brings the new tally to 335, but by June we may have an additional 2 new countries.

Mal. VK6LC
ar

New "Oscar" designator for Tiungsat-1

In keeping with PCsat and Sapphire's change of designators to NO-44 and NO-45 respectively, Tiungsat-1 has also been allocated a sequential "Oscar" number.

Henceforth it will be known as MO-46. All these satellites should by now be appearing under these designators in the Keplerian element sets available from the various sources. Be sure to do the necessary alterations to your tracking software so the automatic updates will work properly.

New "Open-beta" update to InstantTrack Program

Version 1.54 of the InstantTrack satellite tracking program is now available from the AMSAT web site.

It will update previously registered versions of the program. The main feature of the latest updates is to make the entering of the attitude co-ordinates for AO-40 a lot easier. In prior versions some manipulation of the figures was required. This was due to the different orientation of AO-40's "antenna farm" to those of the previous high-orbit birds AO-10 and AO-13.

I found the update worked smoothly and it is now possible to enter the attitude co-ordinates in the form in which they are disseminated. You will need a previously registered version of InstantTrack, at least version 1.50

running in your computer for this update to work. What is an "open-beta" update? Here's how Paul Williamson explains it. "As Franklin and then I developed InstantTrack versions from 0.00 to 1.50, we used a traditional beta-testing scheme. That is, we asked a select group to pre-test each new release prior to the public release, in the faint hope that we would catch all the bugs before you could see them. That worked very well, and we are all indebted to the beta test teams.

However, it does take time and it's a hassle for everybody, so starting with version 1.51 I'm going to try a different,

more casual, approach. When I come up with some changes and have satisfied myself that they are probably working OK, I will go ahead and post them (on the AMSAT site). You will then have a choice. You can continue to use the released version (currently 1.50) if it meets your needs. Or, you can live on the bleeding edge by downloading the newest *open beta* version and testing it yourself. If you find a problem, you can always re-install 1.50 (you did make a safe backup copy of IT150.EXE, didn't you?). So there you are, the choice is yours - go ahead, be adventurous!

PCsat Recovery Efforts

During the past month or two considerable effort has been devoted to the stabilisation of PCsat.

The satellite has been a resounding success in its mission to popularise APRS and packet radio satellite operations in general. Even though it carries state-of-the-art equipment like GPS positioning, it is nonetheless a very simple satellite. It has no CPU on board to control its operations and it has a limited set of command instructions that are based around an ordinary 'common-or-garden' packet radio TNC. Nevertheless it has done all it was designed and expected to do and more. With a limited power budget it was always prone to "negative-budget"

problems when exposed to lengthy eclipses or when all systems were activated at the same time.

PCsat's developer, Bob Bruninga WA4APR had appealed via every means at his disposal for operators to observe the advertised limitations whilst the eclipses were in progress. Despite this many stations, particularly in Europe ignored these appeals and things began to look grim for the long term future of PCsat. It was almost lost on a number of occasions. Recovery efforts are underway and some improvement is evident at the time of writing ... however

PCsat may well have died by the time you read this column. It has been necessary to turn off the digipeater and lower the power output but even this has not deterred some folks from trying repeatedly to digipeat and even to repeatedly attempt to connect to the command system itself.

The situation was made worse because the major control station was in the Northern Hemisphere and the eclipse problem was much more severe there. Bob therefore recruited a number of stations in the Southern Hemisphere to help. Ian ZL1AOX, John VK2XGJ and

The AMSAT group in Australia

The National Co-ordinator of AMSAT-VK is Graham Ratcliff VK5AGR. No formal application is necessary for membership and no membership fees apply. Graham maintains an e-mail mailing list for breaking news and such things as software releases. Members use the AMSAT-Australia HF net as a forum.

AMSAT-Australia HF net

The net meets formally on the second Sunday evening of the month. In winter (end of March until the end of October) the net meets on 3.685 MHz at 1000utc with early check-ins at 0945utc. In summer (end of October until end of March) the net meets on 7.068 MHz at 0900utc with early check-ins at 0845utc. All communication regarding AMSAT-Australia matters can be addressed to:

AMSAT-VK,
GPO Box 2141,
Adelaide, SA. 5001.

Graham's e-mail address is: vk5agr@amsat.org

myself were sent copies of the command software and entrusted with the task of resetting PCsat to its lowest power situation each time it passed over this area. Unfortunately this has been an ongoing job since the long periods of darkness (and some poor operating practices) caused the on-board settings to reset again and again each time the satellite went through an eclipse period, which happened every orbit of course.

In a period of some two months it has not survived a complete orbit without

resetting itself. Bob has devised a strategy to, at least in part, counter the adverse situation brought about by the offending stations. At this time it seems to be working, although it is very time consuming on the part of the control stations. It is hoped that we can coax PCsat through the current eclipse period and return it to normal service in a few weeks. Please be patient. At the time of writing PCsat has been operating without need for reset for nearly two whole days although some instructions

for general power management have been sent up by the control stations just to be on the safe side. The next few weeks will be critical and the next non-eclipse period is short, so Bob may have to make the painful decision to have PCsat go out in a "blaze-of-glory" by turning it on for general operations and leaving it to its fate. In this case it would probably not survive for more than a day or two at the present rate of use (and abuse).

Good squints and great DX on AO-40

Those operators who have made the effort to equip their stations for AO-40 operation have been rewarded lately with some of the best operating conditions to date on this satellite.

Conditions reminiscent of the early days of Oscar-10 occur quite frequently. Remembering that AO-40 is still being commissioned it should be evident that even better times are yet to come. When the current attitude manipulations are completed two very important milestones are still to be rounded. The first will be the switch to 3-axis stabilisation. Implementation and testing of this operation will take some time and a lot of effort by the control stations; but if it all works we can just

about forget about squint angles.

Tests of this system have been very encouraging. The magnetically levitated momentum wheels are a first and their effectiveness will be watched by amateurs and professionals alike. Three-axis stabilisation means that AO-40 will be earth-pointing at all times and that will mean the antennas will always be in their optimum direction for best all-round communications. The second milestone will be the final unfurling of the solar cell panels. With this achieved

and with 3-axis stability it will be possible for controllers to ensure maximum power availability for the satellite and optimum operating conditions for everyone. Deployment of the solar array will allow the release of the HF antenna system, at present coiled up inside the space-frame. This will add another dimension to operation on AO-40. Keep watching the various AMSAT news services via Internet or packet radio for the latest on these milestone events.

First Australian school contact with the International Space Station

March 20th 2002 was a very special day for Tony Hutchison, VK5ZAI, Australian ARISS Co-ordinator and his assistants in Tasmania, Bill Lynd, VK7KHZ, and Dick van Beek, VK7KVB. International Space Station astronaut Carl Walz, KC5TIE, talked directly on 2 meters with youngsters at Zeehan Primary School in Tasmania.

The full story is told by Dick van Beek VK7KVB on page 18.

Then, just a day later, Astronaut Dan Bursch, KD5PNU, on board the International Space Station answered 20 questions put to him by school children on March 21.

Two of the questions came from his own children who attend an elementary School in Nassau Bay, Texas.

The children spoke with Bursch via an Amateur Radio and a teleconferencing linkup. At the time of

writing, pictures and audio clips of the above events are available courtesy of the ARRL on <http://www2.arrl.org/news/stories/2002/03/22/3/?nc=1>

Exciting Times Ahead for Indian Amateurs (and for the rest of us too!)

According to messages appearing on the AMSAT-BB, Amsat-India's proposal for project VUSAT is at a highly advanced stage and nearing final approval by the Indian Space Research Organisation (ISRO).

It is likely that the launch will be scheduled during 2003. Possible configuration would include a mode-B (UV) linear transponder built by Indian amateurs, a DX transponder (a Dutch/Italian project), an FM-message beacon and a telemetry beacon in independent modes of operation. VUSAT will fly on a 40-kg micro-satellite on ISRO's Polar

Satellite Launch Vehicle as a co-passenger. It will be India's first micro-satellite.

At present the status of the project is as follows. The working model of the Dutch transponder has been delivered and is undergoing tests. The Italian transponder has been dispatched and is

expected any time. The UV linear transponder and message beacon are still under development. The circuit board for the telemetry beacon has been delivered. It seems that 2002 and 2003 will be exciting years for Indian radio amateurs and for all of us when VUSAT is launched.

ar

A 'sure thing' QSO

Those of you who have managed a QSO with Ed, P5/4L4FN will be pleased to know that the ARRL DXCC desk has confirmed that his current operations will be accepted towards DXCC. This is good news, not only for those who have already worked Ed but it will no doubt provide the spur for others to get on the air to achieve a 'sure thing' QSO.

The DXCC desk has also confirmed that the VP8THU (South Sandwich Islands, 18th - 22nd of Jan) and VP8GEO (South Georgia, 26th of Jan - 6th of Feb), EP3UN (Iran) and also the 3V8DJ and 3V8SZ (Tunisia, March 2001) operations are also being accepted.

A snippet in The Daily DX for the 29th of March says that the New York Times reported that "Papua New Guinea voted to grant autonomy to fractious Bougainville Island, taking the archipelago a vital step closer toward ending the South Pacific's longest-

running conflict." They continued "PNG analysts say the election of an autonomous Bougainville government can not be held before 2003, citing six months to write a constitution and six to eight months to complete weapons disposal". Look out, we may well be about to have another new DXCC entity appearing on our doorstep.

Mirek, 7X0DX (aka VK3DXI, 9V1XE) has been busy from Algeria recently and has made the headlines by making the first ever satellite contacts from Algeria using UO14. He also says that his

activity on 80 metres was much better than expected and is planning some 160 metre operations when he returns. Up to date details and logs for 7X0DX are available at <http://www.7x0.sp5zcc.waw.pl>

There is quite a bit to report this month, and everyone should find something that piques his or her interest. Get on the bands and have a listen for that piece of rare or interesting DX, and if you manage to find and work it let me know.

The DX

EP, IRAN. Stig, LA7JO, is currently active as EP3UN. He has been heard recently on the 30m, 15m and 12 metre bands using CW. Best frequencies and times to listen out for him are 10103 kHz after 0215 UTC and 21017 and 24901 kHz between 1400 and 1630 UTC. (TNX OPDX)

EP, IRAN. Abdullah, EP2FM has been operating RTTY on 20 metres around 0300 to 0400 and also at 1600 UTC. (TNX OPDX and ARRL DX Bulletin)

FG, GUADALOUPE. Pierre, F6FXS says he will be active as FG/F6FXS from Guadeloupe (NA-102) from the 17th of April until the 16th of May 2002. He will be operating CW only and running modest power, approx. 30 - 40 Watts, to a long wire antenna. His most active times will be between 1400 - 1600 and 2100 - 2200 UTC on 28030, 21030, 14030 and 7023kHz +/- QRM. QSL is via F6FXS. (TNX La Gazette du DX and 425 DX News)

HV, VATICAN CITY. Be on the lookout for HV5PUL from the Vatican City. This call will be active on all HF bands and 6m on the 16th of May. More information regarding the operation is available on their website at <http://www.pul.it/hv5pul.htm> (TNX IW0DJ and 425 DX News)

JT, MONGOLIA. Nicola, I0SNY and Gianni, I8KGZ report that they will be operating from Ulaanbaatar, Mongolia as JT1Y. The operation will last for a couple of weeks beginning on the 21st of May. QSL via I0SNY.

OD, LEBANON. Max, IW0GXY has been granted permission to operate on 6 metres from Lebanon using the callsign OD5/IW0GXY. Activity is expected to last at least until the end of June with a good possibility of extending through until September. Further details can be found on Max's website at <http://www.qsl.net/iw0gxy/index.html> (TNX OZ6OM and 425 DX News)

OX, GREENLAND. Per, OZ1EQC will be active from Greenland (NA-018) on 10, 15, 20, 30, 40 and 80 metres using CW, RTTY, PSK31 and SSTV modes as OX/OZ1EQC. He plans to be on air over the period of the 23rd of April until the 8th of May. Per also plans on some operating from NA-134 and NA-220 if conditions permit. QSL via OZ5KU, Kurt Jensen, Thuroevej 27 Starup, Haderslev, Denmark. (TNX IZ8BRI and 425 DX News)

T9, BOSNIA-HERZEGOVINA. Bernard, F5LPY, will be active as T9/F5LPY until the end of May. He can be found nearly every day around 2030

UTC, on 20 metres CW. He may possibly QSY to other bands if requested but be aware that when working on 40 metres Bernard uses a very sharp filter to combat violent local QRM so you may have to wait patiently while he finely adjusts the tuning on his receiver to get you within his passband. He can also be found working SSB every Sunday morning between 0700-1030 UTC on 20 metres. QSL via F5LPY (please no cards to the T9 bureau). Bernard will QSL 100%, including SWL reports, after he returns home. (TNX F5LPY and OPDX)

TM, FRANCE. Patrick, F6OIE will be active as TM0A from the 19th of May until the 2nd of June. QSL to F6OIE. (TNX F6AJA and 425 DX News)

TM5, FRANCE. Dom, F5SJB, will again be active as TM5CW. His activity will be CW only, running QRP, between the 18th of May and the 1st of June. TM5CW is valid for the Lons-le-Saunier City Telegraphy Award and a special QSL can be obtained via the Bureau or direct to F5SJB, Dominique Meige, F-39130 HAUTECOUR, France or via SPRAT. (TNX F6AJA and OPDX)

TN, CONGO. Josep Gibert, EA3BT and his XYL Nuria Font, EA3WL plan to be active from Congo between the 17th and 27th of May. The couple have requested

the calls TN3B and TN3W but no confirmation as yet whether these will be available. They plan to operate two separate stations each comprising beams and dipoles on 80m – 6m metres using SSB, RTTY and some CW. QSL via EA3BT. (TNX EA3BT and 425 DX News)

V7, **MARSHALL ISLANDS.** Jim Todd, KC7OKZ/V73KZ and his wife Carol, KC7TSX/V73SX are currently on Majuro (OC-029) in the Marshall Islands. Sometime during the next couple of months (dates to be announced) they plan on doing some operating from Ujelang Atoll (OC-???) too. (TNX V73KZ,

Special Events

Belgian Amateur Radio operators have been granted permission to use special prefixes in commemoration of the “Battle of the Golden Spurs” in 1302. Dutch speaking Belgian hams may use the OS prefix instead of ON and all Belgians may use the OR prefix instead of ON during any contests. These prefixes may be used only between the 18th of May and the 11th of July. (TNX The Daily DX)

The Midlands Amateur Radio Club of South Africa will be operating two special event stations during the weekend of the 3rd to the 5th of May. The event will serve to commemorate the various roles played by the British, Boers

DXpeditions

OY and TF, **FAROE ISLANDS and ICELAND.** Tom, DL2RTK and Ric, DL2VFR will be heading into the North Atlantic again travelling by ship to OY and TF. Their itinerary is as follows:

- 20th – 22nd of May. OY/homecall from Strey moy Island (EU-018) in the Faroe Islands.
- 23rd – 24th of May. TF7/homecall from Vestmanneyjar Island (EU-071) from Iceland.
- 25th – 30th of May. TF1/homecall from Iceland (main island) (EU-

Round up

VK0, **MACQUARIE ISLAND.** Toshi, JA1ELY reports that Peter, VK0MQI is a member of the 2002 Australian National Antarctic Research Expedition crew on Macquarie Island (AN-005), he previously operated as VK0AC from the ANARE Davis Base in 1998. Peter was expected to depart for Macquarie Island

and listening 5 - 10kHz up. His equipment will comprise an amplifier, tribander yagi, dipole and a delta loop for the low bands. QSL via IN3ZNR, Fabrizio Vedovelli, Via Gramsci 27, 38100 Trento - TN, Italy. (TNX IN3ZNR and 425 DX News)

Y7, **CHAGOS ISLANDS.** Jesse Falquez, AB5RY will be operating as VQ9J from Chagos over the next few months. He plans on operating on all bands 160 – 10 metres using CW and SSB. Jesse has excellent antennas and will be running 100 watt. QSL direct only via K5QM with a SASE. (TNX K5QM and 425 DX News)

XW, **LAOS.** Fabrizio, IN3ZNR will be active again as XW3ZNR from Vientiane, Laos from the 24th of April until the 4th of May. He plans to active on 28475, 21375, 14275, 7075 and 3775 +/- QRM

and Zulus during the “Anglo Boer South African War of 1899-1902”. The callsign will be ZS100ABW. The two separate stations will be operating mainly on SSB from Lancaster Hill, Vryheid in KwaZulu Natal, South Africa from approximately 1600 UTC on the Friday until the early hours of Sunday morning. A special ‘Remembrance Service’ will then be held in recognition of all those who lost their lives in the “Battle of Holkrans”. Operations will take place preferably on 40 and 20 metres with 80 metre activity during the evenings (depending on the prevailing conditions). All contacts will be acknowledged with an attractive QSL

card. Please QSL either via the Bureau or direct to Midlands Amateur Radio Club, PO Box 100220, Scottsville, 3209, South Africa. A second special event station will be on air on the 31st of May to commemorate another battle that took place at Spioenkop. This was the scene of one of the bloodiest battles fought to relieve the city of Ladysmith, South Africa. Any queries regarding amateur operations of either of the two stations should be directed to Willie Axford, ZS5WI by E-mail to zs5wi@iafrica.com For more information regarding the history of the events contact Sean Friend at seanfriend@dorea.co.za (TNX ZS5WI and OPDX)

021). Activity will possibly include an activation of a Lighthouse, possibly between the 27th – 30th of May for one or two days from Grimsey Island (EU-168) and activation of WLH LH-0140 as TF5/homecall.

Activity will be on SSB and CW on 160 - 6 metres. RTTY and PSK activity will depend on the actual demand. (TNX DL2VFR, 425 DX News and OPDX)

CHATHAM ISLANDS. The Kermadec DX Association is undertaking a

DXpedition to Chatham Island (ZL7) later this year and is on the lookout for experienced SSB and CW operators. Ken Holdom, ZL4HU says, “as this will be a 24 hour per day operation, we are looking for operators who feel they have the willingness and ability to operate during both day time and night time.” If you are interested, or require further information, please contact Ken via Email at zl2hu@clear.net.nz or the Kermadec DX Association, P.O. Box 7, Clyde, Central Otago, New Zealand. (TNX ZL4HU)

and listening 5 - 10kHz up. His equipment will comprise an amplifier, tribander yagi, dipole and a delta loop for the low bands. QSL via IN3ZNR, Fabrizio Vedovelli, Via Gramsci 27, 38100 Trento - TN, Italy. (TNX IN3ZNR and 425 DX News)

JA1ELY. (TNX JA1ELY and 425 DX News)

The Colorado QRP Club has announced that the first annual CQC PSK Contest will be held on the 11th of May. For further details and information visit their website at <http://www.cqc.org/contests/index.htm> (TNX OPDX)

JA1ELY. (TNX JA1ELY and 425 DX News)

The Colorado QRP Club has announced that the first annual CQC PSK Contest will be held on the 11th of May. For further details and information visit their website at <http://www.cqc.org/contests/index.htm> (TNX OPDX)

Adelaide Hills Amateur Radio Society

The March meeting was a members' Buy and Sell, as usual. Much "junk" became much "treasure", also as usual. A very pleasant, social evening.

The April meeting will be an interesting talk by a member of the Riverland Radio Club.

Any amateur visiting Adelaide on the third Thursday of the month is welcome

to come and join us at the Blackwood High School in Seymour Road Blackwood at 7.30.

AHARS participated with enthusiasm in the John Moyle Memorial Field Day again this year. The point score was similar to that of last year but the distribution of the contacts across the bands was very different.

An enjoyable and successful weekend was topped off by a little extra effort when a large water tank was hoisted onto a roof in anticipation of the installation of a solar water heating system. Next year we hope there will be hot water available on demand. There is certainly plenty of sunshine at the field day site.

SERG CONVENTION JUNE 2002

The South East Radio Group,
would like to invite all to our
Annual Radio Convention,
which is conducted over the
Queens Birthday weekend in June.

Saturday 8th and Sunday 9th are the days involved with Sunday being the main one.

The venue remains at the *A&H Society Halls at the Showgrounds, Pick Avenue, Mt. Gambier, SA*

★ Australian Fox Hunting Championships ★

The Australian Fox Hunting Championships will be conducted again as part of the convention along with the normal Trade Displays for both new and pre-loved equipment.

Wayne Kilpatrick (VK5ZX), Secretary
South East Radio Group
Phone: 08 8725 4335, 0407 719 808
Email: serg@internode.on.net

How's DX continued

S21FHQ is the callsign of the newly licenced Headquarters club station of the Foundation for International Amateur Radio Service (FAIRS) in Dhaka, Bangladesh. At the time of writing the club station equipment is pretty basic and the antennas are simple wires. The members hope to erect a beam or two in the near future. The members are expecting high demands for their operating and training activities. If you manage to work the station QSLs can be sent via N4VA. (TNX N4VA and The Daily DX)

P5, NORTH KOREA. Hrane, YT1AD, has released a short statement via Nenad, VE3EXY concerning his failed attempt at operating from P5. He says, "We arrived to Pyongyang on March 5th, where we were welcomed by representatives of Ministry of Telecommunications and Foreign Affairs. We were stationed in Yangakdo Hotel, on the bank of the river with the same name. The hotel has 47 floors, and we were on the 40th floor,

with almost ideal conditions for work. All our equipment was put together, and we were about to start our operation with previously assigned callsign P5A. Unexpectedly the uniformed military official appeared, and imposed ban on our operation, until the permission of military authorities is obtained. It was supposed to be available on March 8th, but nobody showed up, possibly because of holiday. We did not want to risk starting unauthorized operation. Meanwhile we had fun listening all pirates pretending to be us, when we did not make a single contact. Finally, the military official showed up on Sunday and simply said 'No transmission until further notice.' Than we did not have any choice but to leave. After landing in Beijing, our only comment was: Never Again!" (TNX YT1AD)

We can only guess at the reasons behind the last minute refusal of permission for Hrane, YT1AD to operate, perhaps the North Koreans were aware

of, and annoyed by, the pirate operators. If so, this is a sad indictment on our hobby of amateur radio and our attempts at being responsible and respectful amateur radio operators. I can only repeat my opening comments in last months DX Notes, "some types of amateur operators we can all do without!"

Sources

Another rather busy period on the air coming up, and our thanks go to the following individuals and organisations for the information contained in DX Notes this month. 7X0DX, LA7JO, OPDX, IW0DJB, I0SNY, OZ6OM, IZ8BRI, F5LPY, F6AJA, EA3BT, K5QM, V73KZ, IN3ZNR, G0TQJ, DL2VFR, ZL4HU, JA1ELY, N4VA, ZS5WI, YT1AD, Islands On The Web, ARRL DX Bulletin, La Gazette du DX, 425 DX News and The Daily DX.

Contests

Ian Godsil VK3VP
contests@wia.org.au

Be prepared

Greetings to all readers.

The fact that last month my wife and I moved house and I am still in the process of setting up some antennae (as well as getting all the boxes unpacked!) points out to me that the year is proceeding apace and that the VK/ZL contest season is not far away again.

Should you need to contact me, my email address is still contests@wia.org.au, but my only phone number is 0408 123 557.

As well as suggesting that it is time to check your station right through again, may I also suggest that you think carefully about your personal preparation for a contest.

Few, if any, of us can go without sleep for too long and whilst we do not normally have contests that last for 48 hours in VK or ZL, nevertheless it is important to consider what you have been doing in the week and days before a contest. After all, what use is it if, at 2200/2300 hours you are falling asleep or just sending silly messages or entries in the log because your concentration is flagging?

I have read that for some operators they get to the stage where they have no

conscious recollection of having made certain contacts, but there they are in the log! This, I believe, is called 'microsleep' by the scientists. It is a known problem for long-distance motorists and can be a lethal one, eg. if you are driving at a fair speed and go into microsleep, you are not conscious for that brief period, so you could drift off the road. At least if this happened in a contest you would not kill yourself, but it could produce some interesting results!

Even though most of us are not entering long contests (where the Escape or whatever is your cancel key for your logger takes a pounding at 3 a.m.), the moral to all this is to make sure that you have had plenty of rest in the days leading up to a contest.

There are many, many sites on the Internet, which deal with sleep and sleep-deprivation. You may care to look

at some of these –

<http://www.sleepfoundation.org/>
<http://www.sleephomepages.org/htdocs/hotlinks.html>

<http://www.sleepquest.com/>
<http://www.sleepnet.com/depriv.htm>
<http://www.sleepnet.com/definition.html>

Special Event

Last month I noted the coming of a special event to mark the Golden Jubilee of Her Majesty Queen Elizabeth II.

Please mark this in your diaries. It will be a similar format to the Commonwealth (BERU) Contest, but of course a once-only event. And I remind you that a dedicated contest logger, SDJ, is available free at www.ei5di.com.

73 and good contesting,

Ian Godsil VK3VP

Rules: Asia-Pacific Sprint 2002

SSB: Sat 8 June 1100Z–1300Z

CW: Sat 19 Oct 1100Z–1300Z

Object: For stations outside Asia-Pacific region to work as many AP stations as possible in the two-hour limit.

Bands: 20m and 40m only.

Power: max 150 W

Category: Single operator, single radio only.

Exchange: RS/RST plus serial number starting at 001. Stations may be worked only once per band.

Multipliers: prefixes as per WPX rules (Once only, not once per band).

QSY Rule: Calling station must QSY after a QSO at least one kHz on CW and six kHz on SSB.

Final Score: total of QSOs by multipliers.

Logs must contain complete QSO information plus Summary Sheet

indicating claimed score, CQ Zone and T-shirt size.

Send logs by mail to: James Brooks, 26 Jalan Asas, Singapore 678787 three days after contest. Logs may be sent by email in ASCII format to: jamesb@pacific.net.sg

Rules: Novice Contest 2002

from Bob Hockey VK2FI, Contest Manager

Sat 15 June - Sun 16 June 0800Z – 0800Z

Object is to encourage amateur operation in VK, ZL and P2 and to promote contacts with Novice and Club stations. Only VK, ZL and P2 stations are eligible to compete and stations in the same call area may contact each other for contest credit.

Bands: Novice frequencies in the 10, 15 and 80 metre bands. No cross-band operation permitted.

Categories: Single Operator, Club stations and SWL stations.

Modes: SSB and CW.

Call "CQ N" on CW, "CQ Novice Contest" on SSB and if you are involved with a club station then call "CQ Novice Contest Club Station" followed by your callsign.

Exchange RS(T) and serial number commencing with 001 and

CONTEST CALENDAR

May—July 2002

May	4/5	Danish SSTV Contest		
May	4/5	10-10 Intl. QSO Party	(CW/RTTY)	
May	4/5	ARI Intl. DX Contest	(CW/SSB/RTTY)	
May	11/12	VOLTA RTTY Contest		
May	11/12	CQ-M Intl. DX Contest	(CW/SSB/SSTV)	
May	18	Sangster Shield (NZ) part 1	(QRP CW)	(May 02)
May	19	Sangster Shield (NZ) part 2	(QRP CW)	(May 02)
May	18/19	Baltic Contest	(CW/SSB)	
May	25/26	Anatolian RTTY WW Contest		
May	25/26	CQ WW WPX Contest	(CW)	(Feb 02)
June	1	VK/trans-Tasman Contest		(May 02)
June	1/2	South American WW CW Contest		
June	8	QRP Day		(Apr 02)
June	8/9	ANARTS WW RTTY Contest		
June	8/9	Queen Elizabeth II Golden Jubilee Contest	(CW/SSB)	(Apr 02)
June	8	Asia-Pacific Sprint	(SSB)	(May 02)
June	15/16	Novice Contest	(CW/SSB)	(May 02)
June	22/23	SP QRP Contest	(CW)	
June	22/23	Marconi Memorial HF Contest	(CW)	
June	22/23	ARRL Field Day	(All modes)	
July	1	RAC Canada Day Contest	(CW/SSB)	
July	6/7	Internet 6m Contest	(CW/SSB)	
July	13/14	IARU HF World Championship	(CW/SSB)	
July	20	Pacific 160 Metres Contest	(CW/SSB)	(June 02)
July	27/28	Russian RTTY WW Contest	(RTTY)	
July	27/28	IOTA Contest	(CW/SSB)	
July	27	Waitakere Sprint	(SSB)	

incrementing by one for each subsequent contact. SWLs may log up to 10 sequential contacts made by a station and then log at least five other stations before logging the previous station again. The five stations so logged need be a minimum of one contact only.

Score: two points for contact with Full Call/Intermediate stations; five points for contact with Novice stations and 10 points for Club stations. On CW score DOUBLE points.

SWLs score two points for Novice to Full/Intermediate, and Full to Full; five points for Novice to Novice and 10 points for Club stations.

Note RULE CHANGE:

Intermediate stations (J and K calls) now classed as Full Calls.

Logs headed "VK Novice Contest 2002" must show date, time in UTC, band, mode, station contacted, exchanges and total claimed score at the bottom of each page.

A **summary sheet** should show callsign, name, mailing address, category, section, number of valid contacts, claimed score, signed declaration showing signature of operator or responsible club officer for club stations.

Entrants may only submit one log per mode. Logs for entries where the operator uses more than one callsign whilst operating in the contest will not be accepted.

Mail logs to: Novice Contest Manager, Westlakes Amateur Radio Club Ltd., P.O. Box 3001, Teralba, NSW, 2284, by 16 July 2002. Logs may also be e-mailed to: westlakes@hunterlink.net.au

Awards include the Clive Burns Memorial Trophy for the Novice with the highest CW score and the Keith Howard Trophy for the Novice with the highest SSB score. These trophies are held at the Wireless Institute of Australia Federal Office, with a plaque being sent to both winners.

Certificates will be awarded to the highest-scoring Novice in each call area and the highest-scoring station in each section. Certificates are at

N.Z.A.R.T. Sangster Shield Contest

From Stan White ZL2ST, NZART Contest Co-ordinator

18 and 19 May, 2002 0800Z – 1100Z each day

Presented to the amateurs of New Zealand by Mr R Sangster in 1927, the Sangster Shield is for annual competition to be won by the most efficient station (equipment and operator).

Power: To compete for the Sangster Shield and Trophies the output of the transmitter must not exceed 5 watt. Higher power stations are requested to operate above 3530 kHz.

Mode: CW to CW contacts on 80 metres only are permitted.

Repeat Contacts: QSOs with any one station are permitted once only each half hour, based on an "even half hour" basis, eg 0800 - 0830, 0831 - 0900 etc. It is not permissible to claim QSOs with the same station "twice running".

Cypher system:

RST followed by branch number followed by power output - eg 569/11/04 (ie. report 569; branch 11;

power 4 W). Powers over 100 W will be given as 99, while below 10 W will be preceded by 0. VK stations are required to give RST plus a serial number beginning at 001.

Scoring for VK entrants:

VK using 5 W or less to ZL with Power given as 5 W or less - 10 points.

VK using 5 W or less to ZL with Power given as 6 W or more - 5 points.

VK using 6 W or more to ZL with Power given as 5 W or less - 5 points.

VK using 6 W or more to ZL with Power given as 6 W or more - Not permitted for contest purposes.

VK to Overseas - Not permitted for contest purposes.

Final score is total points multiplied by the Number of Branches worked.

Logs: Quarto or A4 size paper -

preferably NZART log sheets.

Data in this order:- date; time; callsign; RST sent; RST received; points claimed.

Summary Sheet to show: entrant's callsign, name and address in BLOCK LETTERS. Number of contacts with stations using 5 W or less. Number of contacts with stations using 6 W or more. List of different branches worked with the number and name of each branch as given in the Call Book (in branch number order) plus the callsign of the station claimed for that branch.

Total score. Description of equipment, antenna and output power used. Signed declaration that all contest rules have been observed.

Send Logs by mail to: Contest Manager, Glenn Kingston ZL2KZ, 53 Tannadyce Street, Wellington 6003, New Zealand, by 19 June 2002.

Rules: VK/trans-Tasman Contest

from Bruce Renn VK3JWZ, Contest Manager

1st Saturday in June 2002, 0800 UTC to 1400 UTC, (in 6 UTC one hour stages).

Aims of Contest

- The VK/trans-Tasman Contest was conceived as a reciprocal event to the NZ Memorial Contest (held in July). The main emphasis is on VK—ZL contacts.
- The scoring system was devised in an attempt to:
 - compensate for geographical location and useable band time to provide, so far as is possible, a level playing field for all.
 - encourage participation by VK5, VK8 and VK6s.
 - promote trans-Tasman contacts, by giving bonus points for VK/ZL contacts.
 - provide some incentive for the clever Operator, by allocating additional bonus points for working multiple "call-areas" in any one hour. The value of these bonus points has been structured to reflect the difficulty of the achievement in regard to distance and population densities.
- Promote/give recognition to QRP operators and SWLs.

- Provide a reasonably short event that doesn't impinge too much on family life or sleep time, while giving 6 hours of constant on-air activity.

General

- The Contest is open only to *all* VK and ZL callsigns.
- The Contest shall be in 6 X 1 hour stages, and stations can only be reworked after the commencement of each hour.

However, stations worked during the 5 minutes before the hour, cannot be reworked until 5 minutes after the hour.
- A station can be worked on Phone and CW, during any one hour stage, only if the Operator is contesting both Categories or QRP Category.
- Sequential numbers, commencing at 001, shall be given and received for all contacts made during the Contest. (RST numerals *not* required).
- Contest details; Rules and a suitable log sheet are available on the Contest web-site: <http://home.iprimus.com.au/vktasman>
Any queries or constructive criticism

should be attached to the log, or emailed to vktasman@hotmail.com

Bands: 80 metre band.

Frequencies:

Phone: 3.540 to 3.625 MHz.

CW: 3.500 to 3.550 MHz.

Note: It is not in the spirit of the Contest to "park" on a frequency.

While this will not be policed, 20 minutes is considered to be the maximum time between QSYs.

Modes: LSB (DSB optional for QRP), CW

Max. TX Power:

LSB: 100 watt pep. (QRP 5 watt pep, LSB or DSB).

CW: 100 watt pz. (QRP 5 watt pz).

Categories:

Cat 1. Single operator - Phone.

Cat 2. Single operator - QRP (Phone and/or CW). - Also eligible to enter Cats 1 or 3.

Cat 3. Single operator - CW.

Multi-operator:

- Club/Group stations shall be permitted to enter Category 1, on the proviso that only ONE Operator

is used in each 1-hour segment, to perform ALL functions without assistance (ie: TX/RX; log and time keeping).

- Any prize awarded to a "multi-operator" entry shall also be awarded equally to the "single-operator" entry that would have otherwise won that prize.
- Club/Group stations are ineligible for the "VK/ trans-Tasman Trophy".

Callsigns:

- VK4s north of the Tropic of Capricorn shall add "Central" after the suffix of their callsign, for all contacts with ZL stations.
- QRP stations shall add "Quebec" after the suffix of their callsigns, for all contacts.

Scoring:

- The final score shall be the sum of the five (5) highest scoring hourly segments, with the lowest hourly score not counted.

Note: This gives the Zs the option of working only 5 hours, if they choose not to stay up until 2am to try to improve their score.

It gives VK6s (who only have 3 hours competition after 7pm) 5 hrs to complete a full Log, if they choose not to start until 5pm to avoid poor propagation after 4pm./ 0800 UTC.

- VK shall be divided into 3 zones (for scoring purposes):
 "East" = VK1, VK2, VK3, VK4 (south of Tropic of Capricorn), VK7 and VK9.
 "Central" = VK4 (north of Tropic of Capricorn), VK5 and VK8.
 "West" = VK6 and VK0.
- VK to VK (except VK/East to VK/West) = 3pts
 VK/East to VK/West = 3pts + 3 (distance) = 6pts
 VK/East to ZL = 5 (distance)+1 (band time)+5 (bonus) = 11pts
 VK/Central to ZL = 7 (distance)+2 (band time) +5 (bonus) = 14pts
 VK/West to ZL = 10 (distance)+5 (band time)+5 (bonus)= 20pts
- ZL to ZL= 3 pts
 ZL to VK/East = 5 (distance) + 5 (bonus) = 10 pts
 ZL to VK/Central = 7 (distance) + 5 (bonus) = 12 pts
 ZL to VK/West = 10 (distance) + 5 (bonus) = 15 pts
 (5 bonus points awarded for each

trans-Tasman contact)

- During each 1 hour segment, additional bonus points shall be awarded as follows:

VK working 4 X VK call areas = 20 bonus points

VK (East) working 3 X ZL call areas = 30 bonus points

VK (Central) working 3 X ZL call areas = 40 bonus points

VK (West) working 2 X ZL call areas = 40 bonus points

ZL working 4 X ZL call areas = 20 bonus points

ZL working 3 X VK (East) call areas = 30 bonus points

ZL working 2 X VK (Central and/or West call areas = 35 bonus points

Note: "Call Areas" are identified by the numeral in the callsign. Multiple "groups" of call areas worked in any hourly segment shall score multiple points (eg: VK (East) working 3 X ZL call areas, twice in one hour = 60 pts.

- QRP to Base Stn = 2 bonus points to each party.
 QRP to QRP Stn = 4 bonus points to each party.
 QRP using homebrew RX & TX = 1 bonus point per contact.

Logs:

- A separate Log shall be submitted for each Category entered.
- Provide a separate Log sheet for each hourly segment, with hourly "contact" sub-totals and "multi-call area bonus" shown at the bottom. Number each Log sheet (eg: 2 of 6).
- For each contact, logs shall record callsign of station worked; numbers given and received, and UTC time.
- A spare column shall be included at the right of each log entry, for contact points score, - (should be calculated after the Contest).
- If six (6) hours are contested, the Log sheet for the lowest-scoring hourly segment shall still be submitted for cross-checking, but shall be indicated as "not included in final score", by ruling a red diagonal line through the page.
- Logs, or log entries that are not clearly legible, in the opinion of the Contest Manager, will not count.

Log Summary

- Logs shall be accompanied by a summary showing the operator's

name, address, email address (if available), callsign, category(s) entered, and total points score claimed.

- VK4s in "Central" zone shall identify as such at the top of their Log Summary sheet, by writing "Central" after their callsign suffix.
- QRP stations claiming "homebrew" points shall indicate accordingly.
- It will be assumed that all entrants submitting logs will have contested in compliance with the Rules.

Lodgement of Logs

Logs must be received either by post, to: VK/trans-Tasman Contest, 28 Crampton Cresc., Rosanna, 3084, Vic, Australia; or by email to: vktasman@hotmail.com in either "Word 2000" (or earlier), or "Text File" (Notepad) formats.

Note: Closing date for receipt of Logs shall be 0700 UTC, 10th July.

Operators are requested to submit their logs (even if you don't think you will win). This will justify the effort and expense involved by the Contest Manager and ensure the on-going success of the Contest.

Awards:

VK/trans-Tasman Trophy: Highest Score

Certificate 1 st	Phone Score
Certificate 2 nd	Phone Score
Certificate 3 rd	Phone Score
Certificate 1 st	QRP
Certificate 1 st	CW
Certificate 2 nd	CW
Certificate 3 rd	CW
Certificate 1 st	VK
Certificate 1 st	ZL
Cert. (Most stations heard) 1 st SWL	
Certificate (Night-owl's Award) Top	
Phone score in final hour	
Certificate (Night-owl's Award) Top	
CW score in final hour	
Certificate Lowest Log Score	

Publication of Rules and Results:

- Rules will be published in the WIA "AR" and NZART "Break-in" magazines, and on the Contest website.
- Results will be published in "AR", "Break-in" and if possible, in "Radiomag" magazine.
- The first 10 place getters in each Category will be published on the Contest website no later than 20 August 2002.

VHF - UHF

AN EXPANDING WORLD

David K Minchin VK5KK

Postal: 10 Harvey Cres, Salisbury Heights, SA, 5109

E-mail: tecknolt@ozemail.com.au EMAIL ADDRESS CHANGED!

Web page: <http://members.ozemail.com.au/~tecknolt>

Fax +61 8 82924501

Phone 0403368066 AH ONLY

All times are in UTC.

50 MHz

The Second hump in the current cycle has been in full swing with contacts above and below the tropics. Mike VK2FLR reports ... the autumn equinox has kicked off to a good start in the Sydney area:

Saturday 22 March (21/3 UTC day): 2148 ZF1DC 55, 2156 TG9SO 54, plus YS1RR heard. VK2ZXC also worked into Cuba. On the 24th of March (22/3 UTC): 2035 K6MYC 529. I was able to snatch Mike from under a wall of ZLs - I have now worked K6MYC on 6 and 2 metres! Heard were other weak Ws on SSB, 5W1SA at up to S4 working a pileup of East Coast VKs, good backscatter from VK3, VK4 and ZL3TY, plus FO3BM and V73GT.

Tuesday 25 March (24/3 UTC): 2138 P43JB 559 (last heard Aruba in 1989!), 2150 PJ2/DL4WK 549, on the 26th March 45.240/250/260 and 46.172 backscatter to the north-east, weak central American signals around but not heard at this QTH... Mike VK2FLR

Ray VK4BLK reports ... here is my report of recent 50 MHz activities. 26/3 at 2313Z, P49V 55/55, 30/3 at 0210Z, TI5KD 53/43, 30/3 from 2313Z to 2341Z, KB6NAN, K6QXY, K6FV & N6RA, 31/3 at 0110Z, W6BYA 59/59, 4/4 at 0148Z, TI7WAM 559/559, 4/4 at 0152Z, TI5BX 55/55. Also during the 144 MHz openings into ZL in March, 20/3/02 at 0918Z, ZL1IU 52/52, at 2049Z, ZL1AVO 56/58 ... 73 Ray VK4BLK

Tony VK4CH reports ... Good propagation on 6 m over Easter break

from VK4. Stations worked in K6 (California) XE2 (Tijuana) and FK8 (New Caledonia) at between 2300Z 310302 and 0100Z 01040Z. Lots of backscatter heard with VK4FNQ and VK4ABW up in North QLD reading up to S3. ZL seemed to having a good time too as many of the K6s and XE2s were heard working them. JA, HL and the other usual northerners have been very strong every night from 0600Z to 1000Z. Last Europeans worked were 9A (Croatia) two weeks ago.

Looks like the cycle hasn't finished just yet! 6 m was open again to the Pacific and north last night 10/4/02. Apart from many, many JAs, KH6 was worked and heard on SSB & CW with NH6RO and KH6SX reading 5/5. A new beacon was heard on 50.013, V73SIX. It was up to 5/9+20 at 10:30 local but no stations were heard from the Marshall Is area. The propagation was so good to JA last night that I worked one station that was using a 2 W SSB handheld with a quarter wave ground plane attached to the railing on his unit. ... Tony VK4CH QG64JQ

VK4CXQ reports on 6 metre activity from Townsville—mid Mar-Apr 2002 ... what a difference a month makes! This time last month there were EUs

everywhere but except for 16-17 Mar with QSOs into IK LZ OK SP S5 and DL the bottom has fallen out of the ionosphere!! Since 17 Mar only QSOs into the Pacific area were heard with a few contacts into TI and XE (very few) All JA districts were active from JA0 to JA9 while 9M6 and DU1 were there at times along with a few more Chinese stations that usual. VR was also heard late at night. Most activity was from KH6 with a few stations up there calling into Japan and Europe.

V73 was heard briefly as was FK8. The occasional HL and DS station also came through. Still waiting on openings to USA, Central and South America ... 73 VK4CXQ

Scott VK4JSR reports ... 6 m has proven to quiet good late in the evening (1300Z - 1430Z) with Hong Kong (VR2) and China (BV/BG) being worked in QG62 over the last few days. A VK2 was also heard Sunday night on scatter calling the VR2's. These are the same conditions that prevailed last year prior to the LP opening between VK4 (QG62) and LU8MB. Those able to keep their eye's opens should spend a little time monitoring the indicators and listening to the band.... it could be worthwhile!!! ... Scott VK4JSR

144 MHz & above

Gordon VK2ZAB reports ... Contacts from here this morning: 2/4/02Z, 2116Z, VK4AML 2M SSB 5/5 5/3 Caseldine [Bris], 2117Z, VK4DFE 2M SSB 5/5 5/3 Maleny, 2118Z, VK4TZL 2M SSB 5/2 5/2 Hervey Bay, 2120Z, VK4AML 70 cm SSB 5/2 5/2 Caseldine, 2138Z, VK2TQP 2M SSB 5/5 5/6 Coffs Harbour, 2142Z, VK2ZCV 2M SSB 5/8 5/9 Pt. Macquarie,

2154Z, VK3II 2M SSB 5/2 5/6 Coronet Bay, 2207Z, VK2ZRE 2M SSB 5/5 5/5 Adaminaby, 2210Z, VK1BG 2M SSB 5/6 5/7 Canberra, 2211Z, VK1CJ 2M SSB 5/5 5/9 Canberra, 2224Z, VK2AAS/p2M SSB 5/7 5/9 Molly Mook, 2228Z, VK7MO 2M SSB 5/3 5/3 Hobart, 2244Z, VK3AXH 2M SSB 5/2 5/3 Mount Helen, 2304Z, VK1BG 70cm SSB 5/8 5/8

Canberra, 2311Z, VK7JG 2M SSB 5/1 4/1 Launceston, 2313Z, VK2TWR 2M SSB 5/8 5/9 Nimmitabel, 2319Z, VK2TWR 70cm SSB 5/2 5/3 Nimmitabel, 2352Z, VK2FO 2M SSB 5/2 5/7 Ulladulla.

Unfortunately nothing heard of Wally VK6WG operating portable / mobile down the east coast of Tasmania in spite of some four hours of off and on calling.

Rex VK7MO came up several times during this period

On 6/4/02 the usual contacts were made on 2 m SSB from Maleny [VK4] to Somerville [VK3]. Less than usual [having done it only once before] was the contact with VK7KPB on Flinders Island at 2231Z on 2 m SSB 5/5 5/6 and at 2248Z on 70 cm SSB 5/2 5/2. Peter made contact with several stations mainly near the coast in Sydney and

south. Was reported to be still working into southern NSW on both 2 m and 70 cm in the afternoon. [7/4/02Z]. Gordon VK2ZAB

Ian VK3AXH reports ... Good propagation from Ballarat both east and west directions Friday 5/4/2002 evening. Beacons heard VK5RSE 2 m 5x9, VK5RSE 70 cm 5x9, VK7RAE 2 m 5x5, VK7RAE 6 m 5x6 & VK3RGI 2 m

5x3. VK5VF was visible on spectrogram but not audible. Had a QSO with Colin VK5DK running 5 watts both ends on 2 m and 70 cm 5x9+, then had a contact on 1296 both around 15 watts 5x9+ both ways. On Saturday morning 6/4/2002 the Tassie 2 m beacon still around S5, Mount Gambier 2 metre beacon had dropped down but 70 still S9.... Ian VK3AXH

Digital "DX" Modes

This part of the column was originally titled WSJT but with JT44 being implemented rapidly in the last few months along with PSK31 activity on 50 MHz, I have bent with the pressure. It is amateur radio. This month we have reports of the first VK to ZL Digital scatter contact as well as the first JT44 EME QSO out of Australia! If you want more information about WSJT & JT44, the best resource is that put together by Rex VK7MO at

<http://www.tased.edu.au/tasonline/vk7wia/>

Mike VK2FLR reports ... on 21 April I completed what was probably the first 144 MHz EME QSO out of Australia on JT44 with GM4JJJ. I was using a single yagi with no elevation; David GM4JJJ was using 4 yagis. Signals peaked at -19 dB in a 2kHz bandwidth! Some years ago I worked David on random CW EME when I had my four yagis up. With JT44 I don't need all that metal!

Just got this for GM4JJJ: Mike, great signal from you, peaking -15dB at times. Very frustrating because you were so strong I could hear you by ear but you obviously had noise problems and could not hear me. At one point early on I was sure you sent O reports (13:15) but after that I noticed that you were sending only calls again, so I had to go back to sending

calls and OOOOOO again. Had almost given up hope as the moon was getting very low at your side and polarity had changed from H to V here then at 13:56 I got RO and finally got 73 at 1401. ... Mike VK2FLR

The first VK to ZL WSJT contact occurred on 13/4/2002 between Rex VK7MO Hobart and Bob ZL3TY Greymouth RE570m, Western side of the South Island. Total path distance of 1950 km. ZL3TY received a 16 report (15db above noise) while VK7MO received a 26 report (7 dB above the noise). The contact took four or five readable pings in both directions to complete over a 45 minute period. Power used at each end of the contact was 100 – 200 watts

Rex VK7MO reports further ... Bob ZL3TY will be on WSJT, FSK441 mode, on 20th & 21st of April 2002 from 0100 UTC to 0200 UTC on 144.230 MHz beaming VK. As he is the easterly station he will TX in the first 30 seconds. Bob will use single tones. To have a chance of working Bob you need to be within 2400 km - and have close to zero degree horizon in his direction. The distance decreases by about 108 km for each degree above the horizon. Sydney, Port Macquarie, Nimmitabel, Canberra, Launceston and Bairnsdale should all be in range.

I have run tests with Bob for six days

and completed on three - the last two in 30 and 35 minutes. Even when we did not complete call signs and reports were exchanged. The info received at both ends for this morning's test is copied below. The info in the columns is as follows:

1. Time of start of RX period
2. Time in seconds from col 1 when ping occurred
3. Duration of ping in ms
4. Signal strength of ping in dB above noise (Bob's best pig was 6 dB and mine 7 dB)
5. Report
6. Difference in frequency in Hz (under 200 Hz is OK)

For further details please consult the WSJT web site that is accessed at the following address which is the index page of the VK7 web site. Then go to the bottom of the index using the slider and click on WSJT Activity in Australia. <http://www.tased.edu.au/tasonline/vk7wia/> ... Rex, VK7MO

John VK3KWA reports ... for information, the following received from Bert ZS6HS: The WSJT program has certainly caught on around here! Yesterday 21 April 2002 ZS6WB made a 6-metre contact with a W7 VIA THE MOON using JT44 ... John VK3KWA

Microwave Round up—UK Visit

Since the last column I have been mostly overseas on a multi-legged business trip through the Middle East, UK and Asia. Amateur Radio took the back seat except for the first weekend in April when I managed (!) to arrive in the UK just in time for the inaugural Six Metre to Microwave Convention on Saturday the 6th of April 2002

Since the RSGB annual VHF Convention has now been discontinued,

individual Society committees have decided to organise their own events. The convention was a single day event, with on-site accommodation / meals and Bar available for both the Friday and Saturday nights, aimed at all interested in the spectrum above 50MHz. It was a joint effort of the RSGB Microwave Committee, the UK 6 metre Group and the RSGB VHF Committee. The Convention was held at the Rease Heath

Agriculture College, approximately 2 miles from Nantwich, Cheshire. That's about 260 km NNW of London and about 60km south of Liverpool.

After shifting a few airline flights to arrive in time, booking a rental car and accommodation over the Internet, from Dubai, a couple of days before the trip was on! I arrived at Heathrow at 7.00pm the Friday night before! Problem number one, the booking agency hadn't passed

on the rental car booking (they'd skimmed 12 pound off my credit card though). Luckily, as always seems to happen, I struck a helpful Australian behind the counter of "Brand X" rental cars.

I was soon on the way, armed with a basic knowledge of UK motorways, a GPS and a map of UK out the Emirates Airline magazine! Just in case, I'd entered in the coordinates of both the hotels and the location of the convention (thanks to the RAC Internet map service) into the GPS. The GPS already having 20,000 worldwide waypoints (I'd forgotten that!) so the tourist map was totally redundant!

I'd booked accommodation at Birmingham, just under an hour from the convention. The first test was at 10.30pm that night finding the hotel after driving up the M40. Bingo, a combination of luck and good management meant I drove straight there! The GPS beeped its 300m warning about the same time the Hotel sign came into view. This time the Internet booking had happened.

Next morning I set out around 8-30pm ringing Sam G4DDK to meet at the pre-arranged point on the M6 North of Wolverhampton. As it turned out Sam wasn't quite ready so I elected to drive on to Nantwich. In daylight it was easy finding Nantwich, but no signs to the Agricultural College. With some "Fox hunting" skills learnt many years ago and the GPS it took a just a few minutes. I was lucky, as it turned out a number of the UK attendees did get lost finding the place! Understatement for the day overheard on air "great day for a drive in Cheshire but a map and some signs would've helped!"

About 80 Amateurs attended including a number of Europeans, one

US and one VK (me) ham. Amongst those I met a few I had worked on 50 MHz (last cycle) but a good number came up to me and told of contacts with a few of the regulars in the 50 MHz part of this column in the prior weeks! Also Peter H44PT (I have forgotten his current G call) attended bringing back memories of his operations from H44 in the late 70's and early 80's. Others met included microwaver's Sam G4DDK and Peter G3PHO and Chris G4DGU, the original founder and owner of Mutek.

Trade stands were set up by the UK Six Metre Group (UKSMG), RSGB Microwave Committee, RSGB Publications, VHF Communications, Linear AMP UK, GH Engineering and Acom. It was heartening to see that there still are some UK manufacturers producing equipment (mostly linear amplifiers) for the market. There was also a small display of homebrew Microwave Equipment from Peter G3PHO.

Various lectures included 3 VHF lectures, 3 Six Metre lectures and 1 microwave lecture. I sat in on several including David G4ASR's "Making more miles on VHF". Controversially he quoted "Tropospheric is a beginners mode" and that Ionespheric DX is the real stuff! What else would you expect when Meteor Scatter rules supreme and most VHF DX working is the realm of "ping jockey's"!! The lecture was highly informative and amongst other things had audio clips of Chris VK5MC's EME signal and Geoff VK8GF's 6-m signal!

Another lecture, by Geoff G3NAQ tackled the race for the first Trans-Atlantic 144 MHz contact from UK to the North America. Apparently there has been a claimed WSJT contact over the 3500km path in late 2001. Ian White G3SEK gave a talk on High Voltage

power supplies. Ian is well known for his range of power supply designs/kits that provide almost bulletproof protection for triode and tetrode linear amplifiers (I have a set here in a 4CX800A amplifier). And Peter G3PHO gave us a travelogue from UK to the Microwave Update 2001 in the US including trudging through all those surplus stores!

I didn't attend any of the 50 MHz lectures as these ran concurrently with the VHF and above lectures. From comments, these were of similar quality and had similar number of attendees. I didn't attend the Dinner that evening, as I had to get back to Oxford before dark. The event was well organised but I'd safely put our own GippsTech Gippsland Technical Conference in the same category for quality and attendance (but with a lot better instructions on how to get there!)

Driving back was easy; I just followed the original GPS track back onto the motorway! The rest of the trip was smooth except for the wind turbulence from the odd BMW doing +120mph on the motorway!!

In closing

A handy site for that quick conversion from Lat & Long to Grid square and vice versa is at <http://www.amsat.org/cgi-bin/gridconv> courtesy of AMSAT.

I'll leave you with this thought.. "Dogs are like people. Usually only one in a group is barking at something in particular; the others are barking at him!"

73s David VK5KK

ar

GB50: Amateur Radio for the Golden Jubilee

Look for the unique callsign "GB50" (Yes; Golf Bravo Fifty) that will be established at Windsor Castle to celebrate the H.M. Queen Elizabeth II's Jubilee (50th Anniversary of her succession to the throne) from 29th May to 9th June 2002.

The station will be run by Cray Valley Radio Society (who made 48,000 QSO's from M2000A in 2000), in association with Burnham Beeches Radio Club, and with the support of the Radio Society of Great Britain.

"GB50" will be active on all bands from 3.5 – 50 MHz on CW, SSB, PSK31 and RTTY, and on 144MHz CW, SSB and FM from 0600 – 2100z daily.

You can check all the latest details at: www.gb50.com including full details of our Awards Program.

Draft Australian ARDF/Foxhunting Lists

After suitable inspiration at the 2001 Urunga Convention, especially noting the kids involved, I thought it could be an advantage if we had a contact list of those involved with fox hunting/ARDF, also a list of venues where these activities take place.

The following is what I have put together. There is a lot of info missing and some of you may be able to add to, suggest other people/venues, remove yourself from the list, make other suggestions etc.

Please forward info to me and I will try and get the lists into shape.

Eventually, maybe we could have this list published, say annually, in AR.

Clubs, groups & individuals involved in fox/hidden transmitter hunting or ARDF

Contact information in various cities/towns (** after town or venue indicates up to date information.)

VK1

Canberra Neil Pickford, VK1KNP.

VK2

Bellingen ** Brian Slarke, VK2ZCQ, Ph (02)6655 1115, e-mail. bjslarke@midcoast.com.au. Brian organises the annual Urunga event.

Blue Mountains ???

Newcastle. ? Graham O'Brien, VK2FA.

Pt. Macquarie **. Oxley Amateur Radio Club. Secretary is Alan Nutt, VK2GD. e-mail

anut@ozemail.com.au

Stroud (Nth of Newcastle). Brian, VK2BI. e-mail vk2bi@bmr.com.au Brian builds some equipment.

VK3

Melbourne **. Jack, VK3WWW, Club EMDRC. Ph (03)9873 2459, email

vk3www@alphalink.com.au Jack is the WIA Australian ARDF coordinator.

Bruce, VK3TJN, Ph (03) 9888 7509, email brucep@netspace.net.au Bruce is secretary of Victoria ARDF Group. Contact for details of planned Vic. Groups ARDF events. NB Planned in conjunction with some orienteering Metro series events. <http://streeto.cable.nu/Sunday/Index.html>

Ballarat. Events held at annual convention. Contact person is required.

VK4

Brisbane.

Redcliffe. Charlie Strong, VK4YZ, email smccab@ats.com.au

Sunshine Coast Radio Club. Ron Marchke VK4GZ is the only contact

I am aware of. More info required. Ipswich. Peter Omerod, VK4CPW, email Peter.Omerod@defense.gov.au Mackay. Brian, VK4DFD, Mackay Amateur Radio Club (MARC), email colman@orion-online.com.au Rockhampton. Clive, VK4ACC, Rockhampton & District Amateur ARC (RADAR Club) Sarina .. Ron, VK4BRG, Sarina Amateur Radio & Electronics Club (SAREC) ** Ph (07)4956 1155, email rongraham@magnet.com.au Townsville. **. Don, VK4MC Townsville Amateur Radio Club (TARC) Ph (W) 4729 3314 email dtterrace@ozemail.com.au

VK5

Mt. Gambier SERG <http://serg.mountgambier.org>

Venues where Fox/Hidden Transmitter Hunting, or ARDF, takes place.

VK1

VK2

Blue Mountains???

Port Macquarie. **. Annual field day Queens Birthday weekend, June. 2 metre pedestrian, 2, 10 and 40 metre mobile events held.

Urunga. **. Sat. & Sun. Easter weekend, lots of hidden TX hunts, pedestrian & mobile events, 80m & 2m bands. Contact Brian, VK2ZCQ, (Bellingen)

VK3

Melbourne. **. Melbourne Fox Hunting Group, 3rd Friday of each month, 2m mobile events often using a "runner" with sniffer equipment in latter stages of the event. Contact Jack, VK3WWW.

Event start posted to major-domo mailing list. "subscribe melb-fox" in e-mail to majordomo@planet.net.au

Ballarat. Quite a number of events (various bands) are held at the annual convention. The last convention was late October 2001. The BARG home page is <http://www.qsl.net/vk3bml/> More information required.

VK4

Sunshine Coast. Seem to be holding some events. Ron Marchke VK4GZ may be able to supply some info. Full info required.

Rockhampton. ** Annual fox hunting during JOTA at Seeoone Park. Also at Clearview See below.

Clearview. ** Combined Mackay, Rockhampton, & Sarina Club Event, Sat. & Sun. of May Day weekend, 3 or 4 events. 2 m pedestrian. Contact Ron VK4BRG (Sarina) Mission Beach. **. Combined Cairns & Townsville Event, Queens Birthday weekend, 2 or 3 events. 2m pedestrian. Contact Don, VK4MC (Townsville)

VK5

Mt. Gambier. Queens Birthday weekend, organised by SERG ?? . Many mobile HF, VHF and pedestrian events, bands utilised are 80m, 40m, 10m, 6m, 2m, 70cm & 23cm. Contact. SERG <http://serg.mountgambier.org>

Adelaide-Auckland 104 **Brisbane-London 147**

Second 2F13-15 Short 3241 km
MHz

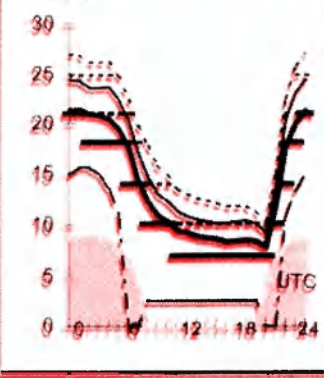

First F 0-5 Long 23498 km
MHz

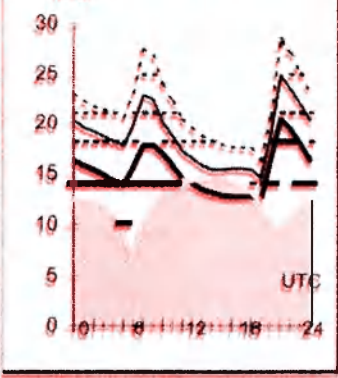

May 2002
T index 100

Legend

- UD
- E-MUF
- F-MUF
- OWF
- ALF

Frequency scale

- >10%
- >50%
- >90%

Time scale

HF Predictions

by Evan Jarman VK3ANI
34 Alandale Court Blackburn Vic 3130

These graphs show the predicted diurnal variation of key frequencies for the nominated circuits. These frequencies as identified in the legend are:-

- Upper Decile (F-layer)
- F-layer Maximum Usable Frequency
- E-layer Maximum Usable Frequency
- Optimum Working Frequency (F-layer)
- Absorption Limiting Frequency (D region)

Shown hourly are the highest frequency amateur bands in ranges between these key frequencies, when usable. The path, propagation mode and Australian terminal bearing are also given for each circuit. These predictions were made with the Ionospheric Prediction Service program: ASAPS Version 4

Adelaide-Cairo 788

First F 0-5 Short 13332 km
MHz

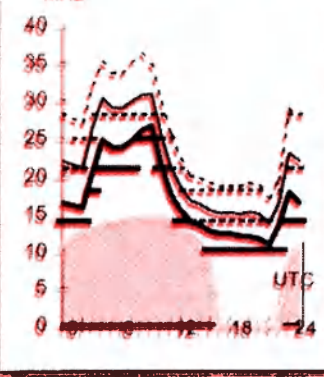

Brisbane-London 577

First F 0-5 Short 16525 km
MHz

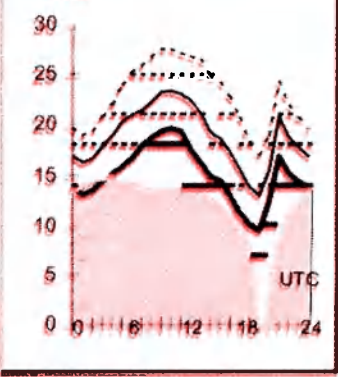

Canberra-Moscow 317

First F 0-5 Short 14481 km
MHz

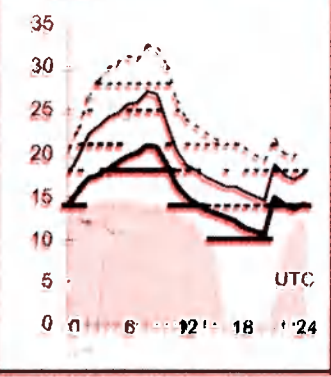

Darwin-Manila 340

Second 2F13-24 Long 3196 km
MHz

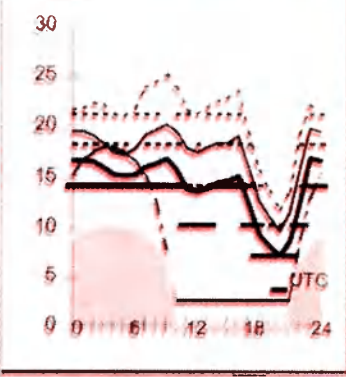

Adelaide-Honolulu 57

Second 4F7-12 4E Short 9160 km
MHz

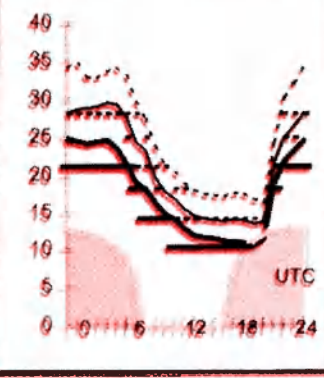

Brisbane-Ottawa 177

First F 0-5 Short 15308 km
MHz

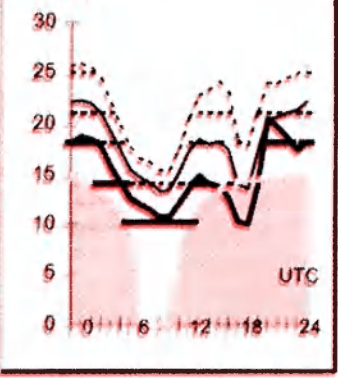

Canberra-New Delhi 503

second 4F6-10 4E Short 10347 km
MHz

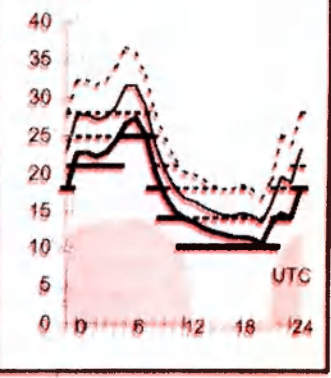

Darwin-Santiago 157

First F 0-5 Short 14423 km
MHz

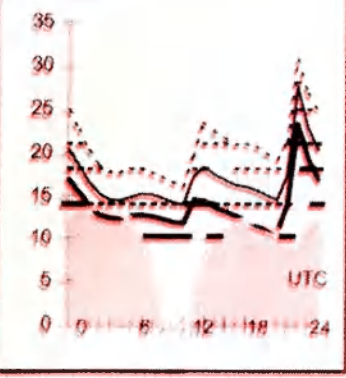

Adelaide-New York 57

First F 0-5 Short 17092 km
MHz

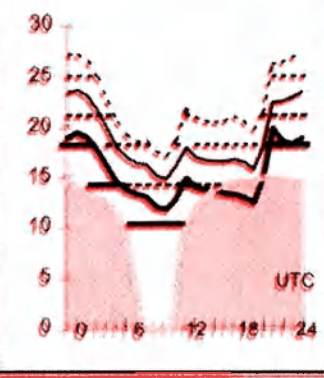

Brisbane-Tokyo 348

Second 3F6-12 3E Short 7159 km
MHz

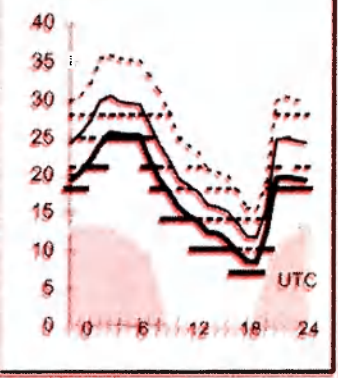

Canberra-Seattle 48

First F 0-5 Short 12709 km
MHz

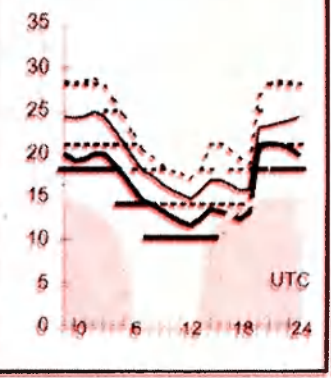

Darwin-Seoul 356

First 2F3-9 2E Short 8873 km
MHz

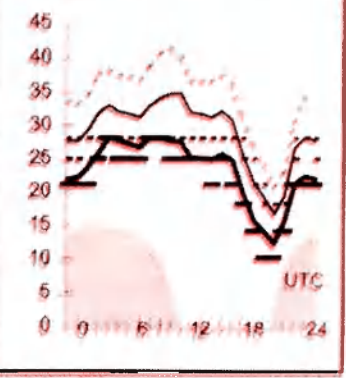

Hobart-Barbados 134 **Melbourne-Capetown 222** **Perth-Buenos Aires 185** **Sydney-Budapest 306**

First F 0-5 Short 15825 km

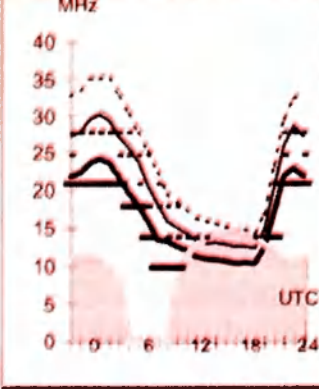

Second 4F5-6 4E Short 10318 km

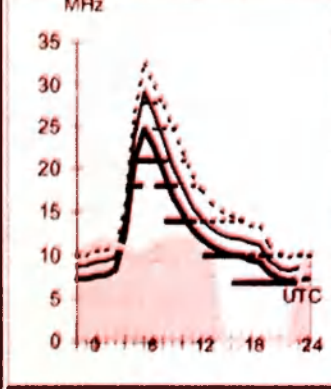

First 3E3-5 3E0 Short 12591 km

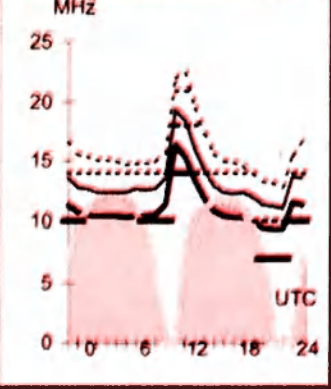

First F 0-5 Short 15779 km

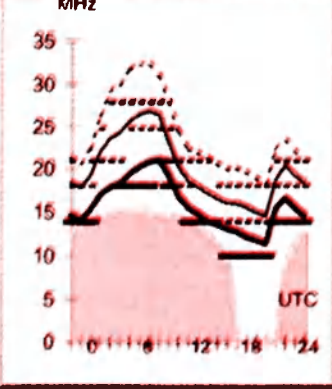

Hobart-Lima 133 **Melbourne-Miamil 94** **Perth-Columbo 312** **Sydney-Chicago 62**

First F 0-5 Short 12421 km

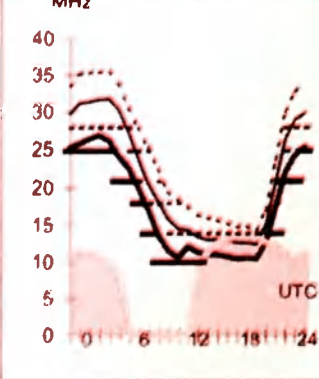

First F 0-5 Short 15584 km

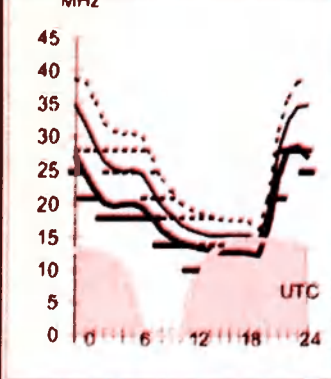

Second 3F10-15 3 Short 5768 km

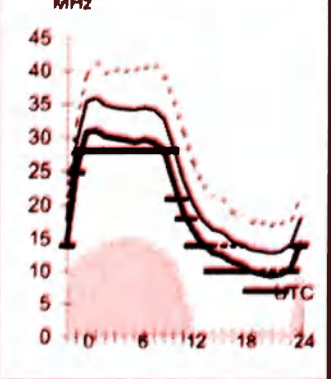

First F 0-5 Short 14876 km

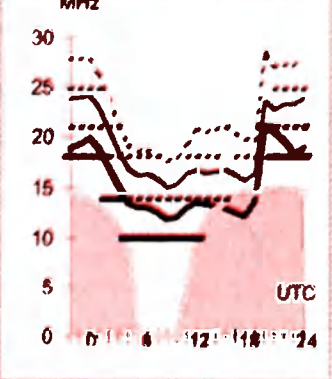

Hobart-London 123 **Melbourne-Senegal 219** **Perth-Osaka 17** **Sydney-Jakarta 294**

First F 0-5 Long 22620 km

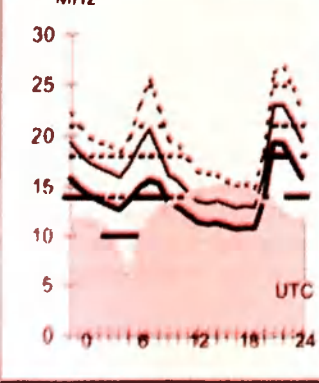

First F 0-5 Short 16910 km

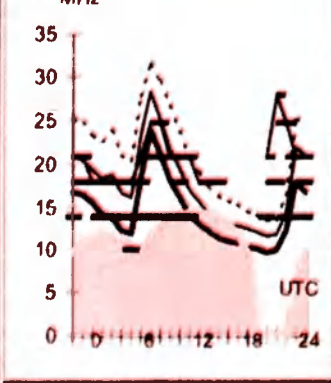

Second 3F5-10 3I Short 7684 km

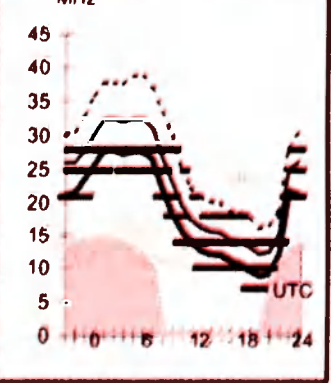

Second 3E11-13 3 Short 5498 km

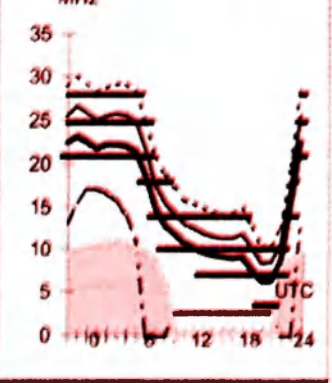

Hobart-London 303 **Melbourne-Suva 65** **Perth-Wellington 119** **Sydney-Pretoria 230**

First F 0-5 Short 17404 km

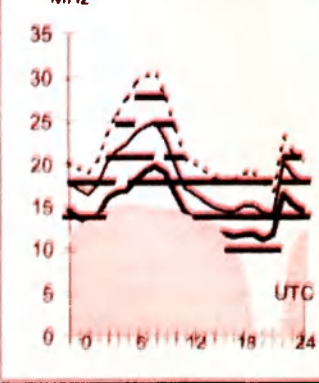

Second 2I 9-12 2I Short 3914 km

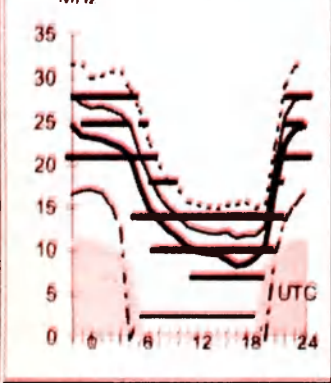

Second 3I 12-13 3 Short 5258 km

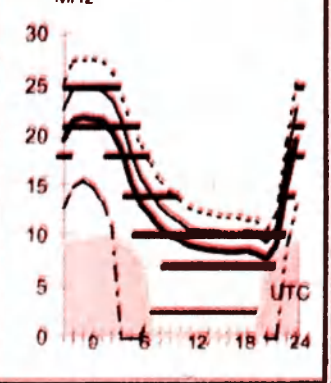

Second 4E3-4 4E Short 11063 km

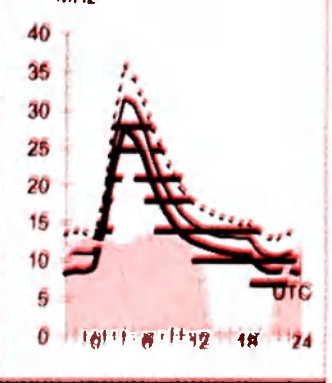

Ham Shack Computers

Alan Gibbs, VK6PG
223 Crimea Street, NORANDA WA 6062
Packet: VK6PG@VK6BBR.#PER.#WA.AUS.OC
Email: vk6pg@tpg.com.au

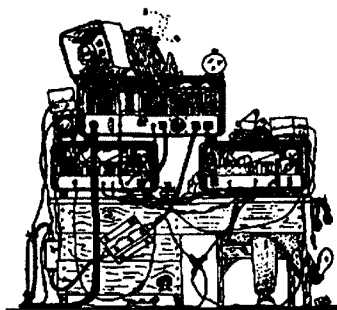

Part 14 – “Packet Radio”

In recent years, Packet Radio has become one of the most under utilised digital modes since the dawn of the Internet revolution. Packet still thrives today thanks to the numerous “unsung heroes” who fund, maintain, and operate the numerous BBSs and interconnecting packet nodes.

Some History...

Prior to the 1970s, radio amateurs were experimenting with RTTY (Radio Teletype) using surplus WWII teleprinters and the world buzzed (diddled) with FSK (Frequency Shift Keying) around 14.085 kHz. Ham Shacks smelled of old automotive engine oil and AR operators tolerated the mechanical noise of whirling teleprinters late into the night. Those were the good old days, Hi. However, RTTY was essentially a point-to-point keyboard-chat communications mode without the ability to store and forward messages.

Computers blossomed during the 1970s and RAs soon developed software that could automate complex routines, run programs, and store information. During the 1980s, the IBM compatible became common place and a “standardised” Disk Operating System (DOS) made information interchange much easier. Based upon the X25 protocol data packet standard, RAs adapted the X25 protocol for Amateur Radio use (called AX25) to enable interactive amateur computer communications between other RAs around the world. The packet boom exploded during the 1980s with thousands of BBSs (Bulletin Boards), nodes and digital repeaters connecting thousands of RAs worldwide.

Many RAs soon realised that a simple 2m FM transceiver and a TNC (Terminal Node Controller) could be used to “connect” with other packet users and leave messages in personal mailboxes. BBSs were established at strategic high ground locations to improve coverage, and could be used to “digipeat” connections to other nodes around the world.

Today, millions of messages travel

between nodes every day – thanks to the many amateur radio BBS operators who freely give their own time and expertise for the benefit of other users.

Telnet operation was soon introduced allowing networks to “link” operators in different countries to one common server (called Ping-Pong). Once the Internet became more widely used, RAs connected their packet stations to the Internet by AX25-TCP/IP translation software. Now, operators could connect with a local BBS, hop onto the Internet, connect to a BBS in Europe or America, further link into a remote AX25 node, and finally connect with an RA in (say) Wisconsin USA and chat live between keyboards. In fact 20 or more RAs can link to a Ping-Pong Server in (say) London (called a Wormhole) and chat away between every continent in the world all at once at NO COST!

The Internet...

...is often blamed for the continuing demise of amateur radio. However, without the Internet, RAs would not be able to enjoy packet radio, IRLP (Internet Relay Linking Project), DX clusters, and a wealth of information interchange from the World Wide Web.

In fact, the Internet and affordable home computers has enhanced the wonder of amateur radio by supporting many new digital modes like PSK31, RTTY, and WSJT. It's the power of the Internet acting as a backbone used to transport AR data that makes packet radio a powerful operating mode in the new millennium.

Getting started with packet...

A recycled 486DX2-50 computer with a 250Mb hard drive, a single 1.44Mb

floppy drive and a spare communications port will do fine when running DOS 6.2. The finest packet software ever produced is TPK 1.82 (4) written by a team of French RAs. For a TNC, again the best available is called the Blakpak marketed by the Australian Amateur Packet Radio Association (AAPRA)(6). The TNC can be purchased fully built and tested for \$85, or \$65 in kit form. These simple yet powerful packet modems are designed to work from packet emulation software (called BayCom 1.6)(5) installed onto your computer – plus TPK 1.82 described above for packet management.

Once the old 486 has been configured and connected to the BayCom modem and a 2m transceiver feeding a 1/4 wave vertical antenna hanging from the shack window – the world is at your fingertips. Running DOS, TPK and BayCom, the 486 is “bulletproof” and runs much faster than the newer Windows applications without “blue screens” and general protection faults that seem to riddle most of the Windows operating systems.

TPK and BayCom software is “freeware” and written by RAs for general use by licensed operators worldwide. Surplus transceivers can be found in the AR press and club junk sales for less than \$75, and a surplus 486DX2-50 with mouse, monitor and keyboard sell for less than \$50 at computer recyclers. Thanks to the frenzied “upgraders” nobody wants a 486 computer anymore. This is excellent news for budding AR packet enthusiasts.

Our more experienced readers will doubtlessly object to the suggestion of the above solution, and argue that some other software is better, faster etc. When asked how they got started, they will tend agree with the writer.

Win 95/98/ME & XP users...

...may prefer a Windows environment for their packet software that will run in a pre-emptive multi-tasking background whilst other powerful programs handle station control and logging etc. Roger Barker, G4IDE is the author of WinPack (5), which has become the most popular Windows-based packet radio program worldwide. However, WinPack still lacks mature message storage facilities and requires extra software called WINPMail (5) to archive and retrieve messages and bulletins. Whilst the above system is stable and very popular, it tends to be clumsy to operate because messages are stored by message number without titles.

WinPack has some nice features. One example being to add the path to your Internet browser so users can send and retrieve HTML files and view them with the browser in full colour. WinPack can also be run with BayCom modems with other emulation software downloaded from the WinPack Web Site (5).

TNCs...

... include the popular Advanced Electronic Applications (AEA) PK232MBX, PK12 and PK900 modems available in the Amateur Press and junk sales. TNC2's MFJ1278's, Kantronics modems and many others are freely on the market these days. However, for operators who want to explore Amtor, Pactor, CW, RTTY and other modes used on the HF bands, a PK232MBX is a good investment being a multi-mode TNC that can be upgraded with DSP and FSK/PSK modes integrated in the one system. But if your interest is just 1200-baud packet messaging, then BayCom is the way to go these days, and let other software run your HF digi-modes from your computer sound card without a TNC at all!

Integrated software...

...is being used by experienced operators to run the station log, control up to three transceivers, turn the antennas AND operate packet all in one software package. YPlog (1) is a good example because it rms all the above features plus a packet terminal program that integrates with the log. The latest YPlog program features YPtty, an integrated RTTY package with hot keys for macro replays that can be "stacked" for

seamless RTTY operation, and the data is automatically entered into the log at the same time. This is delightful for avid testers and DX hunters especially when the integrated terminal program is connected to a local DX cluster node. Watch the cluster, "click" on the DX station of choice and the call is logged, the transceiver changes to the correct mode and operating frequency, the beam automatically moves in the right direction, and you are ready to call the DX station with another "click" on the mouse button! AND – the report and contest serial number is automatically updated for each exchange AND YPlog keeps track of the multipliers and your contest score. (See *Ham Shack Computers*, No. 3 in June 2001 AR for more details).

To handle all of the above software integration a fast computer is needed. I use a Pentium 166 running Windows 98-second edition, and networked to a Celeron 500 running Windows XP acting as a server through to the Internet via a firewall. The systems allow simultaneous operation and live on-line connections to upgrade software and exchange files, pictures, and sounds to other operators and Web Sites worldwide. However, in a corner of the shack still lurks the "no cost" 486DX2-50 running BayCom and TPK linked to the local BBS, which runs faster than the XP server. It never fails and collects all my packet mail and downloads news bulletins automatically while I get on with working DX by just "clicking" the mouse on the Pentium 166.

But I'm not on the Internet!

Many readers get frustrated because most features in this magazine quote references to the Internet, and suggest that being "connected" is the right way to the future. For cash strapped RAs with an assertive interest in our hobby, packet radio is the next best thing – and it's CHEAP. Packet BBSs broadcast header lists (titles) of news messages like QNews from Queensland, software updates and answers to operational problems. Operators can "post" bulletins asking for help in finding a circuit diagram, bugs and hundreds of other activities. Most packet operators are willing to answer your questions in great detail, and future friendships flourish

from these contacts. Leave your packet running when you are out so that other operators can leave messages for you – AND no Telstra telephone connection fees or rental on landlines. All that's needed is an occasional "Thank You" to the sysops (system operators) who run the packet BBSs for all radio amateurs worldwide. They are radio amateurs just like us, and they run their systems as a hobby as we do. Without them, there would be no packet radio system, so please support them. USE or LOSE are the keywords in today's amateur radio world, and can be applied to allocated amateur radio frequencies, national societies, clubs and groups and the networks that help bring us all together: be they AR packet or Internet networks.

What's next?

If your Society or Club sends regular news to members by email on the Internet, ask them to also broadcast the information on the packet network as well. It costs nothing to do and might just help those who cannot afford Internet connections.

Ham Tip No. 14.

Why not ask a friend or your local club members to see their packet stations. Get your Club or Society for a lecture and demonstration. A simple packet station can be carried in a small suitcase, so there's no excuse for your Club or Society to ignore the wishes of members. If it does, membership will continue to diminish! The world is at your fingertips, don't let it slip away.

Ham Shack Computers, No: 15 for next month "Windows XP Review" deals with the deciding issues about upgrading your Windows 98/ME operating system.

- (1) *Ham Shack Computers* Web Site: <http://www2.tpg.com.au/users/vk6pg>
- (2) Ford, S. (1992). *Your Packet Companion*. ARRL; Newington. ISBN: 0-87259-395-9
- (3) Horzepa, S. (1989). *Your Gateway to Packet Radio*. ARRL; Newington. ISBN: 0-87259-26-34
- (4) TPK Home Page: www.f6fbb.org/f1ebn
- (5) WinPack Home Page: www.peak.sys.co.uk
- (6) Australian Amateur Packet Radio Association. (AAPRA) Home Page: www.aapra.org.au
73's de Alan, VK6PG

Reply to Ian Godsfil, Contests Column, *Amateur Radio*, January 2002

Commenting on Clubs / Societies.

I am a member, and currently President, of the Elizabeth Amateur Radio Club/ S.A.VHF Group. It's hard to get people to help or do things for the Club. As you have probably read in AR, our clubrooms are located at the Water Tower at Elizabeth South, The Tower did and still does require work to keep it up to scratch. The property is still owned by the SA Govt and looked after by the Playford (Elizabeth) Council. We have a perpetual lease on it. The people who do most of the work are "oldies" and are retired myself included.

Comments on contests.

In regards the Spring / Summer VHF contests. I believe that the Summer contest this year 2002 was held too close to the summer holidays, many people had only just returned from holidays. I suggest shifting it on a couple of weekends, say after the kids go back to school. Sure it's still in the Bush Fire season and this may make it difficult for "Grid Hoppers" to gain access to their chosen Locator spots.

The time period. The period from midnight to 6/8 o'clock Sunday mornings is a waste of time; you are lucky to get a contact, especially on VHF. A lot of people have other activities. How about making the contest, and others, go till later on the Sunday. Most can run a station for the Saturday

afternoon or evening, or the Sunday afternoon. Break the time up into two 12 hour sections! In regards points for Bands and Modes.

What is wrong with CW contacts on VHF, UHF? Or does this put the "Z" calls at a disadvantage? Say double the points! Most UHF Ops can run SSB/CW. Look at the points you'd get for a 10.GHz CW contact !

As regards CW on UHF, is MCW acceptable on these bands? To key or turn the oscillator off on one of these units would cause stability problems, it would probably "Chirp" out of the bandwidth of some receivers! Sure with MCW you are not switching the RF carrier on and off as with HF CW but it does come out as an interrupted tone at the receiver! In awarding band multiplier points, as 2m/144MHz is more popular and there is more equipment available for this band how about only giving a XI to 2m and X3 to 6m/50MHz, to encourage more activity on 6m. Once upon a time, no it's not a fairy tale' there was an extra point for powering the station from "Non Fossil Fuel". Solar Panels are now easily obtainable. We used to see pictures of people running "Pedal Power" in various Amateur publications.

In regards changing the rules on the Grid Hoppers

I thought the Locator Squares points

were included to promote Portable contest operation? Does this section make it *too hard*? for the contesters who only want to drive to some easy location in their vehicles and run their FM equipment into a couple of whips. or is it jealousy! The eastern states might not win.... ? We saw what happened with the RD contest. VK5 won it for 7 years in a row, so they, the eastern states changed the rules.... ! I trust my comments are of some help in keeping contests active and popular. The interstate rivalry is good for all contests, but it gets a bit annoying at times in its nastiness. Have you ever been to some of the "Fox Hunts"? I have seen it get dangerous! I have been active in amateur radio for 50 yrs, 38 yrs licensed, and all my working life in the Electrical/ Electronics field. I still enjoy all aspects of it, even at 68yrs of age. Some people just recently joining our ranks are amazed at my enthusiasm after all these years. I wonder what is going to happen to amateur radio in the future? Will the 21st Century with all its technology see its demise..! I am concerned but then think, I'll be a 'Silent Key' by the time this happens!

Thanks for running and organising the contests. Keep up the good work.

73 Steve Mahony VK5AIM The "Tooth Pasts" station and one of the "Grid Hoppers".

Change in regulations causes frustration

I emigrated from Italy in 1949 at the age of 29 years and became an Australian citizen shortly after arriving. Considering my limited scholastic achievements from my old country (Primary school) I attended a TAFE run course in order to gain my Full Amateur Certificate of Proficiency, on the first try, some 20 years ago.

I am now retired and derive great pleasure in this hobby and have enjoyed many contacts with my native country. I have even had the pleasure of meeting the daughter of Giulio Marconi.

I often visit my native country Italy, and until 1999, I was always given a

temporary permit from the Italian - Ministero Poste e Telecomunicazioni to operate my VK6QU station in Italy. But, since the year 2000, all permit applications have been refused. The reason I was given is that Australia does not implement the C.E.P.T. licence agreement. Due to this fact, no Australian radio amateur can legally operate in Italy. Can you imagine the frustration for a radio amateur that spends at least 4 months in Italy/Europe every year and not being able to operate his radio because of his Australian licence! Certainly this is not the way to attract new members to our hobby.

Incidentally - all Italian amateurs can operate in Australia with a suitable permit.

However if the situation does not change soon, I will start to lose interest in the hobby, and I will switch to the Internet. No morse, no theory, no regulations, no exams and no licence to worry about.

Could you please look into this matter for me? I hope to hear from you soon.

Ottavio Tonon VK6QU
Cc Minister for Communications - The
Hon. Senator Richard Alston
Minister for Multicultural Interests (WA)-
Dr G Gallop

Look after our "Old Timers"

Many of us amateurs know of fellow amateurs who through advancing age have had to leave their original homes and ham shacks and move into some sort of retirement home or much smaller residence either with their wives or on their own.

We then hear the usual complaint. "I am sorry I can not run my Amateur Radio Station", it may upset some of the other residents. What a shame, these amateurs have probably had an interest in amateur radio for 50 yrs or more, and have no other hobby.

I understood that these "Rest Homes" residents were supposed to enjoy their retirement and old age. Or do the management want the residents to just sit around and wither away in front of the TV!

It seems a shame that a hobby/interest that can assist in keeping one active and with so many interesting aspects is curtailed in this way.

Can our federal body try and remedy this problem? After all many of these amateurs have been WIA members their entire active amateur lives! What about the "Old Timers Club"? Many of their members will eventually fall into this category.

Another difficulty for the "Old Timers" who move into a smaller residence, unit or the like, is antennas. Put up anything like an antenna and there are complaints, visual and or RF. One has to resort to "Invisible or Clandestine" antennas. Remember also these Hams have lost their Shacks/

Workshops or the ability to build "Secret" antennas. Failing sight or an unsteady hand, also make it difficult.

We see suggestions for "Flagpole Antennas" in various publications to overcome these antenna problems. I know of NO commercial manufacturer of such antennas. Similarly with VHF Antennas. The only commercial VHF/UHF antennas are obviously non TV/FM antennas. What's wrong with a dual band Yagi Beam, say 3 Elements on 2 m and 6 Elements on 70cm, that looks like the Multi Band TV antenna? I seem to remember the old Radio and Hobbies magazine of some years ago, publishing a dual band 6 and 2 m antenna! A TV look-a-like antenna, with or without a rotator, vertically polarised would probably not be noticed! Just say it's for Digital TV or FM.

TVI is another problem in the unit type of accommodation. I have seen this with a local amateur and friend. He moved from his home of many years, to a local unit. He took with him a HF Transceiver and a Dual Band VHF/UHF Transceiver.

He asked me to assist him with antennas. That's when the troubled started. I loaned him a HF Mobile Whip, with simple mounting, along with a Dual Band VHF/UHF whip. With the HF whip planted in the front lawn, he only had to run 10 W/QRP power, on any band, some worse than others do, and TV sets started doing "Back Flips". 2m FM was the same. 5 W was all he could run.

70cm FM was the only band he could use; even then much more than 25 W produced "Funnies" on some TV sets. The main problem was the nearby TV sets were only running on "Rabbit Ear" antennas. No outside antennas so the set was running flatout, and highly susceptible to any RF in the vicinity. When spoken to the owners said "I'm a pensioner and can't afford an outside antenna"!

The fact that ACA want \$60:00 to advise the viewers on the solution to their problem and the unit owners don't want to install a common Antenna and Distribution system, does not help the problem.

Our "Old Timers" deserve some help with this problem. Most present amateurs, with luck and good health will be Old Timers in the future, author included! So do you want to give up a hobby you have enjoyed all these years, and turn into a vegetable?

Steve VK5AIM...

PS. My wife Sue came up with a suggestion that local Radio Clubs adopt an "Old Timer" who has moved into a retirement village. Seek him/her out and offer to take them into their shacks or club radio station for some QSOs.

It could be worth a try.

Correction

March AR

There was a problem with photo credit bottom right P25.

The operator is
Graham Mason VK3KMGmd not
Joan YF VK3UCM.

I think the tags identifying the photos may have got mixed up.

Apologies to the people concerned.

Editor

Silent Keys

The WIA regrets to announce
the recent passing of:-

Peter Mulligan VK2ABH

W C Clarke VK2ASM

R (Ross) Weeden VK2PN

Note 1 Views expressed in the letters and opinion columns are those of the authors and do not necessarily represent the policy of the WIA.

2. Some of the letters may be shortened to allow more letters to be published.

Address letters to:

The Editor
Amateur Radio
34 Hawker Crescent
Elizabeth East SA 5117

or email:

edarmag@chariot.net.au

HAMADS

- Hamads may be submitted by email or on the form on the reverse of your current Amateur Radio address flysheet. Please print carefully, especially where case or numerals are critical.
- Please submit separate forms for For Sale and Wanted items, and be sure to include your name, address and telephone number (including STD code) if you do not use the flysheet.
- Eight lines (forty words) per issue free to all WIA members, ninth and tenth lines for name and address. Commercial rates apply for non-members.
- Deceased estates Hamads will be published in full, even if the ad is not fully radio equipment.
- WIA policy recommends that the serial number of all equipment for sale should be included.
- QTHR means the address is correct in the current WIA Call Book.
- Ordinary Hamads from members who are deemed to be in general electronics retail and wholesale distributive trades should be certified as referring only to private articles not being re-sold for merchandising purposes.
- Commercial advertising (Trade Hamads) are pre-payable at \$25.00 for four lines (twenty words), plus \$2.25 per line (or part thereof), with a minimum charge of \$25.00. Cheques are to be made out to: WIA Hamads.
- Copy should be typed or in block letters, and be received by the deadlines shown on page 1 of each issue of Amateur Radio, at:

Email: newsletters@ozemail.com.au **Fax:** 03 9756 7031
Postal: Newsletters Unlimited, PO Box 431, Monbulk Vic 3793

Please send your Hamad by ONE method only (email preferred)

FOR SALE ACT

- Deceased Estate: A complete station comprising - 1) A commercially made desk with three shelves over and a steel filing cabinet under. 2) PHILIPS UHF CB with magnetic mount aerial. 3) YAESU 2m FM transceiver with magnetic mount aerial. 4) TOYO UHF power meter. 5) VK POWER MATE 13.8 volt power supply. 6) YAESU FT-901 transceiver. Immaculate. 7) YAESU YO-901 Multiscope. Ditto. 8) MFJ Antenna tuner. 9) HEATHKIT oil-filled dummy load. Unmarked. 10) KENWOOD SW-200 power meter. 11) CANON P25D desk calculator with printer. 12) Digital clock. 13) Hi-Mound semi-auto key and tone oscillator 14) KENWOOD R-2000 receiver. Immaculate. 15) Trap vertical, 14-AVQ stainless. 16) All interconnect cables. Items are new in appearance, and Operator's handbooks are available. Clear title guaranteed. Call Col Harvey VK1AU on Phone 02 6281 3607 (daytime, please) for further details; for an appointment to view or to make a reasonable offer. E-mail: colharv@telstra.easymail.com.au, until 11 May 02.

WANTED ACT

- ROTATOR for three-element, three-band Yagi antenna (TH-3 Junior) in reasonable condition. Peter VK1CPK Phone 02 6231 1790 or pkloppen@austarmetro.com.au

FOR SALE NSW

- Signal generator LEADER LSG15, six ranges on dial, freq. switch, sig. select, four ranges. Sorry, no manual. Operates very well. S Dogger VK2KSD QTHR AH Phone 02 6677 9292
- MAST ex-DCA triangular self-supporting 6' sections 36' and 5 element tri-band beam (10-15-20). Located NW Sydney. You dismantle. \$400 Bob VK2CAN Phone 02 9416 3727
- WARBIRD DISPLAYS: Rx's, Tx's, modulators, racks, mounts, remotes, some complete COMMAND setups as used in WWII operations. Brian, VK2GCE, Phone 02 9545 2650 or [preferred] brianclarke@idx.com.au

- On behalf of the Wagga Amateur Radio Club: YAESU FT-747 HF radio c/w mic, manual and is boxed \$600.00 ono. YAESU FT-1012 HF radio c/w desk mic \$300.00 ono. YAESU FT-840 HF radio (no FM) c/w mic \$850.00 ono. FT-757GX HF radio c/w mic, manual and FRB-757 relay \$450.00 ono. FL-7000 solid state HF amplifier (600w out) \$2000.00 ono. For more details contact: John vk2yw@wia.org.au or Michael vk3tdv@bigpond.com

WANTED NSW

- AMERITRON mobile linear amp. solid state, Model ALS-500MX. Must be in GWO. John VK2JJS QTHR, Phone 02 9498 2248
- Handbook for YAESU HT FT-209RH and IC SN76488 for audio project. VK2IGS, e-mail igray@nor.com.au
- SUB MINIATURE VALVES: EL70 (or EL71), 6021, 6111, 5718. Will consider equivalents or near equivalents. Contact Pat Brennan VK2ABE, PO Box 158, Tamworth NSW 2340
- A-510 parts: instruction plate, counter-poise and earth-spike, feeder for dipole. Can exchange complete and part radios. Brian, VK2GCE, Phone 02 9545 2650 or [preferred] brianclarke@idx.com.au
- Shack tidy up: I have too many 19" rack mounted pieces of radio gear on the floor that need to be in a rack. If you have a rack that's too big, I could swap a smaller one. What I need is one about 4'-6" tall, 20" deep; the one to swap is 3'-6" tall and 30" deep with removable front, rear and side cover panels in brown/black with cream edges and castors. Brian, VK2GCE, QTHR, Phone 02 9545 2650 or [preferred] brianclarke@idx.com.au
- Desperately wanted by the Blue Mountains Amateur Radio Club: A copy of a service manual for an STC MTR-10 UHF transceiver. If anyone can help please contact Adrian Clout VK2BFN, Phone 02 4758 6797 or 0408 604 366. PS Just a circuit diagram would be extremely helpful

FOR SALE VIC:

- WARBIRD DISPLAYS: Rx's, Tx's, modulators, racks, mounts, remotes, some complete COMMAND and RADAR setups as used in WWII operations. Bill, VK3AQB or jikajika@net2000.com.au
- ICOM IC-745 transceiver, serial no 02053, good order except notch not working, complete with FM board, narrow CW filter and service manual. All WARC HF bands \$600 ono. NOISE BRIDGE OMEGA TE7-02 \$30. EA/DSE 50 W 70 cm amplifier kit unassembled \$100. EA/DSE 100 W 6 m amplifier kit \$100. R Champness VK3UG, 6 Mundoona Court, Mooroopna Vic 3629

WANTED QLD

- 70 centimetre pre-amplifier Bernie VK4OZ QTHR Phone 07 5532 4078, email VK4OZ@austarnet.com.au.
- Transformer 3-4kV @ 1 amp and SK500 or SK510 valve base. Stuart VK4KKG, Phone 07 4972 9871,

FOR SALE WA

- ELECRAFT K2 HF transceiver, 160m to 10m with SSB and Noise Blanker options. Professionally constructed from the kit and only a few weeks old. Meets full specifications and in immaculate condition. Genuine reason for sale, \$1700. Phil. VK6APH Phone 08 9245 2973, e-mail philh@ddd.com

WANTED WA

- MULTIBAND VERTICAL ANTENNA, ideally covering 40 - 10m. Phil VK6APH Phone 08 9245 2973 e-mail philh@ddd.com

FOR SALE TAS

- KENWOOD TS-120S HF transceiver \$250. Kenwood TS-130 HF \$400. KENWOOD MC-50 base Mic \$50. All in GC. Offers pondered. David VK7ZDJ Phone 03 6425 2030. Mobile 0413 219 680
- LINEAR parts suitable for 400 W. Two 813's and bases, tank and loading capacitors, tank coils, band switches. Filament, plate and RF chokes. Trevor VK7TS QTHR, Phone 03 6272 0159, tspargo@netspace.net.au.

**"Hey, Old
Timer..."**

If you have been licensed for more than 25 years you are invited to join the

**Radio Amateurs Old
Timers Club Australia**

or if you have been licensed for less than 25 but more than ten years, you are invited to become an Associate Member of the RAOTC. In either case a \$2.50 joining fee plus \$8.00 for one year or \$15.00 for two years gets you two interesting OTN Journals a year plus good fellowship.

Write to

RAOTC,
3/237 Bluff Road
Sandringham Vic 3191

or call Arthur VK3VQ on 03 9598 4262 or Allan VK3AMD on 03 9570 4610, for an application form.



• APOLLO Base Station Deluxe Model AP808 SN: 204 00 187, 13.8 V – 240 V. PA & Recording inputs \$200.00 ONO. UNIDEN Base Station Model 810E SN: 150 00 168 VGC \$200.00 ONO, GME ELECTROPHONE VHF Marine Radio Model: GX548 SN: 807 12 58 1-25 W remote output. Current Model VGC \$240.00 ONO. L30969. Ph Fax Trevor or David 07 4780 4732

MISCELLANEOUS

• The WIA QSL Collection (now Federal) requires QSLs. All types welcome, especially rare DX pictorial cards, special issue. Please contact the Hon Curator, Ken Matchett VK3TL, 4 Sunrise Hill Road, Montrose Vic 3765, tel. (03) 9728 5350

Email your hamad
Then we just cut and paste.
You proof it, you retain control.

<http://www.hamsearch.com>
a not-for-profit site that is a search engine for hams

TRADE ADS

PSK-31, SSTV, RTTY SOUNDBOARD INTERFACES

Fully isolated, ready to plug in.
<http://www.G3LIV.CO.UK>,
johnny@melvin.com, G3LIV QTHR.

AMIDON FERROMAGNETIC CORES:

For all RF applications. Send business size SASE for data/price to RJ & US Imports, PO Box 431, Kiama NSW 2533 (no enquiries at office please. 14 Boanyo Ave Kiama). www.catchnet.com.au/~rjandusimports

Agencies at: Active Electronics Tas; Truscotts Electronic World, Melbourne; TTS Systems, Tyabb; Tower Communications, Perth; Haven Electronics, Nowra.

HF, VHF, UHF ANTENNAS & ACCESSORIES

Alum towers, guys etc. Diamond VSWR/PWR meters. HD copper ant wire & insulators. TX tubes & pwr transistors. Quality coax cables & connectors. Free advice & catalogue. ATN Antennas Ph 03 5492 2224 Fax 03 5492 2666, email atnant@ruralnet.net.au

PLEASE BE KIND TO OSCAR

Meet Mr Oscar Goldenboy, our Hamad typist

Oscar is not an expert in your field — he thinks Megahertz is what happens when he stubs his toe on a rock.

To help Oscar, please write your hamad legibly, using both capitals and lower case, and use legitimate abbreviations.

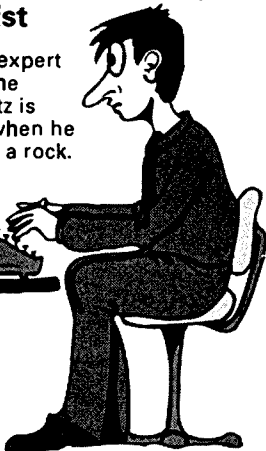

This will reduce the chance of errors being published, which inconveniences everyone.

ADVERTISERS INDEX

Andrews	16
Com-an-tena.....	24
Elektron.....	33
G & C Communications.....	27
Icom.....	OBC
Strictly Ham.....	8
Tower Communications	10
WIA Call Book.....	IFC

PLAN AHEAD

**Remembrance Day Contest
17 & 18 August 2002**

**ALARAMEET
October 5 & 6, 2002,
Murray Bridge, South Australia**

**JOTA and JOTI
October 19 & 20, 2002**

Sunspot Numbers

Monthly average Mar 2002: 98.1

Smoothed Sunspot Number Sep 2001: 114.1

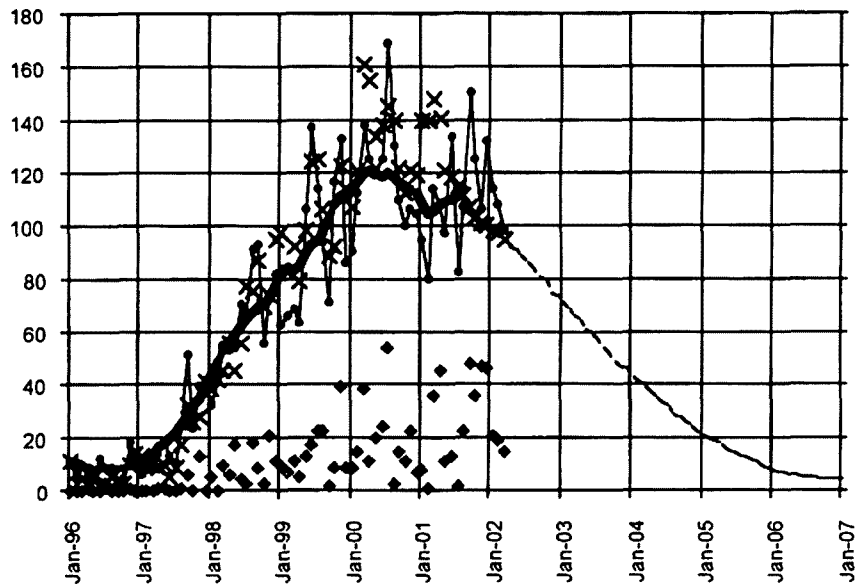

◆ Flares > M1 X T index — SSN
 - - - - - Prediction —●— Sunspot Number Current Cycle: 23

Drawn from monthly data provided by the Ionospheric Prediction Service

TRADE PRACTICES ACT

It is impossible for us to ensure that the advertisements submitted for publication comply with the Trade Practices Act 1974. Therefore, advertisers and advertising agents will appreciate the absolute need for themselves to ensure that the provisions of the Act are strictly complied with.

VICTORIAN CONSUMER AFFAIRS ACT

All advertisers are advised that advertisements containing only a PO Box number as the address cannot be accepted without the addition of the business address of the box-holder or seller of the goods.



Division Directory

The Amateur Radio Service exists for the purpose of self training, intercommunication and technical investigation. It is carried out by amateurs who are duly authorised people interested in radio technique solely with a personal aim and without pecuniary interest.

The Wireless Institute of Australia represents the interests of all radio amateurs throughout Australia. National representation is handled by the executive office under council direction. There is one councillor for each of the seven Divisions. This directory lists all the Divisional offices, broadcast schedules and subscription rates. All enquiries should be directed to your local Division.

Broadcast schedules All frequencies MHz. All times are local.

VK1 Division Australian Capital Territory,
GPO Box 600, Canberra ACT 2601
President Gilbert Hughes
Secretary Peter Kloppenburg
Treasurer Linden S Orr

VK1GH
VK1CPK
VK1LSO

VK1WI: 3.590 LSB, 146.950 FM each Thursday evening from 8.00pm local time. The broadcast text is available on packet, on Internet aus.radio.amateur.misc news group, and on the VK1 Home Page <http://www.vk1.wia.ampr.org>
Annual Membership Fees. Full \$80.00 Pensioner or student \$71.00. Without *Amateur Radio* \$48.00

VK2 Division New South Wales
109 Wigram St, Parramatta NSW
(PO Box 432, Harris Park, 2150)
(Office hours Mon-Fri 1100-1400)
Phone 02 9689 2417
Web: <http://www.ozemail.com.au/~vk2wi>
Freecall 1800 817 644
e-mail: vk2wi@ozemail.com.au
Fax 02 9633 1525

President Terry Davies
Secretary Pat Leeper
Treasurer Chris Minahan

VK2KDK
VK2JPA
VK2EJ

From VK2WI 1.845, 3.595, 7.146*, 10.125, 14.160, 24.950, 28.320, 29.120, 52.120, 52.525, 144.150, 147.000, 438.525, 1281.750 (* morning only) with relays to some of 18.120, 21.170, 584.750 ATV sound. Many country regions relay on 2 m or 70 cm repeaters. Sunday at 1000 and 1930. Highlights included in VK2AWX Newcastle news, Monday 1930 on 3.593 plus 10 m, 2 m, 70 cm, 23 cm. The broadcast text is available on the Internet newsgroup aus.radio.amateur.misc, and on packet radio.
Annual Membership Fees. Full \$80.00 Pensioner or student \$63.00. Without *Amateur Radio* \$50.00

VK3 Division Victoria
40G Victory Boulevard Ashburton VIC 3147
(Office hours Tue 10.00 -2.30)
Phone 03 9885 9261
Web: <http://www.wiavic.org.au>
Fax 03 9885 9298
e-mail: wiavic@wiavic.org.au

President Jim Linton
Secretary John Brown
Treasurer Barry Wilton

VK3PC
VK3JJB
VK3XV

VK3BWI broadcasts on the 1st Sunday of the month at 20.00hrs Primary frequencies, 3.615 DSB, 7.085 LSB, and FM(R)s VK3RML 146.700, VK3RMM 147.250, VK3RWG 147.225, and 70 cm FM(R)s VK3ROU 438.225, and VK3RMU 438.075. Major news under call VK3ZWI on Victorian packet BBS and WIA VIC Web Site.
Annual Membership Fees. Full \$83.00 Pensioner or student \$67.00. Without *Amateur Radio* \$51.00

VK4 Division Queensland
PO Box 199, Wavell Heights, Old. 4012
Phone 07 3221 9377
e-mail: office@wiaq.powenip.com.au
Fax 07 3266 4929
Web: <http://www.wia.org.au/vk4>

President Ewan McLeod
Secretary Bob Cumming
Treasurer Bill McDermott

VK4ERM
VK4YBN
VK4AZM

VK4WIA broadcasts on 1.825 MHz SSB, 3.605 MHz SSB, 7.116 MHz SSB, 10.135 MHz SSB, 14.342 MHz SSB, 21.175 MHz SSB, 28.400 MHz SSB, 29.660 MHz FM (rptr), 147.000 MHz, and 438.525 MHz (in the Brisbane region, and on regional VHF/UHF repeaters) at 0900 hrs K every Sunday morning. QNEWS is repeated Monday evenings, at 19.30 hrs K, on 3.605 MHz SSB and 147.000 MHz FM. On Sunday evenings, at 18.45 hrs K on 3.605SSB and 147.000 FM, a repeat of the previous week's edition of QNEWS is broadcast. Broadcast news in text form on packet is available under WIAQ@VKNET. QNEWS Text and real audio files available from the web site
Annual Membership Fees. Full \$95.00 Pensioner or student \$81.00. Without *Amateur Radio* \$69.00

VK5 Division South Australia and Northern Territory
(GPO Box 1234 Adelaide SA 5001)
Phone 0403 368 066
web: <http://www.sant.wia.org.au>
email: peter.reichelt@bigpond.com

President David Minchin
Secretary Peter Reichelt
Treasurer Trevor Quick

VK5KK
VK5APR
VK5ATQ

VK5WI: 1843 kHz AM, 3.550 MHz LSB, 7.095 AM, 14.175 USB, 28.470 USB, 53.100 FM, 147.000 FM Adelaide, 146.800 FM Mildura, 146.900 FM South East, 146.925 FM Central North, 438.475 FM Adelaide North, ATV Ch 35 579.250 Adelaide. (NT) 3.555 USB, 7.065 USB, 10.125 USB, 146.700 FM, 0900 hrs Sunday. The repeat of the broadcast occurs Monday Nights at 1930hrs on 3585kHz and 146.675 MHz FM. The broadcast is available in 'Realaudio' format from the website at www.sant.wia.org.au Broadcast Page area.
Annual Membership Fees. Full \$88.00 Pensioner or student \$73.00. Without *Amateur Radio* \$58.00

VK6 Division Western Australia
PO Box 10 West Perth WA 6872
Phone 08 9351 8873
Web: <http://www.vk6wia.org>
e-mail: vk6wia@iinet.net.au

President Neil Penfold
Secretary Christine Bastin
Treasurer Bruce Hedland-Thomas

VK6NE
VK6ZLZ
VK6OO

VK6WIA: 146.700 FM(R) Perth at 0930hrs Sunday relayed on 1.865, 3.564, 7.075, 10.125, 14.116, 14.175, 21.185, 29.120 FM, 50.150 and 438.525 MHz, Country relays 3.582, 147.200 (R) Cataby, 147.350 (R) Busselton, 146.900 (R) Mt William (Bunbury), 147.000 (R) Katanning and 147.250 (R) Mt Saddleback. Broadcast repeated on 146.700 at 1900 hrs Sunday relayed on 1.865, 3.564 and 438.525 MHz : country relays on 146.900, 147.000, 147.200, 147.250 and 147.350 MHz..Also in "Real Audio" format from the VK6 WIA website
Annual Membership Fees. Full \$71.00 Pensioner or student \$65.00. Without *Amateur Radio* \$39.00

VK7 Division Tasmania
PO Box 371 Hobart TAS 7001
Phone 03 6234 3553 (BH)
Web: <http://www.tased.edu.au/tasonline/vk7wia>
also through <http://www.wis.org.au/vk7>
email: batesjw@netspace.net.au

President Mike Jenner
Secretary John Bates
Treasurer John Bates

VK7FB
VK7RT
VK7RT

VK7WI: 146.700 MHz FM (VK7RHT) at 0930 hrs Sunday relayed on 147.000 (VK7RAA), 146.725 (VK7RNE), 146.625 (VK7RMD), 3.570, 7.090, 14.130, 52.100, 144.150 (Hobart), repeated Tues 3.590 at 1930 hrs.
Annual Membership Fees. Full \$90.00 Pensioner or student \$77.00. Without *Amateur Radio* \$57.00

VK8 Northern Territory (part of the VK5 Division and relays broadcasts from VK5 as shown, received on 14 or 28 MHz).

Wyong Field Day



Photos: 1, 2, and 3 Flea market. 4, QSL Bureau. 5, Emtronics trader. 6, Explaining trader. 7, Foxhunting in dumpster. Photography by Jim Linton VK3PC

ICOM'S GREAT CHAMPIONS



IC-756PROII **NEW!**

Sharp & soft IF filter shape · Improved 3rd IMD & wide dynamic range
 · One-touch record/play · Digital voice memory · Extended 1/4 Tuning step & BPF functions for SSB-D mode · 32-bit floating-point DSP and 24-bit AD/DA converter · SSB/CW synchronous tuning · 4.9-inch color TFT LCD



ic-718 **A compact HF all band transceiver.**

A superior performer with simple, straightforward operation with keypad. Optional AF DSP capabilities, including noise reduction & auto notch function. It's versatile, compact & loaded with features.



ic-910H **The new dimension in the VHF/UHF world!**

Tri band multimode transceiver · 2M-100W, 70CM - 75W, (optional 23CM, 10W) · 9600bps packet operation.
 · Satellite communication · Reverse/normal tracking doppler shift compensation · CIV capability for PC control



IC-706MKIIG **HF · VHF · UHF** **The amazing evolution of the legendary 706.**

Now includes 70cm @ 20W and 50W on 2m. · Standard feature dsp · Built in sub tone encoder & decoder · Tone scan · Mosfet PA · You get base station performance and features in a mobile rig sized package.



IC-T81A **A remarkably compact quad bander**

VHF/UHF Multiband FM · 2M, 6M, 70CM, 23CM · 124 alphanumeric memory channels · Ni-MH battery
 Tone squelch · Sub tone encoder & decoder that can be independently set · Plus dtmf encoder · Tone scan.

ICOM
 Clearly Ahead

See your nearest Icom dealer or visit our website at www.icom.net.au

2 YR WARRANTY

June 2002
Volume 70 No 6



Amateur Radio

\$ 5.95

Free
with this issue



A few drops of
Homebrew



ALARAMEET

2002

Murray Bridge South Australia 5 & 6 October



The Sunday 40-Metre
CW Net Reaches 1500
Sessions

An **HF** Receiving
Converter

WIA FEDERAL CONVENTION 2002



Peter Parker VK3YE demonstrates a 9 metre collapsible mast (more pictures inside back cover)

ISSN 0002-6859



9 770002 685062 06

Will your station meet **EMR** requirements?



Australian
Amateur Radio

Callbook
2002

Every
shack
should
have one



The "Call Book 2002" is available from
your State Division
Order now to get the member discount

VK1 Division

GPO Box 600, Canberra ACT. 2601

VK2 Division

109 Wigram St, Parramatta NSW
(PO Box 432, Harris Park, 2150)
(Office hours Mon-Fri 1100-1400)
Phone 02 9689 2417
<http://www.ozemail.com.au/~vk2wi>
Freecall 1800 817 644
e-mail: vk2wi@ozemail.com.au

VK3 Division

40G Victory Boulevard
Ashburton VIC 3147
(Office hours Tue 10.00 - 2.30)
Phone 03 9885 9261
<http://www.wiavic.org.au>
Fax 03 9885 9298
e-mail: wiavic@wiavic.org.au

VK4 Division Queensland
PO Box 199, Wavell Heights, Old. 4012
Phone 07 3221 9377 Fax 07 3266 4929
e-mail: office@wiaq.powerup.com.au

VK5 Division (and VK8)

(GPO Box 1234 Adelaide SA 5001)
Phone 0403 368 066
: <http://www.sant.wia.org.au>
email: peter.reichelt@bigpond.com

VK6 Division

PO Box 10 West Perth WA 6872
Phone 08 9351 8873
Web: <http://www.vk6wia.org>
e-mail: vk6wia@inet.net.au

VK7 Division

PO Box 371 Hobart TAS 7001
Phone 03 6234 3553 (BH)
<http://www.tased.edu.au/tasonline/vk7wia>
email: batesjw@netspace.net.au

COMMERCIAL RESELLERS

Please contact June Fox (WIA Federal) on 03 9528 5962



Amateur Radio

The Journal of the Wireless
Institute of Australia
ISSN 0002-6859

Editorial

Editor: Colwyn Low VK5UE
edarmag@chariot.net.au

Technical Editor: Peter Gibson VK3AZL

Publications Committee Members
Ron Fisher VK3OM
Don Jackson VK3DBB
Evan Jarman VK3ANI
Bill Rice VK3ABP
Gil Sones VK3AUI
Bill Roper VK3BR

Advertising

Mrs June Fox,
Tel: (03) 9528 5962

Hamads

"Hamads" Newsletters Unlimited
PO Box 431, Monbulk Vic 3793
Fax: 03 9756 7031
e-mail: newsletters@ozemail.com.au

Office

10/229 Balaclava Road
Caulfield, Victoria
Telephone (03) 9528 5962
Facsimile (03) 9523 8191

Business Hours 9:30am to 3:00pm weekdays

Postal

The Editor AR
34 Hawker Crescent
Elizabeth East
South Australia 5112
Email edarmag@chariot.net.au

Production

Newsletters Unlimited 03 9756 7797

Printer

Streamline Press, Melbourne (03) 9417 2766

Postal Service

IMS (03) 9291 5888

Production Deadlines

Advertising booking and articles for
publication 10th of preceding month.

Hamads and advertising material deadline
18th day of preceding month

The contents of Amateur Radio are Copyright
Wireless Institute of Australia © 2002

General

WIA Federal Convention (WIA Comment)	3
Will your station meet EMR requirements?	4
<i>Jim Linton VK3PC</i>	
The Sunday 40-metre CW net reaches 1500 sessions	14
<i>Drew Diamond VK3XU</i>	
W.I.A. DXCC LIST (February 2002)	17
Women In Radio. Two women involved with radio in two different ways	22
<i>Amateur Radio Survey</i>	29

Technical

An HF Receiving Converter	6
<i>Drew Diamond, VK3XU</i>	
A Few Drops of Home Brew	10
<i>Max Riley VK2ARZ</i>	
Permeability Tuning For Simple AM Radios (Technical Abstracts)	26
<i>Gil Sones VK3AUI</i>	
Digital pF Meter (Technical Abstracts)	26
<i>Gil Sones VK3AUI</i>	
Lightning Detector (Technical Abstracts)	27
<i>Gil Sones VK3AUI</i>	

Columns

Advertisers' Index	55	Hamads	54
ALARA	20	Ham Shack Computers	39
AMSAT	34	HF Predictions	48
Beyond Our Shores	24	How's DX?	36
Contests	41	Over to you	53
Club Notes	23	Silent Key	2, 38
WIA Division News		Spotlight on SWLing	51
VK1 Notes	31	Technical Abstracts	26,27,28
VK3 Notes	31	VHF/UHF - An Expanding World	50
VK4 Notes	33	WIA Comment	3
VK7 Notes	33	WIA Division Directory	56
Editor's Comment	2	WIA Federal Directory	2
Education Notes	46	Will's Page	47

Our cover this month

ALARAMEET 2002 to be held in Murray Bridge SA, on 5 & 6 October. The steamboat, Captain Proud is where some of the sessions will be held

Contributions to Amateur Radio

Amateur Radio is a forum for WIA members' amateur radio experiments, experiences opinions and news. Manuscripts with drawings and or photos are always welcome and will be considered for publication. Articles on disc or email are especially welcome. The WIA cannot be responsible for loss or damage to any material. A pamphlet, How to write for Amateur Radio is available from the Federal Office on receipt of a stamped self-addressed envelope.

Back Issues

Back issues are available directly from the WIA Federal Office (until stocks are exhausted), at \$4.00 each (including postage within Australia) to members.

Photostat copies

When back issues are no longer available, photocopies of articles are available to members at \$2.50 each (plus an additional \$2 for each additional issue in which the article appears).

Disclaimer

The opinions expressed in this publication do not necessarily reflect the official view of the WIA and the WIA cannot be held responsible for incorrect information published.

Amateur Radio Service

A radiocommunication service for the purpose of self-training, intercommunication and technical investigation carried out by amateurs; that is, by duly authorised persons interested in radio technique solely with a personal aim and without pecuniary interest.

Wireless Institute of Australia

The world's first and oldest
National Radio Society
Founded 1910

Representing

The Australian Amateur Radio Service

Member of the

International Amateur Radio Union

Registered Federal Office of the WIA

10/229 Balaclava Road
Caulfield North Vic 3181

Tel: (03) 9528 6962 Fax (03) 9523 8191
<http://www.wia.org.au>

All mail to
PO Box 2175 Caulfield Junction VIC 3161

Business hours: 9.30am-3pm weekdays

Federal Secretary

Peter Naish VK2BPN

Federal Office staff

June Fox Bookkeeper
Rita Trebilco VK3IF Examinations Officer

Council

President	Ernest Hocking	VK1LK
VK1 Federal Councillor	Gilbert Hughes	VK1GH
VK2 Federal Councillor	Barry White	VK2AAB
VK3 Federal Councillor	Jim Linton	VK3PC
VK4 Federal Councillor	David Jones	VK4OF
VK5 Federal Councillor	David Box	VK5OV
VK6 Federal Councillor	Will McGhie	VK6UU
VK7 Federal Councillor	Phil Corby	VK7ZAX

Executive

Brenda Edmonds
David Pilley
Don Wilschelski

VK3KT
VK2AYD
VK4BY

Federal Coordinators

AMSAT	Graham Ratcliff	VK5AGR
ARDF	Jack Bramham	VK3WWW
Awards	Mal Johnson	VK6LC
Contests	Ian Godsil	VK3VP
Education	Ron Smith	VK4AGS
FTAC	John Martin	VK3KWA
Historian	John Edmonds	VK3AFU
IARU	Neil Penfold	VK6NE
Intruder Watch	Harry Andersson	VK8HA
International	John Miller	VK3DJM
Travel Host		
ITU Conference and study group	Gilbert Hughes	VK1GH
OSL Manager (VK9, VK0)	Neil Penfold	VK6NE
Videotapes	VK2 Division	
Web	Joe Burford	VK5UJ
WICEN	John Weir	VK3ZR

ACA Liaison Team

Glen Dunstan VK4DU (Corresponding)
Gilbert Hughes VK1GH
Keith Malcolm VK1ZKM
Peter Naish VK2BPN

Canberra Liaison Officer Richard Jenkins

VK1RJ

Editorial Comment

Colwyn Low VK5UE

Enthusiasm is infectious!

I do tend to procrastinate a bit but this month even the adrenalin has not kicked in until the very, very last minute. I have been frustrated by all the other things in my life keeping me from doing just one or two little things with my Station. I have had the few moments now and then to sort out what I want to do but never the occasion to put them together. I suppose we all have these times.

The article in this issue on EMR has also provided food for thought. Does the end fed wire antenna, with its insulator 2 metres up and at the back of a garden bed meet the separation criteria? If I put the 80 metre loop round the block fence on transmit will it be high enough? Do I have to lift it to at least 5 metres? Can I assume nobody next door ever goes between their shed and the fence? Are they shielded in their tin shed? Lots of food for thought. The real challenge is not to give up.

We have had the federal convention and some change of coordinators. I hope now we can all work for the good of Amateur Radio in Australia and for all Australian Amateurs. There are too few of us to waste time on minor disagreements at the cost of major issues. I hope we can get more of the good will evident at the Convention working to make the WIA function as if it were an Australia wide body and not separate Divisions. The working party will need to sort out what we have to do together for the common good and what we have to do on a regional basis for our own specific benefit.

We need to do something to bring the community usefulness of Amateur

Radio skills more to the notice of the community. We need to make more people aware that Amateur Radio exists as a hobby almost anyone can participate in. We need to advertise when we are out on Field days, when we help with JOTA, when we are on WICEN exercises, when we help a community organisation with communications. Events like the Australian Rally Championships, which might not be viable without WICEN communication support, should be exploited to the full. We need to show that we as Amateur Radio Volunteers can provide a professional service and that this service is available in the case of Civil Emergency. So please make sure when you do help out that your vehicle or tent carries signage for WICEN and AMATEUR RADIO, maybe even a plug for your local Radio Club.

While on that topic we also have to adjust to the fact that what attracted the old guard to Amateur Radio before 1952 is not what will attract people to Amateur Radio in 2002. I still remember 1952 and the things I did but that was 50 years ago and Man has been to the Moon since then!

So keep active, work on new modes, have fun and remember enthusiasm is infectious.

Silent Key

It is with great sadness we record the passing of Kingsley VK5 AKN. His key will be missed. A full obituary will be published in July *Amateur Radio*

WIA Federal Convention

Deja Vu

The day after the 2002 AGM and Federal Convention I found myself in the WIA Federal Office in Caulfield. Browsing through old copies of AR I was delighted to come across a bound set of issues for 1979 and my eye was drawn to two articles in particular. The first was a reference by David Wardlaw, the then WIA Federal President, to the Arnold report and the decision not to implement the proposal to move towards a national organisation. The second was a thank you to members who had made donations towards the funding of WARC 1979. I think the office staff must have wondered just what I was thinking as a very large smile appeared on my face as I thought about the coincidence in light of the outcomes of this year's AGM.

The 2002 AGM

The 2002 AGM topped off a very busy year for the WIA. Although we did not complete everything that we had set out to achieve in 2001/2002 I believe that we met most of our stated aims and more importantly some other unplanned ones. I hope to be able to delivery to members a detailed report on the weekends discussion in the July issue of AR. In the meantime I would refer any member who wishes to find out more to the WIA Victoria web page www.wiavic.org.au which has an excellent summary of the weekend. From my perspective a number of agenda items warrant special mention.

WIA Structure

At this year's AGM the council agreed to establish a small working party to review the current structure and direction of the Institute. In the parlance of modern business this might well be referred to as developing a Strategic Plan. I am currently trying to recruit a small experienced team who can conduct this review. If you believe that you have the experience to assist in this please make contact with me. I am looking for individuals with experience of corporate

structure and knowledge of company law, as well as broader business experience.

AR

Just before the start of the AGM, I sat down with the directors and the publisher to review progress to date. Looking at the pilot results reveals that the decision to place AR onto the news-stands has been well received. The council were presented with future options including:

- stop the current pilot,
- extend the pilot for a further period of time, or
- move to a full Australia wide distribution.

I am pleased to report that the council in principle agreed to move to full distribution of AR throughout Australia subject to confirmation of the May take up.

Whilst on the matter of AR I would like to add my personal thanks to all of you who have taken the time to respond to the survey. For those of you who have included personal notes I will try and get back to you all as soon as practicable.

AR Editor

No small part of the recent success of AR is due the excellent work put in by our editor Colwyn Low. However I am sad to report that Colwyn will be unable to continue as editor beyond the end of this year. As a result I am looking for a willing volunteer to step into Colwyn's boots. You don't have to be a technical wizard, that's what our Publisher and technical editors do. However you do have to be good with words. If you have the time to devote to this task and would like to be able to influence the future



WIA President, Ernie Hocking

direction of amateur radio this is a great opportunity and I would be delighted to hear from you. I am sure that you will all join me in saying a very well deserved thank you to Colwyn for his sterling efforts.

Education and recruitment

We were lucky to have Ron Bertrand in attendance at the AGM as part of the VK4 contingent. Ron provided the council with an enlightening presentation on progress made in respect of the training of new amateurs. As a result of information provided we will be taking the message of the benefits of amateur radio to national and state education authorities over the ensuing months. If you have any contacts in the world of education then I would be delighted to hear from you. We need to sell the message about amateur radio more widely.

On a sadder note I have to report that our long serving education officer Brenda Edmonds was not re-elected this

continued on page 5

Will your station meet EMR requirements?

Jim Linton VK3PC

All radio amateurs will be required to know about new Electromagnetic Radiation (EMR) controls that are expected to be included in amateur station licence conditions from 1 July 2002.

The mandatory EMR controls, limiting the public's exposure to radio frequency radiation from amateur transmitters, already apply to other radio transmitters including mobile phones operating between 3kHz and 300GHz.

The standard being used by the Australian Communications Authority (ACA) is well below the level that is known to have adverse health effects on the human body, and in line with World Health Organisation recommendations.

The general public will become aware of the soon to be introduced EMR controls, through a series of newspaper advertisements placed by the (ACA), which are certain to put amateur stations in the spotlight.

The Wireless Institute of Australia (WIA) has been working with the ACA on the EMR regulatory framework over the past two years.

One of the WIA representatives involved in this project is Keith Malcolm VK1ZKM, has said it would have a minimal impact on the Amateur Service. Most stations will automatically comply with the requirements.

Keith VK1ZKM said, "The framework does not impose any new basic obligations on licensees to operate their transmitters safely in terms of human exposure to RF energy – but it will define requirements to evaluate and the ability to demonstrate compliance.

"In practice this means the identification of locations surrounding transmitting antennas where RF fields exceed the general public exposure guideline limit, and restriction of the access to such locations."

The ACA's framework is to apply only to protect the general public, he said, with radio amateurs defined as "aware users", meaning it does not deal with their exposure. Similarly, the radio

amateur is expected to control exposures of others in their household.

The framework does address the exposure requirements for neighbours and other members of the public, although again it is important to stress that the average amateur station will easily comply.

Compliance Requirements:

The proposed framework defines two levels of compliance action.

Compliance Level 1 - applies to transmitters that are covered by either of the following conditions:

- (a) The total average power fed to all antennas at the site must not exceed 100 watts and antennas must be out of reach
- (b) The bottom of the lowest antenna must be at least 10 metres above ground and the average EIRP does not exceed 3200 watts.

Compliance Level 2 - which requires measurements and documented proof of compliance, applies to all other transmitters.

EMR in licence conditions

It is proposed that the new regulatory framework, which will be reflected in the Licence Condition Determinations (LCDs) for the Amateur Service (and to all apparatus licences), will begin on 1 July 2002.

That means that amateur stations operated under new amateur licences issued on or after that date must comply with the framework. Existing licensees will have until 1 October 2002, to comply.

Keith VK1ZKM said at this time, the

precise wording of the EMR requirements to be included in the LCDs is unknown, because it is still being written. The WIA will continue liaising with the ACA during this process.

However, he said, the ACA through a series of EMR implementation workshops which the WIA attended along with other radio user groups, has made its final proposals well known.

Impact on the Amateur Service

The proposed regulatory framework will have minimal practical impact on the average amateur installation.

Because the compliance category is based on average transmitter power, radio amateurs operating in accordance with the power limits in the Amateur Licence Condition Determination for SSB (400 watt PEP) will easily meet the 100 watt criterion of Category 1 clause (a).

Unprocessed speech signals have a peak to average ratio in excess of 10 dB, so even if reasonable amounts of compression are employed, the average power at 400 W PEP will not exceed 100 watts.

Since the power criterion is based on power at the antenna feed-point, even the 120 watt mean power limit for continuous carrier modes (eg RTTY, AM, FM etc) will comply with the Category 1 clause (a) criterion, when feed-line losses are taken into account in a typical installation.

Compliance with the Category 1 clause (a) criteria then needs only a practical determination of what constitutes "out of reach" for the antenna installation.

This is something of a subjective assessment matter and a realistic determination will depend on the situation.

For a home installation, a simple guideline such as keeping the lowest point of an antenna at least 2 metres above head-height, or installing the antenna at least 2.8 metres from a property boundary or other location accessible to the general public, can be used.

Mobile installations affected too

For mobile installations, clearly such separation distances cannot be achieved, so the best that can be done is to install any antennas such as to minimise the possibility of accidental contact.

This means that centre of roof or centre of boot mountings will be preferred and that "gutter-grip" installations should be avoided.

The mobile amateur station operator transmitting while stationary should be alert to EMR exposure from the antenna to others. It is understood that emergency services are proposing to fix warning stickers to antennas on mobile vehicles.

Operators of beacon or repeater installations that can transmit simultaneously on multiple frequencies will need to determine if their installations comply with either of the Category 1 clause (a) or Category 1 clause (b) criteria.

Even though the licensees of stations

that comply with Compliance Category 1 are not required to undertake an assessment of compliance nor to keep records, it would be wise to make a formal note in the station log, to record output power levels achievable on each operating band. Such a record would serve to justify treating the installation as Category 1.

Very high gain antennas

Operators of specialist stations such as EME or weak-signal tropo-scatter installations that use very high gain antennas may wish to check the field levels around their antenna using either the ACA's self-assessment materials or other methods as defined in AS2772.2 even though they comply with the Category 1 compliance criteria.

Operators using high-power permits or operators of beacon or repeater stations that do not comply with the Category 1 criteria will need to undertake a formal assessment of compliance and keep the records of that assessment.

This assessment can be undertaken using the self-assessment materials compiled by the ACA or by use of any other method of modelling or calculation that can be derived from the methods described in AS2772.2.

The self-assessment materials are available from the ACA web site at <http://www.aca.gov.au/standards/emr/amateur.rtf>.

www.aca.gov.au/standards/emr/amateur.rtf. These materials are based on the exposure guidelines in the ACA standard and provide a conservative (ie errs on the safe side) estimate of minimum separation distances.

Information about the new ARPANSA standard can be found on the ARPANSA WWW site at <http://www.arpansa.gov.au>

Reference Documents

At present there are two sources of reference material that define acceptable levels of general public exposure to RF energy. One of these is the ACA's *Radiocommunications (Electromagnetic Radiation - Human Exposure) Standard* that is derived from the former Australian Standard AS2772.1 (Int)-1998. The second is the recently released ARPANSA standard *Radiation Protection Standard - Maximum exposure levels to radiofrequency fields - 3kHz to 300GHz*. Although there are differences in detail between the practical compliance limits in each standard, they are both derived from the same underlying exposure limit, so either can be used to demonstrate compliance. An additional document, AS2772.2, defines measurement methods and means of determination of compliance with RF exposure limits.

ar

WIA Comment continued

year. Brenda has been in the role of education officer for some 21 years and has performed an excellent job during this time. I am sure that you will all join me in thanking her for her dedicated efforts over such a long period.

Foundation Licence

It is hard to talk about education and recruitment of amateurs these days without reference to the so called "foundation licence". During the weekend we spent a significant amount of time addressing this issues. After much debate it was agreed to approach the ACA to try and progress the matter on the basis of a simple to gain entry qualification

WRC funds

With 2003 fast approaching the matter of funding the WIA delegates to the World Radio Conference was discussed. We have been preparing for this major event for a few years. Amongst the more important aspects of preparation is the matter of funding the WIA delegation. Budgeting in previous years means that we now have almost enough money set aside to just meet the expected costs of sending the delegation. As such it was decided not to impose any further financial levies at this time but rather ask members for donations to cover any further costs of WRC and other international representations. If you are able to make a small donation to help

out in this respect then it will certainly make the funding of this expensive but very important activity simpler for our treasurer.

I will bring this issue of my notes to a close and wish you all 73s. I look forward to hearing your views on any amateur radio related matters and hopefully circumstances will permit me to meet with many more of you over the next 12 months.

Ernest Hocking VK1LK
email: president@wia.org.au

**"Give me a place to stand,
and I will move the Earth"**

Archimedes (ca. 235 bc)
Concerning levers

An HF Receiving Converter

Drew Diamond, VK3XU
45 Gatters Rd.,
WONGA PARK 3115

As promised in a recent article about construction of a 1.8 - 2 MHz receiver (Ref. 1), here are details of the companion converter, necessary to obtain access to our most popular HF bands. Although intended for use with a 'tuneable I.F.' of 1.8 to (about) 2 MHz, the converter may be applied to any other desired I.F. For instance, you may have a receiver which has quite acceptable band-spread, selectivity, image rejection and sensitivity at (say) 2, 3, or 4 MHz, but has increasingly poor performance above (typically) 10 MHz. Some of the lovely old 'boat-anchors' are very much in this category. By using an HF converter, the receiver's essential characteristics at 3 MHz are retained on every desired HF band.

A 3 MHz first I.F. is a good choice in terms of conversion crystal economy, because cheap, off-the-shelf computer crystals are available at 4 MHz (to give access to 7 MHz), an 11 MHz crystal gives access to 14 MHz, a 15 MHz crystal gives access to 18 MHz, and an 18 MHz crystal gives us 21 MHz.

Circuit

In order to obtain satisfactory rejection of image and 'alias' frequencies, it was found necessary to use a three-resonator band-pass filter (Refs. 2 and 3) for each desired band. The usual Butterworth circuit has been re-arranged here to the pi configuration, where two of the coils are effectively in series with the input, thus offering greater attenuation to unwanted HF and VHF signals. Worst case image rejection (signal f minus twice the I.F. = 17.4 MHz) occurs on 21 MHz, where the figure is -45 dB.

Although seldom required, a simple pot style attenuator is fitted at the input. Sensitivity is improved by the inclusion of a prudent amount of RF gain- about 10 dB, supplied by a single 2N3053 (or similar) bipolar transistor Q1 in a conventional 'strong' broadband class A amplifier. Sensitivity of the prototype is better than 0.1 microvolt for 10 dB Signal + Noise : Noise, which typically represents the smallest readable HF signal in a quiet location.

A CMOS switch mixer is again used here, it being is one of the 'strongest' HF mixers build-able with ordinary electronics parts (Ref. 4). Ideally, the output of the CMOS mixer (as with any 'commutated' type mixer) should look into 50 ohms resistive for all frequencies present at the mixer's output (not just the expected 'sum and difference' products), which job is normally done with a

diplexer. It was found that a simple diplexer, a tank comprised of a 4.1 microHenry coil and 1.8 nF capacitor, tuned to the wanted IF frequency (1.8 MHz), and a series 51 ohm 'dump' resistor (where all the unwanted energy is absorbed) does the job rather well. For I.F.'s other than 1.8 MHz, it will be necessary to change the diplexer values. Their reactance should each be 50 ohms. At 3 MHz for example, the coil will need to be 2.7 microHenries (18 turns #26 B&S, T50-2 toroid- or a stock RF choke), and the capacitor should be 1 nF.

When fitted within the 1.8 MHz tuneable I.F., the resulting HF receiver is remarkably immune to strong unwanted signals, and performs very satisfactorily in a real environment.

For a first I.F. of 1.8 MHz, each conversion crystal must be 1.8 MHz lower than the required band, or conversely; $Xtal\ f = \text{desired } f \text{ minus } 1.8$, which gives 1.7 (for 3.5 MHz), 5.2 (7 MHz), 8.2 (10 MHz) 12.2 (14 MHz) and 19.2 (21 MHz). The MPF 102 FET crystal oscillator is capable of powering a wide range of crystal types and frequencies. The 180 degree out-of-phase signals necessary to drive the mixer are obtained using three gates of an ordinary 74HC04 HEX inverter chip.

Internal spur (birdie) production is kept down by the use of shielded wire or miniature coax for signal routing. Rather than use the existing supply rails, the converter is supplied from the receiver's unregulated supply (about 20 Vdc) through separate +6 and +12 V regulator chips, which results in few internal spurs, these being well below equivalent sub-microvolt level.

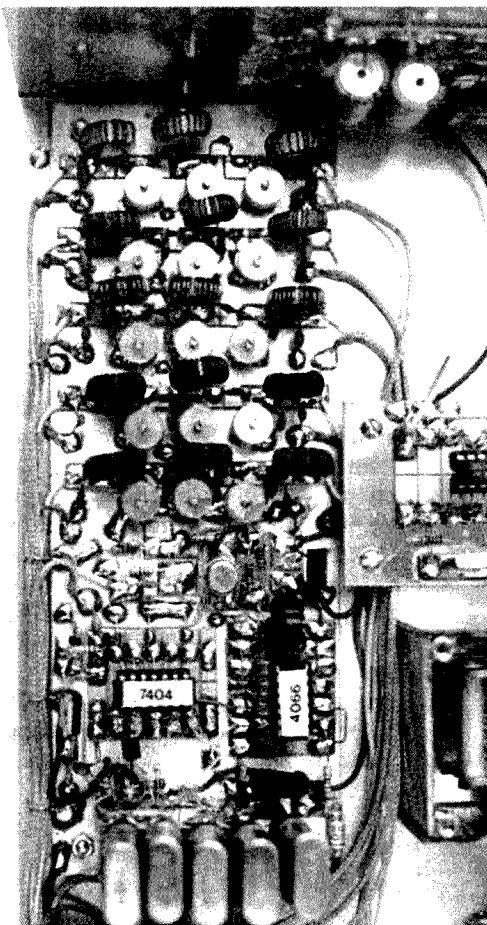

Photo 1. General view of layout

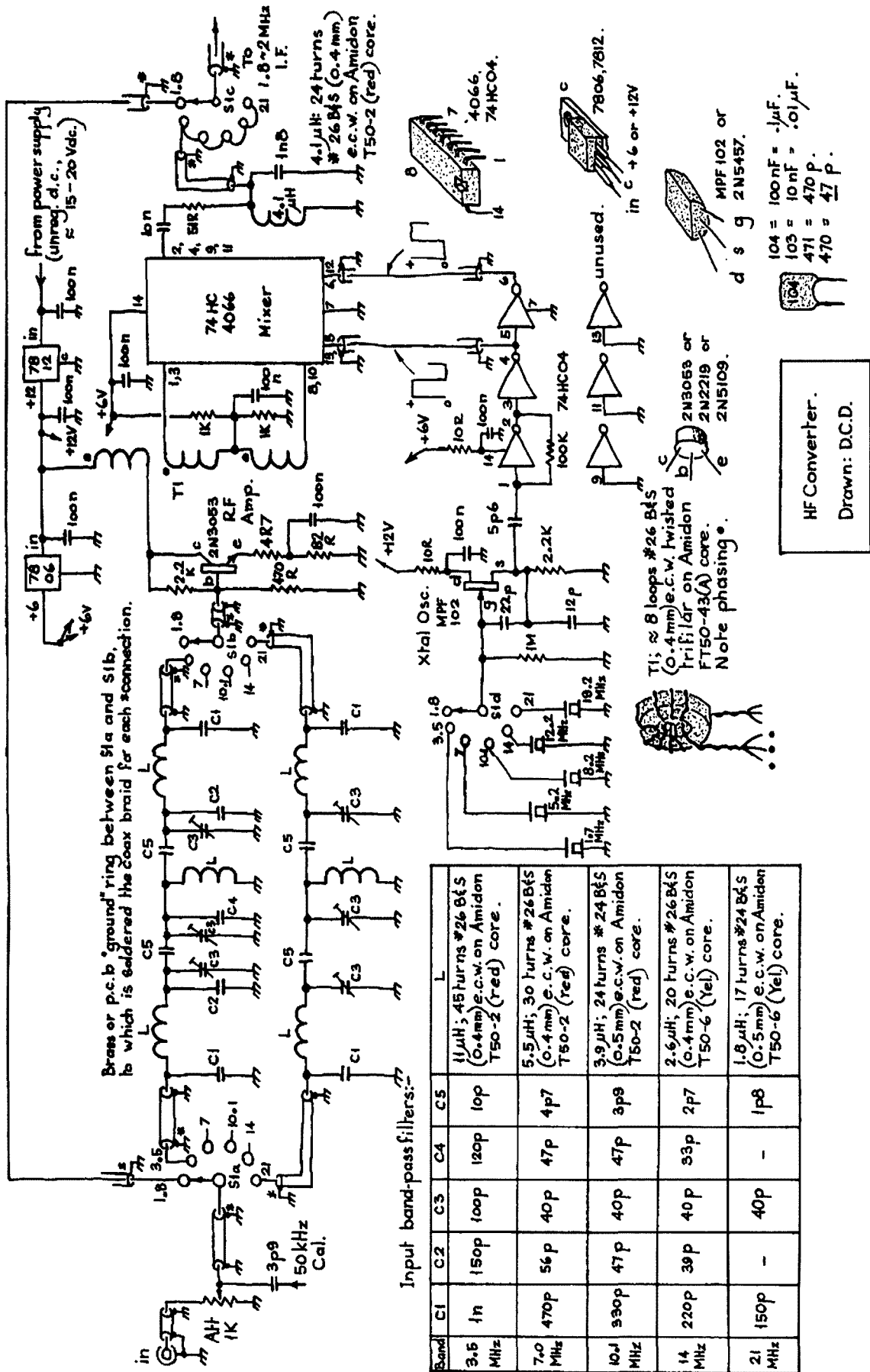

figure 1

STRICTLY HAM

PTY LTD



★ IC-746 PRO

- Icom **WORK THE WORLD** performance
- The best way to get onto HF plus 6 and 2 metres
 - Multifunction hi-res display
 - Direct frequency
 - Shack or portable



★ IC-756 PRO II

- Icom's new HF+50-MHz digital
The performance king Try it to see why
- Multi-colour multi-function screen



★ TH-D7A(G)

- Dual bander
- Effortless 2m & 70cm
- **BUILT IN PACKET**
- 200 alphanumeric memory channels
- 6W from 13.8VDC
- Comes with NiCd battery and charger
- APRS compatible



★ TS-2000

- High performance standards
- Three distinct operation platforms,
 - 1 Traditional transceiver-ful front panel,
 - 2 "Silver box" for mobile use
 - 3 The ARCP-2000 computer control
- 100 watts on HF, 6 metres and 2 metres, 50 watts on 70cm.

★ IC-706MKIIG

Ultra **SMALL**

167(W) x 58 (H) x 200 (D), 2.45kg
Detachable Control Panel/Display
(optional equipment required for remote operation)

SSB/AM/CW/RTTY Narrow Filter Options



★ TM-D700A

Kenwood's new TM-D700A makes the most of exciting SSTV, GPS, and APRS® (Automatic Packet/Position Reporting & rapidly gaining popularity worldwide).
Extra large amber and black display.
Built-in TNC offers a wide range of options, inc. simple packet operation using AX.25

Ham radio is truly entering a new era.



★ TS-50

Mount it in a vehicle, take it on a DX-pedition or use it as a permanent base station transceiver. The easy-to-use menu system adds flexibility, stable operation in any situation.

- DDS with fuzzy control
- 100 Memory channels
- Switchable AGC circuit (SLOW/FAST)
- IF shift Noise blanker (pulse)
- Dual VFOs (A & B)

Outstanding performance



14 CHURCH ST BAYSWATER VIC 3153

Phone (03) 9729 7656

email sales@strictlyham.com.au

Fax 903 9729 7422

www.strictlyham.com.au

Construction

A suggested layout is shown in Photo 1. The five input band-pass filters, CMOS mixer, crystal oscillator, driver and regulator chips are accommodated upon a plain printed circuit board measuring 75 X 195 mm. Layout is not especially critical, and just about any preferred construction method, such as 'dead-bug' should be satisfactory provided that all RF component connections are reasonably short. For the prototype I have used 'paddyboard' style (please see Ref. 5). The '4066 and 74HC04 chips are fitted into sockets, which in turn are attached with 1 mm tinned wires to suitably sized segmented substrates as described in Ref. 5. The circuit shows where 50 ohm miniature coax (or shielded wire- it is very close to 50 ohms, and adequate for short runs) is used for the inter-connections.

For band-changing, a 4-pole/6-position wafer switch is necessary. Like variable capacitors, wafer switches, suited to band-changing duty, are no longer (as far as is known) available from our usual suppliers. They are not rare however, and suitable items should be obtainable from ham-fests, or bartered from radio friends etc. It may be necessary to configure your switch from several individual wafers, as required. If you can arrange for 4-pole 8 or 10-position (as spares for expansion)- so much the better. A circle of sheet brass,

or double-sided circuit board should be interposed between wafers S1a and S1b as a shield, and also as a convenient anchor to which is soldered the coax braids (marked upon the circuit with an asterisk*), thus maintaining the continuity of the coax braid. If not done accordingly, problems may be encountered with excessive internal spur production.

The crystal oscillator components are fitted upon a small board measuring 30 X 45 mm, which is mounted vertically onto the converter board. The 'earthy' side of the five crystals may then be soldered between the top of the oscillator board and the their corresponding wafer switch tags. A suggested layout is pictured in the oblique view, Photo 2.

Tune-up

Inspect all wiring and component locations and confirm that everything is as it should be. Apply power, then measure the +12 and +6 Vdc supplies. If an oscilloscope is available, use a X10 probe and observe the square waveforms that drive the mixer (as shown on the circuit) which confirms that the crystal oscillator is working. Click the bandswitch around and check that all crystals will fire-up in turn. The same X10 probe may be used with a counter to check that the crystals are oscillating at or near their nominal frequency. No

'scope or counter? Listen for the crystal's signal on a general coverage or SW receiver by tuning to each crystal frequency (a portable SW receiver makes a handy tool in radio work).

Set the 1 k attenuator for minimum loss. Pre-set all band-pass filter trim caps to about half capacitance initially. If a signal generator is available, adjust the generator to deliver about 10 or 30 microvolts to the receiver's input (which may be reduced later during final tweaking). Otherwise, simply connect an antenna to the input. Starting at (say) 3.5 MHz, carefully align the three trim caps in the 3.5 MHz input band-pass filter for best sensitivity across the band. With this done, the receiver should sound quite lively. Do the same for the remaining bands fitted.

Parts

DSE, Jaycar, Electronic World and Altronics can supply most of the ordinary electronic components. My 40 pF trim caps and most other components were purchased from my local Jaycar. For good stability, the 12 pF and 22 pF capacitors in the oscillator should be NP0 ceramic types. All others (including coupling and bypass) may be monolithic or ordinary ceramic types. There are no known suppliers (to the hobbyist) of new wafer type band-change switches, but these are by no means rare parts. Ask your mates at the radio club- or look for suitable items at the next swap-meet. See Hamads in AR for your local Amidon supplier.

Bibliography

1. *A Practicable Superhet Receiver for 1.8 - 2 MHz*; Diamond, AR, May 02.
2. *The Double-Tuned Circuit: an Experimenter's Tutorial*; W. Hayward, W7ZOI, QST, Dec. '91.
3. *Extending the Double-Tuned Circuit to Three Resonators*; W. Hayward, W7ZOI, QEX, Mar/Apr '98.
4. *An Ultra-Low Distortion HF Switched FET Mixer*; E. Kushnick, RF Design, Sep. '92.
5. "Paddyboard" Circuit Construction"; Diamond, AR, Feb. '95.

ar

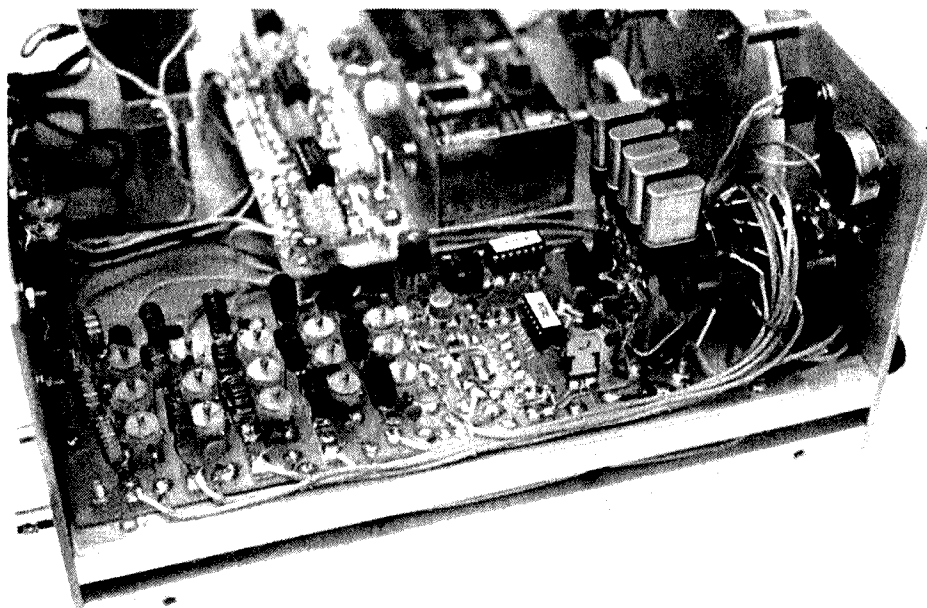

Photo 2. Oblique view showing crystal mounting and switch

A few drops of Home Brew

Drop one DC -91 Revisited

Max Riley VK2ARZ
6 Baringa Road
Mortdale Heights NSW 2223

The first project is a direct conversion receiver based on the DC-91 unit previously described by Drew Diamond (ref. 1). My version of this receiver has been modified to provide additional features and is shown in Photo 1.

These are:

1. A front-panel mounted antenna trimmer.
2. A 20 dB attenuator to assist in reception of very strong signals.
3. AVC applied to the RF amplifier stage.
4. A tuned AF amplifier to reduce the bandwidth on SSB reception and increase the overall gain of the receiver.
5. An active audio filter to provide

sharp selectivity on CW reception. 6, An "S" meter driven by the audio derived AVC.

7. A 100 kHz crystal calibrator.
8. Oscillator tuning bandsread from 3495 to 3705 kHz.

The Photo 2 shows the project during construction. The maze of wires at the top is the leads left long for testing during development. They were finally cut to length and bundled onto cables placed along the divider walls.

The board at the bottom is the DC-91 receiver board. The VFO is in the small shielded box in the centre and the L-shaped section at the top contains the tuned audio amplifier, active audio filter for CW reception and the 100kHz crystal calibrator (contained in the tub-shaped container). The slide switch and push button on the right of the front panel (top right in photo) control the last two units. The phone jack, antenna coaxial connector and attenuator are fitted to the rear panel. At this stage of construction AVC had not been included in the design and the S-meter had not been fitted to the front panel.

The balanced design of the receiver and the complete shielding between sections has resulted in zero radiation from the VFO. The braced construction has produced a unit, which is mechanically and electrically very stable. The power supply and the speaker are housed in a separate cabinet (right of photo). This ensured a VFO with very little frequency drift, as temperature rise within the cabinet is minimal. The space at the rear of the VFO will eventually contain a two-watt CW transmitter.

References and Further Reading.

1. DC-91 Receiver, AR 1991, Drew Diamond VK3XU.

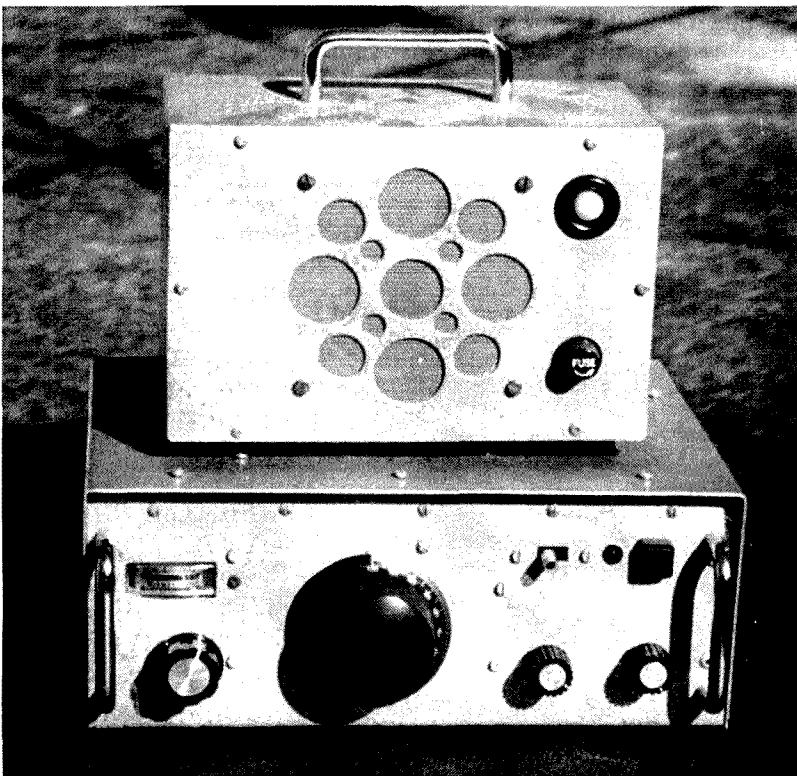

Photo 1. My DC91 with power supply and speaker unit

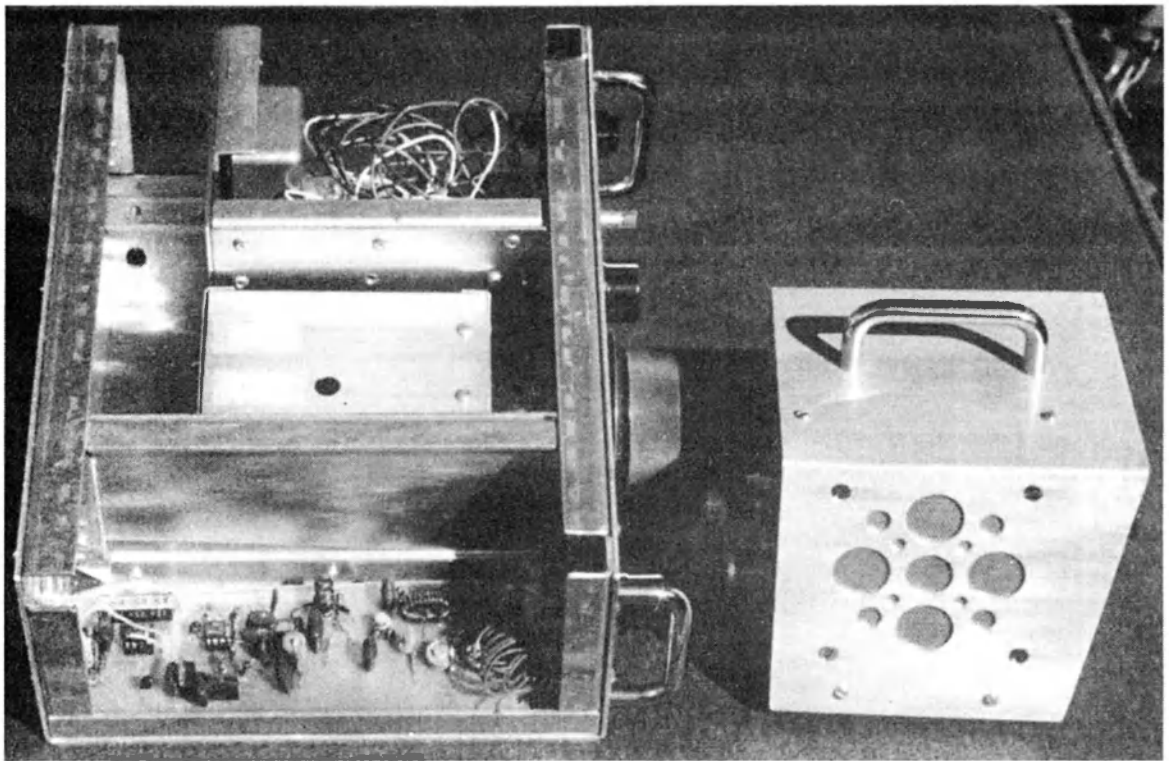

Photo 2. DC91 under construction with the audio output field strength meter on the right



Drop two

Field Strength Meter

The second unit is a sensitive, broadband field strength meter. This unit is based on two articles in QST magazine published 25 years apart, although actual construction did not start until 40 years after the first article was published.

This meter, shown in photo 3, is the one I use for most of my antenna work. The input contains a junction FET in a source follower circuit. Q1 serves only as an impedance transformation device. This permits the short sampling antenna to be matched to the input of the first RF amplifier Q2. Low impedance input is found at the source of Q1, as shown. I elected to use two RF amplifiers rather than one RF amplifier and one dc amplifier. There are no tuned circuits in my Field Strength meter, but if commercial signals interfere with your meter readings (depends on your location); you may add a band pass filter

or a tuned circuit between J1 and the pickup.

The circuit is shown in Figure 1. My unit can provide either visual output via the front panel meter, or loud speaker output from an audio VCO. Refer to the third "Drop". Both these outputs can be delivered remotely via front panel sockets. The switch between the two sockets selects the mode of operation. The level of the dc voltage developed from the amplified and detected signal is set by the potentiometer alongside the meter. This sensitivity control sets the threshold of the meter reading or the onset of the change in audio tone. I adjusted the components of the VCO so

that the audio tone was a low growl in the absence of any signal input. The tone increases in pitch with increased signal input. The rear panel holds terminals for high impedance input and a coaxial socket for low impedance input. It also holds a fuse and a four-pin panel-mounted polarized plug for power input. I normally operate it from a 12 volt dc source, usually a rechargeable gel cell.

The amplifier which drives the detector circuit operates from about 2 to 50 MHz. I use it for a variety of field strength determinations. The audio output mode has been particularly useful for checking RF leakage around

shielded enclosures. It has also been used to locate rectifying joints in downpipes and guttering. These are a constant source of TVI. In these applications, a "snoop loop" connected to a length of coaxial cable is attached to the low impedance input of the unit.

Incidentally, the original QST article (ref. 1) shows the pin connections of the

input FET incorrectly. As a result I destroyed the first FET installed in my amplifier. Please alter your copy of the QST article if you have it in your library. I was unable to obtain the transistors listed in the RF amplifier in this circuit. I used 2N2222s as a replacement. To obtain reasonably linear operation of the RF amplifiers, I changed the 3.3k

forward bias resistors in the two stages so that the collector voltage on each stage was about 60% of the supply voltage.

Reference and Further Reading

1. Learning to use Field-Strength Meters, QST March 1985, Doug DeMaw, W1FB.

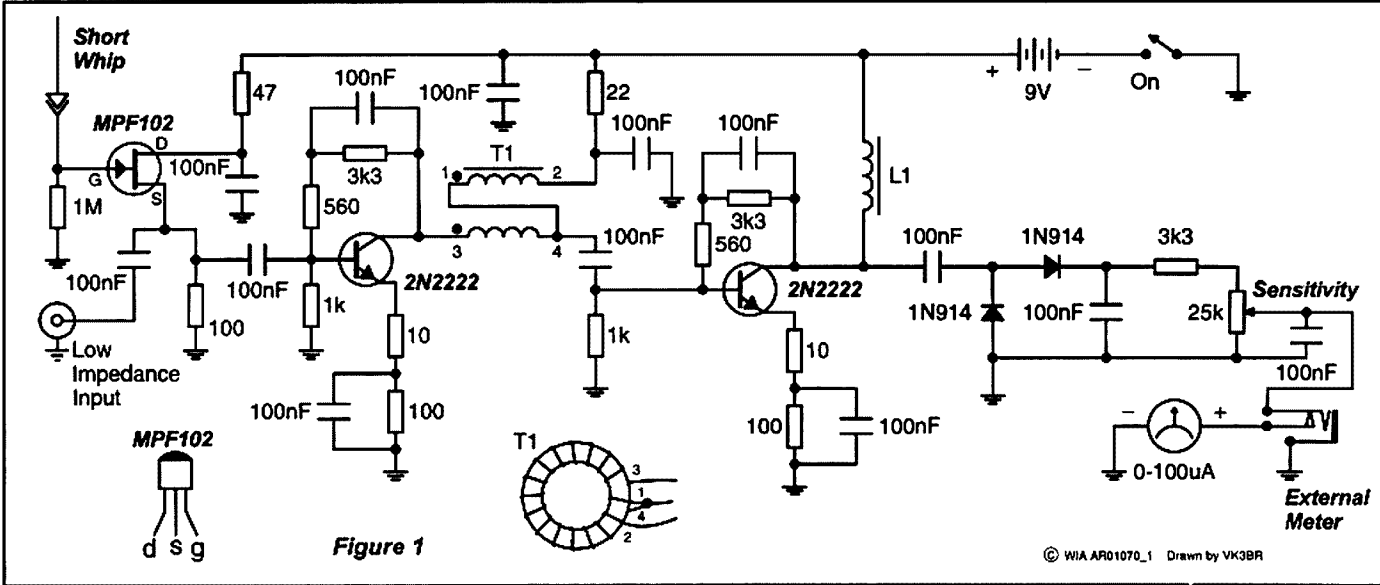

Figure 1

© WIA AR01070_1 Drawn by VK3BR

Figure 1 – Field strength meter schematic.

L1 – 15 turns of No 26 enamel wire on an Amidon FT50-43 toroid core.

T1 – Bifilar wound transformer, 15 bifilar turns (twist No 26 enamel wires for eight twists per inch) on an Amidon FT50-43 toroid core.

Drop Three

Audio Output Meter

Home Brew

QST originally described the audio VCO as a device for meter reading by sightless amateurs (ref. 1). I found the published circuit was unreliable and modified it by inserting a forward bias resistor as shown in the attached circuit. (figure 2) The transistors used in this part of the circuit were NPN and PNP standard replacement types.

Various gadgets have been devised to aid the ham without sight, in tuning his transmitter, and many are doing very well with them. Most of these devices use a voltage picked up at an appropriate point in the transmitter circuit to change the tone of an audio oscillator in accordance with the change in voltage as the transmitter is tuned. Most sightless hams are able to memorize the

particular tone that corresponds to normal transmitter loading.

More recent designs have made use of transistors to reduce bulk and weight and thus render the instrument more convenient to use. However, transistors are sensitive to changes in temperature, and while the operator may have no trouble in determining resonance in his transmitter, he cannot be sure that

transistor drift has not shifted the oscillator pitch corresponding to normal loading. Thus, he may be underloading or overloading without being aware of it.

The unit described here, includes a simple comparator-type calibrator, which automatically compensates for any drift due to temperature effects or component aging. Furthermore, it is not



Photo 3. Field strength meter with audio output

necessary for the operator to memorize audio tones. He can actually "read" current values to an accuracy of 5 per cent or better on a Braille calibrated dial.

Circuit

The system shown in Fig. 2 was developed by W6CKV and the author, and has been used successfully by several of their sightless friends. The operating voltage is taken from the drop across the shunted 0-1 millimeter commonly found in most transmitters, manufactured or homebrew. This voltage (0.03 to 0.1 volt depending upon

the internal resistance of the meter) is fed into a transistor direct current amplifier whose output voltage controls the frequency of an audio oscillator also employing a transistor.

The voltage comparator consists of a simple voltage divider operating from a single dry cell. Potentiometer *R2* is set at various points where its output voltages are the same as the voltage drops across the meter for various current readings. The Braille dial of the potentiometer is calibrated in any desired fractions of the full-scale meter value.

Then it is necessary only to adjust the comparator to obtain the same tone as produced with the meter connected, and read the comparator dial.

In the case of a multi-range meter, the voltage drop across the meter terminals is, of course, the same for all current ranges, so the operator must keep in mind the current range to which the meter is switched.

Reference

1. Meter reading by Sound, QST October 1960, Ken Blaney, W6PIV.

ar

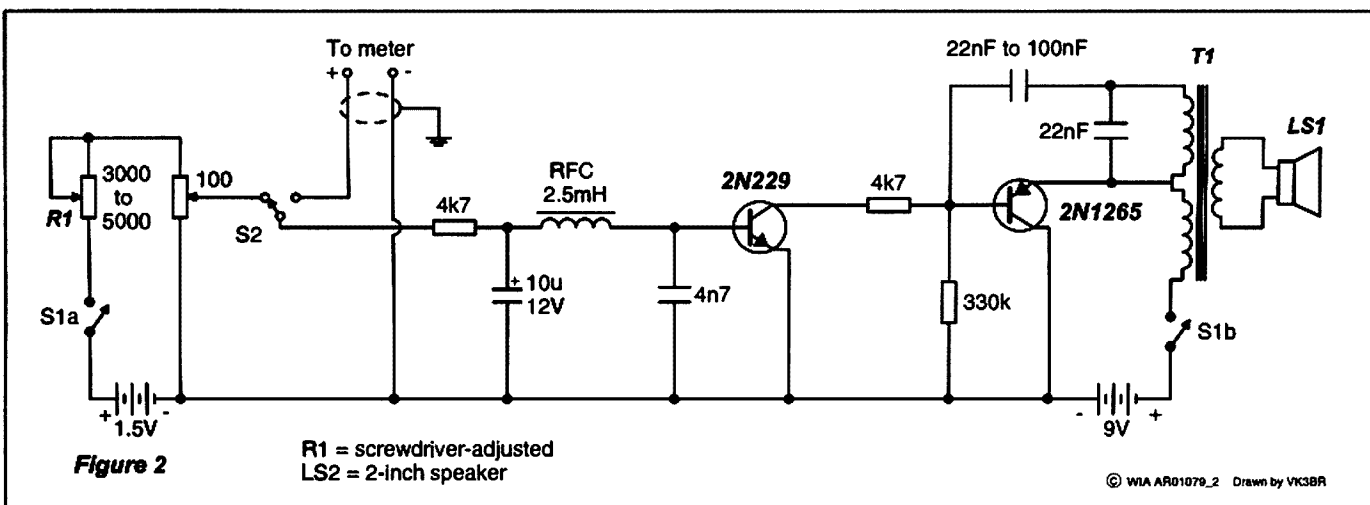

Figure 2 – Audible meter reader schematic.

LS1 – 2 inch speaker.

T1 – transistor output transformer, push-pull to voice coil.

The Sunday 40-metre CW net reaches 1500 sessions

Draw Diamond VK3XU
45 Getters Road,
Wonga Park 3115.

Early in 1973, a group of keen east coast amateurs gathered to discuss the creation of a new style net for CW operators. These fellows beam at us from nearly thirty years ago in Photo 1. By the time you read this, the long-running Sunday morning 40 metre CW net will have clocked-up 1500 sessions. Net number 1 was probably run on the 10th of March 1973, under the control of Frank, VK4II, and a net has taken place almost every Sunday since that date.

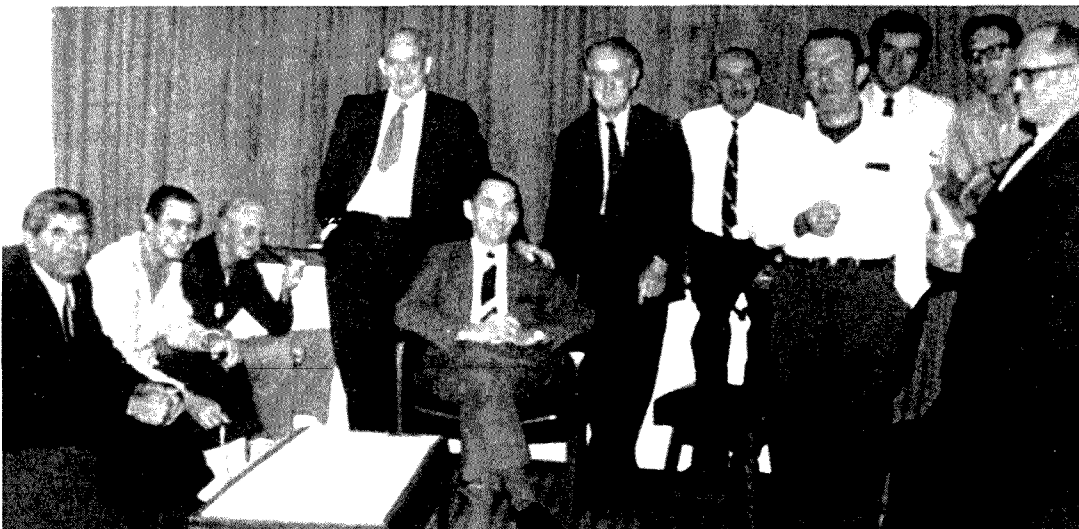

Photo 1. The 1973 CWN meeting; L - R; Wally VK2EW, Al '2BF, wanted known, Dick '2AHR, Don '2SM, Art '2AV, Mac '2ADV, Bill '2XM, Tony '2BWC, Frank '4II, Jack '2YK.

For a conventional net; a group of operators, on an agreed frequency, take turns to have a say- 'round-table' style. On 'phone, such a scheme is generally productive, interesting and workable. On CW however, it's not so easy, due mainly to the varying levels of Morse skills and sending styles of the participants.

Back in 1973 it was thought a new CW net should be egalitarian, and encourage the participation of all interested persons who possess at least moderate Morse proficiency, and wish to polish, or maintain their skill. Only stations that can hear each other shall be 'paired', thus avoiding lost contacts. Speed shall not be a big issue, as the control station will endeavour to find another operator who is prepared to, or prefers to send at similar speed. Operators shall be able to come and go, call-in early or late (within the two-hour session) as desired, no

excuses necessary. And the structure should prevent the net from being wholly dominated or monopolised by any individual (Ref. 2).

The net is still run along the same lines as originally devised, and takes place every Sunday morning (except RD Contest weekend and Christmas Day) from 10 AM to noon EAST. In its 30 year history, over 100 individual stations have taken part at some time. Typical attendance is about 14, each operator enjoying one or more QSOs. A number of SWLs also tune in to the net on a regular basis. In addition to the customary Q-codes, the ARRL QN codes for traffic handling have been adopted for the net, and suit very well. An abridged list of the most commonly used QN-codes (different from aeronautical QN codes) is included here. A full list may be found in Refs. 3 and 4.

This is how it works: The net control

station (NCS) operates on 7025 kHz and calls; "CQ CW NET DE (call-sign) QNI PSE K". QNI is an invitation to report into the net. Rather than function as a round-table, the NCS will attempt to 'pair' stations as they initially call in, or as they return to the control frequency. When reporting in, or re-joining the net, on 7025 kHz send; "(your call-sign) QNI". NCS will acknowledge; "R". If he is busy, or no other station is waiting for a 'partner', NCS will send; "PSE WAIT

(didahdididit)", and go on to find a suitable station for you to work-probably by calling CQ again. If it is thought that you are new to the net, NCS may introduce himself and request your name, at approximately your Morse speed.

When a suitable station is on hand for you, NCS will confirm that you can hear each other, either by checking that the waiting station heard you call in, or by asking a station to QSV (send some V's), then "CAN YOU COPI VK—?. When it is confirmed that both stations hear each other, NCS will nominate a frequency. For example, let's assume that VK3BKU and VK2BWC are to be paired and moved to 7015 kHz. NCS will send; "VK3BKU ES VK2BWC PSE QSY 7015 - VK2BWC"- to which VK2BWC acknowledges by sending "R TU" (received thank you). Then NCS will

send "VK3BKU", to which VK3BKU will reply "RTU". VK3BKU and VK2BWC then move off and establish contact on 7015 kHz. Sounds tricky when written down, but a bit of listening and practice soon has the procedure properly understood.

The paired stations may then chat in the usual one-on-one manner of a QSO for as long as desired. Typical duration is about 10 or 20 minutes, but there are no strict rules. If you 'hit it off' with the other fellow, you can chat for as long as necessary (even beyond the end of the 'net' period, as sometimes happens for a really interesting discussion). Normally though, when the QSO has ended, both stations return to 7025 kHz, and at an appropriate moment report back to the net. If a new QSO is desired, send; "(your callsign) QNI", and await

further instructions from the NCS, as noted above. However, if you wish to leave the net, send; "(your callsign) QNX", which is a request to be excused from the net. NCS will reply with something like; "R (your call-sign) TKS ES 73 - QNX" (thanks for joining in, 73 and you are excused from the net).

To save handling time when communicating with the NCS, all redundant "throat-clearings" such as; message begins (dahdidahdidah) and that old-fashioned (dididahdit) should be omitted. Just listen carefully, then jump in at a suitable pause (doublings do occur, but are soon sorted out), and try not to engage the NCS in lengthy chitchat, especially if things start to get busy.

At noon, the NCS will conclude business by sending a list of participating station call-signs; "QNE - QNS (list of call-signs) - DE (call-sign) QNF", usually with farewells as necessary from listening stations, sometimes just a sprinkling of friendly little dits, and dit dits.

The business of who shall control forthcoming nets is generally worked out



Photo 2. BBQ gathering to celebrate the 1000th CWN session at the home of Don, VK3BKU in Sep. 1992. Back row, L to R; Max VK2ARZ, Ivor '3XB, Geoff '3ED, Roy '3ELB, Joe '3BBN, Drew '3XU, Peter '3APN. Middle row L to R; Tim '3BCN, Len '3DXM, Harvey '3AHU, Ross '3ARC, Mait(land) '5AO, Geoff '3AC. Front row, L to R; Don '3BKU, Arn(old) '3AGW, Mavis '3KS, Eric '2BII, John '3AJY, Neill '5KQ.

among the regular net control stations some weeks in advance, often during the course of the net, or by e-mail. Controllers are usually East Coast (not necessarily fast) operators who have reached a good level of net skill, and can hear signals from VK1, 2,3,4,5 and 7 at least reasonably well under normal propagation conditions. Naturally, regular attendees are encouraged to volunteer for NCS duty when and if they feel able to do the job.

Sadly, several of the operators in the photographs are now silent keys. They would be pleased to know that new stations are welcomed into the net, and sufficient amateurs take on the role of NCS, so the net lives on. If you are keen on CW operation, and have some free time on a Sunday morning, you are invited to tune to 7025 kHz and join in the fun.

Common Use Amateur Radio Net QN Codes

- QNE* Entire net stand by.
- QNF Net is free (not controlled).
- QNI Net stations report in*.

I am reporting into the net.

QNJ Can you copy me? or Can you copy ...?

QNO Station is leaving the net.

QNP Unable to copy you (or....).

QNS Following stations are in the net* (follow with list).

QNS? Request list of stations in the net.

QNT I am leaving the net temporarily (e.g. QNT 5; back in 5 minutes).

QNX You are excused from the net.

QNX Request to be excused from the net.

You are excused from the net*.

* For use only by net control station.

References

1. e-mail and on-air correspondence with Don Ockley, VK3BKU.
2. "The CW Net- A First for Australia"; Frank Miller, VK4II, AR Oct. '73.
3. "Pounding Brass"; Gilbert Griffith, VK3CQ, AR Apr. '88.
4. The ARRL Operating Manual or ARRL Handbook.

ar

Andrews Communication Systems

ESTABLISHED 1976

ACN 001 968 752

ALINCO

Made In Japan



HF+ 6m 100W

- | | |
|---|--------|
| ALL-MODE COMPACT TRANSCEIVER | \$1599 |
| ★ DR-605EA FULL DUPLEX TWINBANDER | \$899 |
| ★ DJ-G5EA FULL FEATURE H/H TWINBANDER | \$549 |
| ★ DJ-V5EA WIDE-RECEIVE DUALBANDER | \$499 |
| ★ DR-435 UHF 35W MOBILE WITH 100ch MEMORY | \$599 |
| ★ EDX-2 AUTOMATIC ANTENNA TUNER | \$599 |
| ★ DJ-X2 NEW H/H SCANNER | \$299 |
| ★ DR-135TP 2m MOBILE 50W & PACKET | \$449 |
| ★ DJ-X2000 ALL MODE HAND-HELD SCANNER | \$999 |

3-YEAR WARRANTY— MASSIVE RANGE
No. 1 ALINCO IMPORTER. Call us

GME ELECTROPHONE



- | | |
|----------------------|-------|
| ★ TX-3400 REMOTE | \$429 |
| ★ TX-3200 UHF, SCANS | \$299 |
| ★ TX-4400 NEW UHF | \$429 |
| ★ TX-6000 UHF H/HELD | \$479 |

PROUDLY MADE IN AUSTRALIA
Authorised Dealer - Plenty of Stock

- ★ Massive range of scanners
- ★ MFJ & KANTRONICS controllers
- ★ 811A \$69 ★ 572B \$175 ★ 3-500ZG \$375
- ★ NEW KENWOOD TK-F7E \$199

- | | |
|---|----------------------|
| ★ 450Ωline \$4/m | ★ RG-213/u100m \$199 |
| ★ Tokyo Hy-Power, Palomar, Zetagi linears | |

EMOTATOR ROTATORS 747SRX

Made in Japan quality

- | | |
|-----------------------------|--------|
| ★ 105TSX MEDIUM HEAVY DUTY | \$799 |
| ★ 747SRX HEAVY DUTY | \$1199 |
| ★ 1200 FXX SUPER HEAVY DUTY | \$1999 |

Exclusive Factory-Direct Importer



ICOM

Made in Japan



IC-706MKIIG \$2499
HF + 6m, + 2m + 70m TRANCEIVER

- | | |
|------------------------------|--------|
| ★ IC-756 Pro HF + 6m, colour | \$Call |
| ★ IC-746 Pro HF + 6m, + 2m | \$3999 |
| ★ IC-718 100W HF SSB | \$1649 |
| ★ IC-910H 2m + 70cm SSB | \$Call |
| ★ IC-207H 2m + 70cm FM | \$699 |

IC-R3 h/held SP version \$599

- TV screen
 - .05-900, 1300-2250 MHz AM/FM
 - 450Ch
- (Regular IC-R3 \$999)



- | | |
|---------------------------|--------|
| ★ IC-R2 COMPACT SCANNER | \$339 |
| ★ IC-R10 ALL-MODE SCANNER | \$699 |
| ★ IC-R75 HF +6m RECEIVER | \$1599 |
| ★ IC-2800H 2m + 70cm FM | \$Call |
- 2 YEAR WARRANTY APPLIES

KENWOOD 1 YEAR WARRANTY Plenty Available

- | | |
|------------------------------|--------|
| ★ TS-50S HF 100W, MOBILE | \$1599 |
| ★ TS-570SG HF + 6m, MOBILE | \$2499 |
| ★ TS-2000 HF + 6m +2m + 70cm | \$3799 |

MASSIVE RANGE OF USED RADIOS

SYNCR0 AUSTRALIA

TRANSCEIVERS — LINEARS — MICS — ANTENNAS — FREQUENCY COUNTERS

- SWR METER METAL CASE \$15
- 3 POSITION ANTENNA SWITCH \$15

TELESCOPES

HIGH QUALITY
BEST PRICES IN AUSTRALIA
REFRACTORS
70mm from..... \$179
Factory direct importer — Massive range



MFJ TUNERS



MANY MORE ACCESSORIES IN STOCK

Uniden SCANNERS

Call for best prices

DIAMOND ANTENNA

FACTORY—DIRECT IMPORTER



- METERS
 - ANTENNAS
 - DIPLEXERS
- CALL

Uniden UHF CB

Please call for best prices

- | | |
|---------------------------------|-------|
| GARMIN GPS from | \$329 |
| Kenwood TK860G 25W UHF | \$799 |
| JAYCAR 40A & 25A Power Supplies | |
| MAGNETIC 400/800MHz (used) ANT | \$9 |
| MASTEROTOR ROTATORS | \$199 |

<http://www.andrewscom.com.au>

MORE INFO & USED RADIOS LIST ON OUR WEBSITE

CALL (02) 9636-9060 or 9688-4301 or FAX 9688-1995

SHOP 8, 41—51 BATHURST ST, GREYSTANES, NSW 2145 Near Great Western Highway

Why pay more? MAIL ORDER TO PO BOX 240, PENDLE HILL, NSW 2145

Some items indent. Prices subject to change without notice - limited stock, some items.

Newsletter Unlimited AAR05/02

129	FT5X	Kerguelen Island	AF	68	39	No	207 OZ	Denmark	EU	18	14	Yes
130	FT5Z	Amsterdam & St. Paul Is.	AF	68	39	No	208 P2	Papua New Guinea	OC	61	28	Yes
131	FW	Wallis & Futuna Island	OC	62	32	No	209 P4	Aruba	SA	11	09	Yes
132	FY	French Guiana	SA	12	09	No	210 P6	Dam. People's Rep. Korea	AS	44	25	No
133	G,GX	England	EU	27	14	Yes	211 PA-PI	Netherlands	EU	27	14	Yes
134	GD,GT	Isle of Man	EU	27	14	Yes	212 PJ2,4,9	Bonaire, Curacao	SA	11	09	Yes
135	GI,GN	Northern Ireland	EU	27	14	Yes		Netherlands Antilles				
136	GJ,GH	Jersey	EU	27	14	Yes	213 PJ5-8	St. Maarten, Saba, St. Eustatius	NA	11	08	Yes
137	GM,GS	Scotland	EU	27	14	Yes						
138	GU,GP	Guernsey	EU	27	14	Yes	214 PP-PY	Brazil	SA	(D)	11	Yes
139	GW,GC	Wales	EU	27	14	Yes	215 PP0-PY0F	Fernando de Noronha	SA	13	11	No
140	H4	Solomon Islands	OC	51	28	Yes	216 PP0-PY0S	St. Peter & St. Paul Rocks	SA	13	11	No
141	H40	Tomotu Province	OC	51	32	No	217 PP0-PY0T	Trindade & Martim Vaz Is.	SA	15	11	No
142	HA,HG	Hungary	EU	28	15	Yes	218 PZ	Suriname	SA	12	09	Yes
143	HB	Switzerland	EU	28	14	Yes	219 R1FJ	Franz Josef Land	EU	75	40	No
144	H80	Liechtenstein	EU	28	14	Yes	220 R1MV	Mal'y Vysotskij Island	EU	29	16	No
145	HC-HD	Ecuador	SA	12	10	Yes	221 S0	Western Sahara	AF	46	33	No
146	HC8-HD8	Galapagos Island	SA	12	10	No	222 S2	Bangladesh	AS	41	22	Yes
147	HH	Haiti	NA	11	08	Yes	223 S5	Slovenia	EU	28	15	Yes
148	HI	Dominican Republic	NA	11	08	Yes	224 S7	Seychelles	AF	53	39	No
149	HJ-HK	Colombia	SA	12	09	Yes	225 S9	Sao Tome & Principe	AF	47	36	No
160	HK0	Malpelo Island	SA	12	09	No	226 SA-SM	Sweden	EU	18	14	Yes
151	HK0	San Andres & Providencia	NA	11	07	No	227 SN-SR	Poland	EU	28	15	Yes
152	HL	Republic of Korea	AS	44	25	Yes	228 ST	Sudan	AF	47,48	34	Yes
153	HO-HP	Panama	NA	11	07	Yes	229 SU	Egypt	AF	38	34	No
154	HO-HR	Honduras	NA	11	07	Yes	230 SV-SZ	Greece	EU	28	20	Yes
155	HS-E2	Thailand	AS	49	26	Yes	231 SV/A	Mount Athos	EU	28	20	No
166	HV	Vatican	EU	28	15	No	232 SV5	Dodecanese	EU	28	20	No
167	HZ	Saudi Arabia	AS	39	21	No	233 SV9	Crete	EU	28	20	No
158	I	Italy	EU	28	15,33	Yes	234 T2	Tuvalu	OC	65	31	No
159	IS0,IMO	Sardinia	EU	28	15	No	235 T30	West Kiribati (Gilbert Is.)	OC	65	31	No
160	J2	Djibouti	AF	48	37	Yes	236 T31	Central Kiribati	OC	62	31	No
161	J3	Grenada	NA	11	08	Yes		(British Phoenix Island)				
162	J5	Guinea-Bissau	AF	46	35	No	237 T32	East Kiribati (Line Is.)	OC	61,63	31	No
163	J6	St. Lucia	NA	11	08	No	238 T33	Banaba Is. (Ocean Is.)	OC	65	31	No
164	J7	Dominica	NA	11	08	Yes	239 T5	Somalia	AF	48	37	No
165	J8	St. Vincent	NA	11	08	No	240 T7	San Marino	EU	28	15	Yes
166	JA-JS	Japan	AS	45	25	Yes	241 T8,KC6	Palau	OC	64	27	No
167	JD1	Minami Torishima	OC	90	27	No	242 T9	Bosnia-Herzegovina	EU	28	15	Yes
168	JD1	Ogasawara	AS	45	27	No	243 TA-TC	Turkey	EU,AS	39	20	Yes
169	JT-JV	Mongolia	AS	32,33	23	Yes	244 TF	Iceland	EU	17	40	Yes
170	JW	Svalbard	EU	18	40	No	245 TG, TD	Guatemala	NA	11	07	Yes
171	JX	Jan Mayen	EU	18	40	No	246 Ti, TE	Costa Rica	NA	11	07	Yes
172	JY	Jordan	AS	39	20	Yes	247 T19	Cocos Island	NA	11	07	No
173	K,W,N, AA-AK	United States of America	NA	6,7,8	3,4,5	Yes	248 TJ	Cameroon	AF	47	36	No
174	KG4	Guantanamo Bay	NA	11	08	No	249 TK	Corsica	EU	28	15	No
175	KH0	Mariana Island	OC	64	27	No	250 TL	Central Africa	AF	47	36	No
176	KH1	Baker & Howland Island	OC	61	31	No	251 TN	Congo (Republic of)	AF	52	36	No
177	KH2	Guam	OC	64	27	Yes	252 TR	Gabon	AF	52	36	Yes
178	KH3	Johnston Island	OC	61	31	Yes	253 TT	Chad	AF	47	36	No
179	KH4	Midway Island	OC	61	31	No	254 TU	Cote d'Ivoire	AF	46	35	Yes
180	KH5	Palmyra & Jarvis Island	OC	61,62	31	No	255 TY	Benin	AF	46	35	No
181	KH5K	Kingman Reef	OC	61	31	No	256 TZ	Mali	AF	46	35	Yes
182	KH6,7	Hawaii	OC	61	31	Yes	257 UA-UI1,3, 4,6, RA-RZ	European Russia	EU	(E)	16	Yes
183	KH7K	Kure Island	OC	61	31	No	258 UA2	Kaliningrad	EU	29	15	No
184	KH8	American Samoa	OC	62	32	No	259 UA-UI8,9,0	Asiatic Russia	AS	(F)	(G)	Yes
185	KH9	Wake Island	OC	65	31	No	RA-RZ					
186	KL7	Alaska	NA	1,2	1	Yes	260 UJ-UM	Uzbekistan	AS	30	17	Yes
187	KP1	Navassa Island	NA	11	08	No	261 UN-UQ	Kazakhstan	AS	29-31	17	Yes
188	KP2	Virgin Island	NA	11	08	Yes	262 UR-UZ	Ukraine	EU	29	16	No
189	KP3,4	Puerto Rico	NA	11	08	Yes	EM-EO					
190	KP5	Desecheo Island	NA	11	08	No	263 V2	Antigua & Barbuda	NA	11	08	Yes
191	LA-LN	Norway	EU	18	14	Yes	264 V3	Belize	NA	11	07	Yes
192	LO-LW	Argentina	SA	14,16	13	Yes	265 V4	St. Kitts & Nevis	NA	11	08	No
193	LX	Luxembourg	EU	27	14	Yes	266 V5	Namibia	AF	57	38	Yes
194	LY	Lithuania	EU	29	15	Yes	267 V6	Micronesia	OC	65	27	No
195	LZ	Bulgaria	EU	28	20	Yes	268 V7	Marshall Island	OC	65	31	Yes
196	OA-OC	Peru	SA	12	10	Yes	269 V8	Brunei	OC	54	28	Yes
197	OD	Lebanon	AS	39	20	Yes	270 VE,VO,VY	Canada	NA	(H)	01-05	Yes
198	OE	Austria	EU	28	15	Yes	271 VK	Australia	OC	(I)	29,30	Yes
199	OF-OI	Finland	EU	18	15	Yes	272 VK0	Heard Island	AF	68	39	No
200	OH0	Aland Island	EU	18	15	No	273 VK0	Macquarie Island	OC	60	30	No
201	OJ0,OH0M	Market Reef	EU	18	15	No	274 VK9C	Cocos-Keeling Island	OC	54	29	No
202	OK-OL	Czech Republic	EU	28	15	Yes	275 VK9L	Lord Howe Island	OC	60	30	No
203	OM	Slovak Republic	EU	28	15	Yes	276 VK9M	Mellish Reef	OC	56	30	No
204	ON-OT	Belgium	EU	27	14	Yes	277 VK9N	Norfolk Island	OC	60	32	No
205	OX	Greenland	NA	5,7,5	40	No	278 VK9W	Willis Island	OC	55	30	No
206	OY	Faroe Islands	EU	18	14	Yes	279 VK9X	Christmas Island	OC	54	29	No

280	VP2E	Anguilla	OC	11	08	No
281	VP2M	Montserrat	NA	11	08	No
282	VP2V	British Virgin Island	NA	11	08	Yes
283	VP5	Turks & Caicos Island	NA	11	08	Yes
284	VP6	Pitcairn Island	OC	63	32	No
285	VP6	Ducie Island	OC	63	32	No
286	VP8	Falkland Island	SA	16	13	Yes
287	VP8, LU	South Georgia Island	SA	73	13	No
288	VP8, LU	South Orkney Island	SA	73	13	No
289	VP8, LU	South Sandwich Island	SA	73	13	No
290	VP8,LU,CE3	South Shetland Island	SA	73	13	No
HF0, 4K1						
291	VP9	Bermuda	NA	11	05	Yes
292	VQ9	Chagos Island	AF	41	39	Yes
293	VR	Hong Kong	AS	44	24	Yes
294	VU	India	AS	41	22	Yes
295	VU	Andaman & Nicobar Island	AS	49	26	No
296	VU	Lakshadweep Island	AS	41	22	No
297	XA-XI	Mexico	NA	10	06	Yes
298	XA4-XI4	Revilla Gigedo	NA	10	06	No
299	XT	Burkina Faso	AF	46	35	Yes
300	XU	Cambodia	AS	49	26	No
301	XW	Laos	AS	49	26	No
302	XX9	Macao	AS	44	24	No
303	XY-XZ	Myanmar	AS	49	26	No
304	YA	Afghanistan	AS	40	21	No
305	YB-YH	Indonesia	OC	51,54	28	Yes
306	YI	Iraq	AS	39	21	Yes
307	YJ	Vanuatu	OC	56	32	Yes
308	YK	Syria	AS	39	20	Yes
309	YL	Latvia	EU	29	15	Yes
310	YN	Nicaragua	NA	11	07	Yes
311	YO-YR	Romania	EU	28	20	Yes
312	YS	El Salvador	NA	11	07	Yes
313	YT-YU,YZ	Yugoslavia	EU	28	15	Yes
314	YV-YY	Venezuela	SA	12	09	Yes
315	YV0	Aves Island	NA	11	08	No
316	Z2	Zimbabwe	AF	53	38	No
317	Z3	Macedonia	EU	28	15	Yes
318	Z4	Albania	EU	28	15	Yes
319	ZB2	Gibraltar	EU	37	14	Yes
320	ZC4	UK Sov Base Areas on Cyprus	AS	39	20	Yes
321	ZD7	St. Helena	AF	66	36	No
322	ZD8	Ascension Island	AF	66	36	Yes
323	ZD9	Tristan da Cunha & Gough Is.	AF	66	38	No
324	ZF	Cayman Island	NA	11	08	Yes
325	ZK1	North Cook Islands	OC	62	32	No
326	ZK1	South Cook Islands	OC	62	32	No
327	ZK2	Niue	OC	62	32	No
328	ZK3	Tokelau Island	OC	62	31	No
329	ZL-ZM	New Zealand	OC	60	32	Yes
330	ZL7	Chatham Island	OC	60	32	No
331	ZL8	Kermadec Island	OC	60	32	No
332	ZL9	Auckland & Campbell Is.	OC	60	32	No
333	ZP	Paraguay	SA	14	11	Yes
334	ZR-ZU	South Africa	AF	57	38	Yes
335	ZS8	Prince Edward & Marion Is.	AF	57	38	No

Deleted Countries

1	Blenheim Reef	AF	41	39	No
2	Geyser Reef	AF	53	39	No
3	Abu Ail Island	AS	39	21	No
4	1M Minerva Reef	OC	62	32	No
5	4W Yemen Arab Republic	AS	39	21	No
6	7J1 Okino Tori-shima	AS	45	27	No
7	8Z4 Saudi Arabia/Iraq (N-Zone)	AS	39	21	No
8	8Z5, 9K3 Kuwait/Saudi Arabia (N-Zone)	AS	39	21	No
9	9S4 Saar	EU	28	14	No
10	9U5 Ruanda-Urundi	AF	52	36	No
11	AC3 Sikkim	AS	41	22	No
12	AC4 Tibet	AS	41	23	No
13	C9 Manchuria	AS	33	24	No
14	CN2 Tangier	AF	37	33	No
15	CR8 Damao, Diu	AS	41	22	No
16	CR8 Goa	AS	41	22	No
17	CR8,CR10 Portuguese Timor	OC	54	28	No
18	DA-DM Germany	EU	28	14	No
19	DM,Y2-9 German Dem. Rep.	EU	28	14	No
20	EA9 Ifni	AF	37	33	No
21	FF French West Africa	AF	46	35	No
22	FH,FB8 Comoros	AF	53	39	No
23	F18 French Indo-China	AS	49	26	No
24	FN8 French India	AS	41	22	No
25	FQ8 French. Equatorial Africa	AF	47,52	36	No
26	HK0 Bajo Nuevo	NA	11	08	No
27	HK0, KP3, Serrana Bank & Roncador Cay	NA	11	07	No
28	I1 Trieste	EU	28	15	No
29	I5 Italian Somaliland	AF	48	37	No
30	J20 Netherlands New Guinea	OC	51	28	No
31	KR6, KR8, Okinawa	AS	45	25	No
JR6, KA6 (Ryukyu Island)					
32	KS4 Swan Island	NA	11	07	No
33	KZ5 Canal Zone	NA	11	07	No
34	OK-OM Czechoslovakia	EU	28	15	No
35	P2, VK9 Papua Territory	OC	51	28	No
36	P2, VK9 Territory New Guinea	OC	51	28	No
37	PK1-3 Java	OC	54	28	No
38	PK4 Sumatra	OC	54	28	No
39	PK5 Netherlands Borneo	OC	54	28	No
40	PK6 Celebe & Molucca Is.	OC	54	28	No
41	ST0 Southern Sudan	AF	47,48	34	No
42	UN1 Karelo-Finnish Republic	EU	19	16	No
43	VO Newfoundland, Labrador	NA	9	02,05	No
44	VQ1, 5H1 Zanzibar	AF	53	37	No
45	VQ6 British Somaliland	AF	48	37	No
46	VQ9 Aldabra	AF	53	39	No
47	VQ9 Desroches	AF	53	39	No
48	VQ9 Farquhar	AF	53	39	No
49	VS2, 9M2 Malaya	AS	54	28	No
50	VS4 Sarawak	OC	54	28	No
51	VS9A,PS People's Dem. Rep. of Yemen	AS	39	21	No
52	VS9H Kuria Muria Island	AS	39	21	No
53	VS9K Karaman Island	AS	39	21	No
54	ZC5 British North Borneo	OC	54	28	No
55	ZC6, 4X1 Palestine	AS	39	20	No
56	ZD4 Gold Coast, Togoland	AF	46	35	No
57	ZS0,1 Penguin Island	AF	57	38	No
58	ZS9 Walvis Bay	AF	57	38	No

Notes:

- DXCC Approved Country total is 335 and 58 Deleted countries.
- VP8 Ducie Island added-Only contacts made 16th. November 2001 and after count, this was officially added to the list 1st June 2002.
- DXCC Accepting P5/4L4FN Contacts
Since early November 2001, Mr. Edisher (Ed) Giorgadze, 4L4FN, a Georgian citizen employed by the United Nations World Food Program, has been active as P5/4L4FN in Pyongyang, DPRK.
DXCC Rule 7 states "Any Amateur Radio operation should take place only with the complete approval and understanding of appropriate administration officials." The rule continues, "In any case, credit will be given for contacts where adequate evidence of authorization by appropriate authorities exists.

The ARRL has now received adequate evidence that the operation by Mr. Giorgadze is being conducted with the knowledge and approval of telecommunications officials in Pyongyang. At the present time, this approval is limited to SSB operation.

The ARRL Awards Committee has met and concurred that the operation should be accredited. As a result, we are pleased to apply that effective immediately, the DXCC Branch will accept SSB contacts with P5/4L4FN for DXCC credit.

Contacts with P5/4L4FN dating back to early November, 2001 will count for this Entity.

4 Typical prefixes used in Antarctica:

3Y0, 3Y1, 3Y2, 3Y5, 4K1, 7S8, 8J1, AT0, AT3, AX0, AZ5, BY, CE9, DP0, DP1, EA0, ED0, EG0, EH0, EM1, FB8, FT4, FT5, FT8, G, HF0, HL5, HP, IA0, KC4, LA, LU1(Z), LZ0, OR4, OR5, PY, R1AN, UA, VK0, VI0, VP8, VU2, Y88, Y90, ZL0, ZL5, ZS1, ZS7, ZX0.

ALARA

Christine Taylor VK5CTY
vk5cty@vk5tty or geencee@oicknowl.com.au

Annual General Meeting

It was our AGM on Monday May 6th, held on air, as usual, and as successful as usual. There were 19 YLs on and conditions were kind for a change so we all could hear most others.

The committee, as nominated was elected, so the office holders are:-

Executive

President	Bev Clayton	VK4NBC
Snr. Vice President	Robyn Gladwin	VK3WX
Jnr. Vice President	Susan Brain	VK7LUV
Secretary	Margaret Scherwin	VK4A0E
Treasurer	Bev Clayton	VK4NBC
Souvenir Custodian	Gwen Tilson	VK3DYL
Minute Secretary	Bron Brown	VK3DYF
Publicity Officer	Christine Taylor	VK3CTY
Editor	Dorothy Bishop	VK2DB

Office Bearers State Representatives

Awards Custodian	Jean Shaw	VK1/2
	Dorothy Bishop	VK2DB
Contest Manager	Marilyn Syme	VK3DMS
	VK3, Judy Atkins	VK3AGC
Sponsorship Sect'y	Maria MeLeod	VK5BMT
	VK4, Margaret Schwerin	VK4A0E
Librarian	Kim Wilson	VK3CYL
	VK5/8, Jean Kopp	VK5TSX
Historian	Tina Clogg	VK5TMC
	VK6, Poppy Bradshaw	VK6YF

After the official meeting was over a general meeting was held and news, weather reports and views exchanged around the country.

A very enjoyable trip to Melbourne

In time for the April ALARA luncheon in Melbourne, I had a visit with my family. As it was school holiday time I suggested my daughter and daughter-in-law would like to join us with their children, which the regular lunchers were kind enough to allow.

The children (and mothers) did not stay all the time, they went riding on trams instead, but when the children were at the table they made me feel proud of them.

The table would have been crowded without the extras I brought along, with Mavis VK3KS, Bron VK3DYF, Jessie VK3VAN, Gwen VK3DYL, Marlene VK3WQ and Jean Shaw. As the photo shows we enjoyed ourselves.



Congratulations

Gwen VK3DYL jumped for joy when she heard that the current P5 operator, Ed who is working in North Korea for a spell, has received written permission to operate, such permission being accepted by ARRL. She IMMEDIATELY checked Ed's Log on the Net to confirm she was definitely in it.

When Gwen receives Ed's card, plus the one for the new entity Ducie Island, which has recently been activated - she will have WORKED THEM ALL. Er well until someone discovers another scrap of land/reef, or whatever, (big enough for a small tent and an antenna pole) which can be declared a NEW country/entity.

ALARA's congratulations to you Gwen. All the other keen Dxers will be joining in Gwen's dance for joy. It is always good news when another country is acknowledged by ARRL.

Field days are here again

Dot VK2DB 'manned' the ALARA table at the Gosford Field Day on Feb 24th assisted by Nancy, who was knitting a very fancy jacket. Every lady who came to the table was interested to see it. YL visitors were June VK4SJ, Agnes VK2GWI, Karen VK2YKB, Val VK4VR, Anne VK4ANN, Linden VK1LSO, and a few ladies without callisngns.

Dot herself knitted really tiny booties for a premature baby when she had time. She also bought the WIA Searchable 2002 Callbook on CD.

Judy VK3AGC was delighted to be able to spend the whole day at the Bendigo Hamfest when her sister offered to come and look after their mother for the day. She said she didn't buy anything but was pleased to meet so many people she knew in the radio world. There were several other YLs present but no members of ALARA.

ALARAMEET 2002

<http://alarammeet2002.8m.com/>

APRS Symposium

(as passed on to this reporter)

Recently VK3 held a symposium, on APRS - Automatic Position Recording System. This system requires a special knowledge and quite a crowd were expected.

The sons of VK3DYL and VK3DYF were involved and "invited" their mothers to provide a barbecue lunch for 60 people, this involved cutting up 100s of onions, tomatoes, buttering NUMEROUS loaves of bread, and preparing associated sundry titbits.

OMs seem to require endless cups of coffee/tea to keep them going during the day, and since the YLs were disinclined to keep washing cups, foam insulated cups were provided, and the kettle was kept boiling.

Gwen and Bron did not understand what the talk was all about, but the day was noted very successful. When the YLs were asked about doing it again the reply was "Not Pygmalion Likely"

That DXpedition later this year

The latest message from Gwen tells me they have started notifying the DX world that the second destination will be Nauru (the first one will be to Lord Howe Island as previously announced), provided the one and only plane in the Air Nauru "fleet" is still flying

They had decided to keep the destination to themselves until accommodation and other plans had been sorted out. It is pretty certain that they will be able to use the callsign C21YL but won't know for sure until they get to the island.

Operating dates should be from 1st - 15th October. The operators will be Elizabeth VE7YL (CW), June VK4SJ, Mio JR3MVF and Gwen VK3DYL., all ALARA members by the way!

QSL for operations and for the Lord

Howe Island dxpedition will both be through Gwen VK3DYL as it was for the expedition two years ago. Why not participate and make Gwen as busy as she was the last time.

TTS Systems Communications Equipment

We stock the LDG Electronics Z11 QRP antenna tuner kit

This little tuner is fully automatic and covers all HF bands. It's an ideal companion for the Yaesu FT817. It's super compact, (127 x 216 x 32 mm) and weighs less than 0.5 Kg.

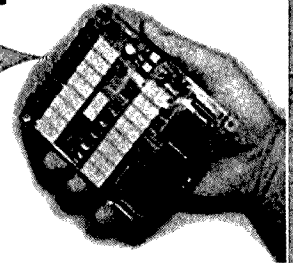

● **Easy to assemble amateur kits**

- **Automatic antenna tuner Kits**
LDG RT11 Remote 150 watt
LDG AT-11MP 150 watt with SWR meter.
Remote control for RT11

- **Transceivers/Transverters/Receivers**
TEN-TEC 2 & 6 meter transceiver kits
TEN-TEC QRP CW HF transceivers kits
TEN-TEC HF Receiver kits
TEN-TEC 2 & 6 meter transverters

* Note these kits are supplied at board level only. Other kits are complete with enclosure

- **Accessory Kits**
RF Dummy Load kits
TTS-450 4:1 Balun Kit
High Power 40 to 500 pf variable capacitor kits
SWR Bridge & Wattmeter kit
Active receive antenna kit *
Budget electronic keyer *
Transmatch tuning bridge *
Microphone speech processor *
Broadband preamp DC to 1Ghz *

All kits include easy to follow step by step assembly instructions. You supply the soldering iron and basic tools.

All kit products can be supplied fully assembled and tested.

- **We can supply the full range of TEN-TEC range of transceivers and HF linears (not kits). Call for details.**
- We also supply a wide range of professional grade RF connectors and cables. Check our web site or call for a free catalog.
- **Lutron 2.5 Ghz Battery operated hand held frequency counters. (0.1 Hz resolution up to 10 Mhz)**

■ We now stock Amidon Iron Powder and Ferrite Cores — Call for an application guide

TTS
Systems

Phone 03 59774808

Fax 03 59774801

Email – info@ttssystems.com.au

Website - www.ttssystems.com.au

Women In Radio

Two women involved with radio in two different ways

Jean Hillier

Jean is one of those people who "did not exist" during WW2, who were not awarded medals or given any glory, but who played a very vital part in our success in the War in the Pacific in particular.

Sixty years ago Jean was cycling from Mundulla to Bordertown to learn Morse Code from the local Postmaster. She was also using her Morse skills, operating the telephone switchboard at the general store/post office, to connect subscribers to the party lines.

With as much impact and shock as the attack on the twin towers on September 11, came the bombing of Darwin on 19th February 1942. The attack and the knowledge that at least one local Mundulla boy had been killed in the attack, fuelled Jean's ambition to use her Morse in the service of Australia.

As soon as that coupon "inviting interested females to fill in a form with a view to being enlisted in the Australian Armed Forces" appeared in the paper, Jean enrolled. Her special skills were immediately of importance. Jean joined the Australian Special Wireless Group, at a camp near Bonegilla in Queensland where she was set to learn the 70 Japanese Kana Morse characters.

Jean hated Kana and still does but it gave her the chance to help defeat Australian enemies. Some of the work Jean and others did is still classified but they are now allowed to share with us some of their experiences. Some of the messages Jean intercepted dealt directly with the bombing raids on Darwin. It

must have been very satisfying to know that you have caused some raids to be aborted and others to be made with many fewer aircraft, just because you had been able to 'listen in' to the radio talk leading to the build up of the bombing force so our fighters were able to intercept some of the planes before they had a chance to drop their bombs on Darwin.

One of the first interceptions Jean made was from a dugout just a mile from an Australian position. When the station went off the air a few days later Jean knew that she had been instrumental in the destruction of that particular outpost of the Japanese war effort.

In 1943 Admiral Yamamoto was shot down as a direct result of Jean's unit's interception of messages detailing his movements. The bombing of Timor airstrips when they were packed with Japanese aircraft came about because the advance warning gained through decoding of messages between the Japanese units. Even a weather report could be useful.

Jean has written a book about her experiences called, "No Medals in this Unit" but the book could not be



Photo first published in Border Chronicle on 21/2/02. Used by permission

published until over 40 years after the events because of the extreme secrecy of the activities. Some parts of the story are still classified and may always be so.

Jean still listens to Morse around the world on an old wartime Kingsley AR7 which will be recognised by a number of amateurs reading this article. It was a robust, reliable receiver, of Australian design and construction which could be carried from place to place over all types of terrain. And it still works.

There are not many Morse signals around now, and most of those remaining are in French, but Jean loves to hear them all. She has kept up her listening speed for over 40 years.

Sue Mahoney



Sue has no licence but has been a member of ALARA for many years. Her OM is Steve VK5AIM, well known over many years on the HF bands and for his contributions to AR and other amateur radio magazines. He is one of the old school, an experimenter.

In a recent issue of AR there was a description of one of the several portable radio rigs Steve

has built and used over the years. These portable rigs allow both Sue and Steve

to "do their own thing" and to do it together. Some years ago Sue became a "genie", she started researching her own, but more particularly, Steve's family tree largely through the material available through the Genealogical Society of South Australia.

Steve found many many relatives he didn't know he had. A few were still living but most of them were under a tombstone somewhere. So Sue decided to find these tombs and photograph the stones to complete the record.

She became aware of the importance, not just to know the words that are on

the tombstone, but to be able to see the stone for yourself. It was fine for Steve and Sue, most of the stones they were interested in were in South Australia, as they were, but often a visitor from interstate or overseas inquires about the cemetery records of their ancestors. How much nicer it would be if they could see the stone as well as read the inscription on a card in an index.

Now Sue has undertaken a project for the GSSA to record and photograph tombstones all over South Australia, particularly those lone graves, station graves and, where they can be found, the stones erected in memory of servicemen killed overseas but precious to their families here, and to future generations.

Sue has a digital camera for the photographs but there is more to the project than just taking a photo. The time of the day must be considered, East facing stones and West facing stones cannot both be 'snapped' at the same time, so there need to be lunch breaks while the sun moves. The inscriptions are often unreadable so care must be employed to clean without damaging the stone surface.

If there is moss in the engraving Steve is supplied with a toothbrush and a

spray can of water to clean "Uncle Fred's" face a bit. Gold inlay will leach out over quite a short time, so if the stone is dark the inscription will become invisible. After cleaning with water ordinary chalk is used to fill the lettering. It does no harm but makes a considerable difference to the photograph.

There are other hazards around cemeteries. So far Sue has not fallen into a grave that has sunk over time but she has had her leg caught up to the ankle in a rabbit hole and had to be rescued by Steve. They have both been bombarded by Magpies and had bull ants run up their legs. So far they have not seen any snakes but they are watchful.

The advice if you wish to photograph tombstones is never to stand on the grave, not because you might be showing disrespect by doing so but to avoid falling into a hole. Instead you straddle the grave or set yourself alongside it where you can see the detail clearly.

Besides the lettering there are often interesting and even sad additions. A child may have a picture of a teddy bear engraved on the headstone, or perhaps

a rattle for a baby or a fast car for a teenager. Sue has found cricket bats and netballs or footballs. A farmer may have a tractor cut into the stone, or maybe a head of wheat.

Some graves cause a lump in the throat, like that of five children buried together, or a tiny metre long grave for a baby, others bring a smile to the face. One grave had a wife with two husbands buried one on either side, another had a husband between his two wives. Sue and Steve have seen all of these.

On many of these expeditions Steve takes along a portable rig, then while Sue is copying the inscription or while they are waiting for the sun to move, Steve fires it up and put out a "CQ". Sometimes he "talks to the world" at other times the bands are dead, prompting the comment from Sue:

"Well what do you expect in a cemetery?"

Next time you hear Steve's call during the day, answer him and ask if he is in a cemetery. Help these two share each other's interest and play amateur radio at the same time.

ar

Club Notes

Adelaide Hills Amateur Radio Society

The May meeting was very well attended to hear Tony VK5ZAI talk about his experiences with space radio technologies.

Tony has become ever more deeply involved with space communication since he was able to assist Andy Thomas to talk to his parents on a regular basis while he was orbiting the world on MIR, several years ago.

Tony kept up his interest after Andy returned to earth and his contact with Andy as well. He has frequently spoken to the Russian astronauts on MIR before it was decommissioned, and to the

various astronauts on the International Space Station.

More recently Tony was invited to the United States to watch a shuttle launch and to tour the Kennedy Space Centre as an honoured guest.

Since his return to VK5 he has arranged for a number of school children to speak to the astronauts on the ISS. He is one of only a handful of amateurs around the world to be capable of

making this sort of communication possible and one of the few permitted to do so.

If you hear of a school undertaking such an exciting project you can be sure Tony will be the facilitator of the experience. Perhaps you know of a school or a teacher who would like to share in this enterprise, if so get in touch with Tony and maybe it will happen.

ar

International Lighthouse Weekend

August 17 and 18 (see How's DX column)

Australian Made ANTENNAS

"Setting a New Standard"

COM-AN-TENA

(Formerly a j and j coman)
83 Belgrave-Hallam Road
HALLAM 3803

All new 5/8 vertical 16 radials	\$145
Dual drive 26-30 5 ele yagi beam	\$305
4 ele 10-11m yagi beam	\$262
5-6-&7 ele high gain antennas 11m	\$call
3 ele delta loop 10-11m	\$320
11m 5/8 vertical/4-1/4 wave radials	\$170
Duoband 10-15 3 ele each band	\$356
Log-periodic 7 ele 13-30 MHz 7.7m boom	\$890
Tri-band 5 ele HB35C s/steel fix	\$730
3 ele 20m computer opt	\$390
3 ele 15m computer opt	\$285
M B Vert Auto switch 10-80m	\$310
40m linear loaded 2 ele beam	\$580
6m 5 ele compt opt beam	\$259
6m 7 ele compt opt beam	\$355
10 ele high performance 2m	\$135
17 ele high performance 70cm	\$119
2m vert 2-5/8 co-linear 4 rad	\$ 96

Special
DEMO 21 metre aluminium mast complete. Tilt over telescopic.
One only \$2600
(new price \$3500)

Guyed Masts

21 metres 13 metres

Winch-up & tilt-over. Aluminium and stainless steel three-sided construction. Auto-brake winches

Free Standing Masts

9.5 metres

New Baluns

1-1 to 16-1 to 3kW



Our Masts meet Australian Standards. We supply all the computations and data you will need for a permit

03 9702 4028

Mob: 0419 542 437

Andy VK3IV

Beyond Our Shores

David A. Pilley VK2AYD
davpil@midcoast.com.au

United Kingdom

A press release issued by the Radiocommunications Agency details the qualifications and examinations for the revised licensing structure for amateur radio.

The first phase was the introduction of the Foundation Licence, a great success and since then over 1500 M3 Foundation Licences have been issued.

The press release states, "a new syllabus for the Intermediate licence will be introduced early in 2003. This will be based on the current (Novice) syllabus

but will exclude those topics covered in the Foundation Licence".

Introduction of the Full licence syllabus is planned for early in 2004. From that date, entry into amateur radio will be exclusively via the Foundation Licence."

(gb2rs)

Digital voice

The ARRL Digital Voice Working Group (DVWG) held a Digital Voice Forum, at the Dayton Hamvention, Dayton, Ohio, May 19, 2002

This is stacking up to be the hottest new mode in Amateur Radio: Digital Voice.

The forum included presentations from world-renowned authorities on digital-audio hardware, software and other technical details.

Applications from rag-chewing to emergency communications to digital audio broadcasting were covered.

Members of the DVWG and some distinguished guests spoke on various topics to get you up to speed on this

exciting technology, APC025.

APCO25 is a national standard for digital voice systems.

From France, Cedric Demeure, talked about digital audio, ham radio and broadcasting. Cedric is also part of a DVWG plan to conduct transatlantic tests of digital voice over Amateur Radio.

To find out more you can e-mail kf6dx@arrl.org

(QNEWS 13/4)

HF Digital Communications Course

In December 2000 the ARRL Certification and Continuing Education Program offered its first on-line class in Amateur Radio Communications. Last December 2001; the programme added its first technical segment, a class on Antenna Modeling.

In April this year the C-CE has introduced its newest on-line course – HF Digital Communications (EC-005). Students taking this course will learn how to configure a station for HF Digital systems including RTTY, PSK31, MFSK, Hellschreiber, PACTOR, Winlink, Clover and more.

The course lasts 8 weeks and for non-ARRL members a charge of US\$90 is made.

For more information visit the C-CE web site <http://www.arrl.org/cce/> (ARRL N/L 12/4)

<http://www.wia.org.au>

check out the WIA webpage today!

Smart Glass

Wet your whistle! Smart glass gets another schooner sooner.

The tedious business of trying to catch the waiter's eye for a refill may be over as a Japanese company has devised a high-tech glass that sends a signal to bar staff telling them instantly when you are ready for another drink.

iGlassware, invented by Mitsubishi, is inspired by the radio tags used to thwart shoplifters.

Each glass has a microchip and a thin radio-frequency coil in its base, and its sides are coated with a thin, transparent conductive film.

That makes the glass behave like a capacitor, as the level of drink falls, so does the insulation and this progressively raises the charge that goes through to the microchip in the glass's base.

When the microchip receives the "full" charge, that means the glass is empty, so it sends a top-up signal to the waiters' station via a small radio coil built into the table, using a frequency similar to those used by mobile phones.

Every glass has its own ID, and its

charge is provided by a radio frequency signal also provided by the table coil.

A far cry from ye olde pub days in the UK when ceramic beer tankards had a whistle baked into their rim. When you needed a refill, you used the whistle to get some service!

Hence the saying... "wet your whistle".

(QNEWS20/4 sourced from vk2wi/jocks journal)

Remember Kon-Tiki

Noted Norwegian explorer and ethnologist Thor Heyerdahl died April 18. He was 87. In 1947, Amateur Radio played a critical role in the success and safety of Heyerdahl's 101-day Kon-Tiki raft expedition, which used the call sign LI2B on the amateur bands. Heyerdahl was attempting to prove that it was possible for South American tribes to have crossed the Pacific from east to

west to settle the Polynesian islands. Two former World War II Norwegian underground radio operators, Kurt Haugland, LA3KY, and Torstein Raaby, operated LI2B aboard the Kon-Tiki using tube gear powered mostly by dry batteries. LI2B kept a schedule with W1AW and other US stations during the historic voyage.

(ARRL N/L 26/4)

Job applicant?

A smile to finish the column!

Back when the telegraph was the fastest method of long-distance communication, a young man applied for a job as a Morse code operator. Answering an ad in the newspaper, he went to the office address that was listed. When he arrived, he entered a large, busy office filled with noise and clatter, including the sound of the telegraph in the background. A sign on the receptionist's counter instructed job applicants to fill out a form and wait until they were summoned to enter the inner office. The young man filled out his form and sat down with the seven other applicants in the waiting area.

After a few minutes, the young man stood up, crossed the room to the door of the inner office, and walked right in. Naturally the other applicants perked up, wondering what was going on. They muttered among themselves that they hadn't heard any summons yet. They

assumed that the young man who went into the office made a mistake and would be disqualified. Within a few minutes, however, the employer escorted the young man out of the office and said to the other applicants, "Gentlemen, thank you very much for coming, but the job has just been filled." The other applicants began grumbling to each other, and one spoke up saying, "Wait a minute, I don't understand. He was the last to come in, and we never even got a chance to be interviewed. Yet he got the job. That's not fair!" The employer said, "I'm sorry, but the last several minutes while you've been sitting here, the telegraph has been ticking out the following message in Morse Code: 'If you understand this message, then come right in. The job is yours.'" None of you heard it or understood it. This young man did. The job is his.

(QNEWS 4/5 Haaken, LC8UBT via VK4WIE)

U.S.A. Statistics

For the first time ever, the population of Amateur Extra class operators topped 100,000 licensees.

According to figures available from the FCC Amateur Radio Statistics Web site <<http://ah0a.org/FCC/index.html>> compiled by Joe Speroni, AH0A, there were 100,153 Extra; 85,690 Advanced; 138,980 General; 319,768 Technician (including Tech Plus); and 38,574 Novice licensees. As of the end of April, there were 683,165 total Amateur Service licensees in the FCC database. According to Speroni's statistics, 1888 new licensees came aboard during April 2002—1800 of them as Technicians.

(ARRL N/L 4/5)

Contributing to

Amateur Radio

is now as easy as sending
an *e-mail!*

Send your articles to:

edarmag@chariot.net.au

Technical Abstracts

Gil Sones VK3AUI
30 Moore Street, Box Hill South, Vic 3128

Permeability Tuning For Simple AM Radios

A novel adjustment method for a permeability tuner was described in Rad Com March 2002 in the Down to Earth column by Don Breen G0FQI. The idea was to use a lipstick container as the screw driven linear adjustment for a variable inductor tuning a simple receiver. A container used for lip salve was used as these are plainer and cheaper and less likely to contain decorative metal parts.

The container used was a "Nivea Lip Care" container which provided both the linear adjuster and the coil former. Similar containers are available locally. The brand is not critical. The construction of the cosmetic holder is shown in Fig 1. A piece of ferrite rod is inserted in place of the lipstick and can be moved using the mechanism. A 35 mm long piece of ferrite rod 9 mm in diameter has tape wound around the end and is inserted in place of the lipstick.

The coil was wound on a former made from the cap of the lipstick. This was 48 mm long and 19 mm in diameter. The top of the cap was cut off. This needs to be done with care as the plastic can split.

A basic crystal set circuit is given in Fig 2. Resistor R1 is 100 kohm and provides a DC return in case a crystal earpiece is used. Diode D1 should be a

Germanium type. The values of C1 and L1 are given in Table 1. These are starting values and may need adjustment to suit the components you use. L2 is 4 to 6 turns wound over the earthy end of L1. The wire used was 0.56 mm or 24 SWG

Turns	SWG	Capacitor C1 pF	MHz Min	MHz Max
80	30	47	1.09	1.96
80	30	100	0.86	1.52
80	30	220	0.63	1.10
80	30	470	0.45	0.76
50	24	47	1.86	3.30
50	24	100	1.48	2.60
50	24	220	1.08	1.87
50	24	470	0.79	1.30
30	24	47	2.81	5.28
30	24	100	2.22	4.07
30	24	220	1.65	2.94
30	24	470	1.20	2.12

but a smaller diameter may be needed for coils with more turns so that they fit on the former.

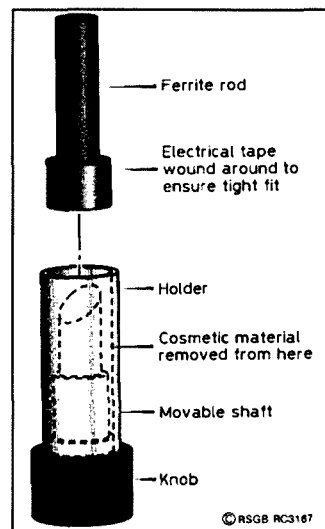

Fig 1. Cutaway View of Lipstick Container.

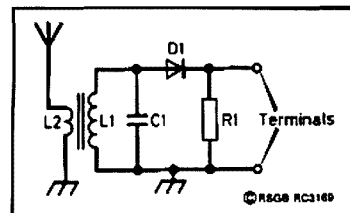

Fig 2. Basic Crystal Set

Digital pF Meter

In the Technical Topics column of Pat Hawker G3VA in Rad Com December 2001 a simple pF meter circuit was given by Brian Horsfall G3GKG. The circuit uses a frequency/period counter as the indicator. The counter is set to measure period and 1 microsecond is equivalent to 1 pF. The circuit should be used over an earthed metal tray when measuring a few thousand pF and above to avoid jittery reading.

The circuit is given in Fig 3. and uses just one integrated circuit. The battery is the common small 9 volt type which is known locally as a type 216. Capacity around the "unknown" part of the circuit should be kept to a minimum. The capacitor C0 is a gimmick capacitor which is just a couple of short

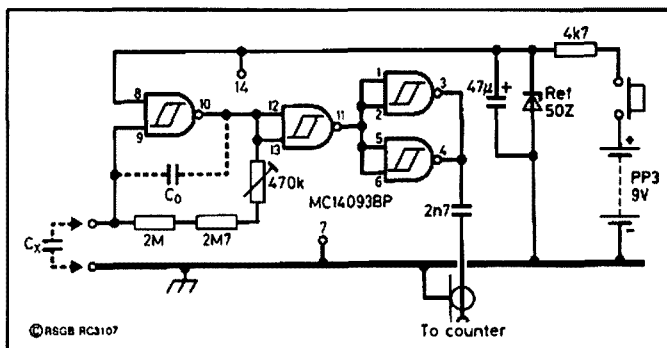

Fig 3. G3GKG's Simple Puffmeter.

insulated wires twisted together and adjusted by untwisting and snipping bits off the ends. If you must you could use a low value trimmer capacitor instead.

An accurately known capacitor of 1000 pF or more is connected as the unknown and the 470 kohm trimpot is

adjusted to give a correct reading on the counter. Then an accurately known value around 10 pF is connected as the unknown and C0, the gimmick capacitor, is adjusted to give the correct reading. If you overshoot with the

gimmick capacitor a replacement is cheap. These adjustments are repeated until you are satisfied with the calibration. If C0 has too high a value then it may be difficult to get low capacitance values to read accurately.

Lightning Detector

A lightning detector appeared in QST April 2002. The author was Bob Radmore N2PWP and the design came from Charles Wenzel of Wenzel Associates. The web site of Charles Wenzel is [www.techlib.com/Electronics/Lightning Detectors](http://www.techlib.com/Electronics/Lightning%20Detectors).

The device is a receiver in the 300 kHz region which detects the static crash which accompanies the lightning. The idea is to alert you prior to the storm reaching you so you can minimise damage from lightning.

The circuit is shown in Fig 4. The device can be built into a small box with

the whip on the top. The whip is tuned approximately by the 10 mH choke in series. The 330 microhenry choke and the 680 pF capacitor form a tuned circuit in the 300 kHz region. The static crash is amplified by Q1 and applied to a lamp flasher circuit. The flasher is adjusted so that it just doesn't flash in normal

conditions by adjusting R4. The amplified static crash can then trip the flasher causing the lamp to flash.

For test purposes a piezo ignition gas stove lighter can be used as a source of static crashes. The detector should be triggerable from approximately 1 metre away.

Continued on page 28

G. & C. COMMUNICATIONS

Authorised dealer for ✓ Kenwood ✓ Icom ✓ Barrett RFDS ✓ GME Electrophone ✓ Uniden ✓ RF Industries

✓ KENWOOD TS2000



All-mode multibander HF/
50/144/440
Auto antenna tuner built-in



✓ ELECTROPHONE TX3400

10 Channel UHF remote mount transceiver
with ten extra receive channels



ICOM IC207H

Amateur 2m/70cm FM mobile transceiver.
Compact dual band unit with detachable
control panel (OPC-600 cable required)

Australia-wide orders welcome. Payment by credit card, cheque or money order
19 Arleon Crescent Cranbourne 3977
Ph: 03 5996 3298 Fax: 03 5995 0184
Email: gccomm@netspace.net.au
www.netspace.net.au/~gccomm

Technical Abstracts continued

Components are not particularly critical. You could build the circuit on come perforated strip board or you could use ugly construction with a piece of PC board laminate as the baseboard. The

lamp is non critical and the type specified has a 2.5 volt 300 mA rating.

The sensitivity will be maximum if the antenna and the 10 mH choke are tuned

to the same frequency as the tuned circuit made up by the 330 microhenry choke and the 680 pF capacitor in the 300 kHz region.

ar

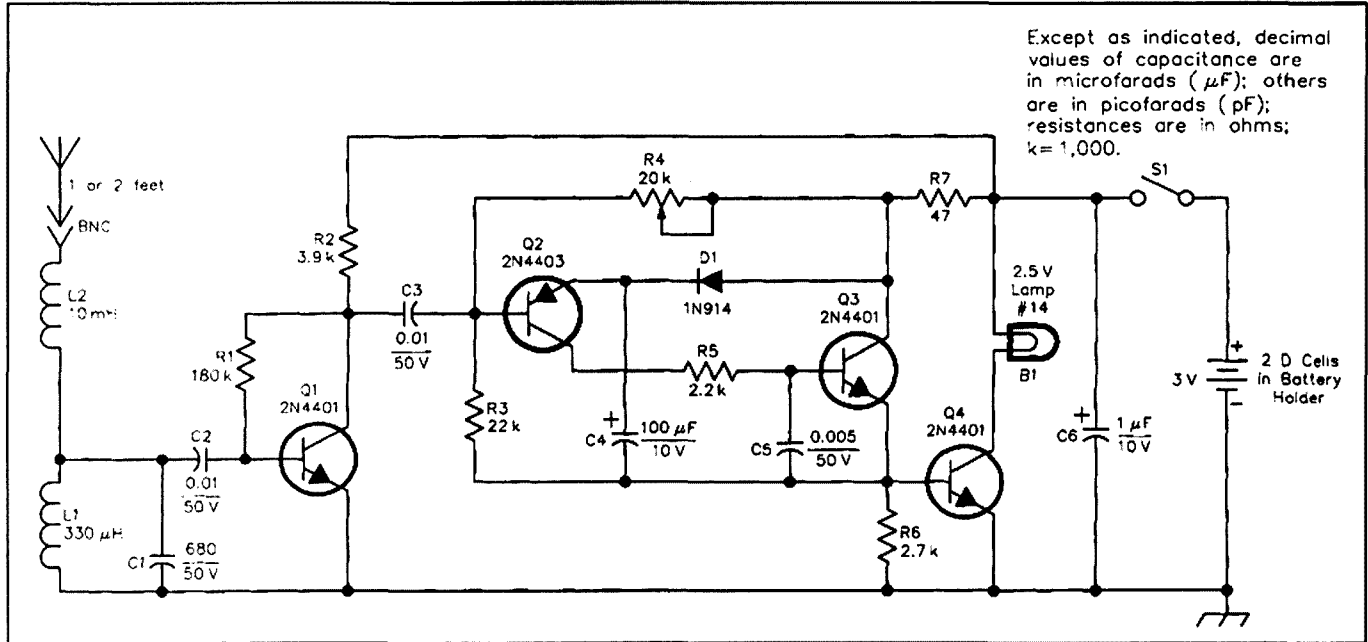

Fig 4 Lightning Detector.

For All Your Requirements

AUTHORISED DEALER

ICOM

KENWOOD

AMATEUR COMMERCIAL
MARINE COMMUNICATIONS

Tower Communications

14 Mary Street
Hazelmere
Western Australia 6055
Telephone: (08) 9274 1118
Facsimile: (08) 9250 3734
E-mail: tower@con.net.au
www: http://www.tower.visionimage.com.au

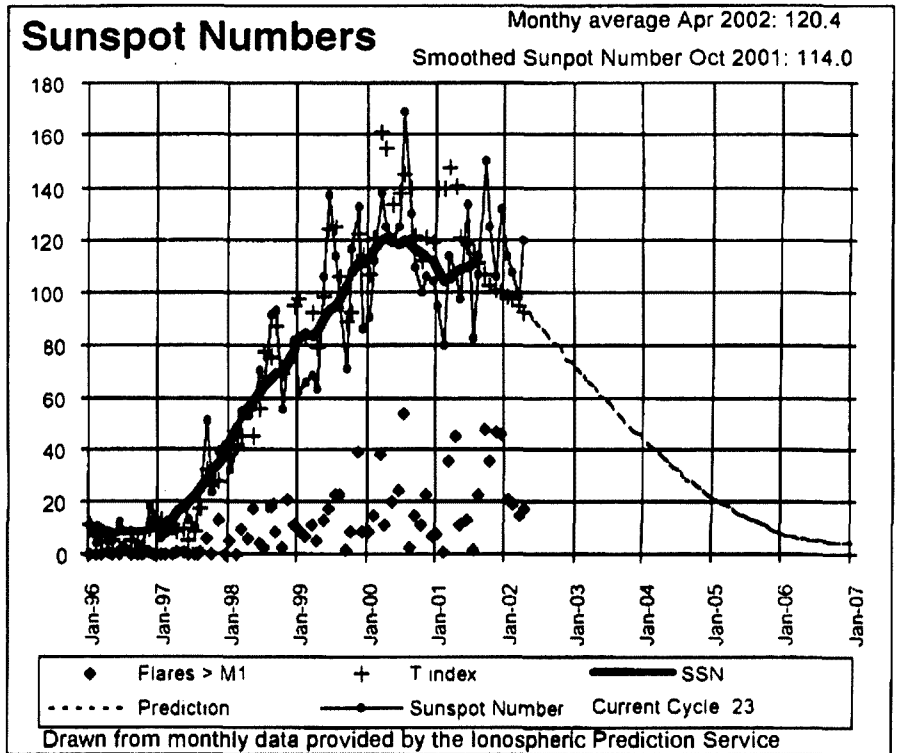

Take Five — Help us to help you

As promised in the last month's AR I take pleasure in including a brief set of survey questions about the WIA and its house journal *Amateur Radio* (AR).

I would be grateful if you could take the time to respond to this survey so that the WIA can better understand how to deliver a quality service to its members, as well as all Australian amateur radio operators.

Completed forms should be returned to me directly.

A copy of this survey can also be found on the WIA web page at www.wia.org.au

All survey responses will be entered into a draw. The first three survey forms drawn will receive a free one year subscription to AR.

Many thanks in advance for your responses

73s from Ernest Hocking VK1LK

1. Are you a current member of the WIA

YES NO

2. Have you been a member of the WIA in the past (If yes, would you please indicate why you have stopped your membership)

YES NO

Comment:

3. Do you subscribe to AR

YES NO

4. Have you subscribed to AR in the past (would you please indicate why you have stopped your subscription)

YES NO

Comment:

5. Would you be interested in a subscription to AR in its current format.

YES NO

6. Would you please indicate what factors would stop you from subscribing to AR:

Print quality Technical content
Cost Other

Comment:

7. Do you believe that the WIA keeps you up to date in amateur radio matters

YES NO

Comment:

8. Do you believe that you are able to have your opinions and views heard by the WIA

YES NO

Comment:

Please return this survey to:

Ernest Hocking
WIA Federal President
PO Box 691
Dickson
ACT 2602

Continues on next page

Separate survey form along this line

9. Indicate how you think the WIA can improve its communications with Australian amateurs.

Comment:

10. Would a electronic subscription to AR be of interest to you? (email or via the World Wide Web)

YES NO

Comment:

11. Are you a currently licenced amateur radio operator?

YES NO

12. Are you an amateur radio operator who currently does not hold a licence?

YES NO

13. Are you interested in becoming an amateur radio operator?

YES NO

14. Is there any specific reason why you do not currently hold a licence?

15. Do you have easy access to the Internet?

YES NO

16. Are you a member of a local radio club?

YES NO

17. Do you currently act in any role in support of amateur radio activities?

YES NO

Role held:

18. Would you be prepared to provide time, or other assistance to the WIA to help other amateurs in the promotion of amateur radio.

YES NO

Comment:

19. Gender

MALE FEMALE

20. Would you please indicate your age

under 20 21—30

31—40 41—50

51—60 61—70

Over 70

If you are a member,

and wish to tell us more about how we can help you feel free to enclose a note.

If you are not a member,

please feel free to include a note about what you see as positive steps WIA could take to better serve amateur radio in general

Only fill in the section opposite if you wish to be in the draw for subscriptions. Name _____ VK _____

If you wish to remain anonymous leave it blank. Address: _____

VK1 Notes

Forward Bias

Peter Kloppenburg VK1CPK

The Trash & Treasure sale at Farrer on Sunday, April 21, 2002 went very well indeed. In fact, so well, that the sausage sizzle was sold out within one hour. Tables and chairs were placed at strategic places so that visitors could enjoy their lunch while observing the goings on. The Long Gully Scouts Group attracted much attention with their sale of surplus to requirements radio gear from the Hughes Centre. Amateurs from all over came to have a look at the stalls, meet old friends, and strike up acquaintances with the younger generation of radio amateurs. The WIA-ACT Division also had a small stall selling Callbooks, Logbooks, and handing out membership application forms and other information regarding amateur radio in the ACT. One item in the sale that created much interest, were the AVO Model 9 multimeters. As they can measure 3000 volts AC/DC, they were a steal at \$25.00. Just goes to prove that owners of linears still want to know what's happening inside these beasts. Those who made an effort to make the Trash & Treasure sale a success were Russell Manning (VK1ZRM), and Richard Gard (VK1RG)

The Division has acquired a valve tester from Lawrence Lawlor (VK1EL), as it was surplus to his requirements. The unit is kept at the Divisional Hamshack in Farrer and will be available for use when general meetings are held.

However, the unit works only on 110 volt ac. Does anyone have a spare 240/110 volt - 50 watt - transformer they want to donate to the Division?

The WIA Federal AGM, otherwise known as the Annual Convention, will occur on 18-19-20 of May in Melbourne. As our President and Federal Councillor, Gilbert Hughes (VK1GH) will be overseas during that time slot; our Vice-President and Alternate Federal Councillor, Phil Longworth (VK1ZPL) will take his place at the convention. At the time of writing this, the committee is busy with discussions about the various motions that have been placed on the agenda, and how to vote on them. We will keep you informed about the result when the minutes of the convention are distributed. The Division is also sending Alan Hawes (VK1WX) as an observer to the convention. Phil and Alan will work together during the very important debates that will result from the various motions that are put to change the future of the WIA, as we know it.

The survey that Alan send out to all the members during the last few weeks has resulted in a much higher response than expected. Almost 60% have responded, and this is very pleasing to the committee. We are hoping that the result of the survey gives a good indication of what the members expect from the Division.

On a different note, an interesting antenna design for a vertical dipole has appeared in the March/April issue of the ARRL's Forum for communications Experimenters, aka QEX. Briefly, the dipole is not split in the middle but is driven by a kind of T-match in the form of a skirt consisting of 2 or 4 copper wires hanging down from the centre of the dipole. Advantage? No ground plane required simple construction, and four nylon guys to hold it up. Now for the good news: For our pensioner members and others on low budgets, you can now have half-yearly membership. When you receive your membership renewal slip, just pay half the annual fee. From then on you will be billed every six months. More Good News! As the Divisional Hamshack is becoming more popular as a meeting place for radio amateurs, Tony Bennett (VK1TB) is setting up a day-time meeting group for senior radio amateurs and those who are retired and don't like travelling at night. The idea is to get together at about 11.00 am, have a snack at lunch time, and depart at about 2.00 pm. Meeting date is still to be decided and depends on feedback. Buses stop every half hour almost in front of the Parks & Garden Depot in Longerenong Street. You can contact Tony by phone on 6258 6418 or via E-mail on: santon@bigpond.net

VK3 Notes

By Peter Mill VK3APO

WIA Victoria web site: www.wiavic.org.au, e-mail: wiavic@wiavic.org.au

Elmer Hall of Fame

A recent Council initiative aimed at recognising the contribution to our hobby of "Elmers". The term Elmer refers to those experienced and knowledgeable individuals who, over the years, have mentored, taught and encouraged prospective radio amateurs and the less experienced operators.

Many of today's radio amateurs can

attribute their involvement and enjoyment in the hobby to an Elmer. WIA Victoria encourages Elmering and believes it is time we paid tribute to Elmers, both past and present.

Members are invited to nominate an Elmer by name and callsign, including silent keys, for induction in the WIA Victoria Elmer Hall of Fame.

Include a short citation of less than 50 words on how the Elmer helped you and

e-mail your nomination to wiavic@wiavic.org.au - put 'Elmer' in the subject line.

Membership Growth

The number of new members joining WIA Victoria is almost double that at the same time last year. Council hopes that some of this increase can be attributed to the new initiatives that have been

implemented over the past months, and that it can be maintained over the coming months.

At a recent WIA Victoria Council meeting 21 new members were accepted. We thank those individuals and club officials who are promoting WIA membership.

WIA Exam Service

There are now 11 clubs that are part of the new WIA Exam Service. An updated list of Examination Team Leaders and their contact details has been put in the Resource section of the WIA Victoria website, and its contents can also be accessed through the WIA Victoria Office.

A check of the list reveals that there are a number of areas within Victoria that do not appear to have convenient availability of an examiner.

Recently appointed Councillor, Jonas Sadauskas VK3VF has been given the job of identifying possible problem areas and reporting his recommendations to the Council.

Club/Group Forum

WIA Victoria will be convening another Club Forum very soon, with Clubs being

invited to submit agenda items. The following items have already been suggested for inclusion in the agenda

- Discussion on the proposed 'Foundation' Licence
- New EMR limits for amateur stations
- The annual availability of special callsign AX3ITU
- Great Australia Science Show 2002
- Classes and Exam scheduling
- WIA Victoria membership conditions for Club Affiliation

Changes for WIA Victoria Council

A number of major changes have occurred. Long serving Councillor, Barry Wilton VK3XV, resigned as Councillor. He had stepped down as Treasurer last December, but remained on the Council during the hand-over period of treasury matters. As always intended, the vacancy created on Council by his resignation, was filled by the new Treasurer, Jim Baxter VK3DBQ.

The Council in reviewing its future decided that due to the lack of suitable candidates, at this time, the Council unanimously ask Jim Linton VK3PC to

continue as President, for the balance of the Council term. Jim VK3PC had announced to the membership late last year his intention to step down as President at this year's annual general meeting. However, at the request of the Council, he will now continue to serve as President until the end of the Council term in 2003. In other developments, two Councillors took on specific tasks. Keith Proctor VK3FT who joined Council late last year is now the Membership Officer looking at ways to increase membership, and retain existing members including the following up members who do not renew their membership. New Councillor, Jonas Sadauskas VK3VF, will monitor the geographic availability of amateur licence exams in Victoria under the new WIA Exam Service. The Council is concerned at the lack of exam teams in some major population centres in Victoria.

In other news from the Council, it is pleasing to learn that WIA Victoria membership remains healthy with double the number of new members when compared with the same period last year and VK3 WIA membership has now exceeded that of VK2.

VK7 Notes

"QRM"

We have been pleased this month to welcome three new members – actually one new and two who have renewed previous memberships. They are K.G. Rappell, VK7YKR, Shane Lynd, VK7KHZ, and Dick van Beek, VK7KVB. Shane was the guiding light behind the VERY successful ARISS contact between the Zeehan State School and the space station last month. We applaud such fine work promoting our hobby. Shane and Dick are two of very few hams on our rugged west coast.

At the Southern branch May meeting they were fortunate to have an informative lecture from Mr John Cole from Hydro Tasmania on the "Basslink" cable project linking Tasmania with the electricity grid of the "island up north". There has been a lot of controversy over whether there should be a simple earth return or a second cable return. It has now been decided that the second

option is best and the project is set to go. The June meeting is an inspection of the Hobart Telephone exchange.

Flinders Island, a much wanted Island on the Air site is becoming more accessible with VK7KPB becoming more active from the island. If any amateur is visiting Flinders don't miss looking him and his XYL Pat up – they are a most hospitable couple. Keep your ears open for a DXpedition in the near future. We are looking to re-activate the "Tassie Devil" net which has been languishing for some time since Bob Jackson on our East coast passed away. Dale, VK3LBJ and Claireen, VK3LCM have been doing a great job of holding it together but it IS a Tasmanian Award and it is about time Tasmanian amateurs took more interest !! It is on 3.59MHz at 8pm EST on Tuesday night. We are investigating a new section in the Devil award for I.R.L.P. contacts.

Experimentation is alive and well in Tassy. Rex Moncur, VK7MO has recently been wandering around the state getting contact on the mainland with Meteor scatter propagation, Very successful too. If any amateurs would like to join him in these experiments contact Rex at his Hobart address. Our "Spectrum" Monday, 7.30pm magazine program from the VK7AX station and broadcast on VHF and 3.59 (+ -) MHz is now in stereo using two of our northwest repeaters. By the time you read this a 7 MHz transmission should be on air.

A very successful combined meeting of the Northern and North-west branches was held at Deloraine one Sunday recently (Hams and their Ladies). Great fellowship and, for people who had not previously seen it, Terry, VK7ZTI, showed the Hydro interactive video of the Northwest Tasmania farm project.

Cheers for now, Ron, VK7RN.

VK4 Notes

Qnews

By Allstair Elrick VK4MV

Kennedy Region Scout Camp Radio Report

Saturday April 13th saw a very large contingent of Joeys, Cubs, Scouts, Venturers and Rovers gather at Camp Tamaroo Bluewater to participate in the Kennedy Region Scout Camp 2002. Many activities were undertaken by the keen youth, some wet and muddy and some to make the gray matter tick. All activities were designed to improve ingenuity and introduce youth to new challenges and concepts. One such activity, conducted twice on Saturday, was the simulation of a typical session of Scouts Cubs On The Air. This is a service, which normally uses the School of the Air frequencies when class is out but this time was conducted on 146.550MHz from a simulated Mount Isa, a simulated Mulga Bush Station and a simulated Nulla Creek Station.

The stations were set up and run by

Steve Watson VK4SGW, Gavin Reibelt VK4ZZ and a band of helpers from the Pimlico-Mundingburra Scout Group and activities always started with the Australian National Anthem and the Scouts Prayer followed by directions on drawing a map, knot tying, active games, the story round and noughts and crosses - all done via radio!! Participants had to use their imagination a bit including the groups moving between each station as "aircraft flights full of new station hands heading out into the bush". Everyone enjoyed the sessions and the equipment performed well.

The next radio-scouting activity will be the activation of the Tropical North Queensland Museum on 15-16 June for the International Museums Weekend.

Flying Pollie!

Amateur radio operators on the 20-metre band had the opportunity last week to work a rare call in an equally rare

situation. Peter VK4TO, on a flight to RAAF Edinburgh, (with permission from pilots and flight crew), used some borrowed equipment to activate his callsign after a long absence from the HF bands to operate aeronautical mobile. Peter, a past president and current member of the TARCinc, is the Federal Member for Herbert in the Parliament of the Commonwealth of Australia, recently appointed Deputy Speaker for the Federal House of Representatives and has involvement in a number of subcommittees dealing with defence and development.

Peter is also planning a bit of a rare event for amateur radio operators in the Australian national capital in the near future. He can't divulge what the event will be, but it will be unique, a first, and it will be on the 2-metre band. So VK1's in Canberra, here's plenty of notice - keep an ear out for VK4TO!

Cable, Connectors, Tools



- RG58C/U Belden 8259 @ \$0.90 per metre
- RG213/U Belden 8267 @ \$4.45 per metre
- RG8/U Belden 9913 Low Loss @ \$5.15 per metre
- RG8/U Belden 9913F7 High Flex Low Loss @ \$5.55 per metre
- RG8/U - RF400 Belden 7810 Low Loss Sweep Tested to 6000MHz @ \$6.30 per metre



- RG58: B80-006 UHF connector (M) @ \$7.65 each
- RG8/213: B80-001 UHF connector (M) @ \$8.80 each
- RG213: B30-001 N connector (M) @ \$9.10 each
- RG8: B30-041 N connector (M) @ \$14.00 each

TOOLS

- Coax Cutters: C.K. @ \$40.00 each
- Strippers: ● Ideal - RG58 @ \$33.00 each
- RG8/213 @ \$53.00 each

- * All prices include GST
- * Minimum order value \$50

payable by Visa, Mastercard, Bankcard or Money Order

* Packing and Delivery \$15 within Australia (Outside Australia P.O.A.)



ABN: 62 088 051 030

email - sales @elektron.com.au or Phone: (03) 9761-3207
Elektron Pty Ltd, Unit 2, 14 Melrich Road, Bayswater, Victoria 3153.

Cellular telephones to the rescue

It seems that the amateur radio satellite fraternity is to some degree indebted to the skyrocketing use of cellular telephones.

Any long-term operator who has used the mode B and J birds over the years will be familiar with the particular kind of QRM emanating from illegal transmitters located to our north. I can recall falling victim to such interference back in the AO-6/7/8 days when we ran the annual Mt Skene expeditions. It was most annoying and sometimes ruined the early minutes of passes coming in from (or going out to) our north.

Recent reports seem to indicate that the situation has eased somewhat and the help has arrived from a most unlikely source, the increasing use of mobile (cellular) telephones. The interference came (and still comes) from illegally operated taxi radios, mobile and base,

fishing boats and their base stations and small businesses talking to their mobiles and hand-helds in Asian countries to our north. These folk had found that amateur radio equipment was cheaply and freely available and that policing was nearly non-existent. It was open-slatheer - spectrum anarchy - and it prevailed for many years.

Lately, it seems that the ubiquitous mobile phone has taken over and is providing many of these folk with a cheaper and more reliable service. A mobile telephone would certainly be more robust in the hands of the casual user than, say an IC-735. Our friends in the USA have suffered with us on this

front. Their problem came from the South American countries where spectrum anarchy also reigned. Recent discussions on the Amsat bulletin board have told of modes B and J becoming usable again in Japan and in southern USA and South America. If this trend continues we could see satellite designers taking it into account when planning frequencies for future amateur radio satellites. They are and always were popular modes, particularly for beginners. In recent years these bands had all but been abandoned by the planners as more and more countries reported the 2m and 70cm bands being almost unusable.

Mark Shuttleworth in space

On 27th April it was reported that the second "Space tourist" Mark Shuttleworth of South Africa had arrived at the International Space Station.

With two other visitors he travelled to ISS aboard a replacement Soyuz "lifeboat". During his short stay Mark was expected to speak to radio amateurs and operate some South African micro-gravity research projects. Shortly after Mark's arrival on the ISS, Tony VK5ZAI, Australian ARISS Co-ordinator was

woken by a phone call from the USA at around 2:15 am and asked if he could be on air within 3 minutes to link a school in South Africa to Mark Shuttleworth on the Space Station. The schedule they had arranged locally had fallen down and they were in a real spot

as several hundred children had been bussed in for the contact. With Tony's help, via the "telebridge" system the event went ahead and Mark was able to speak to the school-kids as planned. The contact received good coverage in the South African press.

Starshine Satellite re-enters

The third in the series of small "mirror-ball" satellites designed to be tracked by schoolchildren around the globe re-entered Earth's atmosphere on Friday April 26th, ending the mission after just over four months in space.

Its expected 8-10 month lifetime was cut short by unusually heavy solar activity. Dubbed Starshine-2 (even though it was the third in the series, see below), the one metre diameter mirror-ball satellite was deployed from shuttle Endeavour during its mission to the space station last December. See the following web site for more details, <http://spaceflightnow.com/news/n0204/27starshine/> Although called Starshine-2, this satellite was actually the third to be launched. Following on from the success of Starshine-1, Starshine-2 was

scheduled and "locked into" a launch spot on the shuttle Endeavour on its trip to the ISS in December 2001. This launch went ahead as planned ... but ... meanwhile, back at the ranch ... due to an unexpected launch opportunity; Starshine-3 obtained an earlier launch and was lofted into orbit as a secondary payload on a Canadian Kodiak launcher in September 2001. Thus the sequence went 1, 3, 2. Starshine-3 is still in orbit although its spin rate is slowing.

Starshine officials say they are preparing another pair of spacecraft for

launch aboard shuttle mission STS-114 in early 2003. As an interesting 'aside' to this story, could I again ask if anyone out there has actually seen any of these satellites? Yes, they had telemetry transmitters in the amateur radio satellite bands but their primary purpose was to be *seen*. Hundreds of school-kids spent thousands of hours polishing the aluminium mirrors so they could see them reflecting the sun's light from space during the morning and evening twilight hours. No one in my group of satellite-watching friends managed to see any

sign of either Starshine 2 or 3. This despite many determined efforts on dark evenings when it *should* have been visible. In fact only one of the group ever

saw Starshine-1 and that was for just a fleeting few flashes on one orbit. Being "seen" was the primary purpose of this series of satellites.... but reports of

sightings seem to very thin on the ground. Perhaps children have better eyes than most amateurs ... hi.

Trans-Atlantic contact using AO-40 K-band downlinks

Mike, N1JEZ has announced what may well prove to be a milestone contact.

Here is a summary of his message posted on the AMSAT bulletin board on 8th May 2002. "I'd like to report a successful trans-atlantic contact this morning with K-band downlinks at both ends between Charlie, G3WDG and (myself) Mike, N1JEZ. First, I'd like to thank Charlie. This particular orbit was not the best in Europe. His super system made things easy. Contact was first established shortly after MA 114. Charlie and I had a very pleasant QSO throughout the window". Details of this contact including sound files of the QSO and pictures of the equipment used can be found on Mike's web site <http://members.aol.com/mike73>

Now, K-band, (24 GHz) may not be everyone's cup of tea but this contact shows that the spirit of adventure is not dead in amateur radio. Even terrestrial contacts on this band are rare and usually involve months of preparation and state-of-the-art gear. Such contacts are by no means trivial. As well as equipment considerations, many orbital and atmospheric conditions need to be met before a successful *satellite* contact can result. It demonstrates the great fortitude of the operators and vindicates the foresight of the AO-40 design team for having included K-band in the design of AO-40. Pioneering folk like Mike and

Charlie are to be congratulated for venturing where few will dare to tread. There have been some other reports of the beacon being heard and of contacts being made. It was only on 14th April that Mike reported to the Amsat News Service that with "a great deal of excitement I'd like to report successful reception of the AO-40 Mode K beacon." Signal levels peaked at S-3, using a 0.5-meter dish with a linear feed. Congratulations guys, this must be about as close as it gets to the "cutting-edge" as far as amateur radio is concerned.

RS-21 - a short-lived but successful educational satellite

On 4th May Alex Papkov of the Kaluga Ground Control in Russia reported to the Amsat News Service that RS-21 had re-entered the atmosphere.

The ground station calculations gave its atmospheric re-entry as being during orbit 711, somewhere above the Pacific Ocean. "Thus, the micro-satellite Kolibri-2000/RS-21", he reported, "had successfully completed its planned operations". He went on, "We consider all aspects of this mission to have been a success. Collaboration between Australian high school students, Russian

Space scientists and Russian high school students has been a highlight ... (of the mission)". The satellite's formal name was the Russian-Australian Scientific and Educational Micro-satellite. Radio Sport RS-21, was remotely launched on March 20, 2002 from a Russian Progress M-1-7 launcher. During its relatively short lifetime, RS-21 transmitted

telemetry data and digitally recorded voice messages from its almost circular orbit just over 200 miles above the Earth. The very low altitude was probably the main cause of its short life in space. More information about the satellite can be found at:

<http://www.arrl.org/news/features/2001/12/16/1/>

The AMSAT group in Australia.

The National Co-ordinator of AMSAT-VK is Graham Ratcliff VK5AGR. No formal application is necessary for membership and no membership fees apply. Graham maintains an e-mail mailing list for breaking news and such things as software releases. Members use the AMSAT-Australia HF net as a forum.

AMSAT-Australia HF net.

The net meets formally on the second Sunday evening of the month. In winter (end of March until the end of October) the net meets on 3.685 MHz at 1000utc with early check-ins at 0945utc. In summer (end of October until end of March) the net meets on 7.068 MHz at 0900utc with early check-ins at 0845utc. All communication regarding AMSAT-Australia matters can be addressed to:

AMSAT-VK,
GPO Box 2141,
Adelaide, SA. 5001.
Graham's email address is:
vk5agr@amsat.org

French amateur "Pico-satellites" launched along with SPOT 5

This will be old news by the time you read it but it is included for archival purposes.

AMSAT-France announced around the time of writing that two French amateur radio picosats are planned to be launched as secondary payloads with the SPOT 5 satellite.

Ariane 4 flight V151 carrying SPOT 5 and IDEFIX amateur payloads is planned the 3rd May 2002. The two picosats, designed, built and funded by AMSAT-France are battery powered and should work for about 40 days. They will remain fastened to the third Ariane 4 stage, which is planned to orbit 800 km

high. Both picosats will transmit NBFM voice recorded messages and digital telemetry data, the first one on 145,840 MHz and the other one on 435,270 MHz. Telemetry data will be transmitted using the now standard Amsat format 400 baud BPSK. Both picosats should be switched on about ten days after the launch. Who knows, they may even survive until you read this column.

Next month I will include the six-monthly summary of all currently operational amateur radio satellites.

How's DX?

Ross Christie, VK3WAC
19 Browns Road, Montrose 3765, Vic.
Email Vk3wac@aol.com

How will my new 160m antenna fair with the new EMR regulations?

The Shortie

A month or so ago I erected a 160m antenna based on an old design by Doug De Maw, W1FB.

The antenna was called 'The Shortie' and was described as inductively loaded top and bottom (the bottom inductor being tapped for fine-tuning), 60 feet long with dual conductors for the radiator spaced 1 foot apart to widen the bandwidth. After constructing the antenna and hauling it up into a tree I was pleasantly surprised that it was almost resonant straight off. For a radial system I ran out three 60 foot radials and four 30 foot radials (laid out as best would fit in my backyard) and bonded them to the post and wire fences. Using this radial system the antenna resonated at 1885kHz with an SWR of 1.8:1 and with a 2:1 SWR bandwidth of 70kHz. It obviously needed lengthening so I took a guess and added 6 feet to the length of the radiator hoping that it would be enough to bring it into the VK allocation on 160m. The guess of 6 feet was a good one and it brought the resonant point down to 1835kHz. The bandwidth stayed almost the same. That evening I

managed to work Tom, W8JI and was impressed when I received a 569 from him. I also worked a few VK4s and VK2s who also gave me good 579 and 599 reports. Since then I have managed to work VK9ML and K1B on it as well as a fair number of other VKs. The winter months are fast approaching and are traditionally the best months for DX on this band so perhaps the best is yet to come. I also wonder how my new 160m antenna will fair with the new EMR regulations?

EMRs

The ACA will introduce new Electromagnetic Radiation (EMR) regulations on the 1st of July and if the current proposal is anything to go by it is likely to have a significant impact on amateur operations.

At the time of writing the ACA has not yet finalised the details of the document and is still adding amendments though it seems that we will all be expected to comply with one of two levels of compliance. Having read some of the

available details on the subject I suspect (and this is a personal opinion) that a large number of us will be at risk of contravening the EMR guidelines in one way or another. The tightening of the EMR regulations in the US and Europe led to many amateurs falling foul of city/council planners when erecting antennas and amateur stations that had been operating effectively for years found themselves at odds again with neighbours (who still had an axe to grind) who gladly used the EMR regulations as a new weapon.

We shall have to wait and see what lies in store for us but it would not surprise me in the least if the antenna installations at a significant number of QTHs fail the physical separation requirements. Mind you, the new regulations may be just the impetus some of us need to get that antenna up into clear air to catch that elusive bit of DX!

Tighter restrictions on operations can only mean further bad news for amateur radio so perhaps we had better get on the air and work some serious DX while we still can.

The DX

CN2PM, MOROCCO. Peter, G3WQU (ex E4/G3WQU), will be based in Laayoune (Western Sahara under Moroccan Administration) for the next couple of years. He says he will be active mainly at the weekends using CW and PSK31. QSL to Peter McKay, MINURSO, P.O. Box 80000, Laayoune, Western Sahara, Morocco. [TNX CN2PM and 425 DX News]

FR/T, TROMELIN ISLAND. Jacques, FR5ZU, intends to be active on all bands using SSB and RTTY using the call FR5ZU/T. As he is working on Tromelin

his times of operation will need to fit in with his off duty hours, the best times to catch him will be between 0200 – 0400, 0900 – 1000 and 1300 – 1500 UTC. QSL to Jacques Quillet, 1 cite Meteorologique, Le Chaudron, 97490 Sainte Clotilde, France. [TNX F5NQL and 425 DX News]

VP8, FALKLAND ISLANDS. Less, GM3ITN, will be visiting the Falkland Islands for a few weeks and will operate as VP8ITN from Saunders Island in the Falklands group from the 15th until the

22nd of June. QSL direct to Less Hamilton (GM3ITN), Halls Land Hardgate, Clydebank Glasgow G81 6NR, SCOTLAND - U.K. [TNX GM3ITN and The Daily DX]

VQ9, CHAGOS ISLAND. Jesse, AB5RY, will be stationed here for quite a while and expects to spend another four months here on duty with the U.S Air Force. Activity has been on all bands using CW and SSB. QSL direct with a SASE to K5QM (CBA). [TNX AB5RY and OPDX]

IOTA Activity

C6, BAHAMAS. John, WZ8D, will be spending some time operating as C6AIE from Abaco Island (NA-080) in the Bahamas from the 3rd until the 13th of June. His main activity will be on 6 and 2 metres but will also spend some time on HF. QSL direct only to John Walker, WZ8D, 1930 Meredith Ln, Loveland, Ohio 45140, USA. [TNX WZ8D and 425 DX News]

JA, JAPAN. JI1PLF/1, 7N1GMK/1 and 7L4PVR/1 announce that they will be active from Hachijo Island (AS-043) from the 7th until the 10th of June. Bands will be 160 – 10 metres CW, SSB and RTTY. QSL via their home calls either

direct or via the JARL bureau. [TNX JI6KVR]

JA, JAPAN. JO1EPY/6 will be active from Kuchinoshima, Tokara Archipelago (AS-049) on 6, 10, 12, 15, 17 and 40 metres using CW and SSB over the period of the 8th until the 10th of June. QSL via home call either direct or through the bureau. [TNX JI6KVR]

SV, GREECE. Dimitris/SV2CCA, Chris/SV2DGH and Giannis/SV2FPU are travelling to Alonissos Island (EU-072) and will be active from the 2nd until the 16th of June. The group will be using the callsign J48ALO and plan to operate

on 80 - 6 metres using CW and SSB. QSL via SV2DGH. Logs will be available at <http://www.qsl.net/sv2dgh> [TNX SV2DGH and 425 DX News]

VE, CANADA. Linda, VE9GLF and Len, VE9MY have plans for a trip to St. Pierre & Miquelon (NA-032) sometime around the end of July. They will be active on most HF bands and will also enter the IOTA Contest. Linda says, "We understand that there is a large demand for this one from Asia and Oceania", so lets not disappoint them. They will keep us informed with more info to follow. [TNX VE9MY]

Special Events

Those into soccer will be aware that Korea and Japan are hosting the FIFA World Cup soccer tournament. What you may not know is that both countries will have a number of special event stations on air to commemorate the games.

Korea will have a pre-event station on air using the call HL17FWC until the end of May. This will be followed by another ten special callsigns (one from each of the Korean call areas) that will be active during the games, from 31st of May until the 30th of June. These will be;

- DT1FWC in Seoul
- DT2FWC in Busan
- DT3FWC in Daegu
- DT4FWC in Incheon
- DT5FWC in Gwangju
- DT6FWC in daejeon
- DT7FWC in Ulsan
- DT8FWC in Suwon
- DT9FWC in Jeonju
- DT0FWC in Seogwipo.

Individual Korean operators will be able to substitute the number 17 for there normal callsign numeral. There will also

be a number of special awards available for these events and further details can be had from DS1BHE at centaurs@hitel.net The QSL route for all special event stations is via HL0HQ. For more information go to <http://fifaworldcup.yahoo.com/en/da/>

Japan will also mark the games by activating ten special callsigns; 8M1C, 8N1C, 8J1C, 8J2C, 8N3C, 8J3C, 8J6C, 8J7C, 8J8C and 8J0C over the period of the 1st of May until the 30th of June. Local hams will be manning the stations, with support from the JARL, and will be allowed to run 1kW. An award called the '2002 Suffix C' will be available to everyone who works one or more of these stations. To claim the award no QSL's will be necessary, simply send a list specifying the date, band and mode to the JARL Award Desk, 1- 14 - 5, Sugamo, Toshima-ku, Tokyo 170-8073 Japan. The fee is eight IRCs or \$8 U.S. or 1,000 Japanese yen. Awards will be available for the following categories, single band, single mode, QRP/QRPp or satellite. Further information can be had

by Email at oper@jarl.or.jp.

The International Lighthouse and Lightship Weekend will begin this year at 0001 UTC on Saturday the 17th and finish at 2359 UTC on Sunday the 18th of August. Like every other year, this event is not a contest. It is simply a chance to get some operating done from an interesting location and to have some fun while we're at it. There is no requirement to be on for the whole weekend, it doesn't need to be a fully fledged operating campaign nor should it be a race to work as many stations as possible. The whole idea is to have fun and to provide contacts for young, old, experienced and new hams alike. The only requirement is that the station is set up near to a lighthouse, lightship or maritime beacon. Information to be included in QSO's is RST, QTH and the ARLHS number of the lighthouse (this can be obtained from arlhs.com/awards/arlhs-numbers.html). If you plan to join in the fun you can download an entry form from vk2ce.com/illw/index.html

DXpeditions

CY9, St PAUL ISLAND. Operators W7XU, N0QJM, W0SD, W0OE, WV2B, VE1AAO and VE9DH will be active from St. Paul island over the period of the 29th of June until the 8th of July. The group will man two fulltime stations and a third part-time during peak propagation. The camp will be set up on the west side of the island where it will have a clear take-off towards Asia, South America,

North America and most of Europe. This will be the first time that operations have taken place from this side of the island because landing is difficult due to the winds and high seas. A 6 m station using CW and SSB, running 1kW to a yagi antenna, will be operating on 50157 kHz listening up. Liaison will be on 28885 and updates will be available via Email on the 6 m site. On HF the team will use

a 'Hex' beam for 20 to 10 metres and vertical for 30 m and 40 m. No operation will take place on 80 m or 160 m. HF modes and frequencies will be RTTY, SSB and CW on 7080, 10115, 14080, 18080, 21080, 24908, 28080, 7005, 10105, 14020, 18100, 21020, 24900, 28020, 14195, 18145, 21295, 24945 and 28495. QSL via W7XU. [TNX W7XU and The Daily DX]

Round up

Hans, L40370, has had a keen ear on the bands lately and has managed to catch XV2J whom he says is a bit of a regular on 15 m CW between 0600 and 0700 UTC. Hans also managed to log the following,

Call	Band	Mode	UTC
HL17FWC	15m	CW	08.00
(QSL via HL0HQ)			
RW1AI/ANT	15m	CW	07.00
OH0/OH3TM	17m	CW	13.45
JA1KJW/JD1	20m	CW	14.30
9J2CA	20m		
5H3RK	30m		

The special callsign IU7LE will be activated on weekends from June until December. The 'Leece and Salento DX Team' will be celebrating 75 years of National A.R.I. The team will be active on all HF bands, including WARC, using CW and SSB. A special QSL card will be available via I7PXV via the bureau or direct. [TNX I7PXV and The Daily DX]

UR, UKRAINE. The special call EM11E (Echo Mike One One Echo) will be aired from various Ukrainian islands between the 1st of May and the 31st of August. The islands are located in the river Dniper, in the Sea of Azov and in the Black Sea. Only the islands in the Black Sea may count for IOTA. QSL via Alexander Shevchenko, UR5EAW,

Pelina str. 29, Dnepropetrovsk 49107 UA, Ukraine. [TNX UR5EAW and 425 DX News]

Paul Pai, BV4FH, reports receiving the formal authorization and documentation for the upcoming BQ9P Pratas Island DXpedition planned for later this year. The operation is expected to take place between the 4th and 13th of June. [TNX BV4FH and The Daily DX]

The Russian Lighthouse Award (RLHA) is a new award and is sponsored by the Russian Robinson Club. A copy of the rules, list of lighthouses and more information can be found at the website <http://www.hamradio.ru/rrc/rlha/> [TNX VA3RJ and 425 DX News]

From the 20th of April Argentinian amateurs whose calls begin in the LU, LW and AZ prefixes have been allowed to use alternative special prefixes. LU can use AY, LW can use L5 and AZ can use L6. The prefix change is to celebrate the 25th anniversary of GACW (Grupo Argentino de CW) and to support the program 'Amateur Radio, a safe way for our children' (perhaps the translator had a little difficulty?) which is sponsored by GACW and by the Radio Club USHUAIA (LU8XW). Further details are available at the Web site <http://geocities.com/rcushu> [TNX OPDX]

An RSGB news report says that for the month of June only all UK stations can use GQ as their prefix instead of their normal prefix. For example; G4BWP can sign GQ4BWP, GM3ITN = GQ3ITN, M0BDW = MQ0BDW, M10BME = MQ0BME and 2E0ANY = 2Q0ANY [TNX RSGB]

If you do a lot of travelling and would like to operate while you are overseas then a new website compiled by Veke, OH2MCN, will be of interest to you. Veke has collected data on what documents and information etc is required to satisfy the communications authorities of over 250 countries. The website can be found at <http://www.qsl.net/oh2mcn/license.htm> [TNX OH2MCN and 425 DX News]

And finally, everyone who has managed to work Ed, P5/4L4FN will be pleased to know that their QSL card is in the mail (or at least the bureau).

Sources

Many thanks to the following individuals and organisations for the information in this months DX Notes.

L40370, F5NQL, GM3ITN, AB5RY, WZ8D, JI6KVR, SV2DGH, VE9MY, I7PXV, GN2PM, UR5EAW, BV4FH, OH2MCN, VA3RJ, W7XU, The Daily DX, RSGB, OPDX, 425 DX News

Silent Key

Hugh Lloyd, VK5BC

Hughie Lloyd was born in 1917, and grew up in the inner suburb of Hindmarsh.

He and his brothers, Bill and Charlie, became amateurs in their 'teens, and there was often rivalry for space to set up new equipment.

Hughie's first job was as a radio engineer for Adelaide radio station 5DN.

In 1942, he moved to the South Australian Riverland to work for radio 5RM. The residence, studio, and transmitting station were all together on the top of a cliff overlooking a bend in the River Murray, midway between the river towns of Berri and Renmark.

Hughie's six children grew up on the property, in an establishment where "all lived and breathed radio."

5DN's lease over 5RM expired in 1952, so Adelaide station 5KA took over the ownership. Hughie continued with his

radio engineering duties until about 1980, but continued in his retirement with his first love, amateur radio.

When 5KA decided to move the 5RM Transmitting site, Hughie negotiated skilfully to ensure that the existing giant masts stayed put. He thus ended up with one of the best antennae farms in the state.

The wider family, and friends of all sorts, would visit the old stone house on the cliff-top. Stories of snakes in the toilet, good fishing, the 1956 flood, and clean (!) Murray water still circulate amongst the family and friends.

Hughie created a considerable collection of home brew gear of all sorts. Only he knew the secret of how they all worked, but each was skilfully and professionally constructed.

He was a winner of the Ross Hull Contest, was active on HF and held

various Australian 6 metre records for many years.

The Amateur Radio fraternity owes a great debt to him, as he tutored many in CW and the technical side of the hobby.

His burial service was held on April 29th, at the Berri Cemetery.

Amongst the large crowd of family, friends, and fellow amateurs, were Lorry Sjoberg (now with radio 5MMM), and Rick Palmer, (representing the Golden Years of Radio.)

We gathered there to say "73" to a man who was a patriarch in the South Australian Riverland, radio broadcasting, and one of the greats of our own great hobby.

Our heartfelt condolences to his wife, Dorn, his children, and to his wider family.

John Elliott VK5EMI

Email : dellio2@bigpond.net.au

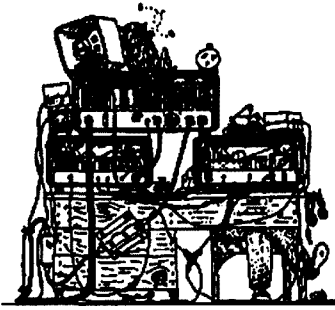

Part 15 Windows XP Review

Few Microsoft Windows™ users have not suffered “blue screens”, lock-ups, and configuration problems with their Ham Shack Computers. Every version of Windows has been subject to worldwide criticism. However, the extent of these problems has been difficult to target because of the myriad of software and hardware in general use. It is quoted that Microsoft Windows XP is the most reliable operating system available on the market today. So, let's look closer.

Radio Amateurs like to fiddle with their computers, they try new software especially for the popular data modes. Installation swamps the hard drive with hundreds of unusual files. Once tried, the software is uninstalled only to leave many files lurking around inside the operating system that can cause problems!

Over time, the operating system reads some of these files resulting in unrelated commands that confuse the system and the computer crashes or just locks up for no apparent reason. “But why?”

Today's software is written for 16-bit or 32-bit FATs (File Allocation Table), and because each package is written in one of these modes we all expect the program to work. Newer MS Windows NT (New Technology), Windows 2000 and Windows XP (XPerience!) use alternate NTFS (New Technology File System) adding another dimension to our woes. Take a look at any software package and its specification describes the type of operation system that is most suited. Each version of Windows also includes “backward compatibility” which means although it might be a 32-bit operating system, it will run 16-bit software. Confusing when NTFS is added to the equation. Most RAs don't want to know about all this “compatibility stuff” – they just want to get on with using their computers, working DX and eliminating “blue screen” problems forever.

Development History

In 1990, Microsoft released Windows 3.0 that was quickly superseded by Windows 3.1 because of problems. Later, Windows 3.11 was born and the world settled down to some degree of reliability using 16-bit applications. In 1994, Windows 95 was promised as being the answer. However three major updates by Microsoft failed to produce a stable operating system. 1997 saw a revamped Windows 95 called Windows 98. Within weeks, Microsoft realised it had got things wrong yet again and posted a fresh copy of Windows 98 (Second Edition) to every registered user of Windows 98. In parallel with all this fumbling, Microsoft had developed Windows NT, using native core NTFS, for professional use and it found success for the first time.

Hence, in 2001 Microsoft enhanced the best attributes of Windows 2000 and NT into their latest offering of Windows XP. Along the way in 1999, Microsoft released Windows ME (Millennium Edition) seemingly Windows 98SE with

a “resprayed front panel, new 6146Bs in the finals and nice shiny knobs” and – you guessed it - more bugs!

Hardware History

Since the dawn of MS Windows, and the subsequent updates along the way that introduced more “bloatware” (bigger and more files in the operating system), the hardware manufactures were having a ball with users trying to upgrade their computers just to keep up with the software. Gone were the days when clever authors tried to write effective, bulletproof applications that were reliable and fitted on one floppy disk. We've all been caught out in the continuous spiral of upgrading hardware and software. Windows XP is supposed to be the answer. Issued in August 2001, XP is already subject to more upgrades.

Windows XP Requirements

If your Ham Shack Computer has LESS than the following specification – stick with Windows 98SE for now.

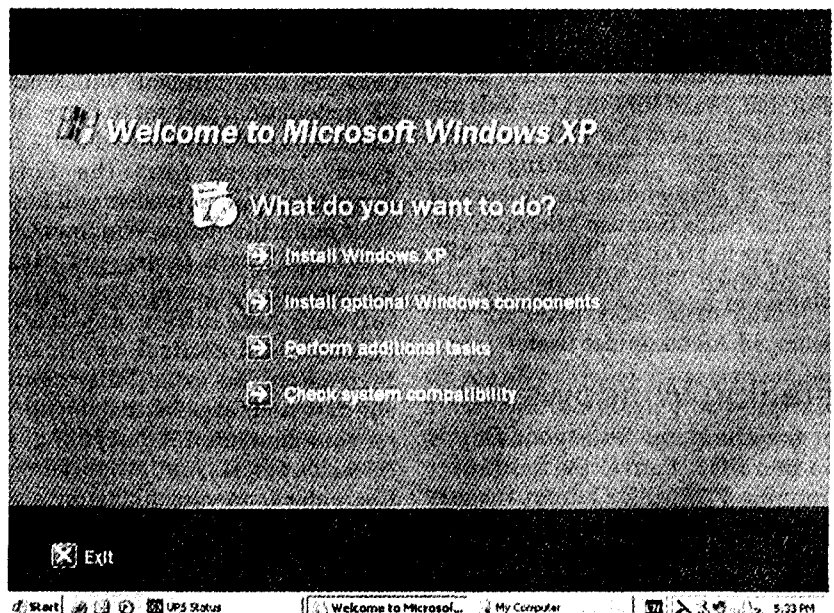

- 500MHz processor (Celeron, AMD Duron, Pentium II/III) minimum.
- 128 MB RAM, 256 preferred.
- 40GB Hard Drive minimum.
- High speed CD-ROM drive.
- BX or higher, PCI PnP Motherboard.
- USB and Serial/Parallel ports.
- High Speed PnP Modem and an Internet Account with your local ISP.

Ready for Windows XP?

XP comes in two flavours. The XP Home Edition and the more expensive XP Professional Edition both vintage August 2001 and each require immediate online authentication and upgrades! Subsets are the full versions and the upgrade versions. Most RA's will opt for the XP Home Edition Upgrade on CD-ROM.

Next, prepare a new floppy disk with your Windows 98SE boot files, CD-ROM install files including COMMAND.COM, FDISK.EXE and FORMAT.COM etc. NEVER EVER install Windows XP as an upgrade otherwise you will be stuck with all your old unidentified files wandering around your new XP installation. If you do, prepare yourself for more frustration because it will ultimately fail and you're back to square-one before the upgrade!

You will need the original Windows 95/98/2000/NT/ME CDs before starting (including the key number), AND ALL your software disks ready for a "clean install". It's assumed that you were wise enough to have backed up ALL your DATA FILES as described in earlier issues of this series. Include some scrap paper for notes, and allow at least one full day's grind to fully setup and get your Ham Shack Computer fully operational. Make sure that the kids are out for the day, and the XYL has some videos to watch in the sitting room. Lashings of sandwiches and plenty of coffee also helps because Microsoft say that you are in for an EXPERIENCE (XP). They are dead right here because it's NOT going to be easy even for our XPerienced AR computer users!

Installing Windows XP

Boot the computer from your floppy drive into DOS. Format the hard drive by running FORMAT C: from the A:\ prompt. Note that all data will be erased in readiness for a "clean install of XP". Once done, boot again and check the BIOS by holding down the DEL key on

the keyboard. Reboot again and let the computer identify the CD-ROM drive as DRIVE D:\ Insert your Windows XP CD-ROM that will AutoPlay bringing up the image shown on the previous page. Select "Install Windows XP" and follow the instructions on the screen when displayed. During the installation you will be asked to insert your previous version of Windows to verify that the installation is legal. Once done, another prompt asks for the Windows XP CD again to continue the installation. When asked to select which type of file system you prefer - SELECT NTFS, then continue. Some 350MB later your computer will boot into Windows XP and you're done (for now anyway, Hi).

Authenticate Windows XP

EVERY NEW INSTALLATION of XP must have online authentication before the user can continue with "their XPerience"! To do this, install your modem and configure the ISP connection from the Control Panel. Place a shortcut on the desktop and connect. Once connected, select START > Help and Support Center > Authenticate XP. A displayed message soon indicates that Microsoft has accepted your installation. Many readers will not be happy with this process but that's the system most modern software developers now use to protect their copyright interests and combat piracy. From now on Microsoft will invite you to update your system for FREE. If you lend your copy of XP to a friend then prepare yourself for legal action by Microsoft Corporation.

Installing your Software

Once you have "fiddled" with your new XP installation, and got to know how it "looks and feels", then tried the "Classic View" options from the Folder> Properties Options, readers will find that XP is much like earlier Windows Classic View but much faster and cleaner. Systematically install your favourite software like office applications, logbook and control applications, DigiPan and so forth. Fully configure and test each application as you work on your computer. If everything works correctly, press on until your Ham Shack Computer is to your liking once again. In most cases you will have to update your component drivers. These include Zip Drives, Scanners, Cameras, and any non Plug and Play devices. Windows

seeks "signed drivers" but most Win 2000/NT drivers will work very well under XP. To complete the fine-tuning of Windows XP and all your programs it will take several weeks of operating, moving ahead each time with small changes. For networked users, XP is a dream running TCP/IP instead of NetBEUI, and XP makes a fine server on your Home Network.

Conclusions

But is it worth the time and money for RAs to upgrade to Windows XP? Yes it is, provided you do a clean install and have the hardware grunt to support NTFS. The writer has had very bad "XPeriences" with over-the-top upgrading where XP has failed miserably. But starting from scratch, a clean install works well and the "blue screens" have hopefully taken their place in the pages of history. Over the last three months, the writer has tested many popular AR applications and every one has performed without fail, which was not the case when the writer was using Windows 98SE.

Ham Tip No. 15.

Before venturing towards Windows XP, do some serious reading and carefully back-up all your data files. *The Windows XP Pocketbook* published by ACP Publishing Pty Ltd (ISBN 1863962530) is available at newsagents for \$19.95 and comes highly recommended. It's understandable and more comprehensive than the Microsoft so called "booklet" included with the Windows XP box package. The Pocketbook covers all the common steps needed to really get things moving quickly, and includes a CD-ROM with common drivers and other applications to streamline your new MS Windows XPerience!

Ham Shack Computers, No: 16 for next month, - "Hard Drive Crash", follows on nicely from this Windows XP Review. Many of the rules are the same. If you've have ever experienced a Hard Drive Crash, you will understand why every AR operator MUST be prepared because, just like the HoleProof™ UnderDaks commercial on TV - "one day yer gunner get caught wiv yer pants down"!

(1) Ham Shack Computers Web Site:
<http://www2.tpg.com.au/users/vk6pg>
 73s de Alan, VK6PG

Contest Calendar

June – August 2002

June	1	VK/trans-Tasman Contest		(May 02)
June	1/2	South American WW CW Contest		
June	8	QRP Day		(Apr 02)
June	8/9	ANARTS WW RTTY Contest		
June	8/9	Queen Elizabeth II Golden Jubilee Contest	(CW/SSB)	(Apr 02)
June	8	Asia-Pacific Sprint	(SSB)	(May 02)
June	15/16	Novice Contest	(CW/SSB)	(May 02)
June	22/23	SP QRP Contest	(CW)	
June	22/23	Marconi Memorial HF Contest	(CW)	
June	22/23	ARRL Field Day	(All modes)	
July	1	RAC Canada Day Contest	(CW/SSB)	
July	6/7	Internet 6 metre Contest	(CW/SSB)	
July	13	Jack Files Contest	(All)	(Jun 02)
July	13/14	IARU HF World Championship	(CW/SSB)	
July	20	Pacific 160 Metres Contest	(CW/SSB)	(Jun 02)
July	27/28	Russian RTTY WW Contest	(RTTY)	
July	27/28	IOTA Contest	(CW/SSB)	
July	27	Waitakere Sprint	(SSB)	
Aug	3	Waitakere Sprint	(CW)	
Aug	3	European HF Championship	(CW/SSB)	
Aug	4	YO DX Contest	(CW/SSB)	
Aug	10/11	Worked All Europe DX Contest	(CW)	
Aug	17	SARTG WW RTTY Contest	(RTTY)	
Aug	17/18	Keymen's Club of Japan Contest	(CW)	
Aug	17/18	SEANET Contest	(All)	(Jul 02)
Aug	17/18	Remembrance Day Contest	(CW/SSB)	(Jun 02)
Aug	24/25	SCC RTTY Championship	(RTTY)	
Aug	24/25	TOEC WW GRID Contest	(CW)	
Aug	24/25	ALARA Contest	(CW/SSB)	(Jun 02)

Greetings to all Readers...

Contests

Ian GodsilVK3VP
contests@wia.org.au

I wonder how many of you like hunting for good DX? If you do, why? Is it just to get an extra country in your log, or is it the feeling that we are all brothers and sisters in Amateur Radio? Have you ever stopped to consider how true this may be?

I would like to suggest this month that our efforts in contests can make us very aware that we may be in contact with all sorts of people — the “big gun” types with massive stations and equally massive sums of money spent on them frequently; the “little pistols” with only moderate equipment (and I suspect that this is most of us); and the “pop guns” —

chaps in war-torn and deprived places like Afghanistan who nevertheless get on air when they can and help themselves as well as us to gain that ‘rare one’.

Behind all this is a desire not only to make our entry in the contest concerned, but to meet one another as fellow citizens of the World and to know that

we are all enjoying the same wonderful hobby and not having to worry about political boundaries or ideologies.

Those of you who do not work HF bands miss out on this experience, so why not give it a try? These contacts are not mode-specific activities, as there are plenty of operators on many modes, including the more recent digital modes.

However, don't expect wonders from poorer countries where there is no money for modern radios and computers. This in itself is a reminder that we all share a common basic knowledge, use of modes and bands and, above all that, a satisfaction that we are Amateur Radio Operators. This can

apply to the quick-fire contact style needed for contests as much as to the friendly chat of a DX QSO.

Plenty of contests coming along now, so look forward to hearing you. Please note the Jack Files Contest in July as we welcome John Spooner VK4AJS to the post of Contest Manager this year

At the time of writing this I am still in the midst of setting up my new shack – very small and cramped it will be, but better than nothing! This reminds me that if the desire is there, it will be possible to find a way.

Good DXing and contesting. 73, Ian Godsil

Rules: Jack Files Contest 2002

from John Spooner VK4AJS Contest Manager

Saturday, 13 July, 2002 0800Z – 1400Z

This contest is sponsored by the WIAQ Division and is in honour of the late Jack Files, a long-serving VK4 WIA councillor.

Object is for amateurs to work as many other amateur stations, and particularly as many different VK4 shires and towns, as possible.

Date: Saturday, 13 July, 2002

Time: 0800UTC – 1400UTC in six one-hour blocks for the purpose of duplicate contacts.

Band: 80 metres only. Use 3.5 MHz – 3.7 MHz to put all licence grades on an equal footing.

Modes: Either CW; SSB; PSK31, or All Modes

Categories: Single Operator; Club Station

Exchange: Non-VK4 stations will send RS(T) plus serial number starting at 001 and incrementing by one for each contact. VK4 stations will send RS(T), serial number and two-letter shire or town code for purposes of multipliers.

Score: One point per contact

Multipliers: Each VK4 Shire or Town counts as a multiplier. **Final Score** is total QSO points X total number of multipliers.

Repeat Contacts: In order to make best use of the band, stations may be contacted once in each hour on each mode. These repeat contacts must not be consecutive.

Logs must show full details of all QSOs and must be accompanied by a Summary Sheet showing operator's name; address; callsign; category and mode entered; claimed score and a declaration that the rules and spirit of the contest were observed.

Send logs by mail to: Files Contest Manager, PO Box 1006, Yeppoon, 4703 Logs may be sent by e-mail in text format to: vk4ajs@optusnet.com.au

Closing date for all entries is 13 August, 2002.

Certificates will be awarded to the top scorers in each mode in each VK State, ZL, P29 and any DX country (i.e. country outside VK, ZL or P29).

Rules Pacific 160 Metres Contest 2002

from Ian Godsil VK3VP, Contest Manager

Saturday, 20 July, 2002. 0700 UTC - 2300 UTC

Object: P2, ZL and VK stations to make as many contacts as possible on 160 metres. DX stations are encouraged to participate, but may only work P2, ZL or VK.

Categories: Single Operator; Multi-operator; SWL

Sections: CW only; SSB only; MIXED

Frequencies: CW: 1810 - 1840 kHz

SSB: 1843 - 1875 kHz

(Note: Guard band 1840 - 1843 kHz. Contacts not permitted)

Exchange: RS(T) plus serial number beginning at 001.

Score:

For P2, ZL, VK -

One point for QSO with own call area;

two points for other call areas in ZL or VK;

three points for Pacific Islands (ZK1, VK9)

For Pacific Islands -

one point for QSO with own call area;

three points for P2, ZL, VK;

five points for QSOs outside P2, ZL, VK.

For stations outside P2, ZL, VK or Pacific Islands -

five points per QSO.

Multiplier:

For P2, ZL, VK –

total number of VK, ZL and P2 call areas worked, plus OTHER DXCC countries.

For stations outside P2, ZL, VK -

total number of P2, ZL and VK call areas worked.

Final Score: Total QSO points times total multipliers.

Certificates: to top scorers in each mode, call area of ZL and VK and in each DXCC country.

Logs: Please show full QSO details of call worked; mode; time UTC; exchange. Include Summary Sheet showing operator's callsign; name; mailing address; category and section entered; points claimed and a signed Declaration. Logs submitted electronically need only show operator's name in lieu of signature, but must show all other information.

Send Logs:

1. *By mail to -*

Ian Godsil VK3VP,

363 Nepean Highway, Chelsea, 3196, Australia

2. *By e-mail* in ASCII/Cabrillo format to:

contests@wia.org.au

by 16 August, 2002

Rules: Remembrance Day Contest 2002

Presented by Alek Petkovic VK6APK

17/18 August 0800Z Sat – 0759Z Sun

Purpose: This contest commemorates the amateurs who died during WWII and is designed to encourage friendly participation and help improve the operating skills of participants. It is held close to 15 August, the date when hostilities ceased in the South-West Pacific area. It is preceded by a short opening address by a notable personality transmitted on various WIA frequencies during the 15 minutes prior to the contest. During this ceremony, a roll call of amateurs who paid the supreme sacrifice is read.

A perpetual trophy is awarded annually to the WIA Division with the best performance. The name of the winning Division is inscribed on the trophy, and that Division then holds the trophy for 12 months. The Division also is given a certificate, as are leading entrants.

Objective: Amateurs in each VK call area will endeavour to contact amateurs in other VK call areas, ZL and P2.

Contest Period: 0800Z Saturday, 17 August to 0759Z Sunday, 18 August, 2002. As a mark of respect, stations are asked to observe 15 minutes' silence prior to the start of the contest, during which the opening ceremony will be broadcast.

Bands: All MF, HF and VHF+ bands (no WARC). On 50 MHz and above amateurs may also contact other amateurs in their own call area.

Rules:

1. Categories:

- (a) High Frequency for operation on bands below 50 MHz;
- (b) Very High Frequency for operation on and above 50 MHz;
- (c) Single Operator;
- (d) Multi-operator;

2. Within each Category the Sections are:

- (a) Transmitting Phone (AM, FM, SSB, TV);
- (b) Transmitting CW (CW); **Note:** Digital modes such as Packet, RTTY, AMTOR, PSK31 etc are excluded from the contest.
- (c) Transmitting Open (a) and (b);
- (d) Receiving (a), (b) or (c).

3. All amateurs in Australia, Papua New Guinea and New Zealand may enter the contest, whether their stations are fixed, portable or mobile.
4. Cross-band and cross-mode contacts are not permitted.
5. Call: "CQ RD", "CQ CONTEST" or "CQ TEST".
6. On bands up to 30 MHz stations may be contacted once per band using each mode, ie twice per band using CW and Phone.
7. On 50 MHz and above, the same station in any call area may be worked using any of the modes listed at intervals of not less than two hours since the previous contact on that band and mode. **Note: Entrants are reminded that Contest operation is not permitted in the band 50.100 – 50.150MHz.**

8a. Both single and multi-operator entries are permitted. To be eligible as a single operator, one person must perform all operating and logging activities without assistance, using his or her own callsign. More than one person can use the same station and remain a single operator providing that each uses his or her own callsign, submits a separate log under that callsign and does not receive operating or logging assistance in any way during the contest.

8b. Holders of more than one licence or callsign may submit a separate entry for each callsign held.

9a. Multi-operator stations are only allowed one transmitter per band/mode at any one time. Simultaneous transmissions on different bands are permitted. Simultaneous transmissions on the same band but different modes are permitted.

9b. Automated operation is not permitted. The operator must have physical control of the station for each contact. CW and voice keyers are permitted, as is the use of computers for logging.

10. **Exchange:** For a contact to be valid, numbers must be exchanged between stations making the contact. Exchange RS for phone and RST for CW, followed by three figures commencing at 001 and incrementing by one for each successive contact.

11. Contacts via repeater (including satellite) are not permitted for scoring purposes. Contacts may be arranged through a repeater. Operation on repeater frequencies in simplex is not permitted.

12. **Score:** on 160 m two points per completed valid contact; on all other bands one point; on CW double points.

13. Logs should be in the format shown below and accompanied by a **Summary Sheet** showing callsign; name; address; category; section; for multi-operator stations a list of the operators; total score; declaration: **I hereby certify that I have operated in accordance with the rules and spirit of the contest**; signed; date.

14. Entrants operating on both HF and VHF are requested to submit **separate logs and summary sheets** for both areas.

15. VK entrants temporarily operating outside their allocated call area, including those outside continental Australia as defined for DXCC, can elect to have their points credited to their home Division by making a statement to that effect on their summary sheet(s).

16. **Send logs and summary sheets by mail to:** RD Contest Co-ordinator, A Petkovic VK6APK, 26 Freeman Way, Marmion, WA 6020, by Friday 20 September, 2002. Endorse envelope "**Remembrance Day Contest**" on front outside. Logs may also be sent by email to: contests@wia.org.au by 13 September, 2002. Late entries will not be eligible.

17. **Certificates** will be awarded to the leading entrants in each section, both single and multi-operator; in each Division; P2 and ZL. Entrants must make at least 10 contacts to be eligible for awards, unless otherwise

decided by the Contest Manager.

18. Any station observed as departing from the generally accepted codes of operating ethics may be disqualified.

Determination of Winning Division:

Unless otherwise elected by the entrant concerned, the scores of VK0 stations will be credited to VK7, and the scores of VK9 to the mainland call area which is geographically closest. Scores of P2, ZL and SWL stations will not be included in these calculations.

For each Division, an "improvement factor" will be calculated as follows:

- (a) For transmitting logs only, HF and VHF "Benchmarks" for each Division will be established, against which its performance for the current year is judged. The same formula will be used for HF and VHF, inserting the appropriate figures:

$$B = 0.25P + 0.75L$$

where B = this year's benchmark, P = last year's total points, and L = last year's benchmark.

- (b) For each Division, HF and VHF Improvement Factors will then be calculated. Once again the same formula will be used for both HF and VHF, inserting appropriate figures:

$$I/F = \text{Total points (this year)}/\text{Benchmark}$$

where I/F = improvement factor.

- (c) For each Division, the HF and VHF Improvement

Factors will then be averaged:

$$\text{Overall I/F} = (\text{HF I/F} + \text{VHF I/F})/2.$$

- (d) The Division which achieves the highest overall improvement factor will be declared the winner.

2002 Benchmarks

These are the total scores which must be obtained by each Division to improve on its results of last year:

Div	HF	VHF
VK1	730	213
VK2	4386	148
VK3	3461	7089
VK4	3711	1239
VK5/8	3694	1760
VK6	2374	4066
VK7	1662	918

Receiving Section Rules

1. This section is open to all SWLs in Australia, Papua New Guinea and New Zealand. No active transmitting station may enter this section.
2. Rules are the same as for the Transmitting Section.
3. Only completed contacts may be logged, ie it is not permissible to log a station calling CQ.
4. The log should be in the format shown below.

Example Summary Sheet

Remembrance Day Contest 2002

Callsign: VK3VP
 Name: Ian Godsil
 Address: 363 Nepean Highway,
 Chelsea, 3196
 Category: HF/Single Operator
 Section: Transmitting CW
 Total Score: 1000
 Declaration: **I hereby certify that I have operated in accordance with the rules and spirit of the Contest.**
 Signed: Ian Godsil
 Date: 30 August 2002

Example Transmitting Log

Remembrance Day Contest 2002

Callsign: VK1XXX
 Category: HF/Multi Operator
 Section: Transmitting Phone

Time Band Mode	Call	Nr Sent	Nr Rcvd	Pts
0801 14 SSB	VK2QQ	58001	59002	1
0802 14 SSB	VK6LL	59002	59001	1
0806 14 SSB	VK5ANW	59003	59001	1
0808 14 SSB	ZL2AGQ	56004	57004	1
0811 14 SSB	VK4XX	59005	59008	1

**Great Service
 and Local Support!**

Shop with



Example Receiving Log

Name/SWL Nr: L33071
 Category: HF
 Section: Receiving Phone

Time Band Mode	Calling	Calling	Nr	Nr	Pts
0801 14 SSB	VK1XXX	VK2QQ	58001	59002	1
0802 14 SSB	VK1XXX	VK6LL	59002	59001	1
0806 14 SSB	VK5ANW	VK1XXX	59001	59003	1
0809 14 SSB	VK7AL	VK2PS	59007	58010	1

ALARA Contest August 2002

Eligibility: All licensed operators throughout the world are invited to participate. Also open to SWLs.

Object: Participation: YL works everyone, OMs & Clubs work YLs only.

One contest (combined phone and CW) run over 30 hours.

Starts: Saturday 24th August 2002 at 0600 hours UTC

Ends: Sunday 25th August 2002 at 1159 hours UTC

Suggested Frequencies: Bands to be used are 3.5, 7, 14, 21, and 28 MHz only.

The following are suggested frequencies for easier location of contacts:

28.380 to 28.410

21.170 to 21.200 and 21.380 to 21.410

14.250 to 14.280

7.070 to 7.100

3.560 to 3.590

Operation:

- Every individual phone or CW contact may be counted.
- There must be an interval of greater than 1 hour between contacts with any one station on any one band and in the same mode.
- No net or list operations
- No crossmode operations.
- No crossband operations.
- All contacts must be made in accordance with operator and station licence regulations.

Procedure:

Phone: call "CQ ALARA CONTEST"

CW: YLs call "CQ TEST ALARA"

OMs call "CQ YL"

Exchanges:

ALARA member: - RS or RST, serial no. starting at 001, ALARA member, name.

YL non-member, OM or Club: - RS or RST, serial no. starting at 001, name, and whether Club station.

OMs, Clubs & SWLs work YLs only.

Scoring:

Phone: 5 points for each ALARA member contacted

4 points for each YL non-member contacted

3 points for each OM or Club station contacted

CW: Contacts where at least 1 operator is Novice class count double points, otherwise same as phone.

OM, SWL, & CLUB:

5 points for each ALARA member logged:

4 points for each YL non-member logged

LOGS: Single log entry (but Australian YLs entering for the Florence McKenzie CW trophy should indicate their CW score separately). Logs must show date/time UTC, band, mode, callsign worked, report & serial no. sent, report & serial no. received, name of operator of station worked, whether it is a Club station, and points claimed.

Sample Log:

Data UTC	Time UTC	Band MHz	Mode	Callsign	RS(T) & Serial No.Sent	RS(T) & Serial No. Rcd	Name	Points
12/11	0135	28	SSB	VK6DE	59001	58028	Bev	5
	0141	21	CW	VK3KS	599002	599045	Mavis	5
	0600	14	SSB	FK8FA	59025	59011	Aimee	5
	1100	3.5	CW	VK2PXS	599129	599004	Bobbie	10
	1103	3.5	SSB	VK3BSP	59130	59006	Joe (Club)	3

LOGS MUST BE SIGNED. Logs also to show full name, callsign and address of operator, and show final score (points claimed). Logs must be legible. No carbon copies. No logs will be returned. Decision of the Contest Manager will be final, and no correspondence will be entered into.

Logs must be received by the Contest Manager by: 31st October 2002.

Contest manager:

Mrs. Marilyn Syme VK3DMS

99 Magnolia Ave.

Mildura, Vic.

Australia 3500

OR: gdsyme@hotmail.com

Florence McKenzie CW Trophy:

This will be awarded to the Australian YL operator with the highest CW score (not necessarily an ALARA member). Minimum score 50 points. The actual trophy, because of the size and weight, will not be forwarded to the winner, but a certificate bearing a photo depicting the trophy will be sent to the winner each year.

CERTIFICATES will be awarded for the following:

Top score overall

Top score phone only

Top score Australian YL CW (Florence McKenzie cert.)

Top score ALARA member in each country and VK call area

Top score YL non-member in each continent

Top score OM in each continent

Top score SWL in each continent

Top score VK novice

Top score overseas YL CW

Top score VK Club station

TROPHIES will be awarded to the following:

Top scoring Australian YL

Top scoring DX YL

Club Stations: Operators of Club stations may use the Club call only for contacts, and MUST identify each contact as with a Club station. Use of personal callsigns while operating as a Club member is not permitted.

**International Museums
Weekend
June 15 & 16**

Education Notes

Brenda M Edmonds, VK3KT

Dare we try for a new entry level?

I have written at other times of the move towards a low entry-level amateur licence. There seems to be a general approval of the idea among a lot of the amateur community. If it becomes a way to stimulate and encourage the development of the hobby, it has the potential to make a major difference to the status of amateur radio in the general community.

Great Britain has recently established what they have called the "Foundation Licence". This relies heavily on the students attending a training course and performing a range of tasks under supervision before gaining the licence, and operating under supervision afterwards. The equipment permitted is approved "black box" or approved kit sets.

It has been suggested that we could do worse than just adopting the UK system as it stands. I have a few problems with that suggestion which I would like to be considered.

For one thing, the UK foundation licence requires demonstrated ability in Morse code, not ability to read it, but ability to recognise the letters by reference to a chart. I would prefer it to be a non-code licence. We are all expecting that the WRC 2003 will abolish the requirement for demonstrated competence in Morse code for an HF licence. At that point, the Australian system will go from having five levels of licence to having only two levels. That seems to me to be the time to introduce a new level. Be assured that I am not anti Morse code. There will always be a place for it on

the airwaves, but the time has passed for it to be mandatory.

Another problem I see is the need for attendance at a training course. Whilst this is an admirable arrangement, I see difficulties and inequalities for those in remoter areas, ie all those more than 50 km from an amateur radio club. If we are to have such a licence, we need to allow for distance education, either computer or correspondence courses, into which it would be hard to build the close supervision required. The UK course is seen as able to be covered in a weekend although it would make a very intense weekend. I would prefer two or three weekends. Perhaps we need teams of instructors to travel to the country areas to present the course and oversee the examinations all in one go.

Supervision of the new licensee's operating practices and station set-up would be possible in the suburban areas, but would require a number of volunteers. This could be done through the clubs to a large extent, but again the more remote candidates miss out.

Do we have the resources needed to be committed to a new licence level? There will be a heavy requirement for volunteers to assist with the training

courses and supervision, and for an examining system to cater for the candidates (assuming there are enough candidates to justify the organisation)

If we intend to try for a new entry level, we need to make an all out effort to increase our recruiting and the community awareness of amateur radio. This entry level is intended to catch the interest of a sector of the community that is interested in radio but does not have the time to spare for or the intellectual desire to understand the complexities of a standard instruction course. It is intended to be a way in, to allow newcomers to sample the joys and satisfaction which we have taken for granted, in the hope that they will be enthused enough to upgrade their qualifications.

There are a lot of details to be discussed, - privileges, callsigns, tenure of licence, as well as the mechanics of the courses. I am interested to hear reader's views, but I am more interested to find out if there is enough goodwill in the amateur community to support the idea and overcome the somewhat pessimistic approach which I have just presented.

ar

Have you thought of helping a *Community Event* with communications?

WICEN in all states helps with communications for safety monitoring, scoring information and general operational reporting.

Examples are the Murray Canoe Marathon, the Australian Rally Championships, Bike-a-thons and Horse Enduros. Lots to choose from and the occasional souvenir.

Rechargeables

Do you hold the belief that rechargeable batteries are not what they claim to be in terms of capacity? Nickel Cadmium batteries in particular always seem to go flat way short of what you expect. Having had much to do with a variety of batteries, and in particular NiCads in my work situation, NiCads have a bad reputation in my mind. They start off okay but after a few dozen cycles are thrown in the bin.

Memory

Memory effect is a commonly held belief with NiCads. If you don't cycle the cells fully down to flat, then a memory effect takes over and the cells have reduced capacity. This is not true! I have read many articles debunking this accepted belief. One such article appeared in NZART's Breakin many years ago. Research on the Internet turned up many such articles about the memory effect and how it has grown from an effect in an early satellite, to be up there with death and taxes. It was noticed that NiCads in an Earth orbiting satellite that went through a very fixed discharge/charge cycle did appear to have a memory effect. However this was an extreme example of charge for the same fixed time followed by discharge for a fixed time as the satellite moved to the night side of the Earth. NiCads usage back on Earth is far more random than this and a memory effect is not why NiCads appear to have a short life. So

what is? I have no figures to back this up, but decades of using NiCads have resulted in the opinion that NiCads can only be cycled for about 50 times before their capacity falls, not the up to 500, or even 1,000 quoted. There are other reasons why NiCads suffer from reduced capacity, such as charging incorrectly causing excessive heating and reverse charging but not memory effect.

Testing

Memory effect aside I still had doubts that brand new NiCads had the stated capacity and have long since abandoned them in favor of Nickel Metal Hydride cells. NiMH cells have become common over the last few years and

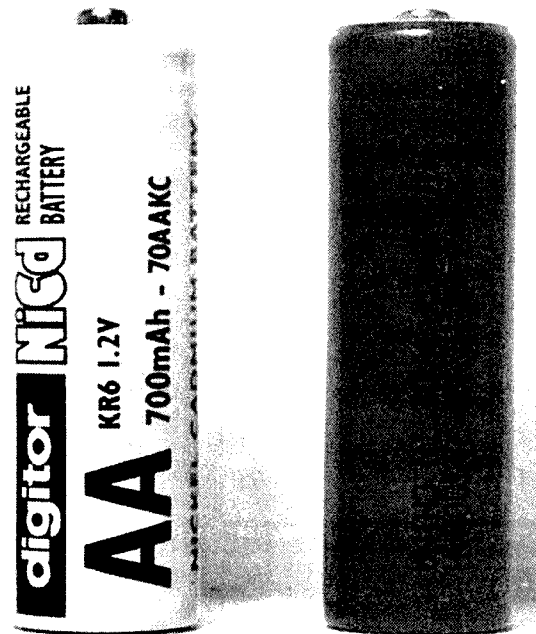

boast capacities more than twice that of the same size NiCad. A 1,800 mAh AA cell is now available for around \$5, which is a serious amount of capacity in an AA cell, provided they actually have that capacity. So I decided to do a capacity test on a NiCad AA and a NiMH AA cell. I chose a brand new 700mAh NiCad and a 1,500 mAh NiMH and discharged each separately at their respective 10 hour rate. So a 70 mAh load was placed on the NiCad and a 150 mAh load on the NiMH.

these cells. Both cells at their 10 hour rate matched their advertised capacity of 700 mAh and 1,500mAh exactly. How both cells perform over many cycles is far more difficult and time consuming to test but on the simple test I performed I was most impressed.

Included are graphs of the discharge of both cells. They are almost identical with the NiMH starting slightly higher and hence showing a slightly steeper decline, but there is little in their differences.

I still have not changed my opinion on the poor life span of NiCads but when brand new they do have their stated capacity. NiMH cells offer much more in terms of capacity and are of a similar price. Shop around for NiMH cells, as the 1,800 mAh cells can be bought for around \$4. This capacity will see your hand held equipment running for considerably longer.

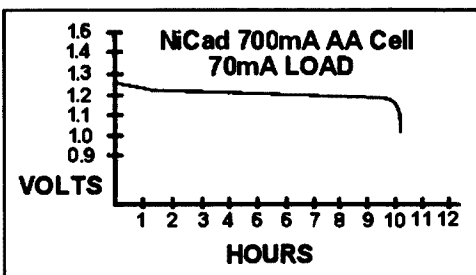

Figure 1

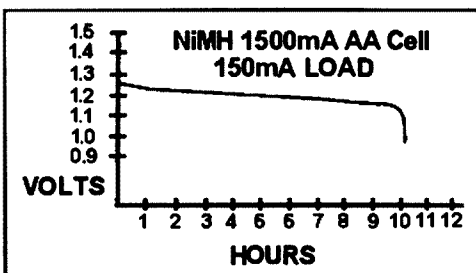

Figure 2

I was stunned when both cells took 10 hours to go down to one volt, the point at which they would be called flat. The flat point is very obvious in both types of cells as the voltage drops over just a few minutes from just below 1.2 volts to 1 volt. Being a skeptic by nature I had to re-think what I thought about the capacity of

Adelaide-Achorage 30 **Brisbane-Berne 315**

First F 0-5 Short 12466 km

First F 0-5 Short 16321 km

June 2002

T Index: 107

HF Predictions

by Evan Jarman VK3ANI
34 Alandale Court Blackburn Vic 3130

These graphs show the predicted diurnal variation of key frequencies for the nominated circuits.

These frequencies are identified in the legend are:-

- Upper Decile (F-layer)
- F-layer Maximum Usable Frequency
- E-layer Maximum Usable Frequency
- Optimum Working Frequency (F-layer)
- Absorption Limiting Frequency (D region)

Shown hourly are the highest frequency amateur bands in ranges between these key frequencies, when usable. The path, propagation mode and Australian terminal bearing are also given for each circuit.

These predictions were made with the Ionospheric Prediction Service program: ASAPs Version 4

Legend
UD
E-MUF
F-MUF
OWF
ALF
>10%
>50%
>90%
Time scale

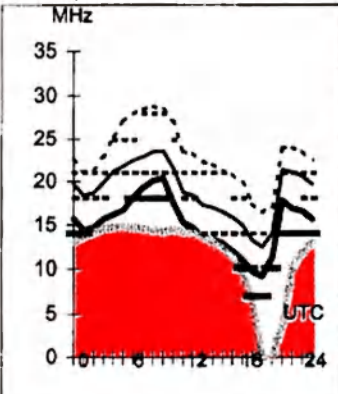
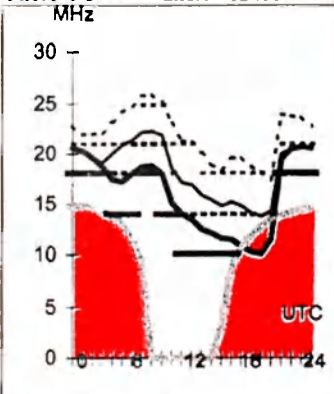

Adelaide-Dakar 233

First F 0-5 Short 16724 km

Brisbane-Los Angeles 59

Second 4F3-8 4E1 Short 11564 km

Canberra-London 136

First F 0-5 Long 23042 km

Darwin-Capetown 231

Second 4F3-5 4E1 Short 11221 km

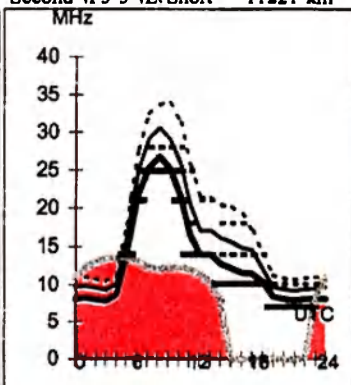
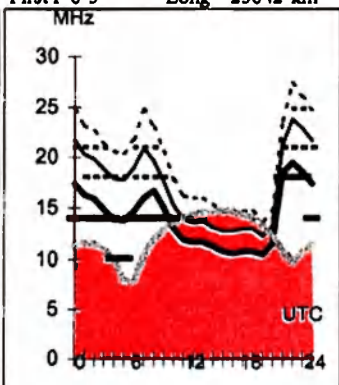
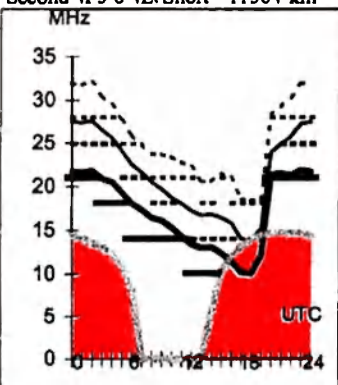
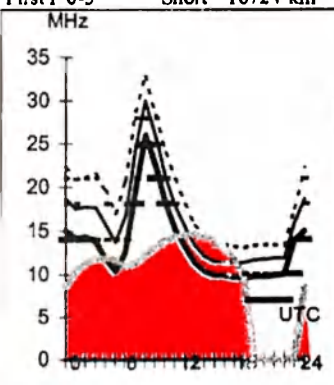

Adelaide-Ottawa 58

First F 0-5 Short 16901 km

Brisbane-Osaka 344

Second 3F6-12 3I Short 7148 km

Canberra-London 316

First F 0-5 Short 16982 km

Darwin-Tokyo 10

First 2F4-9 2E0 Short 5436 km

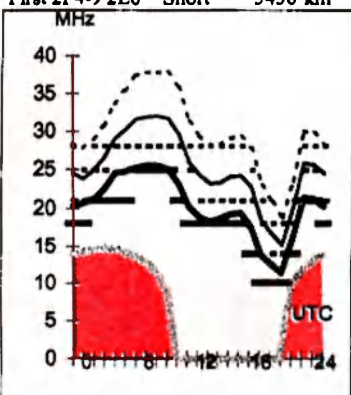
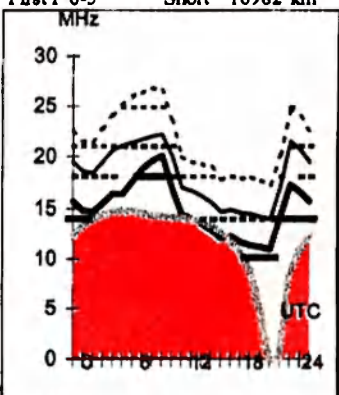
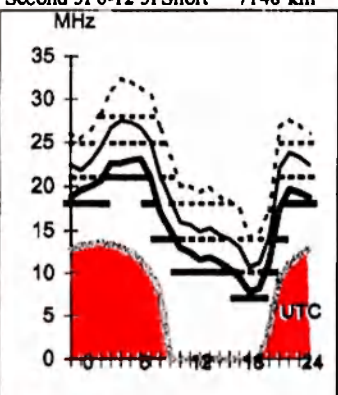
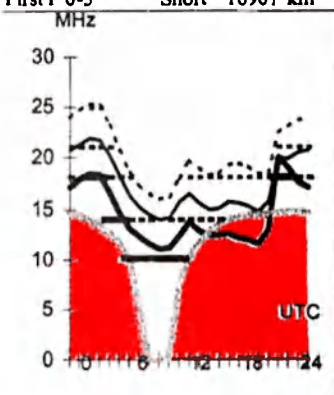

Adelaide-Stockholm 142

First F 0-5 Long 25029 km

Brisbane-Singapore 293

Second 3F9-12 3I Short 6146 km

Canberra-Moscow 317

First F 0-5 Short 14481 km

Darwin-Vancouver 42

First F 0-5 Short 12212 km

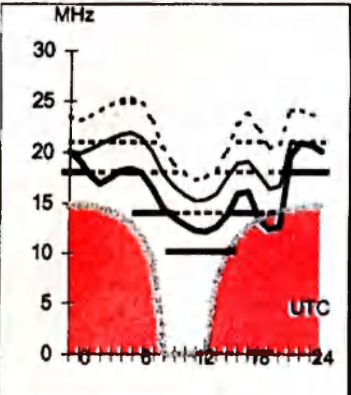
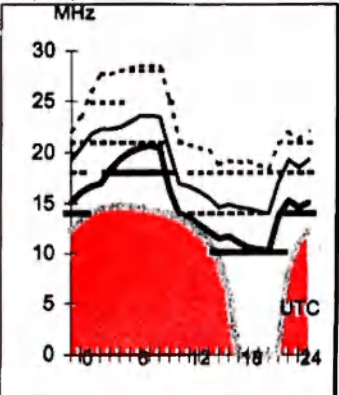
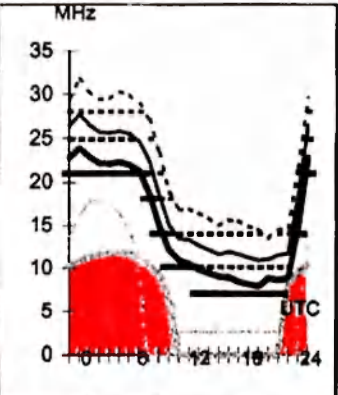
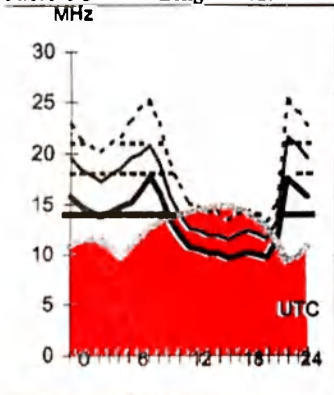

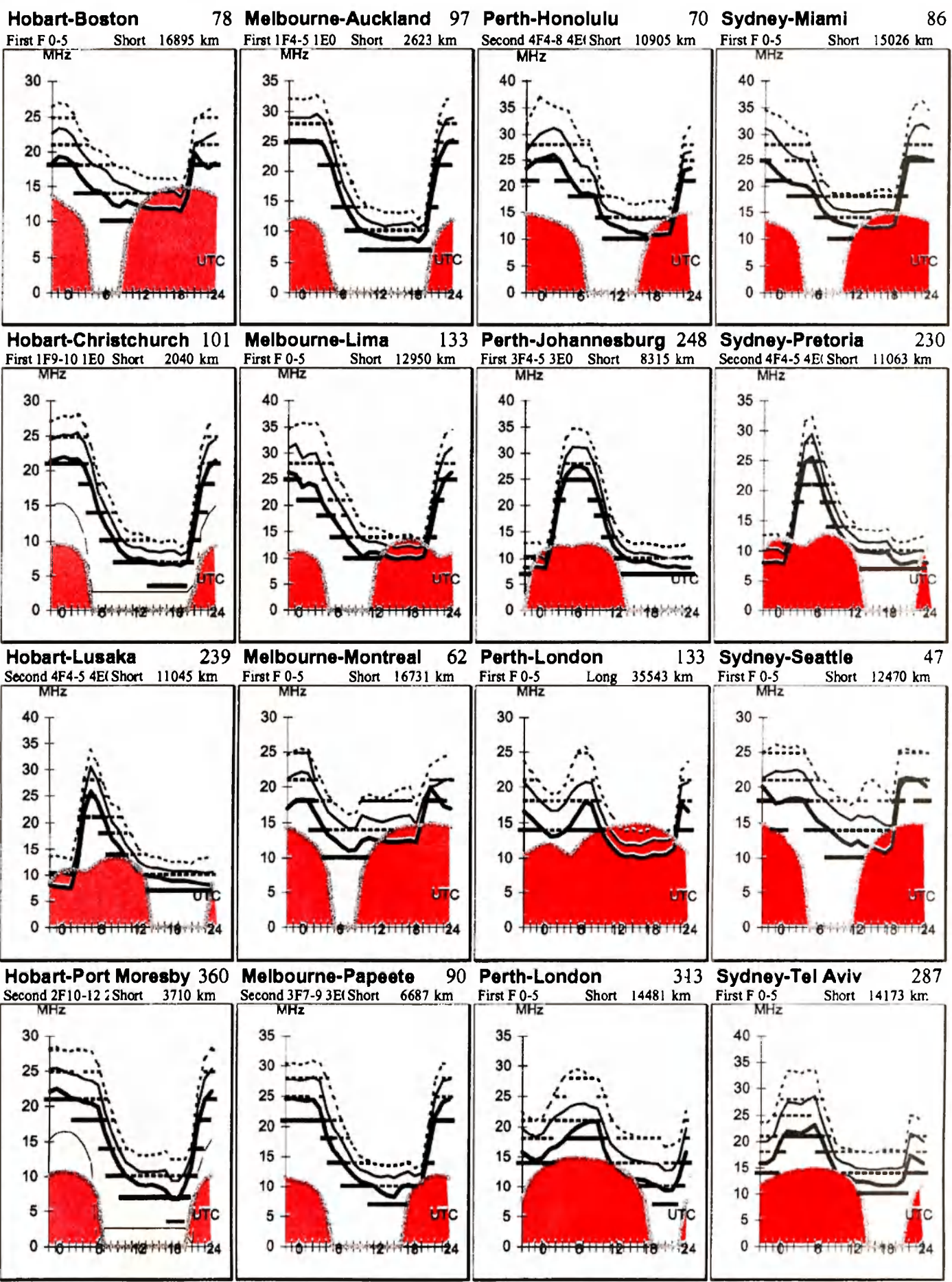

VHF - UHF

AN EXPANDING WORLD

David K Minchin VK5KK

Postal: 10 Harvey Cres, Salisbury Heights, SA, 5109

E-mail: tecknolt@ozemail.com.au Web page: <http://members.ozemail.com.au/~tecknolt>

Phone 0403 368 066 AH ONLY Fax +61 8 82924501

All times are in UTC.

VHF Activity

Bevan VK4CXQ reports on 6 metre activity from Townsville mid April to mid May 02. Such as it is, it is quieter than April! The only activity on a regular basis was the JAs but if you were slow off the mark you missed out there also. The only area of reasonably consistency was the Pacific but it wasn't very good. Worked a YB5 and a DU. A HP2 turned up and I heard a TI, TG, 9V1, VU2, 9M6, FK8, AH7 and ZLs neither of these stations were around for long. A VR2 has just faded out after five minutes. The only bright note was a QSO with K1B Baker Is (the call had me tossed for a while) 73 Bevan VK4CXQ

David VK3ANP reports. ...Allan VK3PA has taken over the 6 m beacon formerly run by Steve VK3OT. He intendeds to have it set-up so you can send a CW sig to the beacon on its freq. during the end of a cycle and have it logged. He intends to have it at his QTH near Bendigo. Lots of interest in JT44 with many contacts being made around the state and into Mt Gambier using 2 m. Have almost had a contact on 432 with VK3KQB using JT44. Brian saw me but I could not decode him. SSB non-existent at the time.

Having regular daily contacts on 6 m with VK7MO using Hell, FSK441 and VFSKCW. This is an approximate 750km path for me to Rex. Also participating are Ian VK3AXH and John VK3ATQ at lesser distances to Rex ... David VK3ANP.

Sporadic Es

Brian, VK3BCZ, reports: Following on from your closing comments in the March column about the decline in 50MHz (and 144/432 MHz) reports over the last few years, I would like to make a plea for reinstating the monthly reports of occurrences of Es in Australia. This, of course, cannot be done without contributions from readers of AR. (We can surely expect some winter time openings in June/July.)

Subsequent to my retirement last year, I have resumed researching the causes of Es after a break of about 40 years!

As a result of doing a search on the Internet, I have discovered that there is still no reliable predictor of the onset of Es in temperate latitudes, despite some excellent research by professionals (who are mostly also amateur radio operators) particularly here and in the USA. Three or four likely factors have been closely investigated and shown to be relevant, but no single factor seems to be relevant in the case of Es in temperate latitudes. A combination of factors seems more likely.

I was somewhat dismayed to find that there were generally many more logged occurrences in the amateur magazines 50 years (and even ten years) ago than there are now. Also it is obvious that the reporting of the fairly regular openings to Europe has taken centre stage in the columns of AR.

In discussion by email with overseas amateurs and researchers, I have found that currently there is a great need for data from the Australian region. Data of the 60s from my logbook has so far produced interesting daily correlations with the data of Dyer-Pocock (in QST magazine). We have been attempting to correlate the annual meteor shower trails, which should reoccur on the same day each year with the days on which Es has been observed. But much more remains to be done on this factor and on the other factors. Here is a chance for amateurs who are widely dispersed across Australia to contribute yet again to the scientific understanding of our wonderful ionosphere.

Reports of Es from the months of February to November would be particularly useful, as would any reports of Es via backscatter. ... Brian VK3BCZ

I concur, the interest in the E layer whether that is Es or Scatter has been boosted by a number of factors (WSJT & JT44 being just one area). I welcome this input no matter how minor.

Digital

Rex VK7MO reports on his portable activity from VK7 on the 4/5th of May 2002 ... QSOs were made from all 5-grid squares visited (QE27 near Queenstown, QE28 Chasm Creek, QE29 Stanley, QE39 Tomahawk & QE49 near Gladstone). Meteor scatter contacts were primarily to Sydney - thanks to Mike VK2FLR and Adrian VK2FZ. I was too close to VK3 for meteor scatter but did make some contacts on tropo, thanks to Barry VK3BJM and Ian VK3AXH. Dale VK5DC was seen and tried valiantly - we nearly made it from QE29, but I did not get a final RRR.

There were some problems which would have made things difficult for people at the other end, eg keeping the battery charged, noise from the genset, noise from Channel 5A in QE28 and QE29 and equipment failure which was fixed courtesy of VK7JG - thanks Joe.

Noise Floor: The vast majority of MS signals are weak under dense pings of less than 6 dB above the noise in a quite location. Thus it necessary to select locations with no more than a few dB noise floor. WSJT makes it easy to measure the noise level and you can compare the noise through the antenna to that in a dummy load. Noise floors were 18 dB near Wynyard, and 9 dB near Burnie due to Channel 5A TV at Table Cape. The solution was to hide at the side of the Nut (a volcanic formation) at Stanley to work from QE29 and to hide in a Valley facing North at Chasm Creek to work from QE28.

In further news, Congratulations go to Neil, VK2EI, on working Bob, ZL3TY, on FSK441 over a distance of 2028 km - a new Australian 2 metre digital record.

John, VK4FNQ, Charters Towers, joined the group last weekend 18/19th of May) and will be looking for contacts during the activity sessions this weekend on 144.230. He should be in range of VK2/3/5.

Gordon, VK2DJG, Armidale, is

Continued on page 52

Spotlight on SWLing

by Robin Laird Harwood VK7RH

It is midwinter here and it is truly amazing how different reception can be from adjacent locations. For example, Radio Bucharest International in Rumania was easily heard at my old QTH at Newstead on 17815 at 0200z although here in the adjoining suburb of Norwood I was not able to hear it. The station is in English yet their pronunciation and overall presentation is extremely poor.

The International situation rapidly escalated at the end of March, following several terrorist actions within Israel that saw the Israelis launch a huge retaliatory military action on the West Bank. This action, coming just at the time of Easter/Passover, dramatically heightened tensions throughout the Middle East and beyond.

Just prior to this, the US Government launched its Middle Easter Radio Network to broadcast 'pro-American' programming, particularly targeted to those under 30. It commenced via FM transmitters in Kuwait and Bahrain and hope to add other FM senders in nearby "friendly" states. However, following the huge reaction in many of these to the Israeli incursion into the West Bank, I would expect that these states could be wary of allowing this US backed station, known as "Radio Sawa", to broadcast on FM. The use of shortwave is a distinct possibility but HF propagation does not broadcast music very well. Apparently they are hoping to woo their listeners by playing American pop music, which is rarely broadcast over Middle Eastern stations.

This 24-hour Arabic network aims is to influence a sizeable audience by subtly putting over the American position of the current Middle East crisis and the ongoing "war on Terrorism". They aim to do this by playing current American and Arabic pop music, interspersed with frequent news bulletins, opinions and commentary. This new network is designed to counter the rise of the Arabic television networks such as the one in Dubai, known as *Al Jazeera*. I believe also a companion Arabic television network to R. Sawa will shortly be operational.

Naturally this has angered several Islamic nations, especially since the Israeli invasion of Palestine early in April. American pop music or culture is rarely heard over the existing Middle Eastern media with the possible

exception of Lebanon. Radio Sawa is currently relayed over FM in Bahrain, Kuwait and Jordan while others are lukewarm to its broadcasts being relayed within their countries. R Sawa replaces existing Arabic programming over the VOA.

In late March /early April, tensions in the Middle East completely spilled over into all out conflict. Israeli troops stormed into areas that had been controlled by the Palestinians, resulting to an increasing casualty toll and damaged infrastructure. All Palestinian media outlets were systemically destroyed as the Israelis were determined to prevent independent coverage of the raging battles. Even the international media came under attack if they got too close to the battle zones.

The war of Words quickly spread to shortwave and satellite. Because the Palestinian leadership were scattered or besieged, the only way they could get their messages back to the population was via shortwave from sympathetic Arab neighbours. Palestine strikes an emotional cord to most Arabs, transcending political rivalries or systems.

As I have been reporting, the Israeli Government decided to abandon shortwave broadcasts of Kol Israel for budgetary reasons. Programming was going to be exclusively streamed via the Internet. This resulted in a predictable outcry from the Jewish Diaspora as well as from listeners worldwide, many having little or no Internet access. A reprieve was granted until July, yet as is often the case, the current situation made shortwave radio indispensable.

There was another sticky situation when the Americans decided to commence their broadcasts to the Caucus region, particularly to Chechnya, after initially postponing it on diplomatic advice. The Russian Government and media became very hostile to what they perceived to be

interference in their internal affairs by Radio Free Europe specifically broadcasting in the Chechen language, which is spoken by the rebels fighting against the Russians. Moscow accused Washington of double standards in their war against terrorism as the Chechen rebels have strong links to the Al Quayedya and Usama Bin Laden. The result is that Moscow will closely monitor the RFE Chechen broadcasts to "correct" any perceived bias or support to the rebels yet will not ban RFE broadcasts being currently aired over domestic stations in Russians. The Chechen programs are naturally not being aired domestically but over shortwave.

There is a clandestine broadcasting station emanating from of all places New Zealand. The station is the Democratic Voice of Burma. The schedule is 1430 to 1530 UTC on 15620 kHz. Programmes originate from the DVB studios in Oslo Norway. This is the first time I have heard of New Zealand allowing their main shortwave transmitters to be used in clandestine broadcasting. 15620 is a non-standard channel and the transmitters located near Lake Taupo, are usually used for Radio New Zealand International. The Democratic Voice of Burma is aired via the Norwegian senders at Kvitsoy earlier and is the program of the Democracy Movement and their Nobel Peace Prize leader Aun Sun Suu Kye, who was recently released from house arrest.

I wonder if the new country of East Timor will be coming up on shortwave. I well remember hearing the former Portuguese colony prior to the Indonesian invasion within our 80-meter amateur allocation on 3680 kHz. It was spasmodic and often came to the attention of the Intruder Watch Coordinators in the early seventies.

The future of the Internet as an audio streaming source was also brought into

Continued on page 52

question, by a completely unrelated court decision. Following the Tapster case, where the record companies successfully shut down a commercial file-swapping program that allowed consumers to download the latest records without paying for them. Napster then tried to go to a subscription base but so far it has not been able to get up and running as substantial damages were awarded.

Also the Recording companies, particularly through their trade organisation, also won the right to get Internet streaming stations to pay for copyright on music played. The Internet has seen the proliferation of independent program makers and enthusiasts instead of commercial organisations compile many of these. If the proposed copyright fees were enforced, many of these independent audio streams would cease, as they

could not afford to pay the annual copyright fee. I should emphasize that this only applies to North America at this stage. We could see independent audio streams appearing from other jurisdictions.

Late in April and early in May, there were experimental broadcasts in the digital broadcasting beamed to Melbourne and Sydney. Senders in Sackville, Juelich and Bonaire took turns to use the DRM platform to gauge its usefulness in this region. There are no commercial or even amateur receiving DRM receivers or software available so it leaves me wondering if DRM will become a white elephant.

ECUADOR. HCJB on the Move. Ecuador-based international missionary broadcaster HCJB is preparing to relocate its current shortwave site from Pifo to the Santa Elena peninsula. The station has just released details of the move,

what's planned, and the projected timetable. Also HCJB-Australia won their appeal against a ruling of the local shire Council, over their proposed Kununurra site. Work has already commenced and they are hoping to be on-air in December of this year. Once this is operational, I believe that HCJB in Quito will no longer broadcast to this region and instead will use the Western Australian senders to target the South Pacific. The move from Pifo is because a new international airport for Quito is being built there. The new site is closer to Guayagil, on the western coast of Ecuador and at sea level, compared to being high up in the Andes mountains at Pifo.

Well that is all for this month. Don't forget you can email me at vk7rh@wia.org.au or snail mail at 20/177 Penquite Road, Norwood TAS 7250.

ar

VHF/UHF:AN EXPANDING WORLD continued

operational but has a high noise level on 144.230 due to a channel 5A TV station nearby. He prefers to work 144.330 and thus it is best to make a specific sked with him. Doug, VK3UM, has drawn attention to a very useful free program for keeping your computer on time at the following address: <http://www.softnic.com/products/timesync/>

ZL3TY can be seen most mornings on 144.230 from 2000 to 2100 UTC. While he is beaming Sydney signals can be seen as far South as Hobart. There is a new version of WSJT available, version

2.0.1, which has minor maintenance improvements compared to 2.0. It can be accessed at: <http://pulsar.princeton.edu/~joe/K1JT/> .. 73s Rex VK7MO

In closing

Apologies for the briefness of this column, you can be assured that it is not so much because of lack of information but simply a lack of time this month! In the past few weeks, my base of work has moved to Melbourne. The resultant

travel (I'm still living in Adelaide) and shortened weekends has limited the column preparation time this month. Next month hopefully things will be a bit more balanced.

In an adjacent panel, you will find the May 2002 updated "Grid square League table" contributed by Guy, VK2KU.

I'll leave you with this thought.. "Success is knowing the difference between cornering people and getting them in your corner"

73s David VK5KK

ar

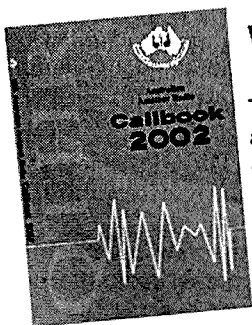

WIA Callbook

This year's callbook is a shortened version containing only the VK call signs and little peripheral information. Its price reflects its shortened format by being considerably less at \$15.00 (plus postage and handling).

or

Callbook on searchable CD Rom.

Order through your local Division
contact details on page 56

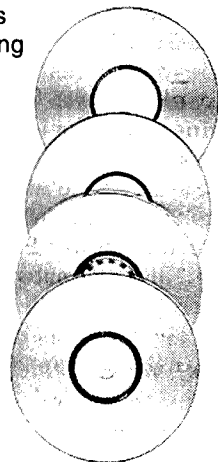

Australian Foundation Licence The Foundation Licence needs to allow all modes and Amateur frequencies above 400 MHz.

I suggest a licence that allows the use of pre-built radio equipment both commercial and amateur built, with a power limit of 10 watts into the antenna.

I see no logic in restricting the Foundation Licence holders to a limited number of modes if they can use a greater number on some of the very same frequencies without a personal licence. What we can provide is training and extended privileges.

An Amateur licence that will provide an incentive for users of the class licenced LIPD and ISM bands would attract a VERY large number of people. From one Brisbane Internet mailing list alone we could attract over 1000 students for a shortened radio-training course. The number of computer users interested in setting up wide area networks using radio frequencies in Australia easily outnumber existing Radio Amateurs.

Very few if any of these students would be initially interested in HF frequencies or modes other than data, it would therefore be a complete waste of time offering HF privileges in any foundation licence.

If we lower the WIA membership fees at the same time as new foundation licence is introduced we will greatly increase the membership. A membership fee of \$25.00 should be more than ample to cover the running on the Institute.

Explanation

FM hand held LIPD radios are now sharing the Amateur 70 cm band along with other LIPD devises using a variety of modes. We are sharing other Amateur bands such as 2.4 GHz with class licenced users that make use of a variety of modes including Spread Spectrum, narrow and wide band FM, FM and AM TV.

Why not take advantage of the modern equipment available rather than trying to restrict new Amateurs to antiquated modes that many do not wish to use.

Comment

There are now a large number of computer users setting up radio networks using the shared amateur bands of 2.4 GHz and higher. These radio experimenters (amateurs) are putting the majority of Licenced Radio Amateurs to shame by building and installing antenna and repeater systems (nodes) and other equipment.

These radio experimenters are the new Radio Amateurs; we can either work with them or continue to fade away while they increase in number.

Alan VK4YAR

References

- QDG Inc. wireless LAN page <http://homepage.powerup.com.au/~qdg/qdgwire.htm>
- Radiocommunications Class Licence (Spread Spectrum Devices) <http://www.aca.gov.au/legal/licence/class/spread.htm>
- Brisbane Mesh <http://www.itee.uq.edu.au/~mesh/>
- Alan Wills VK4YAR
vk4yar@powerup.com.au

GippsTech 2002 Conference

Churchill, July 6 and 7

The fifth annual Gippsland Technical Conference (GippsTech) will focus on issues relating to VHF, UHF and microwave frequencies and their uses for amateur communications. Plans are for technical sessions during the day on Saturday and Sunday morning, including a BBQ lunch on both days. Pauline Corrigan is once again planning a full weekend of activities for accompanying partners.

The social program includes dinner on Saturday evening at Café Gazronomy in Morwell. Cost: \$35 per person, BYO drinks. Please register via the VK3BEZ web site prior to June 28.

Topics identified to date include:

- Using JT44 for tropospheric and EME propagation. (VK2FLR)
- WSJT meteor scatter experiences. (VK7MO)
- Integration of a 1W 10GHz PA with a 650mm offset fed dish. (VK2EI)
- System integration with the Milliwave power amplifier at 24GHz (VK2EI)
- The VK3UM 10 metre dish installation: A pictorial presentation of the installation from start to finish including the

mount, drives, tracking and feed systems. (VK3UM)

- RF Radiation: Does your Station meet the new licensing assessment requirements? Obtaining a High power permit. (VK3UM)
- Transmission line fault finding using a simple homebrew TDR. (VK3ZRX)
- The trials and tribulations of running a basic VHF-UHF station. (Bob VK2TG)
- Basic testing techniques at UHF and above. (Peter ZL1UKG)
- Solving noise problems in modern radio systems. (Bryan VK3YNG)
- Human speech acoustics and the factors affecting speech intelligibility. (John VK2TK)

Further details can be found at the VK3BEZ web site at <http://www.qsl.net/vk3bez/>. Anyone willing to contribute further topics for the program should contact the Chair of the organising committee, Peter VK3KAI, at vk3kai@qsl.net.

HAMADS

- Hamads may be submitted by email or on the form on the reverse of your current Amateur Radio address flysheet. Please print carefully, especially where case or numerals are critical.
- Please submit separate forms for For Sale and Wanted items, and be sure to include your name, address and telephone number (including STD code) if you do not use the flysheet.
- Eight lines (forty words) per issue free to all WIA members, ninth and tenth lines for name and address. Commercial rates apply for non-members.
- Deceased estates Hamads will be published in full, even if the ad is not fully radio equipment.
- WIA policy recommends that the serial number of all equipment for sale should be included.
- QTHR means the address is correct in the current WIA Call Book.
- Ordinary Hamads from members who are deemed to be in general electronics retail and wholesale distributive trades should be certified as referring only to private articles not being re-sold for merchandising purposes.
- Commercial advertising (Trade Hamads) are pre-payable at \$25.00 for four lines (twenty words), plus \$2.25 per line (or part thereof), with a minimum charge of \$25.00. Cheques are to be made out to: WIA Hamads.
- Copy should be typed or in block letters, and be received by the deadlines shown on page 1 of each issue of Amateur Radio, at:

Email: newsletters@ozemail.com.au **Fax:** 03 9756 7031

Postal: Newsletters Unlimited, PO Box 431, Monbulk Vic 3793

Please send your Hamad by ONE method only (email preferred)

FOR SALE NSW

- KENWOOD TS-950S SN 0110087 integral PS-150W output. Dual freq. Receive, narrow SSB filter. Great DX performer \$1700. See it operating. Phone Les VK2CLB Phone 02 9997 1109 or e-mail vk2clb@bigpond.com
- BOOKS from the estate of George Schulze VK2GX. All books are in good condition. RADIO AMATEUR'S HANDBOOKS - years 1947, 1962, 1979 and 1984. RADIO HANDBOOK - ninth edition - by Editors and Engineers - 1942. Wireless Institute of Aust - AMATEURS CALL BOOK 1981-82. SSB AMATEUR SINGLE SIDE BAND - Collins Radio Co. 1962. PRACTICAL RADIO COMMUNICATIONS by Nilson and Horning, 1935. HEATH KIT HANDBOOK - Assembling and using your Variable Frequency Oscillator, Model VF1. RADIOTRON DESIGNER'S HANDBOOK - 3rd Edition - small book - 1944. RADIOTRON DESIGNER'S HANDBOOK - 4th Edition - red cover in 'mint condition' 1953. ADMIRALTY HANDBOOK OF WIRELESS AND TELEGRAPHY, Vol 1 - Magnetism and Electricity - 1938. BENDIX INSTRUCTION BOOK for models RA-B, RA-11 and RA-IJ. Aircraft Radio Receiving Equipment. Please make offers to Vic, Fax 02 9876 5232
- ATN LOG PERIODIC ANTENNA, Model No. 20-30-6L+ 6 metres; 6 m. Boom, 6 elements suits 15/12/10/6 m. bands; 8.5 dbi forward gain; turning radius 4.6 m.; longest element 7.5 m. An excellent antenna with instructions; includes 2kW. Balun, all stainless hardware, \$300. John. VK2JJS. QTHR. Phone 02 9498 2248.
- Warwley Amateur Radio Society is holding an AUCTION OF RADIO AND ELECTRONIC EQUIPMENT at 11:00 on Saturday June 22nd at its clubhouse in Vickery Avenue, Rose Bay. All are welcome to buy or sell. Pre-registration and further details can be found on the web site at www.vk2bv.org or phone Simon, VK2UA, on 02 9328 7141.

- PRC-10 complete in EWO, with accessories, \$175 ono. Spares available. Brian VK2GCE QTHR Phone 02-9545 2650 or [preferred] brianclarke@idx.com.au
- WARBIRD DISPLAYS: Rxs, Tx, modulators, racks, mounts, remotes, some complete COMMAND setups as used in WWII operations. Brian, VK2GCE, Phone 02 9545 2650 or [preferred] brianclarke@idx.com.au
- YAESU FL-2100Z amplifier, VGC. Retirement village problems. \$800. A G Cory VK2DTH Phone 07 4676 3153

WANTED NSW

- PRC-9 or 10 cases - need three; can swap for two PRC-9A cases. Brian, VK2GCE, Phone 02 9545 2650 or [preferred] brianclarke@idx.com.au
- INFORMATION AND EQUIPMENT FOR AMATEUR TELEVISION - 90cm preferred but interested in 23 cm equipment. David Hunt VK2IX QTHR Phone 02 4751 6124
- JAYCAR 12V GEARED MOTOR approx 4 inches long 1 1/2 inches diameter with a 20:1 reduction, sold as surplus stock 5 to 6 years ago. Required for project. Chris VK2YMW Phone 02 9487 2764 AH

FOR SALE VIC

- WARBIRD DISPLAYS: Rxs, Tx, modulators, racks, mounts, remotes, some complete COMMAND and RADAR setups as used in WWII operations. Bill, VK3AQB Phone 03 9337 4902 or jikajika@net2000.com.au
- New offcut lengths ANDREWS HELIAX LDF450A, LDF550A, 16 m - 44 m. Also connectors. Ray VK3ATN QTHR Phone 03 5492 2224, Fax 5492 2666, atnant@ruralnet.net.au
- YAESU FT-101E with service manual and new finals \$250. AUTOMATIC KEY, make unknown. Barry VK3JB QTR Phone 03 9878 8275

- KENWOOD TS-520 transceiver, manual, spare 6146s, microphone, DC lead, S/N 120472. Good condx \$280. TRANSVERTER 70cm all mode microwave modules, model MMT432/28S S/N T432/285 6801920. Good condx \$80. BANDIT triband quad hub cast aluminium. Never used \$50. David VK3ANP QTHR Phone 03 5727 6218

- DECEASED ESTATE: Two metre SWISS QUAD with 70cm. 16 ELEMENT YAGI controlled with horizontal and vertical rotators, controllers, coax and cable \$310 obo. ICOM 751A HF transceiver and PSU \$950 obo. Telescopic antenna mast, fascia/ground mounting approx 13 metres with hand winch, Stolle rotator, controller and cable \$300 obo. DAIWA TWO-METRE LINEAR amp and power supply \$280 obo. LINEAR AMPLIFIER HF with spare tubes \$320 obo. CHIRNSIDE TRIBAND HF beam antenna with coax \$110 obo. LINEAR AMPLIFIER UHF \$80 obo. Five position B & W COAX SWITCH \$60 obo. Lawrie VK3DFE QTHR Phone 03 9807 3995

- ELECTRONICS AUSTRALIA, 1939-2000, AMATEUR RADIO 1970 and on, PRACTICAL WIRELESS 1970-90, PRACTICAL TELEVISION 1970-90. Collection of others. No reasonable offer refused. Will not separate titles. VK3ZIC Phone 03 9336 7837

- ICOM IC-R7100 VHF/UHF receiver as new with original carton & manual \$800. MALDOL LP-1300 log periodic yagi 100-1300MHz (DSE cat D4828) \$150. WELLBROOK ALA1530 active loop antenna (RX only) \$150. These antennas are fully assembled and therefore difficult to transport, so prefer Melbourne area (Tullamarine or Woodend) pickup. Damien VK3RX Phone 03 5427 3121 vk3rx@wia.org.au

- BOOK: "Heathkit - Your Guide to the Amateur Radio Products" \$30 New condition. Damien VK3RX Phone 03 5427 3121 vk3rx@wia.org.au

- ICOM IC-7QA, dual band 2/70, handheld transceiver, brand new, \$250. ICOM IC-551 6m all mode transceiver with 130 watt valve linear \$275. DIAMOND D-130J discone antenna 25-1300MHz Brand New \$150. COLOUR TV 15cm 12VDC-240VAC with AV input, tunes 440 ATV \$200. Ian McDonald VK3AXH QTHR Phone 03 5341 3012, e-mail igm@netconnect.com.au

WANTED VIC

- YAESU FT-225R 2m all mode transceiver in VGC & GWO Damien VK3RX Phone 03 5427 3121 vk3rx@wia.org.au
- COLLINS AM transmitter Type 32V-1 or 32V-2 or 32V-3. Will pay top price for original unit. Roy VK3ARY QTHR Phone 03 9803 1213 or vk3ary@meibpc.org.au
- RADIO NAVIGATOR as operated/used in Avro Anson aeroplane Type R1155 or parts for restoration. All costs paid. Phone 03 5332 2340 Stan VK3SE

FOR SALE QLD

- YAESU digital VFO with handbook \$75. Paul VK4DJ Phone 07 4778 6031
- YAESU FRG-7 receiver 0.5-29.9MHz AM/SSB/CW, with original manual. In daily satisfactory use for Ham and BC, some signs of long use on casing. \$150 ono. Hans L40370 (exHS1ALK), Phone 07 5479 4561, email: hpkiesinger@ozemail.com.au

WANTED QLD

- IC-720A, dead preferably for parts. Stuart VK4KKQ 07 4972 9871

• COLLINS 32S1/2/3 transmitter, prefer with 516F-2 ac power supply. John VK4VK QTHR Phone 07 5538 1759 E-mail: tenalu@dodo.net.au

• COPY of KENWOOD MC-60 Desk Mike SCHEMATIC. Gladly pay for copying and postage. John VK4VK QTHR Phone 07 5538 1759 Email: tenalu@dodo.net.au

• YG-455C CW Filter for Kenwood/TRIO R-2000. Phone Hans L40370 Phone 07 5479 4561 e-mail: hpkiesinger@ozemail.com.au

FOR SALE SA

• 28 Ah 12 volt "DRY-FIT" SEALED GEL-CELLS \$20.00. Large (car battery sized) perfect for portable operation or float charging in the shack. The South East Radio Group VK5SR in Mount Gambier have a number of these batteries for sale. All are charged and tested OK. Any unsold will be available at Mount Gambier Convention in June. Contact Kevin VK5KJ vk5kj@austarnet.com.au or Mobile 0407 799 664

WANTED SA

• BANDSWITCH for early model FL-2100 Yaesu Linear Amplifier (SW1a/b). (80m contacts vaporised). Would consider scrap or defunct amp. Kevin VK5KJ vk5kj@austarnet.com.au or Mobile 0407 799 664

• GRANGER ELECTRONICS (portable) HF SSB transceiver. Malcolm Haskard VK5BA QTHR Phone 08 8280 7192 email malcolm.haskard@unisa.edu.au

• N TYPE CONNECTORS (2) for Bird Wattmeter Type 43 part number 4240-062. Colwyn Low VK5UE Phone 08 8255 2138 e-mail cmlow@chariot.net.au

FOR SALE WA

• KENWOOD TS-520 HF transceiver s/n 010414 with MC-50 mic. 2 m amp QM75 144 PA50 s/n3514. ICOM IC-280 2m s/n03035. FDK multi 7, 2m s/n65128. REALISTIC TRC-415 CB s/n0019532. BC-459A transmitter s/n53303. VALVE TESTER Galstan 223A. Jim VK6CA Phone 08 9622 2804 e-mail vk6ca@dodo.com.au

WANTED WA

• CIRCUIT DIAGRAM and/or component layout for Sharp Radio tape recorder Model GF 5454Z VK6FD, QTHR Phone 08 9362 1170

• DRAKE T4XC/R4C HF transmitter/receiver combination. Also would be interested in T4XB/R4B or separate T4XC and R4C. Suffering from a bad nostalgia attack and want to put together 1970s-style CW station like I used to have. Steve Ireland, VK6VZ. Phone: 08 9298 9330 or e-mail: sire@iinet.net.au

• AUTO ANTENNA TUNER to use with ICOM IC-720 Jim VK6CA Phone 08 9622 2804 e-mail vk6ca@dodo.com.au

MISCELLANEOUS

• The WIA QSL Collection (now Federal) requires QSLs. All types welcome, especially rare DX pictorial cards, special issue. Please contact the Hon Curator, Ken Matchett VK3TL, 4 Sunrise Hill Road, Montrose Vic 3765, tel. (03) 9728 5350

TRADE ADS

PSK-31, SSTV, RTTY SOUNDBOARD INTERFACES

Fully isolated, ready to plug in. <http://www.G3LIV.CO.UK>. johanny@melvin.com, G3LIV QTHR.

AMIDON FERROMAGNETIC CORES:

For all RF applications. Send business size SASE for data/price to RJ & US Imports, PO Box 431, Kiama NSW 2533 (no enquiries at office please. 14 Boandy Ave Kiama). www.catchnet.com.au/rjandusimports

Agencies at: Active Electronics Tas; Truscotts Electronic World, Melbourne; TTS Systems, Tyabb; Tower Communications, Perth; Haven Electronics, Nowra.

HF, VHF, UHF ANTENNAS & ACCESSORIES

Alum towers, guys etc. Diamond VSWR/PWR meters. HD copper ant wire & insulators. TX tubes & pwr transistors. Quality coax cables & connectors. Free advice & catalogue. ATN Antennas Ph 03 5492 2224 Fax 03 5492 2666, email atnant@ruralnet.net.au

<http://www.hamsearch.com>

a not-for-profit site that is a search engine for hams

Email your hamad

Then we just cut and paste.

You proof it, you retain control.

"Hey, Old Timer..."

If you have been licensed for more than 25 years you are invited to join the



Radio Amateurs Old Timers Club Australia

or if you have been licensed for less than 25 but more than ten years, you are invited to become an Associate Member of the RAOTC.

In either case a \$2.50 joining fee plus \$8.00 for one year or \$15.00 for two years gets you two interesting OTN Journals a year plus good fellowship.

Write to

RAOTC,
3/237 Bluff Road
Sandringham VIC 3191

or call Arthur VK3VQ on 03 9598 4262 or Allan VK3AMD on 03 9570 4610, for an application form.

PLEASE BE KIND TO OSCAR

Meet Mr Oscar Goldenboy, our Hamad typist

Oscar is not an expert in your field — he thinks Megahertz is what happens when he stubs his toe on a rock.

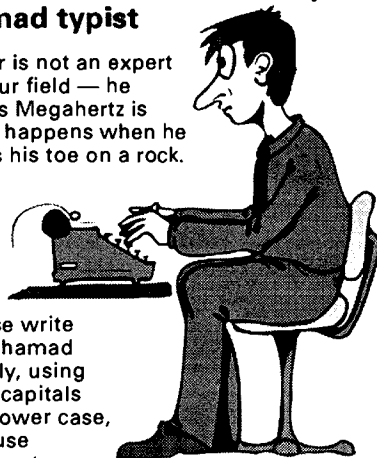

To help Oscar, please write your hamad legibly, using both capitals and lower case, and use legitimate abbreviations.

This will reduce the chance of errors being published, which inconveniences everyone.

ADVERTISERS INDEX

Andrews	16
Com-an-tena.....	24
Elektron.....	33
G & C Communications.....	27
Icom.....	OBC
Strictly Ham.....	8
Tower Communications	28
WIA Call Book.....	IFC

PLAN AHEAD

Remembrance Day Contest
17 & 18 August 2002

ALARAMEET
October 5 & 6, 2002,
Murray Bridge, South Australia

JOTA and JOTI
October 19 & 20,
2002

TRADE PRACTICES ACT

It is impossible for us to ensure that the advertisements submitted for publication comply with the Trade Practices Act 1974. Therefore, advertisers and advertising agents will appreciate the absolute need for themselves to ensure that the provisions of the Act are strictly complied with.

VICTORIAN CONSUMER AFFAIRS ACT

All advertisers are advised that advertisements containing only a PO Box number as the address cannot be accepted without the addition of the business address of the box-holder or seller of the goods.



Division Directory

The Amateur Radio Service exists for the purpose of self training, intercommunication and technical investigation. It is carried out by amateurs who are duly authorised people interested in radio technique solely with a personal aim and without pecuniary interest.

The Wireless Institute of Australia represents the interests of all radio amateurs throughout Australia. National representation is handled by the executive office under council direction. There is one councillor for each of the seven Divisions. This directory lists all the Divisional offices, broadcast schedules and subscription rates. All enquiries should be directed to your local Division.

Broadcast schedules All frequencies MHz. All times are local.

VK1 Division Australian Capital Territory,
GPO Box 600, Canberra ACT 2601
President Gilbert Hughes
Secretary Peter Kloppenburg
Treasurer Linden S Orr

VK1GH
VK1CPK
VK1LSO

VK1WI: 3.590 LSB, 146.950 FM each Thursday evening from 8.00pm local time. The broadcast text is available on packet, on Internet aus.radio.amateur.misc news group, and on the VK1 Home Page <http://www.vk1.wia.ampr.org>
Annual Membership Fees. Full \$80.00 Pensioner or student \$71.00. Without *Amateur Radio* \$48.00

VK2 Division New South Wales
109 Wigram St, Parramatta NSW
(PO Box 432, Harris Park, 2150)
(Office hours Mon-Fri 1100-1400)
Phone 02 9689 2417
Web: <http://www.ozemail.com.au/~vk2wi>
Freecall 1800 817 644

e-mail: vk2wi@ozemail.com.au
Fax 02 9633 1525
President Terry Davies
Secretary Pat Leeper
Treasurer Chris Minahan

VK2KDK
VK2JPA
VK2EJ

From VK2WI 1.845, 3.595, 7.146*, 10.125, 14.160, 24.950, 28.320, 29.120, 52.120, 52.525, 144.150, 147.000, 438.525, 1281.750 (* morning only) with relays to some of 18.120, 21.170, 584.750 ATV sound. Many country regions relay on 2 m or 70 cm repeaters. Sunday at 1000 and 1930. Highlights included in VK2AWX Newcastle news, Monday 1930 on 3.593 plus 10 m, 2 m, 70 cm, 23 cm. The broadcast text is available on the Internet newsgroup aus.radio.amateur.misc, and on packet radio.
Annual Membership Fees. Full \$80.00 Pensioner or student \$63.00. Without *Amateur Radio* \$50.00

VK3 Division Victoria
40G Victory Boulevard Ashburton VIC 3147
(Office hours Tue 10.00 -2.30)
Phone 03 9885 9261
Web: <http://www.wiavic.org.au>
Fax 03 9885 9298

e-mail: wiavic@wiavic.org.au
President Jim Linton
Secretary John Brown
Treasurer Barry Wilton

VK3PC
VK3JJB
VK3XV

VK3BWI broadcasts on the 1st Sunday of the month at 20.00hrs Primary frequencies, 3.615 DSB, 7.085 LSB, and FM(R)s VK3RML 146.700, VK3RMM 147.250, VK3RWG 147.225, and 70 cm FM(R)s VK3ROU 438.225, and VK3RMU 438.075. Major news under call VK3ZWI on Victorian packet BBS and WIA VIC Web Site.
Annual Membership Fees. Full \$83.00 Pensioner or student \$67.00. Without *Amateur Radio* \$51.00

VK4 Division Queensland
PO Box 199, Wavell Heights, Old. 4012
Phone 07 3221 9377
e-mail: office@wiaq.powerup.com.au
Fax 07 3266 4929
Web: <http://www.wia.org.au/vk4>

President Ewan McLeod
Secretary Bob Cumming
Treasurer Bill McDermott

VK4ERM
VK4YBN
VK4AZM

VK4WIA broadcasts on 1.825 MHz SSB, 3.605 MHz SSB, 7.118 MHz SSB, 10.135 MHz SSB, 14.342 MHz SSB, 21.175 MHz SSB, 28.400 MHz SSB, 29.660 MHz FM (rptr), 147.000 MHz, and 438.525 MHz (in the Brisbane region, and on regional VHF/UHF repeaters) at 0900 hrs K every Sunday morning. QNEWS is repeated Monday evenings, at 19.30 hrs K, on 3.605 MHz SSB and 147.000 MHz FM. On Sunday evenings, at 18.45 hrs K on 3.605SSB and 147.000 FM, a repeat of the previous week's edition of QNEWS is broadcast. Broadcast news in text form on packet is available under WIAQ@VKNET. QNEWS Text and real audio files available from the web site
Annual Membership Fees. Full \$95.00 Pensioner or student \$81.00. Without *Amateur Radio* \$69.00

VK5 Division South Australia and Northern Territory
(GPO Box 1234 Adelaide SA 5001)
Phone 0403 368 066
web: <http://www.sant.wia.org.au>
email: peter.reichelt@bigpond.com

President David Minchin
Secretary Peter Reichelt
Treasurer Trevor Quick

VK5KK
VK5APR
VK5ATQ

VK5WI: 1843 kHz AM, 3.550 MHz LSB, 7.095 AM, 14.175 USB, 28.470 USB, 53.100 FM, 147.000 FM Adelaide, 146.800 FM Mildura, 146.900 FM South East, 146.925 FM Central North, 438.475 FM Adelaide North, ATV Ch 35 579.250 Adelaide. (NT) 3.555 LSB, 7.085 LSB, 10.125 USB, 146.700 FM, 0900 hrs Sunday. The repeat of the broadcast occurs Monday Nights at 1930hrs on 3585kHz and 146.675 MHz FM. The broadcast is available in 'Realaudio' format from the website at www.sant.wia.org.au Broadcast Page area.
Annual Membership Fees. Full \$88.00 Pensioner or student \$73.00. Without *Amateur Radio* \$58.00

VK6 Division Western Australia
PO Box 10 West Perth WA 6872
Phone 08 9351 8873
Web: <http://www.vk6wia.org>
e-mail: vk6wia@inet.net.au

President Neil Penfold
Secretary Christine Bastin
Treasurer Bruce Hedland-Thomas

VK6NE
VK6ZLZ
VK6OO

VK6WIA: 146.700 FM(R) Perth at 0930hrs Sunday relayed on 1.865, 3.564, 7.075, 10.125, 14.116, 14.175, 21.185, 29.120 FM, 50.150 and 438.525 MHz. Country relays 3.582, 147.200 (R) Cataby, 147.350 (R) Busseton, 146.900 (R) Mt William (Bunbury), 147.000 (R) Katanning and 147.250 (R) Mt Saddleback. Broadcast repeated on 146.700 at 1900 hrs Sunday relayed on 1.865, 3.564 and 438.525 MHz : country relays on 146.900, 147.000, 147.200, 147.250 and 147.350 MHz..Also in "Real Audio" format from the VK6 WIA website
Annual Membership Fees. Full \$71.00 Pensioner or student \$65.00. Without *Amateur Radio* \$39.00

VK7 Division Tasmania
PO Box 371 Hobart TAS 7001
Phone 03 6234 3553 (BH)
Web: <http://www.tased.edu.au/tasonline/vk7wia>
also through <http://www.wia.org.au/vk7>
email: bataejw@netpace.net.au

President Mike Jenner
Secretary John Bates
Treasurer John Bates

VK7FB
VK7RT
VK7RT

VK7WI: 146.700 MHz FM (VK7RHT) at 0930 hrs Sunday relayed on 147.000 (VK7RAA), 146.725 (VK7RNE), 146.625 (VK7RMD), 3.570, 7.090, 14.130, 52.100, 144.150 (Hobart), repeated Tues 3.590 at 1930 hrs.
Annual Membership Fees. Full \$90.00 Pensioner or student \$77.00. Without *Amateur Radio* \$57.00

VK8 Northern Territory is part of the VK5 Division and relays broadcasts from VK5 as shown, received on 14 or 28 MHz. The broadcast is downloaded via the Internet.

WIA Federal Convention 2002



Federal Executive for 2002/3.

**L-R Don Wilchefski VK4BY;
Peter Naish VK2BPN,
Federal Secretary;
Ernest Hocking VK1LK,
Federal President;
Brenda Edmonds VK3KT;
David Pilley VK2AYD.**



Presentation of the 2001 RD Trophy to Guy Fletcher VK2KU (left) representing VK2 Division. David Jones VK4OF, representing VK4 Division, last year's holders, hands it over.



Memento presentation to NZART visitors



In session



NZART Rep, David Wardlaw VK3ADW, VK5 Delegates David Box VK5OV and Martin Luther VK5GN

ICOM'S GREAT CHAMPIONS



IC-756PROII **NEW!**

Sharp & soft IF filter shape · Improved 3rd IMD & wide dynamic range
 · One-touch record/play · Digital voice memory · Extended 1/4 Tuning step & BPF functions for SSB-D mode · 32-bit floating-point DSP and 24-bit AD/DA converter · SSB/CW synchronous tuning · 4.9-inch color TFT LCD



IC-718 **A compact HF all band transceiver.**

A superior performer with simple, straightforward operation with keypad. Optional AF DSP capabilities, including noise reduction & auto notch function. It's versatile, compact & loaded with features.



IC-910H **The new dimension in the VHF/UHF world!**

Tri band multimode transceiver · 2M -100W, 70CM - 75W, (optional 23CM, 10W) · 9600bps packet operation.
 · Satellite communication · Reverse/normal tracking doppler shift compensation · CIV capability for PC control



IC-706MKIIG **HF · VHF · UHF** **The amazing evolution of the legendary 706.**

Now includes 70cm @ 20W and 50W on 2m. · Standard feature dsp · Built in sub tone encoder & decoder · Tone scan · Mosfet PA · You get base station performance and features in a mobile rig sized package.



IC-T81A **A remarkably compact quad bander**

VHF/UHF Multiband FM · 2M, 6M, 70CM, 23CM · 124 alphanumeric memory channels · Ni-MH battery
 Tone squelch · Sub tone encoder & decoder that can be independently set · Plus dtmf encoder · Tone scan.



See your nearest Icom dealer or visit our website at www.icom.net.au

2 YR WARRANTY

The magazine for AUSTRALIAN Amateurs



July 2002

Volume 70 No 7



Amateur Radio

\$ 5.95



Amateur Radio's **GEM**

**Drew Diamond
VK3XU**



**VK5UH's
Shack in a
Briefcase**



**A basic Microwave signal source
covering 1100 to 1900MHz**

ISSN 0002-6859





Australian
Amateur Radio

Callbook 2002

Every shack should have one



Now also
on
searchable
CD

**The "Call Book 2002" is available from
your State Division
Order now to get the member discount**

VK1 Division

GPO Box 600, Canberra ACT 2601

VK2 Division

109 Wigram St, Parramatta NSW
(PO Box 432, Harris Park, 2150)
(Office hours Mon-Fri 1100-1400)
Phone 02 9689 2417
<http://www.ozemail.com.au/~vk2wi>
Free call 1800 817 644
e-mail: vk2wi@ozemail.com.au

VK3 Division

40G Victory Boulevard
Ashburton VIC 3147
(Office hours Tue 10.00 - 2.30)
Phone 03 9885 9261
<http://www.wiavic.org.au>
Fax 03 9885 9298
e-mail: wiavic@wiavic.org.au

VK4 Division Queensland
PO Box 199, Wavell Heights, Qld. 4012
Phone 07 3221 9377 Fax 07 3266 4929
e-mail: office@wiaq.powerup.com.au

VK5 Division (and VK8)

(GPO Box 1234 Adelaide SA 5001)
Phone 0403 368 066
: <http://www.sant.wia.org.au>
email: peter.reichelt@bigpond.com

VK6 Division

PO Box 10 West Perth WA 6872
Phone 08 9351 8873
Web: <http://www.vk6wia.org>
e-mail: vk6wia@inet.net.au

VK7 Division

PO Box 371 Hobart TAS 7001
Phone 03 6234 3553 (BH)
<http://www.tased.edu.au/tasonline/vk7wia>
email: batesjw@netspace.net.au

COMMERCIAL RESELLERS

Please contact June Fox (WIA Federal) on 03 9528 5962



Amateur Radio

Volume 70
Number 7
July 2002

The Journal of the Wireless
Institute of Australia
ISSN 0002-6859

Editorial

Editor: Colwyn Low VK5UE
edarmag@chariot.net.au

Technical Editor: Peter Gibson VK3AZL

Publications Committee Members

Ron Fisher VK3OM
Don Jackson VK3DBB
Evan Jarman VK3ANI
Bill Rice VK3ABP
Gil Sones VK3AUI
Bill Roper VK3BR

Advertising

Mrs June Fox,
Tel: (03) 9528 5962

Hamads

"Hamads" Newsletters Unlimited
PO Box 431, Monbulk Vic 3793
Fax: 03 9756 7031
e-mail: newsletters@ozemail.com.au

Office

10/229 Balacava Road
Caulfield, Victoria
Telephone (03) 9528 5962
Facsimile (03) 9523 8191

Business Hours 9:30am to 3:00pm weekdays

Postal

The Editor AR
34 Hawker Crescent
Elizabeth East
South Australia 5112
Email edarmag@chariot.net.au

Production

Newsletters Unlimited 03 9756 7797

Printer

Streamline Press, Melbourne (03) 9417 2788

Postal Service

IMS (03) 9291 8888

Production Deadlines

Advertising booking and articles for
publication 10th of preceding month.

Hamads and advertising material deadline
18th day of preceding month

The contents of Amateur Radio are Copyright
Wireless Institute of Australia © 2002

General

WIA Federal Convention 2002. An observer's observations 14	<i>Peter Parker VK3YE</i>
Bordertown Primary School contacts Space station 16	<i>Tony Hutchison VK5ZAI</i>
EMR limits further delayed 17	<i>Jim Linton VK3PC</i>
Licence fees go up 17	
Remembrance Day Contest. Amateur Radio's WW2 Silent Keys 20	<i>Col. Harvey VKIAU</i>
International Lighthouse/Lightship Weekend 22	<i>Mike Dalrymple GM4SUC</i>
WRC 2003 Donations 29	
2 ARISS schools in one day 52	<i>Tony Hutchison VK5ZAI</i>

Technical

The Shack in a Briefcase 4	<i>Ron Holmes VK5VH</i>
A basic Microwave signal source covering 1100 to 1900MHz 11	<i>Dale Hughes, VK2DSH</i>
A low cost microwatt meter 18	<i>Dale Hughes VK2DSH</i>
Log periodic for two metres (Technical Abstracts) 23	<i>Gil Sones VK3AUI</i>
EWE Antenna (Technical Abstracts) 24	<i>Gil Sones VK3AUI</i>
EMC (Technical Abstracts) 26	<i>Gil Sones VK3AUI</i>

Columns

Advertisers' Index 55	HF Predictions 48
ALARA 25	How's DX? 37
AMSAT 32	New WIA Members 19
Beyond Our Shores 28	Over to you 47
Contests 41	Silent Key 17, 46
Club News 39, 52	Spotlight on SWLing 40
WIA Division News	Technical Abstracts 23,24,26
VK1 Notes 30	The last word 55
VK2 Notes 30	VHF/UHF - An Expanding World 50
VK3 Notes 31	WIA Comment 3
Editor's Comment 2	WIA Division Directory 56
Hamads 54	WIA Federal Directory 2
Ham Shack Computers 45	Will's Page 53

Our cover this month

Prolific AR technical contributor Drew Diamond VK3XU. Photo by
Ron Fisher VK3OM. See story page 2

Contributions to Amateur Radio

Amateur Radio is a forum for WIA members' amateur radio experiments, experiences opinions and news. Manuscripts with drawings and/or photos are always welcome and will be considered for publication. Articles on disc or email are especially welcome. The WIA cannot be responsible for loss or damage to any material. A pamphlet, How to write for Amateur Radio is available from the Federal Office on receipt of a stamped self-addressed envelope.

Back Issues

Back issues are available directly from the WIA Federal Office (until stocks are exhausted), at \$4.00 each (including postage within Australia) to members.

Photostat copies

When back issues are no longer available, photocopies of articles are available to members at \$2.50 each (plus an additional \$2 for each additional issue in which the article appears).

Disclaimer

The opinions expressed in this publication do not necessarily reflect the official view of the WIA and the WIA cannot be held responsible for incorrect information published.

Amateur Radio Service

A radiocommunication service for the purpose of self-training, intercommunication and technical investigation carried out by amateurs; that is, by duly authorised persons interested in radio technique solely with a personal aim and without pecuniary interest.

Wireless Institute of Australia

The world's first and oldest
National Radio Society
Founded 1910

Representing
The Australian Amateur Radio Service

Member of the
International Amateur Radio Union

Registered Federal Office of the WIA

10/229 Balaclava Road
Caulfield North Vic 3161

Tel: (03) 9528 6962 Fax (03) 9523 8191
http://www.wia.org.au

All mail to
PO Box 2175 Caulfield Junction VIC 3161

Business hours: 9.30am-3pm weekdays

Federal Secretary

Peter Naish VK2BPN

Federal Office staff

June Fox Bookkeeper
Rita Trebilco VK3IF Examinations Officer

Council

President	Ernest Hocking	VK1LK
VK1 Federal Councillor	Gilbert Hughes	VK1GH
VK2 Federal Councillor	Barry White	VK2AAB
VK3 Federal Councillor	Jim Linton	VK3PC
VK4 Federal Councillor	David Jones	VK4OF
VK5 Federal Councillor	David Box	VK5OV
VK6 Federal Councillor	Willi McGhie	VK8UU
VK7 Federal Councillor	Phil Corby	VK7ZAX

Executive

Brenda Edmonds
David Pilley
Don Wilschetski

VK3KT
VK2AYD
VK4BY

Federal Coordinators

AMSAT	Graham Ratcliff	VK5AGR
ARDF	Jack Bramham	VK3WWW
Awards	Mal Johnson	VK8LC
Contests	Ian Godsill	VK3VP
Education	Ron Smith	VK4AGS
FTAC	John Martin	VK3KWA
Historian	John Edmonds	VK3AFU
IARU	Neil Penfold	VK6NE
Intruder Watch	Harry Andersson	VK8HA
International Travel Host	John Miller	VK3DJM
ITU Conference and study group	Gilbert Hughes	VK1GH
QSL Manager (vks, vko)	Neil Penfold	VK6NE
Videotapes	VK2 Division	
Web	Joe Burford	VK5UJ
WICEN	John Weir	VK3ZRV

ACA Liaison Team

Glen Dunstan VK4DU (Corresponding)	
Gilbert Hughes VK1GH	
Keith Malcolm VK1ZKM	
Peter Naish VK2BPN	
Canberra Liaison Officer Richard Jenkins	VK1RJ

Editorial Comment

Colwyn Low VK5UE

"Use it or Lose it" is always before us

This month has seen me running round in circles and getting nowhere. My address was not on a mailing list and the people who needed to contact me assumed it was. No amount of modern technology gets round that one. Also this month's magazine seems to have had continuous minor delays. Texts seem to have been corrupted and diagrams gone astray. Well you are reading this so we must have overcome the problems.

Amateur radio continues to have hurdles paced in front of it but we still seem able to get over them or round them. The EMC regulations are an inconvenience, which we have to put up with. They are not the greatest problem we have encountered and for most of us no action other than write on a piece of paper, the power we use, the mode we operate and the height of the antenna, will be all that is necessary. For others we will have to consider the antenna placing with respect to the fence line and its height in relation to the power and the average transmit to listen time in our normal operation will solve the problem. The ACA web site does carry charts and tables and formulae, if we have to do a formal assessment.

The next few months have important Amateur Contests and activities, which will keep some of us in our nice cosy shacks and others in their cold

shacks. The Remembrance Day Contest will be held on August 17th and 18th. The ALARA contest is in its new slot of August 24 and 25th. The International Lighthouse Weekend coincides with the RD so you could do the two together. There are also a few Sprints being held in July and August.

The other thing that Winter brings is the opportunity to plan and build new equipment. The chance to look at incorporating a new mode into our stations. We could get a digital interface for PSK or we could build the circuits to give us access to the IRLP. I hear some clubs are experiencing new life from Internet Linked Repeater activities.

Amateur Radio is about communication, learning to be better at communicating and meeting other people to exchange knowledge. Things have changed greatly in the last few decades and we must move with the times. However the old adage "Use it or Lose it" is always before us.

Remember when WRC 2003 was years in the future? Well it is now NEXT YEAR. Have you considered making a contribution to the cost of sending Amateur Representatives from Australia to the conference? The WIA has a fund for this. The Conference will now be in Geneva not Venezuela so the cost to the WIA will most likely go up.

So keep active.

73 Colwyn

July cover

Amateur Radio's gem

This month we have put Drew Diamond on the cover, as for once there is not one of his articles inside.

Drew's interests in Amateur Radio are QRP operations and homebrew equipment. Drew's working life was with the Research Labs of the old PMG Department and its successors. Since then he has spent his time developing useful Ham Radio equipment AND writing it up in a publishable form. His articles in AR are regarded as practicable and have

the reputation that if Drew publishes it, it works and the components are available in Australia. We wish to express our thanks to Drew for all he does for Amateur Radio in general and this Magazine in particular. Drew has published two books of his projects, however only Vol 2 is still available. Contact Drew QTHR.

Photograph by Ron Fisher VK3OM

Some great responses... Thank you!

AR Take 5 Survey

Responses to the survey continue to arrive. So far I have recorded 174 responses to the survey and more appear each day. Thank you to everyone who has taken the time to respond.

For those who included a separate letter I am in the process of responding to you individually - please forgive me if you have not already received a reply - I am working on them and letter writing was never a strong point of mine.

I have not undertaken any full analysis of the responses yet but a number of key issues are clearly identified already:

1. Many of you have referred to the need to smarten up the operation of the WIA particularly in keeping you informed and more importantly listening and responding to your communications. I hope that my monthly comments in AR and the associated broadcasts go some way to addressing your needs. However there is a common theme that we need to make information about current events available to you more regularly. I also note that the majority of you appear to have Internet access and I see this as a great opportunity to use this as a means of getting information to you in a timely manner.

I will be speaking to the other members of the executive in the near future to discuss how we might achieve this improvement in communications. In the meantime don't forget that we already run a very informative web page at www.wia.org.au where information can be published between the monthly issues of AR.

2. Many of you have expressed a concern over the fragmentation of

the WIA into separate Divisions with the associated duplication of administrative functions. A large number of respondents have indicated that they believe that the time has come to move towards a single national body that represents all amateurs in Australia.

3. Many of you have indicated support for continuing to distribute AR on the newsstands. In fact there have been a number of suggestions on how we might improve AR in the future. I have carefully noted these suggestions so that once we have a clearer idea of public interest we can be in a position to examine the technical feasibility of implementing these ideas.
4. Finally I note that the survey strongly confirms that we as a group are indeed mostly male and all on the wrong side of 40. This for me a clear indication that we need to look at recruiting more lady members as well as younger members. I would like to throw you a question: "How do we make amateur radio attractive to the fairer sex and the younger generation?". I look forward to some of you writing to me with your suggestions (especially if you are a member of these two groups).

WIA Structure

Following last month's call for volunteers to assist in the Strategic Review of the WIA, and its structure I have been pleased with the initial response of offers of assistance. I am keen to finalise the composition of the review team and therefore would ask anyone else who is keen to participate in this exercise to make contact with me immediately. We need to move quickly if we are to be in a position to recommend any required changes in time for next year's AGM,

AR

I am pleased to report following in principle agreement of council to move to full distribution of AR throughout Australia that results for the month of June indicate another successful month. I have therefore arranged for the publisher to move to full scale distribution of AR throughout Australia. If anyone knows of any amateur or interested party who experiences any problems in obtaining a copy of AR please drop me a line so that I can liaise with the publisher and distributor in order to quickly resolve any such matters. I hope that as we can establish a sound foundation of the distribution of AR that we will be in a much better position to consider ways to improve the Journal including I hope ways to reduce costs.

WRC 2003

Your response to my request for donations in support of Australia delegates to the World Radio Conference in Venezuela has been incredible. Within a week of AR being published for June, the Federal Office has received well over 200 donations. I hope that we will be able to list the callsigns of all of you who so kindly donated to this important event. The importance of these donations may soon become even more apparent with the recent announcement of the change of venue for the event. I fully expect that wherever the new location is for the conference that the expense that we will incur will almost certainly be as high if not greater than that for the Venezuela conference.

I will bring this issue of my notes to a close and wish you all 73s. I look forward to hearing your views on any amateur radio related matters and hopefully circumstances will permit me to meet with many more of you over the next 12 months.

The Shack in a Briefcase

Section 1

With the reduction in the size of radio transceivers we have come to a situation where something like the FT100 or IC706, all band full power rigs, can be carried around in half a briefcase.

You can even run up to 30 watts on a 12 volt 7 amp-hour gel cell battery, which takes up a little more of the case. With lightweight switch mode power supplies becoming available, the portable shack is a distinct possibility. There is only one catch - the antenna. For many, two 10 metre poles and 20 metres of wire are definitely out of the question. Even the average mobile antenna is very awkward to carry or use unless mounted on a vehicle. I wish to present the "Mini Ant" - an antenna, which will fit in the other half of the briefcase and work on 11 bands!

Photo 1. Ron Holmes VK5UH and his shack

THE "SHACK IN A BRIEFCASE" idea is attractive to many old-timers like myself now living in units or other situations where shack room is scarce and antennas against the skyline are not allowed. My recent article "Invisible Antennas" in *Amateur Radio* of April 2001, recounted some of my early attempts to overcome this. I had some other good ideas built into the roof cavity but these were upset when a cooling system, which filled the area with aluminium ducting, was installed.

What I needed was an antenna that would fit in the other half of the briefcase, could be used indoors or portable, and would operate on 11 of the bands my FT100 uses. I decided that 160 metres was perhaps stretching it a bit too

far. Everything from 80 metres to 70 centimetres would do. This is what I now have and it works amazingly well.

It can hardly be called a DX antenna but recently I sat it on a low table beside the beach at Victor Harbour, set it for 17 m and received a 5/9 report from VK2AYE in Sydney followed by a 15 minute QSO with GW4GTE in Wales who gave me a 5/5-6 report. He was using a shortened dipole at 30 ft (9 metres).

From inside the shack at home I worked WQ9H in Indiana. He was running a kilowatt to a 5 element monoband Yagi but we both gave 5/5 reports in the clear. A quick test from the home QTH on 20 m on the traveller's net gave me 5/5 from Perth, 5/6 from

North Queensland and 5/9 plus 10 in Melbourne. On 40 m (the 7.103 MHz net) all VK5 stations gave 5/7-9 reports. On my regular 80 m net all VK5s gave me 5/9 plus and VK3 5/6. The only problem on 80 is that background noise can swamp an otherwise strong signal. I find 30 m works extremely well and have worked VK4 satisfactorily on 15 m and local stations on 10 m but to date do not have reports on 12 m. On 6 m it allows me at least to operate through the two repeaters in Adelaide. I have not tried it beyond that. Both 2 m and 70 cm work well on a 50 cm vertical being 1/4 wave on 2m and 3/4 wave on 70 cm.

In short, I now have an antenna sitting on the filing cabinet on the other side of the shack, which runs 11 bands and

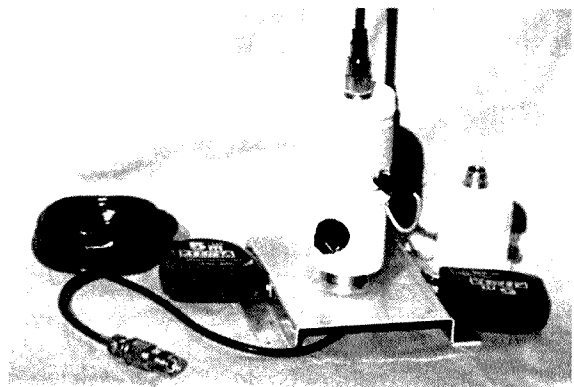

Photo 2. Mark 1

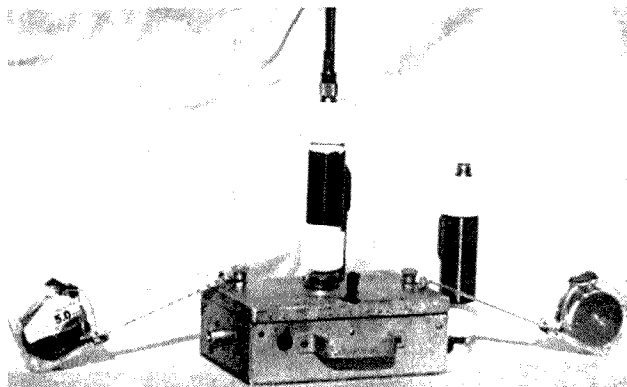

Photo 3. Mark 2

gives me more opportunities for ham operation than I can find time for. When I go away it fits along with the FT100 in the briefcase and can be set up for any band in a few minutes. The response from one Ham I talked to was *Anyone want to buy my 60 ft. tower?* I have given this little antenna a real splurge in this introduction, not because I have something to sell, but because I suspect that when they see what it is, many hams will be inclined to disregard its usefulness. My only answer is *Try it yourself*. Make a single band version for a start as I did if you like. I will give a brief description of models Mark 1 (Photo 2) and Mark 2 (Photo 3), if the editor has room for them, but Mark 3 (Photo 4) is no harder to build and much more useful.

What is it?

This antenna is in essence a base loaded whip. What makes it special is the method of allowing it to be tuned spot on, including the ability to return to that tuning position; and the roll-up radials, or, if you like, counterpoise. In the photos of Mark 1 (Photo 2) and Mark 2 (Photo 3), the preliminary models, Mark 1 (Photo 2) is made of pillboxes with the lids glued to the bottom so that different coils can be added. The coil in use is for 40 m and the spare for 20 m. The bottom container has a 100 pF variable capacitor for final tuning. The radials are 5 metre metal measuring tapes. This worked very well but became bulky with more spare coils. Mark 2 (Photo 3) is built into a metal box, which holds everything for carrying and becomes the base in use. 40 m and 80 m coils are shown. (The box shows signs of wear. It was built by the author 56 years ago as a toilet box for his kit when he was a RAAF radar mechanic in PNG;

using a panel souvenired from a Japanese army transmitter captured by the AIF at Wewak). Mark 3 (Photo 4), which will be described in detail, covers 11 bands and is tuned by means of [A] a tapped coil, using plugs and sockets, [B] the length of the telescopic whip, and [C] the length of the radials. The info for each band is kept before your eyes on a printed card on the front of the antenna.

Building the antenna

You will need - reading from my docket at a well-known electronics store

- Project Box Black 95x 1 60x61mm - 2 of (Not the boxes which have sloping ends)
- Winding Wire 100g 20B&S/or 0.8mm
- UHF Line Plug PL259, RG213/RG8 (You won't need the insert)
- UHF Panel Socket S0239 Square Mount -2 off
- Plug Banana Standard 4mm Red - 2 off
- Plug Banana Standard 4mm Black - 2 off
- Socket Banana Plain 4mm - 10 off. (I got 3 each in red, black and green & 1 yellow)
- Knob Plastic Black Pointer Screw (Or similar for the rotary switch)
- Switch Rotary 6mm 2 Pole 6 Pos 1 Gang (A simpler switch would do if you don't want to include the SWR bridge and dummy load. The SWR bridge and dummy load will be dealt with separately as they are not essential.)
- Socket Banana Bind/Post large block - 2 off (Or any solid terminal connector)
- A telescopic Antenna at least 85 cm long, preferably 95cm or more. (The cheapest way to get this if you don't

have one is from a TV antenna in a "Cheap as Chips" or "Cunninghams" type store.)

- Length of PVC pipe 125mm long and about 42 mm outside diameter.
- Selection of small bolts and nuts.

Many will find most of what is needed in the junk box but I have made sure that everything is available if you no longer have room for a junk box.

Earlier models

Mark 1 (Photo 2)

My first attempt used the "Slow K" pillboxes which I was accumulating as they kept reminding me of coil formers. By gluing lids to the bottom of the containers I could mount them on top of one another as required.

The 40 m coil has 35 turns of cotton covered wire (that shows you how old my junk box is) with the top connected to a S0239 socket mounted on the top lid to which the telescopic whip is screwed, and the bottom to a banana socket on the side near the bottom. A lead and plug from the container with the capacitor connects to this, The 20 m coil is likewise with 16 turns. The bottom container is mounted on a base originally used for a UHF antenna. The tape measure radials cost about \$3 from a Cheap as Chips store.

The coiled coax is because when used with my FT 100 the rig showed high SWR and refused to work. Since the SWR as read on my Osker Block meter with the FT901 was flat, this was a problem. The Yaesu people informed me that sets like the FT100 are full of microchip circuits which are very sensitive to RF on the outside of the coax. The answer was to wind the coax (15 to 20 turns) to form an RF choke. This fixed it.

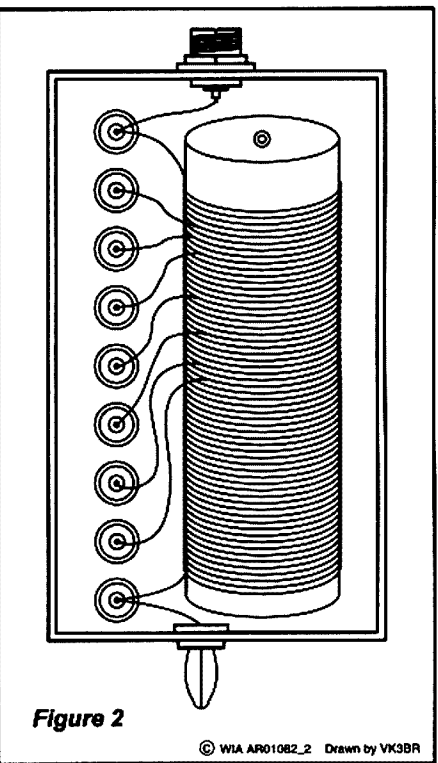
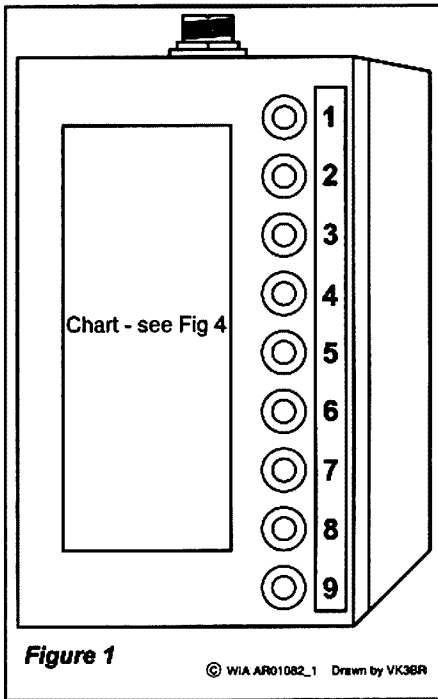

Mark 2 (Photo 3)

This is a much more serviceable arrangement and very convenient as everything, apart from the coax, fits in the 13 cm by 21 cm by 8 cm metal box, which is itself the base. The whip in this case has shorter sections. The coils are wound on a piece of PVC tubing of 35 mm outside diameter about 12 cm long.

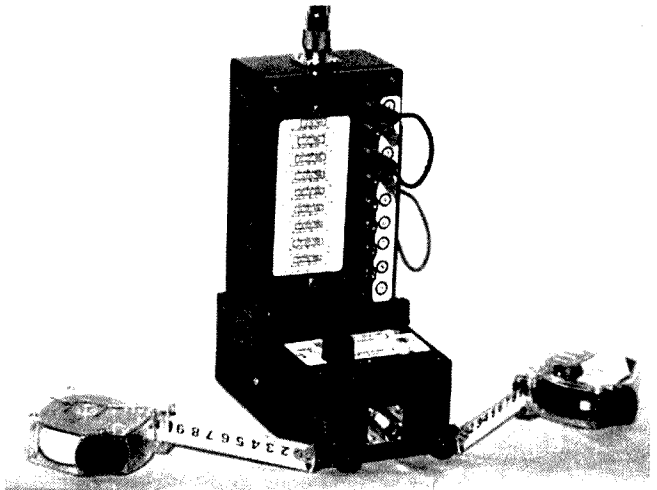

Photo 4. Mark III

This will be found in the hardware store. The end caps will be found nearby. They have a S0239 socket fixed to the top one for the whip and the appropriate arrangements made to screw on to the base depending on the method you use. My 40 m coil has 65 turns of 0.8 mm wire and resonates with a 67 cm whip. The 80 m has 125 turns of 0.63 mm wire and resonates with a 94 cm whip.

Mark 3 (Photo 4).

Whether you go for the "bells and whistles" version or the basic, the top half is the same. See Figs 1 and 2.

The coil winding is probably the way to go first. Drill the mounting holes for the former (the PVC pipe) with the centres 6 mm in from the ends. A 3/16 inch diameter (5mm) hole should fit a suitable short bolt and nut to fix it to the inside of the lid of Project Box 1. Start the winding with three small holes drilled in the former about 7mm apart in line for the first turn and about 10 mm in from the end. At least enough to clear the mounting nut. These should be on the left hand side of the mounted coil looking at the back of the front panel. Drill 3 more small holes 15 mm in from the bottom end. Poke the end of the wire through the first hole about 10 cm, back through the second and through the third leaving the end inside the former. Now wind from the top, stopping every five turns and giving the wire a right angle kink out from the former of a couple of mm with needle-nosed pliers. These will be the tap points and there will be seven, ie the last will be at 35 turns. Now wind the rest of the coil down to the finishing holes at the bottom. There should be about 108 turns altogether but a couple either way won't

matter.

Again leave a few centimetres inside the former.

The front panel (see Fig.1) should now be drilled as per the pattern and the banana sockets fitted. The coil can then be mounted; theappings have the enamel scraped off and tinned, and the connections from coil to sockets soldered using the same wire as for the coil as per Fig. 2. Two sets of plug links should be made using the Banana Plugs at either end of a length of pliable insulated wire just long enough to allow a connection from top to bottom of the sockets. The project box belonging to the front panel should now have the S0239 socket mounted on the top. Draw lines diagonally from the comers with the front panel in place and drill the hole where they cross. If you don't have a big enough drill bit, use the biggest you have and ream it out with a round file. The four small holes can be drilled through and secured with nuts and bolts but make sure the bolts are short enough to avoid the coil former. Small screws may do instead.

In the centre of the bottom of the box drill another hole to take a short bolt to which the bottom of the coil is connected and which fixes the top box to the horizontal bottom one. A couple of small screws from underneath the lid of the bottom box will stop the top one from turning.

The bottom box, Project Box 2, forms the base supporting the antenna and also contains some extras to make it easier to tune. The other S0239 socket is fitted to the front end with a pair of terminals either side of it to which the two roll-up 5 metre tapes are connected using wire

loops soldered to the ends of the tapes. The centre connection of the socket goes to one pole of a 2 pole six position rotary switch. The earth connection goes to the two terminals and the other pole. The rotary switch is mounted on the box lid. Beside it, is another socket into which the telescopic antenna at 50 centimetres is inserted for 2 m (1/4 wave) and 70 cm (3/4 wave). If you like, another S0239 socket can be used but the simple banana socket takes the centre of the 259 plug quite satisfactorily. Switch position 6 goes to this. Position 3 goes to the bolt and bottom of the antenna coil. Mount the switch with the tag nearest the end of the lid. This makes the pointer face the HF antenna on position 3 and the VHF/UHF antenna on position six, if you have the centre of the coax connected to the right pole. Positions 1 and 2 are used for the dummy load and SWR Bridge respectively. Positions 4 and 5 are blank. Also on the lid, between the switch and plug and the vertical antenna box, are mountings for a pair of LEDs, one red and one green. These are indicators from a simple SWR bridge built into the bottom box. Position 2 goes through this to the antenna. Also in the box is a dummy load made of 20 x 1 kΩ 1 watt resistors in parallel. Position 1 goes to this. Provision is also made for a 25kΩ potentiometer to control sensitivity of the SWR indicators. If you decide you do not need this aid to tuning, the switch can be simpler and the

LEDs and sensitivity control omitted. Instructions for building the SWR bridge and dummy load will be the subject of the latter half.

The Telescopic Antenna

This may have various arrangements on the bottom end but one way or another they can be soldered into the centre of a UHF PL259 line plug. This is the kind with a large entrance for 10 mm diameter coax. Cover the bottom end of the whip with a short piece of the outer covering of 3-core mains cable or similar. The insulation is not necessary but it will hold the whip firm in the plug. On the section above the lowest section of the antenna mark with black paint lines 5 cm apart for about 20 cm. This will enable you, knowing the full length of the whip, to quickly adjust it to shorter lengths as required.

Tuning the Antenna

If you wind the coil as per instructions the arrangements indicated in the card made to slip in a clear plastic envelope on the front of Box I (Fig 4 and Photo 3) should be close to correct. If not, you

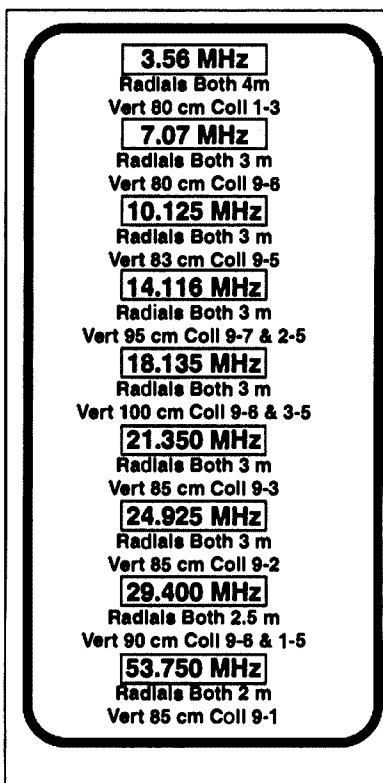

Figure 4. For front of Project Box



may have the more difficult task of getting them right with the help of a GDO or continuous coverage receiver. Noise response once you have removed your hand from the whip will give a good indication to start with. Then you can check for 1:1 SWR.

The purpose of having two sets of linking plugs is to make use of the fact that the closer to the base of the coil you go the more inductance change will be found in the 5 turn coil sections. If you find it difficult to tune to the frequency using the bottom of the coil connected to any one of the other 8 positions; you can find variations in between by using a combination of lower and upper sections.

If your whip is too short, a couple of unshielded alligator clips can be attached to it, either part way up or at the top. Clip one to the whip and the other to the first if required. Sometimes this can make the change from one end of a band to the other very simply.

Note that most frequencies work with 3 metre radials but 80 m requires 4 metres a side and 10 m worked best with 2.5 metres and 6 m with 2 metres.

Continued on page 9

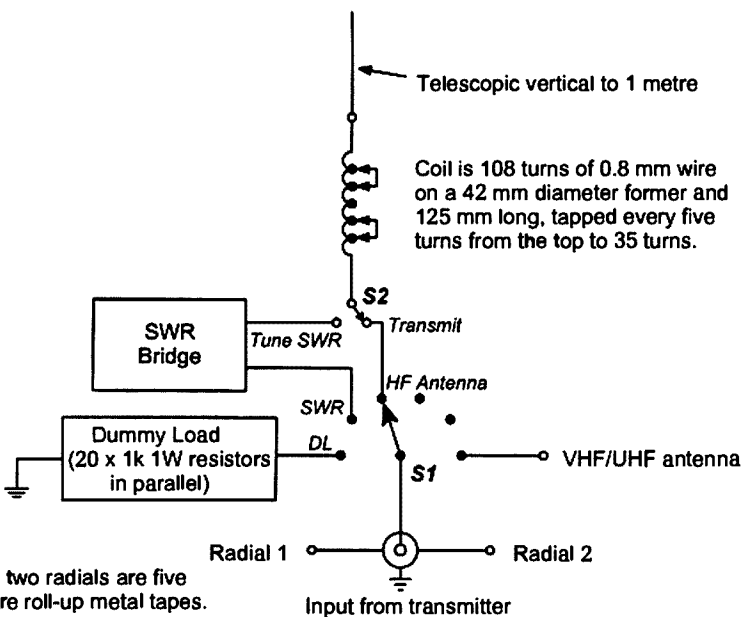

Figure 3

© WIA AR01082_3 Drawn by VK3BR

STRICTLY HAM

PTY LTD



★ IC-746 PRO

- Icom **WORK THE WORLD** performance
- The best way to get onto HF plus 6 and 2 metres
 - Multifunction hi-res display
 - Direct frequency
 - Shack or portable



★ IC-756 PRO/II

- Icom's new HF+50-MHz digital
The performance king Try it to see why
- Multi-colour multi-function screen



★ TH-D7A(G)

- Dual bander
- Effortless 2m & 70cm
- BUILT IN PACKET
- 200 alphanumeric memory channels
- 6W from 13.8VDC
- Comes with NiCd battery and charger
- APRS compatible



★ TS-2000

- High performance standards
- Three distinct operation platforms,
 - 1 Traditional transceiver-full front panel,
 - 2 "Silver box" for mobile use
 - 3 The ARCP-2000 computer control
- 100 watts on HF, 6 metres and 2 metres, 50 watts on 70cm,

★ IC-706MKIIG

Ultra **SMALL**

167(W) x 58 (H) x 200 (D), 2.45kg
Detachable Control Panel/Display
(optional equipment required for remote operation)

SSB/AM/CW/RTTY Narrow Filter Options



★ TM-D700A

Kenwood's new TM-D700A makes the most of exciting SSTV, GPS, and APRS® (Automatic Packet/Position Reporting (rapidly gaining popularity worldwide).
Extra large amber and black display,
Built-in TNC offers a wide range of options, inc. simple packet operation using AX.25

Ham radio is truly entering a new era.



★ TS-50

Mount it in a vehicle, take it on a DX-pedition or use it as a permanent base station transceiver. The easy-to-use menu system adds flexibility, stable operation in any situation.

- DDS with fuzzy control
- 100 Memory channels
- Switchable AGC circuit (SLOW/FAST)
- IF shift Noise blanker (pulse)
- Dual VFOs (A & B)

Outstanding performance



Suppliers and distributors

KANTRONICS-MFJ-DIAMOND-MIRAGE-HY-GAIN-VECTRONICS

14 CHURCH ST BAYSWATER VIC 3153

Phone (03) 9729 7656

email sales@strictlyham.com.au

Fax (03) 9729 7422

www.strictlyham.com.au

The Shack in a Briefcase continued

Section 2

Bells and Whistles

In Saction 1 of this article the major instructions for building the Mini Ant were given. This section is to describe the SWR Bridge and Dummy Load, which I built into the bottom project box. These are to enable tuning of the antenna while it is at too great a distance from the transceiver to be running back and forth while tuning. It is particularly useful in the case of many modem rigs where the SWR meter is built into the transceiver.

In addition to the parts list given previously you will need:

- 2 - RCA plugs and sockets,
- 1 - 3.5mm stereo plug and socket,
- 1 - sealed diecast aluminium box 64 by 58 by 35 mm
- SPDT toggle switch (small),
- 1 - 25k Ω pot.
- 2 - 5mm round LEDs (Premium quality) 1 - Red and 1 - Green with bezels,
- 2 - 1N4148/914 diodes or substitutes,
- 6 - 100 Ω 1 watt resistors
- 2 - 680 Ω 1 watt resistors
- 4 - 0.005mF or 0 01 mF capacitors
- 1 - tag strip 3 lug, (large),
- Scraps of matrix board, hook-up wires.

The idea is that if the initial setting up of the antenna according to the info card does not give you 1:1 SWR at the rig you move to plan B. Send a continuous signal of up to 5 watts from the transceiver into the antenna switched to "Dummy Load", (Position 1). By switching to "Tune SWR" on a small SPDT switch on the lid of the bottom box behind the antenna, and turning the main switch to position 2 "SWR", this signal now goes through the SWR Bridge to the antenna. The two LEDs will probably light up. Adjust the sensitivity control till they are just glowing. Switch back to Dummy load (Position 1) and adjust the vertical whip length a couple of centimetres one way or another, then back to SWR (Position 2). When the green light continues to

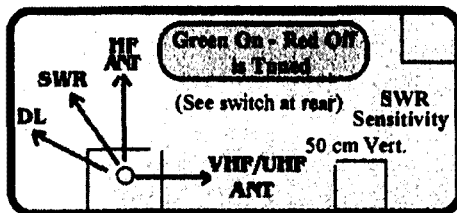

Figure 5a. Front and Top Project Box 2

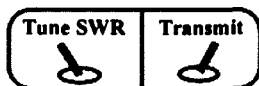

Figure 5b. For back of box 2 if using built in tuning system

glow and the red one goes out you are on frequency. Now turn the rear switch to "Transmit" and the front one to position 3, "HF ANT", and all should be in order.

The 5 watt or less signal can be arranged by sending a CW note with the key closed, or by choosing AM mode and putting a rubber band round the Push to Talk lever on the microphone.

The SWR Bridge

This is based on a circuit appearing in my ARRL Antenna Handbook of 13th edition, 1974 and 17th edition, 1994, and no doubt many others, under the heading "Resistance Bridge". See Fig.9 The original used a meter and switching arrangement as an indicator. I have replaced this with 2 LEDs, green for forward reading and red for reverse, both in circuit all the time the bridge is operating. I have not seen this idea used before but as long as the sensitivity control keeps the LEDs at a reasonably low level it seems sufficiently accurate for the purpose in hand. Of course, even with a meter indicator this level adjustment has to be made. The 680 Ω resistors replace the 47k Ω ones in the original circuit.

I have made the bridge

TUNING PROCEDURE FOR HF
Adjust radials, coil tapings and vertical as per front settings. If antenna is near rig check for flst SWR on rig meter. It should be OK. If not, switch off rig and adjust vertical.

Where antenna is distant from rig do initial adjustments to correct settings, then turn switch to dummy load and feed constant signal of no more than 5 watts to it. Switch to SWR at both front and back of antenna and adjust sensitivity for green LED to glow. If red LED is off while green glows SWR is correct. If not, return to dummy load and adjust vertical. When correct switch to HF ANT at front and Transmit at back.

USING VHF/UHF
Switch to VHF/UHF ANT. Place vertical at 50 cms long in socket. Remove links from HF section. With little adjustment this will work at 1/4 wave on 2 metres and 3/4 on 70 cms.
Radials can be almost anything.

Figure 5c. For back of project box 1

resistors two 100 Ω 1 watt in parallel, rather than the 50 Ω half watt of the original, simply to allow for possible mistakes. Like one I made in the experimental stages by sending well over 5 watts into the system and frying a half-watt resistor.

The drawing of Fig 6 shows that I have also changed the construction from that

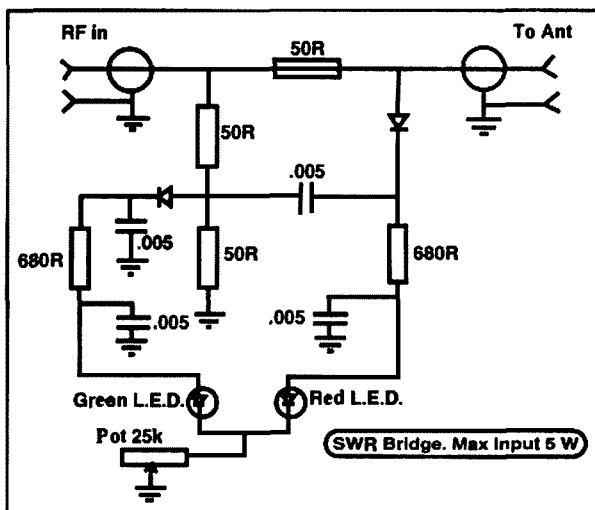

Figure 6. SWR Bridge. All resistors are 1 watt. 50R are 2-100R, 1W, in parallel. I used 1N4148/914 signal diodes and 5 mm round premium qual. LEDs

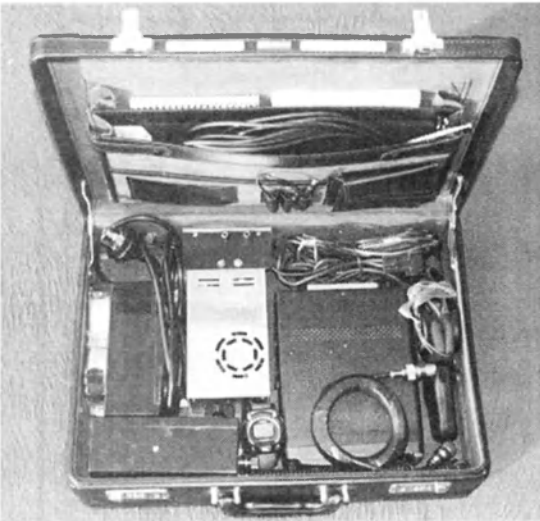

Photo 5. The Shack in the briefcase



Photo 6. The Shack in use at Pt Hughes

in the handbook. I put it in a diecast aluminium box 64 mm by 58 mm by 35 mm. because this fitted neatly. It is attached to the side of the plastic box with a screw. Of course you can make your own box if you wish. The main thing is that all is in a metal shield and that there is as little coupling between the bridge arms as possible.

Power goes into and out of the box via RCA plugs and sockets and to the LEDs and sensitivity pot via a 3.5mm stereo socket and plug. Please note. The diecast box wall is too thick for the nut on the stereo socket to screw right in. You need to file it back so that the plug seats properly. I spent hours looking for a fault in the circuit before I woke up to this.

The SPDT switch at the back end of the bottom box has the centre connected to the antenna base bolt, the lead from position 3 on the front switch to one side and the output of the SWR box to the other.

The Dummy Load

Twenty 1 kΩ 1 watt resistors mounted in parallel along a piece of matrix board or similar, 100mm by 45 mm, will fit along the wall of the plastic box opposite

the SWR box. One connection goes to earth and the other to position 1 on the switch. Even if you don't build in the SWR Bridge the dummy load can be handy when making adjustments.

Two construction hints:

- (1) The RCA plugs and Stereo plug will be best with their covers left off.
- (2) Wire up the 6 position switch and solder lug for the VHF socket before mounting them in the lid.

The other connections to sensitivity potentiometer, 3 lug tag strip, LEDs, antenna coil base and rear switch can be made with the lid of the bottom box fixed to the top box and lying vertically against the edge of the bottom box on the side away from you when the front of the antenna is to your left.

Finally

I have been playing with this antenna for some time now and learning what it

will and won't do. Under good conditions with low noise level it will make you readable at remarkable distances on all bands. Under noisy or poor conditions the other end you will have difficulty being read, even when you can read the other station well. In fact, on receive I have often found the Mini gives better results than a larger antenna because it picks up less noise. I presume this is because it is more precisely tuned than a broadband antenna.

Which leads to its value as a receiving antenna for SWLs. Since I bought the FT 100 with its so wide coverage I have spent many pleasant hours scanning and listening to all sorts of signals. Even if you only build it for this purpose, its portability and ability to tune to so many bands, including those outside the amateur bands, could be well worthwhile.

ar

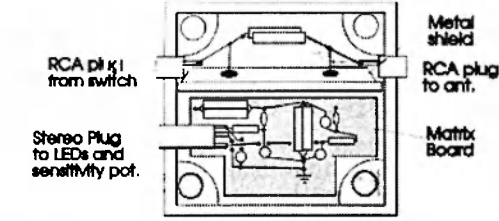

Figure 7a. SWR Bridge in diecast aluminium box

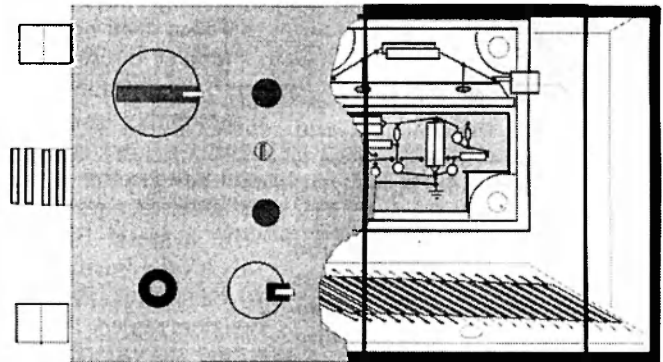

Figure 7b. Cutaway view showing SWR Bridge and Dummy Load inside bottom box. The screw between the LEDs holds a 3 lug tag strip for the LED and sensitivity pot connection. SWR Box lid is off in drawing

A basic Microwave signal source covering 1100 to 1900MHz

Dale Hughes, VK2DSH

A variable frequency oscillator that covers a range of useful frequencies for the microwave experimenter.

The idea for such a device developed while building a receiver for the 21cm Hydrogen emission line. A signal source was needed for testing and aligning the receiving system. A search through the

'Mini-Circuits' catalogue revealed a suitable voltage controlled oscillator was available. This device, part number POS-2120W, covers the range from 1060MHz to 2120MHz. Thus it was useful for the

23cm amateur band as well. The initial idea was to use the VCO module as a free running oscillator. An idea then hatched about using a phase locked loop to lock the VCO to a more stable frequency at a much lower frequency.

A search of various catalogues revealed that there wasn't much in the way of suitable components available. Dick Smith Electronics used to have a 1GHz prescaler (SAB 6456) that might be useful, but they are no longer stocking the device. Sophisticated devices were available that required a microprocessor to operate, but that was getting a bit complicated. As luck would have it, a solution was found in some surplus equipment from the local scrap yard. I obtained for a few dollars some surplus fibre optic video links and the

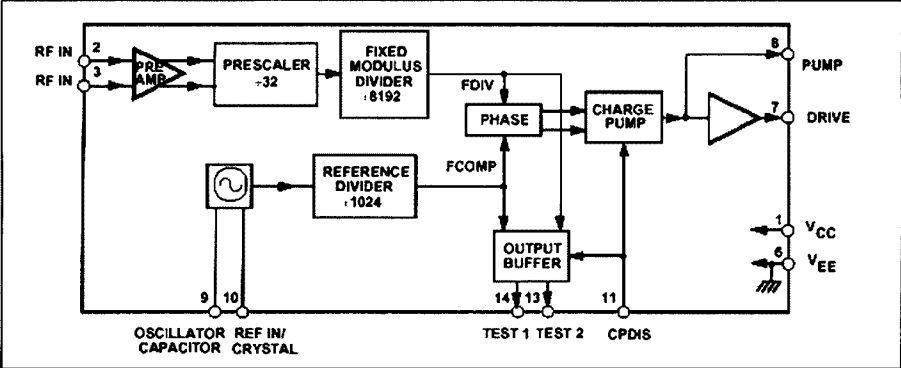

Figure 1: Block diagram of the SP5070

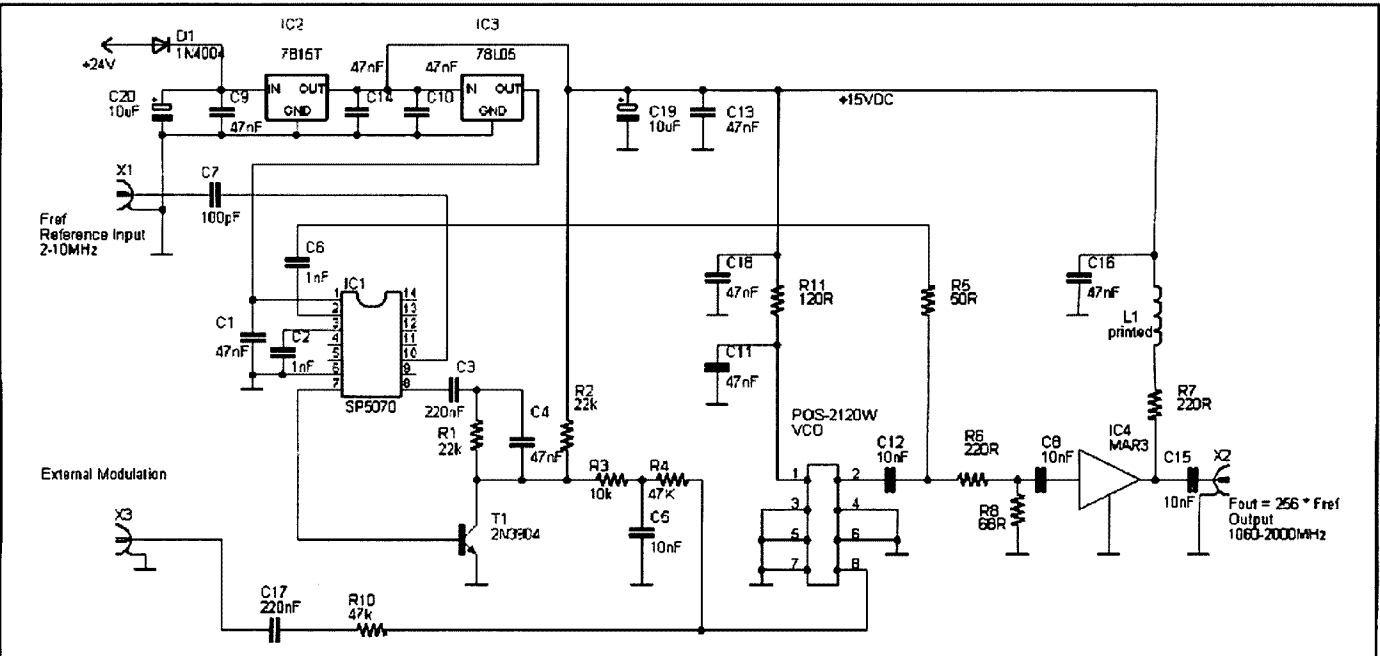

Figure 2: Schematic diagram of the oscillator.

Frequency Vs Tuning voltage

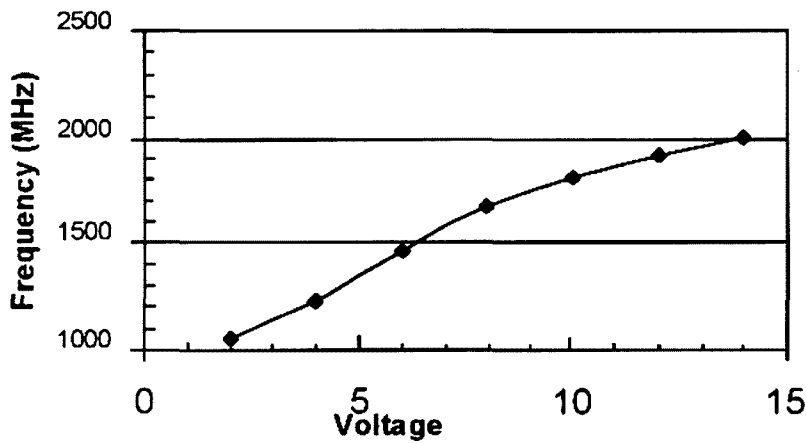

Figure 3: VCO frequency Vs voltage

units contained a suitable device for the oscillator project. The device in question was a SP5070 and a search of the Web provided a set of data sheets. The SP5070 IC is a fixed modulus frequency synthesiser covering the range 300MHz to 2400MHz, hence it contains a set of high speed dividers and a phase comparator. Figure 1 shows a block diagram of the chip.

What makes this chip so useful is that it can be used to control a voltage controlled oscillator which generates an output frequency that is phase locked to a stable low frequency source. The output frequency is two hundred and

fifty six times the input frequency. For example, if the reference frequency is 5MHz, the VCO output frequency is 1280MHz. Thus, the combination of the POS-2120W VCO and a SP5070 forms the basis of a useful wide range microwave frequency source.

The circuit is simple as can be seen in figure 2. A suitable low frequency reference signal with an amplitude of about 500mV, is coupled to pin 10 via a 100pF capacitor. The microwave signal from the VCO is split two ways, a signal of about 300mV is coupled to the high frequency prescaler and divider via pin 2. A MAR 3 MMIC acts as a buffer

amplifier for the oscillator output. The network of resistors and capacitors between the VCO and the MAR 3 provides DC isolation, signal splitting and impedance matching. The VCO, MMIC and prescaler input 'see' approximately 50Ω. In addition, the microwave circuitry is 50 Ω microstrip.

The output signal from the SP5070 phase comparator (pin 7) is filtered by a suitable low pass filter network so that the VCO control voltage is a smooth DC. The SP5070 as includes a 'charge pump' so that the smoothed output voltage is greater than the supply voltage. This is very useful as it considerably simplifies the interface between the SP5070 phase detector and the VCO, as the VCO requires a voltage swing of 20 volts to cover the its rated frequency range. As implemented, this circuit does reach the maximum VCO frequency as the maximum voltage available to the VCO is only 15 volts. The measured frequency swing of the prototype is 1070MHz to 1900MHz.

Provision has been made to frequency modulate the VCO output. A modulating signal is coupled to the VCO frequency control port to modulate the oscillator output frequency. As the modulation frequency is going to be much higher than the cut off frequency of the PLL low pass filter, the mean VCO frequency will still be set by the low frequency reference but will be frequency modulated. Only a few millivolts of signal are required to generate a large frequency shift. See figure 3 for the relationship between VCO control voltage and output frequency. It can be seen that a 1 volt change corresponds to a frequency change of approximately 100MHz, so narrow band FM will require a very small voltage swing!

Construction

The unit is constructed on a double sided circuit board, with the top layer used as a ground plane. Numerous wire links are soldered between the ground areas of the underside of the circuit board and the upper ground plane. As the circuit uses through hole as well as surface mount components, there are components mounted on either side of the board. Coaxial connections to the circuit are made by means of PCB mounted BNC and SMA connectors,

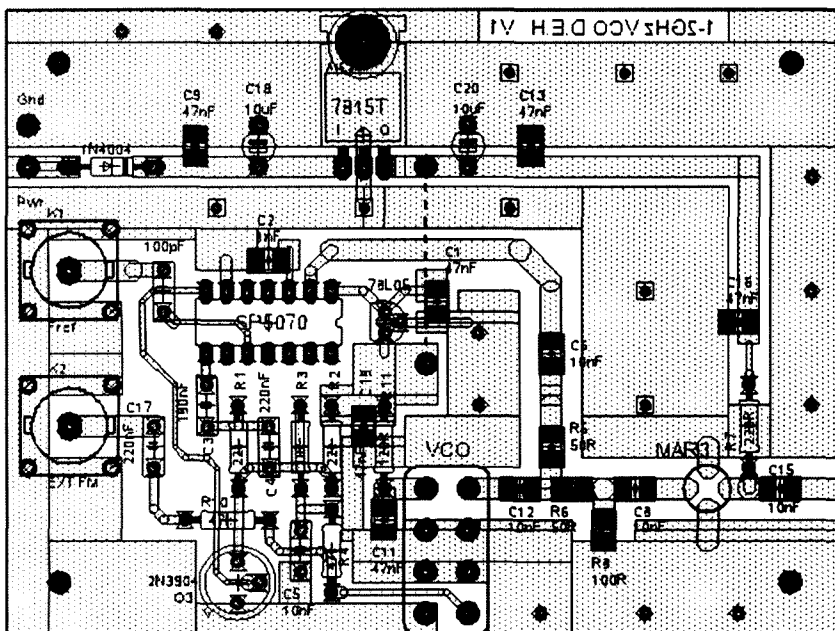

Figure 4: Component layout viewed from the top.

figure 4 shows the placement of the components on the PCB. Figures 6 & 7 show the completed unit.

The surface mount resistors and capacitors were obtained from scrap computer and mobile telephone circuit boards. It is easy to remove the components by heating them with a hot air gun and picking the components off the PCB with a pair of tweezers when the solder melts. It is a good idea to test the components after removal.

When assembling the circuit board, it is best to start with the ground links, followed by the surface mount components and finally the other components. It is useful to tin the copper where the surface mount components are to be mounted. First apply the solder and then use some solder wick to remove the bulk of the solder so that a thin, flat film of solder remains. The surface mount components can then be easily soldered with a minimum of heat. The best solder to use contains 2% of silver, this has the advantage of a slightly lower melting point as well as reducing leeching of silver plating from the surface mount component solder pads.

Component sources

The Mini-Circuits VCO module and MAR 3 MMIC are available from Clarke & Severn Electronics (Ph: 02 9482 1944). As mentioned earlier, scrap computer and mobile telephone boards are a rich source of useful surface mount components and the removal process is an easy skill to master. Obtaining the SP5070 is likely to be a bit more difficult, however it is available by mail order.

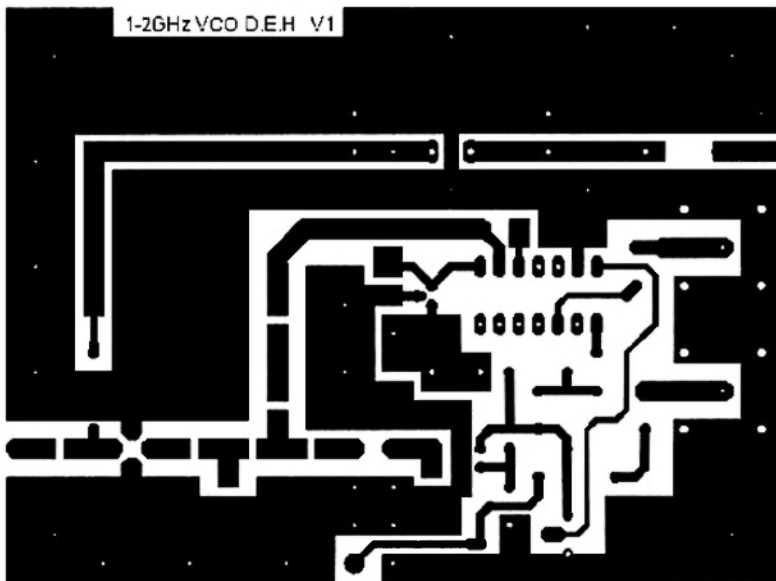

Figure 5: Circuit board artwork viewed from the solder side. The board dimensions are 3 inches by 4 inches. The author can provide this artwork in electronic form if required.

The following web sites are useful:

<http://www.xs4all.nl/~barendh/Indexeng.htm> for purchasing the SP5070 via mail,

<http://electronics.la4.net/Me.htm> for SP5070 data sheets,

<http://www.minicircuits.com> for VCO and MMIC data sheets.

The rest of the components should pose no problems.

Conclusion

The oscillator module is a useful device for microwave experimenters. It can be used as a stand alone test oscillator or

as a frequency source for transmitters and receivers. The circuit is easy to build and get going. It also serves as a simple introduction to using surface mount components.

The schematic diagram and board layouts were done with EAGLE software. It is available off the web and is free for hobby use. It is a very easy to use and versatile PCB and schematic editor. See <http://www.cadsoft.de> for details.

ar

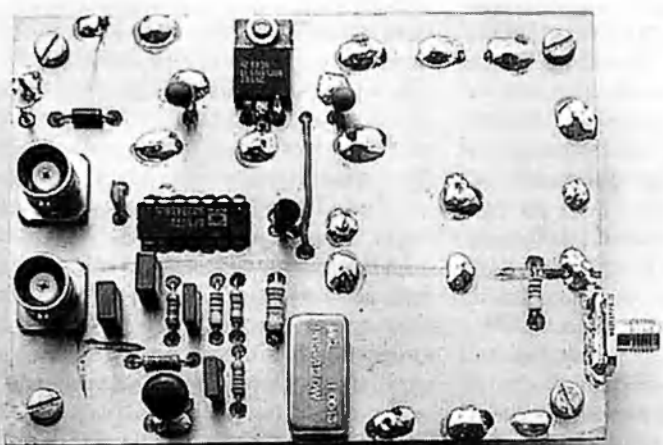

Figure 6: Photograph of the component side of the completed PCB assembly.

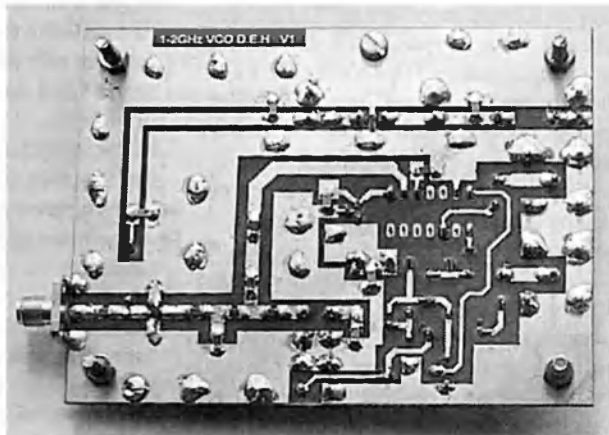

Figure 7: Photograph of the solder side, showing surface mount components.

WIA Federal Convention 2002

An observer's observations

Peter Parker VK3YE

12/8 Walnut St, Carnegie, Vic, 3163

<http://www.alphalink.com.au/~parkerp/>

Earlier this year an e-mail came through from VK6, 'Would you like to be an observer at this year's Federal Convention?'. Being free that weekend, the offer was too good to pass up. Attending would provide an insight into how the WIA works that too few see. Also being a resident of VK3 but a member of VK1 attending the convention as a guest of VK6 did not escape my wry sense of humour!

My Expectations

Before the convention I read annual reports from the various Federal Coordinators and the seventeen motions being put forward by the Divisions.

I had two expectations for the convention. The first was that it made decisions that furthered the progress of amateur radio and the WIA. Secondly I expected the meeting to meet all statutory obligations as regards reporting, election of office bearers, etc.

In forming my opinion on this I made allowance that much of the discussion would be inward-looking. This was because sixteen of the seventeen motions on notice pertained to WIA internal matters and not broader issues related to amateur radio. I also took into account limitations imposed by the WIA's current structure, which can sometimes hinder decision-making.

Observations and recommendations

I do not propose to go into a blow-by-blow description of motions carried and lost at the Convention. These have already been covered by the various state news bulletins and the official report on the Convention by the Federal President. Instead I will report my observations and recommend improvements.

What I saw in Melbourne was a group of hard-working delegates who had the best interests of amateur radio and the WIA at heart, though with occasional differences as to how these were best advanced. Attendees told me that the politics, deals and cliques of previous years were absent in 2002. The result was a convivial atmosphere with divisions mostly cooperating with one another.

Many discussions were enriched by

the presence of representatives from the NZART and the practical expertise of some present (eg Ron Bertrand VK2DQ in education and Martin Luther VK5GN in marketing). The proceedings were kept on topic by the firm but good-humoured chairmanship of Federal President Ernie Hocking VK1LK and the comity of all present.

Particularly beneficial was the reservation of time for informal discussion on both the Friday afternoon and the Saturday. These discussions were on important matters affecting the WIA and amateur radio's future and fit the category of 'important but not urgent'. All too often they are confined

... it is important that delegates have a shared understanding of what is legal and what is not. This is so decision making at future conventions is not stifled by doubts over the legality of motions.

to the end of meetings when attendees are too tired to take them seriously, or are not talked about at all.

The scheduling of this time on the first two days for the important (or strategic) matters was a good move, as was the use of the final day to consider the motions on notice. The tight finish deadline (most attendees had planes to catch) and the fact that much prior discussion had already occurred made it easier to reach a decision on each motion. Having the meeting chairman assigning responsibility for the execution of each motion and providing a time deadline for action was also beneficial and should result on more motions being implemented than in previous years.

A few cases arose where the current Divisional structure can potentially hamper the Convention's ability to make decisions.

One example encountered was in the setting of membership subscriptions. As it happened, no increase in the Federal component was proposed for 2002, so the problem did not arise. However if there was to be a significant increase or decrease in the Federal fee component (for example as part of a scheme to attract new members), at least some divisions would have to convene extraordinary general meetings to ratify the change. One Division said that this would require several weeks and \$1200 to provide the necessary notice to the membership. If all Divisions had to go through this procedure, the cost of implementing a simple decision of Federal Council would be very high, with no guarantee of success.

Another pattern that emerged during the weekend was that several motions were claimed to be illegal by one Division's federal councillor. In all but one case these motions were fairly minor and did not attract the required support. In the one instance where the motion was important, the Division concerned was outvoted and the motion was carried.

A common thread of these motions was that they compelled another separate organisation (in this case the Divisions) to do something (normally to share a cost or go along with a review that *may* propose a restructuring) that the Divisions themselves might not agree to. The Councillor concerned seemed eager not to expose his Division to these potential costs or risks. As mentioned before, this had little effect on the outcome of this year's convention as the motions concerned were fairly minor and failed to attract required support.

To avoid these problems, it is important that delegates have a shared understanding of what is legal and what is not. This is so decision making at future conventions is not stifled by

doubts over the legality of motions. If there is a consistent pattern of important motions running up against legal obstacles relating to the WIA's structure, it is important that reforms be made to correct this. It is hoped that the president's WIA Review and Strategy Committee will address this matter.

A topic raised last year was the issue of communication with members. It would be fair to say that members were better informed about convention outcomes this year than last. The VK3 Division's website carried frequent updates while the convention was in progress. The 200 email subscribers to *APC News* received daily convention reports, with Sunday's update going out barely three hours after the convention concluded. Interstate news services picked up on these reports, meaning that most interested people would have been informed about the convention within one week of it happening. A worthwhile reform for next year could be to offer this 'fast news' service via the Federal website, as well as having reports and details of motions online before the Convention.

Of even greater importance, but linked to the above, is the extent to which the WIA and the Federal Convention relate to the interests and concerns of mainstream radio amateurs. In this connection, it is vital that WIA delegates not be seen as faceless nobodies who meet in ivory towers and don't get on air.

The NZART effectively counters this perception by making its annual Convention the country's key amateur radio event. As well as including delegates from the Branches, the convention is open to ordinary members, who are also encouraged to attend presentations and meetings on various aspects of amateur radio.

Such an event would require significant work to organise. However the convention's host division could provide the required volunteers. A welcome first step would be to make most if not all of the WIA convention proceedings open to visiting members, without requiring that they be appointed as observers first. The convention's on-air profile could be boosted through the use of the seldom-used VK3WIA callsign

(allocated to WIA Federal) operated as a special event station during the weekend.

The WIA's Federal Co-ordinators do much good work in various specialised aspects of amateur radio. Much of this effort is unknown to members. Examples include contests, awards and education.

These topics were discussed during the Convention when reports were received and co-ordinators appointed.

However there are some important facets of amateur radio that do not fall within any federal co-ordinator's bailiwick. An example of a popular interest falling 'between the cracks' and going undiscussed is the promotion of general on-air activity (unrelated to contests or awards) despite its obvious importance and following.

This shows there may be a need to appoint extra co-ordinators for important matters such as raising general on-air activity and promoting amateur radio. Time should also be reserved at future conventions to discuss these topics, as was done this year with Martin Luther's *Marketing Amateur Radio in Australia* paper. This would increase the amount of time the convention spends on important matters and strengthen the WIA's role in increasing and improving amateur radio activity in Australia.

As mentioned before just one of the seventeen motions proposed for the 2002 Convention related directly to the overall welfare of amateur radio. This motion supported a 'Foundation Licence' grade. I found the lack of motions on other substantive matters affecting amateur radio disturbing. This could be for a number of reasons, including:

- i. A perception that everything is right with all aspects of amateur radio activity and nothing needs changing, and even if it did, the WIA couldn't do much about it;
- ii. A fatalistic view that the level of on-air activity is in inexorable decline, and WIA initiatives to

foster renewed activity amongst lapsed and inactive amateurs are futile;

- iii. Some measures are already being implemented by one or more Divisions without Federal motions being required;
- iv. There is a lack of rigorous thought in WIA Divisions about the long-term betterment of amateur radio, the WIA's role in bringing this about, and the will to propose appropriate motions;
- v. There is a gaping chasm between those with the bright ideas and those with the WIA organisational know-how to transform an idea into a carried motion;
- vi. Office bearers are reluctant to sponsor new ideas as they require money and volunteer resources that are not available.

I consider that all the above points above are valid, but that iv and v are most important, followed by i, ii and vi. Several points underlie the need for the organisation to consciously nurture new ideas. This is because ideas are fragile in their early stages and can be easily shouted down.

Very few ideas make the transition to official WIA policy. This is mainly because so few are introduced as motions in the first place. Ideas can also be left to wither and die on the WIA's organisational vine, which is often misunderstood by members, including the idea's original proponent. Those ideas that are successful tend to be either

those derived from overseas (so are seen as 'safe') or those that have powerful and persistent backers within

the WIA organisation able to sustain it through numerous processes.

For us not to be seen as 'idea killers', Divisional and Federal Councils need to become 'idea incubators'. This means being willing to give new ideas a fair hearing, even those that may be controversial. A formal process could also be needed, if necessary involving a new position of 'Federal Ideas Advocate' to act as a 'champion for change', collate ideas and report to the Federal President, Council and Directors.

Continued on page 17

Bordertown Primary School contacts Space station

Tony Hutchison VK5ZAI

May 14, 2002—Astronaut Dan Bursch, KD5PNU, has completed the last QSO in a string of largely successful Amateur Radio on the International Space Station (ARISS) school contacts by Expedition 4 crew members. Taking the controls of NA1SS on May 14, Bursch answered questions posed by 15 students from the Bordertown School in Bordertown, Australia.

Bursch was able to answer all of the students' questions. Near the end of the contact, he told the students to make the most of their education in order to achieve their dreams and goals.

Hundreds of excited students and parents gave Bursch a huge cheer as the ISS went over the horizon and contact ended. The event was covered on Australian radio and TV in prime time—at 8:30 PM local time in Bordertown.

Tony Hutchison, VK5ZAI, in South Australia was the school mentor and the master of ceremonies for the event, which was made possible via a

teleconferencing circuit with Gerald Klatzko, ZS6BTD, in South Africa.

ARISS School Contacts Coordinator Tim Bosma, W6ISS, took advantage of the occasion of the last Expedition 4 school contact to thank all involved for helping to make it a success.

I want to thank everyone involved; the folks at NASA who support this program; the volunteer mentors who prepare the students and the schools; the telebridge station operators who frequently have to get up in the middle of the night to make these contacts; and the organizations—WorldCom, AMSAT

and the ARRL Bosma said.

Your support for this educational program makes it possible for students to talk to the astronauts and get excited about careers in science. This is a once in a lifetime experience for the students, teachers and the parents, and it does make a difference.

ARISS school contacts are expected to resume in late June when the Expedition 5 crew of mission commander and US astronaut Peggy Whitson, KC5ZTD, and Russian cosmonaut Valeri Korzun and Sergei Treschev settles in aboard the ISS

ar

Club News

Gippsland Gate Radio & Electronics Club

Attention past members

Following the AGM in April, Gippy Gate's new President Peter Pavey thanked the outgoing Committee and proceeded to bring together the new office bearers to give the Club a lift.

Amongst other events happening at GGREC, the Annual HAMFEST has been given high priority by the new Committee and promises to be even better than past years. The GGREC HAMFEST has always been a popular event on the Amateur calendar and with all sellers tables booked plus some, it has the grounds for being the most successful yet. If you missed the HAMFEST flyer inserted in AR the venue is — the Girl Guide Hall in Grant St. Cranbourne off the Cranbourne / Frankston Rd. The date to remember is the 20th July and the starting gun will be fired at 10am with sellers gaining entry at 8.30am. Our traditional BBQ will be fired up and some lucky person will win

a great door prize. During the day, raffle tickets will be sold with the prize being a 2 metre FM transceiver valued at \$450.00. Be there on the day or for more details call Reg (VK3UK) on 03 9547 9659.

Another important event on our calendar is the 25th celebration dinner to be held in the guest room at the Cardinia Park Hotel, Beaconsfield. Past members of the Club are especially welcome. A booking will be required. The dinner will be held on Saturday 27th of July. For more information please call either Peter (alias The Pres) on 59983533 or Ian (alias Mr Secretary) on 56252545. Rumor has it that a very special guest has been invited to the dinner.

After a good many years of faithful service, the Club has finally replaced its 2M FM radio. The old Trio with its many crystals for all the best frequencies will be raffled to Club members at a future meeting. This radio has been to the bottom of the Murray River and back (there's a story attached to this) and still works as well as it did on its first QSO.

For those who are aspiring to become licensed or upgrade, we are planning to hold classes again in 2003. More details will be forthcoming in future issues but to get yourself on the "please let me know" list, call either of the above numbers or email the Club at secretary@ggrec.org.au.

ar

EMR limits further delayed

Jim Linton VK3PC

The Electromagnetic Radiation (EMR) limits for amateur stations that were expected to begin on 1 July, have been delayed at least six months.

The Australian Communications Authority (ACA) had planned to implement the EMR human exposure limits through the Licence Condition Determinations for apparatus licences including amateur stations.

However, the ACA has now advised the WIA that it has decided to delay the issuing of the new Licence Condition Determinations to mandate the EMR exposure limits, until it can formally adopt a new radiation exposure standard.

The Australian Radiation Protection and Nuclear Safety Agency has developed a new Radiation Protection Standard Maximum Exposure Levels to Radiofrequency Fields 3kHz to 300 GHz.

The EMR limits that have been proposed by the ACA are based on the lapsed Australian and New Zealand Standard AS2772.1 - and not the new standard.

In practice, there is little difference between the two standards, at least as

far as the Amateur Service is concerned.

The adoption of the new standard won't significantly change the EMR limits already proposed by the ACA and publicised in the June edition of Amateur Radio magazine.

In the meantime the WIA recommends that radio amateurs continue to be sensible with the use of RF energy, and keep in mind the proposed EMR limits when installing antennas.

David Mathison VK2KLV

3 May 1939 – 5 October 2001

Dave Mathison VK2KLV formerly VK4KLV was licensed for 25 years and only held the callsign "KLV"

Dave was a true amateur in the real sense of the term, as he could not be described as a black box operator.

He was always playing around with antenna design and built a spectrum analyser which he based on a published design, but he was not satisfied with it so he redesigned it, and it certainly was a credit to him.

Dave was one of the first to build a

voice operated microphone which he used in his car on the two metre band.

Modification of old commercial radios and reprogramming eproms for them was another of Dave's interests and he had also been involved in the design and construction of a Doppler R.D.F. unit

A keen Clubman, he was a previous Treasurer of the Liverpool Club and he also donated the tower on which the Club's repeater is mounted. He was also a keen member of the Hornsby Club, For many years Dave was the auctioneer for

the Liverpool Club and wielded a baseball bat with great dexterity as part of his auctioneering style

Dave was a hydraulics engineer with Berendson and its predecessors for the past 19 years.

Dave was married to Heather for 35 years and had a son Craig, daughter-in-law Kim and two grandchildren, Jared and Georgia

Farewell mate!

Garry Barker VK2TSR

Hon secretary

Liverpool & District Amateur Radio Club

Silent Key

WIA Federal Convention. An observer's observations

Continued from page 15

Of course having ideas is of little use if there is no one to implement them. For this reason there needs to be a bias towards ideas that are cheap and quick to implement. Ideas whose proponent has agreed to do the work involved should also be fast-tracked.

The implementation of other ideas depends on our ability to motivate non-members to join (made easier if we are no longer seen as 'idea-killers'), retain existing volunteers (by reducing the number who resign due to 'internal politics') and attracting new volunteers. These are all key issues for us and attention to them at future conventions will make the WIA a better organisation.

Did the WIA Federal Convention meet my expectations?

The answer was an emphatic yes, with decisions made on all the important topics brought before it.

The real test now will be whether the motions carried will be acted on during the year. But so far, the signs look good.

I would like to thank the WIA VK6 Division for having me as an observer and thus making this report possible. I highly recommend attendance at a Federal Convention for anyone with a serious interest in amateur radio and the WIA. If you wish to attend, contact your Division beforehand and ask to be made an observer.

Licence fees go up

As part of an annual review, the Australian Communications Authority has increased radiocommunications apparatus licence fees by a 3.5% Consumer Price Index (CPI) adjustment.

The cost of a single year for all amateur station licences from 2 June, 2002, will be \$53.90, which is an increase of \$1.

The ACA advises that the fee for 2-years \$101.10, 3-years \$147.30, 4-years \$193.50 and 5-years \$240.70.

ar

A low cost microwatt meter

Dale Hughee VK2DSH

The need arose to measure RF output from various MMIC amplifiers and oscillators when experimenting with some circuitry for the 23cm amateur band. The following device was easy to build and gives good results.

It is based on a simple diode detector, which normally would not be ideal for very low signal levels, however the addition of a small bias current significantly improves performance. If the input to the device is kept less than 100mV, or 0.2mW (-6dbm) into 50Ω, the detector voltage output is proportional to power input. Power input as small as

20mW (-46dbm) can be measured, this is 1mV into 50Ω. The power range can be extended by using suitable attenuators on the detector input if required. For the theory behind this type of diode detectors see reference (1) P147.

The device is constructed on a small printed circuit board and is housed in

an aluminum enclosure for the purposes of RF screening and thermal stability. Standard G10 fiberglass material is used.

RF input is coupled via a SMA connector to the detection circuitry. DC isolation is provided by C1, C2 & C3. DC isolation is required as the bias diode bias current flows through both diodes and the 50Ω resistor. The 50Ω load resistor consist of two 100Ω resistors in parallel, this reduces stray inductance and increases power handling. Diodes D1 and D2 are in the same SOT143 surface mount package and are well matched as they are packaged together. A small forward bias current is supplied via R4 so that the diodes are always conducting. Capacitors C2, C3 and C5 decouple the bias so that no RF energy is coupled to D2. Two diodes are used so that the effects of temperature drift on the diodes forward voltage drop is reduced. Only one diode (D1) has RF applied to it, the second diode (D2) is used only as a reference so that changes in the diodes can be removed from the output signal. The DC from each diode is fed to the input of a differential amplifier (U1). The bias current components are connected so that they subtract from each other. As the diodes are well matched the difference should be zero, leaving only the detected RF from D1. So that temperature effects are minimized, the complete circuit is mounted on a 1 cm thick piece of aluminum with a matching cover that has a milled cavity to cover the SMD components.

Surface mount components were used to make the unit as small as possible. The AD817AR was salvaged from a junked CD-ROM drive, the SMD capacitors were removed from scrap PCBs. The SMD resistors and the HSMS-2815 dual Schottky diode were purchased from Farnell Electronic Components. Note that almost any op-amp with the same pin connections as the AD817AR could be used.

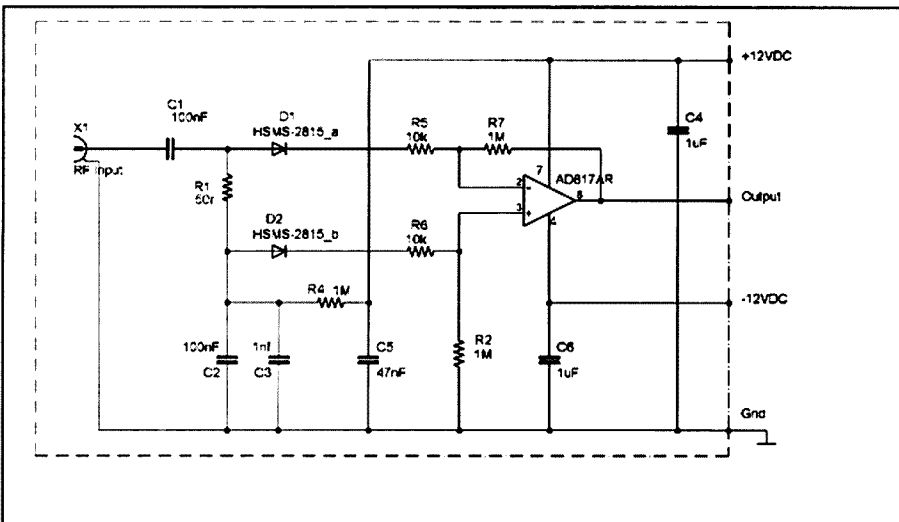

Figure 1: Detector schematic

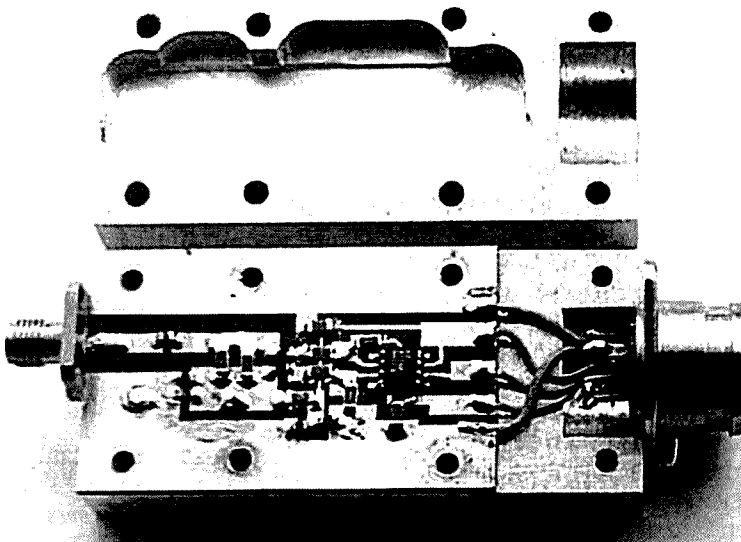

Figure 2: Photograph of the circuit board mounted on the aluminum block.

Performance

The performance of the detector was measured to get an idea of its sensitivity and frequency response.

The results clearly show that for low level signals the diode is operating in the 'square law' region which gives a nicely linear voltage output versus power input. In dbm this range is -46dbm to -6dbm. Above this region the diode enters its linear region and the output voltage is proportional to input voltage rather than power.

The chart shows the response of the detector versus frequency, referenced to the detector response at 10MHz.

Conclusion

The detector design presented here is a low cost device suitable for measuring over a wide range of frequencies. It is easy to construct and uses readily obtainable components and should be very easy to get working.

Reference

Solid State Design For The Radio
Amateur, W Hayward W7ZOI & D
Demaw W1FB, ARRL.

New WIA Members

The WIA bids a warm welcome to the following new members who were entered into the WIA Membership Register during the month of MAY.

L21190 G Gam
L21191 F Backer
L31574 Mr M Willis
L41069 J P Berkhout
L50617 Mr J L Cradock
VK2AEB Mr A E Brown
VK2BS W Buffrey
VK2KVE M Ryan
VK2TEA Mr R B Cooper
VK3AJK Mr J Spark
VK3BE Mr C Howe
VK3EJR Mr J P Rose
VK3ERK Mr S Catterall
VK3GEB Mr R Bird
VK3JXX Mr C Sturgeon
VK3VCD Mr U Zhuang
VK3XK Mr G Kinge
VK3YT Mr M Hutchings
VK4BYX Mr R A McKernan
VK5KIK Mr G R Kent

Component side

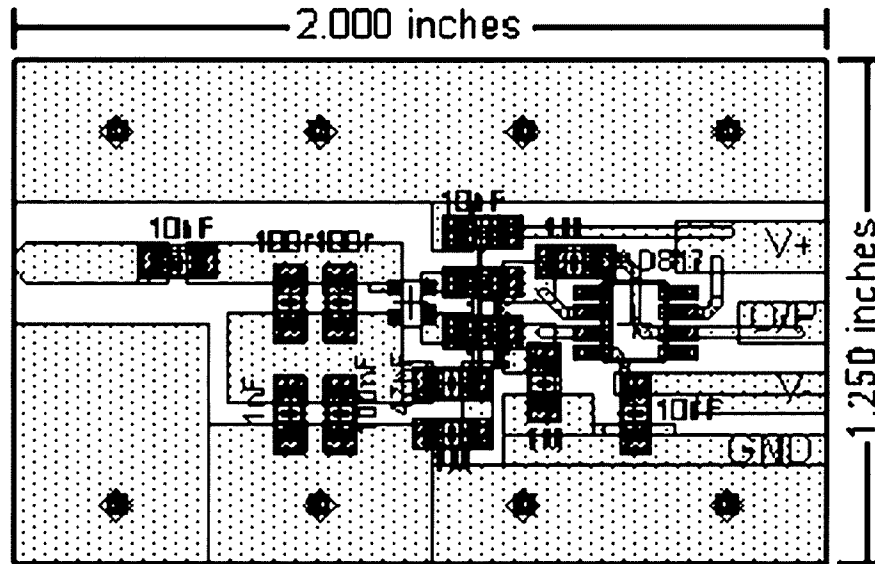

Figure 3: PCB component layout.

Detector Calibration @ 1GHz

$$y = -5.3705x + 0.0014$$

$$R^2 = 0.9983$$

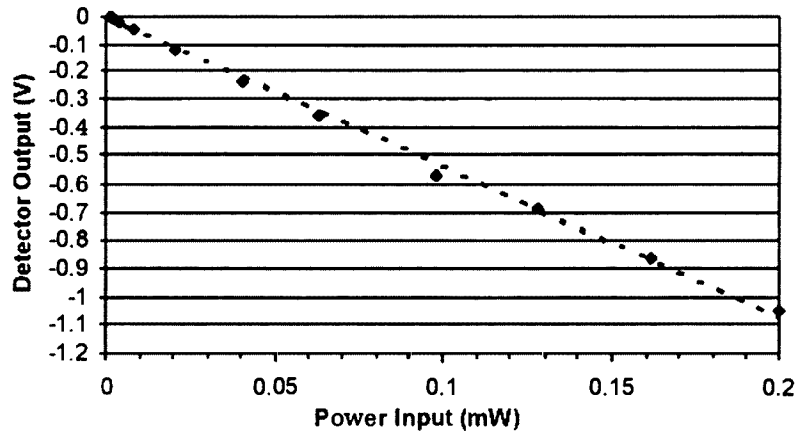

Figure 4: Detector calibration at 1GHz

Detector Frequency Response

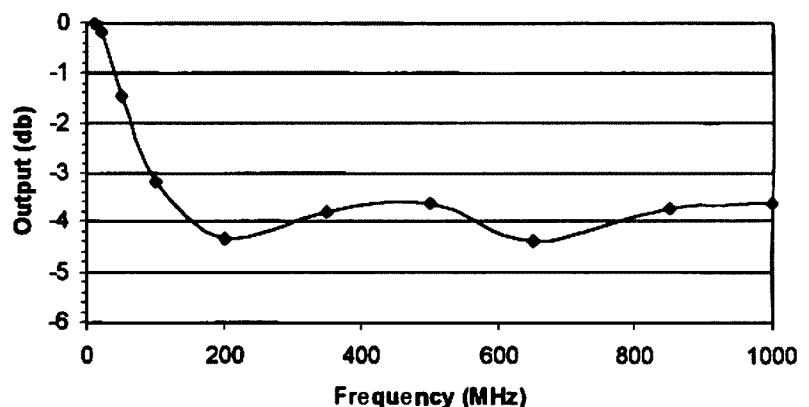

Figure 5: Frequency response

Remembrance Day Contest

The tradition at the RD Contest is to have a silence on the bands and to read out the names of those Radio Amateurs who died while in the Services. Col Harvey has been checking the records in the National War Memorial and what follows is his findings and his views as to how we should refer to those who died.

Amateur Radio's WW2 Silent Keys

Col. Harvey, VKIAU

The annual WIA Remembrance Day Contest names 26 members as having "Paid the Supreme Sacrifice" during WW2. The term is emotive and inaccurate. Here is a summary of the causes of death of those Australian Amateurs.

Executed: VK3HN

Killed in Action: V K 3 S F, VK2BQ

Killed in Flying Battle:

VK3UW, VK3VE, VK6JG, VK5BL, VK6PP

Killed in Ground Battle:

VK2VJ

Murdered by natives: VK4DR

Died in action at sea: V K 3 N G, VK3PV, VK3IE, VK6GR

Died of Illness: VK2JV, VK5BW, VK3OR, VK5AF

Aircraft accident: V K 2 B Q, VK3PL, VK4FS, VK4PR

Accident at sea: V K 3 D Q, VK6KS

Ground accident: V K 2 A J B, VK3GO

Not Yet Found: VK2YK

Brief biographies of these men follow....

VK3IE Mann J.E

Leading Telegraphist. HMAS "Parramatta". D 27/11/41 when the ship was torpedoed off Tobruk with 137 casualties.

VK6GR. Rippen A.H.G

Telegraphist. Presumed killed in action 20/11/41 when HMAS "Sydney" was lost with 645 hands in the Indian Ocean after engaging the German raider "Komoran".

VK2JV Roberts C.D.

NX59083 Signaller. D 3/7/43 in Siam- Illness.

VK3DQ Morris J.D

VX16925 T/Maj. AAMC 2/2 CCS. D 24/6/44 at sea SWPA Accident.

VK3HN McCandlish J Sgt.

VX80269. "M" Special Unit. D 31/8/43. Executed

VK3SF Jones S.W

NX463748 Gunner. 52 Comp. A.A Regt. D 12/11/44 in Dutch New Guinea. Killed in action

VK4DR Laws D.A Lt.

"M" Special Unit. D 5/5/43 New Guinea. Escaped by small Boat from near Pall Mall Plantation in New Britain to Sio in Papua. Later with two others, murdered by supposedly friendly natives near Saidor, South east of Madang

VK5BW Phillips J.G

NX 170111. Cpl. AACCC HQ, RAE 12 Div. D 6/4/41 - Illness

VK6KS, Anderson K. S

S/Sgt. Signals Training Battalion. D 5/3/41 accidental drowning

VK2BQ Easton F.W

429240 F/O 100 Sqdn. RAAF. D 5/3/44 when Beaufort A9-480 crashed shortly after taking off from Vivigani strip Goodenough Island, New Guinea,

VK2VJ Jarvis V. J

300017. Cpl, 3 Sqdn RAAF. D 14/1/41. Middle East in ground battle.

VK2YK Abbott W

Only AW.M record is for Abbott W.R Cpl. 24 Inf Btn. KI A 6/6/45 Bougainville. No W. Abbot found in RAAF Records

VK2AJB Curie G.C

207732 Sgt 3 Sqdn D 17/3/41 in the Middle East as a result of a ground accident.

VK3GO Stephens T.

418036 F/O 518 Sqdn RAF. D 16/8/44. Died as a result of an accident in Scotland.

VK3OR Orr M.D

1700 F/O. AFHQ. D 29/7/41 at Kerang, due to illness.

VK3PL Colthrup J. F

3485 F/O. 3 W.A.G. School. D 21/2/42 when Tiger Moth AI 7-19 crashed at Maryborough aerodrome Q.

VK3UW Burrage J.A

400643 Sgt. 211 Sqdn RAF. D 21/2/42 Sumatra after a flying battle.

VK3VE Snaddon J.E

409361 459 Sqdn RAAF. D 14/7/44 in the Mediterranean as a result of a flying battle

VK4FS Starr F. J

5085 AC 1. 23 Sqdn RAAF. D 12/8/40 in a flying accident off the Queensland Coast

VK4PR Allen R

404945.P/O 13 Squadron RAAF. D 1/1/42 when, following engine failure, Hudson A16-29 dived into the sea off the Molucca Islands. 3 of the 4 crew members were killed.

VK5AF Ives C. A

300407 F/Sgt. Melbourne W/T Station. Died Ascot Vale 6/7/42 due to illness.

VK6JG Goddard J. E

420658 FI/Lt 582 Sqdn RAF. D 8/9/44 over France, result of a flying battle

VK6PP Paterson P. P

260515 FI/Lt 24 Sqdn. RAAF. D 19/1/42 as a result of a flying battle near Rabaul.

VK5BL James B.

May be either James B.G or James B.R. James B.G was W/O 406319 on 603 Sqdn RAF who died 2/5/43 in the Middle East during a flying battle. James BR 417490 was a F/O in 76 Sqdn RAF who died 22/1/44 in a flying battle over Germany

VK3PV Veall R. P

D. Darwin Harbour 19 Feb 1942 when MV "Neptuna" was bombed, caught fire, blew-up & sank.

VK3NG Gunter N.

Wireless Officer SS "Kowarra" D. 24/4/43 when ship torpedoed off Sandy Cape Q. with loss of 35 lives.

Of these 26 Members only 14 died as a result of an encounter with the enemy. Unlike Japanese Kamikase airmen, none

Continued on page 22



Systems

TTS Systems Communications Equipment

FREE CATALOGUE

www.ttssystems.com.au

Check our range of easy-to-assemble amateur kits

Automatic antenna tuner Kits

LGD RT11 Remote 125 watt



Remote control for RT11



LGD AT-11MP 150 watt with SWR meter.



LDG Z11 QRP ANTENNA TUNER

Accessory Kits

- 300 Watt RF Dummy Load
- TTS-450 4:1 Baiun
- High Power 40 to 500 pf variable capacitor
- SWR Bridge & Wattmeter
- Active receive antenna
- Budget electronic keyer
- Transmatch tuning bridge
- Microphone speech processor
- Broadband preamp DC to 1GHz

Transceivers/Transverters/Receivers



TEN-TEC 2 & 6 meter transceiver kits

TEN-TEC QRP CW HF transceivers kits

TEN-TEC HF Receiver kits

TEN-TEC 2 & 6 meter transverters



Ten Tec 1254 receiver Kit

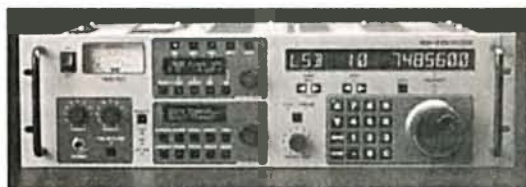

Ten Tec HF DSP RECEIVER



Ten Tec Jupiter HF DSP Transceiver

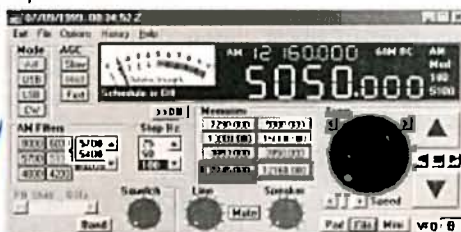

Ten Tec RX 320 PC Radio

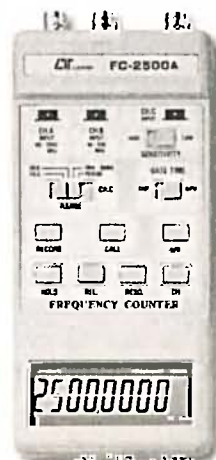

Hand Held Frequency Counter

All kits include easy to follow step by step assembly instructions.

You supply the soldering iron and basic tools!!!
All kit products can be supplied fully assembled and tested.

We now stock Amidon Iron Powder and Ferrite Cores — Call for an application guide

Phone 03 59774808. Fax 03 59774801 info@ttssystems.com.au

International Lighthouse/ Lightship Weekend

18th & 19th August 2002

Mike Dalrymple, Co-ordinator

The 2001 International Lighthouse/Lightship Weekend took place from 0001 UTC on Saturday 18th August until 2359 UTC on Sunday 19th August, when around 354 (30 from VK) amateur radio stations were established at lighthouses and lightships in over 46 countries. In 2002 the period of the event is from 0001 UTC on Saturday 17 August until 2359 UTC on Sunday 18 August 2002. The event is NOT a contest, each station decides how they will operate their station regards modes and bands. Participants are not committed to being on the air during the entire period - only as much as they can.

There are no restrictions on aerials or power. We wish operators to enjoy themselves and have fun whilst making contact with as many amateur radio stations as possible. Some operators say fun - 5,000 contacts - OK, but we request that stations take some time to work the slow operator, the newly licensed and QRP stations. As available space in many lighthouses is filled to capacity, our activity does not have to take place inside the tower itself. Field day type set-up at the light or other building next to the light is OK. Permission MUST be obtained from any interested parties.

The event is used to obtain maximum exposure for our hobby. We invite the press and, QTH permitting, also the public and try to underline the obvious parallel between the international aspect in lighthouses, lightships and amateur radio. We might catch a future radio amateur while creating goodwill for the hobby.

We use the event segment of the 5 'Classic' bands with a centre frequency if conditions are bad, at least we have

one place we can (try to) meet.

We request that the centre frequencies are not used as primary frequencies but as a last point of call to other participating stations.

CW	Freq	Centre
80m	3.510 - 3.540 kHz	3.521 +/-
40m	7.005 - 7.035 kHz	7.021 +/-
20m	14.010 - 14.040 kHz	14.021 +/-
15m	21.010 - 21.040 kHz	21.021 +/-
10m	28.010 - 28.040 kHz	28.021 +/-

PHONE	Freq	Centre
80m	3.650 - 3.750 kHz	3.721 +/-
40m	7.040 - 7.100 kHz	7.051 +/-
20m	14.125 - 14.275 kHz	14.221 +/-
15m	21.150 - 21.250 kHz	21.221 +/-
10m	28.300 - 28.400 kHz	28.351 +/-

Because it is NOT a contest you can operate on any authorised QRGs as per your licence.

To assist other stations we request that participating stations add 'LIGHT', 'LGT', 'LIGHTHOUSE' or 'LIGHTSHIP' after their call. UK stations normally obtain a GB callsign with the letter L in the suffix to assist other stations

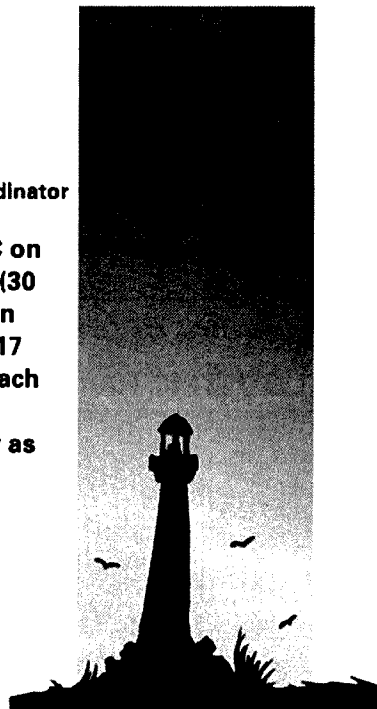

identifying them as a participating station in the event. So come and join us in the fun of the weekend, establish a station at a lighthouse, lightship or maritime beacon. The more the merrier. If you decide to join us in the fun could you let us know the callsign you will use, QTH and QSL information. This will enable me to notify other stations and the media of your participation. You can either use the on-line entry form at www.vk2ce.com/illw or e-mail me direct at gm4suc@compuserve.com The list of entrants for this year is at: www.vk2ce.com/illw/2002.htm. Kevin, VK2CE is the Oceania coordinator for the event so if you have any questions please e-mail him at kevin@vk2ce.com.

73a Mike GM4SUC

Remembrance Day Contest

Continued from page 20

were under orders to sacrifice themselves, although some probably did. On the contrary, policy required them to survive wherever possible to fight another day. Most made it their ambition not to get to God too soon.

Death by natural causes (4) or death by accident (8) does not equate with "Supreme Sacrifice" as understood on the Western Front in WW I.

While there is no doubt that there were many cases of extreme bravery by our servicemen, few of the casualties named

in the R.D Contest preamble approach the concept of a deliberate sacrifice of life.

There is a need to keep use of an emotive term such as "Supreme Sacrifice, in perspective .

An improvement in understanding why we honor our "silent keys" would occur if pre R.D Contest listings avoided inappropriate terminology.

QTH (R)

EDITOR's Note. *There may be a few errors in this which I have been unable to correct, information not available.*

While I feel it is necessary to place those who died in an appropriate category; we really are celebrating the life and death of those who were involved in the war effort away from home. Like ANZAC Day celebrations we now, nearly 60 years on, remember all Radio Amateurs who died as a result of wars, at the time of the Remembrance Day Contest.

If you are able to provide any further information or correct any of the above please inform Col Harvey VK1AU or the Editor. I have noted that VK2BQ appears in two categories VK5UE

ar

Log periodic for two metres

A log periodic antenna for two metres which covers 130 MHz to 170 MHz allowing coverage of adjacent frequencies to two metres was described by L B Cebik W4RNL in October 2001 QST. The antenna offers a computed free space gain of 9.2 dbi which is approximately 7 dbd equivalent to many 3 element yagis but with much greater bandwidth. The front to back ratio is in the 30 db or better region across the two metre band.

The antenna is shown in Fig 1. The antenna dimensions should be adhered to in order to achieve the performance. The boom is a two piece design made from two lengths of 0.75 inch 0.125 inch thick U section channel spaced 5/16th inch apart with insulated spacers. This is fairly critical as it forms the transmission line feeding the elements.

A 4 inch short circuit stub is connected at the rear element. This stub may be shortened to between 2 and 4 inches long to get an extra 2 db of front to back ratio at the expense of reducing the operating frequency range. In the antenna built by W4RNL the stub was made from a piece of RG59 and was shortened by the velocity factor so the physical length was shorter than the electrical length of 4 inches. Another

way of providing the stub is to extend the booms beyond the rear element and short them together 4 inches behind the rear element to form the stub.

The insulators used were plexiglass strips attached to the sides of the booms between elements 1 and 2 and elements 5 and 6. The spacing between the booms can be adjusted to get a better 2 metre band SWR but may result in worsening the wide band performance. The feed line is run along the boom and connected to the booms at the front.

As the booms form a feed line an insulated mounting plate is required to mount the booms to the mast. For vertical polarisation a non conducting mast is needed if it is attached mid boom or within the antenna structure. Similarly the feed line should not be run

parallel to the elements within the antenna structure.

The elements are attached at the centre with each half element attaching to one of the two booms so as to give balanced feed to each element. Element halves attach alternately to upper and lower booms. Element right hand halves of elements 1, 3, 5 attach to the upper boom and the left hand halves attach to the lower boom. The right hand halves of elements 2, 4, 6 attach to the lower boom and the left hand halves attach to the upper boom. This gets the feed line phasing correct for the elements.

Element attachment is shown in Fig 2. The elements are made of 3/16 th inch solid aluminium rod. The element ends are threaded and the element mounting holes in the booms are also threaded. Locking nuts are used on the elements to lock the halves in position. Additional nuts are used at the first and last elements to attach the feed and the stub. The element half lengths and spacings are given in Table 1. The element half lengths need to be increased by 3/8 th inch if the recommended mounting method is used.

Further information on wideband antenna designs can be found on W4RNL's website at www.cebik.com and at the online antenna magazine AntenneX website www.antennex.com. AntenneX is a paid subscription magazine and would be worth the subscription for those interested in antennas but for others there is a lot of free information on their website.

continued next page

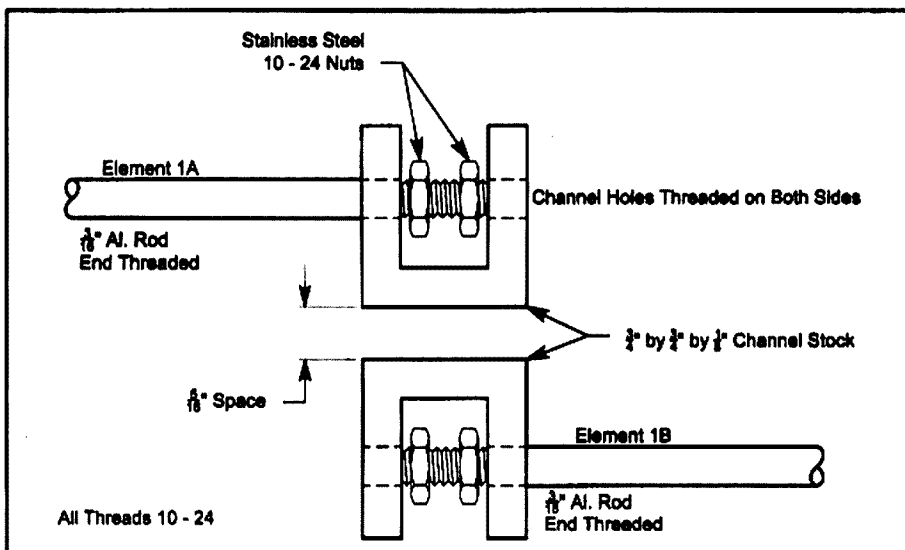

Fig 2. Cutaway End View Twin Boom Element Mounting System.



<http://www.wia.org.au>

Australian Made ANTENNAS

"Setting a New Standard" COM-AN-TENA

(Formerly a j and j coman)
83 Belgrave-Hallam Road
HALLAM 3803

All new 5/8 vertical 16 radials	\$145
Dual drive 26-30 5 ele yagi beam	\$305
4 ele 10-11m yagi beam	\$262
5-6-&7 ele high gain antennas 11m	\$call
3 ele delta loop 10-11m	\$320
11m 5/8 vertical/4-1/4 wave radials	\$170
Duoband 10-15 3 ele each band	\$356
Log-periodic 7 ele 13-30 MHz 7.7m boom	\$890
Tri-band 5 ele HB35C s/steel fix	\$730
3 ele 20m computer opt	\$390
3 ele 15m computer opt	\$285
M B Vert Auto switch 10-80m	\$310
40m linear loaded 2 ele beam	\$580
6m 5 ele compt opt beam	\$259
6m 7 ele compt opt beam	\$355
10 ele high performance 2m	\$135
17 ele high performance 70cm	\$119
2m vert 2-5/8 co-linear 4 rad	\$ 96

Guyed Masts

21 metres 13 metres

Winch-up & tilt-over. Aluminium and stainless steel three-sided construction. Auto-brake winches

Free Standing Masts

9.5 metres

New Baluns

1-1 to 16-1 to 3kW



Our Masts meet Australian Standards. We supply all the computations and data you will need for a permit.

03 9702 4028

Mob: 0419 542 437

Andy VK3IV

Technical Abstracts

Dimensions in inches

Element	Length	Half Length	Spacing	Distance from Rear Element
1	43.02	21.51	-	-
2	39.74	19.87	12.57	12.57
3	36.72	18.36	11.62	24.19
4	33.92	16.96	10.73	34.92
5	31.34	15.67	9.92	44.84
6	28.95	14.48	9.16	54

Dimensions in mm

Element	Length	Half Length	Spacing	Distance from Rear Element
1	546.3	273.2	-	-
2	504.7	252.4	319.4	319.4
3	466.3	233.2	295.1	614.5
4	430.8	215.4	272.6	887.1
5	398.0	199.0	251.9	1138.9
6	367.7	183.9	232.7	1371.6

Table 1. LPDA Dimensions Add 3/8th inch to element half lengths for recommended mounting.

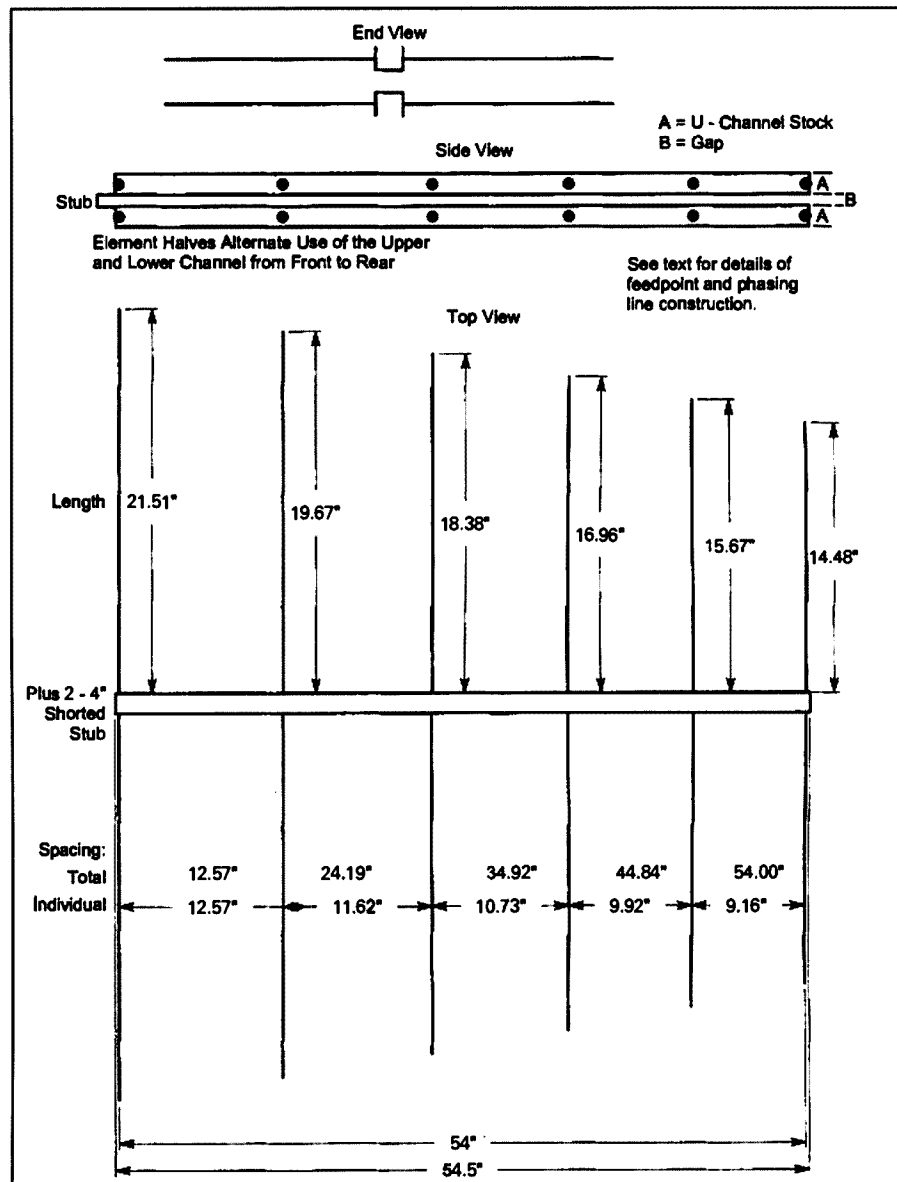

Fig 1. Outline Sketch and Dimensions LPDA

The ALARA Contest

Remember how successful the ALARA Contest was last year with its new conditions. Let's make this one just as good. Unfortunately our Contest is another one of these "use or lose it" situations. Unless we participate for the whole 36 hours and unless we send in our logs on time, we will lose it altogether.

The ALARA Contest will be run on the last full weekend in August, 24th, 25th. It will start at 0000Zulu on our Saturday morning and finish at 1159Zulu on our Sunday evening. By extending the hours this way we can have two evenings on 80 metres for the VK and ZL girls and the daylight hours when we can contact the DX girls. Remember we can repeat contacts with the same station on the

same band after an hour so you can keep in touch. Please participate for as much time as possible.

OMs are very welcome to join in what is as much a chat contest as a serious number exchanging contest. There is always time to talk. We hope there will be some Club stations involved as well, they are always fun.

Awards

This year there are two Awards for which contacts during the Contest may count. As usual the contacts count toward the ALARA AWARD for which you need at least 10 contacts with YL ALARA members from at least five Australian states. The new one is the "33 AWARD" offered in honour of the founder of YLRL, Ethel Smith, K4LMB.

For this you will need to contact at

least 33 YL stations during 2002. Surely you will get some of those during the ALARA Contest.

To obtain the ALARA Award submit your log, signed by two other amateurs to Jean Shaw, QTHR her OM, VK3CMS. For the 33 Award please submit logs to Jeanie Parker, WA6UVF, 28400 Vista Del Valle, Hemet, CA 92544.

Good Luck.

Good Morning!

I had some free time, so what did I do? I checked the computer to see if I'd heard from you!

I use to walk out to a box to retrieve mail. But I'd rather get it instantly, than wait on the snail!

Checking my e-mail is always fun!

I usually get a joke or greeting from someone.

I feel so blessed because on the other end,

I know I've connected with a friend!

When I've had a hard day and need to share,

Here I can find a friend who will listen and care.

And to this friend I hope I've let them know

That I am always there for them also!

Isn't it a strange kind of bond we form? It isn't exactly like the "norm"!

But where is it written, face to face we must be,

For you to be a very good friend to me??

That little joke or note, or just a simple "Hi",

Could be like a ray of sunshine from the sky!

So my E-Mail Pals, this is dedicated to you,

For all the smiles you have made anew!

Always remember this...

A smile is such an easy thing to pass along the way,

Like a ray of summer sunshine,
On a somewhat gloomy day!!

Thank you for your emails!!

The ALARAMEET

Time is marching on. Plans are maturing. Please start sending your deposits or indicating your interest by leaving your names on our website or writing directly to Jean VK5TSX QTHR the call book. The website address is

<http://alaramet2002.8m.com>

When you contact the site, have a look at the forum section and have your say,

too, if you like. Click on any of the links to find out more about the lovely rural town of Murray Bridge.

Jean can also be contacted directly at vk5tsx@bigpond.com

We would love to hear from you. We already have a number of overseas YLs booked and hope that a number of VK5 YLs and OMs will come to some or all of the activities.

pleasure to exchange letters and greetings all around the world. It is quite common, but not obligatory that a sponsored YL will offer reciprocal sponsorship into their own YL organisation so you will get their newsletters at regular intervals, also. In this way you learn about the activities of other ladies with similar interests to yourself.

If you are an active HF operator you can arrange skeds with your sponsor, and these days it is very common to find that you and your sponsored girl are both on email which makes keeping in touch very much easier, of course.

The following verse expresses the pleasure of emails and sponsorship equally well.

Sponsorship

One of the activities of ALARA almost from its inception has been the sponsorship of DX members. At times ALARA has had almost more DX members than we have had local ones, but that is not a problem.

As soon as you join ALARA you can offer to sponsor an overseas YL. We have a Sponsorship Secretary, currently Maria VK5BMT, who is in contact with YL organisations in many countries. She will find you a sponsor if you like, but if you are in radio contact with a YL in any other country you can make arrangements through Maria and our Treasurer, Bev VK4NBC.

Each person sponsored into ALARA receives copies of our Newsletter every three months and you will find it a

EWE Antenna

An interesting directional receiving antenna for 80 and 160 metres and also for Low Frequency appeared in the Antennas column of Peter Dodd G3LDO in Rad Com February 2002. The EWE antenna was originally described by Floyd Koonz WA2WVL in QST Feb 95. The design given was that of Stewart Cameron GM4UTP for use on 3.7 MHz. The EWE antenna is a directional receiving antenna which is small enough to fit into a suburban backyard unlike the beverage which needs to be a wavelength long or more.

The antenna is shown in Fig 3. The total length of the antenna is 12.08 metres. The vertical sections L1 are 3 metres and the horizontal section L2 is 6.08 metres long. The termination is 600 ohms which could be two 1200 ohm metal film or carbon resistors in parallel. The termination is non inductive. The

matching transformer is 12 turns trifilar wound on a T50 core.

The pattern is shown in Fig 4. The zero db scale is about -22 dbi. An amplifier may be required. The antenna design provides directivity at the expense of gain. The gain can be easily made up with an antenna amplifier. You would

need to use an amplifier design with good intermod performance. The antenna is wideband and the 160 metre response is also shown. An array of antennas could be used to provide multiple directions. The antennas could be oriented to null noise sources or to provide maximum signals from desired directions.

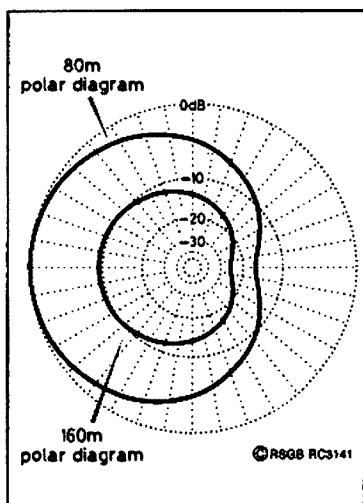

Fig 3. EWE Antenna of GM4UTP

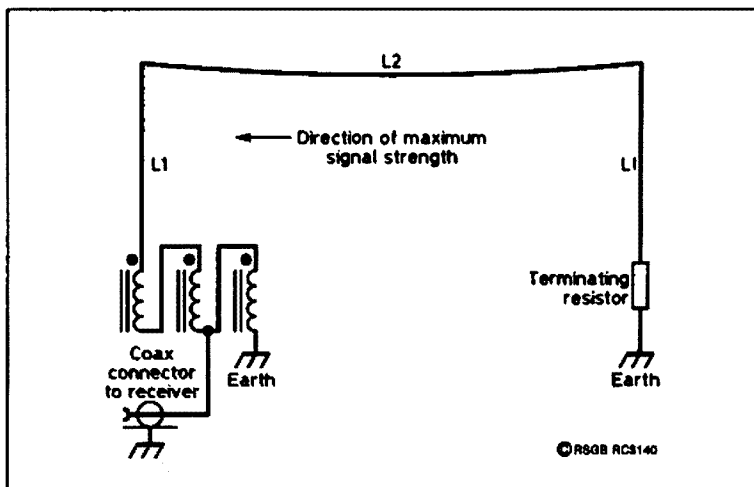

Fig 4. Polar Diagram of EWE Antenna. 0 db scale is approx -22 dbi. Both 80 m and 160 m response shown.

EMC

The EMC column of David Lauder G0SNO in Rad Com February 2002 had some useful information for station setup and EMC work on audio devices. The separation of the equipment and antennas from the house and other devices reminded me of the problems experienced with electronic devices in a household. In one case I heard of an electronic metering device responded in an unfortunate manner to the close proximity of an amateur station antenna system. The bill caused a reaction and some discussions ensued.

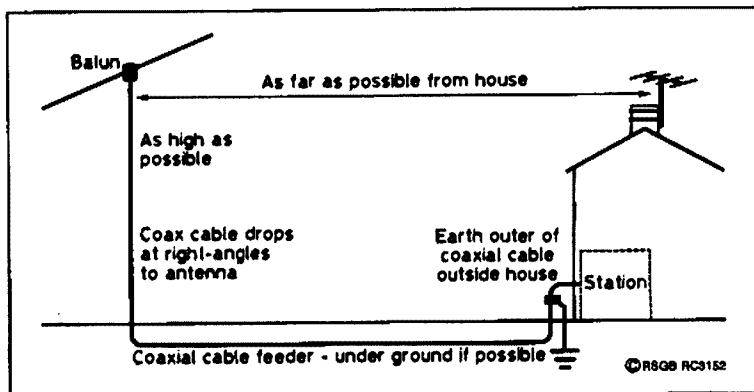

Fig 5. Good Radio Housekeeping. Keep the antenna and feeder system well away from the house.

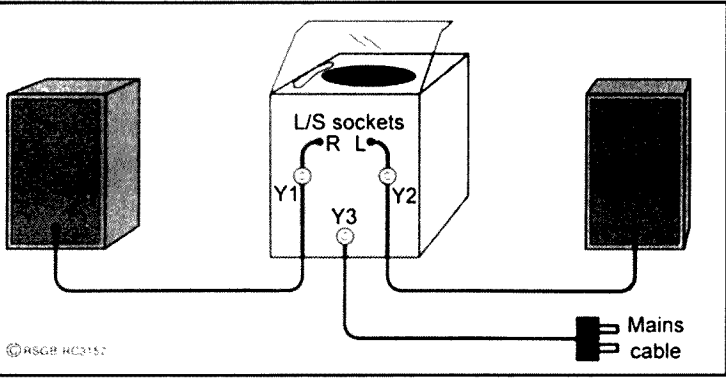

Fig 6. Fitting Ferrite Rings to an Audio System. Ferrites fitted at Y1, Y2, and Y3.

Good radio housekeeping is illustrated in Fig 5. The aim is to get the RF as far as possible from the house and possible EMC problems. This will also help ensure that the radiated RF is going towards making contacts and not causing problems for the operator. The fitting of ferrite rings to choke RF and minimise EMC problems in audio equipment is shown in Fig 6 and Fig 7. Fig 6 is for a standard audio system and

illustrates fitting chokes on the mains and speaker leads to reduce RF getting to the active devices in the amplifier. The rings could be ferrite toroids or the snap on devices made for clipping onto cables. The ferrites are placed at Y1, Y2, and Y3.

In Fig 7 the treatment of the powered

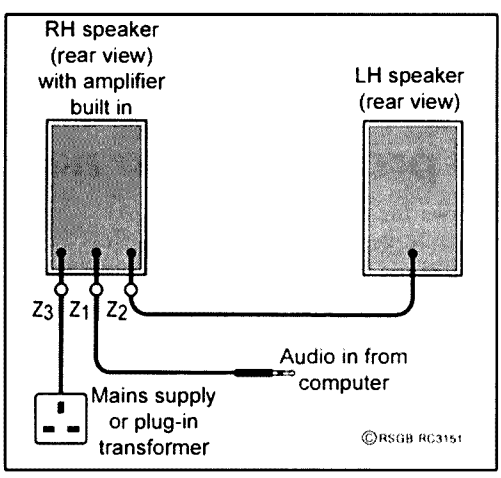

Fig 7. Fitting Ferrite Rings to Computer Speakers. Ferrites fitted at Y1, Y2, and Y3.

loudspeakers of a computer are shown with treatment to minimise EMC problems. Once again the ferrites are placed at positions Z1, Z2, and Z3. The aim is to make the leads lossy to RF and stop them conveying unintended signals into the amplifier.

ar

G. & C. COMMUNICATIONS

Authorised dealer for ✓ Kenwood ✓ Icom ✓ Barrett RFDS ✓ GME Electrophone ✓ Uniden ✓ RF Industries

✓ **KENWOOD TS2000**
All-mode multibander HF/50/144/440
Auto antenna tuner built-in



✓ **ICOM IC706MkII**

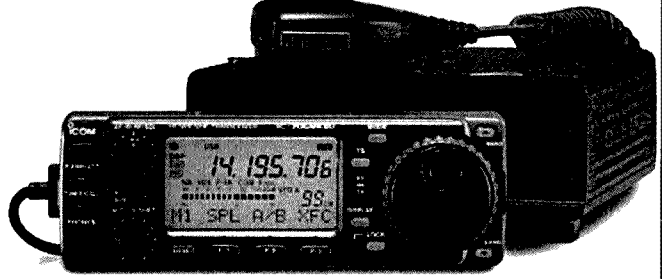

✓ **ELECTROPHONE TX3400**
40 Channel UHF remote mount transceiver with ten extra receive channels

Ultra Small: 167 (W) x 58 (H) x 200 (D), 2.45kg
Detachable Control Panel/Display
SSB/AM/CW/RTTY Narrow Filter Options
2 Optional Crystal Filter Slots
Tone Squelch Standard
107 Alphanumeric Memories (99 regular, 6 scan edges, 2 call)

Australia-wide orders welcome. Payment by credit card, cheque or money order
19 Arleon Crescent Cranbourne 3977
Ph: 03 5996 3298 Fax: 03 5995 0184
Email: gccomm@netspace.net.au
www.netspace.net.au/~gccomm

Beyond Our Shores

David A. Pilley VK2AYD
davpil@midcoast.com.au

FCC proposes two new amateur bands!

Great news for ham radio in the USA! The FCC has proposed going along with ARRL's request for a new domestic (US-only), secondary HF allocation at 5.25 to 5.4 MHz. The FCC also is ready to permit operation on a 136 kHz "sliver band" in the low-frequency (LF) region. And, in response to a third ARRL request, the FCC has proposed elevating Amateur Radio to primary status at 2400 to 2402 MHz.

The FCC said the new 5 MHz band would help amateurs "better match their choice of frequency to existing propagation conditions." The band, if approved, would be the first new amateur HF allocation since World Administrative Radio Conference 1979 gave amateurs 30, 17 and 12 metres—the so-called "WARC Bands." Assuming the 5 MHz band eventually is authorized, it could be a few years before it actually becomes available.

The ARRL said its successful WA2XSY experiments demonstrated that amateurs can coexist with current users and that the band is very suitable for US-to-Caribbean paths. In

comparisons with 80 and 40 metres, the WA2XSY operation also showed the 60-metre band to be the most reliable of the three. The ARRL also argued that a new 150 kHz allocation at 5 MHz could relieve periodic overcrowding on 80 and 40.

If allocated to amateurs on a secondary basis, hams would have to avoid interfering with—and accept interference from—current occupants of the spectrum, as they already do on 30 metres. The band 5.250 to 5.450 MHz now is allocated to Fixed and Mobile services on a co-primary basis in all three ITU regions.

The ARRL asked the FCC for two LF allocations in October 1998—135.7 to 137.8 kHz and 160 to 190 kHz. The FCC said its action on one part of that LF request "proposes changes that would enhance the ability of amateur radio operators to conduct technical experiments, including propagation and antenna design experiments, in the 'low frequency' (LF) range of the radio spectrum."

Several countries in Europe and

elsewhere already have 136 kHz amateur allocations. The first amateur transatlantic contact on the band was recorded in February 2001.

Hams would be secondary to the Fixed and Maritime Mobile services in the 136 kHz allocation. The League said its engineering surveys suggest that hams could operate without causing problems to power line carrier (PLC) systems already active in that vicinity or to government assignments.

Unallocated Part 15 PLC systems are used by electric utilities to send control signals, data and voice.

ARRL's Chief Development Officer Mary Hobart, K1MMH, was among those welcoming the good news from the FCC. "This a wonderful example of the work ARRL conducts in Washington on matters important to the Amateur Radio community," Hobart said. "Thanks to the 10,000 hams who contributed so generously to the 2002 Defense of Frequencies Fund. The success of that campaign helps to make decisions like this possible."

(ARRL N/L Vol21.19 10/5)

Ham radio on the big screen

Amateur Radio is poised to hit the big screen yet again in a movie tentatively titled Phenomenon II. Phenomenon debuted in 1996 and featured John Travolta and his ham operator friend Forest Whitaker. In one scene, Travolta's character appears to be able to copy RTTY transmissions by ear. For the

original Phenomenon movie, ARRL provided several props for the ham radio shack. The sequel is still in the very early stages of development. A researcher working on checking facts in the script contacted ARRL to ask if operators actually used the term "CQ" when initiating contacts! She also told ARRL

Media Relations Manager Jennifer Hagy, N1TDY, that the possibility exists for the creation of a television series based on the Phenomenon movies. No further details were immediately available.

(ARRL N/L Vol21.19 10/5)

Vehicle security

Having heard of stolen vehicles being recovered by activating their cellphone, this true story took my eye.

A ham recently posted a message on the Tucson Amateur Packet Radio APRSSIG e-mail list asking if anyone had received any position packets from the APRS station installed in his vehicle. It seems that his vehicle was stolen and if the perpetrators happened to turn on the station equipment, the position packets might help locate the vehicle.

It was suggested he check

www.findu.com/ to see if his mobile APRS station's position packets had been relayed to the Internet. After checking "findu", he discovered that one of the station's position packets was indeed relayed to the Internet. This clue led authorities to the location revealed by the position packet and resulted in the arrest of the perpetrators and the recovery of various items of stolen property.

(June QST)

Precision APRS Test

According to the ARRL News Letter 25/5, the Air Force Research Labs in the USA planned an experiment using Amateur Radio operators as an auxiliary line of defence. The Precision Emergency Automated Position Reporting System test would consist of 2 aircraft flights. During the flight the aircraft will transmit a distress message. Amateurs will, upon receipt of the message, either email or phone the Air Force. The objective of the exercise will be to measure the timeliness and accuracy of the reports.

The Golden Antenna Award

In Germany there is a town which supports Amateur Radio. It is Bad Bentheim, close to the border with the Netherlands. In 2001 Amateur Radio enthusiasts from all over Europe met at the German-Netherlands Amateur Radio Day for the 33rd time.

Since 1982 the presentation of the Golden Antenna of the town of Bad Bentheim has been one of the highlights

of the gathering. It is an award given to Amateur Radio operators who have helped people in emergencies caused by accidents or natural catastrophes. Recipients have been from Germany, Netherlands, Bolivia, India, Rumania, Turkey, Switzerland, etc.

If you know of any Amateur Radio enthusiast or group whose utilisation of

Amateur Radio technology is connected to humanitarian work then Bad Bentheim would like to hear from you. Write to PO Box 1452, Bad Bentheim 48445, Federal Republic of Germany, or e-mail

to veldhuis@stadtbadbentheim.de. A jury will evaluate the nominations.

(DC9XU@DB0SM.#NDS.DEU.EU)

Promoting amateur radio

Some time back I wrote about the various places that Radio Amateurs in the USA were showing off their Amateur Radio. I was looking through June QST and noticed a few such as "RC Cola & Moon Pie Festival" in Tennessee, "Bread & Honey Festival" in Ontario, "Commemorating the lives of President Reagan and Mrs Nancy Reagan" in California, "Spring Bison Festival" in Pennsylvania, "International Washboard

Festival" in Ohio. But the one that really caught my eye was in Lander, Wyoming, called "Spring Time Comes Late in the Wind River Mountain of Wyoming". That should give you some thoughts. My local club recently had a booth at the "Gray Mardi Gras" (yes, Gray as in hair colour - just for the oldies) and were surprised at the interest Amateur Radio created, especially the Morse transmissions.

Wet string antenna

"Antenna here is a piece of wet string". I guess we've all thought about it at some time! Allan Messenger, G0TLK decided last December to give it a try. Using a 9 metre portable mast with a remote auto ATU and a fairly comprehensive ground system, he slung up 13 metres of string soaked in strong brine as an end-fed sloper antenna. The length was totally

random. The results were excellent contacts on 10, 15, 20 and 40 metres using 20 to 30 watts SSB. He commented that tap water didn't work! Just don't turn the power up or the antenna will dry out! Have you tried any new antennas lately?

(RSGB March RadCom)

Dayton Ohio Hamvention USA

Another era past in May with the Dayton Hamvention 2002 being the 50th anniversary. In spite of chilly weather, the 3 day event drew the usual crowd of between 25,000 and 30,000 visitors.

Among the technical highlights, Yaesu had their new FT-897 on show, which is a pumped up version of the FT-817. Ten-Tec displayed their new Orion transceiver, which is replacing the OMNI. ICOM debuted its new IC-2720 dual-band mobile and its D-Star digital system. Elecraft showed off its new 100 W K2 transceiver.

To top off the 50th anniversary, Mark Elliot, N8WZV and Cyndi Kreiger were married at the Hamvention. Now that should put some idea's into the Field Day organisers here in Australia.

(ARRL N/L 25/5)

WRC 2003 Donations

The following are some of the donations that have been received so far.

On behalf of the Directors and Federal Council I would like to thank you all very much for your generosity.

Your donations are important to us to ensure that the interests of amateur radio are properly represented at WRC 2003

Ernest Hocking VK1LK - Federal President

L70067	VK2BMS	VK2KJM	VK2YN	VK3BTQ	VK3JQ	VK3XEF	VK5CJ	VK5YG	VK6KWM
VK1COB	VK2BPN	VK2KPJ	VK2ZCZ	VK3BWS	VK3JWT	VK3YEV	VK5CL	VK5ZBD	VK6PW
VK1KEP	VK2CWI	VK2KUR	VK2ZGS	VK3CHN	VK3KAV	VK3ZAM	VK5FD	VK5ZLW	VK6QZ
VK1XAI	VK2DCD	VK2LV	VK2ZHP	VK3CHX	VK3KS	VK3ZAN	VK5FF	VK6ABM	VK6SW
VK2AAB	VK2DJM	VK2LY	VK3ABK	VK3CTN	VK3KTJ	VK3ZNR	VK5HN	VK6AFW	VK6VZ
VK2ABE	VK2DKF	VK2MW	VK3ABT	VK3DBX	VK3KTO	VK3ZXY	VK5JAZ	VK6AOK	VK6XME
VK2AFU	VK2DLB	VK2OY	VK3AL	VK3DCF	VK3KVT	VK3ZZG	VK5MX	VK6BMT	VK6YF
VK2AHP	VK2DV	VK2PH	VK3AMD	VK3DSS	VK3NJB	VK4BBL	VK5NNN	VK6CSW	VK7AK
VK2ALZ	VK2DVV	VK2RX	VK3AQ	VK3DVT	VK3PH	VK4MAJ	VK5OV	VK6CU	VK7FJ
VK2AMT	VK2DYP	VK2TBW	VK3AVY	VK3ED	VK3PR	VK4NJJ	VK5QC	VK6CW	VK7KBE
VK2ATU	VK2EHZ	VK2TPH	VK3AXT	VK3EUU	VK3QL	VK5AMR	VK5RK	VK6HH	VK7KMH
VK2AUD	VK2EJP	VK2TRH	VK3BFG	VK3FPL	VK3UU	VK5BA	VK5TW	VK6JAH	VK7PP
VK2AVQ	VK2FLT	VK2VC	VK3BHS	VK3IJ	VK3VQ	VK5BGL	VK5XE	VK6JP	VK7TW
VK2AY	VK2GR	VK2XMF	VK3BML	VK3IQ	VK3WYN	VK5BJE	VK5XQ	VK6KHC	VK8BK
VK2BER	VK2IGS	VK2XRC							

VK1 Notes

Forward Bias

As most of us know, both of our Vice-Presidents went to the Federal Convention that was held on 17, 18, and 19 of May 2002. Alan Hawes (VK1WX) went as an observer, and Phil Longworth (VK1ZPL) went in his capacity as Alternate Federal Councillor. They both reported about the Convention during the General Meeting on May 26. Those who were at this meeting were fully informed about what happened there and the decisions that were made. Other members will have to wait until the Federal Secretary publishes his report in this month's AR.

The first of the regular daytime meetings that Tony Bennett (VK1TB) has started occurred on Tuesday, June 4. During the meeting, it was decided to get together on the second and fourth Tuesday of the month. These meetings will be popular because some of our members have plenty of time on their hands and love an opportunity to talk to other members without having to worry about the problems of traveling at night. How do you get to the Parks &

Garden Depot, you ask? Take Bus 24 from the Woden Interchange and get off at Bus stop No.1 in Lambrigg Street, Farrer. Walk across the Oval to the Depot. It is that easy.

The agenda for these meetings will be announced during the regular Thursday evening broadcasts of VK1WI.

Who is doing what? Waldis Jirgins (VK1WJ) is experimenting with a Directional Discontinuity Ring Radiator (DDRR) antenna and a Crossed-Fields Antenna (CFA) and is having lots of fun. Dave Gibbons is also having fun with CFAs, particularly the loop types and having much success with it. Ray Reinholz (VK1PRG) is busy collecting the ARRL's QST magazines from 1947 onwards until 1970. He is planning to write an article about the beginnings of SSB and FM in the Amateur Radio Service. If you want a copy of an article in any of his collection of QSTs, he is QTHR.

Lawrence Aldridge passed the Novice exam last month (now VK2HLA) and so

Peter Kloppenburg VK1CPK did Harry Watson-Smith. Neil Pickford (VK1KNP) is presently re-programming his station using Linux. Kerry Richens (VK1TKR) and Peter Ellis (VK1KEP) are building 2.4 GHz down-converters for the AO-40 satellite. Olaf Moon (VK1JDX) and Mike Jenkins (VK1MJ) are planning for a radiocommunications museum and Ernest Hocking (VK1LK) is crystallising his thoughts regarding Federal WIA issues. Peter Kloppenburg (VK1CPK) has built himself an electronic lightning detector and is eagerly awaiting the next electric storm. Alan Hawes (Vice-President) is looking for ways to present the statistics of the recent members' survey so that all of us can understand them. Gilbert Hughes (VK1GH) is holidaying in Italy and learning how to say 'CQ DX' in Italian. Peter Ellis is organising for the next Canberra Symposium (Can.Tech. '02), that will be held near the end of the year.

The next General Meeting will be held at Scout Hall in Longerenong St, Farrer on July 22, 2002. Cheers.

VK2 Notes

compiled by Pat Leeper VK2JPA

Some members have expressed concern as to whether the illegality of using mobile phones while driving extends to the use of mobile amateur radio transceivers. Enquires made with the NSW Road Transport Authority produced a definite "OK", with the advice to consult Australian Road Rule number 300 on the RTA website.

Paragraph 2 of this rule states: the definition of "mobile phone does not include a CB radio or any other two-way radio".

We have a list of councillors and their responsibilities for the period 2002-2003.

Terry Davies VK2KDK President; Chris Flak VK2QV Bookshop Manager; Owen Holmwood VK2AEJ Secretary; Brian Kelly VK2WBK NTAC; Geoff McGrorey-Clark VK2EO QSL Bureau; Chris Minahan VK2EJ Treasurer; Terry Ryeland VK2UX Education Officer; John Turner VK2WRT Trash & Treasure.

If you have any problems, contact the officer responsible for assistance. Phone

the office on 02 9689 2417 – leave a message if the office is not manned and we will get back to you.

The next Trash & Treasure will be on Sunday 28th July. Come along and meet old friends, pick up a bargain or two, or set up a stall to move some of your old treasures. Sellers are welcome at 12 noon, and buyers at 12.30pm in the car park of the Institute beneath 109 Wigram Street Parramatta.

That's all for this month, see you next time.

VK3 Notes

By Jim Linton VK3PC

WIA Victoria web site: www.wiavic.org.au
email: wiavic@wiavic.org.au

WIA Victoria Council

At its meeting on 11 June, the following office bearers were elected for the coming period:

President Jim Linton VK3PC
Vice-President Murray Price VK3JKZ
Secretary John Brown VK3JJB
Treasurer Jim Baxter VK3DBQ

As this is the last year of your current Council's three year term of office, election of a new Council will take place at next year's Annual General meeting. To facilitate this, Council* appointed Barry Wilton, VK3XV as Electoral Officer.

*The Articles of WIAVictoria state that the appointment of an Electoral Officer is to be made at an AGM, however as an Electoral Officer is normally only required for a short time once every three years, the AGM held 28 May 1997 delegated this responsibility to Council. This delegation was confirmed again at the AGM held 31 May 2000 and has been exercised with this appointment.

IARU Region 3 Amateur Radio Direction Finding Championships in 2003

A Progress Report from Greg Williams VK3VT, President Victorian ARDF Group to the WIA Victoria Council indicates that planning is well underway for this important event.

It is to be hosted by the Wireless Institute of Australia and will be held in the Ballarat area from Friday 28 November to Wednesday 3 December 2003.

Up to 100 participants from member societies in Region 3 including Japan, Korea, China, Mongolia, New Zealand,

and Australia, as well as guest competitors from other Regions are expected to attend.

WIA Victoria is sponsoring this event and assisting the organising committee with financial backing.

New EMR Regulations

The mandatory electromagnetic radiation (EMR) limits on all apparatus licences, including those for amateur stations, were due to begin on 1 July.

Recently received correspondence indicates that there is still some misinformation circulating amongst the amateur community regarding the EMR regulations.

A factual report on the requirements appeared in last month's Amateur Radio magazine, and is available on the WIA Victoria web-site.

It is important to repeat that EMR regulations are applying to all types of transmitters. They have a minimal impact on the Amateur Service, and in fact give all radio amateurs a measure of protection against ill-informed comments about radiation.

New Members

Council approved nine new applications for membership at this meeting. This brings the total new members for the year to forty-eight which is on target to achieve our goal of returning WIA Victoria to a growth situation after a number of years of declining membership.

It is interesting to note that a number of the new applicants were previously members who had let their membership lapse, but who have now decided to rejoin.

Council would like to think that this surge in new members is in response to

improved communication of the work that is being done at both the local and federal and international level to protect member's privileges and advance the hobby of Amateur Radio.

Repeater/Beacon Update

Internet Repeater Linking (IRLP)

There is quite a lot of activity underway on the IRLP front.

- Gippsland Gate Radio and Electronics Club has applied for a 70 cm frequency for a new IRLP repeater to be sited on the fringe of the SE metropolitan area.
- Twin Cities Radio and Electronics Club have advised that they are supporting the installation of IRLP via the 70 cm repeater VK3RNE.
- Eastern & Mountain Districts Radio Club are continuing their IRLP project via VK3ROU and hope to be 'on the air' soon.
- Geelong Amateur Radio Club is working to get their 70 cm IRLP repeater VK3RGL back on the air after a recent lightning strike.
- Bass IRLP Amateur Radio Group has been issued with the Club Call VK3IRL

Interference on VK3RML - This fault associated with a nearby ethnic language broadcast transmitter has been reported to the ACA and is being followed up to try resolve the problem.

VK3RMH 6 m Beacon - North East Radio Group have advised that their 6 m beacon is not operating at present. A new frequency within revised band planning is being sought. Due to the narrowness and nature of propagation on that band, there is a limit on the number of beacon channels per state.

PLAN AHEAD

**Remembrance Day
Contest
17 & 18 August 2002**

**ALARA Contest
24 & 25 August 2002**

InstantTrack bug fixed

Paul Williamson writes that an annoying bug which appeared in the first open-beta version of InstantTrack ver-1.54 has been fixed.

It was not possible to set the spacecraft attitude to "local-vertical". This is the setting needed for nadir-pointing satellites, i.e. satellites which have their antennas pointing towards the centre of the Earth at all times and therefore have a constantly changing 'attitude' for the purposes of squint-angle calculations.

Download version 1.55 of *InstantTrack* from the AMSAT web site to fix the problem. While we're on the subject, there's a new tutorial available on the *InstantTrack* web pages. The page shows you how to set up the free program cURL to automatically download Keplerian elements from the Internet and update

InstantTrack's database every week. I haven't tried this myself, as *InstantTrack* is not my primary tracking program. The tutorial works with Windows from 95 to XP. The following URL will lead directly to the download page. <http://www.amsat.org/amsat/instanttrack/curl/>

Six-monthly Update of Operational Amateur Radio Satellites

Here is a summary of the amateur radio satellites, which are currently available for regular operations in this part of the world.

This information is compiled from many sources including personal observations of my own and my friends. The information is as current as I can obtain at the time of writing. It relies heavily on the day-to-day happenings on the AMSAT-NA e-mail bulletin board and by listening to and operating the satellites themselves. But it must be remembered that the amateur radio satellite business is very dynamic and changes may occur at any time. The only

effective way to keep up-to-the-minute is to subscribe to the AMSAT-BB and the Amsat-News-Service and receive daily/weekly e-mail information "as-it-happens".

NOTE: From time to time satellites are launched which are designed to be operational only over certain parts of the world. AO-27 and more recently the Saudi-sats are examples and there have been many others. They will not be included in this summary if they are not

available to VK operators. Likewise there are a number of amateur radio satellites, which have failed either partially or totally but are still in orbit. Their keplerian elements are included in the sets available from the usual sources but again I have not included them in this list. If you want information on these birds it can usually be obtained from the AMSAT web site or by subscribing to the AMSAT news service or bulletin board.

The International Space Station

Not an "amateur radio satellite" of course but ISS has carried on the tradition of the Russian space station MIR in giving astronauts an opportunity to participate in amateur radio operation during their leisure time and of course to enable amateur radio operators world wide to make contact with real live astronauts in orbit.

Many astronauts have obtained amateur radio qualifications during their training and most continue their interest after their tour of duty in space has ended. The ISS equipment allows FM voice and packet operation including UI digipeating for APRS activity. Remember the ISS crewmembers are very busy. They have a demanding daily schedule and amateur radio is at best a leisure-time activity. The daily crew schedule which gives an idea when crew members have free time and may be available for Amateur Radio operations can be found

at: <http://spaceflight.nasa.gov/station/timelines/2001/may/index.html>.

You would do well to consult this site before planning to work with ISS. Otherwise you could waste a lot of time listening or worse, calling to no avail. At times the packet radio equipment may be switched into automatic mode, either digipeating or mailbox. When the crewmembers are using voice communication via the amateur radio station, they will use the following callsigns:

Callsigns

U.S. callsign: NA1SS
Russian callsigns: RS0ISS, RZ3DZR
ISS frequencies for packet and voice
Worldwide packet uplink:
145.990 MHz
Region 1 voice uplink:
145.200 MHz
Region 2/3 voice uplink:
144.490 MHz
Worldwide downlink (both modes):
145.800 MHz
TNC callsign NOCALL

The high altitude elliptical orbiters

AO-10

Uplink 435.030 to 435.180 MHz CW/LSB
 Downlink 145.975 to 145.825 MHz CW/USB
 Beacon 145.810 MHz (unmodulated carrier)

Launched: June 16, 1983 by an Ariane launcher from Kourou, French Guiana.

Status: Semi-operational, mode-B. AO-10 has been locked into a 70-cm uplink/2 metre downlink configuration for several years since the on-board computer failed due to radiation damage. AO-10 has been undergoing something of a 're-discovery' since the launch of AO-40, which has attracted a lot more interest in the high orbit birds.

Unlike the Low-Earth-Orbiters (LEOs) the high-orbit satellites are capable of long range, almost hemisphere-wide DX. Over the years many stations notched up their satellite DXCC on AO-10 and AO-13 and today many are doing the same with AO-40. Remember to listen to the beacon regularly while you are operating AO-10 and cease transmission if there is any frequency 'wobble' as you talk or key-down.

Stacey Mills maintains an informative web site for AO-10, which is now our longest serving operational amateur radio satellite. Since the demise of the on-board computer the attitude of AO-10 is unknown and therefore the squint angle cannot be calculated. From time to time an estimate is made of the attitude. Visit Stacey's site at: <http://www.cstone.net/~w4sm/AO-10.html> for the latest information.

AO-40

Launched: November 16, 2000 aboard an Ariane 5 launcher from Kourou, French Guiana.

Status: Currently, the U/L1 to S2 passband is active.

Uplink

U-band 435.550 - 435.800 MHz CW/SSB

L1-band 1269.250 - 1269.500 MHz CW/SSB

L2-band 1268.325 - 1268.575 MHz CW/SSB

Downlink

S2-band 2401.225 - 2401.475 MHz CW/SSB

AO-40 continues to provide good DX, reliable signals and wide footprints. Commissioning is continuing with several important milestones to be passed soon. Due to this commissioning transponder operations may be interrupted at short notice. You should check the AMSAT web site for the latest information before setting up to operate AO-40.

continued next page

The AMSAT group in Australia

The National Co-ordinator of AMSAT-VK is Graham Ratcliff VK5AGR. No formal application is necessary for membership and no membership fees apply. Graham maintains an e-mail mailing list for breaking news and such things as software releases. Members use the AMSAT-Australia HF net as a forum.

AMSAT-Australia HF net

The net meets formally on the second Sunday evening of the month. In winter (end of March until the end of October) the net meets on 3.685 MHz at 1000utc with early check-ins at 0945utc. In summer (end of October until end of March) the net meets on 7.068 MHz at 0900utc with early check-ins at 0845utc. All communication regarding AMSAT-Australia matters can be addressed to:

AMSAT-VK,
 GPO Box 2141,
 Adelaide, SA. 5001.

Graham's e-mail address is: vk5agr@amsat.org

Cable, Connectors, Tools



- RG58C/U Belden 8259 @ \$0.90 per metre
- RG213/U Belden 8267 @ \$4.45 per metre
- RG8/U Belden 9913 Low Loss @ \$5.15 per metre
- RG8/U Belden 9913F7 High Flex Low Loss @ \$5.55 per metre
- RG8/U - RF400 Belden 7810 Low Loss Sweep Tested to 6000MHz @ \$6.30 per metre



- RG58: B80-006 UHF connector (M) @ \$7.65 each
- RG8/213: B80-001 UHF connector (M) @ \$8.80 each
- RG213: B30-001 N connector (M) @ \$9.10 each
- RG8: B30-041 N connector (M) @ \$14.00 each

TOOLS

- Coax Cutters: C.K. @ \$40.00 each
- Strippers: ● Ideal - RG58 @ \$33.00 each
- RG8/213 @ \$53.00 each

* All prices include GST
 * Minimum order value \$50

payable by Visa, Mastercard, Bankcard or Money Order

* Packing and Delivery \$15 within Australia (Outside Australia P.O.A.)



ABN: 62 088 051 030

email - sales @ elektron.com.au or Phone: (03) 9761-3207
 Elektron Pty Ltd, Unit 2, 14 Melrich Road, Bayswater, Victoria 3153.

The Russian RS series

RS-12/13

Uplink 145.910 to 145.950 MHz CW/SSB
Downlink 29.410 to 29.450 MHz CW/SSB
Beacon 29.408 MHz

Launched: February 5, 1991 aboard a Russian Cosmos C launcher

Status: RS-12 was re-activated in mode-A on January 1, 2001.

Local reports indicate that mode-K/T has been operating for a month or so at the time of writing. RS-12 has been giving good results with strong signals being received on the 10m downlink. Simple wire dipole antennas are quite suitable for 15 and 10m operations on the RS birds although many operators use tri-band HF yagis. A suitable uplink antenna for mode-A is a 2m λ wave ground-plane or a λ wave vertical for low elevation passes. The lower elevation passes will give the best DX but for most purposes the λ wave ground-plane antenna will give best all-round results. Try to use a flat metal screen of some kind rather than 3 or 4 radials for the ground plane. Remember, the RS satellites do not invert the signal so if you uplink on USB, the downlink will also be USB and if you uplink near the top of the passband, your signal will come out near the top end of the downlink passband. It's not a bad idea therefore to start out near the middle, ie. 145.930 MHz and listen for your downlink signal around 29.430 MHz. Listen first to the beacon on (or near) 29.408 MHz and only use

enough uplink power to match the signal strength of the beacon. Don't waste your time trying to transmit a signal through the satellite until you can hear the beacon loud and clear. RS-12/13/15 afford the newcomer an easy way to "learn the ropes" and to start out in satellite operation. The latest information on RS-12 and RS-13 can be found on the AC5DK RS-12/13 Satellite Operators page at: <http://www.qsl.net/ac5dk/rs1213/rs1213.html> If RS-12 whets your appetite, a good book like the "Satellite Experimenter's Handbook" will serve you well. For a more detailed look at "hands-on" operating hints on these satellites, see Peter VK5ZGP's contribution in the February and March 2002 columns.

RS-15

Uplink 145.858 to 145.898 MHz CW/SSB
Downlink 29.354 to 29.394 MHz CW/SSB
Beacon 29.352 MHz (intermittent)

SSB meeting frequency 29.380 MHz (unofficial)

Launched: December 26, 1994 from the Baikonur Cosmodrome

Status: Semi-operational, mode-A, using a 2-meter uplink and a 10-meter downlink. Dave, WB6LLO, has operating information for RS-15 on his web site. In addition to satellite data, antenna information for mode-A operation is also featured. The WB6LLO web site URL is: <http://home.san.r.com/doguimont/uploads>

The Japanese FUJIs

FO-20

Uplink 145.90 to 146.00 MHz CW/LSB
Downlink 435.80 to 435.90 MHz CW/USB

Launched: February 07, 1990 by an H1 launcher from the Tanegashima Space Center in Japan. Status: Operational. FO-20 is in mode JA (analog).

FO-29

Launched: August 17, 1996, by an H-2 launcher from the Tanegashima Space Center in Japan.

Status: Operational Voice/CW Mode JA (analog)

Uplink 145.90 to 146.00 MHz CW/LSB
Downlink 435.80 to 435.90 MHz CW/USB

Digital Mode JD

Uplink 145.850 145.870 145.910 MHz FM
Downlink 435.910 MHz 1200-baud BPSK or 9600-baud FSK

Callsign 8J1JCS

Digitalker 435.910 MHz

As with the RS series, beginners on the Fuji satellites would do well to look at the "hands-on" operating hints for these satellites in Peter VK5ZGP's contribution in the February and March 2002 columns.

The packet radio satellites

(store and forward 38k4 baud)

UO-36

Nothing has been heard of this satellite for a year at the time of writing but it's worth keeping an eye out in the hope of its return to service. No pertinent announcements have been forthcoming from Surrey University.

Uplink 145.960 MHz (9600-baud FSK)

Downlink 437.025 MHz 437.400 MHz

Broadcast callsign UO121-11

BBS callsign UO121-12

Launched: April 21, 1999 by a Russian launcher from the Baikonur Cosmodrome.

UO-36 carries a number of imaging payloads, digital store-

and-forward communications and mode L/S transponders.

UO-36 was responsible for the most spectacular earth imaging seen from any of the Surrey satellites.

Further information on UO-36 may be available from: <http://www.sstl.co.uk/>

MO-46 (TIUNGSAT-1)

Uplink 145.850 or 145.925 MHz 9600-baud FSK

Downlink 437.325 MHz

Broadcast callsign MYSAT3-11

BBS callsign MYSAT3-12

Launched: September 26, 2000 aboard a converted Soviet ballistic missile from the Baikonur Cosmodrome.

Status: Operational at 38k4-baud FSK

TiungSat-1 is Malaysia's first micro-satellite and in addition to commercial land and weather imaging payloads, it offers an amateur radio downlink. The amateur radio operations on MO-46 like those of UO-36 centre around the imaging payloads. Often stunning quality earth images are available for download from these satellites. MO-40 and UO-36 are normally in idle-mode with the transmitter turned off to conserve power. Amateur radio operators can turn the transmitter on when it comes into range but it requires additions to your Windows system (WiSP) registry. The registry alterations are listed on the ASMAT web site but if you have trouble locating the instructions I can supply a copy. Remember also that UO-36 and MO-46 both operate at a downlink speed of 38400 (38k4) baud and this requires broad-banding alterations to be made to the IF chain of most receivers. Details are available from <http://www.symek.com>

(store and forward 9600 baud)

UO-22

Uplink 145.900 or 145.975 MHz FM 9600-baud FSK

Downlink 435.120 MHz FM

Broadcast callsign UOSAT5-11

BBS callsign UOSAT5-12

Launched: July 17, 1991 by an Ariane launcher from Kourou, French Guiana.

Status: Operational

UO-22 is operational with 100% downlink efficiency most of each pass. At the time of writing UO-22's only active uplink appears to be 145.900 MHz. The other 'normal' uplink is 145.975 MHz but this not operating despite the telemetry bulletin saying it should be. Try both frequencies if you have trouble uplinking to UO-22. It is the last of the original 'Surrey' 9600 baud digital birds to be still giving good performance. KO-23 has not been heard reliably for a couple of years and KO-25 has been very unreliable for many months. Indications are that neither of these satellites will be recovered. For the sake of brevity I have removed them from this list but if you want more details you can go to the University of Surrey web site and follow the links from there.

(store and forward 1200 baud)

AO-16

Uplink 145.90 / 145.92 / 145.94 / 145.96 MHz FM
(using 1200-baud Manchester FSK)

Downlink 437.025 MHz SSB (Raised Cosine-BPSK 1200-baud PSK)

Mode-S Beacon 2401.1428 MHz

Broadcast callsign PACSAT-11

BBS callsign PACSAT-12

Launched: January 22, 1990 by an Ariane launcher from Kourou, French Guiana.

Status: Semi-operational, the digipeater command is on and AO-16 may be used to digipeat APRS packets.

IO-26

Uplink 145.875 145.900 145.925 145.950 MHz
FM (1200-baud)

Downlink 435.822 MHz SSB

Broadcast callsign ITMSAT-11

BBS callsign ITMSAT-12

Launched: September 26, 1993 by an Ariane launcher from Kourou, French Guiana.

Status: Semi-operational, the digipeater function is on and open for APRS users.

(Dedicated APRS-digipeating 1200 baud)

PCSAT NO-44

Uplink/downlink 145.827 MHz 1200 baud AX-25 AFSK
via PCSAT-1

Aux/Uplink 435.250 MHz 9600 baud
via PCSAT-2 (off)

APRS Downlink 144.390 MHz (Region 2)

Launched: September 30, 2001 aboard an Athena-1 rocket from the Kodiak, Alaska launch complex.

Status: Operational

WB4APR reports PCSat "appears to be in great shape even though it has now (mid-May) entered another maximum eclipse period which should last for about a month. Eclipse periods happen periodically and the only restriction at these times is that we ask for no unattended overnight beacons to be left running."

PCSat is a 1200-baud APRS digipeater designed for use by stations using hand-held or mobile transceivers. Downlinks feed a central web site <http://pcsat.aprs.org>. The APRS-equipped PCSat was built by midshipmen from the U.S. Naval Academy under the guidance of Bob Bruninga, WB4APR.

(Beacon and telemetry only - 1200 baud)

UO-11

Downlink 145.825 MHz FM (1200-baud AFSK, special modem required)

Mode-S Beacon 2401.500 MHz (very useful for testing S-band receiving equipment).

Launched: March 1, 1984 by a Delta-Thor rocket from Vandenberg Air Force Base in California. During the past year, as in the past 18 years, OSCAR-11 has operated continuously on both VHF and S band, with very little attention required from the ground station. The attitude is controlled solely by the gravity gradient boom leaving the satellite's antennas earth-pointing at all times. As a result, signals are reliable and strong. Truly a remarkable record of achievement.

The operating schedule remains unchanged.

ASCII status, summary of operating conditions (210 seconds)

ASCII bulletin (60 seconds)

BINARY SEU, Single Event Upset summary (30 seconds)

ASCII TLM, live telemetry (90 seconds)

ASCII WOD Whole Orbit TLM Data stored for up to 3 orbits (120 seconds)

ASCII bulletin (60 seconds)

BINARY Engineering system housekeeping telemetry (30 seconds)

UO-11 has been a remarkably reliable tool for schools and colleges over the past 18 years. It requires minimum receive capability and has introduced countless students to space science via the brrrrrrp-brrrrrrp of its telemetry beacon. A real success story from the University of Surrey in England. How much electronic equipment do you have in your shack that has been switched on and operating continuously for 18 years?

continued next page

Intruder Watch May 2002

Henry VK8HA

vk8ha@octa4.net.au or Box 619, Humpty Doo, N.T.

This month thanks to Tom Walker VK4BTW and his Intruder Watchers. We will miss Tom's reports and we send him our best wishes.

DX conditions at present are great so many Chinese CB and SSB stations can be heard on 28-29 MHz. Indonesian intruders on SSB can be heard on 21

MHz. Our lack of activity gives these intruders a free go.

Thanks Karl VK6XW for the report on the jamming of the VK6 Travelers Net.

FREQ	DATE	TIME	EMM	DEGS	RST	RPTS	DETAILS
03500	dly	eve	pkt	360	S1	15	Chinese pkt.
03560	dly	1200	A3	—	S9	15	Pyong Yang B/cast Stn.
07000	dly	eve	USB	—	S9	50	Indon Crlms
07015	dly	eve	USB	—	S9	50	Indon Crlms
07025	dly	eve	USB	—	S9	50	Indon Crlms
10105	dly	eve	USB	—	S9	50	Indon Crlms
14000	dly	eve	USB	—	S9	50	Indon Crlms also using LSB
14005	dly	eve	USB	—	S9	50	Indon Crlms
14005	1105	2250	—	330	S3	30	Buzz Saw noisy Xmiss
14005	1005	1208	USB	—	S9	30	Several Male Chinese
14008	1305	1105	USB	360	S9	10	Two Chinese Males Short Messages
14010	1105	2255	AM	360	S1	5	UI B/cast Statio14017
14036	1305	0820	Buzz	300	S1	10	Buzz-Saw Noise + SS3
14040	1505	1300	USB	360	S9	—	Big MOB SHOUTING
14052	1305	0823	Pkt	300	S8	20	'Chou Schriber'
14060	1005	1210	USB	360	S9	mny	same up every 5k
14061	1305	0825	BUZZ	300	S1	mny	Buzz Saw Noise
14080	dly	eve	SSB	—	S9	mny	Indon Crlms.....14100 (masses)
14100	dly	eve	USB	—	S9	199	Indon Crlms
14105	dly	eve	BUZZ	300	SB	mny	Ui.Buzz Saw Emission
14110	dly	eve	USB	—	S9	mny	Indon Crlms
14115	dly	day	USB	—	S9	dly	Indon Crlms Jamming VK6 Travellers NET
14116	dly	day	USB	—	S9	dly	Indon Crlms every DAY
14117	dly	day	USB	—	S9	dly	Indon Crlms
14120	dly	day	USB	—	S9	dly	INDON CRIMS JAMMING VK6 TRAVELLERS NET
14121	1305	0830	PKT	300	S9	10	Chinese 'Chow-Schriber'
14125	1305	0830	USB	—	S9	—	Indon Crlms in TIMOR
14175	3005	1720	BUZZ	300	S3	—	Buzz Saw
14230	3005	0830	USB	—	S9	—	Indon Crlms in Timor
14250	3005	0830	A3E	—	S4	—	Pyong Yang very low lev
14300	3005	0830	CW	330	S3	—	Daily PIPS
18090	1905	2245	Multi	330	S8	—	Sounds like 11-mile 2kw TX-Log Periodic..TX-site closing down

AMSAT continued

The future...on the drawing board

AMSAT-North America has started planning a new low-earth-orbit communications satellite.

Although the satellite will be similar in mass and size to the original MICROSAT design, it will incorporate all new, leading edge electronics and RF technology. The new project will operate as an "easy-sat", as well as serving as a test bed for new technologies. The new "bird" will be named AMSAT-OSCAR E (Echo) until launch. Plans call for the satellite to contain analog and digital VHF/UHF FM transponders and in addition, the new satellite will have the capability to host one or two other experimental payloads yet to be finalised. AMSAT-NA has partnered with an outside contractor, SpaceQuest, Ltd. of Fairfax, Virginia, who will assist in building the satellite bus. AMSAT volunteers are responsible for the design, development, integration and testing of

the various experimental payloads. The spacecraft is now slated to be ready for launch in late 2003. A number of affordable launch opportunities are being actively explored.

I have no further news regarding VUSAT from AMSAT - India. See the May column for some early details of this project from the Indian Space Research Organisation.

...and locally

- Three space-related projects are underway in this part of the world. Groups in NSW, Qld and New Zealand have low-earth-orbit satellites on the drawing board. It is hoped that all these will have an amateur radio component and go

on to become "Oscars". All three projects are still in the planning stages.

- The BlueSAT project is underway at the University of New South Wales. You can find all the details at: <http://www.bluesat.unsw.edu.au>
- The JaeSAT project is being sponsored by the Australian Space Research Institute and is based in Queensland. Their web site is: <http://www.asri.org.au> and you can follow the links from there.
- The KiwiSAT project is being planned by AMSAT-ZL and you can find details at their web site: <http://www.amsat-zl.org.nz> and follow the links from the home page.

ar

Surprising activity on 160m

I have been pleasantly surprised over the past couple of months with the activity on the 160 metre band. Since erecting a shortened vertical (66 feet long with loading coils at the top and bottom, based on a design by Doug DeMaw, W1FB) I have managed to work 5 stations in the USA (with 559 reports both ways), a number of DXpeditions in the South Pacific and a number of VK2s, VK3s, VK4s and a VK5.

My previous antenna for 'casual' listening on 160 had been a G5RV with the feeder tied together and fed against earth via a Z match ATU. This may explain why I had never heard much activity on the band (especially DX) until I had put up and tuned the vertical. The difference between the two antennas has to be heard to be believed; signals that are just audible on the G5RV are at least 4 S points stronger on the vertical. I admit verticals are more prone to picking up interference and QRN than

are horizontal antennas, but 160 is a noisy band at the best of times and anyway there aren't many of us who can manage to get a horizontal dipole for 160 up high enough to be effective! The antenna is simple and easy to construct and I am planning to write it up as an article for AR. I am pleased with the performance of my new antenna and plan on spending a bit of time on 160 over the winter months to see who, where and what DX pops up on the

band.

The IOTA contest will be held over the last weekend of this month (27th and 28th of July) and as usual there will be a large number of operations taking place from rare locations and remote islands all over the world. If you are keen on having QSO's from places that are rare and exotic places then this contest is for you. I'll be having a listen (especially on 160) to see what I can put in the log. Have a listen and let me know what you manage to work or hear.

The DX

5W, SAMOA. Ted, K8AQM and David, K8AA have been granted the callsigns 5W0TR and 5W0AA and will be operating over the period the 2nd until the 12th of July. They planning to be active on all bands 40 – 10 metres mainly CW and digital modes but will also try to get some SSB in as well. QSL route for both calls is via K8AA. [TNX K8AQM and OPDX]

9G, GHANA. Henk, PA3AWW says that he will be working as a volunteer at the Dormaa Hospital in Dormaa-Ahenkro, Ghana for a couple of months (July and August). He has permission to operate with the callsign 9G1AA on the 40, 20 and 15 metre bands, and has a preference for CW. QSL via PA3ERA. [TNX PA3ERA and 425 DX News]

JD, MARCUS ISLAND (Minami Torishima). Osamu, JH1EFP will be paying a visit to the island over the period of the 16th July until the 6th of August. He will be using the JD1YBJ club station, mainly on 17 metres CW and SSB, from 0900 to 1100 or 2000 to 2200Z. Osamu is a radio technician and will be doing some maintenance work on the Loran radiolocation equipment located on the island. QSL route for this

operation only via 2 - 5 - 35 - 405 Miyazaki Cyuouku Chiba, JAPAN 260-0806. [TNX JH1EFP and The Daily DX]

KL, WALRUS ISLANDS. Lanny, W5BOS will be active on all bands 20 – 10 metres using CW and SSB signing W5BOS/KL5 from the *Walrus Islands (NA-121)* over the period of the 8th until the 10th of July. QSL via W5BOS either direct or via the bureau. [TNX W5BOS and 425 DX News]

OJ, MARKET REEF. Seppo, OH1VR is planning a bit of operation from *Market Reef (EU-053)* using the call OJ0VR. He expects to be active from the 8th until the 11th of July. Seppo hopes to spend some time on all bands 160 – 6 metres using CW and SSB. Seppo may have a visit from Vicky, AE9YL and Carl, K9LA during his activity, so keep an ear open for OJ0/AE9YL and OJ0/K9LA as well on the HF bands. QSL via OH1VR for contacts with OJ0VR and to home calls for OJ0/AE9YL and OJ0/K9LA. [TNX NG3K and The Daily DX]

TY, BENIN. French amateurs (F5MOO as TY7Z, F5CWU as TY9F, F5AOV as TY4DX and F1PJB as TY6FB) will be active again from Benin between the 15th of July and the 14th of August. The group

plan to operate on all bands 160-6 metres and hope to do some satellite work too. No QSL information for the activity has been provided but perhaps it'll come later. Alternatively, if you manage to work them and are eager for a QSL card then try their homecalls. [TNX La Gazette du DX and 425 DX News]

YA, AFGHANISTAN. Chris, YA/G0TQJ is currently active from Kabul in Afghanistan and will continue to be so until at least the end of July. QSL via home call direct to C.M. Vernon, 66 Kesteven Road, Stamford, Lincs PE9 1SU, England or via the bureau. [TNX YA/G0TQJ and 425 DX News]

Vlado, Z35M, has been active from **Tirana, Albania** as ZA/Z35M since the 1st of June. He is currently working in Tirana and expects to be there for several years. Vlado hopes to operate CW and SSB on all of the HF bands during his stay. He also points out that the Albanian band plan for 80 m is 3750 – 3800 and 40 m is 7040 – 7100 kHz. He also has a website at <http://www.qsl.net/z35m>. QSL direct only to Z35M, Vladimir Kovaceski, Box 10, Struga 6330, Macedonia. [TNX Z35M and The Daily DX]

IOTA Activity

The IOTA contest will be taking place the last weekend of this month and as usual there are many thousands of individuals and groups planning trips to islands all over the world to compete. For those who are interested in IOTA or if you simply enjoy working rare, remote and exotic islands, then this will be a very interesting and enjoyable weekend.

9A, CROATIA. Emir, 9A6AA plans to be active on 40 and 20 metres SSB from *Zeca Island (EU-136)* on the 26th of July and then *Visoki Island (also part of EU-136)* on the 27th. [TNX 9A6AA and 425 DX News]

9H, MALTA. Maurice, ON4BAM says he will be active on all HF bands using SSB and PSK signing as 9H3Z from *Malta (EU-023)* over the period of the 15th until the 30th of July using a TS450s and wire antennas. He is on vacation but

intends to relax while on leave by entering the IOTA contest. QSL via ON4BAM. [TNX ON4BAM and OPDX]

I, ITALY. Feco, HA8KW is spending a week on *Grado Island (EU-130)* from the 25th of July until the 2nd of August and plans to operate on the 10, 12, 15, 17, 20 and 30 metre bands, mainly CW but with some SSB. He will be using the callsign IV3/HA8KW/P and also intends to enter the IOTA contest as well. QSL via home call direct or via the bureau. [TNX HA8KW, Islands On The Web and 425 DX News]

FP, St PIERRE and MIQUELON ISLANDS. Linda, VE9GLF and Len, VE9MY are planning to be active from *St. Pierre & Miquelon (NA-032)* for a few days at the end of July and will be taking part in the IOTA contest. They are aware

that these islands are particularly sought after in Asia and Oceania so please have a listen and take advantage of the opportunity. QSL via homecalls [TNX VE9GLF]

W, USA. Tony, WF1N and Lou, W1DIG will be active from *Thacher Island (NA-148)* between the 26th and the 28th of July and are planning to participate in the IOTA Contest. QSL via home calls either direct or via the bureau. [TNX WF1N and 425 DX News]

W, USA. Operators from the Federal Way ARC in the USA will be active on all bands 10 - 40 metres as WA7FW/7 from *Whidbey Island (NA-065)* from 00.00 UTC on 20th until 23.59 UTC on the 21st of July. QSL via the operators instructions. [TNX N7UO and 425 DX News]

DXpeditions

CY9, St PAUL ISLAND. A group of American operators, N0QJM, VE1AAO, VE9DH, W0OE, W0SD, W7XU and WV2B are planning a DXpedition to *St Paul Island (NA-094)* over the period of the 29th of June until the 8th of July. There will be two fully manned stations (with a possibility of a third to handle peak periods on HF), one station will operate exclusively on 6 metres (transmit only on 50157kHz listening up) and the second (and possible third station) on HF. No operation on 80 or 160 metres is planned due to the poor characteristics

of these bands in this region at this time of the year. The planned frequencies for the operation are; SSB, 14195 (alt 14145), 18145, 21295, 24945, 28495 kHz, CW, 7005, 10105, 14020, 18100, 21020, 24900, 28020 kHz and RTTY, 7080, 10115, 14080, 18080, 21080, 24908, 28080 kHz. [TNX W0SD and 425 DX News] QSL via W7XU.

HK0, COLOMBIA. A German group of operators, DH7WW, DK8YY, DL2AKT, DL2OAP, DL3ALI, DL4ALI, DL4JS, DL4YY, DL7ZZ, DL8AKI will be joining HC2DX on a trip to *San Andres Island*

(NA-033). The activity will take place over the period of the 16th until the 29th of July. They have requested the call HK0ZZ and are also planning on participating in the IOTA contest. Operation will take place on all bands from 160 - 6 metres (with an emphasis on the lower bands), modes will be SSB, CW, PSK and satellite. QSL route is via the bureau or direct to Ulrich Moeckel DH7WW, Muldenstrasse 1, 08304 Schoenheide, Germany. Logs for the operation will be available at <http://www.ve9dx.com> [TNX DL7ZZ and 425 DX News]

Round up

V7, MARSHALL ISLANDS. Jim Todd, KC7OKZ/V73KZ and his XYL Carol, KC7TSX/V73SX have been on *Majuro Island (OC-029)* in the Marshall Islands since the 28th of January. Apparently they are frequent visitors to various DX nets, e.g. the ANZA Net on 21.205 MHz at 0450 UTC, the Southern Cross Net on 14.226.5 at 1100 UTC and the Bill Bennett Family Net on 14.245 MHz at 1400 UTC. Rumour has it that they are close to receiving permission to operate from the 'forbidden islands' of Taongi and Ujelang. IOTA chasers will be aware that both of these islands are keenly sought after. The pair are planning to leave Majuro for Taongi sometime in late

July. Keep an ear out and give them a call if they come up on air from either of these locations. [TNX G3ZAY and 425 DX News]

ON, BELGIUM. Belgian amateurs have been granted permission, from the 8th of May until the 11th of July, to substitute OR for the normal ON prefix, while those Belgian amateurs who speak Dutch will be allowed to use the OS prefix. As far as I can make out, the special prefixes are to be used in contests only. The occasion is to celebrate the 700th anniversary of the Battle of the Golden Spurs. [TNX ON4CAS and 425 DX News]

DU, PHILLIPINES. Robin, DU9RG has

informed the various DX newsheets that all Philippine amateurs have been granted permission to use the prefix 4D70 (clubs can use DZ70) until the end of the year. The prefixes are to celebrate the 70th anniversary of the Philippine Amateur Radio Association, PARA. [TNX DU9RG and OPDX]

9U, BURUNDI. Gus, SM5DIC/9U5D wants us to know that his good friend and colleague, UN Chief Communication Coordinator, Christian Alemanni in Bujumbura, Burundi, is now a licenced amateur radio operator. His newly issued callsign is 9U5A. The ARCT bureau successfully processed his application and issued him with a full

(legal) licence. He will be forwarding on a copy, along with relevant documents, to the ARRL DXCC office to be confirmed for future claims. Gus says that Christian has had very little operating experience on HF, and none in pile ups, and asks that people 'go easy on him' until he gains some confidence through experience. Previously he has only had a French limited class license and operated only on VHF repeaters at home. Christian, 9U5A will be engaging a fellow French ham as his QSL manager. [TNX SM5DIC/9U5D and OPDX]

ANTARCTIC ACTIVITY. Chris Post, N3SIG says that he is currently back in the United States but that he will be returning to *Ross Island (AN-011)* on the 15th of August. He plans to be active on HF shortly after his return. He also mentions that he managed to get approval for his Antarctic New Zealand license to be renewed and will be operating with the special ZL5CP callsign again, however, he will also be using KC4/N3SIG from the American McMurdo Base Station. Chris's QSL

Manager will be AI3D for both callsigns. [TNX N3SIG and OPDX]

Steve, 7J1AIL (aka K7USJ) is a correspondent for the Associated Press, AP, and has been working in Japan for many years. Like a good reporter he has been keeping his nose to the ground and heard that Kenwood is restructuring and that its President is about to resign. Kenwood admitted that it will shed 2700 jobs (this is 30% of its workforce) and will drastically reduce home audio and visual operations as part of the restructuring plan. Kenwood has not indicated whether this will impact on their amateur radio equipment division. [TNX 7J1AIL and The Daily DX]

Hans, L40370, has been listening around on the bands recently and has

come up with a list of nice callsigns and my thanks go out to him for sending me a copy.

Band	Call	Mode	UTC
40	3D2UM	CW	1340
40	K1B	CW	
30	5X1GS	CW	2000
20	4J6ZZ	CW	2210
20	3V8BB	SSB	0440
20	PJ4M	SSB	2115
20	8P4A	SSB	2145
15	3G1K (CE)	CW	2210
15	E21EIC (HS)	CW	0430
15	ZX3S (PY)	CW	2140
15	9M6/JA1WPX	CW	
15	6W3/UA3VCS	CW	
15	XV9DT	CW	

ar

Sources

Thanks to the following people and organisations for the information contained in DX notes this month. L40370, K8AQM, PA3ERA, JH1EFP, W5BOS, NG3K, YA/G0TQJ, Z35M, 9A6AA, ON4BAM, HA8KW, VE9GLF, WF1N, N7UO, W0SD, DL7ZZ, G3ZAY, ON4CAS, DU9RG, SM5DIC/9U5D, N3SIG, 7J1AIL, OPDX, Islands On The Web, La Gazette du DX, 425 DX News, The Daily DX and the RSGB.

Club News

Southern Radio Group

While not an official radio club, a group of radio amateurs who live on the near South coast of SA, around Victor Harbour (where many people chose to retire) have a luncheon meeting every three months. XYLs and YLs are invited as are friends from the City. On a Sunday in May 20 people enjoyed a good meal together on a lovely sunny day.

The number attending this function varies but the good fellowship doesn't. Thanks for inviting us.

Contact Christine Taylor VK5CTY geencee@picknowl.com.au

Wagga Amateur Radio Club inc - VK2WG

PO Box 294, Wagga Wagga NSW 2650
Clubrooms - Small St Wagga Wagga
For Meeting information contact John Eyles VK2YW 02 69265471 AH IRLP Node - 626 Sunday Net - 7.165 MHz - 12 noon EST Members get together most Saturday mornings at Clubrooms - all welcome.

Adelaide Hills Amateur Radio Society

Last Month Graham VK5ZLZ took the floor at the AHARS meeting and kept everyone interested as he showed how computer power supplies can become the basis of linear amplifiers for your rig.

He had many examples to hand around and most people went away with new ideas and, perhaps an ambition to "have a go", which after all is the aim of such a demonstration.

As usual there were over 50 members present and much good fellowship was enjoyed by all.

If you are going to be in Adelaide on the third Thursday of a month give Geoff VK5TY or Alby VK5TAW a ring or a call on 147.000MHz for details of where and when the next meeting of AHARS will be. You will be made welcome.

For All Your Requirements

AUTHORISED DEALER
ICOM

KENWOOD

AMATEUR COMMERCIAL

Tower
Communications

14 Mary Street
Hazelmere

Western Australia 6055
Telephone: (08) 9274 1118
Facsimile: (08) 9250 3734

E-mail: tower@con.net.au

www: <http://www.tower.visionimage.com.au>

Spotlight on SWLing

Robin Laird Harwood VK7RH

Hamstrung, but strung up nevertheless

Here in this retirement village, I am hamstrung at not being able to string up an outside antenna yet and am still relying on the 21 feet of wire on my curtain rail. Nevertheless I am hearing some interesting signals.

The BBC signal on 9410 kHz has been very reliable over our winter months and comes in from 0200 till past 0600. 12095 kHz does not seem to be as good as in previous years. It has been a year since London discontinued broadcasting via shortwave to Australasia.

You may have come across the Overcomer Ministry programs from many American sites such as WWCR or via the Juelich site in Germany. It is the vehicle for "Brother Stair", a fire and brimstone preacher in South Carolina. He apparently had a small community in Walterboro and hired airtime over many domestic American stations as well as over shortwave stations such as WWCR and WBCQ. He was one of many who predicted date for the end of the World and claimed that it was the prayers of the faithful that prevented it from happening and not a miscalculation on his part.

All apparently was not well within this community as several disaffected individuals also started broadcasting serious allegations over the same shortwave station. Stair ignored these and they eventually came to the attention of District Attorney and after investigations the DA arrested Stair on several sexual charges, later upgraded to rape allegations and Stair is currently in custody awaiting trial. The Stair programs ceased abruptly over several shortwave and domestic outlets although WWCR continued to air previously recorded programming. Stair apparently had a dedicated transmitter exclusively for his programming. There are no indications on when the trial will be held and the judge has refused bail citing the seriousness of the charges.

Australia's Time and Frequency Standard station, VNG, based at the Llandino site of Air Services Australia, ceased operation on June 30th. Funding was withdrawn. The signal on 8638 kHz has been non-operational for six months. It is not clear what will happen now that

VNG has ceased.

Another change that also happened on June 30th is that the weather FAX transmissions via the Belconnen (ACT) and Darwin (NT) Defence Department facilities ceased. These have now commenced from a private operator on contract. These now emanate from Charleville in QLD and Wiluna in WA. Wiluna operates on the former Darwin frequencies of 10550, 13550 and 18060 whilst Charleville operates on the former Belconnen channels of 2628, 5100, 11030 and 13920. The same operator is now also responsible for the broadcast of voice weather bulletins formerly handled by Telstra via the HF coast stations in Perth, Sydney and Melbourne now replaced by Charleville and Wiluna.

Tibet in English

Monitors within Europe have reported that English programs are being heard over shortwave from Lhasa. The frequencies are 6130 and 9490 at around 1630 to 1700. These are being relayed from the local FM station for international tourists within Tibet and aired Monday to Saturday.

The current situation within Afghanistan is still one of continuing turmoil. Although the Al Qaeda and Taliban are well and truly on the run, the domestic political scene is still very fluid. There is continuing intrigue between the various political factions over the spoils of power. Some provincial administrations are allying themselves with nearby countries such as Iran, the CIS or Pakistan and minimising contact with the government in Kabul.

In an effort to counteract this, Radio Afghanistan recently started to broadcast again via shortwave from senders in Norway and the United Arab Emirates. The US and the European Union have assisted materially to re-establish the print and electronic media. Because

there has been a difficulty in communicating to the whole of Afghanistan, programming from Kabul is uplinked to senders in both Norway and the UAE and is being currently heard as follows:

18940 from 1400 to 1700 (Kvitsoy)

15240 from 0200 to 0359 (UAE).

Please note that the latter frequency also has Radio Australia from Shepparton co-channel in English. Also note that this station has nothing to do with the Clandestines on 8700 (Information R) and 15480 (Voice of Afghanistan) which are still being observed in Europe.

Acknowledgments to Glenn Hauser and also the swprograms list on the Internet for background to this month's column. If you have any news or comments, email me at vk7rh@wia.org.au. 73 de VK7RH

PLAN AHEAD

ALARAMEET

**October 5 & 6, 2002,
Murray Bridge, South
Australia**



**In Tune with
Amateur Radio**

Contest Calendar July – September, 2002

July 1	RAC Canada Day Contest	(CW/SSB)	
July 6/7	Internet 6m Contest	(CW/SSB)	
July 13	Jack Files Contest	(All)	(Jun 02)
July 13/14	IARU HF World Championship	(CW/SSB)	
July 20	Pacific 160 Metres Contest	(CW/SSB)	(Jun 02)
July 27/28	Russian RTTY WW Contest	(RTTY)	
July 27/28	IOTA Contest	(CW/SSB)	
July 27	Waitakere Sprint	(SSB)	
Aug 3	Waitakere Sprint	(CW)	
Aug 3	European HF Championship	(CW/SSB)	
Aug 4	YO DX Contest	(CW/SSB)	
Aug 10/11	Worked All Europe DX Contest	(CW)	
Aug 17	SARTG WW RTTY Contest	(RTTY)	
Aug 17/18	Keymen's Club of Japan Contest	(CW)	
Aug 17/18	SEANET Contest	(All)	(Jul 02)
Aug 17/18	Remembrance Day Contest	(CW/SSB)	(Jun 02)
Aug 24/25	SCC RTTY Championship	(RTTY)	
Aug 24/25	TOEC WW GRID Contest		
Aug 24/25	ALARA Contest	(CW/SSB)	(Jun 02)
Sep 7	Digital Modes Contest	(PSK31 etc)	(Jul 02)
Sep 7/8	All Asian DX Contest	(SSB)	
Sep 14/15	Worked All Europe DX Contest	(SSB)	
Sep 21/22	Scandinavian Activity Contest	(CW)	
Sep 28/29	Scandinavian Activity Contest	(SSB)	
Sep 28/29	CQ/RJ WW RTTY Contest	(RTTY)	
Sep 28/29	Anatolian DX Contest	(SSB)	

Greetings to all readers,

Quite a lot of information this month, so please read carefully.

I draw your attention to a new VK contest concentrating on newer digital modes. Details are below and for this we are indebted to the CW Operators' QRP Club based in Adelaide. Please take note and get yourself a program for PSK31 and see if we can make this an interesting inaugural event.

A reminder of the RD and ALARA Contests, both in August, as well as the Seanet Contest being hosted in Australia this year. These need your support – as well as the DX contests, of course!

73 and good contesting, Ian Godsil VK3VP

Results VHF Summer Field Day 2002

from John Martin VK3KWA, Contest Manager

The Summer Field Day is becoming steadily more popular, especially the 6 hour section. The 24 hour single operator section is losing support, although there seems to be agreement that it should not be abolished. Many entrants have commented that 24 hours is too long, but 6 hours is too short.

Two alternatives have been suggested - 8 hours and 12 hours, and I am inclined to prefer 12 hours. An 8 hour stretch isn't much longer than 6 hours, and for most people it would still mean staying overnight, so we might as well make it 12 hours. To make it more flexible, the 12 hours could be in one continuous block or in two six-hour periods. That would allow anyone to do a full Saturday, or they could start late or finish early on the Saturday and make up the other 6 hours on the Sunday.

There is also some support for a 6 hour multi-operator section. I will have to think about this because it would mean that there would be five sections in the contest rather than the existing four.

The other issue is the grid-hopping bonus. It can give a major advantage but could discourage some entrants who don't wish to pull up sticks and keep moving to get a good score. I think the bonus is a good idea but it may need to be reduced a little.

There were also a couple of other suggestions about the 6 metre scoring - some say it is too low, and others would rather see it dropped to zero. There was also a suggestion that there should be a CW section. I think I will pass on this

one because it would mean yet another section, and in any case CW provides its own rewards by allowing extra contacts that can't be made with other modes.

If you have comments on any of these ideas, please write or email to jmartin@xcel.net.au.

Turning now to the logs, much of the score checking was done by Mark VK3TLW - thanks Mark. Some logs needed to be re-scored or didn't provide all of the necessary information - for example addresses or postcodes, or the full names of all of the operators. But the main problem is the grid square points. Remember that you can claim ten

points for each square you activate, plus ten for each square you work on each band. But each square you work can only be counted once, no matter how many squares you have worked it from.

The scoring system is rather complex, so to make it easier I have prepared a pro-forma scoring table. A copy has been mailed to all entrants, and it will also be posted on the WIA Federal web site.

Finally, the results. The overall winner this year is Barry VK3BJM. First place in Section B goes to Peter VK3KAI. In the multi-operator section, the GARC has done it yet again, and the top home station was Charlie VK3FMD. Congratulations to all.

Summer Field Day 2002: Results

Call/Name	Locator(s)	6 m	2 m	70 cm	23 cm	12 cm	9 cm	3 cm	TTL
Section A: Single Operator, 24 Hours									
VK3BJM, B. Miller	QF13	67	807	715	640	-	-	-	2229
VK3AEF, J. Bywaters	QF03	33	483	655	368	-	-	-	1599
VK5KBJ, B. Bates	PF95	39	570	435	-	-	-	-	1044
VK5AR, A. Raftery	PF92, PF93	21	426	570	-	-	-	-	1017
Section B: Single Operator, 6 Hours									
VK3KAI, P. Freeman	QF21, 22, 31, 32	21	237	385	432	320	320	430	1887
VK5MX, M. Millar	PF85, 86, 95, 96	97	333	555	792	-	-	-	1777
VK5UE, C. Low	PF85, 86, 95, 96	95	336	550	784	-	-	-	1765
VK3AXH, I. McDonald	QF12	408	625	384	-	-	-	-	1417
VK3YE, P. Parker	QF22	48	384	560	-	-	-	-	992
VK3UPS, C. Sturgeon	QF22	49	378	565	-	-	-	-	992
VK3HZ, D. Smith	QF22	-	345	430	-	-	-	-	775
VK5AIM, S. Mahony	PF95	25	126	200	192	-	-	-	543
VK4QE, D. Friend	QG53	-	96	160	168	-	-	-	424
VK4LP, J. Lemura	QG62	-	123	195	-	-	-	-	318
VK4EV, R. Everingham	QG62	-	102	195	-	-	-	-	297
VK2EI, N. Sandford	QF68	-	243	-	-	-	-	-	243

Section C: Multi Operator, 24 Hours

VK3ATL, GARC (1)	QF21	91	888	985	1040	-	-	210	3214
VK3BEZ, EZRC (2)	QF31	33	267	395	424	370	350	470	2309
VK3EK, EGARC (3)	QF32	46	471	565	520	210	-	-	1812
VK5OQ, (4)	PF95	28	123	190	240	-	-	-	581

Section D: Home Station, 24 Hours

VK3FMD, C. Kahwagi	QF22	75	618	845	944	210	210	-	2902
VK3BDL, M. Goode	QF22	84	639	840	736	-	-	-	2299
VK3AUI, G. Sones	QF22	67	306	460	392	-	-	-	1225
VK5GN, M. Luther	PF95	35	150	180	-	-	-	-	365
VK3VP, I. Godsil	QF21	35	120	-	-	-	-	-	155
VK3TRD, D. Rolfe	Check log								

- (1) Geelong Amateur Radio Club: C. Gnaccarini VK3BRZ, D. Learmonth VK3XLD, C. Leone VK3BCL, K. Jewell VK3AKK.
- (2) Eastern Zone Radio Club: R. Edgar VK3WRE, B. Young VK3BBB, G. Francis VK3HV, K. Brown VK3DMW.
- (3) East Gippsland Amateur Radio Club: I. Foster VK3ST, P. Maskrey VK3HBR, D. Pendergast VK3DMP, M. Stanford VK3VLR, R. Ashlin VK3EK
- (4) K. Gooley VK5OQ, J. Sayers VK5JQ, K. Thole VK5HKT.

Results Ross Hull VHF+ Contest 2001 - 2002

from John Martin VK3KWA, Contest Manager

Activity in the 2001- 2002 contest was lower than usual, mainly due to very poor propagation. Some regular entrants were absent this time, but there were also some new entrants and others who sent in logs for the first time in some years.

In both the seven day and two day sections, the first two places go to VK4. Congratulations to Glenn VK4TZL for

winning the contest for the second time. Tony VK4CH came second, but turned the tables on Glenn by coming first in the two day section.

It was interesting to see two entrants - Wally VK6KZ and Peter VK3KAI - operating on a total of seven different bands. Even more interesting is the fact that Wally pipped all of the eastern state entries to get the top score on 23 cm.

Also of interest was the log from Alain FK8CA, who gained top score on 6 metres in the two day section.

Thanks to all who sent in logs, and thanks also to Mark VK3TLW for his assistance in checking the logs. I hope next year will see a break in the drought of propagation and a much higher level of activity.

Ross Hull Contest 2001 - 2002: Results

Call/Name	6 m	2 m	70 cm	23 cm	12 cm	9 cm	6 cm	3 cm	TTL
Section A: Best 7 Days									
VK4TZL, G. McNeil	413	741	300	32	10	-	-	-	1496
VK4CH, A. McRae	483	380	270	24	-	-	-	-	1157
VK3AXH, I. McDonald	18	354	370	80	-	-	-	-	822
VK6KZ, W. Howse	42	153	100	136	70	-	30	80	611
VK2TG, R. Demkiw	69	294	75	-	-	-	-	-	438
VK2EI, N. Sandford	-	405	-	-	-	-	-	-	405
VK3KAI, P. Freeman	1	69	55	24	30	10	-	40	229
VK3AUI, G. Sones	20	57	80	56	-	-	-	-	213
VK6ADI, B. Burns	113	12	-	-	-	-	-	-	125
VK4KZR, R. Preston	-	87	-	16	-	-	-	10	113
VK3HV, G. Francis	46	21	-	-	-	-	-	-	67
VK3VP, I. Godsil	10	12	-	-	-	-	-	-	22

Call/Name	6 m	2 m	70 cm	23 cm	12 cm	9 cm	6 cm	3 cm	TTL
Section B: Best 2 Days									
VK4CH, A. McRae	334	161	95	16	-	-	-	-	606
VK4TZL, G. McNeil	162	315	100	16	10	-	-	-	603
VK3AEF, J. Bywaters	11	228	255	80	-	-	-	-	564
VK3AXH, I. McDonald	3	168	250	80	-	-	-	-	501
FK8CA, A. Gouillard	450	-	-	-	-	-	-	-	450
VK3KAI, P. Freeman	1	54	55	24	30	10	-	40	214
VK3AUI, G. Sones	20	57	80	56	-	-	-	-	213
VK6KZ, W. Howse	17	60	35	40	20	-	20	20	212
VK2EI, N. Sandford	-	198	-	-	-	-	-	-	198
VK2TG, R. Demkiw	45	75	20	-	-	-	-	-	140
VK4KZR, R. Preston	-	18	-	16	-	-	-	-	10 44

Ross Hull Contest: List Of Winners, 1950 - 2002

1950 - 1951	VK5QR	R. Galle	1968 - 1969	VK5ZKR	C. M. Hutchesson	1985 - 1986	VK3ZBJ	G. L. C. Jenkins
1951 - 1952	VK5BC	H. Lloyd	1969 - 1970	VK3ZER	R. W. Wilkinson	1986 - 1987	VK3ZBJ	G. L. C. Jenkins
1952 - 1953	VK4KK	A. K. Bradford	1970 - 1971	VK4ZFB	E. F. Blanch	1987 - 1988	VK5NC	T. D. Niven
1953 - 1954	VK6BO	R. J. Everingham	1971 - 1972	VK5SU	J. W. K. Adams	1988 - 1989	VK5NC	T. D. Niven
1954 - 1955	VK4NG	R. Greenwood	1972 - 1973	VK5SU	J. W. K. Adams	1989 - 1990	VK3XRS	R. K. W. Steedman
1955 - 1956	VK3GM	G. McCullough	1973 - 1974	VK5SU	J. W. K. Adams	1990 - 1991	VK3XRS	R. K. W. Steedman
1956 - 1957	VK3ALZ	I. F. Berwick	1974 - 1975	VK5SU	J. W. K. Adams	1991 - 1992	VK3XRS	R. K. W. Steedman
1957 - 1958	VK3ALZ	I. F. Berwick	1975 - 1976	VK5SU	J. W. K. Adams	1992 - 1993	VK3XRS	R. K. W. Steedman
1958 - 1959	VK3ALZ	I. F. Berwick	1976 - 1977	VK4DO	H. L. Hobler	1993 - 1994	VK3XRS	R. K. W. Steedman
1959 - 1960	VK4ZAX	D. R. Horgan	1977 - 1978	VK3OT	S. R. Gregory	1994 - 1995	VK3XRS	R. K. W. Steedman
1960 - 1961	VK3ARZ	W. Roper	1978 - 1979	VK4DO	H. L. Hobler	1995 - 1996	VK2FZ/4	A. Pollock
1961 - 1962	VK5ZDR	M. J. McMahon	1979 - 1980	VK3ATN	T. R. Naughton	1996 - 1997	VK2FZ/4	A. Pollock
1962 - 1963	VK4ZAX	D. R. Horgan	1980 - 1981	VK6KZ	W. J. Howse	1997 - 1998	VK2FZ/4	A. Pollock
1963 - 1964	VK5ZDR	M. J. McMahon	1981 - 1982	VK6KZ	W. J. Howse	1998 - 1999	VK3XPD	A. P. Devlin
1964 - 1965	VK3ZER	R. W. Wilkinson	1982 - 1983	VK6KZ	W. J. Howse	1999 - 2000	VK3EK	R. G. Ashlin
1965 - 1966	VK3ZDM	J. R. Beames	1983 - 1984	VK6KZ	W. J. Howse	2000 - 2001	VK4TZL	G. R. McNeil
1966 - 1967	VK5HP	J. H. Lehmann	1984 - 1985	VK3ZBJ	G. L. C. Jenkins	2001 - 2002	VK4TZL	G. R. McNeil
1967 - 1968	VK3ZER	R. W. Wilkinson						

Rules SEANET Contest 2002

from Ben Koh VK6XC, SEANET Secretary

17/18 August, 2002

1200UTC Sat - 1200UTC Sunday

The organisers of the SEANET Convention 2002 invite all radio amateurs world-wide to participate in the SEANET 2002 Contest. This contest is associated with the 30th Annual SEANET Convention in Perth, Western Australia to be held 1st - 3rd November 2002, in the spirit of amateur radio world-wide friendship. The format of the contest will remain the same as last year, in accordance with the wishes of the contestants. The contest will therefore be a single 24 hour contest incorporating CW, Voice and digital modes.

Purpose of contest:

To promote two-way amateur radio communication within the SEANET Region and between the SEANET region and the rest of the world using various modes.

Contest times & dates:

Start 1200 GMT Saturday 17th August,

Finish 1200 GMT Sunday 18th August (24 hours)

Bands/frequencies:

160, 80, 40, 20, 15, and 10 metres (No WARC) Frequencies should be used as appropriate to the mode and station licence.

Modes:

CW; SSB/FM; Digital (RTTY, AMTOR, PACTOR I/II, CLOVER, PSK31 etc.)

Classifications:

SEANET stations -

- Single-band - Single operator - mixed mode
- Multi-band - Single operator - mixed mode
- Multi-band - Multi operator - mixed mode
- Single-band - Single operator - single mode (i.e. CW, Voice or Digital)
- Multi-band - Single operator - single mode
- WORLD-WIDE Stations (outside SEANET Region) -
- Single-band - Single operator - mixed mode
- Multi-band - Single operator - mixed mode
- Multi-band - Multi operator - mixed mode
- Single-band - Single operator - single mode (i.e. CW, Voice or Digital)
- Multi-band - Single operator - single mode

Power Input: As stipulated in the regulations governing the licence of the operator.

Exchange: RS(T) report plus serial numbers starting with 001 and increased by one for each successive contact.

Scoring Rules: SEANET stations may contact World-Wide and SEANET stations, AND stations within own country. World-Wide stations may ONLY contact SEANET stations. For the purpose of the contest "SEANET" stations are defined as those operating from the following ITU zones -

- 41 - 4S7,8Q7,A5,AP,S2,VQ9,VU,VU(Laccadive)
- 42 - 9N,B/BY
- 43 - B/BY
- 44 - BV,B/BY,HL,P5,VR2,XX9
- 45 - JA,JD1(Ogasawara)
- 49 - 3W,E2,HS,XU,XV,XW,XY,XZ,VU(Andaman),
- 50 - 1S,9M0(Spratly),DU
- 51 - H4,P29,YB
- 54 - 9M2,9M6,9M8,9V1,V8,VK9C,VK9X,YB,4W
- 55 - VK,VK9W
- 56 - 3D2,FK,VK9M,YJ
- 58 - VK
- 59 - VK
- 60 - VK0(Macquarie Is) VK0M, VKOL, VK9N, ZL, ZL7, ZL8, ZL9
- 64 - T8, KC6, KH0, KH2,
- 65 - C2, KH9, T2, T30, T33, V6, V7
- 90 - JD1 (Minami Torishima)

The DXCC Entity list for multiplier scoring purposes is:
1S/9M0(Spratly), 3D2, 3W/XV, 4S7, 8Q7, 9M2, 9M6/9M8, 9N, 9V1, A5, AP, B/BY, BV, C2, DU/DT/4F, FK, H4, HL, HS/E2, JA, JD1(Minami Torishima), JD1, KC6, KH0, KH2, KH9, P5, P29, S2, T2, T30, T33, T8, V6, V7, V8, VK, VK0L, VK0M, VK9C, VK9M, VK9N, VK9W, VK9X, VQ9, VR2, VU, VU(Andaman), VU(Laccadive), VU, XU, XW, XX, XY/XZ, YB/YC, YJ, ZL, ZL7, ZL8, ZL9

Scoring:

Contacts between WORLD-WIDE and SEANET Stations = 10 points.

Contacts between SEANET stations in DIFFERENT SEANET countries/entities = 10 points.

Contacts between SEANET stations in the SAME country/entity = 5 points.

Each DXCC Country/Entity worked counts as a multiplier, but only counts once regardless of band or mode. A multiplier can be claimed for working your own country, but QSO points cannot be claimed except for contacts between stations within a SEANET country/entity.

Note: for mixed-mode entries QSO points can be claimed with the same station on each of the three modes, and for multi-band entries QSO points can be claimed for QSOs with the same station on different bands. Note that only one contact per mode is allowed on each band with the same station. E.g. A "Voice" mode contact can only be made once per band with the same station. SSB or FM can be used for the contact, but points cannot be claimed for an SSB and an FM contact with the same station.

Similarly on digital, any digital mode can be used to make a digital mode contact with the same station, but points cannot be claimed for more than one digital mode with the same station.

Scores should be calculated as follows:

For single-band entries: Multiply total QSO points x total multipliers. E.g. 10 QSOs x 10 points = 100 QSO points x 2 mults = 200 points.

For multi-band entries: Add QSO points for all bands then add the unique multipliers. Multiply total QSO points by total multipliers.

(Multipliers count like the WPX Contest, i.e. once only, not once per band, and not once per mode.)

Restrictions:

Contacts on cross modes or cross bands will not count. Operators are not allowed to transmit two or more signals at the same time on the same band. Entries which contain errors or unmarked duplicates are liable to a reduction of points. Any entrant who uses methods contrary to the spirit of the contest may be subject to disqualification. The decision of the SEANET contest organisers shall be final. All stations may use Internet or Packet Cluster "Spotting". Multi-band, multi-operator stations must not use more than one transmitter/transceiver at the same time for contacts, except that a second receiver/transceiver may be used for "spotting" only. The "spotting" station must not transmit or make any kind of contact.

Logs and summary sheets:

All entries should be in the form of written or computerised logs and summary sheets showing claimed scores band by band, plus the total score claimed must be signed by the person responsible for the entry. Details required are operator's name and address; date; time UTC; band; mode; exchange; claimed score and multipliers (listed); signature of operator. Entries made on computer diskettes or by email should use ASCII(text) format.

Send entries by email to: Ray Gerrard HS0/G3NOM g3nom@rast.or.th

Logs may be sent by mail to: SEANET Contest 2002, Ray Gerrard, PO Box 69, Bangkok Airport Post Office 10112, Thailand.

Entries should be received not later than 30th September 2002.

Results will be announced at the SEANET 2002 Convention at The Acacia Hotel in Perth, Australia, on 2nd November 2002, and will be published on the SEANET 2002 Web Site: <http://www.qsl.net/seanet2002>

If you require a result slip, please enclose three IRCs together with your entry. The winners of each category will be awarded a trophy, and runners up a certificate.

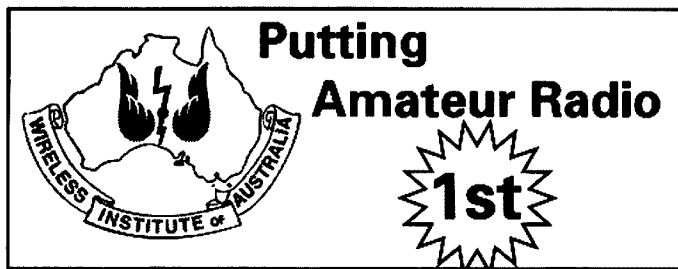

Ham Shack Computers

Alan Gibbs, VK6PG
223 Crimea Street, Noranda WA 6062
Email: vk6pg@tpg.com.au

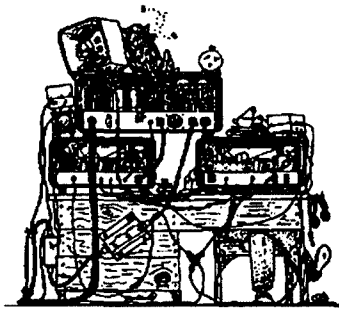

Part 16 – Hard Drive **CRASH!**

Any computer user might experience a Hard Drive Crash. Whether the computer is new or an Old Faithful, the day might come when suddenly the screen goes blank or the computer will not boot (start up). What do you do next?

The important thing is not to wait until you experience a hard drive crash by planning and implementing a data backup process. This entails collecting a few items of software on 1.44-MB floppy disks just in case the inevitable happens. The cost is a few cents but well worth the small effort needed to boot-up your computer and diagnose the problem. For readers with a limited knowledge about computers, there are two choices:

1. Get someone to fix the problem which is going to cost big money, or ...
2. Do the job yourself! For assertive readers, option 2 is by far the best because you will learn more about your computer, and have preserved "The Ham Spirit" - the very essence of Amateur Radio.

Hard Drive Basics

These days, computers are almost fully electronic except for fans, mechanical input and output data devices like floppy drives, Zip drives and of course the internal hard drive itself. If a floppy disk fails, then simply insert another disk and try again - easy. However, the internal hard drive stores the operating system and all the data files as well. If the hard drive fails - you have lost everything!

Hard drives contain several rotating discs on a single motor driven shaft. The disks are double sided and electro-chemically coated with a magnetic substrate. Near each disk surface, a magnetic head skims over the surface enabling data to be read and written to the disk. Drives can have say 15 heads each connected to moving arms allowing radial movement just like the pick-up arm on a Hi-Fi turntable except in

miniature. Hard drives are manufactured in a near vacuum, dust free environment and are high precision devices where calibration measurements are measured in microns. Data is divided between each disk surface in HEADS, CYLINDERS, SECTORS and CLUSTERS, and the CAPACITY that determines the total data storage that the drive can accept. For example, your existing 4-GB drive might have 8944CY, 15HDS, 63SECT and 8,452,080CHS. It's easy to identify once the gobbledegook jargon is understood.

Hard drives sometimes fail because of random power failures, power surges, switching off the computer without exiting software properly, mechanical knocks, the heads have touched the disk surface causing scratches, air has permeated the drive case and contaminated the disk surfaces, and lastly because the drive was installed incorrectly. The drive should sit flat to the horizontal - NEVER mounted on its side, which causes mechanical stress due to the influence of gravitational forces. If your drive is mounted properly, you are gentle with your computer, and regularly run diagnostic procedures - then there is not much that can be done to prevent hard drive failure. It just "happens" as the saying goes!

Data Backup

Wise readers backup important data and configuration files. This column has stressed the importance of doing this many times. If some readers choose to ignore this well founded advice then they will be in for a nasty surprise if, and when, their hard drive ever fails.

"It won't happen to me" they chant - Oh yes it can!

Collecting Tools & Data

1. Create an "Emergency Boot Disk" to a new 1.44-MB floppy disk from your Windows 95/98/2000/NT/ME/XP operating system. Move the disk protect switch to safe mode. Make sure that FDISK and FORMAT are included in the collection of boot files.
2. Backup all your data files to floppies, or removable Zip disks. Make a copy of the BIOS settings

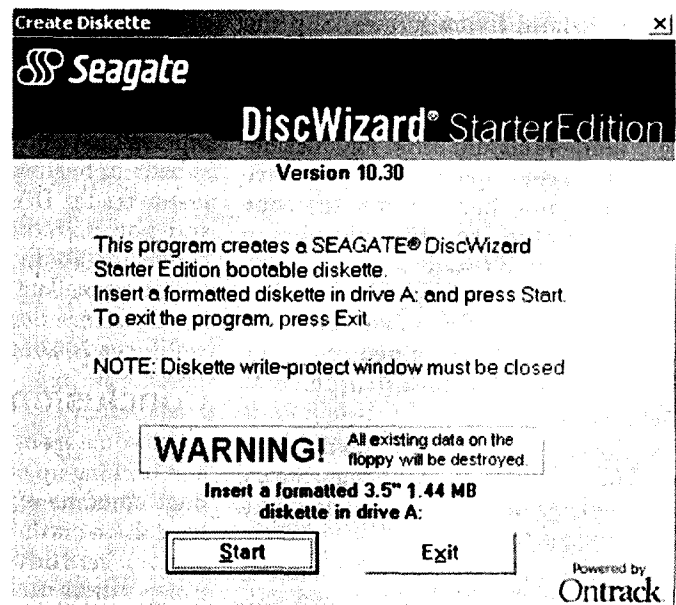

and add to your documentation for future reference

3. Download a copy of your hard drive manufacturer's installation program. Using Seagate as an example, download their Disk Wizard Software (2) (see the image on previous page) to a temporary folder and execute the file to compile the boot and wizard program onto another new floppy disk in the A:\ drive.
4. Gather up ALL your operating system CD-ROMs, emergency, disk wizard floppies together with documentation and place them in a suitable box just in case you are in trouble later on.

New Hard Drives

In today's world 40GB is about the smallest drive that can easily be bought over the counter. If your computer is really old (about three years!). The old drive might be a 2GB or 4GB, which were common around 1997/8. These days hard drive capacity has increased 10 fold, so the replacement will offer some advantages in the long term. A good choice might be a new 40GB Seagate Barracuda at well below the \$200 mark over the counter. These new drives are silent in operation.

Installation

1. Once the old hard drive has failed, remove the case screws and locate the dud drive.
2. Remove the power and multi-pin connectors, and remove the four crosshead fixing screws. Slip the drive out from the back or front of the drive housing.
3. On the back edge of the new drive, jumpers should be set for "master" or "slave" operation. If you have just one hard drive in your computer, set the jumper to "master". If two drives are used on the same cable, and the new drive is ADDED to the ribbon cable, use the secondary connector on the harness and set the drive jumper to "slave".
4. Install the new drive into the same bay, secure each of the four screws, and reconnect the power and multi-pin connector.

Booting First Time

Insert the "wizard" floppy into drive A:\ and switch on. The computer will boot (start up) and the program will identify and install your new drive within seconds. Other features include updating the BIOS to flash ROM, diagnosing your hard drive(s), running a partitioning wizard and much more. The Seagate wizard also handles FAT16 FAT32 and NTFS (see last month's column) and will soft format your new hard drive.

Installing your software

This is a real grind and takes a very long time to rebuild the file structure of your new drive. Start by installing your operating system, then each application one by one and testing at each step until the computer is back to normal in your Ham Shack once again. Readers will bless the day when you backed up data and specialised important files. These include "My Favourites", email "Address Book" and Internet settings – AND of course - the MAIN STATION LOGBOOK and other information associated with your Ham Shack Computer activities.

Running a Mirror Drive

Many wise AR's use two hard drives either as a "master" plus a "slave" or the second drive connected to the secondary IDE connector on the motherboard. It means paying out for a second drive (D:\) the same size as the C:\ drive and using special software to copy the files from C:\ to the new drive D:\. The process is automated so every file from the working C:\ drive is synchronised with the D:\ drive. If the C:\ drive should fail, then the D:\ drive can replace the C:\ drive and the computer is back in business within 10 minutes! Just make the D:\ drive into a "master" and pop it into the C:\ drive ribbon connector. To do all this easily, Norton Ghost is excellent and can be purchased in a "package deal" along with Norton AntiVirus 2002 and Norton Firewall.

Conclusions

A little time spent collecting information and backing up essential files will save huge amounts of time in the event of a hard drive crash. In addition, if you are short on hard drive space, then installing a bigger drive can solve many problems.

The same procedure described herein can be used. There are many tales of woe circulating around the AR fraternity every day about "computer crashes". But if prepared, users can solve their own problems cheaply and effectively in just one afternoon in the shack. To those who think it's all too complicated, read this column again. Soldering irons are not required to work on computers these days unlike the modern station transceiver where the skills of a specialist micro-surgeon are required! Repairing a computer is simple compared to repairing modern transceivers – yet we each profess to understand transceivers! Ironic really when the requirements to gain an Amateur Radio Licence is considered in the same context! Computer prices have never been lower than they are today. Hence, computer components have become more versatile, more powerful, and much cheaper than AR electronic components. It is this productivity that has made computers so attractive to RA's worldwide.

Ham Tip 16: Replace missing or damaged screws from a computer screw kit – (DSE H1675)

Ham Shack Computers, No: 17 next month - "CQ Contest". Have you noticed pictures of contest stations with computers? Are you talking to a computer or the contest operator? For more, see you next month.

- (1) Ham Shack Computers Web Site:
www2.tpg.com.au/users/vk6pg
- (2) Seagate Corporation Web Site:
www.seagate.com
73s de Alan, VK6PG

ar

Silent Keys

The WIA regrets to announce the recent passing of:-

- B J (Barrie) Lakey VK3BL
- R M Churchward VK3VL
- G (George) Harmer VK4XW
- E J Harrison VK5AEH
- V V (Vic) Noble VK5AGX

Are new EMR regulations a threat?

Jim Linton's (VK3PC) article raises some interesting issues that all amateur radio operators need to become more aware of.

Not least of all is that the new regulations are a massive threat to our chosen activity. Recent years have seen a steady decrease in the number of active radio amateurs for various reasons already discussed by others through this media. I would like to alert readers to the fact that these new regulations pose an even bigger threat than anything we have experienced till now.

Readers need to realise that we are a minority group and as far as the general public (read local councils) are concerned we add absolutely no value to the community. In fact we are a definite nuisance with the burden of permits and complaining neighbours. Unless the Mayor is an AR enthusiast himself (herself) you can expect to find no sympathy. Local councils are increasingly becoming more restrictive in what is allowed within city confines - not less so. Be prepared to encounter

only hostility from the local enforcement (council) agents.

Keep in mind that the law makes no provision for common sense - rest assured when a complaint is being investigated, the letter of the law is what will count and if the regulations are going to be as stated in Jim's article, be prepared for a massive impact. By way of illustration, consider part a) of Compliance level 1 which states ".....and antennas much be out of reach." This provides a guaranteed opening for an inspector to condemn every single station currently in existence. Out of reach will require a means of preventing determined or accidental access by any person. Taking the electricity industry as an example, this probably means a physical barrier consisting of barbed wire at least 1 m wide around the base about 2 m above ground level to prevent anybody (drunk, mad or otherwise) from climbing up towards the antenna. And what about that portable that you have been happily lugging around? Better sell it quickly because there is simply no way

you can meet " must be out reach". If this sounds silly to you, please think again. Local councils do not care about amateur radio (or common sense) and they will use each and every opening within the regulations to shut you down as soon as there is a single complaint from somebody.

Part b) is another issue, lowest part of the antenna 10m above ground? My current vertical is not even that long! I suspect there are already councils that most likely will not allow you to erect anything this high off the ground to start off with. Be assured antennas will become an endangered species if this stipulation is allowed to stand. And without antennas, there is no AR.

We need to lobby for appropriate wording that is specific and narrow so that there can be no local interpretation by councils. We ignore this seemingly innocuous new regulation at our own peril.

Pieter J Kriel VK5AUA

Jim Linton VK3PC answers EMR critics

It is pleasing to see that our joint efforts resulted in the timely publishing in the June edition of AR magazine the article "Will your station meet EMR requirements?"

Comments I have received on it from club officials and WIA office-bearers are all in praise that this information presented in plain language is widely available.

The article was written drawing on the knowledge and experiences of the WIA team involved in the EMR issue with the ACA, Keith Malcolm VK1ZKM and Gilbert Hughes VK1GH, and also sourced directly to written material supplied to the WIA by the ACA.

It is disappointing that a few radio amateurs are actively promoting misinformation about the proposed EMR limits, either out of a simple misunderstanding or for other reasons.

A letter I received from Ian Godsil VK3VP is an example of the simple misunderstanding that is occurring. Ian now agrees after discussion with myself that he missed the key word "either"

which precedes Compliance Level 1 (a) and (b).

Another letter by Pieter J Kriel VK5AUA also demonstrates the same misunderstanding, unless of course his station is going to transmit in excess of 3200 watts EIRP.

I disagree with Pieter when he describes the proposed EMR limits as being a "massive threat" to amateur radio. While this may currently be the case in a number of European countries where local EMR limits are extremely rigid, the ACA has adopted an appropriate response to EMR.

An important thing to remember is that there is no change proposed to the current situation. It is already an implied condition of licence that an amateur installation complies with the exposure guidelines of the former Australian Standard (AS 2772.1).

What is being proposed in the new ACA EMR regime is the requirement by radio amateurs to be able to demonstrate compliance with EMR exposure limits.

Pieter also comments emotively on his

perception of local government's attitude to amateur radio and may be speaking from personal experience, I do not know. However, it is not local government's role to be involved in EMR compliance, and this is purely the jurisdiction of the ACA.

Should a neighbour complain to the local council about EMR, or interference, then the radio amateur would be wise if they cannot quickly resolve the matter, to refer it to the ACA for clarification or investigation.

I welcome further debate on EMR, which is a most important issue for the WIA and the amateur radio fraternity. Fortunately the six month delay in introducing the new rules gives us sufficient time to discuss and be informed about how radio amateurs can be "good EMR citizens".

Jim Linton VK3PC

Views expressed on this page are those of the authors and do not necessarily represent the policy of the WIA

HF Predictions

by Evan Jarman VK3ANI

34 Alandale Court Blackburn Vic 3130

These graphs show the predicted diurnal variation of key frequencies for the nominated circuits.

These frequencies as identified in the legend are:-

- Upper Decile (F-layer)
- F-layer Maximum Usable Frequency
- E-layer Maximum Usable Frequency
- Optimum Working Frequency (F-layer)
- Absorption Limiting Frequency (D region)

Shown hourly are the highest frequency amateur bands in ranges between these key frequencies, when usable. The path, propagation mode and Australian terminal bearing are also given for each circuit.

These predictions were made with the Ionospheric Prediction Service program: ASAPS Version 4

July 2002

T index: 100

Legend

UD
 F-MUF
 F-MUF
 OMF
 ALF
 >10%
 >50%
 >90%
 Time scale

Adelaide-London 132

First F 0-5 Long 23755 km

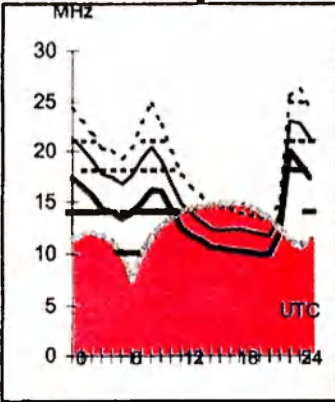

Brisbane-Honlara 21

First IF8-10 IE0 Short 2131 km

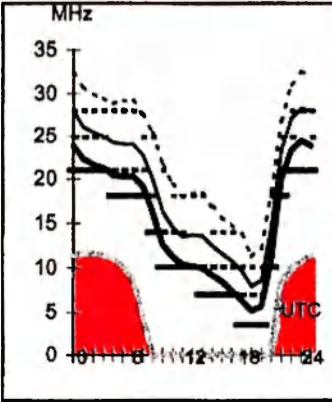

Adelaide-London 312

First F 0-5 Short 16269 km

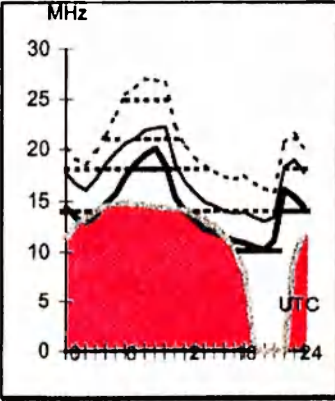

Brisbane-Montevideo 154

First F 0-5 Short 12432 km

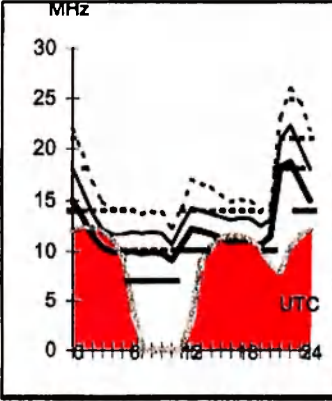

Canberra-Auckland 102

First IF7-8 IE0 Short 2300 km

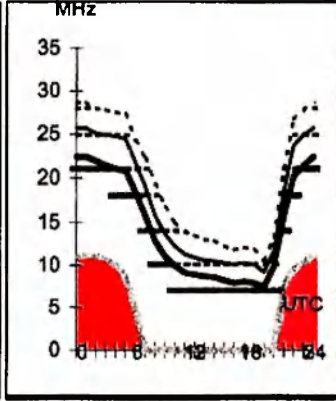

Darwin-Seattle 44

First F 0-5 Short 12282 km

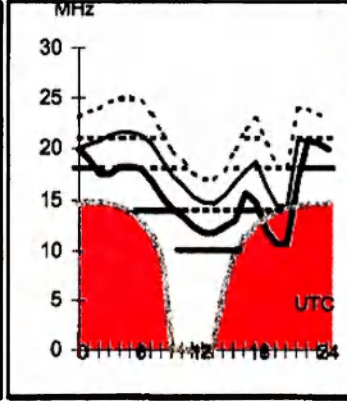

Adelaide-Los Angeles 66

First F 0-5 Short 13159 km

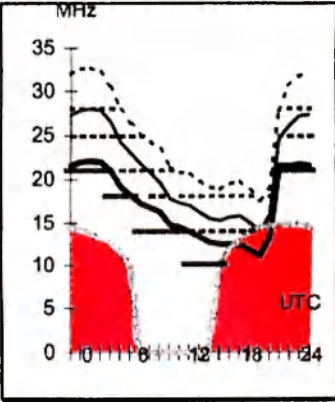

Brisbane-Tokyo 348

Second 3F6-12 3I Short 7159 km

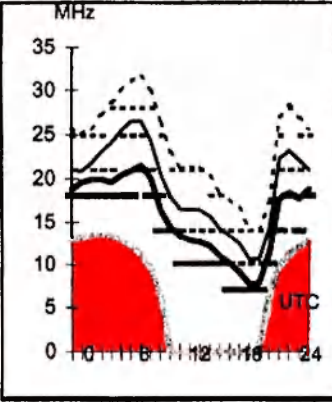

Canberra-Honolulu 50

First 3F3-7 3E0 Short 8407 km

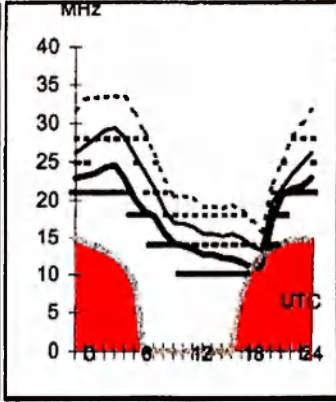

Darwin-Singapore 295

Second 2F12-20 Short 3351 km

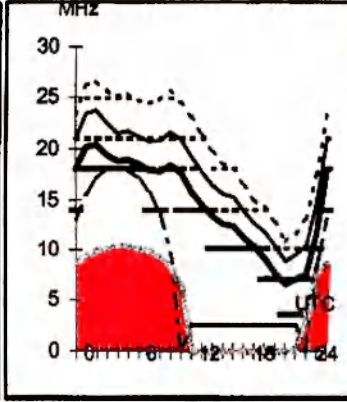

Adelaide-Pretoria 238

Second 4F5-6 4E1 Short 10064 km

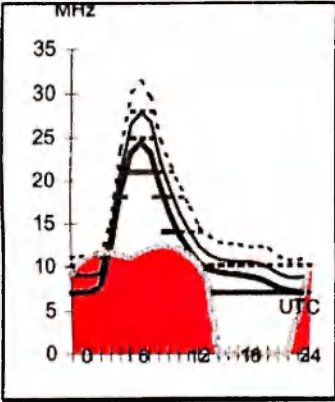

Brisbane-Wellington 133

First IF5-7 IE0 Short 2507 km

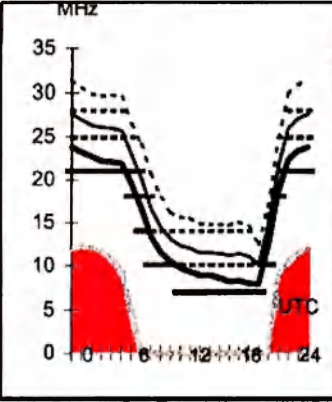

Canberra-Paris 130

First F 0-5 Short 23100 km

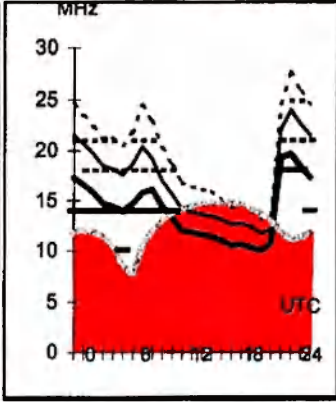

Darwin-Tel Aviv 301

First 4F3-10 4E0 Short 11302 km

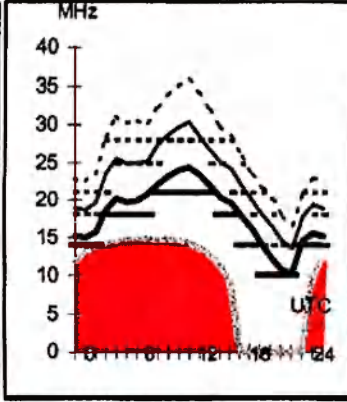

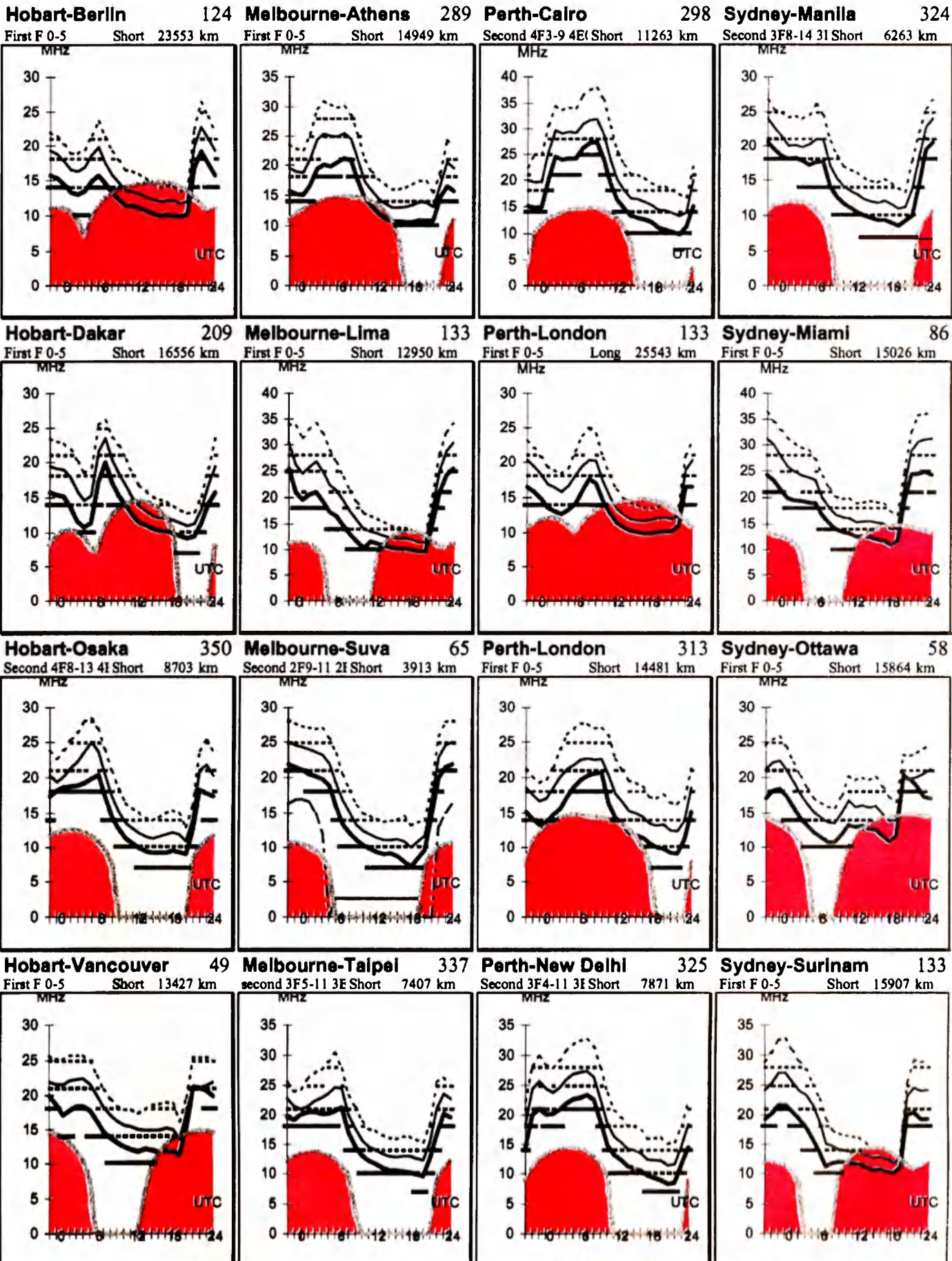

VHF/UHF

AN EXPANDING WORLD

David K Minchin VK5KK

Postal: 10 Harvey Cres, Salisbury Heights, SA, 5109

E-mail: tecknolt@ozemail.com.au

Web page: <http://members.ozemail.com.au/~tecknolt>

Fax: +61 8 8292 4501 Phone: 0403 368 066 AH ONLY

All times are in UTC.

50 MHz

John VK3KWA reports ... a claim has been made for the first VK9 long path record for the 6-metre band. The details are: VK9ML to PY5CC, date 15/04/02, distance 25517.3 km. VK9ML was operating from Mellish Reef and the operator at the time of the contact was Katsu, JH7OHF. Peter PY5CC is located at Matinhos in the state of Parana in the south of Brazil.

Also, VK3SIX is not closing but is operating intermittently as a manned station until it can be relicensed under the call sign VK3RMV, due to ACA instruction that beacons may be operated only under "R" call signs ... John VK3KWA.

Bevan VK4CXQ reports ...not much to report from Townsville on the 6 metre activity in the area. There really hasn't been any, which at this time on the year is not a surprise. Some JAs have been coming through but the signals have not lasted for very long. It's a case of "hear them, work them or you miss them". Have worked a few inlc JD1BKZ but that is all. Recd a QSL from A45XR after sending over two of mine (both direct with IRCs) ... Bevan -VK4CXQ-Townsville

Neville VK2QF reports ... it has been an interesting if not challenging cycle from this location. Openings have been brief compared to the luxury of cycle 22, which has made us complacent with the quality of the paths that can be possible on this band!

Personally: 6m DXCC in September 2000, over 20 new entities this cycle, and these prefixes in total worked so far: (62) KH2, VK9M, P43, JT1, ZF1, DU7, KL7, BD4, VE7, FW, CE0Y, ZK1 [N], YJ8, YS1, VK9N, 9A, I, EH3, S52, OM3, SP9, OK1, OE3, DL7, YV1, VR2, 3D2, PJ2, EY8, VP5, J87, 9M2, ZK2, AH8, V31, TG9, VP6, TX0, 9M6, HR1, FO5 [T], 3D2[R], P29, W6, 3F3, HL5, TI5, YN1, KH4, BV2, JD1 [O], JD1 [MT], T33, T88, XE1, YB9, KH6, FK8, VK8, V73, JA1, ZL2.

It's been a lot of fun to study the propagation and know "when to go and when to show" to catch the best openings. The season came after a promising level of solar activity in December. Unfortunately conditions trended down toward the equinox. This pattern has been the sequence through out this cycle almost appearing to run in opposition to the behavior of cycle 22 where solid peaks tended to occur near the equinox [coincidental but providing great six metre propagation].

Excellent TEP conditions were present in early February to Japan. Several days of European indicators in the usual 8 to 10Z window but low in strength. On the 21st GORUZ [Conrad] did recognise some CW from VK2QF using EME computer enhanced DSP techniques and EI7BMB also heard similar at 1140 to 1209Z on that day.

Early March showed good indicators from Asia by TEP with propagation from Central America and the Caribbean Sea

in the usual 2030 to 0Z window. Little was heard in mid March until the 24th with a reasonable North American opening and some Pacific stations heard [5W, FO3 etc]. Probably the surprise of the season was to work Aruba and the Netherlands Antilles toward the end of March and to hear them both on other days also. Spanish stations were able to hear the Mt Mowbullian [Towoomba] video in the late March and early April period, unfortunately the Mt Ulandra [Wagga Wagga] video was never reported. This is classic of this region with regards to this type of propagation for some anomalous reason [probably due I suspect to E layer for example in the target area acting as an ALF to 50MHz propagation yet as a vector to the more frequent paths to VK4 and VK3].

Mid April had several promising days. Propagation began with solid backscatter indicators from the East [ZL video signals on 45MHz]. Brief contacts were made into Central and North America. Later Oceania and South East Asian signals were strong, especially Indonesian, Singapore and East Malaysia. Unfortunately no propagation was heard from Africa in the expected window of mid to late April. This was despite the usual Hawaii to South African propagation so familiar during Cycle 22

The next equinox will be an interesting one; it could be the end of productive paths for this location on 50MHz.

Neville VK2QF

Digital "DX" Modes

Reg VK7MO reports ... John VK2TK joined the group and copied a number of stations including ZL3TY over the weekend of 15/16th of June 2002. Gavin VK3HY joined in listening (looking) mode. Bob, ZL3TY, Joe, VK7JG, and Rex, VK7MO, all made their first JT44 EME contacts.

Ian, VK3AXH, has kindly agreed to take over "WSJT News" and running the 7085 liaison while I am away on the mainland. I will be away for an undetermined time, awaiting my first grandchild, attending GippsTech and activating some rare grid squares in outback VK2/5 and possibly VK8. I

should be found on FSK441, 144.330, from 7.00 to 8:00 am most mornings TXing second period. When I am within range of active stations I will also try JT44, 144.225 and 432.225 from 7.00 to 8.00 in the evening, TXing second period. Times are Eastern Australian Times. If I happen to be within mobile

range liaison can be on 0408 147 808. Otherwise I will try liaison prior to these times on HF, 3650 or 7085.

The Type C effort on Sunday did not work out, as we did not seem to have any VK5s or VK4s on. Following a discussion on 40 meters we will go to Type A on both Saturday and Sunday unless we have advice that a VK5 or VK4 station will be on for the Sunday. I have also changed the format of a Type C so that all other stations TX to VK5 when we do run with a Type C.

Type A VK3/5/7 TX's first to the North, VK2/4 TX's second and to the South

Type B VK7/2 TX's first to the North, VK5/3/4 TX's second and to the South

Type C VK7/3/2/4 TX's first to the West, VK5 TX's second to the East
If any VK5s or VK4s would like a Type

B or Type C on any Sunday please let Ian, VK3AXH know prior to Thursday each week so he can promulgate any change via the reflector ... Reg VK7MO

John VK3KWA reports ... There is now a new national Digital Modes record (WSJT FSK441) for 2 metres: VK2EI to ZL3TY, 14/05/02, 2028.2 km. The previous record, also set with WSJT, was: VK4TZL to VK7MO, 17/11/01, 2017.3 km. ... VK3KWA

From overseas comes the first "claimed" 50 MHz digital EME contact ... Lance, W7GJ, had been frustrated during this past solar cycle peak by the rarity of European and other 6-metre DX into Montana, despite his 70-foot Yagi and 1500 W. So he built an array of four Yagis on an el-az mount in hopes of making up for the lack of F-layer propagation with EME contacts. Lance made a few CW contacts off the Moon,

but these proved to be quite difficult until he tried the new JT44 program. He discovered it was much easier to complete EME contacts with single-Yagi stations when the Moon was near the DX station's horizon using the new digital mode.

W7GJ's first such contact was with ZS6WB on April 21, perhaps the first 6-metre EME contact using JT44. Lance could make out a clear trace on his Spectran digital audio filter waterfall display during his QSO. Based on his initial experiences, Lance thinks he could complete with any 100 W station with a moderately sized Yagi and good receiver preamp. It also seems likely that pairs well equipped single-Yagi stations could also make EME contacts using JT44 when the Moon was near the horizon for both stations. .. Courtesy of Emil W3EP, QST.

EME Report

Doug VK3UM reports on his EME activity on the 15th and 16th of June, 2002. Managed to get on for a short time and found conditions 'normal' and worked the following (no new ones) all random contacts on 432 MHz EME.

15/06/02

UTC

1009 VK4AFL 55N 55N TH RH
1037 DL8OBU 53N 54N TH RH
1054 JH4JLV 53N 44N TV RV

16/06/02

0223 K9SLQ 55N 55N TV RV

0244	K1FO	56N 56N TV RH
0254	KU4F	56N 56N TV RH
0300	N9AB	55N 56N TV RH
0315	JA4BLC	33N 55N TH RH
0335	JA6AHB	54N 55N TH RV
0910	UA3PTW	54N 56N TH RH
1106	OM1TL	43N 44N TH RH
1116	G3LTF	55N 56N TH RV
1123	DF3RU	55N 55N TH RH
1134	G4YTL	54N 54N TH RH

Doug VK3UM

From Emil W3EP, editor of QST's World above 50 MHz column RW3BP completed his first 24 GHz EME contacts

with W5LUA, VE4MA, and AA6IW between April 18 and 21, according to Barry Malowanchuk, VE4MA, who has been one of the pioneers of microwave EME activity. The Moon was just 7.5 degrees above the horizon for RW3BP during his third QSO, which added considerably to atmospheric absorption and noise. VE4MA went on to work VE7CLD and AA6IW for his third and fourth initial contacts. All stations ran at least 75 W from travelling-wave tube amplifiers.

AO40 portable operation from Algeria

Mirek VK3DXI reports ... I will be shortly going back to Algeria again. It is possibly my last trip, as the project is almost completed. Arrival in Algeria possibly first or second week of July, for period of 3-4 weeks..

I will try again all bands, 160-10 m plus AO40.6 metre is NOT allowed so far.

I will have a limited free time, as it is a business trip. Possible operating times after 16:00 UTC and before 05:00. Fridays, I will try to have free for ham radio. I am bringing also a portable set up for AO40 as before!

Updates and details of my activities,

sound recordings of some contacts, visitor book (pse post any special requests) and log-on-line at: <http://www.7x0.sp5zcc.waw.pl> QSL via DL4DBR ... Mirek 7X0DX, VK3DXI, VK2DXI, 9V1XE, SP5IXI

Oscar 7 returns from the dead!

The AMSAT-OSCAR 7 satellite suddenly has come back to life after being dormant for more than 20 years. First heard June 21 by Pat Gowan, G3IOR, AO-7 subsequently has been monitored and used by

Several other amateurs. AO-7 was launched November 15, 1974. It remained operational for more than six

years before succumbing to battery failure in 1981.

"I'm blown away," was the reaction of AO-7 Project Manager Jan King, W3GEY. "So, this old war horse of a spacecraft seems to have come back from the dead if only for a few moments." Exclaimed satellite enthusiast and AMSAT Vice President for User Services

Bruce Paige, KK5DO, "This is really awesome." Paige said the latest turn of events makes AO-7 is the oldest amateur satellite that's still working. AMSAT-NA has now listed AO-7 as "semi-operational"

AMSAT says it seems certain the satellite is running only off its solar panels, not from the onboard batteries,

2 ARISS schools in one day

Tony Hutcheson VK5ZAI

NEWINGTON, CT, Apr 30, 2002—Astronaut Dan Bursch, KD5PNU, aboard the International Space Station, concedes that he and his crew mates sometimes get on each others' nerves. The comment came today as Bursch answered questions from an enthusiastic group of youngsters at Woodland Middle School on New York's Long Island.

If you can imagine taking a long family trip and never getting out of the car for six months, Bursch said, replying to a question about whether he and his crew mates ever get frustrated or annoyed with each other. The three ISS crew members occasionally bug each other over little things, Bursch said, and when that happens, they usually go off and do something else by themselves.

Onboard with Bursch are Expedition 4 crew commander Yury Onufrienko, RK3DUO, and astronaut Carl Walz, KC5TIE. Visiting this week are space tourist Mark Shuttleworth of South Africa, cosmonaut Yuri Gidzeno of Russia and European Space Agency astronaut Roberto Vittori, IZ6ERU, of Italy.

The Woodland contact was the first of two Amateur Radio on the International Space Station (ARISS) school QSOs today—an ARISS first. After a missed schedule earlier in the day, a contact between Shuttleworth and South African students was promptly—and successfully—rescheduled.

A few hours after the Woodland contact, Shuttleworth was a no-show for a scheduled contact with students from more than a dozen schools in South Africa's in Kwazulu Natal province. Through a series of telephone calls, ARISS was able to reschedule the contact during a pass over Australia, have the Russian mission control center notify Shuttleworth and even arouse a

sleeping Tony Hutchison, VK5ZAI, in South Australia to handle Earth-station duties.

Shuttleworth was able to answer questions from five of the South African students, turning the earlier disappointment into delight. At least two additional ARISS schools involving Shuttleworth have been set for this week, making it the busiest ARISS schedule on record since the first crew came aboard the ISS in November 2000. On April 29, Shuttleworth told students at his alma mater in Cape Town that he's living his own dream in space.

ARRL report April 30, 2002.

ar

VHF/UHF – an expanding world continued

so it will be operational only while it's in sunlight. King speculates that the batteries, which shorted as they failed two decades ago, now are "un-shortening" and causing the satellite to come back to life.

For those attempting to use AO-7, Mode A (2 metres up/10 metres down) is not a problem, but Mode B (70 cm up/

2 metres down) is. Because of changes in the international Radio Regulations that went into effect in the 1970s as AO-7 was under construction, the 432.1 MHz uplink frequency is no longer authorized for space communications.

Built by a multinational team under the direction of AMSAT-NA, AO-7 carries Mode A (145.850-950 MHz

uplink; 29.400-500 MHz downlink) and Mode B (432.180-120 MHz uplink; 145.920-980 MHz downlink) linear transponders plus beacons on 29.500 and 145.700 MHz. A 2304.1 MHz beacon was never turned on because of international treaty constraints. For additional information on AO-7 on its Web site, <http://www.amsat.org>. (Courtesy of AMSAT News)

Microwave Round Up

This month a quick tip on extending the range of your spectrum analyser to 24 GHz or a crude ATV Rx converter for the same band .. Kerry N6IZW reports ... I was running some out of band frequency response tests on a K-Band DBS TV LNB the other day and saw something that might prove to be useful for Amateur use.

Although they are designed to convert 12.2-12.7 GHz down to 950-1450 MHz, they also respond to harmonics of the LO. It turns out that the second harmonic of the internal DRO type oscillator running at 11.25 GHz (note those used in Australia have a 11.3 GHz

DRO .. VK5KK) mixes with a 24 GHz input to produce an IF output of 1.5 GHz. While this is outside of the specified IF range of the LNB (950-1450 MHz) it appears to respond well out to nearly 1700 MHz. The sensitivity is not great as one might expect but it might be useful as a crude down converter allowing 24 GHz TX in the low milliwatt range to be observed on a lower frequency spectrum analyser.

Potentially useful responses I found are: 20.8-21.5 GHz LO second harmonic high side mix and 23.4-24.2 GHz LO second harmonic low side mix. It also responds to the third harmonic of the

LO receiving: 32-32.7 GHz LO third harmonic high side mix and 34.6-35.4 GHz LO third harmonic low side mix ... Kerry N6IZW

In closing

I look forward to catching up with a number of the regulars at Gippstech this month; a full report will be in the August column.

I'll leave you with this thought.. "Next to the Dog, man's best friend is the Waste Paper basket!"

73s David VK5KK

ar

At long last...

After years of discussion Perth finally has a 10 metre repeater. There had been much interest in such a repeater for Perth but it required the doing, and equally important finding a location. Tony VK6YAG and Jay VK6YJS were able to put all this together and the repeater is now on air from two test locations (receive and transmit site).

Ten-metre propagation between Perth and the East coast of Australia has been exceptionally good for several years. The Melbourne repeater, VK3RHF is heard in Perth most of the time during daylight hour's noise free.

While mentioning the Melbourne

repeater VK3RHF, with inputs from several other bands, how about someone with technical knowledge of the repeater writing an article for Amateur Radio magazine. This is a great repeater that has been on air for a couple of decades

and some of us would like to know more about it.

The following article was written by Tony for VK6's repeater group annual newsletter and is reproduced below with Tony's permission.

Perth's new 10 metre FM repeater

Perth has a new 10-metre repeater. It has been under design and construction for about the last 18 months and is now finished and is licensed and on air. All of this work has been done by Tony Green (VK6YAG) with help from Jay (VK6YJS). After listening to and working various repeaters across Australia and around the world we made a note of the good and bad points of the various machines we encountered. These things influenced the design of our machine.

One of the main "bad" things was that when DX was good it was possible to "hit" more than one repeater at the same time. The received mess that came back was frustrating to say the least. Another, perhaps more serious concern is the pirate activity that seems to extend right through the whole 10 metre band.

An easy fix to both problems was to fit a CTCSS decoder to the input of the 10-metre receiver. The need to have a CTCSS encoder to use this repeater is not as bad as it first seems as only one station needs to send this signal as the decoder goes to "open" access for a few minutes to give other stations without a CTCSS encoder a chance to reply.

The other features include a DTMF controller, which can turn the decoder off and make the repeater "open" access. There are several user DTMF commands. Each command is made up of 2 sequential DTMF tones. The first tone is always a # or *. This must be held

on for about 1 to 2 seconds followed by a digit. (1,2,3...9). In each case * turns the option "ON" and # switches the option "OFF". Here is a list of the user commands:

- *1 NOISE BLANKER ON
- #1 NOISE BLANKER OFF
- *3 CTCSS DECODE TIMER ON
- #3 CTCSS DECODE TIMER OFF
- *2 CTCSS ENCODER ON
- #2 CTCSS ENCODER OFF
- *4 HI MUTE ON
- #4 HI MUTE OFF
- 9 ANNOUNCE TIME (no * or # needed)

The inclusions of an adjustable noise blanker and mute level setting are features not normally required on VHF but considered a must on 10 metres FM.

The repeater features voice recorder/playback module for ident, DTMF command confirmation and a talking clock. The repeater can be patched into the NEWSWEST link to re-transmit the weekly news broadcast. Other safeguards and control functions have been included to ensure the repeater will or can be shut down remotely in case of malfunction or interference.

Basic specifications (proposed)

Output frequency	29.680MHz
Input frequency	29.580MHz
CTCSS tone	179.9Hz

(see notes)
Power output 120 W FM
RX site Bedfordale
TX site Leeming
Leeming temporarily, we are looking for another site.

By Tony VK6YAG

Hardware

The repeater is essentially 'home brew' and is comprised of four radios, with their associated controllers, timers and ident boards. The main difference with an HF repeater is the need for isolation between the RX and TX antennas.

This is achieved with separate RX/TX sites using UHF radios and YAGI antennas to link the two sites.

The HF receiver is based on a Tait T499 lowband. The UHF link transmitter is a modified Motorola handheld with an FM828 PA. The UHF link receiver is also a modified Motorola handheld. The HF exciter is based on a Tait T499, an intermediate amplifier using a 2N5591 transistor and a home brew final PA using an MRF421 transistor.

Various audio filters and leveling amplifiers are used to maintain audio frequency response and deviation.

Special thanks go to various people including Fritz VK6UZ, Bob VK6TRA, Rob VK6JRC, Jay VK6YJS and the West Australian repeater group for their support.

ar

HAMADS

- Hamads may be submitted by email or on the form on the reverse of your current Amateur Radio address flysheet. Please print carefully, especially where case or numerals are critical.
- Please submit separate forms for For Sale and Wanted items, and be sure to include your name, address and telephone number (including STD code) if you do not use the flysheet.
- Eight lines (forty words) per issue free to all WIA members, ninth and tenth lines for name and address. Commercial rates apply for non-members.
- Deceased estates Hamads will be published in full, even if the ad is not fully radio equipment.
- WIA policy recommends that the serial number of all equipment for sale should be included.
- QTHR means the address is correct in the current WIA Call Book.
- Ordinary Hamads from members who are deemed to be in general electronics retail and wholesale distributive trades should be certified as referring only to private articles not being re-sold for merchandising purposes.
- Commercial advertising (Trade Hamads) are pre-payable at \$25.00 for four lines (twenty words), plus \$2.25 per line (or part thereof), with a minimum charge of \$25.00. Cheques are to be made out to: WIA Hamads.
- Copy should be typed or in block letters, and be received by the deadlines shown on page 1 of each issue of Amateur Radio, at:

Email: newsletters@ozemail.com.au **Fax:** 03 9756 7031

Postal: Newsletters Unlimited, PO Box 431, Monbulk Vic 3793

Please send your Hamad by ONE method only (email preferred)

FOR SALE NSW

- ICOM IC-251A all mode 144MHz transceiver. C/W box and handbook, power cord and mic. VGC \$300 ono. Fred VK2DV. Phone 02 6583 7095
- MECHANICAL-ELECTRONIC ANALOG COMPUTER, made in 1962 by Martin Marietta, USA. Weight ca 35kg \$250. VK2EDD, Phone 02 4982 9847
- YAESU FT-847 Transceiver, brand new condition in original carton. Suit new buyer. All HF through to beyond 70cm + satellite operation with full duplex etc. S/N 8G060458. \$2500 ono. Contact Les VK2KLD Phone 02 4297 2737 or 0419 295 371.
- COMPUTER: CPU 166MHz, RAM 166Mb, H/ drive 2.1Gb, CDR 44X, F/disc 1.44Mb, Videocard 3.1Mb, ISA Soundcard, Keyboard, Mouse, New speakers, 15" monitor, Running Win 95, Software includes Word 2000, Excel, Publisher, Adobe Acrobat. \$500 ONO. John jwallvk2@tsn.cc or Phone/fax: 02 6568 3323
- SHACK CLEARANCE FOR VK2APT (Sadly, Jack is now a nursing home intensive-care resident). CENTURY 21 HF Comms Rcvr, EC \$100. DATONG D70 Morse Tutor 5-40wpm \$50. KENWOOD DM-81 Dip Meter, as new, all coils \$100. KENWOOD TR-7850 2 m FM 45/10W, GC \$200. EMTRON EAT-300 Tuner, GC \$100. YAESU FRT-7700 ATU for FRG-7700, GC \$50. KENWOOD MC-50 Desk Mic, well used, OK \$50. KENWOOD MC-60 Desk Mic, paint rough, OK \$50. BELCO BR8 L/C/R bridge GC \$30. KENWOOD TH-25AT 2 m HH DC1, HMC-2, BC-10 GC \$175. BECKMAN DVM TECH310 leather case, quality unit EC \$50. KENWOOD HC-10 World Clock Fair \$20. KENWOOD RD-300 300 W Dummy Load \$50. TOYO T100 Dummy Load 100 W \$25. MICRONTA SWR/FS Meter FC \$25. KYORITSU K109 SWR Meter OK \$25. Q-CRAFT SWR2 SWR Meter \$25. ARKON IR530 Cordless Headphones, never used \$100. KENWOOD MB-430 Mounting bracket, new \$10. TELERADIO 27 MHz Marine Tcwr, mic, six channels \$50. AEA Moscow Muffler -Collectors!! \$10.

TAILTWISTER Rotator control unit-unknown condx \$50. BELCO ARF300 Sig Gen 18Hz-200MHz GC \$100. ICOM IC-22S, Not working, Mic, HB Pwr supply \$25. DSE Centurion Pwr supply 2A 13.8V GC \$20. DSE Big Dick Pwr supply 0-12A, 12-24V \$50. KDC Pwr supply 4.5-12V, FC \$15. P1 Pwr supply 13.8V 10A, reg, GC \$100 UNIVERSITY MVA100 Multimeter, battered, no probes, OK \$10. REALISTIC 22-0278 Multimeter, tiny, no probes, GC \$10. REALISTIC 22-198a DMM GC \$50. SWAN 350 HF SSB PS-230 Pwr supply still goes well! \$100. DAIWA CN620A SWR/PWR Meter X-needles \$30. YAESU FL-2100z Linear GC \$600. HALLICRAFTERS HT44 - Early SSB TX REAL COLLECTOR'S ITEM! \$100. COMPLETE KENWOOD STATION, all in good used condition: TS-830 HF TCVR \$500, SP-230 SPEAKER \$50, SM-220 STATION MONITOR \$200, VFO-230 \$100, SW-2000 SWR/PWR METER \$50 or \$750 complete station. All prices ONO. Serial numbers available, most items with manuals. Transmitting equipment to licenced amateurs only. Stan Bourke VK2EL QTHR (Ulladulla) Phone (02)4455 5825 sbourke@shoal.net.au

WANTED NSW

• YAESU FRG-9600 schematic circuit diagram. Costs reimbursed. Art VK2AS Phone 02 9416 7784 or astowar1@bigpond.com

FOR SALE VIC

- New offcut lengths ANDREWS HELIAX LDF-450A, LDF-550A, 16 m - 44 m. Also connectors. Ray VK3ATN QTHR Phone 03 5492 2224, Fax 5492 2666, atnant@ruralnet.net.au
- REALISTIC DX-302 RECEIVER, 10kHz to 30MHz LED display 240 or 12 volt, with service manual \$120 ono VK3JM QTHR Phone 03 9801 4972
- ICOM IC-22S mobile 2m transceiver, very good condition, with power lead and mobile bracket. \$155 plus postage. YAESU 470 2m/70cm handheld, 5 watt output power, in very good condition, with original packaging and rechargeable pack. \$265 plus postage. VK3DVD

Phone 03 9879 8804, or CrachiFranz@optushome.com.au

- YAESU FT-100 Transceiver. SN: 9D022175. All band all mode - 160m to 70cm, 100W HF and 6m, 50W 2m and 20W 70cm. Detachable front panel. Perfect mobile rig, very small. Reason for sale is buying base rig. Demonstrate and/or on air contact. \$2000 Paul VK3DPW Phone 03 5989 2964, 0414 314 025.
- EPROMS, mixed lot of about 80 (used), 2764 (12), 27128 (46), 27512 (16) new cost \$400+, the lot for \$40. Terry VK3ZXY QTHR Phone 03 9592 3514, email vk3zxy@leithy.com
- VALVE TESTER Taylor 45C with handbook (can email photos), good condition, \$80. Terry VK3ZXY QTHR Phone 03 9592 3514, email vk3zxy@leithy.com

WANTED VIC

- Does anyone have Eddystone RX's no longer being used? Models wanted EC10 or 960. Like to hear from you. Call Bruce VK3YBW QTHR. Phone 03 9527 2661 after 6pm most evenings, or leave message.
- SPECIFICATIONS and set-up measurement for the CHIRNSIDE 6 ELE TRIBAND beam. VK3BE Colin Phone 03 5668 2109, 0429 614 368
- RADIO SERVICE MANUALS (Australian Official), Vol 7 (1949) & Vol 8 (1949). Please advise prices etc if you have one or either (or later volumes). Terry VK3ZXY QTHR Phone 03 9592 3514, email vk3zxy@leithy.com
- Help! I need a Service Manual (or a facsimile of same) for a PYE OVERLAND model F25 FM738D/V/12 valve VHF transceiver that I am trying to rebuild (remember when Australia had a manufacturing base?). VK2CPR. Please phone BH 03 5723 8335 or AH 02 6021 5008, shielphi@galen.sand.catholic.edu.au, QTHR
- INSERT FOR KENWOOD MIC type MC-42S, MC-60A or similar or complete microphone. Insert impedance is quoted at 500 ohm and measures 300 ohm DC resistance. Any reasonable price. Please contact Graeme VK3BGH. Email: harmanco@bigpond.com phone mobile: 0419 343 190
- CIRCUIT DIAGRAM AND ALIGNMENT details of the KIMBERLEY 102 UHF carphone for conversion to 432 MHz. Philip VK3YAZ QTHR Phone 0417 014636 pjohnsto@melbpc.org.au
- Copy of Drew Diamond's *Radio projects for the amateur - Volume 1*. Neil VK3IJ. Email neilvk3ij@hotmail.com.au or phone 03 9369 1010

FOR SALE QLD

- CUSHCRAFT A3S BEAM including CAL-AV EB-1 ferrite balun, excellent condition, \$500. VIBROPLEX: The original Presentation bug with gold plated base top, collector's item, serial no. 269552, mint condition, \$250. Contact: Carsten VK4OA QTHR Phone 07 3264 6443 Mobile: 0419 966 111 E-mail: pedersen@powerup.com.au

WANTED QLD

- WORKSHOP MANUALS for KENWOOD TS-43X (TS-430S) and KENWOOD TS-711A. Good photocopies are OK. VK4YE. Phone 07 5543 6053 or email bouch@parkridgshs.edu.au
- MANUALS for ICOM IC-701 and YAESU FT-980, photocopies OK and all expenses paid. Reply VK4DV QTHR, mervd@rocknet.net.au

Internet "question banks" essential for training newcomers

I have read with interest the June Education Notes by Brenda Edmonds and hold many of the same reservations about the "Foundation Licence", particularly the supervision of newcomers.

One of the difficulties of training people in Australia for an amateur licence has been the fact that the only available official requirement for the theory exam has been the syllabus. This, unfortunately, is open to an interpretation which leads educators to

teach too much information to make sure that enough has been imparted. No text book on the subject has been written by an author who has had access to the relevant question bank so there is no really authentic study material. Many of the "trial" question banks and exams contain questions other than those likely to be asked in an official exam.

It is with great joy that I learnt that the WIA has released the Regulations question bank onto the internet and will soon have printed copies available.

There is also a possibility that, in the not too distant future, it may release the AOCIP and Limited theory question banks and that will be something to look forward to. It will also bring us into line with the USA, New Zealand and Canadian fraternities who publish their question banks on the internet. May we grow and prosper in useful comradeship.

73. Nail Trainor VK3J

FOR SALE SA

• RCI 2950 ten metre rig \$375. FT-8100R dual band mobile with separation kit \$850. TS 520S KENWOOD HF \$200. DSP-9 audio noise filter \$100. Mark VK5KMK QTHR. Phone week days 08 8356 8325 or 08 8836 7279,

• RADIO MAGAZINES, ANTENNAS (both mobile and base), DIAMOND SWR power meter, aluminium tubing, much more, VK5MAP Paul. Send SASE to QTHR or phone 08 8651 2398.

WANTED SA

• OPERATOR'S INSTRUCTIONS FOR MICRONTA MULTIMETER Model 22-202B. VK5MAP Paul. Phone 08 8651 2398 or QTHR

FOR SALE TAS

• KENWOOD VOX3 new, low pass filter 500 W. ICOM LC-36 leather handheld case, new, suit IC-2GAT & IC-4GA. ALINCO EDC21 charger, new. MALDOL 2m/6m duplexer YAESU

• FRG-9600 scanner receiver, new. ZETAGI MB + 9 base mic, as new. ROGER BEEP ECHO METER etc. ICOM IC-718 HF/ceiver, new in box \$1320. YAESU FRG-9600 scanner receiver, new. What offers? ZETAGI MB + 9 base mic, new & wired for Icom \$75.00. Allen VK7AN Phone 03 6327 1171, mobile 0419 755 124

MISCELLANEOUS

• The WIA QSL Collection (now Federal) requires QSLs. All types welcome, especially rare DX pictorial cards, special issue. Please contact the Hon Curator, Ken Matchett VK3TL, 4 Sunrise Hill Road, Montrose Vic 3765, tel. (03) 9728 5350

ADVERTISERS INDEX

Com-an-tena.....	24
Elektron.....	33
G & C Communications.....	27
Icom.....	OBC
Strictly Ham.....	8
Tower Communications	39
WIA Call Book.....	IFC

TRADE ADS

PSK-31, SSTV, RTTY SOUNDBOARD INTERFACES

Fully isolated, ready to plug in.
<http://www.G3LIV.CO.UK>,
johnny@melvin.com, G3LIV QTHR.

AMIDON FERROMAGNETIC CORES:

For all RF applications. Send business size SASE for data/price to RJ & US Imports, PO Box 431, Kiama NSW 2533 (no enquiries at office please. 14 Boanyo Ave Kiama). www.catchnet.com.au/~rjandusimports

Agencies at: Active Electronics Tas; Truscotts Electronic World, Melbourne; TTS Systems, Tyabb; Tower Communications, Perth; Haven Electronics, Nowra.

HF, VHF, UHF ANTENNAS & ACCESSORIES

Alum towers, guys etc. Diamond VSWR/PWR meters. HD copper ant wire & insulators. TX tubes & pwr transistors. Quality coax cables & connectors. Free advice & catalogue. ATN Antennas Ph 03 5492 2224 Fax 03 5492 2666, email atnant@ruralnet.net.au

<http://www.hamsearch.com>

a not-for-profit site that is a search engine for hams

PLAN AHEAD

JOTA and JOTI
October 19 & 20,
2002

TRADE PRACTICES ACT

It is impossible for us to ensure that the advertisements submitted for publication comply with the Trade Practices Act 1974. Therefore, advertisers and advertising agents will appreciate the absolute need for themselves to ensure that the provisions of the Act are strictly complied with.

VICTORIAN CONSUMER AFFAIRS ACT

All advertisers are advised that advertisements containing only a PO Box number as the address cannot be accepted without the addition of the business address of the box-holder or seller of the goods.

"Hey, Old Timer..."

If you have been licensed for more than 25 years you are invited to join the



Radio Amateurs Old Timers Club Australia

or if you have been licensed for less than 25 but more than ten years, you are invited to become an Associate Member of the RAOTC.

In either case a \$2.50 joining fee plus \$8.00 for one year or \$15.00 for two years gets you two interesting OTN Journals a year plus good fellowship.

Write to

RAOTC,
3/237 Bluff Road
Sandringham VIC 3191

or call Arthur VK3VQ on 03 9598 4262 or Allan VK3AMD on 03 9570 4610, for an application form.

Email your hamad

Then we just cut and paste.
You proof it, you retain control.

Division Directory

The Amateur Radio Service exists for the purpose of self training, intercommunication and technical investigation. It is carried out by amateurs who are duly authorised people interested in radio technique solely with a personal aim and without pecuniary interest.

The Wireless Institute of Australia represents the interests of all radio amateurs throughout Australia. National representation is handled by the executive office under council direction. There is one councillor for each of the seven Divisions. This directory lists all the Divisional offices, broadcast schedules and subscription rates. All enquiries should be directed to your local Division.



Broadcast schedules All frequencies MHz. All times are local.

VK1 Division Australian Capital Territory,
GPO Box 600, Canberra ACT 2601
President Gilbert Hughes
Secretary Peter Kloppenburg
Treasurer Linden S Orr

VK1GH
VK1CPK
VK1LSO

VK1WI: 3.590 LSB, 146.950 FM each Thursday evening from 8.00pm local time. The broadcast text is available on packet, on Internet aus.radio.amateur.misc news group, and on the VK1 Home Page <http://www.vk1.wia.ampr.org>

Annual Membership Fees. Full \$80.00 Pensioner or student \$71.00. Without *Amateur Radio* \$48.00

VK2 Division New South Wales
109 Wigram St, Parramatta NSW
(PO Box 432, Harris Park, 2150)
(Office hours Mon-Fri 1100-1400)
Phone 02 9689 2417
Web: <http://www.ozemail.com.au/~vk2wi>
Freecall 1800 817 644

e-mail: vk2wi@ozemail.com.au

Fax 02 9633 1525

President Tony Davies

Secretary Pat Leeper

Treasurer Chris Minahan

VK2KDK
VK2JPA
VK2EJ

From VK2WI 1.845, 3.595, 7.146*, 10.125, 14.160, 24.950, 28.320, 29.120, 52.120, 52.525, 144.150, 147.000, 438.525, 1281.750 (* morning only) with relays to some of 18.120, 21.170, 584.750 ATV sound. Many country regions relay on 2 m or 70 cm repeaters. Sunday at 1000 and 1930. Highlights included in VK2AWX Newcastle news, Monday 1930 on 3.593 plus 10 m, 2 m, 70 cm, 23 cm. The broadcast text is available on the Internet newsgroup aus.radio.amateur.misc, and on packet radio.

Annual Membership Fees. Full \$80.00 Pensioner or student \$63.00. Without *Amateur Radio* \$50.00

VK3 Division Victoria
40G Victory Boulevard Ashburton VIC 3147
(Office hours Tue 10.00 -2.30)
Phone 03 9885 9261

Web: <http://www.wiavic.org.au>

Fax 03 9885 9298

e-mail: wiavic@wiavic.org.au

President Jim Linton

Secretary John Brown

Treasurer Barry Wilton

VK3PC
VK3JJB
VK3XV

VK3BWI broadcasts on the 1st Sunday of the month at 20.00hrs Primary frequencies, 3.615 DSB, 7.085 LSB, and FM(R)s VK3RML 146.700, VK3RMM 147.250, VK3RWG 147.225, and 70 cm FM(R)s VK3ROU 438.225, and VK3RMU 438.075. Major news under call VK3ZWI on Victorian packet BBS and WIA VIC Web Site.

Annual Membership Fees. Full \$83.00 Pensioner or student \$67.00. Without *Amateur Radio* \$51.00

VK4 Division Queensland
PO Box 199, Wavell Heights, Old. 4012
Phone 07 3221 9377

e-mail: office@wiaq.powerup.com.au

Fax 07 3266 4929

Web: <http://www.wia.org.au/Vk4>

President Ewan McLeod

Secretary Bob Cumming

Treasurer Bill McDermott

VK4ERM
VK4YBN
VK4AZM

VK4WIA broadcasts on 1.825 MHz SSB, 3.605 MHz SSB, 7.118 MHz SSB, 10.135 MHz SSB, 14.342 MHz SSB, 21.175 MHz SSB, 28.400 MHz SSB, 29.660 MHz FM (rptr), 147.000 MHz, and 438.525 MHz (in the Brisbane region, and on regional VHF/UHF repeaters) at 0900 hrs K every Sunday morning. QNEWS is repeated Monday evenings, at 19.30 hrs K, on 3.605 MHz SSB and 147.000 MHz FM. On Sunday evenings, at 18.45 hrs K on 3.605SSB and 147.000 FM, a repeat of the previous week's edition of QNEWS is broadcast. Broadcast news in text form on packet is available under WIAQ@VKNET. QNEWS Text and real audio files available from the web site

Annual Membership Fees. Full \$95.00 Pensioner or student \$81.00. Without *Amateur Radio* \$69.00

VK5 Division South Australia and Northern Territory
(GPO Box 1234 Adelaide SA 5001)
Phone 0403 368 066

web: <http://www.sant.wia.org.au>

e-mail: peter.reichert@bigpond.com

President Trevor Quick

Secretary Peter Reichelt

Treasurer Trevor Quick

VK5ATQ
VK5APR
VK5ATQ

VK5WI: 1843 kHz AM, 3.550 MHz LSB, 7.095 AM, 14.175 USB, 28.470 USB, 53.100 FM, 147.000 FM Adelaide, 146.800 FM Mildura, 146.900 FM South East, 146.925 FM Central North, 438.475 FM Adelaide North, ATV Ch 35 579.250 Adelaide. (NT) 3.555 LSB, 7.065 LSB, 10.125 USB, 146.700 FM, 0900 hrs Sunday. The repeat of the broadcast occurs Monday Nights at 1930hrs on 3585kHz and 146.675 MHz FM. The broadcast is available in 'RealAudio' format from the website at www.sant.wia.org.au Broadcast Page area.

Annual Membership Fees. Full \$88.00 Pensioner or student \$73.00. Without *Amateur Radio* \$58.00

VK6 Division Western Australia
PO Box 10 West Perth WA 6872
Phone 08 9351 8873

Web: <http://www.vk6wia.org>

e-mail: vk6wia@inet.net.au

President Nell Penfold

Secretary Christine Bastin

Treasurer Bruce Hedland-Thomas

VK6NE
VK6ZLZ
VK6OO

VK6WIA: 146.700 FM(R) Perth at 0930hrs Sunday relayed on 1.865, 3.564, 7.075, 10.125, 14.116, 14.175, 21.185, 29.120 FM, 50.150 and 438.525 MHz, Country relays 3.582, 147.200 (R) Catby, 147.350 (R) Busselton, 146.900 (R) Mt William (Bunbury), 147.000 (R) Katanning and 147.250 (R) Mt Saddleback. Broadcast repeated on 146.700 at 1900 hrs Sunday relayed on 1.865, 3.564 and 438.525 MHz : country relays on 148.900, 147.000, 147.200, 147.250 and 147.350 MHz..Also in "RealAudio" format from the VK6 WIA website

Annual Membership Fees. Full \$71.00 Pensioner or student \$65.00. Without *Amateur Radio* \$39.00

VK7 Division Tasmania
PO Box 371 Hobart TAS 7001
Phone 03 6234 3653 (BH)
Web: <http://www.tased.edu.au/tasonline/vk7wia>
also through <http://www.wia.org.au/vk7>

e-mail: batesjw@netspace.net.au

President Mike Jenner

Secretary John Bates

Treasurer John Bates

VK7FB
VK7RT
VK7RT

VK7WI: 146.700 MHz FM (VK7RHT) at 0930 hrs Sunday relayed on 147.000 (VK7RAA), 148.726 (VK7RNE), 146.625 (VK7RMD), 3.570, 7.090, 14.130, 52.100, 144.150 (Hobart), repeated Tues 3.690 at 1930 hrs.

Annual Membership Fees. Full \$90.00 Pensioner or student \$77.00. Without *Amateur Radio* \$57.00

VK8 Northern Territory is part of the VK5 Division and relays broadcasts from VK5 as shown, received on 14 or 28 MHz. The broadcast is downloaded via the Internet.

RD

participants and their equipment



VK2AYD David Pilley's Station



VK5UM Mike Richardson

1/65 Caffrey Street, McLaren Vale 5171
The set up for the 2001 RD was as follows:
TCVR TS440S 100W
3 element Triband Yagi - 10/15/20
Inverted Dipoles 40/80
1/4 wave Semi Vertical - horizontal 160
Currently the Antenna is a 10 - 80 Vertical by Com-ant-ena.



VK4DO Wally Watkins



VK4LT Al Carter

At 86 Al is still active. Enters the Open section as it lets him save his voice. He thinks he has participated in every RD Contest. Says each year will be the last but !! He was licenced in 1938 and was in AIF Army Sigs from 1939 to 1946.



VK6AFW Tony Wong

Tony has been VK6 CW section leader in 2001,2000,1998,1996,1993,1992,1987 and 1986



VK6LC Mal Johnson

I gained 1st place for H.F. Phone section for the 2001 RD Contest. Certificate No. 25 dated 1.3.2002.

My comments for the contest:

I did enjoy the 2001 RD contest as it was a pleasure to catch up with many old friends and meet many new Amateurs with a spirit of "Remembrance Day". I look forward to it each year hoping to meet you and others next RDC.

Being also a retired Royal Australian Sig that served in military action appreciates all those "unsung heroes" (signalman and signalwomen) that paid the supreme sacrifice and did more for us than we will really ever know or read.

Mal. VK6LC

Be the predator, not the prey

IC-756PROII (HF/6m) Amateur Transceiver



ICOM raises the bar of excellence with the world's most powerful DSP technology in amateur radio history with the IC-756PROII. From the box to heavy contest action, in a matter of seconds. Imagine the fun and excitement of creating your own filter width and shape while on the air, rag chewing, or in the middle of a pile-up!!

Features include:

- Sharp & soft, IF filter shape
- No optional filters to buy
- 41 selectable IF Filter bandwidths
- Choice of 3 filters per mode
- Improved 3rd IMD & wide dynamic range
- Triple band stacking register
- Built-in Antenna Tuner
- Two levels of receiver pre-amp
- Three levels of attenuator
- Dual watch on same band
- IF DSP
- 13.8V DC operation
- 5 to 100W SSB,CW,FM,RTTY (including RTTY decoder)
- 4 to 40W AM
- Dual Antenna Sockets
- Real Time Spectrum Scope
- One-touch record/play
- Digital voice memory
- Extended 1/4 tuning step & BPF functions for SSB-D mode
- 32 bit floating point DSP and 24 bit AD/DA converter
- SSB / CW synchronous tuning
- 8 Display types
- 7 Font Types
- Memory Keyer
- 4.9 inch color TFT LCD

ICOM

Clearly Ahead

Find your nearest ICOM dealer at

www.icom.net.au

or (03) 9387 0666

VIC Strictly Ham (03) 9729 7656, Harris Communications (03) 9347 6264
NSW Amateur Transceiver Radio Centre (02) 9896 2545
QLD Kyle Communications (07) 3857 4400
SA Tower Communications (08) 9274 1118
VIC ICS (08) 8447 3688

PH1ST/AM01

The magazine for **AUSTRALIAN** Amateurs

August 2002
Volume 70 No 8



Amateur Radio

\$ 5.95



**How to
Grow a
Radio Club**

Blue Mountain RC speak
from experience

High scorer Brad VK2JBC

holds his Dad's 1971 WIA certificate
alongside his own 2001 RD Contest certificate

ISSN 0002-6859



A Capacitance Bridge for Radio Work
by Drew Diamond, VK3XU

Superconductivity - What is it?



Australian
Amateur Radio

Callbook
2002

Every
shack
should
have one



Now also
on
searchable
CD

The "Call Book 2002" is available from
your State Division
Order now to get the member discount

VK1 Division

GPO Box 600, Canberra ACT.2601

VK2 Division

109 Wigram St, Parramatta NSW
(PO Box 432, Harris Park, 2150)
(Office hours Mon-Fri 1100-1400)
Phone 02 9689 2417

<http://www.ozemail.com.au/~vk2wi>

Freecall 1800 817 644

e-mail: vk2wi@ozemail.com.au

VK3 Division

40G Victory Boulevard
Ashburton VIC 3147
(Office hours Tue 10.00 - 2.30)
Phone 03 9885 9261

<http://www.wiavic.org.au>

Fax 03 9885 9298

e-mail: wiavic@wiavic.org.au

VK4 Division Queensland

PO Box 199, Wavell Heights, Old. 4012
Phone 07 3221 9377 Fax 07 3266 4929
e-mail: office@wiaq.powerup.com.au

VK5 Division (and VK8)

(GPO Box 1234 Adelaide SA 5001)
Phone 0403 368 066

:<http://www.sant.wia.org.au>

email: peter.reichelt@bigpond.com

VK6 Division

PO Box 10 West Perth WA 6872
Phone 08 9351 8873

Web: <http://www.vk6wia.org>

e-mail: vk6wia@iinet.net.au

VK7 Division

PO Box 371 Hobart TAS 7001

Phone 03 6234 3553 (BH)

<http://www.tased.edu.au/tasonline/vk7wia>

email: batesjw@netspace.net.au

COMMERCIAL RESELLERS

Please contact June Fox (WIA Federal) on 03 9528 5962



Amateur Radio

The Journal of the Wireless
Institute of Australia
ISSN 0002-6859

Editorial

Editor: Colwyn Low VK5UE
edarmag@charlot.net.au

Technical Editor: Peter Gibson VK3AZL

Publications Committee Members
Ron Fisher VK3OM
Don Jackson VK3DBB
Evan Jarman VK3ANI
Bill Rice VK3ABP
Gill Sones VK3AUI
Bill Roper VK3BR

Advertising

Mrs June Fox,
Tel: (03) 9528 5962

Hamads

"Hamads" Newsletters Unlimited
PO Box 431, Monbulk Vic 3793
Fax: 03 9756 7031
e-mail: newsletters@ozemail.com.au

Office

10/229 Balaclava Road
Caulfield, Victoria
Telephone (03) 9528 5962
Facsimile (03) 9523 8191

Business Hours 9:30am to 3:00pm weekdays

Postal

The Editor AR
34 Hawker Crescent
Elizabeth East
South Australia 5112
Email edarmag@charlot.net.au

Production

Newsletters Unlimited 03 9758 7797

Printer

Streamline Press, Melbourne (03) 9417 2766

Postal Service

IMB (03) 8231 5866

Production Deadlines

Advertising booking and articles for
publication 10th of preceding month.

Hamads and advertising material deadline
18th day of preceding month

The contents of Amateur Radio are Copyright
Wireless Institute of Australia © 2002

General

How to reverse the direction of a downward spiralling club	11
<i>Phil. Derbyshire, VK2FIL</i>	
More Interesting Pre-War QSLs	17
<i>Ken Matchett VK3TL</i>	
SEANET 2002 Convention	19
<i>Barrle Burns VK6ADI</i>	

Technical

A Capacitance Bridge for Radio Work	4
<i>Drew Diamond, VK3XU</i>	
Superconductivity: what is it?	8
<i>Paul Clutter VK2SPC</i>	
DTMF encoder from an old telephone	15
<i>Don Grimble, VK6KAR</i>	
Copper wire current ratings and usage (Technical Abstracts)	26
<i>Gill Sones VK3AUI</i>	
Top Drive (Technical Abstracts)	27
<i>Gill Sones VK3AUI</i>	
Shortening Screws (Technical Abstracts)	26
<i>Gill Sones VK3AUI</i>	

Columns

Advertisers' Index	55	Hamads	54
ALARA	20	Ham Shack Computers	50
AMSAT	38	HF Predictions	48
Beyond Our Shores	24	How's DX?	34
Contests	41	New WIA Members	33
Club News	22, 29	Over to you	52
DXCC Standings	45	Silent Key	16, 37, 46
WIA Division News		Spotlight on SWLing	23
VK1 Notes	30	Technical Abstracts	26, 27, 29
VK2 Notes	30	VHF/UHF – An Expanding World	46
VK3 Notes	31	WIA Comment	3
VK4 Notes	32	WIA Division Directory	56
Editor's Comment	2	WIA Federal Directory	2
Education Corner	33	Will's Page	40

Our cover this month

See cover story, page 2

Contributions to Amateur Radio

Amateur Radio is a forum for WIA members' amateur radio experiments, experiences opinions and news. Manuscripts with drawings and or photos are always welcome and will be considered for publication. Articles on disc or email are especially welcome. The WIA cannot be responsible for loss or damage to any material. A pamphlet, How to write for Amateur Radio is available from the Federal Office on receipt of a stamped self-addressed envelope.

Back Issues

Back issues are available directly from the WIA Federal Office (until stocks are exhausted), at \$4.00 each (including postage within Australia) to members.

Photostat copies

When back issues are no longer available, photocopies of articles are available to members at \$2.50 each (plus an additional \$2 for each additional issue in which the article appears).

Disclaimer

The opinions expressed in this publication do not necessarily reflect the official view of the WIA and the WIA cannot be held responsible for incorrect information published.

Amateur Radio Service

A radiocommunication service for the purpose of self-training, intercommunication and technical investigation carried out by amateurs; that is, by duly authorised persons interested in radio technique solely with a personal aim and without pecuniary interest.

Wireless Institute of Australia

The world's first and oldest
National Radio Society
Founded 1910

Representing

The Australian Amateur Radio Service

Member of the

International Amateur Radio Union

Registered Federal Office of the WIA

10/229 Balaclava Road
Caulfield North Vic 3161

Tel: (03) 9528 5962 Fax (03) 9523 8191
<http://www.wia.org.au>

All mail to

PO Box 2175 Caulfield Junction VIC 3161

Business hours: 9.30am-3pm weekdays

Federal Secretary

Peter Naish VK2BPN

Federal Office staff

June Fox Bookkeeper
Rita Trebilco VK3IF Examinations Officer

Council

President	Ernest Hocking	VK1LK
VK1 Federal Councillor	Gilbert Hughes	VK1GH
VK2 Federal Councillor	Barry White	VK2AAB
VK3 Federal Councillor	Jim Linton	VK3PC
VK4 Federal Councillor	David Jones	VK4OF
VK5 Federal Councillor	David Box	VK5OV
VK6 Federal Councillor	Will McGhie	VK6UU
VK7 Federal Councillor	Phil Corby	VK7ZAX

Executive

Brenda Edmonds VK3KT
David Pilley VK2AYD
Don Wilschefski VK4BY

Federal Coordinators

AMSAT	Graham Ratcliff	VK5AGR
ARDF	Jack Bramham	VK3WWW
Awards	Mai Johnson	VK6LC
Contests	Ian Godsill	VK3VP
Education	Ron Smith	VK4AGS
FTAC	John Martin	VK3KWA
Historian	John Edmonds	VK3AFU
IARU	Neil Penfold	VK6NE
Intruder Watch	Harry Andersson	VK8HA
International Travel Host	John Miller	VK3DJM
ITU Conference and study group	Gilbert Hughes	VK1GH
QSL Manager (vks, vko)	Neil Penfold	VK6NE
Videotapes	VK2 Division	
Web	Joe Burford	VK5UJ
WICEN	John Weir	VK3ZR

ACA Liaison Team

Glen Dunstan VK4DU (Corresponding)
Gilbert Hughes VK1GH
Keith Malcolm VK1ZKM
Peter Naish VK2BPN

Editorial Comment

Colwyn Low VK5UE

Time for activity

This month sees several contest activities, the Remembrance Day and ALARA Contests. If you are into contests please participate. If you have never tried well you have to start somewhere.

This year I might try and get a reasonable number of CW contacts but I will have to do a bit of brushing up. If I do not use my Key very often I revert further into translating dots and dashes in my head to letters and then writing them down. I have never really got to hearing and automatically recognising symbols unless I have listened to a lot of Morse just above a speed I am comfortable with. What then surprises me is that what I have written does actually make sense. I have always aspired to being able to read code in the background. Maybe when I give up editing AR at the end of the year I will be able to sit down and practice enough to achieve this aim, but then there is.....

Apologies to Ron Homes VK5VH who wrote the "Shack in a Briefcase" article we published last month. I got his call sign incorrect on the front page. Ron tells me (he is still speaking to me) that he has had a few queries and he will provide answers in September AR. If you have any queries please contact Ron.

Photographs

Now to ask a favour from our contributors. This month there has been considerable trouble with photographs which were supplied only as imbedded objects in the text. We also have trouble with scanned pictures and figures, which have been compressed. It needs a very good compression/decompression algorithm to get near the original after processing. Where an

article has figures and photographs it is useful to have them imbedded in the text to show placement, however in these cases please supply the graphics separately.

If you are offering a photograph as a possible cover, the preferred orientation is portrait. Please scan electronically at 600dpi and save as a jpg. It should then be about a 1 Mb file. Similarly if you use a digital camera, a usable photo will produce a jpg of about a Mb. That is a high-resolution digital photograph. Neither Newsletters nor I have trouble with Megabyte or larger files. The body of the magazine is worked up at 300dpi.

Club resurrection

This month we feature an article from the Blue Mountains ARC on how they turned the club around. I hope there are a few ideas in the article for your club. If your club has activities which are popular then please write to AR so we can all benefit from your experience. I would be interested also in your views on what in Amateur radio is most attractive to the under 20s.

Activity suggestions

Plan for the Summer Field Days. Actually *do* something about a computer or with it. Can you help the local Radio Club with a project, or share some of your experience with them at a meeting? What can my club do to attract more members? There must be lots more so please do something to help your fellow Amateurs.

73 Colwyn.

Cover Story

Photo is Brad VK2JBC, who gained the highest score in the VK2 division HF phone single operator of the 2001 RD Contest.

Brad says "that after a long period of inactivity my interest in amateur radio was rekindled when I became aware of Yaesu's portable HF to UHF transceiver the FT817. A few months prior to the 2001 Contest, I began going through some of my dad's (silent key -Cecil VK2CEC) old Amateur Radio

documents and I noticed that in 1971 he won this section of the RD Contest. In 1971 his call was VK2BEC. Seeing as 2001 was the 30 year anniversary, I decided to have a go".

The picture shows Brad holding his dad's 1971 WIA certificate as well as his own 2001 RD Contest certificate.



AR Take 5 Survey

I have today closed off the survey having received some 242 responses to date. Thank you to everyone who responded. As promised when the survey was launched there was a draw conducted to determine the winners of a free subscription to AR for one year. I am pleased to announce that the names

selected were:

- Alan Simpson VK4AAE, and
- Chris Gates of Lake Tyers Beach in Victoria (Chris is not licensed yet but is working towards his examinations).

Also as promised here are the results of the survey:

Question	Percentage	Comment	Question	Percentage	Comment
State	2% VK1 20% VK2 27% VK3 19% VK4 12% VK5 7% VK6 5% VK7 0.5% VK8 7.5% Not specified	Indicative only of State based membership	Are you happy that members opinions can be heard within the WIA?	76%	Many members have observed that their communications to state and Federal officers have been ignored (*see below)
Are you currently a WIA Member?	78%	We need to find a way to communicate with non members since this indicates that we are missing a large number of possible amateurs.	How can we improve communications?		Around 50% of the responses made suggestions ranging from wider use of broadcasts through to increased use of email.
Have you held a WIA membership in the past?	28%	Many ex members have left because of high cost, or belief that they are not listened to.	Would you be interested in an electronic version of AR?	33%	This is a significant number of members who would like see AR delivered electronically. Many of these suggested that this could be done at a reduced subscription rate
Do you receive an AR subscription?	72%	Of the members who subscribe many comments were made that we need to ensure that we maintain a high standard of content.	Do you currently hold a licence?	88%	The 12% who don't hold a licence fall into those who have let their licence drop due to high costs, or are not yet licensed.
Have you held a past AR subscription?	23%	Many people have stopped their subscription because they feel that it is: <ul style="list-style-type: none"> • Late • Not of high enough quality • Lacks technical material 	Do you have access to the Internet?	69%	This is a high proportion when compared with other groups and indicates that we should be using the Internet more to communicate with amateurs.
Would like to subscribe to AR on the newsstands?	46%	There seems to a lot of support for the choice introduced by having AR on the newsstands.	Are you a member of a club	50%	Only around 50% of respondents are club members, or get involved in club activities. We therefore need to find ways to talk directly to these members.
Are you happy with the way that the WIA keeps members informed?	88%	Although many members are happy with current flow of information there were many comments about making it more timely and more frequent.	Sex	99% Male 1% Female	We fail the equal opportunity criteria and definitely need to recruit more women to the hobby.

continued on page 16

A Capacitance Bridge for Radio Work

Drew Diamond, VK3XU
45 Gatters Road, Wonga Park, 3115.

For the measurement of passive radio components, a good inductance-capacitance-resistance (LCR) bridge is still probably the most ideal tool. But they are usually expensive, even second-hand, and do tend to be rather in the 'boat-anchor' category.

Generally, the lowest capacitance range of a low-cost contemporary 3.5-digit DMM has a full-scale reading of perhaps 2 nF (2000 pF), and for routine capacitor measurements, such direct-reading meters are certainly very handy for ordinary electronics work. However, the serious experimenter soon finds that the resolution, when measuring small values, common in radio, is rather poor. So, if it is needed to measure a small variable capacitor for a VFO for instance, whose range may be (typically) 5 to perhaps 15 pF, there is usually insufficient resolution to permit a

satisfactory measurement. Furthermore, such meters do not usually take account of any leakage resistance present in the capacitor under test, as they work on the effect of the total series impedance. Erroneous readings may therefore be obtained where the capacitor has significant internal resistance.

A better method is to use one of the true bridge configurations, such as the classic Wheatstone pattern (Refs 1 and 3). Our ears make an excellent detector in precision measurements. If there is some fault with the capacitor (not uncommon in older silvered micas and

some ceramics), such as low equivalent parallel resistance (high leakage), or excessive equivalent series resistance; the bridge will not balance well, indicated by a "shallow" or vague null. A good, high Q (low D) capacitor will always give a satisfyingly deep null when measured in a true bridge. When building a high-stability oscillator for example, it would be sensible to check every capacitor for correct value, good stability and high Q before installation, thus avoiding the possibility of having to later troubleshoot a wobbly, jumpy (or won't fire-up) oscillator.

Offered here are details of a simple Wheatstone capacitance bridge, made from easily obtained parts. Measuring range is from 1 pF to 10 uF in six overlapping ranges. For instance, on the 10 pF range, 10 pF lies at mid-range of the calibrated 'multiply by' dial, so that capacitors from 1 pF to 100 pF may be measured. On the next range, 100 pF is at mid-dial, which provides a measuring range of 10 to 1000 pF (1 nF), and so on, up to 10 uF. The prototype is a capacitance-only bridge for two reasons; resistance is generally measurable with an ordinary multimeter, and need not be repeated for this instrument. Inductance capability would rather complicate the job, and the extra wiring needed would spoil the minimum measurable capacitance. In any event, for best accuracy, radio inductors are usually best measured at or near their intended operating frequency.

Circuit

Our ears are quite sensitive at about 1 kHz, which is probably why bridge manufacturers chose this frequency very early. In this iteration, an approximately 1 kHz tone is generated by a common NE-555 timer chip (see Fig. 1), wired as an astable oscillator. Wave shape does not particularly matter here. The oscillator signal is applied to the primary of a 3 k : 3 k interstage transformer. The secondary winding (centre tap not used) drives a conventional Wheatstone bridge. Any one of a set of six capacitor 'standards' is selectable with switch S1.

Each side of the 1 k 'multiply by' pot, whose slider is connected to foil- or "ground" ("ground" here is circuit board foil common, not necessarily earth ground) effectively forms the ratio-arms for the left-hand side of the bridge. 100 W resistors at each end of the 1 k pot prevents crowding at the ends of the

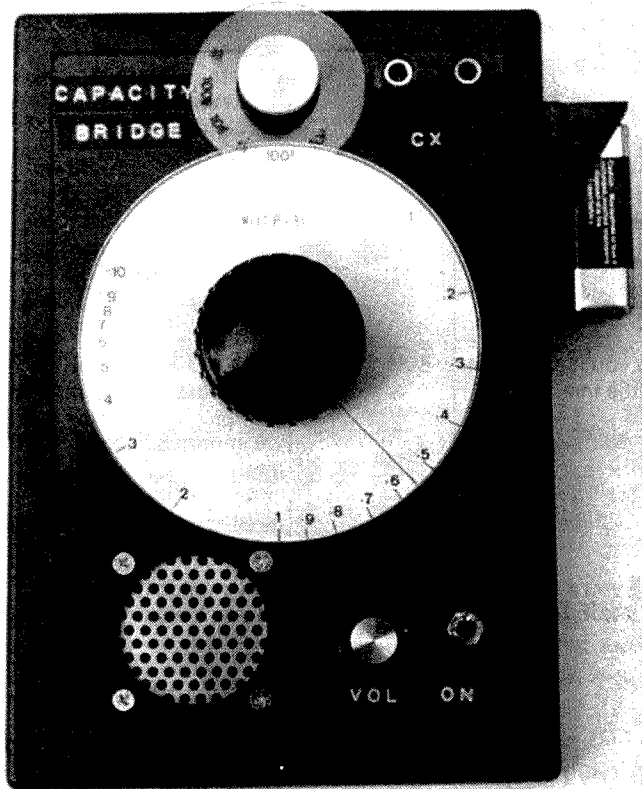

Photo 1. Capacitance Bridge

'multiply by' dial. The 1 k ratio pot thus provides a 100:1 measuring range for each setting of S1, which greatly improves the utility of the instrument, as noted above. When the 100 pF capacitor is in circuit for example, and a good 100 pF capacitor is connected to the "CX" terminals, the bridge will be "in balance" when the slider of the 1 k pot is at about mid-travel. That is, the tone potential between the "Hi" terminal and ground is zero.

The "Hi" terminal is connected to the top of the 25 k (Vol)ume pot, whose slider is presented to the input of a popular LM-386 amplifier chip and 'speaker, wired for maximum gain.

Construction

To keep 'stray' capacitance to a minimum (and thus insure an ability to measure small values), a sloping panel style plastic case, measuring 134 W x 189 D x 32 (55) H mm was chosen to house the prototype. Any plastic case style that you prefer should serve. The 9 V 'transistor' battery and holder may be fitted inside or outside the case, as desired.

A suggested 'paddyboard' (Ref. 2) style circuit board layout is shown in Fig. 2 and Photo 2. Layout is not particularly critical, but wiring and component lead lengths should be kept reasonably short, particularly those associated with the bridge circuit. The '555 and '386 chips may be fitted into 8-pin I.C. sockets, which have fine (about 0.6 mm) tinned wires attached, and are soldered upon suitably sized (about 30 x 25 mm) segmented substrate boards (or you could use 'experimenter' boards, available from DSE and Jaycar), which in turn are super-glued, copper side up upon the main circuit board.

Use shielded wire where shown in order to prevent mains hum pick-up (which would mask the null). The case of the 25 k (Vol)ume pot should be connected to the shielded wire braid as shown on the circuit.

For good resolution on the 'multiply by' dial, it should be as large as can reasonably be accommodated. That shown is a 90 mm diameter aluminium disk, with two coats of white auto spray undercoat paint. The 1 k pot is located at about the middle of the circuit board and case, where the threaded bush is

used to secure these parts. The dial cursor is a same diameter disk of 3 mm thick Perspex which may be machined to size in a "poor-man's lathe" (disk is rod-sawed to approximate size- 1/4" hole drilled into chuck of electric drill in bench vice- smooth file applied to rotating edge). Scribe a cursor line from the centre to the circumference, and fill with black crayon. The disk is then glued to the back of a suitably sized knob.

Calibration and Operation

Verify that all components are wired properly, and that polarized components are correctly oriented- pay particular attention to the LM-386 and NE 555. Set both pots to about mid-travel, and then switch on. You should hear a 1 kHz tone. Connect (say) a known good 100 pF capacitor to the CX terminals. With S1 in the 100 pF position, carefully adjust the 'multiply by' knob for a deep null in the tone, which should occur at about mid-travel. Use just sufficient volume for comfortable listening. Connect various values of capacitance to check the operation of all other ranges, and observe that a good null is achieved on each range.

Obtain a collection of 'calibration' capacitors (preferably 'styryoseal' or 'dipped silver mica' types for stability, low D and low leakage). A set of ten 100 pF caps is suggested. On the 1 nF range; starting with a single 100 pF, progressively null and mark (on your dial- with a pencil) each capacitance from 100 pF to 1000 pF (1 nF) by paralleling units for 200 pF, 300 pF... and so on. These points should be labelled 0.1, 0.2, 0.3 and so on up to 1. The same caps may be used to calibrate the 100 pF to 1000 pF (1nF) marks with S1 in the 100 pF position, which are marked 2 (200 pF), 3(300 pF) 4, and so on. Note that '1' should lie at about mid-range, and the scale of the 'multiply by' dial holds for every range. If desired, use rub-on letters or similar (from stationer's) and apply appropriate calibrations to your dial.

After calibration, you should have a good 'feel' for the instrument. In the 10 pF position, and with no capacitor connected to CX, it should be possible to obtain a fair null right down below the 0.1 position on the 'multiply by' dial- which is just the capacitance of your terminals- something less than 1 pF. Connect a 1 pF capacitor, and check that a good null can be had just a little above the 0.1 mark, thus proving that the lowest range is working correctly. Use just sufficient 'volume' to detect the null- otherwise the null may be masked.

Parts

The components specified are available from our usual electronics suppliers, such as Altronics, Dick Smith

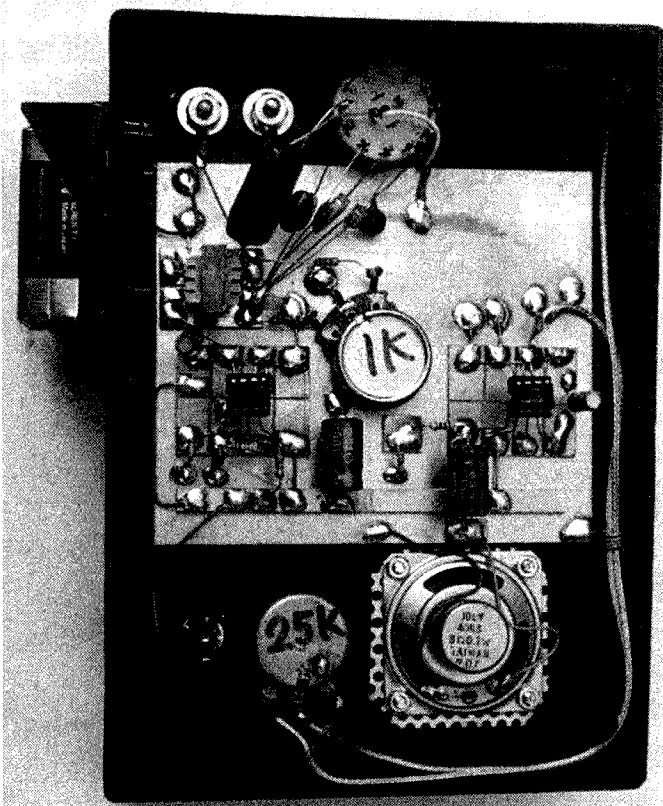

Photo 2. Internal View

STRICTLY HAM

PTY LTD



IC-746 PRO

- Icom **WORK THE WORLD** performance
- The best way to get onto HF plus 6 and 2 metres
 - Multifunction hi-res display
 - Direct frequency
 - Shack or portable



IC-756 PRO/II

- Icom's new HF+50-MHz digital
The performance king Try it to see why
- Multi-colour multi-function screen



TH-D7A(G)

- Dual bander
- Effortless 2m & 70cm
- BUILT IN PACKET
- 200 alphanumeric memory channels
- 6W from 13.8VDC
- Comes with NiCd battery and charger
- APRS compatible



TS-2000

- High performance standards
- Three distinct operation platforms,
 - 1 Traditional transceiver-full front panel,
 - 2 "Silver box" for mobile use
 - 3 The ARCP-2000 computer control
- 100 watts on HF, 6 metres and 2 metres, 50 watts on 70cm,

IC-706MKIIG

Ultra **SMALL**

167(W) x 58 (H) x 200 (D), 2.45kg
Detachable Control Panel/Display
(optional equipment required for remote operation)

SSB/AM/CW/RTTY Narrow Filter Options



TM-D700A

Kenwood's new TM-D700A makes the most of exciting SSTV, GPS, and APRS® (Automatic Packet/Position Reporting (rapidly gaining popularity worldwide), Extra large amber and black display, Built-in TNC offers a wide range of options, inc. simple packet operation using AX.25

Ham radio is truly entering a new era.



TS-50

Mount it in a vehicle, take it on a DX-pedition or use it as a permanent base station transceiver. The easy-to-use menu system adds flexibility,

- DDS with fuzzy control
- 100 Memory channels
- Switchable AGC circuit (SLOW/FAST)
- IF shift Noise blanker (pulse)
- Dual VFOs (A & B)

Outstanding performance



Suppliers and distributors

KANTRONICS-MFJ-DIAMOND-MIRAGE-HY-GAIN-VECTRONICS

14 CHURCH ST BAYSWATER VIC 3153

Phone (03) 9729 7656

email sales@strictlyham.com.au

Fax (03) 9729 7422

www.strictlyham.com.au

Superconductivity: what is it?

Paul Clutter VK2SPC
52 Keats Avenue, Bateau Bay NSW 2261

Superconductivity is a phenomenon occurring in many electrical conductors in which the electrons responsible for conduction undergo a collective transition into an ordered state with many unique and remarkable properties. These include the vanishing of resistance, the appearance of unusual magnetic effects, and substantial alteration of many thermal properties.

Superconductivity was discovered in 1911 by H K Onnes in Leiden, Netherlands while studying the temperature dependence of the critical resistance of mercury within a few degrees of absolute zero. He observed that the resistance dropped sharply to an unmeasurable value at a temperature of -452 degrees Fahrenheit, or 4.2 degrees Kelvin (see Fig 1). This is called the transition or critical temperature.

Between 1911 and 1986 several thousand superconductive alloys and compounds were found including about 50 metallic elements. From 1986 superconductive alloys were found that had higher critical temperatures which only require liquid nitrogen to cool them. Liquid nitrogen is 500 times less expensive than liquid helium for cooling. A compound of mercury, thallium, barium, calcium, copper, and oxygen has a superconductivity temperature of -209 degrees Fahrenheit and only requires liquid nitrogen (-321 degrees F) to cool it.

In 1933 W Meissner and R Ochsenfeld discovered that a metal cooled to superconductivity in a moderate magnetic field expels the field from its interior. This discovery demonstrated that superconductivity involves more than simply very high or infinite electrical conductivity. Today, many research labs around the world are trying to bring the transition temperature of superconductivity up to room temperature which, if achieved, will revolutionise just about everything which requires power to operate.

Huge inefficient power cables would give way to very thin wires carrying all the energy we need, saving power companies and customers billions of dollars a year and also helping to slash greenhouse emissions. That whopping

big power transformer in your power supply would shrink to a quarter its size, with double the power.

In Detroit, Michigan, for example, some 30,000 homes are getting power down superconductive cables cooled by liquid nitrogen. US Naval engineers are building superconductive motors where wires can carry vast currents without heating, resulting in massive magnetic fields, which make extremely compact and powerful motors.

A team in Zagreb, Croatia claim to have developed a new

Today, many research labs around the world are trying to bring the transition temperature of superconductivity up to room temperature which, if achieved, will revolutionise just about everything which requires power to operate.

superconductivity material, a mixture of lead carbonate, lead, and silver oxides which will superconduct up to 30 degrees Celsius. However, they have not been able to supply other labs with samples, raising some doubts; where other labs have the formula they have not been able to produce the results. The Zagreb team say they should have samples very soon. On the down side, as with many new inventions and discoveries, the cost is staggeringly expensive.

An example of this, historically, was the cost of a radiotelephone transatlantic call from the USA to Europe which, in about 1920, cost \$75 for three minutes

plus plenty of QRM! Compare that with similar costs today.

What does superconductivity have to do with perpetual motion? The total reduction of resistance in a device may increase the possibility of perpetual motion. If a superconductive metal is made into a toroid and a current is induced into it, the current will flow around it indefinitely. Adding windings would give everlasting power. Induced currents have been observed to persist in superconductive loops for several years. Very precise measurements of the magnetic field produced by a persistent current using nuclear magnetic resonance over short periods of time have established that the super current decay time is at least 100,000 years. This implies that the resistance in the superconductive state is at least 10¹² times less than in the normal state.

However, the scientific definition of perpetual motion is such that any device must not use any energy in its function and is able to last indefinitely. Scores of ideas which depend on natural forces such as air pressure, temperature, and tides have been submitted to patent offices.

For instance, there are "atmos" clocks, which operate by atmospheric pressure and temperature. A slack membrane diaphragm can detect down to a pressure of 0.00036 pounds per square inch, operating a barometric unit to wind the mainspring. The temperature changes expanding ethyl chloride sealed in a drum operating as an aneroid can run a clock for 48 hours with a variation of only two degrees Fahrenheit. With greater pressure and temperature changes these clocks will be fully wound and run for more than 100 days,

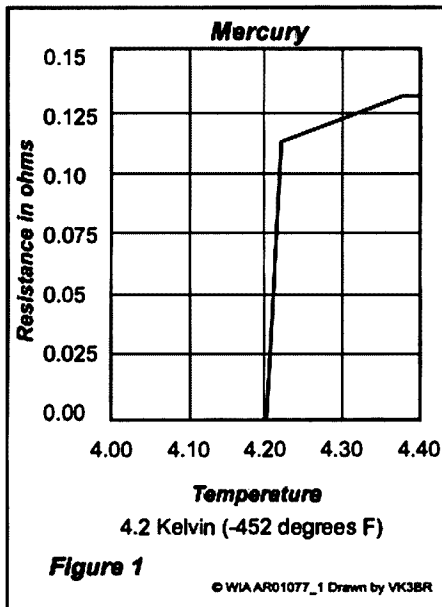

Fig 1 - A graph showing the superconductive transition temperature of Mercury at 4.2 degrees Kelvin (452 degrees Fahrenheit).

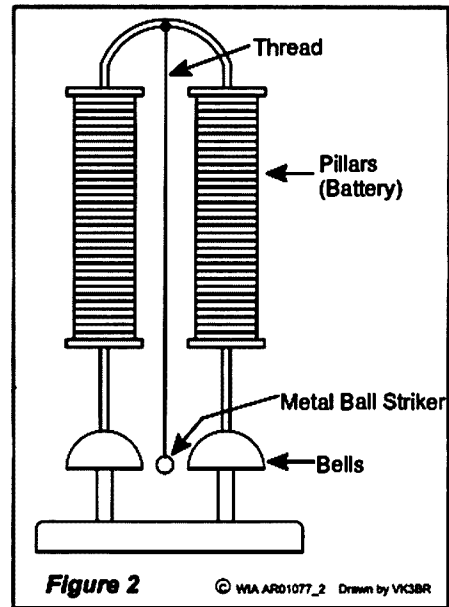

Fig 2 - Bell device which has been operating since 1840 (see text).

depending on their mechanical design. The rotating pendulum is used instead of the swinging pendulum in many clocks because the unwinding power of the mainspring is slower and lasts longer. However, these devices, which depend on natural forces, are not acceptable because the scientists claim that one day there will be no more forces due to the expanding sun, which will wipe them out.

Finally, a bit of interesting trivia. Fig 2 shows a bell device, which has been operating since 1840, the year in which

it was assembled. Reverend Robert Walker spotted it in a London instrument maker's shop. He purchased the bell and took it to Oxford University where he was a Reader in Experimental Philosophy, and it has been there in the university's Clarendon Laboratory ever since. There is no visible mechanical source of energy to account for the continuous movement of the metal ball striker suspended by a thread between the pillars. Each pillar consists of some 2000 pairs of zinc foil and paper discs impregnated with manganese dioxide.

Together, they produce about 2000 volts at an extremely low current. The long lasting batteries are connected to the bells, which give them opposite charges. The ball striker gets a positive charge from the positive bell then becomes attracted to the negative bell which charges it negatively and of course it goes back to the positive bell again. Due to the very low current, the bells will continue to chime until the batteries run out, possibly well into the 21st century

ar

WRC 2003 – Donations

The following are some of the donations that have been received so far.

On behalf of the Directors and Federal Council I would like to thank you all very much for your generosity. Your donations are important to us to ensure that the interests of amateur radio are properly represented at WRC 2003
Ernest Hocking VK1LK - Federal President

VK1DE	VK3NJR	VK2EVK	VK5GN	VK3AAW	VK6LC
VK1LN	VK3OW	VK2EXW	VK5HK	VK3ABT	VK6VK
VK1ZXW	VK3OWF	VK2II	VK5LP	VK3ADM	VK6YR
VK2AGG	VK3UG	VK2KUZ	VK5NWH	VK3AJL	VK7CCC
VK2AJE	VK3UV	VK2NBZ	VK5NX	VK3ANP	VK7KGB
VK2AJN	VK3ZAI	VK2SW	VK5VH	VK3APC	VK7KH
VK2AY	VK3ZCZ	VK2TM	VK6AGE	VK3AQU	VK7RM
VK2BHT	VK4AES	VK2TQ	VK6IU	VK3AYQ	VK7RN
VK2BOD	VK4BHC	VK2YWH	VK6JQ	VK3BCZ	VK7TB
VK2BU	VK4JS	VK2ZIL	VK6JX	VK3BZA	
VK2BVU	VK5AO	VK2ZIP	VK6KC	VK3DKT	
VK2DB	VK5APC	VK2ZOI	VK6KG	VK3HY	
VK2DLY	VK5BS	VK2ZSA	VK6KW	VK3NDNS	
VK2EDP	VK5BX	VK2ZSP	VK6KXH		

How to reverse the direction of a downward spiralling club

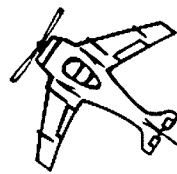

The resurrection of the BMARC

Many clubs are experiencing a downward turn in membership and general interest in amateur radio.

This article is presented as an example of how we can turn our hobby around. There are many more ways to do this apart from what is written here, this is just our story.

By Phil. Derbyshire, VK2FIL
President, Blue Mountains Amateur Radio Club Inc

About six years ago the *Blue Mountains Amateur Radio Club* was sliding down hill. The membership was falling and although the bank balance was in the black, just, only about 15 members (or less) turned up at meetings. We were doing no projects, and the club's two-metre repeater was off line more often than not. When it was on line it did not have a very large service area, and was generally noisy and had interference. The size of the club may sound reasonable, but as the club was going nowhere and doing nothing, there was a danger of further deterioration with a motion on the books to wind up the club.

Sound familiar? I think at least some of it would apply to many clubs today, especially with the added costs now imposed in the way of land rates, rents, insurance increases etc. I think there are a lot of clubs, especially in country areas, looking for a way to turn things around.

What changed?

A new committee which was committed (excuse the pun) to putting the fun and excitement back into HAM radio, and one other further ingredient, MONEY. We were in a position where we had to do something, but did not have the funds to do anything. What was developed was a plan to incorporate all of the above with the aim of having a sustained revival. The committee decided to run the club like a company. This meant we had to make some cold commercial decisions and be adaptable.

Items put on the agenda:

- Increase the bank account balance
- Get the members interested in the club and keep the interest.

- Increase the size of the membership, and keep the members renewing their membership.

- Involve the members in the club projects.
- Find a new location to hold meetings.
- Build a club station.
- Revitalise the 2m repeater.
- Make the club more accessible to others.

The first thing was to find a way to inject additional funds in to the coffers. At the time the FM900 radios came onto the market. We bought a pallet load of them. This was followed but a few



The motley crew for the 2001 John Moyle Field Day at Hill End, John VK2QN, Danny VK2DC, Guy VK2KU, Phil VK2FIL and Stephen VKAVW. This crew came 3rd overall in the contest (a rougher bunch you would not want to see!)



The Rex Black Memorial Trophy is on the left, the trophy on the right is the one given to the recipient.

“workshop” weekends where many members turned up and worked on ALL the radios to convert them to the 2m band. These were then sold off to the members at a fairly cheap price and a dearer price to non-members. The membership rose a little.

Next project was to revitalise the two repeaters. Adrian, VK2BFN, organised for the rebuilding of the 2 repeater, and the 70cm repeater being relocated to be with the 2m repeater at Lawson in the Blue Mountains. The third repeater (for 70cm) was given to the Nepean Amateur Radio Group. The height of the aerials were increased so that the tip was some 80 feet (24.39 m for the metrically minded) above the ground. Given that Lawson is 700 m above sea level, this gave the two repeaters massive footprints. Both repeaters can now be accessed from Shellharbour in the South and as far as Gosford in the North, all this while being mobile. The 2 m repeater has also been worked from as far as Kiama and Mittagong

These two projects stimulated the members very substantially, and increased the size of the bank balance at the same time. The 2 m repeater was seen to be the “flag ship” of the club. We then put a telephone line into it so that it could be controlled remotely by the repeater manager. This meant that, as the repeater is software controlled, it would be more reliable as the manager

could do work on the repeater from home. (The repeater needs only a 486 PC). The telephone line is also put onto divert to one of the committee members. This is so that the number can be advertised for prospective new members. When they telephone, the prospective member can make direct contact with a committee person. We then made it a policy to put an “ident” on to each of the repeaters, using the voice of one of the members’ wives, preferably the one related to the member who did the work on that particular repeater. This was seen as away of involving the family in the hobby.

We also set up a comprehensive web page, set up and maintained by Steve, VK2BGL. This, amongst other things allows prospective members to download a membership application form. This has been extremely successful. The web page also has the current edition of our monthly magazine “Ragchew”. The rest of the web page is taken up with many useful links and the latest news about the club.

Next it was time to find a better location for the clubrooms. This was because we had out-grown the existing location. We first approached the local council with our request. They came up with some suggestions, but we found them to be in a great need of repair, in the wrong location or the rent was too high for us to pay. Then we heard about St Columba’s college at North Springwood. They were running electronics classes for the high school students and they were also putting together a 14 m diameter dish to be used as a radio telescope. They also needed some help to finish the project. We had a member who was a teacher at the college, so we applied for the use of one of their rooms as a meeting room. This all comes at a price; there is no such thing as a rent-free premise. In return we help with radio telescope, and provide help with the electronic classes in any way we can. One of the ideas in moving into a school like this is to foster a “mentor” type situation with the students. The type of help we have given to the

school has been via donations of computers, software and steel cupboards for the storage of electronic equipment.

For some time there had been talk within the club about linking our 2 m repeater via the Internet. Steve VK2BGL started to experiment with various programs and got the 2 m repeater on the Internet and linked with Nottingham in England, an experiment so successful that a number of links were made with places like Italy, Germany, Iceland, and USA to name a few. This was the beginning of us all hearing the foreign call signs on our local repeaters.

IRLP first

We had for some time been trying to link up with a “sister” club overseas. We found the Blue Mountain Amateur Radio Club in Collingwood, Ontario, Canada. On making contact with the club’s President, Doug Measures, VE3TVD, he told us about the IRLP system that was being set up in Canada and the USA. At that time I think there were only about 20 nodes in the world, and these only in Canada and the USA. We were put in touch with Dave Cameron (in Vancouver) who developed the IRLP system. Peter VK2YX picked up the ball and made all the necessary contact with Dave and bought in a board and software. From this he put together the first IRLP node on the East Coast of Australia (the first node in Australia was in Fremantle in VK6). This node was connected to the 2 m repeater (VK2RBM). This created a lot of interest

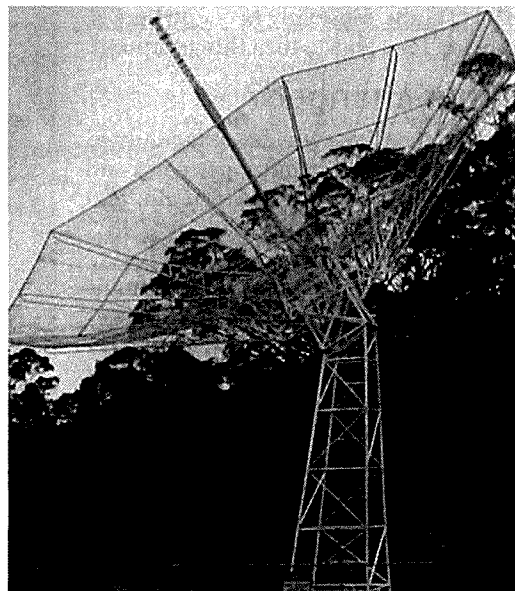

14m Dish radio telescope at St Columba’s

in the repeater and it soon became probably the most used repeater in Sydney. Peter then embarked on a series of lectures to various clubs through out the state on the virtues of the IRLP system. The rest is history.

Q News

The next experiment Peter embarked on was the relaying of "Q News" over the 2 m repeater. This was met with fair success, but did stimulate a lot of interest outside the club. This is still in the experimental stage as we have problems with the electricity supply at our Lawson site. But these problems will be solved soon and the "Q News" will return to air. At this time I would like to make a point to all. It has been said that this relay of "Q News" is set up as being competition with the WIA broadcasts. **THIS IS CERTAINLY NOT THE CASE.** This is set up as a service to the amateur population in general and to try and stimulate interest in HAM radio.

Trophies

It was decided that an incentive type award was needed. An annual trophy was introduced. This is the "Rex Black Memorial Trophy". There are two parts to the trophy, the perpetual trophy, and a smaller trophy, which is presented to the winner. The trophy is given to a member who has shown exceptional service to the club, amateur radio or for self-improvement. The trophy takes the form of a transmitter valve (like an 813) set on a trophy base. The perpetual trophy is a vacuum capacitor (from a large commercial transmitter) on a trophy base. On this all the winners names and call signs are engraved with the year in which these people won the trophy.

Ways to raise money for projects

Two ways we raised a lot of funds were by having regular impromptu auctions. These were not advertised and were generally organised via one of the committee members. These were not advertised on purpose. This way members did not know when the auctions were and had to come along to find out. (There! The secret is out, fellow members!!!) The other thing we did with the auctions was to make sure that anything which was sold was of quality.



2002 John Moyle Contest. The HF station as seen from the VHF station

No junk! The club also set up a shop. This is run every meeting and again only quality and cheap prices. We gave the shop manager, Adrian VK2BFN, a float and he buys up in bulk from whatever source he sees fit.

These two activities are a continuing source of funds. On some nights we make as much as \$200 from either. We have also run several raffles, the prizes being open money orders at Dick Smiths, and sometimes bottles of port. John VK2IUI has donated two Realistic 10 m radios over the past 12 months. These were raffled over extended periods (like 6 to 9 months) and were great fundraisers. One other way we were able to raise funds was through donations to the club.

This was in the way of members and "friends of the club" donating amateur radio or related equipment, the total funds from these going to the club.

Foxhunts were another activity in which the club engaged. These were generally held on a Friday night and ended with a port and biscuits supplied by the fox. On other occasions these were held on the weekend and concluded with a BBQ. The fox for these



2002 John Moyle Contest. Inside the HF station Andy, VK2TVI at the controls

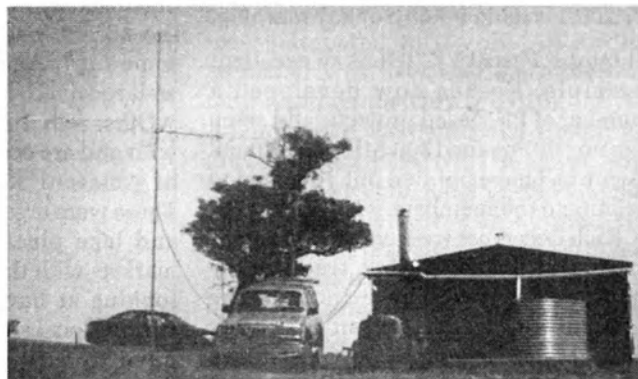

2002 John Moyle Contest – the VHF station. The two stations were within 400 m of each other, this ensured no cross band interference.

activities was generally Danny VK2DC or Steve VK2AVW.

The next project is getting something happening on 6 m FM. Currently we are building a 6 m repeater. This project should be on air early in the very near future and currently is fairly well advanced. The follow up project is a 10 m repeater.

To show you some of the projects that have come from items sold at these



2000 John Moyle Contest. Pascal, VK2IHL at the controls of another part of the HF station



2000 John Moyle Contest. Dave, VK2JDC waking up on Sunday morning.

auctions, Pascal VK2IHL is an excellent example. He has now developed a number of PIC based projects, and some pre amplifiers for 1296 MHz and 70cm. Again as I have pointed out you need to stimulate the members.

Each December we have the Christmas party and this is the time we have the giving of prizes. These include the "home brew" competition and "Rex Black Memorial" trophy. At the AGM we have prizes for "operator with the most successful net".

Our magazine, "Ragchew" is another area we improved. For years it was only one double-sided page. Kevin VK2KEV took over the editing of the magazine and completely revamped it. Now it contains photos and is usually around 10 pages and on some occasions has reached some 20 odd pages. There are even some paid adverts with its pages. If you wish to see a copy of the magazine, go to our web site and download it.

Membership increasing

Now we get between 25 and 40 turning up at meetings. The membership has just reached around 100 in number. The members are from as far away as Davidson, Newtown, Concord, the Sutherland area and Liverpool. I might add that the members in these areas do turn up at North Springwood for the meetings on a Friday night. The members are also delegated tasks; all the hard work is not left just to the committee.

Another area that was well covered was the area of education. This was carried out by Terry VK2UX, and assisted by Dave VK2IH and Adrian VK2BFN. Terry did the lower Mountains while Adrian did the mid and upper Mountains. With members referring any and all non licensed enquirers, they were faced with carrying out classes spread out over several days during the week.

Two of our members, at different times, have organised 2 m FM contests. Initially these were organised by Guy VK2KU. Their primary object was to stimulate interest in VHF generally. The contests ran for a few years and had a consistent number of entries each year. The contest was organised for the VHF DX Group, but with the backing of the Blue Mountains Amateur Radio Club. In 2001 another similar contest was organised by Roger, VK2TEA. This time the accent was on "Get up and have some fun". And again the contest was well received.

Other activities we have been involved with and are continuing with is a series of Amateur Radio demonstrations. These were organised by Dave, VK2JDC, and take place at various week end markets with the local area. We are also looking at having demonstrations at various local shows. This will mean we have to hire an area and set up a demonstration over two days.

We are regular participants in the "John Moyle Field Day" contest. We usually make it a camp-out affair and have even used it as a demonstration to the public. In this case we advertised our presence in the local newspaper.

Other fundraising has been through a car boot sale held in conjunction with the Nepean Amateur Radio Group. This was fairly successful and we are looking at this with the view of holding a "Hamfest" in the West of Sydney. On a club level we have organised club badges, club T-shirts, and is now looking

at club caps and mugs.

After each meeting there was a talk which took the form of a lecture on an amateur related topic, or other subjects as diverse as astronomy with viewing nights. Also during the evening we hold a raffle or two. The prizes vary from port to open orders at Dick Smiths or similar, as mentioned earlier.

Contact information for BMARC

Postal address: PO Box 54
Springwood NSW 2777.

Club callsign: VK2HZ 10m

Repeater: 29.680 MHz - (Under construction, on some time in 2002)

6m Repeater: 53.875 MHz

2m Repeater: 147.050 MHz +
70cm: 438.375 MHz

Web page: <http://www.qsl.net/bmarc>

Telephone Number: 02 4759.3950

2m net: Wednesday night at 2000 hrs
on 2m repeater 80m net:

Tuesday night at 2000 hrs on
3.543 +/- QRM

Meeting Location: St Columba's
College Hawkesbury Road North
Springwood

Meeting Time: 2000 hrs, first Friday of
the month.

Well there you have it

I guess what I am really saying is that you need a hard working committee (and club members), open minds, lateral thinking, and little bit of money does make it easier. All of the above ideas may seem like simple and small things. Individually they probably are, but collectively they work.

The other trick is to keep up the momentum. That is where the real gain is. The one last thing I can not stress enough is that all this is not the work or the ideas of just one person. It is a collective effort, and that is what makes the difference. The committee cannot do all the work. Members have to take on the responsibility of making the club work for them. After all, the club represents the members as a collective body. The other important thing is make sure you keep the members' interest. If you do this they will keep coming to meetings and other events organised by the club.

ar

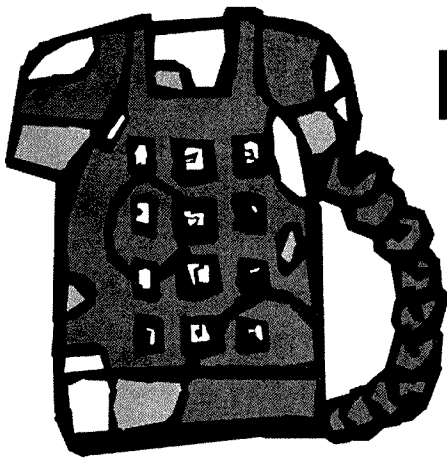

DTMF encoder from an old telephone

Don Grumble, VK6KAR

Parts needed:

- A suitable plastic zippy box,
- old push button telephone (series 800 type is good),
- A 100 ohm 1/4w resistor,
- 1 TIP29C or TIP31 *OR* similar NPN transistor *OR* BD679 NPN Darlington pair transistor with a 4k7 ohms 1/4w resistor, or other audio amplifier,
- an 8 ohm speaker, suitable switch,
- 9 volt battery snap connector, (AA battery holder and power socket are optional items).

Generally in almost every push button telephone there is a DTMF encoder chip capable of producing the DTMF tones for the IRLP repeater system.

I had an old push button telephone amongst my Junk box called a series 800 telephone that was only capable of pulse dialling. The dial on this old Telstra telephone has a push button assembly that is easily removable.

The chip on it was found to be a Mostek MK5089 and this chip is capable of both pulse dialling and DTMF (not used) dialling functions.

The assembly contains a large zener diode that knocks the DC level from about 50 volt down to 5 volt for this chip. I wired a 100 ohm resistor to the cathode end of the zener diode and fed +9 volt into the zener via the resistor (The anode was connected to 0 volt. An audio amplifier was used to determine the output pin on the chip (PIN 16).

Then pin16 was connected directly to the base of a TIP29C NPN transistor, the collector was connected to +9 volt and an 8 ohm speaker was connected between the TIP29C emitter and ground (0 volt). A TIP31 NPN or other similar transistor will also work well. A BD139 should work equally well.

The circuit works well with voltages from 9 to 13.8 volt and I put in all together with transistor and speaker in a plastic zippy box.

I have opened other push button telephones and have found that they all had zener diodes in them (some had two zener diodes) after 2 bridge rectifiers (bridge is used to convert the AC ring voltage to dc).

The zener diode or diodes will be in close proximity to the bridge rectifiers. The cathode end on the zener diode is often indicated by a black coloured band around its body or "thinner" on cathode end (see diagram).

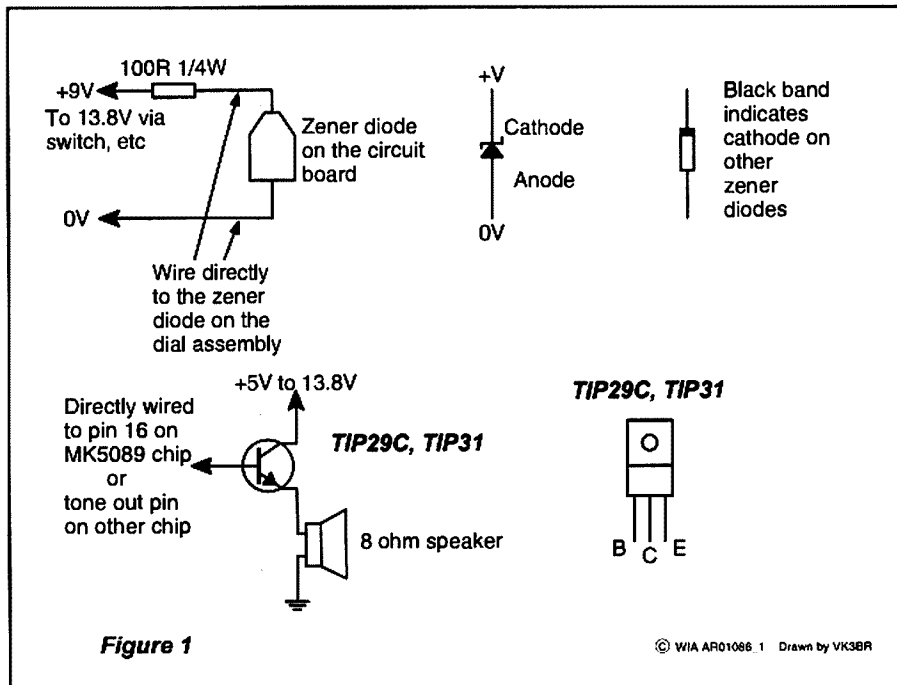

The wiring to the on board zener diode and the output circuit

I could use all of these other push button telephones to produce DTMF tones by similarly wiring a series resistor to the zener diode and use an audio amp to find the output pin. The output can then be fed in to a single transistor or a Darlington pair transistor stage such as a BD679 or similar via a 4k7 ohm resistor on the base lead.

You could also use a separate audio amplifier if you wanted to be over careful not to blow up the DTMF chip (The chips will easy handle loads down to 500 ohm minimum at 5 volt so don't connect the speaker direct to the chip).

Many of these DTMF chips will work on a large voltage range (3 to 10 volt), 5 volt seems to be a happy level in the middle, to assume all these chips will work on. So wire in a series resistor on the relevant zener (diode or diodes) and away you go.

Data on various DTMF chips (obtained from the semiconductor manufacturer Internet sites):

Philips PCD3310 20pin DIL chip
TONE OUT=pin 3
VDD (+5 volt)=pin19
VSS (0 volt)=pin 4

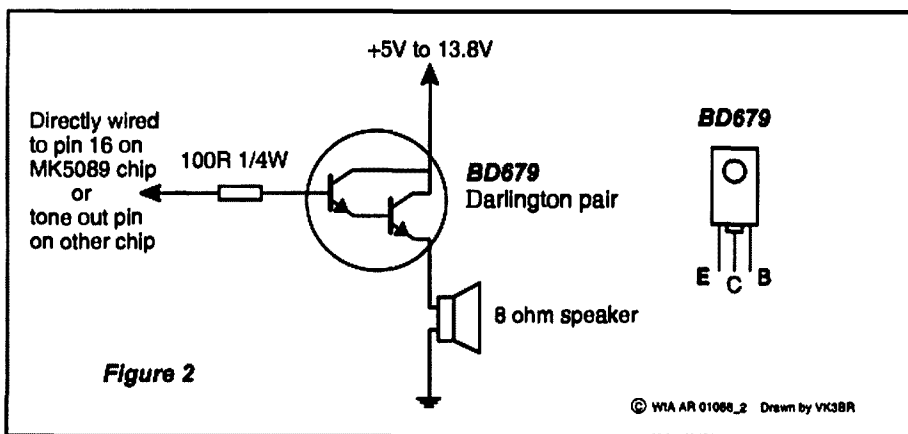

Figure 2

Alternative audio output circuit

Motorola MC145416. 20pin DIL chip
TONE OUT=pin19
VDD (+5 volt)=pin 2
VSS (0 volt)=pin 7
Motorola MC145412, MC145413,
145512. 18pin DIL chips
TONE OUT=pin18
VDD (+5 volt)=pin1
VSS (0 volt)=pin6

Mostek MK5087, MK5089. 16pin DIL chips
TONE OUT=pin16
VDD(+5 volt)=pin1
VSS(0 volt)=pin6

WIA Comment

continued from page 3

I would like to offer any amateur the opportunity to talk to me directly on any matter of concern either via my mail box or email.

In conclusion the survey indicates a number of areas which we need to improve. I will be talking to the council and the executive over the next few months to see what we can do to address your comments.

Other Business

Apart from dealing with the survey, and writing to many of you who so kindly included personal comments this has been a very quiet month on the Federal scene. I can though report that the ACA have made a start on the evaluation of a new set of examination papers.

Operating and Experimentation

This month I found myself at home for a few days having injured my back and had the opportunity to do some amateur radio. Stuck in a chair for most of the

day and unable to move I was curious to see what I could do. Obviously homebrew was out of the question, but what about operating. Not so easy since getting to the shack was too difficult. Fortunately I own a transceiver with a remote control facility and the computers in the house are all networked together. So with a little ingenuity I was able to remotely control the transceiver. How though was I to key the transmitter? I tried using the SpeakFreely software package and instead of a microphone connected a morse keyer to the microphone socket on the PC next to my chair and lo and behold I was on air (at least on 2m with the signal monitored on a hand held). I cannot report any cw contacts from the lounge yet but now that I know that it can be done I look forward to being able to try a live QSO. All in all it reminded me of the fun to be had in the hobby.

I will bring this issue to a close and wish you all 73s. I look forward to hearing your views on any amateur radio

related matters and hopefully circumstances will permit me to meet with many more of you over the next 12 months.

Ernest Hocking VK1LK
email: president@wia.org.au or via PO
Box 691, Dickson, ACT 2602

Silent Keys

The WIA regrets to announce the recent passing of:-

- D (David) Parry VK2CX
- A D (Alan) Cook VK3AUC
- J C (Jack) Mathews VK3SY
- R Crawford VK3URC
- W S Strong ZL3TX

More interesting Pre-War QSLs

Hon. Curator: Ken Matchett VK3TL
4 Sunrise Hill Road, Montrose Vie 3765
Tel: (03) 9728 5350

W8CBF: prayers for kidnapped baby

This is a pre-war QSL dated 5 March 1932 and was sent to VK3HL, the late Allan Hutchings, known throughout the world of amateur radio as one of its greatest DX-ers. Allan obtained his experimental licence (as it was then known) in 1922 when 'spark' ruled. He became a 'SK' in 1973. The QSL was sent from Columbus, Ohio by James A. Porter.

At the time of the QSO the prefix W was allocated to Stateside licensees, K being allocated only to external territories such as Alaska and Hawaii. The W8 prefix was allocated to Ohio, New York, (all counties not included in the W2 allocation), Pennsylvania, (all counties not included in W3) as well as West Virginia and part of Michigan. After World War Two prefix allocation became much simpler, whole States being allocated a particular prefix. (The situation has, during the last few years, changed again since it is no longer possible to associate any callsign with a particular State of the USA.)

In his report Mr Porter uses the old form of signal report QSA5. R6 (Strength readability) and QRI-PDC (Tone: Pure D.C). The 210 valve used here as an oscillator and frequency doubler was one of the most popular valves of the late 1920s and early 1930s. It was a low power triode with one of the new ceramic bases and had a peak power output of 15 watts.

One of the most interesting features of this particular QSL is the remark 'I sent your expressions of Hope of Baby to Lindbergh'. Apparently this QSL was in response to Allan Hutchings' comments on the tragic Lindbergh

kidnapping and his hope that the child would be returned safely to its parents. Charles Lindbergh was, at the time of this QSO, an aviation hero who, in his Ryan monoplane, 'The Spirit of St Louis', had successfully made the first non-stop flight from New York to Europe (20 May 1927). Soon after, he married Anne Morrow, the daughter of the US Ambassador to Mexico. Prayers for the kidnapped child were offered throughout the world but remained unanswered. His infant son was found dead, the kidnapper being subsequently convicted and executed.

425 FRESB AVENUE	★ ★ ★	COLUMBUS OHIO
RADIO <u>VK3HL</u> Acknowledging QSO <u>MRH 5</u> , 1932, at <u>6.15 A^M</u> E.S.T.		
UR SIGS QSA <u>5</u> R <u>6</u> QRI <u>PDC</u> QRM <u>SKM</u> QRN <u>SKM</u> QRG <u>40</u> MC.		
A R R L	W8CBF	A R R L
XMTR: 210 Xtal, 210 Doub., 50 Buff., Ux 852 Amp. RCVR: 1 RF es 2 aud.		
Remarks <u>I sent Expressions of Hope of Baby to Lindbergh.</u>		
PSE QSL? <u>YOUR</u> GIVE US A BUZZ <u>"4TB AS"</u> JAMES A. PORTER, Opr.		
<u>Copied You on Loud Speaker sure FB, 73</u>		

continued next page

ARTHUR D. EVANS, 21 Glyndon Ave., Brighton, S.5., Victoria
AUSTRALIA

V
K
A
D
E

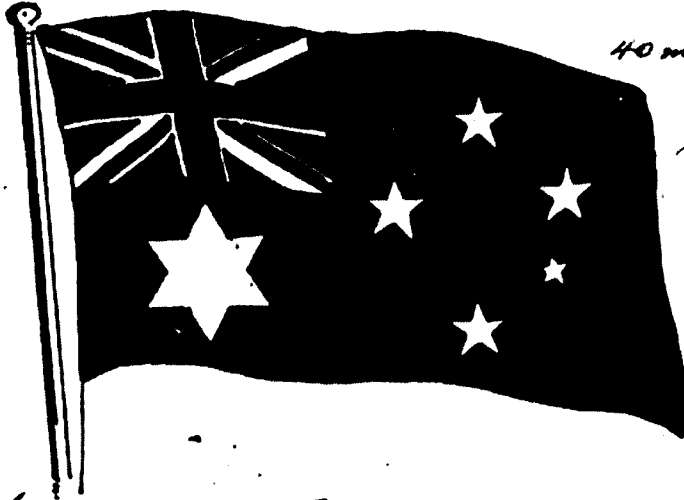

ANTENNA

40 m ² wave *gfh*

RECEIVER

of det & pentode audio

TO RADIO

VK5 DC

Yr. *phone* sigs.

recd hr. *12/5/35*

from *10.52-12.15*

to 4.0 P.M.E.S.T.

Q.R.G. *4.0* mx.

R.A. Q.S.B. Q.S.A. Q.R.H. Q.R.N. Q.R.M.

Remarks *Notes under: Dull & overcast - occasional rain*

P.S.E. Q.S.L. O.M.

Best D.X. and 73 *Arthur*

(P.T.O.)

VKADE: SWL feedback much appreciated

Not a QSL card missing a numeral in its prefix but a pre-war short-wave listener (SWL) report. Reports from SWLs were much welcomed in pre-war days since DX and even interstate contacts were not easy to obtain, considering the relatively simple equipment (almost always 'home-brew') and the low power used.

Callsigns used by SWLs took many forms such as VK3QSL, VK-DX and VK-SWL. Like the QSL shown, the initials of the SWL were frequently used in the callsign. This particular QSL dated 12 May 1935 belonged to Arthur D. Evans, currently VK3VQ and the Hon. Secretary of the Radio Amateurs Old Timers Club

of Australia. The QSL is rather unusual in that it is amongst the very few pictorial QSLs printed before the war.

Arthur's contact was on the 40 m band with VK5DC Elmore Shepard, 'the Voice of Norwood', who was licensed at the time to play music on the air. In fact, on the reverse side of the card Arthur gives

some details of his reception of the song 'Smoke gets in your eyes'. The hours of commercial radio transmissions were, at the time, not as extensive as they are today, many listeners throughout Australia welcoming amateur radio transmissions, particularly on a Sunday morning.

**Great Service
and Local
Support**

Shop with **A
R**
Advertisers

Are you handling the estate of a SK?

The WIA National QSL Collection could benefit greatly by your forwarding to the Hon Curator any QSL cards belonging to the deceased estate.

Postage costs can be refunded, but please first phone Ken VK3TL the Hon Curator of the collection on (03) 9728 5350.

Your assistance and help would be most appreciated.

Ken VK3TL

SEANET 2002 Convention

Perth November 1st, 2nd & 3rd.

By Barrie Burns VK6ADI

The 30th Seanet Convention will be held in Perth W.A. on the above dates and hosted by the Northern Corridor Radio Group.

I have been involved with Seanet for over 10 years and felt the need to put pen to paper and tell my fellow VK Amateurs of my enthusiasm and experiences of being involved with the Seanet organisation.

For the uninitiated, Seanet stands for South East Amateur Radio Network

Seanet was established in 1964 on 20 metres (14.320MHz) commencing 1200 UTC.

The objective of the Net is to promote fellowship among the Hams as well as passing on DX news, testing radio equipment and handling medical and emergency traffic.

The early Amateurs involved in the Net decided to have an "Eyeball Meeting" and the first Convention took place on an Island of Penang, Malaysia, in December 1971 and was attended by about 30 Amateurs.

Since then the numbers have grown to up to 200 - 300 delegates at some of the Conventions and include many Countries attending outside of Asia.

I first became involved in Seanet in 1992 while I was in Darwin. My callsign was VK8DI which I still retain and may be remembered by quite a few of my fellow hams as I was quite active from Darwin for over 30 years.

In 1990, Gary VK8GW, gave us a talk at the Darwin Amateur Radio Club on his attendance to the Seanet Conventions in Malaysia and Thailand and told us of the great times and friendships he made with the South East hams.

He convinced the DARC members that Darwin should host a Seanet Convention to promote Amateur Radio in Australia and this took place in 1992 and was attended by approx 60 delegates and partners from overseas.

With the success of this one, Darwin was host again in 1997... this too was very successful

The Convention runs over 3 days with fellowship, banquets, tours and Technical planetary and discussion sessions organised by the host country.

In 1994 I attended my first overseas Convention held in Malacca, Malaysia and never looked back since.

So how come Perth got it in 2002 when we are outside the South East Asia region.

I moved down to Perth in 1997 when I retired from the N.T. Public Service and settled on a little 100 acre property just outside of Beverley with my XYL Judy.

In the year 2000 I attended the Seanet Convention in Pattaya, Thailand as a VK6 with two other delegates from W.A., Ben VK6XC and Eddie VK6AEA.

During the Convention we were approached by several Asian hams about the chances of having a convention here in Perth as a lot of them relate to Perth through business, family and property interests, besides they said, it is the prettiest state in Australia!

The three of us discussed the request and decided that if we can get a Radio Club in Perth to support us We would give it a go.

We approached the Northern Corridor Radio Group with our submission and to our delight the members supported the concept as it gave them a challenging project as well as helping to promote Amateur Radio in Australia. They could also combine the Convention with their annual "Ham Fest" exhibition for November 2002.

The NCRG is a very progressive club with some 60 odd members and operate their own station VK6ANC as well as Repeaters, Packet Radio and IRLP networks.

For those who have not been to one of these Conventions, I would urge you to give it a close consideration as Perth is a good place to visit in November and the experience that is gained by meeting and "eyeballing" fellow hams from overseas is unsurpassed as well as participating in events arranged by the host club.

Additional information on the Seanet Convention can be

acquired from our web sight www.qsl.net/seanet2002 or by writing to Secretary Ben Koh VK6XC PO Box 73 Forrestfield W.A.

The Seanet 2002 Committee members are -

ChairmanTrevor Ward VK6HTW

Secretary ... Ben Koh VK6XC

Treasurer ... Eddie Reece VK6AEA

Hospitality ... Barrie Burns VK6ADI

Technical James McBride VK6FJA

Advisers Ian Johnson VK6HWJ & Ebby Lucas VK6DJ

Oversea coordinator ...LikWei VK6YLV

The committee and NCRG members wish to acknowledge and thank the Federal and State WIA for their financial support in running this Convention as it will benefit the awareness of Amateur Radio in Australia.

Looking forward in seeing as many VKs as possible in Perth in Nov. 2002.

73s de Barrie VK6ADI/VK8DI

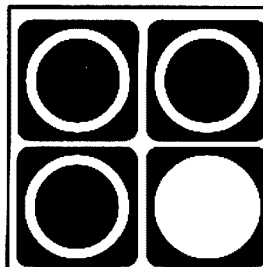

SEANET

SEANET has no permanent Secretariat as such, the devoted net controllers work out a schedule among themselves to run the net.

It is through the net controllers that the net has been useful in many ways such as passing news on DX and DX-peditions, handling emergency and medical traffic amid assigning frequencies for stations wishing to work each other, although SEANET is not a DX net.

Members of this 37 year old network that spans both the most crowded areas of the world Indonesia and most sparsely populated Micronesia, can take credit for many actual life saving communications activities, such as answering distress calls from yachts and handling traffic for medical emergencies and special medicines.

SEANET  **2002**

The Contest

Saturday 24th August at 0600 UTC to Sunday 25th at 1159 UTC.

August is a busy month on the radio. For ALARA members our own Contest is the most important. Let us *all* participate this year. Let us renew the special YL friendships that are part of membership of ALARA by talking to each other, not just once, but several times during the ALARA Contest.

With the new format introduced last year we can make contact with each other again and again as long as we allow at least an hour between contacts, and the two evenings also allow us to use 80 metres twice. So let us not miss out.

The Contest runs from Saturday 24th August at 0600 UTC to Sunday 25th at 1159 UTC. Mark it in your diary now.

The ALARA award and the 33 Award

As always, contacts made with ALARA members in our contest are permitted for inclusion in the list of ten (10) contacts with YL VK/ZL members - from at least five call areas - that are the requirements for this award. It is an attractive addition to your "Brag Board" as it has pictures of all the flower emblems of the Australian states in colour on it.

Applications for this award should be signed by two other amateurs who have sighted the ten recorded contacts in your log book and sent to Jean Shaw 10

OMs, please join in this very friendly contest. We love having you there and having a chance to chat with you. There is less pressure to make a massive number of contacts in the ALARA Contest than in almost any other radio contest, so hopefully we will see you there.

We were delighted to have a winner of the Florence McKenzie Trophy last year, when Pat VK3OZ won it, so let us try again this year. Pat is one of the regular CW operators among the YLs these days but she is not alone, we all can send and receive a CW contact even if we do not do so often.

Florence McKenzie was, we think, the

Huntingfield Dve, Hoppers Crossing 3029.

The 33 Award is for all amateurs who work 33 different YLs on any frequency or band (not including repeater contacts) during 2002.

A log showing the frequency, date and time and the first name of all the YLs contacted should be sent to Jeanne Parker WA6UVF 28400 Vista del Valle, Hemet, CA92544

Please enclose an IRC with your log which must be postmarked before Dec 31 2002.

If you read the rules of the contest you realise that whatever your licence type you can participate in the Remembrance Day Contest. Whether you have had your licence for years or are a new licensee you will find there is a large difference in the activity on the air during a contest compared with that at normal times. Contests always seem very exciting. Have a go this year, whether you have done so before or not, but be sure to put your log in if you make even as few as five contacts.

Logs count toward your state score in the Remembrance Day Contest so are very important. All the details for sending in your logs are in the June AR on page 43. There is a snail mail and an email address.

very first YL operator in Australia so it is fitting that her trophy is awarded for CW contacts. She also taught thousands of men and women CW during WW2 so they could help our war effort as Jean Hillier (*AR June 2002 "Women in Radio"*) did. If you hear someone ask for a CW contact, please help them make up the numbers for our special trophy. Anyone asking for special contacts will be patient if your speed is not very high, but do *have* a go.

Most importantly in the ALARA Contest, send your log in to the Contest Manager, Marilyn VK3DMS 99 Magnolia Street, MILDURA 3500 or by email to gdsymes@hotmail.com

A few small tips on learning CW

Monday Net recently discussed how to learn for your CW exam. Everyone agreed that once you know your letters there is only one way to prepare for the exam. That is to listen, listen, listen - writing down what you hear all the time.

About how to learn your letters there was more discussion. Some learned the letters in the order of the alphabet a,b,c... Some started with letters that have only one or two or three similar sounds e,t,i,m... Some started with letters that have opposite sounds a,n, r,k.. I learned using the system devised many many years ago by Margaret Mills G3ACC.

We all, except one, "heard" the sounds as 'dit and dahs', except Mary VK5AMD. She had no one to teach her or to tell her that that was the standard way to 'hear' the sounds so she learned them as 'pips and peas'.

However Mary had one special assistant. One of her daughters was a pianist. This lass made up sentences using the letters Mary was learning at that stage, then she 'sent' the sentences as a series of 'pips and peas' using just one note on the keyboard.

There are many ways to learn the same skill.

Editors Note: *There is a good Learning program on the NZART web site and also I think on the TARC site*

Remembrance Day Contest

The Remembrance Day Contest is on the weekend of August 17/18th and runs from 0800 UTC on Saturday evening to 0759 UTC on Sunday. While I doubt if too many of us will be staying up for the whole 24 hours I hope to see you on air sometime during that weekend.

While we none of us wish to glorify war we should acknowledge the sacrifices made by our men and women in the services during those crucial years. One way we can say "thank you" to them is by participating in the Remembrance Day Contest, especially if we are there at the starting of the contest and listen to the opening address.

Over the years there have been some very prominent people giving that address and I am sure this year will be no exception.



TTS Systems Communications Equipment

Systems

FREE CATALOGUE

www.ttssystems.com.au

Check our range of easy-to-assemble amateur kits

Automatic antenna tuner Kits

LGD RT11 Remote 125 watt



Remote control for RT11



LGD AT-11MP 150 watt with SWR meter.



LDG Z11 QRP ANTENNA TUNER

Accessory Kits

- 300 Watt RF Dummy Load
- TTS-450 4:1 Balun
- High Power 40 to 500 pf variable capacitor
- SWR Bridge & Wattmeter
- Active receive antenna
- Budget electronic keyer
- Transmatch tuning bridge
- Microphone speech processor
- Broadband preamp DC to 1GHz

Transceivers/Transverters/Receivers



TEN-TEC
2 & 6 meter transceiver kits:

TEN-TEC
QRP CW HF transceivers kits

TEN-TEC
HF Receiver kits

TEN-TEC
2 & 6 meter transverters



Ten Tec 1254 receiver Kit



Ten Tec HF DSP RECEIVER



Ten Tec Jupiter HF DSP Transceiver



Ten Tec RX 320 PC Radio

All kits include easy to follow step by step assembly instructions.

You supply the soldering iron and basic tools!!!
All kit products can be supplied fully assembled and tested.

We now stock Amidon Iron Powder and Ferrite Cores — Call for an application guide

Phone 03 59774808. Fax 03 59774801 info@ttssystems.com.au

Club News

Adelaide Hills Amateur Radio Society

The Mid-year Dinner was moved forward to June this year at the request of the chef at the venue AHARS uses. The diners agreed it was a good idea to make the move so the dinner could be before the regular chef went on maternity leave.

The meal was delicious. This year there were no complaints at all from club members. It is not always easy to please everyone, whatever the activity.

The meeting in August will be back to the normal venue, the Blackwood High School in Seymour Road,

Blackwood. It will start at 7.30 although many members arrive before that then to take advantage of any bit and pieces available for purchase, on the back bench. There are often odds and ends from deceased estates or someone's shack cleanout. Someone else's junk is

always treasure to someone. All proceeds from these items go into club funds.

The topic for the evening in August will be "What to do When.." It should be an interesting meeting.

There is a website for VK5BAR on the WIASANT information board.

Northern Corridor Radio Group HAMFEST 2002

HAMFEST 2002 will be held on Sunday the 3rd of November 2002 at the Cyril Jackson Centre in Bassendean, Western Australia. This is the same venue as last year. It will start at 8 am for Sellers and 9 am for Buyers and will finish at 1 pm.

This year HAMFEST will be held in conjunction with the SEANET (South East Asia Network) Convention. SEANET always attracts a large group of overseas visitors and thus this HAMFEST will provide a great opportunity for local exhibitors to show their wares.

The kitchen will provide a range of snacks and drinks and a place to sit and

enjoy these whilst you have an eyeball with new and old acquaintances.

Country and interstate visitors can, if they choose, stay overnight at the Acacia Hotel (incl Breakfast) and attend the SEANET convention Grand Dinner on Saturday night. Prices and details are available on the SEANET webpage.

There will be a number of attractive door prizes on offer.

For further information:-

NCRG webpage:

<http://www.ncrg.org.au/>

SEANET webpage:

<http://www.qsl.net/seanet2002/index.htm>

HAMFEST:

jackborthen@bigpond.com

SEANET: vk6xc@qsl.net or vk6xc@eon.net.au

PLAN AHEAD

SEANET  **2002**

Convention

1 - 3 November 2002

hosted by

Northern Corridor Radio Group

NCRG HAMFEST

SUNDAY 3 November 2002, 9am - 1pm

at the

Cyril Jackson Centre in Bassendean, WA

Club Secretaries

This is your page

Publicise your coming event, or send news of your club to:

The Editor
Amateur Radio
34 Hawker Crescent
Elizabeth East SA 5112

or email:

edarmag@chariot.net.au

A sad day at Newstead

On May 16, I stopped monitoring at my former site at Newstead, after 45 years of pleasurable listening and DXing.

I started off early in 1957 with a Kreisler D/W mantle radio, which had 540 to 1650 kHz and 6 to 18 MHz. In those days there was no digital readout so one had to rely on the announced frequencies. On short-wave the set also had a 910 kHz image which made it difficult determining which was the correct frequency.

I can remember that the first station I heard and logged in 1957 was, not surprisingly, the ABC Domestic Short-wave service from either Melbourne or Sydney on the 49 metre band. Sadly they are no longer with us.

My first antenna was just a string of wire slung up on to a curtain rail. It worked until I managed to get a proper outside antenna up a few weeks later. It was approximately 54 feet in length and a single strand wire. Ironically I have come full circle as my current antenna here in this unit is 21 feet of wire in a similar configuration.

It was so easy to hear the BBC Pacific Service on 7150 kHz with the 4 pm News, followed by "Radio Newsreel". Ironically it was relayed over one of the domestic networks on weekdays, allowing for comparisons of reception quality. Another regular was Noumea on 7170 kHz and I frequently used this station to assist my French comprehension while at secondary school.

The highlight of my monitoring at Newstead was hearing that Russia had launched the first man in space. I remember listening to a very excited announcer from Radio Peking, probably "Peking Pearl", reading the TASS dispatch. It was not announced over our radio stations for several hours and I well remember excitedly blurting this out to my incredulous family that Man was orbiting in space. They naturally assumed I was making it up and did not believe me until it was confirmed on the local ABC station several hours later.

Another major highlight was the Kennedy assassination on November

23rd 1963. I was woken early at around 6:30 am by my parents who had heard an item on the early morning news from Sydney that the President had been shot. I immediately turned on the AFRTS, which was on 11715 kHz from memory. They were relaying newsfeeds from the various American networks that he had been assassinated.

I can also remember hearing the Apollo Space Missions being relayed via ground stations back to Houston. They had audio buried underneath a multimode transmission and it was extremely difficult to decipher the speech. The link was very close to the 20 metre amateur band and the audio on the HF link was between 8 to 30 seconds ahead of that on the domestic media or VOA.

Now it is all over as all the antennas have been pulled down and receivers put away in storage after 45 years of activity at Newstead.

Incidentally the final station from my Newstead log was on 15070 kHz and remained a mystery for a while. It was at 0359 UTC on USB with full carrier, being very weak and it was playing "Please Release Me" with Englebert Humperdick. After the song had ended, the signal dramatically faded out, making it difficult to identify. It apparently was a Dutch hobby pirate station known as "Radio Alpha Lima International" and was only running 250 watts! The operator confirmed my report and alleges he is active mostly at weekends.

Despite closing the Newstead location, I emphasize that I have not given away short wave listening at all.

I am continuing despite the confines of this retirement village. It is not on the scale of my previous set-up yet I already have found that propagation here is quite different. I am now able to hear African signals on the Short Path, which was not possible at Newstead because of a hill 300 metres away blocking them. Radio Zambia comes in here very well on 6265

kHz from 2145 till sign-off at 2200. They seem to run a trivial pursuit competition with a female compere and they conclude their transmissions with their National Anthem, identical to one of the two tunes of the South African National Anthem.

Radio Finland has indeed ceased broadcasting in English and other languages via short wave, although programming in Finnish and Swedish continues. Kol Israel from Jerusalem found funding to continue their short-wave broadcasts from their July 1st deadline.

The broadcasting of programming via the Internet received a blow, following a decision of the US Copyright Office to introduce royalty charges, similar to those for radio and television. This is applicable primarily in the US and already two of the largest streaming audio sources there have either folded or are introducing fees to access their services. Tim Gaynor from Queensland is currently investigating avenues to put DX programming on the web.

Yahoo also had an audio streaming service, known as broadcast.com. Many international and domestic broadcasters had been signed up on this facility. Some will now have to put up their own sites outside of America or discontinue streaming altogether. American sites will be charging listeners who wish to use streamed audio.

The America religious broadcaster, Family Radio in San Francisco recently signed an agreement with Merlin, the British transmission broker, to use their worldwide facilities to air their programs, in addition to their Okeechobee, Florida site. The BBC World Service currently uses them to broadcast to Central and South America. I wonder if Merlin will use the Florida site for their other clients.

Well that is all for this month. Don't forget you can email me at vk7rh@wia.org.au or via snail mail to 20/177 Penquite Road, Norwood TAS 7250.

Australian Made ANTENNAS

"Setting a New Standard"

COM-AN-TENA

(Formerly A J And J Coman)

6 Mulr Court
CHELSEA HEIGHTS 3196

All new 5/6 vertical 16 radials	\$145
Dual drive 26-30 5 ele yagi beam	\$305
4 ele 10-11m yagi beam	\$262
5-6-&7 ele high gain antennas 11m	\$call
3 ele delta loop 10-11m	\$320
11m 5/8 vertical/4-1/4 wave radials	\$170
Duoband 10-15 3 ele each band	\$356
Log-periodic 7 ele 13-30 MHz 7.7m boom	\$890
Tri-band 5 ele HB35C s/steel fix	\$730
3 ele 20m computer opt	\$390
3 ele 15m computer opt	\$285
M B Vert Auto switch 10-80m	\$310
40m linear loaded 2 ele beam	\$580
6m 5 ele compt opt beam	\$259
6m 7 ele compt opt beam	\$355
10 ele high performance 2m	\$135
17 ele high performance 70cm	\$119
2m vert 2-5/8 co-linear 4 rad	\$ 96

Guyed Masts

21 metres 13 metres

Winch-up & tilt-over. Aluminium and stainless steel three-sided construction. Auto-brake winches

Free Standing Masts

9.5 metres

New Baluns

1-1 to 16-1 to 3kV



03 9773 3271

Mob: 0419 542 437

Andy VK3IV

Beyond Our Shores

David A. Pilley VK2AYD
davpil@midcoast.com.au

WRC-03 now in Geneva, Switzerland

The conference had been scheduled to be held in Caracas, Venezuela, but this is not now possible.

Citing economic concerns, the Venezuelan National Commission of Telecommunications (CONATEL) has advised the International Telecommunication Union (ITU) Secretary-General Yoshio Utsumi that it will be unable to host WRC-03.

Geneva has now offered to host the event and it is still planned for 9th June to 4th July. There are several issues of importance to radio amateurs on the conference agenda, including harmonization of the 7-MHz amateur and broadcasting allocations. Other Amateur Radio-related issues on the

WRC-03 agenda include the revision of Article 25 of the International Radio Regulations—the basic rules for the Amateur and Amateur-Satellite services.

Among other issues, this includes the issue of whether to retain the treaty requirement to demonstrate Morse code proficiency for access to amateur bands below 30 MHz.

Rest assured, wherever the conference is held, the IARU teams will be there to support the Radio Amateurs around the world.

We here in Australia, will have representatives there and we desperately need your support. Why not include a small donation with your next renewal subs?

Satellite Communications Course

It is interesting to follow the ARRL's Certification and Continuing Education Programme.

The latest on-line course is Satellite Communications (EC-007).

This is the sixth course in the growing list of continuing education offered by the ARRL. QST Editor and satellite enthusiast Steve Ford, WB8IMY, developed the curriculum. The course contains material from Ford's articles, as well as new material. Resources were also provided by AMSAT-NA. Ford has written many QST articles on amateur satellites and is the author of ARRL's HF Digital Handbook.

The ARRL Satellite Course is intended

for amateurs who have never operated satellites before. The course opens with a review of amateur satellite history. Students will move on to a study of satellite tracking, orbiting relay stations, FM repeater satellites and the International Space Station. It continues with lessons and exercises on FM satellites, the Fuji Sats, AMSAT-OSCAR 40 setup and operation. The final lessons cover store-and-forward digital satellites, APRS and future satellites. Details about the ARRL Certification and Continuing Education Program are on the ARRL Certification and Continuing Education Web page <http://www.arrl.org/cce/>.

WRTC – 2002

This column was written before the World Radio Team Championship contest was held in Finland during the IARU contest July 13/14. Regretfully Australia (or NZ) was not represented in this great event, although we have had a team in the past two WRTC contests.

As a competitor from WRTC-96 I have been monitoring the WRTC Internet reflector. You would really be surprised at the 'hype' that develops from the teams just prior to the event. There is

much concern about competing in the sauna after the event!

Santa Claus, who lives in Korvatunturi, Lapland, has a bureau in Rovaniemi and is OH9SCL? So this Christmas keep an ear open for the great man, he may be able to add a new rig for you on his sleigh!

Finland is rated the least corrupt country and has a 100% literacy rate. Is it true that every one at Nokia has a ham ticket?

The lights go out for Eddystone Radio, "silent key" after 89 years

July 6/7 2002 was to have been the the 90th anniversary of the registration of Stratton & Co as a limited company, they being the company from which Eddystone Radio evolved.

Those who are unfamiliar with Eddystone probably only know it as a producer of short wave receivers for use by radio amateurs and SWLs. The last of the line was the pretty, solidly made but very ordinary transistorised EC10, the circuitry of which differed little from that of el cheapo pocket portable radios of the era. Hence, many amateurs may have assumed that Eddystone went out of business years ago - not so.

Eddystone continued to make very sophisticated radios for use in commercial and military applications, often 'ruggedised and tropicalised', always with a high degree of reliability, incorporating built in test equipment ("BITE") for self diagnosis of failures. They also manufactured a great deal of broadcast transmitting equipment.

Some years ago they were taken over by Marconi before that company went "pear shaped", and later by "Megahertz Communications". Chris Pettitt, G0EYO, former MD, now patron of the "Eddystone User Group" revealed that

Megahertz, and hence Eddystone, had gone into administration, so they have gone out of business.

The Eddystone name, broadcast intellectual property rights and stock, have been sold to a small radio broadcast firm called SBS based in Hastings, England, with whom Eddystone had been working with for some years. The receiver side of Eddystone is now in abeyance and may not be resurrected.

Off the hair and on the air

Perhaps the most remarkable thing about Eddystone is that it only came into existence in the 1920's due to a change in womens' hairstyles! Stratton used to make millions of hair-grips, but when suddenly long hair went out of fashion in favour of "bobbed" styles, the market for hair-grips collapsed almost overnight.

At that time radio was in its infancy, there was much interest in it as a scientific experimental hobby, and a market for high quality components was emerging. Eddystone satisfied that market, later developing into producing short wave receivers, and during the war, many items both radio and non-radio were produced.

Early in the war, the factory was bombed, and the local indoor swimming pool was commandeered for Eddystone to get back into production, which they did in a few short days. That factory was affectionately nicknamed "The Bathtub" and Eddystone has remained at those premises to this day.

The callsign G6SL was allocated to Stratton for use at the pre-war Eddystone factory, and today is held by Chris Pettitt G0EYO.

The Eddystone User Group was founded in 1990, and is a non-profit making group for Eddystone Enthusiasts. It produces six 48 page "Lighthouse" newsletters a year, full of technical data, fault finding tips, historical articles and ads. Annual subs are 14.00 Pound Details from:

Græme Wormald, G3GGL,
15 Sabrina Drive,
Bewdley, Worcs., 01299 403372.
e-mail g3ggl@euophony.net

Another all-ham crew settles in aboard the ISS

The crew of *International Space Station Expedition 5*, US astronaut Peggy Whitson, KC5ZTD; Russian cosmonaut and crew commander Valery Korzun, RZ3FK; and cosmonaut Sergei Treshev, RZ3FU, is settling in aboard the space outpost. The increment 5 crew is the second all-ham crew to serve a duty tour aboard the ISS. The Expedition 5 team will be in space for 4-1/2 months.



Cosmonaut Valery G. Korzun (RZ3FK) (left), Expedition Five mission commander; Astronaut Peggy A. Whitson (KC5ZTD) and Cosmonaut Sergei Y. Treshev (RZ3FU)

Scheduled *Amateur Radio on the International Space Station* (ARISS) school contacts are set to resume in early July, when QSOs have been penciled in with the Progymnasium Rosenfeld in Rosenfeld, Germany, and the Adler Planetarium and Astronomy Museum in Chicago. Other contacts with schools and educational institutions in the US and abroad are pending.

Although school contacts have been on hold during the crew transition, all has not been silent on the ARISS front. Korzun occasionally has been active on 2 meters as RSOISS and even made a few contacts during the U.S. Field Day in mid June.

(ARRL N/L 30/6)

Short waves

Hamvention's decline

The decline of visitors to our local Field Day this year was not a one-off.

The great Hamvention held each year at Dayton, Ohio, USA has also been in decline over the past few years with attendance this year down to 24,832. (That's a greater number than Australia's licenced Amateurs).

They say their peak attendance was in 1993 when 33,669 attended. About a 26% decline over those years.

Pedal wireless? No, it's Recycled Radios

A vote in the European Parliament in April foreshadows that all electrical and electronic equipment sold in Britain after 2005 will have to be recycled at the manufacturer's expense.

Under new European legislation, householders will not be able to throw away unwanted electrical or electronic goods but will have to sort them out ready for collection and recycling. It is forecast that prices are likely to rise by up to 5 percent

If you have news from overseas please email or snail me.

Technical Abstracts

Gil Sones VK3AUI
30 Moore Street, Box South, Vic 3128

Copper wire current ratings and usage

The use of PVC insulated flexible wire to rewind transformers has come to my notice. This is potentially dangerous due to a misunderstanding of the current ratings often given in some catalogs. It has occurred due to the difficulty of rewinding transformer cores originally used in microwave oven transformers. These cannot be easily disassembled due to their construction. Rewinding low voltage high current windings is therefore difficult due to the need to fit thick and hard to bend wire onto the former.

The use of PVC covered wire as the winding in a transformer may be dangerous. Insulation may melt and lead to a short circuit and a fire with disastrous consequences. In order to fit the limited space available the wire may be too thin resulting in heat build up. The current ratings given in many catalogs for PVC covered flexible wires are for other uses and are not intended for uses such as rewinding transformers.

PVC covered wire ratings for other uses may be misleading. They make assumptions regarding use and ventilation which are different to the situation in a transformer winding. Ratings are usually given with regard to voltage drop or for an acceptable temperature rise under conditions which are usually well ventilated or cooled by air movement.

Mains extension leads are an example of a rating which is only valid with the lead laid out in a manner which ensures good ventilation and cooling. Operation coiled up can lead to a molten mess which many of us have seen.

Wire ratings are given for a specific application and should not be applied in a different application. The ARRL Data Book 1976 page 45 gives the rating of 16

AWG (B&S) enamelled copper wire 0.0508 inches diameter (1.29 mm dia approx 1.3 mm squared area) as :- 22Amps in open air, 13 Amps in bundles or conduit, 3.69 Amps in a transformer winding. As you can see the rating varies widely according to the use. Plastic covered wire would have a lower current rating due to the increased thermal insulation of the thicker plastic coating.

An alternative to a single hard to fit large cross section wire size is to use a number of smaller diameter wires in parallel. This is how a flexible wire is obtained. You should make sure that the parallel wires are the same length and gauge and have the same path around the former. Use wire which is rated for use in a transformer and has adequate ratings in such service. The wires should provide a winding with low losses and should be easy to wind. The lack of bulky insulation will give space to achieve a suitable winding. The enamel used on winding wire usually has good performance at transformer operating temperatures. You can measure and check the temperature rise in the winding using methods given in books on transformers and their design.

Microwave oven transformers are purpose built. They may look like conventional transformers but they are designed and function differently. They can be pressed into service but due regard should be given to the differences in design and construction.

They have magnetic shunts which should be removed for normal amateur service. The shunts provide leakage reactance used as part of a regulator arrangement. They also have other differences in construction. The insulation may be different at the ends of the High Voltage winding. This can lead to trouble if the winding is used in bridge or voltage doubler rectifier circuits. Information concerning these transformers has appeared in AR May 1998, Rad Com Jan 1998, and QEX Jan & Feb 1998.

A fire in a transformer could have very serious consequences. You should be very conservative when designing or rewinding transformers as the consequences of failure are severe. Your insurance company or a court may not be very impressed with your attempts to save a dollar in pressing something into service for which it was not intended.

Silent Key

Kingsley Brauer VK5AKN. A Tribute

It was with great sadness that we learnt of the passing of our good friend Kingsley in April 2002.

Kingsley was a foundation member of the 21.185 MHz Travellers Net and had been actively participating by assisting mobiles throughout Australia for about twelve years. He was a valued friend to all who were involved in the Net, regardless of whether they were mobiles,

base stations or fellow operators who ran the Net

He was a man who had true amateur spirit and worked diligently for amateur radio in many respects.

We are all thankful for the life of Kingsley and extend our sympathy to Maureen and the family.

Syd Harvey VK6SMH and 21.185 Travel Net controller. 03/06/02

Editors Note. Kingsley ran the WIA SA Division Slow Morse program for many years and his enthusiasm and determination to keep this program going, helped many aspiring amateurs get their ticket. We all owe a lot to Kingsley. VK5UE

Top Drive

In Rad Com April and May 2002 Tony Preedy G3LNP described elevated feed of a mast with a triband yagi for operation on LF and the 80 and 160 metre bands. This involved insulating the yagi from the tower and feeding the system between the yagi, as top loading, and the mast which was earthed at the base. This resulted in improved efficiency particularly on the LF bands available to UK amateurs. The scheme is made much easier by the availability of remote tuners.

The idea of top feed or elevated feed originated in studies of shipboard antenna performance. The feed from the radio room high on the superstructure was found to perform very well as the structure of the ship acted as an earthed mast below the feed point. This gave better than the originally expected performance.

The remote tuner used should be one designed to match a wide range of impedances to a coaxial line at the power level in use. There are a number of remote tuners available which can match to random wire antennas which should be suitable. A low loss design should be selected.

There is a problem in insulating the Yagi from the tower. There are very large mechanical stresses on the rotating pipe that the yagi is clamped to and making this an insulator requires careful consideration. The materials used must be capable of handling the arduous conditions. Failure could result in the antenna coming down with very serious consequences.

Tony G3LNP used a length of "TUFNOL" rod which is made of phenolic resin bonded fabric to join the rotating pipe from the rotator to the pipe to which the antenna boom is clamped. This material was not cheap but was strong enough. The jointing piece is

shown in Fig 1. Use of a lathe is required to make this piece. It is critical. The rod came from RS components and the RS catalog number is RS 374-376. It was big enough to make two insulators. The insulator rod should be fastened to the steel tubes by using both epoxy glue and through bolting to fasten the whole assembly together.

The length of the insulating section is determined by the insulation requirements for the feed on the lowest LF band. The voltage appearing across the mast insulator is shown in Table 1. The gap is relatively modest for 1.8 MHz and 3.5 MHz but for LF it is much greater. Thus if only 1.8 MHz or 3.5 MHz

G. & C. COMMUNICATIONS

Authorised dealer for ✓ Kenwood ✓ Icom ✓ Barrett RFDS ✓ GME Electrophone ✓ Uniden ✓ RF Industries

✓ KENWOOD TS2000

All-mode multibander HF/50/144/440
Auto antenna tuner built-in



✓ ICOM IC706MkII

Ultra Small: 167 (W) x 58 (H) x 200 (D), 2.45kg
Detachable Control Panel/Display
SSB/AM/CW/RTTY Narrow Filter Options
2 Optional Crystal Filter Slots
Tone Squelch Standard
107 Alphanumeric Memories (99 regular, 6 scan edges, 2 call)



✓ ELECTROPHONE TX3400

40 Channel
UHF remote
mount
transceiver
with ten extra
receive
channels



Australia-wide orders welcome. Payment by credit card, cheque or money order

19 Arleon Crescent Cranbourne 3977

Ph: 03 5996 3298 Fax: 03 5995 0184

Email: gccomm@netspace.net.au

www.netspace.net.au/~gccomm

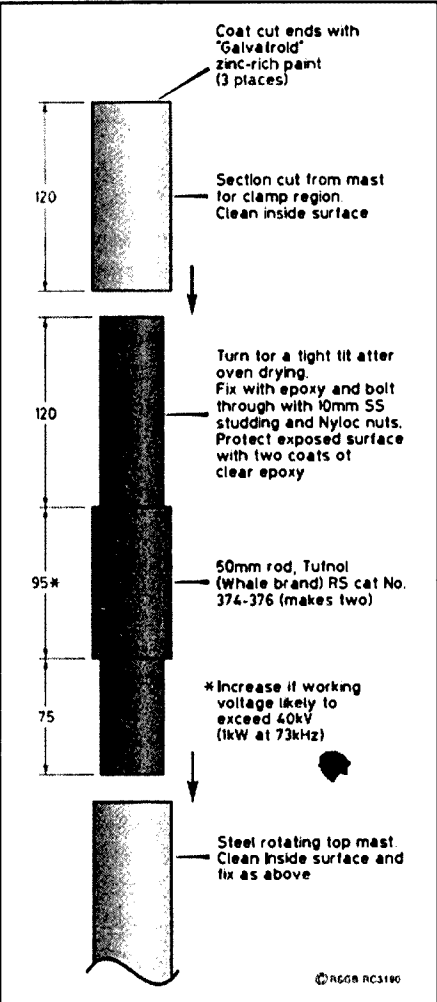

Fig 1. Insulator Used for Top Feed to isolate HF Yagi from mast.

were to be used a shorter insulating section would be possible or some alternative insulating arrangement could be used. Remember though that the mechanical stresses must be considered and adequately provided for.

The computed feed impedance at the elevated feed point between the simulated HF Yagi and a grounded telescopic mast is shown in Fig 2. ELNEC was used to compute the feed impedance. EZNEC which is a later windows program from W7EL can be obtained as a free download from <http://eznec.com> in a demo form. The measured VSWR of the top feed is shown in Fig 3. The measured VSWR is without any attempt at tuning. For operation on 1.8 MHz and 3.5 MHz a remote mast head mounted auto tuner can be used to match to the coaxial feedline. The feedline can be remote relay switched to the beam bypassing the tuner for operation on 14 to 28 MHz using the yagi. The remote relay switch

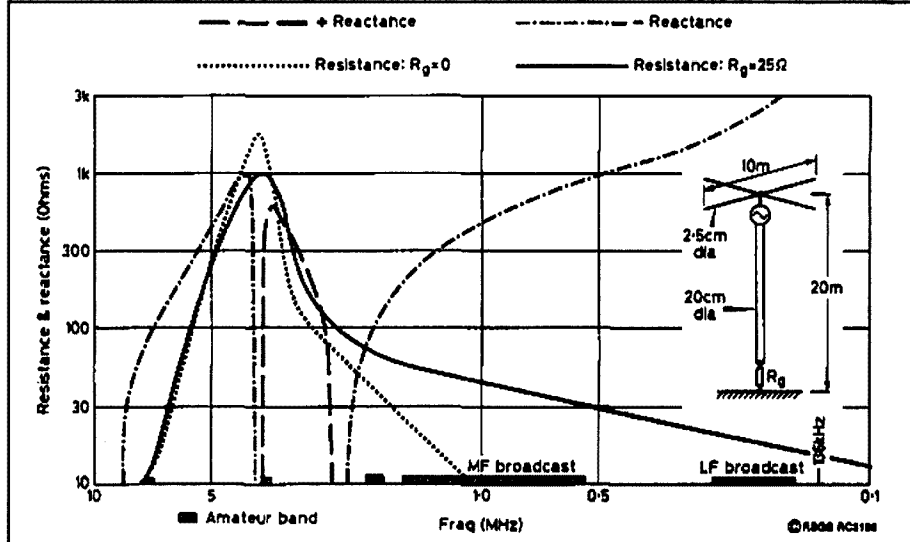

Fig 2. Computed Impedance of elevated feedpoint between simulated HF Yagi and grounded telescopic mast.

has to have good insulation but if LF operation is not required this should not be too hard.

The mast used was 20 metres high and resonance was just above 1.8 MHz and so a slightly higher mast would have yielded a resonant system. Cranking the tower down to 8 metres gave resonance in the 3.5 MHz band. A remote tuner gave operation on both 1.8 MHz and 3.5 MHz. The control cables should be screened and both the control cable screen and the coaxial cable screen should be bonded to the mast both at the top and at the bottom.

This feed system could be used with a mast and a large TV antenna to form a disguised antenna system. The tuner would appear to be just a large masthead amplifier. This might be a solution in some situations. The matching range of the tuner would be important as the system would be somewhat smaller.

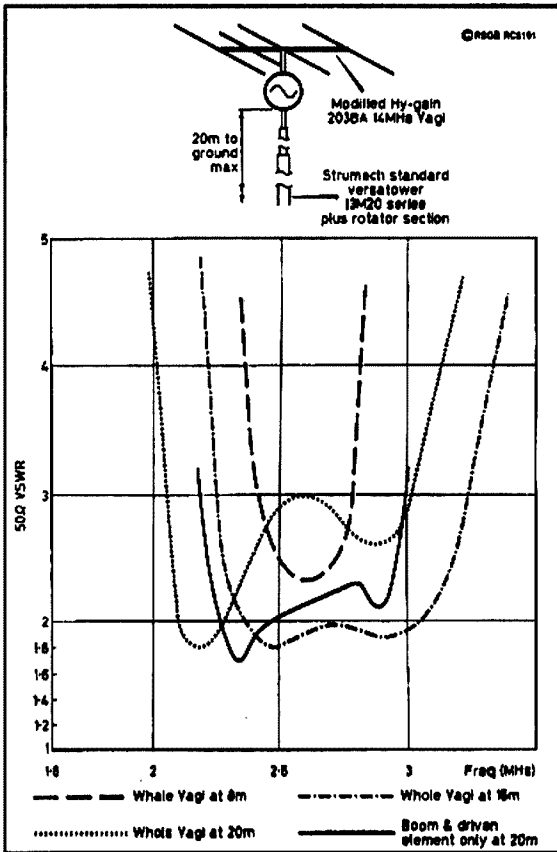

Fig 3. Measured VSWR without any attempt at tuning for top feed between HF Yagi and the top of a 20 metre high mast.

Table 1. Mast Insulator Requirements

Frequ MHz	Power dBW	Gain dBi	Tuna & Feed dB	Input dBW	Input Ohms	Parallel R Ohms	Potential V RMS	Gap mm
0.073	0	-24	-6	30	1000	1.4 M Ohm	37,000	93
0.136	0	-18.7	-3	21.7	160	0.79 M Ohm	11,000	28
1.85	26	-0.8	-0.5	26.5	450	470	480	1.2
3.6	26	-0.2	-0.8	26.8	480	1100	730	1.8

(0 dBW is 1 W, 20 dBW is 100 W, 26 dBW is 400 W and 30 dBW is 1000 W)

Shortening Screws

An idea for cleaning up the cut ends of screws that have been shortened appeared in the In Practice column of Ian White G3SEK in Rad Com April 2002. The idea comes from Colin G3VTS and is shown in Fig 4.

The idea involves the use of suitable Taps to thread a number of holes drilled in a plate. The holes near the edge are then slit using a small saw. The X-acto fine saw blades used by modellers which fit into an X-acto knife handle were recommended.

The slits make cutting edges which can be used to help clean up the threads

of screws which have been cut. The plate can be gripped in a vice when being used. The plate will help minimise the amount of filing required when cleaning up cut threads. It is cheaper than using a good die and if damaged it is cheap to replace.

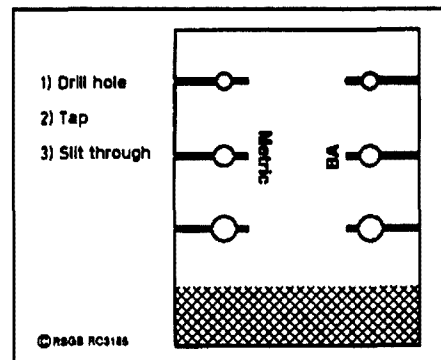

Fig 4. G3VTS plate for cleaning up screw threads. Plate can be gripped where shown at the bottom in a vice.

Club News

Gippsland Gate Radio & Electronics Club

GGREC is continuing its long list of events with the following details.

Publishing dates of AR prevent notification of earlier events but starting on August 11th, we are holding a bicycle ride (or walk if it gets too steep) at Lysterfield Park.

The ride / walk will be followed up with a BBQ in the above park. This is a day that anyone can attend. Don't stay away because you haven't got a bike. There's plenty for us non-riders to do as well. More details will follow in the Club mag, or on our website. This is a good chance to advertise that also at www.ggrec.org.au.

GGREC has a general meeting every third Friday of the month with the meeting on August 16th featuring David Wilson who will rekindle our interest in TEN TEC equipment. Promises to show some good gear. At 8 or you're late.

September will see several events taking place beginning with our monthly Prac. Night on the 6th. These so called "Prac." Nights are popular with the members and often become a great occasion to simply catch up with others and talk.

Discussion doesn't always revolve around Amateur Radio thus adding extra spice to the evening. These meetings as well as our general meetings are open to all who wish to come and play with equipment or simply to "catch up". Members and visitors are encouraged to attend.

Peter Pavey (the Pres) who leads a double life as our Amateur exam coordinator wishes to announce that the next exam will take place on the 7th September. Applications will close on the 16th August for this one but keep in mind that Peter organizes regular exams so contact him on 03 5998 3533.

Reg VK3UK has organized another Pub night on the 14th September and has kept the details to himself at the moment. Keep in touch and I am sure we can extract the relevant information from him before the day.

At our meeting on the third Friday of the month, the 20th September, I have succumbed to numerous requests to give

a demonstration of X10 remotely operated electrical controllers. (Well at least one person asked me to do it)

This equipment has a few gimmicky applications as well as serious ones, but there may be a place in your home where remote switching of lights or power may help your lifestyle. Some of this gear is take home and plug-in.

Oh by the way - who am I? Well you'll have to come and see on the 20th September. 8 p.m. is a good time to arrive at the Clubroom in the Girl Guide Hall, Grant St Cranbourne.

Hear from the people who make amateur radio - subscribe to

**Amateur
Radio
today!**

VK1 notes

Forward Bias

The guest speaker at the general meeting on Monday, June 24, 2002 was Darryl Hill. Although not a radio amateur but an electrician who is had become an Electrical Inspector was involved with training, Darryl had close associations with radio amateurs throughout his life. Many of his colleagues were either licensed or CB operators.

The subject that Darryl spoke to was Electrical Safety. This is a subject close to our hearts, because the hamshack is usually a ramshackle entanglement of wires, coax, and power cords improperly terminated or dangerously overloaded. Darryl was usually horrified whenever he entered any of his mate's ham shacks. However, there was light at the end of the tunnel. He said that the industry was adhering to a set of Australian Standards that imposed limitations on work practises, manufactured products and components, and the circumstances under which a person was permitted to work on electrical installations.

For hams, this is an important issue because most of us assume that we know everything there is to know about electricity, but how wrong can you be.

It appears that anybody can work at installations that carry ac voltages not higher than 50 volts, and dc voltages not higher than 120 volts. The reason for this latitude is that these voltages are not considered to be life threatening! Darryl

brought along a box with samples of electrical connectors, sockets, general power points (GPOs), and cables of all kinds that had been the cause of a home fire.

He showed how electric blankets can cause fires, and how, by being inattentive to standards, cable extensions and multiple GPO boards are easily overloaded, and causing fires. At this latter stage in the proceedings, Kerry Richens (VK1KRF), very ably assisted Darryl by demonstrating what happens to electrical installations when they are subjected to acidic and sulfuric gasses. With photographs, he showed how wiring and electrical terminals could quickly disintegrate if not inspected on a regular basis. Kerry also showed three items of test equipment from his workplace used to test appliance specifications and their electrical safety. All in all, it was a very useful couple of hours that we spent with Darryl and Kerry.

A change of name. The symposium that is to be held in Canberra on Sunday, 17 November had its name changed to "One Tech '02". This was necessary, as "Can. Tech. '02" was a name too close to the name of a company operating in the ACT.

A volunteer is required to take over the job of "Manager - Inward QSL cards". This position has been filled by

Ray Reinholtz (VK1PRG) for the usual term of three years, and now needs to be handed over to another member. The job description is rather short: 1. Collect QSL-Card packages from the City Post Office on a weekly basis. 2. Sort QSL cards by the recipients' callsigns. 3. Deposit sorted cards in the QSL-Card Receptacle. 4. Attend general meetings.

Detailed instructions about how to deal with the monthly membership list, cards for non-members and non-financial members will be provided during hand-over. Interested? Call Ray on 6288-4804 or Peter on 6231 1790.

The Division is sponsoring the establishment of a 6-metre beacon in the ACT. Anyone interested in participating in this project call Peter on 6231 1790.

Who is doing what? Dave Webb got a pass for the Novice theory examination in March this year. Peter Kloppenburg (VK1CPK) is building Crossed-Field-Antennas and having success with them. Bob Howie has donated a 240/110-volt autotransformer to the Division to energise the valve tester, which can now be used by our members. Peter Ellis is using steel wire to manufacture a couple of centre-loaded whip antennas for mobile use. The next General Meeting will be on Monday, August 25, 2002 at 8.00 pm in the Scouts Hall, Longerenong Street, Farrer.

Cheers.

VK2 notes

Pat Leeper VK2JPA

Radio VNG Extension

In a letter received by the Parramatta office, Dr Richard Brittain, Legal Metrology Officer/Secretary National Time Committee, has advised that the National Standards Commission has decided to extend the Radio VNG Service to the end of 2002.

Education news

Prospective amateurs who are studying

Theory, Regulations and Morse code on their own to gain a licence are advised that the VK2 Education Officer will be on hand at the VK2 offices on Monday nights, from 7 pm to 9 pm to assist with any study problems. The office is located upstairs at 109 Wigram Street Parramatta, and parking is available beneath the building.

Here are examination dates for the remainder of the year, closing dates for applications in brackets - 8th September

(29th August), 20th October (10th October), 1st December (21st November).

Bookshop on Line

Readers with Internet access can now find the division's bookshop "On Line" Fire up your favourite web browser on members.ozemail.com.au/~vk2wi/bookshop/

That's all for this month, see you next time.

VK3 Notes

By Jim Linton VK3PC

WIA Victoria web site: www.wiavic.org.au

email: wiavic@wiavic.org.au

Ron Wilkinson Award

Nominations are invited for this annual WIA award that recognises special achievement in any facet of amateur radio.

The award is named in the memory of Ron Wilkinson VK3AKC who set a number of VHF and UHF distance records over the post-WW2 decades, including work on 1296 MHz moonbounce.

Do you know of a single individual, or a group of radio amateurs who are special achievers?

Then propose them to the WIA Victoria Council with a full explanation of why you think they deserve this high recognition.

Does WIA Victoria communicate?

A survey of those who buy Amateur Radio magazine at newsagents throughout Australia indicates that they believe the WIA is not communicating well enough.

The fewer than 200 respondents to the survey feel the WIA can communicate better about what it is doing.

This finding is a little puzzling to WIA Victoria. The WIA Victoria Council considers that, through its website and other media, it has been communicating effectively, particularly in the past year or so.

Perhaps our website is not being read by those non-members who are now buying AR magazine? Or maybe their comments concern perceptions formed years ago, or relate to some other WIA Divisions?

The WIA Victoria Council would like to hear from any member who has views on this matter, and suggestions of how

we can better communicate within the restraints of our resources. If you are a non-member reading this in AR magazine, we'd like to hear directly from you too.

QSL Bureaux

A reminder that WIA Victoria operates both inwards and outwards QSL Bureaux free to members as a membership service.

It is necessary to make application to register for the Bureau to receive or send cards.

Information sheets and registration forms are sent to all new members and available on request.

The savings in postage by using the Bureaux certainly make this a very worthwhile service for many members active on the HF bands.

Contest and special event activity

Putting the Wireless Institute of Australia (WIA) in this year's IARU HF

World Championship 13-14 July was VK3WI, using a mix of Phone and CW.

WIA Victoria Councillor, Jim Baxter VK3DBQ operated VK3WI and reports that many DX stations were very pleased to score the WIA zone in their log.

The contest rules call for participants to exchange their ITU zones, or headquarters stations use their official IARU member society abbreviation.

Jim VK3DBQ said it was a very friendly contest and a number of contacts were the result of mentions in DX news bulletins that the WIA zone would be on air.

Poor conditions made it difficult going, but VK3WI made 146 contacts including 40 other IARU headquarters stations, and a total of 36 countries.

Earlier AX3ITU, the special event call sign of WIA Victoria for International Telecommunications Day, was much sought after both locally and overseas.

Members of WIA Victoria affiliated Eastern and Mountain District Radio Club, activated the call sign during the 24 hours of 17 May, making just over 300 contacts.

The club reports that its HF phone operators were Tom VK3ZZ, Keith VK3FT, Gwen VK3DYL and Carl VK3EMF. While Drew VK3XU as usual picked up better than a contact a minute on HF CW.

Contacts were also made in IRLP by Ken VK3HKR, and white cane operator Dave VK3AAD operated on both VHF and UHF, with Peter VK3DI briskly entering the contacts in the log.

Although the total number of contacts is slightly down on last year, when the conditions were favourable, the contact rate was very good.

Another GASS display

WIA Victoria and a number of its affiliated clubs will mount an amateur radio display at this year's Great Australian Science Show (GASS).

The event coordinator, WIA Victoria Councillor Barry Robinson VK3JBR, Secretary John Brown VK3JJB, and club representatives have already met to plan, resource and roster the display.

GASS attracts school students, teachers, parents and the general public from throughout Victoria, and should be an excellent opportunity to promote our hobby.

Held at the Melbourne Museum, the amateur radio on show segment is Friday 23 to Sunday 25 August, the last three days of Science Week.

Club secretaries please note

The pages of *Amateur Radio* are freely open to all radio clubs which are members of WIA.

With the news-stand distribution of the magazine this represents an excellent opportunity to put the activities of your club in front of potential new members. Contact the editor for details of style form and deadlines.

Amateur radio suppliers please note

Amateur Radio is the only widely available print vehicle that specifically targets amateur radio in Australia.

With the news-stand distribution of the magazine this represents an excellent opportunity to put your message in front of 6000 customers each month.

Call *Newsletters Unlimited* (03) 9756 7797 for details.

Qnews

Fast Tracked Exams

Mike Jenner VK7FB the Divisional President of Tasmania has told his members "One of the most enlightening things that came up during the informal session of the WIA AGM was when Ron Bertrand from VK4 spoke about their education programs and "cram course" for the Novice Licence. Ron claims a 90% pass rate for a 3-day 'cram' course! That's right, 3 days! The course in its extended form is conducted as 45 minutes a day for 3 weeks.

VK7FB intends to follow up on these ideas and will make it one of his aims this year to instigate some of them in Tasmania. Others who'd like to know more contact the Gold Coast Amateur Radio Society (www.javerang.com.au/hamradio/gcarsi/), Secretary Sue VK4VAA on (07) 5545 0955 or VK2DQ Ron Bertrand via <http://www.radioelectronicschool.com>

Hams on Air

WIN-TV coverage of the new after-hours doctor call diversion system being trialed in Townsville centred around the QLD Ambulance communication centre in Hugh Street. Amongst all the officials seen, was Len VK4ALS who is one of the main instigators of the project.

ABC-TV and the Nine Network out of Brisbane on Tuesday May 28th covered the trial of a new bushwalkers emergency beacon and showed in an extended shot - the receiver used by ground search parties to pinpoint the beacon. Did that receiver look very familiar to followers of ARDF in VK? It's an EPIRB DF receiver designed and built

Amateur Radio has been appearing on news-stands for the last four months.

It will continue to do so.

It is the only local amateur radio magazine publishing regularly.

Divisions are urged to provide their message for publication so that news of amateur radio activity can reach as many people as possible through the pages of AR

by Ron Graham Enterprises of Sarina QLD. The amateur radio world knows Ron by the callsign VK4BRG.

The Townsville Sun May 28th carried a half page article on Heather and Steve Watson. Amateur Radio gets a mention as hams know Steve as VK4SGW, your friendly Australian Radio Scouting Co-ordinator. Real radio (well ABC wireless) rates a mention, as Heather is on air during their local morning show with a "Law" segment.

True Old Timer

Henry Fulford, VK4AHF, has just reached another milestone in his eventful life, 90 years of living! Henry recently celebrated his 90th birthday in Atherton. He resides at Carinya Hostel with his wife, Alice, and is still active on the ham bands and is often heard on the local two metre repeaters.

Well Done Awards

Recently during festivities at South Mission Beach for FNNQARG, WIAQ Vice President Gavin VK4ZZ presented Don VK4MC with his "Thank You" certificate from WIAQ for work done during council year 2001-2. Wally VK4DO received his Merit Award and Badge from WIAQ, the badge presented by WIAQ FNQ Rep and Councillor Dale VK4DMC and the certificate presented by WIAQ Vice President Gavin VK4ZZ.

Worth Repeating

VK4RSC, 146.850 and 438.075 is in its final operating place after the erection of a new mast, the repeater is housed in the club's own shed on the edge of the Maleny escarpment with a new tilt-over free-standing mast engineered by club member Wayne VK4SWC (Salt Water Crocodile). Repeater manager Len VK4ALF would appreciate it if you could call in on 146.850 after a broadcast to give them an idea of coverage.

Testing is taking place to link the 438.075 repeater to the Darling Downs Area VHF repeater on the Bunya Mountains to foster more activity on the 70 cm band. Recent tests on Monday had a link to Dalby via the 438.075 repeater,

using a sub-audible tone of 162.2Hz. The results are very gratifying, and the Dalby Repeater has never been so busy according to SCARC users.

FNNQARG

The get together at South Mission Beach was a great success again this year, although setting up Friday was conducted in a tropical downpour, there was sun for the rest of the weekend.

Those attending took part in such diverse activities as a trip to the Tully Markets, which resulted in many strange things brought back. The Saturday Night concert by Electrical Caution, the band of renown, had everyone tapping their feet and singing along. Saturday Night also saw a Karaoke session happening thanks to Ian VK4ZT's midi-text Karaoke program on his laptop computer. Sound was amplified and it was amazing to see that everyone knew the words to the ABBA songs!

ARDF RadioSport, first back home after finding all the beacons, including the one hidden behind the reception desk, Ian VK4ZT. The FNNQARG Cricket Match, and Cairns/Atherton won the match. The out of the trailer auction had some amazing treasure, and raffles, 1st prize, a ICOM IC-Q7A pocket rocket donated by Navcom Electronics was won by Matt VK4HAM from Cairns. 2nd prize, an ICOM IC-V8 VHF handheld donated by ICOM Australia was won by Wayne VK4WDM from Alice River. A great weekend - just need a holiday now to recover from it! It's that great - FNNQARG! More reports and all the activities in Townsville at www.vk4tub.org/tarc/

Sunfest

The Sunshine Coast Amateur Radio Club Hamfest will be held on Saturday 7 September in the Woombye School of Arts lower hall, with doors open at 9.00am. For further information and table bookings contact Ron VK4GZ, telephone 5448 4063, e-mail sunfest@scarc.net, or PO Box 80 Nambour 4560.

73's from Allstair VK4MV

Essentially a licence in Amateur radio is a licence to learn. The licence is a beginning, not an end.

This is my first article as Federal Education Co-ordinator. I take on this role fully realizing I am stepping into very big shoes. Brenda, VK3KT, has worked with dedication, enthusiasm, and creativity for just so long.

I am sure I have the support of all readers, and many more who are not readers, in extending to Brenda a great thank-you for all her efforts. Words cannot express the debt of gratitude we all owe Brenda.

In this the first article I will briefly introduce myself and share with you some of my vision for the future.

I first became involved in electronics and radio when, at about the age of nine, I helped a grand-uncle finish a multi-band HF receiver that had been featured in the then "Radio and Hobbies". In my early teens I helped rebuild the radio from scratch with new components on a new chassis.

In my mid-teens I scrounged enough components and the appropriate valve to add a BFO to the receiver as that was about the time SSB transmissions were starting to appear amongst the amateur signals.

It was much later in life, in the mid-70s, that I became a licensed operator.

My professional career as an educator started in the late 60s. I have been a science and mathematics teacher for most of the time since then. My speciality is physics.

For the past five years I have been a lecturer in the university system working for faculties of engineering, education, and science. I am currently at the James Golston Faculty of Engineering and Physical Systems at Central Queensland University. I

mention this particular faculty as, along with the education faculty, it has very innovative and effective educational practices, which produce professionals of a quality that the other institutions can only be envious of.

As a professional educator I have a history of innovation to achieve high levels of quality learning and, so the locals tell me, I have an ability to see the real issues lying behind smokescreens of various types.

Education is just so basic to amateur radio. One of the fundamental purposes, to me the most fundamental, of amateur radio is self-training. Essentially a licence in Amateur radio is a licence to learn. The licence is a beginning, not an end. You don't have to look very hard to see that much learning does take place in amateur radio activities in all sorts of ways and in a very diverse range of technological and social areas.

So part of my vision is to encourage this life-long learning and as far as possible to remove barriers which prevent or restrict life-long learning.

Amateur radio is an activity firmly based in technology. As any student of history can tell you, technology has developed, and is still developing, at an ever increasing rate. So the next part of my vision is to have organizational, regulatory, and educational, structures and procedures so set up that they can readily respond to advances in technology.

Two examples of where current systems have failed, or at least are certainly groaning, are the debate and problems with the Internet and amateur radio, and the increasing complexity in the exams as more and more digital

modes and integrated circuits are added. We need a system that is proactive here rather than reactive.

The third part of my vision links all the previous ideas together. The entry qualification procedures, exam system if you like, needs to be based on the real ethos of amateur radio as a licence to learn. The system needs to reasonably utilize appropriate modern technology and be able to readily respond to developments in technology. Further the system needs to appropriately utilize the best of educational practice in areas such as syllabi specification and assessment procedures.

The last part of my vision I will mention is essentially the idea of "recognizing prior learning". This is well established in other areas of education and training.

I am very interested in utilizing the resources of the whole spectrum of education to be able to ultimately accept assessment systems from institutions which may not assess in the same way as is practised currently by amateur radio, but develop learning to an appropriate standard for amateur radio qualifications and can certify that standard. This is closely linked to how we specify our syllabi.

If I were to attempt the difficult task of summarizing my vision it would be to try to be ahead of the action rather than reacting to the past. If we pride ourselves as understanding and using technologies from the past, present, and the future, and for us this is a good recipe for growth and fun, then we need an educational structure that supports and enhances the wide diversity of activities which is amateur radio.

New WIA Members

The WIA bids a warm welcome to the following new members entered into the WIA Membership Register in JUNE

L41068	Mr A Clarey	VK2RO	Mr R J Conway	VK3HAT	Mr A Trumble	VK6XT	Mr R S Hill
L60426	Mr M J Bell	VK2TRA	R E Archer	VK3HY	Mr G W Brain	VK7GO	Mr R J Wing
L60427	Mr I Garnett	VK2TSB	Mr S R Benko	VK3MDI	Mr C McGregor	VK7YBY	Mr D Andrews
VK1RY	Mr F W N Ryan	VK3CEM	Mr F McCowan	VK3UFR	Mr P B Rowan	VK3IRL	Bass Amateur Radio Group
VK2DSG	Mr L A Keppie	VK3DGZ	Mr D Harrod	VK4GE	Mr E G Ginn		
VK2JRL	Mr R L Torv	VK3FGE	Mr D Bell	VK6BK	Mr A M Petch		
VK2LRS	R D A Sinderberry	VK3FGY	Mr J Ferguson	VK8CV	Mr A J Preston		
VK2PEB	J F Pincock	VK3FKB	Mr P Shanahan	VK8HTW	Mr T W Ward		

How's DX?

Ross Christie, VK3WAC

19 Browns Road, Montrose 3765, Vic.

Email Vk3wac@aol.com

It appears that the financial pressures common to us all are beginning to make themselves felt at an international level. A recent bulletin from the ARRL reported that due to extreme financial pressures Venezuela was unable to host the World Radiocommunications Conference 2003 in Caracas.

The Venezuelan National Commission of Telecommunications (CONATEL) recommended that the ITU seek an alternative venue. The ITU was placed under a great deal of pressure to find an alternative host for WRC 2003. After some hurried meetings the ITU staff have arranged to have the WRC 2003 held in Geneva Switzerland over the period of the 9th of June until the 4th of July 2003. The ITU staff should be commended for finding an alternative in so short a time.

Two important issues concerning amateur radio will be discussed, one is the realignment of the 40m amateur band and the other is the use of Morse code (CW) on bands below 30MHz.

North Korea is still making an impact on the amateur bands in the guise of Ed, P5/4L4FN. Ed has been very busy at work and on the bands, especially 15m. To try to increase the number of modes and bands on air from P5 Ed has been busy assembling various pieces of equipment sent to him by his QSL manager Bruce, KK5DO. Bruce says that the equipment, a HEX beam and rotator, a complete satellite station and the 6, 12 and 17m options for his existing Butternut vertical should see Ed on AO-40 (SSB only) and 6m soon. The HEX beam will give Ed the ability to 'aim' his signal to specific target areas.

Ed, P5/4L4FN is also quite active on RTTY. So much so that Don, AA5AU, has put together a special Internet page to help those who wish to try this mode and score themselves a contact with P5. The internet page can be found at <http://www.aa5au.com/rtty>

The web page has details on how to download a program called MMRTTY, how to load it into your PC and how to get started on RTTY. According to Don every current DXCC entity has RTTY privileges, except BS7, and RTTY is invariably one of the modes operated by the many DXpeditions. If you want to

contact Don directly with a question he can be reached at aa5au@bellsouth.net and will happily answer all queries.

The celebration of the Queen's Golden Jubilee has come to an end. According to comments furnished from visitors (amateurs and members of the general public) the event, GB50, was probably one of the highest profile special event stations ever mounted in the UK.

For the operators who manned the stations it must have been something extra special being involved and surrounded by the pageantry and ceremony that centred around Windsor Castle. The special event stations managed 24,727 QSO's from 145 DXCC entities and every day hundreds of visitors dropped by to witness for themselves the operation of the amateur radio stations specially set up for the occasion.

Many of the visitors were allowed the opportunity to exchange greetings on air with other members of the public in other countries. These visitors also showed a lot of interest in the RSGB's 'Amateur Radio Experience' exhibition. This can only be beneficial to the ranks of Amateur Radio in the long run. Visiting amateurs from as far afield as JA, W, ZS, ZL and VK also took the opportunity to operate the stations. Some statistics;

Band	QSO's
80	461
40	4124
30	1463
20	4187
17	3921
15	6790
12	1408
10	1174
6	849
2	370

Mode	QSO's
CW	12,221
SSB	12,214
FM	126
RTTY	113
PSK	53

Don Fields, G3XTT, responsible for the publicity, deserves special mention for his efforts, and Owen Cross, G4DFI, also deserves thanks, especially after he has finished processing all the QSL cards

for the entire operation. If you managed a QSO with one of the special event stations then cards can be sent via the bureau or direct to Owen Cross, G4DFI, 28 Garden Avenue, Bexleyheath, Kent DA7 4LF, England.

The DX

5V, TOGO.(1) Francois, VE2XO will be travelling to Lome, Togo for some recreation and will be active as 5V7XO over the period of the 25th until the 31st of August. He says that his preferred modes will be RTTY and SSB on the 10, 12, 15, 17 and 20 metre bands, possibly some activity on 8 metres too. QSL via home call to Francois Normant, 3054 avenue Lacombe, Montreal QC H3T 1L4, Canada. [TNX VE2XO and 425 DX News]

OX, GREENLAND. (2) Michael, OX3LG will be operating on HF and 6metres using SSB and CW from Kook Island (NA-220), Greenland between the 1st of August and the 1st of October. QSL via OZ1ACB, Allis Andersen, Kagsaavej 34, DK-2730 Herlev, Denmark. [TNX DL2VFR]

SU, EGYPT.(3) Bob Blumberg, K4RB, is a keen contester who has just been issued with an Egyptian licence, SU9US. Bob plans to take part in most CW contests and some SSB contests from his QTH in Cairo. QSL via K4DX direct only with a SAE with and IRC etc to cover postage. [TNX K4RB and OPDX]

V51, NAMIBIA. (4) Nick, ZL1IU, has a daily sked with Kosie, V51E, on 3793kHz from 0520 to 0535 UTC. He says signals peak at approximately 0530 UTC on this difficult path. Nick sets his antenna to beam at 45 degrees, over North America, which seems to be the most favourable path as they have been successful a number of times. Also, Aki, 5R8FU, who was S9 in NZ a few weeks ago has also been invited to take part in a sked between 1900 to 1945 UTC. Nick says he welcomes anyone who wishes to join in. [TNX The Daily DX]

IOTA Activity

FO, FRENCH POLYNESIA.(5) Paolo, IK2QPR plans to be active using the call FO/IK2QPR from Bora Bora (OC-067) in French Polynesia from the 10th until the 14th of August. He will be active on all

bands 80 – 10 metres CW and SSB. QSL via the bureau or to IK2QPR, Paolo Fava, via Bertani 8, 46100 Mantova, Italy. [TNX IK2QPR and 425 DX News]

9H, MALTA.(6) Jose, EA5KW will be active from Gozo Island (EU-023) on the 12th until the 18th of August and has requested the call 9H3KW but still awaits official confirmation. Plans are to operate SSB, CW, RTTY and PSK31. QSL via home call. [TNX EA5KW and 425 DX News]

FP, ST. PIERRE AND MIQUELON.(7) Paul, K9OT and Peg, KB9LIE will operate from Miquelon (NA-032) over the 11th until the 19th of August as FP/K9OT and FP/KB9LIE. Activity will take place on all bands 80-6 metres on CW and SSB (160m will be attempted but no guarantees). The pair are on holiday so they will be using modest equipment and power, 100 watts to wire and vertical antennas. Emphasis will be placed on 30, 17, and 12 metres. They also plan to enter the North American QSO Party SSB Contest using the Green River Valley ARS club callsign FP/K9WM. QSL via the bureau to their homecalls, except FP/K9WM QSLs which go to NN9K. [TNX K9OT and OPDX]

V8, BRUNEL. (8) Dario, IT9SSI, Elvira, IV3FSG and Antonio, IZ8CCW will operate from Bandar Sri Begawan, Brunei (OC-088) over the 5th until the

11th of August after their trip to YB, Indonesia. They plan activity on all HF bands using SSB, CW, RTTY, PSK31 and possibly SSTV. The group have a web page at <http://www.mdx.org/v8a> [TNX IZ8CCW and 425 DX News]

Special Events

LY, LITHUANIA.(9) Seven stations from Klaipeda, Lithuania will be on air using the LY750 prefix from the 5th of July until the 5th of August to celebrate the 750th anniversary of Klaipeda. The seven stations will be LY750TG (LY2TG), LY750BE (LY3BE), LY750EC (LY2EC), LY750FE (LY2FE), LY750CT (LY1CT), LY750PDA (LY2PDA) and LY750SV (LY2SV). QSL via P.O. Box 1000, Vilnius 2001, Lithuania or P.O. Box 70, Klaipeda 5800, Lithuania. There is a special award for working the LY750 stations, for further information please contact Eugene, LY3BE at ly3be@mail.ru [TNX LY3BE and 425 DX News]

SP, POLAND.(10) The Prezes BGK, SP9PGB, will put to air the special event callsign SN150HZ (Sierra November One Five Zero Hotel Zulu) to celebrate the 150th birthday anniversary of Hugo Zapalowicz. Activity will take place using CW, SSB, RTTY, SSTV and PSK between the 15th of July and the 31st of August. Hugo Zapalowicz was a Polish explorer who championed the

preservation of nature, was the author of many natural science and geological papers and studied the family names from the region of the Babia Gora Mountains. He enjoyed climbing and highland folk customs. Babia Gora Mountain is 1725m high in Polish Carpatia Mountains. QSL via the Bureau to SP9PGB.

Mike, GM4SUC, wants to remind us that the International Lighthouse/Lightship Weekend will take place from 0001UTC Saturday the 17th until 2359 UTC Sunday the 18th of August. Already over 100 entries from 27 countries have been registered so far on the official web page run by VK2CE at <http://vk2ce.com/illw>. You don't necessarily need to be in a Lighthouse or lightship, simply being in the vicinity of a recognised maritime navigation installation will suffice, so join in for a weekend of radio and fun. This is definitely NOT a contest but a weekend to enjoy playing radio with your friends and meeting new people. If you have any questions or need to contact Mike for any reason at all he can be emailed at gm4suc@compuserve.com

DXpeditions

XY, MYANMAR (BURMA).(11) The DXpedition schedule has been finalised and now includes the dates, locations and activity: August 2-8th Y a n g o n

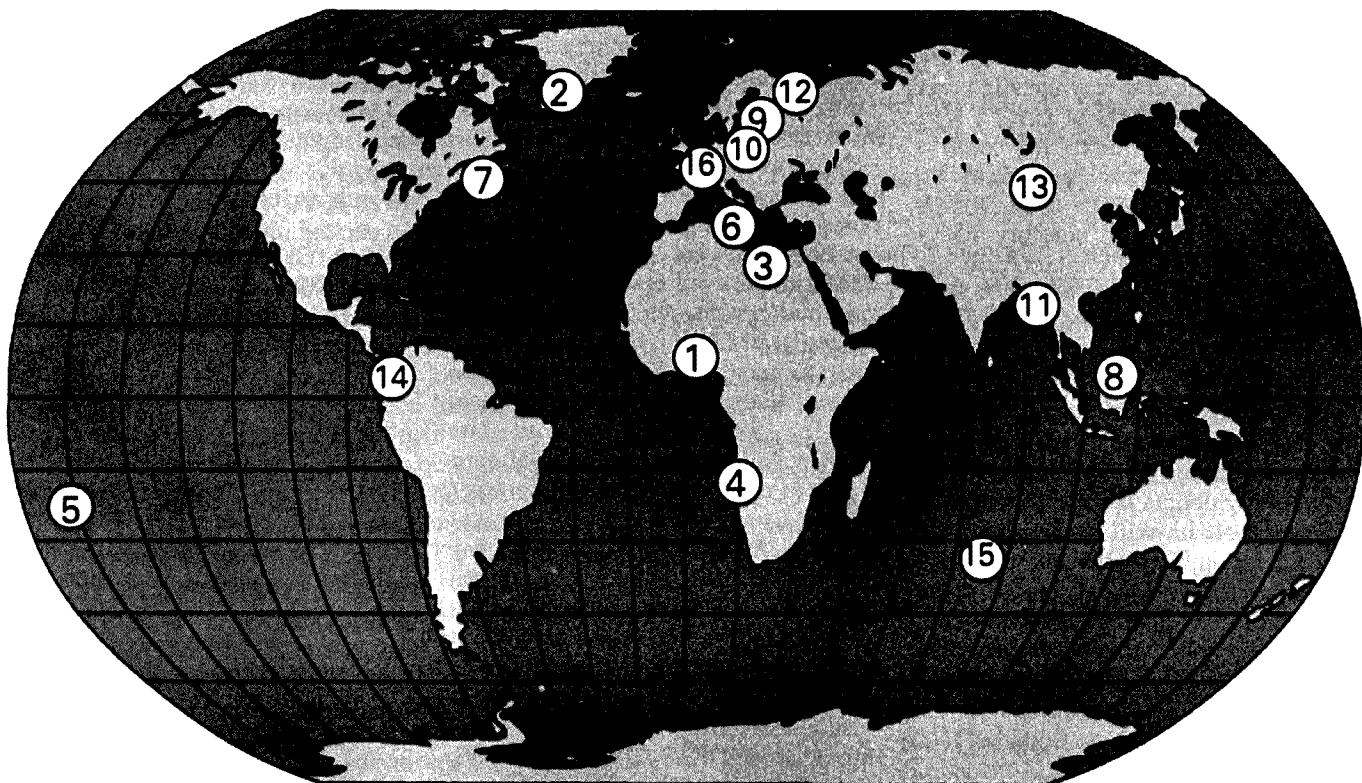

(Rangoon), 80 -10 metres, including WARC and 6m, using one station.

August 9-22nd Ngapali (near Thandwe on the Arakan coast), 160- 10 metres, including WARC and

6m, using up to 4 stations.

August 16-19th Apaw-Ye Kyun, New IOTA (Arrakan Group) 80-10 metres, including WARC and

6m, using 2 stations minimum.

The callsigns to be used are XY3C (CW), XY5T (SSB) and XY7V (digital modes). QSL XY3C via DL4KQ, XY5T via IN3ZNR, XY7V via DL8KBJ, either direct or through the bureau. For further details visit the web page for the DXpedition at <http://www.dxpedition.de/myanmar2000> [TNX IN3ZNR, 425 DX News and The Daily DX]

MOUNTAIN POLAR DXPEDITION.

(12) Members of the Russian Robinson Club plan to be on air from the Khibiny Mountains in the Kola Peninsula (RM-0101 for the Russian Mountain Award) from the 9th until the 23rd of August as R3RRC/1. Activity will take place on HF and VHF (no other details).

JT, MONGOLIA.(13) Ken, K4ZW, is planning another trip to Mongolia this time to concentrate on 80 and 160 metre operations and Karl, K4YT, is planning to accompany him. The date for the trip is set for September, the exact dates will be released later. The two intend to erect beverage antennas and hope to be able to improve the ground system under the Titanex vertical that was installed last November at the QTH of JT1CO. Ken says he is willing to hand carry cards to Mongolia and is extremely confident he can get cards for QSO's with JT1CO, JT1BG and JT1BV and possibly others as well. Ken can be contacted at his callbook address (please include a SAE with an IRC or Greenstamp) or via Email at K4ZW@staffnet.com [TNX The Daily DX]

HK0, COLOMBIA.(14) Roberto, EA4DX, is expecting his licence and travel documents to be confirmed for his trip to Providencia Island, Colombia. If all goes well he will be departing for Bogota, Colombia on the 14th of August and will be on air as HK0/EA4DX on the 20th. Roberto plans to be operational until the 30th of August. Pilot stations have been assigned and are JI6KVR for Japan and EA5BY and EA5FID for the rest of the world. QSL via EA4DX. [TNX EA4DX and The Daily DX]

Round up

FT/Z, AMSTERDAM ISLAND.(15) Rumour are circulating that Caroline, F4DOT (a YL operator) is to travel to Amsterdam Island from Reunion Island on a fishing boat. If the rumours are correct, she may stay there until at least January, and possibly February 2003. This means that Caroline would be the first operator to operate from Amsterdam Island.

However, Caroline is a novice operator and expects only to operate on 6 metres. So if you manage a QSO please show some patience and help her all you can as her operating experience is rather limited. She will be using the call FT1Z, the first time this prefix has ever been on air. [TNX F4DOT and OPDX]

TM, FRANCE.(16)TM2CMM is to be the special French callsign for the Chatelleraud Radio Club special event station celebrating the world championship of hot air ballooning. The event is to be held over the period of the 18th of August until the 1st of September. QSL to F5KOK via bureau [TNX The Daily DX]

RARE QSL CARDS WANTED. Tom, K8CX and Maurice, F5NQL are looking for rare and interesting QSL cards to put on the online Ham Gallery. They already have an extensive display and are always on the lookout for additional cards from rare and exotic locations. Currently they are searching for cards from the following locations/periods;

F18 French Indochina (now Vietnam) before December 1950, 20th

FN8 French Indian settlements of Ponfichery, Chandernagor, Mahe, Yanaon and Karikal, (now VU), before October 1954, 31st.

They don't need the original QSL; a good photograph, photocopy or digital image (in BMP or JPG format) would gladly be accepted. Tom can be reached at k8cx@hamgallery.com and Maurice, F5NQL at f5nql@aol.com or maurice_f5nql@nomade.fr The QSL card display can be found at <http://hamgallery.com/>

Champ, XW1IC/E21EIC, is a very busy amateur operator, making over a 1,000 QSOs each day. He can be found on 15, 17, 20 and 30 metres operating CW but comes up on SSB between 1500 and 0000 UTC.

He is using a TS-850 with 100 watts into a C3 and A4S. QSL via E21EIC. [TNX The daily DX]

HP, PANAMA. Enrique, HP1IBF, says that Panamanian amateurs have been granted access to the 30 metre band again after some intense lobbying of the Government.

Enrique says "tenacious efforts of the Radio Club of Panama and of many individual amateurs" and "after lengthy discussions, debates and public hearings, Panama's amateurs convinced authorities to reconsider the value of amateur activity to the community - as well as the importance of having Panama's regulations conform to international conventions and agreements that it had already signed."

Take note VK hams, this just goes to show what can be achieved by a presenting a united front to a Government authority.

The Philippine Amateur Radio Association (PARA) is celebrating its 70th anniversary. As such, Philippine amateurs have been authorised to use the special prefixes of 4D70 (for individual stations) and DZ70 (for club stations) until the 31st of December 2003.

And now for something completely different (as they say in the classics!). This from an article in OPDX. "INTERESTING OPERATION OF THE WEEK. Look for the "Naturist Amateur Radio Club's" station, NU5DE, to be active from 0000z, July 8th through 2400z, July 14th, from Austin, TX. Activity will take place during the 27th Annual North American Nude Awareness Celebration. Suggested frequencies are: 7265, 14265, 21365 and 28465. QSL via: Naturist Amateur Radio Club, P.O. Box 200812, Austin, TX 78720-0812." I only hope they didn't get too excited in the 'pile-ups'!!

Sources

As always, the details in this months edition of DX Notes have been collected from a number of individuals and organisations, all of who deserve our thanks for allowing it to be published in AR magazine.

This month our thanks go to KK5DO, AA5AU, G3XTT, VE2XO, DL2VFR, K4RB, IK2QPR, EA5KW, K9OT, IZ8CCW, LY3BE, SP9PGB, GM4SUC, IN3ZNR, K4ZW, F4DOT, TM2CMM, K8CX, E21EIC, HP1IBF, The Philippine Amateur Radio Association, The Russian Robinson Club, 425 DX News, OPDX and The Daily DX.

Ken Hanby VK4IS

The Queensland Sunshine Coast amateur radio fraternity and amateur radio in general will be the poorer for the loss of well-known identity Ken Hanby VK4IS. Ken passed away in Westmead Public Hospital, Sydney on 11 June 2002 after a period of diabetes caused complications.

Ken was born on 13 April 1923 at Methley Junction, Yorkshire, England. At about 16 years of age he joined the Home Guard and learned all about battle with a broomstick instead of a gun.

He enlisted in the British Army when Pearl Harbour was raided in 1942, and served during World War II as a radio operator in the Middle East and Europe.

Leaving the army as a sergeant in 1947, Ken came to Melbourne working initially as a motor trimmer, and later with his brother Ray took over the family soft furnishing business *Hanby Interiors* at Frankston.

Ken married Edna in 1957 and in 1965 he became a father to Karen and her brother Marc who were left with Ken and Edna to raise.

Ken retired from business in the early 1970s and in 1977 was diagnosed as diabetic. He spent many holidays in Queensland and in 1986 bought a unit at Caloundra.

He joined the Sunshine Coast Amateur Radio Club, upgraded his qualifications to AOCIP and became a Wireless Institute accredited examiner. A keen amateur with an abiding interest in many facets of the hobby, Ken was elected club president in 1990, a position he held for four years.

Although of limited mobility, Ken led by example: he attended the many JOTA camps; he participated in the field during John Moyle Contests until his movements became restricted when he operated portable after lugging a car battery to the roof of his apartment block; he took part in fox hunts; and his solo efforts in the RedSun Rally can only be commended.

He rostered volunteers to broadcast morse practice sessions on Sunday night and on 9 July 1993 instituted the Sunshine Coast Amateur Radio Club

'Good Morning Net'. The morse broadcasts and Good Morning Net are ongoing.

On 16 April 1994 Ken was presented with the Wireless Institute of Australia Queensland, Distinguished Service Award, for his service to the Sunshine Coast Amateur Radio Club and amateur radio in general.

Edna who was in a nursing home in Caloundra for some years passed away in September 2000. In August 2001 Ken returned to Melbourne to seek treatment for his advancing medical condition and was immediately hospitalised. He was subsequently 'kidnapped' by Karen who cared for him in Sydney until he became silent key.

A big man in the lives of family members, Ken is survived by Karen and Marc, their extended families, and relatives in Australia and England.

Sadly missed by his many amateur radio friends and all who knew him, vale Ken.

Ron VK4GZ

Club News

O.R.A.R.C. - Port Macquarie NSW

The Oxley Region Amateur Radio Club held its AGM on August 3. The retiring President, Bruce Walker, VK2HOT, gave an excellent report on the past year with the Club's participation in numerous events that included the R.D. and John Moyle Contests.

Other activities included JOTA, Lighthouse on-air event and participation in a local event known as the Gray Madri Gras. A great opportunity to show off Amateur Radio to the locals. Attendance to the annual Port Macquarie Field Day held every year over the Queens Birthday weekend was slightly down on previous years, however the Fox-hunt participation was as strong as ever.

The clubrooms received a new computer and HF rig as well as new antenna's being installed. The Middle Brother VHF Repeater on 146.7 MHz has been in great shape over the year thanks to supervision by VK2TT. Unfortunately the VK2RCN Repeater on 147.0 MHz is still off air.

Alan Nutt, VK2GD, was installed as the President for the ensuing year.

The ORARC meets on the first Saturday of each month at 2 pm at the SES Building, Port Macquarie. For more information call 02 6582 3557 or

email anut@ozemail.com.au (de VK2AYD)

ONE-TECH 02

The ACT Division is to sponsor a technical symposium
"One Tech '02"

on Sunday, November 17, 2002.

Packed with technical subjects of interest to Radio Amateurs, there will be also be presentations from Government, Industry, and Universities on radio and electronic subjects.

All presentations will be limited to 40 minutes.

Two streams of presentations will allow attendees to choose their preferred subject.

A heart-friendly lunch is included. Family members can attend just for the lunch, and also enjoy other activities that Canberra has to offer.

For more information, visit the Division's Website at:

WWW.VK1.WIA.AMPR.ORG

or contact the convener, Peter Ellis (VK1KEP) at

PUBLICITY@VK1.WIA.AMPR.ORG

or WIA ACT Division,

P.O. Box 600, Canberra City, ACT, 2601.

Oscar-7 is back after 22 years of silence

A Most Remarkable Happening

It was on Friday 21st June that Pat Gowen G3IOR came up with some startling news. He had monitored a transmission that appeared to be coming from the long lost amateur radio satellite AO-7.

Had it not been for Pat's impeccable reputation among the AMSAT community this 'news' would have been treated with some skepticism - but as it turned out - many people began to confirm his observation and it seemed the impossible had happened. AMSAT-Oscar-7 had begun transmitting Morse code telemetry on its familiar old frequency on 2 metres.

Over the next few days there must have been hundreds - if not thousands - of antennas pointed in its direction and it was soon discovered that the transponders were also working. Within a few orbits it was obvious to all that AO-7 was only appearing when lit by the Sun. Just a few days later as the contact tally mounted, the Atlantic Ocean was spanned once again via AO-7 for the first time in almost 22 years.

Even more remarkable is the fact that Pat Gowen who "re-discovered" AO-7 was one of those who originally worked on its construction. Old-timer gurus and original builders of AO-7 like Jan King and Tom Clark came to light with possible reasons for its re-appearance.

AO-7 was launched and commissioned in November 1974. It really was an "amateur radio" satellite. Its component units were designed and built in home workshops by radio amateurs from many countries and it was assembled in Jan King's basement radio shack by such AMSAT notables as Jan, Tom Clark, Karl Meinzer, Werner Haas and others.

This was real amateur radio. No computers. No clean rooms or space qualified components, just good old fashioned know-how. And it worked! I remember it as a stalwart of our early Mt Skene expeditions in the mid to late 1970s. It was to serve the amateur radio satellite community for 6 years until one

by one its NiCad cells short circuited and eventually it went silent in early 1981.

The consensus of opinion supports the belief that at least one of the cells has somehow 'un-short-circuited' itself allowing power from the solar panels to reach the electronics. Remarkably most of the electronics still work after nearly 30 years orbiting in the harsh space environment. When both AO-6 and its successor AO-7 failed early due to battery trouble, AMSAT pioneer Larry Kayser, VA3LK devised a method of matching NiCad cells.

The longevity of subsequent satellites using such 'matched' cells has proven beyond doubt the success of Larry's method. The University of Surrey's UOSAT-2 (UO-11) was equipped with ordinary commercial cells which were selected and matched using Larry's method and it's record speaks for itself. It is still operational after 75000 orbits and 18 years of reliable operation.

AO-7 had modes A and B linear transponders that switched modes with a timer. The high orbit of 1400+ kilometres gave it the largest coverage of any amateur satellite up to that time. All of Australia and New Zealand could fit into its huge footprint making ZL to VK6 satellite contacts a possibility for the first time and contacts with the islands to our north became commonplace.

Pass times of 20 - 25 minutes made rag-chewing the order of the day on AO-7 and the Doppler shift was easy to deal with, even using mode-B. This was because AO-7 gave us our first taste of an inverting transponder, a concept which went on to become the standard for all VHF-UHF Oscars to come.

Much of the operating etiquette still in use today was developed on AO-7. Modes A and B gear became mandatory on our annual mountain-topping operations during the years from 1975 to 1980. It was sad to say good bye to our old friend AO-7 but when it finally went silent it had already been succeeded by AO-8. Shortly afterwards

the really high altitude AO-10 took over as our satellite of choice in 1983.

But we all had a soft spot for "seven" as it was known, never suspecting it would make an unscheduled return to the airwaves in 2002. Keplerian elements are available from the usual sources and the operating frequencies are as follows:

Two to ten metre linear transponder.

Input 145.850 to 145.950 MHz
Output 29.40 to 29.50 MHz

Seventy cm to two metre transponder.

Input 432-125 to 432-175 MHz
Output 145.975 to 145.925 MHz
Output passband is INVERTED.

Beacons — 29.502 MHz — 145.975 MHz — 435.1 MHz — 2304.1 MHz

Operating Modes:

Mode A. — 2 to 10 metre - when this transponder is on, the 29.502 MHz beacon sends 20wpm Morse code telemetry.

Mode B. — 70 cm to 2 metre - when this transponder is on, the 145.975 MHz beacon sends 20wpm Morse code telemetry.

Although the 850 Hz FSK teletype beacon has been heard, it is not transmitting meaningful data. A search is on as I write this to see if anyone can hear the 2304.1 MHz beacon.

Speculation has now surfaced as to whether any other long defunct bird may start transmitting again. If AO-7 can do it - why not AO-8 or perhaps even AO-6. Maybe we should be doing a SETI-like search of the beacon frequencies of all the old amateur radio satellites.

If Pat G3IOR hadn't listened we still may not know that AO-7 is on the air. Do have a listen to AO-7, even if only for old times sake.

Oscar 7 — born 15/111974 Lomboc Calif. Octahedral, 360mm tall, 424mm across. Three mode. Previous last noted contact 1981.

ISS Active Again on Packet and Voice

Recent American field-day activity sparks an increase in amateur radio activity on ISS.

Apart from the many scheduled school contacts, general AR activity on ISS had been sparse.

The field day however seemed to liven things up quite a bit and it should be worth the effort to keep a watch on the ISS packet radio and voice frequencies. Many voice contacts have been reported over the past few weeks and the packet equipment appears to be running almost continuously.

General information regarding amateur radio activity on board ISS can be found at the following NASA web-site:

<http://spaceflight.nasa.gov/station/reference/radio/>

In planning your listening schedule consult the ISS daily crew schedule which gives an idea when crew members have free time and may be available for

Amateur Radio operations. This information is available at <http://spaceflight.nasa.gov/station/timelines/>

In a more general sense a detailed breakdown of the amateur radio antenna installation on ISS with some excellent pictures and diagrams can be downloaded at:

<http://ariss.gsfc.nasa.gov/EVAs/amsat01.pdf>

A Couple of Hardy Annuals

Oh no ... not the old "Repeater-on-the-moon" question again!

Every now and then the question of putting an amateur radio package of some sort on the moon comes up on the Amsat bulletin board.

Just a few weeks ago it appeared again and as usual it spawned a bunch of replies some supporting and some ridiculing the idea.

James Miller G3RUH wrote an excellent piece on this topic in Amsat-UK's "Oscar-News" some years ago. It's available on their web-site if you want a good read. It's titled "The Earth Moved".

Broadly it boils down to this. The idea has been proposed and even got as far as space being reserved for the package under the driver's seat on a lunar rover vehicle on one of the late manned moon missions. But there are problems, big problems. When you work out the link budget it turns out that if the signal is to

be available to modestly equipped amateur radio earth-stations then the moon installation would need either/ both a lot of power and/or a very high gain antenna system.

Any high power installation on the moon would be fraught with difficulty as its batteries would need to withstand alternate roasting and freezing temperatures during the 14 day long moon-day and moon-night. Keeping the batteries charged and in good order would be a mammoth task.

As if that's not enough, a high gain antenna would need to be steered to follow the Earth due to the moon's libration which causes the Earth to describe little figure-of-eight patterns in the moon-sky. The problems associated with designing, building and somehow ensuring the longevity of any

mechanical tracking apparatus just don't beat thinking about.

Sure the job may possibly be done with electronically steerable phased arrays, but once again no easy job. Such a high gain antenna would be essential to receive signals from low powered amateur radio stations on Earth.

After all those points have been addressed you then have to organise a launch and soft landing on the moon. My advice to those who are pushing for Amsat to consider such a system is "Don't hold your breath".

ar

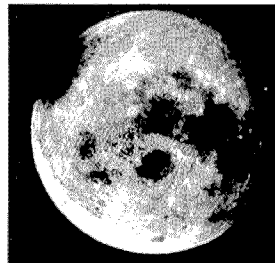

And while we are out there...

The second question that comes up from time to time is "Why don't we get some astronomers to photograph our satellites in orbit for trouble-shooting purposes.

This question is usually triggered by some photographs appearing somewhere on the world-wide-web of ISS or old pictures of MIR taken from the ground. The questioners should note just how much smaller our satellites are than ISS.

The web pictures are usually taken by very advanced amateur astronomers or professionals using large telescopes. Even the best of the best amateur installations can only get fuzzy pictures of objects as large as ISS. Their best effort to photograph even our largest satellite

(AO-40) wouldn't be good enough to get anything more than a tiny fuzzy blob on their CCD cameras. This might be interesting but hardly good enough to be of any practical use to someone trying to fathom a problem like was Oscar-10 struck a glancing blow by the rocket casing on separation?

So, what about asking professional astronomers with really big telescopes to have a look. Telescopes like Kitt Peak and Mt Palomar are booked up for years in advance on research projects. Besides - their tracking mechanisms are designed to follow slow moving objects like planets and stars, not fast moving satellites.

Once again, anything is possible but - don't hold your breath.

The AMSAT group in Australia.

The National Co-ordinator of AMSAT-VK is Graham Ratcliff VK5AGR. No formal application is necessary for membership and no membership fees apply. Graham maintains an email mailing list for breaking news and such things as software releases. Members use the AMSAT-Australia HF net as a forum.

AMSAT-Australia HF net.

The net meets formally on the second Sunday evening of the month. In winter (end of March until the end of October) the net meets on 3.685 MHz at 1000utc with early check-ins at 0945utc. In summer (end of October until end of March) the net meets on 7.068 MHz at 0900utc with early check-ins at 0845utc. All communication regarding AMSAT-Australia matters can be addressed to: AMSAT-VK, GPO Box 2141, Adelaide, SA. 5001. Graham's email address is: vk5agr@amsat.org

HDD Crash

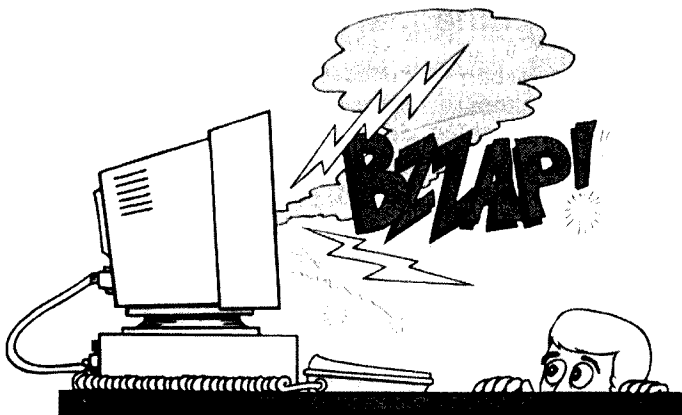

It happens to all computer users at some time and often more than once, the dreaded hard disk crash.

Such a failure of a hard disk can really mess up your day, or should I say in reality, several days.

My PII 266 is used mainly for internet, word processing and graphics, and for several months had the odd problem booting (starting up), with reports of a missing or corrupted file from time to time on boot up. The problem was solved by re booting. As the problem was only a minor inconvenience it was ignored.

However one evening the blue screen of death (major software or hardware problem) came up with the message "unable to write to drive C". Now this did not look good, but hitting the enter key took the computer back to normal operation and it was possible to write to the hard drive.

However the long and short of it was the "unable to write to drive C" continued to come up from time to time and a scan of the C drive showed all was not well, with a couple of bad sectors, and worst of all, Scandisk (the program that tests the read write performance of the hard disk) would crash. Eventually on start up the computer would not even recognise the hard disk at BIOS level (basic input output system).

For the non-computer reader, a computer has a basic program (BIOS) on the motherboard that among several other things recognises hardware such as hard drives. The hard drive would work from time to time but there was little point in delaying the inevitable, a new hard drive was needed.

Having learnt the lesson about backing up no data was lost but buying a replacement hard drive and reloading all the drivers and software followed by setting up the Internet etc is a lengthy process. Time spent in the past getting all the software together in one place was time well spent, so a hard disk was purchased and installed with a minor hitch of being told that a 40 gigabyte hard disk would work in a PII 266. It would not, as computers of this age usually only recognise hard disks smaller than 32-gigabyte. So another trip to get the right hard drive. All went well and the computer is back working.

Hard disk prices sure have come down in price per gigabyte. I remember not so long ago a one gigabyte hard drive costing \$1,000! Ten years on they are about \$5 per gigabyte.

This is my excuse for having little time to write much for this month's column. A total of three days on and off was spent returning the computer back to use. I had also backed up my e-mail address book so little drama there.

Windows XP

I have had the opportunity to have a play with Windows XP and a couple of observations. When setting up a computer from

scratch, Windows XP can do the complete job without the need for any driver disks.

Windows XP contains a large selection of drivers and just goes right through without asking for anything.

When Windows XP does not have a particular driver and asks for a driver disk, as soon as you put the CD or floppy in, it goes to the disk and scans it for the driver and then loads it. This is a great improvement in manually sorting through confusing directories to find the right driver.

Radio Circuits

While looking at the VK6WIA web page I found a link to circuits of many amateur radio transceivers.

Have a look at http://hamradio.online.ru/sch_eng.html



Contest Calendar

August – October, 2002

Aug	3	Waitakere Sprint	(CW)	
Aug	3	European HF Championship	(CW/SSB)	
Aug	4	YO DX Contest	(CW/SSB)	
Aug	10/11	Worked All Europe DX Contest	(CW)	
Aug	17	SARTG WW RTTY Contest	(RTTY)	
Aug	17/18	Keymen's Club of Japan Contest	(CW)	
Aug	17/18	SEANET Contest	(All)	(Jul 02)
Aug	17/18	Remembrance Day Contest	(CW/SSB)	(Jun 02)
Aug	24/25	SCC RTTY Championship	(RTTY)	
Aug	24/25	TOEC WW GRID Contest		
Aug	24/25	ALARA Contest	(CW/SSB)	(Jul 02)
Sep	7	Digital Modes Contest	(PSK31 etc)	(Jul 02)
Sep	7/8	All Asian DX Contest	(SSB)	
Sep	14/15	Worked All Europe DX Contest	(SSB)	
Sep	21/22	Scandinavian Activity Contest	(CW)	
Sep	28/29	Scandinavian Activity Contest	(SSB)	
Sep	28/29	CQ/RJ WW RTTY Contest	(RTTY)	
Sep	28/29	Anatolian DX Contest	(SSB)	
Oct	5/6	Oceania DX Contest	(SSB)	(Aug 02)
Oct	6	RSGB 21/28 MHz Contest	(SSB)	
Oct	10	Ten-Ten Intl. Day Sprint	(All)	
Oct	12/13	Oceania DX Contest	(CW)	(Aug 02)
Oct	19/20	JARTS WW RTTY Contest	(RTTY)	
Oct	20	Asia-Pacific Sprint	(CW)	
Oct	20	RSGB 21/28 MHz Contest	(CW)	
Oct	26/27	CO WW DX Contest	(SSB)	

Greetings to all readers....

This month I must warn you don't trust 'em.

On previous occasions I have suggested that you take every care in checking your log before sending it off to the Contest Manager.

I can report that if ever a lesson needed to be learned, this is it and I am the bunny who should learn it.

As I was preparing these notes I had an email from the Manager of the Oceania DX Contest to say that the 2001 results were almost complete, but that MY log had no scores attached. This puzzled me, as it was the first time I had used my logger to convert to the new Cabrillo format. I found the printed results rather confusing to read, but it LOOKED OK, so off it went.

August is a month of several VK

contests, so as well as urging you to get involved, I also urge that you check very carefully your final log.

On the subject of Cabrillo, this seems to be the new standard for log submission. Initiated by the ARRL, it is an easy system for computers to read and therefore to cross-check from one log to another.

Many contests are now checked this way – in fact the Oceania DX Contest is now done fully in Cabrillo format.

This means that EVERY log must be converted to Cabrillo by a team of

willing volunteers, and this is a very big task in its own right. After this the logs are run through checking tools, and the outcome is either a string of anomalies caused by the typing process, or finally the results.

For this reason I urge you all to equip yourselves with a logger capable of producing Cabrillo files, but not to forget to check the output even so. I find it best now to submit all logs in the Cabrillo format and leave the handling to the Contest Manager.

73 and good contesting, Ian Godsil VK3VP

Results CQ WW WPX CW Contest 2001

(VK/ZL only - Call/callscore)

VK8AV	All	735,768
VK5GN	"	666,250
VK4DX	"	1,622,264
VK2DPD	"	308,550
VK4TT	28	342,236
VK3VP	All	2,639
	QRP/section	
ZL3CW	"	745,108
ZL1AIH	28	116,754
ZL1TM	7	110,464
ZL6QH	All	5,701,696

Multi-multi section

Results IOTA 2002

(VKs only - Call/score/section)

VK2CZ	72,540	Multi-op.	
VK4TT	14,985	12-hours	CW
VK6NU	85,500	12-hours	SSB
VK3MMY	30,360	"	"
VK1JD	29,484	"	"

Results Harry Angel Sprint 2002

From Ian Godsil VK3VP,
Contest Manager

CW: Place/callscore

1 st	VK5NJ	50 points
2 nd	VK4BUI	18 points

SSB: Place/callscore

1 st	VK5SR	27 points
2 nd	VK2JAH	26 points
3 rd	VK2LCD	16 points
=4 th	VK3ABP	8 points
	VK2EJK	8 points
6 th	VK4NPF	7 points

MIXED: Place/callscore

1 st	VK2AYD	41 points
2 nd	VK8AV2	3 points
3 rd	VK1AI	21 points
4 th	VK4EV	18 points
5 th	VK4VP	13 points

Comments: Many thanks indeed to those who took part and sent their logs. As you can see, not a large number, but again several stations that took part did not send logs. Please reconsider this strategy for future events. We need your entry!!

I am very happy to see several regular contesters in the above list, as well as some whose callsigns are unknown to me. Thank you all very much indeed and I hope that we shall see you in future VK events.

I understand that the certificates for the 2001 event were never issued, so please be assured that this will be dealt with - hopefully by the time that you read these notes.

Again, many thanks and see you in the next VK contest.

Ian Godsil VK3VP

Contest results

VK/ trans Tasman Contest - Complete Results

Overall Winner

(VK/ trans-Tasman Trophy):

VK7KHZ (Thomas Lynd, aged 10, - 2nd Operator under supervision of licensee, Bill Lynd).



Category 1 (Phone):

Place	Call	Score
1 st	VK7KHZ Thomas Lynd	2192
2 nd	VK2AKJ Jim Patrick	2164
= 3 rd	ZL4AL Club Station Gerry Christie, Neil Gilder, John Graham	2148
= 3 rd	VK3IO score Ron Tremayne	2043
5	ZL4DX	1972
6	ZL2KO	1954
7	ZL2AUB	1954
8	VK2AYD	1832
9	VK3BGH	1816
10	ZL1BYZ	1557
11	VK2QV	1364
12	ZL3REX	1262
13	ZL1WT	1218
14	VK2JAH	1196
15	VK7VH	1174
16	VK2LCD	1171

17	VK3BTV	1130
18	ZL4AS	1025
19	VK7NDO/Q	1001
20	ZL1ALZ	790
21	ZL1PZ	781
22	ZL2CAT	702
23	VK3LCM	692
24	VK5EMI	664
25	VK2JDC	643
26	VK6XT	491
27	VK2IGS	477
28	VK2LEE	423
29	ZL2ACJ	359
30	ZL1AAS	310
31	VK3JWZ	298 (ineligible)
32	VK3FN	235
33	VK5KMC	205
34	VK3YB/Q	205
35	VK3HV/Q	198
36	VK2AFL/Q	172
37	VK4FNQ	172
38	ZL1IE	161
39	VK3DBQ	146
40	ZL3DW	113
41	VK2BQS	104
42	VK3MGZ	101
43	VK6ADI	85
44	VK5ET	68
45	ZL1TW	55
46	VK6KI	21
47	VK4KHQ	12
48	VK2JWA	6

Category 2a (Phone/QRP):

Place	Call	Score
1 st	VK7NDO David O'Brien	1001
2 nd	VK3FN Tony Bland	235
3 rd	VK3HV George Francis	198
	VK2AFL	172

Category 2b (CW/QRP):

Place	Call	Score
1 st	VK3JS Ian Godsil	734
2 nd	ZL2AVL Bill Luscombe	571
3 rd	VK5BLS Barry Samuel	281
	VK2KET	268
	VK2AVQ	186

Category 3 (Single Operator - CW):

Place	Call	Score
1 st	VK3JS Ian Godsil	734
2 nd	ZL2AVL Bill Luscombe	571
3 rd	VK2AYD David Pilley	429
	VK3BBT	390
	VK3MV	376
	VK5BLS	281
	ZL1PZ (check Log only)	240
	VK3XU	237
	ZL1TW	177
	ZL3REX (check Log only)	142
	VK4XY	163
	ZL1ALZ	81
	ZL2ACJ	79
	VK5ET	36
	VK8HA	0
* 1 st VK:	VK7KHZ Thomas Lynd	2192
* 1 st ZL:	ZL4AL Club Station	2148

* Night-Owl's Bucket-mouth Award"
(Highest Phone score in last hour): 517
ZL4AS Club Station

* Night-Owl's Paddle-pumper Award"
(Highest CW score in last hour): 68 VK3JS
Ian Godsil

* Lowest Scoring Log Award: 0 VK8HA
Henry Anderson

The 2002 Oceania DX Contest Oct—5/6

1. SPECIAL NOTES for the 2002 Contest

- While paper logging is acceptable it is easier for the contest committee to get the results out quickly if electronic logging is used—especially for logs containing more than 50 contacts.
- Electronic logs are preferred in the Cabrillo format, which is generated by most of the popular contest logging software. If Cabrillo is not used then the log and summary sheet must be in plain ASCII text format.
- Single-Op Single Band logs are to record ALL contacts made by the station—both on the band chosen for the entry and on any other bands. (2002 rule change)
- 7 new plaques/trophies are available for the 2002 contest
- The start time has been brought forward to 0800 UTC (2001 rule change)
- Further information on the contest is available from the Oceania DX Contest web site at www.nzart.org.nz/nzart/update/contests/oceania/

2. THE AIM of the contest is to promote HF contacts with stations in the Oceania region (VK, ZL, Pacific Islands and other locations within the IARU “Worked All Continents” Oceania boundary).

3. CONTEST PERIODS:

PHONE Contest: 0800 UTC Saturday 5 October to
0800 UTC Sunday 6 October
CW Contest: 0800 UTC Saturday 12 October to
0800 UTC Sunday 13 October

4. THE OBJECT is for

- Oceania transmitting stations to contact as many stations as possible both inside and outside the Oceania region.
- Non-Oceania transmitting stations to contact as many stations as possible inside the Oceania region. Contacts from “one non-Oceania to another non-Oceania” station are NOT permitted.
- Oceania receiving (SWL) stations to hear as many stations as possible both inside and outside the Oceania region.
- Non-Oceania receiving (SWL) stations to hear as many stations as possible inside the Oceania region. Logging of non-Oceania stations is NOT permitted.

5. BANDS: 160 m—10 m (no WARC bands).

6. ENTRY CATEGORIES:

- **Single-Op**—Single Operator, All Bands or Single Band. Single operator stations are where one person performs all operating, logging and spotting functions. Only one transmitted signal is allowed at any time.
- **Multi-One**—Multiple Operator, Single Transmitter, All Bands. Only one transmitter and one band permitted during the same time period (defined as 10 minutes). Exception: One—and only one—other band may be used during any 10-minute period if—and only if—the station worked is a new multiplier. Logs found in violation of the 10-minute rule will be reclassified as Multi-Multi. Use a separate serial number for the multiplier station. All operation must take place from the same operating site.
- **Multi-Multi**—Multiple Operator, Multiple Transmitter, All Bands. No limit to transmitters, but only one signal and running station allowed per band. Use separate serial numbers for each band. Note: All transmitters and receivers must be located within a 500 metre diameter area or within property limits of the station licensee, whichever is greater. All operation must take place from the same operating site.

- **SWL**—Short Wave Listener (Receive Only) All Bands. The same callsign for the “station being worked” must not appear more than once in any group of 3 consecutive log entries.

7. EXCHANGE: RS(T) report plus a three or four digit number starting at 001 and incrementing by one for each contact. Multi-One entries are to use a separate serial number for the Multiplier station. Multi-Multi entries are to use a separate serial number for each band.

8. MULTIPLIER: The multiplier is the number of different prefixes worked. Note that the same prefix may be counted once on each band for multiplier credit.

A prefix is the letter/numerical combination that forms the first part of the amateur call—the same as the CQ WPX contest definition.

Examples of valid prefixes are N8, W8, WD8, HG1, HG19, KC2, OE2, OE25, etc. Any difference in the numbering, lettering, or order of the same shall constitute a separate prefix. A station operating from a DXCC country different from that indicated by its callsign is required to sign portable. The portable prefix must be an authorized prefix of the country/call area of operation. In cases of portable operation, the portable designator will then become the prefix.

Example: N8BJQ operating from Wake Island would sign N8BJQ/KH9 or N8BJQ/NH9. KH6XXX operating from Ohio must use an authorized prefix for the U.S. 8th district (W8, K8, etc.) Portable designators without numbers will be assigned a zero (0) after the second letter of the portable designator to form the prefix. Example: N8BJQ/PA would become PA0. All calls without numbers will be assigned a zero (Ø) after the first two letters to form the prefix. Example: XEFTJW would count as XEØ. Maritime mobile, mobile, /A, /E, /J, /P, or interim license class identifiers do not count as prefixes.

Special event, commemorative, and other unique prefix stations are encouraged to participate. Prefixes must be assigned by the licensing authority of the country of operation.

9. CONTACT POINTS: All entries score twenty points per contact on 160 m; ten points on 80 m; five points on 40 m; one point on 20 m; two points on 15 m; and three points on 10 m.

Note that the same station may only be counted once on each band for contact points credit.

10. THE FINAL SCORE is the sum of the contact points multiplied by the multiplier (total number of prefixes worked), i.e., sum of contact points from all bands multiplied by the total number of prefixes worked on all bands (remember that the same prefix can be counted once on each band).

11. GENERAL LOG REQUIREMENTS: Transmitting entries are to submit a log showing the following details for each contact—date, time in UTC, callsign of station worked, RS(T) and serial number sent, RS(T) and serial number received.

SWL entries are to submit a log showing the following details for each contact—date, time in UTC, callsign of “station heard”, callsign of “station being worked”, RS(T) and serial number sent by the heard station. Note that the same callsign may appear only once in any group of 3 consecutive entries in the “station being worked” column.

All logs must be submitted in date/time order—except for Multi-Multi logs which may be grouped by band and then in date/time order.

Single-Op Single Band logs are to record ALL contacts made by the station—both on the band chosen for the entry and on any other bands.

12. ELECTRONIC LOGS are preferred –especially for logs containing more than 50 contacts.

Electronic logs should, where possible, be submitted in the Cabrillo format. The Cabrillo log file must include both an accurately completed header (containing the summary information) and the QSO log data. All of the fields in the Cabrillo header must be completed except for the ARRL Section, Power, Category Overlay and Soapbox lines. See the Oceania DX Contest web site at www.nzart.org.nz/nzart/update/contests/oceania/ for more information about the Cabrillo format requirements.

If you cannot submit a Cabrillo log, then you may submit the plain ASCII text output from most of the popular logging software such as TR, CT, NA, Writelog etc. All non-Cabrillo logs must be accompanied by a separate summary file in plain ASCII text—following the requirements for paper log summary sheets in Section 13 below.

Note that all electronic log files must be in plain ASCII text. Output files from word processors (such as Word documents), database programs (such as Excel spread sheets) or logging program .bin files that are not ASCII text files are NOT acceptable for submissions. Log information in columns is to be separated by character spaces—do not use Tabs or other formatting characters for this purpose.

File names are to include the call sign used during the contest and an appropriate file extension—e.g., ZL2WB submits a Cabrillo file—it should be named ZL2WB.LOG.

The files are to be submitted as an e-mail attachment or posted on a 3.5" diskette. Only one entry is to be included in each submission.

Files sent via e-mail must be sent as attachments, not as the text of the e-mail. Send the files to phoctest@nzart.org.nz (for PHONE entries) or cwoctest@nzart.org.nz (for CW entries).

Do NOT zip files. The E-mail message subject line must include the entry's call sign, Mode (CW or PHONE), entry category and the word "OCEANIA" in the Subject line.

Diskettes are to be posted to: Oceania DX Contest, c/o Wellington Amateur Radio Club Inc., PO Box 6464, Wellington 6030, New Zealand with the entry's call sign, Mode (CW or PHONE), entry category and the word "OCEANIA" clearly marked on the front of the package. All diskettes submitted become property of the Oceania DX Contest Committee and are not returnable.

13. PAPER LOGS: Electronic Logs are preferred (as per the requirements in 12 above) but if this is not possible then paper logs in the following format are acceptable.

Paper logs are to include additional columns showing the contact points and new multiplier prefixes claimed against individual contacts. Multiplier prefixes should only be shown for the FIRST TIME that they are worked on each band. Duplicate contacts must be clearly shown—DO NOT delete duplicate contacts.

Furthermore each paper log is to be accompanied by an alpha/numeric checklist of claimed multiplier prefixes worked on each band plus a summary sheet that clearly states

- The station's callsign
- Operator name/s and callsign/s
- Entrant's name and mailing address
- Mode and Category entered
- Contact points claimed on each band
- Number of multiplier prefixes claimed on each band
- Total claimed score
- A declaration that all contest rules and radio regulations have been observed.

Official log sheets and summary can be downloaded from the

Oceania DX Contest web site at www.nzart.org.nz/nzart/update/contests/oceania/ or obtained by sending a "Self Addressed and Stamped Envelope" to the address below with sufficient postage. If official forms are not available then you may make your own in accordance with the general requirements outlined above and in Section 11.

Paper logs are to be posted to: Oceania DX Contest, c/o Wellington Amateur Radio Club Inc., PO Box 6464, Wellington 6030, New Zealand. Only one entry is to be included in each submission. Airmail is preferred if you are submitting a log from outside VK or ZL.

14. DEADLINE—All logs must be emailed or postmarked NO LATER than 25 November 2002. The reception of logs will be confirmed via email (for electronic submissions) and a listing of all logs received will be posted on the Oceania DX Contest web site at www.nzart.org.nz/nzart/update/contests/oceania/.

15. AWARDS

Certificates will be awarded to the top scoring station in each category listed under Section 6 for each IARU WAC continent and each country.

The following trophies and plaques will also be awarded

OCEANIA

- Top entrant from Oceania in Single Operator All Band Phone category—Ron Wills, ZL2TT Memorial trophy sponsored by ZL2GI, ZL2AL, Wellington Amateur Radio Club and NZART.
- Top entrant from Oceania in Single Operator All Band CW category—Frank Hine, VK2QL Memorial trophy sponsored by WIA Federal.
- Top entrant from VK5 or VK8 Call areas in Single Operator All Band Phone category—Plaque sponsored by WIA South Australian Division
- Top entrant from VK5 or VK8 Call area in Single Operator All Band CW category—Plaque sponsored by WIA South Australian Division
- Top entrant from VK7 Call area in Single Operator All Band Phone category—Plaque sponsored by WIA Tasmanian Division
- Top entrant from VK7 Call area in Single Operator All Band CW category—Plaque sponsored by WIA Tasmanian Division

ASIA

- Top Entrant from Asia in Single Operator All Band Phone category—Plaque sponsored by Australia Eastern Mountain and Districts Radio Club
- Top Entrant from Asia for Single Operator All Band CW category—Plaque sponsored by Australia Eastern Mountain and Districts Radio Club

NORTH AMERICA

- Top Entrant from North America in Single Operator All Band Phone category—Plaque sponsored by N6RO

Additional awards may also be applied at the discretion of the Contest Committee.

16. DISQUALIFICATION: Violation of the contest rules, unsporting conduct, taking credit for excessive duplicate contacts, unverifiable contacts or multipliers will be deemed sufficient cause for disqualification. The use of non-amateur radio means such as telephones or email, or the use of packet, to solicit contacts during the contest is unsporting and the entry may be subject to disqualification. In matters of dispute, the actions and decisions of the Contest Committee are final.

17. FURTHER INFORMATION: The latest information about the contest will be published on the Oceania DX Contest Web site at

www.nzart.org.nz/nzart/update/contests/oceania/.

W.I.A. DXCC standings (335) (June 30 2002)

Callsign	Countries	Callsign	Countries	Callsign	Countries	Callsign	Countries
HONOUR ROLL (326) PHONE				VK4ARB	159/160	VK5WO	335/371
VK4LC	335/382	VK4BP	159/000	VK3QI	335/350	VK4CHB	177/179
VK5WO	335/367	VK2GSN	152/000	VK7BC	334/343	VK6APH	171/172
VK3QI	335/349	VK7LUV	148/000	VK6HD	333/360	9A4KA	168/000
VK6LK	334/359	VK2EJK	144/000	VK3OT	333/347	SM6PRX	162/169
VK3EW	334/340	VK2SPS	141/143	VK3AKK	333/346	VK3VB	153/155
VK3DYL	334/340	VK8LC	136/000	VK4UA	331/347	VK2SPS	142/143
VK3SX	334/340	OK1ZSZ	136/000	VK4AAR	330/334	ON9MCR	129/140
VK5MS	333/387	VK3DQ	133/147	VK2AVZ	329/340	VK3OZ	126/127
VK3AKK	333/346	VK2LEE	130/132	VK3UY	328/331	VK7CQ	123/125
VK2FGI	333/339	VK4VIS	126/128	GENERAL LISTING - OPEN			
VK6HD	332/358	VK2IRP	125/101	VK3JI	322/351	VK2AJE	100/000
VK4UA	331/345	TG8NE	125/000	VK3AMK	322/341	GENERAL LISTING - RTTY	
VK1ZL	331/337	SM6PRX	121/126	VK4LV	320/319	VK3EBP	253/255
VK6NE	330/346	VK2MH	116/118	VK4DV	313/328	VK2BQS	124/126
VK3OT	330/344	VK2YN	113/115	VK6RO	311/317	VK3AMK	100/102
VK4OH	330/337	JA8XDM	111/000	VK4ICU	311/313	VK5RY	100/102
CT1EEN	330/000	C21DJ	109/000	VK4DP	309/323	GEN-LISTING - 6M. OPEN	
VK2AVZ	329/340	VK3MRG	108/000	VK3DP	305/308	VK4ABW	101/000
VK3CSR	329/338	VK5UO	107/110	VK2UK	303/298	GEN-LISTING - 2M. OPEN	
VK2DEJ	329/335	ZS6IR	102/104	VK6LC	291/294	(Vacant)	
VK4AAR	328/332	C21NJ	102/000	VK7TS	285/286	GEN-LISTING - SATELLITE	
VK3YJ	326/332	VK2FZR	102/000	VK3CIM	282/286	VR2XMT	112/114
GENERAL LISTING - PHONE				VK2EJM	101/103	GENERAL LISTING - SSTV	
VK7BC	324/329	VK3KTO	101/102	VK1PRG	101/000	(Vacant)	
EA3AKN	323/331	HONOUR ROLL (326) CW				GENERAL LISTING - DIGITAL	
VK3AMK	321/340	VK3QI	334/346	VK3KS	307/335	(Vacant)	
VK6VS	319/323	VK6HD	333/354	VK3AKK	300/305	GENERAL LISTING - FAX	
VK5FV	319/322	VK5WO	331/347	VK4LV	297/300	(Vacant)	
VK4SJ	315/316	GENERAL LISTING - CW				GENERAL LISTING - FAX	
VK4LV	313/307	VK3KS	307/335	VK4ICU	291/000	(Vacant)	
VK3JI	310/325	VK3AKK	300/305	VK3JI	274/299	GENERAL LISTING - SATELLITE	
VK6APK	310/315	VK4LV	297/300	VK7BC	246/255	VR2XMT 112/114	
VK5WV	306/326	VK4ICU	291/000	VK6MK	246/249	GENERAL LISTING - SSTV	
VK6RO	305/311	VK3DP	245/247	VK3DP	245/247	(Vacant)	
VK6ABS	304/000	VK2CWS	244/246	VK2CWS	244/246	GENERAL LISTING - DIGITAL	
VK4ICU	303/305	VK4DA	237/239	VK4DA	237/239	(Vacant)	
VK3IR	302/306	VK3DQ	234/261	VK8AM	236/000	GENERAL LISTING - FAX	
VK1TX	300/000	VK3CIM	228/229	VK2YN	204/206	(Vacant)	
VK6DY	297/301	IK1ZOD	210/000	VK2FHN	193/000	GENERAL LISTING - SATELLITE	
VK4DP	293/305	VK4DP	205/216	VK2BQS	181/184	VR2XMT 112/114	
VK2UK	292/297	VK7TS	204/000	GENERAL LISTING - SSTV			
VK6LC	289/292	VK7RO	201/204	(Vacant)			
VK4EJ	286/288	VK2YN	197/199	GENERAL LISTING - DIGITAL			
VK4BAY	283/286	VK6HW	179/182	(Vacant)			
VK3DP	274/277	VK5UO	165/166	GENERAL LISTING - FAX			
VK2HV	272/000	VK4UA	155/145	(Vacant)			
VK7TS	270/271	OK12BNC	144/000	GENERAL LISTING - SATELLITE			
VK6ANC	265/269	VK4AAR	143/145	VR2XMT 112/114			
VK2CA	265/000	VK8AM	138/000	GENERAL LISTING - SSTV			
VK3VQ	261/278	NTM	135/000	(Vacant)			
VK3UY	260/262	VK7DQ	131/132	GENERAL LISTING - DIGITAL			
VK5IE	258/261	DK6AP	120/000	(Vacant)			
VK3CIM	250/254	VK8KV	112/113	GENERAL LISTING - FAX			
VK8KTC	231/233	K5QNM	110/113	(Vacant)			
VK6APW	228/229	VK5BWW	110/113	GENERAL LISTING - SATELLITE			
VK8AM	225/000	SM6GZN	110/111	VR2XMT 112/114			
VK3SM	222/242	OK1FED	109/000	GENERAL LISTING - SSTV			
VK4IL	212/000	VK4CXQ	106/000	(Vacant)			
VK4AO	203/000	UR5BCJ	103/105	GENERAL LISTING - DIGITAL			
VK3DVT	201/204	VK3DG	102/000	(Vacant)			
VK6BH	200/000	SM6PRX	101/102	GENERAL LISTING - FAX			
PY2DBU	195/197	HONOUR ROLL (326) OPEN				GENERAL LISTING - SATELLITE	
VK2FHN	190/000	VK4LC	335/382	VR2XMT 112/114			
VK7JAB	186/000	GENERAL LISTING - CW				GENERAL LISTING - SSTV	
G0VXX	184/000	VX3YJ 326/332				(Vacant)	
VK6APH	168/169	HONOUR ROLL (326) PHONE				GENERAL LISTING - DIGITAL	
VK4CHB	167/168	VK4ARB	159/160	VX3YJ 326/332			
VK2BQS	164/167	VK4BP	159/000	VX3YJ 326/332			
LU5DSE	161/000	VK2GSN	152/000	VX3YJ 326/332			
<p>The W.I.A. Federal Awards DXCC program congratulates Bill VK4LC, the first VK to achieve dual 335, "Phone & Open", and Austin VK5WO and Peter VK3QI for achieving 335 countries. The W.I.A. DXCC program has been audited to the month of June, if you find your Callsign not listed it means you have not updated in the past 5 years or your score has dropped below 100.</p> <p>The W.I.A. Awards program advises, with any submissions they can not accept just a country list.</p> <p>The W.I.A. Awards Program General Rules have not changed. They are: Applicants need to hold QSL cards for all QSO's claimed. However "do not send QSL cards" with your application or update. A list of all two way contacts is needed, which should list the following:</p> <p>Callsign of station contacted, country worked, date, time, frequency and mode as shown on check sheets. At the bottom of the check list a declaration signed by an official of a recognised society or by two licensed radio amateurs. Signatories to the declaration should clearly indicate their names and callsigns. Copies of the rules and current DXCC country lists are available, direct by email or hard copy via the post. Email to awards@wia.org.au or post to Federal Awards Manager P.O.Box 196, Cannington, Western Australia. 6987. Thank you Mal. VK6LC</p>							

VHF - UHF.. AN EXPANDING WORLD

David K Minchin VK5KK

Postal: 10 Harvey Cres, Salisbury Heights, SA, 5109

E-mail: tecknolt@ozemail.com.au EMAIL ADDRESS CHANGED!

Web page: <http://members.ozemail.com.au/~tecknolt>

Fax: +61 8 82924501

Phone: 0403 368 066 AH ONLY

All times are in UTC.

50 MHz

The following information is courtesy of Bill G4UPS. St. Pierre & Miquelon (46 50 N, 56 20 W). These islands in the North Atlantic Ocean, south of Newfoundland, were first settled by the French in the early 17th century and represent the sole remaining vestige of France's once vast North American possessions. FP/NA1CW has given a new country to many 6 m buffs. The call sign NA1CW is the new call for Tim N1RZ. Grid square GN17VA (46 50 N, 56 20 W)

Angola: Heard I3LLH, the QSL manager for D2EB informing a G station that he had only received the logs from D2EB up to September 2001. A further QSO with Henry, I3LLH on 29th June confirmed that he was having difficulty obtaining the logs of D2EB. He had over 1,000 QSL cards but had so far only received logs up to September 2000. So it looks as if we are going to wait some time before we receive the QSL cards!!!

Switzerland: A new beacon heard on 3 June 2002 for the first time..1724 UTC on 50.058.5 HB9SIX JN47KM a CW beacon and very strong 599 with lots of HB9 activity at that time.

NEW 6 m BEACON: A new beacon heard on 29th June at 1046 UTC for an extended period - SR3SIX 50.015mhz locator JN92DF. Reported to Brian G3HBR and he was also hearing weaker than this location. Beacon peaked 579.

GippsTech 2002

The fourth technical symposium run by the Eastern Zone ARC, entitled "GippsTech 2002", was held over the weekend of the 6th & 7th of July 2002 at the Gippsland Campus of Monash University, located in Churchill.

Churchill is about 2 hours drive east of Melbourne. The Gippsland Technical Conference (GippsTech 2002) had its focus on a number of topics of relevance to amateurs interested in amateur VHF, UHF and Microwave communications. Without doubt this was the biggest and

most successful one of the series so far! Attendance, including partners, exceeded 100, fast approaching the attendances of similar events in the US and the UK. Dare I say that "GippsTech 2002" outdid the RSGB Microwave & UKSMG Conference I attended, in the UK, in April 2002!

Amateur operators attended from all states (and one ZL) except VK6 this year. The contingent from both VK2 and VK5 had more than doubled in numbers over last year. Those who attended had a wide variety of interests with an even distribution amongst weak signal working and microwave.

Chaired by Peter Freeman, VK3KAI, GippsTech 2002 coverage was expanded with a good flow between full-blown technical presentations and some shorter segments.

Current Digital modes being used for Weak signal work using software by Joe K1JT was one of the main subjects discussed. It shows how much has occurred since last year when we were looking at Hellscriber and PSK31 as the state of the art! While PSK31 is still in regular use on HF I didn't hear anyone talking about Hellscriber this year!

Neil Sandford VK2EI followed on from last year's 24 GHz presentation with changes made to his 24 GHz portable system to include the surplus 500mW "Millewave" 25 GHz PA modules obtained from the USA. The estimated power output is in the region of 300-400 mW. This is nearly a 10-db improvement over the previously used power levels using DB6NT PA's with 2 x MGF1302's in the PA.

Trevor VK5NC also had photos of his updated system using the same PA as well. Russell VK3ZQB has been busy updating his system and VK5KK is working to complete his upgrade to the same level. With 600 mm dishes, bigger guns will be out "breaking records" on 24 GHz this coming summer!

Doug VK3UM gave a pictorial talk on

the building of his EME system including the installation of the 10-metre dish. One could imagine the engineering and time required to do it properly, with the extra challenges of being on an exposed hill, the dish being blown half way down the hill at one stage ... close to being irrecoverable.

Doug also gave a run down on his pending European "EME pilgrimage", no doubt we will have more to report on that in the next few months.

Other talks covered Antenna software (NEC), VHF propagation, Circuit simulation, Antenna construction and more. The display of equipment was expanded with static items related to the lectures over the two days. Traders also had parts and kits for sale. The room was packed for the two days showing the high level of enthusiasm generated

There was a predominance of microwave gear from the Eastern Zone ARC members. If you think microwave communications isn't becoming popular, think again! In the previous twelve months, Peter VK3KAI, helped circulate a number of "White box" 10 GHz transverters, some of these completed and displayed. The quality and innovation evident in the systems was high. We might not have the number of operators as Europe but the equipment is on par (or better!).

The hard copy material for the conference will again be collated into the proceedings for 2002. The Eastern Zone ARC is to be congratulated on the well-organized event (including the partners program) along with the work done by the presenters.

Spare copies of Proceedings for the previous 3 Symposiums are still available for sale.

For further information, look on the Eastern Zone ARC website at <http://www.qsl.net/vk3bez/index.htm> or contact Peter VK3KAI (QTHR).

Digital "DX" Modes

Rex VK7MO supplied the following:

FSK441

Meteor activity seems to be improving with a number of stations reporting one or two burns of a few seconds during the activity sessions recently.

The activity sessions will continue as Type A on 144.230. I will ask Ian, VK3AXH, to run the 40-metre report-back session on the Saturday morning.

Adrian, VK2FZ, reports significantly increased meteor ping rates on the Geelong beacon in the evenings, which he relates to current shower activity. He will be on listening on 144.230 each weekday evening in Type A format, beaming south, from 9:30 pm to 10:30 pm local up to 10 August. He will only transmit if he sees something. He welcomes any calls.

Rare Grid Square QE36

I will have been portable on Saturday 3 August from Tinderbox in QE36 South of Hobart, from 0815 local (2215 UTC) on 144.330 for at least 90 minutes or as long as I see new signals. Following my recent rare grid square exercise to the mainland I have amended the procedures slightly for rare grid square operations as follows:

I will have called CQ VK7MO and looked for stations to respond with a report eg VK7MO 26 VK3AXH 2626 I responded VK3AXH R16R16 and looked for VK3AXH RRR. When I got VK3AXH RRR I sent 73 and gave a report to the next station on my list eg 73 VK3AEF R27R27 VK3AXH sends 73 in single tones when he receives my 73. I dropped the 73 when I received the single tone 73 and replaced this by hash and a number to indicate the number of stations still on my list including the station being called eg #2 VK3AEF R27R27.

FSK441 Technical

Joe Taylor, K1JT, has advised that on single tones WSJT uses a bandwidth of 43 Hz compared to 441 Hz for standard code. This potentially provides up to 10 dB improvement on single tones but to gain full benefit of this improvement you must be tuned to within 21 Hz.

Joe also advises that the full 10dB improvement is only achieved if you have a low noise environment and can set the QRN to a low value – say 3 or less. The shorter duration required to

receive single tones also allows one to use the peak of a ping thus further improving performance.

Noted that the narrow bandwidth, 43 Hz, filter is run for each receive segment as well as the normal 441 Hz filter, independent of whether the single tone box is ticked. This means that single tone reception is always available with single tone messages being reported in a separate column to the left of the standard messages. The purpose of ticking the single tone box is to transmit in single tone format; this does not effect what is received.

John Martin VK3KWA reports ... three new national Digital Modes records have been set in the last month: New 2 metre record VK7MO/3 to ZL3TY, 09/07/02 2142.5 km (FSK441). New 70cm record VK3FMD to VK5OA 28/06/02 375.7 km (JT44) to be broken the following day by: VK3KAI to VK5OA, 29/06/02 496.7 km (JT44)

If you want more information about WSJT & JT44, the best resource is that put together by Rex VK7MO at <http://www.tased.edu.au/tasonline/vk7wia/>

Microwave Round Up

Barry VE4MA reports ... I have been busy performing 47 GHz Sun Noise Tests in recent weeks and comparing notes with Al W5LUA, Gary AD6FP and Will W0EOM. There are few people looking at sun noise or even capable of doing so at this frequency. There is a shortage of large antennas rated for this frequency.

Measurements were taken using 1, 2, 3, 4, 6, 8 and 10 ft dishes and all receivers are believed to have Noise Figure of about 4.5 dB. Cold sky to ground measurements are about 1.3 dB using the feedhorns alone

Here are the Sun Noise results:
W5LUA 15 " Prime Focus 39 GHz Dish 1.4 dB Sun Noise
VE4MA 30 inch Offset Metal 2.4 dB
W5LUA 24" Prime Focus 39 GHz Dish 2.5 dB Sun Noise
VE4MA 4 ft Offset Plastic dish 3.6 dB
W0EOM 2 ft dish 4.1 dB
VE4MA 6 ft Offset Fibreglass dish 5.0 dB
AD6FP 3 ft Precision (95 GHz) dish 5.2 dB
W5LUA 10 ft (24 GHz EME dish) 5.7 dB
Sun & 0.4 dB Moon Noise
VE4MA same 4 ft Offset Plastic dish with Aluminium foil now on surface 6.4 dB
VE4MA 8 ft (24 GHz EME dish) 6.9 dB

The remarkable thing is the 3.3 dB gain improvement in the 4 ft offset dish performance with the addition of aluminium foil. The plastic/ fibreglass offset dishes seem to be reasonably

accurate but the reflecting material imbedded in the surface is not very effective at this frequency (designed for 14 GHz). The 30-inch metal offset dish does not seem to be efficient, nor are the 39 GHz dishes.

The 4 ft dish I was using was part of a General Instrument 12 GHz receiving system and has 8 large 5/16inch bolt heads sitting on the surface. I will be modifying this for rounded heads.

The foil was attached with wallpaper cement (temporary) and subsequently painted with white latex paint to reduce the heating of the feedhorn!! ... Barry VE4MA

In closing

David VK2CZ reports ... Latitude and Longitude details of every town, hill, swamp etc in Australia is available on the web and it's not an Aussie web site!! It also includes 98% of suburbs as well. It's a two-step approach to get information:

1. Look up the site name and get the Lat/Long at <http://gnpswww.nima.mil/geonames/GNS/index.jsp>
HINT: Go to the Gazetteer Search Window and select Australia, generally look for PPA codes in the results - Populated areas means towns.
2. Enter the Lat/Longs into the Grid Square converter at <http://www.amsat.org/amsat/toys/gridconv.html>

This data is unclassified - but will give you an idea of what is known about our geography!! I've found it's accurate for the 6 digit Maidenhead, but be careful you get the correct location you want ... David VK2CZ/VK8AA

News is a little bit light on again this month, better than fifty percent seems to be WSJT/JT44 related These modes are doing their best to keep the VHF bands active over winter. Discussions after Gippstech 2002 might see JT44 being used on higher frequencies once a number of stability issues are sorted out. I believe a number of "digital records" are yet to be established above 1200 MHz!

I am now nearly 2/3rds permanent resident in Melbourne (weekends only in Adelaide). I am slowly migrating over some of the microwave gear for summer so it won't be long before VK5KK/P3 will be in action!

I'll leave you with this thought.. *"The trouble with being punctual is that people think that you have nothing more important to do"*

73s David VK5KK

ar

Adelaide-Amman 292

First F 0-5 Long 13022 km

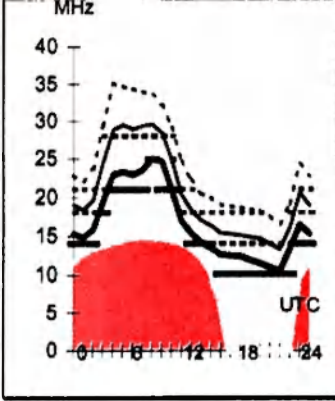

Brisbane-Auckland 123

First F 7-9 I E0 Short 2290 km

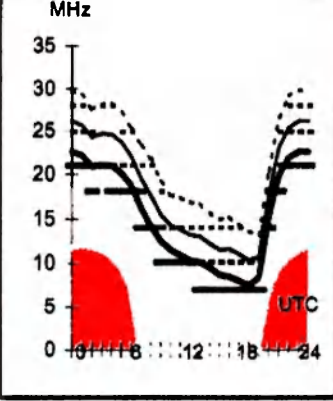

August 2002
T Index: 100

Legend
Frequency scale
UD
E-MUF
F-MUF
OMF
ALF
>10%
>50%
>90%
Time scale

HF Predictions

by **Evan Jarman VK3ANI**
34 Alandale Court Blackburn Vic 3130

These graphs show the predicted diurnal variation of key frequencies for the nominated circuits.
These frequencies as identified in the legend are:-
• Upper Decile (F-layer)
• F-layer Maximum Usable Frequency
• E-layer Maximum Usable Frequency
• Optimum Working Frequency (F-layer)
• Absorption Limiting Frequency (D region)
Shown hourly are the highest frequency amateur bands in ranges between these key frequencies, when usable.
The path, propagation mode and Australian terminal bearing are also given for each circuit.
These predictions were made with the Ionospheric Prediction Service program: ASAPS Version 4

Adelaide-Invercargil 126

Second 4F16-19 < Short 2796 km

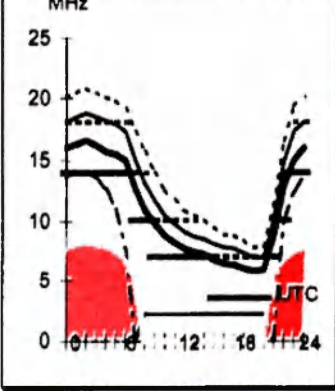

Brisbane-Dakar 217

First F 0-5 Short 18279 km

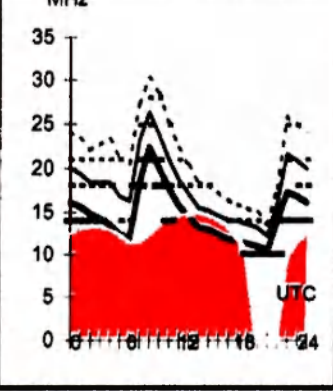

Canberra-Lusaka 239

Second 4F3-4 4E(Short 11620 km

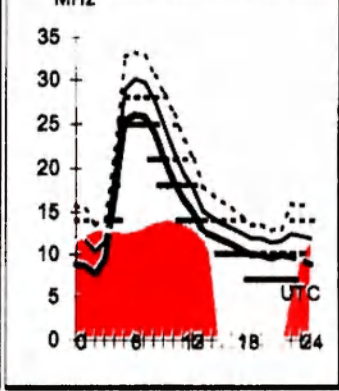

Darwin-London 145

First F 0-5 Long 26171 km

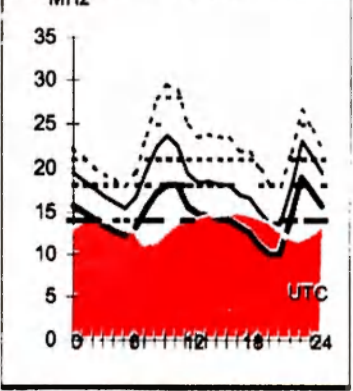

Adelaide-New York 67

First F 0-5 Short 17092 km

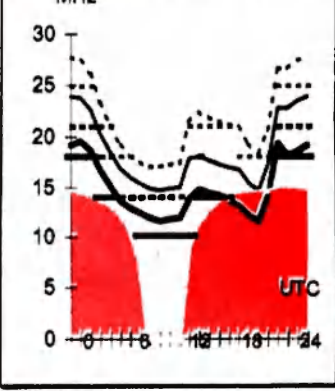

Brisbane-Honolulu 49

Second 3F5-10 3I Short 7596 km

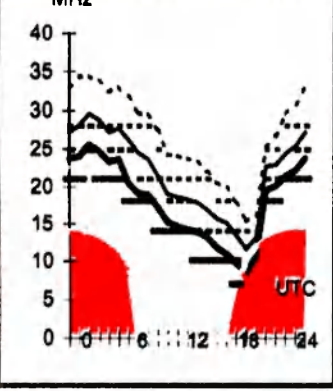

Canberra-Moscow 317

First F 0-5 Short 14481 km

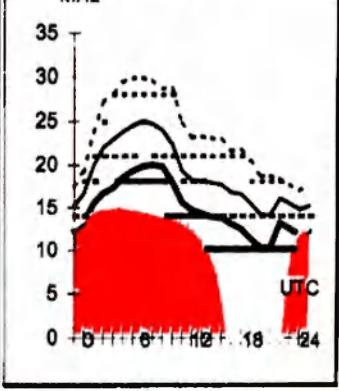

Darwin-London 375

First F 0-5 Short 13853 km

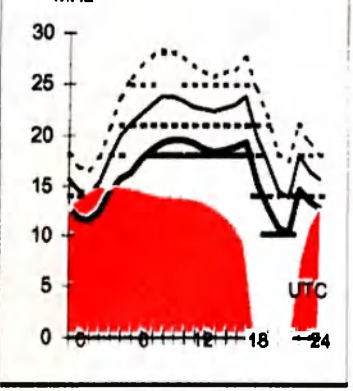

Adelaide-Rome 296

First F 0-5 Short 15337 km

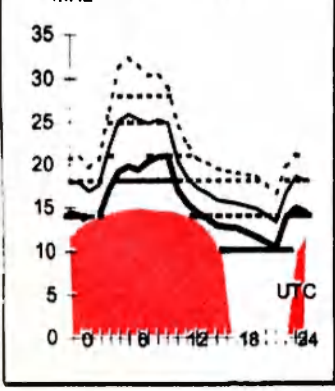

Brisbane-Singapore 293

First F 5-7 I E0 Short 6147 km

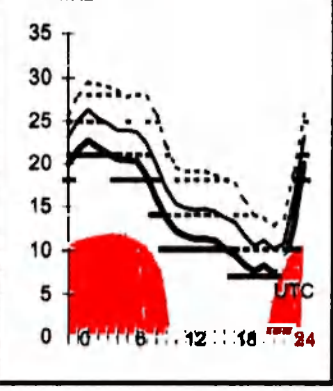

Canberra-Tokyo 357

Second 3F4-9 3E(Short 7948 km

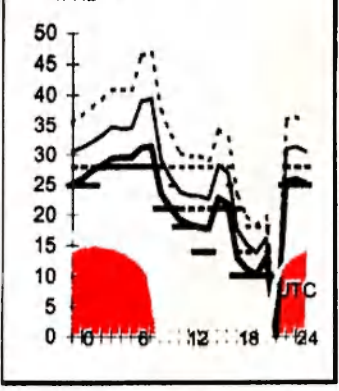

Darwin-Pretoria 247

First 4F3-10 4E0 Short 10639 km

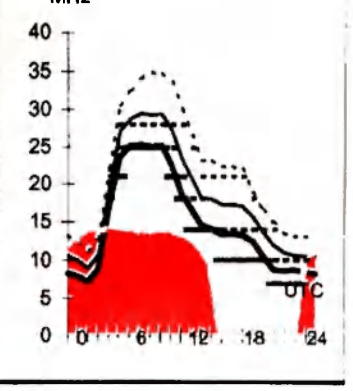

Hobart-Montevideo 161

Second 4F3-4 4E Short 11044 km
MHz

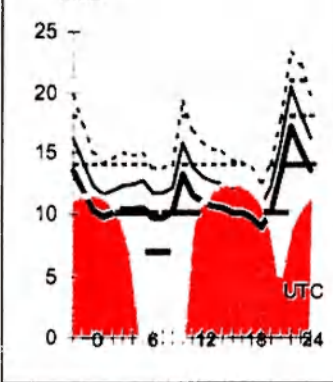

Melbourne-Budapest 302

First F 0-5 Short 15558 km
MHz

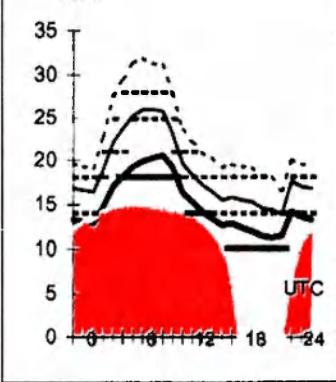

Perth-Capetown 237

First 3F3-4 3E0 Short 8703 km
MHz

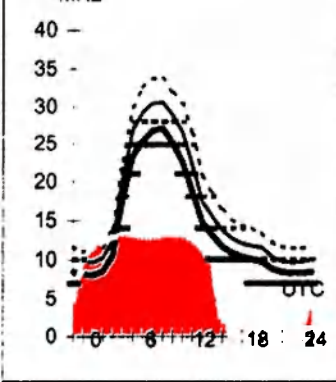

Sydney-Chicago 62

First F 0-5 Short 14876 km
MHz

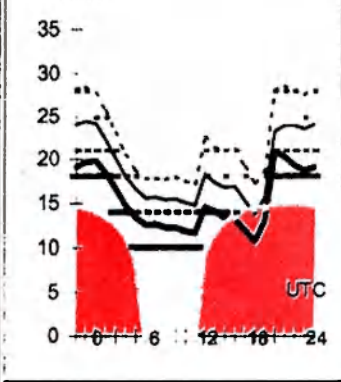

Hobart-Stockholm 136

First F 0-5 Long 23871 km
MHz

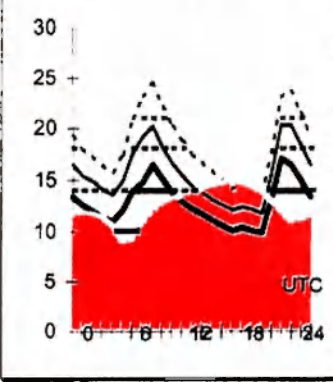

Melbourne-Jakarta 303

First 2F4-7 2E0 Short 5214 km
MHz

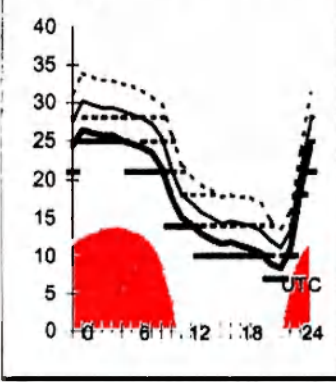

Perth-Osaka 17

Second 3F5-10 3E Short 7684 km
MHz

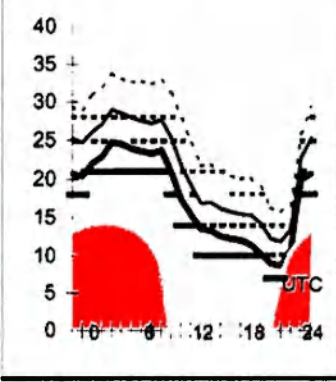

Sydney-London 139

First F 0-5 Long 33032 km
MHz

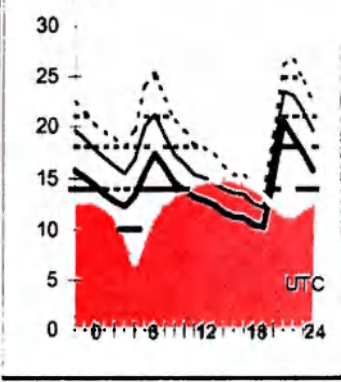

Hobart-Suva 56

First 2F9-12 2E0 Short 4011 km
MHz

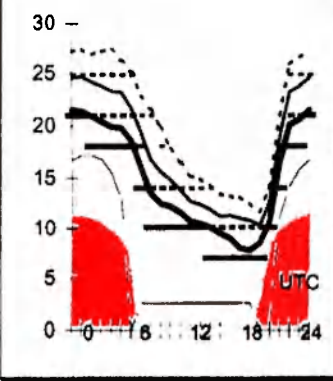

Melbourne-Manilava 332

First 2F1-6 2E0 Short 6341 km
MHz

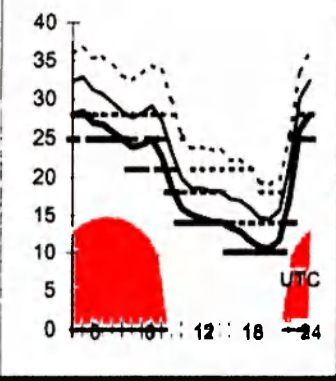

Perth-Santiago 174

First F 0-5 Short 12709 km
MHz

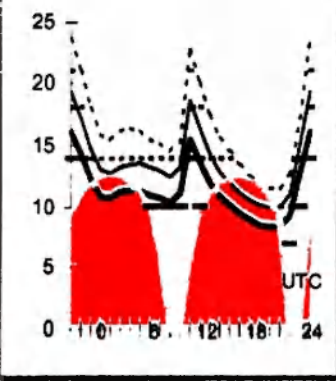

Sydney-London 319

First F 0-5 Short 16992 km
MHz

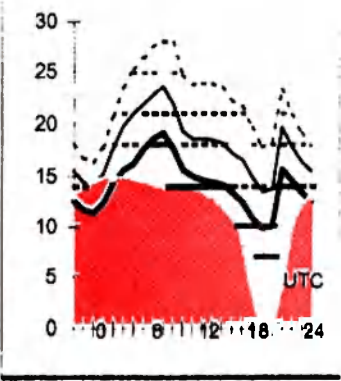

Hobart-Vancouver 49

First F 0-5 Short 13427 km
MHz

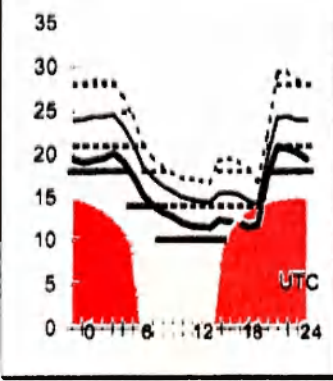

Melbourne-New Delhi 306

Second 4F5-11 4E Short 10200 km
MHz

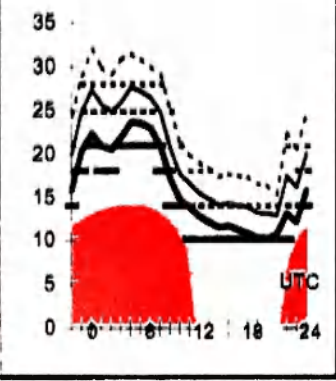

Perth-Tel Aviv 302

Second 4F4-9 4E Short 11091 km
MHz

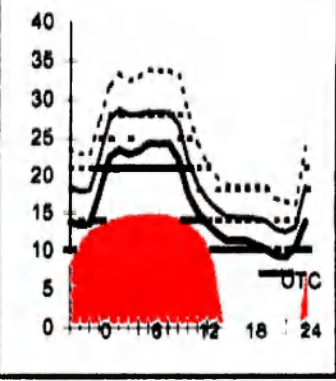

Sydney-Rio de Janeiro 164

First F 0-5 Short 13519 km
MHz

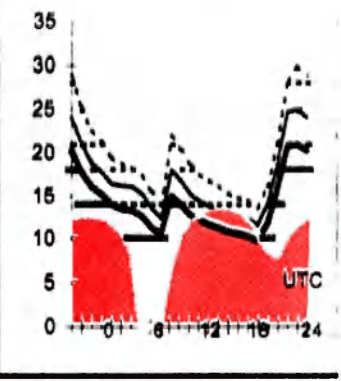

Ham Shack Computers Part 17

CQ Contest

Alan Gibbs, VK6PG
 223 Crimea Street, NORANDA WA 6062
 Email: vk6pg@tpg.com.au

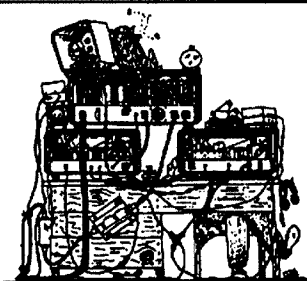

YLogging along with your contest results (or even just your own records)

SSB Contesting

This can also be done with YLog in the SSB Contest Mode. It requires the user to prepare a set of .WAV files that are linked to each of the function keys (F1 - F8) where F1 is labelled "CQ TEST", F2 might be "59+serial number" and so on. To interface the sound card output to the transceiver, the low-level audio line input or the microphone input socket must be accessed.

Modern transceivers with audio line input and output sockets are fine, but if you are stuck with only the microphone input socket, it can be messy changing from Contest Mode to Microphone Mode unless they are correctly integrated by mixing.

Once done the system is just as easy to use as the CW keying technique. For more details on how to achieve SSB Contest operation, see the Help file in the YLog software package.

Using the above techniques, your Ham Shack Computer does the hard work by integrating all your software options with your station AR equipment. From now on you should be able to operate in a CW, SSB, RTTY, PSK31 contest, or just leisurely "search and pounce" for DX on the HF bands using your local packet DX cluster all at the same time from your computer screen!

But what does it all this actually look like on the computer screen? Read on...

The image (facing) of the total screen area on the writer's Ham Shack Computer looks awesome at first. So, let's move around each window and see what's happening.

The CW keys window shows the pre-programmed macros for a contest. The F1 key does the CQing, F2 to call a station before a QSO is established. INTRO sends HISCALL de MYCALL, and the cascaded F3, F4, and F5 are used

If you think this edition of Ham Shack Computers is just for contesters then read on.

It's valid for the keen CW, SSB and data contesters and the casual rag chewer who just wants to make life easier in a modern technology setting. The Internet reveals well over 100 contesting and logging programs currently in use by thousands of Radio Amateurs worldwide - but which one is best for you? Readers can only decide by experimentation.

However, the writer's choice is YLog by Tony Field, VE6YP (1) because of its ease of use, stability on all Windows platforms, versatility, on line support, low cost, and the ability to run on a network.

The Hardware...

It depends if you decide to key the transceiver from a computer sound card or directly from the parallel printer port.

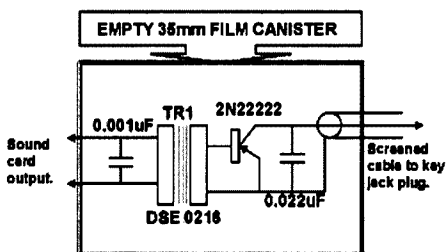

SOUND CARD KEYS BUILT INSIDE A FILM CANISTER

PSK31 interface (2) would already have the ideal housing for the sound card CW keyer because the interface box already has connections from the sound card output thus avoiding duplicating more leads.

Add the new circuitry inside the interface box and a new lead to connect the keyer to the transceiver keying jack.

The transformer offers DC isolation between the transceiver and the computer, and the advantage of this technique means that all other digital modes can be used without fiddling with the connections. With the right software it becomes streamlined and very easy to use on the various multi-modes.

CW Software

With YLog in the CW transmit mode, a 3kHz tone is generated from the sound card output. This tone is fed to TR1, the 2N2222 saturates pulling down the collector to ground thus keying on the transmitter.

The primary winding of TR1 and the 0.001uf capacitor resonate at about 3kHz improving the sensitivity. The resulting CW keying generated is clean and simple, and avoids any modifications to the transceiver or its interfacing plugs and sockets. Lastly, either keyer can be built from junk box parts in about one hour all ready for your next on air contest or rag chewing session.

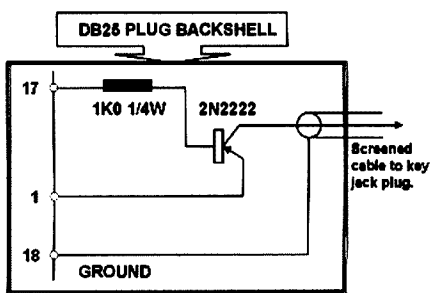

PARALLEL PORT KEYS BUILT INSIDE A DB25 PLUG

The parallel port keyer interface shown in the diagram above can be built inside a DB25 plastic backshell for less than \$5, including the plug and backshell components. The installation is neat and tidy with just a screened cable with a 1/4" jack plug into the transceiver key socket.

If you prefer to use the sound card output to key the transceiver, the bottom circuit fits easily into a recycled 35mm film canister. Readers who built the

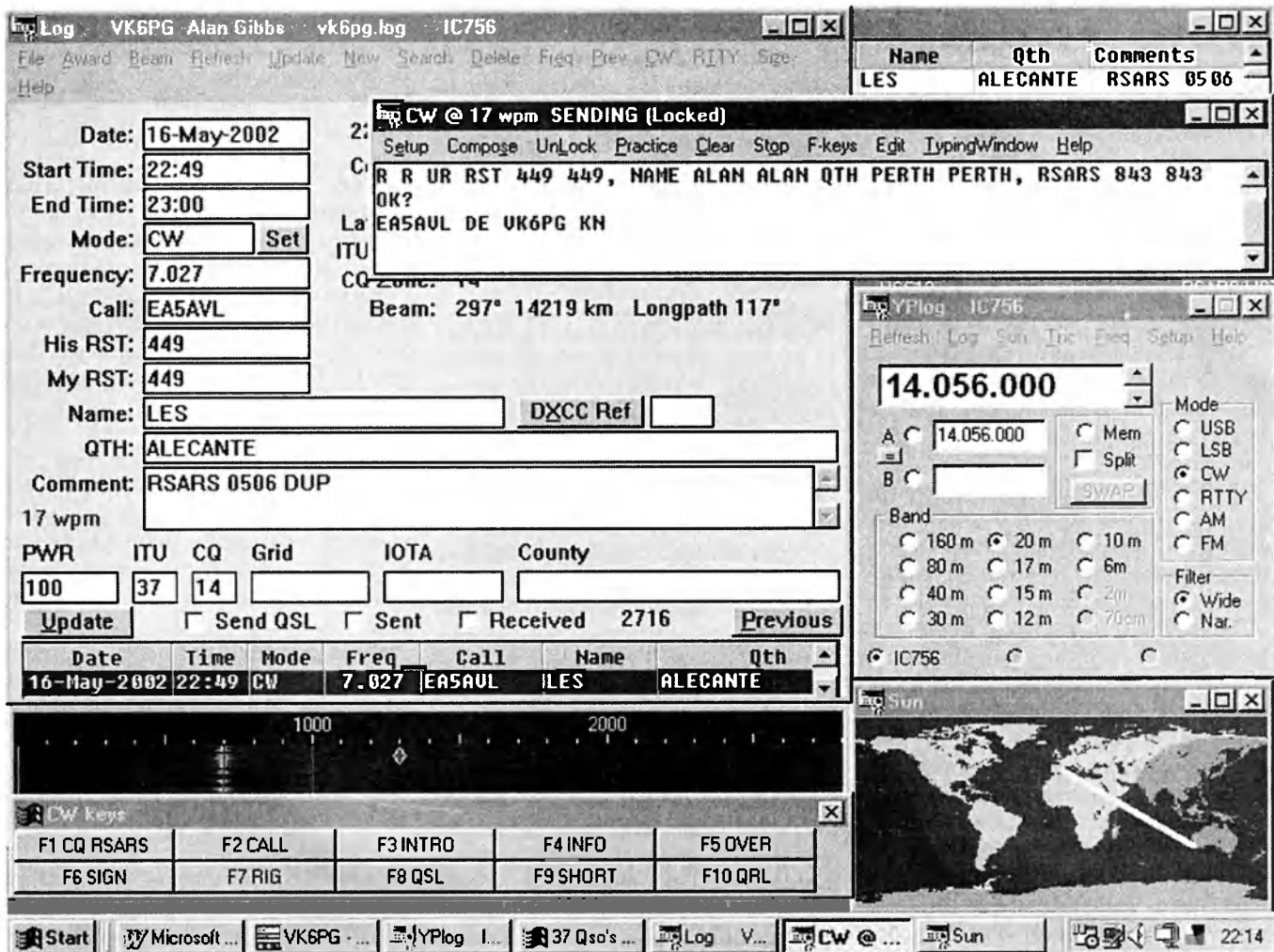

for sending the exchange seen in the SENDING window at the top right. F6 has the message R 73 ES GL HISCALL de MYCALL VA to complete the exchange.

Entering a callsign in the appropriate field in the log generates the RST information, checks for duplicates (as shown), and F9 fills in the name and QTH automatically. The CW menu offers the option to run CW in the S+P (Search and Pounce) mode, and to add the serial number after the RST. Automatic serial incrementation is created when the contact has been Updated and the log is cleared ready for the next contact. The transceiver command screen is seen on the right where rapid band changes and filters or mode switching can be done by a simple mouse click. If a new call is entered in the log, the beam swings around automatically, bearings and distances are displayed, and a pointer appears on the Mercator Map in the lower right of the screen.

All the important windows are displayed on the computer screen, and by "clicking" onto a specific window it can be brought to the front for perusal and operation. However, the layout shown allows the operator just one "click" anywhere on the screen to make things happen in a fraction of a second.

The full YPlog Contest Mode has options to enter the rules and points accumulated for particular contests, bands, IOTA etc, and automatically collects and calculates the scores, QSO rate per hour and much more. Specific contests like the CQ World Wide CW DX Contest is already programmed into the software. Just add your callsign and the computer does the rest for you. Scraps of paper and dupe sheets have gone into history! Once the contest has finished, your new contest log can be merged with your usual station log, or converted to AIDF format and sent by email to the Contest Manager within minutes of the contest ending, Hi

Ham Tip No. 17.

If the DigiPan waterfall is windowed as well, you'll be able to SEE the pileups, accurately, set your DSP filters, sneak into a tiny gap, grab the new station and be off while the others are still grubbing around in the pileup and henpecking QRM!

Ham Shack Computers, Part 18 next month features modern Log Keeping on your Ham Shack Computer.

(1) VE6YP Logging and Control: www.members.shaw.ca/ve6yp

(2) PSK31-The Easy Way. VK6PG.

In AR Magazine, March 2000 & June 2001. Or download free from: www2.tpg.com.au/users/vk6pg/vk6sig

(3) Ham Shack Computers Web: www2.tpg.com.au/users/vk6pg

73 ES GL IN TEST DE VK6PG VA a

arr

Over to you

Attention to our "Old Timers"

The Editor AR Magazine

For a few years now some amateurs have expressed views of the ultimate demise of amateur radio with the Internet overshadowing our hobby. Personally I didn't want to believe it and thought those views were somewhat an over-reaction, but now I'm not so sure.

Why were many of us drawn to amateur radio? Communication across space without wires? Being able to contact people in different countries around the world?

The more technically minded wanted more, to understand the whys and wherefores, to experiment, to investigate different systems, to try various types of antennas and to try new frequencies.

There will remain a need for technically minded people who understand electromagnetic radiation in the RF spectrum, but realistically the clamour of youth queuing up for admission to the amateur ranks has diminished. Isolated small flare-ups may occur when tasty carrots are dangled by well meaning folk, but the fact is our numbers are decreasing.

As Steve, VK5AIM, said in the May issue of AR, let's 'look after our Old Timers'. Those of them that practically need to relocate to a retirement village have very limited opportunity to continue their life-long hobby. Surely we should do everything we can so that they may continue as members of the amateur fraternity.

Let's look at the broader picture and put aside the nit-pickers and pedantic souls who enjoy searching out tiny inequalities in rules and regulations that don't really matter. Small wonder this country is going backwards, the small minded are holding us back! Dare I mention the Morse Code debacle?

ILINK and ECHOLINK provide amateurs in retirement villages with a means to continue contacting other amateurs around the world, many of them being long time friends in AR. Persistent opposition could alienate more radio amateurs from the WIA.

I liked Will McGhie, VK6UU's article too.

73, Murray Burford, VK5ZQ.

Attention to Attenuators

Designers and designer constructors of attenuators (pads) often neglect to calculate the power ratings of the chosen resistor components. That design fault can result in wild chirping of the shack smoke detector or worse if not detected in time.

Consider the following example- a 10dB section pad required to reduce 10 watts input to one watt.

The standard component resistors are 96.25 ohm input and output shunts connected by a 71.15 ohm series element. The input 96.25 resistor must absorb $(50/96.5) \times 10 = 5.2$ watts; of the remaining 4.8 watts the series 71.5 ohm must absorb $(71.15/104.1) \times 4.8 = 3.28$ watts; the load of 1 watt and the output 96.5ohm shunt account for the final 1.52 watts. It is common practice to use equal rating, input and output shunts, but that is only necessary if the pad is reversible.

An analysis of a 10dB 10 watt Tee pad, comprising two 26 ohm series elements and a 35 ohm shunt element, show that the resistor ratings should be, 3.7 watts for the input series 26 ohm, 4.8 watts for the 35 ohm shunt and 0.52 watt for the output series 26 ohm.

If choosing ratings and values becomes too complicated I suggest, three 3dB tandem pads for the ten watt 10 dB job. In that configuration the highest rating resistor is 3 watts in the first pad, 0.8 watts, in the second and less than 0.5 watts is the highest rating in the last pad. An unavoidable mismatch loss in the chain will probably supply the extra dB.

It is of course possible to design and produce a single 10 dB 10 watt pad. Designers will need to brush up on their resistor circuit analysis for the above analyses but it is not difficult and a worthwhile "self training" exercise.

Lindsay Lawless VK3ANJ.

Will's Page, May AR — Attention to Regulations

The Editor AR Magazine.

Some people love 'em. I am sure many sit on their bottoms just conjuring up new rules and regulations thus accumulating mountains of stuff which many of the perpetrators themselves may be partly drowned in, having lost the meaning or intent of many rules anyway. No wonder arguments rage on the interpretation of many regulations.

I recall a vehicle incident at a

roundabout where a woman driver thought she had acted correctly, the police thought she had acted correctly, but in a subsequent court case, a judge ruled otherwise! What chance road safety?

The "Regs" exam amateur radio candidates are required to sit for use to cause little trouble "everybody" used to pass. Now things are different, "everyone" doesn't pass 'Regs.', it comprises so much 'Gobbledegook' (borrowed from Neville Williams) that the theory exam causes them less anxiety.

As an example just look at the transmission types codes, viz. 3K00J3E, 16K0F2D and 6M25C3FMN. What a lot of unnecessary stuff to cram into one's memory for an exam. Gobbledegook at it's finest! Surely all one needs to know is that the information exists and where to find it.

Will may have got a little 'carried away' in his article, but that's often what's needed to get peoples' attention.

73, Murray Burford, VK5ZQ.

Attention to detail

Dear OM Colwyn,

About your "Editor's Note" appended to my article in AR July 2000.

Why did you say "there may be a few errors in this which I have been unable to correct, information not available".

If you think there are errors in material submitted, your first duty as Editor is to consult the author, not publish comment that can be taken as disparaging.

You note the double entry about VK2BQ. An email or a phone call from you to me could have explained why he appeared in two categories in my analysis.

Three years ago I had not resolved which category best fitted the circumstances of VK2BQ's death.

Being familiar with air operations out of Vivigani airstrip I felt an explanatory footnote was not needed because a perceptive reader could see that Flying Officer Easton's aircraft crashed in friendly territory shortly after take off.

In 1944 the nearest Japanese with a gun (or sword) would have been on New Britain about an hour's flight away. It is pulling a long bow to claim that this accident even though it resulted in deaths was a result of an encounter with

Over to you

the enemy, a criteria I believe to be necessary for inclusion on a proper "Honour Roll". The "Killed in action" is therefore not relevant and should be deleted.

I note your use of the Royal Pronoun "We" in your penultimate paragraph. Who are "We" ?

Determination of policy about a legitimate W.I.A. Honour Roll is a matter for the Federal Executive. There are significant problems surrounding this issue. Not the least of which is doubt about the completeness of the list and whether it is a national or membership listing.

Off-the-top of one's head comment such as yours does not help produce a result that gives credit where credit is due.

By all means list the names of all who wore a uniform in WW2 but don't make the mistake of including those who never heard a shot fired on a Roll that honors brave people like VK3HN, VK4DR etc who were killed as a result of confronting an enemy.

73 Col Harvey VK1AU

Further Editor's Note

I am sorry my wording caused offence. I was purely trawling for further information, rather than questioning the accuracy of Col's work or his sources.

I highlighted the double entry to head off comments that it was there. I appreciated why Col had a double entry. I suppose I got a bit carried away using "we" and "I" might have been more appropriate. VK5UE

GOT SOMETHING TO SAY ABOUT AMATEUR RADIO THE W.I.A. THIS MAGAZINE THE A.C.A.

THIS IS THE PLACE TO DO IT

Entering the entry level debate

The Editor AR

The participants in the current discussions about "entry level" licensing and the future of amateur radio could include consideration of Pat Hawker's article on those subjects in his Technical Topics column of August 1988.

The following is a precis.

'The ITU Radio Regulations identify radio amateurs as "duly authorised persons interested in radio technique". It accepts that when authorised to venture on the airwaves newcomers, may have only the minimal technical knowledge required by their own national authorities. The Radio Regulations do not stipulate any requirement for a technical examination, although this is taken for granted, or to define the speeds to be achieved in the obligatory morse test for operation below 30 MHz.

But an 'interest in radio technique' does indicate that licensed amateurs should not be content to be purely users of entertainment appliances. Also it doesn't mean that only those who build their own equipment can be considered true amateurs.

There is no shame in starting young, or as a beginner with a bare minimum of technical understanding—but there is

no excuse for remaining a technical ignoramus, year in, year out, time spent filling the spectrum with idle chatter, content to remain appliance operators, openly professing no real technical interest or knowledge.

The radio amateur has always been well served with technical publications, books, periodicals, and opportunities for self training. But books are meant for a modicum of study, and not for propping up a wonky transceiver or looking good on a shelf."

Pat was more emotive than appears from the above, but he draws attention to some points which we overlook. The literature available mostly requires a level of technical literacy suitable only for "home brewers".

Journals such as AR and Rad.Com. should endeavour to include some real technical papers; AR has included some in past issues: the discussion about Aircraft Enhancement of VHF propagation for example.

Surely there are similar articles available or is it that the publications committee is suppressing these in favour of construction recipes in the belief that home brewers are the only true amateurs.

Lindsay Lawless VK3ANJ

Sunspot Numbers

Monthly Sunspot Average Jun 2002: 88.5

Annual Sunspot Average Dec 2001: 114.7

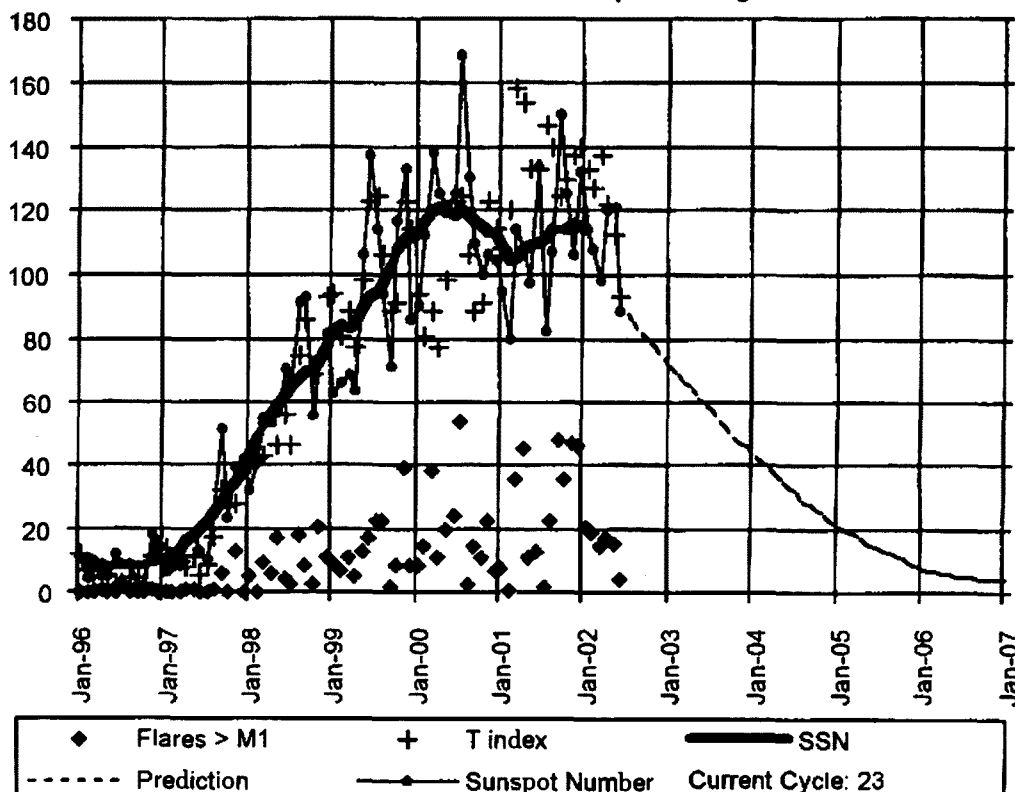

Drawn from monthly data provided by the Ionospheric Prediction Service

HAMADS

- Hamads may be submitted by email or on the form on the reverse of your current Amateur Radio address flysheet. Please print carefully, especially where case or numerals are critical.
- Please submit separate forms for For Sale and Wanted items, and be sure to include your name, address and telephone number (including STD code) if you do not use the flysheet.
- Eight lines (forty words) per issue free to all WIA members, ninth and tenth lines for name and address. Commercial rates apply for non-members.
- Deceased estates Hamads will be published in full, even if the ad is not fully radio equipment.
- WIA policy recommends that the serial number of all equipment for sale should be included.
- QTHR means the address is correct in the current WIA Call Book.
- Ordinary Hamads from members who are deemed to be in general electronics retail and wholesale distributive trades should be certified as referring only to private articles not being re-sold for merchandising purposes.
- Commercial advertising (Trade Hamads) are pre-payable at \$25.00 for four lines (twenty words), plus \$2.25 per line (or part thereof), with a minimum charge of \$25.00. Cheques are to be made out to: WIA Hamads.
- Copy should be typed or in block letters, and be received by the deadlines shown on page 1 of each issue of Amateur Radio, at:

Email: newsletters@ozemail.com.au Fax: 03 9756 7031

Postal: Newsletters Unlimited, PO Box 431, Monbulk Vic 3793

Please send your Hamad by ONE method only (email preferred)

FOR SALE ACT.

- **Kenwood TS-130S** 100 watt HF transceiver with microphone, owner's manual and service manual. \$600. **Kenwood TR-9130** 25 watt 2 m multimode transceiver with microphone, owner's manual and service manual, mobile mounting bracket and BO-9 base unit to match TS-130 on the desk. \$350. **Icom IC-2A** 2 m synthesised handheld transceiver with charger, carry case, manual, headset and mic/speaker. \$150. **Icom IC-4E** 70 cm synthesised handheld transceiver with charger, carry case, manual, and mic/speaker. \$150. **Icom IC-22S** 2 m transceiver. Used for packet radio but loudspeaker audio low. With manual and mobile bracket. \$75. **HP320LX WindowsCE** handheld computer. Supplied with TNC program for portable packet use as well as standard Windows CE software (Outlook, Word, Paint, etc). With docking adaptor, charger, 4Mb RAM card and manuals. \$100. **HP200** handheld computer. **MS-DOS** handheld unit with 10Mb ram card and manuals. \$100. **AEA PK88** TNC with manual. \$100. All items have had one careful owner/reluctant seller and all with original shipping cartons if required. Contact Ray VK1ZJR on Phone 0419 601 738 or rroche@msn.com.au or via PO Box 3391, Weston Creek, ACT 2611.

FOR SALE NSW

- **Icom 27A** with soft cover \$280. **Alinco DJCH** (credit card size) 70cm with spkr mic \$40. Yam multi-speed modem \$100. **Realistic 30cm** hand-held scanner \$80. **Digitor 2 m** 30 W power amplifier \$90. All in excellent condition with manuals. Chris VK2MQX QTHR Phone 0425 301 539 BH, 02 9636 7730 AH
- **Antenna Tower 80ft** Southern Cross galv. Angle iron 3 leg free standing in five sections \$400. Vlad VK2EKO Phone 02 6684 1238
- **STC studio microphones**, models 4038 Ribbon 36 ohms impedance, 4037 Dynamic 25 ohms impedance, as new condition. Make an offer. John VK2ZCG. Phone 02 9587 2920

- **Kenwood 215A** handheld 2 m transceiver complete with antennas, handbook, charger station, GWO, \$300. Phone Geoff VK2HJ. Phone 02 4655 9731 or 02 4655 1588
- **TEK 500 series CRO components**. CA plug-in, still in the government contractor's wrapping, 53/54K plug-in, some valves and Model B ScopeMobile CRO trolley. Brian VK2GCE. Phone 02 9545 2650 or [preferred] brianclarke@idx.com.au

WANTED NSW

- **PRC-9 or 10 cases** - need three; can swap for two PRC-9A cases. Brian, VK2GCE. Phone 02 9545 2650 or [preferred] brianclarke@idx.com.au
- **Service manual** or copy for **Codan 6924 HF transceiver**. All costs met. Please contact John VK2FAF. Phone 02 9449 8848, email wilkie01@ozemail.com.au
- **Top cap connector for 6146A**, needed for pending homebrew project. Boat anchor **Hallcrafters S-88, S-99, SX-99, SX-100** or similar circa 1957. Condition unimportant, but hopefully intact and functional. Will pay Australian dollars. Stephen VK2BLQ QTHR Phone 02 9419 6788 email lowingsr@aol.com
- **Kenwood TS-870, BIRD 43 inserts** - 50H, 100H, 250H. **Valves** 2-1000 and 4CX1600B, Tom, vk2oe@arrl.net or VK2OE PO Box 5252 Wollongong NSW 2520

FOR SALE VIC

- **Icom IC-260A** mobile all mode with memories, incl book \$450. **Icom IC-22S** Mobile 2 m FM \$175. **Europa 2m transverter** now a 100 W linear \$100. **Europa 800V power supply**, suit above \$175. **Heath linear amplifier** 5 band 2 X 572B \$200. **Power supply** by A Bles 1000 V to 2400 V, suit above. **Hallcrafters receiver** .5 to 30 MHz bandspread tuning with transformer \$200. **Eddystone receiver** six bandspread ham bands only incl 1.8 MHz 12 valve \$150. **Yaesu**

mobile aerials set 2m to 80m \$100. **McLeod mobile HF multitap** \$300. **Rotator** for 2 m aerials with control 110V \$150. **Radio altimeter meter** ID14A/APNI \$20. **Siemens twin cavity Assy** tunes 432 MHz, as new \$200. **Linear line PA 2m** box 17" X 8", internal p/s, twin meters, RF switching \$150. **Pedestal for tower base rotation** \$20. **1/4 HP 230V motor** with gearbox \$20. **Power supply 12V 3 amp** conservative \$30. **Minilite headset** for mobile use, in wallet \$30. **Philips dynamic desk microphone** \$30. VK3DS. QTHR. Phone 03 5332 3226

• **Free AR mags back to 1953**. Others. Must take the lot. Sell **Heathkit 2 m FM** with matching PS \$95. **Home brew linear 20-15 m** spare 813 PS \$25. Alan VK3AMT. QTHR. Phone 03 9789 9106

• **Yaesu FT-757GX** 4L133092 \$600. Kevin Phone 9792 9503

• New offcut lengths **ANDREWS HELIAX LDF-450A, LDF-550A**, 16 m - 44 m. Also connectors. Ray VK3ATN. QTHR. Phone 03 5492 2224, Fax 5492 2666, atnant@ruralnet.net.au

• **Gap Eagle vertical antenna** moving to antenna farm. Offers. Bill VK3WTM. Phone 03 9798 7702

• **Yaesu FT-990** with service manual v.g.c. \$1200. **Kenwood TS 850S** with service manual g.c. \$350. **Yaesu FL-2100Z** (no valves) with manual \$50. **AIWA microphone** DM-51 g.c. \$50. **Keyer electronic** g.c. \$100. **Kent key** g.c. \$50. **Voltmeter** 0-300 AC g.c. \$50. **Kenwood SP-230** with filters, **DSP-9** "Time wave" g.c., **Panther PS 732** g.c., **Cushcraft** Multiband HF vertical R7 \$100. VK3MJ. Phone 03 9458 4769

• **Garmin 12 GPS** in very good condition \$400 Contact either Ian VK3AQU or Christopher VK3KQU AH on Phone 03 5751 1631

• **Antenna HB-35C** 5 Element Triband Yagi, 14, 21 & 28 MHz Stainless hardware. Excellent condition \$450. Julian VK3EJR. Phone 0418 578 214 julianrose@elektron.com.au

• **Yaesu FT-920** Transmitter: 100 watts output on 160-6 metres. Miscellaneous: 127 Memory Channels, VFO and Channel Scanning, Dual Watch, FM Module, original mic and manual included. New in box. Frankston \$2200 Phone 03 9789 4968

• **Test equipment, Goodwill Model GFG-8015S** Digital Multifunction Generator 0.2 Hz to 2 MHz sweep, Sine, Sq, Tri output with user manual/tech hand book, can email photos), very good condition, \$140. Also **Goodwill Audio Millivoltmeter model GVT-706A**, 12 ranges, -60dBm to +50dBm VGC \$60. Terry VK3ZXY. QTHR. Phone 03 9592 3514, email vk3zxy@leithy.com

• **6 metre 100 watt Linear Amp Kit components**, AEM K-6349, PCB (drilled) Matched Pair MRF492 90 W PA transistors, antenna changeover relay to suit PCB, all other components basically standard items, complete with 10 page detailed kit assembly article, \$55 incl P & I. Terry VK3ZXY. QTHR. Phone 03 9592 3514, email vk3zxy@leithy.com

• **KENWOOD TS-430S** with manuals \$450, **AT-250 autotuner** \$200. **SW-200A** 1.8-150 MHz PWR/SWR meter \$150. **MC-80** mic \$50. **YAESU FP700** power supply \$150, **Dominion Electronics 13.8V 20A PS** \$100, **TECH TE-15 dipper** \$50, **NALLY 2 section winch-up tower** with **AIGA ART3000C HD rotator** and controller and **HIDAKA 3-element tri-band**

beam coax etc - \$650. Call Dave VK3DHF Phone (BH) 03 9419 4815 Email d.shaw@bom.gov.au

WANTED VIC

- **Bass for whip antenna** size 9/16 UNF advise cost and P/P John VK3HCT. Phone 03 9580 8369
- **Circuit and/or manual for Crammond CTR25 transceiver.** Kevin VK3CKL. QTHR Phone 9792 9503

WANTED QLD

- **Kenwood TS-830S workshop manual needed.** Will refund any costs. Phone 07 3390 7762 or ronroucher@powerup.com.au. Ron VK4CRO QTHR
- **WWII suitcase transmitter receiver Type 3 Mark II and Type A Mark III, also S-phone 13 Mk IV, No 19 set, No 11 set** with or without p/s or part sets. Ray VK4FH. Phone 07 3299 3819, fax 07 3299 3821, PO Box 5263, Daisy Hill Qld 4128. Cash paid. Will collect all states.
- **Copy of IC-701 manual and schematic, also large roller inductor,** reasonable price. Stuart VK4KKQ. Phone 07 4972 9871
- **Manual Kenwood R-2000,** will pay for photocopies. **500Hz filter YG-455C** for R-2000 needed, offers to L40370 Hans Phone 07 5479 4561 hpkiesinger@ozemail.com.au (ex HS1ALK)

TRADE ADS

PSK-31, SSTV, RTTY SOUNDBOARD INTERFACES

Fully isolated, ready to plug in. <http://www.G3LIV.CO.UK>, johnny@melvin.com, G3LIV QTHR.

AMIDON FERROMAGNETIC CORES:

For all RF/electronic applications. See our website for complete data
on all cores including prices. RJ & US Imports, PO Box 431, Kiama NSW
2533. www.catchnet.com.au/~rjandusimports.

Agencies at: Active Electronics Tas; Truscotts Electronic World, Melbourne; TTS Systems, Tyabb; Tower Communications, Perth; Haven Electronics, Nowra.

HF, VHF, UHF ANTENNAS & ACCESSORIES

Alum towers, guys etc. Diamond VSWR/PWR meters. HD copper ant wire & insulators. TX tubes & pwr transistors. Quality coax cables & connectors. Free advice & catalogue. ATN Antennas Ph 03 5492 2224 Fax 03 5492 2666, email atnant@ruralnet.net.au

MISCELLANEOUS

- The WIA QSL Collection (now Federal) requires QSLs. All types welcome, especially rare DX pictorial cards, special issue. Please contact the Hon Curator, Ken Matchett VK3TL, 4 Sunrise Hill Road, Montrose Vic 3765, tel. (03) 9728 5350

FOR SALE SA

- **Kenwood TS-930** HF transceiver \$1000. **Yaesu FT-840** HF transceiver \$1000. **Icom IC-725** HF transceiver \$800. Serial numbers 3120019 and 3L041267 and 05932. All very good condition with owner's and service manuals. Grant VK5AMC. QTHR. Phone 08 8836 3240
 - **HQ-1** 2 element mini beam 20, 15, 10, 6 metres, also **10 metre telescopic mast.** Ken Harris VK5AL QTHR, Phone 08 8278 4403
- WANTED SA
- **Copy assembly manual** or circuit diagram for **Heathkit Transistor Tester model IM-36.** Any help appreciated. Keith VK5OQ. Phone 08 8280 7430 keithg@senet.com.au

WANTED WA

- **Collins 75A4 receiver.** Would consider swapping for my Collins R390 general coverage receiver or other old valve equipment. Suffering from a nostalgia attack and am putting together a 1950s amateur band station. Steve Ireland, VK6VZ. Phone: 08 9298 9330 or email: sire@inet.net.au
- Your surplus equipment for sale on the **Bring and Buy counter** at HAMFEST 3/11/2002. Tables also available. Information from jackborthen@bigpond.com.

WANTED TAS

- **Siemens Level Meter Model D2055** (200Hz - 620 kHz). Can anybody help? Contact Trevor VK7TB either by email at cabriggs@optusnet.com.au, or by phone at 03 6398 2118

<http://www.hamsearch.com>
a not-for-profit site that is a search engine for hams

PLAN AHEAD

**JOTA and JOTI
October 19 & 20,
2002**

ADVERTISERS INDEX

Com-an-tena.....	24
G & C Communications.....	27
Icom.....	OBC
Strictly Ham.....	8
WIA Call Book.....	IFC

TRADE PRACTICES ACT

It is impossible for us to ensure that the advertisements submitted for publication comply with the Trade Practices Act 1974. Therefore, advertisers and advertising agents will appreciate the absolute need for themselves to ensure that the provisions of the Act are strictly complied with.

VICTORIAN CONSUMER AFFAIRS ACT

All advertisers are advised that advertisements containing only a PO Box number as the address cannot be accepted without the addition of the business address of the box-holder or seller of the goods.

THE WIA BOOKSHOP

DISCOUNTS FOR WIA MEMBERS

ARRL

RSGB

EDUCATIONAL

CALLBOOKS

COMPREHENSIVE RANGE

109 Wigram Street, Parramatta, New South Wales, Australia. PO Box 432, Harris Park, NSW, Australia 2150. Phone: +61 2 9689-2417, Facsimile: +61 2 9633-1525 Toll free in New South Wales outside Sydney: 1800 817-644 Office Open 11am - 2pm Tuesdays & Thursdays Email: vk2wi@ozemail.com.au Web <http://www.ozemail.com.au/~vk2wi> We take mail, phone, email and fax orders

"Hey, Old Timer..."

If you have been licensed for more than 25 years you are invited to join the



Radio Amateurs Old Timers Club Australia

or if you have been licensed for less than 25 but more than ten years, you are invited to become an Associate Member of the RAOTC.

In either case a \$2.50 joining fee plus \$8.00 for one year or \$15.00 for two years gets you two interesting OTN Journals a year plus good fellowship.

Write to

RAOTC,
3/237 Bluff Road
Sandringham VIC 3191

or call Arthur VK3VQ on 03 9598 4262 or Allan VK3AMD on 03 9570 4610, for an application form.

Email your hamad

Then we just cut and paste.

You proof it, you retain control.

**TRADERS
Advertise in**



03 9756 7797

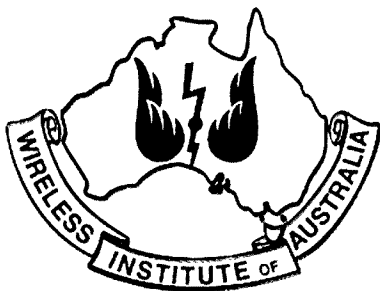

Division Directory

The Amateur Radio Service exists for the purpose of self training, intercommunication and technical investigation. It is carried out by amateurs who are duly authorised people interested in radio technique solely with a personal aim and without pecuniary interest.

The Wireless Institute of Australia represents the interests of all radio amateurs throughout Australia. National representation is handled by the executive office under council direction. There is one councillor for each of the seven Divisions. This directory lists all the Divisional offices, broadcast schedules and subscription rates. All enquiries should be directed to your local Division.

Broadcast schedules All frequencies MHz. All times are local.

VK1 Division Australian Capital Territory,
GPO Box 800, Canberra ACT 2801
President Gilbert Hughes
Secretary Petar Kloppenburg
Treasurer Linden S Orr

VK1GH
VK1CFK
VK1LSO

VK1WI: 3.590 LSB, 146.950 FM each Thursday evening from 8.00pm local time. The broadcast text is available on packet, on Internet *aus.radio.amateur.misc* news group, and on the VK1 Home Page <http://www.vk1.wia.ampr.org>

Annual Membership Fees. Full \$80.00 Pensioner or student \$71.00. Without *Amateur Radio* \$48.00

VK2 Division New South Wales
109 Wigram St, Parramatta NSW
(PO Box 432, Harris Park, 2150)
(Office hours Mon-Fri 1100-1400)
Phone 02 9669 2417
Web: <http://www.ozemail.com.au/~vk2wl>
Freecall 1800 817 644

e-mail: vk2wl@ozemail.com.au
Fax 02 9633 1525

President Terry Davies
Secretary Pat Leeper
Treasurer Chris Minahan

VK2KDK
VK2JPA
VK2EJ

From VK2WI 1.845, 3.595, 7.146*, 10.125, 14.160, 24.950, 28.320, 29.120, 52.120, 52.525, 144.150, 147.000, 438.525, 1281.750 (* morning only) with relays to some of 18.120, 21.170, 584.750 ATV sound. Many country regions relay on 2 m or 70 cm repeaters. Sunday at 1000 and 1930. Highlights included in VK2AWX Newcastle news, Monday 1930 on 3.593 plus 10 m, 2 m, 70 cm, 23 cm. The broadcast text is available on the Internet newsgroup *aus.radio.amateur.misc*, and on packet radio.

Annual Membership Fees. Full \$80.00 Pensioner or student \$63.00. Without *Amateur Radio* \$50.00

VK3 Division Victoria
40G Victory Boulevard Ashburton VIC 3147
(Office hours Tue 10.00-2.30)
Phone 03 9685 9261
Web: <http://www.wiavic.org.au>
Fax 03 9685 9296

e-mail: wiavic@wiavic.org.au

President Jim Linton
Secretary John Brown
Treasurer Barry Wilton

VK3PC
VK3JJB
VK3XV

VK3BWI broadcasts on the 1st Sunday of the month at 20.00hrs Primary frequencies, 3.615 DSB, 7.085 LSB, and FM(R)s VK3RML 146.700, VK3RMM 147.250, VK3RWG 147.225, and 70 cm FM(R)s VK3ROU 438.225, and VK3RMU 438.075. Major news under call VK3ZWI on Victorian packet BBS and WIA VIC Web Site.

Annual Membership Fees. Full \$83.00 Pensioner or student \$67.00. Without *Amateur Radio* \$51.00

VK4 Division Queensland
PO Box 199, Wavell Heights, Qld. 4012
Phone 07 3221 9377
e-mail: office@wiaq.powerup.com.au
Fax 07 3266 4929

Web: <http://www.wia.org.au/vk4>

President Ewan McLeod
Secretary Bob Cumming
Treasurer Bill McDermott

VK4ERM
VK4YBN
VK4AZM

VK4WIA broadcasts on 1.825 MHz SSB, 3.605 MHz SSB, 7.118 MHz SSB, 10.135 MHz SSB, 14.342 MHz SSB, 21.175 MHz SSB, 28.400 MHz SSB, 29.660 MHz FM (rptr), 147.000 MHz, and 438.525 MHz (in the Brisbane region, and on regional VHF/UHF repeaters) at 0900 hrs K every Sunday morning. QNEWS is repeated Monday evenings, at 19.30 hrs K, on 3.605 MHz SSB and 147.000 MHz FM. On Sunday evenings, at 18.45 hrs K on 3.605SSB and 147.000 FM, a repeat of the previous week's edition of QNEWS is broadcast. Broadcast news in text form on packet is available under WIAQ@VKNET. QNEWS Text and real audio files available from the web site

Annual Membership Fees. Full \$95.00 Pensioner or student \$81.00. Without *Amateur Radio* \$69.00

VK5 Division South Australia and Northern Territory
(GPO Box 1234 Adelaide SA 5001)
Phone 0403 368 068
web: <http://www.aant.wia.org.au>
email: peter.reichert@bigpond.com

President Trevor Quick
Secretary Peter Reichelt
Treasurer Trevor Quick

VK5ATQ
VK5APR
VK6ATQ

VK5WI: 1843 kHz AM, 3.550 MHz LSB, 7.095 AM, 14.175 USB, 28.470 USB, 53.100 FM, 147.000 FM Adelaide, 146.800 FM Mildura, 146.900 FM South East, 146.925 FM Central North, 438.475 FM Adelaide North, ATV Ch 35 879.250 Adelaide. (NT) 3.555 LSB, 7.085 LSB, 10.125 USB, 146.700 FM, 0900 hrs Sunday. The repeat of the broadcast occurs Monday Nights at 1930hrs on 3585kHz and 146.875 MHz FM. The broadcast is available in 'RealAudio' format from the websites at www.aant.wia.org.au Broadcast Page area.

Annual Membership Fees. Full \$88.00 Pensioner or student \$73.00. Without *Amateur Radio* \$86.00

VK6 Division Western Australia
PO Box 10 West Perth WA 6872
Phone 08 9381 8873
Web: <http://www.vk6wia.org>
e-mail: vk6wia@lnet.net.au

President Neil Panfold
Secretary Christine Bastin
Treasurer Bruce Hedland-Thomas

VK6NE
VK6ZLZ
VK6OO

VK6WIA: 146.700 FM(R) Perth at 0930hrs Sunday relayed on 1.888, 3.564, 7.075, 10.126, 14.118, 14.178, 21.188, 29.120 FM, 60.150 and 438.828 MHz, Country relays 3.682, 147.200 (R) Cataby, 147.360 (R) Busselton, 148.900 (R) Mt William (Bunbury), 147.000 (R) Katanning and 147.280 (R) Mt Saddleback. Broadcast repeated on 146.700 at 1900 hrs Sunday relayed on 1.888, 3.684 and 438.828 MHz : country relays on 146.900, 147.000, 147.200, 147.260 and 147.360 MHz. Also in "Real Audio" format from the VK6 WIA website

Annual Membership Fees. Full \$71.00 Pensioner or student \$66.00. Without *Amateur Radio* \$39.00

VK7 Division Tasmania
PO Box 371 Hobart TAS 7001
Phone 03 8234 3653 (BH)
Web: <http://www.tased.edu.au/tasonline/vk7wia>
also through <http://www.wia.org.au/vk7>
email: bataajw@netpace.net.au

President Mike Jenner
Secretary John Bates
Treasurer John Bates

VK7FB
VK7RT
VK7RT

VK7WI: 146.700 MHz FM (VK7RHT) at 0930 hrs Sunday relayed on 147.000 (VK7RAA), 146.728 (VK7RNE), 146.826 (VK7RMD), 3.670, 7.090, 14.130, 62.100, 144.160 (Hobart), repeated Tues 3.690 at 1930 hrs.

Annual Membership Fees. Full \$90.00 Pensioner or student \$77.00. Without *Amateur Radio* \$67.00

VK8 Northern Territory is part of the VK5 Division and relays broadcasts from VK5 as shown, received on 14 or 28 MHz. The broadcast is downloaded via the Internet.

South Australian South Coast Radio Group



The people are from left to right standing:

Graham Peters, VK5KGP (Victor Harbor), Gary Herden, Vx5ZK (Goolwa)

Seated: Jim McLachlan VK5NB (Morphetville), Heather McLachlan, Morna Haines (xyl VK5ZD Alan).

Jim has just been donated an old radio chassis by 5KGP and 5ZK, which he will use in a current restoration project.

Radio Games

Bill Main (VK6ZX) and Diane Main (VK6KYL) were presented with a Service Award for operating the Goldfields District Scouts Radio Station VK6SZ for 25 years

The Awards were presented on Saturday March 23rd 2002 by the Assistant Branch Commissioner for Scouts WA, Larry Lucas in Kalgoorlie at a Scout Information Day for the Goldfields District.

Bill and Diane, as members of The Goldfields District Section of the Branch Radio and Electronics Team, have been operating the station for JOTA each year since 1978. They have also participated in the RD Contest for a period of some 13 years, taking out the Peter Hughes Trophy for WA Scout Stations in the RD Contest on no less than 11 occasions. On the first Friday of each month they can be heard running the station for the WA Scout Net on 80 m. If you are able to help a Scout or Guide group participate in the "Radio Games" night tune in to 3.600MHz at 1100Z on the first Friday of each month (except school holidays).



At the presentation. L to R: Assistant Branch Commissioner Larry Lucas, Diane VK6KYL & Bill VK6ZX

ICOM'S GREAT CHAMPIONS



IC-756PROII

NO FILTERS REQUIRED

Sharp & soft IF filter shape • Improved 3rd IMD & wide dynamic range • One-touch record/play
 Digital voice memory • Extended 1/4 Tuning step & BPF functions for SSB-D mode • 32-bit floating-point DSP
 and 24-bit AD/DA converter • SSB/CW synchronous tuning • 4.9-inch color TFT LCD



IC-718 A compact HF all band transceiver.

A superior performer with simple, straightforward operation with keypad • Optional AF DSP capabilities, including noise reduction & auto notch function • It's versatile, compact & loaded with features.



IC-910H The new dimension in the VHF/UHF world!

Tri band multimode transceiver • 2M - 100W, 70CM - 75W (optional 23CM, 10W) • 9600bps packet operation • Satellite communication
 Reverse/normal tracking doppler shift compensation
 CIV capability for PC control • Optional 2.4G down convertor.



IC-706MKIIG HF • VHF UHF

The amazing evolution of the legendary 706.

Now includes 70cm @ 20W and 50W on 2m
 Standard feature dsp • Built in sub tone encoder & decoder
 Tone scan • Mosfet PA • You get base station performance and features in a mobile rig sized package.



IC-T90A A new 5W Triband handheld

VHF/UHF FM 2M, 6M, & 70CM
 Wideband receive 495 KHz - 1 GHz
 555 Alphanumeric memories • 13 Scan modes
 DTCSS & CTCSS encode & decode
 DTMF encoder (10 memories)
 Wide/narrow transmit capability.



ICOM

Clearly Ahead

2 YR WARRANTY

find your nearest ICOM dealer at

www.icom.net.au or (03) 9387 0666

The magazine for **AUSTRALIAN** Amateurs



September 2002

Volume 70 No 9



Amateur Radio

\$ 5.95

**How to fix your radio
so it actually works!**

*An amateur tells how he
transformed his nightmare
into a success story*



**Radio controlled
Model Aircraft**

WICEN works

CAR RALLIES

**A Digital
Frequency
Display**

**Rohan Magrath,
aged 2, son of
Shane VK2KEP:
"if I can do it,
anybody can!"**



**Still on a
high!**

**Trans Tasman VK
contest winner,
Thomas Lynd,
son of Bill VK7KHZ**

ISSN 0002-6859



9 770002 685093 09



Australian
Amateur Radio

Callbook
2002

Every
shack
should
have one



Now also
on
searchable
CD

The "Call Book 2002" is available from
your State Division
Order now to get the member discount

VK1 Division

GPO Box 600, Canberra ACT 2601

VK2 Division

109 Wigram St, Parramatta NSW
(PO Box 432, Harris Park, 2150)
(Office hours Mon-Fri 1100-1400)
Phone 02 9689 2417
<http://www.ozemail.com.au/~vk2wi>
Freecall 1800 817 644
e-mail: vk2wi@ozemail.com.au

VK3 Division

40G Victory Boulevard
Ashburton VIC 3147
(Office hours Tue 10.00 - 2.30)
Phone 03 9885 9261
<http://www.wiavic.org.au>
Fax 03 9885 9298
e-mail: wiavic@wiavic.org.au

VK4 Division Queensland
PO Box 199, Wavell Heights, Old. 4012
Phone 07 3221 9377 Fax 07 3266 4929
e-mail: office@wiaq.powerup.com.au

VK5 Division (and VK8)

(GPO Box 1234 Adelaide SA 5001)
Phone 0403 368 066
: <http://www.sant.wia.org.au>
email: peter.reichelt@bigpond.com

VK6 Division

PO Box 10 West Perth WA 6872
Phone 08 9351 8873
Web: <http://www.vk6wia.org>
e-mail: vk6wia@inet.net.au

VK7 Division

PO Box 371 Hobart TAS 7001
Phone 03 6234 3553 (BH)
<http://www.tased.edu.au/tasonline/vk7wia>
email: batesjw@netspace.net.au

COMMERCIAL RESELLERS

Please contact June Fox (WIA Federal) on 03 9528 5962



Amateur Radio

The Journal of the Wireless
Institute of Australia
ISSN 0002-6859

Editorial

Editor: Colwyn Low VK5UE
edarmag@chariot.net.au

Technical Editor: Peter Gibson VK3AZL

Publications Committee Members

Ron Fisher	VK3OM
Don Jackson	VK3DBB
Evan Jarman	VK3ANI
Bill Rice	VK3ABP
Gil Sones	VK3AUI
Bill Roper	VK3BR

Advertising

Mrs June Fox,
Tel: (03) 9528 5962

Hamads

"Hamads" Newsletters Unlimited
PO Box 431, Monbulk Vic 3793
Fax: 03 9758 7031
e-mail: newsletters@ozemail.com.au

Office

10/229 Balaclava Road
Caulfield, Victoria
Telephone (03) 9528 5962
Facsimile (03) 9523 8191

Business Hours 9:30am to 3:00pm weekdays

Postal

The Editor AR
34 Hawker Crescent
Elizabeth East
South Australia 5112
Email edarmag@chariot.net.au

Production

Newsletters Unlimited 03 9758 7797

Printer

Streamline Press, Melbourne (03) 9417 2766

Postal Service

IMS (03) 9291 5888

Production Deadlines

Advertising booking and articles for
publication 10th of preceding month.

Hamads and advertising material deadline
18th day of preceding month

The contents of Amateur Radio are Copyright
Wireless Institute of Australia © 2002

General

What are band plans for?	37
<i>Draw Diamond, VK3XU</i>	
The close of an era	44
<i>John Bennet VK3ZA/VK2SIG</i>	
Car Rallies in Tasmania and South Australia — WICEN support	17
<i>Colwyn Low VK5UE, Ray Finlayson VK7TRF and Christine Taylor VK5CTY</i>	
How I got my Licence - 25 years to VK—me	24
<i>VK3PPP Adam Trumble</i>	
Writing for Amateur Radio	28
<i>John Nleman</i>	
Amateur Radio Station Records	25
<i>James McLachlan VK5NB</i>	
Free Passages To Tasmania	25
War Birds	27

Technical

Fixing your radio so it actually works!	4
<i>Mervyn Millar VK5MX</i>	
A Digital Frequency Display	6
<i>By Phil Rice VK3BHR</i>	
The Radio Control Of Model Aircraft	9
<i>Godfrey Williams VK5BGW</i>	
More about the Shack in a Briefcase	15
<i>by Ron Holmes VK5VH</i>	

Columns

Advertisers' Index	55	Hamads	54
ALARA	36	Ham Shack Computers	34
AMSAT	38	HF Predictions	48
Beyond Our Shores	40	How's DX?	46
Contests	20	Intruder Watch	42
Trans Tasman Winner	21	New WIA Members	19
Calendar	22	Over to you	53
Remembrance Day	23	Silent Key	52
Club News	33	Spotlight on SWLing	43
WIA Division News		Technical abstracts	26
VK1 Notes	31	Rigid Stayed Mast	26
VK2 Notes	30	Grounded Tower Elevated Feed	26
VK3 Notes	31	Stealthy Delta	27
VK4 Notes	32	VHF/UHF — An Expanding World	50
VK6 Notes	33	WIA Comment	3
VK7 Notes	30	WIA Division Directory	56
Editor's Comment	2	WIA Federal Directory	2

Our cover this month

See cover story, page 2

Contributions to Amateur Radio

Amateur Radio is a forum for WIA members' amateur radio experiments, experiences opinions and news. Manuscripts with drawings and or photos are always welcome and will be considered for publication. Articles on disc or email are especially welcome. The WIA cannot be responsible for loss or damage to any material. A pamphlet, How to write for Amateur Radio is available from the Federal Office on receipt of a stamped self-addressed envelope.

Back Issues

Back issues are available directly from the WIA Federal Office (until stocks are exhausted), at \$4.00 each (including postage within Australia) to members.

Photostat copies

When back issues are no longer available, photocopies of articles are available to members at \$2.50 each (plus an additional \$2 for each additional issue in which the article appears).

Disclaimer

The opinions expressed in this publication do not necessarily reflect the official view of the WIA and the WIA cannot be held responsible for incorrect information published.

Amateur Radio Service

A radiocommunication service for the purpose of self-training, intercommunication and technical investigation carried out by amateurs; that is, by duly authorised persons interested in radio technique solely with a personal aim and without pecuniary interest.

Wireless Institute of Australia

The world's first and oldest
National Radio Society
Founded 1910

Representing

The Australian Amateur Radio Service

Member of the
International Amateur Radio Union

Registered Federal Office of the WIA

10/229 Balaclava Road
Caulfield North Vic 3161

Tel: (03) 9528 6992 Fax (03) 9523 8191
<http://www.wia.org.au>

All mail to
PO Box 2175 Caulfield Junction VIC 3181

Business hours: 9.30am-3pm weekdays

Federal Secretary

Peter Naish VK2BPN

Federal Office staff

June Fox Bookkeeper
Rita Trebilco VK3IF Examinations Officer

Council

President	Ernest Hocking	VK1LK
VK1 Federal Councillor	Gilbert Hughes	VK1GH
VK2 Federal Councillor	Barry White	VK2AAB
VK3 Federal Councillor	Jim Linton	VK3PC
VK4 Federal Councillor	David Jones	VK4OF
VK5 Federal Councillor	David Box	VK5OV
VK6 Federal Councillor	Will McGhie	VK6UU
VK7 Federal Councillor	Phil Corby	VK7ZAX

Executive

Brenda Edmonds VK3KT
David Pilley VK2AYD
Don Wilschefski VK4BY

Federal Coordinators

AMSAT	Graham Ratcliff	VK5AGR
ARDF	Jack Bramham	VK3WWW
Awards	Mai Johnson	VK6LC
Contests	Ian Godall	VK3VP
Education	Ron Smith	VK4AGS
FTAC	John Martin	VK3KWA
Historian	John Edmonds	VK3AFU
IARU	Neil Penfold	VK8NE
Intruder Watch	Harry Andersson	VK8HA
International Travel Host	John Miller	VK3DJM
ITU Conference and study group	Gilbert Hughes	VK1GH
QSL Manager (Vks, VKs)	Neil Penfold	VK8NE
Videotapes	VK2 Division	
Web	Joe Burford	VK6UU
WICEN	John Weir	VK3ZRV

ACA Liaison Team

Glen Dunstan VK4DU (Corresponding)
Gilbert Hughes VK1GH
Keith Malcolm VK1ZKM
Peter Naish VK2BPN

Editorial comment

Colwyn Low VK5UE

This last month has been a bit hectic. We seem to have slipped again for no single reason. We are trying to get back to delivery to Australia Post by 7th of the month of issue and next year hope to pull it back another week. However you should note that material is included as it comes to hand so there is still some currency in each issue.

I had to spend some time collecting information on WICEN support of Car rallies in SA and Tasmania to go with articles supplied on the Saxon Safari Rally in Tasmania and the Classic Adelaide and the Coopers Pale Ale Rally SA in South Australia for this issue. I learnt a bit in the process. I have to say that I do get some satisfaction from being part of a helpful and well-organised activity. There are many ways we can participate in Amateur Radio support of community events. Hopefully most of us can do something. Any of these events gets Amateur Radio in the public eye and we have to make ourselves more visible.

Next month I hope to publish some reviews of Ron Bertram's Cram Novice Course. This course is a 1-hour a day for 4 weeks or a solid three-day commitment. You can do it on your own. Results of study in Club environments have been 90% pass rates!

Young Amateur!

'One morning while still in bed, I heard strange sounds coming from my shack.



Investigating, I found Rohan, my two year old son, had managed to set himself up as a CW Operator — fortunately the radio was off! I grabbed the camera, and made the shot.

I have recently used the photo as the art work for my new QSL card.'

Shane Magrath VK2KEP

Interesting thought. Kids of that age pick up languages really easily, perhaps it might also work with CW (Sub-ed)

I did get round to operation in the RD and found it good operating. I had the best contacts I have had in years with ZL and I did a bit to work up my CW skills. I had 7 out of 60 contacts on CW. It certainly confirmed to me that practice makes better.

I have to find the time to sort out some support to JOTA on October 19 – 20th and see if I can get the opportunity to have a free look at the cars and the action in the Classic Adelaide rally on October 17 – 20th. Packet will play an important part in the support of this year's Classic Adelaide so I will have to check out how I can set up a packet station in my Beetle. Seeing it still has a 6 V system I need to ensure I have some 12 V batteries. My 70 Ah battery is on its last legs (one cell is dying).

The TV program the *Human Race* involves a round the world race/rally. The contacts in each country are all to be radio amateurs. Australia is included. If you would like to know more, have a look at <http://www.etcsl.com/humanrace/index2.html>. The race is on and concludes in December this year.

This month think about doing something new with Amateur Radio. We can all learn something new and don't forget that "If you don't use it you lose it applies to your brain as well as your physical capabilities.

73 Colwyn VK5UE

Cover Story

Not so young amateur

But not so old amateur.

Shown in the inset photo, Thomas Lynd, 10 year old son of Bill Lynd, VK7KHZ, operated under supervision in the Trans Tasman VK contest and won.

This just shows that youth and enthusiasm can still get you places in Amateur Radio.



An Amateur Code of Ethics

The Remembrance Day (RD) Contest was held over the weekend of the 17th and 18th of August.

I was torn between giving the contest a go or spending time preparing a paper on the proposed Foundation Licence.

Why not give both a go I thought. A quick review of the Contest Rules indicated that double points could be made by operating CW so I decided that that had to be the way I'd go. I missed the start of the contest since I had agreed to help at a WICEN event supporting a local Car Rally in Canberra.

In between a number of short bouts at the key I still managed to write my document and still have a great day's amateur radio. All in all I had a ball, met lots of familiar names on air, and all at speeds that put me firmly in the novice CW operator category.

So what's the point of this story. The one thing that stuck in my mind during the whole weekend was the way that amateurs put themselves out for others.

Amateurs have a long history of community involvement. Amateurs often give freely of their time to contribute to community events such as those held by WICEN.

Amateurs also take great pride in remembering those who gave their lives in defence of the Australian ideal as witnessed by the large number of people who make the effort to take part in the RD contest. The RD contest is not the big publicity event that we see on the television but rather a quiet celebration of dedication.

Not only that but I was delighted to participate in a contest where the fellow contestants seemed as interested in wishing each other good luck as in winning the event. For me the RD lived up to its reputation as the 'friendly contest'.

Wielding the big Stick

However not everything that we hear on the air is so polite. Of late I have been made aware of a number of cases where amateurs appear to have operated in a

manner which does not do credit to the amateur radio service.

The current amateur licence conditions have dropped the requirements that operators use only reasonable language and act in a courteous manner on air. This situation has been forced upon the legislators due to the practical difficulty of enforcing such a rule.

However as amateurs I believe that we should, all endeavour to be polite to each other when operating on air. It does not cost anything to behave well. Most of us do not comment on good behaviour, however poor manners and poor behaviour are always remembered.

An Amateur Radio Credo or Code of Ethics

One of the letters that I received during the recent Take Five survey was from John Rogers VK7JK who proposed the idea of establishing an amateur credo or code of ethics (space does not permit me to include all of John's credo here but I have arranged for it to be put on the WIA web page).

John's view is one that very much originates in the QRP camp. There must be a way that we can widen his view to capture the full breadth of amateur radio activities.

I would be delighted to be able to set up a project to define an amateur radio code of ethics. If there is anyone who would like to take up the challenge then please drop me a line.

Miscellaneous matters

WIA Strategic Assessment

Since last month's notes a team of very capable volunteers has come forward and we have made a start on the WIA Strategic Assessment. At this stage we are reviewing our Terms of Reference and establishing our approach to completing the work.

We will be seeking further input over the next few months on a number of aspects of WIA operations. I hope to be able to report further on our progress in coming months.

Re-appointment of Federal Director

On Sunday 25th of August the Federal council and executive held a telephone conference to formally re-elect David Pilley, VK2AYD, as a WIA director.



This election had to be held since David has reached that wonderful age where despite having a wealth of experience, the Australian Securities and Investment Commission (ASIC) requires that he be specially appointed every year.

Welcome back David and well done for joining the ranks of the respected Elders of Amateur Radio.

Foundation Licence

As referred to earlier a few of us are currently working on a paper that sets out the WIA position on a Foundation licence.

This paper sets out the basis of a WIA proposal to the ACA for the creation of a foundation or entry level licence to amateur radio. This initiative has been prompted by the successful implementation of such a licence in the UK last year.

I would hope that in the next few weeks the paper will be circulated via Divisions for comment by members. If you would like to be involved in this process then please contact your local Divisional councillor for a copy of the paper. I will also arrange for a copy of the paper to be on the WIA web page.

I will bring this month's note to a close and wish you all 73s. I look forward to hearing from you on any amateur radio matters.

Ernest Hocking
VK1LK



Fixing your radio so it actually works!

Mervyn Millar VK5MX

31 Rickaby Street, Croydon Park 5008

So you want to fix your radio? Well so did I, and it almost became a nightmare. This is how the bad dream finally turned out to be a Success Story.

For Christmas 1978 my wife decided on a present befitting an Amateur soon to join the ranks of a Full Call Licensee — a brand new Fukuyama Multi-800D 2 metre FM Transceiver. I failed the exam with 62% of 70%. But I still got the pressy! It had 2 to 25 watt variable output power, an external Digital Display, 800 channels and a few 'nice' features, which I had not realised, until I finally got that full-call.

The Multi-800D had two memories: Simplex, plus 600 minus 600 and a 'Free Split'. On Memory 1 you transmitted on the frequency (unseen on the display) and received on the frequency shown on the displays. Memory 2 did the opposite.

It had a variable power out control, which doubled as a SWR indicator. If the SWR to the antenna was good, the variable pot would move the meter pointer in a somewhat linear fashion. If the SWR was poor, the full range of the control pot moved the meter pointer only a short way from zero.

The tuning was done using a single knob with eight positions: 4 for frequencies up, and 4 for frequencies down. This knob was spring loaded, so it returned to the centre position each time you let it go. The first position was a notch for clicking 5 kHz at a time. The next clicked frequency over slowly. The third position was faster and the fourth stepped the whole 144 MHz to 147,995 MHz in 10 seconds. You could count either up or down by turning the switch clockwise or anticlockwise.

At every 100 kHz a 'beep' was heard. If the radio was removed from the power supply, the "OKI" SMS Memories would hold data for up to 3 days. This tiny current came from a Zener Diode, a 1,200 uF capacitor and the 5 V. line. If voltage fell to about 0.5 V., data would be lost and would need reprogramming when power was restored.

Over the years some minor faults occurred. The current limiting resistors

in the display circuits are in seven IC-like packs. These had crumbled away, so the displays were not lighting up, but after replacement with ordinary components, they were as good as new. The radio had lost audio signal due to a 'dry jointed' capacitor in the transmit board. It had never been soldered in and fell out easily when given a gentle tug.

Everything went well until 1993. I was testing some very large capacitors, about 0.47 Farads, on the memory, when, unnoticed, a capacitor 'pigtail' fell into the radio's innards.

I switched on, and 'Phuuuuzzz!' then silence!

Burnt tracks on the board, 2 display segments blown, and a couple of burned diodes. Not too bad, I thought. I'll fix this pretty quick. New displays, diodes, repaired tracks.

Alas, no joy! The display was doing funny things. More problems. I had joined up too many tracks. This one was supposed to be opened (a different model radio). So I opened that track and bewdy! It worked.

When I tried on the repeater frequency, VK5RAD, some other Amateurs told me

it was 'off' frequency. Checking the actual output frequency showed the 144.000, 144.005, 144.010 and 144.015 MHz readings to be the same frequency.

The output frequency

Counting up, towards the upper frequency of 147,995 MHz, revealed each set was wrong, in other words the 10, 30, 50, 70, and 90 kHz ending were all output, to the odd number base. So 144.000 144.005, was 144.010, and output was 144.010. When the count read 144.015, or 144.020, or output read, 144.025, output was still 144.020 MHz.

Hmmmm. So the Multi 800D sat on the bench in pieces for many years. I reckoned a number of IC chips had blown up. When big fires were raging, near Sydney (1994?) I made a pact: Fix It Or Throw It Away. I found out a number of chips were available. One of these was a M53238, although this was not one I wanted, and was quoted at \$126.40 plus tax, plus freight, 4 of them in stock. I thought I would give them a miss.

Another chip available was a M53274 costing \$8 each. I bought 2 of them, then decided to get as many chips as I could

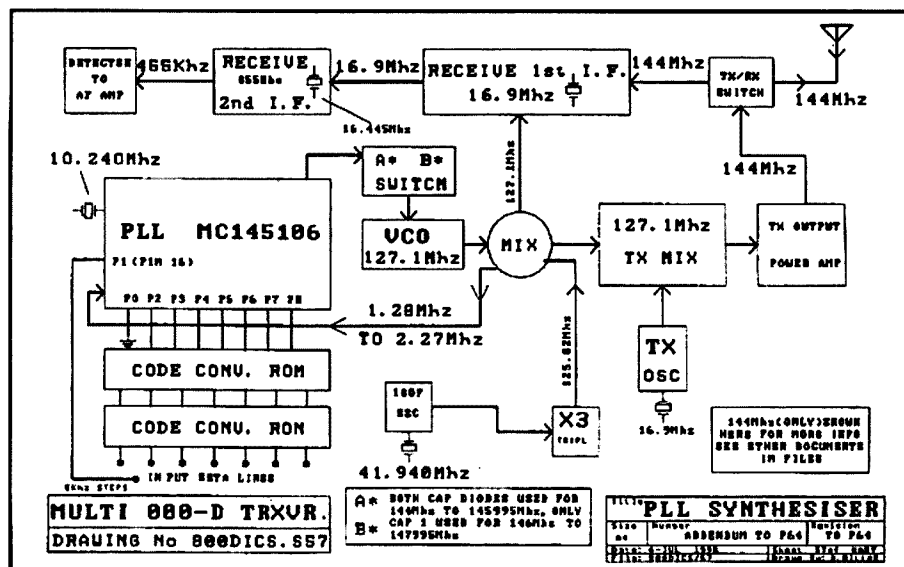

as spares. I built up a 'Workshop Manual' of all the information acquired so far.

That was in early 1997 and because of other commitments, the thing got left on the bench, in pieces, as usual.

The full range

In May 1998 the time arrived to dust off the old Multi 800D and throw it into the rubbish bin. But wait, just one more time — can it be fixed?

Maybe, just maybe. Firstly I needed the full range of ICs I had bought some time before, the Motorola chips were all plugged into sockets and easily obtained and purchased for about \$2 each. I looked for a M53345, a 1 of 10 Decoder, located in the Phase Lock Loop.

This little beastie puts the oscillator into circuit with the right crystal as needed. This little chip is a godsend. It is a 74LS145 and I have cracked the 'Mitsubishi' (In house) code. If you have followed me so far, you will be able to crack the code too.

The M53238 is a quad, 2 input and gate/s. I bought 15 or so 60¢ old computer boards, at our local (Robbies) disposal shop which makes the chips 4 cents each. Compare this with the \$126 plus! Nice work if you can get it. Having got the spare chips, I bought some books and did some studying. (See references). The books I purchased are excellent material, easily read and understood.

The counter

Were the faults in the counter, the PLL, wiring tracks or where?

Firstly the internal counter was saying the same as the external one, i.e. 144.000 and + 5 to 144.005 MHz when notched up. One click of the dial knob. Dusting off the logic probe, I did some random checks of the counter output and all seemed OK. Then a brilliant idea occurred to me.

Can the 486 computer be used to look for any frequency which reads the same? I think it can. There are eleven data lines from the counter to the PLL. I logic probed the lot, putting the results in a chart, e.g. 00000000000, 00000000001, 00000000010 etc. for all 800 Channels.

Next I created a database and typed the results into the computer which 'sorted' the data from the lowest to highest number, e.g. 00000000000, to 11111111111, all 800 Channels. Not one number was the same.

Next I repeated the exercise and this time the data was fed into the PLL Chip,



(after the PROMS): again 800 readings + 800 inputs to the PC. Result: exactly the same. No doubled-up numbers at all.

Perhaps the Phase Lock Loop integrated circuit chip was crook?

The next job was to remove the 2s compliment pin (Pin 12) from OKI SMS 5807 PLL chip (it sure squealed). I noted volts on pin 12 of the IC socket were rising and falling as frequency altered. An applied +5 V to the leg of the PLL pin 12 altered the output not at all.

Darn, where would I get a MSM 5807 PLL? OKI in Japan don't make or stock these anymore. An MB 8719 by Fujitsu was available, but it had 6 input pins where 8 were really needed. A couple of these were bought and one was 'mocked' into the PLL socket. I was on the right track, the frequencies were all OK right up to 144.775 MHz then 145.775, 146.775, and 147.775.

A VHF radio repairer who owed me favours had three Motorola MC 145106. PLL I.C. chips making his stock shelves bow in the middle. For a sum the weight was removed and Multi 800D had a new PLL and two spares just in case other pigtailed happen to fall into the works.

There just remained the simple matter of putting the MC 145106 into a mock-up, check it out, then place the new socket (different pin-outs and more pins), solder it in and replace the lid.

Somewhere, sometime in all the fiddling, someone said that the messy brown gooey glue slopped all over components on the PLL board could cause problems. Dampness gets in, can't escape, and the frequency may become 'odd'. So I scraped that dirty brown gooey all off.

When I tried the old Multi 800D it performed beautifully. On the air, just a

great performance, like a bought one! Only one thing left to do — put the covers on, switch it on, give it a run.

But talk about unstable! Touch the case and it rings like a microphone/speaker in a public address system.

Remove the covers, all is OK again.

Note: the brown glue is important! It is used to hold everything firm and solid so that it cannot vibrate. As the circuit is very sensitive it will pick up vibrations. The output from the speaker in the lid of the case sets up the microphonics and off it goes like a Banshee Wailer in the desert! A couple of squirts of *Araldite* around the coils and up over the associated parts fixed this problem.

At last the covers were really on and the job was done.

Conclusion

Cost of repairs was \$50, not including all the spare parts. The price was for 4 Seven Segment Displays, 1 MB8719 PLL and 1 MC 145106 PLL and Socket.

The gain/s for me were: -

- 1) Satisfaction of getting the radio working again.
- 2) Learning the 'fun'damentals of the PLL System.
- 3) Passing on the Information (discovered), to other amateurs.

References.

Electronics Australia, September 1978 Page 106 "A review", FDK Multi 800D Transceiver.

The CB PLL Data Book, by Lou Franklin, Published by CBC International. ISBN 0943132-05-3

Understanding and Repairing CB Radios, by Lou Franklin Published by CBC International. ISBN 0-943132-24-X
The Engineers Notebook, by Forrest M Mimms, Pub.HighText ISBN 1-878707-03-5

A Digital Frequency Display

By Phil Rice VK3BHR

Lot 601K Durston's Road, Maiden Gully Vic. 3551

<http://ironbark.bendigo.latrobe.edu.au/~rice>

This project is intended to be an accurate frequency display for a HF direct conversion or superhet receiver. It has user settable IF offsets so that it can calculate the actual receiver frequency. It also makes a nice 40MHz. frequency meter with 10Hz. resolution.

The design uses a PIC 16F84 single chip microcomputer to perform the frequency measurement and to format the result for display on a 16 character LCD display.

It is based on a frequency meter and VFO stabiliser by Eamon Skelton EI9GQ. It initially started as an exact copy however I couldn't resist the urge to modify the hardware and the software. It is now missing the VFO stabiliser function of Eamon's design, but has user settable IF offsets (which can be zero for DC receivers) and can handle high or low side local oscillators and display 'USB' or 'LSB' when appropriate.

How it works:

The input signal is buffered by a FET source follower then amplified by two 74LS00 NAND gates, biased into their linear region. Two further NAND gates allow the buffered input, or a signal from the PIC, to clock the 74HC393 8 bit binary counter. Overflow from the counter is counted by the PIC's internal 8 bit prescaler and 8 bit counter registers.

The PIC controls gating of the input signal into the 393 counter. At the conclusion of the counting period (0.4 second), the PIC tickles the 393 until it rolls over. The PIC counts how many clock pulses are needed and from this calculates the count in the 393. The PIC similarly flushes its internal prescaler, as it can't be read directly.

The final 8 bits of the count are read directly from the internal counter register. The complete count is formed by joining all 3 bytes together to make a 24 bit binary number, then dividing this by 4. (This limits the maximum measured frequency to just over 41.9MHz.)

The remainder of the PIC program adds or subtracts the IF offset (if required) converts the result into ASCII characters appends 'USB' or 'LSB' if appropriate and sends the lot to a dot matrix display module (the type that uses a Hitachi HD4780 controller).

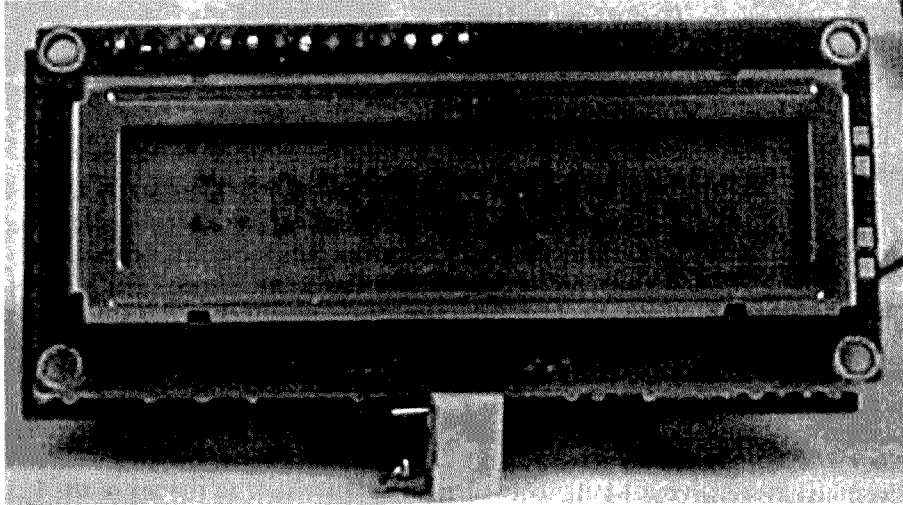

A smart looking addition to your set-up

The hardware:

My version was assembled on matrix board (the type that has an array of copper donuts on a 0.1 inch grid). The whole circuit plugs onto the back of the LCD module. A longer connecting cable could be used as it carries only 'slow' digital signals. Layout isn't too critical and the matrix board version works reliably to just over 40MHz.

Programming the IF offsets:

Two pins on the PIC (pins 12 and 13) select one of 3 IF offsets. Pin 11, when pulled low indicates that the local oscillator is on the high side of the received frequency. Finally, pin 10 when pulsed low, initiates programming of the selected IF offset frequency. While the IF offset is being programmed, the RF input must be connected to the appropriate BFO oscillator.

For normal operation, the RF input is connected to the receiver's local oscillator and the PIC uses the stored values of the IF offsets to calculate the received frequency. If neither BFO selection pin is pulled low, the PIC calculates the average BFO frequency

and uses this to calculate the received frequency. If no offset is required, just measure and store 0Hz for both offsets (or pull both pins 12 and 13 low to use the third offset).

Other similar designs

Eamon Skelton, EI9GQ, has a combined Frequency Meter and VFO Stabiliser using the PIC 16F84. It has two hard coded IF offsets. Eamon's design can be found on the web at <http://homepage.tinet.ie/~ei9gq/stab.html>

Richard Hosking, VK6BRO, also has a combined Frequency Meter and VFO Stabiliser on his web page at <http://members.iinet.net.au/~richardh/vfostab.htm>.

It uses an Atmel AVR AT90S1200 single chip microcomputer and provides 16 manually programmed IF offsets. Richard has boards for sale at \$15 each.

Getting the software:

For Eamon and Richard's designs, visit their respective web pages. It's all there.

The source code for this version is available on the web at <http://ironbark.bendigo.latrobe.edu.au/~rice>

If you don't want to go to the trouble of building a programmer and downloading the software (you will also need the Microchip PIC assembler), then I

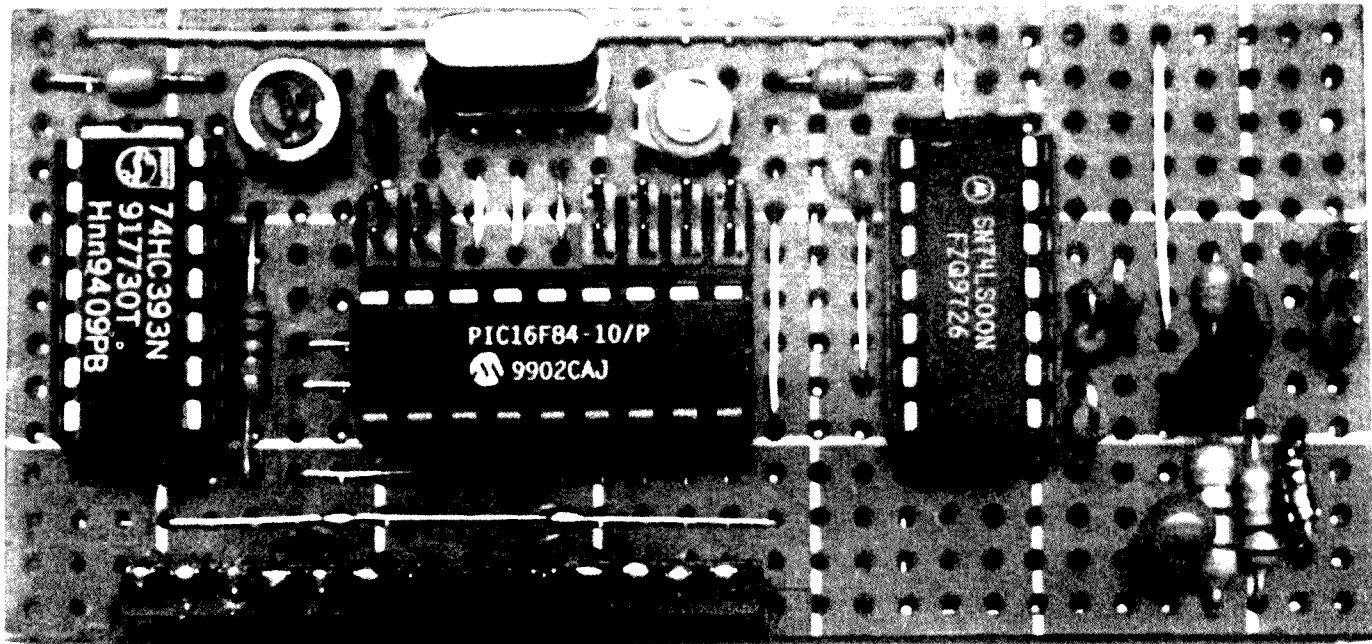

Component layout on matrix board

could be persuaded to visit my local Dick Smith store and buy a chip. I would like to cover my costs (just the price of the chip plus postage). Also, I can personalise the 'sign on' message - at the moment, it proudly announces 'DFM 3.0 - VK3BHR' for 4 seconds. You probably don't want that.

Conclusion:

Now you no longer need dials, pulleys, pointers and string to indicate what frequency your favourite receiver or transmitter is almost on.

The LCD display module, the PIC16F84 and all other parts can be obtained from Jaycar.

Together, they can measure your frequency to a resolution of 10Hz. Accuracy is another matter since the measurement is referenced to a rather crude crystal oscillator. I would expect an error of +/- 100Hz. at 30MHz. even when calibrated. An external oscillator could be used to improve accuracy.

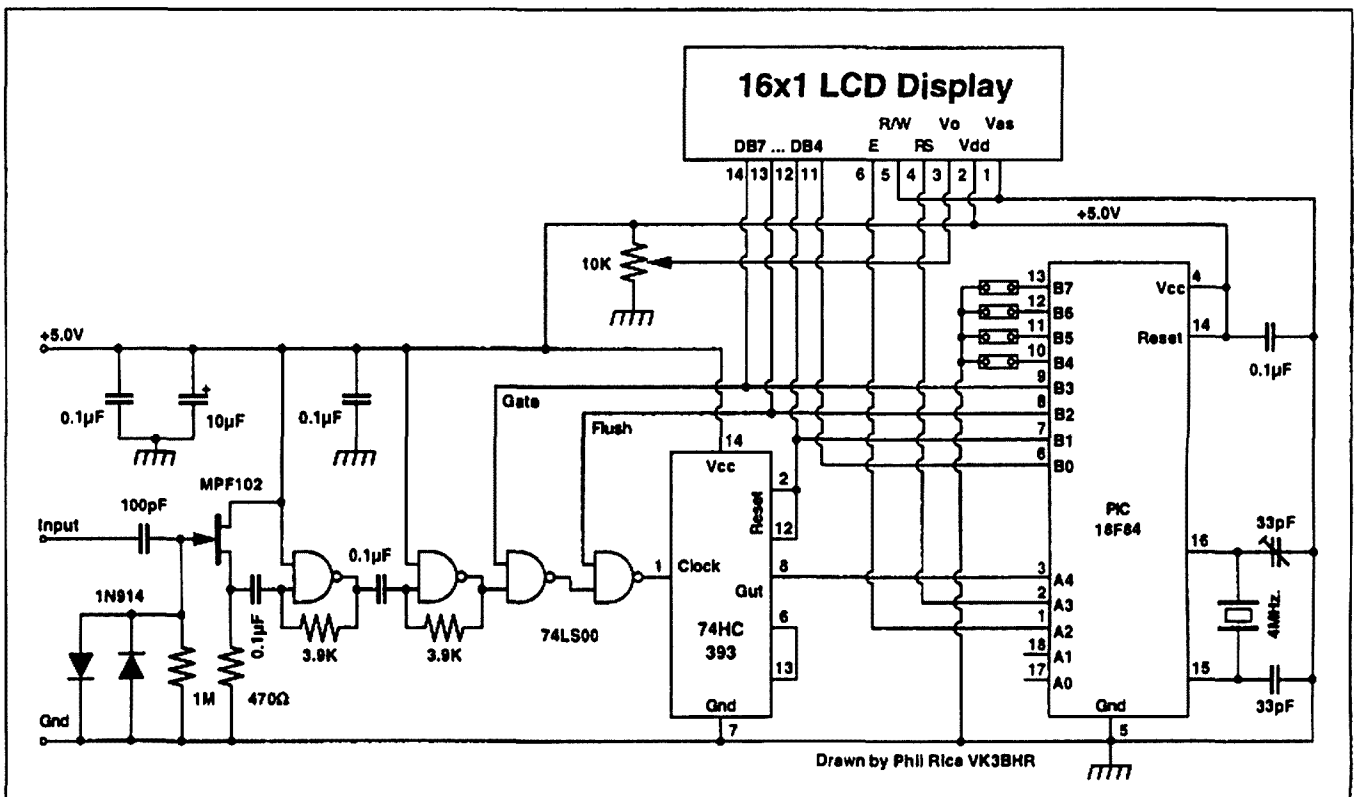

Circuit of digital Frequency Meter

HF and VHF Transceivers, Autotuners and Kits

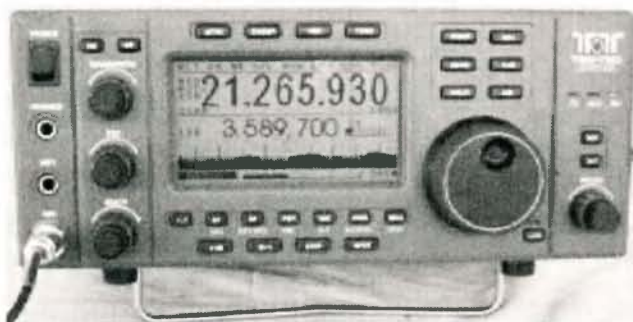

TEN-TEC

Jupiter HF DSP Transceiver

Easy-to-read LCD main panel display.
34 built-in receive filters—300 to 8000 Hz.
Multi-function meter provides bar graph and digital readout of signal strength, TX power and SWR.
Band sweep function
Seven selectable main tuning rates

Get Kitted Out

"It goes better on something you mode yourself"



Z11 QRP Auto Tuner Kit



HF Receiver Kit



AT11-MP Auto Tuner Kit

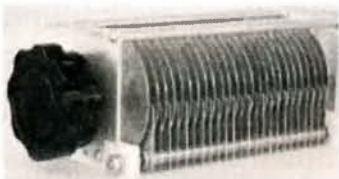

H.V. Variable Capacitor Kit



Dummy Load Kit



10-2M Transverter Kit



RT11 Remote Auto Tuner Kit



About to be released from Ten-Tec The Orion HF 32 bit DSP Transceiver and the Argonaut V QRP IF-DSP Transceiver.

TEN-TEC

We have RF Cables, Connectors and Baluns

★ All kits include easy-to-follow step by step assembly instructions.

You supply the soldering iron and basic tools!!!

All kit products can be supplied fully assembled and tested.

Service and Support for all Ten-Tec and LDG equipment

We stock Amidon Iron Powder and Ferrite Cores — Call for an application guide

Phone 03 59774808. Fax 03 59774801 info@ttssystems.com.au

The Radio Control Of Model Aircraft

Godfrey Williams VK5BGW

14 Jenolan Crescent, Hillbank S.A. 5112

Now for something completely different, a Monty Python phrase I think, but here it is, a brief history plus my experiences up to the present time of my other passion, that is the building and flying of radio control model aircraft, including as much emphasis as possible on the related electronic systems. The ARRL handbook briefly discusses this subject (See references).

I became interested in model aircraft in my early teens, my activities being limited to diesel powered tethered flying, two long wires attached to a handle at one end and to the aircraft at the other end which via a bell-crank mechanism, provided elevator control and confined the model to flying in a tight circle.

During the early 1960s, while on an overseas posting, I purchased by mail order from England, a very nice completely transistorised radio control outfit, comprising a handheld control box (the transmitter), a receiver and escapement for installation in the aircraft.

Using transistors this outfit was quite innovative for its day, although primitive by today's standards. My historical knowledge of the methods used in the earlier years are rather scant, but they involved home built valve equipment and the aircraft having to tote heavy filament and plate voltage batteries. The transmitter being too heavy to hold sat on the ground. The operator used a remote wired pushbutton to key the transmitter on and off.

The receiver used would generally be a single valve super-regenerative or TRF type, a super-het because of its weight and size being out of the question. These arrangements proved to be unreliable and prone to interference, so if a model was flown and recovered without mishap, the model flyer considered it a good day and went home happy. It is worth noting that the transistor was very quickly adopted for radio control use.

The outfit I purchased was by and large a miniaturized version of those primitive arrangements and suffered the same tendency towards unreliability, particularly as the frequency then used for model radio control was 27 MHz.

The transmitter was in AM mode and



AUTHORS QUARTER SCALE MODEL OF A MINI-CAB. THE WINGSPAN IS 6 FEET AND WEIGHT 4 KILOGRAMS. THE POWER PLANT IS A 15 CC FOUR-STROKE DIESEL.

had only one control, a pushbutton which keyed the carrier on or off. The receiver was a super-regenerative type requiring a 6 volt supply, upon the transmitter being keyed the receiver detected the signal, amplified it to a level sufficient to switch a transistor, which in turn activated a sensitive relay and then via another battery circuit operated a device called an escapement.

The escapement was a rotary electro-mechanical device having a solenoid that was triggered by the relay circuit. This particular escapement had four positions, thus each time the transmitter was keyed the rotor would move to the next position. The motive power for this rotor was supplied by a long twisted rubber band. One end was attached to the rotor and the other end being fixed at the tail of the aircraft. The rotor via a long wooden rod rotated a tiny crank handle at the tail, which via a wire loop

moved the rudder through its various positions. This arrangement was all contained within the fuselage.

Flying

The model aircraft in question had rudder only control, it was trimmed for a gentle descending glide with the engine stopped and the engine thrust line was angled upward slightly to give a gentle climb when the engine was running. This meant that the operator only had to worry about the direction the model was travelling in and would generally try to keep the aircraft flying a circuit while ascending or descending. By limiting the engine run time one could insure that the model did not climb too high also the number of control inputs was limited by the number of twists in the rubber band.

With rudder only control the four positions of the escapement meant that

starting from say, rudder in neutral, one momentary press of the push button gave right full rudder, press it again and you have rudder neutral, the next press gives left full rudder and the fourth press brings you back to the original neutral position.

Thus if you apply right rudder and then neutralize it and you find that you require right rudder again it is necessary to go through left rudder and the second neutral position before you can apply right rudder again, also it is vital to remember while the rudder is in neutral which is the next position, left or right.

The reader by now will appreciate that there is a high potential for confusion to occur, particularly in the heat of the moment. For the operator never having flown this type of model to say I shouldn't get confused probably belongs in the "Famous last words" category.

Early one humid and windless Singapore morning, with my newly completed model, I trekked off to the local park full of anticipation as to the nature of my first radio-controlled flight. In the days leading up to this flight I had conducted many dry runs with the system and felt that I could handle the combination of button strokes required to be in full control. So with the little diesel engine running sweetly and the rudder in neutral I hand launched the model and it climbed away. At this stage I had forgotten to note what was the next position of the rudder left or right? Anyway the model continued to gently climb away. It was now time to turn it, and that's when I became unstuck. I momentarily pressed the button the model turning viciously to the right, so I quickly pressed the button again to center the rudder but it continued to turn steeply and was losing height.

What the aircraft needed was some left rudder applied to level the wings, however by this time I had become confused and as the saying goes "When in doubt panic" and panic I did. I now began doing stupid

things with pushbutton so the model was now doing crazy antics in the sky. It eventually slammed into the side of some flats reducing the balsa wood and paper structure to a crumpled mess.

So my first venture into flying a radio controlled model aircraft turned out to be a disaster however I persevered over time and with a new model some semblance of control was eventually achieved.

Progress

During this time there were rather expensive but more sophisticated radio control systems on the market. These systems provided more than one flight control so rudder, throttle, elevator and aileron were possible. This was achieved by modulating the AM carrier with separate tones for each control required. The receiver was designed to detect each individual tone and trigger a designated servo (motor and gearbox) linked to the control surface. Although rather large by today's standards, crystal controlled super-het receivers became available and were regarded as a prized possession.

To detect each tone some receivers used a bank of fine metal reeds, each one being tuned to and stimulated by the received tone. Four controls required eight tones thus a bank of eight reeds was required. This was not a reliable system as engine vibration and other factors could upset these delicate devices. One advantage with this more sophisticated system however was we could now dispense with the horrid escapement.

Our control box now had two pushbuttons or a two way switch for

each control e.g. left right, up or down, fast or slow, bank right or bank left. Still the motive power for each control was make or break E.C. Neutral rudder or full rudder, neutral elevator or full elevator and so on. Adding to the problems described was always the chance of a "Shoot down" meaning QRM on 27 MHz causing the aircraft to become uncontrollable and crash. After returning to Australia and re-entering civvy street I dabbled for a while but other more important events took over my life so I abandoned the hobby.

During the early part of 1980 I became aware of the existence of a much improved radio control system. Although still in AM mode it comprised a crystal controlled super-het receiver and crystal controlled transmitter having two joysticks and providing proportional control. Thus the servo driving the control surface moved in sympathy with the joystick.

This system was known as "Pulse Position Modulation" because the transmitter produced pulses of variable frame rates. The servos consisted of amplifier, pulse detector, motor and gearbox and a miniature potentiometer connected to the output shaft, thus the servo was able to follow precisely the movements of the joystick.

The receiver was about the size of two matchboxes and used an I.F. of 455 kHz plus a very smooth and powerful AGC circuit. As a model aircraft is moving rapidly towards or away from the transmitter gain levels vary so an AGC system is essential.

A further feature was two frequency bands dedicated to the radio control of

ANOTHER VIEW OF THE MINI-CAB SHOWING ONE AILERON SERVO.



models 29.7 to 30 MHz and 36 to 36.55 MHz. With crystal control, a number of channels could be assigned to each band; thus more than one aircraft could be flown at the same time. Amateurs, who are aero-modelers, can and do use the Ham bands as an alternative, in particular the 6 metre band. With AM systems a safe channel spacing of 40 kHz is the practice.

Model flying was now a much more predictable affair, precision and realistic maneuvers such as aerobatics, landings and takeoffs, circuits and bumps and taxiing just like the full size equivalent became commonplace.

One maneuver I admire is known as a "Knife Edge", the model is rotated so that the wings are perpendicular the aircraft is now (with sufficient speed) using its fuselage as the lift generator.

Skilful pilots can fly circuits in this manner, however as the tailplane and elevators are now perpendicular and the tailfin and rudder are horizontal their functions change. In other words if the wings are rotated clockwise to the vertical position right rudder becomes down elevator, left rudder up elevator, up elevator becomes right rudder and down elevator left rudder.

If the wings are rotated anti-clockwise to the vertical position, everything is reversed. I avoid this manner of flight, as I don't want to become confused yet again! If the wings are rotated 180 degrees, the model is now flying upside down. Here, the elevator and rudder controls are reversed but the aileron control is unchanged.

Although the equipment available was well designed occasionally mishaps still occurred mainly because of the lack of good quality control, due I think to the fact that the manufactures had a "Toy" mentality.

This was to change however as models became larger, more sophisticated and more expensive. Modelers were demanding greater reliability and avoiding equipment with a bad name. Some aircraft besides having the four primary controls may also employ retractable undercarriage and flaps. Now with reliable equipment models wear out rather than be written

off in a crash. It is not uncommon in the present day, for a model to be worth in excess of a thousand dollars or more.

Equipment

I also took an interest in the electronic systems and constructed various support devices like battery chargers, Nicad recyclers and so on. FM mode equipment began to replace the AM systems, lower component count and simpler receivers (No AGC) plus capture effect enhanced the FM systems.

Tiny narrow band ceramic and mechanical I.F. filters were replacing up to three I.F. coils further reducing receiver size and weight, plus giving a better band pass characteristic thus cutting down on the possibility of adjacent channel interference. The transmitter used the varying pulse widths applied to a varicap circuit to frequency modulate the signal. As the bandwidth for FM was narrow (10kHz) frequency shift keying would be a more accurate description.

To further stimulate my interest in the electronics, circuits for the home constructor became available so I could construct my own radio control equipment.

Quite a few of these designs for the receiver made use of a chip familiar to amateurs (MC3357). Another chip used being familiar to amateurs is the S042 mixer which together with its partner S041 produces a very sensitive and reliable receiver.

Some amateurs will be aware that the

MC 3357 was used in some early 2 metre sets, and I have observed that pager interference is more severe with sets using this particular chip. Pin 3 is the mixer output being an open collector requiring a 1k5 to 2k resistor connected to the positive rail. Here the mixer gain is high being the source of the cross modulation problems. To prevent these problems, some radio control receiver circuit designs reduced the mixer gain by increasing the value of this resistor up to 100k.

One single high Q screened inductor with no amplification comprised the front end of the receiver and a simple crystal controlled oscillator resonated 455 kHz below the channel frequency. The circuit following the mixer consisted of two miniature 455 kHz mechanical filters with a simple one transistor amplifier between them. A common 4015 chip providing the decoding plus allowing up to eight separate proportional controls. A simple voltage regulator circuit helps to protect the receiver from variations caused by servo drain. A block schematic of the receiver circuit appears in FIG. 1.

Each transmitter has two joysticks each one having two main potentiometers set in gimbals plus two extra pots as trims, the outer pot connections connected to the regulated positive and negative rails respectively while the wiper is connected to the channel input pin of the encoder chip. By swapping the outer connections the

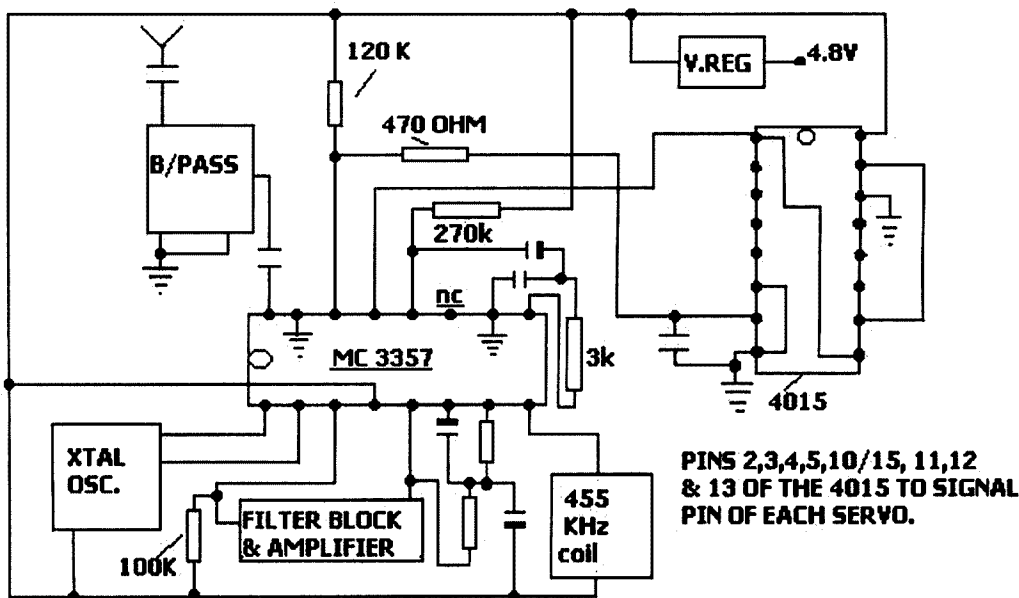
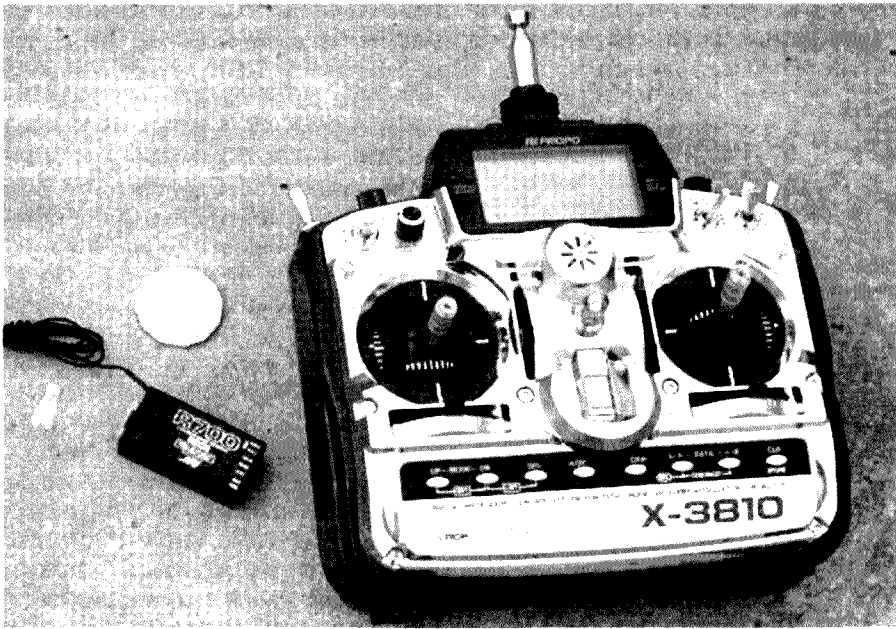

FIG. 1 AN FM RADIO CONTROL RECEIVER USING THE MC 3357.



and legs, and he or she is flying by the seat of their pants, that is being able to feel what the aircraft is doing.

A radio-controlled model is different. One can only see what the aircraft is doing. Most model flyers have aileron and throttle on the right hand joystick and rudder and elevator on the left-hand stick. This may seem strange to a full size pilot but seems a better arrangement for the model flyer seeing as there is no tactile sense.

One problem that the model flyer has is depth perception, your eyes can play tricks, and one can start seeing "long", when making a landing approach. The model seems close enough, yet ends up landing some distance away. This is not a problem when flying in a large paddock but if you are flying in and out of a small area there is a danger of running into trees, fences etc. Added to this is the further problem that when a model is coming towards you and you are facing it, right stick means left wing down and vice versa.

Engines

The most popular engine used in models is the glow-plug diesel. The glow-plug

direction of servo travel in the aircraft is reversed.

The encoder chip (NE 5044) by Signetics was produced specifically for radio control systems, its partner (NE5045) was a decoder designed for the receivers and was used in some designs. The RF section used a PNP transistor as a varicap, this being fed to a half frequency crystal oscillator. A coil and capacitor arrangement identical to that used at the front end of the receiver extracted the second harmonic 36 MHz. This then was coupled to a well known 2N3866 RF power transistor.

Following this was a low pass filter, again using high Q inductors, following that a miniature choke resonated the telescopic whip antenna. A block Schematic of the transmitter encoding circuit and RF section appears in FIG 3. A further chip produced by Signetics was the servo amplifier (NE544). A schematic of the servo arrangement

appears in FIG. 2.

I spent some time experimenting with receivers, in particular dual conversion examples, mixing circuits for transmitters using simple op-amps allowing one control to be mixed with another, e.g. ailerons mixed in with elevator control as is required with delta wing models. Eventually I exhausted all possibilities and looking for something different to do, I constructed a receiver for the 6 metre amateur band including a converter for the 2 metre band, hence my enthusiasm for, and entry into, the world of amateur radio.

Physically being able to fly a full size aircraft is no help in learning to fly a model aircraft and vice versa. In a full size aircraft the control yoke and rudder pedals become an extension of the pilots arms

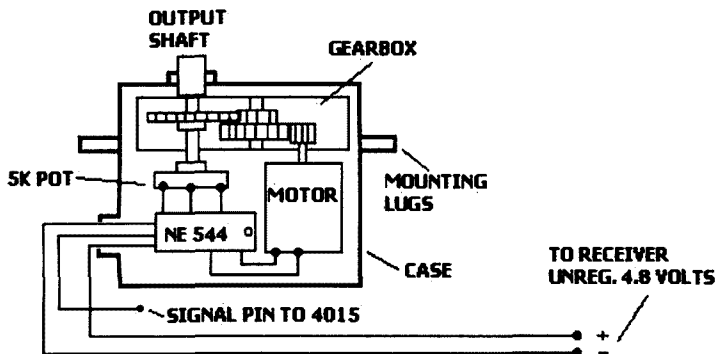

FIG. 2 TYPICAL SERVO ARRANGEMENT

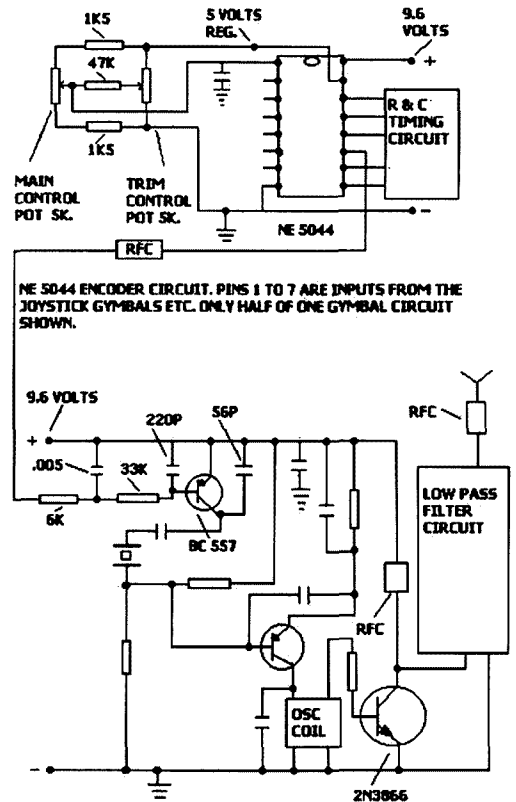

FIG 3 ENCODER & RF SECTION FOR A FM RADIO CONTROL TRANSMITTER.

is an element of tungsten steel, which for starting, is heated by battery power. After the engine is running the power to the element is no longer needed, as cylinder head temperature is sufficient to keep it glowing. These diesel engines can be two or four stroke. The latter even in very small engines have a camshaft, pushrods, rockers and of course valves and valve springs.

The four-stroke engine has a realistic sound when compared to the two stroke. Single, twin and radial three and five cylinder examples are available. The fuel used is methanol and castor or synthetic oil in a 4 to 1 ratio.

The fuel tank used will be the clunk type, that is the internal draw tube is flexible and weighted so that fuel draw is always from the bottom of the tank regardless of the attitude of the model. Fuel draw is achieved by the suction of the engine and some exhaust pressure can be applied to the tank to assist.

Needless to say with such a basic method of fuel feed to the engine only careful management will ensure reliability. This becomes vital when flying a multi-engine model. Perusing some of the magazines dedicated to this hobby (see references), one will see photographs of magnificent examples of multi-engine scale models being detailed down to the last simulated rivet and panel line. There are examples of huge 20 foot wing span examples of B29's, Lancaster's, Dakotas and so on.

Good engineering and management ensure that each engine runs reliably because if one or more engines should fail the flyer has a problem.

In a full size aircraft, say for instance a twin engine type, if the right hand engine should fail, immediately the aircraft will yaw to the right as all the power is on the left hand side. Added to this the dead propeller is now causing drag, further yawing the aircraft to the right. The pilot will now be using large amounts of left rudder to counteract the yaw, but he or she will also feather the propeller on the dead engine, that is turn the blades so that they present the least amount of wind resistance.

This facility is not available for model aircraft so the flyer has double trouble as well as not having any tactile sense so they are in a bit of bother. The golden rule is never turn towards the dead engine, as the aircraft may not recover.

One solution is to shut down the good

engine and allow the model to glide in, however the model is now experiencing drag from two propellers so to keep flying speed the model must have a nose down attitude and therefore will lose height rapidly.

Electric power is also a solution but these motors haven't the raw power of a diesel or petrol engine nevertheless they are continually being developed and are improving at time goes by. Battery technology is advancing and making likely the increased use of electric power in the future.

One exciting newcomer for models is the jet turbine engine, at present very expensive and perhaps not yet fully developed. For hobbyists who have metal skills the jet turbine is a real candidate for home construction. As an alternative, model jet aircraft use ducted fan propulsion. A high revving two-stroke diesel engine driving a multi-blade small diameter propeller contained within a relatively long tube.

Final comments

Aero-modelers mostly operate their aircraft within a club environment that usually provides a permanent flying site, third party insurance, instructors, safety guidelines and generally a good humoured social atmosphere.

Construction methods for the airframes vary, frameworks of balsa and spruce are common. Heat shrink plastic film is very popular for covering the airframe, other methods such as expanded polystyrene foam with a thin veneer of timber, fibreglass moldings and even cardboard are used.

Safety is always a concern, the integrity of airframes, control surface linkages and so on goes without saying but radio safety, a pet subject of mine, needs to be continually addressed. The majority of models are not large and because of weight considerations a 4.8 volt 500 mA Nicad pack provides power for the receiver and the servos. Careful monitoring of the efficiency of Nicad packs in use is vital, an aging 500 mA pack (four AA's) may lose a cell, usually by going short circuit, the remaining 3.6 volts isn't sufficient to support the receiver and servo's so the model will most definitely crash out of control.

The so-called "memory effect" of nickel cadmium batteries has claimed many a model. The flyer may habitually

have three 15 minute flights every week but on an occasion decides to fly for the fourth time. At this point although having previously been fully charged the Nicad pack, as if it has a memory, goes prematurely flat with disastrous results. The answer of course is to give the pack a monthly full discharge and recharge.

The power output of the transmitters is around the 750 milliwatt mark and the receivers have a sensitivity of around 3 microvolt. This gives, with the model airborne, sufficient range to the point where an average 5 foot wingspan model is virtually out of sight. Although the receivers are of good design and quality they are still susceptible to QRM such as fundamental overload from a nearby powerful transmitter e.g. a mobile travelling on a road in the vicinity of the flying site. Also, during times of high solar activity, international signals may appear on the frequency. The frequencies allocated to radio control models, differs from country to country.

A typical scenario for a mishap is if the Nicad pack is nearing marginal voltage plus one or more control surfaces and linkages are binding a little, causing the servo's to draw more current than they should. Some even brief QRM effects the frequency causing a servo to glitch, which momentarily pulls the Nicad pack voltage lower. All of the servo's may now glitch because with voltage low they will begin hunting for their correct position further reducing battery voltage.

At this stage the model will be out of control and the operator in state of panic will be frantically manipulating each joystick and in turn causing more servo movement. Of course this further reduces the system's integrity and a crash will occur. It requires a lot of self-discipline to leave the joysticks alone and see if the model will recover itself.

Keeping the whole system in tip top shape will to a great extent help to combat QRM and as I have explained to my fellow modelers many times, attention to detail is the answer, any seemingly insignificant oversights will when added together make a big difference.

There could very well be for each control surface up to ten points of maintenance when considering the servo's connection to the receiver plus linkages, interconnecting cables etc. The installation of the receiver, servo's, switch harness and battery pack is

important. Protection from engine vibration and oil rich exhaust fumes is essential. The receiver antenna, generally about a metre of wire, must be routed away from the servo's and metal parts.

The design and manufacture of radio control equipment for the hobbyist has kept pace with technology, surface mount practices are now standard and the transmitters are computerized. A modern day transmitter will have a relatively large LCD illustrating the status of all the programmable functions.

The facility of limitless mixing options grows, end point adjustments for each channel, reversing the servo direction, exponential travel, to name a few. The transmitter can be programmed so that for a landing, the undercarriage will lower and the flaps will automatically extend if the throttle control is brought back to idle.

Ailerons can be mixed with rudder to provide automatic co-ordinated turns. Delta wing aircraft having combined ailerons and elevators, V tail aircraft with combined rudder and elevator, differential aileron movement and so on.

The receivers are generally single conversion with a 10kHz channel width, for safety's sake the practice is to allow a 20 kHz spacing. Some systems have a failsafe facility. If interference is present the receiver will lock the controls at a programmable point e.g. throttle back, a slight descent and gentle turn.

I know little about radio-controlled model helicopters. These marvels of model engineering have to be seen to be believed. The computerized transmitter has begun a new dimension in this vastly different type of flying. The ability to electronically co-ordinate the main rotor, tail rotor, engine speed and gyro has removed many of the difficulties in flying this type of model.

Radio controlled models have other uses other than for recreation. Military use them for photo-reconnaissance and target practice. Commercially they are used for photographing crops, surveys and air sampling.

As amateurs generally adopt an area as their own within the hobby, so to do radio aircraft modelers. Some enthusiasts confine their activities to general sport flying, or building and

flying finely detailed scale models, the Super-Marine Spitfire being a favourite.

Large models are constructed for towing radio controlled model gliders just like the full size practice. Some enthusiasts practice endurance flying, that is, the model with a substantial fuel load is flown, usually in a circuit for hours on end or the model is chased by and controlled from a vehicle.

The circuits shown are mainly block schematic, some component values being shown. Should you require additional information, I can supply the manufacturers application notes on the receipt of a large S.A.E. The references list some web sites that are well worth a visit.

References:

- Airborne magazine. (Aust.)
- Radio control models & electronics magazine. (UK)
- ARRL handbook 1991.
- Radio control model news magazine. (UK)
- Web sites:
<http://www.airbornemagazine.com.au>
www.ozemail.com.au/~rcmn

G. & C. COMMUNICATIONS

Authorised dealer for ✓ Kenwood ✓ Icom ✓ Barrett RFDS ✓ GME Electrophone ✓ Uniden ✓ RF Industries

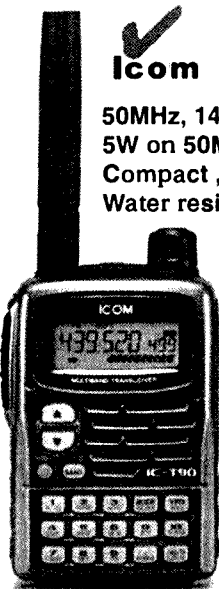

Icom IC T90A

50MHz, 144MHz, 430MHz
 5W on 50MHz, 144MHz, 430MHz
 Compact, rugged
 Water resistant

intuitive operation
 DTCS, CTCSS
 pocket beep
 555 memory channels
 14 high speed scans



ICOM IC207H

Amateur 2m/70cm FM mobile transceiver.
 Compact dual band unit with detachable control panel (OPC-600 cable required)

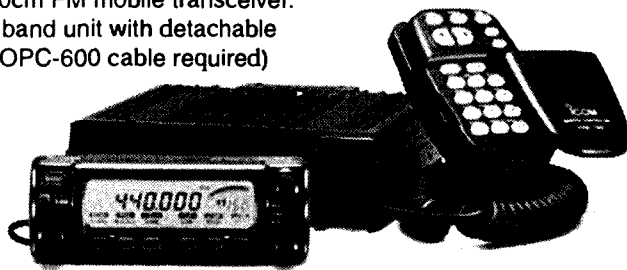

ELECTROPHONE TX3400

40 Channel UHF remote mount transceiver with ten extra receive channels

Australia-wide orders welcome. Payment by credit card, cheque or money order
 19 Arleon Crescent Cranbourne 3977
 Ph: 03 5996 3298 Fax: 03 5995 0184
 Email: gccomm@netspace.net.au
www.netspace.net.au/~gccomm

More about the Shack in a Briefcase

by Ron Holmes VK5VH , 8/22 Marden Rd. Marden SA 5070

Since the publication of my article under this heading in the July issue I have received a number of comments and questions. I appreciate the many positive comments and would like to make more clear the matters on which there were questions in case others have them also.

1. The Power Capability

The only references in the article were to using 30 watts from a 7 amp hour gel cell and to keeping the power down to 5 watts when using the S.W.R. bridge. In practice I normally use 100 watts P.E.P. from a car battery or a 13.8 volt supply. Unfortunately the caption intended to go under the photograph of the open briefcase. (Photo 5.) which was sent after the original material, missed out. (see below)-

The switchmode power supply concerned was designed for "testing high power automotive equipment such as car audio and radio communications." It is not a 'stand alone' unit as 240 v terminals are exposed. So I have mounted it to remain in the briefcase with 13.8 volt terminals connected to sockets on an insulating

section at the back which covers the 240 v. connections. Naturally the case remains open when in use for cooling.

2. Tuning Possibilities

One question was why not use variable capacity in the tuning. Actually I did this in Mark 1 with a 100 pf variable from the junkbox and it worked OK but I did not include it in the final design for three reasons. Firstly I wanted to design something for which anyone could go to the shop and get the parts. Midget variables suitable for 100W are not easily available to my knowledge. Secondly I found that a vernier control was needed to get it spot on and return to the same frequency. The plugs and length of vertical were easier to replicate. Thirdly, I could be wrong, but it seemed to me that a self-resonant inductance would all radiate whereas a capacitance would not. Certainly the power output meter moved further.

Incidentally, the figures given in fig 4. are not necessarily the only possibilities. Generally speaking it would seem best to make the whip as long as possible consistent with carrying it in the case and keeping it below the ceiling. I should also mention that I have found that on 80 metres the radials at 5m, the coil connected 4-6, and the vertical at 98 cm gives a considerably wider bandwidth than the original suggestions.



3. In Practice

In the article I mentioned that with this antenna you may have difficulty being read in a noisy environment. A striking example happened recently in my regular 3.56 MHz sked. Most members were in the Adelaide area surrounding my QTH with standard antennas. Steve was away on holiday at Mildura 400 km distant, operating stationary mobile. It was a very noisy night. When I tested the Mini Antenna the Adelaide group had trouble reading me through the noise although I could read all of them well. The interesting point was that Steve, VK5ZB, at Mildura gave me a 5/8 report with perfect copy.

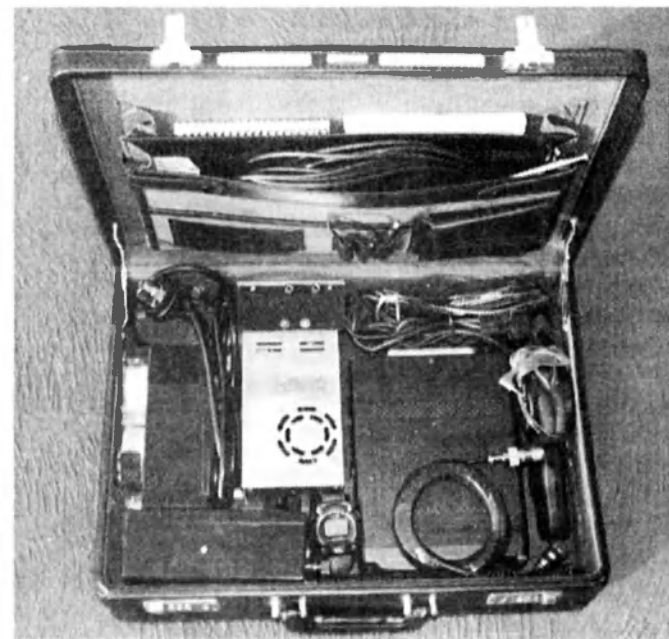

Here is the "Shack in a Brief-case" complete with an 18 amp (continuous rate) Switchmode Power supply from Jaycar which I have found operates satisfactorily at 100 watts PEP SSB. It is much lighter than the 7 amp hour Gel Cell which I now use in a backpack set-up for which I have purchased, but not tested, a solar panel trickle charger.'

STRICTLY HAM

PTY LTD

★ TS-50

Mount it in a vehicle, take it on a DX-pedition or use it as a permanent base station transceiver. The easy-to-use menu system adds flexibility, stable operation in any situation.

- DDS with fuzzy control
- 100 Memory channels Outstanding performance



SSHH...

Coming Soon IT-R5

This little ripper handheld is so new we aren't allowed to tell you



about it on paper (but its an IC-R2 on steroids)

CALL US

★ TH-D7A(G)

- Dual bander
- Effortless 2m & 70cm
- BUILT IN PACKET
- 200 alphanumeric memory channels
- 6W from 13.8VDC
- Comes with NiCd battery and charger
- APRS compatible



★ IC-756 PRO/II

Icom's new HF+50-MHz digital
The performance king Try it to see why
• Multi-colour multi-function screen



CABLE



★ IC-746 PRO

Icom WORK THE WORLD performance
• The best way to get onto HF plus 6 and 2 metres
• Multifunction hi-res display
• Direct frequency • Shack or portable

ROTATORS

★ IC-T90A

50MHz, 144MHz, 430MHz multi band with 0.495-999.990MHz wide band receiver



5W output on 50MHz, 144MHz, 430MHz Li-Ion battery

Compact, rugged, Water resistant. Intuitive keypad, DTCS, CTCSS, pocket beep. Total 555 memory channels 14 high speed

★ IC-2720H



Dual band mobile transceiver. VHF/VHF UHF/UHF or VHF/UHF simultaneous receive capability, independent tuning and packet communication. Colourful backlit LCD, stylish design

★ TS-2000

- Three operation platforms,
 - 1 Traditional transceiver-full front panel,
 - 2 "Silver box" for mobile use
 - 3 ARCP-2000 computer control
- 100 watts on HF, 6 metres and 2 metres, 50 watts on 70cm,



★ IC-706MKIIG

167(W) x 58 (H) x 200 (D), 2.45kg Detachable Control Panel/Display (optional equip. required for remote operation)
SSB/AM/CW/RTTY Narrow Filter Options



★ TM-D700A

Kenwood's new TM-D700A makes the most of exciting SSTV, GPS, and APRS® (Automatic Packet/Position Reporting System rapidly gaining popularity worldwide). Extra large amber and black display. Built-in TNC offers a wide range of options, inc. simple packet operation using AX.25

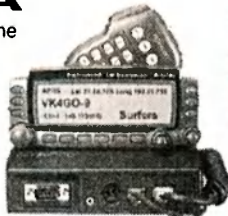

Ham radio is truly entering a new era.

Suppliers and distributors

KANTRONICS-MFJ-DIAMOND-MIRAGE-HY-GAIN-VECTRONICS

14 CHURCH ST BAYSWATER VIC 3153

Phone (03) 9729 7656

Fax (03) 9729 7422

email sales@strictlyham.com.au

www.strictlyham.com.au

Wicen Community Support Car Rallies in Tasmania and South Australia

Colwyn Low VK5UE, Ray Finlayson VK7TRF and Christine Taylor VK5CTY

The Wireless Institute of Australia Civil Emergency Network provides support to a variety of community sponsored events as part of its ongoing training in providing emergency communications. Knowledge gained in establishing propagation paths and practice in message handling are both important aspects of these exercises.

About the rallies

I have received articles on the WICEN operations in support of the Tasmanian Saxon Southern Safari Rally from Ron Finlayson VK7TRF Publicity Officer Southern Tasmania Branch and the Christine Taylor VK5CTY on the Classic Adelaide Rally. I have also participated in support of the Cooper's Pale Ale Rally of SA so this article draws on three sources.

The Saxon and the Pale Ale are rounds of the Australian Rally Championship and have also been considered as possible rounds of the World Rally Championship. Targa Tasmania is a rally run in Tasmania under FIA (the International Rally Body) rules. This year, Classic Adelaide will also be run under FIA rules.

They mainly run their Special Sections on forest dirt roads. The Classic Adelaide is run on sealed roads. However the areas chosen for the rallies are in the areas where there are lots of hills, valleys, narrow twisty roads and generally places where it is difficult to establish direct communications links to Rally Control.

The Saxon Rally is mainly in the Derwent Valley north of Hobart in the Mt Lloyd - Plenty Valley Forest.

The Cooper's Pale Ale is run mainly in the Mt Crawford Forest Reserves in the Adelaide Hills and the Classic Adelaide in the areas north and south of Adelaide, but behind the Adelaide Hills and some sections are run in the Hills.

Each of the Rally courses requires the use of repeaters and translators to carry communications from the Special Stage Start and Finish points and also from the within stage SOS points back to Rally HQ.

The Saxon Southern Safari Communications Networks

Communications is via three major networks (with some having sub nets), plus individual UHF CB links between competition vehicles and their support crews. The first is the 'On Course net' comprising the local Forestry system of a repeater, mobiles and the vehicles they are mounted in, for the emergency FIV units stationed at all starts, stops and any SOS (midway safety-on-stage and pronounced "soss") points. It also provides a link to the "On Course-Mobile-Officials".

Next, the 'Stage networks'. An individual Stage net handles the link between each Stage Commander, his/her Deputy and the SOS points and allows for vehicle tracking. This uses a transfer of start and stop times between stations and an observance of vehicle progress through the stage. Any action required

for a competitive car missing en-route can be initiated without delay. Because of the amount of radio traffic involved when there are a number of consecutive stages in close proximity, the Stage radio traffic was divided between a local CB repeater and four mid band VHF repeaters borrowed from "Targa Tasmania". One of these repeaters was situated on Mt Lloyd to cover the long stage, the others on various high points suitable for their particular stages.

The Targa radios are mostly recycled FM900s on their own set of six mid-band VHF frequencies in simplex mode and operated by the volunteers as required, or via six portable repeaters that WICEN are normally given the job of supervising during Targa. There can be around ten stages on each day, with each day being in a different part of the State.

continues



The Saxon and the Pale Ale rallies are part of the Australian Rally Championship and the cars, such as this Lancer are state of the art 4WD grunt. Delivery of communications must match the sophistication and expenditure involved.

The Mt Lloyd UHF CB Repeater is normally for use by the local population, but for the event a deal is done and the event usually gets good cooperation from the regular users.

Lastly, the 'Command Net'. This is where WICEN comes in. Apart from the Finish stage and the stage in the hop field where mobile phones did the trick, we covered all locations. The net again covers each start and stop point but also has a path back to the Command Centre in Hobart (Rally Base), and handles the overall event-permission-to-proceed and progress information as well as the competitors' stage timings for compilation. The progressive timings and therefore placings in the different classes are then faxed or radioed back to the course for the teams to see mid event as well as for instant results at the last stage. Rally Base coordinates all of the stages and also liaises with the

Emergency Services as the event uses open public roads between stages.

WICEN Radio Plan for Southern Saxon Safari

We used two separate nets to allow for the heavy volume of radio traffic, but even then we had two stages on one net and three on the other, arranged in a leap frog fashion with several overlaps. Clear, concise messages with distinct call signs applicable to the event and stage were the order of the day.

Firstly, we used a 2 m amateur duplex net via a portable repeater situated on Mt Lloyd to link between stations on the forest floor. This was crossbanded with 70cm for the path out of the forest, down the twisty Derwent Valley to the city based Command Centre (Rally Base). However, with the terrain being a factor and the weather an unknown, this was

backed up with a second 70cm crossbanded link at a different site near Hobart.

Secondly, we ran a similar net (but using a private frequency VHF repeater system, crossbanded with an accompanying private UHF frequency also with a second path as a backup), which is run by one of our members and is used by our members for just such purposes. This second net also allows us to use non-amateur-licensed WICEN members so as to give us a wider coverage, as well as giving us our own backup.

For those who may not know, WICEN in Tassie is a WIA only operation, but we have a number of family members and others interested in radio as a hobby or as volunteer Fire Service operators who enjoy the challenge enough to come onto our team.

The Classic Adelaide and Coopers Pale Ale Communications Networks

There are two separate networks. One that is run using the South Australian Government Emergency Services trunked Radio Network the GRN. The other is Amateur Radio under WICEN.

The GRN carries all the Rally organization Administration traffic and links Official Course Cars, Stage Commanders and the Rally HQ. Rally HQ has total control at all times. The WICEN nets carry safety traffic and scoring traffic.

This year on the Coopers Pale Ale WICEN ran both voice and packet scoring nets with voice as the primary. These nets provide scoring information back to Rally HQ and safety and management traffic. The scoring traffic is handled on a polled system. The net controller calls each stage when they want information. This allows for very efficient information gathering.

Stage operators can initiate emergency traffic if required. The packet system worked so well next year packet will most likely be primary. WICEN nets also connected the intra stage operators

Considerable work has to be done by the WICEN team beforehand. They have to site repeaters or translators on strategic hilltops and test them extensively during the weeks before the Rally.

It is not easy to get good radio paths from some of the locations used in the

Classic Adelaide and the Coopers Pale Ale.

Radio operators using the Rally maps have to find out precisely where the start or finish of their section is. Then they have to find a suitable spot, off the road, from which they can make radio contact with headquarters through the allocated channel.

Sometimes it is quite easy, at other times moving a few metres further along the road will make all the difference between a marginal contact (not good enough under these circumstances) and a solid signal both ways.

The WICEN radio design team has to plan the whole network. Wherever possible it uses 2 metre for field stations and translates back to HQ on 70cm. In operation this can require simultaneous operation by up to 5 operators with a transceiver and computer at rally control.

In the field most operators also carry a UHF transceiver as well, just in case. Care needs to be exercised in choosing local net frequencies so that they do not interfere with the UHF backbone. The dedicated WICEN repeaters are used wherever possible; however, in and around Adelaide we have a number of permanent repeaters, which are used if necessary.

The Classic Network

A number of permanent and portable repeaters are used. The dedicated WICEN repeater is set up on Anstey's Hill with its attendant power supply (most recently WICEN has been experimenting with a solar powered unit). This has to be serviced each day in preparation for use. It must not fail at the critical time.

Crafers is the site of the most heavily used repeater around Adelaide so it is not utilized for the rally. Instead, a simplex transceiver or translator is set up on the Crafers site, operating on. Other translators/simplex transceivers are moved around as required. The two regular repeaters most often used, when a radio path is not possible through the

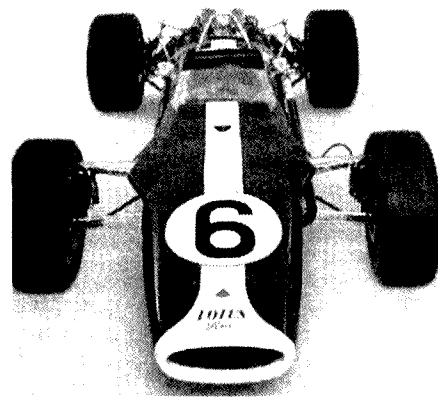

Lotus-Ford 49, a 1968 open wheeler, 3 litre, 415 bhp. A Classic entry

dedicated units, are on Willunga Hill and at Mt Beevor station. With so many choices and channels the radio room at the HQ suit at the Hilton Hotel in Adelaide is very busy. There can be as many as five sections in use at once. Further the radio path from the start and the finish of a particular section is not necessarily the same!

The Cooper's Pale Ale Network

The set up is similar to that described above, but the forest sections means the network for this Rally is more localized member's home stations used as translators. This year four relay repeater/translators were used, VK5UJ at One Tree Hill, VK5RAH at Houghton, VK5RMB at Murray Bridge and VK5RBV at Angaston. These were linked back to the Rally Headquarters at the Wayville Show Grounds in Adelaide. An Emergency Network "Quickfire" ran through a repeater on Mt Crawford. All linked to HQ on 70cm frequencies.

Post-meetings with Rally Officials allow for input on relocation of stage start and finishes to improve communication reliability. This year's Pale Ale Section Start and Finishes were moved out of the valley floors to allow better communications.

Rally Emergency Events

Accidents do occur and Stages have to be stopped. The FIV (First Intervention Vehicle) with Medical Officers and Fire Marshals have to be authorised to enter the stage BUT ONLY FROM THE START. You do not want cars still competing to meet an FIV or an Ambulance head on. Messages have to be passed on status of rally cars, accident victims and whether the stage is halted or abandoned around stages and back to Rally HQ.



Jaguar E-Type, another classic entry

The Operators

You have to be dedicated to Amateur Radio, WICEN and Community Service to be part of these events, but then some of that is the Amateur Spirit. In Tasmania radio operators and road marshals can camp overnight on the stage. Now southern Tasmania in June is cold at night! The Adelaide Hills at 4.30am can be both cold and shrouded in mist. Yet intrepid Hams do these things just to support a community event. The survey crews spend a lot of their free time checking where stages are to be sited and checking if signals will ever get out of those locations. One Classic Adelaide stage had no room for the Radio Operator's transceivers and aerials and a hand held had to be used to relay the times to the stage's main operating position.

To the best of my knowledge no WICEN support has ever failed to do the job it was set up to support. However,

we have transferred to backup networks and put an extra stage on a network. That says a lot for the dedication and skill of members and professionalism with which they carry out their tasks.

In the Classic Adelaide Rally more than 80 amateurs plus some friends and families are required over 4 days. The rally area stretches about 160km from Victor Harbor to the Barossa Valley.

The Coopers Pale Ale Rally SA has 9 separate stages run on each of the two days, some stages are covered twice in the one day. A local Radio Club runs each stage.

Solar and wind power for remote repeaters is now available to WICEN SA.

Want something different?

If you want to do something a little different and show the Community Service face of Amateur Radio to the community how about volunteering to help with a local event? They occur in all states and cover a variety of events.

ar

New WIA Members

The WIA bids a warm welcome to new members who were entered into the WIA Membership Register during the month of JULY

L31575	J Day
L41069	P M E Frangenheim
L41070	Mr C Deeb
L50371	R G Seaton
VK1PRG	Mr R G Reinholtz
VK2CIM	Mr P Presutti

VK2HOT	Mr B Walker
VK3BAM	R Thorpe
VK3AP	Mr T Kalkandis
VK3AXE	J H Mitchell
VK3BQC	Mr I F Collier
VK3CFF	Mr A F Meyndert
VK3CGB	Mr C G R Brett
VK3GMR	C Baker
VK3JGS	G Sumner
VK3JY	Mr S G Phillips

VK3QC	B Plowman
VK4AAT	T E Stewart
VK4NN	Mr W Purser
VK4TAY	Mr C F McCarty
VK5ADE	Mr S D Cameron
VK5AFZ	Mr R F Hancock
VK5ALS	Mr G G Stewart
VK5KTT	Mr T Taddeo
VK6KAD	Mr D J Muldownie
VK7KPG	Mr P R Godden
VK7ZDJ	Mr D J Spicer

Contests

Central Highlands Amateur Radio Club of Tasmania (CHARCoT)

80m Dash for the Wadda Cup

Overview

CHARCoT is a Tasmanian based amateur radio club that has over 130 members from all parts of the country. A weekly Quiz is held every Thursday evening at 8.00pm local time on 3.585MHz. The club also holds 2 social gatherings each year, held in the Central Highlands of Tasmania.

One particular get together is held near the township of Waddamana, the site of Tasmania's first hydro electric power station. The landscape of the Central Highlands is stunningly different and it is fitting that the contest trophy is named after the area.

CHARCoT fosters on air contact and provides the opportunity for members to meet socially. With this in mind, it was decided that we should hold an annual contest that is fun, friendly and a little different from the norm. Thus, the CHARCoT 80m Dash for the Wadda Cup was born.

One major difference from other sprint type contests is that at the end of the 80m Dash, a score roll call will be held to reveal the provisional winner of the Wadda Cup.

Contest bonus

The contest also offers amateurs the opportunity of accumulating contacts for 2 Tasmanian awards. The CHARCoT Tassie Trout Award is available to any amateur that makes contact with 14 CHARCoT members. Full details, including the current membership list, are available on the club's website www.vk2ce.com/vk7cht

Also, the Tasmanian Division of the WIA has the Tasmanian Devil Award. Contact with 50 VK7 amateurs is the only requirement on HF. More details are available on the VK7 division website www.tased.edu.au/tasonline/vk7wia

Contest aims

- Encourage on air activity in a short, friendly contest.
- Provide amateurs with the opportunity of accumulating contacts for the Tassie Trout Award

and the Tasmanian Devil Award.

- Encourage entry by first time contesters.
- Promote on air activity of VK7 amateurs.

Contest date and time

The contest will be held on Thursday 28 November, 2002. The contest will be 30 minutes duration. The start time is 0900 UTC (8.00pm ESST) until 0930 UTC (8.30pm ESST)

Contest launch

The contest manager for the 2002 80m Dash for the Wadda Cup is Vince Henderson, VK7VH. The contest manager will operate as VK7CHT (CHARCoT club callsign) during the contest. Contact with VK7CHT will earn 2 bonus points. VK7CHT will not be eligible for the Wadda Cup or any contest award certificates.

All contestants are asked to listen on 3.585MHz (+/-), 15 minutes prior to the start of the contest. CHARCoT President Bob Geeves, VK7KZ, will give a short address and officially launch the inaugural 80m Dash for the Wadda Cup.

VK7CHT will give a time check, on this frequency, 2 minutes before the start time.

General rules

1. The contest is open to all VK amateurs.
2. A station may only be worked once during the contest.
3. Sequential numbers, commencing at 001, shall be given and received for all contacts made during the contest. (RS numbers are not required).
4. The contest is phone only, using LSB on the 80m band. Frequencies to be used are from 3.540MHz to 3.625MHz.
5. Maximum power is 100 watts.
6. Single operator entries only. No multi-operator entries are allowed.

Scoring

1. Contact with any VK amateur scores 1 point.
2. Contact with VK7CHT scores 1 contact point plus 2 bonus points = 3 points.

The CONTACT and MOVE rule

1. After a calling station makes a contact, the calling station must move their calling frequency by at least 5kHz.
2. A station answering a calling station may make 1 call on the same frequency and exchange numbers with another station. The calling station must then move their calling frequency by at least 5kHz. Example - VK7VH calls CQ contest on 3.560MHz. VK7KZ answers the call and exchanges numbers with VK7VH. When the contact is completed, VK7VH must move frequency by at least 5kHz. VK7KZ may then call CQ contest on 3.560MHz. VK2CE answers VK7KZ and exchanges numbers. VK7KZ must move at least 5kHz etc etc.
3. VK7CHT is the only exception to this rule.

Logs

1. All participants must keep a separate contest log sheet. Use 4 headings - UTC time, Station worked, Number sent, Number received.
2. Retain your log for checking. You will be advised if your log is required by the contest manager.
3. The contest winner and 2nd place contestants must send their log to -

The Wadda Cup Contest Manager
3/84 Clare Street
Newtown 7008
Tas.

The winner
All contest participants are asked to listen for VK7CHT on 3.585 (+/-) immediately after the conclusion of the

contest. Add up the number of contact that you made, during the contest, and if you worked VK7CHT add 2 bonus points to your final score. Follow the on air role call to find out the provisional winner of the Wadda Cup and other contest award certificate winners.

1. The winner will be the entrant with the highest score.
2. Should there be more than one entrant with the highest score, an on air countback will be conducted by the contest manager. The countback will be based on the number of contacts made during specific time blocks. Although the count back procedure will be decided prior to the contest, details will only be revealed during the countback.
3. The provisional winner and 2nd place contestants will be declared official when logs have been received and checked by the contest manager.
4. The contest manager's decision will be final.

The awards

1. The winner will be awarded the Wadda Cup, suitably engraved, for a period of 12 months. The Wadda Cup will remain with the club secretariat and be on display at all important club functions. The winner will also receive the first place award certificate.
2. All 2nd place contestants will receive an award certificate.

Results

When the contest manager has verified all logs, the results will be published on the CHARCoT website.

Results will also appear in Amateur Radio magazine.

Whether you are a keen contester or someone that has not tried contesting before, we encourage you to have a go at the 80m Dash for the Wadda Cup. You may even pick up enough contacts to apply for the Trout Award or the Tassie Devil Award.

The most important thing is that you have fun during the contest and join in the roll call at the end of the contest. (A glass of port may be in order !!)

Goodluck

Vince Henderson VK7VH, Contest Manager



Trans Tasman Winner

Thomas Lynd, son of Bill Lynd, VK7KHZ, operated under supervision in the Trans Tasman VK contest and won. This just shows that youth and enthusiasm can still get you places in Amateur Radio. Below is Bill's description of how 10 year old Thomas reacted when the Certificate arrived confirming HE HAD WON.

The following is the message sent to Bill Renn VK3JWZ, the contest Manager.

"Hi Bruce

What a surprise !! Young Thomas has been on a high since arriving home tonight and opening his mail. I really did not expect he would win anything, I must admit though he was really determined to operate the full six hours and he made me really sit back and take notice, I guess all those portable DX operations he has accompanied me with have paid off!

He is just so happy with his certificates he intends to take them to school tomorrow.

I will arrange the digital photos later this week. I will get Thomas to send you a thank you mail (after he comes down from the clouds)

Bill - VK7KHZ"

So please take note and encourage young people to participate in Amateur Radio activities as soon as they feel able and want to.

ColwynVK5UE

PLAN AHEAD

SEANET  2002

Convention

1 - 3 November 2002

hosted by
Northern Corridor Radio Group

CONTESTS

Contest Calendar September – November 2002

Sep	7	Digital Modes Contest	(PSK31 etc)	(Jul 02)
Sep	7/8	All Asian DX Contest	(SSB)	
Sep	14/15	Worked All Europe DX Contest	(SSB)	
Sep	21/22	Scandinavian Activity Contest	(CW)	
Sep	28/29	Scandinavian Activity Contest	(SSB)	
Sep	28/29	CQ/RJ WW RTTY Contest	(RTTY)	
Sep	28/29	Anatolian DX Contest	(SSB)	
Oct	5	8 th TARA Rumble		
Oct	5/6	Oceania DX Contest	(SSB)	(Aug 02)
Oct	6	RSGB 21/28 MHz Contest	(SSB)	
Oct	10	Ten-Ten Intl. Day Sprint	(All)	
Oct	12/13	Oceania DX Contest	(CW)	(Aug 02)
Oct	19/20	JARTS WW RTTY Contest	(RTTY)	
Oct	20	Asia-Pacific Sprint	(CW)	
Oct	20	RSGB 21/28 MHz Contest	(CW)	
Oct	26/27	CQ WW DX Contest	(SSB)	
Nov	1-7	HA-QRP Contest		
Nov	3	High Speed Club Contest		
Nov	8-10	JA International DX Contest	(SSB)	
Nov	9	Anatolian PSK31 Contest		
Nov	9/10	WAE RTTY Contest		
Nov	9/10	OK/OM DX Contest	(CW)	
Nov	16/17	LZ DX Contest (CW)		
Nov	16/17	All Austrian 160 Metres DX Contest	(CW)	
Nov	16/17	RSGB 160 Metres DX Contest	(CW)	
Nov	23/24	CQ WW DX Contest	(CW)	
Nov	23/24	CQ SWL Challenge	(CW)	

Greetings to all readers.

This year has not been the most successful for me in keeping up with all the administrative side of contesting in Australia. Some of this was due to moving QTH in April and some to a computer upgrade – which seems to lead to other things along the way.

For those occasional times when the contest web site was not entirely accurate, I apologise most sincerely.

I was interested, however, about July to read of the latest attitudes to contesting adopted by some of the "big" operators overseas, particularly in America. I have noted previously that the average sum spent per annum on improving a "big gun" contest station in USA is over \$5000.

The ideal for these operators is a complete station for all six bands. Ideals are rarely reached, but in this case the ideal of six different transceivers is not necessarily needed, because two rigs can be so easily controlled by one computer. What is necessary, of course, is a complete set of antennas, switchable by computer, as well as by hand.

Feelings are mixed on whether Packet Spotting Nets and DX Nets are useful and/or in the spirit of the contest or not. However, many of these stations would have such facilities.

So far these are only general comments, but in the multi-operator areas there has been a great change of approach. The clever contesters working multi-operator (whether two or multi) now have antennas and receivers that

can listen on the same band whilst the main transceiver is already operating. Why? These stations have gone past the idea of just getting as many contacts as possible, to chasing multipliers. Makes sense, does it not? You will obviously gain more points at the end of the contest by having more multipliers than you will by just having more QSOs than the other operator.

So I hope that you can imagine a team of helpers just tuning bands looking for unworked multipliers and then directing the main operators to those frequencies – or no doubt working it themselves if things are going well for the main ops. Sounds fun? Well, in today's world of networked computer logging, anything is possible!!

I wonder how far behind ideas like

this are we in Australia and New Zealand? I know that we have some very capable contesters who have done well on the world stage, but are they approaching their contests like this?

Are many of you reading this even at the stage of thinking about trying the bigger WW events? I certainly hope that you are and that you will be heard in the Oceania DX Contests in October – only a few weeks away from the time you receive this magazine.

When you see ideas such as those above and then listen to our local contests, you would have to agree that we VK operators are a long way back in the field of operations. I know that the popular contest in VK has always been the RD every August, but at the same time this often gets advertised (NOT by me, I may add) as the “friendly contest”.

I have long felt that this immediately undermines the concept of contesting, to gain as many points as possible, and substitutes the notion that it is an annual get-together – with “giving a few numbers” thrown in!

Contests can be a genuine challenge and not negative things that need get in the way of our comfortable routines. Some of the ideas presented this month are very serious indeed on the parts of those stations who implement them. Let’s hope that we too can learn something from them and strive to improve our station and operating techniques.

I’ll be listening for you in the RD. Good luck!

73, Ian Godsil VK3PV

Remembrance Day Talk 2002

by Mr. Horrie Young VK2AMZ

Former crewman on HMAS Krait and long-serving Radio Inspector.

The Remembrance Day Contest must rank among the most important contests in the Amateur calendar, for not only is it an important measure of amateur communication skills, but it also serves to remind us of our good fortune in being able to pursue the hobby of Amateur Radio with reasonable independence and freedom, unlike the populations of some of the other countries of the world.

But we should not take this freedom for granted, because it was bought at a great price in human suffering – much of it being experienced by our own armed services, particularly by those who served during World War II; although subsequent conflicts have also suffered casualties.

It is a matter of record that a significant number of amateur operators in this country were well to the fore in volunteering their services at the commencement of hostilities, and it is equally true that many served in combat with considerable distinction. (See story elsewhere)

Amateurs were represented in all theatres of warfare on land, sea and in the air, and who could forget the almost unbelievable part played by the Coastwatchers of M Force, along with the amazing work carried out by the so-called “stay behind parties” of the Secret Wireless Service attached to Z Special Unit and Services Reconnaissance Department.

These men operated continuously deep inside enemy-occupied territory transmitting intelligence information of incalculable strategic value back to their parent bases in Australia. It goes without saying that there was a good sprinkling

of Amateur Operators among their ranks.

Unfortunately, a number of them were captured and suffered badly at the hands of their captors in prison of war camps. However, it is with some satisfaction and admiration that we note their typical ingenuity in overcoming adversity by putting together makeshift secret receivers, and in some instances transmitting equipment, in order to gain some idea of what was happening in the world outside their barbed wire enclosures.

Regrettably a number paid the supreme sacrifice. So it is on this day that we are afforded the opportunity to remember the part they played in enabling Amateurs in this country to continue the way of life so cherished by all, free from fear of any who might seek to harm us.

With the number of qualified amateur operators approaching the 17,000 mark and growing, it is a wise Government indeed that continues to make this service available, while Amateurs in return are able to respond by making available to the Nation a significant pool of skilled communicators, ready and well-trained to help out in any emergencies that might arise, be it floods, bushfires or whatever.

I know you will all be anxious to get on with the business at hand, so I will simply conclude by quoting a few of the words immortalized by Banyon in his poem “Ode to the Fallen” — ‘At the going down of the sun and in the morning, we will remember them’.

Happy hunting.

May you have a rewarding contest!

Results

CQ WW RTTY DX Contest

2001

(VKs only:

Call	cat	score
VK6GOM	SOAB High Pwr	632,388
VK4WPX	SOAB High Pwr	301,718
VK4DZ	SOAB Low Pwr	327,807
VK2DPD	SOAB Low Pwr	311,952
VK5GN	SOAB Low Pwr	232,680
VK2KM	SO 15M	116,480

Results

IOTA 2002

(VKs only -

Call	score	section
VK2CZ	72,540	Multi-op.
VK4TT	14,985	12-hours CW
VK8NU	85,500	12-hours SSB
VK3MMY	30,360	" "
VK1JD	29,484	" "

HMAS Krait, then Kofuku Maru, was liberated from Singapore before the fall, spent some time rescuing people along the east Coast of Sumatra. She found her way to Australia from India and was famously used to carry Z Special Force on a highly successful clandestine raid on Japanese vessels in Singapore harbour. Currently MV Krait is part of the Australian War Memorial's Collection.



How I got my Licence. - 25 years to VK—me

VK3PPP Adam Trumble

We've all read about people who take years to get their driving licence. Now you can read about one who took 25 years to get an amateur licence! Although, to be fair, I didn't sit any exam more than once.

I got interested in radio shortly after I left school and we moved house in the mid-seventies. A friend in my new neighbourhood introduced me to CB. In those days, there were 23 27MHz channels and they were all illegal!

It wasn't long, though, until the regulator of the day legalised CB (and introduced individual licencing). 27MHz was to be a temporary CB band, pending a new UHF band.

By the time the UHF was available, there were so many 27MHz sets around, they couldn't be phased out, so Australian CBers now have 80 available channels, 40 HF and 40 UHF.

In the late seventies. I met a friend of my father's who had a shack out the back. Here was a full amateur. My interest was piqued and I signed up for the WIA full amateur licence course, which involved theory classes in Brunswick and Morse Code cassette tapes. I bought a Yaesu FRG 7 HF receiver and had antennas bristling all over the house.

But not long after I caught the flying bug and gave my radio studies away. The Yaesu was sold and even the CBs fell by the wayside more than 10 years ago.

A few months ago, a US amateur friend regenerated my interest in amateur radio, so I searched the Web and found the Radio and Electronics School and Ron Bertrand (VK2DQ).

This time I set my sights a little lower, aiming for the Novice Limited licence.

Emails were exchanged and I was soon the recipient of a couple of CD ROMs.

Ron's four week Novice Cram Course material allows you to learn what you need to know to pass the Regulations and Novice Theory exams in a short time, with the ability to ask questions of a facilitator, by email.

This suited me and I was ready to sit my exams in less than the four weeks. These were sat at the local radio club, and the pass results duly arrived in the post, followed by the Certificate of Proficiency and licence - VK3HAT.

Now I had the licence, but no radio; a situation soon rectified.

My choice of what sort of equipment to buy was limited to the 2 metre and 70 cm bands. With a very uninterested wife, the prospect of creating a shack at home, or putting antennas anywhere visible, were limited.

Anyway, I wanted some flexibility, so I decided on a dual-band handheld unit.

I was surprised at the small size of the radios on the market. My new purchase was about the size of a mobile 'phone.

Travelling regularly, my first contact was standing outside my hotel in North Ryde (Northern Sydney) and darting inside periodically to avoid the passing rain showers.

After some reading about IRLP, my second contact was conducted on an in-Rollerblade expedition by the banks of Melbourne's Yarra River, via the VK3RMH repeater. I first spoke to a local amateur, and then connected to IRLP node 461 in Massachusetts and contacted my friend.

This IRLP thing was all new to me, and is a fantastic facility for those restricted to the higher frequencies.

I learned that even with the "big" battery, the little "rubber-ducky" antenna that came with the radio was a limiting feature and I could not activate the IRLP node from home.

A couple of additional purchases saw me with a better (but still less than optimal) antenna and a cable able to connect my handheld to my 20+ year old 13.8V power supply, thus boosting my output somewhat.

I can now reliably connect to the IRLP node if I stand on the sofa by one window in the bedroom at home!

When not on family duties, my preferred method of transport is a BMW motorcycle. This meant the next challenge was operating motorcycle mobile! Without spending a heap of money, this is not easy. No one seems to make anything to assist in this regard.

A motorcycle is a noisy thing and riders must wear a helmet, so forget the handheld speaker.

Finding a helmet with built-in microphone and speaker seems an impossibility (anyway, helmets are expensive). Mucking around with an existing helmet is also a risky proposition, jeopardising the Australian Standards certification.

Fortunately, the handheld manufacturer produces a portable VOX hands free (a bit like a mobile 'phone one), so I was soon equipped with one of those. Now, how to mount and operate the thing? It turned out that part was easy, just so long as I don't want to adjust anything once I'm underway!

I bought a small camera case and cut a hole in the top for the rubber-ducky antenna. Turn the unit on, put it in the case, put the case on the handlebars using the belt strap, connect the PTT/VOX switch to a conveniently placed wire near the left handgrip, plug in the ear piece, put on the helmet, velcro in the mike and I'm away. I decided not to bother with the VOX - the ambient noise would probably activate the mike even with the sensitivity turned down.

My first effort, on the way to work, was a qualified success. At highway speeds, I couldn't hear, but now I know to turn it up.

I have also worked mobile pushbike - that worked too, but my average speed falls away the more I talk!

I have concluded that the small antennas are a bit limited, so my next project is mounting a more substantial one on the motorbike.

Meanwhile, after gaining my Novice Limited licence, I decided to brush up my Morse. I had brushed up once before - 20 years ago to get an endorsement on my Pilot's licence - the test then was 10-

WMP receiving groups of 2 and 3 letters, repeated twice. It wasn't hard.

Unfortunately I had thrown out the old tapes, but the Internet came to the rescue. I found a free application and brushed up to 5-WPM standard - I still had my old key. Now I'm VK3PPP!

73 Adam Trumble

I can now reliably connect to the IRLP node if I stand on the sofa by one window in the bedroom at home!

I have also worked mobile pushbike - that worked too, but my average speed falls away the more I talk!

Travels with 'mike'

Free Passages To Tasmania

Don't get too excited, it doesn't refer to you personally. Free transportation ceased about 1850 ! I am referring to free travel for your car, campervan or motor home. So bring your radio gear rather than your ball and chain. Though on the other hand...

With the introduction of our two new superfast daily ferries from September 1st, your mode of transport arrives free of charge. And you previously deprived people on the northern island can now indulge yourselves with your visit to "heaven itself" - Tasmania of course. And bring your required radio rigs.

Practically all of Tasmania is covered by VHF and UHF repeaters with (fingers crossed) amateurs answering your calls. Here's a list - starting with 2metres.

N'-west & west coast

VK7RMD. 146.625 Mount Duncan (behind Ulverstone) covering the complete coast to Marawah and through to the Tamar Valley.

VK7RNW 146.750 Lonah (on a coastal headland near Ulverstone) mostly similar coverage, hits some blank RMD spots. Both are accessible well out to sea with handhelds.

VK7RWC. 147.075, Mount Read, (near Rosebery), positive offset, covers most of the rugged west coast area. Permanently linked to VK7RMD, 70cm. **WARNING** - hams in this area are a bit thin on the ground !

I.R.L.P. available alternate days on VK7RMD and VK7RNW.

North Tasmania (centred on Launceston)

VK7RAA. 147.000 Mount Barrow (East of Launceston) covers all of the central north and well down into the midlands.

VK7RNE. 146.725, Tower Hill (behind Ben Lomond) covers the North-East and upper East coast. Linked to 70cm. **VK7RAB** on Mt. Arthur.

VK7REC 146.900 Snow Hill (South of Fingal) covers the lower East Coast and central midlands.

Southern Tasmania (centred on Hobart)

VK7RHT 146.700, Guy Fawkes Hill (near Hobart airport) Good coverage of southern midlands, Derwent valley, Hobart area, but very patchy southwards down the Channel area.

VK7RAF, 146.650. Mt. Faulkner, (above Claremont) similar coverage to RHT, linked to northern 70cm. **VK7RAB** by CTCSS tone.

VK7RBW, 147.875. offset 1.8megs, 146.075, carries the Hobart I.R.L.P.node.

70 cm. Repeaters

North west coast

VK7RMD. 438.600 Mt. Duncan, linked to RWC, 2 metres.

VK7RAC, 438.650, Table Cape (near Wynyard)

Northern (Launceston area)

VK7RAB, 438.550 Mt. Arthur covers most of northern Tasmania

VK7RBH, 438.675 Launceston, covering the Tamar valley.

Central Highlands

VK7RIN, 438.500 Barren Tier, (just south of Great Lake) covering the central Highlands.

Southern Hobart Area

VK7RTC, 438.600 Mt Nelson (behind Sandy Bay), good coverage of Hobart area.

So there you have it - plenty of hams around Tassy to welcome you. Just drive to Port Melbourne with your rigs, get on the ships and enjoy yourselves around this great island State.

WARNING - 14 days absolute minimum - there's so much to enjoy. See you soon. Ron, VK7RN.

Amateur Radio Station Records

James McLachlan VK5NB 7 Austral Tce Morphettville 5043
email jimac@picknowl.com.au

If you had to provide a list of your Amateur radio transceivers and equipment for insurance, or for the person assisting your family dispose of it, how would the details be ascertained i.e. the serial numbers?

Following years of working experience with equipment registers, recently I have been assisting with deceased estates. Most amateurs keep no records for their station. Once we found the receipt, box and manual but no set.

Are your station records correct?

To best record station equipment:

1 Set up a station assets register.

This can be a note book with columns noting equipment, serial number, purchase and value (for insurance) etc.

2 Computer formatted record

Have the detail recorded as above. Put it on a disc to be kept else where.

3 Create a document folder

Keep relevant documents and a note for each piece of equipment here.

4 Insurance

Keep a photo of the shack showing all the station. Perhaps also photos of each of the radios etc, with a description on the reverse. This assist, in checking of the records for a non-amateur.

5 Remote records

In-shack records are no insurance use if there is a fire. Copies at a different location will make your claim easier.

If you have your own system and have your station records protected, well done, you are one of a few.

Deceased estates;

A current record will make it easier for the next of kin to manage things and see your equipment passed on to another ham who will appreciate it.

None of us want to discuss death, but to help your family, record the contact numbers for those you wish to handle the disposition of your beloved station.

The WIA SA Division provide a free service to assist past members families remove and dispose of the station and equipment.

If you require further information you can contact us on email or by phone. ar

Technical abstracts

Rigid Stayed Mast

This space saver could get you out of a tight spot.

In the Technical Topics column of Pat Hawker G3VA in Rad Com May 2002 an interesting antenna support mast appeared. The mast was the work of Ian Waters G3KKD. The mast was designed to be used right on your property boundary and uses rigid stays instead of guy wires. This could be useful for smaller size properties which are common today when a HF antenna must be accommodated.

The mast is shown in Fig 1. Tubes are used instead of guy wires to support a mast located on the property boundary. They are placed at right angles to each other and also oriented to share the load from the HF antenna on the mast. The tubes are joined to the mast by straps made of 14 to 16 gauge galvanised steel. Suitable galvanised steel strap may be found amongst the builders supplies in hardware shops. The stays are attached to anchor stakes driven into the ground.

This mast could also be useful to raise the ends of HF antennas which may have been attached to the fence in the past in order to meet the requirements of the new EMR rules. It should be fairly easy to raise the end of an antenna high enough to comply.

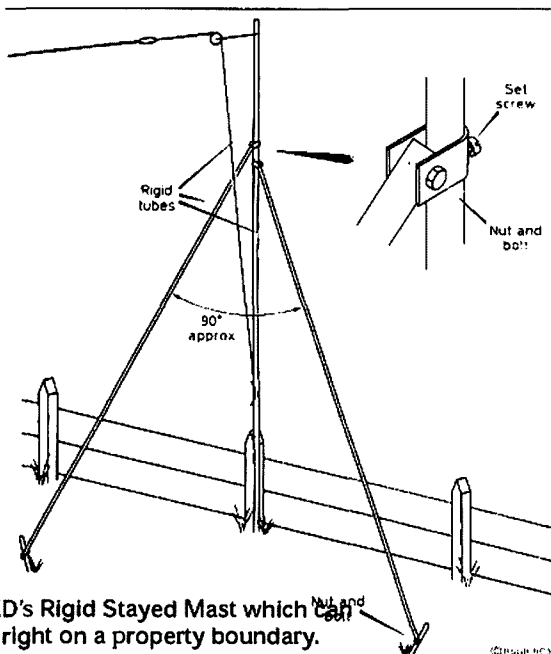

Fig 1. G3KKD's Rigid Stayed Mast which can be erected right on a property boundary.

Stealthy Delta

Keeping a low profile can pay off for urban amateurs

In May 2002 QST Steve Ford WB8IMY described his low visual profile Delta Loop which is threaded through a tree. The antenna is tuned at the feedpoint by a remote automatic tuning unit. This minimises losses due to high SWR on a coax cable run to the operating position. Buried coax is a lot harder to see than an open wire feeder but a high SWR could give high losses.

The antenna is tuned by an SGC-237 tuner at the feedpoint. This tuner senses RF and tunes automatically. It is mounted at the feedpoint which is in the bottom wire of a triangular loop made out of 80 feet of wire. (approx 24.5 metres) The wire is threaded through a tree to minimise visual impact with the bottom wire several feet off the ground. The feedline and the power lead to the tuner are run underground to the tuner from the operating position in the house.

The antenna is shown in Fig 3. The exact dimensions are not particularly critical as the tuner will compensate. Some trimming may give improved matching by making matching easier on some bands. The exact shape of the loop will be modified by the supports available. The bottom of the loop and the location of the tuner should be high enough to allow access under the loop. The EMR rules may influence this.

If you are trying to figure out how to connect to the tuner then the author WB8IMY simply connected one end of the loop to the tuner case/earth stud and the other end to the insulated terminal. Should you be troubled by RF on the cables to the tuner a choke made by colling the

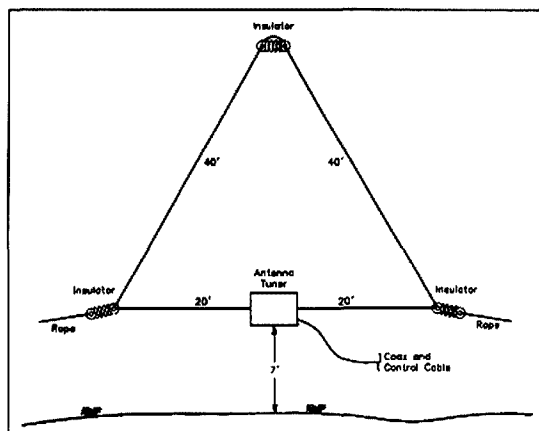

Fig 3. Stealthy Delta Antenna.

cables or running them through some ferrite rings should do the trick.

While Steve WB8IMY used an SGC-237 tuner other brands of tuner could be used. The main requirement is a reasonably wide matching range and a housing which can be mounted out in the weather. Steve WB8IMY was able to obtain a match from 80 to 6 metres.

Correction

A correction to the July Article on "Microwave wattmeters"

Page 18 Centre column first line should have been "20 microwatt (-46dbm)" not "20 mW (milliwatt as printed)"

NCRG HAMFEST

SUNDAY 3 November 2002, 9am - 1pm

Cyril Jackson Centre in Bassendean, WA

Grounded Tower Elevated Feed

Also featured in the Technical Topics column of Pat Hawker G3VA in Rad Com May 2002 was a grounded tower fed with an elevated feed. This came originally from Thomas Russell N4KG in QST June 1994.

The antenna is a top loaded reverse fed elevated ground plane with the tower earthed and top loaded by a TH7 Yagi. The setup is shown in Fig 2. The system resonated at 3.6 MHz with the dimensions shown and had a 17 ohm feed impedance. The matching section shown enabled feed with 75 ohm cable. The cable outer is connected to the mast at the feed point and the cable inner is connected to the elevated radials. The tower is earthed at the base.

The original article by N4KG was noted by Dr John Belrose VE2CV in a paper at an ICAP conference in April 1997 and also in Technical Topics Rad Com April 1998 and Technical Topics Scrapbook 1995-1999.

The antenna also shows how to use scrap cable TV cable as a cheap low loss feedline.

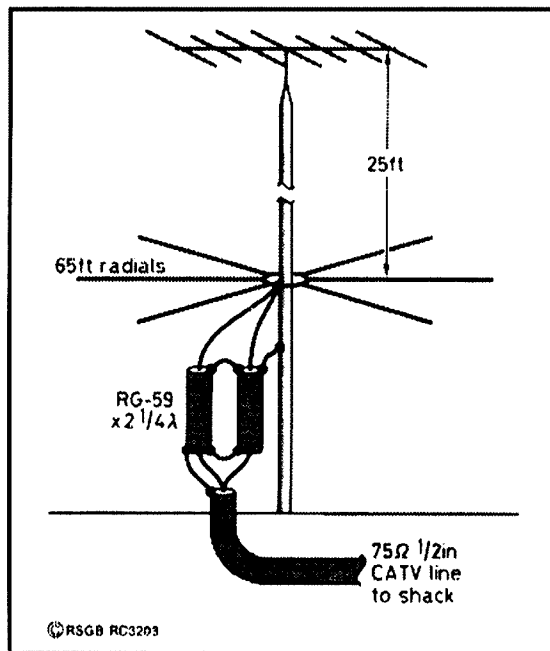

Fig 2. 3.6 MHz Top Loaded Reverse Fed Ground Plane Antenna. The tower is resonated on 80 meters and is top loaded by a TH7 Yagi.

War Birds

Over the weekend of 3-4 August HAMS from the far north of Queensland gathered at Mareeba airport to put on a display of World War Two command radio equipment. These SCR 274N were used in B24 and other aircraft. Contact was made with VK4RAN in ex HMAS DIAMINTINA in Brisbane by CW on 40 metres.

Hams present were Nick Watling VK4YT, Chris Gill, Keith Searle and XYL Barbara, Aub McKibben VK4AFO, Ron Petrich VK4ACZ, Mike Patterson VK4MIK, Ron Goodhew VK4EMF, Wayne Richter VK4ARM, Dennis Bauer VK4JDJ, Alan Whiting VK4HBN, Bill Lochridge VK4WL, VK4BJM J. McKenna

and Ian Mullins. Other Hams were a VK3, VK7 and a visitor from Gibraltar.

The War Birds club members took amateurs for a fly in Winjeel, Nanchang and Harvard aircraft. These flights in these older military aircraft were both enjoyable and informative. A barbecue was held at the end of the day and DX

and DX Broadcast tracking continued into the night.

It is envisioned that the radio display will become a regular feature at this bi-annual event. Hopefully it will become another regular get together for the HAMS.

73s de VK4MIK

Cable and Connectors

Belden

- RG58C/U Beiden 8259 @ \$0.90 per metre
- RG213/U Beiden 8267 @ \$4.45 per metre
- RG8/U Beiden 9913 Low Loss @ \$5.15 per metre
- RG8/U Beiden 9913F7 High Flex Low Loss @ \$5.55 per metre
- RG8/U - RF400 Beiden 7810 Low Loss Sweep Tested to 6000MHz @ \$6.30 per metre

LINK

- RG58: B80-006 UHF connector (M) @ \$7.65 each
- RG8/213: B80-001 UHF connector (M) @ \$8.80 each
- RG213: B30-001 N connector (M) @ \$9.10 each
- RG8: B30-041 N connector(M) @ \$14.00 each

connektron Pty Ltd

ABN 19 413 484 007

email sales@connektron.com.au or Phone (03) 9761-5220
connektron Pty Ltd, 45 - 49 Merrindale Drive, Croydon South, Victoria 3036

www.eonnektron.com.au

- * All prices include GST
- * Minimum order value \$50 payable by Visa, Mastercard, Bankcard or Money Order
- * Packing and Delivery \$15 within Australia (Outside Australia P.O.A.)

Writing for Amateur Radio

Most amateurs can talk under wet cement when in their shack. But these very same people get an attack of the "I couldn't do that" syndrome when they are asked to write an article for the mag.

Of course you can write!

Writing on a subject you know, for an audience that is interested, is really easy. It is just like constructing a radio project, as any written piece is made up of bits that are put together on a paper 'plug-in board' to make a whole that works.. Let's consider the two types of writing, technical and general interest.

General Interest or Feature Articles

You have at least one feature story in you. The general interest writing formula is just a case of arranging facts, quotes, points of view and anecdotes in such an order to enthrall the reader.

Start

Use an anecdote to grab the reader.

Theme

State your theme. One paragraph.

Facts

Use some facts or quotes to explain your theme.

Anecdotes

Use another couple of light, bright examples to lift interest.

Facts

A few more facts and quotes.

Another anecdote

This maintains interest.

Pictures are great

Conclusion

Sum up the point or finish with the moral of the story.

Subject matter for AR

Anything at all that happens to an amateur operator, any interesting people you meet on the air or in the flesh in a radio context is all the basis for a story.

Do you have a point of view about amateur radio? Terrific. 'Air it and wear it', as strongly held opinions make for great reading.

Especially remember the golden

rule: interesting subject matter makes interesting articles — *ordinary people doing extraordinary things or extraordinary people doing ordinary things.*

Interesting DX locations make good copy and provide a great pictures.

Local events that are significant for radio amateurs are also of great general interest, especially if the lessons or relevance can be applied nationally.

Tips to make features fly

- Use your own voice and use the words that you use in conversation. (*Note that sentence. Only one word in the 13 has more than one syllable. Very easy reading, very easy writing*)
- Write directly and in the first person. *I talked to Bob* is infinitely better than *a conversation ensued between Bob and myself*
- Write big and edit yourself hard. Having too much material initially is great. It means that you can prune it back to a tight piece.
- Include a picture. Get a picture into the story, the editor will love you, the sub-editor (who makes it all fit), will love you and many more people will read it.
- Stick to your theme. Don't tack on a stray idea. Write another article.

Photographs

Good photos get your article published.

Technical stuff

Standard colour prints from the one hour shop are quite satisfactory.

Digital cameras are great but please use pixel resolution of 300dpi or greater. (*72 dpi is absolutely useless for print.*)

Project photography

Drape a light bed-sheet over a chair, sit the project on it and shoot against the draped back.

Use natural light or fixed lighting and slower exposure to avoid hard shadow. If you must flash, angle a white board out of shot so it reflects to kill the shadow.

If you have a SLR, point the flash at various angles and take a shot at each angle, then open up the aperture and select a slow speed and shoot sans flash.

Make the shots tell the story in sequence. Label each photo clearly, either by attaching a note with sticky tape to the back or, for preference, writing on the back or front **BUT ONLY AT THE VERY EDGE OF THE IMAGE.**

Photograph the completed project.

People photography

If you are shooting people, get them close together against a light background and away from the wall, this avoids the 'big head' effect.

People doing things are better than 'shake and smile' or 'footy team' shots. Awards are better shot with people kissing the certificate or holding it near their ear with a grin rather than "the president presenting..." shot.

Cover Photographs

Any radio related aspect is good, any colour photograph is good, but all are much better with both people and rigs in them. If you want a compendium shot, let us put it together for you.

Cover photographs must tell a story.

Cameras do lie

We can manipulate photographs so any photo *that is in focus* is a good one. Old scratched photos can be made like near new.

Pack them with a protective stiff cardboard and include a copyright release in the form. "I... of..., hold the copyright of this photograph(s) and grant *Amateur Radio* initial and residual rights to reproduce it in the course of their publishing activities."

Writing Technical articles

(Sourced and updated from Bill Roper's 1992 AR article)

Amateurs love simple equipment construction and design articles Most will not build the project but will enjoy following the steps in their mind.

But someone somewhere will build the project so it must be technically correct or the mail will pour in, or even worse, damage or injury may result.

Reports of experimental procedures or equipment are always popular but remember that you are writing for a great range of skills. Gear your article at entry level rather than advanced, you are talking to amateurs, not engineers.

The Plan

Outline what you want to say, and what you want to get across. For construction articles follow this format.

Introduction

" We are going to build a better mousetrap "

Object

" This will remove mice more efficiently "

Theory

" Irradiation kills mice "

Construction

" First take a small nuclear device.. "

Alignment, test and adjust

" Now it is assembled, focus the laser beam on the mouse's..... "

Summary

" Having built this much better mousetrap..... "

Tech Rules — OK

The general rules for interesting writing also apply to technical articles.

- Use positive or direct sentences and talk in the first person .
- Start a new paragraph with each new thought. (Any paragraph of more than sixty words is almost certainly too long.)
- diagrams and photographs are good.
- Avoid unusual abbreviations.

Specifically in tech articles

- Use subheads. Capitals and lower case, never all caps
- Spell Check the work. Especially ensure that proper names and technical terms are correct.
- Minimise the maths, They are not

usually necessary in AR construction articles. Our readers prefer practical projects designed and ready to build. Graphs are next best, maths are last.

- Show only the mathematical steps that introduce new logic.
- Acknowledge other people's work.

Abbreviations, symbols.

Follow the AGPS *STYLE GUIDE* generally and *ARRL Handbook* for tech material.

The common abbreviations are written: Hz, kHz, MHz, GHz, mF, pF, H, mH, W, mW, kW, MW, V, mV, kV, MV, A, mA, m, mm, cm, km, B, dB. Do not use full stops or pluralise these.

Separate these abbreviations from the number, ie 10 MHz not 10MHz.

Acronyms are generally capitalised, use AM, FM, CW, SSB, RTTY, ATV, RF, IF, RMS, VFO, AGC, but use ac and dc. The text flow should be informal, but keep away from *hammy* abbreviations such as xtal, XYL xmtr etc.

Find out how your computer does Greek symbols and use them. But always provide a hard copy print out of your text, in case the printer's computer has Ω where you have μ (On Macs the Keycaps under APPLE in the menu bar finds the way, on PCs in Word Insert>Symbol is the way)

Diagrams Illustrations and Schematics

Supply the drawings on separate papers/files and note them in your text. Do not paste them electronically into the text.

We can clean up drawings if needed. But make sure that your sketches are correct, complete, neat, clean and readable. Faxes usually will not do.

Put parts values on the schematic and include a separate parts list. Use terms R1 and C2 etc. Label the drawings numerically; Fig 1, Fig 2, etc.

At the end of your article list the figures with a caption by each one.

Put the article title, your call sign and /or your name on every piece of paper.

If in doubt, call Newsletters Unlimited before you start. (03) 9756 7797

PC Board

If your project involves a PC board, send a positive of the board. Separately sketch out the component layout. If the positive is not the same size as the board, tell us.

Submitting articles

Manuscript Submission

- Include a covering note itemising what you have included in the submission such as copy, schematics, photos, captions.
- Provide a brief biography, readers like to know a little about the writer, With 1000 word articles and up, supply a headshot if you wish.
- Identify fully every separate sheet.
- Number and callsign the pages.
- Electronic submission is 1000% better than laser, which is 500% better than ink jet, which is better than ribbon print, which is better than hand block capitals, all of which are far better than longhand.

Electronic submission.

An absolute:

Paste your callsign into every file title as the last thing you do before despatch..

We prefer Word files but.rtf and ASCII.txt files are also acceptable. If you cannot save in one of these formats, save in your format but note the format type on the disc and on the manuscript cover.

If you have electronically generated diagrams, please provide these saved at 300 dpi as tiffs, jpeg or EPS.

Attachments to email are most highly preferred, CD, 3 inch discs, are all very acceptable means of transport.

Absolutely critical:

Supply a hard copy, printed exactly from the discs or files you supply us.

What will happen

The editors will arrange publication of your article at the earliest possible opportunity. This may be a little time, as we may wish to include it as a special feature, or 'balance' a particular issue.

Ask early

If you have any doubts about processes, call either the editor Colwyn, or John or Gill at Newsletters Unlimited before you start. It saves you and us a lot of time.

Please submit all material to

The Editor, Amateur Radio
34 Hawker Crescent
Elizabeth East
South Australia 5112
email armag@chariot.net.au.
Tel or fax: (08) 8255 2138

ar

Division News

VK2 Notes

by Pat Leeper VK2JPA

The NSW Division recently held a Trash and Treasure at Wigram Street, which was well attended and quite successful. The weather was kind and ensured a good roll-up on the day.



1. John VK2WRT helps potential buyers with their choices.



2. Some of the amateurs attending



3. Aub, VK2AXT, Divisional Librarian, sells magazines to Max VK2AFE

The success reflected the effort that John VK2WRT, the Divisional Trash & Treasure Officer, and others had put into the project.

Home brew

After the Trash & Treasure, there was a Home Brew meeting upstairs where Mark VK2XOF and Stephen VK2TQ gave talks to about twenty interested amateurs.

Stephen has forty years experience as an engineer in various metal processes and gave a very interesting talk on metal-working that can be done with a home workshop.

Assisted by Peter VK2EMU, he showed various examples of methods of making all the aspects of boxes for home brew gear.



4. Stephen VK2TQ checks his notes while delivering his talk on metalworking.

It is good to see that home brewing is still thriving. These meetings are held every two months after the Trash & Treasure, which is on the last Sunday of the odd months during the year.

Sixteen Candidates

At the August examinations held at Wigram Street, there were sixteen students sitting for the various subjects. Who said amateur radio is a dying hobby!

Examination dates

The examination dates for the rest of the year (excluding September) will be the 20th of October and 1st of December. Applications are due on the Thursday 10 days before the exam date.

That's all for this month → see you next time.

VK7 Notes

What with ATV, meteor scatter contacts, good exam results, Subaru Safari with WICEN, things are starting to happen around Tasmania.

Scattering everywhere

Rex Moncur, VK7MO, is really into this moonbounce, meteor scatter and other sub-audible communication techniques, travelling all over the country, testing here, testing there, having a great time and leaving some of us Plebs staggering!! He's been guest speaking around our branches.

Exam results

VK7RO, Richard was quite chuffed this week when all three of his pupils sat for their respective ham exams and all passed. Congratulations to the pupils (hopefully three new calls on air?) and to Richard, their teacher.

ATV

ATV is being rejuvenated in the South with the weekly broadcast from the Domain centre televised.

Our "Spectrum" Monday night magazine programme has been televised for some months now on the North-west coast. Our 670 node IRLP from VK7AX in Ulverstone is now using ADSL broadband – it has improved its use greatly. We are getting a lot of contacts to the extent that we are having problem finding hams here with enough time to answer them all.

VE6MOM, Fred, in Calgary has now got his "Tassy Devil" award, he is now pushing for the top award of 100 Tasmanian stations with the help of our IRLP nodes.

Subaru safari

The Southern WICEN group, with Gavin O'Shea, VK7HGO at the helm had a very successful Comms exercise on the 10th and 11th of August when 17 amateurs and 21 helpers did the communications for the Subaru Safari rally through the Styx valley forestry roads south of Hobart. One portable WICEN repeater and a commercial High band rig on top of Mt. Lloyd enabled some very difficult terrain to be covered. Starts at 5am were the norm, only two amateurs got lost in the maze of forestry roads but there was really no excuse for one of these who had his GPS with him !!

Altogether a very commendable performance for our Southern hams.

Cheers for now,

Ron, VK7RN

VK1 Notes

Forward Bias

Peter Kloppenburg VK1CPK

Refrigeration is not a subject that you would expect to hear about at a meeting of Radio Amateurs, although every one of us enjoys the benefit of having a fridge in the home. Because of their reliability, we never bother much about their principles of operation. However, because most of us are curious about scientific processes, the committee accepted an offer from Robert D. Dew (VK1DE) to talk to us about fridges and explain exactly how they work.

So it was on the evening of Tuesday, July 22 that Bob explained how fridges work. He said that refrigeration takes place in a loop of copper tubing to which four devices are connected, each performing an important function. In order of succession, they are compressor; condenser; vent or metering circuit; and evaporator. Bob explained that the refrigerant that runs through the tubing is Freon. The important characteristic of Freon, and of all other refrigerants, is that when compressed

and then suddenly released through a vent, the resulting vapour drops by more than 40 degrees in temperature. This vapour runs through the evaporator that is located in the top section of the fridge. Cooling the air inside the fridge is achieved through convection.

With drawings, Bob explained that the compressor receives the low pressure vapour from the evaporator and adds pressure and heat to it. The Freon then enters the condenser where it loses much of this heat and turns into a liquid again. From there, the Freon passes through the vent under high pressure, and turns into a low temperature vapour again.

Bob was very thorough in explaining the theory of operation, and demonstrated the operation of the components of the loop by showing their insides through cut-away sections. With photos and drawings, he showed us what large refrigeration plants look like. These included industrial size

compressors, cooling towers, and huge circulation fans. Near the end of the evening, we were so well informed about refrigeration that we nearly felt confident enough to apply for a job as refrigeration consultant at Parliament House.

Who is doing what: Gilbert Hughes (VK1GH) and Richard Elliott (VK1KRE) have used an UHF direction finder to locate LIPD devices that interfere with our 70-cm repeaters. Eric Piraner (VK1EP) has donated a vacuum cleaner to the Division for duty at the Farrer Hamshack. Kerry Richens (VK1KRF) has been appointed Farrer Station Coordinator and is busy performing maintenance duties.

The next General Meeting will be held on Monday, September 22, 2002 at the Head Quarters of the Australian Maritime Safety Authority (AMSA), 25 Constitution Avenue, Canberra City, at 20.30 pm. (look for the Ernst & Young building)

VK3 Notes

By Jim Linton VK3PC

WIA Victoria web site: www.wiavic.org.au
email: wiavic@wiavic.org.au

It was a GASS

The Great Australian Science Show 2002 included an impressive display of amateur radio. Due to time constraints in writing these notes for AR magazine, a full report is not possible.

However it was a delight to see the look of amazement on the faces of children wearing headphones and taking part in an IRLP contact with a radio amateur in New York.

The WIA Victoria and its member clubs had a team of volunteers in attendance over three days of the GASS held in the Melbourne Museum.

Apologies for the briefness of this report which results in a lack of the recognition due to the team of about twenty volunteers who rostered over a three day effort – congratulations on your weeks of planning which resulted in an eye-catching display that included a large HF beam suspended from the ceiling.

RD Contest true purpose

In recent times the reason for the WIA's Remembrance Day Contest as a commemorative event may have become misunderstood by some.

Sadly there are those who are still wrongly describing the RD Contest as being in memory of those who died in all wars.

A ham news item headlined "A special tribute for Remembrance Day 2002", said, and we quote: "Remembrance Day pays tribute to those who 'paid the supreme sacrifice' during World War Two. However, like ANZAC Day, now honours ALL Amateurs who died as a result of wars during this the 2002 RD Contest weekend."

This interpretation of the purpose of the contest is incorrect. The WIA created the RD Contest to specifically commemorate the radio amateurs who died as a result of being involved World War 2.

It is held close to 15 August, VJ Day, the date when hostilities ceased in the southwest Pacific area.

Let it forever remain to be a commemorative event for WWII, and not be corrupted as being in memory of those who died in all wars.

Not all amateurs who lost their lives due to WWII were Signallers but a great proportion were. Sigs attached to platoons did it tough, apart from personal gear and weapon they also carried the radio and its spares.



continues over page

VK 3 continues

WIA Exam Service

After a slow start, the number of exam teams in Victoria has grown to 14. This gives a fair geographic spread of exam centres and apart from north-central Victoria most of the state is covered.

WIA Victoria Councillor, Jonas Sadauskas VK3VF is monitoring the situation and may approach clubs and individuals who were previously involved in exams to see if they can fill in any gaps in the examiner network.

A full list of the WIA Exam Service Team Leaders and their contact details can be found in the Resources section of the WIA Victoria website.

Foundation Licence update

Further consideration has been given to the introduction of a new low level entry licence, similar to the British

Foundation Licence. Indications remain that the ACA is unlikely to change Australia's amateur licensing system until early 2004.

Currently there are five licence grades in VK. The expected end to mandatory Morse code testing for amateur licences at the World Radio-communications Conference 2003, will cut this to two – Novice and Unrestricted.

Should the Foundation Licence be introduced post WRC03, then there would be three licences. There are indications that, long term, the ACA would prefer just two types of licences.

The WIA has been discussing the concept of a Foundation Licence with the ACA, and apart from it still not wanting to introduce a new licence before the implementation of changes

out of WRC03, it is prepared to consider a detailed representation from the WIA on the matter.

At a recent WIA Victoria Clubs Forum the issue of the Foundation Licence was discussed, with some club officials reporting people wanting to get on a waiting list for the new licence.

The Forum also agreed that the Foundation Licence examination paper should be a combination theory and regulations test, and that a pass in it be a prerequisite for higher grades of licence.

This would mean that the Foundation Licence exam paper would replace the current Regulations Exam, as we know it today.

Such a change would also meet the ACA's desire to simplify the licensing systems.

VK4 Notes - Qnews

Bundaberg Social Meeting

The social meeting held at the Bundaberg SES HQ on 20th July was a very successful gathering with 25 attending.

The IRLP demonstration created a lot of interest, as did the hands-on playing with some of the more expensive test gear available to commercial technicians.

So successful was the gathering in fact that the Club decided to put aside 41 years of tradition of having the AGM on the fourth Wednesday night of August, and changing it to the last Saturday afternoon of August. One thoughtful 'farmer' Club Member even half filled the tray of his pick-up with avocados and sweet potatoes for members to help themselves.

The older members were amazed by the re-appearance of an amateur whose last QSO was thirty-five years ago and has kept his callsign for all that time and wants to get back on the air.

Special Interest Groups VHF

How many radio amateurs would like to get technical and contribute to the design of a new project?

This is what they'll be doing after a recent meeting of the Brisbane VHF Group. The proposed constructional

project is something interesting and useful - a 2.4 GHz down converter for receiving S-band satellite transmissions. Overall design, selection of available components, and the practicalities of real amateurs actually getting such a down converter going. Both constructing and testing it.

RF construction still ranks high on the agenda of the Brisbane VHF Group! Both VHF Group members and other interested amateurs are welcome to join in this exercise at meetings on Wednesday evenings. That's at the Kelvin Grove High School starting, as usual, around 7:30 pm. Hope to see you there!

Gold Coast Net

Kay VK4HKA is running a women's net, 4.00 pm Gold Coast repeater 146.700. The first net by all accounts was a great success. All are welcome to join in.

Short Wave Listening

Stephen Hogan an SWL from Emmaville, New South Wales, recently qualified for the prestigious Sunshine Coast Amateur Radio Club, Pelican Award.

Stephen uses a YAESU FRG-8800 communications receiver and a long wire antenna. For some years Stephen has found enjoyment listening in to the club's 80 Metre Net conducted each

Compiled by Allstair Eirick VK4MV

Thursday night at 7.00pm on 3.595 MHz. Stephen forwarded comprehensive logs for 6 June and 22 June, 2002 and should soon receive the award. Congratulations Stephen.

Hamfest

Now don't forget the Hamfest of course on November 9, Albert Waterways Hall Broadbeach. Outdoor tables as well as car boot selling with lots of bargains.

Digital Changing Partners

The Queensland Digital group (QDG) has lost all of its HF forward partners and is trying to find Amateurs that want to use RF instead of Internet forwarding.

Of course we COULD give you an email address, but the QDG sensibly NOT wishing to be reliant on the Internet and believing Amateur communications should not be reliant on non-Amateur links has these frequencies for you.

If you would like to participate try these frequencies: 7.030 (USB) or 7033 (LSB) for those who don't want to use USB, 10.144 - 14.101.7 - 18.102.2 all USB.

Any BBS that would like to be a forward partner please attempt to connect to VK4TX-0 (BBS on HF) or the router VK4TX-8 on any of the above nodes. 1200 baud PSK (PSK carrier of 1500 Hz)

73s from Allstair

VK6 Notes

Members active with their QSLing, should be aware that there are a number of countries that have no incoming bureau.

Cards therefore cannot be forwarded to the following :

A5, A6, D2, J5, KH0, KH1, KH4, KH5, KH7K, KH8, KH9, KP1, KP5, P5, S7, T2, T3, T5, T8, TJ, TL, TN, TT, TY, V6, VP2M, XU, XW, XZ, YA, ZD9, 3C0, 3C, 3W, 3X, 5A, 5R, 5T, 5U, 7O, 7Q, 8Q, 9N, 9U, 9X.

Countries that restrict the forwarding of QSL cards to anyone other than members of that country's national society include the following: Egypt, Monaco, France, Morocco, Germany, Poland, Japan, Portugal.

Please when having new QSL cards printed remember the following:

Bureaux are becoming concerned that with automation, there is a necessity for cards to be of a more conforming size. The size, which has been found to be the most favoured, is 70 to 110 mm, by 120 to 160 mm., preferably sized at 110mm by 150mm. The weight to be under 3 grams. Postal charges are still on the increase for overseas mail and the weight of cards is the usual determining factor. So to assist the bureau, please keep your QSL cards as lightweight as possible.

And please, on the back right hand corner of the card, print in large print the callsign of the destination station.

as this helps greatly when sorting the cards into their country of destination at the bureau. If in the callsign there is a U make it look like a U and not a V.

A change has taken place over the last year or two, with the large overseas bureaux now posting with longer intervals between their dispatches, with packages naturally being heavier. It is usual now to receive boxes of cards from W, DL, and JA, weighing in at 1 kg or more. A box of cards from France arrived recently, with the previous delivery being over 12 months ago. It weighed in at 1.9 kg. and on the same day, one from UA at 1.7 kg.

Hopefully in a month or two, a regular VK6 column will appear. Till then 73 VK6NE

Club News

ADELAIDE HILLS ARS

In July AHARS visited to Entech; a local manufacturer of printed circuit boards of such excellent quality that they are exported all round the world.

About 50 club members toured the establishment where each process in the manufacture of high quality printed circuit boards was explained to us. It was interesting to see the mix of high tech and low-tech methods used.

Many members were pleased to see familiar computer programs being used to design the layouts of each layer (up to eight layers can be done). The complex and specialised drilling machines and photoexposure techniques caused a certain amount of comment.

A breath of fresh air came at the very last process, the one that adds the labels for the components etc., as this is done by silk screening using squeegees. That we all understand. It is interesting that no more complicated or more accurate method has been found to replace the simple silk screen to add the letters we look for when we need to understand a circuit or to replace a component (where that is possible).

Another, almost Club activity this month was to welcome to South Australia a visiting family of amateurs from G-land. OM Colin holds several callsigns as he has operated in a number of countries, YL Sally has a full call and daughter Lindsay has one of the new foundation callsigns. Brother David is still working on it but will probably succumb.

John VK5EMI hosted a barbecue at his home for the visitors to which a number of AHARS amateurs were invited, then, on the Wednesday, the group, with John and his XYL Diedre joined Geoff and Christine at their bush shack for a small taste of the life away from the city.

Hopefully if other amateurs are planning to visit anywhere in VK-land they will let some of the locals know so they can be welcomed into our homes.

Gippsland Gate Radio & Electronics Club Notes

Members of the GGREC wish to thank all who helped or participated in this years Hamfest. Girls you were great. It was bigger and better than ever. It is a "must do" for a lot of Amateurs now. We have outgrown our venue and are already revising next year's event. As will be appreciated, a lot of organizing goes into this event and a special thanks has to go to our top man who got out of a flu bed to make sure the day succeeded. Reg Goddard, VK3UK, A VERY BIG THANK YOU.

Our Club has use of the "VI" prefix to mark the 25th year of existence. The Club callsign VI3BJA will be used at Club events and by allocated operators until the end of the year. We will be sending confirmation to those who contact the Club when using this callsign, so if you hear it on any band at any time give it a call to help celebrate our 25th year.

As the year is winding down, we still have a few things on the Club scene to keep the members interested. Saturday the 14th is to be a Pub night at the Highway Club in Noble Park. The September general meeting on the 20th will feature a demonstration of some of the equipment on the market used in conjunction with "Home Automation" which even in its simplest form can make your life a little easier. Come along and see what technology has to offer. The October general meeting will see Phil Pavey VK3YB give a talk and demo on some of the latest digital modes. This takes a lot of keeping up with but our man Phil knows what noises are what.

No introduction is necessary for the annual JOTA/JOTI. Bruno, VK3BFT will be OIC this year. As usual, your support will be requested so come forward to assist. Operators will be recruited at the next meeting. Please help. Even an hour or two makes a difference and spells others.

Please note that if someone you know is sitting an Amateur exam, the last one for the year, to be run by Peter VK3VB will be on the 30th November. The closing date for applications is the 15th November. This will be your last chance to get a callsign (& perhaps a new radio) for Christmas.

CUATNM = See you at the next meeting.

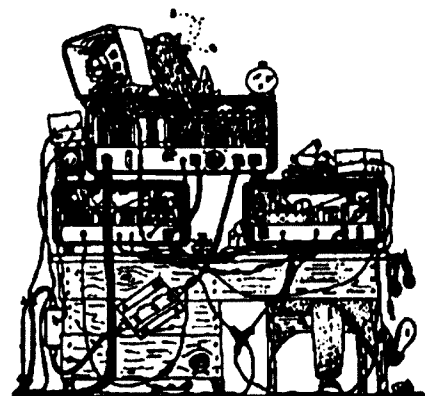

Part 18 – Log Keeping

Radio Amateurs, especially our experienced veterans, have stacks of old differentsized logbooks lurking on bookshelves creating a panoramic history of their owner's operating skills. However, finding an elusive DX station entry amongst the pile becomes very tedious. Once a computer has been installed in your Ham Shack, the first use that comes to mind is an electronic version of your old and new paper logbook(s). Separate logs are needed for alternative call signs, contests, special events, and DXpeditions. If you could do all this on one application with search, merge, export and

import and much more – life would be easier, with extra time to enjoy a wonderful hobby with less paperwork.

UTC	kHz	Mode	Call	Sent	Rcvd	Name	QTH
24-08-2001 08:12:20	14070.000	BPSK	F5ONG	559	599	Yves	Lesan
29-08-2001 06:50:58	14070.000	BPSK	VK2RAS/1	599	599	Dave	Canberra
29-08-2001 06:56:37	14070.000	BPSK	G3KOJ	599	599	Ray	Waterlooville
29-08-2001 07:09:30	14070.000	BPSK	G3KOJ	599	599	Ray	Waterlooville
29-08-2001 07:12:42	14070.000	BPSK	G3ZFZ	559	559	Gordon	Barrow
29-08-2001 07:23:58	14070.000	BPSK	G3ZFZ	559	559	Gordon	Barrow
25-09-2001 07:00:27	14070.000	BPSK	VK2RAS	599	599	David	Sydney
28-09-2001 07:11:08	14070.000	BPSK	VK5AL	599	599	Ken	Adelaide
28-09-2001 07:29:11	14070.000	BPSK	G4TGK	449	559	John	New Romney

In today's world, finding a Ham Radio dealer or Society that even advertises and sells logbooks has become a rarity. There must be a message in here somewhere that suggests there is a better way to manage the activities of your AR operations. What's needed is a simple display on your computer screen giving contact details and the ability to search and manipulate the data similar to the basic image shown here taken from the DigiPan Logbook.

Research...

...via the Internet reveals well over 100 different computerised logbook programs designed for Amateur Radio use. Most have differing characteristics and many are complicated to use and not interchangeable with other users especially contest managers. To survey and evaluate this myriad of programs would take years of work, so we usually decide which program is best based upon recommendations from other users. Visiting a friends shack, or from a demonstration at your local club, and by actually seeing the applications in use then applying the knowledge gained to your own specific requirements is by far the best tactic.

Diversity...

...defines what you want the program to do, and which operating system is used on your computer. For example, there are excellent DOS based programs like HAMCOM that run on old XT/286 computers (VK2VN, QTHR) but they are limited and don't have all the options to control your station equipment AND give you access to all the modern digital modes offered in Windows based programs. It's a difficult decision to which the reader must ultimately decide. The more modern Windows based programs are versatile and have colourful displays, maps, external control for rotators, and many other virtues including specific parameters for

contesting and multiple log keeping. The writer has settled on YPlog (1) because of its simplicity, diversity, and stability on all Windows platforms including Microsoft XP.

Printing QSL labels, duplicate QSO checking, IOTA identities, full station control and regular updates for country lists are all desirable attributes in a modern Log Keeping program. Short Wave Listeners too would find YPlog an asset. For DX hunters, YPlog can also run packet messaging, Telnet, and DX clusters where spots are just "clicked" and automatically entered into the log to save time. Ideal for S+P (search and pounce) operating on the crowded DX bands.

Problems...

...for readers to consider are what do I do about the old logbooks? How long would it take to enter every QSO into the new electronic logbook? The answer is not simple. Decide from what date you are to commence the new electronic log and stick with it because to re-enter thousands of contacts made over many years would take forever. However, for newly licensed operators, this is a dream come true when starting from scratch in a magnificent lifelong hobby.

Backing up your log is a MUST DO job just in case your computer crashes and everything is lost in "cipher-space" forever.

continues over

Options...

...are counted in their hundreds now the whole concept has been "computerised". For example, a YPlog logbook window is shown below. Note the detail given for date, time, country, zones, beam heading, contact number (2771), DX CC reference. At the top of the screen, note the options like File, Award, Beam, Refresh, Update, New, Search, Delete, Freq, Prev, CW, RTTY, and Size.

Yp Log VK6PG Alan Gibbs vk6pg.log IC756

File Award Beam Refresh Update New Search Delete Freq Prev CW RTTY Size Help

Date: 11-Jun-2002 09:05:25 Local 01:05:25 UTC

Start Time: 07:07 Country: Eu - England

Mode: CW Set Time: 01:04 [Standard]

Frequency: 14.056 Zones: ITU 27 CQ 14

Call: GQ3SIG Beam: 313° 14465 km Longpath 133'

His RST: 559

My RST: 569 DXCC Ref:

Name: DAVID 2771

QTH: LIMAVADY

Comment: RSARS F005

Date	Time	Mode	Freq	Call	Name	Qth
22-Jun-2002	09:14	CW	14.058	K4JAI	AL	MIAMI, FL
22-Jun-2002	09:06	CW	14.058	W4EDE	LEE	MIAMI, FL
22-Jun-2002	08:37	CW	14.058	KAOYXX	BILL	DESMOINES, IA
19-Jun-2002	23:40	CW	14.058	G2DZF	JIM	WORTHING
11-Jun-2002	07:07	CW	14.056	GQ3SIG	DAVID	LIMAVADY
10-Jun-2002	12:00	CW	14.058	W4EDE	LEE	MIAMI, FL

Selecting File reveals a drop down menu offering hundreds more options which the reader is invited to explore like the quick view DX CC statistics shown below.

DxccReport.txt - Notepad

File Edit Search Help

DXCC COUNTRY COUNT BY MODE

SSB	CW	RTTY	FM	Total	
20	87	68	1	112	Worked
12	55	31	0	60	Confirmed

Popular Logging Programs...

...include CTlog, TRlog, Shacklog (2) and SDLog (3) written by EI5DI, and many more, all of which have differing parameters and should be explored by intended users who seek specific options that are desirable in their own circumstances. One option taken from YPlog is the opportunity to operate SSB or CW directly from the Logging Program (see AR Magazine last month). These attributes would not only suit contesters

and DX hunters, but operators who have difficulties using a Morse code key or keyer. YPlog sends perfect code every time and is much easier to read in the heavy QRM on the DX bands.

Once programs like these are tried and used on your Ham Shack Computer, life will never quite be the same again.

For readers who prefer to stay with their paper logbooks, then why not use your Ham Shack Computer to print the

pages and compile an expanding logbook in a plastic covered ring binder. The results are terrific. On the other hand, most logbook computer programs have options to automatically print the logbook pages so you can add them to your expanding ring binder. The results look very professional.

Tracking information...

...for duplicate contacts is easy with computerised logging. It saves on duplicated cards and relieves QSL managers from processing unwanted cards. Alternately, programs can track much-needed cards and reminds you accordingly - a nice feature of its own.

Summary

Making the final decision is a personal one that should not be taken lightly. However, once done, your whole AR operating practices will become streamlined - then stick with it. The writer offers YPlog as just one suggestion, but there are many more programs currently available that are equally as good. Many programs use "plug-ins" like HamScope and MMTTY for multi-mode enthusiasts where the data is linked to the electronic logbook as well as sending and receiving on air contacts.

Ham Tip No. 18

Look at the *Ham Shack Computers* Web Site links for YPlog and download AZIMUTH, a program that displays maps of the world in Great Circle or Mercator views. Other information includes grid squares, latitude and longitude values, Maidenhead squares and is ideal for VHF/UHF enthusiasts seeking accurate DX information.

Ham Shack Computers, Part 19 - "Computer QRN" for next month discusses ways to minimise QRN interference heard on your AR receiver. Suggestions will be listed in a quest to quieten your computer so that you can dig out those weak signals without listening to buzzing noises generated by your Ham Shack Computer!

References:

1. *Ham Shack Computers* Web: www2.tpg.com.au/users/vk6pg
2. ShackLog: www.shacklog.com.uk
3. SDlog EI5DI www.ei5di.com

GL ES 73 TU CU DN THE LOG DE
ALAN, VK6PG SK

ar

Happy Birthday to ALARA

The last weekend in July is always celebrated as ALARA's birthday. In 1975 the idea of an organisation to extend the interests of women in amateur radio was conceived by Norma (at that time) VK3AYL, a university student from a family background of amateur radio (her mother Bobby still holds the callsign VK3PXS). The idea was taken up with enthusiasm by other YL amateurs and by XYLs of amateurs generally.

After a couple of meetings in Melbourne LARA was launched to YL amateurs in the other states, with Myrna VK5YW, Heather VK2HD, Linda VK4LL, Anne VK7LY and a VK6WL taking it in turns to conduct a weekly Net.

Currently there are well over 100 YLs in ALARA in Australia and nearly as many sponsored members in countries all round the world, the sponsorship/ friendship idea becoming part of ALARA almost from its inception.

A Birthday Net is held on the last Saturday evening in July and Birthday Luncheons are held in some of the states each year on the Sunday.

This year there was a conflict with the New Zealand 80 metre Sprint, for the first hour of the net, nevertheless there were nine YLs at one time or another during the second hour including two ZLs, Bev ZL10S and Cella ZL1ALK, and five out of the seven states of Australia were represented by the VKs.

VK5 Birthday Luncheon

This was attended by 11 YLs and 6 OMs. One of the guest YLs was a surprise as Marilyn VK3DMS had arranged to come to Adelaide that weekend for a visit and to attend a Woodworking Show with some friends. Marilyn took the opportunity to come the very first birthday lunch she'd ever enjoyed. It is not easy for country people to be in the



city at just the right time.

Mary VK5AMD and Lorraine VK5LM, two of the regular attenders from the country were missing this year but Janet VK5NEI from Wasleys and Meg VK5YG and Jennifer VK5ANW from Murray Bridge were present.

Two of the YLs do not have licences, Sue and Lesley, but ALARA has always had a number of non-amateur members. Shirley VK5JSH was delighted to be able to fit in the luncheon before she went across to VK6 to help her daughter settle two small children into their new home.

We were pleased to have Debbie VK5JT; one of our youngest members present, Jeanne VK5JQ and her OM Keith managed to organise their teenagers so they were able to attend (as they plan to do again for the ALARAMEET).

Jean VK5TSX our State Rep and Christine VK5CTY made up the eleven YLs. Though perhaps the number should really have been 12 because VK5GAL was also there. She sat in the middle of the table. She has been to several of the Birthday luncheon and also went across the Nullarbor to the Perth ALARAMEET even though her maker, Meg was not there for that occasion.

Palermo 2002 YL Meeting

The 6th International YL Meeting was recently held in Palermo, Sicily, with 76 YLs and 33 OMs attending. All present talked non-stop, exchanged greetings, hugs and kisses and small gifts over the 4 days of the Meet and managed to enjoy themselves in spite of the unseasonal heat and humidity. We discovered that Sicily is not FLAT - we were continually climbing steps or steep slopes to see the sights or pop in to that "handy" little café for a cold drink.

A radio station had been set up at the



hotel with the callsign of IQ9YL which created dog-piles in Europe but didn't have much propagation to VK at the proper times.

During the days, bus trips had been arranged when we saw interesting ruins, cathedrals, catacombs, cork trees, old towns, the Marsala winery (where we toasted absent ALARA members) and Cefalu's medieval laundry (wrongly translated in our programme as "medieval lavatory", causing some bemusement when we finally saw it!).

Planned evening activities included a formal Dinner (with speeches, singers/ dancers etc.) and a Folklore Night where we were all supposed to wear national costumes. Bev VK6DE, and I settled for Aussie hats with corks dangling and we each carried a 15" high kangaroo on the end of a 2' spring so she bounced when we walked, causing much hilarity. We declined to sing *Waltzing Matilda*.

I had handed out copies of a sheet of "typical Aussie tucker" and I now have visions of the Japanese population being introduced en masse to lamingtons!

All left the Meet with bags of interesting "goodies" and an invitation from the YLs from South Korea to visit them in Seoul in 2004.

de Gwen, VK3DYL

October ALARAMEET Report

As of early August we have over 40 definite bookings and nearly as many others who are interested, so it all sounds as if it is ready and rearing to go.

An interesting program of activities are planned including a dinner on the Saturday evening to which most of the Lower Murray amateurs and wives are coming along with a number of other VK5s. We would be delighted for any touring/visiting YLs and their OMs to join us for the dinner, too, but do ask that you let us know beforehand so we can book for you.

Contact Jean VK5TSX by phone (QTH callbook and phonebook) or my email on vk5tsx@bigpond.com please.

73, Christine

What are band plans for?

According to Old Timers; way back in the 20's and 30's, our bands had no real 'band-plan'. Progressive stations employed crystal control, and as these were expensive items, just one or two crystals had to serve for both CW Morse and AM work.

As can be imagined, this mix of modes caused significant technical and operational problems. During the late 40's and early 50's, due to greatly improved components and techniques, there was a rapid change from predominately crystal control (or less than perfect VFO), to VFO control of frequency of a (usually) quite acceptable standard. Amateurs were thus largely able to transmit on any frequency within an authorised band.

As far as can reasonably be determined, band-planning was being observed to a significant degree in the United States during the 1930's (Ref. 1). Certainly by 1944 a graphical band-plan was published by the A.R.R.L. (Ref. 2). But by that time, the war had caused amateur radio to be closed down in most countries.

When the amateur frequencies were fully returned in the late 40's, there was a huge influx of new enthusiasts, and, with the availability of cheap war-surplus radio equipment, our bands were alive with AM and CW signals. It was soon realised that an even-handed method was needed to bring about a degree of order, and so make more efficient use of the amateur spectrum.

The topic of a workable band-plan was raised by European radio societies in May 1949 (Geneva), and more thoroughly thrashed out and agreed upon in Paris during May 1950 (Ref. 3). From the beginning, band plans have been voluntary in most countries, in the belief that considerate amateurs would remain sensitive to the needs of their fellow spectrum users.

It appears that the rest of the world followed Europe and America's lead, and the HF band-plans that we now enjoy are largely based upon this early work.

Today, more than ever in the past, there are even stronger technical and operational reasons for us to adopt band-plans. Consider that in addition to 'phone and CW, we now have many extra modes such as digital and slow-scan TV.

With an agreed band-plan, users of the various modes have only to search a limited range of frequencies in order to find a contact on a given mode. For example, on 50 MHz, a CW enthusiast need only tune from 50.100 to about 50.109 MHz during a DX "opening" to find contacts.

Furthermore, on our lower bands (particularly 1.8 MHz) it is not uncommon, where limited space is a factor, to have to use an antenna which can only cover part of a band, and so the antenna is "tuned" for that portion of the band where the desired mode is approved.

Our existing band-plans have been worked out by consultation, and have evolved over many years to (by and large) reflect the needs of our radio community. By separating wide-band modes (like SSB and SSTV) from narrow modes (CW and most digital), the likelihood of mutual interference is greatly reduced. Band-plans align remarkably well on a world scale, so that serious DX enthusiasts may reasonably expect to contact stations of the same mode on an agreed part of a band. DX "windows" are a particularly good example.

Furthermore, it is quite possible that a distress call may go out on one of our frequencies. It would be tragic if such a signal were lost due to interference from some inept operator insisting on his right to operate "wherever he chooses". Even if a frequency appears to be unoccupied, it is wrong in principle; and in practice, to use a wide mode at any time on any part of a band which is designated for narrow modes. There may be a signal there that is down below the noise floor and yet be readable with the right equipment.

When we have a genuine commitment to something worthwhile (like our radio avocation), most of us "play the game", and gladly obey the rules because it's

part of the understanding. Sadly, we have a few of our fraternity who feel that they have some grievance with the band-plan, and continue to use a mode which is inappropriate for a particular part of a band. An occasional breach is usually tolerated by ethical users, and is excused as being due to an operating error, or lack of experience.

But when an infringement is perceived to be deliberate, sustained, repeated, and even scurrilous in nature, then probity is challenged.

We have a communal responsibility for correct and orderly conduct on our precious bands. Ethical amateurs should therefore resist the temptation to take hostile issue with such transgressions. If a polite explanation and request to move is ignored; leave it alone. An on-air slanging-match solves nothing, and may actually aggravate such behavior.

It must always be remembered that, although these selfish operators are mocking the band-plan, they are nevertheless still entitled, by the terms of their licence, to work in any part of an authorised band that they choose.

In summary; the orderly, efficient and safe use of our frequencies is aided by band-plans. Band-plans apply to all amateurs- WIA members and non-members. Unfortunately, we have in our ranks a hand-full of disgruntled operators, who appear to be bent upon undoing the valuable work of dedicated radio amateurs over decades. We must try to ignore their poor example, and not be drawn into such anti-social behavior. Band-plans are published on the Internet, and in the WIA Callbook.

Drew Diamond, VK3XU.

Even if a frequency appears to be unoccupied, it is wrong in principle, and in practice, to use a wide mode at any time on any part of a band which is designated for narrow modes.

References:

1. "The Editor's Mill" (editorial); QST, Oct. 1936, pp 9-10.
2. ARRL Handbook, 1944, pp 14-15.
3. "World at Their Fingertips"; John Clarricoats, G6CL, RSGB, 1967, pp 219-220.

AMSAT-DL aims high - VERY high.

AMSAT-DL (Germany) announces formal go-ahead for future space missions "Phase 3-E" and "Phase 5-A". A new era for Amateur Radio and Amateur Space Science.

In July 2002 the AMSAT-DL (Germany) board of directors gave the go-ahead to develop and build the two spacecraft, AMSAT-Phase 3-E (P3E) and AMSAT-Phase 5-A (P5A). Very favourable responses expressed in a recent AMSAT-DL member's survey led to the decision.

Both will be created in a common development process by an international team led by AMSAT-DL.

The P3E satellite is to be launched as a communication and scientific platform into a highly elliptical Earth orbit.

The second project with the working name "AMSAT - Phase-5A" is destined to enter an orbit around the planet Mars. Yes, you read that right - MARS! The spacecraft will then transmit scientific data from on-board experiments to Earth.

It will also provide a repeater function - from experimental packages to be launched from P5A itself, some into the Martian upper atmosphere and some to the Martian surface. Obviously this is a very ambitious project and has been the "holy grail" of Karl Meinzer for many

years. Karl must be delighted that it now seems to be coming to fruition.

The latest of the phase-3 series, P3D (AO-40), showed sufficient propulsion and bus capabilities to reach Mars. Based on experience and the great interest during the AMSAT-DL International Satellite-Workshop last year, the P5A spacecraft will carry scientific experiments and sub-payloads to be released towards the Martian surface.

Suitable launch windows to Mars exist in 2007 and 2009. Two or three years earlier P3-E will be launched in an orbit around Earth and is expected to continue the successful series of AMSAT-Phase 3 satellites.

The main task of P3E is to serve as communication platform for the nearly 2 million radio amateurs worldwide. Using existing technology and implementing the results of the member's survey, several transponders on frequencies between 145 MHz and 10 GHz are planned for P3E. Details will be fixed in a design and payload meeting in the second half of 2002.

Additionally the P3-E spacecraft will be an important test bed for some technology needed for the Mars mission. Work on the P3-bus has been started and a number of modules are already under construction. So far all AMSAT-DL satellite missions in 1980, 83, 88 and 2000 were launched with ARIANE-launchers from French Guyana into geostationary transfer orbits.

The excellent co-operation between Arianespace (with its current ARIANE-5 launch system) and AMSAT-DL resulted in the development of various arrangements for the launch of secondary payloads on-board ARIANE launches. Thus Arianespace will be the first obvious choice for the launches of P3E and P5A.

The initial project announcement was made in late July via the AMSAT News Service by Peter Gülzow, DB2OS, President of AMSAT-DL and Frank Sperber, DL6DBN, Vice President AMSAT-DL. As was the case in all previous such ventures, Prof. Dr. Karl Meinzer, DJ4ZC is project leader.

AO-7 Continues to Surprise

The unexpected return of AO-7 to the airwaves has attracted the attention of commercial science publications and the BBC.

Since its revival a few months ago, AO-7 continues to grip the imagination of the amateur radio satellite community.

Contacts are reported daily on the Amsat-BB and more exciting things are being discovered as time goes on.

Mike N1JEZ and others from the original AO-7 control team back in the 80s have been experimenting to see if AO-7 can still be reliably commanded.

Surprisingly the old bird has responded positively to seven of the original commands and the testing is continuing. Mike will report soon on the final results of the command tests.

Overseas technical journals have also taken up the story of how this amateur-built satellite has sprung back to life after more than 20 years circling silently in

the frigid cold of space.

UK electronics trade journal *Electronics Weekly* featured a cover story with front-page picture of AO-7. The BBC recently interviewed Pat Gowan G3IOR who was one of the original "movers and shakers" of AO-7 and who coincidentally, discovered its return to service. Audio tapes of the CW telemetry and voice contacts were played during the interview.

All in all a very positive publicity for

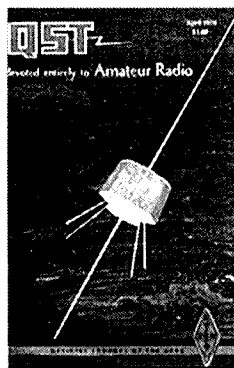

AO-7 as it was conceptualised on the cover of ARRL's QST in April 1974

If you were wondering why Surrey has been so quiet!

Surrey Satellite Technology, Ltd. recently signed contracts for the launch of eight satellites aboard three Russian Cosmos rockets between 2002 and 2004.

The launches will begin the Surrey-coordinated Disaster Monitoring Constellation of small satellites. The constellation will feature satellites owned by Algeria, China, Nigeria, Thailand, Turkey, Vietnam and Britain.

In the past many of Surrey's commercial satellites have carried amateur radio packages as well. We can only hope. We may see the current maximum 38k4 downlink speed pushed even higher.

GO-32 soon to be switched to BBS mode

The Israeli Technion Institute's satellite TECHSAT-1B (GO-32) is reported almost ready to be switched - experimentally - into amateur BBS mode.

TECHSAT-1B was launched on July 10, 1998 from the Baikonur Cosmodrome. It can be heard transmitting a burst of 9600 baud data every 30 seconds on 435.225 MHz. It's difficult to tell with just a burst of data every now and then but the signal seems to be quite strong.

Arrangements are being made by the controllers to hire an amateur operator to publicise the forthcoming opening of

the BBS to the amateur radio community. No doubt news of the event will be appearing on the AMSAT-BB and other modes such as packet.

In the meantime watch out for breaking news on: <http://www.iarc.org/techsat> This is welcome and timely news for digital satellite fans as the choice is rather limited at the moment (see digital satellite survey below).

Digital Satellite Survey

The amateur radio satellite field is very wide. Not many folk would or could 'work all the oscars'. There are not enough hours in the day. I often have to rely on second-hand information when reporting happenings.

The one area I try to keep abreast of is that of the "high-speed digital satellites", with my station set up some years ago to cope with these beasts. At the time of writing the only high-speed digital birds still performing well are UO-22 and MO-46.

These are both "UoSats" type satellites, UO-22 from the University of Surrey itself and MO-46 from Malaysia.

UO-22, which operates at 9600 baud, is still carrying lots of international packet radio mail as well as functioning perfectly in its store-and-forward mailbox mode. Launched in 1991, UO-22 has proved to be a very reliable resource for amateur radio satellite operators.

KO-23 went silent last year and KO-25 has been transmitting just a carrier for some months. In the meantime UO-22 has once again been carrying the bulk of the daily mail traffic. It continues to provide a strong downlink signal and the

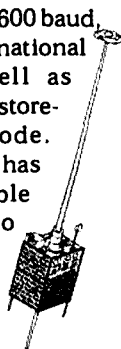

download efficiency hovers around 100% during most of each pass.

MO-46, previously known as TungSat-1, continues to work well at 38k4 baud. Its signal is also very strong and the download efficiency runs at around 100% for most of each pass - and that represents a lot of downloaded data - sometimes over 2.5 Mbytes per pass. The wide angle and high-resolution cameras have been active again and some good pictures have been received in the past few weeks.

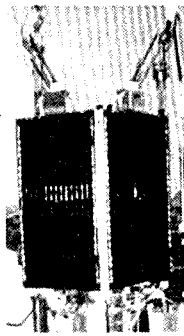

Although many of the images are interesting, MO-46 has never been able to match the superb resolution of UO-36 in its hey-day. UO-36 has not been responding to switch-on commands for some months now.

AO-10 returns to service after a long eclipse

AO-10 is again coming out of 'hibernation'. The now quite ancient high orbiter has been locked into mode-B operation for several years.

Uplink to AO-10 on 70cm and downlink on 2m, remembering that the transponder is inverting.

AO-10 has been drifting in attitude for years now and forecasts of its alt/alon (altitude) are not reliable. Sometimes the antennas will be in a favourable attitude, sometimes not. The solar cells are not always at optimum aspect to the Sun so battery charge is also uncertain.

When the attitude is favourable for both sun-angle and antenna squint, the old bird is capable of excellent performance with good DX and strong signals.

Operators should watch carefully for signs of FM-ing on received signals or on the beacon. Such FM-ing indicates that power is low due to poor sun-angle. Stacey Mills W4SM maintains a web-site for all matters regarding AO-10. Refer to

UoSats-Oscar-11's 2-metre Beacon silent

Just as this column was being prepared, Clive Wallis G3CWV reported that the 145.826 MHz beacon on UO-11 was not operating.

The "S"-band beacon is still working and many reports have been received in the last few days indicating that it is operating as normal and still serving as a valuable weak-signal source for those testing receive equipment for AO-40. Clive reports that the Surrey team are working to get the 2m beacon back in operation.

UO-11 is one of our longest serving and most reliable satellites. The 2m beacon has been transmitting its telemetry to schools and colleges and amateurs around the world since 1984. A few days before the 2m beacon went silent an unexpected change occurred in the format of the telemetry. It began sending ASCII telemetry continuously. There may have been a system glitch, causing the diary cycle to default to ASCII telemetry.

The change occurred around 23rd July 2002. Ground control are aware of the problem, and will probably have to reload some of the software. UO-11 users should watch for Clive's regular updates on the AMSAT-BB.

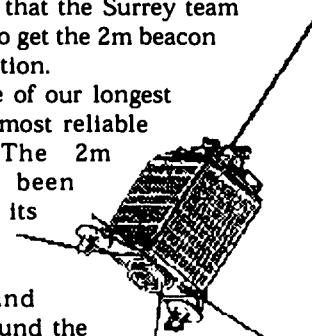

The AMSAT group in Australia.

The National Co-ordinator of AMSAT-VK is Graham Ratcliff VK5AGR. No formal application is necessary for membership and no membership fees apply. Graham maintains an email mailing list for breaking news and such things as software releases. Members use the AMSAT-Australia HF net as a forum.

AMSAT-Australia HF net.

The net meets formally on the second Sunday evening of the month. In winter (end of March until the end of October) the net meets on 3.685 MHz at 1000utc with early check-ins at 0945utc. In summer (end of October until end of March) the net meets on 7.068 MHz at 0900utc with early check-ins at 0845utc. All communication regarding AMSAT-Australia matters can be addressed to: AMSAT-VK, GPO Box 2141, Adelaide, SA. 5001. Graham's email address is: vk5agr@amsat.org

Beyond Our Shores

David A. Pilley VK2AYD
Davpil@midcoast.com.au

If you have interesting news from beyond our shores why not share it with us - email or snail mail are welcome.

A tribute

Through "A-R" I would like to extend congratulations to an Amateur that I've known 'in word' if not 'in person'. Pat Hawker, G3VA, has researched and written the column called "Technical Topics" in the RSGB Journal "RadCom" for the past 45 years. Pat's column has covered nearly every subject from the original crystal set to SMT (Surface Mount Technology). His presentation of various antenna's used around the world alone has in itself been a great ongoing story. The column is so popular that the RSGB published two excellent books called "Technical Topics 1985-89" and

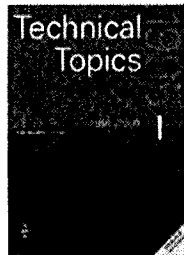

"Technical Topics 1990-94". A copy is a must in every Amateurs reference library. Check with the VK2 Library. They are great value and make fascinating reading.

WRTC 2002

Very special congratulations to Jeff Steinman, N5TJ and Don Street, K1TO, who took home the World Radio Team Championship gold for the 3rd consecutive time.



Jeff Steinman, left, Dan Street seated and referee Dave Lawley (G4BUO) in Timo Keskinen's (OH2HXP) borrowed shack some 70k from Helsinki (photo Ernst Ekstroem, OH2LXB)

This 'Olympic' Amateur Radio event took place in Finland and was organised jointly by the Finnish Contest Club and the Finnish Amateur Radio League. 52 teams from around the world gathered in Finland to compete in this great event and I can assure you it is tough when you are competing with the best of the best. Six years ago Martin Luther VK5GN and I represented Australia at San Francisco and we still bear the scars!

Using the call OJ3A Jeff and Dan racked up 2,782 QSO's giving them 1,629,798 points. Second place was RA3AUU with RV1AW operating as OJ8E with 1,619,226 points followed by DL2CC with DL6FBL operating as OJ6V with 1,608,673. Just 21,125 points separating the gold from bronze. Very close scoring and proof that language is no barrier!

All 52 teams had similar equipment to keep the playing field level and for the first time an on-line real-time scoreboard was provided. Antenna's were at circa 12 metres high and power was restricted to 100watts. Finnish Amateurs opened their stations and homes to the contestants for this great event.

Again - well done Jeff and Dan.

UK Foundation Licence

Radio Society of Great Britain President Bob Whelan, G3PJT, says the new Foundation class entry-level amateur ticket in the UK has proven to be a grand success, especially among youth.

Since the Foundation license went into effect January 1, it's attracted some 700 brand-new amateurs in the UK, 250 of them under the age of 21.

Whelan said "The balance of the 2500 Foundation licensees are those who upgraded their VHF-only privileges to gain the limited HF access the Foundation ticket offers." He went to say,

"The interesting thing is that we're getting a very good response from schools, from Scouts, from Guides, from all those young people's organizations

and it looks to us like, for the first time, it's going to change around the fortunes of Amateur Radio in the UK."

The Foundation license has made the HF bands much more accessible to newcomers as well as to Class B VHF-only "no code" licensees.

To comply with the current international Radio Regulations, applicants demonstrate Morse proficiency by completing what's called a "Morse assessment." Class B licensees need only complete the Morse assessment to qualify for the Foundation license. Applicants work with a Morse tutor for the assessment, and there is no Morse speed requirement. The RSGB says the entire Morse assessment takes about 30 minutes. Applicants also must pass a 20-question written examination that covers a wide range of radio and electronics basics.

Holder's of the Foundation ticket gain access to most amateur bands from 136 kHz through 440 MHz—with the notable exception of 10 meters—using CW, SSB, or digital modes. Foundation licensees may operate with 10 W output using only commercially manufactured equipment or "properly designed" commercial kits. Licensees are issued call signs from the M3AAA-M3ZZZ series.

There are approximately 60,000 amateurs in the UK.

Gibraltar recently announced that it was instituting a Foundation license based on the UK example. Gibraltar Foundation licensees are expected to be 'air-borne' in July this year and will be issued ZB3 call sign prefixes.

500 kc/s on disc

For those of you with Maritime backgrounds you may be interested to know the last moments before this famous distress frequency was closed in 1997 have been recorded for prosperity on video. The video includes extracts from the "Titanic" and final messages from many coastal stations. Details of this 'memory' can be found at www.discoveryfilms.co.uk

U.S. President thanks radio amateurs

President George W. Bush has sent his greetings to all Amateur Radio operators, acknowledging their role in emergency communications (especially following the September 11 tragedy) and in generating international goodwill.

The White House letter came as hams in the US marked Amateur Radio Week June 17-23 and got ready to participate in ARRL Field Day—an emergency preparedness exercise. "I salute amateur radio operators for your work on behalf of public safety officials," the President said. "I also commend your interest in communicating with persons in other parts of the world and learning about other cultures and countries. Your involvement builds understanding and goodwill around the globe."

(ARRL N/L)

The 5MHz experiment is underway

With all the talk that Amateurs in the USA may be allocated a new band in the 5MHz region, it is interesting to read that Amateurs in the UK are already into it!

The RSGB announced that the MOD and RA had granted permission for the allocation of five spot frequencies in the 5250 to 5450kHz band. The frequencies will be in the form of 3-kHz bandwidth channels by way of a Notice of Variation to the amateur radio licence.

As this is a controlled experiment, applicants will be required to report findings and results to the RSGB, which is tasked with providing both the RA and the MOD with reports on findings as the experiment progresses. It was expected that the first NOV's would be issued by the RA on or around the 1st of August.

The purpose of the experiment is to carry out propagation and antenna investigations aimed at improving the understanding of NVIS propagation. The frequencies assigned are 5260, 5280, 5290, 5400 and 5405kHz the experiment is anticipated to run for a period not exceeding four years. New rigs – new antennas – sounds really interesting!

(It would be interesting for Amateurs in Australia to have similar frequencies allocated to allow studies world wide – on the understanding it is for research and not just across-town chatter).

PY has new amateur band

According to Brazilian amateur Marcus, PY3CRX / PY2PLL, the Brazilian licensing authority ANATEL has agreed that the 135.7 to 137.8kHz band can be allocated to radio amateurs on a secondary basis. No date was mentioned for the new band's introduction. Marcus comments that the band is, or will be, also available in Paraguay and Uruguay.

(RSGB N/L)

New amateur radio antennas to be installed on ISS

The last two Amateur Radio antennas are scheduled to be installed this month on the International Space Station's Zvezda Service Module—the crew's living quarters. The specially designed flexible-tape antennas will support Amateur Radio on the International Space Station (ARISS) VHF and UHF operation and are similar to an antenna installed last January 14 by the Expedition 4 crew.

ARISS International Group Chairman Frank Bauer, KA3HDO, said ARISS was working with its Russian partners on EVA procedures. "Once these antennas are installed and some September tests are completed in Russia, additional ISS ham radio equipment will be installed in the Service Module," he said.

ARISS initial ham station gear—a single-band Ericsson 5-W hand-held transceiver for 2 meters—is installed in the Zarya Functional Cargo Block (FCB) using an antenna initially installed to aid docking operations and EVAs. The new VHF-UHF antennas and a flexible-tape HF antenna also installed January 25 are designed for and dedicated to ARISS operations. There is no HF gear aboard the ISS at this point.

Installation of the new antenna on Zvezda makes possible two separate ham stations aboard Space Station Alpha. Bauer said the additional gear due to be installed in the Service Module is one of the 5-W 70-cm transceivers already aboard the ISS. The ARISS 2-meter transceiver now in use from the FCB will remain operational. "This will provide multiband operation," he said. Plans down the road call for installing HF gear at the ARISS station as well as higher power VHF and UHF equipment.

(ARRL N/L 3/8)

Australian Made **ANTENNAS**

"Setting a New Standard"
COM-AN-TENA
(Formerly A J And J Coman)

6 Muir Court
CHELSEA HEIGHTS 3196

All new 5/8 vertical 16 radials	\$145
Dual drive 26-30 5 ele yagi beam	\$305
4 ele 10-11m yagi beam	\$262
5-6-&7 ele high gain antennas 11m	\$call
3 ele delta loop 10-11m	\$320
11m 5/8 vertical/4-1/4 wave radials	\$170
Duoband 10-15 3 ele each band	\$356
Log-periodic 7 ele 13-30 MHz 7.7m boom	\$890
Tri-band 5 ele HB35C s/steel fix	\$730
3 ele 20m computer opt	\$390
3 ele 15m computer opt	\$285
M B Vert Auto switch 10-80m	\$310
40m linear loaded 2 ele beam	\$580
6m 5 ele compt opt beam	\$259
6m 7 ele compt opt beam	\$355
10 ele high performance 2m	\$135
17 ele high performance 70cm	\$119
2m vert 2-5/8 co-linear 4 rad	\$ 96

Guyed Masts

21 metres 13 metres
Winch-up & tilt-over. Aluminium and stainless steel
three-sided construction. Auto-brake winches

Free Standing Masts

9.5 metres
New Baluns
1-1 to 16-1 to 3kW



Our Masts meet Australian Standards. We supply all the computations and data you will need for a permit.

03 9773 3271
Mob: 0419 542 437
Andy VK3IV

Intruder Watch

Henry VK8HA

Report for July 2002

The INDON CRIMS on 14MHz seem to be moving up the band as their frequencies are being more occupied by Radio Amateurs and Chinese Noise Makers...21MHz is OK below 21100, but there are more and more Indon Crims on the upper end of the band....28MHz is full of Chinese Intruders as usual which makes working UK and EU QRP stations almost impossible

Please keep up the 'Occupancy Rate' to deter the Intruders. The 360 degrees bearings are from Albany in VK6, and others from Humpty Doo. Karl, VK6XW, is going up north VK6 to try to 'warm up' a bit as it has been cold down the bottom end of VK-land. Enjoy your stay Karl.

Cheers and all the best from Henry in Humpty Doo, vk8ha@octa4.net.au

FREQ	DATE	TIME	EMM	DEGS	RST	RPRTS	DETAILS
07000	dly	1100	USB	—	S9	dly	Indon Crims
07015	dly	1115	USB	—	S9	dly	Indon Crims
07083	2307	1222	F1	—	S8	—	UI Multichannel
10105	dly	1130	USB	—	S9	dly	Indon Crims. all over the 10 Meg band
14000	1507	0825	USB	360	S9	dly	Asian male-female msg-several in grps
14005	1207	0025	USB	360	S9	dly	Asian four males one female, chat and sing
14006	0807	0910	USB	360	S9	dly	Asian..twop groups. separate operations not in skip
14025	1307	0930	USB	360	S9	dly	Asian two chatting
14025	0407	1250	LSB	360	S9	dly	YB0,messages and instructions. One is Boss
14040	2507	1212	A3E	—	S5	—	2 ui b/cast stations
14044	1307	0130	USB	360	S9	dly	Asians. Usual grps call contact til 0140. 2nd grp 0145-0200
14044	0407	0135	USB	360	S9	dly	Asian, three males chat Korean? Diesel noise on one station
14044	0507	0015	USB	360	S9	dly	Asians chatting. Can hear boat motor on one of them
14045	0307	0400	USB	360	S9	—	Asian..giving short messages..Not YB0..
14052	0907	0145	USB	360	S9	dly	Asians. two males chatting
14060	0307	0400	USB	360	S9	dly	YB0..also 14080 LSB-14085.USB 090-100-110-115
14065	2607	2335	A3E	350	S1	—	B/cast station in Indonesian +HET + VOA
14066	1907	1200	USB	—	S5	—	Chinese
14080	0807	0810	USB	360	S9	dly	YB0-bussy from 080-115 + 120
14085	1707	0845	USB	360	S9	dly	YB0-male-female chat whistlers +80-90-100-105
14090	2007	1100	USB	360	S9	dly	Indon Crims on USB and LSB also 095
14100	1407	1100	USB	360	S9	dly	Masses of Indons. on USB/LSB screaming - yelling - singing
14100	2007	2320	USB	330	S9	dly	Indon Crims in Timor
14100	0307	0800	BUZZ	330	S9	—	R7B? jamming the Indon Crims !!
14100	0507	2300	""	330	S9	—	same as above !!
14100	2607	2335	A3E	350	S5	—	B/cast station in Indonesian
14102	1807	0040	USB	360	S9	—	Asians. two male using VOX msg s all the time .hear boat eng.
14115							Daily heavy harmful interference to the VK6 travellers NET. They do not respond to request to vacate the frequency
14116	0807	0305	USB	360	S9	often	Asian. Messages not YB0 nor Chinese, comes up often
14116	2207	0203	USB	—	S9	—	Asian. interfering with TRAV.NET.opr complained
14116	2707	2350	PKT	330	S3	—	Chinese Packet
14120	0207	0300	USB	360	S9	diy	YB0. Splatter onto Trav.Net.
14120	1307	0830	USB	360	S9	diy	YB0. Sing-chat-2 male, 1female at 0920 other grp on LSB
14120	1807	0845	LSB	360	S9	dly	YB0. Big Group
14125	0907	1155	R7	290	S5	—	UI Multi. Jamming Indon Crims
14130	0107	0525	USB	360	S9	dly	YB0. males and females .chat singing
14130	1507	0635	USB	360	S9	dly	YB0..male-female-chat-as if they own the place
14166	0907	1150	R7	280	S9	—	UI Multi
14250	2707	2350	A3E	—	S1	dly	Pyong Yang B/cast
14266	2707	2345	PKT	330	S5	—	Chin. packet(Chouschrlber)330dges strong.360 degs low lev stn
14310	0907	1130	CW	340?	S5	dly	2 pips/sec..+ short pkt waterfall burst
14311	2707	2340	PKT	330	S5	—	Daily Pips + Chinese pkt
21025	2107	1200	PIC	350	S9	—	Sounds like PICOLO..short break at 1225
21080	2107	1135	A3E	350?	S2	—	UI B/cast stn. PY??
21080	3007	1204	A3E	—	S5	—	PY in Chinese + 2nd stn also in Chinese NEWS
21210	2107	1137	A3E	330	S2	—	News in Eng. re Iran./11389 female in English
21250	2107	1140	A3E	—	S3	—	PY ?...+ some indon CB crims
28022	2707	1152	CW	330	S2	—	BEACON '3OBS'

Editor's note: I will publish these lists every few months so you can see what is happening and that it does not go away.

We all need to be vigilant and as noted above if a lot of amateur activity is maintained the interferers move elsewhere.

Editor Colwyn VK6UE

Spotlight on SWLing

by Robin L. Harwood VK7RH

This month is the first anniversary of the terrorist outrages in the US at New York's, World Trade Centre (WTC), together with the Pentagon and at a third remote Pennsylvanian location. Over 2,000 people were killed on the 11th of September, an event that has become rather traumatic and burned forever in the psyche of the residents of America's largest city as well as the entire nation. Expect the airwaves to be full comment about the event.

I do expect that the memorial events will be extensively covered along with retrospective analysis of the 9-11 saga 12 months on.

I do expect that the ceremonies on September 11th will be carried live via the VOA. Frequencies to be monitored are 6100 and 9645 kHz. These will commence as early as 1130 UTC and continue for 100 minutes, although these ceremonies will continue throughout the day.

Barely a month after the attack, America retaliated with a massive show of air power followed by a coordinated ground assault by specialist forces with the bulk of the fighting being done by rebel Afghani forces, primarily based in the north of the country.

As we now know, the hated Taliban regime was quickly overthrown and eventually replaced with an all-party transitional administration headed by Mr. Karzai in Kabul. American and other allied Special Forces went after the Al-Qaeda and Taliban bands scattered across the mountainous and harsh terrain.

The media scene within Afghanistan has stabilised as the Kabul regime has acquired additional broadcasting capability and can be heard over shortwave via the Abu Dhabi transmitters, which are managed by Merlin.

The unofficial Voice of Afghanistan, which was operating from London, has given conflicting information about its future. It's wealthy Afghan backer said he was suspending programming for three months, after touring the war ravaged nation but nearly a week later, information presumably from Merlin, stated it had permanently ceased transmitting.

Also programming from Radio Free Afghanistan and the VOA were combined into a 24-hour stream instead of having separate formats. Again the Abu Dhabi senders are used as well as FM relays in the major cities, particularly Kabul and Kandahar.

Also the BFBS that was operating for British peacekeepers ceased when they were replaced by Turkish troops. Naturally a 24-hour Turkish program is operating at Bagram and Kabul along with a German language program for troops from that nation. They also have programming in Dari and Pashtoo. A small, localised AFTRTS operation is at Bagram and is not heard away from the base.

As you are no doubt aware, America has made it clear that they want to get rid of the Iraqi regime of Saddam Hussein at all costs. Again shortwave will be extensively used both overtly and covertly. However neighboring nations are extremely nervous about this intention and have distanced themselves in various degrees like many in the wider international community.

Iraq is not heard well on shortwave and its senders are rather unstable. They are reported to be around 11747 kHz but drift about or are covered by other international stations.

Incidentally I am hearing Iraq's neighbour and foe, Iran. When first heard, it sounded very similar to China Radio International. It is quite easily heard on 9570 in English at 2200 till signing off at 2225. The Voice of the Islamic Republic of Iran (VOIRI) seems to have made quite an effort to produce interesting topics, with a number of telephone interviews and reports from outside of Iran. They are not complimentary of American foreign policy, as you would expect.

The Australian Time and Standard Frequency station, VNG, continued operations beyond June 30th following numerous representations. However they are not going to continue beyond December 31st 2002.

This six months grace period is to allow users to find alternative sources of time and frequency standardisation. The possibility of another operator taking over the service is extremely remote, as the existing service was unable to maintain funding.

June 30th also saw the final closure of the Australian HF Maritime stations in Sydney, Melbourne, Brisbane, Townsville and Perth after 84 years of continuous service.

I heard the final broadcast on 6215 and 8176 kHz at 2355 from VIM. Another operator has since taken over the service of both the voice and radiifax bulletins of meteorological information for mariners from two locations at Charleville (QLD and Wiluna (WA). Frequencies for the voice bulletins are 6504 or 6230 and 8176 or 8297 kHz. Penta Commstat also run skeds with Met bulletins and also communicates with small craft to radio in their positions and intentions. The location to me is unclear as they used to be at Gosford.

Papua-Niugini had a rather drawn out election a few weeks back and it took a long while to announce the returns. Many provincial SW stations, which had become inactive, came back on-air for the election and are still operational.

The majority of them can be found between 3.2 and 3.4 MHz. The powerhouse station in Moresby is easily heard on 4890 kHz. Also the rebel Bougainville station supporting Francis Ono also re-appeared on 3850 kHz and audible from 0955 till around 1100. I believe they are running only 80 watts on AM. QSL reports go to Sam Voron, VK2BVS QTHR.

Don't forget that news can be emailed to me at vk7rh@wia.org.au. All the best with listening- 73 de VK7RH

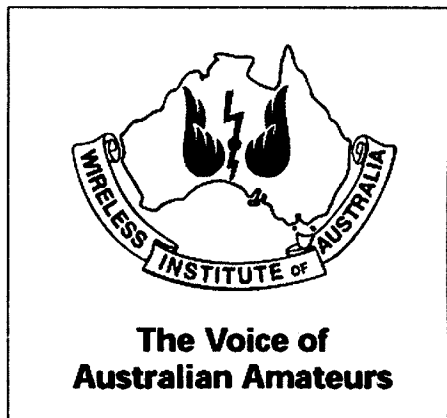

The Close of an Era

Vale Alan Vagg VK3AGV

Alan George Vagg, VK3AGV, became a Silent Key on Wednesday, July 24, 2002, aged 97. This was a man who started with spark generator transmission, went through valve radio, helped run and set up radio networks for New Guinea where communication was either 'in' the air, 'on' the air or nearly impossible.

He was also the last person to have 'spoken' to Amelia Earhardt and was the commander of clandestine radio operators of the New Guinea Volunteer Rifles, an organisation that worked behind and indeed in enemy lines.

With his passing, Australia has lost an extraordinary contributor to radio communication; a brave, fearless and modest former Army officer; and a perfect gentleman. I have lost a dear friend, compatriot and mentor whose help and friendship during 52 year's association is difficult to express in words.

Each and every person who had the good fortune to know or come in contact with Alan was the richer for having done so.

Born to Roberta and George Vagg in Bairnsdale, Victoria, in March 1905, Alan was the second of six children; three boys and three girls. His father managed the local butter factory and later moved to Melbourne to the butter company's head office.

After attending the Middle Park School, Alan joined the Royal Australian Navy in 1919 as a Cadet Telegraphist, at the age of 14 years and six months. Technically, Australia was still at war although hostilities had ceased in November 1918.

Alan trained at the Communications School, HMAS Cerberus, on Westernport Bay in Victoria. Following this, he was variously Watch Keeping Telegraphist at Cerberus and the Garden Island Naval Base in Sydney Harbour (the base was truly an island at that time). He also served at Naval Staff Office Port Melbourne (later HMAS Lonsdale) and aboard the survey ship Geranium.

Alan grew with marine radio as it grew. He operated and worked with the earliest of spark transmitters through to the latest types before the introduction of valved equipment which he first saw at the age of 16, at Cerberus.

He often said that telegraphy was "... in his blood". Two of his uncles were both surveyors and telegraphists in the team which constructed the Overland Telegraph from Darwin to Adelaide in the 1870-1872. An aunt was the last female telegraphist of the Post Office

Telegraph Service, retiring in the 1920's.

In the early 1920's the Navy was winding back numbers and scrapping ships following the Great War. The future for Alan was not bright so he applied to leave the Navy, having decided to become a merchant marine ship Radio Officer. Toward that end, he completed his First Class Radio Operator's Certificate and qualified as an Electrician.

After leaving the Navy, Alan did a lot of electrical work in Australia before moving to New Guinea to join the Bulolo Gold Dredging Company where, as an electrician, he installed a new 650 kVA hydro-electric power station using a Westinghouse Pelton Wheel. Following that, he joined Amalgamated Wireless Australasia Limited (AWA) in charge of their Coastal Radio Station Network at Bulolo.

The Bulolo station, VLT, functioned as a combined Coast and Aeronautical radio service. The aviation aspect handled mainly aircraft flying-in machinery and personnel to the Huon Gulf goldfields. The Coast station handled shipping movements, weather information, public telegrams and freight information.

Although phone (speech) was used on occasions on the radio, CW (Morse code) was the preferred means of communication.

During his time at VLT, Alan had many contacts with aviatrix Amelia Earhardt during her round-the-World flight. He was also the last person to have contact with her after she left New Guinea to overfly the Pacific Ocean. Using CW she told Alan she was descending from 7,500 feet to get below low cloud. That as her last message – Alan called and listened for her: to no avail. No

confirmed trace of her has ever been found and her disappearance remains shrouded in mystery.

The original equipment at Bulolo was Ham-built and Alan re-built it all, including the 5kW transmitter. He particularly used the ARRL Handbook in his endeavours to improve the antenna systems to achieve better range; bearing in mind that station VLT was about 80km inland, in a valley surrounded by mountains around 3,000 metres high.

Using the Amateur Radio callsign VK9DM, Alan established contact with Ham station VK3ZZ in Melbourne, a neighbour of his brother Desmond, a RAN engineer. In this way Alan was able to maintain contact with his family in Australia.

He often reminisced about these contacts. He would work no station other than VK3ZZ; much to the consternation of other Hams around the World who were eager to have a rare contact with New Guinea. The reason Alan only worked VK3ZZ was because he 'fired-up' the 5,000 watt VLT transmitter to talk with his brother and certainly didn't want to work anyone else with that power and have to

explain the nature of his 'Ham' equipment. Under Australian administration at that time, Ham stations were limited to a power of 100 watts!

In 1939, Alan joined the New Guinea Volunteer Rifles, an Army Citizen Force militia unit, and formed their Signals Section. Shortly after the Japanese entered the war in 1941, the Vagg's house at Bulolo was bombed and destroyed. VLT was also damaged. Alan, his wife and their son were on leave in Australia at the time. Alan returned to New Guinea to the NGVR which had been mobilised

John Bennet
Lieutenant-Colonel (retired)
VK3ZAVK2SIG

Alan only ever worked VK3ZZ because he 'fired-up' the 5,000 watt VLT transmitter to do it and didn't want to have to explain the exact nature of his 'Ham' equipment. ...Ham stations were then officially limited to 100 watts!

and to VLT. His wife, who had been in New Guinea for ten years, was not allowed to return. Lieutenant Alan Vagg and his signalmen trained day and night; meanwhile Alan kept VLT operational as well.

As the Japanese advanced into New Guinea and the bombing increased, VLT was destroyed and Alan and his signallers took to the jungle. They had virtually no Army radio equipment and used whatever they could get their hands on. They salvaged what they could from VLT and got a few AWA 3BA and 3BZ tele-radios from plantations.

Alan had signals operators all over the Territory – a few men scattered here and there – sending back information on Japanese troop and air movements which was relayed to Australian Army headquarters in Port Moresby. Alan spent over two years living in native villages and in the jungle, moving from place to place, often hurriedly at night, to avoid capture. On several occasions the Japanese were so close to his hiding place that Alan could see them or hear them talking.

His unit still had little equipment. In one attempt to get more radios to Alan, the Army air-dropped two complete radio stations to him. One parachute load slammed into a cliff face and the radio disintegrated into small fragments, falling into the valley below.

Alan often worked and sent radio messages from observation positions perilously close to the enemy. Once, lying in long grass while observing a ship unloading Japanese troops, equipment and a cargo of bombs and other stores, he saw an oil tanker sneaking into Labu Harbour at last light. He sent a signal to Port Moresby and at first light next morning "...in came the bombers and up she went", he said.

Captain Vagg, as he now was, moved from the jungle and villages back to Port Moresby to become the Chief Signals Officer at Headquarters New Guinea Force; for which he established the Army's main radio station. During this period he took a Signals Detachment from Lae in New Guinea to Tulagi, the then capital of the Solomon Islands – the first Australians there – as the American Marines were forcing the Japanese out of Guadalcanal. The station Alan established linked Tulagi with Port Moresby.

Alan's health was badly affected by his time in the jungles of New Guinea and

its privations. He was to suffer great pain for the rest of his life from tropical ulcers which could never be healed. Such was his strength of character and cheerful disposition that very few people ever knew of his suffering.

After the War, Alan returned to AWA and to New Guinea together with his family. First to Port Moresby, then Lae and finally to establish and operate a new Coast Station, VIJ, at Samarai near the eastern tip of the island.

In 1950 Alan joined the staff at AWA's Melbourne office in the Engineering Department under the late Bert Pringle. Also in that group were the late Alec Stewart, VK3BMS, and myself, John Bennett. From then on we were great mates. Alan, Alec and I worked together on many radio and communication projects of national significance, some of which were highly classified. We worked hard and often played hard – as mates do.

About 25 years ago, 19 ex-AWA engineering staff from all over Australia got together to form a weekly radio network to stay in touch. All of us were First Class Commercial Radio Operators who also held Amateur Radio Station (Ham) licences.

By 2002, time had taken its toll. Seventeen had become Silent Keys. Alan

and I were the last two of the original group. Some years ago our AWA network was joined by Ron Collett, VK2LU, the former Chief Engineer of broadcasting station 2UW, with whom I once worked in Sydney.

When Alan went into a Hostel where he could not have his Ham gear, he generously gave it to Jim Fes, former Marine Manager of AWA in Melbourne. Jim, a long-time friend of Alan and myself, then took-out the Ham callsign VK3CAN and joined our Wednesday morning sked on 40 metres. Jim Fes has been a tower of strength to Alan both before and since he went into the Hostel and is a most welcome member of our little group: So now we are three!

At his retirement function at AWA, Alan said: "...AWA is the most wonderful organisation outside the Military. The atmosphere in the Company had to be experienced to be understood. We were a group of highly specialised engineers, often working on our own, left to get on with the job. Engineering people were great people. Meeting such a lot of nice blokes was outstanding".

The greatest and most outstanding bloke of them all was Alan George Vagg. Farewell true friend.

AR SK



Alan Vagg commanded the signals group of the New Guinea Volunteer Rifles, a militia unit well experienced in New Guinea and with its people and terrain. The radio group played an important part in the defeat of the Japanese on Australia's doorstep in the dark days of 1942-43. Living individually in the jungle, often within earshot of the enemy, they monitored movements of the invading forces, and along with the better known Coast Watchers and other observers relayed information to Port Moresby. This up-to-the minute intelligence enabled

allied forces to take either early defensive or extremely effective offensive action. In a terrain with more up and down than flat and where much movement of material and troops was by barge and aircraft, knowing the exact position the enemy was critical. The intelligence allowed the best use of allied aircraft, in the early days a limited resource. In particular the ground-hugging Beaufort Bombers, known as Whispering Death because of their unheard approaches up the valleys, relied heavily on good intelligence.

How's DX?

Ross Christie VK3WAC

19 Browns Road, Montrose 3765, Vic.

Email vk3wac@aol.com

There has been rumours for a few years now that the local electricity and communications companies wish to roll out a new data communications service in the main population centres of Australia similar to the PLT system currently under evaluation in the UK and elsewhere.

This service utilises frequencies in the HF range of 2 – 30MHz. The system uses the power supply lines and is therefore unshielded and gets everywhere.

In the UK there have been extensive trials of the service with the result that broadband QRM is being experienced not only by amateur operators but also Ministry of Defence installations, Air Traffic Control Networks (in Europe too!), radio astronomers and numerous other legitimate services and users of the HF spectrum.

Similar tests have recently been completed in Japan. However, news just to hand reveals that the Japanese authorities have refused to allow permission for the system to be put into service citing unreasonable levels of broadband noise (QRM) that would effect HF band users. Hopefully our own government will take note of the reasons behind the Japanese refusal when it considers a similar application by Australian companies to install similar equipment.

In a recent report from the RSGB it appears that Tim Kirby, G4VXE, who lives in Windsor is one of the very first UK operators to receive a special 'Notice of Variation' to his licence that allows him to operate on five spot frequencies, each 3kHz wide, at 5260, 5280, 5290, 5400 and 5405kHz.

This will be an ongoing experiment lasting up to 5 years and all results and findings are to be reported to the RSGB. The RSGB is then required to submit the said results to the Radio Communications authorities and also the Ministry of Defence. The NoVs were to commence on the 5th of August and according to the RSGB "Within a few minutes Tim was on the air using a 100 watt transceiver and an end-fed wire tuned for the 5MHz band. Tim reports working GONBD in Wallasey, G3RXH in North Yorkshire, MW0AQD in South Wales, G0HNW in Huddersfield, G3JFS in Plymouth and G3YXM in Birmingham on the first day of operation.

His first impression of 5MHz

propagation is that UK signals seem to be consistent throughout the day and evening. "Even at around 2045 local time, I was getting excellent reports from the Midlands - notably better than on 40 metres", he said.

There seem to be long periods of fading and at Tim's location a lot of local noise, but he added: "It's really exciting to have the chance to unravel propagation on a 'new' band, first-hand."

Amateur operators in the US have also been conducting propagation experiments around the 5MHz band for some time now and Charles Harpole, K4VUD, who has permission from the FCC to operate on their slice of 5MHz spectrum would like to try for trans-Atlantic contacts on the band. He has encouraged authorised UK stations to contact him to set up a 'sked'.

For those interested in having a listen for the USA or the UK on 5MHz you can contact Charles at k4vud@hotmail.com and find out what his schedule is going to be, and for the UK the RSGB will have a list of authorised stations at ar.dept@rsgb.org.uk and will no doubt put you in contact with them.

I wonder if there is any approaches being made to the ACA here in Australia for a similar arrangement for VK amateurs? Probing the propagation across the Pacific to the USA would be an interesting experiment.

The DX

3D2, ROTUMA. Stephane, J28VS will be on the air from Rotuma (OC-060) as 3D2VS/p between the 30th of Aug until the 5th of Sept. He hopes to be able to operate on all the HF bands using SSB. Later in the month, from the 6th until the 11th, he plans to be active from Suva (OC-016) again on all HF bands. QSL via F6KHM either direct or through the bureau. [TNX J28VS and 425 DX News]

5B4, CYPRUS. Alan, G3PMR is planning on holidaying in Cyprus with his XYL. They will be staying at the QTH

of Mike, 5B4AGX. Alan is hoping to get on the air as often as possible using the call 5B/G3PMR between the 12th and 18th of September using CW and SSB. QSL via G3PMR. [TNX G3PMR and The Daily DX]

7Q, MALAWI. Ely, IN3VZE, is heading to Malawi again and is expected to be active using the call 7Q7CE again from September 22nd through October 8th. QSL via IN3VZE via the Bureau or direct to Ely Camin, C.so 3 Novembre 136/2, 38100 Trento, ITALY. [TNX IN3VZE and OPDX]

C5, THE GAMBIA. John, G4IRN, has plans to be active from here as C5/G4IRN from the 6th until the 13th of September. Operation will mainly take place on CW on the 80 - 10 metre bands using 100 watt and simple wire antennas. QSL to G4IRN: 31 Greenwood Road, Thames Ditton, Surrey, KT7 0DU, England, UK. [TNX G4IRN and OPDX]

CE9, CHILE / SOUTH SHETLAND. Ricardo, CE9R will be active on 15 and 10 metres SSB from the Chilean Antarctic Base "Presidente Eduardo Frei Montalva" (WABA CE-03) on King George Island (AN-010). He will be there until late September. QSL via CE3HDI. [TNX CE3HDI and 425 DX News]

DXpeditions

9H, MALTA. A group of 14 Dutch amateurs will be heading to Malta for a bit of holiday/DXpedition recreation.

This will make it their 15th trip to Malta and to commemorate the event they have applied for and received the special call sign 9H9PA (possibly the first 9H9 call ever issued). The operation will take place from the 16th of September until the 6th of October.

They are planning activity on all bands from 2 to 40 metres, including the WARC bands. Modes will be CW, SSB and digital. They may also attempt some operation on 80 and 160m depending on what antennas they can erect on the available supports.

The QTH on MALTA will be in the city

of Qawra (Grid Loc. JM75FV and IOTA EU-023). The following operators (with their own 9H3 callsigns) will participate; Sletse PA1XA as 9H3AAG, Peter PA7PTR as 9H3TE, Ton PA1SL as 9H3AB, Louis PA0LRK as 9H3LRK, Rob PE9PE as 9H3PE, Frits PA0BEA as 9H3IE, Andre PA3HGP as 9H3S, Hans PA3FYG as 9H3AAL, Jaap PE1NGF as 9H3X, Bill PA3BIZ as 9H3ON, Ger PA0OI as 9H3OI, Sjirk PE1OFJ as 9H3YM, Barry PA3FEO as 9H3QF and Ruben PD3RUB as 9H3ZR.

All QSLs for the 9H3 callsigns will be via the respective PA home callsign. The QSL Manager for 9H9PA will be

PA7DX, Anton Kerkhof,
Blaublonke 2, 8401 MG GORREDIJK,
The Netherlands.

The group will be attempting to maintain an on-line log as well as posting some photographs on their web page at <http://www.vrza.nl>

A52, BHUTAN. After receiving some very appreciated help John, KP2A and his XYL have had their tickets, visas and amateur licence organised and are now ready to travel to Bhutan for a holiday.

John plans to get on air from the "Ham Centre" as A52DX from the 11th until the 18th of Sept. He hopes to get some time in on all HF bands including 6 metres using SSB and CW. John also says "if all goes well and with a little bit of luck, there will be online logs available at <http://kp2a.vi/> during and after the operation." QSL the A52DX operation via W3Hnk. [TNX KP2A and The Daily DX]

OJ0, MARKET REEF (EU-053). The "QLF DX TEAM" will be active from here from the 31st of Aug until the 7th of Sept.

They have applied for the callsign OJ0LA from the Finnish PTT. The operators will be LA5UKA, LA6YEA, LA8SDA, LA9VDA and OJ0/LB1NE. OH0RJ has also been invited to join them if he can make it. Modes will mainly be CW and SSB, however some RTTY activity may take place if there is enough demand for it. Activity will be on all bands 160-10 metres with extra efforts taken on 10, 12, 15, 80 and 160. QSL OJ0LA to LA9VDA.

Note, if you wish to QSL direct please send a SASE + 1 IRC or 2 USD. QSL for OJ0/LB1NE is via his CBA, QSL OJ0RJ via OH0RJ. For more info visit <http://home.c21.net/la6yea/> [TNX LA9VDA, VK6VZ and OPDX]

Round up

Industry Canada has granted permission for the use of the national special event callsigns to celebrate the 125th anniversary of Japanese Immigration to Canada. The permission is valid from the 1st of Sept until the 31st of Oct 2002.

The special event prefixes are as follows; CK1 for VE1, CJ1 for VA1, CK2 for VE2, CJ2 for VA2, CK3 for VE3, CJ3 for VA3, CK4 for VE4, CJ4 for VA4, CK5 for VE5, CJ5 for VA5, CK6 for VE6, CJ6 for VA6, CK7 for VE7, CJ7 for VA7, CK8 for VE8, CK9 for VE9, CY1 for VO1, CY2 for VO2, CZ0 for VY0, CZ1 for VY1 and CZ2 for VY2. [TNX OPDX]

C6, BAHAMAS. Al, K3TKJ will be operating as C6ALW from Andros Island (NA-001) in the Bahamas from the 14th of Aug until the 18th of Sept. He will be operating on all bands 40 – 6 metres with an emphasis on 6 m. Modes will be CW and SSB on 6m but only SSB on the HF bands. Dave, N3DB hopes to join Al over the period of the 26th of Aug until the 5th of Sept. [TNX K3TKJ and The Daily DX]

9A, CROATIA. It has been 10 years since the 9A prefix was allocated to Croatian amateurs and the Croatian Amateur Radio Association (<http://www.hamradio.hr>) is sponsoring a special award for contacts made on HF, VHF (including 6m) between the 5th of July and the 31st of December 2002. The award is also available to SWL's.

Further information is available by e-mail from Denis Vincek, 9A3Z at 9a3z@hamradio.hr [TNX 9A3Z and 425 DX News]

WFC CONTEST. The QRZ Amateur Radio Group of Sussex is organising the first annual World Friendship Challenge for licensed amateurs and SWL's. It is to be held from 11 UTC on 14 September to 11 UTC on the 15th. There are trophies for section winners, certificates for 2nd and 3rd place in each section. Commemorative QSL Cards and certificates will be available.

For further information please e-mail qrz@jandc.demon.co.uk [TNX M0CHW and 425 DX News]

YA, AFGHANISTAN. Peter, ON6TT, says that the station YA5T has now made 40,462 contacts since November 2001 and AP2ARS has made roughly 30,000 QSOs since early 2001.

After a break over the summer months Peter will be back in Pakistan for 2 or 3 weeks and says, "we still have the

antennas up, but need to bring the radios back into the country."

The beginning of September until at least mid October will see the UN team travelling around Afghanistan installing satellite communications for the UN World Food Program. They will not be staying in any one place for more than two weeks so there will be some YA5T activity but only with limited power and basic antennas.

After the completion of this installation work the group expect to leave central Asia but they expect to work approximately another 10,000 QSO's form Afghanistan and probably another 2,000 QSO's form Pakistan. [TNX ON6TT and The Daily DX]

JT, MONGOLIA. Ken Claerbout, K4ZW has begun putting the final touches to his planned trip to Mongolia. If all goes well Ken and Karl Renz, K4YT, will be in Ulaanbaator from the 9th until the 15th of Sept. The pair plan to be on air as much as possible until the 15th of Sept. Ken will use the call JT1/K4ZW. Karl's call has not been issued as yet. QSL JT1/K4ZW via homecall. [TNX K4ZW and The Daily DX]

VK0, MACQUARIE ISLAND. Paul, A35RK, reports that VK0MQI has been checking into the ANZA net on 14183kHz the past few weekends shortly after 0500 UTC. Paul doesn't know if this will continue to be a regular appearance but that "it might be worth a listen if you need VK0/M." [TNX A35RK and The Daily DX]

A bit of late news just to hand. Apparently the DXCC desk are now accepting confirmations for RTTY QSOs with Ed, P5/4L4FN dating back until November 2001. So those of you who have managed to work Ed on RTTY can breathe a sigh of relief. [TNX N4AA and DX Magazine]

Sources

The details in this month's edition of DX Notes have been collected from a number of individuals and organisations, all of which deserve our thanks.

Thanks go to N4AA, A35RK, K4ZW, ON6TT, M0CHW, 9A3Z, K3TKJ, LA9VDA, VK6VZ, KP2A, CE3HD, PA7DX, G4IRN, G3PMR, IN3VZE, J28VS, DX Magazine, OPDX, The Daily DX and 425 DX News How's DX?

ar

Adelaide-Anchorage 30

First F 0-5 Short 12466 km

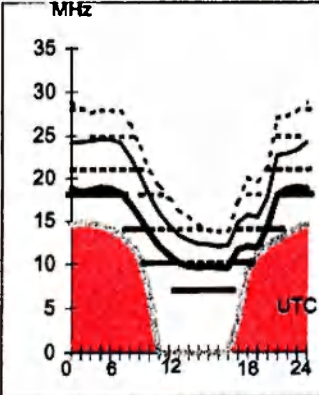

Brisbane-Lima 122

First F 0-5 Short 13056 km

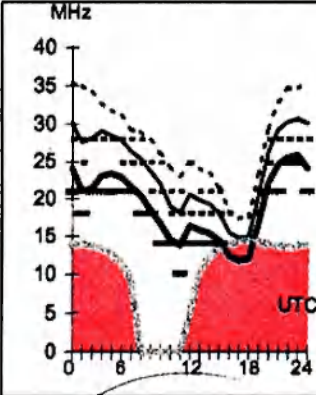

September 2002

T Index: 94

Legend

- UD
- E-MUF
- F-MUF
- OWF
- ALF
- >10%
- >50%
- >90%
- Time scale

HF Predictions

by Evan Jarman VK3ANI

34 Alandale Court Blackburn Vic 3130

These graphs show the predicted diurnal variation of key frequencies for the nominated circuits.

These frequencies as identified in the legend are:-

- Upper Decile (F-layer)
- F-layer Maximum Usable Frequency
- E-layer Maximum Usable Frequency
- Optimum Working Frequency (F-layer)
- Absorption Limiting Frequency (D region)

Shown hourly are the highest frequency amateur bands in ranges between these key frequencies, when usable. The path, propagation mode and Australian terminal bearing are also given for each circuit.

These predictions were made with the Ionospheric Prediction Service program: ASAPS Version 4

Adelaide-Budapest 305

First F 0-5 Short 14908 km

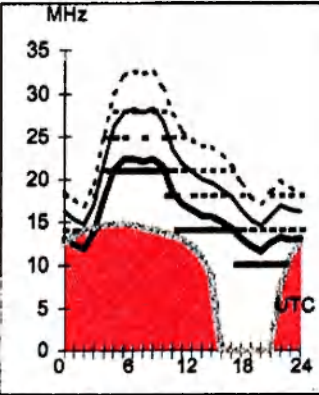

Brisbane-London 147

First F 0-5 Long 23496 km

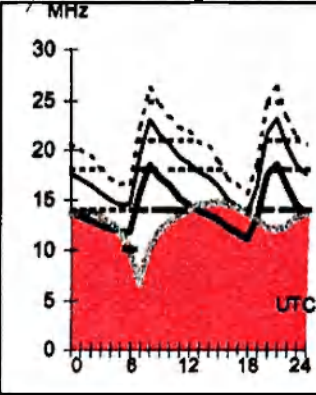

Canberra-Lusaka 239

Second 4F3-5 4E Short 11620 km

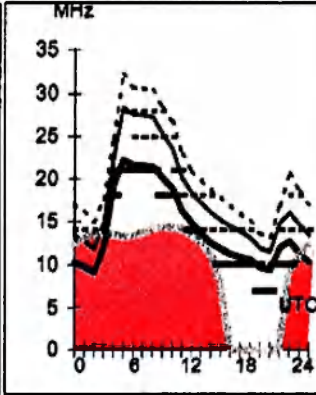

Darwin-Honolulu 65

Second 4F8-14 4I Short 8635 km

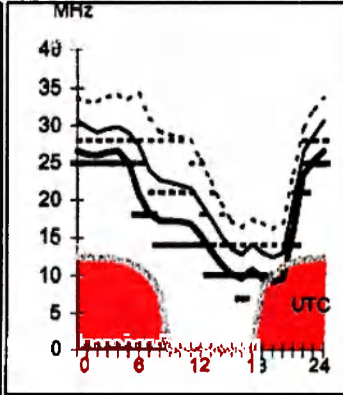

Adelaide-Suva 75

First 2F5-11 2E0 Short 4340 km

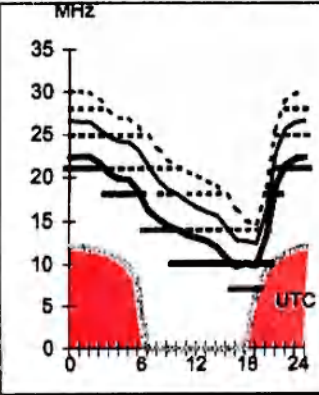

Brisbane-London 327

First F 0-5 Short 16526 km

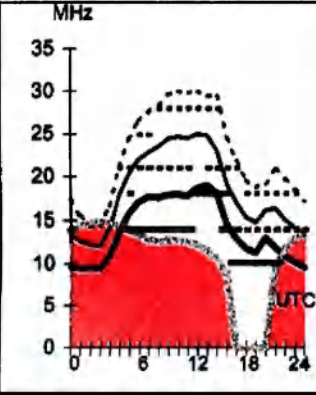

Canberra-Manila 327

Second 3F8-15 3I Short 6286 km

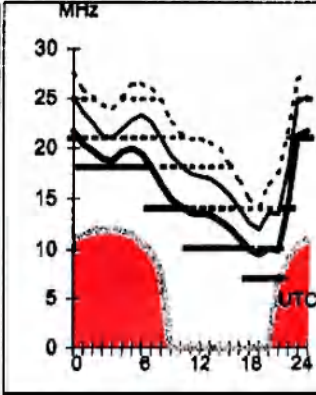

Darwin-Johannesburg 241

Second 4F4-7 4E Short 10639 km

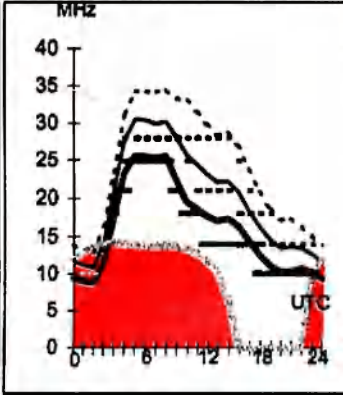

Adelaide-Warsaw 312

First F 0-5 Short 14818 km

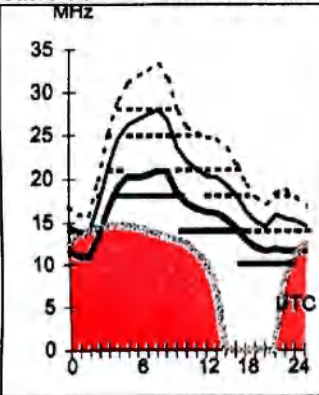

Brisbane-Seattle 44

Second 4F2-6 4E Short 11846 km

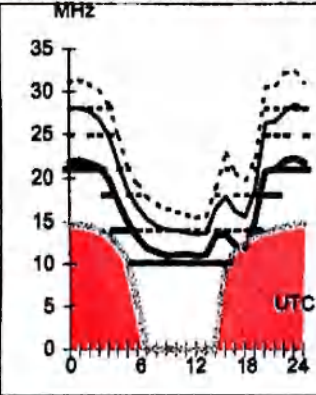

Canberra-Ottawa 59

First F 0-5 Short 16100 km

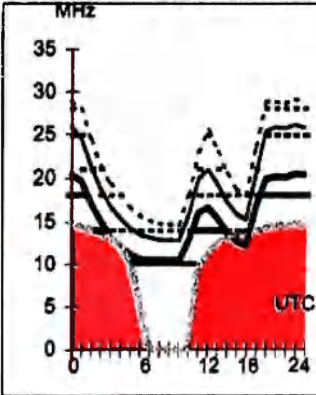

Darwin-Wellington 135

Second 3F11-15 3 Short 5322 km

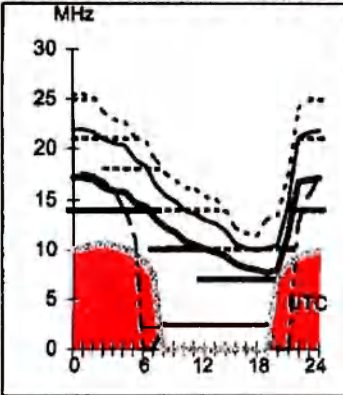

Hobart-Capetown 220 **Melbourne-London 131** **Perth-Kuala Lumpur 336** **Sydney-Loa Angeles 61**

Second 4F5-8 4E/ Short 10026 km

First F 0-5 Long 23118 km

First 2F8-14 2E0 Short 4179 km

First F 0-5 Short 12075 km

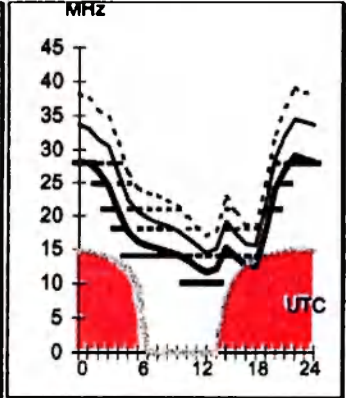
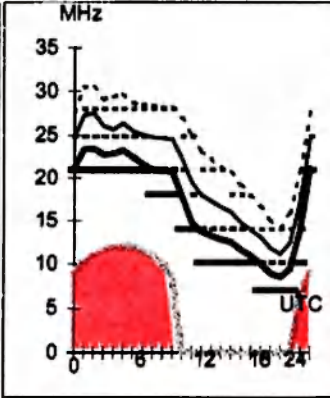
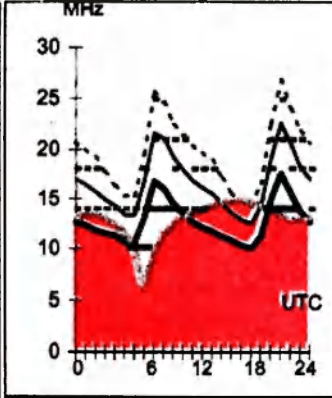
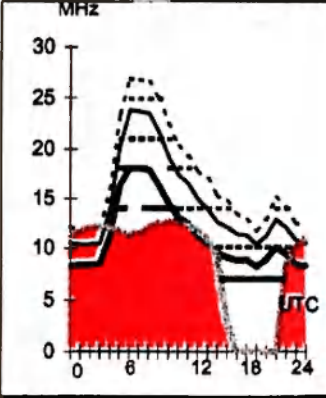

Hobart-New York 80

Melbourne-London 311

Perth-RhodeJanelro 203

Sydney-Rawalpindi 139

First F 0-5 Short 16609 km

First F 0-5 Short 16906 km

First F 0-5 Short 13523 km

Second 4F4-9 4E/ Short 11066 km

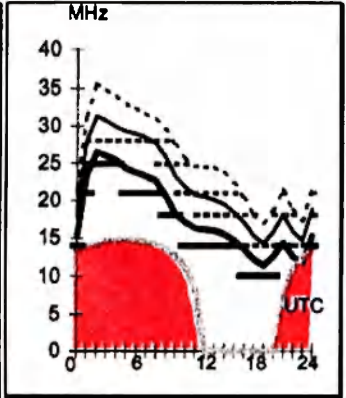
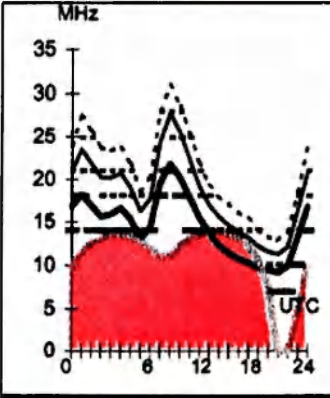
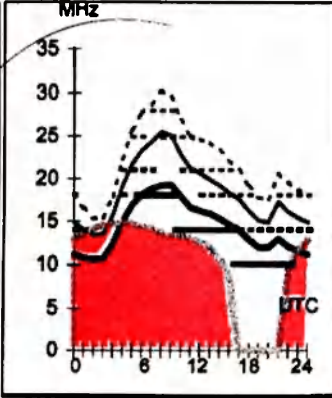
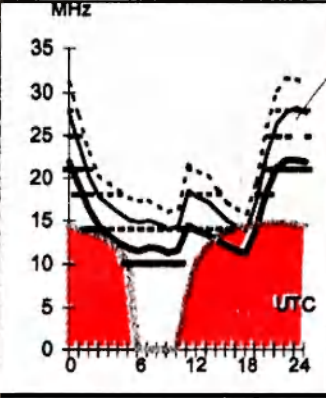

Hobart-Port Moreaby 360

Melbourne-Pretoria 234

Perth-Stockholm 144

Sydney-Santiago 145

Second 2F11-14 ; Short 3710 km

Second 4F5-8 4E/ Short 10353 km

First F 0-5 Long 26577 km

Second 4F3-5 4E/ Short 11347 km

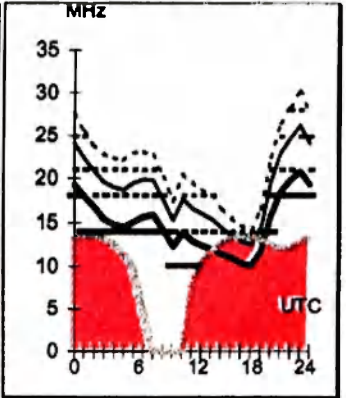
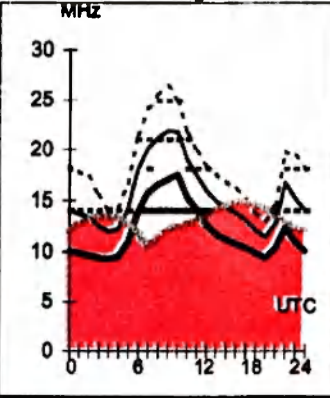
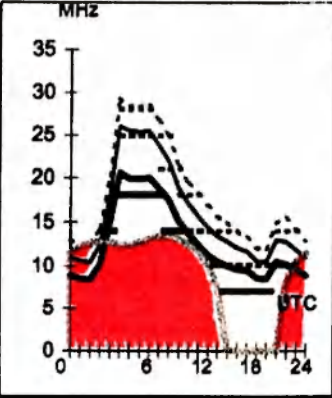
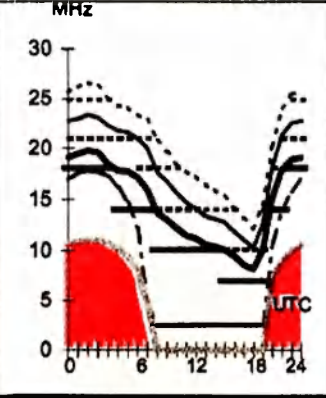

Hobart-Rome 284

Melbourne-Tokyo 356

Perth-Vancouver 50

Sydney-Singapore 298

First F 0-5 Short 16350 km

Second 4F9-15 4I Short 8191 km

First F 0-5 Short 14823 km

Second 3F8-13 3I Short 6296 km

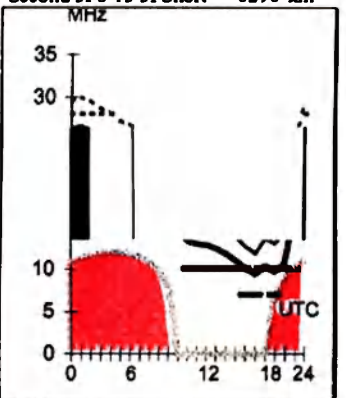
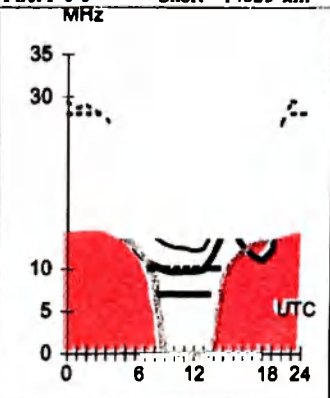
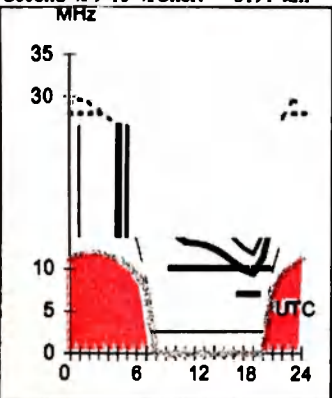
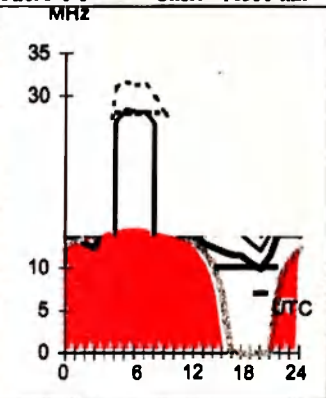

VHF - UHF.. AN EXPANDING WORLD

David K Minchin VK6KK

Postal: 10 Harvey Cres, Salisbury Heights, SA, 5109

E-mail: tecknolt@ozemail.com.au

Web page: <http://members.ozemail.com.au/~tecknolt>

Fax: +61 8 82924501

Phone: 0403368066 AH ONLY

All times are in UTC.

50 MHz

John Martin VK3KWA reports: a new 6-metre beacon in Nauru will become QRV on 9 September. Details are:

Callsign: C21SIX

Location: Memen Hotel, Nauru

Locator: RI39LL

Frequency: 50.038 MHz

Mode: FSK 170 Hz shift

Power: 20 watts

Antenna: dipole

Reports to: C21RH@internode.on.net

Details and photos at www.users.on.net/c21six.htm

Current site is temporary - a move is planned to a better site with a better antenna. Information supplied via Peter C21TA. John VK3KWA

Bevan VK4CXQ reports: I guess some news is better than none! At last some signals from up north but mostly from JA land. The QSO's occurred late July and early Aug and included most JA districts. Also in the log are 2xHLs and a 6K2. In all 40 QSO's. It's been very quiet since then but could pick up with the KCJ contest this weekend. Nothing from the Pacific areas or America-yet QSL cards from JY9NX, TA1AZ, D44BS, DL's and quite a few from Japan.

Tony VK4CH reports: Last night 21/8 08:30Z 6 m was open from my QTH in Hervey Bay to JA, HL etc. Signals were 5/9+20 +++++ Hopefully this is the beginning of another great 6 m season. On 22/8/2002 6 m was again open to JA etc. Signals were not as strong and only 11 stations worked. Opening lasted from about 7pm to just before 8pm local Call areas 1,2,3,5 & 8.

Mike ZL3TIC reports: Over the past few weeks the ZL3SIX beacon has been off air due to maintenance and building access from today it is all back on. Look forward to any reports.

Frequency 50.040 MHz. Also do not forget the ZL3TEN beacon on 28.228 MHz. Mike ZL3TIC

144 MHz & Above

Gordon VK2ZAB has been posting his daily contacts on various modes on the VKF reflector so the bands aren't exactly dead but contributions for this part of the column are zero this month. As punishment I have published more than the usual amount of microwave information!

John VK3KWA reports: Please note the dates for the Spring Field Day: November 2 - 3, 2002. The Summer Field Day is normally held over the final weekend of the Ross Hull contest. The Ross Hull Contest will run from December 26 2002 to January 12 2003 placing the Summer Field Day on the weekend of January 11/12 2003 ... John VK3KWA.

Digital "DX" Modes

FSK441

Ian, VK3AXH, Jim, VK3AEF and Rex, VK7MO have been testing the performance of single tones compared to a 100 ms message necessary to send two call signs and a report. Single tones gain an advantage of 10 db due to the use of narrower bandwidth and a further amount that varies with distance due to the shorter period required.

The theory suggests the overall benefit should be around 24 dB at 630 km falling to around 14 dB at 2000 km. This is equivalent to an increase in the number of correctly decodable signals of 15 to 1 at 660 kms falling to 4 to 1 at 2000 kms. The tests confirm the theory and demonstrate the significant advantages in completing a QSO with single tones. They should, however, only be used after both call signs have been exchanged both ways and off the focus frequency.

Stations active this weekend (31/8/2002) were, VK2FZ, VK2AWD, VK3HY, VK3AXH, VK3AEF, VK4TZL, VK5DK and VK7MO.

WSJT "EME Echo" Mode

K1JT's, Joe Taylor's web site tells of a new mode for checking EME performance coming shortly:

"The long promised "EME Echo" mode in WSJT will be ready for release soon. In this mode WSJT transmits a tone of known frequency for 2 seconds, waits for the echo from the moon, and receives for 2 seconds, repeating the whole cycle every 6 seconds. The return echo is analyzed, integrated, and presented as a *spectral plot*. Doppler shift is accounted for, and birdie-evasion techniques built in. This mode should be a very useful tool for evaluating one's station. The example plot (on site) shows the echo return from my own station, using an FT-847 barefoot. The power output was 30 watts at the antenna (4 x 9 el yags, no elevation control). The integration time was 22 minutes, the EME path degradation 2.9 dB, and the measured signal level -37.6 dB relative to the noise in a 2500 Hz bandwidth."

JT44

Bob, ZL3TY, has been getting good results with his new 4 bay yagi on two metre. He has worked DF2ZC and has been seen getting close with a number of other EU stations.

Mike VK2FLR reports from the EME conference as follows: A session moderated by G3SEK at the Prague EME Conference supported the following calling frequencies for JT44 on EME as follows 144.160 MHz, 432.044 MHz & 1296.044 MHz. Note that these are for EME only and are subject to final determination by the IARU. This should not affect the arrangements you and VK3KWA have worked out for VK, which seem to be working well.

Joe Taylor is pleased to hear about the level of WSJT activity in VK and ZL. He will soon be releasing the EME echo test add-on to JT44 and is working on a coherent detection scheme for JT44 which will double the advantage of signal repetition from the current 1.5 dB to 3.0 dB. Rex VK7MO

Microwave Round up

Looking around on Ebay for microwave bits turns up some interesting items now and again. For one reason or another I have been looking at things that connect to WR-42 waveguide to build a second 24 GHz transverter. This has turned up a number of items including flexible waveguide, circulators, flanges, mixers and antennae.

Antennae generally aren't of too much interest as 99% are overseas making freight prohibitive but one vendor in NSW has had on offer 330mm & 660mm dishes with 23 GHz feeds in the past month. These are ex commercial link dishes with chaparral feeds terminating in WR42 through the centre of the dish. I grabbed one of the 660mm dishes. The 330mm dish would probably be more manageable for general 24 GHz working (i.e. not as sharp!) and cheaper to freight around Australia.

The dishes come with a radome and cover. Unless you are thinking of using the dish as originally intended (tower mounted) the radome is surplus to requirements. I removed the radome just leaving the dish and feed assembly ... reducing the weight to about 5kgs. I mounted the transverter box on the rear flange (about 250mm diameter). The end result is reasonably solid 660mm dish with 38dbd gain. The 3.2mm Aluminium material and 25mm wide perimeter lip is rigid enough to keep the reflector true. As the material is soft alloy I have put a length of automotive "edge capping" around the rim, the sort of stuff used around doorframes on cars.

The feed shows a plotted return loss of better than 25db from 21.2 - 23.6 GHz. In comparative tests the return loss is still better than 20 db 500 MHz higher making it perfect for 24 GHz use. For more information email:

whimp1@shoalhaven.net.au

The following will explain how some overseas events end up with so many goodies are door prize give aways! Stan WA1ECF reports ... "Microwave Update 2002, 24-25-26-27 October in Enfield CT is shaping up to be the major event this year for ham radio Microwavers as well as VHF and UHF enthusiasts.

I am expecting 250 to 300 people from around the world. As the Door prize Chairperson, I am asking each of you to contribute to the success of this national event. Does your employer manufacture or distribute items of interest to hams?

If so who do I contact to solicit a donation? Name, telephone number, email address would be handy.

Does your employer have excess inventory that will only be put in the dumpster? If so, ham radio usable items could be donated. Have you made a special printed circuit board with published articles? If so consider donating a few PCBs or kits. Do you deal with part vendors or sales representatives on ham radio usable items? If so, hit up these local folks for a donation. Stan, WA1ECF. For more details of the 2002 Microwave update, next month please go to <http://www.microwaveupdate.org/>

We don't have many 10 GHz beacon's in VK unfortunately ... VK5VF is currently in between sites as the tree's around the original Mt. Lofty site have grown too high! From overseas, however, the following details of a new 10 GHz beacon installed at the QTH of W3LPL in Glenwood Maryland (20 miles north of Washington DC) in FM19LG are of interest. This beacon features a CW store and forward processor to help amateurs verify that their 10 GHz systems are working!

TX frequency: 10368.300 MHz nominal

TX power out: 20 mW

TX antenna gain: +12 dB to -3 dB (variations due to proximity to tower)

Ground elevation: 600 feet above sea level

Height above ground: 190 feet

Receiver frequency: plus or minus 3 kHz from beacon TX frequency

Receiver sensitivity: -106 dBm

The beacon oscillator is a Frequency West brick. Typical drift has been about plus or minus 2kHz. To access the beacon receiver point your antenna at W3LPL (FM19LG) and tune in the beacon in CW mode. Set your transmitter to transmit CW 3 kHz below your receive frequency. You can transmit to the beacon any time it is not IDing or repeating back another signal. Send a minimum of 5 or 6 characters, a maximum of less than 12 seconds of CW. The beacon will repeat your CW (keep it under 40 WPM) followed by your signal strength in dBm (the minus before the number is left off). This means that smaller signal strength numbers are stronger signals.

The acceptance bandwidth of the receiver is about one kHz. With a little practice, you can figure out what TX offsets will work for you. For those with good receivers, you will need to have 40 dB of receiver S/N before the beacon will hear you - that is a strong signal!

If you hear the beacon repeating garbage, one of five things is likely happening: It's raining at W3LPLs QTH (local rain scatter). Or the wind is high at W3LPLs QTH (vibration noise) or somebody is trying to send SSB or FM through the CW detector (IT WON'T WORK). The beacon receiver is a little noisy at times and will occasionally capture random noise. Most of those events lead to "104" or "105" signal levels (very weak).

My thanks to Frank, W3LPL for the use of his tower and to Craig, WA3TID for ground crew duties in the blazing heat. Mike, W3IP

In closing

It seems that an experienced model aircraft enthusiast, Maynard Hill, has been trying to fly a model from Newfoundland to Ireland. He has tried 3 times and has now aborted the 4th and final attempt.

Maynard holds a number of model aircraft records, including altitude of about 26,000 feet. This aircraft, which could only be considered a model if it was under 5 kg, was duplicated 4 times. Each model has had radio control, a GPS receiver, a batch of digital control, the usual aircraft controls of elevator, rudder, aileron and flaps and a satellite transceiver so that the launchers could "see" where it was. It sent location, airspeed, altitude, and temperature, as well as engine RPM. Half the weight was model, the other half fuel.

The first two ditched fairly close to his home, but TAM3 (Trans-Atlantic-Model) seems to have flown about 750km or about 25% of the total distance! For further info go to <http://tam.plannet21.com/>

Doug's VK3UM's radiation calculator program, as demonstrated at GippsTech 2002 in July is now available for download at <http://www.qsl.net/sm2cew>

I'll leave you with this thought.. "Middle age is when you have a choice of two temptations, you choose the one that will get you home earlier"

73s David VK5KK

Silent Key

Vic (Vincent) Noble VK5AGX

After a long illness Vic Noble VK5AGX passed away on 28th February 2002 at the age of 87.

In 1984 he won the HF Contest Championship Competition for outstanding performance. Vic wrote many articles on his experiences. The original publication of the attached is not known.

Laurence Of Arabia (AC Shaw) RAF CALSHOT, 1934

by Vic Noble

On completion of recruit training at RAF Uxbridge in late 1933, I was posted to RAF Calshot in February 1934, and following the usual selection interviews found myself a member of 201 Squadron

My immediate responsibilities as a wader, especially under winter conditions, made me more determined to hasten my application requesting a Wireless Operators' course. Having previously served in the RAF Special Reserve, (1932/3) as a W/Opr with 502 (Ulster) Bomber Sqn at RAF Aldergrove, I convinced the Station Signals Officer that I would be an asset to the Sqn radio personnel, and to my delight an internal posting earmarked me as a W/T W/Opr awaiting a course at the Electrical & Wireless School RAF Cranwell

I already was in possession of a Marconi Marine Radio Certificate, having sat for same at the Belfast School of Telegraphy early in 1932. Whilst serving with the Special Reserve I was selected with a regular W/Opr and Cpl to set up a temporary receiving station at Londonderry (NI) with instructions from Air Ministry to receive Met reports and other information pertaining to the flight of General Balbo's fleet of Savoia flying boats on a cruise to America for the Chicago World Fair.

The twin-hulled Italian monoplanes made a great impression, especially on the five Southampton crews when they arrived at Londonderry from Oban to

welcome the Italian visitors. I believe 201 Sqn used Oban as an exercise base.

These two factors apparently influenced the powers that be when I was summoned to the Sigs Officer's office and told providing I passed a high-speed morse test I would be immediately employed at the Station Met Office receiving Met reports (Synoptics), as the civilian W/Opr had been taken seriously ill and would be hospitalised for some time.

I passed the test with flying colours and with the Sigs Officer proceeded to the Met office for an interview with the Senior Met Officer. The job entailed shift work with transport provided from the domestic site (both ways). Further "perks" included excused all duties, parades etc and, needless to say, the envy of all my hut mates and the SWO!

Whilst working at the Met Office I had the great honour of meeting Lawrence of Arabia, who visited the office when working on the high speed launches and requested weather reports over all the waters in the Solent and around the Isle of Wight. He never spoke much but would sit opposite me gazing at the lines of figures that I would be writing and awaiting the "break-down" of the synoptics by the Met staff.

Some days he would be in civilian clothes, other days attired in scruffy and oil-stained uniform. He would take from his pocket crumpled up pieces of paper,

with diagrams and write down a few words.

The first day he saw me tuning the receiver, he enquired from the Met officer why I was taking the synoptics and was obviously disturbed at the news of the civilian's illness! Some days if I happened to call at the NAAFI canteen, Shaw would also be ordering a "Tea & Wad", give me a wink and retire to a corner to read a newspaper.

Orders were promulgated in Daily Routine Orders to the effect that All Ranks were reminded to refrain from speaking with AC Shaw. You would only speak if and when Shaw spoke to you. I believe Shaw was also aware of this frequently promulgated order. To see an officer salute an air craftsman FIRST, as happened when he would be walking around the base, was something "out of the blue" yet taken for granted!

I might add that whilst serving with No. 6 Sqn detachment at Semakh on the shores of Lake Tiberias (tented accommodation) in 1938 we had the privilege of daily visits to the Trans-Jordan Frontier Force camp nearby and made very welcome in their All Ranks canteen. On one of the walls was a very large portrait of their beloved and trusted friend Lawrence of Arabia in his full Arab dress and most impressive. Apparently, or so we were told, on special nights a toast is drunk to the Great Man.

Silent Keys

David Jessop Parry, VK2CX

It is my sad duty to record the passing of David VK2CX at his home in Mollymook, after a long illness. David was born in Sydney in 1921 and was educated at Penshurst, NSW. He was employed by CSR Ltd as an Electrical Engineer and served in the RAAF in New Guinea and the Islands during WW2. When David resumed his previous occupation he and Judy lived in Melbourne and Sydney until they

retired to Mollymook in 1979.

Largely due to the influence of John VK2BTQ and Frank VK2HQ (now also silent keys), David gained his amateur licence in 1981 as VK2CDP. He was a tireless worker for the Mid South Coast Club from that date until his death.

At the request of the family of his long-time friend Jack Evans of Nelsons Bay, David took over the callsign VK2CX in 1996. David was truly one of nature's

gentlemen, a devoted family member, a keen sportsman and a person who was ever ready to offer a helping hand.

He is sadly missed by all who knew him.

**From Stan Burke, VK2EL
Secretary, Mid South Coast ARC**

**The WIA regrets to announce the recent passing of:-
A J Cooper VK3VZV**

Over to you

Academic costcutting is an opportunity to awaken amateur radio interest.

For me, a retired academic, engineering students should be taught to merge theory and practise to produce working products within time and cost constraints. Of late academia is changing in a way I believe is detrimental.

Let me explain. Staff reductions have increased workloads and since laboratory sessions require greater effort and resources they are the first to suffer.

Equipment is expensive, needs maintenance and constant checking to ensure OH&S requirements are met. The cost of building space means cutting down on laboratories and the disposal of all surplus equipment and components, including technology museum areas. Public liability insurance costs have increased, so practical sessions using rotating machinery or high voltages are frowned upon.

Thus the current trend in many universities is to narrow teaching and research to theoretical and system aspects, replacing practical work by computer simulation.

While simulation methods are essential, so are the hands on aspects of

engineering, else students know little about practical issues such as, parasitic oscillations, some capacitors are polarity sensitive, what is inside an IC or how to achieve high reliability soldering.

Perhaps this trend provides an opportunity for the WIA to give support to tertiary educational establishments (I gather TAFE has similar problems) and at the same time interest students in amateur radio.

Since universities are concentrating on system design, project work is mainly writing software or purchasing modules and assembling them into systems. The WIA could help at the module level, using proven amateur radio designs.

For example, I was pleased to see VK2DSH's microwave signal source appear in a recent AR as it provided help for an RF source in a university experimental synthetic aperture radar project.

One could also tap into the many professional kits available from US clubs, students assembling and using them in novel and interesting ways, all part of the learning process.

University library funds are also limited and often the first periodicals to go are the practical ones; my University canceling subscriptions to *QST* and *Elektor*. Is this another area we can assist - complementary issues of AR?

How WIA co-operation is achieved will vary from institution to institution; a student Comms. Club, a micro satellite interest group, participation in final year student projects all possibilities. Whatever is done has to be well done - relevant, practical, professional and with enthusiasm.

I suggest that ideas from all Divisions be shared. Gaining student interest in our hobby is only one of several benefits, for I am sure that in return both graduates and academic staff would be willing to professionally support us, including writing papers for AR and giving talks at meetings. Above all industry will get better graduates.

Malcolm Haskard VK5BA

HELP WANTED

WINNIE THE WAR WINNER

Amateur Radio is planning a story in December about *Winnie the War Winner*, a clandestine radio that was built from junk and scrounged parts, and which operated from Timor in 1942.

Associated with the operation were: Capt George Parker, Cpl John Sargent, LCpl John Donovan, Sig. Max (Joe) Loveless and K Richards.

Joe Loveless worked with 7ZL in Hobart in the 1930's and the units mentioned are Fortress Signals Section, Signals 8th Div, 2/2 AIF Independent Co. and Sparrowforce.

We would appreciate any information that may be in the possession of any reader.

CONTACT JOHN NIEMAN

236 Olinda - Monbulk Road, Monbulk VIC 3793
(03) 9766 7797 OR FAX (03) 9756 7031
captname@ozemail.com.au

HELP WANTED

Amateur Radio is planning a 'readers' issue in December. With time on the reader's hands we want to include extra articles and projects of general interest. If you have any thoughts, contact either the editor or Newsletters Unlimited. Details on contents page

Sunspot Numbers

Monthly average Jul 2002: 108.6

Smoothed Sunspot Number Jan 2002: 113.5

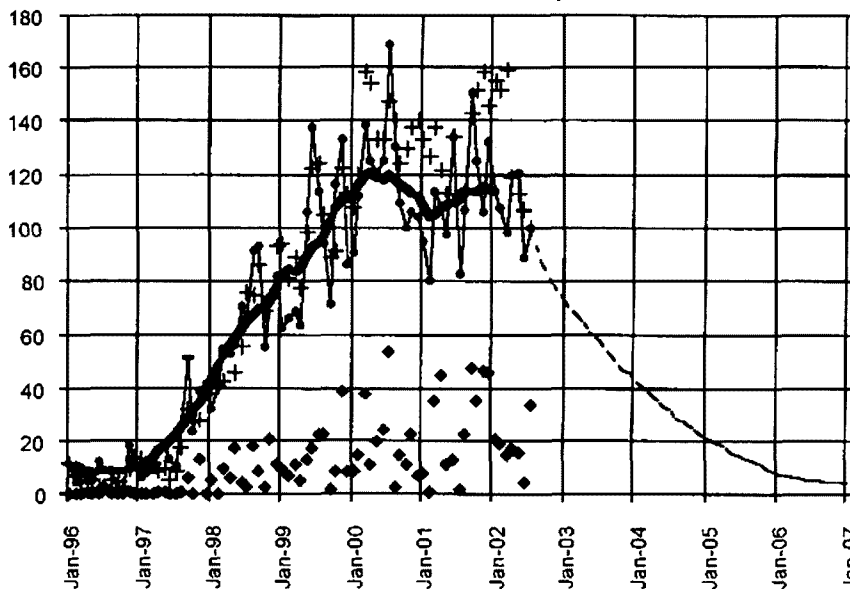

◆ Flares > M1 + T index — SSN
- - - - - Prediction —●— Sunspot Number Current Cycle: 23
Drawn from monthly data provided by the Ionospheric Prediction Service

HAMADS

100mm square front panel meter. Many switches, knobs, etc. Typical top quality HP construction. \$35 OBO. John VK3GF QTHR Phone 03 5562 5545, email johnc@anson.com.au.

- Hamads may be submitted by email or on the form on the reverse of your current Amateur Radio address flysheet. Please print carefully, especially where case or numerals are critical.
- Please submit separate forms for For Sale and Wanted items, and be sure to include your name, address and telephone number (including STD code) if you do not use the flysheet.
- Eight lines (forty words) per issue free to all WIA members, ninth and tenth lines for name and address. Commercial rates apply for non-members.
- Deceased estates Hamads will be published in full, even if the ad is not fully radio equipment.
- WIA policy recommends that the serial number of all equipment for sale should be included.
- QTHR means the address is correct in the current WIA Call Book.
- Ordinary Hamads from members who are deemed to be in general electronics retail and wholesale distributive trades should be certified as referring only to private articles not being re-sold for merchandising purposes.
- Commercial advertising (Trade Hamads) are pre-payable at \$25.00 for four lines (twenty words), plus \$2.25 per line (or part thereof), with a minimum charge of \$25.00. Cheques are to be made out to: WIA Hamads.
- Copy should be typed or in block letters, and be received by the deadlines shown on page 1 of each issue of Amateur Radio, at:

Email: newsletters@ozemail.com.au Fax: 03 9756 7031
Postal: Newsletters Unlimited, PO Box 431, Monbulk Vic 3793

Please send your Hamad by ONE method only (email preferred)

FOR SALE NSW

- **KINGSLEY radio receiver model KCR/11, UNIVERSITY radio equipment valve tester model TST**, both units condition unknown, ex VK2AZW. Offers to VK2BKG QTHR. Buyer to collect.
- **COLLINS 301-1 amp** in good condition \$850 email vk2co@yahoo.com.
- Estate of the late David Parry VK2CX. (Sadly another South Coast Silent Key). **YAESU FT-757GX HF TCVR GC**, box, copy manual, with **YAESU MD-1 Desk Mic** \$650. **YAESU FRG-7 Receiver**, fair, no manual \$100. **ICOM IC-726 HF/6m TCVR**, box, mic, manual GC \$750. **HY-GAIN RF550A SWR/WATTMETER 400/4000W**, fair \$50. **PacCOM TNC-320** no manual, GC \$100. **PHILIPS FM-900 2m 99Ch**, fair \$100. **PHILIPS FM-828**, Xtals VK2RMU Packet 144.875, fair \$30. **TRIDIPPER TE15 Dip Meter**, complete, as new \$50. **OMEGA-T Antenna Noise Bridge** \$25. **HEATHKIT IM2B VTVM**, 240v, probes, manual, GC \$50. **REVEX S20 2-way co-ax switch DC-1GHz** \$20. **DAIWA CS201 2-way co-ax switch** \$10. **POWER SUPPLY, HB**, 13.5V 15A well-made \$50. **ARRL Handbook 1984**, fair \$10. **ARRL antenna book, 2000**, as new \$20. **USA Callbook 1992**, free for postage. **RADIOTRON Designer's Handbook**, 4th Edition, collectors, fair \$40. Serial numbers available. Transmitting equipment to licensed amateurs. All prices ONO. Stan Bourke VK2EL QTHR (Ulladulla) Phone 02 4455 5825 sbourke@shoal.net.au.

WANTED NSW

- **Circuit manual** or any info on **YAESU FRT-770**. Happy to pay any costs plus. Cliff, Phone 02 6972 3788 or ciord@simplex.net.au.
- Can anyone help with any or all of the following: (1) **Circuit of HP 410C VTVM**. (2) **Receiver 0.5 to 30 MHz** with digital readout for SWL. (3) **Coil box AR-7 Band A**. Buy or swap for Band E coil box. QTHR or Phone 02 9791 0366 VK2ACV.

- **Headphones YAESU or KENWOOD brand**. Must be good condition. Please state model. Colin, VK2LV, QTHR, Phone 02 9363 4561, cbm@zip.com.au.
- **Four way co-ax antenna switch**. Up to 30 MHz at 100 watts. Noel VK2BCA, Phone 02 4977 3449. email nollaig@acay.com.au.
- **Service manual for a MARCONI AM/FM Signal generator Model TF996A/S**. All costs met. Adrian Clout VK2BFN Phone 02 4758 6797, 0408 604 366 adrian_clout@storagetek.com, vk2bfm@vk2wi

FOR SALE VIC

- **Handbooks A-510** plus circuits and service instructions. G.C \$15, poor condition \$10. **Yellow band No. 22** handbook with circuits G.C \$12. **Manual AT5/ARB**, fair condition \$25. **Manual** with circuits, fair condition **SCR536/BC6N** \$8. **User handbook C42** G.C. \$6. All plus pack & post. Rodney VK3UG QTHR. Phone 03 5825 1354.
- **Linear FL-2100B V.G.C.**, Original packing box, valves OK \$575. **Transverter 10 m - 40 m - 80 m** with 100 watt output and exciter \$250. **Beam 10 m 3 element** heavy duty with balun \$75. **Prop pitch motor** with transformers \$210. **FT-747** in VGC original carton & accessories \$550. VK3CX Phone 03 5422 2860.
- **Quad** made in USA 4 bands made of alum fib glass. Freq are 28MHz, 21MHz, 17MHz, 14MHz, set up, will help to dismantle \$500. VK3FJ. Phone 03 5672 2722 Wonthaggi.
- **ICOM IC-T8A H/held 6m, 2m & 70cm**. Serial No. 001084, EC c/w NiMH & drycell batt pack, leath. case & speaker mic \$375.00. **IC-Q7A Handheld 2m & 70cm** Serial No. 003191, EC wideband Rx 30-1310MHz. leath. case \$185.00 David VK3YLV QTHR Phone AH 03 5382 4000.
- **HEWLETT PACKARD Distortion Analyser 330C**. S/N 246-10064. Contains 2 speed geared vernier dial in cast frame with 4 gang 450pF (approx) tuning capacitor. Ceramic insulation. Eleven valves, 6SJ7, 6J5, etc.

WANTED VIC

- **JOHNSON VIKING 500** transmitter and handbook (circa 1957). **JR Radio Service handbook VR series 1964. Instructions for valve tester TMS T-36B. No 128 Army transceiver and handbook**. Rod Champness VK3UG QTHR. Phone 03 5825 1354.
- **External controller for an IC-701 type IC-RM2**. Ian VK3JQ Phone AH 03 5428 7364, BH 03 9338 0344 or vk3jg@netscape.net.
- **ICOM TV-1200 ATV adapter** in good condition. Ian VK3ZBI QTHR Phone 03 9598 5362.
- **Valves 12BY7A, S2001A, 6146**. A transceiver **KENWOOD TS-520, TS-820 or TS-830**. VK3CFF QTHR Phone 03 5338 1927.
- **RF section for FRR-59A receiver**. The missing half of this radio must be out there somewhere! Please help. Morris VK3DOG Phone 03 9824 8988.
- **Circuit Diagram or handbook relevant to BWD Sine & Square Wave Generator Model 112B**. Also Volume 1 of **The Admiralty Handbook Of Wireless Telegraphy 1938**. VK3WG Bill Phone 03 9596 1914 or Fax 9596 8337 or email ghq@hyperlink.net.au.
- **Very desperately seeking for Wireless Set No 11**: One three pin male chassis power socket (triangular pattern with two big pins) and two female plugs to suit. A PRESS TO TUNE switch (S5A) and PULL FOR RC switch (S6A). Rectangular black bakelite front panel jack cover (the one with 3 holes labelled PHONES and LINE). One nameplate for LP PSU. One PSU case with or without power supply chassis (HP or LP unit). **For my R-1155 Rx** the big dial knob. Clem VK3CYD Phone 03 5126 2064 clem@dcsi.net.au.

FOR SALE QLD

- A bargain for someone: **ICOM-R75 receiver**. Under warranty until Christmas \$1200. Jim Phone 07 4157 2287.
- **2 x 3-S00Z** brand new **EIMAC USA \$250.00 ea. Oscilloscope HUNG CHANG OS 620** never used \$450.00. **MIRAGE 2 m 30 watt** linear Exc. Cond. \$50.00. **KEN Rotor KR-800** complete VGC \$300.00. **KENWOOD TM-241A 2 m rig (50 watt)** as new \$350.00. **ASTRON RS12A p.s.** 13.5 V x 12 A, exc. cond. \$250.00 Reg VK4XH Phone 07 3219 7642 rhardman@bigpond.net.au.
- **6 metre Linear Amp. TOKYO Hi-Power 1K/6** with pair good 4CX250B's PLUS spare pair of NEW tubes c/w handbook and circuit. \$850. **IC-505** transceiver, 12 watts out, will drive above amp. \$250. Wally VK4DO, Phone 07 4788 8462, vk4do@ballyhoo.com.au.

WANTED QLD

- **TAIT VHF high-band transceiver**, one or more for non-commercial project **Model T535** preferred but other models considered. Bill Pickering VK4WP, 10 Marina Pde, Ingham 4850. Phone 07 4776 1718. Email wpickering@ozemail.com.au
- **UHF SWR meter** good to 70cm. VK4ANR, Phone 07 4783 3398 or email miriglen@austarnet.com.

• **COLLINS 3251 (or S2 or S3) Transmitter.** Prefer with 516F-2 ac power supply. John VK4VK QTHR. Phone 07 5538 1759, email: tenalu@dodo.net.au.

• **Workshop manual for FT-B90.** Will pay for photostat and all costs involved. VK4DV QTHR any call book.

• **Sohamatic for HITACHI V162B Oscilloscope.** Please contact me at frankwinter@optusnet.com.au or PO Box 198, Buderim, QLD 4556. VK4BLF

FOR SALE SA

• **YAESU FT-77 HF txvr** Solid-State 100 W base/mobile 80 m-10 m WARC bands, mobile cradle. **DAIWA CN-620 swr/power** X-needle meter & **YAESU MH-1B8 mio.** \$365 s/n 3C021759. **YAESU FP-700 13V20A** matching power supply inc.bit/in spkr.all cables & manuals all vgc orig.packing. \$195 s/n 3C020575. You collect, Ron VK5SD QTHR Phone 08 8337 6540. Mobile 0401371263 Email ramos@charlot.com.au.

• To whom it may be of interest in the Adelaide Metro area: **4 very good morse tapes** to be **GIVEN away** to someone on 80 m. I have acquired 5 tapes but only require one. Phone me at around 1800 hours any day. Phone 08 8294 6906. A genuine offer to be of assistance to somebody. M.M. Gell VK5ZLC QTHR

WANTED WA

• **ICOM SM-6 desk mic:** Vaso VK6VAS Phone 08 9964 2385 or email: vk6vas@westnet.com.au

MISCELLANEOUS

• I have a **208 set**, a small military HF transmitter-receiver using 1.4 V octal tubes made by Radio Corporation, Melbourne in 1943. I am interested in the **history of these units** (I have the manual and technical info) and would be very interested to receive any anecdotes or other information on their specification, design, manufacture and deployment during WW II. I can be contacted by email: bjk@ihug.co.nz Barry Kirkwood, ZL1DD

MISCELLANEOUS

• The WIA QSL Collection (now Federal) requires QSLs. All types welcome, especially rare DX pictorial cards, special issue. Please contact the Hon Curator, Ken Matchett VK3TL, 4 Sunrise Hill Road, Montrose Vic 3765, tel. (03) 9728 5350

HELP WANTED

MARKETING RESEARCH

We are now distributing *Amateur Radio* through the news-stands. If you have internet (for ease of response) we would appreciate it if you could check your local newsagents and ask if they carry it, and if they do, do they sell it out? If you have a local electronics shop who might be interested in carrying it as a counter sales item, that address would also be helpful.

email the info, whatever the answers, along with your postcode, to John at

captnnemo@ozemail.com.au

<http://www.hamsearch.com>

• not-for-profit site that is a search engine for hams

TRADE ADS

PSK-31, SSTV, RTTY SOUNDBOARD INTERFACES

Fully Isolated, ready to plug in.
<http://www.G3LIV.CO.UK>,
Johnny@melvin.com, G3LIV QTHR.

AMIDON FERROMAGNETIC CORES:

For all RF applications. Send business size SASE for data/price to RJ & US Imports, PO Box 431, Klama NSW 2533 A 3.5" PC disk containing all data is available for \$5.00 incl. post.

www.catchnet.com.au/~rjandusimports

Agencies at: Active Electronics Tas; Truscotts Electronic World, Melbourne; TTS Systems, Tyabb; Tower Communications, Perth; Haven Electronics, Nowra.

HF, VHF, UHF ANTENNAS & ACCESSORIES

Alum towers, guys etc. Diamond VSWR/PWR meters. HD copper ant wire & Insulators. TX tubes & pwr transistors. Quality coax cables & connectors. Free advice & catalogue. ATN Antennas Ph 03 5492 2224 Fax 03 54922666, email atnant@ruralnet.net.au

Radio Old Timers Club Of SA

ANNUAL LUNCHEON

The annual Luncheon will be held on Thursday 24th October 2002 (12 noon for 12.30 for lunch) at the

**Marion Hotel
Main Road, Mitchell Park**

RSVP to one of the following committee members before 20.10.02

President : Jack Townsend VK5HT
Phone 8295 2209
Secretary: Ray Deane VK5RK
Phone 8271 5401
Asst..Secretary: Ron Coat VK5RV
Phone 8296 6681

Public Transport : Bus 243 Stop 24
Ray Deane ,Honorary Secretary

ADVERTISERS INDEX

Com-an-tena.....	41
G & C Communications.....	14
Icom.....	OBC
Strictly Ham.....	8
TTS.....	16
connektron.....	27
WIA Call Book.....	IFC

TRADE PRACTICES ACT

It is impossible for us to ensure that the advertisements submitted for publication comply with the Trade Practices Act 1974. Therefore, advertisers and advertising agents will appreciate the absolute need for themselves to ensure that the provisions of the Act are strictly complied with.

VICTORIAN CONSUMER AFFAIRS ACT

All advertisers are advised that advertisements containing only a PO Box number as the address cannot be accepted without the addition of the business address of the box-holder or seller of the goods.

THE WIA BOOKSHOP

DISCOUNTS FOR WIA MEMBERS

ARRL

RSQB

EDUCATIONAL

CALLBOOKS

COMPREHENSIVE RANGE

109 Wigram Street, Parramatta, New South Wales, Australia. PO Box 432, Harris Park, NSW, Australia 2150. Phone: +61 2 9689-2417, Facsimile: +61 2 9633-1525 Toll free in New South Wales outside Sydney: 1800 817-644 Office Open 11am - 2pm Tuesdays & Thursdays Email: vk2wl@ozemail.com.au Web <http://www.ozemail.com.au/~vk2wl> We take mail, phone, email and fax orders

"Hey, Old Timer..."

If you have been licensed for more than 25 years you are invited to join the



Radio Amateurs Old Timers Club Australia

or if you have been licensed for less than 25 but more than ten years, you are invited to become an Associate Member of the RAOTC.

In either case a \$5.00 joining fee plus \$8.00 for one year or \$15.00 for two years gets you two interesting OTN Journals a year plus good fellowship.

Write to

RAOTC,
3/237 Bluff Road
Sandringham VIC 3191

or call Arthur VK3VQ on 03 9598 4262 or Allan VK3AMD on 03 9570 4610, for an application form.

Email your hamad

Then we just cut and paste.

*You proof it,
you retain control.*



Division Directory

The Amateur Radio Service exists for the purpose of self training, intercommunication and technical investigation. It is carried out by amateurs who are duly authorised people interested in radio technique solely with a personal aim and without pecuniary interest.

The Wireless Institute of Australia represents the interests of all radio amateurs throughout Australia. National representation is handled by the executive office under council direction. There is one councillor for each of the seven Divisions. This directory lists all the Divisional offices, broadcast schedules and subscription rates. All enquiries should be directed to your local Division.

Broadcast schedules All frequencies MHz. All times are local.

VK1 Division Australian Capital Territory,
GPO Box 600, Canberra ACT 2601
President Gilbert Hughes
Secretary Peter Kloppenburg
Treasurer Linden S Orr

VK1GH
VK1CPK
VK1LSO

VK1WI: 3.590 LSB, 146.950 FM each Thursday evening from 8.00pm local time. The broadcast text is available on packet, on Internet [aus.radio.amateur.misc](http://www.vk1.wia.ampr.org) news group, and on the VK1 Home Page <http://www.vk1.wia.ampr.org>

Annual Membership Fees. Full \$80.00 Pensioner or student \$71.00. Without *Amateur Radio* \$48.00

VK2 Division New South Wales
109 Wigram St, Parramatta NSW
(PO Box 432, Harris Park, 2150)
(Office hours Mon-Fri 1100-1400)
Phone 02 9689 2417
Web: <http://www.ozemail.com.au/~vk2wi>
Freecall 1800 817 644
e-mail: vk2wi@ozemail.com.au
Fax 02 9633 1525

President Terry Davies
Secretary Pat Leeper
Treasurer Chris Minahan

VK2KDK
VK2JPA
VK2EJ

From VK2WI 1.845, 3.595, 7.146*, 10.125, 14.160, 24.950, 28.320, 29.120, 52.120, 52.525, 144.150, 147.000, 438.525, 1281.750 (* morning only) with relays to some of 18.120, 21.170, 584.750 ATV sound. Many country regions relay on 2 m or 70 cm repeaters. Sunday at 1000 and 1930. Highlights included in VK2AWX Newcastle news, Monday 1930 on 3.593 plus 10 m, 2 m, 70 cm, 23 cm. The broadcast text is available on the Internet newsgroup [aus.radio.amateur.misc](http://www.vk1.wia.ampr.org), and on packet radio.

Annual Membership Fees. Full \$80.00 Pensioner or student \$63.00. Without *Amateur Radio* \$50.00

VK3 Division Victoria
40G Victory Boulevard Ashburton VIC 3147
(Office hours Tue 10.00 -2.30)
Phone 03 9885 9261
Web: <http://www.wiavic.org.au>
Fax 03 9885 9298
e-mail: wiavic@wiavic.org.au

President Jim Linton
Secretary John Brown
Treasurer Barry Wilton

VK3PC
VK3JJB
VK3XV

VK3BWI broadcasts on the 1st Sunday of the month at 20.00hrs Primary frequencies, 3.615 DSB, 7.085 LSB, and FM(R)s VK3RML 146.700, VK3RMM 147.250, VK3RWG 147.225, and 70 cm FM(R)s VK3ROU 438.225, and VK3RMU 438.075. Major news under call VK3ZWI on Victorian packet BBS and WIA VIC Web Site.

Annual Membership Fees. Full \$83.00 Pensioner or student \$67.00. Without *Amateur Radio* \$51.00

VK4 Division Queensland
PO Box 199, Wavell Heights, Old. 4012
Phone 07 3221 9377
e-mail: office@wiaq.powen.jp.com.au
Fax 07 3266 4929
Web: <http://www.wia.org.au/vk4>

President Ewan McLeod
Secretary Bob Cumming
Treasurer Bill McDermott

VK4ERM
VK4YBN
VK4AZM

VK4WIA broadcasts on 1.825 MHz SSB, 3.605 MHz SSB, 7.118 MHz SSB, 10.135 MHz SSB, 14.342 MHz SSB, 21.175 MHz SSB, 28.400 MHz SSB, 29.680 MHz FM (rptr), 147.000 MHz, and 438.525 MHz (in the Brisbane region, and on regional VHF/UHF repeaters) at 0900 hrs K every Sunday morning. QNEWS is repeated Monday evenings, at 19.30 hrs K, on 3.605 MHz SSB and 147.000 MHz FM. On Sunday evenings, at 18.45 hrs K on 3.605SSB and 147.000 FM, a repeat of the previous week's edition of QNEWS is broadcast. Broadcast news in text form on packet is available under WIAQ@VKNET. QNEWS Text and real audio files available from the web site

Annual Membership Fees. Full \$95.00 Pensioner or student \$81.00. Without *Amateur Radio* \$69.00

VK5 Division South Australia and Northern Territory
(GPO Box 1234 Adelaide SA 5001)
Phone 08 8294-2992.
web: <http://www.sant.wia.org.au>
email: peter.reichelt@bigpond.com

President Trevor Quirk
Secretary Peter Reichelt
Treasurer Trevor Quirk

VK5ATQ
VK5APR
VK5ATQ

VK5WI: 1843 kHz AM, 3.550 MHz LSB, 7.095 AM, 14.175 USB, 28.470 USB, 53.100 FM, 147.000 FM Adelaide, 146.800 FM Mildura, 146.900 FM South East, 148.925 FM Central North, 438.475 FM Adelaide North, ATV Ch 35 579.250 Adelaide. (NT) 3.555 LSB, 7.065 LSB, 10.125 USB, 146.700 FM, 0900 hrs Sunday. The repeat of the broadcast occurs Monday Nights at 1930hrs on 3585kHz and 146.675 MHz FM. The broadcast is available in 'RealAudio' format from the website at www.sant.wia.org.au/BroadcastPage area.

Annual Membership Fees. Full \$88.00 Pensioner or student \$73.00. Without *Amateur Radio* \$58.00

VK6 Division Western Australia
PO Box 10 West Perth WA 6872
Phone 08 9246 3642
Web: <http://www.wia.org.au/vk6>
e-mail: vk6wia@wia.org.au

President Neil Penfold
Secretary Roy Watkins
Treasurer Bruce Hedland-Thomas

VK6NE
VK6XV
VK6OO

VK6WIA: 146.700 FM(R) Perth at 0930hrs Sunday relayed on 1.865, 3.564, 7.075, 10.125, 14.116, 14.175, 21.185, 29.120 FM, 50.150 and 438.525 MHz, Country relays 3.582, 147.200 (R) Cataby, 147.350 (R) Busselton, 148.900 (R) Mt William (Bunbury), 147.000 (R) Katanning and 147.250 (R) Mt Saddleback. Broadcast repeated on 146.700 at 1900 hrs Sunday relayed on 1.865, 3.564 and 438.525 MHz : country relays on 146.900, 147.000, 147.200, 147.250 and 147.350 MHz. Also in "Real Audio" format from the VK6 WIA website

Annual Membership Fees. Full \$71.00 Pensioner or student \$65.00. Without *Amateur Radio* \$39.00

VK7 Division Tasmania
PO Box 371 Hobart TAS 7001
Phone 03 6234 3553 (BH)
Web: <http://www.tased.edu.au/tasonline/vk7wia>
also through <http://www.wia.org.au/vk7>
email: batesjw@netspace.net.au

President Mike Jenner
Secretary John Bates
Treasurer John Bates

VK7FB
VK7RT
VK7RT

VK7WI: 146.700 MHz FM (VK7RHT) at 0930 hrs Sunday relayed on 147.000 (VK7RAA), 146.725 (VK7RNE), 146.625 (VK7RMD), 3.570, 7.090, 14.130, 52.100, 144.150 (Hobart), repeated Tues 3.590 at 1930 hrs.

Annual Membership Fees. Full \$90.00 Pensioner or student \$77.00. Without *Amateur Radio* \$57.00

VK8 Northern Territory is part of the VK5 Division and relays broadcasts from VK5 as shown, received on 14 or 28 MHz. The broadcast is downloaded via the Internet.

Antenna at VK3MO



Ian Williams VK3MO has always been a big antenna enthusiast. His latest effort is the biggest yet. There are four, four element wide spaced quads stacked with the top one at just under 200 feet. The quads can be selected individually or all four together. Ian calculates the gain at just less than 20dbi.

The entire tower rotates and has a total weight of eight tons. The system works on 20 metres only. It is most likely the biggest amateur antenna in Australia and certainly one of the biggest in the world.

Photographs Ron Fisher VK3OM



ICOM'S GREAT CHAMPIONS



**NO
FILTERS
REQUIRED**

IC-7400 (746 PRO)

- Sharp & soft IF filter shape • 100W HF /6m /2m • Digital twin PBT
- DSP • SSB / CW synchronous tuning • Built in antenna tuner
- RTTY demod / decoder • Digital RF speech processor
- Microphone equaliser.



IC-910H The new dimension in the VHF/UHF world!

- Tri band multimode transceiver • 2M - 100W, 70CM - 75W, (optional 23CM, 10W) • 9600bps packet operation • Satellite communication Reverse/normal tracking doppler shift compensation
- CIV capability for PC control • Optional 2.4G down converter.



IC-718 A compact HF all band transceiver.

- A superior performer with simple, straightforward operation with keypad • Optional AF DSP capabilities, including noise reduction & auto notch function • It's versatile, compact & loaded with features.



IC-706MKIIG HF • VHF UHF

The amazing evolution of the legendary 706.

- Now includes 70cm @ 20W and 50W on 2m
- Standard feature dsp • Built in sub tone encoder & decoder
- Tone scan • MosFET PA • You get base station performance and features in a mobile rig sized package.

IC-T90A A new 5W Triband handheld

- VHF/UHF FM 2M, 6M, & 70CM
- Wideband receive 495 KHz - 1 GHz
- 555 Alphanumeric memories • 13 Scan modes
- DTCS & CTCSS encode & decode
- DTMF encoder (10 memones)
- Wide/narrow transmit capability.



ICOM

Clearly Ahead

2 YR WARRANTY

find your nearest ICOM dealer at

www.icom.net.au or (03) 9387 0666

The magazine for **AUSTRALIAN** Amateurs



October 2002
Volume 70 No 10



Amateur Radio

\$ 5.95

Winner!

2001 Amateur Radio

Technical Award



A Simple HF Signal Source

by **Diamond VK6XU**

The QRP
(Quite Reasonably Priced)
Keyer

Zener Diodes:
still useful

Low Loss Current Mode Balun
for 1.8 - 30 MHz

Dr Wally Howse VK6KZ

wins with his article

"VHF, UHF and microwave propagation and The Great Australian Bight"

— AR March 2001

What does a **Centurion tank**, **Seacat destroyer**, searching for the origins of the universe, and the **human larynx** have in common?

They were all part of a unique mix of presentations given at

ISSN 0002-6859

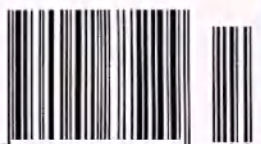

9 770002 4685109 10

GippsTech2002

Callbook 2003 We're different this time!

We are doing it digitally, **and** as a bound copy. Callbook 2003 will have 180 pages containing all of the information required by Australian amateurs close to hand.

 And as a special bonus we will be offering extra information on the disc!

The Book

The bound book will be the full edition callbook with all of the VK callsigns listed in a cleaned-up and easy read form. Also in the book will be pages of information about beacons and packets and rules and regulations and repeaters and frequencies and bands and a thousand and one other useful bits of information. All in a clear, logical book that could take pride of place in your shack or on your bookcase.

The Disc

This will have all the information that is in the book and two great extra benefits.

It will carry a comprehensive amount of printable Greater Circle information and best of all—

 **It's searchable by any parameter.**

Which means you can >FIND> any bit of the detail in any list to get the full detail of what you want to know.

For instance, Do you want to check which amateurs live near you? Easy, ask the program to >FIND> your postcode or the ones around you.

Its also a lot cheaper and more convenient than constantly dialling up the internet, and the callsign information is presented much more conveniently.

We also intend to offer the disc at a lesser price than the book and also offer a special deal on buying the book and the disc as a set.

Look for full details in November's  Amateur Radio

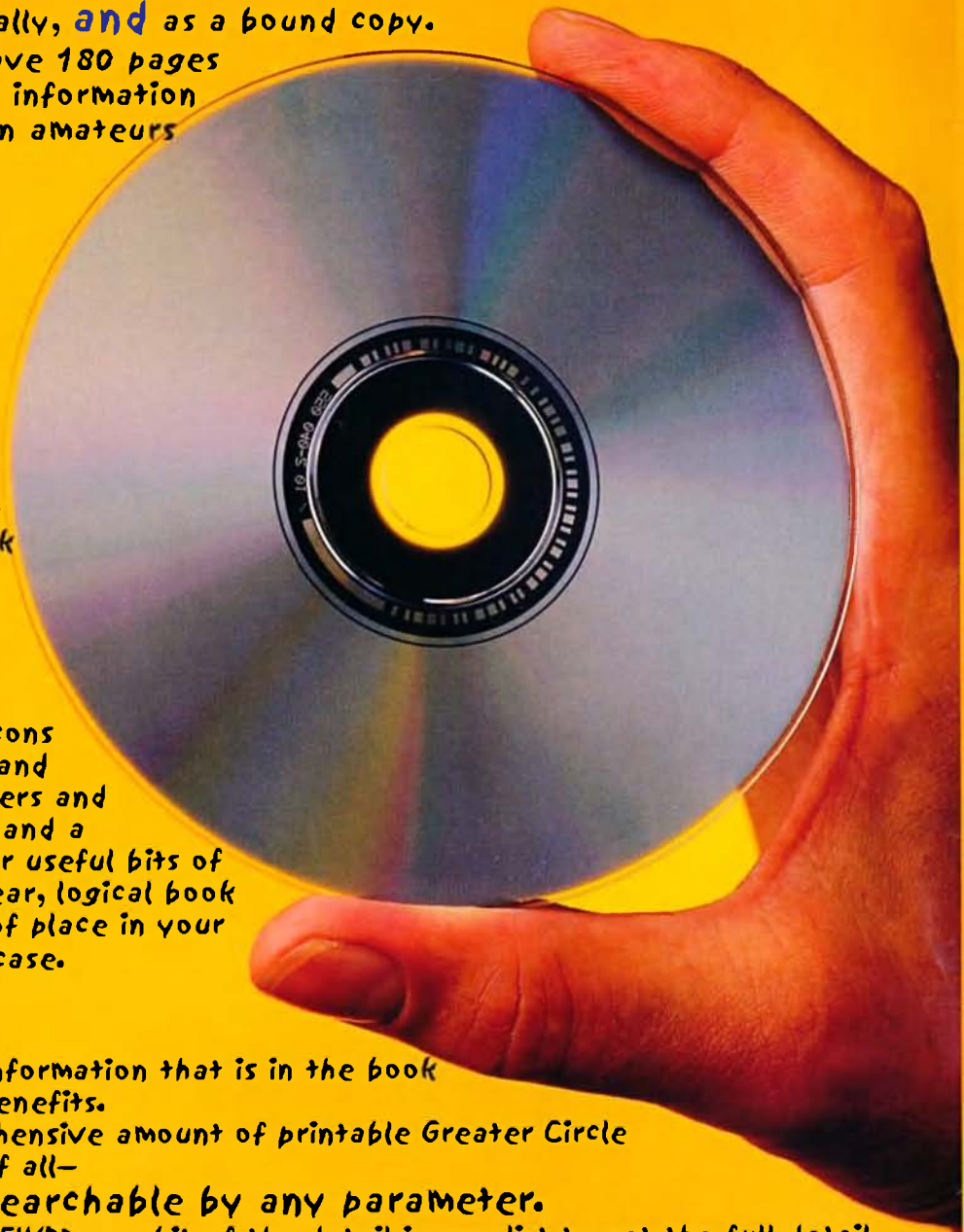



Amateur Radio

The Journal of the Wireless
Institute of Australia
ISSN 0002-6859

Editorial

Editor: Colwyn Low VK5UE
edarmag@chariot.net.au

Technical Editor: Peter Gibson VK3AZL

Publications Committee Members
Ron Fisher VK3OM
Don Jackson VK3DBB
Evan Jarman VK3ANI
Bill Rice VK3ABP
Gil Sones VK3AUI
Bill Roper VK3BR

Advertising

Mrs June Fox,
Tel: (03) 9528 5962

Hamads

"Hamads" Newsletters Unlimited
PO Box 431, Monbulk Vic 3793
Fax: 03 9756 7031
e-mail: newsletters@ozemail.com.au

Office

10/229 Balaclava Road
Caulfield, Victoria
Telephone (03) 9528 5962
Facsimile (03) 9523 8191

Business Hours 9:30am to 3:00pm weekdays

Postal

The Editor AR
34 Hawker Crescent
Elizabeth East
South Australia 5112
Email edarmag@chariot.net.au

Production

Newsletters Unlimited 03 9756 7797

Printer

Streamline Press, Melbourne (03) 9417 2766

Postal Service

IMS (03) 9291 5888

Production Deadlines

Advertising booking and articles for
publication 10th of preceding month.

Hamads and advertising material deadline
18th day of preceding month

The contents of Amateur Radio are Copyright
Wireless Institute of Australia © 2002

General

International Pharmacists Ham Group	7
<i>Andrea Paglula IZ7ECB,</i>	
New Guinea Engineer. The Memoirs of Les Bell M.B.E.	11
<i>Gillian Heming Shadbolt</i>	
GippsTech2002 – radio amateur education PLUS+	12
<i>Jim Linton VK3PC</i>	
Novice Cram Course. A Review	15
<i>C. Low VK5UE, B. Edmonds VK3KT and C. Taylor VK5CTY</i>	
Novice Cram Course Review. Ron Bertrand replies	17
Dr Wally Howse VK6KZ wins AR Technical Award	23
<i>Cover Story</i>	
Book Review: A radio active life	44

Technical

A Simple HF Signal Source	4
<i>Drew Diamond, VK3XU</i>	
Low Loss Current Mode Balun For 1.8 –30 MHz	9
<i>Peter Woodland VK3ZPW</i>	
The QRP (Quite Reasonably Priced) Keyer	10
<i>Keith Sherlock, VK2WO. QTHR</i>	
Zener Diodes: still useful	18
<i>Lloyd Butler VK5BR</i>	
Linear Loaded Dipole (Technical Abstracts)	20
<i>Gil Sones VK3AUI</i>	
Making An LEO Audible (Technical Abstracts)	21
<i>Gil Sones VK3AUI</i>	
Blu Tack Swarf Catcher (Technical Abstracts)	43
<i>Gil Sones VK3AUI</i>	
Power Line Monitor	22
<i>Wim van den Broek PA0JEB, translated by VK3BHW.</i>	

Columns

Advertisers' Index	55	Gridsquare standings	30
ALARA	26	Hamads	54
AMSAT	34	Ham Shack Computers	39
Beyond Our Shores	27	HF Predictions	48
Contests	41	How's DX?	36
Club News	24	Over to you	51
WIA Division News		Silent Key	29
VK1 Notes	31	Spotlight on SWLing	28
VK2 Notes	32	Technical Abstracts	26, 27, 29
VK4 Notes	33	VHF/UHF – An Expanding World	46
VK6 Notes	31	WIA Comment	3
VK7 Notes	32	WIA Division Directory	56
Editor's Comment	2	WIA Federal Directory	2
Education Corner	45		

Our cover this month

see story page 23

Contributions to Amateur Radio

Amateur Radio is a forum for WIA members' amateur radio experiments, experiences opinions and news. Manuscripts with drawings and or photos are always welcome and will be considered for publication. Articles on disc or email are especially welcome. The WIA cannot be responsible for loss or damage to any material. A pamphlet, How to write for Amateur Radio is available from the Federal Office on receipt of a stamped self-addressed envelope.

Back Issues

Back issues are available directly from the WIA Federal Office (until stocks are exhausted), at \$4.00 each (including postage within Australia) to members.

Photostat copies

When back issues are no longer available, photocopies of articles are available to members at \$2.50 each (plus an additional \$2 for each additional issue in which the article appears).

Disclaimer

The opinions expressed in this publication do not necessarily reflect the official view of the WIA and the WIA cannot be held responsible for incorrect information published.

Amateur Radio Service

A radiocommunication service for the purpose of self-training, intercommunication and technical investigation carried out by amateurs; that is, by duly authorised persons interested in radio technique solely with a personal aim and without pecuniary interest.

Wireless Institute of Australia

The world's first and oldest
National Radio Society
Founded 1910

Representing

The Australian Amateur Radio Service

Member of the

International Amateur Radio Union

Registered Federal Office of the WIA

10/229 Balacraiva Road
Caulfield North Vic 3161

Tel: (03) 9528 5962 Fax (03) 9523 8191
<http://www.wia.org.au>

All mail to
PO Box 2175 Caulfield Junction VIC 3161

Business hours: 9.30am-3pm weekdays

Federal Secretary

Peter Nalsh VK2BPN

Federal Office staff

Jane Fox Bookkeeper
Rita Trebilco VK3IF Examinations Officer

Council

President	Ernest Hocking	VK1LK
VK1 Federal Councillor	Gilbert Hughes	VK1GH
VK2 Federal Councillor	Barry White	VK2AAB
VK3 Federal Councillor	Jim Linton	VK3PC
VK4 Federal Councillor	David Jones	VK4OF
VK5 Federal Councillor	David Box	VK5OV
VK6 Federal Councillor	Wili McGhie	VK6UU
VK7 Federal Councillor	Phil Corby	VK7ZAX

Executive

Brenda Edmonds
David Pilley
Don Wilachetaki

VK3KT
VK2AYD
VK4BY

Federal Coordinators

AMSAT	Graham Rateliff	VK5AGR
ARDF	Jack Bramham	VK3WWW
Awards	Mal Johnson	VK8LC
Contests	Ian Godall	VK3VP
Education	Ron Smith	VK4AGS
FTAC	John Martin	VK3KWA
Historian	John Edmonds	VK3AFU
YARU	Neil Penfold	VK8NE
Intruder Watch	Harry Anderson	VK8HA
International Travel Host	John Miller	VK3DJM
ITU Conference and study group	Gilbert Hughes	VK1GH
QSL Manager (VKs, VKs)	Neil Penfold	VK8NE
Videotapes	VK2 Division	
Web	Joe Burford	VK6UJ
WICEN	John Walr	VK3ZR

ACA Liaison Team

Glen Dunstan VK4DU (Corresponding)
Gilbert Hughes VK1GH
Keith Malcolm VK1ZKM
Peter Nalsh VK2BPN

Editorial Comment

Colwyn Low VK5UE

What is Amateur radio today?

I think this is no longer a simple question. There are some things those of us who are over 50 think should be included in any list. Radio waves and communication. Those of us in this group may think that the amateur radio activity has to be radio waves from beginning to end. If we feel we should only stick with the essence of amateur radio maybe we are painting ourselves into a corner with spark transmitters, coherer detectors and morse code. If we agree that we should move with the time and the technology that develops then amateur radio is no longer just radio waves in the air. It is a lot of other means of communication as well. To day we use Internet to arrange skeds to learn about Dxpeditons and be informed of special propagation opportunities for microwave communications. We could do it years ago with snail mail and telephones.

What makes using the Internet, computers and satelites not amateur radio?

These questions need to be discussed as we move to new licencing conditions. What are the important things to know about communications using all things electronic? Is it more important to know in great detail how our transceiver does function inside or how to use it properly to establish communication and not cause interference? If we start people at the know how to do it stage, we can teach them the greater detail later.

Amateur radio has always been radio waves plus something. Today's something is so large most of us only fully comprehend part of it. As long as

we have a good working knowledge of the equipment we use and the modes it works with, we should be accepted as amateurs. Just because we do not use a mode or particular part of the spectrum does not make us any less an amateur. I keep thinking the next few months are when I will get into digital modes, but I do not. My current excuse is that things are changing so quickly I will wait until one standard is supreme. This of course means I will never start. What I really have to do is get a sound card in the packet computer and take it to the shack with the trusty FT101 and actually work PSK31 or what ever. Maybe if I get a month off over Christmas I WILL DO IT.

The September issue got very late from a whole lot of sequential small delays. Hopefully this issue is much earlier and we can keep to a better schedule. The main requirement is that all columns, advertisements and OTU letters are with me by 10th preceding month.

We hope to produce a 64 page issue in December and then a January - February issue in late January. Producing this magazine over Christmas is just about impossible.

There have been several discussions within the Publications Committee about the quality of the magazine with regard to cover photograph definition, the quality of the inside paper and how the printed material looks. At present we are producing the magazine for a minimal cost per copy distributed. Any change would put a significant cost increase in the delivered cost. As we already have members not receiving AR because of cost and members complaining about the WIA subscription and what they get for it. I wonder if it is prudent to chase an upgrade in the look of AR if it only comes with an increased price tag and no other changes.

email address for contributions:

edarmag@chariot.net.au

The Foundation Licence and the future of Amateur Radio

Since last months notes a large amount of my time has been devoted to thinking about the future of amateur radio. Two things have been in my thoughts during this time. The first is that in these times of budgetary constraint many organisations are looking carefully at how they conduct their business. We already know that the ACA is being forced to examine their operations in order to focus on delivering key Government initiatives. As a result many aspects of their business is being devolved to deregulated markets and what remains is being stream lined to seek efficiency gains. Second is an observation that today's workplace seems to demand more and more from us with the result that many of us no longer seem to have the time to devote to hobbies and other community activities. In this sort of environment what is the future role of amateur radio in today's society. What do we want from amateur radio in the future?

Convergence

We increasingly see the convergence of radio and IT. In fact Government now lumps the two together under the heading of the Information and Communications Technology (ICT) banner. On a day-to-day basis we see the impact of this convergence on amateur radio. Already Internet linking is commonplace, most of the radios that we buy today can be described as coming under the heading of "Software Defined Radio (SDR) where it is the computer programs that determine the characteristics of the radio more so that the electronics within it. Throughout Australia many community groups are using the Industrial and Scientific allocations of frequencies in the 2.4 GHz band to experiment with linking together computers using Wireless LANs. Many of this new wave of experimenters know lots about computers but little about radio. We

should be encouraging them to join our hobby and share in the enjoyment and challenges that are on offer. Radio is changing and we as amateurs need to change in order to attract new entrants into the hobby.

Overseas activities

The activities of the Radio Society of Great Britain (RSGB) and the UK Radio Communications Authority (RA) in developing and promoting the adoption of an entry level or Foundation licence have already been widely publicised. After the initial flurry of activities that these new licences created their real importance is beginning to emerge. It will however be a while before the full impact of the licence on the future of amateur radio is fully known. However the important lesson that I believe we need to learn here in Australia is that we need to change and adapt to a changing environment. It is no good resting on our laurels and assuming that the next generation of amateurs will simply "appear out of the wood work".

If we accept that changes to the current amateur licence are required in order to attract the next generation of amateurs then the first question we need to ask is what form would such a licence take. "Ah ha" I hear you say that's what the Novice licence is for. Whilst I'm sure that that was the intention at the time that it was introduced there is today much evidence that the current Novice licence has failed at attracting new entrants to the hobby of amateur radio.

The form of an Australian Entry Level licence

Many of you will make the observation that you have worked extremely hard to obtain your licence. I can only agree with this but note that today's examination is a far cry from the examinations run before 1980 when the theory examination was about being able to recreate and analyse complex valve circuits. So things have already changed, and we can be certain that they will

continue to change. The question I would ask is can we afford not to make amateur radio accessible to a new generation of builders and operators.

If we accept that we need to adapt and lobby the ACA to adopt a new licence aimed at attracting new entrants into the hobby then the next question to ask is what form should it take. There are of course many approaches to this including:

1. Remain with the current licence arrangements but change the entry and examination requirements.
2. Introduce a new licence category aimed at the next generation of amateurs with privileges and entry requirements in line with modern education and technology practices

I would encourage all of you to review the UK Foundation licence, speak to potential amateurs of the future and form your own opinions.

Conclusion

I personally believe that the amateur radio community needs to accept the need for change and embrace the adoption of a new amateur radio licence. In order for this to happen there are two things that I would ask from you. The first is to think about what it is that you believe would make an entry level licence attractive to newcomers as well as acceptable to you. Secondly I would ask that you take the time to tell the WIA about your thoughts on this important issue. This means telling you local WIA Divisional representatives, and writing directly to me. If we can get the future licensing and entry requirements right then amateur radio has a very bright future in Australia. If we don't then the membership and licensing statistics already tell us clearly that within a generation amateur radio will be a thing of the past. So please take the time to think about this matter and please, please tell us about your conclusions.

So with this call to action I will say goodbye for this months notes and wish you all well until next month.

73s de Ernest Hocking VKILK

ar

A Simple HF Signal Source

Drew Diamond, VK3XU
45 Gatters Rd.,
Wonga Park, 3115.

A signal generator is one of the most useful tools in receiver tests, and finds application in a wide range of tasks. Since the greater portion of QRP and experimental work apparently occurs on the popular "harmonic" bands of 3.5, 7, 14, 21 and 28 MHz, it was decided to make a handy little signal source to cover these frequencies.



Photo 1. Simple Signal Source

Circuit

Fortuitously, an ordinary, cheap 3.58 MHz ceramic resonator may be powered by an MPF 102 FET in a variable crystal oscillator (VXO) circuit to provide a stable signal which is adjustable from about 3.5 to 3.6 MHz (Fig. 1). The oscillator signal is fed to one gate of a 74HC04 hex-inverter chip, biased with a 100 k resistor for linear operation, then buffered by the second inverter, whose output is applied to the remaining four gates, all wired in parallel to form the output amplifier. The 100 nF coupling capacitor and two 100 ohm resistors effectively configure the generator's

output impedance to about 50 ohm. The 1 V peak-peak square wave thus obtained is rich in harmonics, right up through 28 MHz.

To obtain an 'equivalent' microvolt or sub-microvolt level for receiver sensitivity tests, our square-wave signal must be passed through an appropriate attenuator, typically about 70 to 100 dB. An attenuator similar to that described in Ref. 1 or 2 is suggested as an essential aid to small-signal work.

Construction

For coax connected microvolt tests, the oscillator must be housed in an RF-tight metal box. Aluminium or continuously soldered double-sided printed board is suggested. The homemade box of the prototype, pictured in Photo 1, measures 150 x 75 x 65 mm WHD, but any metal box of similar dimensions would do.

A suggested 'paddyboard' (Ref. 3) circuit board layout is shown in Photo 2, and

Fig. 2. The 74HC04 chip is fitted into a 14-pin DIL IC socket, which in turn is soldered- using tinned copper wires of about 0.6 mm, upon a segmented substrate measuring 25 x 30 mm. However any preferred wiring method- including 'ugly' style should work satisfactorily, provided that component leads are made reasonably short.

The variable capacitor may be a physically small 300 (95 plus 205) or 450 pF part. To prevent signal leakage, the capacitor's shaft should not protrude from the box, so some kind of internal dial is recommended. My drum dial consists of a rectangle of thin aluminium sheet fixed with c'sunk wood-screws upon a cylinder of wood (e.g. chipboard) made with a hole-saw (visible in Photo 4). The 0.25" hole produced by the pilot drill of the 'saw is a good friction fit onto the variable capacitor shaft. A 0.25" plastic extension (#3 knitting needle) is fitted into the other end of the cylinder for attachment of a suitable knob. The dial assembly should be white undercoated to receive suitable calibrations.

The stability of the ceramic resonator may be significantly improved by increasing its thermal mass. One method

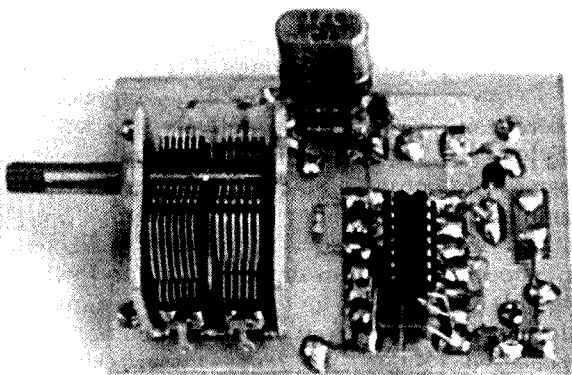

Photo 2. Circuit Board

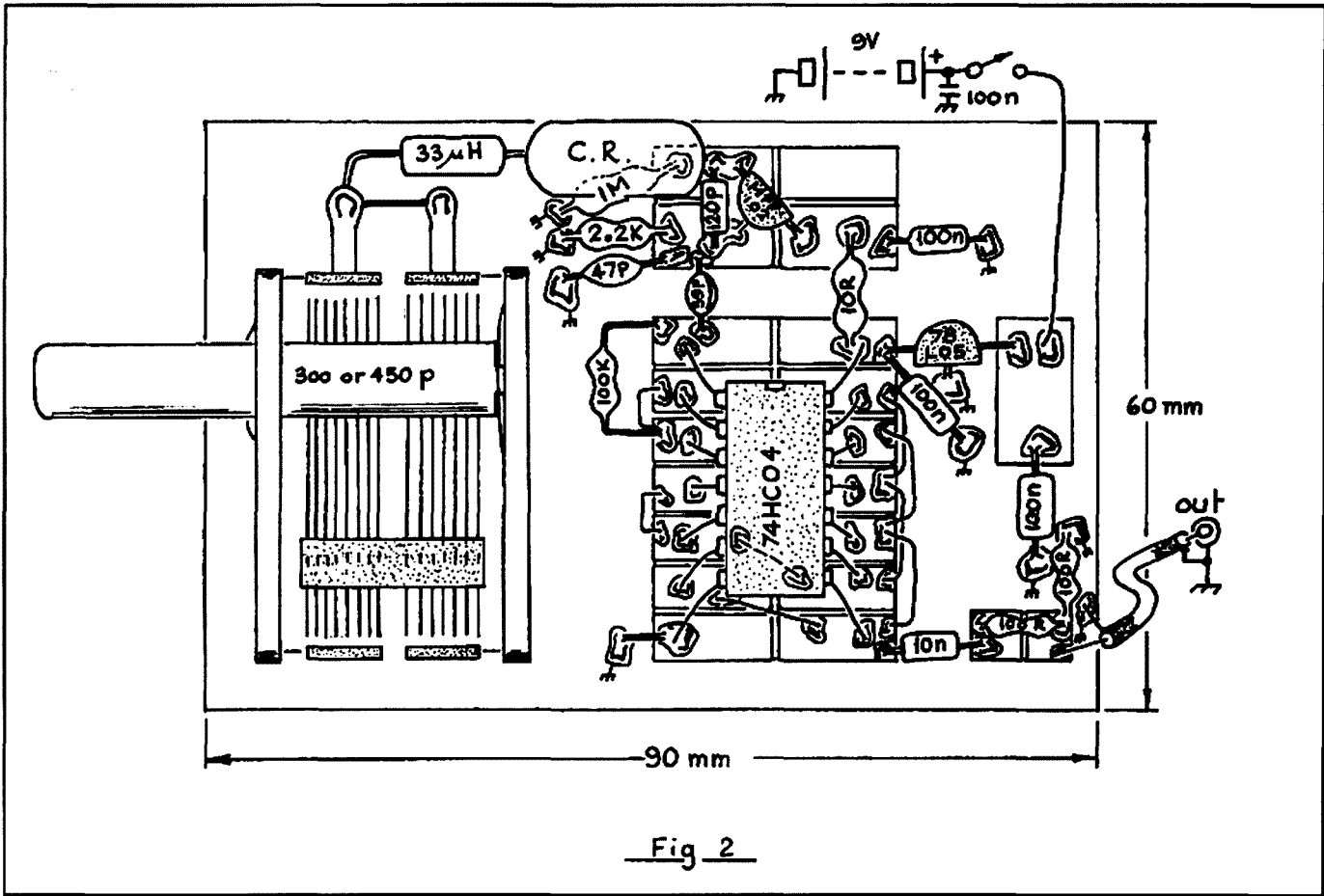

Fig 2

Figure 2

is to enclose the device inside a style 'D' crystal case. Using long-nose pliers, grip a defunct/unwanted crystal by its pins, and grip the case top with a second pair of pliers. Heat the case in a gas flame. After a few seconds, the solder will melt, allowing the top of the case to be separated from the base. Remove the fine wires which attach to the quartz plate, then, using new fine tinned wires (about 0.6 mm) attach the ceramic resonator, as depicted in Photo 3. Fill the inside of the case with petroleum jelly, then re-attach the case top. Some grease may ooze out of the join during

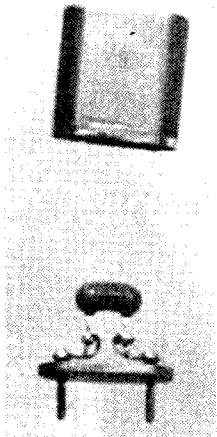

Photo 3. Modified crystal

soldering, but it does not interfere with the job.

Depending upon preference, the 9 V 'transistor' battery may be fitted internal or external to the box. An external holder has been fitted for the prototype, which does not measurably increase signal leakage provided that the positive battery tag of the holder is by-passed to chassis ground with a 100 nF ceramic or monolithic capacitor, and the negative tag is also grounded right there where the tags poke through the box wall.

Calibration and Operation

Before switch on, check again the accuracy of your wiring, and that the 74HC04, 78L05 and FET are installed correctly. If an oscilloscope is available, connect the signal source to the 'scope input using a 50 ohm cable. A suitable 50 ohm through termination must be connected to the 'scope input to get a good picture of the output wave-shape, which should be a fair square-wave of

about 1 V p-p. No 'scope? Apply a screwdriver blade to the output connector (to act as small radiator) and listen for the signal on the station receiver. You should be able to vary the signal frequency between about 3.5 and 3.6 MHz. When all is well, with the means available to you, calibrate the dial scale; a single line cal point serves (for example) 3.500-7.000-14.000-21.000-28.000, then 3.510-7.020-14.040-21.060-28.080, and so on.

When performing weak/small signal receiver tests, a 10 dB/step 100 dB attenuator (Refs. 1 and 2) must be interposed between the signal source and receiver input in a 'coax' set-up. If you can plainly hear the 3.5 MHz signal with -100 dB in line, and -70 dB on the higher bands, then the receiver's sensitivity is well down into the microvolt region, and probably sufficiently sensitive for all normal radio work.

Parts

Most of the components are available from our familiar electronics suppliers, including Altronics, DSE and Jaycar. Additionally, 3.58 MHz ceramic resonators may be purchased from Electronic World (03 9723 3860), or from suppliers to the TV service trade. I have a few spares, so if you have trouble purchasing one, please drop me a line at the address shown above. The 33 uH R.F.C. is a Jaycar P/N LF-1528.

References and Further Reading

1. *A Step Attenuator for Receiver Sensitivity Measurements*; Diamond, AR, Aug. '99.
2. *Test Equipment for the Radio Amateur*; C. Smith, G4FZH (Ed.); RSGB, p109.
3. *"Paddyboard" Circuit Construction*; Diamond, AR, Feb. '95.

ar

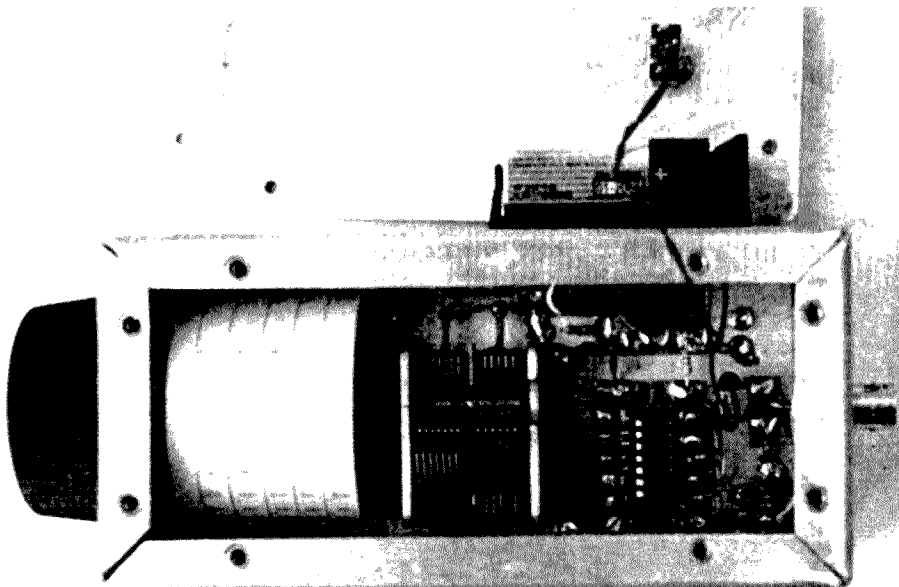

Photo 4. Internal view

International Pharmacists Ham Group

On March 18th, 2002 the I.P.H.G. was constituted to unite HAM Pharmacists, to promote radio-initiatives, to establish friendship and to help the people who need any possible aid the Group can provide. The Group is apolitical and does not recognize any difference of race or religion among its members.

<http://www.malpensa.it/iphg/index.htm>

Membership

The Membership is free and open to all those that are both Pharmacists and Radioamateurs over the world.

I.P.H.G. Story

The I.P.H.G. results from an idea of Andrea Pagliula, IZ7ECB and Pier Luigi Anzini, IK2UVR. Andrea, in early days of March 2002, made a search on internet inserting the keyword "Pharmacist". The search gave him many call-signs of OMs Pharmacists. Andrea sent them all an email with the intention of

establishing a Web Site on which to list all HAM Pharmacists over the world. He got many e-mails in return. After some trials, the Web Site was built, with a proper logo, a forum, and a page for each member. Recently the Site has moved on a new and stronger server. The original members were about 20, and many other still are joining the Group, from all the continents.

We would like to inform your members about I.P.H.G. by an article on your journal and by your links.

73 de Andrea Pagliula IZ7ECB,
IPHG # 001, Supervisor
International Pharmacists Ham Group

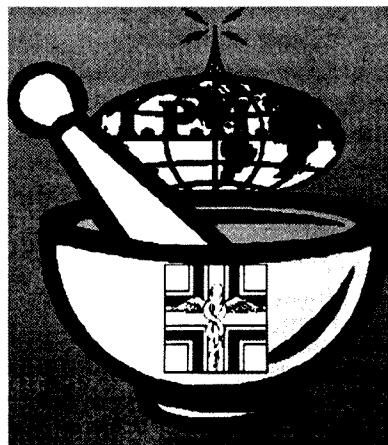

STRICTLY HAM

PTY LTD

★ TS-50

Mount it in a vehicle, take it on a DX-pedition or use it as a permanent base station transceiver. The easy-to-use menu system adds flexibility, stable operation in any situation.

- DDS with fuzzy control
- 100 Memory channels Outstanding performance



★ TH-D7A(G)

- Dual bander
- Effortless 2m & 70cm
- BUILT IN PACKET
- 200 alphanumeric memory channels
- 6W from 13.8VDC
- Comes with NiCd battery and charger
- APRS compatible



★ IC-756 PRO/II

Icom's new HF+50-MHz digital
The performance king Try it to see why

- Multi-colour multi-function screen

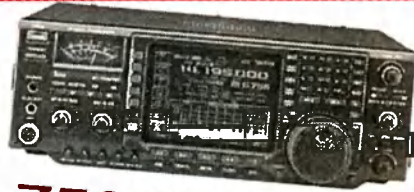

CABLE



★ IC-746 PRO

Icom WORK THE WORLD performance
The best way to get onto HF plus 6 and 2 metres

- Multifunction hi-res display
- Direct frequency
- Shack or portable

★ IC-2720H



Dual band mobile transceiver. VHF/VHF UHF/UHF or VHF/UHF simultaneous receive capability, independent tuning and packet communication. Colourful backlit LCD, stylish design

★ TS-2000

- Three operation platforms.
- 1 Traditional transceiver-full front panel.
- 2 "Silver box" for mobile use
- 3 ARCP-2000 computer control
- 100 watts on HF, 6 metres and 2 metres. 50 watts on 70cm.



★ IC-706MKIIG

Ultra SMALL

167(W) x 58 (H) x 200 (D), 2.45kg Detachable Control Panel/Display (optional equip. required for remote operation)
SSB/AM/CW/RTTY Narrow Filter Options



★ TM-D700A

Kenwood's new TM-D700A makes the most of exciting SSTV, GPS, and APRS® (Automatic Packet/Position Reporting System rapidly gaining popularity worldwide), Extra large amber and black display. Built-in TNC offers a wide range of options, inc. simple packet operation using AX.25

Ham radio is truly entering a new era.



SSHH...

Coming Soon
IT-R5

This little ripper handheld is so new we aren't allowed to tell you



about it on paper (but its an IC-R2 on steroids)

CALL US

ROTATORS

★ IC-T90A

50MHz, 144MHz, 430MHz multi band with 0.495-999.990MHz wide band receiver



5W output on 50MHz, 144MHz, 430MHz Li-Ion battery

Compact, rugged. Water resistant. Intuitive keypad, DTCS, CTCSS, pocket beep. Total 555 memory channels 14 high speed

Suppliers and distributors

KANTRONICS-MFJ-DIAMOND-MIRAGE-HY-GAIN-VECTRONICS

14 CHURCH ST BAYSWATER VIC 3153

Phone (03) 9729 7656

Fax (03) 9729 7422

email sales@strictlyham.com.au

www.strictlyham.com.au

Low Loss Current Mode Balun For 1.8 -30 MHz

By Peter Woodland VK3ZPW

This balun/choke design will give an impedance step up ratio of four times (1 : 4). Great for feeding a ladder line to an all band antenna like a G5RV or similar.

This design is a modified version of the Guanella current mode balun that has recently been made so popular.

It will cover the whole of HF with very little loss (below my measurement capabilities) or core heating for power levels up to around 500 watts.

Parts required are 4 high permeability manganese zinc ferrite "E" cores, 2 x 300mm lengths of 92 ohm coaxial cable, (lan cable) and some 5 minute epoxy.

Ferrites used are Neosid type F5, initial permeability (μ_i) 1600 and a saturation flux density (B_{sat}) of 470 milli Tesla (mT). Part number 32-110-25.

Any high permeability ferrite cores will work but there may be some trade off in certain areas of performance. Example- a pair of cores should have an effective magnetic path length of 97mm and an effective volume of 17600³mm. to give a 500 watt rating.

Putting it together

Glue the two halves of the E cores together and press together firmly so that most of the glue is squeezed out of the join. Let the glue dry.

Wind 5 turns of the coaxial cable though the core windows, and leave equal amounts of cable coming out. Do this on both sets of cores, strip the ends and solder as per the diagram. The link is only used to force a balance in respect to ground but is normally not needed.

Ralph VK1BRH supplied the schematic diagram.

For more information go to the web site of Ralph Holland VK1BRH. <http://www.arising.com.au/people/Holland/Ralph/CMBalun.htm>



Coax cable windings



Input and output wiring

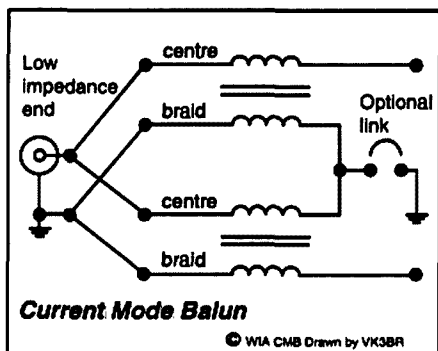

Schematic of the current mode balun

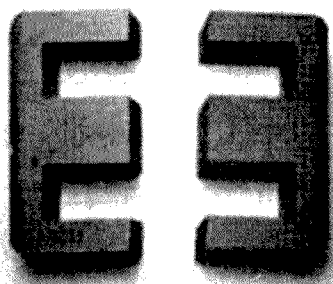

E Cores

Gold Coast Amateur Radio Club
25th HAMFESTival 2002
9th November

Albert Waterways Community Centre
Corner Hooker Boulevard and Sunshine Boulevard
Broadbeach

Apply to the Secretary
Sue Tomkins VK4VAA

Display tables still available \$15 prepaid or \$20 on the day. Car boot areas also available.

Directly west of Pacific Fair Shopping Centre Gold Coast. Phone: 07 5545 0955, email: bob.tomkins@bigpond.com

The QRP (Quite Reasonably Priced) Keyer

Keith Sherlock, VK2WO. QTHR

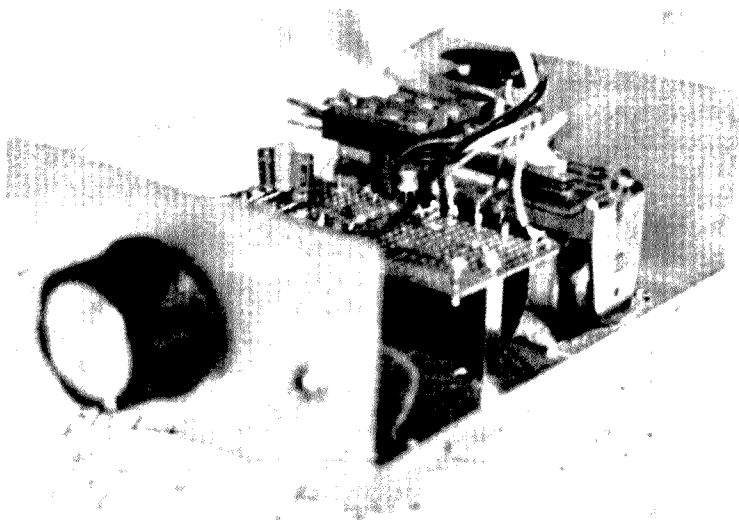

The 3000 type relay could justifiably be regarded as having been the backbone of most telecommunication facilities used during the period immediately following World War Two. Designed, I believe, by British Post Office engineers it was adapted to provide a multitude of functions. If there has not been a book written about it, then there should have been!

In Australia, STC, for example, must have produced the relays by the thousands, along with ancillary equipment. The keyer described requires a 12 volt 3000 type, or equivalent relay, with at least one

changeover contact set. It is also desirable that the relay armature be fitted with a bronze stud. The stud prevents ferrous-to-ferrous contact between armature and pole face in order to overcome "hang on".

The circuit makes no provision for timing those dot-length periods between elements of the morse letters. These are provided, however, by the dynamics of the relay. Without modification, modern miniature relays are quite unsuitable. Ideally, a 3000 type relay with a balanced pair of changeover contacts would be used. The operation is quite simple, but for those unfamiliar with such relay operation, the function is briefly as follows: With the paddle pushed, say to the dot contact, the 4.7µF capacitor charges within milliseconds. This now provides base current to the transistor, which operates the relay to close the keying circuit. At the same time the charging voltage is removed from the capacitor by the opening contact. However, the charged capacitor holds the relay in operation until such time as the discharge through the R network across the capacitor is sufficiently reduced. The relay then reverts to normality and the process begins again. So a series of dots continues as long as the paddle is held to the dot contact. The dashes are similarly formed. 3:1 dash-to-dot ratio may be adjusted to individual requirements by altering the capacitance values to suit. Modern

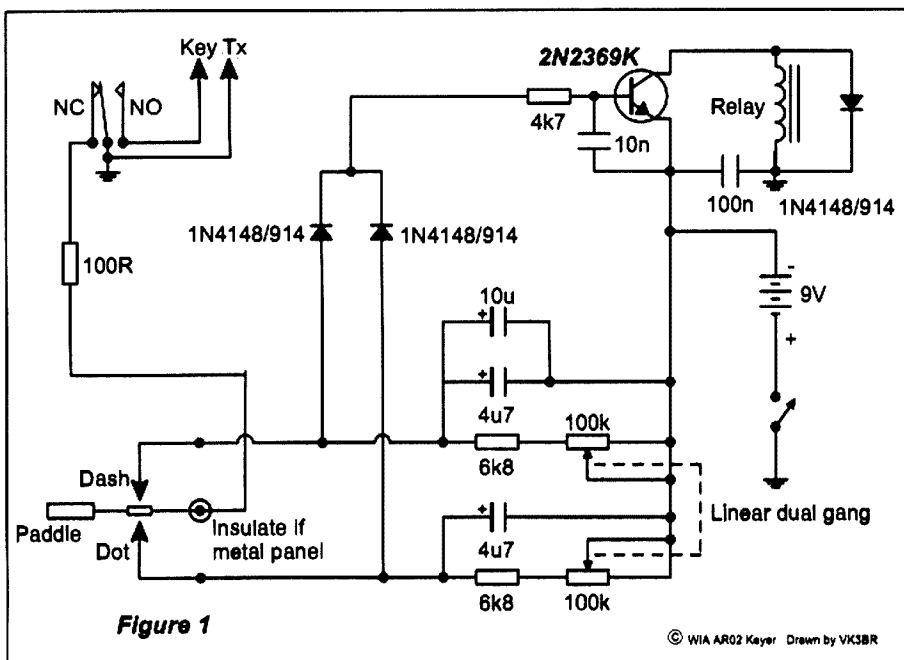

Figure 1

© WIA AR02 Keyer Drawn by VK5BR

Figure 1

New Guinea Engineer

The Memoirs of Les Bell M.B.E.

Gillian Heming Shadbolt

Wartime WW II Royal Australian Air Force Flying Officer Les Bell MBE recounts startling tales of settlement in Northern Queensland, the equatorial coconut and gold empires of German and Austalian New Guinea, and the country's island archipelagos.

In 1914 Les, aged 10, won his first Scout badge for collecting sugar bags for use in WWI but he valued most his introduction to Morse Code. As a radio amateur (ham) Les maintained contact with operators around the world, among others, from Stampede City, China, Japan and the Napier Women Operators Club in New Zealand. The American Radio Relay League Inc. honoured him with their highest A1 Operator Certificate. Les served in radar units in the Pacific war and won his MBE at the Battle of New Britain. In the war had killed Japanese but, in the peace that followed, he and his canny wife Bertha booked a tour of Japan and stayed 18 weeks.

In 1945 Les returned to Kavieng and cleared away daisy cutter bombs among the detritus of war. Retiring to

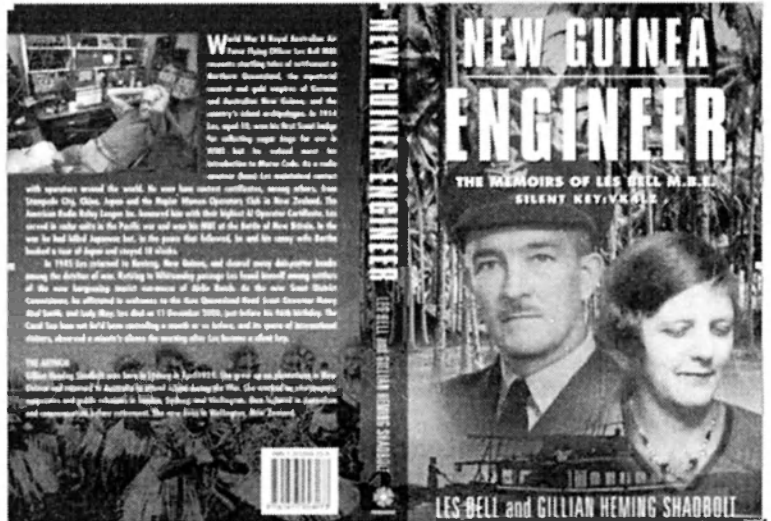

Whitsunday Passage Les found himself among settlers of the now burgeoning tourist sun-mecca of Airlie Beach. As the new Scout District Commissioner, he officiated in welcomes to the then Queensland Head Scout Governor Henry Abel Smith, and Lady May.

Les died on December 11, 2000—just before his 96 th birthday. The Coral Sea ham net he'd been controlling a month or so before, and its quota of international visitors, observed a

minute's silence the morning after Les became a silent key.

The Author

Gillian Heming Shadbolt was born in Sydney in April, 1929. She grew up on plantations in New Guinea and returned to Australia as a refugee. She worked on newspapers, magazines and public relations in London, Sydney, and Wellington, then lectured in journalism and communication before retirement.

ar

The QRP Keyer (continued)

electrolytic capacitors, with their remarkable capacitance values for so small a component, have leakages that equate to a few tens of thousands of ohms; so low-leakage types are desirable and have been found to meet requirements quite satisfactorily. A 100 ohm resistor is provided in consideration of both paddle and relay contacts. The 6.8 kohm resistors account for the highest operating speed and may be varied somewhat in order to set that speed. Reducing the resistor values increases the speed.

The transistor used is the 2N2369A

that is very much akin to the 2N2222A. Obviously there are many NPN types which would suit.

The circuit is essentially a monostable multivibrator with the "key up" condition as the stable state. With values shown, the keying speed ranges from about 12 to over 30 wpm.

The slow speed, however, is determined to a great extent by the electrolytic capacitor leakage.

The keyer allows the sending of eminently readable CW and indeed is almost "as good as a bought one". It has

a very desirable feature in that it is, compared with some purely electronic models, quite easy to use. That is, of course, due to the relatively gentle on/off functions of the relay.

The reverse diode across the relay winding takes care of the back e.m.f. and aids smooth relay operation.

This is an interesting home brew project for those who enjoy the "Gentlemen's mode" and is quite suitable for QRP portable operation.

ar

GippsTech2002

-radio amateur education PLUS+

By Jim Linton VK3PC

What does a Centurion tank, Seacat destroyer, searching for the origins of the universe, and the human larynx have in common?

Answer: They were all part of a unique mix of presentations given at GippsTech 2002.

This annual conference organised by the WIA Eastern Zone Amateur Radio Club (1) in Victoria has had its 5th and most successful conference in July.

A total of 106 (up from 57 in 2001) attended, 86 of these radio amateurs and experimenters, with 20 partners who sojourned through the Gippsland region under the guidance of Pauline Corrigan (partner of Tom Corrigan VK3XBG).

The Partners' Program is credited with making it possible for many Hams to attend, and it also appears that enthusiastic spouses, having attended once, want to repeat the experience resulting in "must attend" directives being issued in their households.



How it all began

Chairman of the organising committee, Peter Freeman VK3KAI backed up by a dedicated group of supporters has established a technical conference that primarily concerns weak-signal techniques, VHF, UHF and Microwave operation.

Peter VK3KAI explains that while WIA EZARC (formerly the WIA Victoria Eastern Zone established in 1938) held

traditional hamfests over many years, these were of mixed success.

About five years ago when the club committee was considering whether to hold another hamfest, he and Ralph Edgar VK3WRE suggested a technical conference, and GippsTech was born.

Being an observer of similar events in the United States through their printed proceedings, and aware of a couple of

technical gatherings in VK1 in the past, Peter VK3KAI had been thinking about the possibility of a local event for several years.

GippsTech itself has played a key role in promoting VHF, UHF and Microwave activity, helped to educate on weak signal techniques, been an avenue for the sharing of

information, and is here to stay hopefully for many years to come.

Among those attending were the leaders in their field of activity rubbing shoulders with those wanting to learn more, and a few who found parts of the event at the Churchill Campus of Monash University "too technical" or "too basic" – but you can't completely please everyone.

At the end of the conference all left feeling inspired. It was also an excellent eye-ball networking occasion, and the Saturday night annual dinner at Café Gaztromony in Morwell was packed.

The main part of GippsTech is conducted in a university lecture theatre and in all 16 presentations were made over the two days. In a separate room there were displays and a little trading activity in bits and pieces related to the conference theme.

A number of those giving technical presentations were later in the display room answering questions and showing off their hardware.



The 2002 Conference Program

The purpose of this article is not to cover all the presentations in detail. That is the role of the published proceedings (2).

The first speaker was Doug McArthur VK3UM whose topic was *RF Radiation: Does your station meet the new licensing assessment requirements? Obtaining a High Power permit.*

Despite his topic being nobbled somewhat by the unexpected late postponement by the Australian Communications Authority of introducing EMR controls that were to have begun on 1 July 2002, Doug gave a very informative presentation.

He has been involved in EMR since 1988 as an occupational health and safety requirement. Doug's view is that EMR is being misunderstood by some in the amateur radio fraternity.

Doug said, "A lot of myths can be heard on air. For 99% of us we won't have to do a thing. The rest of us will have to do a few things."

He acknowledged that the WIA, in its

liaison with the ACA, had done a tremendous job but in his view the ACA's released (now withdrawn) compliance requirements for EMR are flawed.

Doug described the compliance regime as being like an "RF speeding ticket", which suggests that while the simple approach of EMR meets the needs of 99% of amateur radio installations, more work is needed on the remaining 1% where compliance may not be so clear cut.

He provided an insight into the high power permit for a 10-metre dish on his country property that is used for celestial communications. Later in a pictorial presentation Doug VK3UM showed how the dish was installed, on top of a turret mounting bearing for a Centurion tank.

John Clark VK2TK gave the only non-radio presentation on "Speech acoustics and intelligibility". It was interesting to learn how speech is generated, its source, filtering and output.

John VK2TK said research indicates that shouting actually reduces intelligibility while the use of normal conversation vocabulary of 4,000 or so words can help.

He also referred to "top-down processing" which is the term given to listeners filling in gaps, indistinct or lost words.

For weak-signal work, John VK2TK suggested it may be worth experimenting with

narrower passbands than are currently used in SSB.

Using a Vocoder that has a speech analyser that converts analog speech waveforms into narrowband digital signals, a 500Hz bandwidth may be possible.

Rex Moncur VK7MO spoke of his WSJT FSK441 meteor scatter experiences. Rex and Ian McDonald VK3AXH began using this very interesting mode in October 2001.

There are now some 30 VKs known to be on WSJT for MS working, which was released by Joe Taylor K1JT in July 2001.

Rex VK7MO described how, when he went to VK8 to activate a gridsquare on WSJT, he had pile-ups of six stations eagerly seeking to make contact.

He still expresses fascination in how WSJT works. His presentation included an easy to understand explanation of the "mode", its equipment requirements, propagation availability, and typical distances achieved.

Depending on pings from the trails of meteors to provide propagation, contacts take up to 60 minutes or longer to complete. Signal reports are two numbers – the first the duration of the meteor burst, and the second the signal strength in dB above the noise.

In another presentation, Mike Farrell

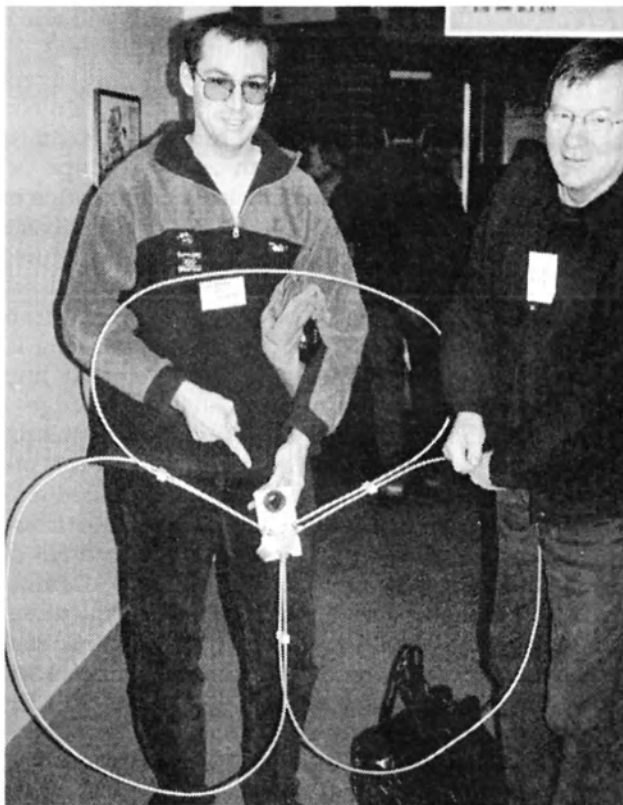

VK2FLR described WSJT JT44 that was released in April this year with the claim that for steady signals, it could outperform CW by 10dB.

JT44 has become popular for tropospheric and EME (moon bounce) propagation due to it being most efficient for sub-audible signals. Mike VK2FLR said it has made EME working possible for many without the use of large scale antennas and high power.

JT44 differs from WSJT in that it requires both stations at the end of a contact to have time-synchronised transmitters and receivers, with many using shareware clock programs or other means.

Peter Loveridge ZL1UKG spoke on basic testing techniques at UHF and above. At home his kitchen table is set up as an antenna range. Later in the conference he gave a pictorial demonstration of a fellow ZL who has set up a steerable dish antenna.

By luck someone spotted a Seacat missile launcher (from a destroyer) in a scrap metal yard, available for its metal weight price. Through amateur ingenuity and adaptation, the once highly priced technology used in aiming missiles now steers a 6-metre EME dish.

The CSIRO's involvement in looking for a site to locate the next generation radio telescope, a square kilometre array, was explained by Brian Thomas VK2AMT.

A site in Western Australia has been examined for its radio quietness. Although a final decision on the location is expected in about eight years for the multi-nation project, which will provide 100 times more collection area than any other telescope.

It will also require radio quietness protection through legislation to create a 50km quiet zone (no transmitters) so the telescope can gather information on the origins of the universe.

The lecture program was peppered by four mini-presentations by Peter Ward, who is not a radio amateur but has vast knowledge of antenna theory and practicalities.

Other presentations included *The trials and tribulations of running basic VHF-UHF stations* Bob Demkiw VK2TG, *Solving noise problems in modern radio systems* Bryan Ackerley VK3YNG, *Predicting Es propagation* Brian Tiderman, *Integration of a 1W 10GHz PA with a 650mm offset fed dish and System integration with Milliwave power amplifier at 24GHz*, Neil Sandford VK2EI.

The program also included demonstrations, *Transmission line fault-finding using a simple homebrew TDR* John Morrissey, *Aids for predicting Aircraft Enhancement* Barry Miller VK3BJM, and *The Broomstick - an antenna for FM satellites* George Francis VK3HV.

- (1) WIA EZARC <http://www.qsl.net/vk3bez/>
- (2) The proceedings for 2002 will be



available later at a cost of \$20 including post and packing from the WIA Eastern Zone Amateur Radio Club (Inc)

C/- PO Box 273, Churchill, Victoria, 3842. Some back copies of previous proceedings are also available at \$10 each plus \$5 P&P per package. Inquiries first via e-mail to vk3kai@qsl.net

ar

Correction

VHF SWR and Watt Meters

The formula for the impedance of a round conductor in a square outer given in the article "VHF SWR and Watt Meters" by Paul Clutter VK2SPC is wrong. (Amateur Radio Magazine January 2002 page 4)

This formula ($Z = 138 \log 1.178D/d$) gives an impedance which is over ten percent too high at mid range (around 50 ohms). Whereas this is unlikely to make a noticeable difference to the performance of the meters described in the article it is completely unacceptable

if it is used as a reference for making VHF power divider transformers which commonly use this form of construction. It would make the VSWR completely unacceptable. It is therefore important to get it correct.

It is doubtful whether or not there is an absolutely correct formula but there are at least five close approximations that give values that are within a few decimal points of each other and the measured values of this type of transmission line.

The simplest of these is given in the ARRL UHF/Microwave Experimenter's Manual on page 9-15

$$Z = 138 \log 1.08D/d$$

This appears to be taken from H. A. Wheeler, Proc. IRE, 38, 1400-1403, Dec 1950. Another readily found reference is "Reference Data for Radio Engineers" (The ITT Handbook) sixth edition page 24-22.

The incorrect formula given in the article was from an RSGB publication.

Gordon McDonald VK2ZAB

Novice Cram Course

A Review

C. Low VK5UE,
B. Edmonds VK3KT and
C. Taylor VK5CTY

The comments that follow were brought together by the editor. We have all been through the course but of course we did not have to do the exam. This issue contains other comment, in OTU letters, on a student's reaction.

The principle claim of the course is "You work through the course in about 4 weeks, at 1 hour a day, on your own (with arranged mentor/facilitator support) or you do it in three days in a group environment and you get a Novice Licence". This all has to be done with an exam booked just after you finish your study. This pressure helps keep you focused. The claims by the author Ron Bertrand VK2DQ seem to be accurate. Most students do pass first time and get a Novice Licence. Ron's letter to me quoted 56 passes out of 66 earlier this year.

Now for the more detailed critique. The course requires a computer and some knowledge of how to use it. I wondered how the instructions on how to fix faulty display could be read, if you had this problem. One of the reviewers had some problems with their computer configuration not being compatible. The presentation is a bit "amateurish" there are many places where corrections are made on the fly and the whole course would leave a better impression if a tidied up version were produced.

The course seemed to be built around Question banks from 1987. Now while the material does get the student through it would be greatly improved if the current Question bank were the source. Unfortunately some of the questions presented are no longer in the Question Database and the current Regulations include the changes to frequency access following from the morse qualification being reduced to 5 wpm. There is a lot of intuition in the selection of material. It would be hoped this was continually being updated by feed back from students when they have taken the exam.

The course does include a number of inaccuracies e.g. when referring to call sign allocation by classes it was not pointed out that all 2-letter callsigns are

full calls but these will not affect the outcome.

Some of the responses to students' responses to the drills were considered flippant if not rude.

The course would benefit with the inclusion of some instruction on what parts should be printed for easier reference (and possibly how to do this). There is also a place for a bibliography of the material quoted and where the books can possibly be obtained i.e. from the local radio club, the council library or purchased from a local bookstore or the WIA VK2 Bookstore.

The course is limited to getting the student a Novice licence. The classes run by other groups have a much broader

Ron Bertrand's course gets you started and provided you realise that when Ron's Course has got you your licence, you have just taken the first step on a long journey

aim. They want to produce a student who can pass the full call exam and knows more than the exam requires. This can deter some students. Ron Bertrand's course gets you started and provided you realise that when Ron's Course has got you your licence, you have just taken the first step on a long journey. You have become involved in a most satisfying hobby that can give you a lifetime of pleasure.

Finally the WIA hopes to have the current Question Banks on the web soon, these question banks include questions on the changes to Novice privileges granted since 1991.

How do you get into the course?

Contact Radio and Electronics School manager@radioelectronicschool.com or telephone Ron Bertrand VK2DQ Manager Radio & Electronics School 07 5573 2795. (12-5 PM) Course information at <http://www.radioelectronicschool.com>

The course costs \$15 and the material supplied is on 2 CDs. The drills timeout in about 4 weeks as a further incentive to work through the course in the 4 weeks recommended.

The course consists of

1. A set of multiple choice exam questions NBANK.DOC which you must print out.
2. A set of 30 PC based video Theory tutorials.
3. A set of 23 PC based software Novice Theory drills covering 23 exam categories.
4. A set of 6 PC based video Amateur Regulations tutorials.
5. A set of 5 Radio Regulations software drills.
6. Other optional documents in the DOC folder.

In conclusion the course is short and snappy. If you do the work it will get you a Novice licence in 4 weeks. (Exam dates permitting) but it is a bit rough at the edges and will benefit from continual updating.

You will still have to learn a lot about Amateur Radio when you finish. You have only placed your foot on the first step of the learning ladder.

We wish you well with your study.

er

See Ron Bertrand's response and student's letter on page 17



TTS Systems Communications Equipment

Systems

FREE CATALOGUE

www.ttssystems.com.au

HF and VHF Transceivers, Autotuners and Kits



Jupiter HF DSP Transceiver

Easy-to-read LCD main panel display.
34 built-in receive filters—300 to 8000 Hz.
Multi-function meter provides bar graph and digital readout of signal strength, TX power and SWR.
Band sweep function
Seven selectable main tuning rates

Get Kitted Out

"It goes better on something you made yourself"



Z11 QRP Auto Tuner Kit



HF Receiver Kit



AT11-MP Auto Tuner Kit

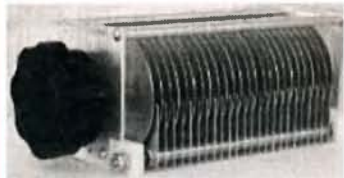

H.V. Variable Capacitor Kit



Dummy Load Kit

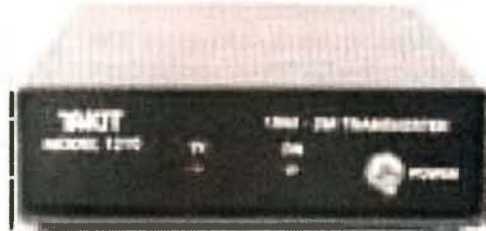

10-2M Transverter Kit



RT11 Remote Auto Tuner Kit



About to be released from Ten-Tec The Orion HF 32 bit DSP Transceiver and the Argonaut V QRP IF-DSP Transceiver.



We have RF Cables, Connectors and Baluns

★ All kits include easy-to-follow step by step assembly instructions.

You supply the soldering iron and basic tools!!!

All kit products can be supplied fully assembled and tested.

We stock Amidon Iron Powder and Ferrite Cores — Call for an application guide

Phone 03 59774808. Fax 03 59774801 info@ttssystems.com.au

Novice Cram Course Review: Ron Bertrand replies

Thank you for a copy of the draft review. I don't agree with many of the things said in the review but that's okay. The course stands on its merits.

The style is laid back and on the fly and does not try to hide it. There is even the odd mistake - most are fixed as we go.

I think what has been missed is:-

Each student enrolled in the R&E School has access to email or telephone contact with a facilitator - so you would not be left on your own with monitor or software usage problems.

There is an enrolment process for students - that process has..." What sort of computer, sound card etc do you have?"

Most students report they enjoy the laid back style and the humour no one has ever reported being offended.

This is one course of 3 that the R&E school conducts. I don't like the reference regarding "classes run by other groups have a much broader aim". The R&E school runs 3 courses to suit student needs - I believe that the comprehensive courses that we run are second to none in this country. "Verifiable" enrollment for the year commencing Jan 1 2002 is 328 students. The student is informed

of everything that they should print out. The 1987 question bank is not used - neither is the latest question bank - the set of questions used is drawn from both of those sources and some are made up.

The course is a Novice Limited course - that is its purpose. In the documentation the R&E school encourages the student to continue their enrollment with a more comprehensive course.

The Fast Track course was created because of the creeping Novice theory standard and poor Novice syllabus design. As an educator I can take a beginner to Novice theory via a comprehensive course in 16 weeks. However I could take that same beginner via a comprehensive course to the AOCF theory in 20 weeks! Which would you do! This is from my experience 28 years teaching of some 4500+ amateur radio students. So most students just elect to do the AOCF course.

Hence the Novice Fast Track course was done as a quick starter (never

intended to be distributed - just happened by popular demand) and a prelude to the AOCF course BUT it is okay for a Novice Limited to stop at Novice Limited - it does not have to be a stepping stone - it is okay for it to be the finish.

The drills are set to time out in "about" 5 weeks. The suggestions of bibliography etc or to add any material or information not directly required for passing the exam is not warranted as the student is an enrollee of the school and is via the school provided with all study materials to obtain an AOCF theory exam pass for free -so why would we direct them to purchase materials that we provide for free. The "free" theory notes from the school cannot be matched by "any" external source from the school.

EDITORS Note. Not all of the above was available to the reviewers. Their comments refer only to the 2 CD course material supplied by The Radio and Electronics School.

ar

Thank you to my Elmers

Just a short note to ask if you would consider publishing my vote of thanks to the two people who helped me achieve a pass in my Unrestricted AOCF exam which I sat last month here in Perth WA.

They are Ron Bertrand VK2DQ who wrote the Internet Radio & Electronics Theory Course that I used & later spent a lot of time going over possible exam questions.

Ron also sent me his disk based on the use of a scientific calculator for solving Math questions for AOCF. As a 74 yr old my limited ability at Maths diminished many years ago and I was hopeless while

at school any way. This maths disk was a miracle for me.

Secondly my Facilitator here in Perth, Mike Todd VK6JMA. Mike remained totally unfazed by my continuous questions and by my many dubious answers to my assignments. He spent countless hours, patiently explaining the reason for the correct answers.

These two remarkable people put up with me for a whole long year. Without their voluntary support I would not have survived.

Thank you both.

Sincerely
Graham Hewitt VK6HE

Club News

Gold Coast Amateur Radio Club

A highly successful 3-Day Cram Course was run by Ron Bertrand VK2DQ. 20 students and 18 passed. The club now has some new H class operators. An AOCF course is still in progress.

JOTA will bring 2 Scout Groups to the Club Station. There will be about 30 Scouts and an overnight stay is planned.

We have been invited to the 100yr anniversary of the laying of the first trans Pacific cable from Main Beach, Gold Coast, Australia to California USA.

Roy Cotterill VK4LPV President, 07 5539 3530,
email: roykath1@bigpond.com

Zener Diodes: still useful

(Originally published in the Adelaide Hills Amateur Radio Society Bulletin, March-April 2001)

By Lloyd Butler VK6BR

These days, voltage regulator ICs are quite cheap and to establish a voltage regulated rail, the common approach is to use one of these. However there is still a place for the Zener Diode and they are useful for such applications as providing a further break down in voltage for some part of the circuit or providing a voltage reference. Here are a few notes on how to use them to get best voltage regulation.

The Zener diode is the name given to a silicon diode which is operated in a reverse connected mode beyond the point where voltage breakdown occurs. At this point there is a sharp turn over of the voltage versus current curve to a condition where voltage across the diode approaches a fairly constant value independent of current. Typical circuit for Zener reference is given in figure 1. The complete diode curve including the reverse characteristic is shown in figure 2.

The name Zener was given to this breakdown effect because it was first

believed to be due to the mechanism described by Zener in his theory of breakdown phenomena in dielectrics. Later on it was realised that not one but two mechanisms were responsible for the characteristics of Zener Diodes.

We are told that the Zener effect is a quantum mechanical effect in which electron pairs are generated directly from the energy of the electric fields. This effect is responsible for breakdown in diodes designed to have a breakdown voltage less than about 5 volts. Such a mechanism produces a negative temperature coefficient. That is, a decrease in developed Zener voltage as temperature rises.

As such, the general name given to a Zener diode is somewhat of a misnomer because for diodes with breakdown voltages greater than 7 volts, the

breakdown is caused by a different mechanism called the Avalanche or Avalanche Multiplication effect. This mechanism produces a positive temperature coefficient, opposite to the Zener effect.

For diodes between 5 and 7 volts, both mechanisms occur and hence the temperature coefficients tend to cancel and such diodes have a very low temperature coefficient.

Figure 3 taken from some data sheets of the very early STC Z2 series Zener diodes is a very good illustration of how temperature coefficient varies with breakdown voltage. In selecting a Zener voltage for best temperature stability, 5 volt has been a favoured value. The curve (figure 2) supports this selection.

One idea for voltage rails above 5 volts is to use two Zener diodes in series to

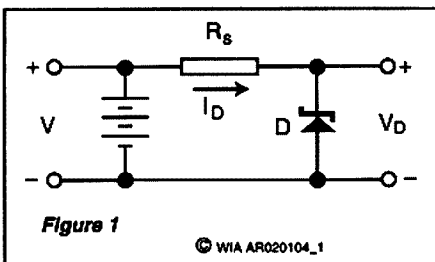

Figure 1. Typical Zener regulator circuit

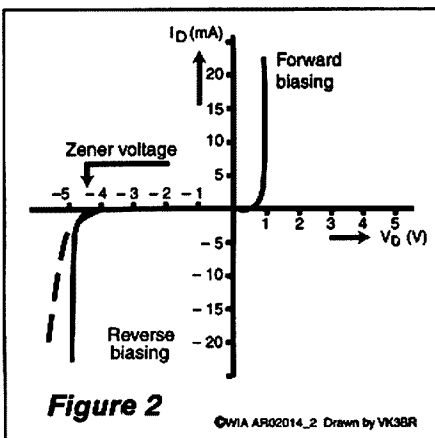

Figure 2 - Forward & Reverse characteristics of a silicon Zener

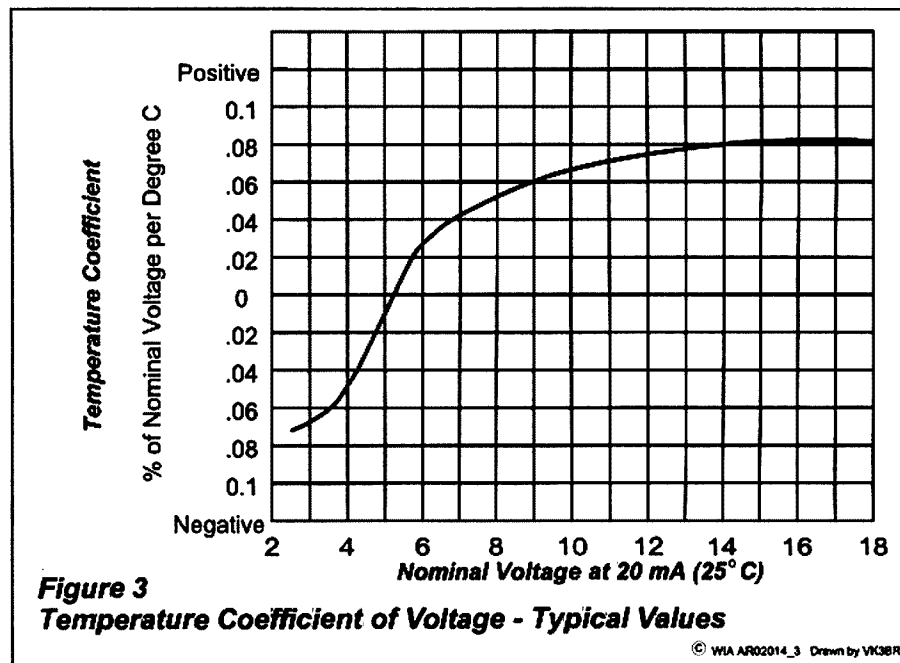

Figure 3 - Temperature Coefficient of voltage Typical values.

make up the required rail voltage, one above 5 volts and one below 5 volts so that the different temperature coefficients tend to cancel.

Another idea is to select the rail voltage a multiple of 5 volt and connect 5 V Zeners in series eg for 10 V rail use two 5 V Zeners. For 15 V rail use three in series.

A further idea suggested in a number of publications is to connect an ordinary silicon diode, forward connected, in series with the Zener diode so that the negative coefficient of the ordinary diode cancels the positive coefficient of the Zener diode. Of course this would only work for Zener diodes above 5 V and the 0.6 V drop of the ordinary diode would have to be added to the resultant regulated voltage.

In setting up the regulator circuit shown in figure 1, resistor R_s is chosen to ensure that the current through the Zener diode is sufficient to place operation beyond the bend in the reverse curve and into the almost vertical section of the curve. One interesting point is that diodes operating above 7 V using avalanche breakdown have a sharper turning curve than those below 5 V using Zener breakdown.

This is fine for a constant load at the Zener diode regulator output. However if the load is variable, there is also the further consideration of voltage regulation determined by the slope of that near vertical section of the curve. In figure 2, the solid line shows good regulation whereas the dotted line shows poor regulation. The regulator dynamic resistance is equal to the reciprocal of the slope of that section of the curve (ie. dV/dI). Hence the lower the dynamic resistance, the better the voltage regulation. Another point concerning the two types of breakdown is that diodes operating above 7 V give better regulation than those below 5 V do.

Figure 4 shows an interesting set of curves that plot dynamic resistance against breakdown voltage for different currents through the diode. This shows that lowest dynamic resistance (and hence best regulation) is achieved using diodes around 7 to 8 volt. It also shows that the dynamic resistance falls as the diode current is increased.

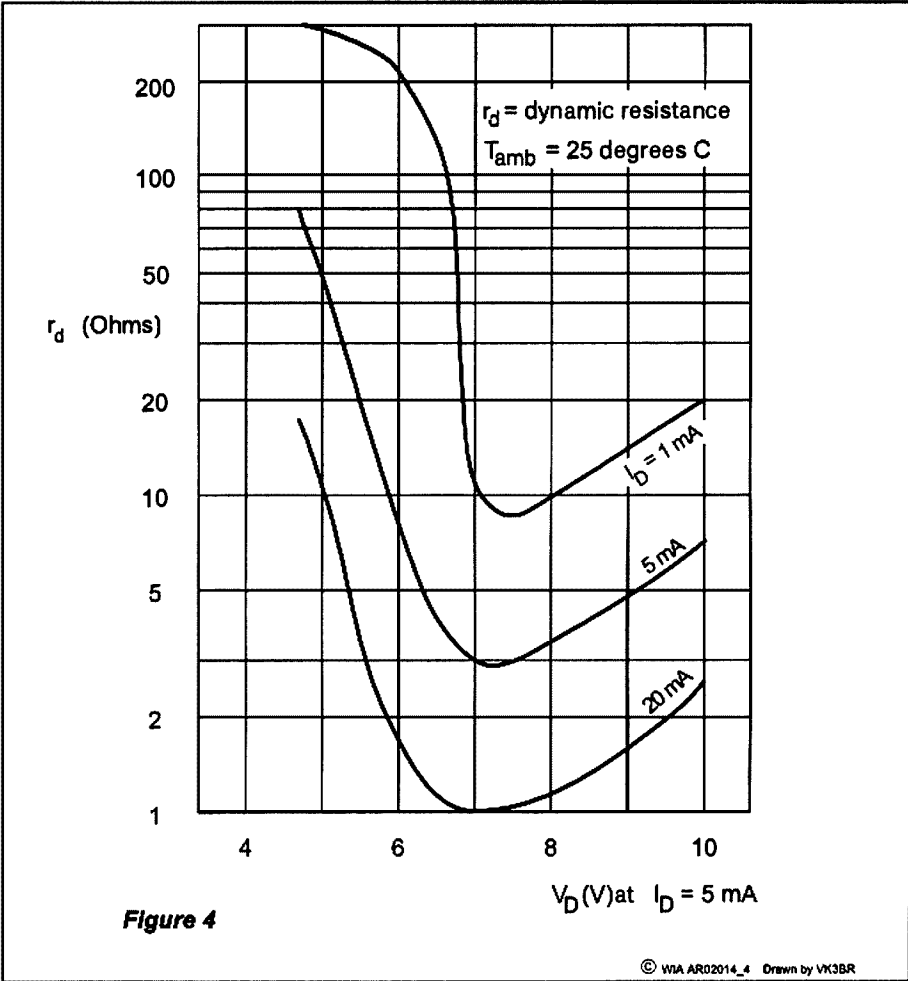

Figure 4

© WIA AR02014_4 Drawn by VK3BR

Figure 4 - Dynamic Resistance as function of Zener voltage for various values of constant inverse current

So for best regulation, we might use zener diodes around 7-8 volts (or a series multiple of them) and run plenty of current through them. On the second point we might call a halt and rather than waste power in the diode we might choose instead to use the more efficient series regulator I/C for the variable load application. It really all depends on the particular circuit operation.

Most of us have used a Zener diode at

some time or other to derive a lower voltage or provide a voltage reference. It's all very simple - a shunt Zener diode and a series resistor. However a little thought to the characteristics I have discussed might be useful in better achieving the desired circuit operation.

Reference

Zener Diodes & their Application - Miniwatt Digest, July 1966

Final call!

SEANET  **2002**

Convention

1-3 November, 2002

www.qsl.net/seanet2002

hosted by Northern Corridor Radio Group

Technical Abstracts

Gil Sones VK3AUI
30 Moore Street, Box Hill South Vic 3128

Linear Loaded Dipole

A shortened dipole for 40 metres which used linear loading was described by Lew Gordon K4VX in July 2002 QST. The linear loading was performed by lengths of 450 Ohm ladder line. The loading elements were placed in circuit at the centre of the dipole at the feed point.

The antenna is shown in Fig 1. The loading elements made from 450 Ohm ladder line are supported on the dipole by threading the ladder line onto the dipole wire. The ladder line insulation has holes punched in it every 6 inches and the dipole wire is threaded through these holes. The dipole wire supports the ladder line and maintains the relative position with respect to the ladder line loading element in this way. The outer ends of the ladder line are shorted together and must be kept

insulated from the dipole by taping them well. The ends are fixed in position by a nylon cord which is fastened to the dipole element by a split bolt connector and tied and taped to the ladder line.

The antenna is fed with 50 ohm coax and Lew K4VX used a choke or current type balun at the feed point. This was a simple one made by coiling up some feed line. A commercial balun could be used but a simple coil of coax is quite effective.

The SWR curve of the antenna built by Lew K4VX is given in Fig 2. The antenna was initially cut for 7.025 MHz with the dipole 46 feet long and the loading lines 12 feet long. Scaling is not quite as simple as with a simple dipole. Lew tried shortening the dipole tips and the loading lines by scaling to 7.125 MHz and moved his initial antenna to 7.2 MHz. Then after some experiments he came to the lengths given in Fig 1. If you wish to move the resonance the dipole lengths are probably the simplest to adjust for moderate frequency excursions.

The antenna wire used was 12 gauge copperweld. A similar diameter wire would be suitable and adjustment to the length to trim the resonance would be in order. The antenna is only moderately shortened and should offer performance close to a full size antenna. Experimenters could try the technique on 80 metres but should be prepared for some experimentation to get it onto frequency.

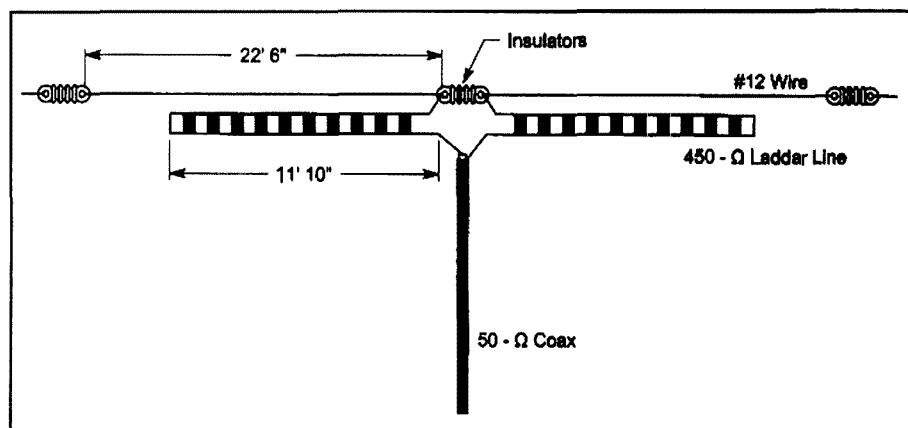

Fig 1. K4VX Linear Loaded 7 MHz Dipole. The 450 ohm ladder line is actually threaded onto the 12 gauge antenna wire for support.

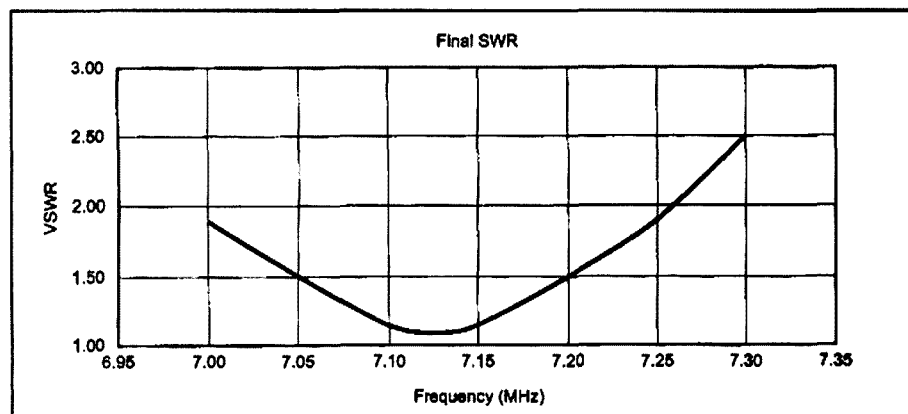

Fig 2. SWR Curve of K4VX Linear Loaded Dipole.

Check

DX

peditions

in the

How's DX?

Column

Making An LED Audible

Sometimes an LED Indicator would be handier as an audible indication. In the Hints and Kinks column of Bob Schstgen KU7G In QST July 2002 a way of adding an audible indication to an LED circuit was given by Michael A Covington N4TMI.

Two ways of adding an audible indication are shown in Fig 3. The simplest is shown in Fig 3a and consists of simply connecting a 3 volt piezo buzzer in parallel with the LED. This will not be very loud but it is a simple solution.

A louder sound will be given by the circuit given in Fig 3b. This uses a piezo sounder instead of a buzzer. The transistor multivibrator provides more drive to give higher (louder) audio output. The resistor and capacitor values can be modified to provide a sound to your taste.

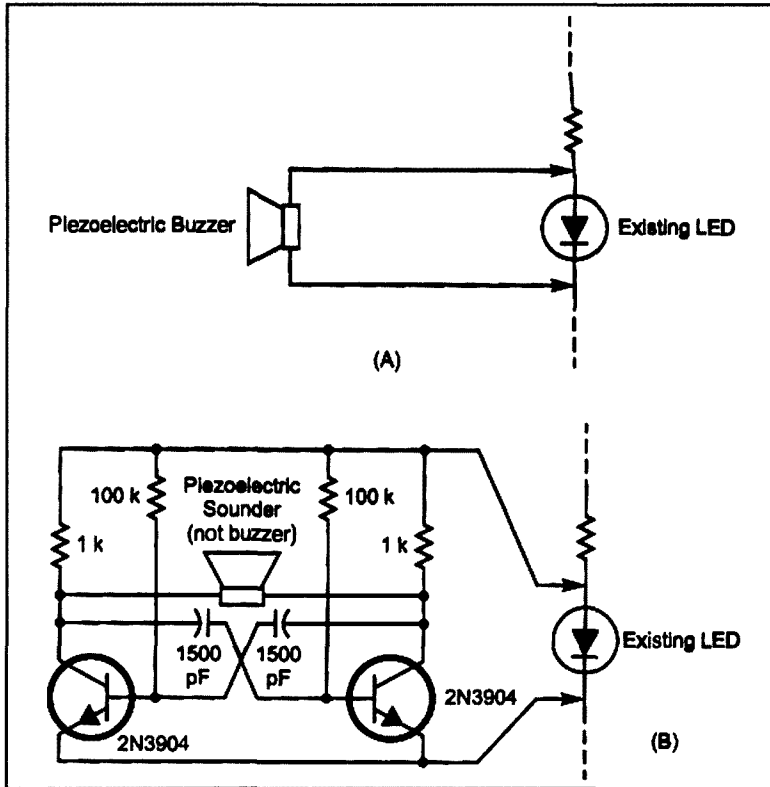

Fig 3. (a) 3 volt Piezo buzzer sounds faintly. (b) Oscillator provides greater drive to Piezo Sounder.

G. & C. COMMUNICATIONS

Authorised dealer for ✓ Kenwood ✓ Icom ✓ Barrett RFDS ✓ GME Electrophone ✓ Uniden ✓ RF Industries



✓ Icom IC T90A

50MHz, 144MHz,
430MHz
5W on 50MHz, 144MHz,
430MHz
Compact, rugged
Water resistant
Intuitive operation
DTCS,
CTCSS
Pocket beep
555 memory channels
14 high speed scans



✓ ICOM IC207H

Amateur 2m/70cm FM mobile transceiver.

Compact dual band unit with detachable control panel (OPC-600 cable required)

Frequency coverage (Unit: MHz)
VHF: Tx: 144-148 Rx: 118-174 *
UHF: Rx/Tx: 440-450
* Guaranteed 144-148

Output power:
VHF 50 W, 20 W, 10 W, 5 W selectable
UHF 35 W, 20 W, 10 W, 5 W selectable

✓ ICOM IC718

HF All Band Amateur transceiver
USB, LSB, CW, RTTY (FSK) and AM are built in

Simple operation
One Touch Band Switching
Dir. Freq. Keypad Input
Auto Tuning Steps (TS).
Easy to Use Front Panel Controls
Front Mounted Loud Speaker

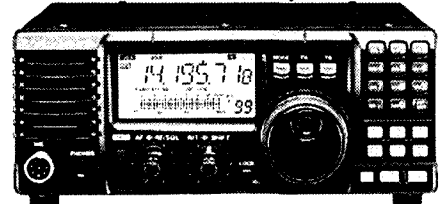

Australia-wide orders welcome. Payment by credit card, cheque or money order

19 Arleon Crescent Cranbourne 3977

Ph: 03 5996 3298 Fax: 03 5995 0184

Email: gccomm@netspace.net.au

www.netspace.net.au/~gccomm

Power Line Monitor

Wim van den Broek, PA0JEB

published in "Electron" magazine, March 2002, translated by VK3BHW.

An auxiliary used in conjunction with an oscilloscope to determine accurately what is delivered to the power socket in your home besides the promised clean 240Vac/50 Hz.

For some time now the possibility of digital signals via the 240Vac power line, Power Line Communication (PLC for short), has been in the wind, and might possibly already be present. The announcement of a test in the town of Arnhem really fired up my curiosity.

To connect the oscilloscope straight to the 240 Vac is far too dangerous. The circuit I propose has two signal paths.

Voltage isolation is essential. The reason for this should be well understood by the reader, if not, do not attempt this project.

The first channel provides a clean 50 Hz signal of relative small amplitude. This serves to trigger the oscilloscope jitter free. On a two channel oscilloscope it serves to show the phase relationship between the two signals.

The low-pass filter in this signal path is a choke and requires a few Henry. As my junkbox could not deliver, I used the primary of a small mains transformer. The values of the capacitors didn't appear to be critical at all. The signal coming from this filter is nice and clean. The attenuator depends on the voltage available and the sensitivity of the oscilloscope and is usually not necessary.

The second channel serves to suppress the 50 Hz as much as possible with the intent to observe the higher frequencies properly amplified for good observation. The required voltage isolation is obtained with parts from a filter as used in computers, TV's and video recorders.

Stripping some of this equipment every now and then provides a treasure of goodies.

The filter consists of two windings on a toroid core, normally used to prevent switch mode noise getting into the power net. Here it is used with a small coupling capacitor to separate the components higher than 50 Hz from the 240Vac.

A resistor of 4k7 ohm across the secondary of the core is used to dampen ringing of the winding. This transformer with the in series connected capacitor needs some closer scrutiny. The higher the frequency you anticipate the smaller the capacitor should be. Also the inductance of the coil should then be smaller.

However a toroid core with two windings of 10 turns each and a series capacitor of 100pF was used in my hometown of Voorthuizen (near Arnhem).

However hopeful the propagandists of PLC might be the power grid doesn't look like a good medium for HF signals. The reactive capacitance of the grid is far too small for the purpose of PLC.

The best results obtained, that is to say in the frequency band below 1 MHz,

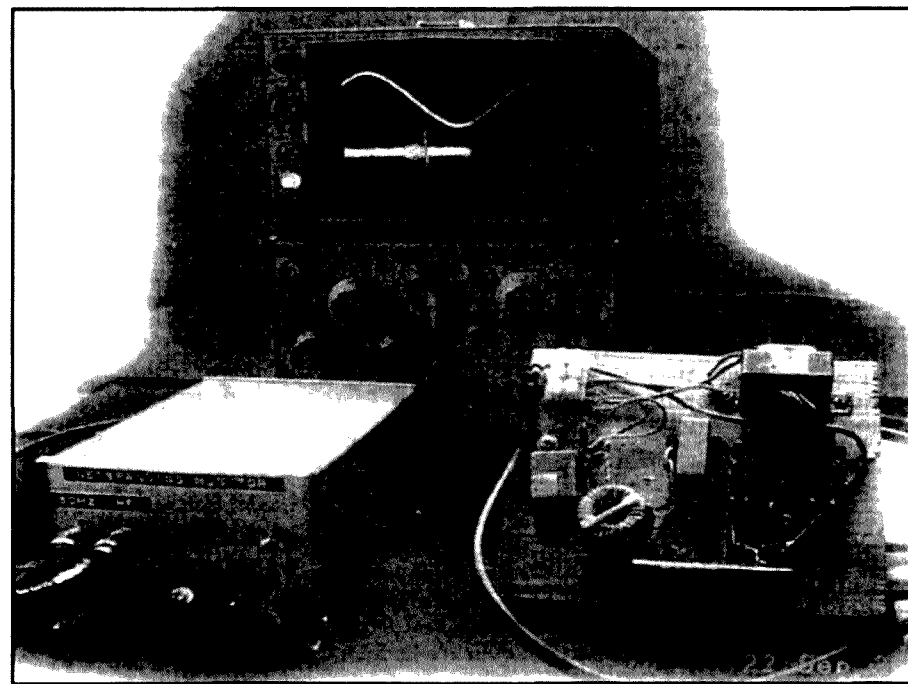

Figure 1

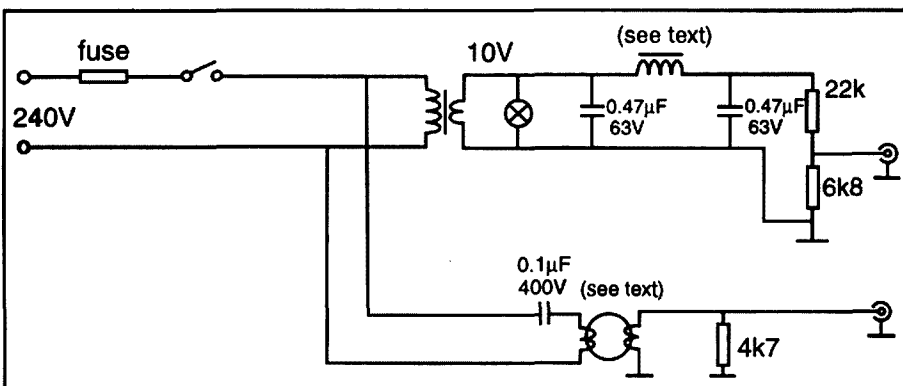

Figure 2

Dr Wally Howse VK6KZ wins AR Technical Award

Every year the Publications Committee of Amateur Radio Magazine reviews the material we have published in the previous year.

We look for the article which has greatest merit for its technical content and a contributor who has contributed significantly to the Amateur Radio Magazine and Amateur Radio.

Dr Wally Howse VK6KZ had done considerable research both in the scientific literature and practically on the conditions, which affect propagation at VHF, UHF and microwave frequencies across the Great Australian Bight from the Australian West Coast to South Australia and Victoria. The article was also well presented.

Wally was awarded the Amateur Radio Technical Award for 2001 for an article titled "VHF, UHF and microwave propagation and The Great Australian Bight", which appeared in the March 2001 edition of AR Magazine.



Malcolm Johnson VK6LC (VK6 WIA vice president) presented the award on behalf of the WIA to Dr. Wally Howse (VK6KZ).

Power Line Monitor continued

were with two 30 turn windings on the toroid core and a capacitor between 10 and 100 nF. Make sure that the capacitor has a rating of at least 400V.

The result is quite interesting. Besides a number of switching pulses, which are almost continuously present with a relatively low amplitude, sometimes pulses of many volts are present. Sine wave like signals of about 400 Hz are also observed.

The circuit enables us to correlate the interference we observe on amateur

bands with the activities observed on the power grid. In this way we can determine if our fears for PLC interference can be substantiated. It also can be a contribution to arguments for the rights of anyone besides amateurs, who could suffer from a substantially interfered with. RF spectrum

Lots of fun with the project.

Written by Wim van den Broek, PA0JEB,
Voorthuizen, Netherlands,
ar

JOTA and JOTI

October 19 & 20, 2002

Join

WIA

today



WIA is active in:

- QSL services
- Major role in amateur radio education
- Coordination of contests and awards
- Monitoring of illegal activity

“There is no denying that radio today still has all the magic that attracted people to the hobby all those years ago, when it first emerged onto an unsuspecting world.”

Ernie Hocking, President
Amateur Radio April 2002

How to join WIA

- Through your local amateur radio club
- Through your Division (contact details on inside back cover)
- Contact WIA Federal Office (03) 9528 5962

Australian Made ANTENNAS

"Setting a New Standard" COM-AN-TENA

(Formerly a j and j coman)

6 Muir Court
CHELSEA HEIGHTS 3196

All new 5/8 vertical 16 radials	\$145
Dual drive 26-30 5 ele yagi beam	\$305
4 ele 10-11m yagi beam	\$262
5-6-&7 ele high gain antennas 11m	\$call
3 ele delta loop 10-11m	\$320
11m 5/8 vertical/4-1/4 wave radials	\$170
Duoband 10-15 3 ele each band	\$356
Log-periodic 7 ele 13-30 MHz 7.7m boom	\$890
Tri-band 5 ele HB35C s/steel fix	\$730
3 ele 20m computer opt	\$390
3 ele 15m computer opt	\$285
M B Vert Auto switch 10-80m	\$310
40m linear loaded 2 ele beam	\$580
6m 5 ele compt opt beam	\$259
6m 7 ele compt opt beam	\$355
10 ele high performance 2m	\$135
17 ele high performance 70cm	\$119
2m vert 2-5/8 co-linear 4 rad	\$ 96

Guyed Masts

21 metres 13 metres

Winch-up & tilt-over. Aluminium and stainless steel three-sided construction. Auto-brake winches

Free Standing Masts

9.5 metres

New Baluns

1-1 to 16-1 to 3kW



03 9773 3271

Mob: 0419 542 437

Andy VK3IV

Club News

Adelaide Hills Amateur Radio Society

The talk last month was titled "What to do when.." Geoff VK5TY, from his considerable experience, discussed a few of the problems you can encounter when you are asked to provide a sound system by your local school, Probus Club or other organisation.

Somehow people come to think that because you are a radio amateur you also automatically know all about microphones and loudspeakers for all situations. What these people overlook is that the equipment suitable for a radio shack cannot be just transported out of doors or into a large hall and work equally well there.

He had a number of items to show and explain and demonstrated the difference between the requirements of a hall and fete in terms of adequate sounds. What works in one place can sound very thin, or much too loud in another place. Horses for courses.

An interesting talk

The next meeting will be addressed by John VK5EV. It will be very enlightening to those contemplating whether or not to enter the digital TV age. John has been involved in this technology for some time so should give us some insights.

That meeting and all regular meetings will be held on the third Thursday of the month starting at 7.30. Everyone is welcome to attend.

AHARS annual "Buy and Sell" will be on again on 23rd November in the usual venue, the Westbourne Park RSL Hall, Goodwood Road Westbourne Park. Sellers tables \$10 each with access from 8.00, entry to the hall from 9.00 for \$2 a head.

Come along to grab some bargains and to meet your friends.

The photo was taken last year. Wall to wall people!



Southern Group Luncheon

The group of amateurs, who live in and around Goolwa, gathered again in August for lunch and a chat. As you can see they make a cheerful bunch. I wonder how many of them you

recognise and how many of them you have worked on the air. Some of them have been operators for many, many years.



Gippsland Gate Radio and Electronics Club

I trust that everyone who attended last month's General Meeting found the talk on Home Automation interesting. Shows where the future is in home electronics.

As a matter of interest, it looks like we have found a new venue for our Annual Hamfest (White Elephant Sale). With a bit of organizing, I am sure we will put on a pretty good show in 2003. We will be announcing the new venue soon and will begin taking bookings from then, so keep an eye on this space for more information or visit our website.

October means JOTA to all amateurs with this year's event following usual organization at the GGREC meeting rooms. Keep the 19th free to assist with the day's operation. The night before JOTA is the General Meeting for the

month that will feature Phil Pavey showing off his talents using the latest digital modes for Amateurs.

As a wind down from JOTA, the following Saturday (the 26th) will see the first of this season's Fox Hunts held. Details will follow soon so get out the DF antennas and brush off the cobwebs. Plans are being put together for a trip to French Island. If you are interested keep the 9th November free and stay in touch for more information.

November's General Meeting features guest speaker Mike Krochman whose talk is entitled "Fun on Four Continents".

While we are on this date, please note that if you or someone you know is planning to sit an Amateur exam, the last

one for the year, to be run by Peter VK3VB, will be held on the 30th November. This means that the closing date for applications is the 15th November. This will be your last chance to get a callsign (& perhaps a new radio) for Christmas.

Since the Pub Nights are such a success, another one is to be held on 23rd November. This one is to be confirmed but if popularity dictates, it will be held at the Cranbourne RSL or Tooradin Hotel.

Don't forget our usual Prac. Night on the first Friday of the month and the General Meeting on the third Friday of the month.

For more information as always visit www.ggrec.org.au

Central Highlands Amateur Radio Club of Tasmania (CHARCoT)

The Central Highlands Amateur Radio Club of Tasmania (CHARCoT) has recently announced a new contest that is a little different from the norm.

The contest will be known as the 80 metre Dash for the Wadda Cup, and is open to all VK amateurs.

It will be held on Thursday 28 November, 2002, starting at 1000 UTC (or 8.00pm ESST).

As the name implies, the contest will be a dash to make as many contacts as possible during a 30-minute period.

The contest manager, Vince Henderson VK7VH, will operate the CHARCoT club callsign VK7CHT. Contact with this station will earn the contester bonus points.

When the contest has concluded, all contestants will gather on 3.585 MHz to join in a roll call and find out who is the provisional winner of the Wadda Cup

contest. If there is a tie, a countback procedure will be used. The winner will have their name and callsign etched in glory on the Wadda Cup and, along with 2nd place contestants, will receive a contest award certificate.

The main aims of the contest are to –

- Encourage on air activity in a short, friendly contest.
- Provide amateurs with the opportunity of accumulating contacts for the CHARCoT Tassie Trout Award and the Tasmanian Division of the WIA Tasmanian Devil Award.
- Encourage entry of first time contesters.

- Promote on air activity of VK7 amateurs.

Full contest details are available on the CHARCoT website www.vk2ce.com/vk7cht

Also, look for details in Amateur Radio magazine.

CHARCoT holds a regular Thursday night Quiz net on 3.585 MHz, starting at 8.00 pm (EST). Further information may be obtained on this net.

So, if you want to have some fun in a quick fire contest, have a go at the 80 m Dash for the Wadda Cup. Remember, the date is Thursday 28 November, 2002, starting at 1000 UTC (or 8.00pm ESST).

73s

Vince Henderson VK7VH, Contest Manager.

Summerland ARC Support of Horse Enduro

HORSE ENDURO - Eden Creek. 6-8 Sept

An excellent weekend was had in fine weather. Unfortunately due to illness and work callouts we were short of operators. We could only cover the three priority checkpoints, skipping three others. Non radio people were put in the gaps. However it all worked.

Four rides were run up to 40 km each day, starting from 0500 until about 1400K. Longer than planned but the heat dragged them out.

No major dramas, only four horses needing farrier shoeing, no medical emergencies. Equipment and comms all worked OK, some fine tuning to be done as always.

It is hoped to have more operators next February. Come along.



A general view of the COMCEN and area.

ALARA

Christine Taylor VK5CTY

vk5cty@vk5tty or geencee@picknowl.com.au

The Contest

Conditions were marvellous this year. Hope you made lots of contacts. Hope you also remember to send in your logs. All OM and Club stations are welcome as well as YL stations.

Did you note the change of email address? Email logs should be sent to Marilyn VK3DMS
dgsyme@hotmail.com.au

Bonuses to the ALARA Contest

Unlike contacts made during net-operation, contacts made during contests can be used for awards. The ALARA Award has been going for many years and only requires 10 YL contacts as long as they include contacts from at least five VK states. These are not difficult to obtain when all the bands can be used at some time during the day and two evenings. I hope you took advantage

A couple of items from our newsletters

Did you know that there is an organisation to provide information about our marvellous hobby, to handicapped people? The acronym is IPHA (for Information Program for Handicapped people interested in Amateur radio).

There is a web site <http://www.users.bigpond.com/tobbe/iphah.htm>

Agnes VK2GWI/PA3ADR is the coordinator for the IARU in Region 1 and would love to hear from you if you know of any programs that are appropriate. Only if we know what the various clubs around the world are doing can we encourage handicapped people to join

Barbara has done it again!

Barbara VK3BYK has scooped the pool for lingerie and nightwear, at the Adelaide Show AGAIN. Every year Barbara enters six or more items and each year she wins many prizes. This year there are at least six garments with "First Prize" tickets on them. What's more the garments are really beautiful and would be a joy to wear.

Our congratulations, Barbara.

Or they can be sent to her at 99 Magnolia Street MILDURA 3500

If you are coming to Murray Bridge, as long as you remember both to take your log to the ALARAMEET and to pass it on to Marilyn there, that would be in time.

Logs must be in by 31st October 2002.

of it.

The 33 Award is a one-off award, only available during the 2002 calendar year. It requires 33 YL contacts with no restrictions on QTH. I hope you are getting close to that one, too.

The addresses to which you need to apply for these awards were in the previous "Amateur Radio" magazine.

our ranks. Amateur radio is a hobby that is peculiarly suitable for less mobile people to enjoy in exactly the same way as we enjoy it. Not all hobbies are as appropriate.

A story was sent to Dot VK2DB some time ago about the "black box" designed by Dr David Warren, in Australia, in the 1950s. These recorders have become mandatory and invaluable in aircraft all over the world. It first proved its worth in a crash near Mackay in 1963.

However, the "black box" is NOT black. It is red, a much more visible colour, you must admit. Let us hope we never have need of a red black box ourselves.

Now how about some others showing off the very great handcraft skills we see at the ALARAMEETS. While it is nice to see them there, it is a thrill to see them displayed for all to enjoy, and to be able to say to people standing around. "I know that lady"

Let us all share some of the glory. Show it off!!

ALARA does appreciate the number of regular OMs who now participate each year. This year there were more ZLs than usual on the Saturday evening, which was, unfortunately the only time I was able to be there.

A Special VK3 Luncheon

Recently the VK3 girls had a special luncheon to celebrate Mavis VK3KS's 61 years on air. The photo shows Mavis, Robyn VK3WX, Bron VK3DYF and Jessie VK3VAN and was taken by Gwen VK3DYL.

Well done Mavis. We look forward to many more years on air for you, too.



The DXpedition

Did you make contact with VK9YL on Lord Howe Island, or ZK1XYL on either of the Cook Islands? Don't forget to send for your cards to confirm the contacts.

The QSL manager will be Gwen VK3DYL, as before. She is waiting for your applications with bated breath.

Murray Bridge

By the time you read this the ALARAMEET in Murray Bridge will be all over and we will be looking forward to the next MEET in three years time. This can be said with complete confidence because experience has shown that these meets are just a lot of fun and a lot of chatter as we all renew old friendships and make new ones.

Japan Power Line Decision

Japan has been working on the problems of interference from Powerline Telecommunications Systems. Following extensive trials, the Ministry of Public Management, Home Affairs, Posts and Telecommunications has decided not to permit the roll-out of PLT systems operating in the range 2 to 30MHz in Japan. Japanese studies have shown that emissions from PLT are harmful to HF communications and all

requests from PLT manufacturers to operate PLT systems on HF have been refused. It is understood that the Japanese amateur society, JARL, has been actively working with the government, along with radio astronomers, broadcasters and others, to assess the impact of PLT systems on the radio spectrum. We understand that this decision has been given much publicity in the Japanese national press, which has

highlighted concerns about interference to safety-of-life services. In Europe, the RSGB continues to press for tight limits on emissions from cable telecommunications systems such as PLT, and is working with other HF users to try to ensure that the spectrum remains uncontaminated by wideband noise.

(GB2RS)

Vale World Amateur Radio Call Book

Remember those wonderful big books with the flying horse on the front and inside the call signs, names and addresses of Amateurs throughout the world. If you still have one then save it, it will soon be a valuable antique! Now the CD ROM is in demise.

Radio Amateur Callbook (USA) is throwing in the towel and will cease

publication of its CD-ROM Callbook product effective with its winter 2003 edition, which will come out in November. "Due to accessibility to the FCC database via the Internet, sales have declined to levels that make it unprofitable to publish future editions," publisher Bob Hughes announced in a recent news release. In 1997, citing

"rising costs and increasing demand for electronic publishing" the company phased out its telephone-book-size paper North American and international editions in favor of its CD-ROM product. The 1997 Callbook—the 75th edition—was the last hard-copy version available. The Callbook began publishing in 1920.

(ARRL N/L 9/8)

UK "Fivemeggers" enjoying experimental activity

The so-called "Fivemegs Experiment" in the United Kingdom got off to an enthusiastic start in early August. Several amateur stations wasted no time in obtaining the required Notice of Variance—or NoV—to operate as part of the experiment to investigate band propagation. The Radio Society of Great Britain (RSGB) announced in July that the Radiocommunications Agency (RA) and the UK's Ministry of Defence have granted permission to allocate five frequencies in the range 5250 kHz to 5450 kHz.

"We now have over 200 Full Class A license holders authorised to operate on the five spot frequencies," said RSGB Spectrum Director Gordon Adams, G3LEQ, who is directing the experiment. Frequencies available in the UK are 5260, 5280, 5290, 5400 and 5405 kHz. Gordon says 5400 kHz is serving as a calling channel, but UK stations have been looking for US experimental activity on 5260 kHz. Activity in the UK has been on upper sideband.

Responding to an ARRL petition earlier this year, the FCC has proposed allocating 5250 to 5400 kHz to US amateurs on a secondary basis. US operation under the ARRL's WA2XSY Experimental license continues on an occasional basis. Charly Harpole, K4VUD—a WA2XSY participant in Florida—reports that Paul Gaskell, G4MWO, in England confirmed reception of Harpole's 5-MHz CW signal on August 8 at 0200 UTC.

A transatlantic two-way on 5 MHz is the next logical step, but it's unclear if WA2XSY participants are permitted to work the UK experimenters within the scope of the WA2XSY license. The ARRL is researching that question. In the meantime, cross-band contacts remain an alternative.

As propagation indicators, the UK experimenters are listening for WWCR, an international short-wave broadcaster at 5070 kHz. WA2XSY experimental stations in the US were advised to check

for USB stations RAF Volmet on 5450 kHz and Shannon Volmet on 5505 kHz.

Tim Kirby, G4VXE, was one of the first UK amateurs to receive a NoV on August 5. "Within a few minutes he was on the air using a 100-W transceiver and an end-fed wire tuned for the 5-MHz band," the RSGB reported. He worked several other stations in England and Wales on his first day of operation. The RSGB said Kirby's first impression of 5-MHz propagation was that UK signals seem to be consistent throughout the day and evening and that signals were better on 60 metres than on 40 metres for certain paths.

For more information on the UK experimental activity on 5 MHz, visit The Fivemegs Experiment page <<http://www.rsgb.org/licensing/fivemegs/fivemegs.htm>> on the RSGB Web site.

(ARRL N/L 16/8)

continued page 29

Spotlight on SWLing

by Robin L. Harwood VK7RH

No escape!

As predicted, there was no escape from it! The events of September 11th 2001 were retrospectively analysed. The remembrance ceremonies for victims in Washington, New York and Pennsylvania were broadcast with a wide cross-section of views. The main service in New York at "Ground Zero" was broadcast live over many international and domestic shortwave stations, together with the other ceremonies.

At present, the Bush Administration is having difficulty persuading other nations and allies to join their crusade against Iraq and its leader, Saddam Hussein. This is reflected in broadcasts from the official VOA and also surrogate broadcasters such as Radio Liberty and especially the Arabic "R. Sawa". The day after the "Ground Zero" commemoration, President Bush addressed the United Nations General Assembly to state the American case against Saddam Hussein and Iraq. This too was broadcast live.

R. Sawa unpopular

'R. Sawa' which in Arabic translates as together, recently inaugurated a powerful MW sender in Cyprus to add to senders in the Gulf. 'R. Sawa' is supposed to be available over domestic FM but the Americans are having difficulty in obtaining channels in many Islamic countries such as Saudi Arabia and Egypt, both allies of America. Apparently the program content does not go down well with the conservative Islamic administrations. That is why MW and shortwave are the primary platforms used to transmit the soft-sell message of modern American and Arabic popular music, interspersed with frequent news bulletins favourable to American interests.

Spy traffic

Expect an increase not only in propaganda output, but also in diplomatic and military traffic via HF. A good indicator will be an increase in spy number cipher traffic to agents scattered worldwide. The British use Interval signals to introduce their numbers using either 'Cherry Ripe' or the "Lincolnshire Poacher". The Israelis are often easily identified from their continuous tape loop with callsigns such as "Charlie India Oscar two". Many of

these spy number stations are close to the existing amateur bands and naturally vary their schedules and operating frequencies. Don't expect though to crack their ciphers.

One spy numbers station has been running a regular schedule on the same channel for decades. It is believed to be in Taiwan and known as the "New Star station". It is usually on 8300 kHz but of late has been on their alternative channel of 8375. The carrier seems to be permanently there and it seems to transmit at 1100Z and 1300Z. According

Expect an increase not only in propaganda output, but also in diplomatic and military traffic via HF.

to recent monitored traffic it actually solicited reports on its signal and gave a Hotmail email address.

I very much doubt agents could have managed to send any worthwhile traffic because the email address would have been flooded with SPAM. Anybody who has used Hotmail will attest to that.

Radio Finland cuts back

Paul, VK4DJ asks if Radio Finland was really going to cease broadcasting in English via shortwave because the current schedule did not indicate that. The board of YLE, its parent organisation, confirmed that it will cease all foreign language programs via shortwave except Finnish, Swedish, Russian and Latin. The weekly news bulletin on Saturdays will continue. Finland must be the only station with a news broadcast in Latin. The Vatican broadcasts Latin liturgies but not the news. English and the other language services will continue via the Internet and on domestic radio for tourists and

travellers to the main Finnish cities. English is slated to finish over shortwave at the commencement of the B-02 period, October 27th. However the cutbacks have already been put into place.

Antenna suggestions

I also received a very interesting suggestion from Felix VK4FUQ about installing a matcher to my antenna. Felix uses a Sangean ATS 505 multiband portable in his bedroom and found that naturally it overloaded with an external aerial so he devised an "L" matcher that works very well with 21 feet of wire. He wrote:

"It improves the performance of the short wire very considerably by the simple expedient of improved impedance matching. The fundamental resonant frequency of a short wire about 21ft long is around 11 MHz, only series inductance is needed to electrically load the wire to quarter wave resonance on lower frequencies, the varicap serves no useful purpose and should be switched out. On frequencies higher than resonance, the varicap should be switched in circuit and used to tune out the inductive reactance of the wire. It works! This is really nothing to building the unit. All one requires, is a tapped coil wound on a short ferrite rod (I used 40 turns all up tapped every few turns), a multiway rotary switch, a miniature tuning capacitor (both gangs connected about 260pf total capacitance), and a switch, to short out the tuning cap, when used on lower frequencies. I find my L match, when used with a 25 ft wire, extends the low end to a least 2.5 MHz and on the high side, all the way to 30 MHz with greatly

improved performance overall. Incidentally, no earth connection is needed."

A very interesting suggestion for those with multiband portables and I may try it myself with the Digitor when I go away on vacation. However it does not have an external antenna position like the Sangean, only a whip, and I have noted that it does work with my Kenwood ATU, attenuating overloaded signals.

I also received an email informing me that Pat, presumably VK7GV, managed

to obtain help getting his external antenna erected at his retirement village. Thanks to all, who have wished me well in my endeavours to finally get an outside antenna. However this location is prone to high winds, especially at the equinox and it was fortunate that it had not been erected because I am certain it would have been blown over.

Summer Time

Don't forget that some of us do revert to Summer Time this month. Tasmania is

the first one on the 6th followed by our cousins across the Tasman on the 13th. VK1, 2, 3 and 5 revert on the 27th whilst VK4, 6 and 8 remain fixed on Standard Time.

Any news or comments can be forwarded to me at my email address at vk7rh@wia.org.au or to the snail mail address below.

Until next time, the very best of 73
- Robin L. Harwood VK7RH,
20/177 Penquite Road, Norwood, Tas. 7250

ar

Beyond Our Shores continued

Global Ham Ticket

Ham radio has moved another step closer to an internationally recognized license. Delegates to the Third Regular Assembly of the Inter-American Telecommunication Commission (CITEL) this month approved a resolution that would extend reciprocal recognition of the International Amateur Radio Permit (IARP) Convention to member states of the European Conference of Postal and Telecommunications Administrations (CEPT).

The resolution includes as a goal "to promote the development of a global

Radio Amateur Permit working with other regional organizations within the framework of the International Telecommunication Union."

ARRL Technical Relations Specialist Jon Siverling, WB3ERA, attended the CITEL Assembly August 12-16 in Washington, DC, as a member of the US delegation. "In an ideal world, we'll one day have an international Amateur Radio permit that's like an international driver's license—good around the world," Siverling said. He conceded that CITEL-CEPT reciprocity will not benefit US amateurs, however. Only licensees

elsewhere in the Americas would be affected, since US licensees already enjoy automatic or nearly automatic reciprocal licensing in many countries throughout Europe and the Americas.

(ARRL N/L 23/8)

It's a wonderful dream. It's a pity Australia does not completely reciprocate with the CEPT as the USA and other countries have done. Saying "DL/VK2AYD" in Germany is a great way to attract interest in our Country and maybe promote tourism. Instead I have to use another call sign.

ar

WRC 2003

The following are some of the donations that have been received so far.

On behalf of the Directors and Federal Council I would like to thank you all very much for your generosity.

Your donations are important to us to ensure that the interests of amateur radio are properly represented at WRC 2003

Ernest Hocking VK1LK - Federal President

L30700	VK3KAI	VK2SKY	VK5ZYS
L30978	VK3KAU	VK2SO	VK6AAJ
VK1CDS	VK3KWH	VK2STD	VK6ADI
VK1ENG	VK3LC	VK2UAI	VK6BCU
VK1GH	VK3PDX	VK2UX	VK6BR
VK1KED	VK3RS	VK2WL	VK6FRE
VK2BBJ	VK3TCR	VK3ALU	VK6FV
VK2CNP	VK3XP	VK3BIL	VK6LZ
VK2COT	VK3YE	VK3BQO	VK6OU
VK2DT	VK3ZLN	VK3BRF	VK6ZLZ
VK2EFT	VK4MHV	VK3CAZ	VK7EE
VK2FAF	VK4ZRT	VK3CEK	VK7FC
VK2GHB	VK5ALM	VK3DOU	VK7HSC
VK2GIF	VK5EMI	VK3DPE	VK7KY
VK2JGH	VK5KJL	VK3DYL	VK8NUE
VK2KIQ	VK5UV	VK3HX	
VK2PR	VK5WO		

Silent Key

John Ramsay Trevena
VK3AZX, my Dad

The purpose of this letter is to let the Wireless Institute of Australia know of my father's passing. John Ramsay Trevena received his certificate of proficiency on the 14th September 1950 and his Amateur Station Licence number 8485 on the 25th September. His call sign was VK3AZX (Able Zebra Xray) which we hope to hand on to another HAM who regarded my father as a mentor.

If you could mention his name in your magazine I would be grateful.

Kind Regards, Rhonda Lawrence
r.lawrence@thrifty.com.au

Gridsquare Standings at 30 August 2002

144 MHz Terrestrial

VK2FLR	Mike	73
VK2ZAB	Gordon	70
VK2KU	Guy	63
VK3BRZ	Chas	62
VK2DVZ	Ross	59
VK3EK	Rob	57
VK3TMP	Max	53
VK3BDL	Mike	50
VK3CY	Des	50
VK3XLD	David	49
VK3ZLS	Les	49
VK3FMD	Charlie	48
VK2EI	Neil	46
VK2MP	Rej	45
VK3WRE	Ralph	44
VK2DXE	Alan	43
VK3KAI	Peter	43
VK3BJM	Barry	42
VK3CAT	Tony	39
VK3KEG	Trevor	39
VK7MO	Rex	31
VK4KZR	Rod	29
VK4TZL	Glenn	28
VK6HK	Don	28
VK3KME	Chris	22
VK4DFE	Chris	21
VK2TG	Bob	20
VK3YB	Phil	20
VK3TLW	Mark	19
VK6KZ	Wally	19
VK2TK	John	17
VK3AL	Alan	17
VK6KZ/p	Wally	16
VK3DMW	Ken	13
VK2DXE/p	Alan	10
VK3ANP	David	10
VK2LRR	Leigh	5
VK2TWO	Andrew	5
VK2CZ	David	1

144 MHz EME

VK2FLR	Mike	89
VK3CY	Des	66
VK2KU	Guy	21
VK3KEG	Trevor	4
VK2DVZ	Ross	2
VK3FMD	Charlie	2
VK7MO	Rex	1

432 MHz

VK2ZAB	Gordon	47
VK3BRZ	Chas	45
VK3XLD	David	43
VK3FMD	Charlie	38
VK3ZLS	Les	36
VK3EK	Rob	32

VK2KU	Guy	29
VK3BJM	Barry	29
VK2DVZ	Ross	27
VK3BDL	Mike	26
VK3KAI	Peter	25
VK3TMP	Max	25
VK3WRE	Ralph	24
VK3CY	Des	23
VK2MP	Rej	22
VK3KEG	Trevor	21
VK3CAT	Tony	14
VK4KZR	Rod	14
VK7MO	Rex	14
VK3TLW	Mark	13
VK6KZ	Wally	12
VK2TK	John	11
VK3AL	Alan	10
VK3ANP	David	10
VK2TG	Bob	8
VK3KME	Chris	8
VK3YB	Phil	8
VK6KZ/p	Wally	8
VK2FLR	Mike	5
VK4TZL	Glenn	5
VK2CZ	David	3
VK2TWO	Andrew	3
VK4DFE	Chris	3
VK2DXE/p	Alan	2
VK3DMW	Ken	1

1296 MHz

VK3XLD	David	29
VK3BRZ	Chas	27
VK2ZAB	Gordon	25
VK3FMD	Charlie	23
VK3ZLS	Les	23
VK2KU	Guy	19
VK3EK	Rob	19
VK3KWA	John	19
VK3WRE	Ralph	16
VK3KAI	Peter	14
VK2DVZ	Ross	13
VK3BDL	Mike	12
VK3BJM	Barry	12
VK3TMP	Max	11
VK4KZR	Rod	9
VK7MO	Rex	9
VK2TK	John	8
VK3TLW	Mark	8
VK3AL	Alan	7
VK6KZ/p	Wally	5
VK2MP	Rej	4
VK6KZ	Wally	4
VK3KEG	Trevor	3
VK3YB	Phil	3
VK2DXE/p	Alan	2
VK3BVP	Shane	2

VK3CY	Des	2
VK2CZ	David	1
VK3DMW	Ken	1
VK4TZL	Glenn	1

2.4 GHz

VK3WRE	Ralph	8
VK3KAI	Peter	7
VK3EK	Rob	4
VK3FMD	Charlie	4
VK6KZ	Wally	4
VK3BJM	Barry	3
VK4KZR	Rod	2
VK3TLW	Mark	1
VK4TZL	Glenn	1

3.4 GHz

VK3KAI	Peter	4
VK6KZ	Wally	4
VK3EK	Rob	3
VK3FMD	Charlie	3
VK3WRE	Ralph	3

5.7 GHz

VK3FMD	Charlie	7
VK3WRE	Ralph	7
VK3KAI	Peter	5
VK6KZ	Wally	4
VK3BJM	Barry	2
VK3XLD	David	2
VK6BHT	Neil	2

10 GHz

VK6BHT	Neil	9
VK3FMD	Charlie	6
VK6KZ	Wally	5
VK3EK	Rob	4
VK3KAI	Peter	4
VK3WRE	Ralph	4
VK3XLD	David	4
VK2EI	Neil	2
VK3BJM	Barry	2
VK3TLW	Mark	1

24 GHz

VK6BHT	Neil	3
VK2EI	Neil	2
VK6KZ	Wally	2

Additions, updates and requests for the guidelines to Guy VK2KU, vk2ku@hermes.net.au, or by mail (QTHR 2002).

Next update of this table will be in mid November 2002.

Stations who do not confirm their status for more than 12 months may be dropped from the table.

VK1 Notes

Forward Bias

A sign of the rapid development in the technical equipment available to the Radio Amateur community is the speed at which it gets rid of outdated computers, transceivers, components from the junk box, and literature pertaining to the hobby. This was very evident at the Trash & Treasure sale that was held on Monday, August 26, '02 at the Scout Hall in Longerenong Street, Farrer.

On sale were two-year old computers, complete VHF repeaters, 12-volt power supplies, and junkboxes full of parts. There were enough parts available to build several transmitters and receivers. For a few dollars, you could buy books on programming and hand-held calculators of the types that are still on

sale in the bookshops. Many almost new, C-Band oscillators, wave guides, and associated test gear was also on sale. Some of the merchandise not sold that evening was offered free to anyone wanting to take it away.

Just a reminder (1) that the One-Tech '02 symposium is scheduled for Sunday, November 17, '02. Entrance fee is \$20 with free lunch. Check for further details on the ACT Website as they develop.

Another reminder (2) is the Extraordinary meeting that is being held on November 25, 2002. Several changes to the Objects and Rules (O & R) are proposed by the Committee affecting the numbers that make up a quorum, and the use of the Internet for notifying members about Annual General

Peter Kloppenburg VK1CPK

Meetings and Extra-Ordinary Meetings. We urge every member to attend this meeting in person, as a quorum of 30 is required to pass any motion. Every member will receive a letter announcing this special meeting, together with a copy of the proposed changes to the O & R. Also enclosed will be a proxy voting form that can be used by any member unable to attend.

Reminding again (3), Tony Bennett VK1BT is continuing with the open-house sessions being held at the hamshack in Longerenong St, Farrer on alternate Tuesdays.

The next general meeting will be held on Monday, October 28, 2002 at the Scout Hall, Longerenong St., Farrer, at 8.00 pm. Cheers. Peter (VK1CPK)

VK6 Notes

Welcome to the return of this column to the magazine. I hope to, over the coming months, put Western Australia back on the map regarding Amateur and WIA activities. I was the youngest Secretary of a WIA affiliated Radio Club, the Redlands Radio and Electronics Society (VK4), way back in 1979. It has been a long time between jobs!

Newsweek Joins the Digital Age

We have just purchased two state of the art Sony Minidisk recorders, one portable and one for the studio. These items have replaced some very tired analogue equipment that is no longer economical to repair. Listeners to Newsweek broadcasts every Sunday will soon enjoy a new level of audio quality. Many thanks to Tony Savory, VK6TS, for his research and manufacture of cables to introduce this new equipment to the WIA broadcast station.

Public Liability Insurance Rears its Ugly Head

The Northern Corridor Radio Group submitted a letter to the WIA regarding public liability insurance. They have to relocate their clubrooms due to the sale of Carine TAFE. Nobody would take them on if they could not provide a public liability insurance cover of at least \$10 Million Dollars. The WIA agreed to upgrade their insurance cover to match this amount as it has become the norm since the events of September 11. Insurance cover had not been upgraded since 1991, so this improvement seems realistic in our current litigious climate. We look forward to the NCRG moving their activities seamlessly to their new location.

The new insurance details will benefit all clubs that are affiliated with the WIA.

Problems Administering Examinations

Trevor, VK6HTW, outlined problems in administering the Exam service. An exam paper was received with the answers already circled! A Morse tape also contained background Morse signals. Thankfully emergency copies were available to rectify the situation. The cost of exams was also discussed. Do the charges incurred reflect the true cost of administering the exam service? Further investigations will be pursued with WIA Federal to find an answer to this question.

If anyone has any items of interest for inclusion in this column could they please contact me via Email: bear42@bigpond.com or Packet: vk6tnc@vk6bbs.#PER.#WA.AUS.OC

VK7 News

The Divisional Council has been trying something new during September – A Council meeting by email !. When all is done the results will be assessed, any complaints sorted out, and VK7 may be on the way to setting up another cost cutting measure with no more travel allowances or room hire. It will give the councillors more time to think through any decisions as well. The meeting is running over a few days and if successful will again show that rather than detract from our hobby the internet can be a great tool on the administrative side of Amateur radio

JOTA will soon be upon us and we are hoping for good co-operation between AR and the Scouts and Guides. Some of our groups are working to include IRLP contacts this year.

Our Central Highlands Amateur Radio Group, (CHARCoT) is hoping that the inaugural “Wadda Cup” catches the imagination of all VK Amateurs. Designed as an 80 metre dash running for half an hour from 0900UTC on the 28th November, among other advantages it will give participants, will be the chance to accumulate contacts for the “Tassie Trout Award” and our long

running “Devil Award”. Wadda is short for Waddamana – the first central highlands hydro power station, now decommissioned.

Our Southern Branch’s plans to have their September meeting atop Mt. Wellington went awry when that weatherman up top decided it was a no-go at 4000 feet. The meeting, to visit the new high power analogue and digital transmitting facility up on top is re-scheduled for the October meeting. We will now all keep everything crossed.

Cheers for now Ron, VK7RN.

VK2 Notes

by Pat Leeper VK2JPA

We welcome three new members this month. They are Stanley Clark VK2AYI, Patrick Sharples VK2IOW and Peter Collen VK2ZEE. We hope they have many happy years in the hobby.

The NSW Divisional Council held its monthly meeting by invitation at the Westlakes Amateur Radio Club premises on Friday 13th September.

Prior to the meeting, the VK2 President, Terry Davies VK2KDK was shown around the QSL Bureau (which is run by Westlakes) by Alex Efimov VK2ZM, the QSL Manager.

Westlakes members provided refreshments before the meeting which were very welcome and appreciated by, the councilors who had come from Sydney and the Tamworth area.

The meeting was held in the club library where Geoff McGrorey-Clark, VK2EO, as Westlakes President, welcomed Terry with a joke.

The council conducted its normal business while Westlakes members looked on. The club members were free to ask questions during the meeting.

Two councilors were unable to attend on the night. These were John Turner, VK2WRT, who was ill, and Chris Minahan VK2EJ who had work commitments preventing him travelling to Teralba.

It was decided at the meeting to hold the Conference of Affiliated Clubs on the morning of Saturday 30th November, with the Divisional Christmas Party following in the afternoon. So mark that date in your diary for a get-together with the council and friends on that day.

The last Trash & Treasure for the year will be held on 24th November, followed as usual by the Home Brew Group meeting.

The last examinations for the year will be held on 1st of December. Applications are due on Thursday 21st November.

The office will close for the holidays on 20th December.

If you know of anyone needing help to pass the examinations, please note that the Parramatta office is open Monday nights, 7-9 pm, with Terry VK2UX, the Divisional Education

Officer, in attendance to offer help with any problem with theory. Terry is only too happy to assist anyone having difficulty with their studies.

That’s all for this month. CU next time.

VK2 Morse Training Transmission

Readers may be aware that the previous VK2RCW morse training transmission was transferred to the NSW Division earlier this year and has been operating on 2 metres.

The 80 metre portion of this service has now resumed operation on the original frequency of 3699 kHz — in conjunction with the outlet on 2 metres, 145.650 MHz.

The 80 metre service has about 25 watts to a dipole antenna. Coverage reports are most welcome. We would also like to hear from those using the service to learn morse code. Reports to the Parramatta office.



Have you heard this week’s Divisional Broadcast?

See page 56 for times and frequencies

VK4 Notes

Qnews

From Alistair Elrick VK4MV

Cycle Queensland

WICEN operated a secure network for a total of 69.6 hrs over 8 days during the recent bike ride from Bundaberg to Brisbane. Traffic from stations was logged every 2 to 5 minutes during this time.

WICEN operators were on comms from 0500 through 2000 hrs most days, a total of 21 operators assisted for a total of 656 operator hours.

Mostly VHF repeater comms were used, including the group's portable repeater and Cross band VHF/UHF. UHF and HF were used at various times. APRS was used to track the Water truck and the SAG wagon and worked well when these vehicles were in simplex range of either base or other monitoring stations.

Four road incidents required ambulance attendance for transport to a local hospital. All incidents were bike-to-bike or individual bike incidents.

As the conscripted WICEN organiser for this event Ed VK4JEN thanks all operators who helped make this event the success it was in terms of communications. This exercise has indicated that WICEN can sustain long term emergency comms.

QLD QSL Bureau comes unstuck

WIAQ Council has decided that QSL stickers will no longer be sold. Stickers

already purchased by members will be honoured but an account will now be required.

New members to the Institute will be credited \$2.50 at both the Inwards and Outwards QSL Bureau, so can receive QSL cards initially without contacting the bureau. The Inwards Bureau processed about 8000 cards in August.

Curly Winds not far way

It's coming up to Curly Wind (Cyclone) season in tropical North Queensland, so it's time for all Amateur radio stations in the North to check out home and portable equipment to ensure that the transceivers, antennae, batteries and charging systems are in top condition. These items may be called upon to help out the general community during the cyclone season and need to be reliable to be of use.

Secretary in Print

The Brisbane Amateur Radio Club has a very interesting Secretary. His name is Peter Holtham VK4COG. Peter has had an article published in the August edition of Silicon Chip.

The article is called "The How, When, Where and Why of a Tantalum Capacitor". So, if you wish to find out about the mining for Tantalum in Western Australia it is suggested that you read this very interesting article.

Cable from the Gold Coast

On October 31 the club will be putting on a display at Southport High, assisting the organisers in the centenary celebrations of the laying of the first cable from the USA across the Pacific to Main Beach on the Gold Coast.

Then look forward to November 9 to the Gold Coast Hamfest, at Albert Waterways Hall, Broadbeach. Outdoor tables and car boot selling with lots of bargains. Open to the public at 9 am.

The organisation committee invites you to participate in this event by displaying and/or selling your goods and equipment or just promoting your club and hobby interest. Alternatively, support the valuable community work done by the Club; give your pre-loved old stuff a new home by donating any old or end of line stock to the Club.

If you wish to reserve a table on the day, please contact Susan or Bob on (07) 5545 0955 or Email

bob.tomkins@bigpond.com

Dedication to the cause

Maryborough Amateur Radio Club held its AGM on Tuesday 03/09/02. The entire Executive was elected to the same positions as last year, with NO changes. That puts Col Paton VK4BCP up for his 30th year as Secretary, now that IS a love of the hobby! Well done Col.

Cable and Connectors

- | | |
|--|--------------------|
| ● RG58C/U Belden 8259 | @ \$0.90 per metre |
| ● RG213/U Belden 8267 | @ \$4.45 per metre |
| ● RG8/U Belden 9913 Low Loss | @ \$5.15 per metre |
| ● RG8/U Belden 9913F7 High Flex Low Loss | @ \$5.55 per metre |
| ● RG8/U - RF400 Belden 7810 Low Loss Sweep Tested to 6000MHz | @ \$6.30 per metre |
| ● RG58: B80-006 UHF connector (M) | @ \$7.65 each |
| ● RG8/213: B80-001 UHF connector (M) | @ \$8.80 each |
| ● RG213: B30-001 N connector (M) | @ \$9.10 each |
| ● RG8: B30-041 N connector(M) | @ \$14.00 each |

connektron

 Pty Ltd

ABN 19 413 484 007

email sales@connektron.com.au or Phone (03) 9761-5220

connektron Pty Ltd, 45 - 49 Merrindale Drive, Croydon South, Victoria 3036

www.connektron.com.au

* All prices include GST

* Minimum order value \$50 payable by Visa, Mastercard, Bankcard or Money Order

* Packing and Delivery \$15 within Australia (Outside Australia P.O.A.)

Alternatives to AZ/EL Tracking Systems

You often hear people complain that the satellite game is too expensive to get into because of the need for AZ/EL tracking antennas.

Now it's true that if you want the very best results under all circumstances then a good AZ/EL tracking system is a must. Good rotator systems can cost the best part of \$2000 when you add the tracking hardware and computer software for full auto-track. It turns into an expensive exercise. Most folk justify this by acknowledging that the gear is robust and has a long working life – and – by sneaking up on it a bit at a time, grabbing an item here and there, you can spread the cost out. My rotator was purchased at a hamfest. I built my first tracker from a well-known circuit board design, you didn't even need a computer.

But, no matter which way you look at it, the whole exercise can be rather daunting for the newcomer. There are alternatives. On our mountain-topping expeditions we used a number of "el-cheapo" tracking systems. The first was a high gain co-linear dipole array that could be tilted over at an angle that followed the satellite's path across the sky. This is only suitable for LEO satellites although I can remember using

it occasionally for perigee passes of AO-10. The "main-lobe" of the antenna is disc shaped centred around the axis of the dipoles and provided you get the tilt angle right, the satellite will go across the sky always in the best part of the main lobe.

In practice we used 4 dipoles, end-to-end and fed in phase at 145 MHz, all attached to a long wooden pole. The pole

My rotator was purchased at a hamfest. I built my first tracker from a well-known circuit board design, you didn't even need a computer.

was mounted vertically to begin with and held up by a simple "A" framework that would allow it to be tilted over to match the maximum elevation of that particular satellite pass. No rotators at all - and it worked well. Some time later, this time from my backyard, we used a tiltable mast and ONE rotator (an old channel-master TV rotor) to do a better job. Once again if you tilted the mast over to the maximum elevation of the satellite, this system allowed several light yagis to be turned to follow the LEO satellite across the sky. A vast improvement and still no need for expensive AZ/EL rotators. The mast was actually 2 masts, one guyed and standing on the ground and the other slightly longer and hinged to the top of the first

mast. The bottom of the tiltable mast could be swung out to the maximum elevation of that particular pass. The TV rotor was fixed to the top of the tilt-able mast and it would allow the antennas to follow the satellite across the sky. Neither of these schemes was particularly high-tech but they were inexpensive and they worked.

There's nothing haphazard about the theory behind these ideas. All antennas have an effective "beamwidth", whether they be yagis or phased arrays. Apart from very high gain designs they are usually quite forgiving of small pointing errors. Both these systems allow the satellite to be in the main lobe of the antenna for pretty well all of each pass. We regularly worked AO-6, AO-7 and AO-8 from horizon to horizon using these antennas. A vast improvement from a fixed antenna of any sort.

Such systems would work just as well today. So if a full auto-track AZ/EL system is too daunting or too expensive, there are alternatives. Get out the books and go to it. Remember too that when the high-orbit birds, AO-10 and AO-40 are out there, near apogee and squints are good. You don't need to auto-track at all. A tripod mounted antenna system can be made with more than enough gain to do the job and at apogee the satellite is nearly stationary in the sky for long periods. My standard antenna systems for AO-10, AO-13, and Arsene were all tripod mounted in the backyard and aimed by hand.

The AMSAT group in Australia

The National Co-ordinator of AMSAT-VK is Graham Ratcliff VK5AGR. No formal application is necessary for membership and no membership fees apply. Graham maintains an email mailing list for breaking news and such things as software releases. Members use the AMSAT-Australia HF net as a forum.

AMSAT-Australia HF net

The net meets formally on the second Sunday evening of the month. In winter (end of March until the end of October) the net meets on 3.685 MHz at 1000utc with early check-ins at 0945utc. In summer (end of October until end of March) the net meets on 7.068 MHz at 0900utc with early check-ins at 0845utc. All communication regarding AMSAT-Australia matters can be addressed to:

AMSAT-VK,
GPO Box 2141, Adelaide, SA. 5001.
Graham's email address is: vk5agr@amsat.org

AO-40

Still undergoing commissioning. AO-40 is providing excellent DX contacts using L/S and U/S modes. Many reports come to hand of people using very small portable gear. It's turning into a 'rare-DX' satellite with many DX-peditions appearing from exotic countries and

IOTAs and grid squares. A very effective L/S antenna system can be made small enough to be carried in a suitcase and mounted on a tripod. For the more adventurous, AO-40 mode-L/S is the way to go.

ARISS Installation nears completion

The last two of four Amateur Radio antennas on the International Space Station have been installed.

On August 26th, two crew members attached the final two VHF-UHF flexible-tape antennas to the ISS Service Module. Installation of the new ARISS antennas on the crew's living quarters makes possible two separate ham stations aboard the orbiting outpost, one for VHF operation, the other for UHF (70 cm).

The first two antennas were installed during January space walks. Frank Bauer, the ARISS Chairman, continues the story, "There are now 4 antennas on ISS. Each of these antennas supports multi-band operation. Actually 3 of the 4 antennas are identical. Each of these antennas can support 2 metre, 70 cm, L band, and S band transmit and receive. On the fourth antenna, the 2 metre/70 cm whip is replaced with a 2.5 metre long whip (vertical). This antenna will support HF operations, particularly 10 meters".

Frank continues, "Right now we could support 70 cm operation using the Ericsson radio. We are still waiting for the Russians to certify the use of this equipment with the new antennas. In the near future we will have a dual-band 2

metre/70 cm radio along with the 70 cm radio. When these two systems are installed, we will hook one up to each of the two downward facing antennas. For a while, each radio system will use a separate antenna system. When we add

Signals are strong but if you are seeking a voice contact...consult the web site for ...times the crew are available for chatting on the amateur radio. They have a very busy daily schedule and will normally only be on the air during their recreation time.

additional equipment, we will evaluate the antenna uses. For now, we don't have any L band or S band equipment under development, but several ideas are in the works. Eventually HF operations will use the WA4 antenna". The Russians provided the feed-through devices. The US team did the hardware integration and certification. The Italian team, U.S.

team and Russian team all developed portions of the hardware". Many thanks to ANS and ARRL for the above information.

More complete details may be obtained by downloading a paper entitled "2001: an Amateur Radio Space Odyssey on the International Space Station". This paper details the development of ARISS and discusses the four ARISS antennas. It is available via:

<http://ariss.gsfc.nasa.gov/EVAs/amsat01.pdf>

During the past month or so voice contacts have been made with Valery Korzun and Sergei Treschev. Packet activity has also resumed. Signals are strong but if you are seeking a voice contact be sure to consult the web site below for information regarding the times that the crew are available for chatting on the amateur radio. They have a very busy daily schedule and will normally only be on the air during their recreation time. The ISS daily crew schedule can be found at:

<http://spaceflight.nasa.gov/station/timelines/>

TechSat-1

There is no sign of BBS activity from this bird at the time of writing. It is still transmitting telemetry bursts and no further news is to hand regarding when the BBS will be open for amateur use.

UO-22

The overall amount of packet radio satellite traffic has slowed due in part to 'telnet-ing' and other Internet related activities impinging on the terrestrial packet radio system. As a result more and more BBS traffic is appearing on UO-22. It is often reminiscent of the early days to see the amount of personal mail and general broadcast messages, pictures and technical data flowing via this reliable old bird - and you don't need a phone line to do it.

UO-46

This 38k4 satellite has been in "on-again-off-again" mode lately. It will be working perfectly with lots of pictures to download, 100% efficiency - and then suddenly it won't respond to turn-on commands. The down periods usually last a few days.

PCSat

A recent bout of ill health forced me to drop my controller duties for this bird. The control team members are still managing to keep it 'afloat' for APRS use by travelers and others. PCSat may be coming to the end of its useful life but it has paved the way to a whole new area of activity for amateur radio satellites. It's a pretty safe bet that most new birds will fly APRS digipeating hardware.

ar

? Have you tried...

DXing, microwaves, CW, high speed data, ATV, operating portable, slow scan TV, QRP, contesting, homebrewing, AM, UHF, packet radio, foxhunting, building repeaters, JOTA, 160 metres or publicising amateur radio?

WRITE ABOUT IT and send it to

Amateur Radio

the magazine which covers more facets of amateur radio than any other.

edarmag@chariot.net.au

How's DX?

Ross Christie VK3WAC
19 Browns Road, Montrose 3765, Vic.
Email Vk3wac@aol.com

Climbing Amateur Radio

Not much happening DX wise at my QTH these past few weeks, how about at yours? 160 m has been a bit quiet (noisy QRM/QRN wise as usual) here with little to report. The 10 m band is beginning to pick up into central Europe in the early evening with signals peaking at around 559 to 569, hopefully propagation will improve further. The Northern hemisphere has had quite a good summer DX wise so perhaps we can look forward to the same.

A couple of interesting notes. Firstly, Amateur Radio has just been put on the map, literally. Vladimir, EY8HB, and a couple of other climbers (non hams) have been granted official permission to name a previously unscaled 5879 metre high mountain peak after the hobby of Amateur Radio. Vladimir and his friends installed a solar powered radio beacon on the summit of 'Amateur Radio Peak' to provide a fitting and lasting acknowledgement of the occasion. The beacon, EY1ARP/B, transmits on 28107.5 kHz and radiates less than 1 watt. No details were given on the type of antenna used. The QRP power level is due to the very limited amount of

energy provided by the solar cells. The current state of 10 metre propagation should ensure the beacon signal is heard over a considerable area. If you manage to hear it here in VK please drop Vladimir a QSL card via the bureau to let him know just how far it reached.

And secondly, an oceanographic research buoy is about to be released from the Argentinian vessel Balizador to drift with the ocean currents and provide scientists with speed, direction and weather information. The buoy will also carry an interactive beacon that will send position, weather and temperature information to hams. The beacon will operate on 14026 then 28192.5 kHz in a

15 minute cycle, the format of the message will be approx. as follows "VVV LU0ARC/MM LU0ARC/MM 21/08/02 1537 UTC 35.08 S 0 57.02 W 13.7 V LIGHT 098 TC 28.0 TW 20." Carlos, LU5DZB, is looking for signal reports. These can be forwarded to Carlos at cuchin@speedy.com.ar.

So there you are, even if the DX is not up to specification you can exercise your ears and receivers by participating in collecting some oceanographic data. You never know you may be helping to explain and alleviate the effects of El Nino and La Nina induced droughts!

The DX

4S, SRI LANKA. Denver, 4S7DA, says that there is a new operator on air from Sri Lanka. His name is Ranjith and his callsign is 4S7KM and his preferred mode is CW on 20 and 15 metres. Apparently Ranjith has been very active lately so listen out for him on 20 metres around 1030 and 1430 UTC. QSL via the bureau or direct to Ranjith Peiris, 4S7KM, 37/6, Chapel Road, Nugegoda, Sri Lanka. [TNX 4S7DA and OPDX/KB8NW]

5T, MAURITANIA. Nicolas Sinieokoff, 5T5SN, is active again from Nouakchott, Mauritania. QSL direct to Giorgio Tabilio, IZ1BZV, P.O. Box 95, 19100 La Spezia - SP, Italy. [TNX IZ1BZV and 425 DX News]

5W, SAMOA. Bill, W7TVF (5W0VF) is heading back to Apia, Samoa (OC-097). He should arrive there around the 18th of Nov and stay until the 9th of Dec. Bill hopes to be active on all HF bands and 6 metres with a beacon running on 50.104 MHz. He will attempt some

RTTY and PSK31. If you need 5W on a particular band or mode you can try and arrange a sched with Bill via Email at bill.w7tvf@air-internet.com [TNX W7TVF and The Daily DX]

5Z, KENYA. Alex, PA3DZN, has been posted to Kenya by UNICEF on a new assignment. He says he will be there for 2 to 3 years and has been issued the callsign 5Z4DZ which he says he hopes to put to good use. QSL via Alex van Hengel, PA1AW, De Manning 15, 2995AE Heerjansdam, The Netherlands. [TNX PA3DZN and The Daily DX]

9H, MALTA. Gerd, DJ4KW and Gisela, DK9GG are planning to operate from Gozo (EU-023) from the 26th of Sept until the 8th of Oct. They will be using CW and digital modes. [TNX DJ4KW and 425 DX News]

FH, FRANCE. Bernie, F6BLK, will be on air as TO8MZ from Mayotte (AF-027) between the 30th of Sept and the 9th of Oct. Modes will be mainly CW and some SSB. QSL via F6BLK either direct or via

the bureau. [TNX F6BLK and 425 DX News]

GJ, JERSEY. Chris, G0WFFH, says he will be signing as GJ0WFFH/p from Jersey beginning on the 5th and finishing on the 12th of Oct. He is planning on operating portable QRP on all bands 160 -10 metres, SSB only. Chris says that he will be using a kite supported antenna and is looking forward to some breezy days. Look for him on the HF bands during the daytime and especially on the lower frequencies late at night. QSL via G0DBX. [TNX G0WFFH and OPDX/KB8NW]

KC4, ANTARCTICA. Mike Fokin, RW1AI, will operate as KC4/N2TA from 'East Camp', this is the US area co-sited with the Russian 'Vostok' station. He will be operating CW on all HF bands from 40 - 10 metres over a period of 5 months beginning late August. QSL cards will be processed when Mike arrives home early next year so don't

expect a card in a hurry. QSL direct only to P.O. Box 392, Brooklyn, NY 11230, USA. [TNX UA1AKE and 425 DX News]

LU, ARGENTINA. Mariano, LU4EJ plans to be active as LU4EJ/D from Ariadna Island (SA-021) from the 4th until the 6th of Oct. He is planning to use spot frequencies on or around 3680, 7080, 14260, 14200, 21260, 21300, 28460, 28560 and 50110 kHz. QSL via LU4EJ. [TNX LU4EJ and 425 DX News]

TK, CORSICA. Vasek, DL4FF, says that he will be on Corsica from the 8th of Sept until the 4th of Oct. He hopes to operate on all HF bands 160 – 10 metres using CW and SSB using the callsign TK/DL4FF. QSL via DL4FF either direct or via the bureau. [TNX DL4FF and 425 DX News]

TP, FRANCE. Francis, F6FQK, says that next activity of the Radio Club of the Council of Europe (TP2CE) is

scheduled for the weekend of the 19th and 20th of Oct using the callsign TP3CE during the JARTS WW RTTY contest. [TNX F6FQK and 425 DX News]

TY, BENIN. Pat, I8QLS, Piero, W1NA/I8CZW and Gino, I8ULL, will all be active from Benin between the 19th until the 28th of Oct. They will all participate as single operator/single band stations during the contest (I8QLS using the call TY2LS will be on 10m, W1NA on 15m and I8ULL on 20m). Prior to the contest they will operate on the low HF bands, WARC bands and 6 metres mainly using CW. Their QSL manager is Cirio, I8ACB. [TNX I8QLS and OPDX/KB8NW]

V6, MICRONESIA. A news release from The Diamond DX Club says that Nando, IT9YRE; Gaetano, IT9GAI and Claudio, I1SNW will be active as V63RE, V63GH and V63WN respectively from Nomwin Island from the 24th until the

27th of Oct, then from Etal Island from the 30th of Oct until the 4th of Nov. QSL route for the group is via IT9YRE.

VP2, MONTSERRAT. Geno, WA3IOU and his XYL Marlene, N3LGY, will be operating from here as VP2MEB and VP2MAB from the 14th until the 25th of Oct. The couple will be staying at the QTH of Keith, VP2MEG. QSL to their home callsigns. [TNX WA3IOU and OPDX]

ZD8, ASCENSION ISLAND. Jim, N6TJ, will be using the callsign ZD8Z from Ascension Island over the period of the 16th until the 29th of Oct. He will also make a serious entry in the CQ World Wide SSB DX Contest. Jim is planning for activity on 160 and 80 metres and the WARC bands using CW and SSB. QSL direct only via VE3HO. [TNX N6TJ and The Daily DX]

Special Events

A special event station commemorating the '14th Busan Asian Games' has been on air since the 10th of August and will continue until the 23rd of October. The special event stations are HL14AG and DT14AG. Activity will take place on all bands 80-10 metres, including the WARC bands and VHF/UHF using SSB, CW, FM, RTTY and SSTV. Four special awards are available and further information can be found by Emailing to ds5psn@hanmail.net QSL via HL0BHQ either direct (KARL Busan Branch, P.O.Box 88, Busanjin, 614-013, Korea) or via the bureau. A series of certificates is also available for working both HL14AG, DT14AG and stations located in the 43 Asian countries participating in the games. [TNX DS5PSN, HL0BHQ and OPDX/KB8NW]

The special event station JU840C will be active from the 21st until the 31st of Oct to celebrate the 840th anniversary of Gengis Khan (Chinggis Khaan) the founder of the Mongolian empire. The Mongolian Radio Sport Federation (MRSF) is organising an international DXpedition to the birthplace of Chinggis Khaan in Khentii province some 270 km from Ulaanbaatar. [TNX MRSF and OPDX/KB8NW]

8N1OGA will be on air on all bands 160 - 6 metres from Chichijima, Ogasawara (JD1) as a special event station celebrating the JARL's 75th anniversary. The station will be on the

air from around the 18th of Sept until the end of January 2003. [TNX The Daily DX]

6J, MEXICO. FMRE (Federacion Mexicana de Radio Experimentadores) is celebrating its 70th anniversary and all Mexican radio amateurs have been authorised to use the special prefix 6J in lieu of XE when working DX stations. Use of this special prefix is allowed until the 31st of Dec 2002. Also, a special event station, 6F1LM, is being activated by a group of individual amateurs and radio clubs for the remainder of the year. A specially produced QSL card will be sent to every contact they make. QSL VIA BUREAU ONLY. DO NOT send SASE's, IRCs or Green Stamps. [TNX XE1KK and OPDX/KB8NW]

DXpeditions

KH8, AMERICAN SAMOA. A Multi-national team of DXers is heading for American Samoa (KH8) with plans to begin operating on the 26th of Oct. The group will concentrate on Europe when propagation permits, especially on 160 m, ostensibly to give European stations a chance to log IOTA OC-077. The team is currently studying the propagation forecasts for 160 metres. They intend to activate two islands, Tutuila Island (IOTA OC-045) and Ofu Island (IOTA OC-077), at the same time with three operators on each island. The two groups will be operating using CW, SSB, RTTY, PSK31 and SSTV. The dates are

as follows; 29th Oct until the 8th of Nov from Tutuila Island and the 30th of Oct until the 8th of Nov from Ofu Island. The team consists of 6 operators. Glyn Jones GW0ANA, Team Leader, Doug Roberts, G0WMW, Dr. Markus Dornach, DL9RCF, Roger Mulzer, DL5RBW, David Flack, AH6HY, Thomas Steinmann, DJ6OI. Local help on KH8 will be provided by Larry Gandy, AH8LG. Check the DXpedition Web page at <http://www.ukdxers.co.uk> for further information.

Bengt, SM7EQL, and Ronnie, SM7DKF, will be operating as ZK1EQL and ZK1DKF from two of the South Cook Islands this month. Dates are as follows; Rarotonga (IOTA OC-013) from the 1st until the 3rd, Mangaia Island (OC-159) the 4th until the 11th and followed by another stint on Rarotonga on the 12th until the 14th. They are planning on using preferred spot frequencies, +/- QRM, on 7005, 10115, 14005, 18095, 21005, 28005, 14269, 18129, 21269, 24959 and 28469 kHz. Modes will be CW and SSB only. QSL via their respective home calls. [TNX SM7EQL and The daily DX]

The Kermadec DX Association has organised a DXpedition to the Chatham Islands, ZL7, over the period of the 17th until the 28th of October. No schedule has been issued regarding bands or times as the Dxpeditors will be judging propagation and conditions on a day to

day basis. The callsign for the operation has been issued but is being kept secret until the activity kicks off to ward off any misuse or pirating of the call as in previous DXpeditions. The team will consist of Hiro Miyake, JF1OCQ; Reinhard Maute, DF4TD; Steve Taylor, G4EDG; Paul Rubinfeld, WF5T; Bill Beyer, N2WB; Dave Anderson, KW4DA; Al Hernandez, K3VN; Murray Woodfield, ZL1CN; Wilber Knol, ZL2BSJ; Stan White, ZL2ST; Bob McQuarrie, ZL3TY and Ken Holdom, ZL4HU, who is the team Leader. There will be no on line logs, pilots and no E-qsling. The team is planning this as a 'back to basics DXpedition' and hopes to restore some of the fun and sense of

Round up

Martijn, PA3GFE, is heading off to South America a six month combined holiday and volunteer work program. He will be taking along a FT817, HF amplifier and a multiband dipole. Martijn says he will be as active as possible, conditions and time permitting, on 40 – 10 metres SSB with some 6m activity if the band is open. He will operate as OA/PA3GFE from Arequipa, Peru until the 1st of January and, assuming he can obtain a temporary licence in Ecuador, he will operate there until the 31st of March. QSL via the bureau to his homecall. [TNX PA3GFE and The Daily DX]

Peter, G3WQU/CN2PM (ex E4/G3WQU), is currently working for the Moroccan government in the Western Sahara. He says he will be on air as much as possible during his spare time (probably the weekends) using CW and PSK31 on HF until at least mid 2004. QSL direct to Peter McKay, MINURSO, P.O. Box 80000, Laayoune, Western Sahara, Morocco. [TNX G3WQU and The Daily DX]

Patrick, F6BLQ/9Q1A, has been assured by the Ministry of PT&T in Kinshasa, Democratic Republic of Congo that the callsigns 9Q0AR, 9Q1YL, 9Q1MM, 9Q1KS and 9Q1A will be re-issued for as long as they are required after the upcoming signing of the next Radiocom Regulations Decree. [TNX F6BLQ/9Q1A and The Daily DX]

The ARRL news web site recently carried a report that the 'Logbook of the World' computer system upgrade is progressing nicely and full

achievement in having a QSO with them. [TNX ZL4HU and OPDX/KB8NW]

A group of YL ops namely Elizabeth, VE7YL; June, VK4SJ; Mio, JR3MVF; and Gwen, VK3DYL, have organised themselves a trip to Nauru (OC-031) where they will operate as C21YL from the 1st until the 14th of Oct. If you hear the girls on air please give them a call. The teams original choice of location was disrupted when they were informed that there was going to be a severe shortage of accommodation due to the influx of UN personnel supervising the processing of refugees in the South Pacific. QSL via VK3DYL. [TNX VK3DYL]

implementation is expected by August or September. To quote the ARRL "Both the Enterprise software and DXCC program are scheduled for implementation September 1, 2002. Implementation of the eCommerce will follow by one month. Logbook of the World is on track for initial implementation in September." This new system will satisfy those who have been advocating a quicker and cheaper alternative to the traditional 'hard copy' QSL bureaux, but I wonder just how long it will be before someone learns how to 'hack' the system and lay it open to abuse?

Jon Rudy, DU9/N0NM, is now in the Philippines for the LF band season. Lately, the DX cluster spots have him listed on 3505 kHz at 0915 and 1315 UTC. Apparently he has improved the radial system on his vertical antenna and erected two new antennas for reception. He says "the antenna system has 45 radials, but if the wire is too obvious it seems to disappear"! On 160 m his SWR is lowest at 1820 kHz. His operating plan is to begin operating at around 0945 UTC listening for US stations for the first hour with the occasional listen during the local evening. He also says he will rise early at 2100 UTC for European stations. Propagation into VK should be reasonable in our mid evening so have a listen for Jon on or about 1823 kHz. [TNX The Daily DX]

Carl Smith, N4AA, DX editor for QRZ DX and The DX Magazine is again

3X, GUINEA. A group of seven German operators will operate as 3XY7C from Guinea beginning the 30th of Oct until the 13th of Nov. Plans are to operate on all bands 160 – 6 metres using CW, SSB, RTTY and PSK31 (an attempt may be made to operate SSTV). The equipment will comprise four transceivers, 2 amplifiers, a TH3 for 20/15/10, a A3WS (17/12), 2 Titanex V80E Lowband Verticals, a GP for 40/30 and another R5 Multiband GP. QSL is via DL7DF either direct or via bureau. Logs will be available during the DXpedition at <http://www.qsl.net/dl7df/3x> [TNX DF3CB and 425 DX News]

readying himself for the annual 'DX Magazine 2002 Most Wanted Survey'. The results of this survey are probably the most consulted by DXpeditioners. As Carl says "The more input received, the better the overall results will be for everyone". Please make time to visit Carl's site and complete an on-line survey form at http://www.dxpub.com/dx_survey2002.html. A complete table of results will be published in the January/February 2003 issue of The DX Magazine; also the top 100 for the world will be listed on the DX Publishing's Web page at <http://www.dxpub.com/> in mid January 2003.

Sources

Quite a mixed bag this month of DX news and information.

Thanks to the following individuals and organisations for the permission to use the information in DX Notes:

4S7DA, IZ1BZV, W7TVF, PA3DZN, DJ4KW, F6BLK, G0WFH, UA1AKE, LU4EJ, DL4FF, F6FQK, I8QLS, IT9YRE, WA3IOU, N6TJ, DS5PSN, HL0BHQ, MRSF, XE1KK, SM7EQL, ZL4HU, VK3DYL, DF3CB, PA3GFE, G3WQU, F6BLQ/9Q1A, ARRL, LU5DZB, N4AA, OPDX/KB8NW, 425 DX News, The Daily DX, ARRL, RSGB, QRZ DX and The DX Magazine.

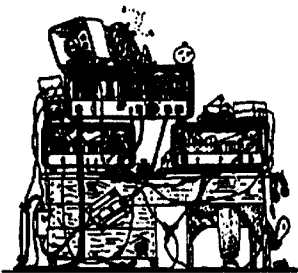

Part 19

Computer Noises

Adding a Ham Shack Computer opens new opportunities in the field of Amateur Radio – especially automation and access to the newer digital modes. However, the RF noise generated by computers can be so great that it destroys the enjoyment of the hobby. This article offers some simple tips on how to diagnose and minimise these “buzzing noises” down to a tolerable level and renew your enthusiasm in AR once more!

Listening on any HF Amateur band, “buzz-saw” and other spurious noises (birdies) can usually be heard all over the spectrum. Some noises wander around slightly whilst others are wideband. Switching off the computer reveals a nice quiet band, and with the computer on, and the monitor switched off other spurious signals might be revealed. Some experiments must first be made to determine if the interference is coming from the computer, monitor, or both. In most cases you will never completely remove all the problems, but most attain levels below operating annoyance.

Computers are complex digital devices with a myriad of switching waveforms containing high levels of harmonic content. Square waves are everywhere, and in particular, monitor displays where switch-mode power supplies and high intensity line and field drive signals radiate intensely. Plastic monitor cases are useless in screening out these interfering waveforms. The object is to operate both the receiver and computer with a minimum of mutual interference. Start by listening with the receiver connected to the station dummy load and then with each antenna in turn.

If spurious signals are evident with the dummy load, then severe problems exist, and this is where you should start first. Be prepared for some intense detective work but in the end you will succeed. The following steps can be each tried until the interference has been reduced to an acceptable level. There are no guarantees because every computer and shack installation has its own characteristics. However, the assertive RA will win given patience and an inquiring mind.

Spend time tracking these “birdies” by

drawing up a paper chart showing where they occur on the receiver dial, and whether they occur with the monitor on or off, and with which antenna etc. Once the extent is known try the following techniques in turn until the station is fully operational with the computer working normally.

- ① Make sure you have installed a proper station ground connected to a copper earth rod just outside the shack. The rod should be driven into the ground to at least 1.5 metres. Use thick coax braid to connect the rod to a common terminal in the shack, and each item of equipment is linked to this one terminal. The more copper in the ground – the better the signal earth will be, and your station will perform better anyway!
- ② Install an earth terminal to the computer chassis and connect to the shack earth terminal. Check for “birdies” again which should now be somewhat reduced in level.
- ③ Check with the monitor switched off. If problems exist in the monitor fit an earth terminal to the monitor chassis and connect with coax braid back to the station earth. This should further reduce the problems.
- ④ Make sure ALL your shack apparatus is connected to the common station earth with thick coax braiding covered in cheap black flexible reticulation pipe to prevent further noise by chaffing on adjacent radio equipment.
- ⑤ If the monitor suffers from severe radiation, remove the plastic case and carefully cover the inside of the case with aluminium kitchen foil. Contact adhesive dabbed on with an old paintbrush keeps the foil in

place, use a second brush to push the foil into the profile of the case, but make sure that the foil is kept in one piece to maintain electrical conductivity over the whole area. Once done, drill through the case rear - fit a 3mm round head bolt, solder tag, serrated washer forming a solid earth connection. A short length of insulated black wire is added between the solder tag and the metal chassis of the monitor. Before assembly, check that the foil is clear of any circuitry and final re-assembly is safe. Once done, check for “birdies” again. You should be pleasantly surprised at the reduction of radiation, and the effort taken will be well worth the time consumed.

- ⑥ Once assembled, check the levels of the spurious again from your previous readings. Levels should be lower with some that are now well below the receiver noise floor. However, tests should now reveal antenna or mains born spurious.
- ⑦ Connect a short length of RG58 coax to your receiver and terminate the far end with a 10-turn small loop of hook up wire. Use this “snoop loop” to move around the computer to determine where further problems are sourced.
- ⑧ Mains born radiation can be minimised by fitting clamp-on Ferrite Suppressors (DSE D5370) to the mains input cables nearest to the computer AND the monitor. Try another on the monitor VGA lead. In severe cases, DSE (D5350) Antenna Balun Toroids wound with several turns of the power cable have also proved successful. Unfortunately the power plug has to be cut off so that the cable can

be wound around the toroid to fill the center hole leaving enough cable to terminate a new power plug. If no success, fit a new cable and use the modified cable on another device until the noise source is identified.

8. One of the most successful cures for mains born interference is to fit the following filter **INSIDE** the case of each piece of shack equipment:

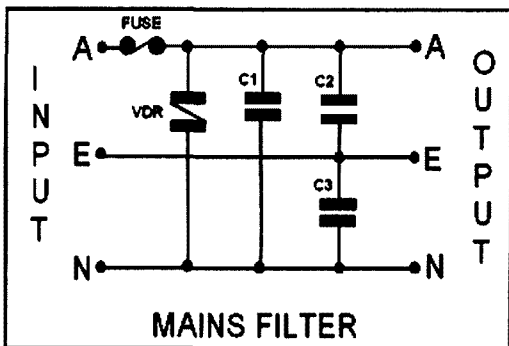

C1, C2 and C3 are 0.01 μ F 3kV ceramic RF bypass capacitors (DSE R2400) and the VDR is a Metal Oxide Varistor (DSE R1802) used to clip high voltage spikes. Fuses are recommended just in case the VDR breaks down under severe conditions. The whole assembly is constructed on a 3-lug, large tag strip (DSE P4804) and mounted inside the equipment near to the mains input wiring. This modification is vital in rural and mining areas where the supply voltage varies dramatically – and is essential where the so called “double insulated” plug packs are used with two-pin, figure eight cable – and NO EARTH is common. The writer has fitted many of these devices to electronic equipment in regional areas with huge success where the devastation was rife – especially with laptop computers that “floated above earth”!

9. Laptop computers have lower radiation due to the nature of flat LCD screens. However, they still suffer from “leaky” plastic cases and may be fed with internal “double insulated” two-pin mains cables. Earthing can be a problem but can be overcome by fitting a DB9 metal backshell (Jaycar PP0800) to an unused comport connected by insulated coax braiding to firmly ground the

metallic case to the station earth.

10. TNCs, test gear, low voltage power supplies, clocks and other devices should also be checked with the receiver “snoop loop” to ensure that each device and any interconnecting wiring is not adding to the overall “birdie” problem in and around your shack installation.

11. Once the suggestions offered from 1-10 have each been tried, the next area will be your antenna installation. Operators with towers, rotators and big beams installed away from the operating position will be much better off than those with long wires, verticals and roof mounted antennas. Spurious radiation from unscreened rotator cables (check the rotator manufacturers circuit diagram first to avoid error) can be minimised by fitting 0.01 μ F 3kV Ceramic bypass capacitors (DSE R2400). Fit the same mains filter described in 8 to the rotator power unit and ground the case by replacing the power cord with an approved 3-core cable.

12. Ensure that towers, masts, feeders catenary cables and other metal objects are all firmly grounded to prevent them from re-radiating spurious “birdies” emanating from your computer(s) and other RF devices. Make sure that any antenna tuners are also firmly grounded to the station common earth system.

By now your computer should be very quiet indeed, and you have gained the advantage of a more efficient Amateur Radio Station. However, in very difficult cases, some monitors are dreadful radiators! Try swapping monitors with a friend. Some can be very good, whilst others with “Low Radiation” clearly visible on the front panel can be pathetic and a mockery of modern EMC standards. Some of the better brands can be the worst radiators of spurious in the AR shack. Fortunately, desktop computers are still made in metal cases and can be properly earthed. Sometimes a poorly bonding case with badly fitting lids, sides and front panels may need to be “linked” with hook up wire to avoid radiation. If building your own computer, choose a high quality case with slotted sides and bonding strips. Ask your dealer for a peep at the inside

of the case before purchase. If the lids and sides just screw together over painted metalwork – be very suspicious and move on to another dealer.

Summary

Most of the common solutions to computer radiation have been covered. However, there are many more to be found in EMC Handbooks from around the world. There is no one solution, and success depends upon your own vigilance and patience in tracking down these problems. Use your own experience of RFI and TVI detection and you will eventually cure the problems forever – until you upgrade to yet another new computer, Hi

The writer has three fully operational computers ethernet linked together in the shack – all operating at once with little or no spurious on any of the HF, VHF or UHF bands. DX low level received signals are enjoyed daily. However, there are many of the suggestions from this article “hanging” around the shack wiring to achieve satisfaction. Go for it and be a “birdie detective” and enjoy the wonders of the digital age in your own quiet Ham Shack. Remember that you will not totally eliminate all the interference, but you will reduce the level to an enjoyable conclusion. Lastly, harmonics from next door’s television line time-base will still be detected especially on the LF bands. Not much we can do here except make sure your antenna is placed as far away as practicable and swallow your pride!

Ham Tip No. 19

Never build little devices like PSK31 interfaces, AF filters, ATUs, DSPs and audio processors in plastic boxes. Screen everything including speaker leads, 12-volt supply leads, electronic Morse keys and the like. If you do this, your “birdie problem” will be easier to track and cure. The DigiPan waterfall also makes a superb “birdie tracker” – just try it once and you’ll never ever turn back

Ham Shack Computers, Part 20 “DX Clusters” – next month offers tips on integrating your computer, rig control and packet VHF station to spot and work rare DX stations with a few mouse “clicks”!

(1) Ham Shack Computers Web:
<http://www2.tpg.com.au/users/vk6pg>
 73s de Alan, VK6PG

Contest Calendar October – December, 2002

Oct	5	8 th TARA Rumble		
Oct	5/6	Oceania DX Contest	(SSB)	(Aug 02)
Oct	6	RSGB 21/28 MHz Contest	(SSB)	
Oct	10	Ten-Ten Intl. Day Sprint	(All)	
Oct	12/13	Oceania DX Contest	(CW)	(Aug 02)
Oct	19/20	JARTS WW RTTY Contest	(RTTY)	
Oct	20	Asia-Pacific Sprint	(CW)	
Oct	20	RSGB 21/28 MHz Contest	(CW)	
Oct	26/27	CQ WW DX Contest	(SSB)	
Nov	1-7	HA-QRP Contest		
Nov	2/3	VHF/UHF Field Day	(CW/SSB)	(Oct 02)
Nov	3	High Speed Club Contest		
Nov	8-10	JA International DX Contest	(SSB)	
Nov	9	Anatolian PSK31 Contest		
Nov	9/10	WAE RTTY Contest		
Nov	9/10	OK/OM DX Contest	(CW)	
Nov	16/17	LZ DX Contest	(CW)	
Nov	16/17	All Austrian 160 Metres DX Contest	(CW)	
Nov	16/17	RSGB 160 Metres DX Contest	(CW)	
Nov	23/24	CQ WW DX Contest	(CW)	
Nov	23/24	CQ SWL Challenge	(CW)	
Dec	6-8	ARRL 160 Metres Contest	(CW)	
Dec	14/15	ARRL 10 Metres Contest	(CW/SSB)	
Dec	21	OK DX RTTY Contest		
Dec	28	RAC Canada Winter Contest	(CW/SSB)	
Dec	28/29	Original QRP Contest	(CW)	
Dec	28/29	Stew Perry Top Band Distance Challenge	(CW)	

Greetings to all contesters and readers

We are all very much aware that today we live in an age where we want almost instant decisions and resolutions to questions. With this idea goes the concept of "the more the better" when it comes to equipment, or the cost thereof.

For contesters this is showing up in the form of more antennas as number one priority, access to packet and DX spotting nets in number two slot and now, for the really enthusiastic station, more radio gear to enhance operations on the same band as the station is currently working as well as keeping an

eye on the other bands for multipliers. *If you did not see my comments on this style of operation, please find a copy of last month's magazine.*

These days when it comes to publication of rules and results, it must be said that the Internet is quick and all information is readily available to

everyone when posted. Not surprisingly, many people now turn to the Net for latest information about a particular contest – often via a dedicated site, or if not then via a general site, e.g. our local vkham.com contest page (<http://www.vkham.com/contest/>).

However nice it is to think that

everything in the garden is rosy; in practice it is not so. I have always been conscious of the fact that many operators are no longer working with lots of cash to spend on computers and radio equipment. These people rely on publications such as "Amateur Radio" to keep them informed, assisted by broadcasts from time to time, e.g. QNEWS on Sundays.

Written publications do, however, take a long time to prepare. These notes that you read now in October were submitted to the Editor at the end of August. Columnists and Editor must always be thinking in advance (quite easy to do once you get into the way of it). However, it also means that sometimes information arrives at a columnist's desk that just cannot be put into print in time. Sadly it must be left on the desk and eventually sent to the waste paper bin.

The other difficulty that sometimes arises is lack of space for certain items. I

noticed that this happened to this column in July, when I had sent details of a new digital mode contest rostered for September. When the magazine arrived there were no rules for the Digimode event. Such is life and there is no need to lose sleep over it — we can always try again at a later date. I mention it only so that you, the readers, may be aware that sometimes things may seem a little out-of-date. This is where use can be made of the broadcasts and Internet to draw attention to changes or things not previously advertised. Such avenues are invaluable and, even if you do not have Internet access at home, I certainly would urge you to do so via your local Library. There are people there these days ready and willing to help us find our way around computers and the Net. No ham need miss out on news of almost any aspect of our hobby that we may be interested in.

Contesters, of course, know all this and use logging programs to assist with their contesting, as well as submitting their logs via email after the event. Computers figure large in their shacks, as they would in shacks of keen Dxers — not to mention connecting to Packet and DX Clusters, as well as radio control.

So my purpose in these notes this month is to make you aware that it is not always easy to keep right up with the latest as far as a print medium is concerned, but using the Internet does make things easier. Whichever way you choose, please do keep up your interest and participation in contesting.

You will note that this month is Oceania DX month. By the time you read this the contest will be over, but I hope that you were not afraid — you jumped in and "had a go"! Now all you have to do is send in your log!

73 and good contesting, Ian Godsil VK3VP

Results Of Pacific 160 Metres Contest 2002

Section: MIXED

Place	Callsign	Score
1 st	ZL2AS*	712
2 nd	ZL2RX	531
3 rd	ZL3TY	410
4 th	VK3APC/P	204
5 th	ZL2AJB	165
6 th	VK3DBQ	24

ZL2s CF, LF, DW

Section: PHONE

Place	Callsign	Score
1 st	VK3BF/VK3CKD	371
2 nd	VK3KTO	203
3 rd	VK3EK	192
4 th	VK7JGD	88
5 th	VK3JWZ	60
6 th	ZL2CD	36

Section: CW

Place	Callsign	Score
1 st	VK3IO	1260
2 nd	VK6VZ	847
3 rd	VK2AYD	231
4 th	VK3ET	210
5 th	VK8AV	198
6 th	ZL2CD	196
7 th	W7LR	160
8 th	VK3MV	154
9 th	K6SE	45
10 th	VK4TJ	36
11 th	VK3VB	12

Meet hams where you live.

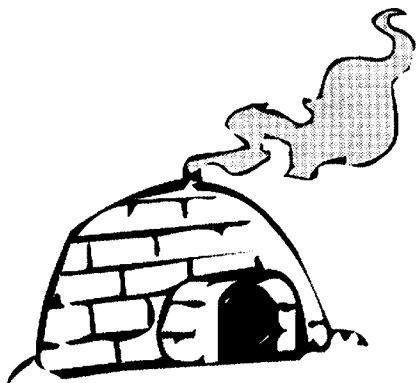

Join your local club. Find the address in this year's WIA Callbook. Now available on serchable CD

Statistics:

A total of 23 logs was received, 13 of these via email.

Comments:

Email is certainly now a popular method of submitting logs, as several were received on the Monday following the contest.

I thank all those who took part, both the regular contestants and a good showing from VK3s JWZ and KTO and VK7JGD to whom the HF bands became available recently. Thank you very much for your interest in this and other contest events.

I apologise that the points for DX QSOs were not printed in "Amateur Radio" magazine. These things do sometimes happen, but all logs were checked and corrections made where necessary.

Suggestions have been made for improving the rules for 2003, so if you have any ideas PLEASE let me know either by postal mail, or to email: vk3vp@vkham.com

Thank you again and good contesting.

73, Ian Godsil VK3VP

Spring VHF-UHF Field Day 2002

From John Martin (VK3KWA), Contest Manager

Dates: November 2 and 3, 2002.

Duration in all call areas other than VK6: 0100 UTC Saturday to 0100 UTC Sunday.

Duration in VK6 only: 0400 UTC Saturday to 0400 UTC Sunday.

Sections

- A: Portable station, single operator, 24 hours.
- B: Portable station, single operator, any 6 consecutive hours.
- C: Portable station, multiple operator, 24 hours.
- D: Home station, 24 hours.

Single operator stations may enter both Section A and Section B. If the winner of Section A has also entered Section B, his log will be excluded from Section B.

If two operators set up a joint station, they may enter Section C under a single callsign, or sections A/B under separate callsigns. If they enter Sections A or B, they may not claim contacts with each other. Stations with more than two operators must enter Section C.

General Rules

One callsign per station. Operators of stations in Section C may not make contest exchanges using callsigns other than the club or group callsign. Operation may be from any location, or from more than one location. You may work stations within your own locator square.

A station is portable only if all of its equipment, including antennas, is transported to a location which is not the normal location of any amateur station.

Repeater, satellite and crossband contacts are not permitted. No contest operation is allowed below 50.150 MHz. Recognised DX calling frequencies must not be used for any contest activity. Suggested procedure is to call on 0.150 on each band, and QSY up.

Contest Exchange: RS (or RST) reports, a serial number, and your four digit Maidenhead locator.

Repeat Contacts: Stations may be worked again on each band after three hours. If the station is moved to a new location in a different locator square, repeat contacts may be made immediately. If the station moves back into the previous locator square, the three hour limit still applies to stations worked from that square.

Scoring: For each band, score 10 points for each locator square in which your station operates, plus 10 points for each locator square worked, plus 1 point per contact. Multiply the total by the band multiplier as follows:

6 m	2 m	70 cm	23 cm	Higher
x 1	x 3	x 5	x 8	x 10

Then total the scores for all bands.

Scoring Table

A cover sheet is printed separately.

This Cover Sheet and scoring table, ready to print out and fill in, may be obtained from the e-mail address given below. Otherwise please follow the following format. In this sample the operator has operated from one locator and worked four locators on each band:

Band	Locators Activated	Locators Worked	QSOs	Multiplier	Band Total
6 m	10	+ 40	+ 40	x 1	= 90
2 m	10	+ 40	+ 30	x 3	= 240
70 cm	10	+ 40	+ 20	x 5	= 350
Overall Total					= 680

continued next page

Technical Abstract

Blu Tack Swarf Catcher

An interesting application for Blu Tack from EI2IH appeared in the In Practice column of Ian White G3SEK in Rad Com June 2002.

The idea is to use a lump of Blu Tack to catch swarf when drilling a hole in an equipment panel. A large lump of Blu Tack is simply stuck on the back of the panel where the hole is to be drilled and this traps any swarf. The Blu Tack and swarf are then simply removed. A lot easier than masking and carefully vacuuming.

Other uses for Blu Tack had appeared previously in Ian's column. These were

to hold nuts in inaccessible locations and to take dental impressions of components to be used in drilling a PCB. Another use was as a removeable sealant for such things as rotator cables. Apparently Blu Tack works outdoors and it is often easier to find than specialised sealants. It is not as good as a specialised sealant such as Coax-Seal but if it is to hand it may well save the day.

It's on again!
AHARS
Buy And Sell
November 23rd
Westbourne Park
RSL Hall
Goodwood Road
Just South of "Big W"
Doors open at 9.00
 (see Club News, page 24)

Book Review

A radio active life

Harry Atkinson VK6WZ has written an account of his life in country broadcasting stations and as an audiophile.

Harry was born legally blind but he says his mother kept the fact a secret from him so he had a fairly normal upbringing. He says it took a world war to give him his first full time job in radio, which he heard of through another amateur. He went to 6GE Geraldton WA as announcer/copywriter subsequently rising to become its manager for 15 years. He then went to Albany WA to set up a new commercial broadcast station 6VA. As well as running an audio shop for ten years, he worked at stations 6KG Kalgoorlie and 6WB Katanning.

The book includes serious discussion of the early history of commercial

broadcasting in WA as well as many amusing anecdotes of life in a radio station. These are written in the racy, entertaining style which typified his advertising copy. He tells of the breaking of the news of Pearl Harbour, when the station had to do an early morning ring-around to get an audience. Also the time an amateur was found to be jamming the nearby, secret radar station. He tells with great humour of the time the Army tried to recruit him but when he failed the eyesight test (!), gave him a pair of binoculars and made him a Coast Watcher. He also never loses sight of his amateur radio background while

writing.

The book includes examples of his witty advertising copy, his program scripts and his story writing. It is, as a former radio station programme manager has commented, an entertaining read with extra significance for radio hams.

The book has been published posthumously by Harry's widow. Requests for copies should be directed to Bruce Hedland-Thomas VK6OO, QTHR or Tel. 08 9271 9529. The price is \$20 posted.

ar

Contests (continued)

Logs: Show each contact: UTC time, frequency, station worked, serial numbers and locator numbers exchanged, points claimed.

The front sheet should contain the names and call signs of all operators; postal address; station location and Maidenhead locator; the section entered; the scoring table; and a signed declaration that the Contest Manager's decision will be accepted as final.

Entries: Paper logs may be posted to the Manager, Spring VHF-UHF Field Day, 3 Vernal Avenue, Mitcham, Vic 3132. Electronic logs can be e-mailed to jmartin@xcel.net.au. The following formats are acceptable: ASCII text; RTF, doc; XLS; MDB; or PUB. Logs must be received by Monday, November 25, 2002. Early logs will be appreciated.

ar

SCORING TABLE

Band	Locators Activated	Locators Worked	QSOs Made	Total	Band Multiplier	Band Total
	10 points each	10 points each	1 point each			
50 MHz	+	+	=		x 1=	
144 MHz	+	+	=		x =	
432 MHz	+	+	=		x 5=	
1296 MHz	+	+	=		x 8=	
2.4 GHz	+	+	=		x 1=	
3.4 GHz	+	+	=		x 1=	
5.7 GHz	+	+	=		x 1=	
10 GHz	+	+	=		x =	
Higher	+	+	=		x 10=	
				FINAL TOTAL=		

Cover Sheet WIA VHF-UHF Field Day

Date:/...../.....

Section entered: Station call sign:

- A Single operator 12 hours
- B Single operator 6 hours
- C Multi operator 24 hours
- D Home station 24 hours

If entering more than one section, please use a separate copy of this sheet for each section.

Call signs and names of all operators:

For Section A or B, time periods to be scored:

For Section A, either one 12 hour period or two 6 hour periods. For Section B, one 6 hour period only.

The station operated from the following grid locators:

Postal address for notification of results:

I/We agree that the Contest Manager's decision will be accepted as final.

Signed:

The non-pretend universe

In the last article I referred to the fundamental concept in amateur radio of "licence to learn". If this is so fundamental it automatically follows that various study packages, courses, etc, to help people join this quite wonderful worldwide activity should encourage this fundamental concept.

One way this can be achieved, and at the same time increase the effectiveness of any course, is for the course to show that the electronic universe is not a pretend one, but is rather a real one.

It would be possible to fill this magazine for many years with articles referring to what is known about the learning process and what works, and what does not, with education. However, an accurate, if simple, summary would be that learning is most effective when three conditions are met. One condition is that learning for understanding is superior to learning for memorising. The second condition is that course structures should match the learning style of the students. The third condition is that learning activities should maximize the involvement of different parts of the brain.

There are many ways of achieving these three conditions in conducting a course. However, one method, which is not particularly effective, is the traditional lecture. On the other hand one very useful tool for the educator is to include as many activities which are real events in the universe. This is a non-pretend universe.

While not all courses will have access to the various items of equipment or facilities to have the real universe (hands on activities) in the course, some will. In addition if the local amateur radio educator can form a partnership with an educational institution such as a TAFE College, university, or local secondary school some more doors will open.

The list of real universe possibilities is very large. I would like to mention some which are perhaps a bit different from the usual or expected.

Not everybody would have access to signal generators but there is now software which will allow a sound card to be an audio generator. This can be used in conjunction with software,

which allows a sound card to be an audio oscilloscope. To go a little further, many of the DVMs on sale have reasonable accuracy at audio frequencies.

So in addition to measuring voltage and current for resistors try it for a car tail light bulb which shows the effect of temperature. Then go further and using audio frequencies make measurements with capacitors and inductors showing ideas related to reactance and resonance.

The proverbial plug-in breadboard is useful for many circuits. One, which is a little different, is to start with the commonly available 3580 crystal and use it to show various oscillators. The

...with partnerships, innovation, experimentation, and even fun, we can help future amateurs to learn more effectively and efficiently

oscillator can be detected using an HF rig tuned to 80 m. While crude and not best practice for transmitters you can low level AM the oscillator at a high audio frequency, say 15 kHz or even higher, and using the HF rig find the sidebands. Some scanning receivers have simple spectrumscopes, which can be used here as well. You can go further and show harmonics and distortion.

The behaviour of waves is easy if you can work with your local high school science department. Ripple tanks show many wave phenomena. The long steel springs show phase reversal or not upon reflection, speed change with refraction, and standing waves. It goes without saying that if you involve the teachers/lecturers they may well not only run this session for you but want to study themselves or encourage their students to do so.

If the secondary school has physics in the curriculum it might have a 10 GHz transmitter and receiver as well as mirrors, prisms, and lenses suitable for the 3 cm waves. So reflection, interference, and refraction are all possible. Sending the 3 cm waves over a curved metal surface, copper or aluminium preferred, a simulation of ground wave propagation is possible.

Using a bare wire strip line a few metres long, a 2 m rig at low power, and simple diode probes, standing waves in feedlines can be shown. Working again with rigs at low power on either 2 m or 10 m simple dipoles can be hung up and adjusted for length in a normal classroom or meeting room.

I could go on with others as the list is rather endless, but with partnerships, innovation, experimentation, and even fun, we can help future amateurs to learn more effectively and efficiently. I invite the brewers (electronic not the liquid type) to design simple circuits to help educators.

I would encourage our dedicated educators to develop partnerships with local educational institutions and work with them, not just use their rooms.

ar

STOP PRESS

JOTA

The Bass Amateur Radio IRLP Group will be using node 633 during the JOTA weekend from 9am Saturday and Sunday from the Dromana Sea Scouts Hall in Dromana Victoria

VHF - UHF

AN EXPANDING WORLD

David K Minchin VK5KK

Postal: 10 Harvey Cres, Salisbury Heights, SA, 5109

E-mail: tecknolt@ozemail.com.au

Web page: <http://members.ozemail.com.au/~tecknolt>

Phone: 0403 368 066 AH only

All times are in UTC.

50 MHz

Reports so far from VK and overseas seem to indicate this equinox is a slow starter for F2/TEP.

Bevan VK4CXQ reportsActivity Townsville on 6 metres mid Aug-mid Sept on CW. Sounds as if the band is starting to liven up just a little over the past month.

All JA districts were heard/worked except JA8 but including JD1. Some

were difficult even on CW but some solid QSOs were made, 43 in total. Also worked was BG9 (again) some Koreans (south) DS and HL and KH6SX from Hawaii. KH6SX is a regular operator and his signals have been very good these last few nights. Heard him QSO FK8 a

few times about a week ago. No other signals from the Pacific area nor from the north west as yet but the TV has been strong at times ...

Bevan VK4CXQ

144 MHz and above

SSB activity is aive and well! Guy VK2 KU reports ... VK2KU SSB Log for Week ending Sunday 15 September 2002, for multiple contacts the best report is given.

144 MHz: 400 W to 4x12 element yagis on 6m booms at 13.5m (feeder loss 1.2dB),

432 MHz: 100 W to 1x20 element Yagi

on 3.7m boom at 12.9m (feeder loss 3.2dB),

1296 MHz: 10 W to 4x30 element yagis

on 2.5m booms at 14.6m (feeder loss 4.7dB).

My low loss feeders are only partly installed at present.

144 MHz	VK1CJ	58 58	212km	144 MHz	VK2ZRE	56 57	292km
144 MHz	VK1ZQR	57 57	207km	144 MHz	VK3AJN	55 59	487km
144 MHz	VK2AAS	59 59	63km	144 MHz	VK3BWT	54 57	431km
144 MHz	VK2DCJ	59 59	18km	144 MHz	VK3CGR	53 53	568km
144 MHz	VK2DVZ	59 59	285km	144 MHz	VK3II	53 53	689km
144 MHz	VK2FLR	59 59	72km	144 MHz	VK3KAI	54 55	627km
144 MHz	VK2FMB	52 52	459km	144 MHz	VK4AFL	54 54	739km
144 MHz	VK2KWM	54 59	354km	144 MHz	VK4AML	52 52	748km
144 MHz	VK2MP	58 59	190km	144 MHz	VK4ARN	51 51	721km
144 MHz	VK2TG	59 59	49km	432 MHz	VK1CJ	54 52	212km
144 MHz	VK2TK	59 59	7km	432 MHz	VK2DVZ	54 55	285km
144 MHz	VK2TQP	52 57	438km	432 MHz	VK2MP	53 55	190km
144 MHz	VK2XGJ	59 59	94km	432 MHz	VK2TK	59 59	7km
144 MHz	VK2ZAB	59 59	66km	432 MHz	VK2ZAB	59 59	66km
144 MHz	VK2ZCV	55 56	346km	1296 MHz	VK2DVZ	53 51	285km

Guy VK2KU

Digital DX

Debate has been raging about the validity of digital modes when applied to the grid squares standing list as a result of new Digital modes figuring in a number of new grid square claims.

Unfortunately, in some corners, the debate lost sight of the purpose of lists such as this. I believe that to be the promotion of activity in areas that aren't normally active on the VHF bands and the advancing of our hobby. Maybe

history repeating itself ... debates like this have happened before in other areas along more traditional lines. Morse vs. Voice I believe! Not for me to take sides but move on please!

New Caledonia

Keep in mind the skeds with FK8CA that start on 1 October. I will give you the details again in next week's news.

73 Rex, VK7MO

FSK441 over the weekend 21/22 Sept 2002

John VK2TK has overcome his computer soundcard problems and made his first FSK441 contact.

Other stations on this weekend were: VK1WJ, VK2FZ, VK2FLR, VK2AWD, VK2FLR, VK2TQP (receiving), VK3KAI, VK3AEF, VK3AXH, VK5DK, VK4TZL and VK7MO.

Gavin, VK3HY and Rex, VK7MO completed what they believe to be the

shortest VK FSK441 2 metre meteor scatter contact at 585 km.

Next weekend will be Type A on Saturday and Type B on Sunday on 144.230. However, in addition on the Sunday, we run, as a trial, a Type A on 144.330. Dave, VK2AWD will be on

144.330 on the Sunday and others are welcome to join - he will be looking for VK3/5 stations. The purpose is to open up options for Sydney stations now there are a number operating.

Microwave News

New 24 GHz World Record

This month we have a report from the USA detailing the confirmed new world record on 24 GHz ... at 542 km, nearly 100kms further than the previous mark.

On September 7, 2002 at 1235UTC, WW2R/5 and W5LUA made a record breaking contact on 24192 MHz. Dave was operating portable in EM41HC near Natchez, Miss and W5LUA was operating from his home in EM13QC, Allen, Texas. CW signals of 549 were exchanged.

DX based on 6 digit to 6 digit grid square is 337.3 miles or 542.8 km

The equipment at WW2R/5 consisted of a 2 ft dish fed through 2 foot of flexible waveguide by a retuned Hughes 12-18GHz TWT running 11 W output. The 1.8dB HEMT preamplifier was mounted directly on the waveguide switch. The homemade transverter fed an IC402 at 435MHz. Frequency calibration was achieved by a frequency counter locked to GPS by an HP Z3801A time/frequency standard.

Signals on 10GHz were consistently around 10dB above the noise. After the QSY to 24GHz, and overcoming the surprise of hearing anything, initial signals were estimated at around 6dB above the noise but by the end of the QSO were barely audible above the noise.

The equipment at W5LUA consisted of a 2 ft MACOM dish with azimuth and elevation control at 65ft. LNA noise figure at the dish measured 3 dB. I was using an Alelco TWT producing 50 watts in the shack. The actual power getting to the dish was considerably less. I had two 1.5 dB loss WR-42 flexible pieces of waveguide in the shack feeding about 60 ft of EW-180 waveguide with about 4 dB loss and another 1.5 dB loss WR-42 flexible jumper at the antenna. The

transmit losses add up to 8.5 dB giving me about 7 watts at the feed. My azimuth rotator is an Orion 2800, which allows me to get to within tenths of a degree. I use a small actuator to give me about -1 to +16 degrees elevation control. This worked OK for horizon shots for AO-40. We first tried 10 GHz where signals were 5 to 10 dB over the noise. We made an easy contact and then QSYed to 24 GHz where I was much surprised to hear Dave about 10 to 15 dB over the noise on a nice peak. The initial peak may have been due to airplane scatter but afterwards the signals became more constant, they settled in about 10 dB over the noise for several minutes and an easy QSO resulted.

Based on 6 digit grid square to 6 digit grid square EM13QC to EM41HC DX = 337.3 miles or 542.8km.

Based on actual latitude/longitude locations, the DX calculates to be 338.2 miles or 544.3 km establishing a new world record on 24192 MHz.

W5LUA 33 deg 6 min 53 sec North by 96 deg 36 min 54 sec West. WW2R/5 (from map) 31 deg 7 min 22 sec North by 91 deg 20 min 33 sec West.

Weather at EM41HC was 75 degrees F and 88% relative humidity with relatively clear skies with some high clouds. Weather at EM13QC was 72 degrees F and 70% relative humidity with skies partly cloudy.

Attempts to repeat the contact over the same path 12 hours after the initial QSO resulted in no signals being identifiable either way on 10GHz, suggesting the morning QSO was under enhanced

tropo conditions. No signals were heard on 2 metres or 70 cm at the time of the contact. The sked was setup earlier in the week via email with no liaison on any band including cellular! Numerous attempts over a slightly shorter TX-MS path on 10GHz in July also resulted in no signals being identified.

Submitted by W5LUA and WW2R on
September 9, 2002

In closing

I'll leave you with this thought.. "If you spent as much time doing the things you worry about getting done as we do worrying about doing them, you wouldn't have anything to worry about!"

73s David VK5KK
ar

**Want to learn more
about amateur radio?**

**Education is a WIA
membership service**



**Contact your Division for
information
(see Directory on page 56)**

Adelaide-Auckland 104

Second 2F13-19 2 Short 3241 km

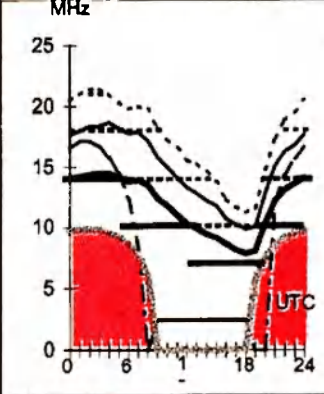

Brisbane-Chicago 57

First F 0-5 Short 14361 km

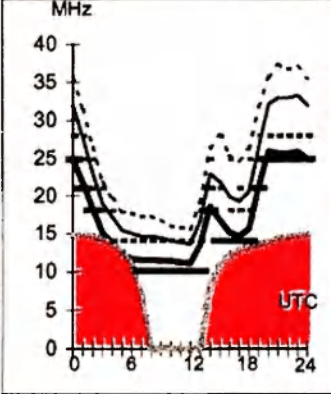

October 2002

T index: 88

Legend

UD
 E-MUF
 F-MUF
 OMF
 AL
 >10%
 >60%
 >90%

Frequency scale
 Time scale

HF Predictions

by Evan Jarman VK3ANI
 34 Alandale Court Blackburn Vic 3130

These graphs show the predicted diurnal variation of key frequencies for the nominated circuits. These frequencies as identified in the legend are:-

- Upper Decile (F-layer)
- F-layer Maximum Usable Frequency
- E-layer Maximum Usable Frequency
- Optimum Working Frequency (F-layer)
- Absorption Limiting Frequency (D region)

Shown hourly are the highest frequency amateur bands in ranges between these key frequencies, when usable. The path, propagation mode and Australian terminal bearing are also given for each circuit. These predictions were made with the Ionospheric Prediction Service program: ASAPS Version 4

Adelaide-London 132

First F 0-5 Long 23755 km

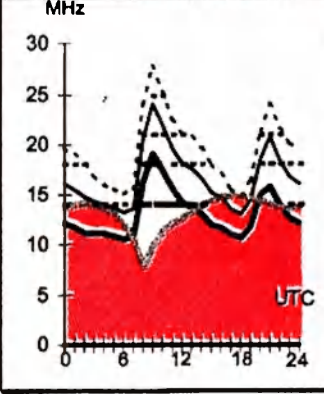

Brisbane-Honolulu 49

Second 3F5-10 3I Short 7569 km

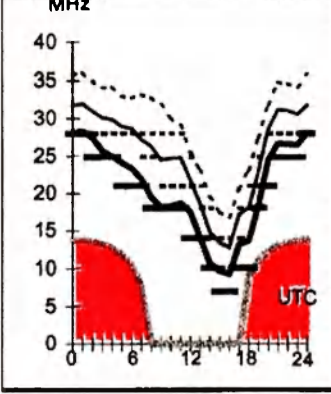

Canberra-Dakar 214

First F 0-5 Short 17361 km

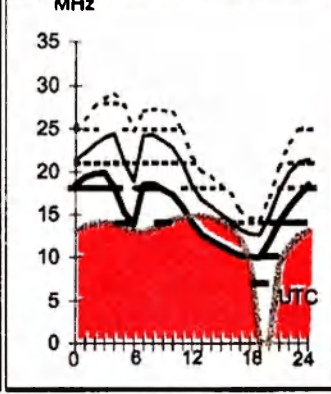

Darwin-Christchurch 139

First 2F4-8 2E0 Short 5262 km

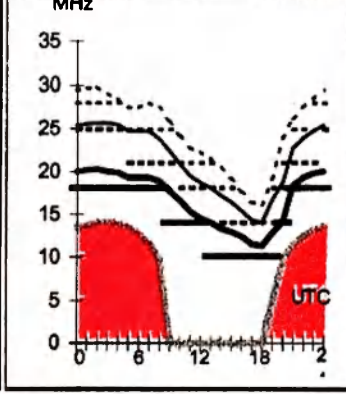

Adelaide-London 312

First F 0-5 Short 16269 km

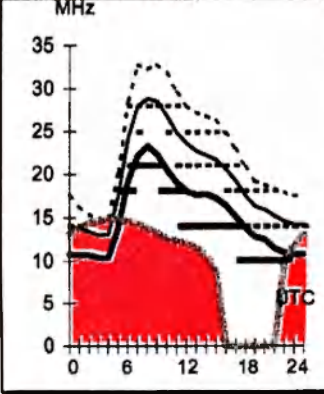

Brisbane-Moscow 321

First F 0-5 Short 14071 km

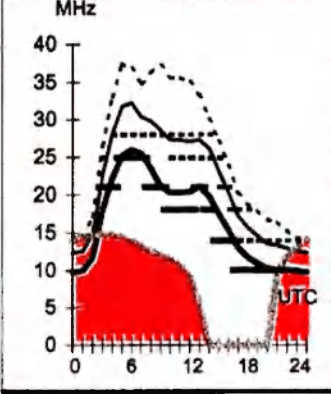

Canberra-New Delhi 303

Second 4F5-11 4I Short 10347 km

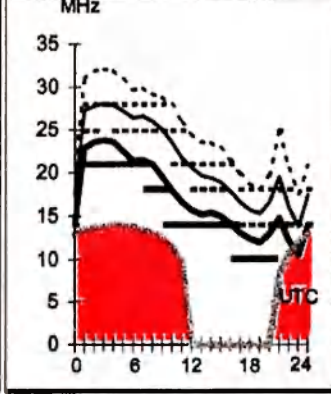

Darwin-Manila 340

First 1F1-10 1E0 Short 3196 km

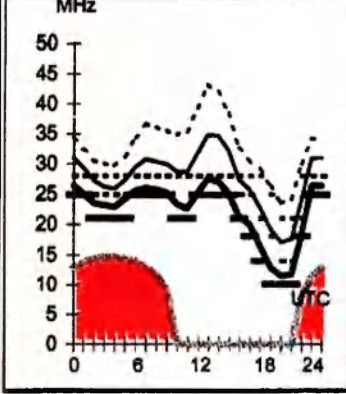

Adelaide-Tokyo 1

Second 3F5-10 3I Short 7855 km

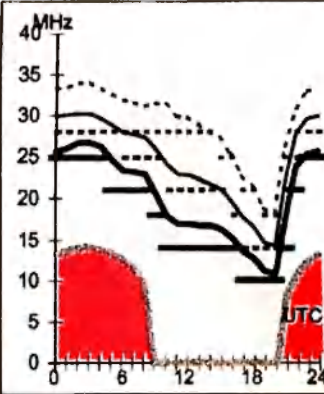

Brisbane-Singapore 293

Second 3F9-15 3I Short 6146 km

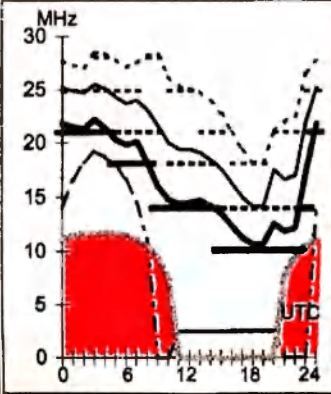

Canberra-Washington 70

First F 0-5 Short 15938 km

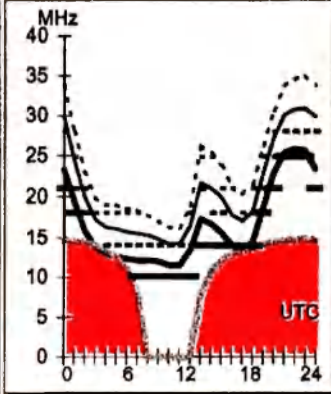

Darwin-Osaka 5

First 2F4-12 2E0 Short 5262 km

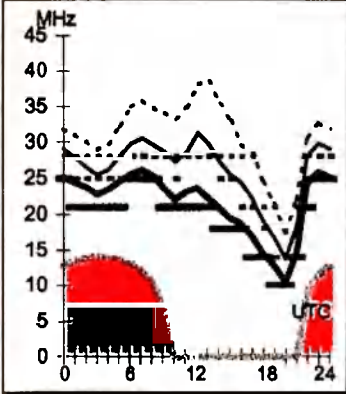

Hobart-Amman 283 **Melbourne-Bangkok** 312 **Perth-Harare** 257 **Sydney-Johannesbur** 230

First F 0-5 Short 14002 km Second 3F5-12 3E Short 7372 km First 3F3-7 3E0 Short 8496 km Second 4F4-8 4E1 Short 11035 km

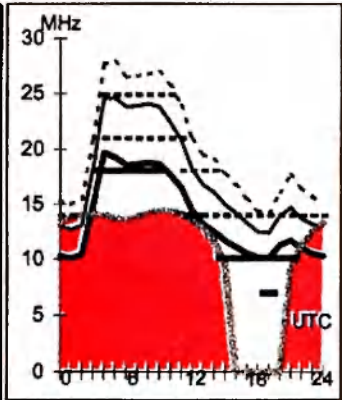
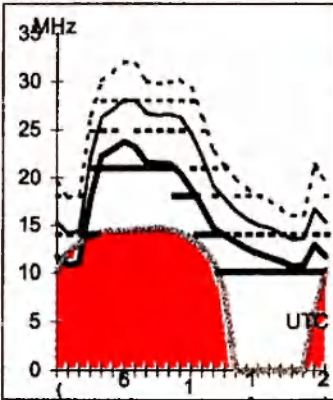
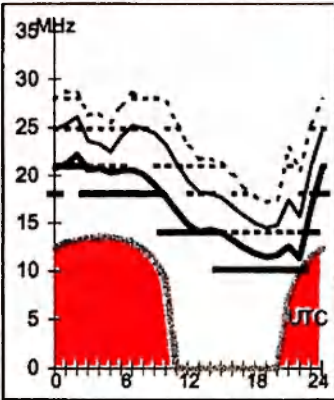
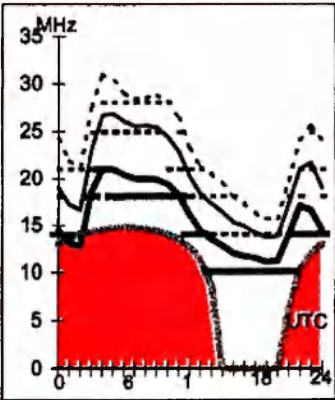

Hobart-Calgary 51 **Melbourne-LosAngel** 65 **Perth-Lima** 162 **Sydney-London** 139

First F 0-5 Short 14066 km First F 0-5 Short 12771 km First F 0-5 Short 14930 km First F 0-5 Long 23032 km

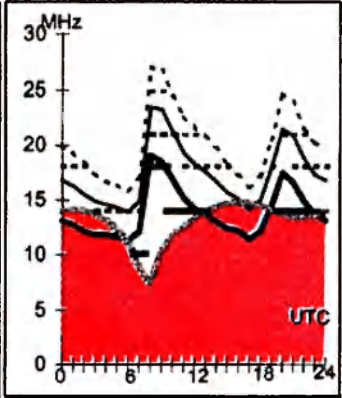
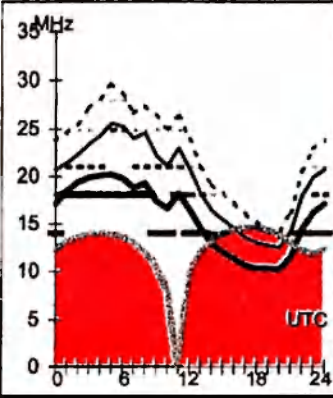
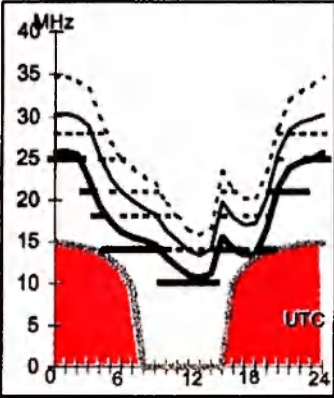
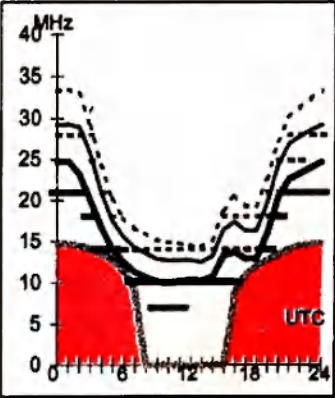

Hobart-Lusaka 239 **Melbourne-Seattle** 50 **Perth-Ottawa** 30 **Sydney-London** 319

Second 4F4-8 4E1 Short 11045 km First F 0-5 Short 13178 km First F 0-5 Short 18212 km First F 0-5 Short 16992 km

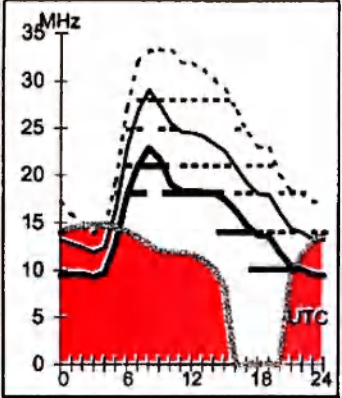
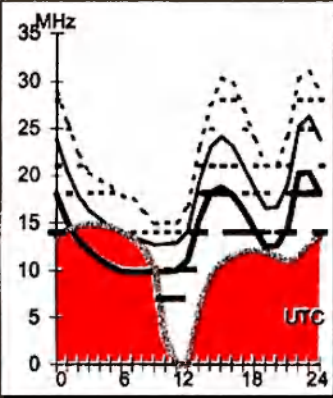
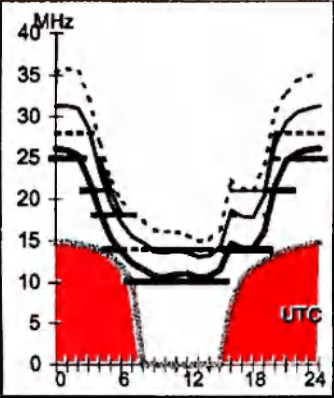
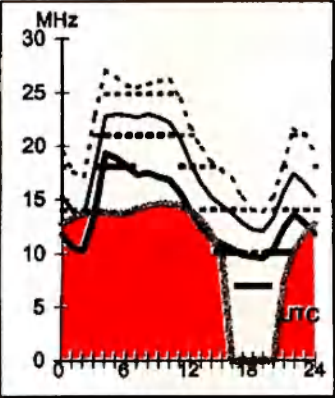

Hobart-RiodeJaneiro 169 **Melbourne-Stockholm** 140 **Perth-Tokyo** -20 **Sydney-Port Moresby** 351

First F 0-5 Short 12620 km First F 0-5 Long 24424 km Second 3F4-10 3E Short 7923 km First 1F4-7 1E0 Short 2740 km

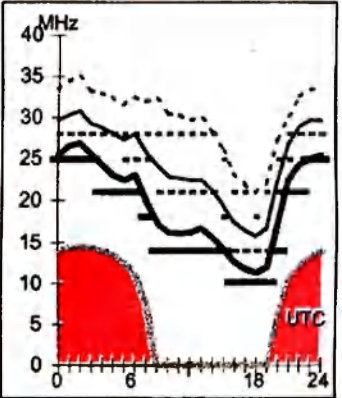
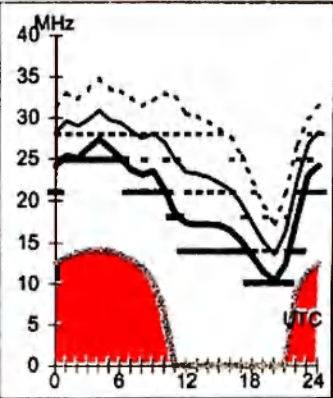
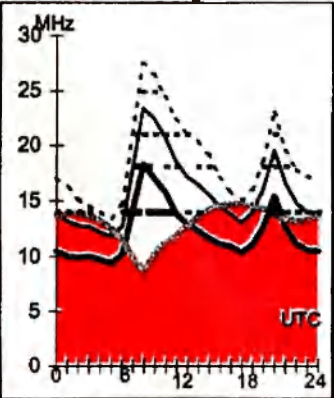
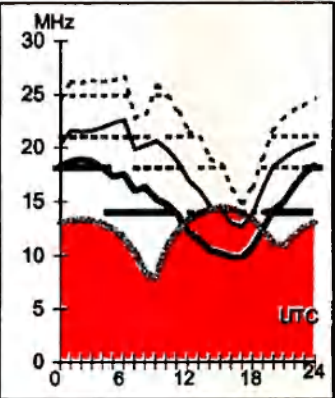

IRLP

Internet Radio Linking Project

David Byrne VK3DRB

IRLP is a lot of fun! It works by using the Internet as a medium for the long haul. You get to talk to other amateurs often with good sound quality from many places in the world. Often they are just amateurs mobile, but remember, if you are calling a node at Upper Kumbukta West at 3 am in the morning their time, you might not get a reply!

What is required to work IRLP?

A rig with a DTMF tone generator. If you don't have the DTMF generator, go to this link: <http://www.dsptutor.freeuk.com/dtmf/TG102.html> and generate the tones through your sound card. A program called "Vox Studio 3" <http://www.xentec.be> is a more elaborate tool to generate DTMF. Just generate the DTMF up to your computer speakers as you press PTT. There are also acoustically coupled tone dialers around. In case you are in experimental mode, another alternative is to modify an el-cheapo push button phone to generate DTMF, powering the 5V circuit by an external power supply and tapping off the DTMF as buttons are pressed. If you have a CRO, it is not a bad exercise

in learning about DTMF and the scanned keyboard matrix whilst you are at it. But DO NOT wire any of your equipment to a phone or modify a phone that is to be connected to the public telephone switching network! In other words, kiss goodbye to that phone ever being connected onto a phone line again. This might be a good idea if you have teenagers in the house!

To make a contact

Go to <http://www.irlp.net/15-status/frame.html> and see where you would like to make a contact.

- (1) Listen on the local node frequency to make sure it is not in use. If in doubt, ask.
- (2) Key your transmitter and dial the node you wish to contact, followed by a '0' to connect. After letting go of the PTT button, wait until you hear an acknowledgment message

that you are connected or otherwise.

- (3) Listen for a few seconds to ensure others are not talking on the node, then just say, for example "VK3DI in Melbourne Australia listening." If you make a contact, and it is your turn to talk, ALWAYS press PTT and hold it for 2 seconds prior to talking, else your voice will be cut off at the start.
- (4) Be aware that nodes are often set up on normal repeaters, so they can time out.
- (5) ALWAYS end the transmission by sending DTMF with the node number followed by a '1' character. To not do this leaves the channel open. Reflector users get rather annoyed when a channel is left open and there is a local QSO going

VK and ZL IRLP NODES September 2002

Node	Callsign	Location	Freq	Prefix/Tone	Node	Callsign	Location	Freq	Prefix/Tone
600	VK2RBM	Sydney	147.050+		637	VK3RSH	Swan Hill	146.900-	
601	VK2RMP	Wollongong	146.850-		638	VK3RNE	Albury-Wodonga	439.425-	
	VK2RIS	Nowra	146.975-		639	VK3JED	Experimental	146.550s	
	VK2RBT	Bateman's Bay	146.675-		640	VK4RGC	Brisbane	147.050s	
602	VK2RMB	Terry Hills	146.875-		641	VK4FC	Bundaberg	147.800-	
603	VK2RMR	Mt Riverview	439.575-		642	VK4SX	Bundaberg	438.776-	
604	VK2RTZ	Newcastle	146.775-		643	VK4CCV	Brisbane	146.875-	
605	VK2RCZ	Sydney	439.425-		648	VK4RCA	Cairns	146.950-	
606	VK2RAG	Gosford	438.075-		650	VK6RAH	Adelaide Hills	146.776-	
610	VK6RNC	Perth	146.625-			VK6RSA	Adelaide City	438.025-	
611	VK1RBM	Canberra	438.025-		651	VK6RAC	Port Lincoln	146.760-	
620	VK6RFM	Fremantle	146.950-		660	VK6AMS	Karratha	146.700-	
621	VK2TTA	Wahroonga	439.250s		661	VK6RAL	Albany	146.726-	
622	VK2RIC	Lismore	438.675-		662	VK6XAA	Collie	148.900-	
624	VK2SRS	Cooma	147.375+		670	VK7AX	Ulverstone	146.760-	
625	VK2ROT	Paddington	438.575-	123Hz	671	VK7RHT	Lindisfarne	148.700-	
626	VK2RWG	Wagga Wagga	147.125+		672	VK7HTW	Murdunda	Special Events (Also	
630	VK3RGL	Melbourne	TBA				backup for 671)		
631	VK3RWA	Western Vic	147.100+		680	VK8ZAB	Darwin	146.860s	
632	VK3RRU	Merbein	438.525-		690	ZL3TMB	Christchurch	147.200+	
633	VK3RPU	Arthur's Seat	439.725-	Nat	691	ZL2LD	Wellington Rgn	148.726-	
634	VK3DRB	Mt Waverley	146.475s		692	ZL2WKI	Palmerston Nth	146.626-	
635	VK3RMH	Melbourne	438.325-		695	ZL1BQ	Auckland	146.700-	
636	VK3ROU	Olinda	438.225-						

Note. The National Prefix is issued quarterly. Contact your local IRLP node administrator for the current prefix.

'The close of an era'

I've just completed reading September AR. I always enjoy AR.

The article "The close of an Era" about Alan Vagg's life was very well done. However the paragraph under the picture carried an error in the information.

The last sentence should have read "In particular the ground hugging BRISTOL BEAUFIGHTERS" and not Beaufort Bombers.

The Beaufighter had two radial engines and was armed with 4 Cannon 20mm and 6 wing guns 0.303 Browning. They could carry bombs but mainly performed strafing at very low level i.e. 50 to 200ft, hence the "Whispering Death."

The two Australian Beufighter squadrons were Nos. 30 and 31. The first

went to NC and the second to Darwin. Later the second also went to NG.

A Beaufort has been "renewed" and resides in the Moorabbin Air Museum in Victoria.

Allan Carman VK3AQH

WICEN and rallies

I must say the story about WICEN and rallies was very good also Rod VK7TRF did a very good job. I must add that here in Tassie there are two other events that would not happen with out the help of amateurs.

Rally Tasmania and The Examiner Challenge 2002 both events are held in the North West of the state and require the help from our members in the South.

Rally Tasmania is on bitumen and

looks like becoming a stage of the Australian Rally Championship (ARC) circuit soon, they want to have two events on bitumen surface and the rest on gravel roads.

The Examiner Challenge is what we call a poor mans Targa event makes a good training and set up event for Targa.

As you can see The Saxon Safari has now changed to Subaru Safari for the next five years. At the debrief for Subaru

Safari held a few weeks ago the Clerk of the Course had this to say about WICEN, "Without your time, effort and expertise, it would not be possible to run the event." We have now been asked to do the stage net as well as the command net.

Cheers & 73s Gavin O'Shea VK7HGO
WICEN South Co-ordinator.

1. Views expressed in the letters and opinion columns are those of the authors and do not necessarily represent the policy of the WIA

2. Some of the letters may be shortened to allow more letters to be published

Address letters to:

The Editor
Amateur Radio
34 Hawker Crescent
Elizabeth East SA 5117

or email:
edarmag@chariot.net.au

IRLP continued

on in a far away land. Remember, when you are finished, ALWAYS disconnect and listen for the closing message.

Example: Let's say we want to connect to the WA2DCI node in New York. Press 4220 to connect. When finished, press 4221. Simple!

Aspects of Sound Quality

One other point is that IRLP contacts are generally of exceptional quality, EXCEPT when the bloke you are talking to at the other end is using a hand held

on a bus! The signal is scratchy into his repeater or node. The other problem that occasionally crops up is packet loss. Often this is caused by a bottleneck in the Internet where some packets (henceforth pieces of sound) are lost. Other problem is that voice can sometimes double over itself. Fortunately these problems are not that often. Sometimes just disconnecting and then reconnecting to a node fixes the problem.

Finally, simplex nodes are different to real repeaters. If you are listening to a simplex node, you might only hear one

side of the conversation, especially if the input signal is QRP right next to the node. On repeaters, you hear both sides of the conversation.

IRLP is no replacement for HF DX'ing. A good analogy is, HF is like fishing... a fisherman enjoys fishing and he never knows what he is going to catch. IRLP is a bit like going to the fish shop to buy your fish.

There are more than 500 active nodes on the planet and growing rapidly. Eventually it will go to 4 digit node addresses (plus the 1 or 0 on the end)

de David, VK3DRB
ar

Why amateur radio is dying

First, my name is Ashley Geelan, I'm 26 years old and reside in Melbourne. My shack consists of a Pye MTR1 MK2, Uniden Washington, AOR 8200 Mk 2 and all these antenna are up my 50ft roof mounted tower. (I had Hills Industries make me a clothes-line like hoist for my discone etc) and have been a user of CB and scanners since I was 10 years old.

I have written the following as a response to an article written in "Over To You" August 2002 (Vol 70 #8) titled "Attention to our 'Old Timers'". As a young man who wished to be an amateur for years I can tell you, why I believe amateur radio is dying, rapidly. I don't know of one person interested in amateur radio, out of a group of 30 guys I know (we used to be the old Greensborough animal mode guys on Ch18 AM when I was in high school). Of all these ex-CBers I know and see every weekend (they are my social mates) not one even has slight interest in radios anymore. My younger brother and I are the only two locals who even still have CBs.

I am not aware of one other person under 28 (besides myself) who even knows what 27 MHz, UHF CB or Amateur radio are, let alone has an interest in them.

I have wanted to become an amateur for 10 years but the information is not readily available. And as Dick Smith, Tandy, etc no longer have an interest in

radio, I believe that the decrease in radio services will be rather rapid. Not one of the companies (except TimePlus) listed for Victoria in the old *R & C* still exist. It is now hard enough to get parts for a brand new AOR 8200 scanner (DSE sold me the scanner, but refuse to get in the slot cards etc) and look at the quality CBs they now sell!!!

In the time I've been on CB (1989 to present) I have seen a rapid decline in product availability. You can't get a new CB SWR meter anywhere in Melbourne (I mean the old \$30 Tandy/DSE 27MHz

I've wanted to get my novice (if that's your first licence) for six years, but have seen little if any information about where to go to get one. It wasn't until after 6 months of searching I saw this mag *Amateur Radio* in newsagents, took it home and realised that the organisation I needed to contact was the WIA in order to get my licence.

SWR meters, not the \$300 Revex). So how can you guys seriously expect newcomers to your hobby, when what really are the feeder channels to Amateur radio are all but dead. Go to DSE and look at the quality (if you call it that) of the CBs, which most amateurs originally came from. The best CB in DSE is a PRO-520XL, they don't even sell the Uniden GrantXL anymore.

With bad quality CBs to start, and no customer service in stores like DSE to do with Communications, it will be only a matter of time before DSE scrap selling Yaesu radios. (When purchasing my AOR 8200II scanner in May from the Preston Powerhouse they tried to tell me for half an hour it was a mobile phone!)

I've wanted to get my novice (if that's your first licence) for six years, but have seen little if any information about where to go to get one. It wasn't until after 6 months of searching I saw this mag *Amateur Radio* in newsagents, took

it home and realised that the organisation I needed to contact was the WIA in order to get my licence. You need to broaden the audience, even one ad in metropolitan daily would generate some interest, as if you'd done that from time to time I might've known about this organisation's existence five years ago, instead of finding out about WIA yesterday, and even then only by luck that I needed smokes, stopped in the newsagent and AR was staring me in the face. If I didn't smoke I still wouldn't know where to start and I wouldn't have written this letter.

I have been looking since *Radiomag*, (ex *CB Action Amateur*, *Radio Action* then *Radio & Communications*) for a journal about Australian radio and only found your WIA Amateur Magazine in the Heidelberg newsagency, and I've been looking for a radio mag every week since January 2002.

You won't have any new amateurs join the ranks unless we all (amateurs and CBers) get together and get the CB (both UHF and 27 MHz) even semi-popular again. Without a feeder channel that is similar to amateur radio, ie any other form of radio communications, amateur radio will die as you can't have that many young members. It takes me hours of explaining to friends what AR and CB are and they don't seem very interested until you tell them it's like a mobile phone without the bill, just set-up costs and the cost of 13.8Vdc. If no one I know (which includes 40 CFA volunteers from Eltham CFA) knows what AR is how do you expect them to become interested.

Our Communications Officer for the Yarra Group (CFA) was not aware the amateurs could become the communications network in the event of another Ash Wednesday.

Yours sincerely,

Ashley Stephen Geelan
50 Wahroonga Crescent
Greensborough, VIC 3088
(03)9435 8966

ageelan@bigpond.com
"Alley Cat Greensborough" after 5pm
27.175MHz (18) AM
"ACBRO 365" when DX-ing is SSB

Support the WIA



**Australia's
Amateur Radio
Organisation**

Math for AR

The September 02 version of "Writing for AR" repeats the restrictions on the use of math by authors of technical articles. That is an unwarranted imposition which could cause embarrassment for authors and publishers, restricting, as it does the ability to predict by technical analysis the in-use performance of a design.

The operating integrity of a design can only be predicted in most cases by the use of technical description which includes math more sophisticated than arithmetic; authors should include such predictions to assure constructors that the end product will perform as intended and be free of design fault. If

such assurance cannot be provided by appropriate analysis the designer should be obliged to supply certified results of lab or bench proving tests. If none of those assurances are available, an editorial note should be attached with appropriate warnings of the possible consequences. The disclaimer on page one of each AR issue does not absolve the designer and the publisher of responsibility for malfunction caused by faulty design or construction instructions. Design ideas presented for development by readers should also include supporting technical analysis and appropriate math but in those cases

it is understood that the reader is responsible for the end performance of a product based on the idea.

The words beginning with "Minimise the math..." used in the instruction reveal the originator's very limited understanding of the subject and there is no evidence presented to support the statement "Our readers prefer practical projects...". Does such evidence exist? I haven't seen it. The originator seems to be attempting to restrict content to his/her personal preferences.

Lindsay Lawless VK3ANJ
Box 760
Lakes Entrance 3909

What are band plans for

I have no great argument with the article by Drew Diamond, AR September 2002 p37. However I was saddened by the tenor of his article, which in my view seems to partially exonerate band-plan offenders and suggests that the rest of us 'be reasonable' (my words) in our attitude to persistent and willful culprits.

I certainly agree that on-air slanging matches do us all more harm than good.

But so does, doing nothing at all! At the very least it may (and probably will) be seen as tacit approval of such activities.

Persistent offenders who have rejected all reasonable requests to comply with our voluntary band-planning should at least be given the 'cold shoulder' treatment. Their CQ calls (on any frequency), and/or their requests to participate in other on-air activities such as scheduled on-air 'nets', could very

properly be completely ignored. No need for any discussion, just ignore them. This action may (probably will) result in some on-air abuse. This should, of course, also be ignored. I believe this is a fair and mature method of expressing disquiet at the actions of an unreasonable few, and is in keeping with our widely accepted responsibility for our own 'self regulation'.

Ray Turner VK2COX

'Hooks' for new recruits

Back in April the Brenda Edmonds Education Notes called for "hooks" for new recruits. I was moved to do something so I contacted the "Northern Times" through my grandson Gavin Leslie, a journalist with the paper. The paper is a Quest Community newspaper distributed in Caboolture and Pine Rivers shires and has a circulation of some 73,000.

Laurie Ernst VK4KLE

Editor's precis of the article:

In brief there is a photograph of Laurie VK4KLE, Ron VK4BF, Ernie VK4GE and Tom VK4MWT.

They were identified as amateur radio operators who regularly helped with the Scout and Guide Jamboree on the Air.

The article went on to say "Ningi amateur operator Laurie (VK4KLE) said amateur radio was more than using a walkie talkie or a CB radio. Also known as ham radio, it is the personal use of radio equipment for local, world wide and even space communications and experimentation he said".

The article then continued pointing out the technical nature of the hobby and the examination required to practice it.

There was also a panel with information on JOTA and how to contact Scouts Queensland and the WIA.

Thanks Laurie for taking up the challenge so well. Colwyn VK5UE Editor AR

KOALA Crystals

Back in April 2002 AR I had an article "Tree Top Tester" published. Any amateur who would like to try out the system now has a chance. I have collected Bower Bird style12 of the 14.318 MHz crystals from old PC boards.

So if you send me QTHR a Stamped Self Addressed envelope including a QSL card, I will send you back a "Koala Crystal" by return mail. They all work in my little "Test Oscillator". So they should work in most Xtal Oscillator Circuits.

First in best dressed!

Steve VK5AIM

PS I did find a Koala at a local Church Sale, but I haven't got around to filling him/her up! Steve

HAMADS

FOR SALE NSW

• **Yaesu HF FT DX-560** good condition \$350. **Yaesu FT690-R** 6 metre all mode g/cond \$250. **Kenwood HF TS-520** & digi 5 \$500g/cond. **Eddystone receiver 840C** model \$220. **Rotator** super heavy duty 100 ft cable 240/12 V D-C. Motor control box model Emotator MXX 1103 brand new \$1200. Contact V Hee VK2KVV Phone 02 4630 9158

• **Phillips P900** 2 metre tcvr modified for amateur bands, mounting bracket. One spare control head. Two spare mikes plus frequency chart, v.g. order \$110 ono. LK Furner VK2ANI, Phone 02 6920 4180

• **Mast 108 foot**, nine inch triangular lattice, galvanised, with climbing rungs. In 18 six foot sections, pick up Sydney metro \$690. **Kenwood TS-430S** transceiver, one owner, s/n 3050417, original carton, with mounting brackets MB-430, \$490. Contact Tony VK2BBJ 02 4360 2234

• **Antenna tower 100 foot** Southern Cross dismantled in sections, ready to go. \$550 VK2DRH QTHR Phone 02 9771 4031

WANTED NSW

• **YC-7B digital display** for FT-7B Yaesu. Can anyone help? Particulars to L K Furner VK2ANI Phone 02 6920 4180

• **Service Manual** for a **MARCONI INSTRUMENTS Spectrum Analyser model TF 2370**. All costs met. Sam Faber VK2GLN Phone 02 4340 2765 vk2gln@wia.org.au

FOR SALE VIC

• **Sanwa multimeter model N 501**, 2 microamp FSD 500k/Volt movement taut band suspension ex RAAF. Good condition \$30 Bob VK3CAY QTHR jrkemp@melbpc.org.au 03 9398 2714

• **BC-221 Freq Meter WW2** Precision equip with original charts & PSU \$150. **Yaesu FT-301** Complete Line-up with PSU, ATU, Monitor Scope, Remote VFO. Excellent order a collectors item you can use. \$2000. Offers considered. VK3DBD QTHR Phone 02 607 270 570 or email vk3dbd@rm.quik.com.au

• **Antenna HB-35C 5 Element Triband Yagi**, 14, 21 & 28 MHz Stainless hardware. Excellent condition \$450 ONO. Julian VK3EJR Phone 0418 578 214 julianrose@connektron.com.au

• Deceased estate VK3BBP. **SWAN RF Power Meter Model WM-1500** 5/50/1500 watts HF. \$90. "Variac" auto transformer **WARBURTON FRANKI** 240V ac in, 0-280V ac out. **Oscilloscope, DICK SMITH**, sweep range to 100 kHz, \$50. **Coax relay**, PL-259 sockets, coil 25VDC, \$35. Bill VK3BHW, Phone 03 5149 7340, vk3bhw@amsat.org.

WANTED VIC

• **Restoring old valve radios** and need circuits. Have Australian official Radio Service Manuals Vol 2, 3, 4, 5, 12, 13 & 14 and would like others to fill gaps. Have a spare Vol 5 if anyone needs it. Bill VK3ZWO Phone 03 9598 6304

• **Yaesu FL-2100Z Linear** or similar, WARC bands essential. Sensible price paid. Can collect reasonable distance. Email vk3dbd@rm.quik.com.au or Phone 02 6027 0570

FOR SALE QLD

• **Collins rig, Rx 75S-3, Tx 32S-3**, power supply, microphone, manuals and spare valves. \$2250. John VK4VCF. Phone 07 3264 8061 or 0411 104 921

FOR SALE SA

• **Yaesu FT-77 HF tcvr** Solid State 100w base/mobile 80m-10m WARC bands, Mobile Cradle. **Daiwa CN-520** swr/power X-needle meter and **Yaesu MH-1B8** mic. \$365 s/n 3C021759. **Yaesu FP-700** 13V/20A matching Power Supply inc. built-in spkr. All cables and Manuals all vgc orig. vpacking. \$195 s/n 3C020575. You collect, Ron VK5SD QTHR Phone 08 8337 6540. Mobile 0401371263 Email rsamos@chariot.com.au.

WANTED SA

• **To restore Army Landrover Series III** fitted for radio we need: **for Radio Set AN/GRC-160**: amplifier power supply group OA-3633, mounting MT-1029, cable CX-4720. And **for Radio Set AN/GRC-106A**: amplifier AM-3349, mounting MT-3140, headset H-227/U, key telegraph KY-116/U and copy of manual TM 11-5820-520-35. Harro VK5HK QTHR Phone 08 8323 9622

WANTED WA

• **Power transformer for Yaesu YO-901 multiscope** or complete unit with good transformer. VK6ABS QTHR Phone 08 9075 4136

FOR SALE NT

• **Kenwood PS-50** 13.8V/20A power supply s/n 7020487 \$190 **RD-300** DC-150 MHz dummy load \$90. **Icom IC-720A** Ham Tx general coverage receiver s/n 14388 \$390. **IC-26H** 2m FM Hipower s/n 1189 \$180. **Tait T296** 13.8V/10A power supply \$90. All units good working order. Jeff VK8GF QTHR Phone 08 8952 1016, email vk8gf@austarnet.com.au

TRADE ADS

PSK-31, SSTV, RTTY SOUNDBOARD INTERFACES

Fully isolated, ready to plug in. <http://www.G3LIV.CO.UK>, johnny@melvin.com, G3LIV QTHR.

AMIDON FERROMAGNETIC CORES:

For all RF/electronic applications. See our website for complete data

on all cores including prices. RJ & US Imports, PO Box 431, Kiama NSW

2533. www.catchnet.com.au/~rjandusimports.

Agencies at: Active Electronics Tas; Truscotts Electronic World, Melbourne; TTS Systems, Tyabb; Tower Communications, Perth; Haven Electronics, Nowra.

HF, VHF, UHF ANTENNAS & ACCESSORIES

Alum towers, guys etc. Diamond VSWR/PWR meters. HD copper ant wire & insulators. TX tubes & pwr transistors. Quality coax cables & connectors. Free advice & catalogue.

ATN Antennas Ph 03 5492 2224 Fax 03 5492 2666, email atnatt@ruralnet.net.au

MISCELLANEOUS

• The WIA QSL Collection (now Federal) requires QSLs. All types welcome, especially rare DX pictorial cards, special issue. Please contact the Hon Curator, Ken Matchett VK3TL, 4 Sunrise Hill Road, Montrose Vic 3765, tel. (03) 9728 5350

About hamads...

- Hamads may be submitted by **email** or on the **form on the reverse of your current Amateur Radio address flysheet** Please print carefully, especially where case or numerals are critical.
- Please submit separate forms for For Sale and Wanted items, and be sure to include your name, address and telephone number (including STD code) if you do not use the flysheet.
- Eight lines (forty words) per issue free to all WIA members, ninth and tenth lines for name and address. Commercial rates apply for non-members.
- Deceased estates Hamads will be published in full, even if the ad is not fully radio equipment.
- WIA policy recommends that the serial number of all equipment for sale should be included.

- QTHR means the address is correct in the current WIA Call Book.
- Ordinary Hamads from members who are deemed to be in general electronics retail and wholesale distributive trades should be certified as referring only to private articles not being re-sold for merchandising purposes.
- Commercial advertising (Trade Hamads) are pre-payable at \$25.00 for four lines (twenty words), plus \$2.25 per line (or part thereof), with a minimum charge of \$25.00. Cheques are to be made out to: WIA Hamads.
- Copy should be typed or printed clearly, and be received by the deadlines shown on page 1 of each issue of Amateur Radio, at:

Email: newsletters@ozemail.com.au

Fax: 03 9756 7031

Postal: Newsletters Unlimited, PO Box 431, Monbulk Vic 3793

The Proud Parents Parade

September AR showed what "Harmonics" can get up to. Here is a further claim to fame.

Does any one else wish to make claims for generating more proficient "Harmonics"?



Rohan Mcgrath on the cover of September AR

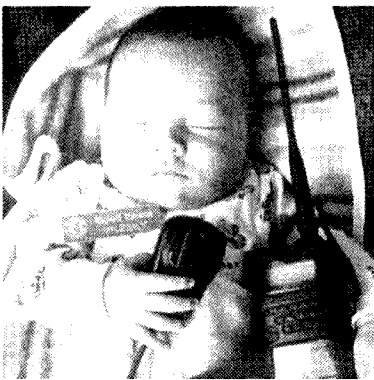

Sean Murnane

The endearing photo of young Rohan Mcgrath on the cover of the September issue of AR has inspired me to send you a photo my XYL Miki took a few months ago, of my then 6 week old son, Sean.

Although he was too young to even pretend to have a QSO, you have to admit he has the makings of a good grip on the microphone!

73 Richard Murnane VK2SKY

PLAN AHEAD

SEANET 2002

Perth

November 1st, 2nd & 3rd

One-Tech Sunday

Canberra

November 17

TRADERS
 Advertise in **AR**
 03 9756 7797

ADVERTISERS INDEX

Com-an-tena.....	24
Connektron.....	33
G & C Communications.....	27
Icom.....	OBC
Strictly Ham.....	8
TTS.....	16
WIA Call Book.....	IFC

Radio Old Timers Club of SA

ANNUAL LUNCHEON

The annual Luncheon will be held on **Thursday 24th October 2002** (12 noon for 12.30 lunch)

at the

Marion Hotel

Main Road, Mitchell Park

President: Jack Townsend VK5HT

Phone 08 8295 2209

Secretary: Ray Deane VK5RK

Phone 08 8271 5401

Asst. Secretary Ron Coat VK5RV

Phone 08 8296 6681

Public Transport: **Bus 243, Stop 24**
 Ray Deane, Honorary Secretary

<http://www.hamsearch.com>
 a not-for-profit site that is a search engine for hams

TRADE PRACTICES ACT

It is impossible for us to ensure that the advertisements submitted for publication comply with the Trade Practices Act 1974. Therefore, advertisers and advertising agents will appreciate the absolute need for themselves to ensure that the provisions of the Act are strictly complied with.

VICTORIAN CONSUMER AFFAIRS ACT

All advertisers are advised that advertisements containing only a PO Box number as the address cannot be accepted without the addition of the business address of the box-holder or seller of the goods.

THE WIA BOOKSHOP

DISCOUNTS FOR WIA MEMBERS

ARRL

RSGB

EDUCATIONAL

CALLBOOKS

COMPREHENSIVE RANGE

109 Wigram Street, Parramatta, New South Wales, Australia. PO Box 432, Harris Park, NSW, Australia 2150. Phone: +61 2 9689-2417, Facsimile: +61 2 9633-1525 Toll free in New South Wales outside Sydney: 1800 817-644 Office Open 11am - 2pm Tuesdays & Thursdays Email: vk2wl@ozemail.com.au Web http://www.ozemail.com.au/~vk2wl We take mail, phone, email and fax orders

"Hey, Old Timer..."

If you have been licensed for more than 25 years you are invited to join the



Radio Amateurs Old Timers Club Australia

or if you have been licensed for less than 25 but more than ten years, you are invited to become an Associate Member of the RAOTC.

In either case a \$2.50 joining fee plus \$8.00 for one year or \$15.00 for two years gets you two interesting OTN Journals a year plus good fellowship.

Write to

RAOTC,
 3/237 Bluff Road
 Sandringham VIC 3191

or call Arthur VK3VQ on 03 9598 4262 or Allan VK3AMD on 03 9570 4610, for an application form.

Email your hamad

Then we just cut and paste.

You proof it, you retain control.



Division Directory

The Amateur Radio Service exists for the purpose of self training, intercommunication and technical investigation. It is carried out by amateurs who are duly authorised people interested in radio technique solely with a personal aim and without pecuniary interest.

The Wireless Institute of Australia represents the interests of all radio amateurs throughout Australia. National representation is handled by the executive office under council direction. There is one councillor for each of the seven Divisions. This directory lists all the Divisional offices, broadcast schedules and subscription rates. All enquiries should be directed to your local Division.

Broadcast schedules All frequencies MHz. All times are local.

VK1 Division Australian Capital Territory,
GPO Box 600, Canberra ACT 2601
President Gilbert Hughes VK1GH
Secretary Peter Kloppenburg VK1CPK
Treasurer Linden S Orr VK1LSO

VK1WI: 3.590 LSB, 146.950 FM each Thursday evening from 8.00pm local time. The broadcast text is available on packet, on Internet [aus.radio.amateur.misc](http://www.amsat.org/aus.radio.amateur.misc) news group, and on the VK1 Home Page <http://www.vk1.wia.ampr.org>

Annual Membership Fees. Full \$80.00 Pensioner or student \$71.00. Without *Amateur Radio* \$48.00

VK2 Division New South Wales
109 Wigram St, Parramatta NSW
(PO Box 432, Harris Park, 2150)
(Office hours Mon-Fri 1100-1400)
Phone 02 9689 2417
Web: <http://www.ozemail.com.au/~vk2wi>
Freecall 1800 817 644
e-mail: vk2wi@ozemail.com.au
Fax 02 9633 1525
President Terry Davies VK2KDK
Secretary Pat Leeper VK2JPA
Treasurer Chris Minahan VK2EJ

From VK2WI 1.845, 3.595, 7.146*, 10.125, 14.160, 24.950, 28.320, 29.120, 52.120, 52.525, 144.150, 147.000, 438.525, 1281.750 (* morning only) with relays to some of 18.120, 21.170, 584.750 ATV sound. Many country regions relay on 2 m or 70 cm repeaters. Sunday at 1000 and 1930. Highlights included in VK2AWX Newcastle news, Monday 1930 on 3.593 plus 10 m, 2 m, 70 cm, 23 cm. The broadcast text is available on the Internet newsgroup [aus.radio.amateur.misc](http://www.amsat.org/aus.radio.amateur.misc), and on packet radio.

Annual Membership Fees. Full \$80.00 Pensioner or student \$63.00. Without *Amateur Radio* \$50.00

VK3 Division Victoria
40G Victory Boulevard Ashburton VIC 3147
(Office hours Tue 10.00 -2.30)
Phone 03 9885 9261
Web: <http://www.wiavic.org.au>
Fax 03 9885 9298
e-mail: wiavic@wiavic.org.au
President Jim Linton VK3PC
Secretary John Brown VK3JJB
Treasurer Bany Wilton VK3XV

VK3BWI broadcasts on the 1st Sunday of the month at 20.00hrs Primary frequencies, 3.615 DSB, 7.085 LSB, and FM(R)s VK3RML 146.700, VK3RMM 147.250, VK3RWG 147.225, and 70 cm FM(R)s VK3ROU 438.225, and VK3RMU 438.075. Major news under call VK3ZWI on Victorian packet BBS and WIA VIC Web Site.

Annual Membership Fees. Full \$83.00 Pensioner or student \$67.00. Without *Amateur Radio* \$51.00

VK4 Division Queensland
PO Box 199, Wavell Heights, Old. 4012
Phone 07 3221 9377
e-mail: office@wiaq.powerup.com.au
Fax 07 3266 4929
Web: <http://www.wia.org.au/vk4>
President Ewan McLeod VK4ERM
Secretary Bob Cumming VK4YBN
Treasurer Bill McDermott VK4AZM

VK4WIA broadcasts on 1.825 MHz SSB, 3.605 MHz SSB, 7.118 MHz SSB, 10.135 MHz SSB, 14.342 MHz SSB, 21.175 MHz SSB, 28.400 MHz SSB, 29.660 MHz FM (rptr), 147.000 MHz, and 438.525 MHz (in the Brisbane region, and on regional VHF/UHF repeaters) at 0900 hrs K every Sunday morning. QNEWS is repeated Monday evenings, at 19.30 hrs K, on 3.605 MHz SSB and 147.000 MHz FM. On Sunday evenings, at 18.45 hrs K on 3.605SSB and 147.000 FM, a repeat of the previous week's edition of QNEWS is broadcast. Broadcast news in text form on packet is available under WIAQ@VKNET. QNEWS Text and real audio files available from the web site

Annual Membership Fees. Full \$95.00 Pensioner or student \$81.00. Without *Amateur Radio* \$69.00

VK5 Division South Australia and Northern Territory
(GPO Box 1234 Adelaide SA 5001)
Phone 08 8294 8992
web:<http://www.sant.wia.org.au>
email: peter.reichelt@bigpond.com
President Trevor Quick VK5ATQ
Secretary Peter Reichelt VK5APR
Treasurer Trevor Quick VK5ATQ

VK5WI: 1843 kHz AM, 3.550 MHz LSB, 7.095 AM, 14.175 USB, 28.470 USB, 53.100 FM, 147.000 FM Adelaide, 146.800 FM Mildura, 146.900 FM South East, 146.925 FM Central North, 438.475 FM Adelaide North, ATV Ch 35 579.250 Adelaide. (NT) 3.555 LSB, 7.065 LSB, 10.125 USB, 146.700 FM, 0900 hrs Sunday. The repeat of the broadcast occurs Monday Nights at 1930hrs on 3585kHz and 146.675 MHz FM. The broadcast is available in 'Realaudio' format from the website at www.sant.wia.org.au Broadcast Page area.

Annual Membership Fees. Full \$88.00 Pensioner or student \$73.00. Without *Amateur Radio* \$58.00

VK6 Division Western Australia
PO Box 10 West Perth WA 6872
Phone 08 9351 8873
Web: <http://www.vk6wia.org>
e-mail: vk6wia@inet.net.au
President Neil Penfold VK6NE
Secretary Christine Bastin VK6ZLZ
Treasurer Bruce Hedland-Thomas VK6OO

VK6WIA: 146.700 FM(R) Perth at 0930hrs Sunday relayed on 1.865, 3.564, 7.075, 10.125, 14.116, 14.175, 21.185, 29.120 FM, 50.150 and 438.525 MHz, Country relays 3.582, 147.200 (R) Cataby, 147.350 (R) Busselton, 146.900 (R) Mt William (Bunbury), 147.000 (R) Katanning and 147.250 (R) Mt Saddleback. Broadcast repeated on 146.700 at 1900 hrs Sunday relayed on 1.865, 3.564 and 438.525 MHz : country relays on 146.900, 147.000, 147.200, 147.250 and 147.350 MHz. Also in "Real Audio" format from the VK6 WIA website

Annual Membership Fees. Full \$71.00 Pensioner or student \$65.00. Without *Amateur Radio* \$39.00

VK7 Division Tasmania
PO Box 371 Hobart TAS 7001
Phone 03 6234 3553 (BH)
Web: <http://www.tased.edu.au/tasonline/vk7wia>
also through <http://www.wia.org.au/vk7>
email: batesjw@netspace.net.au
President Mike Jenner VK7FB
Secretary John Bates VK7RT
Treasurer John Bates VK7RT

VK7WI: 146.700 MHz FM (VK7RHT) at 0930 hrs Sunday relayed on 147.000 (VK7RAA), 146.725 (VK7RNE), 146.625 (VK7RMD), 3.570, 7.090, 14.130, 52.100, 144.150 (Hobart), repeated Tues 3.590 at 1930 hrs.

Annual Membership Fees. Full \$90.00 Pensioner or student \$77.00. Without *Amateur Radio* \$57.00

VK8 Northern Territory is part of the VK5 Division and relays broadcasts from VK5 as shown, received on 14 or 28 MHz. The broadcast is downloaded via the Internet.

The wonderful world of discovery: **JOTA** and **JOTI**



Sea Scouts enjoy the experience of being 'on air'



Gavin VK4ZZ, Scout Leader and Amateur in both roles

Jamboree on the Air and Jamboree on the Internet JOTA and JOTI 2002. October 19-20

This is the 45th year Scouts and Guides with the help of Radio Amateurs have come together in a worldwide event. Lots of people to meet and talk to. Lots of new things to be learnt by Scouts, Guides and Amateurs.

Last year one group of Venturers was fortunate to be able to talk to the International Space Station.

Hopefully some 20,00 Scouts and Guides in Australia will join a million others in 216 countries to make this the best Jamboree ever.

Scouts Australia is the largest Youth Organisation in Australia with over 80,000 male and female members. So if you get a last minute request for help from a local group please try and get them on air or Internet. You can contact your local group or go to Scouts Australia on 1800072688 or www.scouts.com.au

Shepparton Hamfest

**Sunday,
15 September 2002**

Shepparton photos by Ron Fisher VK3OM



***“Wall to wall
people!”***

ICOM'S GREAT CHAMPIONS



**NO
FILTERS
REQUIRED**

IC-7400 (746 PRO)

- Sharp & soft IF filter shape • 100W HF /6m /2m • Digital twin PB1
- DSP • SSB / CW synchronous tuning • Built in antenna tuner
- RTTY demod / decoder • Digital RF speech processor
- Microphone equaliser.



IC-910H The new dimension in the VHF/UHF world!

Tri band multimode transceiver • 2M -100W, 70CM - 75W, (optional 23CM, 10W) • 9600bps packet operation • Satellite communication Reverse/normal tracking doppler shift compensation
CIV capability for PC control • Optional 2.4G down convertor.



IC-718 A compact HF all band transceiver.

A superior performer with simple, straightforward operation with keypad • Optional AF DSP capabilities, including noise reduction & auto notch function • It's versatile, compact & loaded with features.



IC-706MKIIG HF • VHF UHF

The amazing evolution of the legendary 706.

Now includes 70cm @ 20W and 50W on 2m
Standard feature dsp • Built in sub tone encoder & decoder
Tone scan • MosFET PA • You get base station performance and features in a mobile rig sized package.

IC-T90A A new 5W Triband handheld

VHF/UHF FM 2M, 6M, & 70CM
Wideband receive 495 KHz - 1 GHz
555 Alphanumeric memories • 13 Scan modes
DTCS & CTCSS encode & decode
DTMF encoder (10 memories)
Wide/narrow transmit capability.



ICOM

Clearly Ahead

2 YR WARRANTY

find your nearest ICOM dealer at

www.icom.net.au or (03) 9387 0666

The magazine for **AUSTRALIAN** Amateurs



November 2002

Volume 70 No 11



Amateur Radio

\$ 5.95

Diamond:

A 25 W AM/CW

**Valve Transmitter
for 1.8 and 3.5 MHz**

Low Drop-out

Voltage Regulator

*Is it a bird?
Is it a plane?
It's a VHF reflector!*

VK3BJM goes out on
the track following
flight paths

The *RS20
POWER SUPPLY
20 amps of
recycled grunt
for SSB
*Recycler's Special

ISSN 0002-6859



9 770002 685116 11

Callbook 2003

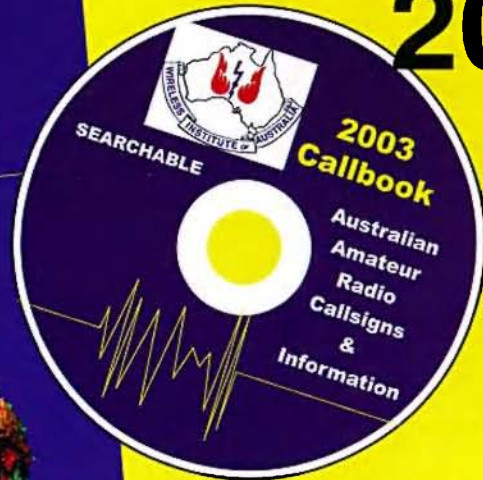

**TWO FOR
THE PRICE
OF ONE.**

This year we are offering the full Callbook/Handbook as a handsome **BOUND COPY** that would grace any shack or bookcase **AND** as a **FULLY SEARCHABLE DISC**

Both publications contain all Australian callsigns by callsign order in easy-read format and about 60 pages all about beacons, packets, rules and regulations, repeaters, frequencies and bands and much other useful information all in one convenient unit.

⚙️ And as a special bonus on the disc alone, Greater Circle information.

ABOUT SEARCHING ON THE DISC

The material in the disc is distilled into Acrobat files. Which means that any word in the disc can be found by using the Acrobat Reader's >SEARCH>.

Example. Say you wanted to know who in your area had an amateur callsign/licence.

Easy — put in your postcode, do a search and there are your choices. (we have included Acrobat Reader)

And about that two for the price of one offer.

WIA, through its Divisions and other outlets is making the set, full book and even fuller disc, available for a delivered price that compares extremely favourably with the 2001 price of the book alone.

Contact your division to place your order now. Details on page 16.



Amateur Radio

The Journal of the Wireless
Institute of Australia
ISSN 0002-6859

Editorial

Editor: Colwyn Low VK5UE
edamag@chariot.net.au

Technical Editor: Peter Gibson VK3AZL

Publications Committee Members
Ron Fisher VK3OM
Don Jackson VK3DBB
Evan Jarman VK3ANI
Bill Rice VK3ABP
Gil Sones VK3AUI
Bill Roper VK3BR

Advertising

Mrs June Fox,
Tel: (03) 9528 5962

Hamads

"Hamads" Newsletters Unlimited
PO Box 431, Monbulk Vic 3793
Fax: 03 9756 7031
e-mail: newsletters@ozemail.com.au

Office

10/229 Balaclava Road
Caulfield, Victoria
Telephone (03) 9528 5962
Facsimile (03) 9523 8191

Business Hours 9:30am to 3:00pm weekdays

Postal

The Editor AR
34 Hawker Crescent
Elizabeth East
South Australia 5112
Email edamag@chariot.net.au

Production

Newsletters Unlimited 03 9756 7797

Printer

Streamline Press, Melbourne (03) 9417 2788

Postal Service

IMS (03) 9291 5888

Production Deadlines

Advertising booking and articles for
publication 10th of preceding month.

Hamads and advertising material deadline
18th day of preceding month

The contents of Amateur Radio are Copyright
Wireless Institute of Australia © 2002

General

VHF reflectors in plane view	18
Barry Miller VK3BJM	
Journey Round my Uncle	21
N J Hurll VK4HH	
A sad farewell	34
Eric Jamieson VK5LP	
Lieutenant-Colonel Sir Evan Nepean Bt - Silent Key	46

Technical

A 25 W AM/CW Valve Transmitter for 1.8 and 3.5 MHz	4
Drew Diamond, VK3XU	
Low drop-out voltage regulator	9
Keith Gooley VK5OQ	
The RS20 Power Supply	11
Jim Tregelias VK5JST	
The RS20 Power Supply Cautionary Note	17
Large loop with balance feed (Technical Abstracts)	20
Gil Sones VK3AUI	
FOXX11 Mini Transceiver (Technical Abstracts)	28
Gil Sones VK3AUI	
Bypass Capacitors (Technical Abstracts)	29
Gil Sones VK3AUI	
Boom Correction Factors in Yagi Antennas	29
Gordon McDonald VK2ZAB	

Columns

Advertisers' Index	55	Hamads	54
ALARA	22	Ham Shack Computers	39
AMSAT	34	HF Predictions	48
Awards	35	How's DX?	37
Beyond Our Shores	45	Over to you	53
Contests	41	Silent Keys	20, 32, 34, 46, 47
Club News	24	Spotlight on SWLing	47
WIA Division News		Technical Abstracts	20, 28, 29
VK1 Notes	30	VHF/UHF - An Expanding World	50
VK2 Notes	31	WIA Comment	3
VK3 Notes	31	WIA Division Directory	56
VK4 Notes	32	WIA Federal Directory	2
VK6 Notes	33	Will's Page	52
Editor's Comment	2		

see story page 18

Contributions to Amateur Radio

Amateur Radio is a forum for WIA members' amateur radio experiments, experiences opinions and news. Manuscripts with drawings and or photos are always welcome and will be considered for publication. Articles on disc or email are especially welcome. The WIA cannot be responsible for loss or damage to any material. A pamphlet, How to write for Amateur Radio is available from the Federal Office on receipt of a stamped self-addressed envelope.

Back issues

Back issues are available directly from the WIA Federal Office (until stocks are exhausted), at \$4.00 each (including postage within Australia) to members.

Photostat copies

When back issues are no longer available, photocopies of articles are available to members at \$2.50 each (plus an additional \$2 for each additional issue in which the article appears).

Disclaimer

The opinions expressed in this publication do not necessarily reflect the official view of the WIA and the WIA cannot be held responsible for incorrect information published.

Amateur Radio Service

A radiocommunication service for the purpose of self-training, intercommunication and technical investigation carried out by amateurs; that is, by duly authorised persons interested in radio technique solely with a personal aim and without pecuniary interest.

Wireless Institute of Australia

The world's first and oldest
National Radio Society
Founded 1910

Representing

The Australian Amateur Radio Service

Member of the

International Amateur Radio Union

Registered Federal Office of the WIA

10/229 Balaclava Road
Caulfield North Vic 3181

Tel: (03) 9528 5962 Fax (03) 9523 8191
<http://www.wia.org.au>

All mail to

PO Box 2175 Caulfield Junction VIC 3181

Business hours: 9.30am-3pm weekdays

Federal Secretary

Peter Naish VK2BPN

Federal Office staff

June Fox Bookkeeper
Rita Trebilco VK3IF Examinations Officer

Council

President	Ernest Hocking	VK1LK
VK1 Federal Councillor	Gilbert Hughes	VK1GH
VK2 Federal Councillor	Barry White	VK2AAB
VK3 Federal Councillor	Jim Linton	VK3PC
VK4 Federal Councillor	David Jones	VK4OF
VK5 Federal Councillor	David Box	VK5OV
VK6 Federal Councillor	Will McGhie	VK8UU
VK7 Federal Councillor	Phil Corby	VK7ZAX

Executive

Brenda Edmonds
David Pillay
Don Wlechefski

VK3KT
VK2AYD
VK4BY

Federal Coordinators

AMSAT	Graham Ratcliff	VK5AGR
ARDF	Jack Bramham	VK3WWW
Awards	Mal Johnson	VK8LC
Contests	Ian Godsil	VK3VP
Education	Ron Smith	VK4AGS
FTAC	John Martin	VK3KWA
Historian	John Edmonds	VK3AFU
IARU	Nell Penfold	VK8NE
Intruder Watch	Harry Anderson	VK8HA
International Travel Host	John Miller	VK3DJM
ITU Conference and study group	Gilbert Hughes	VK1GH
QSL Manager (Vks, VKs)	Nell Penfold	VK8NE
Videotapes	VK2 Division	
Web	Joe Burford	VK5UJ
WICEN	John Weir	VK3ZR

ACA Liaison Team

Glen Dunstan VK4DU (Corresponding)
Gilbert Hughes VK1GH
Keith Malcolm VK1ZKM
Peter Naish VK2BPN

Editorial Comment

Colwyn Low VK5UE

Taking time out to have fun! (Fun?)

This has been a month when the home front took over my life and Christmas suddenly was very close. I did get out with WICEN and helped make the Classic Adelaide Rally a great success. I had a certain amount of trepidation as I had said I had packet and I could put it in the Beetle. I had never had it out of a building away from the mains. So starting with 6 V main VW battery and 6 V secondary battery I had 12 V. But then I had to run the back up radios and the modem and would the internal battery in the 10 year old Toshiba laptop hold up for the 2 hours plus of reporting the competition stage of the rally? As luck would have it the VW system worked for the pre rally check out and I was able to borrow a 75Ah 12 V truck battery for the rally. It all worked so well I thought it was not working. The 5/8 whip on 145 MHz and the 8030 with the MJF 1270B worked perfectly. The main problem was sunlight on the liquid crystal display on the laptop. Steve VK5AIM who came with me to operate the voice net brought his solar cell and was able to keep current flowing into the battery. His set up also worked perfectly.

I had been looking forward to spending time on the Spring VHF/UHF Field Day but that was not to be. It can be good fun moving around and setting up and seeing how you can work out of different locations. Round Adelaide you seem to have a choice of taking to the hills or way out on the plains. If you head for the Hills then you must stay close to the western face or you

lose all the people on the plain. You may be lucky and work a few stations in the eastern states but propagation has to be right. If you head for the plains you are limited as to how far west you go and keep your feet dry. You can go NW which I have done several times or you can drive a few hundred km and operate from the southern end of Yorke Peninsula and work across Spencer Gulf to the not so adventurous operating close to their homes in Adelaide. It does require some planning and the time to do the travelling.

This month's issue filled up rather quicker than I expected, so I was not frantically looking for material. However I do not have any photographs of suitable quality for a magazine cover at present. I need good clear photographs, with good contrast between the subject and the background. They are generally more interesting if they show people and equipment. They should be taken portrait orientation, that is long axis vertical. If a digital camera is used I need high resolution, a half Meg plus file. So if you are out operating this summer please see if you can take a photo for the cover of AR.

Reminders. Next issue is December / January and will be 64 inside pages. The following issue will be February 2003. Ross Hull VHF contest starts December 26th.

So as we need to use our frequencies to keep them, chase DX, rag chew, experiment or operate in the contests but have fun as well!

73 Colwyn VK5UE

Book Review—New Guinea Engineer

In the October issue of AR we published a review of this book on page 11.

Unfortunately we left out the following.

Publisher Rosenberg Publishing Pty Ltd. PO Box 6125 Dural Delivery Centre NSW 2158.

Telephone 02 9654 1502 Email rosenbergpub@smartchat.net.au.

The ISBN 1 877058076. rrp \$29.95 October 2002.

With this information any bookshop should be able to get you a copy.

Ernest Hocking VK1LK
WIA Federal President
president@wia.org.au
PO Box 691, Dickson ACT 2602

A Busy Time

Writing this month's president's notes has proved to be extremely difficult. Amongst the reasons for this were a change of job and falling prey to some sort of flu bug. During this time I have been stuck by something that I feel sure we all know – namely that amateur radio is for the majority of us a hobby. This brings me to the theme of this month's notes namely the importance of the volunteer.

Volunteers

Amateur radio is full of volunteers. We all know of the excellent work performed by WICEN. In the past few weeks we have witnessed a continuation of the round of international terrorism with the appalling attacks in Bali and then in Moscow. I am sure that many of us have been touched by these awful acts. In addition we are rapidly entering the bush fire season throughout Australia. Up until now we can be thankful that the activities that many of us participate in support of WICEN activities have been in support of community events such as car rallies, and community events such as fun runs. However recent events serve to remind us of the more serious purpose of the training and service that WICEN volunteers train for. I, as I am sure you do, hope and pray that we will never be called upon to have to call upon our WICEN volunteers to serve Australia in

a real crisis. However recent events do serve to remind us of the importance of such assistance to the Australian community in times of need. I would ask you all to continue to support our voluntary activities in any way that you can.

WIA volunteers

Talking of volunteers we are always looking for volunteers to support WIA Federal activities. Amongst the current open posts are those of AR editor, federal contest coordinator, call book editor, and marketer. If you believe you have the skills and time to help out then I would be delighted to hear from you. As with any voluntary work it can be demanding but the rewards by far out-way the demands. If you are interested in helping then please drop me a line and we can talk to discuss options in more detail.

Foundation licence

The draft foundation licence paper is still being discussed by the WIA council and divisions. As suspected at the time of its distribution there are many aspects of the proposal that have caused a few concerns. For example comparison of the current UK Foundation licence privileges with the Australian novice licence reveal that the direct adoption of the UK model would lead to a situation where a foundation licence holder would hold greater privileges than a novice operator. However this is

ultimately something that I am sure that we can overcome by observing that whilst amateurs struggled with packet radio for many years general access to the Internet does not require that the general public be examined in digital electronics and networking. More important than these issues is the fact that the foundation licence provides a means to rekindle an interest in amateur radio in a new generation of amateur radio operators. This optimism has been borne out by the UK experience with the scheme there attracting significant numbers of new entrants to the hobby. I am sure that you will all agree that we need to be able to look forward if we are to ensure the future of amateur radio and be prepared to look critically at our current licensing privileges.

In conclusion I note that despite the pressures of work and other activities that amateur radio is an extremely rewarding hobby. Although at some points in our lives it may prove to be a challenge to focus as much time on our hobby as we would like it will always be there for us to enjoy. So until next month's note I wish you all the very best and I look forward to hearing from you all. If you have recently written to me then please be assured that I will get around to replying – it will take me a little time to get to respond to the large number of letters that I have received in recent weeks.

73s de Ernje VK1LK

New WIA Members

The WIA bids a warm welcome to the following new members who were entered into the WIA Membership Register during the months of AUGUST and SEPTEMBER

L21192	Mr L T Jones	VK4BVM	Mr P R Fraser	VK1XLW	Mr B L Williams	VK3JHN	Mr J Simister
L50753	P S Russell	VK4HRM	Mr R Midson	VK2AYI	S Clark	VK3KOS	Mr R J Williams
VK1BSM	Mr G W Collins	VK4YAP	Mr E Fardin	VK2IOW	P Staples	VK4AJL	Mr G E
VK2AGC	Mr C G Cottle	VK5HKT	Mr K T Thole	VK2ZEE	P Collen		Glendinning
VK2HEJ	Mr J R Veters	VK5VK	Mr B Hubbard	VK3FML	Mr M Boudreaux	VK4ZS	Mr I M Mowat
VK2JTV	Mr P F Mahoney	VK6KHD	Mr N H Dudley	VK3HFS	Mr G Stowell	VK5VST	Mr S T Vickery
VK2TTG	Mr S Morton	VK7CV	P C Holland	VK3HSS	Mr K Sadler		
VK2TUI	Mr A R Smith	L10179	D F Fatouros	VK3JA	Central Goldfields		
VK2ZK	Mr B S Spindor	VK1KT	Mr K E Threlfall		ARC		

A 25 W AM/CW Valve Transmitter for 1.8 and 3.5 MHz

Drew Diamond, VK3XU
45 Gatters Rd., Wonga Park, 3115.

Amplitude modulation transmission for local and interstate 'phone work has many supporters, particularly on our two lowest frequency bands; 1.8 and 3.5 MHz. For instance, in the Melbourne area, the friendly weekday 11 a.m. "Coffee-Break" net has been going for at least 30 years on 1.825 MHz. And at night, 1.843 MHz is a good spot for AM users. Also, a large group of AM fans gather for a "round-table" on Friday nights at 1100 Z on 3.566 MHz. As a fraternity, AMer's are generally experimenters, "home-brewers" and modifiers of commercial rigs.

This project is an answer to numerous suggestions and requests for "a simple, effective, AM transmitter- using valves and obtainable parts". My first effort, a plate and screen-modulated 50 watt, turned out to be a rather large and heavy "boat-anchor". So it was felt that something smaller and lighter would be more acceptable.

Several of the parts required can no longer be purchased new. However, an earnest attempt has been made to employ components, which may reasonably be obtained without too much difficulty. The power transformer for instance, is a type which was specified in various Electronics Australia "Playmaster" amplifiers of the 60s and 70s, and so it is a good bet that similar items are still lying around in junk-boxes all over the country just

waiting to be included in a worthwhile project. The need for a modulation transformer has been dodged by choosing clamp-tube modulation of the screen (Ref. 1 pp259-260) and control grid. Such "efficiency" methods are sometimes unkindly regarded as "band-aid" or emergency schemes. Never the less, considerable experimental work has gone into the prototype model, with the result that the quality of speech and modulation depth is very satisfactory, and good to complimentary on-air reports have been received.

Output power into a 50 ohm load is about 20 to 25 W on AM, and 25 W on CW. Harmonics of 1.8 and 3.5 MHz are approximately 40 dB below fundamental- which is quite satisfactory for a such a simple pi-coupled output power amplifier. When put through the

(usually) necessary antenna coupler, harmonic radiation should be sufficiently low for all normal work. In practice, the 25 W AM signal, fed into a quarter-wave long inverted 'L' or similar antenna should result in good readability reports from most operators in and across town, and interstate contacts are possible at night.

Circuit

To keep things simple, crystal control is employed because most known AM enthusiasts seem to gather on just a few frequencies, typically 1.825 MHz day, 3.566, 1.843 and 3.580 MHz night, these latter two being cheap off-the-shelf crystal frequencies. A 6C1.6 power pentode at V1 is wired as an electron-coupled Pierce oscillator (Ref. 1 p161), where the screen grid (pin 3 or 8) acts as 'plate', and the amplified output signal is extracted from the un-tuned plate at pin 6. The suppressor grid (pin 7) effectively screens the plate from the crystal circuit, and thus we get an oscillator and buffer in one envelope. Isolation is very good, with no "pulling" of the crystal frequency by variations in output loading, or "FMing" caused by modulation.

Oscillator signal is applied to the control grid of the power amplifier (P. A.), pin 5 of V2, a common 6DQ6 beam power tetrode (much used in B & W TV sets). The maximum plate voltage for the 6DQ6 is specified as 770 Vdc (Ref 2). In this iteration, high-tension supply is about 660 Vdc. A bias of about -50 Vdc is applied to the control grid via a 22 k resistor. Screen grid of the P.A. (pin 4) is sourced through 14.1 k Ω (three 4.7 k Ω 5 W resistors in series). Plate impedance



Photo 1. 25W AM/CW Transmitter

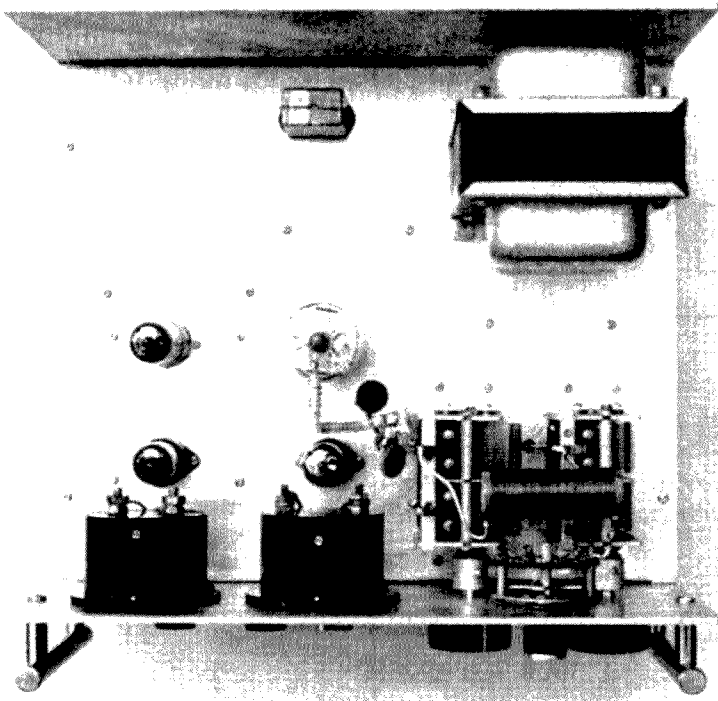

Photo 2. Above chassis view

excessive chirp or whoop. Voltage across the open key contacts is a safe 25 Vdc.

For satisfactory modulation characteristics, it was found that a plate supply of between 650 and 700 Vdc works best. The power transformer has a HT winding of 285-0-285 Vac which, when applied to a full-wave bridge rectifier, gives about 660 Vdc supply under load. The c.t. of the winding provides 330 Vdc for the remaining circuitry. The 100 μ F/400 VW filter capacitors assure a smooth, low ripple supply. For negative bias, the three 6.3 Vac heater windings are connected in series for 19 Vac, then applied to a voltage doubler for the -50 V bias supply.

Construction

Let me state a warning: The voltages used in this transmitter are quite capable of killing a person. All mains wiring must therefore be adequately covered to prevent accidental contact. A top and bottom cover are essential- the top cap of the 6DQ6 is always alive with 660 Vdc. You are aware of the danger, but a visitor may not be- that "shiny glass thing with the funny hat" would be irresistible to children.

At local metal re-cyclers, and at very reasonable cost, I had a bit of luck in finding much of the necessary chassis material, including perforated sheet for the top and bottom covers. My homemade aluminium box measures 305 x 205 x 265 mm WHD, and is made in a similar manner to that described in Ref. 4 (see also Refs 5 and 6 if you are new to "chassis bashing"). It could be made smaller if desired, but not so diminutive that any needed work is difficult. Remember also that a fair amount of waste heat is generated, particularly around the 6DQ6, which will need to be able to ventilate adequately. Front and rear panels are 3 mm al. sheet, which are supported by 12 mm square section connecting rods. The chassis pan may be 1.3 or 1.6 mm aluminium.

Photo 3 is a below chassis view. Layout is not at all critical, although the oscillator V1 and speech-amp. V3 should be located fairly close to the front panel in order to keep sensitive wiring reasonably short (take care V1 and V3 do not clash with the meters). The crystal socket(s) should be mounted upon the front panel, adjacent the delta f capacitor (which provides a small

of the P.A. is matched to a nominal 50W load with a simple pi-coupler network, comprising a coil and ordinary dual-gang 450 pF/section variable capacitors- a single section for tuning, and two sections for loading adjustment. A 2.5 mH choke is connected across the loading capacitor in order to provide a dc path, and thus lessen the possibility of voltage breakdown between the capacitor's plates. More importantly to ensure that, should the 1 nF plate coupling capacitor fail, the mains fuse will blow, and thus prevent 660 Vdc from reaching the output connector.

The modulator/clamp V4 is connected between the screen of V2 and chassis ground, where the effective plate-cathode resistance of the valve may be varied by altering the value of negative voltage applied to the control grid (pin 2 or 9). The 10 k bias pot may therefore be adjusted to set the screen voltage, which in turn controls the value of standing plate current, and hence the power delivered to the load. In AM mode, a plate current of between about 60 and 75 mA yields best modulation characteristics. Under these conditions, the modulator may now be used to vary the screen voltage at an audio rate.

Most tetrodes cannot be made to go right down to zero output when the screen voltage is made a low value, and

100 % modulation is therefore difficult to achieve under normal conditions. The valve's transfer characteristic is also quite non-linear at low levels of screen voltage. In order to 'pinch-off' the plate current (and thus reduce the output to zero) more effectively on negative peaks of the modulating waveform, a small amount of modulation signal is also applied via the 220 nF capacitor and 15 k resistor to the control grid of V2. By having a reserve of power availability (or "head-room"), positive swings of screen voltage will cause the P.A. to deliver additional power on these peaks, and hence achieve a level of modulation that is "fuller" than that normally obtainable with simple screen modulation.

Audio signal from dynamic or electret microphone is applied to a 12AX7 double triode speech amplifier (Ref. 3 p251). This amplifier circuit, in my experience, is one of the simplest and easiest to get working. I have used it many times in various projects. And 12AX7s are not difficult to obtain- even new.

In CW mode, the oscillator's cathode is keyed. Keyed waveform is shaped by inclusion of the 2.2 μ F capacitor in combination with a 100 Ω resistor. Provided that the crystal is not pulled too far off its nominal frequency, the keyed wave is quite clean, without

adjustment in crystal frequency). The delta f cap. may be an MSP 95 + 200 pF, or a 90 + 90 pF.

Our usual electronics suppliers have tag boards and tag strips, which are ideal for mounting "valve" type components. Use ordinary hook-up wire (twisted into pairs with a hand-drill) for the heater wiring and other connections. The +660 Vdc run should be made with suitably voltage-rated insulated wire. Note that a rubber grommet should be fitted where the 660 Vdc connections pass through the chassis (plate current meter and V2 plate choke). The same applies to any transformer wires, which must pass through the chassis.

If you have one of those nice chassis-mount 2.5 mH chokes for V2, use it. Otherwise, an ordinary 3 pin choke will need to be mounted upon a stand-off insulator. I used a length of nylon rod, with solder tags fitted. The choke should be suitably current rated (i.e. measure less than about 30Ω d.c.). The plate parasitic suppressor for V2 is 4 turns of #20 tinned copper wire wound upon a 47 ohm 1 W resistor. I could not find a top cap connector, so fabricated one by colling a length of small brass wire rod upon a slightly under-sized drill shank to fit the 6DQ6 plate top cap.

Various common materials were tested for use as tank coil former, including 40 mm poly water pipe wound with #18 B&S e.c.w. Paradoxically, 20 mm orange plastic electrical conduit material, wound with 60 turns of #20 B&S e.c.w., which is more conservative of space, gave as good results as the larger former, in that the output power is the same; 25 W for 75 mA plate current. Do not use the lossy grey material.

A plate current meter is mandatory, one of about 100 or 150 mA f.s.d. would be ideal. A grid current meter is not essential, but handy. On 1.8 MHz, grid current is typically 1.5 or 2 mA (depending on crystal activity). On 3.5 MHz it is rather less; typically about 0.5 mA. The -50 V bias supply eliminates the need for the more usual class C bias obtained by rectification of the drive signal- no drive, no PA plate current in this case. My model uses a 10 mA meter, but a 5 mA would be better.

Operation

Confirm that all wiring is correct, and that polarised components (diodes and electrolytic capacitors) are properly

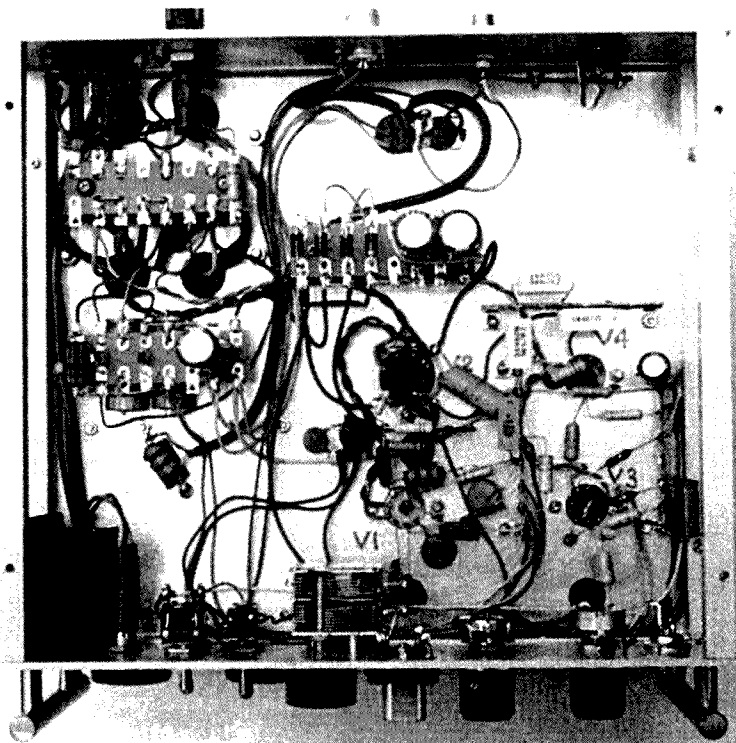

Photo 3. Below chassis view

oriented. Remove all valves. If you are the fortunate owner of a "Variac", bring the input voltage up slowly, and with your multimeter on the 1000 V range, observe that the main HT (660 V) supply comes up to about 700 V. Carefully measure the 330 V and -50 V supplies. No Variac? Wire a 240 V 60 W lamp in series with the transformer primary. Cover all exposed connections. Apply mains voltage- the lamp will glow briefly, then, all being well, should extinguish, or die down to a dull orange glow. Carefully measure the 660, 330 and -50 V supplies.

Switch off, wait 30 sec. for the electrolytics to discharge, then insert the 6CL6 oscillator valve V1, and a suitable crystal. Switch to AM mode, then close the PTT line. Relay 'A' must pull in. You should be able to hear the crystal oscillator signal on the station receiver, which should have a pure "T9" note-free of FM and hum.

Withdraw the mains plug, wait 30 sec., and install the remaining valves. With the mode switch on AM, PTT open (RX mode), Pwr pot at minimum bias (i.e V4 hard on), crystal installed, P.A. tank band-switch set to correspond with the crystal, and a suitably rated 50 ohm power meter or dummy load connected

to the transmitter's output; apply mains power. As the valves warm up, there should be no plate current indicated. If the plate current rises to an alarming level, switch off, unplug and find out why (may be "gassy" 6DQ6). All being well thus far, switch to TX and adjust the Pwr pot for about 60 mA, then quickly adjust the tune and load capacitors for maximum output, where you will observe a corresponding 'dip' in plate current. Take care that you do not tune to a harmonic, which is the unwanted power peak obtainable at a smaller value of C than the main peak. At 60 mA plate current you should have about 15 or 20 W output power indicated, and at 75 mA the power output should be about 25 W. You may be able to briefly crank the power up to 50 W or so, but the 6DQ6's rating is then exceeded.

An oscilloscope is the most ideal tool to set up the modulation percentage level. If available, hook the 'scope's X10 probe across the output connector, then speak into the microphone. Adjust the mic. gain pot for 100 % modulation, indicated by bright spots just occurring at the zero crossings, and nicely rounded peaks. A steady whistle should produce

continued on page 10



TTS Systems Communications Equipment

FREE CATALOGUE 

www.ttssystems.com.au

HF and VHF Transceivers, Autotuners and Kits

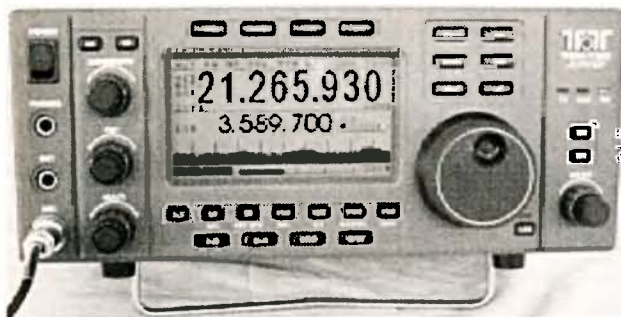

Jupiter HF DSP Transceiver

Easy-to-read LCD main panel display.
34 built-in receive filters—300 to 8000 Hz.
Multi-function meter provides bar graph and digital readout of signal strength, TX power and SWR.
Band sweep function
Seven selectable main tuning rates

Get Kitted Out

"It goes better on something you made yourself"



Z11 QRP Auto Tuner Kit



HF Receiver Kit



AT11-MP Auto Tuner Kit

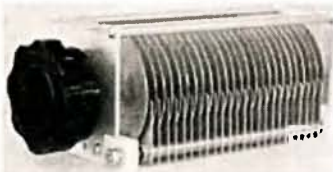

H.V. Variable Capacitor Kit



Dummy Load Kit

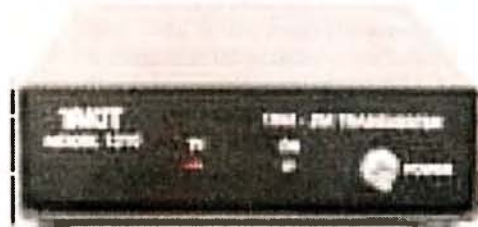

10-2M Transverter Kit



RT11 Remote Auto Tuner Kit



About to be released from Ten-Tec The Orion HF 32 bit DSP Transceiver and the Argonaut V QRP IF-DSP Transceiver.



We have RF Cables, Connectors and Baluns

★ All kits include easy-to-follow step by step assembly instructions.

You supply the soldering iron and basic tools!!!

All kit products can be supplied fully assembled and tested.

 Service and Support for all Ten-Tec and LDG equipment

We stock Amidon Iron Powder and Ferrite Cores — Call for an application guide

Phone 03 59774808. Fax 03 59774801 info@ttssystems.com.au

Low drop-out voltage regulator

Keith Gooley VK50Q

A voltage regulator for operating nominal 12 volt low power radios from a vehicle.

This discrete component voltage regulator is intended for powering a hand-held radio from a 12 volt vehicle electrical system. A typical hand held has a maximum supply rating of 13 volts. In my case it is a Yaesu FT-50R and I am unwilling to test this rating by connecting it directly to the 12 volt system in the car. This nominal 12 volts can rise to over 14 volts when the battery is fully charged and the alternator is running fast, supplying the other requirements of the car. In addition, there are large transients on a vehicle system plus noise and "hash" from a variety of sources. It is therefore desirable to protect the radio from the worst of these.

Why build a regulator from discrete components? Surely there are IC's around which will do the job. Well, yes there are. The National Semiconductor LM2940T-12 would fit the bill but there are 3 reasons why I didn't use it. Firstly, I didn't have one and they are not that readily available (read not stocked by Dick Smith at all their stores). Secondly, I like to do it myself and there is more satisfaction in producing a design that works than simply dropping in an IC. Thirdly, this design has a lower voltage drop than the IC, 0.2 compared with 0.5.

So when the engine is off and the battery volts are dropping towards 12, my design will keep the voltage to the radio up to 12 longer than the IC. However, there are disadvantages, mainly in the area of protection against excessive current and reverse battery connection. But then we all know IC regulators are not immune from failure due to these factors, in spite of what the data sheet says.

So, that's the what is it? And why? Now the how? Low drop regulators invariably use a PNP pass transistor in the positive lead and this function is carried out by TR1 a readily available MJE2955. When power is applied to the input, current flows through R1 turning TR2 hard on. The resulting collector current in TR2 turns TR1 on. The output voltage rises until the zener diode draws sufficient current to turn on TR3. This tends to turn off TR2 and the output voltage stabilises at a point equal to the sum of the zener voltage and the forward base-emitter voltage of TR3.

If the load current increases, the output voltage will tend to fall and so

TR3 will draw less current and TR2 will turn on harder supplying the base current to TR1 necessary for it to maintain the output voltage constant. The usefulness of this circuit becomes clear when the input voltage drops towards 12 volts. If the point is reached where the input voltage is not high enough to keep the output regulated, zener diode D1 no longer draws enough current to keep TR3 in its active region and the latter turns off. TR2 then pulls maximum base current from TR1 which is turned hard on, giving minimum voltage drop from input to output, in this case about 0.2 volts at 1 amp load current.

Construction

The prototype was built on a small section of single sided laminate as shown in the photograph. Holes were

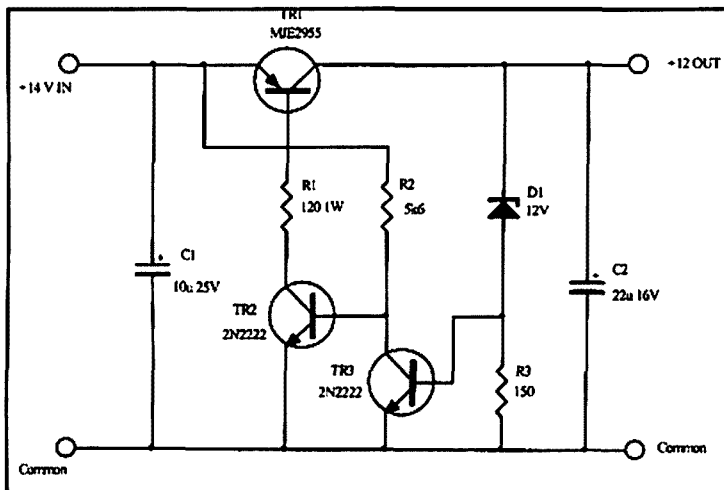
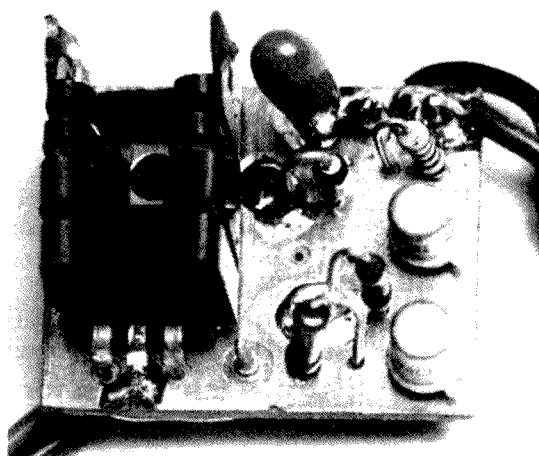

Figure 1. Low Voltage Drop Voltage Regulator

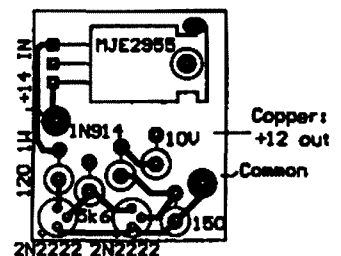

Figure 2. Circuit board layout

continued on next page

Low drop-out voltage regulator

Continued from page 9

drilled for the components using the PCB layout as a template and the component leads used to make connections on the underside of the board. This method of construction was described in reference 1. Constructors may use the layout supplied to make their own PCB or build the regulator on matrix board. The layout gives enough room to accommodate a heatsink (for example DSE #H3403). The top copper layer in the prototype is used for the positive output rather than the more usual common lead as the pass transistor TR1 collector can be mounted directly on the heatsink without the need for an insulator and the heatsink is in turn attached to the board.

I have specified 2N2222's for TR2 and TR3 but any general purpose NPN small signal transistor will do, eg BC547, 8,9 BC107,8,9 BC337. This latter would be a good choice for TR2 which can draw 100 mA when full on.

Having completed the regulator and tested it for correct operation, all that is required is to connect a DC lighter plug to the input lead and an appropriate plug to the output lead. I used a coaxial DC plug that then plugs into the lead to the radio. It would be a good idea to insulate the completed regulator with electrical tape or as I did with large diameter heatshrink tube.

Conclusion

A low voltage drop discrete component regulator is described enabling transceivers requiring a maximum of 12 volts to be safely operated from a vehicle electrical system. The design described has a lower voltage drop than an integrated circuit type of regulator.

Reference

Gooley, Keith VK5OQ "A 10 MHz Crystal Reference Oscillator"
Amateur Radio August 2001

ar

A 25 W AM/CW Valve Transmitter for 1.8 and 3.5 MHz

Continued from page 7

a "text-book" 100 % sine-wave modulation pattern.

Without an oscilloscope, the quality and percentage can be checked on your station receiver. The signal must not be so strong as to overload the receiver. Increase the mic. gain until perceptible distortion occurs, then back off a little from that point. Best AM should be obtained with a tuned plate current of between about 60 and 75 mA. The three 1.5 nF (0.0015 μ F) coupling caps in the speech amp were found necessary with my voice/microphone. However, you may find that larger values, typically 10 nF (0.01 μ F) may give a "rounder" sound.

On CW mode, plug in an ordinary Morse key, then switch to TX. Adjust the plate current to about 75 mA. When the key is open, the plate current should fall back to zero- or a fairly low value, ideally less than 30 mA. Provided that the crystal is reasonably active, and not "pulled" too far, keying should sound clean, without excessive clicks or chirps.

Parts

Items such as 1 W and smaller resistors, 5 W wire resistors, polyester capacitors, 400 or 450 V electrolytic caps, tag strips, connectors, pots, 1 kV diodes, ceramic caps, winding wire, valve sockets, 12 V relay (with two sets of c/o contacts), toggle and rotary switches, knobs etc. are known to be collectively available from our usual electronics suppliers, including Altronics, DSE, Jaycar and Electronic World. 2 W resistors and many of the above should also be obtainable from your local supplier to the TV service trade. Things like the power transformer, two-gang variable capacitors (the ordinary kind, as used in valve B.C. sets), meter(s), silver mica capacitors, 2.5 mH chokes (to carry more than 100 mA) and valves, are usually (in my experience) procurable at hamfests. And if you are in a radio club, one of the members is sure to have that needed item- just ask. Finally, new 6DQ6, 12AX7 and 6CL6 (or the cheaper 6197)

valves are available by mail order from at least one USA supplier. I always receive good service from; Antique Electronic Supply, 6221 South Maple Ave, Tempe, AZ, 85283, USA. For pricing, check out their web site at: www.tubesandmore.com

References and Further Reading

1. The Amateur Radio Handbook, 3rd edition, 1961, RSGB.
2. RCA Receiving Tube Manual; Technical Series RC-23.
3. The Radio Amateur's Handbook, 43rd edition, 1966, ARRL.
4. "From Circuit to Chassis"; Diamond, AR, Dec. '00.
5. "How to Lay Out a Transmitter"; Byron Goodman, W1DX, QST, July '51.
6. "How to Build a Transmitter"; Byron Goodman, W1DX, QST, Dec. '51.

ar

Coming next issue...



Some Uses for a
Dip Oscillator
Drew Diamond



Measuring Echoes
and Propagation on
the HF Bands
Peter Kloppenburg



The No PA 40 metre
DSB transceiver
Peter Parker

The *RS20 Power Supply

*Recycler's Special

20 amps of recycled grunt for SSB

Jim Tregellas VK5JST

A heavy duty 13.8V power supply is a fine thing to have in the shack , but unless you acquire one secondhand, is an expensive little beastie to buy. This means building one should be considered, not only for the cost savings, but also because you can brag about it to your mates on air. Of course, careful consideration must be given to the properties of the completed supply, and after talking to a few of my friends who have built their own and fallen into all the traps, here are the printable ones: RF proof, easy to make, commonly available parts used, but above all cheap. (Other suggestions such as 'catches fire infrequently ' were ignored)

Well, last things first. Breaking down the construction costs of a heavy duty regulated supply, they are in order:

1. The transformer (around \$80)
2. The main filter electrolytics - new, these are a frightening price and you can expect no change from \$80
3. The case - a metal case is well beyond the workshop capabilities of many amateurs and is quite expensive to buy (if you can).

4. The meter - around \$20 - \$27 (either digital or analog)
5. The electronics - transistors, resistors, diodes, etc.
6. All the bits - fuseholders, terminals, switches, solder tags, nuts and bolts, power cords, etc.

Dealing with these in turn, we can reduce the cost greatly by rewinding a microwave transformer (about \$5 total),

scrounging old computer grade electrolytics (lots around), and designing the electronics to be so RF proof that a wooden case can be used - yes, that's right-wooden ! If you are really stuck for a dollar, then good supply regulation and overload protection also allow all metering to be deleted. Finally the wooden case allows 1/4 inch bolts and washers to be substituted for expensive terminals or connectors. If you can't put

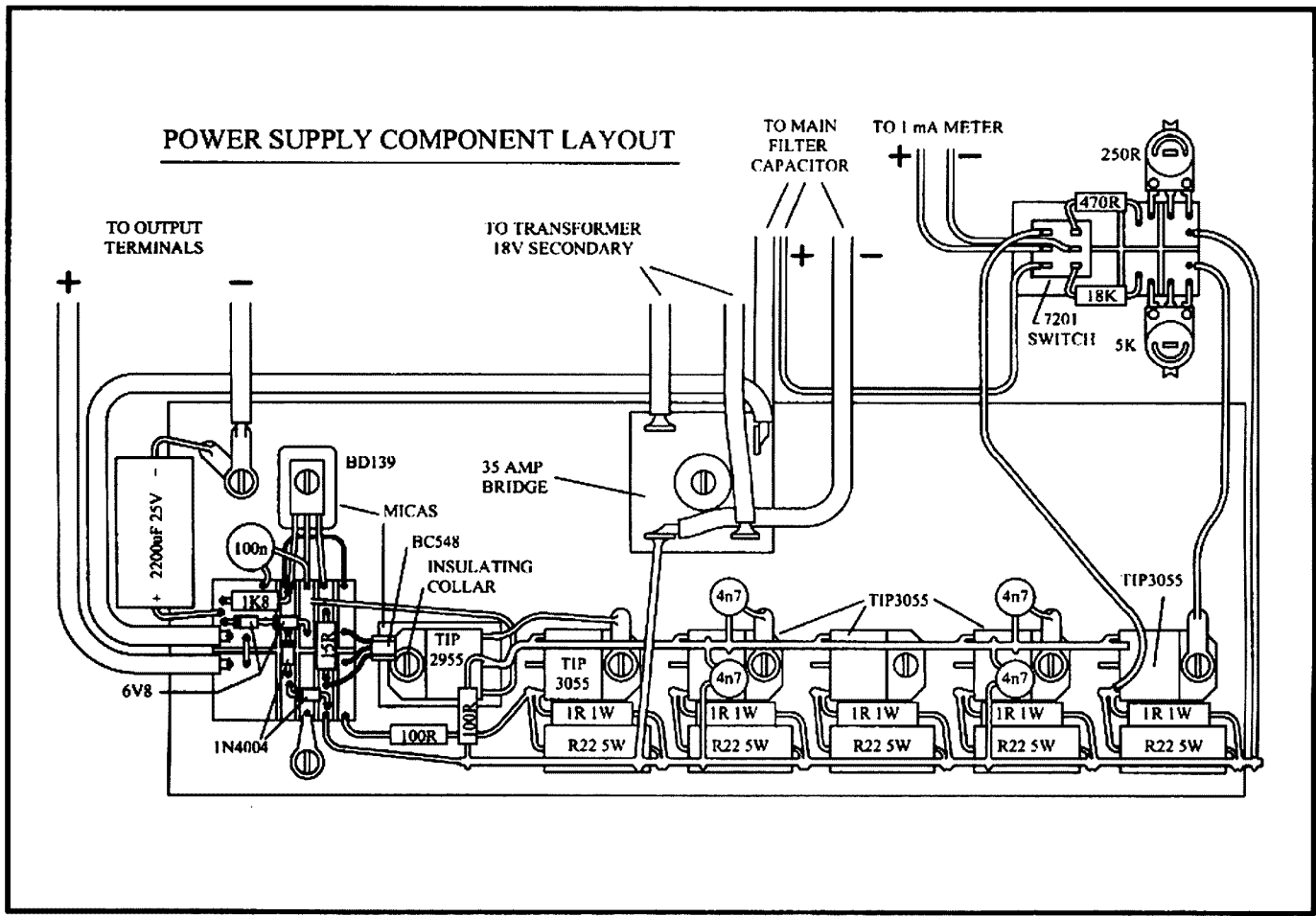

Figure 1. Component layout

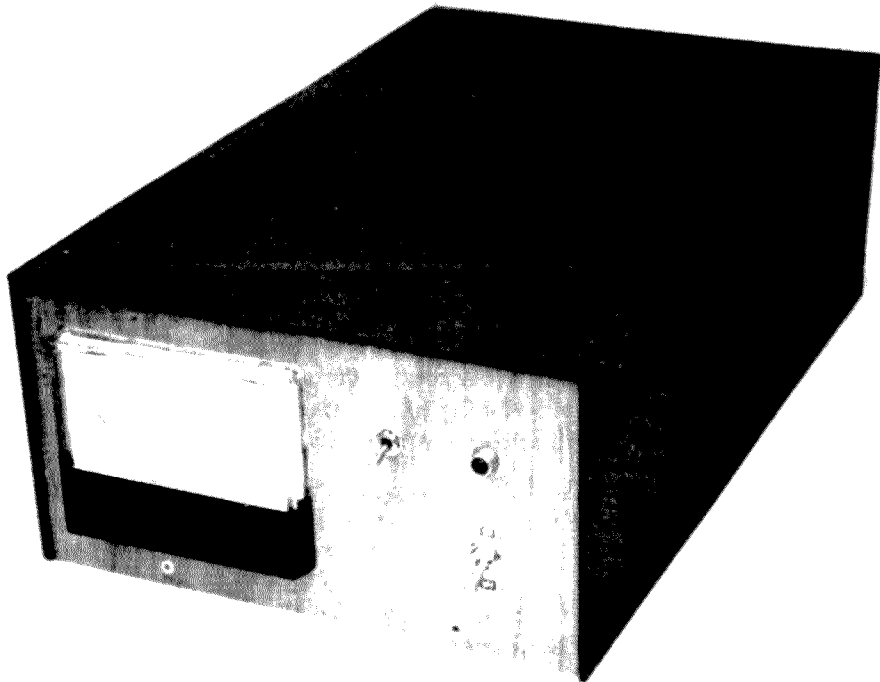

Photo 1. Completed Power Supply

the whole thing together for less than \$50 then frankly you don't even qualify for the junior scrappers league.

Moving on to the other points, manufacture is easy as no etched PCB is used. Boards are simply made by using a hacksaw to cut through the copper overlay on the PCB material breaking it up into separate parts. Details are given in the drawings.

Keeping the supply RF proof is another matter entirely. During the development of this supply, several designs were tested based around such chips as the 723 regulator, the 3140 op amp, and a 7912 three terminal regulator with bypass transistors. In all cases, the high gain of the control amplifier forced the use of a PCB with a ground plane to which everything was heavily bypassed.

This limited RF interference and also prevented motorboating and high frequency instability (a common problem in high current circuits such as power supplies and audio amplifiers) as the ground plane acts as both an RF shield and a single point ground.

However, for home construction, the use of a double sided PCB is undesirable and anyway, the performance of each of these circuits is totally over the top. After all, 13.8 volt ham rigs are designed for use in a car where the supply voltage wanders all over the place. Two volt of variation is quite typical. Regulator circuits which hold the output voltage constant within a few millivolt for all conditions of load are simply not required. It is much more important that the output voltage is free of noise and ripple, and the published design does this very well. Noise and ripple are well under 5 millivolt peak to peak, and output regulation (no load to full load) is around 200 millivolt. A simple control circuit is used without overall feedback and the result is a cheap, very stable design. RF proofing is provided by physically earthing the heatsink, and also using it as a ground plane. The collectors of the TIP3055's are also physically earthed to the heatsink (no micas), and so a good section of the circuit is actually at earth potential. Two other advantages are easy assembly and excellent heatsinking.

How it works

The first section of the circuit is the transformer, rectifier, filter capacitor and bleed resistor which turns the incoming 240 volt AC into roughly smoothed DC. At first glance, this is a simple circuit and so the operation is rarely discussed anywhere in detail. However, being a very high current supply, this really is a different can of worms and needs to be completely understood, if for no other reason than to prevent rectifiers failing and electrolytics either overheating or exploding. Those of you who are already planning to increase the output current above 20 amps should read the next section very carefully as you won't find it in any common text.

The circuit operates by topping up the charge stored in the electrolytic capacitor every half cycle via the rectifier. Under load, it is desirable that the AC ripple voltage existing across the filter capacitor is kept low and for this

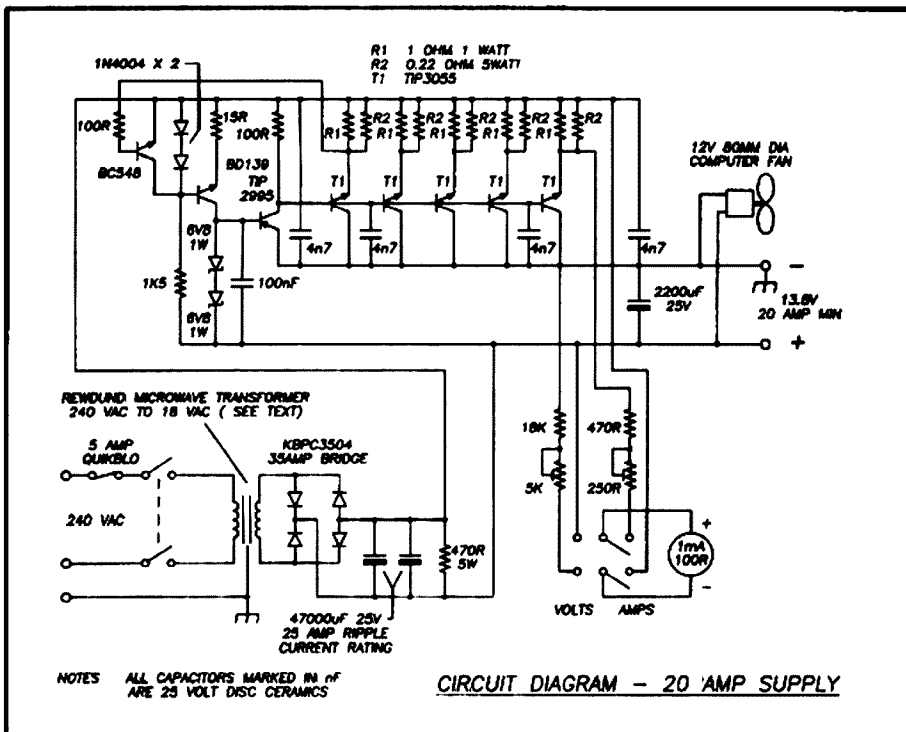
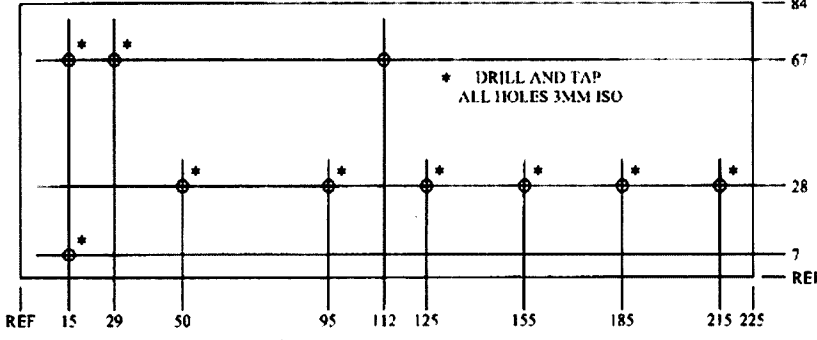

Figure 2. Circuit diagram

to occur, the recharging must occur in a very short time just before the peak of the cycle. If the ripple allowed is 10%, then very roughly the recharging must occur in around 10% of the cycle. If the average current delivered by the supply is 20 amps, then the average current during the recharging period must be around 200 amps. This huge current peak must be tolerated by both the rectifier and filter capacitor. Another way of looking at this problem is to regard the charging current spike as 20 amps of dc together with a large AC current superimposed on top of it. This AC component flows through the filter capacitor internal loss resistance causing large amounts of heat to be generated. For these reasons, filter capacitors used in high current supplies have three published ratings, capacitance, maximum DC operating voltage and RMS ripple current rating. If reference is made to the famous Schade curves for rectifiers (see references), for the ripple percentages used in this design the relationship between the RMS AC ripple current and DC output current is around 2.5. This means that the filter capacitors used here must have an RMS ripple current rating of at least 50 amps. Capacitors with these sorts of ratings are physically large, to provide the big surface area necessary to get rid of the internally generated heat. I would recommend one computer grade 100,000 microfarad 25 volt aluminium electrolytic around 140mm long by 75mm dia. or 2 @ 47,000 microfarad 25 volt aluminium electrolytics around 105mm long by 75mm dia. Smaller capacitors **must not** be used unless you have specifications which clearly show that they have ripple current ratings at



HEATSINK DETAIL - JAYCAR HEATSINK HH-8530

Figure 3. Heatsink drilling

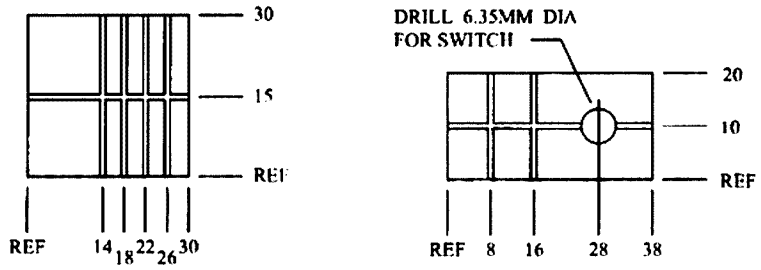

GENTLY CUT THRU COPPER LAYER ON PCB USING A HACKSAW BLADE TO FORM PAD PATTERNS SHOWN ABOVE

PCB MANUFACTURING DETAILS

Figure 4. Manufacturing details

40 deg. C of at least 50 amps for a single unit or 25 amps for each of 2 units.

An even worse situation occurs at switch-on of the supply as the electrolytics are fully discharged and represent a short circuit. If this should happen at the peak of the cycle, enormous peak currents flow and the principal thing which limits the peak current is the winding resistance of the transformer primary and secondary. (It is not surprising that the house lights

blink!) The 35 amp bridge used in this design has a single surge rating of 475 amps and in order not to exceed this rating, a particular wire gauge has been selected for the rewinding of the transformer secondary (2.5 square mm). **Under no circumstances** should this be varied.

So much for the operation of the simple part of the circuit. The next bit is the constant current source (BD139) and 6.8 volt zeners. This part of the circuit reduces the ripple existing across the filter capacitors by around 70 db to produce a clean stable reference voltage of 14.5 volt. Current flowing through the 1K5 resistor forward biases the two 1N4004's producing an almost ripple free voltage of 1.4 volt across the base emitter junction and 15 ohm emitter resistor of the BD139. Thus 0.7 volt exists across the 15 ohm resistor, setting the collector current of this transistor to about 50 ma. Most of this current flows through the two zeners, further reducing ripple and producing the 14.5 volt reference potential (and yes the zeners are 6.8volt but this is measured at a test current of 5ma, not the 50ma used here).

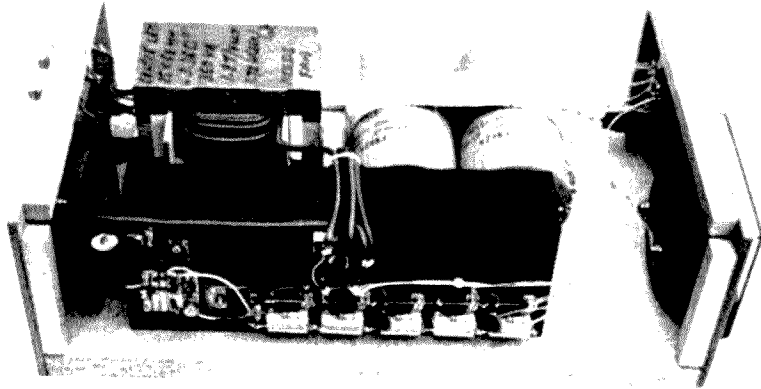
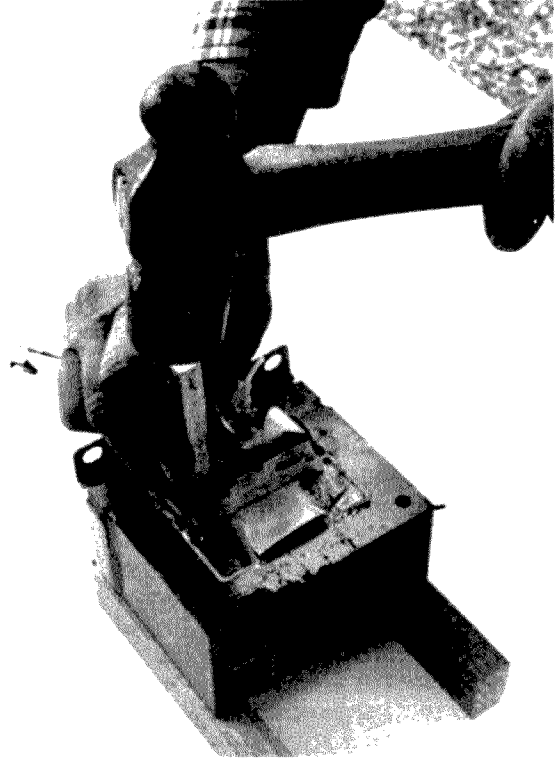
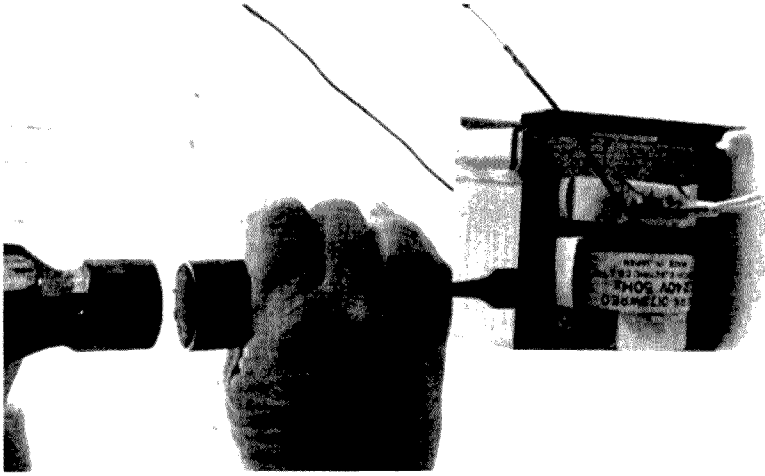

Photo 2. Inside View



Photos 3 and 4. Removing the old secondary

So the power supply output voltage is 13.8volt, due to 0.7volt being lost across the base emitter of the TIP2955.

The last part of the circuit consisting of a TIP2955 and five TIP3055s is really just a big compound emitter follower. At very low output currents (less than 7 ma), the only transistor supplying the output is the TIP2955. This is because there is insufficient voltage existing across the 100 ohm collector resistor to turn on the TIP3055's. However once this limit is exceeded, the TIP3055's progressively turn on, supplying whatever current is required. The five emitter resistor sets of 0.22 and 1 ohm simply ensure that the total output current is equally shared by each of the 3055's. At a current of 4 amps through each 3055, or 20 amps total, 0.7 volt exists across each emitter resistor combination, turning on the BC548 which then starts to shut down the constant current source. This limits the maximum output current to 20 amps. By the way, don't try to cut out any of the 3055's. If you check the specs, you'll discover that the maximum current a 3055 can handle with 20 volt across it (output short-circuit) is 4.5 amps.

Rewinding the transformer

Before you start this job, remember that the transformer is connected to the 240 volt ac mains and that mistakes can be fatal. For this reason, your workmanship must be first class. If you have any doubts about your abilities then either find someone who is qualified to inspect your work and tell you whether it is acceptable, or find a professional who

will do the work for you. Remember also that the transformer core must be physically connected to the mains earth, and that the primary must be fused as per the circuit diagram.

I used a transformer from a 750 watt Sharp unit but any transformer from a microwave oven having a larger power output can be used. The smaller units use 1.2 turns/volt meaning that the 18 volt secondary needs 22 turns. The larger units from 1 kW 'nukers' have bigger cores and use 1 turn/volt (18 secondary turns). The problem with most modern microwave transformers is that the cores have been welded together and cannot be dis-assembled for rewinding. Some other method has to be found for quickly removing the secondary winding. Now is the time to don your blue and white striped apron because the best way of doing this is with an old wood chisel and a large hammer (see photographs). As can be seen from the photos the secondary is removed by using the chisel to cut off the protruding C-section of copper on either side of the core. Work parallel to the surface of the laminations at surface level, alternately attacking the winding from either side. Prise off the bits of copper winding you cut through as you go. Be careful not to damage the smaller primary winding. When you have removed the protruding copper on both sides of the core, drive out the remaining plug of lacquer and copper from the lamination window, using a 12mm square punch. Next remove the magnetron filament winding. This will probably be 3 or 4 turns of heavy wire

sitting on top of the magnetic shunts. Note the number of turns. Most magnetrons use a 3.3 volt filament and this should give you some clue as to the turns/volt used on your core. Now, using the same square punch, remove the magnetic shunt on both sides of the window. This is a group of small I-shaped laminations which sit directly above the 240 volt primary. Clean up the window removing all loose insulation. Using a sharp Stanley knife, cut a couple of I-shaped pieces of 3mm thick craft wood or 3-ply of exactly the same width as the window. These are placed in the same position as the magnetic shunts just removed and force the primary and secondary windings to be well separated. Use the cardboard from an old manilla folder or heavy masking tape to line the rest of the window, making sure that anything which could damage the insulation on the secondary winding is very well covered. In particular, sharp edges must be turned into smooth radiuses by using lots of tape.

Quickly wind a temporary secondary with 5 turns of any old plastic insulated wire, connect 240 volt to the primary, and measure the AC secondary voltage. Calculate the turns/volt and hence calculate the number of secondary turns you need for the 18 volt winding.

Remove the temporary secondary and wind the real secondary using standard plastic insulated 7 x 0.69mm wire. Make sure that the insulation on the wire you use is rated for continuous operation at 90 degrees Centigrade or more (lower temperature ratings are not available these days anyway). The plastic insulation has an outside diameter of just a fraction under 4mm. Electricians use this wire in either single or 3 core form to wire 20 amp power outlets (white outer sheath). In the old imperial terms it is known as 7 strands of 0.026 inch dia. copper. Another way of referring to this cable is by referring to the copper cross-sectional area that is 2.5 square millimetre. You will need around 6 to 7 metre for the secondary. You can use any wire you like for the secondary, provided the insulation will take high temperatures and the cross sectional area is 2.5 square millimetre. Heavier wire will cause the bridge rectifier to fail because the peak currents will be too high. Smaller diameter wire will simply overheat. However, you will discover that a 7 metre length of single strand wire is very difficult to wind neatly. Wires with 2.5 square millimetre cross section are also available with many more than seven strands, and are very flexible and easy to wind. Wind the secondary neatly in layers, making sure that a minimum gap of 3 millimetre exists between it and any part of the primary winding. It may be necessary to bind some parts of the winding with tape to ensure this. The winding which results will deliver

18volt no load or about 15 volt at full load.

An aid to neatly winding the secondary is to cut some more bits of 3mm ply to exactly fit the height of the window. These can be used to force the turns to sit flat through the window as you wind each layer.

Assembling the supply

The first thing to do is gather all your bits together and design and make your box. Remember that a fan is mandatory (you can get a good quiet one from an old computer power supply) because the iron in a microwave transformer is flogged to death to keep both costs and weight to a minimum. Unventilated, they get very hot after about 30 minutes.

I made my case using 19mm chipboard for the base, 5mm thick 3-ply for the front and rear panel, and 3mm masonite for the lid top and sides. The front and rear panels of the case were drilled to accommodate switches, meters, fuse holders, etc. Then 12mm square timber was nailed and glued around everything but the bottom edge of these panels to provide a timber frame for the lid retaining screws. The completed panels were then nailed and glued to the base. The lid of the box was assembled using 12mm square timber at the junction of each of the panels. Everything was both nailed and glued for strength. A pattern of air holes was included at the front of both of the lid side panels to ensure that good ventilation was obtained.

All of the components on the heatsink were then assembled (see diagram). Finally, all components (case bottom, heatsink, transformer, electros, front and rear panel bits, etc. etc.) were married together to produce a unit ready for final wiring and testing.

Wiring and testing the brute

Simple enough really- use the left over 7 X 0.69mm wire for all the high current wiring (see the heatsink diagram) and thin plastic covered multi strand wire for all the rest. Wire up the transformer, rectifier, filter cap. and bleed resistor first and test the assembly. Watch your rectifier and electrolytic capacitor polarities like a hawk. If things go wrong, they will do so in a big way. Next, complete the voltage reference circuitry and test that (14.5 volt across the zeners). Last, add the super emitter follower and test the completed supply. A 60 watt headlamp bulb makes an excellent load. Testing the current limit is not easy and involves laying your hands on a 0.5 ohm 300 watt resistor. Do not just short the supply terminals and hope. If the current limit does not work the damage will be awesome. With the 0.5 ohm in circuit, 27 amp will flow if the limit is not working and the output voltage will be 13.8 volt. If the current limit is working, the terminal voltage will be around 10 volt and the current around 21 amp.

Continued on page 17

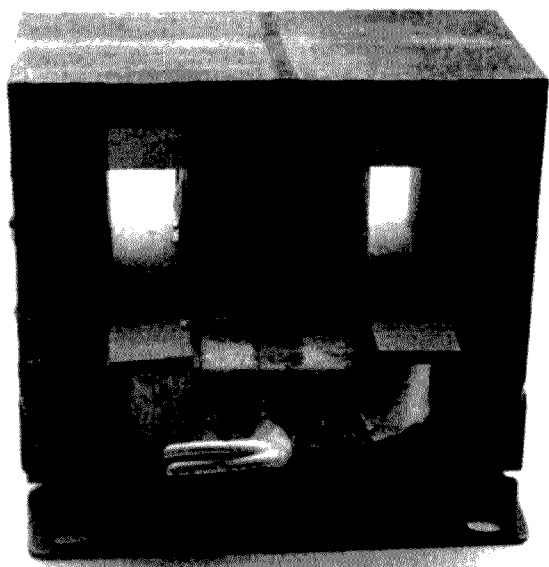

Photo 6. The core ready for rewinding

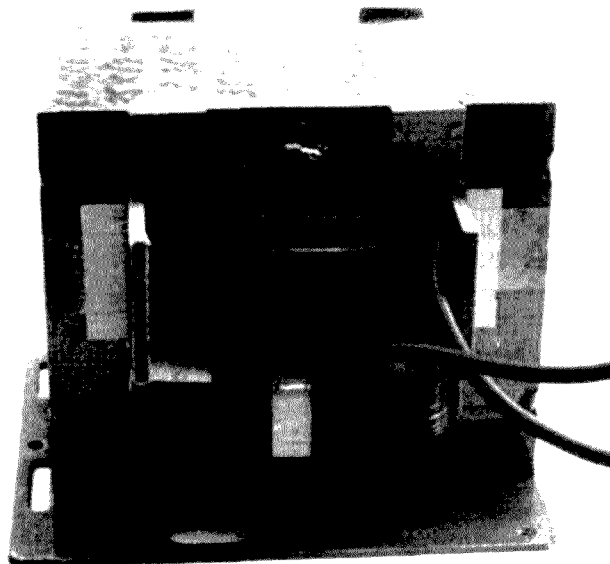

Photo 7. The completed rewind

G. & C. COMMUNICATIONS

Authorised dealer for **✓Kenwood ✓Icom ✓Barrett RFDS ✓GME Electrophone ✓Uniden ✓RF Industries**

TE-33 3 element tri-band yagi antenna

The most popular tribander.
Storm proved in the Pacific islands.

Excellent performance. wide bandwidth, high gain, low SWR, high F/B ratio.

Marine grade S/S h/ware.

6063T83 aluminium tube and specially machined heavy duty aluminium brackets.

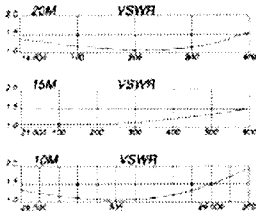
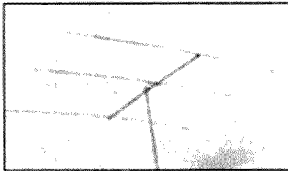

World famous names in HF and VHF Amateur Transceivers

27 Mhz and UHF CB Radios

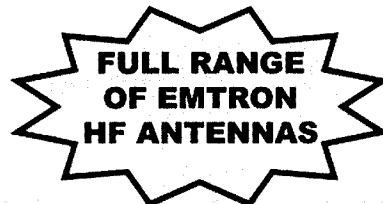

HF and UHF LINEAR AMPLIFIERS



Australia-wide orders welcome. Payment by credit card, cheque or money order
19 Arleon Crescent Cranbourne 3977 Email: gcomm@netspace.net.au
Ph: 03 5996 3298 Fax: 03 5995 0184 www.netspace.net.au/~gcomm

Order your Callbook and CD through your Division now

VK1 Division

Australian Capital Territory,
GPO Box 600, Canberra ACT 2601

VK2 Division New South Wales

109 Wigram St, Parramatta NSW
(PO Box 432, Harris Park, 2150)
(Hours Tue, Thurs, Fri 1100-1400)
Phone 02 9689 2417

Web: <http://www.wiansw.org.au>
Freecall 1800 817 644

e-mail: vk2wi@ozemail.com.au
Fax 02 9633 1525

VK3 Division Victoria

40G Victory Bvd Ashburton VIC 3147
(Office hours Tue 10.00 -2.30)
Phone 03 9885 9261

Web: <http://www.wiavic.org.au>
Fax 03 9885 9298

e-mail: wiavic@wiavic.org.au

VK4 Division Queensland

PO Box 199, Wavell Hts, Qld. 4012
Phone 07 3221 9377

e-mail: office@wiaq.powerup.com.au
Fax 07 3266 4929

Web: <http://www.wia.org.au/vk4>

WIA 2003 Callbook Book and CD pack

Get pricing and delivery details from your Division

Easy read

VK3CGE NG Emery 1 Beaumont Crt MONTROSE VIC 3765
VK3CGM GB Manders 8/33 St Georges Rd ELSTERNWICK VIC 3185
VK3CGP GW Potter 4 Omeo Crt TAWONGA SOUTH VIC 3698
VK3CGR Paul Timothy McMahon Lot 2 Stratford Rd MAEFRA VIC 3860
VK3CGT GT Garde 46 Douglas St
VK3CGU HJ Bassi Lot 80

Bold calls

VK5 Division

South Aust. & Northern Terr.
(GPO Box 1234 Adelaide SA 5001)
Phone 08 8294 2992

web:<http://www.sant.wia.org.au>
email: peter.reicheit@bigpond.com

VK6 Division Western Australia

PO Box 10 West Perth WA 6872
Phone 08 9351 8873

Web: <http://www.vk6wia.org>
e-mail: vk6wia@inet.net.au

All calls

and technical information

completely searchable

on the CD by **any** parameter.

**Seven times
faster than Internet**

VK7 Division Tasmania

PO Box 371 Hobart TAS 7001
Phone 03 6234 3553 (BH)

<http://www.tased.edu.au/tasonline/vk7wia>
also through <http://www.wia.org.au/vk7>
email: batesjw@netspace.net.au

The *RS20 Power Supply

Continued from page 15

Briefly connect the 0.5 ohm and see what happens. Do not leave the output shorted for minutes. The heatsink size and power supply design have been optimized for SSB operation (regular peaks to 20amps NOT the continuous drain of 20 amps which happens in FM and AM operation). I made my 0.5 ohm resistor from nichrome wire reclaimed from an old bar radiator and immersed it in a bucket of water. Steel wire of around 1mm dia obtainable from your local hardware shop for picture hanging could also probably be pressed into service but I haven't tried it.

Adding more muscle

The supply can be relatively easily extended in capacity - here are the steps. First, throw away the mickey mouse 35 amp bridge (which is really flat out supplying 20 amps into a capacitive load) and replace it with some heavy

stud mounted diodes, e.g. BYX52s or similar which have peak forward current ratings of 800 amps or more. These will need to be mounted on a decent sized heatsink. Use a transformer from a 1kW microwave and rewind the secondary using heavy multistrand wire with an area of around 4 to 6mm square (see your auto electrician). Add filter capacitors as necessary to get the appropriate capacitance (50,000uF per 10 amps) and ripple current rating (25 amps of ripple current rating at 40 degrees C for every 10 amp of DC output). Add TIP3055s at the rate of one 3055 for every 4 amp additional output. Drop the 15 ohm emitter resistor in the constant current source to 12 ohm (30 amp) or 10 ohm (35 amp). Beef up the heatsinks to suit your application.

Have fun and try not to liberate the magic smoke which makes all electronics work

References

- Schade Curves Radiotron Designers Handbook, Fourth Edition 1952 pp 1171-1182
- National Semiconductor Voltage Regulator Handbook
- Electrolytic Data Rifa Capacitor Handbook 1992
- Philips Components Handbooks - various
- Radio Spares Catalogue 1998
- Sprague Capacitor Leaflets 1987
- Bridge Rectifier Data International Rectifier Home Page for GBPC 3504 or <http://www.irf.com>
- KBPC 3504 TIP3055.TIP2955. Motorola Semiconductor Data
- MJE3055, MJE2955 Texas Instruments Semiconductor Data

ar



The RS20 Power Supply *Cautionary Note*

The use of rewind transformers from recycled household equipment occurs quite often these days. There are aspects of transformers however which need particular attention from those who have never fried one or have forgotten what did fry it. Anyone who has operated a radiator on a coiled up extension cord and fused the cord into a solid mass on the reel knows that every thing that conducts electricity has resistance and so heat is generated in use. There are therefore restrictions on the use of specific types of wire. There are limitations depending on the wire gauge, the insulation and the environment in which it is used.

The following are the reviewer's comments re the wire suggested for rewinding the transformer in this article.

"Many amateur constructors may be prone to take liberties when interpreting a design to fit what they have available.

The major problem in this case is the rating of the wire used in rewinding the transformer. In the wire tables in ARRL and RSGB publications the rating of enameled copper wire with the same cross section is given as 7.4 amp. This is less than 40% of the DC output current even without further derating due to the insulation type and maximum operating temperature allowable and the higher rating required due to supplying the load

via a rectifier and a capacitor input filter.

In order to get a sufficient wire size multiple parallel wires could be used. This may exceed the transformer window area. A bundle of parallel enameled wire, with a suitable combined rating as per the tables given in the amateur handbooks, may be a way out.

The peak current rating of the rectifier could be addressed by using one with a higher peak rating or by limiting peak current by some means such as a limiting resistor."

Note re-Power Transistors

"Note that the 3055 transistors come in several different packages and they are not interchangeable in high power circuits. The TIP3055s used in the prototype will work, any substitution should be selected with care. Many amateurs use the most available or cheapest available types and this may present a problem if some generic types are used."

ar

VHF reflectors in plane view

Barry Miller VK3BJM

**Barry
VK3BJM
explores
the ups
and downs
of chasing
planes and
fulfills two
passions**



Barry VK3BJM, morning 21/4/02, Waukaringa PF97RR

I have a number of passions in life, and high on the list are camping and amateur radio – particularly the VHF, UHF and SHF bands. It's true that I often combine the two. Whilst out on previous excursions, I've become interested in how much Aircraft Enhanced Propagation (AEP) can offer the portable VHF/UHF operator. This may be due to a "law" which states quite clearly that during a planned portable operation, Tropospheric Enhancement shall vanish completely.

So, 'Necessity being the Mother of Invention', I started asking questions of those who knew about AEP, and collecting maps and flight information. My goal was to assemble a map of southeast Australia, onto which I could transfer promising flight paths. From this, I could plan trips to out-of-the-way places, from which to work back into Melbourne, or anywhere else that had established VHF/UHF stations.

Contacts using AEP occur regularly over 700 km paths. It has been suggested that a particularly favourable (read large and high!) aircraft may provide propagation out to 900 km – absolute

tops. I am interested in this area between 700 and 900 km. I purchased some aeronautical charts (Scale 1:1,000,000) and, using tape, assembled them into a single map. The northwest corner of the map is at Lat. 28 S, Long. 138 E; and covers all of mainland Australia south to Adelaide, and east to the Gold Coast.

Go Northwest, Young Man!

I like travelling into South Australia – the Flinders Ranges is favourite area of mine – and the first flight paths I marked out were the international paths from

Melbourne to Asia. One in particular caught my eye. It is an outbound route from Melbourne, called H164. If you were to draw a straight line from Melbourne Airport to Leigh Creek South, SA, then you would just about have this route plotted. Leigh Creek is about 900 km from Melbourne.

I have a friend, Dave, who lives not far from this route, in Maldon, Victoria. He suggested that, from visual observation, it was a busy route. I needed little more encouragement! Dave also enjoys going bush, and required little encouragement, either.

We agreed to travel up to a spot just

north of Ouyen for the first night. The next day, in order to try something a bit different, we would continue on through Mildura before heading west across towards Lake Victoria, then north through the Danggali Conservation Park to Yunta. We would then whiz up the Barrier Highway towards Manna Hill – which happens to be under the HI64 route. Day 3 would see us go back towards Yunta, then northwest to the old Waukaringa Goldfield. Day 4 would be a long drive back to Maldon, going via Broken Hill.

Our portable station:

As we were going to attempt contacts over a sizable distance, I chose to take a sizable antenna array. On 2 m, this consisted of a pair of 10-element, DL6WU-design yagi. These would be “stacked”, with a three-metre spacing, hopefully to give us in the order of 14 dBd gain. There was also a 15-element, DL6WU-design yagi for 70cm, to go on the six-metre mast. These would all be connected to an Icom IC-706 MkII G, with power amplifiers providing 160 watts on 2 m, and 100 W on 70 cm. I planned to use a “RAJE Electronics” PIC-based CW keyer, to save my larynx.

There was also an Icom IC-729, to provide HF liaison on 40 or 80 m, connected to a wire vertical supported by a “Squid-pole” – a 7-metre, telescoping, fibreglass tube.

Day 1:

Mathematically, the number of possible delays in leaving on schedule is the square of the number of trip participants. We left Maldon at 0630Z Thursday afternoon (18/5/2002), a few hours behind schedule. Arriving at Wedderburn gave us an opportunity to meet Des VK3CY, for the first time, and for Des to see the horizontally polarised mobile antenna that I use for 2 m – known as a “Big Wheel” or “Cloverleaf”. This was an opportunity too good to miss for all concerned. We moved on a bit after 0700Z.

Having had an example of haute cuisine, Sea Lake style – a warning shout of “Don’t mind the noise”, as the box of frozen meat patties was dropped on the concrete floor to break them up – an example of the banter that should earn the chef his own TV cooking show – we motored on until we arrived at

Hattah at 1045Z. It was too dark to find the track out to the Hattah trig point, which seemed to be the only spot acknowledged as a hill on our map. We decided to set-up camp, just outside the boundary of the National Park. I found that I had a problem with the mast, which required attention in daylight. That meant we could only erect one 2 m yagi. We worked VK3CY on the “Big Wheel”, and Des relayed the mast situation to others whilst we put the yagi up. We then worked VK3XPD, VK3KEG, VK3FMD, VK3II, VK3BDL, VK5DK, VK3ZQB, and VK3XDQ.

The location proved very interesting for observing aircraft. Dave spotted the first whilst we set up the yagi. A contrail lit by moonlight against a clear sky is a surprisingly beautiful thing. We saw three planes from Sydney bound for

Waukaringa is located 349 km to the NNW of Yunta (PF97rr), and is a goldfield ghost town. We spent about three hours exploring the area, and half an hour cutting rusty wire from around the transmission shaft. I found a large quantity of angular iron pyrites during this exercise – mostly imbedded in my back and shoulders.

Adelaide, one outbound from Melbourne on the path to Leigh Creek, and two Melbourne-bound from Adelaide. We experimented with the last two we saw, using the Adelaide and Mt Gambier beacons. The beacons were both only 4x1 via troppo.

The first experiment involved a Sydney>Adelaide flight. The flight path was almost, but not quite parallel with our beam heading to Adelaide. We peaked the beam on VK5VF (320 km away), and noted the signal as the plane strayed into the pattern of the yagi. These figures are only approximate, but at about 20 degrees from the beam heading, fast flutter appeared. The flutter reduced to a slow beat as the plane neared the horizon, and then stopped leaving a signal nearer to 5x1.

The second was with an Adelaide>Melbourne flight. This time

the flight path was perpendicular to our beam heading to VK5RSE (347 km to the south). Again fast flutter appeared as the plane cut the beam heading – at the peak, the RS got to 5x6. The pass was obviously shorter, due to the angle between flight path and beam heading.

Being able to see the plane, thanks to the navigation lights, as it caused these effects seemed pretty nifty.

Day 2:

We were up not long after the sun rose, and commenced proceedings with a freshly brewed plunger coffee. Little luxuries are so important! I put out a call on 2 m, and worked VK3GOM, VK3AEF, VK3CY, VK3II, VK3AXH, VK3FIQ, and VK3KQB. All RS reports were up on the previous night. I called Gordon, VK2ZAB, on the mobile phone, and ran a CW keyer from 2305Z to 2340Z with the yagi pointed to Sydney. I believe nothing was heard. We were packed up and on the road a bit after 0001Z.

We had a late breakfast and refuelled the vehicle at Mildura. Then we left the comfort of the GSM network (HA!) and headed west to Lake Victoria, then north through the Danggali Conservation Park. The last mobile contacts we had on 2 m were with VK3AEF and VK3CY, from near the Darling River Ana Branch at QF05vw. The unsealed road is fair, and the drive through this region was enjoyable, but we will probably use the bitumen more next time. We

arrived at Yunta at 0630Z, and headed for Manna Hill. As luck would have it, we were unable to locate a suitable spot in the area I really wanted. The sun was starting to set, so we decided on a ridge adjacent to a Telstra installation 15 km back towards Yunta, called Mt Edwards, PF97vm.

Of course, the Telstra installation had a paging (or similar) device on 148.810 MHz. It was blarping every 30 seconds and causing a degree of de-sense to the 2 m receiver, despite being half a kilometre from our position. Coinciding with our arrival, a Boeing 747 passed overhead, heading NW. It was the last plane we saw that night.

We made the modification to the mast, and erected the 2 m yagi array, and the single 70 cm yagi – in the dark! We checked and heard beacons from Adelaide, Mt Gambier, and Mildura –

but none were terribly strong. I cooked up the pasta and the Bolognese sauce, and we ate with gusto. Unfortunately, I forgot to open the bottle of Cabernet Merlot that I'd carefully packed to go with the meal.

There were a few stations on the liaison frequency on 80 m, and we discussed the pros and cons of 2 m vs 70 cm propagation. It was suggested that we run the keyer on 70 cm towards Melbourne for a number of hours, and we did. Sadly, Chas VK3BRZ heard nothing at Lara, though Charlie VK3FMD, in Malvern East, reported having heard one burst including the "K" at the end of a transmission. Eventually we gave up. Steve VK5RU/VK5ZBK then called us on 80 m, from St Agnes (about 15 km NE of Adelaide). A contact on 2 m followed, and while signals were not huge, it was a comfortable QSO.

Day 3:

On Saturday morning we ran the keyer again on 2 m until 2300Z, but without success. We packed up, and headed to Yunta. There we had a late breakfast, and a shower at the Yunta Roadhouse. Just before midday, we headed out the road to Waukaringa.

Waukaringa is located 349 km to the NNW of Yunta (PF97rr), and is a goldfield ghost town. We spent about three hours exploring the area, and half an hour cutting rusty wire from around the transmission shaft. I found a large

quantity of angular iron pyrites during this exercise – mostly imbedded in my back and shoulders.

There is a ridge overlooking the field, and it was on this ridge that we decided to set-up camp. At about 0530Z, we were told to move from 7070 kHz, as the frequency would be in use for 24 hours as part of a WICEN exercise. We shifted to 7080 – and wondered how many stations would not be able to find us.

During the set-up, the squid pole suffered a mechanical failure on being raised - the wall collapsed on the lowest section. We overcame this by running a 1.8 m length of galvanised pipe (that I just happened to have lying about the car) up the centre of the squid pole. We decided to only put up a single 2 m yagi, and the 70 cm yagi - wimps, yes. While it was still light, I cooked the pork curry, and we ate as the sun set.

We ran the keyer on 2 m towards Melbourne. At 1107Z, Jim VK3AEF at Nhill reported the keyer was audible. I went to voice, and a contact was completed - 5x1 each way over the 500 km path. Much whooping ensued.

Charlie VK3FMD arrived on 80 m a little later, with a little info on QANTAS flights leaving Melbourne. We could see planes on the flight-path regularly this time - we counted six for the night. Charlie advised there was a flight to Kuala Lumpur leaving at 1245Z (2245EST). We were guessing that it would reach the mid-point about 45 minutes later. Sadly, Charlie heard

nothing during a 15-minute window either side of 1330Z, though 5 meteor pings were noted. During this time, I noted a station calling me. At 1347Z, I swung the yagi towards Adelaide, and again worked Steve VK5ZBK. Signals were much stronger this night (5x6), with less QSB.

Incidentally, the next plane we saw went past at 1451Z - if it was "our" plane (the Kuala Lumpur flight), then perhaps the midpoint is 1 hour into the flight... We wondered – did we give up too soon?

Day 4:

Again, nothing was heard on Sunday morning. We were packed up and mobile at 0020Z. We then drove for a bit over 11 hours, reaching Maldon at 1245Z on Sunday night. We broke the trip by a few stops, including one at the Thackaringa Microwave Repeater station where I was able to access the GSM network (Broken Hill cell) for the first time since leaving Mildura. I confess I find it astounding that there is no GSM (or CDMA) network along the Barrier Highway between Hallett and Broken Hill, considering the number of microwave repeater sites and vehicle traffic along the highway.

The wash-up:

Both Dave and I had a great time. Working Jim from Waukaringa, and Steve from both locations, meant the trip was worthwhile. We didn't succeed in working into Melbourne, but I haven't given up hope. I need to do more research on the scheduling of flights, and time taken to reach midpoints. And there may still be improvements I can make to the portable station, to increase our chances of success. Erecting stacked 2 m yagi arrays is a job best handled by 2 people. Fortunately, I don't think I will have any trouble getting Dave to go on another trip like this. But whether the distance between the bottom yagi and the ground is sufficient to allow the array to work as well as it should, and therefore make the whole assembly worthwhile, is open to debate.

The only downer to the trip was the loss of my 14-year old Akubra hat, somewhere around Waukaringa, we think. So if anyone should be near Waukaringa and happen upon it, or spot a wedge-tailed eagle with the brim pulled low over the beak, please let me know.

Silent Key

John Thornthwaite VK2ATO

It is my sad duty to record the passing of John Thornthwaite VK2ATO. John passed away, suddenly, at Milton Hospital on 14th October 2002.

First licenced in early 1950s, John was, at that time, employed by AWA in its Maritime Division at Leichhart. He and his brother VK2AZO (also a Silent Key) were very active on VHF in the 50s and 60s in the Sydney area. John was also a very keen bushwalker and often combined this activity with VHF portable/mobile operation.

When he retired in 1978, John moved to Lake Conjola where he became an active member and office-bearer of the

Mid South Coast Club. He was one of the famous "two Johns" team who carried out duties of repeater officers for this club for nearly 20 years. Under his care, our repeaters at VK2RMU established an exceptional record of reliability. John was also a long-term member of the NSW Division of the WIA.

John was a quiet, gentle man who will be missed by all of the members of the Mid South Coast Club and by his friends outside the amateur ranks.

Vale John.

Stan VK2EL, Hon Sec.,
Mid South Coast Amateur Radio Club Inc.

ar

ar

Journey Round my Uncle: VK4HH Norman Hurll

N J Hurll
166 Keppel Lodge
Rosemary Bay Village
Bayview Street
Rosemary Bay 4216

During a recent visit to my uncle, Norman Hurll, the issue of your oldest active operator arose. Norman's story was of great interest to me and is repeated here for your information.

His first registration was in the form of a temporary permit issued by the Admiral in charge of the Navy at Garden Island, Sydney in 1919. Shortly afterwards, the Navy handed administration of all radios to the Post Master General's department who issued Norman's first licence 2BC. Between the wars Norman moved to Queensland to farm bananas at Burleigh. He gave up his NSW licence and obtained a Queensland registration. Returning to Sydney after four years he reacquired his NSW licence. This together with all amateur licences was cancelled with the outbreak of WWII and equipment impounded.

He joined up and became an Army Signals officer serving in Sydney and Darwin. With the end of WWII Norman's equipment was returned but it was some years before he became active again.

He returned to active ranks operating from his home in Strathfield and later Killara. Retiring to Rosemary Bay in Queensland in the 1980s, he transferred his call to VK4HH. Having just turned 97 he is not as active as previously but extends his best wishes to all amateur radio operators.

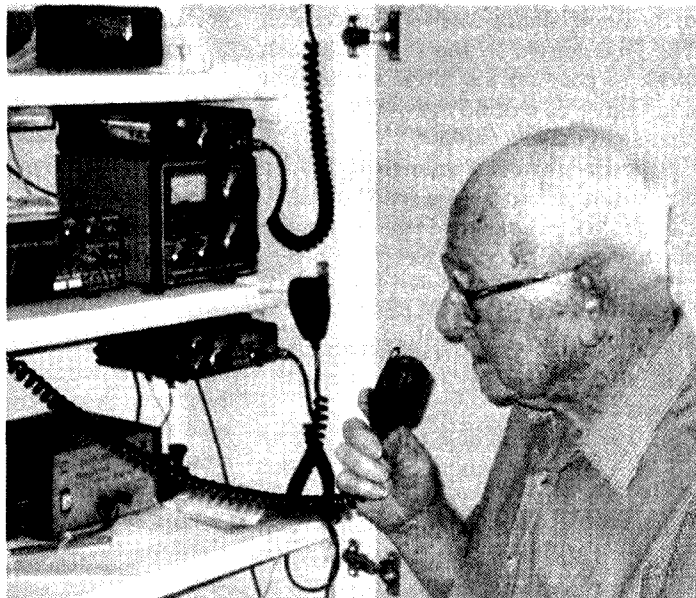

ar

Cable and Connectors

Belden

- RG58C/U Belden 8259 @ \$0.90 per metre
- RG213/U Belden 8267 @ \$4.45 per metre
- RG8/U Belden 9913 Low Loss @ \$5.15 per metre
- RG8/U Belden 9913F7 High Flex Low Loss @ \$5.55 per metre
- RG8/U - RF400 Belden 7810 Low Loss Sweep Tested to 6000MHz @ \$6.30 per metre

LINK

- RG58: B80-006 UHF connector (M) @ \$7.65 each
- RG8/213: B80-001 UHF connector (M) @ \$8.80 each
- RG213: B30-001 N connector (M) @ \$9.10 each
- RG8: B30-041 N connector(M) @ \$14.00 each

connektron Pty Ltd

ABN 19 413 484 007

email sales@connektron.com.au or Phone (03) 9761-5220
connektron Pty Ltd, 45 - 49 Merrindale Drive, Croydon South, Victoria 3036

www.connektron.com.au

* All prices include GST

* Minimum order value \$50 payable by Visa, Mastercard, Bankcard or Money Order

* Packing and Delivery \$15 within Australia (Outside Australia P.O.A.)

Apart from the ALARAMEET

The Dxpediton to Lord Howe Island and to the Cook Islands was very successful. The girls joined in the 222 Nets each week to pass on the latest excitement and to give YL around the world another chance to make a contact.

If you were lucky enough to talk to anyone do make sure you send your QSL cards to Gwen so you can get one of the special cards in return. Keep her busy!

The Contest Logs

I hope you sent these logs in because you will be too late by the time this magazine comes out.

You will still be able to apply for an ALARA Award, though. So check your log to see if it gave you the extra state call signs you needed. Ten contacts from at least 5 VK states is all it takes to be eligible for a very attractive award to hang on the wall.

An item of general interest

We all know about the tiny radio transmitters used to track animals in the wild because we see the amazing results of such tracking on our TVs quite often but a couple of new applications of the same techniques have been

implemented recently by an Australian company.

Something like 8000 upmarket cars, such as Porsches are now fitted with transponders made by Quicktrak. A number of specialist car thieves have been caught in the act by these devices.

That is not an unexpected use for a transponder but for them to be used in vending machines is surprising. No, the vending machines are not being stolen; instead the transponders can send to the drinks makers information warnings when the vending machine needs refilling. Apparently the cost of the transponder is insignificant compared with the cost of unnecessary journeys to fill machines that do not need filling.

This is an example of some lateral thinking.

Travellers

On their way to Murray Bridge Poppy VK6YF and Bev VK6DE visited Kangaroo Island and had a cruise on a paddle steamer (the tour of Kangaroo Island had been rather hectic so they were pleased to have a peaceful time to recuperate). They met up with Agnes VK2AGWI and OM Henk on the boat and all had a great time, enjoying the passing scenery and the company. One

of the highlights was the entertainment night at Nildottie where the local history was described in song and with a light show and 'real' sheep shearing was demonstrated. All of this under the stars made it a memorable night.

For Raija SMØHNV her visit to the Maritime Museum at Port Adelaide (she had been part of the Dxpediton on Lord Howe Island and had visited friends in Brisbane before coming to Adelaide and Murray Bridge) was a mixed one. The exhibition was based on the ship "Vasar". This ship had sunk in Stockholm harbour on its maiden voyage where it lay for over 500 years before it was floated and preserved. It is now touring the world as an exhibition instead of as the warship it was planned to be. Of course as Raija comes from Stockholm it was a case of "coals to Newcastle", however I am told that the "Vasar" was only part of the whole Maritime Museum display so there was plenty that was new to see as well.

Pat VK3OZ and OM Peter spent a week at Nelson on the Glenelg River on their way to Murray Bridge, contacting Mary VK5AMD on 2-metres and participating in the 222 Net on 20 metres, while Val VK4VR and OM Brian visited Marilyn VK3DMS and Geoff before following them to Murray Bridge.

The ALARAMEET at Murray Bridge

Almost as many people were at the 'informal' Friday evening meal as were at the actual MEET because it was not easy to be at the Community Centre by 9.00am if you had to come from Adelaide - though Sue and OM Steve VK5AIM did just that each day. They were very keen!

It was marvellous to see again all our 'old' friends and to meet all the new ones. There were lots of hugs all round. Well if we all need eight hugs a day for good health, as we are told, we have much good health stored up from the ALARAMEET. Everyone was especially

delighted to see Bev VK4NBC and Judy VK3AGC arrive at the dinner on Friday night. Judy had been awaiting the birth of a grandchild (due on 27th Sept) to decide whether or not she would be able to come to the MEET and Bev was staying with her while she recovered from a very bad bruising, so there was considerable uncertainty about their attendance.

There were 27 VK YLs, 10 ZL YLs and 2 DX YLs. With OMs there were 60 attendees with several who deserve special mention. Murray, OM of Mary VK5AMD, Les, OM of Lorraine VK5LM

and Libby XYL of Steve ZL2UCX attended the whole MEET but are not amateurs themselves - and survived. Rob VK5RG attended without his XYL who had a family christening in VK4. Trevor VK5ATQ, President of the VK5 Division, along with Hans VK5XY and XYL Leslie came to the dinner to represent the rest of the VK5 amateurs.

Norma VK2YL and Frank VK2AKG brought their three beautiful daughters, Christine, Michelle and Lorraine, along - very brave of Mum and Dad and of the girls. They said they enjoyed all the activities. To cap off the visitors, Bev's

two "kids" were introduced to the group. They also feature in the photos.

Registration was computerised and worked well (with computers you can never be sure) so that we were ready for the photograph session on time. That also ran like clockwork - perhaps we are used to having our photos taken at these MEETS now - so that we had plenty of time to have the photos developed and copied so that everyone took home a record of the group. We were all rather flash-burned in the eyes at the end, but it was fun.

After a light lunch that could be eaten out on the balcony of the Community Centre overlooking the river if we wished, we embarked on the Captain Proud (a real paddle boat) for a pleasant cruise up to where we could see the house that belongs to Meg VK5YG and OM David, and down as far as Long Island with lots of people in holiday shacks and houseboats to wave to while enjoying scones and cream. The YLs and a few privileged OMs actually saw one of the paddles turning through a window in the powder room!

Everyone agreed that the meal at the Racecourse was very good indeed where we were pleased to welcome Hans VK5YX and his XYL Leslie, and Rob VK5RG to join us. Both of these OMs are known to many of the Travellers Net users and hence to many of the VK attendees. Unfortunately just before the end of the evening Bev VK4NBC began to feel unwell. By next morning Judy VK3AGC was also ill so after all the effort to get to the ALARAMEET they had to miss the rest of the fun. The verdict was "Pokey Poison". Bev and Judy were the only people to play the pokies at the Community Centre that morning!! Of course, it was probably something they

picked up on their rushed trip from Taradale, as no one else was ill, but the verdict stands!

We gathered at the Centre early next morning and boarded a bus in time to be at Monarto Open Range Zoo when the gates opened at 10.00. This was a first for most of us and a very interesting tour. Because we were early we had numbers of animals that came close to the bus.



settlers in VK built their own houses. The OMs were sorry that the best engine display was closed, but they could at least look through the windows of that building

On the Saturday a special presentation was made to Pat VK3OZ. She has won the Florence McKenzie Trophy in the ALARA Contest for the last two years, and we are told, probably for this year as well. It was great to be able to actually present the trophy instead of just a photograph of it. Congratulations Pat.

An ALARA Special Award was given to Bev in appreciation of all she has done for ALARA over the years and particularly for the way she was able to plan and run the Brisbane MEET under very difficult conditions. Thanks Bev.

On Sunday Norma, now VK2YL, was asked to cut a cake made by Jean VK5TSX, the organiser of this very successful

MEET. The cake was followed by the drawing of the Special Effort prizes (there were many more items than had been planned by the VK5s because a number of YLs brought along

lovely gifts to add to the table). Many people went home with craft and gift items they will treasure for years. Then we had the 'Mars Bar Awards' which you have to attend an ALARAMEET to know about.

A vote was taken to decide the venue for the next ALARAMEET as both Alice Springs and Mildura had been suggested. We will be going to Mildura in three years time. Hope to see you there!

ar

<http://www.wia.org.au>

**check out the WIA
webpage today!**

Australian Made
ANTENNAS

"Setting a New Standard"
COM-AN-TENA

(Formerly a j and j coman)

6 Mulr Court
CHELSEA HEIGHTS 3196

All new 5/8 vertical 16 radials	\$145
Dual drive 26-30 5 ele yagi beam	\$305
4 ele 10-11m yagi beam	\$262
5-6-&7 ele high gain antennas 11m	\$call
3 ele delta loop 10-11m	\$320
11m 5/8 vertical/4-1/4 wave radials	\$170
Duoband 10-15 3 ele each band	\$356
Log-periodic 7 ele 13-30 MHz 7.7m boom	\$890
Tri-band 5 ele HB35C s/steel fix	\$730
3 ele 20m computer opt	\$390
3 ele 15m computer opt	\$285
M B Vert Auto switch 10-80m	\$310
40m linear loaded 2 ele beam	\$580
6m 5 ele compt opt beam	\$259
6m 7 ele compt opt beam	\$355
10 ele high performance 2m	\$135
17 ele high performance 70cm	\$119
2m vert 2-5/8 co-linear 4 rad	\$ 96

Guyed Masts

21 metres 13 metres

Winch-up & tilt-over. Aluminium and stainless steel three-sided construction. Auto-brake winches

Free Standing Masts

9.5 metres

New Baluns

1-1 to 16-1 to 3kW



Our Masts meet Australian Standards. We supply all the computations and data you will need for a permit.

03 9773 3271

Mob: 0419 542 437

Andy VK3IV

Club Notes

Adelaide Hills Amateur Radio Society

The coming of the digital box

The talk given by John VK5EV was extremely interesting. He gave us a demonstration on digital television compared to the analogue version with which we are all so familiar. Especially in areas where the signal strength is low or where normal TV suffers from ghosting, digital is vastly superior. In areas where there are no signal problems the advantages are the increased number of channels available and the general high quality picture.

Whether Australians will buy sufficient digital TVs or converter boxes before the changeover date is a moot point. The situation is much the same as the US and the UK experienced. People are reluctant to lay out a great deal of money without being sure there is sufficient difference to warrant the expense.

Aside from the visual demonstration John had many interesting tales to tell about the technical problems involved in the changeover of the antennas and the transmitters.

Perhaps the most surprising aspect was that, for this enterprise, one company, John's employer, was responsible for the change from analogue to digital television for all three commercial stations in VK5. They were also involved in changing the antennas for the ABC and SBS but the transmitter change was handled by the ABC's own technical staff.

Totally different antennas are required for digital television even though, in Australia, we are using VHF frequencies. The rest of the world has gone to UHF for digital TV. The old antennas had to be removed, then the new ones installed, all without loss of signal to the consumers.

A Russian helicopter was used, with a large, very efficient, Russian speaking crew. Unfortunately they arrived without official flight clearance at just the time when Ansett aircraft were due for extensive overhauls. So the helicopter sat on the tarmac for ten days at \$1,000 a day waiting for inspection and clearance!

The skill demonstrated by the

helicopter crew made the cost unimportant. There was only one hitch in the entire operation caused by an earth wire that was not disconnected. The pilot hovered the aircraft exactly over the spot while the earthwire was cut so the section was free to go.

When each section of the antennas was almost unbolted, ready for lift-off the helicopter would approach and four heads would appear in the open doorway. These four men guided the pilot onto the exact spot, the last bolts were undone the piece was lifted away. To install the new antennas the same procedure was used.

Once the technicians were ready to install the transmitters another problem arose. The transmitters (two different manufacturers so the best could be chosen after testing) had been ordered and notification had arrived of their departure but they had not arrived in Adelaide. Several days later a storeman in another state rang though to ask if we were looking for a number of boxes this big? The boxes were sent on and duly tested and installed.

The transmitters were not connected to the antennas immediately. John and his team wanted to be sure everything was correctly matched before power was applied. Just as well. On one station there were some connectors improperly tightened. Fixing that improved the situation but still did not give a good match (using a simple matching device - as proper amateurs would). Someone from interstate was called in, only to find that some section on the main connecting board inside the building had been installed upside down. Now there was a good match. Now the transmitters were connected to the aerials and a signal went out.

John had obviously prepared his material very well and had a number of slides to illustrate particular points. We now know a little more what we can expect if and when we are all forced to make the change from analogue TV to digital TV as we were forced to change our phones of choice.

Gippsland Gate Radio & Electronics Club Notes

I trust that everyone who attended September's General Meeting found the talk on Home Automation interesting. Shows where the future is in home electronics and computers.

Everyone should be pleased to know that we have finalized bookings for the new Hamfest venue. We now have a hall around 4 times bigger than our present hall and it has lots of undercover space. Don't be confused though as our regular meetings are still at the Guide Hall. This is only for our annual Hamfest / Sale. So we are as of now, taking bookings for sellers for the 2003 event in July. With the extra space, I am sure we can entice more sellers and maybe a few commercial sellers as well. With this amount of floor space, we need as many bookings as we can get. If you are interested in getting in early, you can contact the Club on email at:

hamfest@hubbatech.com.au or ring me on 0418339779.

Rumor has it that our IRLP project has taken a step forward with the allocation of frequencies for the repeater. Now all we need is a bit more hardware. More information as the project progresses. By now of course JOTA would be over for another year and I trust all amateurs had the usual amount of fun. It is a good time to try out the field set up skills as a lot of us pick up the entire shack and transport it to a remote site to do the operating. I hope the enthusiasm didn't wane, as the following weekend should have seen the first of our Club Fox Hunts being held. If all went well, I was the fox. Results will be published next issue Club Notes. December has hit us so quickly that it hardly seems like a year at all since we had our last Club breakup.

But here it is again and this year Phil (VK3YB) and Kathy have graciously allowed us to invade their home in Cranbourne North on 14th. More details will be in the Club mag or get them at the meeting. There will be NO General Meeting in December as per usual and the first meeting for January will be the General Meeting on January 17th. Looking ahead at Australia Day Weekend, the venue chosen by popular demand is at Neerim / Jindivik. Caravans and tents are welcome at the ground but bookings are required. For those wondering, the Australia Day weekend is the 25th, 26th, 27th in 2003. Well I think that takes us far enough into the future for this edition so to all who read this, have a Merry Christmas, a great New Year and I hope you all get new radios from Santa. Stay safe in 2003.

Central Coast Amateur Radio Club

The Central Coast Amateur Radio Club Hosts the Southern Hemisphere's Largest Amateur Radio and Communications Show

On Sunday 23rd February 2003 the Central Coast is host to the largest gathering of Radio Amateurs, Radio Communications Enthusiasts, Computer and Electronic Hobbyists in the Southern Hemisphere. More than 2000 people from 40 clubs and organisation from all over Australia and the Pacific will converge on Wyong Racecourse to display and trade the latest radio communications equipment. Exhibits and operating displays will show and demonstrate:

- All facets of Amateur Radio
- CB Radio
- Shortwave Listening and Scanning
- Packet Radio - Computerised Communications
- Television and Multimedia transmission and reception demonstrations
- Interesting technical lectures, seminars and workshops
- Electronic construction
- Exhibits of Vintage and Historical Radio collecting and restoration
- Volunteer Emergency Communications
- Satellite Reception

- Hobby computing
- Internet communications
- Radio Fox Hunting
- Truckloads of pre-loved equipment at give away prices in the flea market and disposals areas.
- See all major Radio and Electronics equipment suppliers together under one roof with many dealers showing the latest offerings and great bargains

Throughout the day there will be several seminar sessions and workshops on topical subjects, with presentations from experts and equipment suppliers, including talks on the latest technology.

Plenty of off street parking is available within Wyong Racecourse grounds. Tea, coffee and biscuits will be available from 8.30 am to 3.00 p.m. at no charge in the Dining Room. Hot and cold food can also be purchased within Wyong Racecourse.

Anyone with an interest in radio communications or electronics can contact the event organisers, The Central Coast Amateur Radio Club, by phoning 02 4340 2500 for more information. There is an extensive and informative web site covering the Field Day at www.ccarc.org.au.

Gates to the Racecourse will be open to the public from 8.30am Entrance fee: Adults \$10.00, Seniors Card, pensioner concession, students \$5.00, Children under 12 free.



ar

Technical Abstracts

Gil Sones VK3AUI
30 Moore Street, Box Hill South Vic 3128

Large loop with balanced feed

The use of a large horizontal loop as a multiband antenna was discussed in QST April 2002 by Kirk A Kleinschmidt NT0Z. The idea was also featured by Pat Hawker G3VA in his Technical Topics column in Rad Com September 2002. Pat G3VA described his setup on a small suburban house lot near London which he had used successfully for many years.

Kirk NT0Z used a loop intermediate in size between 40 and 80 metres of the desirable wavelength circumference. The aim is to get as large a loop in the air as possible in order to get reasonable performance on the lower bands. The loop was fed initially with coax and a tuner. However to get lower losses the feed line was changed to open wire line and a balanced tuner was used. In addition to the lower losses of the open wire line the noise pickup was improved due to reduced pickup on the balanced line. Noise can be picked up on the feedline in the vicinity of household

noise sources and balanced line is less susceptible to this.

The loop is shown in Fig 1. While this diagram shows a full wavelength loop for 80 or 40 metres this is desirable but not essential. Similarly while a height of 40 feet is shown both greater height and lesser height is useable. The height is whatever you can manage. The best shape is square or maybe a circle if you can work out how to suspend a circular loop. However rectangular and triangular loops will work but remember the aim is to get a large area for the available perimeter wire length so avoid

narrow loops if possible. The dimensions for a one wavelength loop perimeter are for 80 metres 272 feet and for 40 metres 142 feet. The loop should be square so the sides are one quarter of the perimeter. However not everyone can make the loop square. Just try and do the best you can. The length can be different too as the tuner and the open wire feed allow for a considerable range of adjustment.

The secret of having low losses and minimising feed line noise pickup is to use open wire line feed. The balanced nature of the feed line minimises noise pickup. A coaxial line picks up noise on the outside of the line which can be coupled into circuit fairly easily if matching and coupling is not up to scratch such as is often the case when feeding a balanced antenna with coax and a makeshift balun or no balun. A high SWR can also contribute to line losses particularly when matching the antenna at the transmitter end of the feed line. This is illustrated in Table 1.

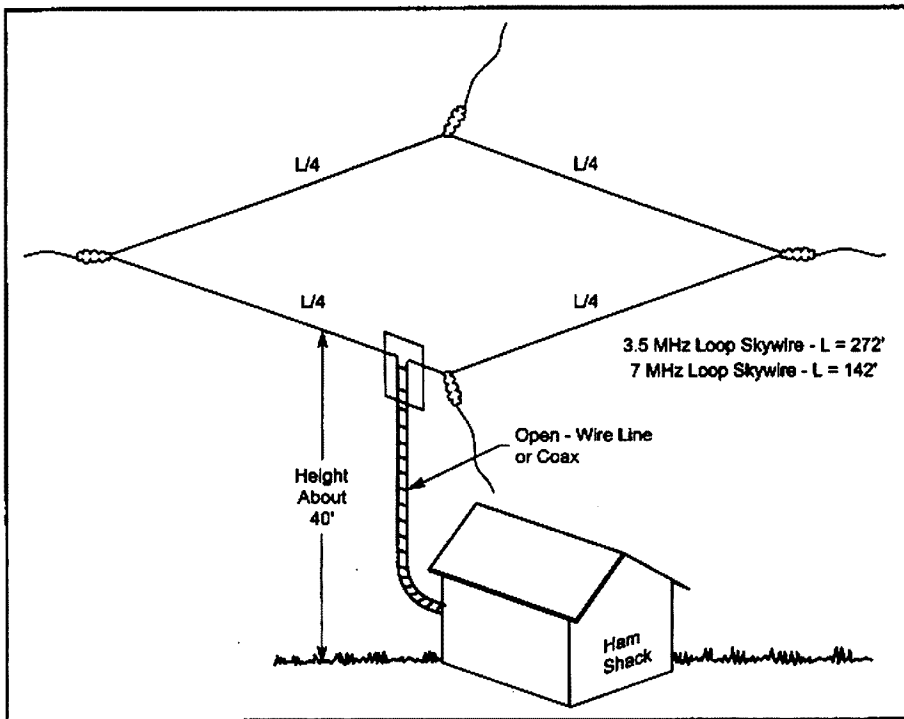

Fig 1. Horizontal Loop. Put up the largest loop you can. Keep loop as square as possible. Perfect symmetry is not important. Use balanced Open Wire Feed for best performance.

Table 1. Comparison of Loss of Belden 8214 Coaxial Cable To 450 Ohm ladder Line. Belden 8214 is a Foam Dielectric RG213/RG8 type cable.

Table calculated by Dean Straw N6BV QST Senior Assistant Technical Editor. Cable Length 50 feet. Antenna 66 foot dipole at 30 feet.

Frequ MHz	Belden 8214	450 balanced line
1.9	26.9	8.82
3.8	13.7	1.37
7.15	0.19	0.07
10.14	2.85	0.07
14.27	5.3	0.15
18.14	6.96	0.31
21.4	0.78	0.12
24.9	3.94	0.13
28.5	5.69	0.18

Kirk NT0Z used 450 Ohm ladder line to feed his loop and built a balanced tuner to use at the shack end of the line. This tuner based on a design by AG6K connects the balanced L Network tuner directly to the balanced ladder line and places the balun on the 50 Ohm matched side near to the transmitter. This reduces stress on the balun and ensures efficient balanced matching of the open wire ladder line. The tuner is shown in Fig 2. This tuner has appeared in a number of ARRL publications. The capacitor can be on the load side or on the transmitter side of the twin ganged roller inductors depending on the load to be matched. The inductors are roller inductors ganged together. The roller inductors are expensive and other tuners may be attractive.

Another solution to the coupler is to use one of the other balanced coupler

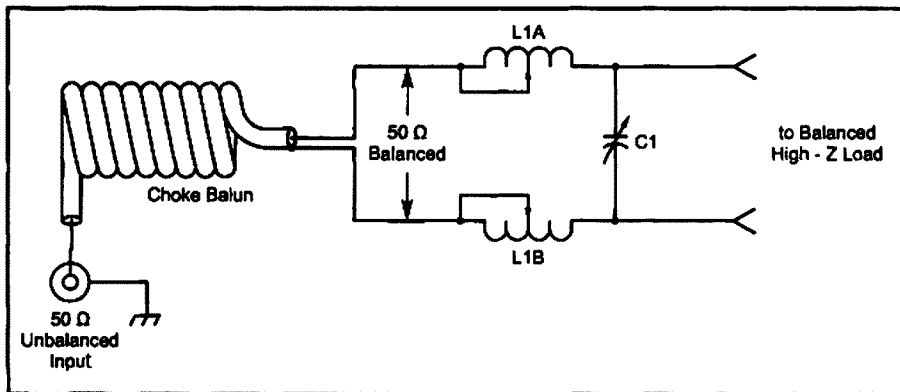

Fig 2. Balanced Tuner based on work of Rich Measures AG6K. The roller inductors are coupled together. The Balun is a roll of coax. The balun only has to cope with the 1: 1 balance to unbalance and not with a high SWR. The capacitor can be either side of the inductors depending on the load to be matched.

designs such as Drew VK3XU's Swinging Link Coupler described in AR July 2000. Also possible would be the use of a remote mounted automatic

antenna coupler such as an SGC 231 with appropriate decoupling to suppress currents on the coax outer.

The Central Coast Field Day

for

RADIO AMATEURS AND ENTHUSIASTS, COMPUTER AND ELECTRONIC HOBBYISTS

Sunday 23rd February, 2003

Wyong Racecourse. Gates open 8.30 am

Truck loads of pre-loved equipment at giveaway prices in the flea market and disposals area.

See all major radio and electronics equipment suppliers together under one roof with many dealers showing the latest offerings and great bargains (see web site for latest list)

Radio fox hunts

Amateur television transmission demonstrations

Packet Radio - Computerised Communications Displays

Vintage and Historical Radio Exhibits

Interesting technical lectures, seminars and workshops (see web site for latest list)

Scanning and Dx Listening displays and information

DON'T MISS THE BIGGEST FIELD DAY AND HAMFEST IN THE SOUTHERN HEMISPHERE

Presented since 1957 by THE CENTRAL COAST AMATEUR RADIO CLUB INC.

For further information write to The CCARC, PO Box 346, Woy Woy, 2256 NSW

Phone 02 43402500, Web www.ccarc.org.au Email vk2afy@hotmail.com

FOXX-11 Mini Transceiver

A simple QRP transceiver appeared in The QRP column of Dave Ingram K4TWJ in CQ June 2002. This is one of the kit mini transceivers from Kanga US. They are up to the FOXX-111 which is the latest in the line. The design started with GM3OXX and the kits have been developed by Bill Kelsey N8ET of Kanga US.

The circuit is shown in Fig 3. The final transistor Q2 is used both as the TX final transistor and as the receive mixer/detector. The xtal and the low pass filter are for the band of operation. The later FOXX-111 has a couple of extra features.

The filter components could be found by looking up a similar design in one of the Amateur Handbooks. The design is not critical as it only needs to suppress the harmonics to an acceptable level.

The kits are designed so that the rig can be fitted into an "ALTOIDS" mint lolly tin. Similar tins are used for similar products locally.

Kanga Products have a web site at: www.bright.net/~kanga/kanga/

PLAN AHEAD

December/January
Ross Hull VHF Contest
 between December 26, 2002
 and January 12, 2003.
 (Details page 43)

Summer VHF/UHF
Field Day
 ★ ★ ★ ★ ★

February
VK3GH Hamfest,
Healesville

Central Coast Field Day,
Wyong (see page 27)

Gosford Field Day

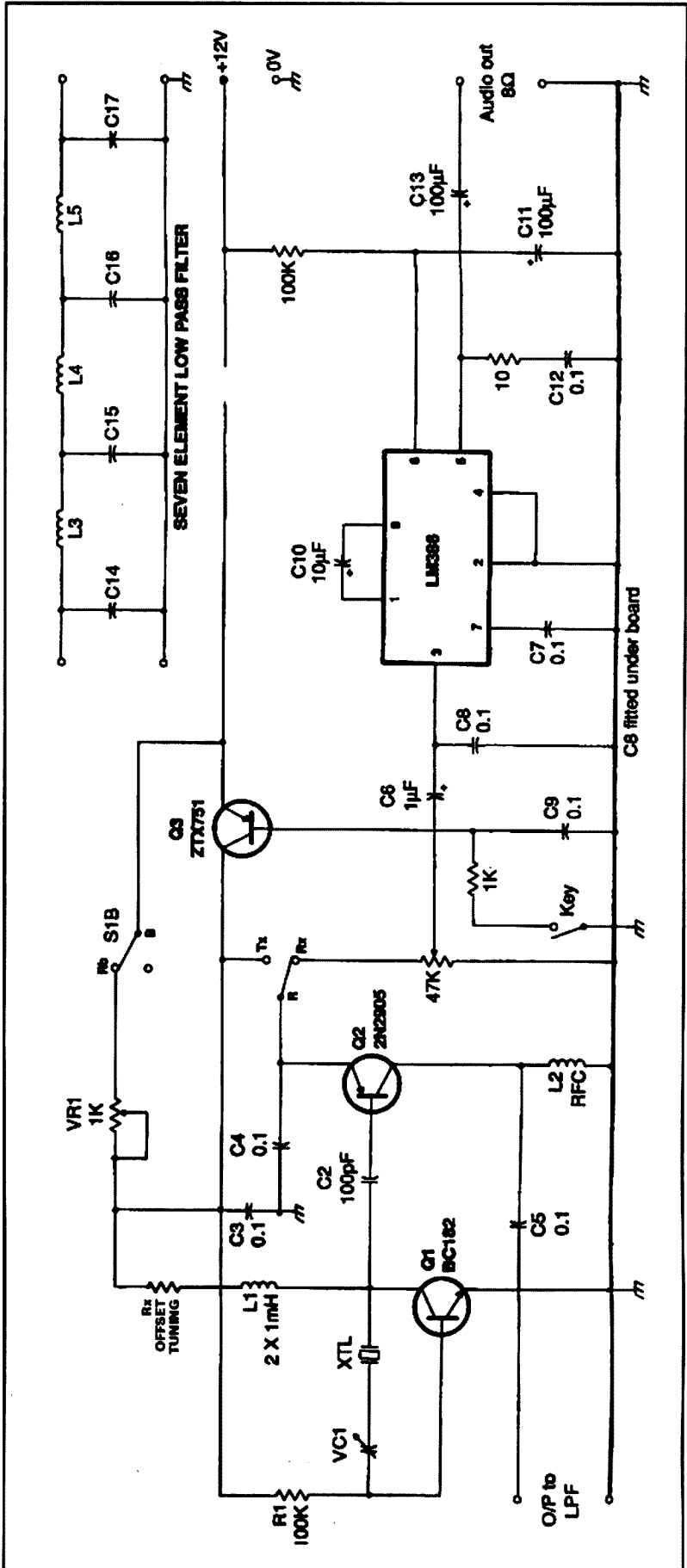

Fig 3. FOXX-11 Transceiver . Filter Components chosen for band of operation.

Boom Correction Factors in Yagi Antennas

Gordon McDonald VK2ZAB

This is for all Yagi home brewers and anyone else who may be interested:

Determining the increase in length of Yagi elements passing through a metal boom was brought out of the realm of guesswork by the procedure developed by Guy VK2KU and published in AR and QEX a couple of years ago. The correction factor determined by Guy's method applies to booms of circular cross section and it was thought that booms of different shape, particularly square section, would require more or less correction than that required for circular sections and that this would need to be determined by experiment.

An anticipated requirement of the near future motivated me to carry out the experiments necessary to determine these corrections. Briefly the experimental set up requires the construction of a simple Yagi [three elements] on an insulated boom with provision to substitute metal booms for the director in such a way as to maintain the spacing between it and the driven element plus the means to change the length of the director in small increments. The Yagi is then fed with a signal from an RF generator through an isolating pad and a directional coupler.

The return port of the coupler is connected to an indicator [Spectrum Analyser] so that return loss can be measured.

To relate the results to Guy's method, the length of a 0.42 wavelength director at the test frequency [450 MHz] was cut and this 280 mm long 6.35 mm diameter element was mounted in the insulated boom. Return loss was measured at 18 dB.

A circular metal boom of 25 mm diameter was then substituted and directors increasing in size in 1 mm increments progressively installed, checking the return loss at each increment. This was found to come to 18dB with a director of 293 mm indicating that this was electrically equivalent to the insulated boom with a 280 mm director. Having thus experimentally determined that the correction factor for boom and element diameter used was $293 - 280 = 13$ mm, the correction factor was calculated using Guy's procedure. This was found to be 12.5mm. This was deemed to be acceptable correlation.

Next the metal 25 mm square boom was installed and return loss measured for changes in director length as before. The 18 dB point was reached for a director length of 295 mm indicating that the correction required in this case was 15mm.

Therefore, the procedure for determining the correction factor for square booms is: Determine the correction for a round boom of the same diameter as the length of the side of the square intended for use using Guy's procedure and add 20%. [15 mm - 12.5 mm = 2.5 mm. $2.5/12.5 = 1/5 = 20\%$]

The correction factor for a channel section boom [like a square with one side missing] was also experimentally determined and found to be the same as that for a round boom of the same diameter as the side of the channel.

Note that in the case of both the square and the channel the element was mounted through the centre of the side. Some variation may occur if the element is mounted off center. [Why anyone would want to do this I don't know but the question has been asked].

ar

Technical Abstracts *continued*

Bypass Capacitors

RF Bypass capacitors were discussed in the In Practice column of Ian White G3SEK In Rad Com July 2002. The choice of the right bypass capacitor requires some thought. The construction of the capacitor affects its properties and lead inductance and leakage or losses need to be considered as well as the capacitance value. A table giving the reactance of capacitors was given and is reproduced as Table 2. This is useful but needs to be viewed with regard to the impedance of the circuit to be bypassed as well as the lead inductance and loss resistance of the bypass capacitor.

A surface mount capacitor will have a very short lead length and a ceramic disc or monolithic type will be able to be used with short leads. Plastic film

Table 2. Capacitor Reactance The values marked with an * may not be achievable due to the self inductance and loss resistance of the capacitor.

Capacitance	Reactance ohms at Frequency					
	10kHz	100 kHz	1MHz	10MHz	100MHz	1GHz
100 pF	160,000	16,000	1,600	160	16	1.6
1 nF (1000 pF)	16,000	1,600	160	16	1.6	*0.16
10 nF (10,000pF, 0.01mF)	1,600	160	16	1.6	*0.16	*0.016
100 nF (100,000pF, 0.1mF)	160	16	1.6	*0.16	*0.016	*0.0016
1.0 mF	16	1.6	*0.16	*0.016	*0.0016	*0.00016
10 mF	1.6	*0.16	*0.016	*0.0016	*0.00016	*0.000016

type capacitors may have somewhat greater self inductance. Similarly a TAG tantalum electrolytic may have less self inductance than an aluminium electrolytic. Electrolytics may also have loss resistance which is significant.

These considerations need to be taken into account when selecting bypass capacitors. The very low values of reactance in Table 2 are marked with an "*" and may be difficult to realize in practice.

ar

VK1 Notes

Forward Bias

Eighty years ago, when SS Titanic got into trouble, its radio officer sent a SOS and position message on 500 kHz. At the time, there were no organised, land-based radio monitoring stations listening on that frequency 24 hours a day. Other ships in the Atlantic Ocean monitored the frequency irregularly, and only one nearby ship answered the SOS from the Titanic, and responded to the emergency. That disastrous event caused the governments of a number of countries to put together a plan to set up an international system to monitor maritime emergency frequencies worldwide and arrange rescue operations whenever and wherever needed. Australia was one of these countries, and began to build up a system of coastal radio stations that provided a 24-hour monitoring service for maritime distress signals. This service is now known as the Australian Maritime Safety Authority (AMSA), with its head office in Canberra.

Fortunately, for members of the ACT Division, an invitation was extended to visit AMSA's operations centre by Michael Collinson (VK1MA), who is a Communications and Systems Officer with AMSA. 48 members, some with their wives, accepted the invitation and fronted up at the entrance to the building at 8.00 pm on Monday, September 22, 2002.

As Radio Amateurs, we all felt at home as soon as we walked into the operations centre. There were computers and monitors everywhere, some monitors had very large screens displaying maps of sea lanes covering areas from the North of Papua-New Guinea, down to the coastal periphery of the Antarctic,

and from the East of New Zealand to far into the Indian Ocean. Being familiar with Automatic Position Reporting System (APRS), we instantly recognised the meaning of all the annotations that the operators put on the monitor screens to indicate an incident or the position of a particular vessel. Just before we had arrived, an incident had occurred on the East Coast of Australia where a fishing boat had complained to AMSA that a bulk carrier was bearing down on it at great speed, which didn't allow for the nets to be hauled in. We never found out how the incident ended because we were moving from one section of the centre to the other. Like any other command centre, the walls were covered with maps, each extending from the floor to the ceiling. They showed large areas of the Southern Hemisphere around our place in the sun. Looking at the maps, we were quietly working out how many skip zones between Canberra and Djakarta, Beijing, Wellington, and Tokyo.

The centre itself is not equipped with receivers, transmitters, or (dish)antennas. These are located in strategic areas around Australia. One transmitter/receiver site is near Brisbane and the other near Perth in Western Australia. Transmitter output power is one kilowatt into highly directional antennas to cover specific areas of the oceans. All the equipment is remotely controlled from the operations centre with their individual status displayed on monitors. 50 operational frequencies are allocated to AMSA in the maritime service bands. Just as for radio amateurs, all the usual HF bands are provided for

to ensure 24-hour coverage of a particular area on the globe. The bands covered are 137, 72, 48, 36, 24, and the 18 metre bands. The exact frequencies are available from the ACA. One aspect of the visit that should be mentioned was the display of emergency beacons. Again, all of us are familiar with beacons because we monitor them constantly to know when the band(s) are open. However, these are distress beacons that are carried by ships, mariners, aircraft, and travelers in the outback. Some of them are so small they fit into your shirt pocket. When activated, they transmit information to earth-orbiting satellites that are moving in polar orbits around the globe. The satellites, acting as our familiar repeaters, retransmit the information to AMSA's Rescue Coordination Centre (RCC) where appropriate action is taken. Early distress beacons operated on 121.5 and/or 243 MHz, but these are now being replaced by ones that transmit only on 406 MHz. They are highly efficient devices using surface mount technology, programmable memory systems, and lithium batteries. When activated, they transmit for two days and have an omnidirectional transmit pattern that is easily received by an orbiting satellite or a hand-held direction finder.

This and That: David Thearle finished Ron Bertrand's on-line course and passed Novice and Regulation exams. Lyle Williams (VK1XLW) passed the Morse sending exam and is well on the way to get higher qualifications.

The next general meeting will on 27 October 2002 at Scout Hall, Longerenong St. Farrer, at 8.00 pm.

Snail mail address for contributions: **The Editor**

email address for contributions:

edarmag@chariot.net.au

**Amateur Radio
34 Hawker Crescent
Elizabeth East SA 5112**

VK2 Notes

by Pat Leeper VK2JPA

If you know of anyone needing help to pass the examinations, please note that the Parramatta office is open Tuesday nights, 7-9 pm, with Terry VK2UX, the Divisional Education Officer, in attendance to offer help with any problem with theory. Terry is only too happy to assist anyone having difficulty with their studies.

The NSW Division now has the call sign of VK2WHQ that is intended for use from WIA premises in contests.

The Conference of Affiliated Clubs

will be held on the morning of Saturday 30th November, with the Divisional Christmas Party following in the afternoon. So mark that date in your diary for a get-together with the council and friends on that day.

There will be a total clean-out of the last of the Deceased Estate items by the end of the year. Most of this will be available at the next Trash & Treasure on 24th November, so come early to have a chance to pick up some bargains.

The Homebrew Group will again be

happening after the T&T, at about 2pm, upstairs in the WIA meeting room at 109 Wigram Street Parramatta. The group attracts around twenty members, with interesting talks very pertinent to lovers of homebrew projects.

The last examinations for the year will be held on 1st of December. Applications are due on Thursday 21st November.

The office will close for the holidays on 20th December.

That's all for this month.

VK3 Notes

By Jim Linton VK3PC

WIA Victoria web site: www.wiavic.org.au

email: wiavic@wiavic.org.au

Readers' issue of AR magazine

In a brief "Help Wanted" announcement on page 53 of the September issue of Amateur Radio magazine, is contained a plea for contributions to make the December issue more reader friendly than usual.

The Editor Colwyn Low VK5UE believes that with more time on our hands over the summer, that edition of the magazine should include extra articles and projects of general interest.

Give it a thought. What are you doing that could be written up for AR magazine?

If you are responding to the request, don't forget to let the Editor know that your contribution is for the December "readers' issue" edition.

(Please send contributions direct to Editor in SA. Editor)

Happy birthday Icom

It is now 20 years since Icom Australia began. A supporter of the WIA, this communications company has expanded over the past two decades far beyond the amateur radio sector.

Seems just like yesterday, although it

was in the mid 1980s, when I was invited to visit the Icom Australia headquarters in Melbourne to meet the Icom's founder, Tokuzo Inoue, JA3FA.

This month Icom Australia is marking its 20th birthday, and I am honoured to have received a personal invitation to join in the celebration that includes a river cruise.

WIA Victoria Council Elections

The three-year term of office for the WIA Victoria Council will conclude at the Annual General Meeting in May 2003.

Nominations are invited for the 2003-2006 Council and they will close at noon on Friday 21 February 2003. Nominations will only be accepted on forms available from the Secretary.

WIA Victoria 2002 Annual General meeting/Notices of Motion

The closing date for receipt of Notices of Motion for the AGM is noon on Friday 21 February 2003.

Members are reminded that notices of motion must comply with Company Law as well as the WIA Victoria Articles, be signed by at least three financial members and reach the Secretary by the closing date.

Christmas/New Year Holiday break

The WIA Victoria office will close at noon on Tuesday 17 December 2002 and re-open on Tuesday 4 February 2003. Membership applications received by post during this period will be processed.

During the holidays, a recorded message on the WIA Victoria office number 9885 9261 will provide emergency telephone contact numbers. Fax facilities at the office will not be available at the office during the holiday period.

VK3BWI Broadcast

The final broadcast for 2002 will go to air at 8.00 pm on Sunday 3 December. Transmissions will recommence on Sunday 2 February 2003.

While the office is closed, any material for the broadcast should be sent by post to WIA Victoria, or preferably be forwarded by email to wiavic@wiavic.org.au. A reminder that during the holiday period no fax service is available.

VK4 Notes

Qnews

Cairns on the Air

News from John VK4JKL, President of the Cairns Amateur Radio Club Inc, along with some corrections from Geoff VK4XUK, about upgrade and repair work recently completed at the VK4RCA Mount Yarrabah repeater site.

(Mount Yarrabah repeater site is located at 16deg58minS 145deg50minE, elevation 632 m ASL)

The UHF Voice Repeater on 439.350 - 433.350MHz has been refurbished and is back on air. The transmit and receive antennas are split with the UHF transmit antenna being a home brew J-pole in a PVC radome mounted low on the tower. Transmitter power is 40 W high 10 W low (DTMF switchable). The UHF receiver is cabled via a VHF/UHF diplexer to a dual band Diamond X-200A that is 5 m above the UHF TX antenna to provide TX/RX isolation.

VHF TX/RX is via the dual band antenna, through the VHF/UHF diplexer and into a set of 3RX and 3TX filters to provide TX/RX isolation. The VK4RCA VHF Voice Repeater is on 146.950/146.350MHz.

The VK4RCA team is asking for hams in the region to test the upgraded installation on VHF and UHF and provide a report on how they consider the new work to be performing. Already

Geoff VK4XUK has had a report from Tablelander Bill VK4WL mobile/parked near Mareeba on UHF repeater. He was getting in well and receiving S7 with repeater on Hi and S5 with repeater on Lo. Remember too that VK4RCA is on IRLP node 648.

Send your reports on packet to: vk4jkl@vk4xuk.fnq.qld.aus.oc or to vk4xuk@vk4xuk.fnq.qld.aus.oc

VHF DX

The Spring and Summer VHF/UHF season is fast approaching with all the interesting propagation that comes at this time of the year. On both 6 and 2 metres, 'Sporadic E' is at its maximum likelihood, and the potential for coastal ducting up and down the Queensland coastline and well into New South Wales combine to make this a very interesting time of the year!

VK4JKL who along with VK4FUQ retransmit QNEWS on 7.070/7.072 MHz from Far North Queensland recently worked Rick P29KFS in Port Moresby on the P29 repeater, another Rebroadcaster of the Q. On 147.000 MHz Rick and Jim P29JB had a good noise free signal to the VK4JKL beam, looking South. Well, the path seemed solid, so after putting in a "break" Rick came back and confirmed it WAS the P29 repeater

Compiled by Alistair Elrick VK4MV

and sure enough, there was the ID soon after. (JKL didn't doubt KFS for a minute.. HI)

EMR Software

Though the date for the introduction of the ACA's electromagnetic radiation framework for radio amateurs is still uncertain, amateurs have been busy devising software to help calculate their station's compliance. Two pieces of software are available, both by Doug Macarthur VK3UM. One is a site radiation calculator while the other is a site radiation graph calculator. Both can be downloaded from the website of the WIA Eastern Zone Amateur Radio Club. <http://www.qsl.net/vk3bez/>

Broadcast Band News

The \$6 million dollar radio Voice International Asia Pacific Broadcast Centre was officially opened in Maroochydore on VK4's Sunshine Coast by the man behind the project, multi millionaire Bob Edmiston of the UK. The center originates programs of a Christian nature for use on Short Wave using the former Radio Australia transmitters at Cox's Peninsular, near Darwin in VK8 and the footprint covers one-third of the globe.

73s from Alistair

Silent Key

Ian Sewell VK3IK

Ian Sewell, who passed away recently at the age of 82 years, was one of the diminishing group of amateurs who were licenced before World War 2. He received his licence in 1938 and was active in the first few years on the old five metre band. When activities resumed in 1946 he joined a group on 40 metres known as the Night Owls. Round table contacts would go on into the early hours of the morning. The group even published a newsletter called the Night Owl Heterodyne. Amazingly, a few copies still exist but it seems that the only member still around is Bill Holland VK3XC.

Soon after the war, Ian was co-opted into the Amateur radio Publications Committee through the efforts of Herb Stevens VK3JO. Ian was appointed circulation manager a position he held until the early 1950s. In those days, copies of AR had to be individually wrapped before posting to members. A job that Ian ably co-ordinated. These sessions often went very late into the night. Present day committee members think they have a hard job but at least we don't have to do that. A rare tribute was paid to Ian when a photograph of his and Lyn's wedding was published in the April 1951 edition of AR.

During the war, Ian worked at Commonwealth Aircraft where he formed a life long friendship with Bill VK3XC. In the early 1950s he worked with the late Bob Cunningham VK3ML. At that time Bob was the importer of Eddystone receivers and slightly later, the famous Geloso VFOs. Ian stayed with the Cunningham Organisation until he retired.

Our sympathy goes to Lyn and her family.

Bill Holland VK3XC, Herb Stevens VK3JO
and Ron Fisher VK3OM

ar

VK6 Notes

This is my second submission for AR Magazine. It looks like I am here for the long haul! In this world of instant communication it is taking me some time to adjust to writing an article that will not be read for four weeks, reminds me of the movie "Back to the Future." Hopefully I will get my head around this limitation of the print media and not submit information that could be regarded as history by the time you get to read it. Here goes, I will try to do my best.

Hamfest and SEANet

As you read this article both these events will be well and truly over. At the present time, Trevor, VK6HTW, states that numbers for SEANet are around the 50 to 60 mark and Hamfest table booking are around 30. It looks like these events will be well catered for.

Ham Radio to the Rescue

On Sunday 22nd September the town of Bindoon on the northern outskirts of Perth suffered a complete telecommunications failure. All phone lines and mobiles went dead. Luckily VK6HGM, Glen, came to the rescue and drove to a nearby hill with his 2 m rig. He put out a call for help on our

Roleystone repeater, located many kilometres to the south and not line of sight. Glen's plea for help was answered by Geoff VK6AX almost as a reflex action. You see Geoff, a member of the Old Timers Network, started his career as a ships Radio Officer at the age of 17. Answering an SOS was second nature to him. In fact he told me he once responded to over 40 SOS calls in a day, during heavy storms off the coast of England! Geoff initially called Telstra, but found their automated menu system both frustrating and time consuming. He then rang Police Communications and relayed the fault. The town of Bindoon had its telephone system restored within 30 minutes. The townsfolk probably have no idea how amateur radio quickly fixed their problems, but relaying stories like this can give us a warm fuzzy feeling.

Ham Radio Course in 2003

VK6 can welcome four new operators since the last exams were held. Further exams will be held in October and December. Anyone wishing to get their license will be pleased to know that Neil VK6BDO will be running a comprehensive course next year, over 47 weeks. This course contains several

modules including Regulations and Morse code. All levels of License, Novice, Limited and Full Call will be catered for. The WIA will subsidise the cost of this course to make it attractive to potential candidates. A location for the study group will be made in the future to suit the geographical location of candidates.

News in Brief

CTCSS is to be introduced on 70cm repeaters to solve the problem of LIPD interference.

Mal, VK6LC, has returned from his extensive trip from Perth to Cape York and the Torres Strait Islands. Look forward to his comprehensive article in a following edition of AR Magazine.

Bruce, VK6OO, informed Council that a book has been published posthumously regarding the life of Harry Atkinson, VK6WZ, about his radio industry experiences. This book will be available at Hamfest or via VK6OO. More info on the book release at <http://www.vk6wia.org>

Alan, VK6PG, informed me that he has won the Royal Signals Amateur Radio Society Anniversary Contest 2002. Is this a first for VK6?

Contacts for the Column vk6notes@vk6wia.org

Join

WIA today



WIA is active in:

- QSL services
- Major role in amateur radio education
- Coordination of contests and awards
- Monitoring of illegal activity

“There is no denying that radio today still has all the magic that attracted people to the hobby all those years ago, when it first emerged onto an unsuspecting world.”

Ernie Hocking, President
Amateur Radio April 2002

How to join WIA

- Through your local amateur radio club
- Through your Division (contact details on inside back cover)
- Contact WIA Federal Office (03) 9528 5962

A sad farewell

The time has come

I never expected that the end would come in this manner. But the sad facts are that the VHF/UHF station of VK5LP no longer exists! After 41 years of licensed operating, the station has been dismantled and the equipment returned to its original cartons ready for an eventual sale.

Because I am so well known throughout the amateur fraternity, both in Australia and overseas, some explanation is due to readers of my former columns, *VHF/UHF - An Expanding World* - and to those at the far end of many thousands of radio contacts since 1961.

The demise really started when, due to damage to my spinal chord, I was confined to a wheelchair from 1990. This ended one of my great loves, that of portable operating, for which I had a Kombi van full of equipment, separate from the home station, which could be moved at very short notice to a suitable elevated site.

The equipment in the home station gave almost faultless performance, but the antennas were my problem. Due to the very strong winds at Meningie, my six metre beam suffered fractured and broken elements. Eventually these were strengthened and remained intact. In the meantime, static discharges caused by lightning repeatedly damaged the 70 cm and 23 cm mast-head amplifiers. For some reason the one on two metres seemed immune!

So the problems were not in the shack but outside where I could not get at them for repairs. On many occasions my friend David VK5KK, often assisted by his father Keith VK5AKM and Mark VK5AVQ, effected repairs for me, despite the 400 km round trip to do so. Over the years, several others arrived to assist, one group headed by Trevor VK5NC and Colin VK5DK, came from far-away Mount Gambier. Colwyn VK5UE and his rock-climbing son Andrew also assisted.

Eventually, pressure of his daily work

load prevented David VK5KK from attending, so for the past three years the MHAs have not been repaired. The final straw came recently when I discovered that galahs were gradually destroying the coaxial cables to the antennas - they rest on them in their hundreds - so I can't defeat them. Repairs could be made today and tomorrow the wretched birds could destroy them again!

So I am most grateful for the assistance that has been given me over the years, but I have no alternative but to close the station. In place thereof, I am still writing articles and books so will not be idle. I will retain my callsign and the TS680S which has a general coverage receiver in it as well as the capability of working on the HF bands should I ever feel the need. Won't life be different! At this emotional time, my thanks to so many for your wonderful support over the years that I was on the air.

73 de Eric Jamleson VK5LP.

Awards

Mal Johnson VK6LC, Awards Manager

The Federal Awards Program has just received Legal W.I.A. Microsoft 2000 software and a new XP computer, provided by myself including a state of the art photo and paper scanner.

This new system is dedicated to our awards program and as time progresses all manual archived and current manual documentation will be digitised giving us faster retrieval and security on all records. Monthly updates and backup compact discs will be maintained with me and the Federal Office. The Awards Data base and new awards template files are developed on this computer and now we are able to forward the pull down files to our National Web Site.

As a notice to all members our Federal Awards computer email system is a stand alone system and does support the latest antivirus active scanning programs and if an email is received that contains any virus or worms etc it will be deleted, therefore if you correspond and don't receive a reply within 5 days try your friends computer to send me a email.

"You, without knowing it may be infected!"

ar

WIA DXCC Standings

The next list will be published in February 2003 AR.

Mal Johnson, VK6LC, the W.I.A. Federal Awards Manager will need all new applications and updates to be processed by 14th December 2002.

This will allow Mal to adjust them as required and pass to the Editor by January 7th 2003.

If all goes well to publish the January /February issue of AR about 24th January 2003.

Mal has just returned back from holidays after a long 4wd trek to Cape York and advises the Federal Awards Office is now active and very busy. This Office will be open over the Xmas and New Year periods, unfortunately DXers never have holidays.

Silent Keys

The WIA regrets to announce the recent passing of:-

A J Cooper VK3VZV and E J Harrison VK5AEH

GO-32 BBS activated

At the time of writing the BBS software had been uploaded to GO-32 and the BBS is running – but is not yet fully functional.

The directory is holding several messages and the satellite is responding to requests for directory filling. The downlink signal is quite strong and it looks as though GO-32 will be a

welcome and timely addition to the dwindling fleet of digital birds. With KO-23 out of action and KO-25 in poor shape, UO-22 has been the only fully functional 9600 baud satellite available. The GO-32 control station operators have reported that the BBS software is not yet in final form, the transmitter only being activated when a directory fill is

requested. It is not as yet sending the required information to activate the download efficiency indicator in WiSP so this is always showing 0% even though the efficiency is obviously quite high. This will be rectified in a subsequent software upload. For those who may have missed the details of this 'new' digital satellite here is a summary.

TECHSAT-1B GO-32

Downlink: 435.325, 435.225 MHz FM (9600-baud FSK)

Uplinks: 145.860, 145.880, 145.890, 145.930 FM

Broadcast Callsign: 4XTECH-11

BBS Callsign: 4XTECH-12

Launched: July 10, 1998 by a Russian Zenit rocket from the Baikonur Cosmodrome. Status: Semi-operational.

As of August 18th 2002, BBS Software is running. There is a Beacon every 60 seconds. Directory and Files "download only" mode.

The downlink is FSK compatible with standard 9600 baud TNCs. It "sounds" similar to UO22/KO23/KO25. If the BBS is loaded, you will be able to work it

using WiSP. If the BBS is not loaded, and you leave the TNC in KISS and open a terminal program, you should see the text "TECHSAT V.xx" about once a minute. For more info check: <http://www.iarc.org/techsat/>

Latest Jottings on AO-40

AO-40 experimental transponder operation started on May 05, 2001 at approximately 08:00 UTC when the U-band and L1-band uplinks were connected to the S-2 transmitter passband downlink via the Matrix switch.

The command team has taken another set of images, which just manage to capture the earth in one corner of the field of view. That has enabled calculation of ALON and ALAT figures. It turns out that AO-40 is in a good attitude to provide power and at the same time, protect the cameras from direct sunlight. Therefore the station keeping magnetorquing has been terminated and AO-40 will begin drifting past the sun. At approximately ALON = 330 the ALAT can be lowered.

All this is allowing the control team to collect valuable data, which will help to orient AO-40 to optimum values when 3-axis stabilisation is activated. If you have 20 metre capability you can listen for the new "AMSAT Net for Beginners", which started on July 17th and has been held weekly each Thursday 0200-0330 UTC although this may be a bit early in the day for propagation to this part of the world. If you are an Internet surfer you can join the net by connecting to

node "925", the Western reflector in Las Vegas NV. (<http://www.irlp.net>).

In the near future the squint angles and solar angles will be worsening. The AO-40 command team has announced that the passbands will be turned off in about 7 days as solar/squint angles worsen. The passbands will be re-established in several weeks, when AO-40 comes out of drift and ALAT begins lowering. When AO-40 gets to that point, the best conditions will be shortly after perigee. The schedule will be adjusted accordingly. AO-40 should be back to ALON/ALAT = 0/0 about November 15th. It will be allowed to stay there until early March 2003.

On an entirely different tack, Roy VE7BPB in Vancouver reports he has had success with his testing using the JT44 weak signal program through AO-40. Conditions are best for CW/SSB signals when the squint angle is less than 20 degrees. Roy says he has had success with high squint angles around 45 to 50

The AMSAT group in Australia

The National Co-ordinator of AMSAT-VK is Graham Ratcliff VK5AGR. No formal application is necessary for membership and no membership fees apply. Graham maintains an email mailing list for breaking news and such things as software releases. Members use the AMSAT-Australia HF net as a forum.

AMSAT-Australia HF net

The net meets formally on the second Sunday evening of the month. In winter (end of March until the end of October) the net meets on 3.685 MHz at 1000 UTC with early check-ins at 0945 UTC. In summer (end of October until end of March) the net meets on 7.068 MHz at 0900 UTC with early check-ins at 0845 UTC. All communication regarding AMSAT-Australia matters can be addressed to:

AMSAT-VK,
GPO Box 2141,
Adelaide, SA. 5001.

Graham's email address is:
vk5agr@amsat.org

degrees when no other stations could be heard. Weak signal modes like JT44 present a new area for genuine experimentation on AO-40. Roy said in an earlier message he posted, "I found that one difficulty is knowing where your downlink signal will be in relation to your uplink signal. The normal practice of just tuning for your own carrier doesn't work too well because you can't hear it." He found that he can run a program called Spectran, which helped him to reliably tune in his signals, even when they were below audibility. (If you have trouble accepting this situation, do some reading about JT-44 and weak signal reception in general).

It's a fascinating area and well worth a look for the 'inquiring minders' out there.

Roy goes on, "I was able to find my own signal fairly quickly, and from there the JT44 frequency display got me down to the last few hertz. The JT44 sync tones seem to be around 1300 hertz, so by tuning the receiver, and watching Spectran for the train of pulses at about 1300 Hz, I could quickly find my downlink. And as a bonus, it would be a good way to identify another JT44 station that you couldn't hear. The pulse train is quite unique, with the higher frequency tones showing up as random dots next to the sync pulses."

If the prospect of experimenting with JT-44 excites you, here is a list of links for additional information and downloads of the software packages mentioned:

Joe Taylor, K1JT's, "official" Web site at

<http://pulsar.princeton.edu/~joe/K1JT/>

Additional JT44 links:

<http://www.vhfdx.de/ws/jt44.htm>

<http://www.qsl.net/wb5apd/jt44-eme.html>

<http://www.pingjockey.net/cgi-bin/pingtalk>

The Spectran web page is at:

<http://www.qsl.net/padan/spectran.html>

[from ANS]

Want a QSL card from AO-7?

A small number of the ORIGINAL two batches of AO-7 SWL QSL cards from the 1970s have been discovered in the AMSAT offices.

You had better get in early. The original message from AMSAT didn't mention numbers - but the number is limited. At the time of writing they were still being issued to applicants. They are not all perfect, but they are ORIGINAL, and are available for those that send an AO-7 reception report to: Andy MacAllister -

W5ACM, 14714 Knights Way Drive, Houston, TX 77083-5640. Please include a business-size SASE with your reception report. Might be worth a try.

While we're on the subject of nostalgia - reprints of the December 1974 AMSAT Newsletter are now available. This issue was published shortly after the launch

of AMSAT-OSCAR-7. Not only is it full of AO-7 information, but also is fascinating to read. To get a copy, send a \$5 donation (\$6 for non-U.S. addresses) made out to "AMSAT" to: Andy MacAllister - W5ACM, 14714 Knights Way Drive, Houston, TX 77083-5640.

[from ANS]

Bad news regarding RS-12/13

For some months now reports have been coming in from regular operators questioning the status of RS-12/13.

The two amateur radio packages that constitute RS-12/13 are part of the larger Russian COSMOS 2123 satellite. It appears (although this report is officially unconfirmed at the time of writing) that COSMOS 2123 suffered a major electrical breakdown due to solar flare activity during late July and early August 2002. It's still being reported that efforts are underway to effect repairs, although the chance of success is small. So far we have had no encouraging news. We may have to face the fact that RS-12/13 has gone for good. These two 'packages' had a large following word-wide including many in VK and they will be sadly missed. They were among the most successful of all the RS series 'satellites'.

Marked increase in voice activity from ISS

Since last month there has been a noticeable and welcome increase in the voice operations from the International Space Station.

ARISS school contacts have resumed with the Expedition 5 crew of mission commander/U.S. astronaut Peggy Whitson, KC5ZTD, and Russian cosmonauts Valery Korzun, RZ3FK and Sergei Treschev, RZ3FU. Valery and Sergei have been heard making general voice contacts fairly regularly and Peggy has been heard in 'telebridge' contact with school children with the help of Tony VK5ZAI. All in all a general increase in amateur radio activity that is pleasing to see.

PLAN AHEAD

for March 2003

★ Eastern and Mountain District Hamfest, Heathmont

★
★
★
★

★ John Moyle Field Day

★
★
★
★

★ Bass AR IRLP Group Hamfest, Boneo

★
★
★
★

★ Urunga Field Day

Gearing up for summer DXing

I managed to tear myself away from other 'distractions and occupations' to spend an hour or so on air during the last week in September and managed to work YL2PQ, EA5FW, RK1PWA, UA6NY and SP9CCD all on 12 metres. This is a strange band. Activity seems to wax and wane with no particular pattern. It should behave like 10 m, but even when 10 m is open and active, often there is little or no activity on 12 m while at other times there is DX to be had with ease.

The 30 m band can also throw up a surprise or two. Working into the US is easy on this band in our early evenings and it is interesting to listen to stations in the Eastern states increase in strength, followed by the more Western states as

the sunrise sweeps across the USA. Occasionally propagation on 30 m is particularly good towards stations in Antarctica and I had a recent CW QSO with Mike, RW1AI/ant who is currently stationed at the Russian Antarctic base 'Vostok'. During our QSO I happened to mention that we were having a bit of 'cool' weather in Melbourne, especially in the early mornings. I knew that Antarctica is the coldest place on Earth but I suddenly felt very warm indeed when Mike replied that his outside temperature was -60°C . Mike mentioned that the lowest minimum temperature ever recorded on Earth was -88°C , also recorded at Vostok. I felt positively sweaty because having experienced

temperatures of -24°C I could imagine the 'nip' in the air at his QTH!

I am looking forward to working some 160 m DX after being told by a couple of operators that DX activity on this band increases during summer. I have added 4 more radial wires, each about 45 feet long, to my W1FB 'shorty' vertical, so hopefully it'll perform a little bit better. After adding the extra radials I noticed that the 2:1 swr bandwidth narrowed slightly (about 3 kHz). Is there any antenna expert out there who can enlighten me as to the reason behind the narrowing bandwidth?

There will be some interesting DX on the bands this month, especially from the frozen regions to the south of us. Have fun and hope to hear you on the air.

The DX

3C, EQUATORIAL GUINEA. Vitaly, VE6JO, says that he will be here from the 2nd until the 24th of November. He has been issued with the callsign 3C2A and has been granted access to all bands and modes and is currently awaiting its arrival in the post or via FAX. His equipment will comprise a FT-847, Sigma-5 vertical and some wire antennas for the 40, 80 and (maybe) 160 m bands. He is also trying to locate a small beam and solid state amplifier. [TNX VE6JO and OPDX]

5R, MADAGASCAR. Phil, G3SWH, and his XYL will be returning to Madagascar for a holiday from the 5th until the 19th of November. He is expecting to have his 5R8HA call reissued for the period of his visit. Phil plans to operate from a number of locations on the main island (IOTA AF-013) between the 5th and 13th and from Nosy Komba (IOTA AF-057) between the 14th and the 19th. This is a holiday type activity but he hopes to be on air as much as possible on all bands 40 - 10 metres CW only. QSL via G3SWH, either direct with a SASE and return postage or via the RSGB bureau. [TNX G3SWH and OPDX]

9K, KUWAIT. John, W4NU, is currently active as W4NU/9K2 on Sundays after 1800Z around 21250kHz moving to 14200kHz when the bands open to the USA. He says that he only

gets on air every second Sunday due to work commitments and expects to be in Kuwait until at least early January. Nancy, NK4U is John's QSL manager. [TNX W4NU and OPDX]

9M6, EAST MALAYSIA. Kazu, JA1RJU, will be active as 9M6JU over the period of the 18th until the 25th of November. He is planning to operate on HF and 6metres. QSL via JA1RJU. [TNX JA1RJU and OPDX/KB8NW]

CT9, MADEIRA ISLAND. Rudi, DK7PE, says that he and a group of seven other members of the Lufthansa Amateur Radio Club will be operating as CT9DLH from the 7th until the 11th of November. They plan on operating on all bands 160 - 10 metres using SSB, CW and PSK. QSL via DL4FP. [TNX DK7PE and OPDX]

EA8, CANARY ISLANDS. Cesare, I5WEA is planning a trip to Tenerife where he will operate as EA8/I5WEA. He will be there until the 20th of November and says he will be concentrating mainly on the 30, 21, 14 and 12 metre bands. QSL via I5WEA. [TNX I5WEA and 425 DX News]

FO, AUSTRAL ISLANDS. Tony, 3D2AG, is planning on operating from Rapa Island (OC-051) in the Austral Islands. Tony expects to arrive there in late October with expectations of staying

for approximately 1 month. He will be using basic wire antennas so don't expect a huge signal from him. No QSL route is given but try his home call via the bureau. [TNX 3D2AG and OPDX]

J28, DJIBOUTI. Vincent, F8UNF, is currently active as J28UN and will continue so until at least the 1st of June 2003. Activity is planned for all bands 160-10 metres using CW and SSB. He mentions that his favourite band/mode is 10 metres using SSB, however this may be a little early in the morning for us in VK. If you manage a QSO then QSL direct via F8UNF, Vincent Charles, BP 12, 54760 Leyr, France. [TNX F8UNF and OPDX]

P5, NORTH KOREA. Ed, P5/4L4FN, is again very active and has begun appearing on 10 metres (around 2200Z on 28530 kHz) where he says he is getting out very well on using a new Hex beam. According to the KK5DO P5 website Ed has expressed an interest in working licensed kids of 16 years or younger who have the appropriate licence, so you youngsters should take advantage of a great opportunity of making a QSO with P5. Also mentioned on the website is that Ed has had over 15000 QSOs on 10 metres. [TNX P5/4L4FN and OPDX]

PJ2, NETHERLANDS ANTILLES.

Joeke, PA0VDV, will be on air again from Curacao using the callsign PJ2/PA0VDV over the period of the 10th of Nov until the 2nd of Dec. He will only be using CW on 80 - 10 metres with a preference for the WARC bands. QSL via the bureau or direct to: Joeke van der Velde, Delleburen 1, 8421 RP Oldeberkoop, Netherlands. [TNX PA0VDV and OPDX]

PY, SOUTH SHETLAND ISLANDS.

Oleg, UA1PBA is one of the radio operators at Russian research station "Bellingshausen" (R1ANF, WABA UA-04). He says that he will make a serious effort to operate as R1ANF/p from the "Padre Balduino Rambo" refuge. This station was erected in 1985 and is located on the Fildes Peninsula of King George Island in the South Shetlands (AN-010) and has never been operated from using amateur radio. Award

hunters should be aware that this will be a great opportunity for a new location for the WABA programme. [TNX DL5EBE and 425 DX News]

TT8, CHAD. Pascal, F5PTM, will be operating as TT8ZZ until early December. He received his authorisation and licence on the 24th of September. He hopes to operate on all bands from 80 - 6 metres mostly using CW. He has already been very active on the 17, 12 and 10 metre bands. QSL via F5PTM. [TNX F5PTM and OPDX]

UR, ANTARCTICA. Alex, EM1KGG, is currently stationed at the Russian base "Akademik Vernadsky" (WABA UR-01, IOTA AN-006). Those looking for a QSO with him are advised to be up bright and early to have a listen around 21200 kHz at approx. 18.00 - 18.30 UTC on Saturdays and Sundays. This is when Alex is most likely to be on and is also

when he has a sched with Paul, UT1KY. QSL via UT7UA. [TNX UT7WZA and 425 DX News]

ZL5, ANTARCTICA. Chris Post, N3SIG, is again active as ZL5CP from Scott Base (WABA ZL-02) on Ross Island (AN-011). Best time to catch him is between 0500 and 0700 UTC (a much more reasonable hour!) on approx. 14243 kHz. QSL via AI3D. [TNX DL5EBE and 425 DX News]

ZS, ANTARCTICA. Anton, ZS7/ZS4AGA is planning to be on air from "E-Base" (WABA ZS-04) on the Fimbul Ice Shelf in mid to late November. Currently he is stationed at "SANAE IV" the South African Antarctic base at Vesleskarvet in Queen Maud Land (WABA ZS-03). He expects to be calling in to the Antarctica net on 21275 kHz on Mondays at 1700 UTC (again, you'll have to be up bright and early!). [TNX DL5EBE and 425 DX News]

DXpeditions

CY0, SABLE ISLAND. Various rumours are going around that a group of Canadians, namely George/VE3NZ, Nick/VE3EY and Lali/VE3NE, will be signing as CY0MM from Sable Island over the period of the 15th until the 26th of November. They are planning activity on HF and 6 metres using CW, SSB and RTTY modes. Their website at <http://www.dipole.com> has more information. [TNX VE3NZ and OPDX/KB8NW]

KH8, AMERICAN SAMOA. Glyn, GW0ANA, who is the team manager of the upcoming KH8 DXpedition, has

issued the following details and callsigns for their KH8 dual IOTA DXpedition to the islands of Tutuila and Ofu:

- Operations from the Island of Tutuila (IOTA OC-045) will use the callsign K8T (KILO 8 TANGO). Activity begins from Tutuila on the 28th of Oct and ends on the 8th of Nov. The QSL route for this IOTA is via Glyn, GW0ANA, only and the address is in any international callbook or can be found on the web on QRZ.com.
- Operations from the Island of Ofu

(IOTA OC-007) will use the callsign K8O (KILO 8 OSCAR). This operation starts on the 29th of Oct and ends on the 7th of Nov. The dates and times for this arm of the operation may vary as flying to and from the island is heavily dictated by the weather. However, the team will give it their best shot and will operate from Ofu for as long as possible. The QSL route for this IOTA is via David, AH6HY, only and the address can be located in any US callbook or on the web on QRZ.com [TNX GW0ANA and OPDX].

Round up

8N1, OGASAWARA ISLANDS. The JARL wants to remind us that a commemorative DXpedition is currently on air from the Ogasawara Islands to celebrate the JARL's 75th anniversary. Activity began on the 15th of September and should last until around mid March 2003. The callsign is 8N1OGA and activity is on all bands and modes. [TNX OPDX]

Alex, PA3DZN (ex TL5A, 9Q2L, 9X5EE, D25L, etc) has been re-assigned to Kenya by UNICEF for the next two years at least and is currently operating as 5Z4DZ. He arrived there in April and wasted no time in putting plans together for a station to operate on 40 - 10 metres. Alex says that "Kenyan operators do not yet have access to the 6, 30 and 160 metre bands but the Radio Society of Kenya is lobbying very hard for 30 and

160 m privileges. 6 metres is especially difficult as Kenyan TV still broadcasts in the 50 MHz band." Alex is hoping that he can gain permission to use 160 m as this is his favourite band. During his stay he expects to do some travelling through Eastern/Southern Africa but doesn't expect to be QRV much unless he is invited to operate as a guest from a local ham operators shack. QSL is via PA1AW, Alex van Hengel, De Manning 15, 2995AE Heerjansdam, The Netherlands.

Some news for the paper chasers. The DXCC recently released details of their new **30 metre (10 MHz) Single Band DXCC award**. The DXCC said, "Applications for this award will be accepted from the 1st of October 2002. The 30 Metre DXCC certificates will be dated but not numbered. 30 metre

credits will count toward the DeSoto Cup competition that ends on the 30th of September 2003. They will also be included in the DXCC Annual List Totals for the period ending on that date. A 30 Metre endorsement to 5 Band DXCC will also be available". [TNX DXCC and 425 DX News]

Sources

The information above was supplied by the following individuals and organisations; VE6JO, G3SWH, W4NU, JA1RJU, DK7PE, I5WEA, 3D2AG, F8UNF, P5/4L4FN, PA0VDV, DL5EBE, F5PTM, UT7WZA, VE3NZ, GW0ANA, PA3DZN, JARL, DXCC, 425 DX News and OPDX. Our thanks are extended to all for allowing it to be published in Amateur Radio's DX Notes.

ar

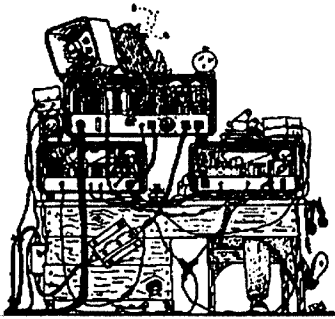

Part 20 DX Clusters

One of the most exciting activities in Amateur Radio (AR) today is chasing rare DX stations worldwide. Collecting countries worked for a DXCC Award (100 different countries), hunting for Zones (WAZ Award), working IOTA (Islands on the Air) or just climbing DX ladders is fascinating. Some awards can take years to do whilst others can be done in one weekend like the World Radio Magazine 31-on-31 Award using PSK31. Whatever your fancy, this edition of Ham Shack Computers offers several automated solutions to seek out DX stations, using your own computer, connected to a packet radio DX Cluster or via the Internet.

Via a Packet Radio Node

Packet Radio also offers exceptional services to RAs, and it's a much cheaper alternative than the Internet - thanks to the many RA system operators (sysops) worldwide. Some bulletin board packet radio networks offer DX Cluster access in addition to the usual messaging, Telnet, and file transfer services (FTP). Some links also have "Ping Pong" or "Wormhole" access using Telnet so that operators worldwide can keyboard chat live - along with other RAs. This technique allows operators to network and track the activity of specific DX stations. The writer has used this system to connect with the USA, Canada, New Zealand, and the UK at the same time, when the group is active on the DX bands waiting for a specific DX station to appear. This is like a huge net spread out ready to "pounce" before the rest of the world realises that the DX station is active!

Packet Equipment

Almost any modern two-metre mobile rig will do fine when connected to a simple BayCom modem. The writer uses a surplus Philips FM92 transceiver and the Blakpak BayCom modem (2) built from a kit for less than \$50. The antenna is a ground independent half-wave vertical that gives solid access to a local BBS network with DX Cluster features. The cluster postings are gathered from other BBSs around the world - each with a connection to the Internet. This means that you, the user, can access the postings without the high cost of connections.

```
Telnet wr3d.dxcluster.net
*** Connected to WR3D in Baltimore
Hello VK6PG, this is WR3D in Baltimore MD, USA
running DXSpider V1.50 build 56.989
*** we are now using our new server ***
*****
28460.9 4J6IAS 22-Sep-2002 1852Z ql via RAIQQ <PA6COR>
28460.6 4K6INS 22-Sep-2002 1854Z qsl raiqq <DL5MDM>
28002.0 PV4HGM 22-Sep-2002 1854Z <DJ0FU>
24916.9 J15USJ/4 22-Sep-2002 1851Z as-841 <DL1AAU>
21025.6 OH2BCD 22-Sep-2002 1851Z <K2SX>
*****
Date Hour SFI A K Forecast Logger
22-Sep-2002 09 159 ? 2 R-21? No storms->Min.R1 <JA3QGI>
*****
Cluster: 398 nodes, 6 local / 1707 total users Max users 2208 Uptime 27 08:03
Please enter your name, set/name <your name>
Please enter your QTH, set/qth <your qth>
Please enter your location with set/location or set/gra
Please enter your Home Node, set/homename <your home DX Cluster>
VK6PG de WR3D 22-Sep-2002 1854Z >
DX de IT9DAA: 28496.0 C98DC 50S > 510 AF-072 1852Z JM76
DX de JR4LNG: 24928.6 E810J RTTY UY FB SIG. 1854Z
DX de DB3BW: 144370.0 E83DXU in Jo42 ufb pin 1854Z
DX de K2SX: 21041.5 SM6IQD 1854Z FN30
```

Via the Internet

Modern broadband Internet connections are becoming more popular as the cost connection continues to drop in price. The advantages being that it's possible to have a live continuous Internet connection and a separate dial-up telephone available all on the one broadband line connection. A Telnet DX Cluster connection to WR3D in Baltimore USA, via your Internet browser program, is shown in the adjacent image.

Once connected for the first time you are asked for a username (your callsign) and password (your first name). The last five DX Spots are shown, and once the welcome and date/time rolls through, then the live DX postings follow continuously as your shack session proceeds. Watch for callsigns needed and set your transceiver to the frequency listed and join in the chase.

Via Magazine DX Columns

Most AR Magazines publish first class DX columns with short stories on DX-peditions and activities from rare or unusual countries. However, it can take many weeks for the information to be processed, printed and finally distributed in print. There is nothing worse than finding out that North Korea was active last week! This is fine given plenty of forewarning of DX activity, however, you might forget, be working, on holidays or doing family chores and unavailable to grab the scheduled contacts. In short, magazines these days tend to provide written supplementary information whilst a DX Cluster offers a "real time" dynamic experience at a time when you are in your shack and active on air all at the same time.

Packet TTY			
Connection	To-Log	DX-Spot	Monitor-Mode Settings Edit Help
ALL de DL4FAY:	oh7hdu	could u try	29300 ????
DX de DL1DQW:	28009.0	HR1LW	12382 (Honduras, Distrito
ALL de UA6LGR:	RK3AZ	via SM0JHF	. 73 poka
DX de W4FOA:	14003.3	TG9AKC	CQn (moved here)
DX de EA5WU:	18074.0	HB0/DL30CH	12382 (Guatemala, Guatemal
DX de UE9AA:	50101.0	GD0TEP	539
ALL de RK3AZ:	9a1ccy-3	Tnx info.	73 de Arc!
DX de K5YA:	7004.5	EX8F	12392 (Liechtenstein)
DX de JA2PJC:	1021.6	N5TW	579 cq
DX de M0BCG:	50095.0	VE1ZJ	cq
ALL de RK3AZ:	ua61gr	TNX!	12372 (Isle of Man, Full L
DX de G0JHC:	50115.0	UE1YX	59 cq DX
DX de JR4QZH:	50180.1	9M9/7M2UPR	5W+DP DE GET
ALL de EA4EKL:	RK3AZ	info----->	www.qsl.net/s92jhf/ 73s
DX de IZ0DPL:	24945.0	EX2T	Ulad
DX de DL5MG:	28021.2	RU3DNN	clg SSB-CQ in CW part ???!
DX de IZ0DPL:	24945.0	EX2T	Ulad qsl direct
DX de JM1IGJ:	50180.0	9M9/7M2UPR	12402 (Kyrgyzstan, Talass)
DX de W4CK:	28014.0	0P0GS	12402 (Russia (EU), Moskov
DX de IZ0DQ0:	29420.0	GW3PYD	12432 (Kyrgyzstan, Talass)
DX de K5YA:	7007.0	EY7AF	12372
DX de W4FOA:	14012.6	UU2EN	12432 (Belgium)
DX de AA4XR:	14008.0	4S7CF	12432 (Wales, Full Licence
ALL de RK3AZ:	W4CK	Hello, Mark!	12452 (Tadzhikistan, Lenin
DX de W4FOA:	14012.6	KP4YD	12442 (India)
DX de IZ7AUH:	29400.0	A61AS	12442 (Sri Lanka (Ceylon))
		Same freq as UU2EN	12442 (Puerto Rico)
		FM	12472 (United Arab Emirate

The Automated DX Cluster

YLog by VE6YP (3), the well-known Logging and Control software, includes a Packet Radio Terminal Program as part of its extensive package. With all the other options in YLog running, connection to any packet or Internet DX Cluster node is possible. The image displayed above shows a typical listing from a packet radio DX cluster. As an example, the posting for KP4YD on 14012.6 was made by W4FOA at 1244Z. By just "clicking" onto this posting, the data is automatically entered into the YLog logbook ready for you to call, and hopefully, work the station. However, that's not all. YLog can automatically turn your beam in the right direction, and if you have customised the CW or SSB options and have the "F Keys" displayed on your screen, the process of "spotting" the DX, calling and working the station has been fully automated. Many readers of this series have opted for YLog as their default Control and Logging program, and will already understand this process.

Typical Applications

For serious operators who seek only DX spots on particular bands or modes, YLog has options to select a filter that

rejects all other spots and only displays stations of specific interest. A good example earlier this year was using WSJT on 50MHz spanning the Atlantic Ocean between the USA and Europe. The DX clusters assisted in establishing many new contacts - and a number of VHF/UHF world records were broken. Moonbounce on VHF/UHF is another application where the DX cluster reins supreme. A single posting to the cluster can establish if the wanted station is QRV and ready to receive the DX call. Confirmation of reception can also be posted where the two stations are using the cluster for simple communication whilst the radio operation progresses. After all, it's not much good calling a station if he's not there! The DX cluster solves this problem for you.

DX clusters MUST NOT BE USED FOR CONTESTING. Many contest rules forbid this, as it would cause havoc especially on the HF bands where a myriad of operators worldwide are ready to pounce on the poor unsuspecting DX station. Use the cluster for exactly what it was intended for - finding DX stations dynamically. Jump in and call the wanted station at the appropriate time and you'll be rewarded many times. Once done, leave the channel clear for others to work the DX.

Summary

This topic has given an overview of setting up and operating through a DX Cluster. Simple gear and the right software on your Ham Shack Computer can lift your country score easily. Many operators have worked 100 countries for a DXCC Award in just one weekend! However, the problem being to get all the return QSL cards won't be easy. Watch the cluster postings for QSL information and be prepared to send your own QSL card by airmail directly.

Ham Tip No. 20

If you don't have a DX Cluster in your area, use Telnet to link to a node that does. Ask your friends for advice on this.

Ham Shack Computers, Part 21 - "Morse Code" next month explains a simple way to learn Morse from your computer, using free software.

- (1) Ham Shack Computers Web: www2.tpg.com.au/users/vk6pg
- (2) Australian Amateur Packet Radio Association (AAPRA) Home Page: www.aapra.org.au
- (3) YLog Home Page: www.members.shaw.ca/ve6yp

73s de Alan, VK6PG/G3PHG

ar

Contest Calendar November 2002 – January 2003

Nov	1-7	HA-QRP Contest		
Nov	2/3	VHF/UHF Field Day	(CW/SSB)	(Oct 02)
Nov	3	NZ Straight Key Night		
Nov	3	High Speed Club Contest		
Nov	8-10	JA International DX Contest	(SSB)	
Nov	9	Anatolian PSK31 Contest		
Nov	9/10	WAE RTTY Contest		
Nov	9/10	OK/OM DX Contest	(CW)	
Nov	16/17	LZ DX Contest	(CW)	
Nov	16/17	All Austrian 160 Metres DX Contest	(CW)	
Nov	16/17	RSGB 160 Metres DX Contest	(CW)	
Nov	23/24	CQ WW DX Contest	(CW)	
Nov	23/24	CQ SWL Challenge	(CW)	
Dec	6-8	ARRL 160 Metres Contest	(CW)	
Dec	14/15	ARRL 10 Metres Contest	(CW/SSB)	
Dec	21	OK DX RTTY Contest		
Dec	26	Ross Hull Memorial VHF Contest		(Nov 02)
Jan	13			
Dec	28	RAC Canada Winter Contest	(CW/SSB)	
Dec	28/29	Original QRP Contest	(CW)	
Dec	28/29	Stew Perry Top Band Distance Challenge	(CW)	
Jan	4/5	ARRL RTTY Roundup		
Jan	11/12	VHF+ Summer Field Day	(CW/SSB)	(Dec 02)
Jan	19	HA DX Contest	(CW)	
Jan	24-26	CQ 160 Metres Contest	(CW)	
Jan	25/26	REF DX Contest	(CW)	

Results Jack Files Contest 2002

From John Spooner VK4AJS, Contest Manager

Well, the Jack Files Contest has been and gone for 2002. Although there were not a lot of participants, those who did have generally relayed that they enjoyed the evening.

There was a strong showing of club numbers from the RADAR and the Bayside Amateur Radio Club. As well there were several non-VK4 stations that worked the contest and submitted their log sheets.

A big thank you must go to the stations that were not participating in the contest but were kind enough to give out numbers to those who were participating. Also deserving recognition was the effort of Frank VK4CAU who went to the trouble to drive to a location well west of Rockhampton so as to activate 2 shires by moving from the Daringa Shire to the Fitzroy Shire during the course of the evening.

The fact that there were not a great number of stations to collect numbers from meant a lot of stations who have not talked on air for a while took the opportunity to have lengthy chats between the hourly exchange of numbers. Also stations that have not been active on HF for a long time were encouraged to turn up and enjoy the evening.

The results for the 2002 Jack Files Contest are as follows-

VK4 single operator: VK4LMB Mike from Rockhampton with a score of 530 Pts.

VK4 club station: VK4BAR Bayside Amateur Radio Club with a score of 1440 Pts.

VK2 single operator: VK2LCD Chris from Woodburn with a score of 605 Pts.

VK3 single operator: VK3CAT Tony from Melbourne with a score of 90 Pts.

No logs were received from any other states or countries other than those listed above as the winners of their states.

All contacts were made using phone; no logs were submitted using any other modes.

Well there it is in black and white, so a big thanks to all who took part and would you kindly send any suggestions on the future rules or running of this event. Hopefully next year will see a further growth of interest in this event as was experienced this year.

Results Waitakere Sprints 2002

From Alex Learmond ZL1BVK, Contest Manager

SSB Sprint

Call	Points	Certificate
VK5NJ	56	1st Overall
VK4SN	48	Second VK
VK3WWW	43	Third VK
VK4FJ	41	
VK2GJC	40	
VK3DYL	36	
VK3JS	35	
VK2LCD	24	
VK7JAB	16	
VK3BSE	15	
VK7LUV	7	
ZL2CD	52	Highest ZL2
ZL1PC	47	Highest ZL1
ZL1ALZ	46	
ZL1BVK	46	
ZL2TW	46	
ZL3DC/1	46	
ZL1BYZ	45	
ZL2ADN	44	
ZL1DK	42	
ZL1KB	40	
ZL1OS	40	
ZL2AJB	40	
ZL1WT	34	
ZL1TW	31	
ZL4IM	31	Highest ZL4
ZL2MD	29	

ZL1ACZ	28	
ZL1AUW	25	
ZL4AR	21	
ZL4GU	20	
ZL1NE	19	
ZL1WI	17	
ZL3GL	14	Highest ZL3

Check Logs gratefully received:

ZL1AKY, ZL1ALK, ZL1MW

CW Sprint

Call	Points	Certificate
VK3JS	33	1st Overall
VK5NJ	18	2nd VK
VK4SN	16	3rd VK
ZL1ALZ	23	1st ZL1
ZL1AIH	22	
ZL2AJB	22	1st ZL2
ZL1DK	21	
ZL1PC	21	
ZL1TW	21	
ZL2ADN	20	
ZL1BYZ	19	
ZL2CD	19	
ZL2AUB	18	
ZL2AVL	17	
ZL1WI	15	
ZL2TW	14	
ZL1ACZ	12	

ZL4IM	10	1st ZL4
ZL1WT	7	
ZL1AUW	6	
ZL1BVK	5	

Check log gratefully received:- ZL2MD

Sprint Champion for 2002:- VK5NJ 148 Points

Combined scores:

Call	CW	SSB	Con-tacts	Pts
VK5NJ	18	56	74	148
ZL2CD	19	52	71	142
VK3JS	33	36	69	138
ZL1ALZ	23	46	69	138
ZL1PC	21	47	68	136
VK4SN	16	48	64	128
ZL1BYZ	19	45	64	128
ZL2ADN	20	44	64	128
ZL1DK	21	42	63	126
ZL2AJB	22	40	62	124
ZL2TW	14	46	60	120
ZL1TW	21	31	52	104
ZL1BVK	5	46	51	102
ZL1WT	7	34	41	82
ZL4IM	10	31	41	82
ZL1ACZ	12	28	40	80
ZL1WI	15	17	32	64
ZL1AUW	6	25	31	62

Results NZ Memorial Contest 2002

From Stan White ZL2ST, NZART Contest Co-ordinator

VKs only

VK2CZ	405 points
VK2LCD	366 points

Results John Moyle Field Day 2002

From Eric Fittock VK4NEF Contest Manager

Stn.	S/M OP	Mode	Band	Points
Portable, Six Hour				
VK5SR	Multi-op	All Mode	All Band	1618 *
VK2BOR	Multi-op	All Mode	All Band	642 *
VK3APC	Multi-op	All Mode	All Band	628
VK2BV	Multi-op	All Mode	HF	62 *
VK3YE	Single	All Mode	HF	146 *
VK3BJM	Single	All Mode	VHF/UHF	872 *
VK5NJ	Single	CW	HF	62 *
VK4SK	Single	CW	HF	46
VK3DPW	Single	Phone	All Band	588 *
VK2IRP	Single	Phone	HF	62 *
VK2GR	Single	Phone	HF	58 *
VK3BD	Single	Phone	HF	48
VK5AVQ	Single	Phone	VHF/UHF	292 *

Stn.	S/M OP	Mode	Band	Points
VK4IF	Single	Phone	VHF/UHF	152 *
VK3VP	Single	Phone	VHF/UHF	56
Portable, 24 Hour				
VK3ER	Multi-op	All Mode	All Band	7492 *
VK4WIS	Multi-op	All Mode	All Band	5020 *
VK3CNE	Multi-op	All Mode	All Band	3938 *
VK2SRC	Multi-op	All Mode	All Band	2630
VK4BAR	Multi-op	All Mode	All Band	1952
VK2HZ	Multi-op	All Mode	All Band	1662
VK2ADX	Multi-op	All Mode	All Band	1472
VK3GH	Multi-op	All Mode	All Band	1132
VK3EK	Multi-op	All Mode	All Band	812
VK5BAR	Multi-op	All Mode	HF	598 *

VK2IBT	Multi-op	All Mode	HF	418	
VK5ARC	Multi-op	All Mode	VHF/UHF	4090	*
VK3ALT	Multi-op	All Mode	VHF/UHF	1840	
VK5MX	Single	All Mode	All Band	392	*
VK4EV	Single	All Mode	HF	216	*
VK5AIM	Single	All Mode	VHF/UHF	396	*
VK3JS	Single	CW	All Band	166	**
VK4VG	Single	Phone	HF	184	*
VK3WB	Single	Phone	HF	120	
VK5UE	Single	Phone	VHF/UHF	340	*
VK2KC	Single	Phone	VHF/UHF	40	

HOME, 24 Hour

VK4WIL	Multi-op	All Mode	All Band	304	*
VK3DBQ	Single	All Mode	All Band	195	*
VK3ATN	Single	All Mode	All Band	140	*
VK3KCD	Single	All Mode	All Band	101	*

VK2TG	Single	All Mode	All Band	53	
VK2EA	Single	All Mode	All Band	43	
VK2GJ	Single	All Mode	All Band	25	
VK2IGS	Single	All Mode	All Band	20	
VK2XIE	Single	All Mode	All Band	15	
VK2AAC	Single	All Mode	All Band	8	

HOME, 6 Hour

VK3KTO	Single	All Mode	All Band	107	*
VK2MRV	Single	All Mode	All Band	87	*
VK5AR	Single	All Mode	All Band	52	*
VK3VD	Single	All Mode	All Band	12	

SWL, 24 Hour None

Check logs : VK5RG VK5GN VK4PJ VK3CKD

* = Certificate Winners

** = Presidents Cup Winner

Comments from 2002 JMFD

An enjoyable contest again despite poor Wx and propagation. Whole team eaten alive by mosquitoes this year but no major equipment failures. *VK5SR*

Trying to find a clear hill near the city is not easy now, my first field day for a long time. Some good VHF conditions, but more on SSB would have been nice. *VK5AVQ*

Most embarrassing moment, (deleted) trying to adjust the time on a digital volt meter. *VK3ER*

We had SSB gear for 2.4, 3.4 and 10GHz but propagation from our location was not good. Our score doesn't reflect too much on the size of the station but, for all of our operators it was the first time in a contest. But the social side

of the weekend was really good for our club. *VK3EK*

Power was supplied totally from the sun, with 4x68 W panels on the shack, which was a half size Austin bus converted to a mobile home. Storage was 480Ah, and it got down to 10.9 V before the sun started to top up the batteries on Sunday morning. *VK5ARC*

Rules Ross Hull Memorial VHF-UHF Contest 2002 - 2003

from John Martin (*VK3KWA*), Contest Manager

The next Ross Hull Contest will be held between December 26, 2002 and January 12, 2003. The rules are unchanged from last year.

The contest is open to all amateurs, and all operating modes are permitted. Traditionally most activity has been on SSB or CW, although there has also been some FM activity. During the last year there has been quite an upsurge in the use of digital modes, and it will be interesting to see what effect this will have on contest activity this year.

But no matter what modes you prefer to use, summer is the time for DX, so give it a try and see what you can do. And please send in a log, so I can send you a nice certificate in return.

The Contest

The WIA maintains a perpetual trophy in honour of the late Ross A. Hull and his pioneering achievements in VHF and UHF operation. The name of each year's contest winner is engraved on the trophy, and other awards may be made in the various divisions of the contest. The contest is open to all amateurs.

Duration

0000 UTC Thursday December 26, 2002 to 2400 UTC Sunday January 12, 2003. In Eastern Summer Time, that is 11 a.m. on December 26 to 11 a.m. on January 13.

Sections

- A. Best 7 UTC days nominated by the entrant.
- B. Best 2 UTC days nominated by the entrant.

Entrants may submit logs for either or both sections. The nominated UTC days need not be consecutive. The overall winner will be the top scorer in Section A. If the overall winner has also entered Section B, his/her log will be excluded from Section B.

General Rules

One callsign and one operator per station. One contact per station per band per UTC day. Repeater, satellite and crossband contacts are not permitted. No contest activity is permitted below 50.150 MHz. Recognised DX calling frequencies must not be used for contest calls, exchanges or liaison. Suggested

procedure is to call on 0.150 on each band, and QSY up if necessary. All rulings of the contest manager will be accepted as final.

Penalties

Minor errors in distance estimates or calculations may be corrected and the score adjusted. Contacts made on recognised calling frequencies will be credited if the entrant provides an explanation of why it was not practical to use another frequency. Otherwise such contacts will be disallowed. Persistent unjustified use of calling frequencies or false log entries will lead to disqualification.

Contest Exchange

RS (or RST) reports plus a serial number. Serial numbers need not be consecutive. For difficult propagation modes such as meteor scatter, exchange of a total of two digits is sufficient for a valid contact.

Scoring

For 2 metres and above, one point per 100 km or part thereof (i.e. up to 99 km: 1 point, 100 - 199 km: 2 points, etc).

For 6 metres only, contacts below 1000

km: as above. Contacts from 1000 km to 2400 km, 2 points regardless of distance. Contacts over 2400 km, 20 points regardless of distance.

The band multipliers are:
 6 m 2 m 70 cm 23 cm Higher
 x1 x3 x5 x8 x10

Logs

Logs must cover the full contest period and contain the following for each contact:

- Date and UTC time.
- Station location (if operating portable).
- Specific FREQUENCY (not just band) and callsign of station worked.
- Approximate location or grid locator of station worked.
- Reports and serial numbers sent and received.
- Estimated distance worked and points claimed, including the band multiplier.

Separate scoring columns for each band would be helpful.

Cover Sheet

Logs must be supplied with a cover sheet containing:

- Operator's callsign, name and address.
- Station location (if different from the postal address).
- Section(s) entered, and a list of the UTC days to be scored.
- A scoring table set out as the example below.
- A signed declaration that the station has been operated in accordance with the rules and spirit of the contest, and that the contest manager's ruling will be accepted as final.

Please use the following format for your scoring table. If you wish you can cross-check by adding the daily totals across the table, but please make sure that you include the separate band totals.

Date	6 m	2 m	70 cm	23 cm	etc
Day 1	xxx	xxx	xxx	xxx	xxx
Day 2	xxx	xxx	xxx	xxx	xxx
etc.					
Total	xxx	+	xxx	+	xxx
	+ xxx		+ xxx		= xxx
(GRAND TOTAL)					

A sample cover sheet has been posted on the VK-VHF e-mail reflector, and copies can also be obtained from the e-mail address given below.

Deadline

Paper logs may be posted to the Manager, Ross Hull Contest, 3 Vernal Avenue, Mitcham, Vic 3132. Electronic logs can be e-mailed to jmartin@xcel.net.au. The following log formats are acceptable: ASCII text, Office 97 RTF, DOC, XLS or MDB. If you use Office 2000, please save the files in Office 97 format.

Logs must be received by **Friday, February 7, 2003**. Early logs would be appreciated.

Note on Calculating Distances

Absolute accuracy is not required. All you need to know is whether the other station is above or below the nearest multiple of 100 km. An easy method is to use a compass to draw 100 km circles around your location on a map. Better estimates can be made from six-digit Maidenhead locators, using a computer program, which can be obtained by sending an e-mail to the address given above.

Announcement

Ian Godsil VK3VP

Some months ago I had my first warning that being a Senior Citizen brings with it a decline in one's abilities to do things as readily as previously. My wife also finds the same thing happening.

Because of this, I am sorry to announce that I must relinquish my position of Federal Contest Co-ordinator as from next year's WIA AGM.

There are some very able people out there who may like to consider taking over this position.

A Job Description is attached so that you can consider offering your services to the Federal President, Ernie Hocking VK1LK, via Federal Office, or president@wia.org.au

I shall be most willing to assist the new incumbent in any way that I can, and certainly hope to continue as a participant in contests.

Good contesting and 73.

Ian Godsil VK3VP

ar

Federal Contest Co-ordinator Job Specification

Applicants for the position of Federal Contest Co-ordinator are asked to consider the following guidelines —

1. To report frequently to the member of the Federal Executive appointed to oversee Contest activity and to keep him fully informed, especially of budgetary costs;
2. to liaise frequently with the Federal Office;
3. to write an Annual Report in February each year for presentation at the WIA's Annual General Meeting;
4. to liaise closely with the NZART Contest Co-ordinator;
5. to liaise closely with other Contest Co-ordinators and Managers, both in Oceania and world wide;
6. to produce a monthly information column in "Amateur Radio";
7. to organise for production and forwarding of trophies at various times each year as appropriate;
8. to keep accurate records of trophy winners and to arrange for engraving of Perpetual Trophies;
9. to see that information is available on the World Wide Web;
10. to oversee the supplies of available certificates and to organise replacements when necessary;
11. to write and post certificates on behalf of individual Contest Managers;
12. to arrange a speaker for the annual Remembrance Day Contest and to produce and distribute tapes of the speech for each Division and to arrange for audio to be available on the Internet;
13. to be available via telephone, postal mail and e-mail.

Beyond Our Shores

David A. Pilley VK2AYD
davpil@midcoast.com.au

Some items in this column have previously been broadcast on 'QNEWS'. If you have interesting news from overseas, please send it to the above e-mail address or snail mail.

ITHE

The International Travel Host Exchange, or ITHE, is a programme administered by the German national society, DARC & ARRL. It provides radio amateurs with the possibility of free accommodation with other amateurs around the world

in exchange for you offering accommodation to overseas Amateurs. Most members are in Europe, but there are also amateurs registered in Australia, Canada, India, Indonesia, Japan, Malaysia, New Zealand, Syria, Thailand

and the USA. If you would like further information, please contact Thilo by e-mail: d19kce@darf.de

In VK the WIA Coordinator is John Miller VK3DJM e-mail ithe@wia.org.au
(rsgb/qnews)

Sweden Hamvention

A major new European amateur radio event will take place in Gothenburg for the first time in April next year. The 'Scandinavian HamVention 2003' will be a big 'ham-fest' where Scandinavian and other European radio amateurs can get together. A traditional Scandinavian amateur radio dinner will be held and there will also be a special ladies' program. The Swedish national amateur radio organisation, the SSA, will hold its annual meeting at the same time. Further details are on the Scandinavian HamVention website.

(qnews)

Asteroid followers

Amateur Radio operators listened out for scientists bouncing radio signals off asteroid 2002 NY40 as it did a "flyby" of Earth August 15-20. 2002 NY40 asteroid came close enough to Earth that it was said to be visible to sky watchers using binoculars. Arecibo Radio Observatory in Puerto Rico "pinged" the satellite with radio signals as it approached Earth. Transmitting about 900 kW with 73 dB of gain towards the asteroid with received signal centered at 2380.0 MHz. The signal had a bandwidth of up to 20 MHz.

(sourced from AMSAT.ORG)

5 MHz: Go – No Go!

You may recall in the September "AR" I wrote about the 5 MHz experiment. Now a couple of months underway I thought you might like an update.

The purpose of the allocations were for experimental propagation purposes and antenna investigations aimed at improving the understanding of Near Zenithal Radiation or NVIS (Near Vertical Incidence Skywave) communication via the ionosphere. Quite a number of U.K. stations are taking part in these experiments.

In the USA the situation is somewhat cloudy. The National Telecommunications and Information Administration (NTIA) has recommended that the FCC not grant an ARRL petition for a domestic-only, secondary Amateur Radio allocation at 5 MHz. The NTIA regulates radio

spectrum allocated to the U.S. Federal government. NTIA said Federal agencies are making extensive use of HF for emergency services and believes the Commission's current proposal does not adequately provide for protection from harmful interference to these critical government operations primary in the band. *(They obviously are not affected by the S.E. Asia chit chat that we endure on HF!).* One objection was from The Home Plug Powerline Alliance (HPPA) who were concerned about interference with their 5 MHz appliances! The ARRL continue their battle to secure use of these frequencies.

For those of you interested in Short Wave listening and the U.K. 5 MHz scene, the frequencies are 5260, 5280, 5290, 5400 and 5405 kHz. Each frequency has a 3 kHz bandwidth channel. For operators to use these frequencies they must have a full unrestricted licence and must apply for special permission. Reports on their findings must be regularly sent to the RSGB and the RA. It is expected the time period for use of this band to conduct these experiments will be four years. Already reports have been received from New Zealand.

(RSGB Sept RadCom and ARRL N/L V21/25)

30 metre DXCC

For you DXCC enthusiasts the ARRL DXCC Desk has announced the addition of a 30-metre (10-MHz) single-band DXCC award. Applications for this award will be accepted starting October

1. The 30-metre DXCC certificates will be dated but not numbered. For more information visit dxcc@arrl.org
(ARRL N/L V21/25)

continued next page

Amateur Radio

By subscription with your WIA
membership,
or now in your newsagent

Silent Key

Lieutenant-Colonel Sir Evan Nepean, Bt

From The Weekly Telegraph Issue No 557 27/03/02

Renowned amateur radio operator and member of the British Political Mission to Tibet Lieutenant-Colonel Sir Evan Nepean, 6th Bt, who has died aged 92, was one of the world's best-known operators of amateur radio. call sign G5YN; he was also the last surviving member of the British Political Mission to Tibet in 1936.

Radio was Nepean's lifelong passion - he was to become the longest serving member of the Radio Society of Great Britain, notching up 75 years' membership - and it was as a subaltern serving in the Peshawar District Signals on the North West Frontier of India that he went on the mission to Tibet.

It was in the summer of 1936 that Nepean and a fellow wireless expert in the Royal Signals, Lt. Sidney Dagg, joined the mission led by B J (later Sir Basil) Gould. Among other members of the party was Hugh Richardson, who would some months later become

Britain's last diplomatic envoy in Lasha.

The mission had been proposed by the government of Tibet, then under Regency between Dalai Lamas. They wanted Britain to mediate for the return of the Panchen Lama, the second most senior religious leader in Tibet, who had fled to China in 1923 after falling out with the 13th Dalai.

Nepean set up his tent, sharing it with the transmitter and the receiver, in the Deyki Lingka garden, the mission's base. The aerial was supported on a 40ft mast, and regular contact was kept up with India on the 30-metre wave. Contact was also made with amateurs and Nepean's then call sign, AC4YN, became known around the world - AC4 being for Tibet, YN being two of Nepean's initials. He helped to film the mission with a 16 mm cine camera, and played football as a member of the "Mission Marinots" team against "Lhasa United".



Nepean in the fur-lined Afghan coat which he wore on the Tibet mission

Beyond Our Shores *continued*

Vintage 1AW QSL brings record price

How valuable is (or will be) your QSL card?

In the USA an old 1AW QSL apparently set a price record for the sale of a single QSL card. A vintage Hiram Percy Maxim 1AW card recently sold for \$US 2,125 on the eBay auction site. The winning bidder was a Californian and is a very serious QSL collector. The seller pledged to donate half of his sale commission to the W1AW Endowment Fund. The 1AW

card appears to verify reception of 9CTR on a wavelength of 193 metres rather than a two-way contact. "You were calling another 9," Maxim wrote in the card's "Remarks" section. Although the card proclaims "American Radio Relay League Station 1AW" across the top, the now-famous call sign was Maxim's own personal call sign at the time, not the

League's, and Maxim operated from his home on Hartford.

Until the 1AW card sale, it is believed the highest known price paid for a single QSL card was more than \$US 1,100 for an AC4YN QSL from the Tibet DXpedition of Sir Evan Nepean, G5YN, who died last March at age 92.

(ARRL N/L V21/37)

Argentina: LU - 136 kHz allocation

You may recall reading that Brazil was about to allocate a small band segment on 135 kHz. Roberto Beviglia, LU4BR, President of the Argentinean National Amateur Radio Society, has told the RSGB that, as a result of a rule proposal made to the Argentine radio regulatory department by the RCA, a portion of the

136 kHz band has been allocated to the amateur service on a secondary basis in Argentina. The segment of 135.7 to 135.8 kHz will be coordinated by the RCA until it is finally assigned on a primary basis in a year's time. These are the same frequencies that were sort by Brazil.

(gb2rs news)

If you have interesting overseas news, please share it with us.

Email to

davpil@midcoast.com.au

or mail to VK2AYD

ar

Spotlight On SWLing

by Robin L. Harwood VK7RH.

Some unusual listening!

The year is rapidly drawing to a close and shortwave is still there. Radio Finland did indeed drop programming in English, German and Spanish on the 27th of October yet Finnish and Swedish continues along with Russian. It is unclear whether they will continue with the weekly news bulletin in classical Latin. It was the first and only radio station to do so. The Vatican Radio only has Liturgical broadcasts in Latin

Yet another station has ended their foreign language programming. Radio Austria International (ROI) has dropped programming in Esperanto and Arabic. Radio China International remains one of the very few broadcasting programming in the artificial language of Esperanto.

The *Bayernrischen Rundfunk* in Munich has been a stalwart on 6085 kHz for many decades. This regional station is apparently going to leave shortwave on December 31st. They say it is only temporary but many are wondering if it will be indeed permanent. The best time to hear this station is at 2000 UTC onwards. Don't be confused though as DW from Cologne is on 6075.

Incidentally I came across Swiss Radio

International (SRI) from Berne on 13645 kHz at 2130Z. They were broadcasting in the Swiss-German dialect. I assume that SRI would be doing 30-minute blocks in Italian and French either before or after this German segment. Presumably this was directed to Africa as they have abandoned most of the other areas. There were frequent plugs for their online presence at www.swissinfo.org.

The Islamic holy month of Ramadan commences on the 6th of November. During the daylight hours, believers fast to sunset. Many Islamic broadcasters extend their programming to accommodate this and it may be possible to hear stations that are not normally heard. Many Indonesian regional shortwave stations run all night programming during Ramadan.

There is some confusion when daylight saving time commences in Brazil. I have seen that this will commence on the 3rd of November and go through till February 15th. This may mean the Brazilians may sign on earlier at 0800Z, but as we are in daylight I do not expect that many Brazilian stations would be heard here in southeastern

Australia. The Brazilians mainly use the 90 and 120 metre tropical allocation.

Tensions continue in the Middle East and this is reflected on shortwave. I am hearing plenty of bubble jamming stations pop up on odd channels where Clandestines operate. There is a cat and mouse game with the Clandestines frequently changing channels to avoid these bubble jammers. It is easier hearing the jammers than the Clandestines. You can hear them often within aeronautical and maritime allocations e.g. 8850, 12350 kHz at 1300Z or later at 1900Z. It is believed that both Iran and Iraq may be the source of these jammers.

I recently received an email from a trusted friend on Australian marine HF frequencies. There was an attachment that immediately alerted my antivirus software. It was the Bugbear virus, which was quickly quarantined. Unfortunately this virus altered my friend's email address and I was unable to retrieve the current one.

Therefore I will no longer accept attachments with emails unless by prior arrangement.

Well that is all for this month. Keep listening and 73.

ar

Silent Key

Ron Fisher VK3OM

Vale Arie Bless, one time VK2AVA

Arie Bless VK2AVA, one of the real characters of Australian amateur radio passed away recently. Arie was born in the Netherlands but before migrating to Australia spent many years in Indonesia operating under the call signs PK4DA and PK2DX. He then settled in Springwood just west of Sydney. In the early 1960s he opened a business of importing and selling amateur radio equipment. Sideband Electronics

Engineering became well known for their range of American transceivers. The first of many advertisements in "Amateur Radio" appeared in July 1964 issue announcing the arrival of the Galaxy Range of SSB transceivers. That same issue of "AR" had a story of an SSB convention held in Hamilton Victoria where Arie gave a talk on "recent trends in the development of SSB transceivers". He also had a new Galaxy Transceiver

on display as a typical modern product from the USA.

At his Springwood location Arie built big antennas including a full size three element 40 metre beam which he used for daily skeds with the UK on long path in our afternoons. All were welcome on 7095kHz and many amateurs were initiated into the delights of 40 metre DX. Thanks Arie for enriching amateur radio in Australia

Below is a translation from Dutch (*Electron* September 2002)

Arie was a well known and respected radio amateur for over 70 years and had many friends all over the world. He lived for many years in Indonesia as PK4DA/PK2DX. After having lived for some time in Ecle, Arie went to the spacious

Australia, where his hobby could really come into its own. Building antennas was his reason for living. His home as well as his farm became a real antenna field. Arie was the daily beacon for many. We will remember Arie as a great

friend, who was there when he was needed, even if he had to take a plane from VK to PA! Arie we hope that you have now found peace. Many will miss you. We wish that his children find strength in this.

Verroen family (PAOAVN, PDOMIJN)
ar

Adelaide-Capetown 226

Second 4F5-12 4E Short 10155 km

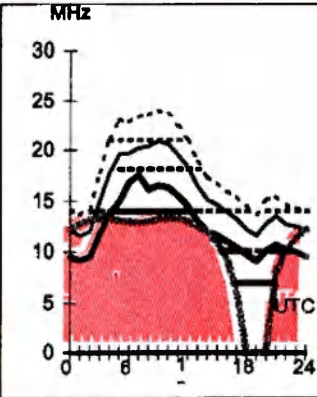
**Brisbane-Dublin 335**

First F 0-5 Short 16670 km

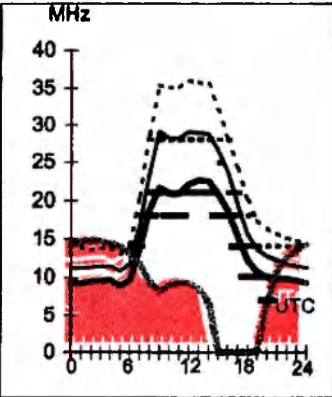
**November 2002**

T Index: 82

Legend

Frequency scale

UD

E-MUF

F-MUF

OWF

ALF

>10%

50%

90%

Time scale

HF Predictions

by Evan Jarman VK3ANI
34 Alandale Court Blackburn Vic 3130

These graphs show the predicted diurnal variation of key frequencies for the nominated circuits.

These frequencies as identified in the legend are:-

- Upper Decile (F-layer)
- F-layer Maximum Usable Frequency
- E-layer Maximum Usable Frequency
- Optimum Working Frequency (F-layer)
- Absorption Limiting Frequency (D region)

Shown hourly are the highest frequency amateur bands in ranges between these key frequencies, when usable.

The path, propagation mode and Australian terminal bearing are also given for each circuit.

These predictions were made with the Ionospheric Prediction Service program: ASAPs Version 4

Adelaide-Honolulu 57

Second 4F7-13 4E Short 9160 km

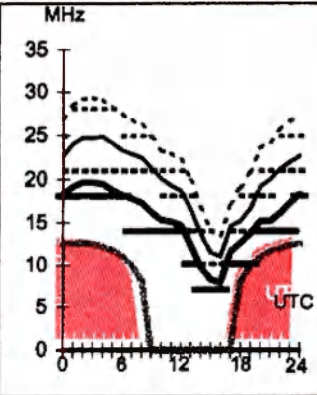
**Brisbane-Lima 122**

First F 0-5 Short 13056 km

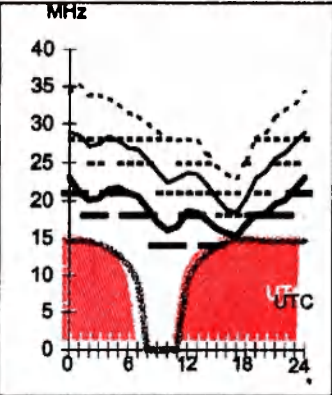
**Canberra-Barbados 123**

First F 0-5 Short 16232 km

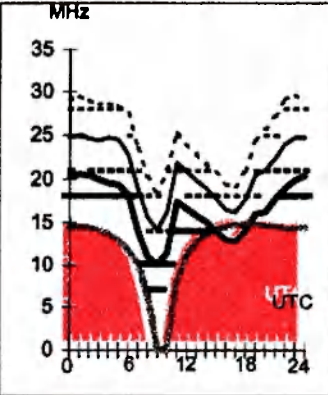
**Darwin-Bangkok 310**

First 2F7-18 2E0 Short 4435 km

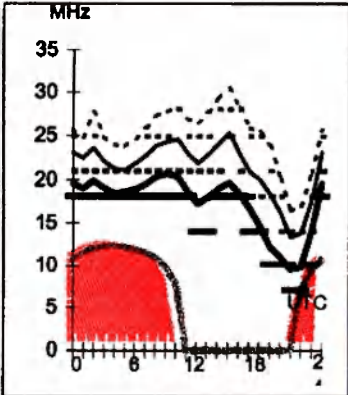
**Adelaide-Lusaka 246**

Second 4F4-10 4E Short 10787 km

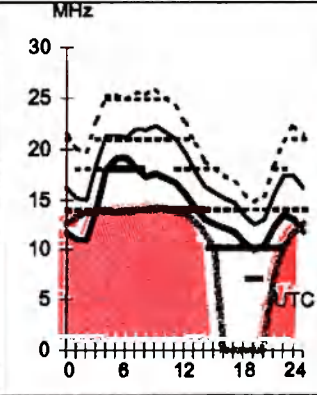
**Brisbane-Seattle 44**

Second 4F2-6 4E Short 11846 km

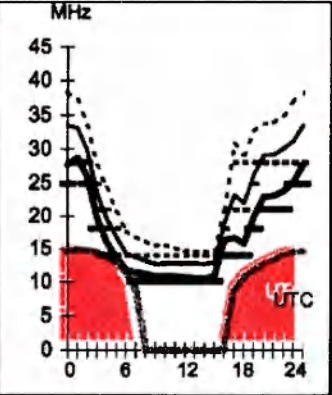
**Canberra-London 136**

First F 0-5 Long 23042 km

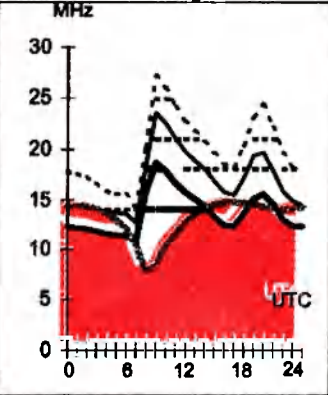
**Darwin-San Francisco 54**

First F 0-5 Short 12316 km

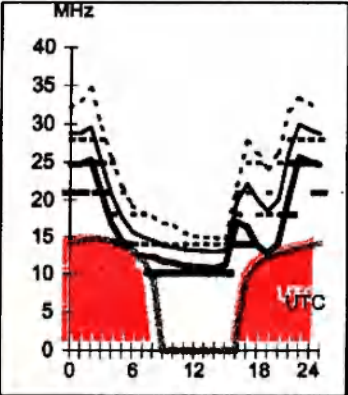
**Adelaide-Singapore 311**

First 2F4-10 2E0 Short 5414 km

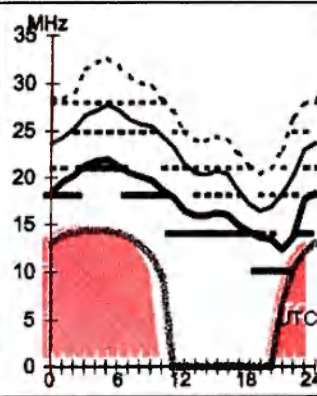
**Brisbane-Tokyo 348**

Second 3F6-11 3E Short 7159 km

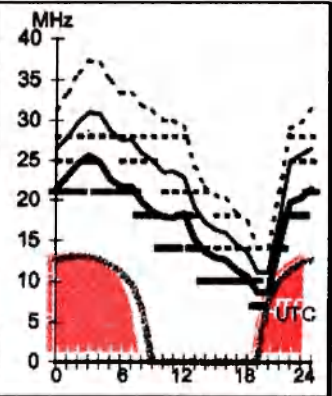
**Canberra-London 316**

First F 0-5 Short 16982 km

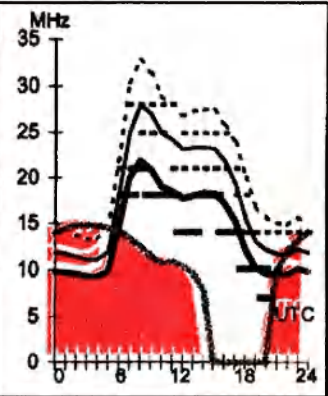
**Darwin-Seoul 356**

Second 3F10-19 3E Short 5575 km

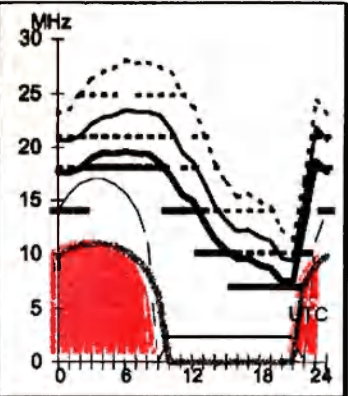

Hobart-Anchorage 28 **Melbourne-Chicago 67** **Perth-London 133** **Sydney-Invercargill 139**
 First F 0-5 Short 12871 km First F 0-5 Short 15568 km First F 0-5 Long 25543 km First F 0-5 Short 2017 km

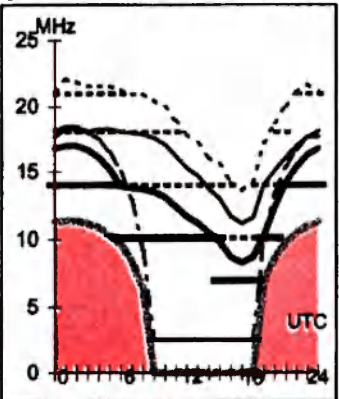
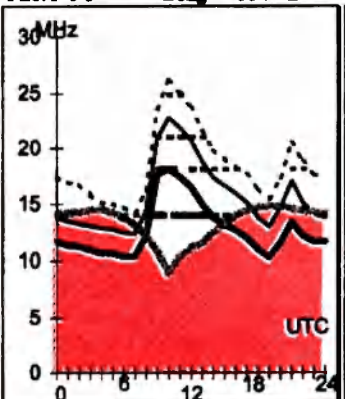
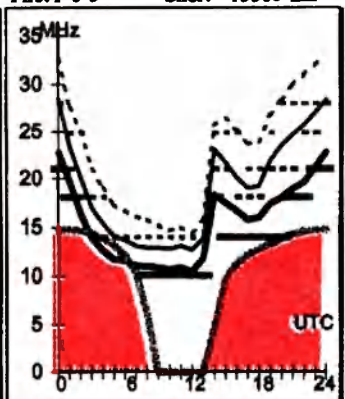
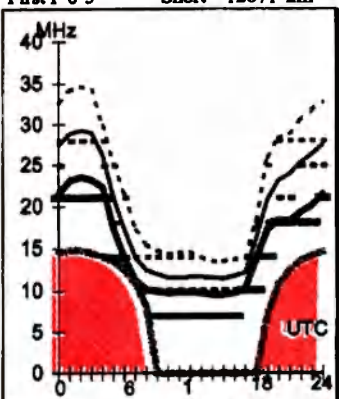

Hobart-Dakar 209 **Melbourne-Moscow 316** **Perth-London 313** **Sydney-New York 66**
 First F 0-5 Short 16556 km First F 0-5 Short 14428 km First F 0-5 Short 14481 km First F 0-5 Short 15988 km

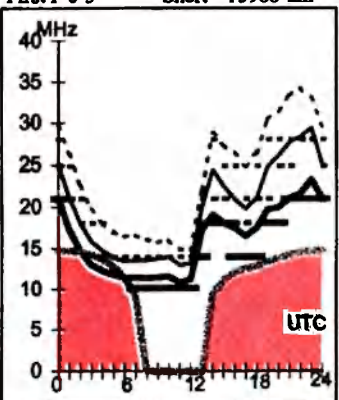
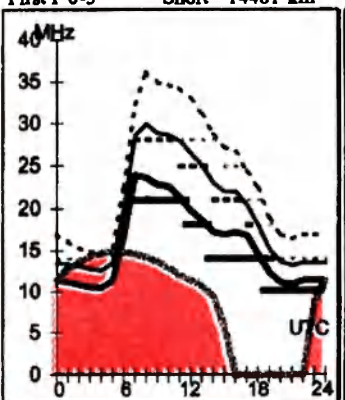
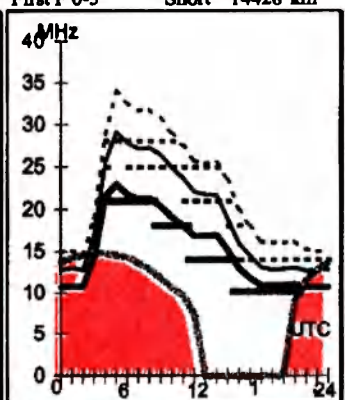
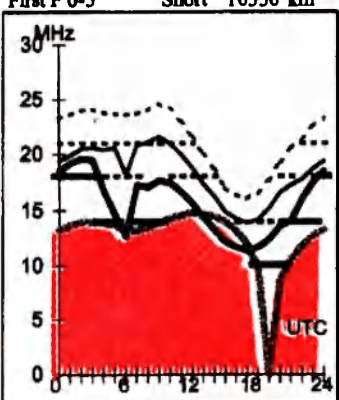

Hobart-Montevideo 161 **Melbourne-Nairobi 258** **Perth-Ottawa 30** **Sydney-Tel Aviv 287**
 Second 4F6-8 4E1 Short 11044 km Second 4F3-8 4E1 Short 11501 km First F 0-5 Short 18212 km First F 0-5 Short 14173 km

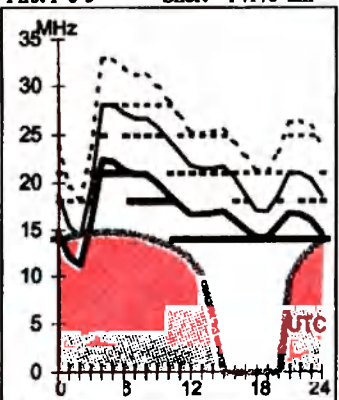
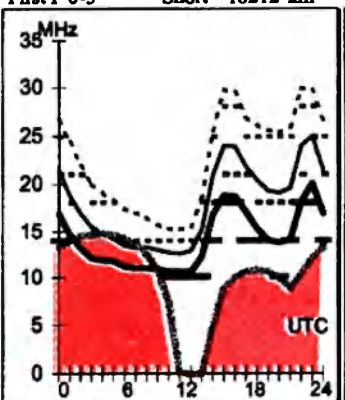
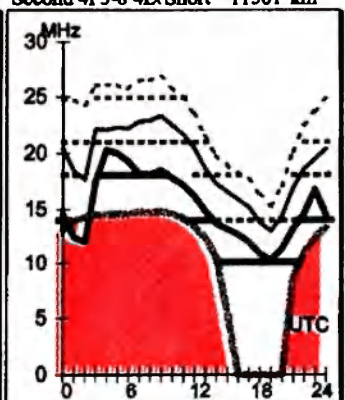
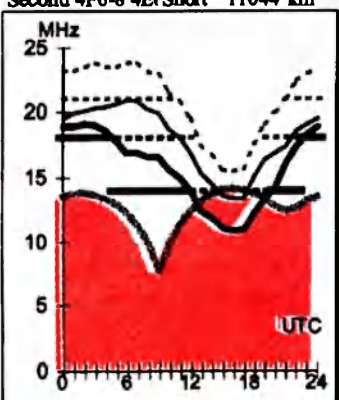

Hobart-Vancouver 49 **Melbourne-Santiago 150** **Perth-Rio de Janeiro 203** **Sydney-St Petersburg 143**
 First F 0-5 Short 13427 km Second 4F4-8 4E1 Short 11273 km First F 0-5 Short 13523 km First F 0-5 Short 25123 km

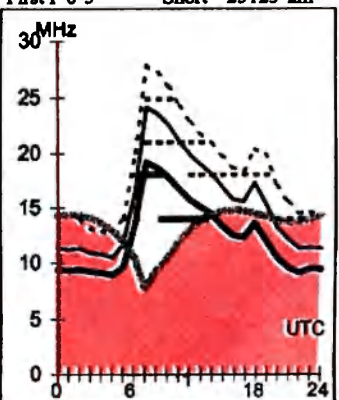
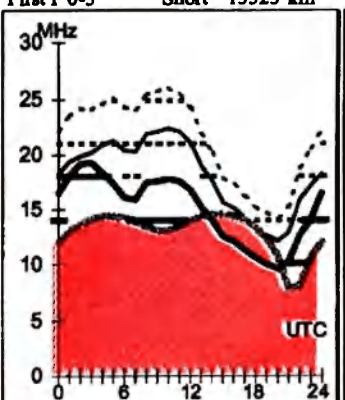
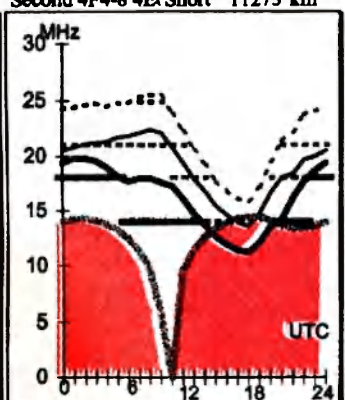
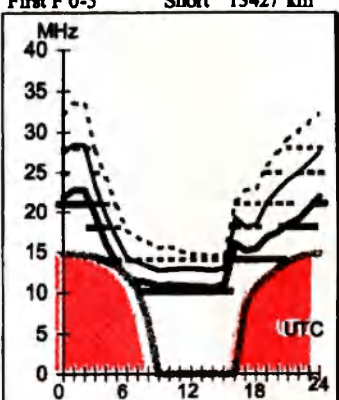

VHF - UHF.. AN EXPANDING WORLD

David K Minchin VK5KK

Postal: 10 Harvey Cres, Salisbury Heights, SA, 5109 Phone: 0403 368 066 AH ONLY

E-mail: tecknolt@ozemail.com.au Web page: <http://members.ozemail.com.au/~tecknolt>

All times are in UTC.

50 MHz

Bevan VK4CXQ reports ... A quick look at some of the 6 metre activity from Townsville from mid Sept to mid Oct. Activity increased somewhat during the period but was rather spread around with only Japan standing out as the main source of any sustained activity. HK6SX was heard on a regular basis with some 599 signals received. Four other KH6/7 stations were working the Pacific and Japan in some good conditions. Other stations briefly heard were VR2s, V73, VK8, FK8 and 5W1SA. Some VK stations also qualified. The 5W1 station was worked on 6Oct but has not been heard since. In all activity has been down on this time last year but a clearer picture should emerge by mid November ... Bevan VK4CXQ Townsville

Both the ZL3TEN 28.228 MHz and

ZL3SIX/B 50.040 MHz are back on air due to major overhaul just in time for the F2/ES season!!! Reports more than welcome at service@mycom.co.nz ...

Mike Foubister ZL3TIC

Bob ZL3TY reports .. ZL7C Chatham Is DXpedition will have stations operating on 6 m and 2 m. I have been asked to set up the VHF stations, which will use an FT100 kindly loaned by Duncan ZL3JT.

On 6 m we will have a 5-element yagi and will operate on 50.117 as much as possible. A CW beacon will operate probably on 50.117.6 zero beat. I hope to have WSJT operational so if you want to try Skeds on this mode I will try to fit them in. FSK441 would result in almost certain QSO's at the distance between ZL and ZL7 on 6. If you want to try this

it would be advisable for you to have prior experience of using this mode before any Skeds. This will greatly enhance your chance of success.

Unfortunately the distance from ZL7 to VK probably rules out this possibility, however VK is a much better prospect on other propagation modes.

For 2m we will be using the same FT100 with an amp, about 150W out to a 12-element yagi horizontally polarised. Random calls will be put out on 144.1 and WSJT Skeds can be arranged. Since the FT100 will probably reside primarily on 6m, 2m operations will probably be infrequent, more probable if conditions seem favourable. We depart for ZL7 on 15 October and return 28 October 2002 ... Bob ZL3TY

144 MHz and above

Mirek VK3DXI/VK2DXI/VK6DXI reports on his Dxpediton to 9M8 East Malaysia ... After operation as 9V1XE and 7XODX on AO40, I have managed to arrange another AO40 mini DXpedition, this time to Sarawak, East Malaysia as 9M8DX. As during my previous trips over there, Festus 9M8FH made all local arrangements. Allan 9M8MA made club room available to me and arranged permit with hotel for all the "roof work". I have stayed at Holiday Inn Kuching. On last floor of the hotel is a clubroom of 9M8RC, which I have operated from.

I have traveled from Singapore to Kuching Sarawak on 26.08.2002 and returned to Singapore on 29.08.2002 My main purpose of the travel was to activate 9M8 on AO40 and give a "show and tell" to local 9M8's on satellite UO14 and AO40 operation Due to weather limitation (big tropical storms) and high squint angles during some parts of AO40 visibility, actual operation on satellite was on 28.08 between 02:00 - 02:30, and 14:50-15:30, and 20:15 till 21:30, so in reality few hours only.

Some 32 QSO were made on AO40, with 4 continents and following countries: DL, I, SM, YB, OE, ZS, JA, VK. From VK I worked: VK1VI (both CW and

SSB) and VK3KOS As the operation was a last minute arranged event, not much publicity was possible. It was announced though via AMSAT web bulletin as well as on AMSAT e-mail bulletin board and W3UR DX bulletin. I have done some HF as well, including RTTY and PSK31, and CW/SSB

Rig used: AO40: Downlink: K5GNA 2" grid antenna with AIDC down converter and FT817 as a receiver. Uplink: home made 2 x 11 element yagi's as per WA5VJB and IC706MkIIIG plus Mirage D1010 amplifier Alinco DM330-MV switching supply PC notebook Compaq Armada. The entire station fits in normal luggage within 20 kg airline limit. On HF I have also used club station's Hy-Gain Explorer for 20,15 and 10 m ... Mirek VK3DXI/VK2DXI/VK6DXI

Mike VK4MIK reports ... you may be interested in the events of late last week and weekend (27 - 29th of September 2002). The Hepburn site at www.iprimus.ca/~hepburnw/dx/dx.htm indicated that ducting was good plus the prevailing weather pattern was also indicating 2 meters would be under the influence of ducting. John VK4JKL heard P29 stations on the VK4RCA repeater and notified all on packet. I had been trying

to make a contact with Felix VK4FUQ via VK4RAT repeater, in Townsville, for some time and on the Saturday was able to make this contact plus later in the day, when the ducting was on the decline, with Gavin VK4ZZ. Mat VK4HAM also was able to get into Townsville repeater from his QTH in Cairns - showing that limited novices can also join in the dx offered by ducting.

The Tableland Radio Group has established a repeater on the eastern edge of the Atherton Tableland, 60 kms, to the south of Cairns. This provides access from Innisfail, to the south, most of the tablelands and into Cairns. Details are at ACA register of Radio-communications Licences at site ID441009. There is a bit of interest in Bill Hepburn tables as they seem to be very precise ... 73s Mike VK4MIK

Tim VK2ZTM reports ... With some changes last weekend (28/29th of September 2002) to antennas for the packet system it has been possible to return the VK2RSY 2 metre beacon - 144.420 MHz - to service. There is still some fine-tuning to be done to keep these various transmitters from fighting with each other. Also yet to be carried out is the relocation of the VHF and UHF

beacon antennas to an elevated mounting for improved coverage, a project still in the planning stage.

The Dural, NSW system now supports a complement of 5 beacons, 6 repeaters, 2 Morse training and 2 packet

Digital DX

Rex VK7MO reports ... I have now received the advice below from Glenn, VK4TZL, that he worked FK8CA on FSK441 - so that is very pleasing and at least we know Alain was on. I don't have an explanation for the weak signals. I think at this stage we should wait and see if Alain sends us a snail mail report and find out what he received and what he would like to try next. Wayne VK2TQP also copied one ping from Alain.

Further ... I have received advice from Glenn, VK4TZL, that we will have two FK8 stations operating next weekend (26/27th of October 2002). ALAIN FK8CA and Patrice FK8HA On the Saturday the FK8 sked will be in the hour before the activity session but on the Sunday with the switch to daylight saving in Vic/NSW it will be at the same

transmissions that are in continuous service. Some beacons and the Morse system are off air during the broadcast periods. In the broadcast format 3 of the repeaters with up to a further 10 transmitters are in use. Add to these the

time. Thus for the Sunday I suggest NSW stations abandon the Type B and try for FK8. FK8 will TX in the first period.

It is pleasing to see Phil, VK3YB, getting a group going each Thursday night from 0830 to 0900 local (Vic/NSW) time on 144.225. Liaison via <http://www.chris.org/cgi-bin/jt44talk>. There may also be some VFSKCW on 144.220 at the same time ... Rex, VK7MO

A new release of WSJT is the first to include the EME Echo mode. This mode allows you to detect and measure your own lunar echoes, even if they are far too weak to hear. The mode can be highly useful for evaluating your station performance, even if you prefer to use CW rather than JT44 for your EME QSO's. If you are a present user of WSJT with no

regional and remote relays and on some mornings a further 15 or more transmitters are in use. This is a real effort and we thank all involved in providing this facility ... Tim Mills VK2ZTM for the WIA Dural Committee

interest in detecting and measuring your EME echoes, you will find no significant advantages to upgrading to WSJT Version 2.3.0. With the exception of a minor bug fix, the FSK441 and JT44 modes are essentially unchanged.

You can download the upgrade from the WSJT home page, <http://pulsar.princeton.edu/~joe/KIJT>, and soon also from the European mirror site <http://www.qsl.net/dk5ya>. To upgrade an existing WSJT installation of Version 1.9.4 or later you should download and execute the file UPD230.EXE, which will replace your existing files WSJT.EXE and WSJT1.DLL with new files of the same name. It should be possible to detect your own signals on two metres with a single yagi and 120 watts.

Microwave News: Offset dishes vs. Prime Focus dishes?

For small dishes, the feed blockage is significant on a prime focus dish, so the offset has a significant advantage. Even on larger dishes, feed and support structure have some blockage loss. Measurements and operating experience suggest that a 450mm offset dish at 10 GHz can perform as well as a 600mm conventional dish with a good feed and feed line.

Better feeds are available for offset dishes, with modest illumination angles, than are available for wide illumination angles. Deep dishes, with $f/D < 0.35$, are particularly hard to illuminate efficiently.

In closing

It is with regret I have to announce that Eric VK5LP has advised me that the VHF/UHF station of VK5LP ceased operating in August 2002. After 41 years of licensed activity on the bands from 50 to 1296 MHz and 10 GHz, his disability and wheelchair confinement prevents him from operating, due in the main to his inability to keep his station operational.

The final crunch came with the destruction of his antenna system by galahs and the likelihood such destruction would continue if repairs

My belief is that the ones used for TVRO were under illuminated for better G/T. The feedline is an important factor. With an offset dish, it is not hard to keep it to a few inches, while a conventional dish either has a feedline of at least the focal length, or has a large box of equipment behind the feed.

Offset dishes can be quieter on receive. Most of the time, they are pointed so that the feed is pointed at quiet sky, making them quieter. Also, a better feed pattern picks up less stray noise, while the feed support structure on a conventional dish

tends to add scattered noise. Radio astronomy dishes take pains to control the shape of the support structure to minimize these effects ... from Paul Wade W1GHZ

For views of a slightly larger dish, images of the reinstallation of the Parkes Radio Telescope (THE DISH!) zenith gearboxes, look at John Sarkissian's latest web page http://www.parkes.atnf.csiro.au/people/jsarkiss/shutdown_2002/. They are just starting the fourth day of grinding each tooth of the rack!

were made. Eric has retained his TS680S because of its capacity to operate on the HF & 6M bands and has a general coverage receiver included. He will retain his callsign, his interest in VHF/UHF and membership of the WIA. See elsewhere in the magazine for further details. Eric has had a long period of enjoyable activity on VHF and UHF and made many friends. He thanks them all for their companionship and particularly their support during the 30 years he wrote "VHF-UHF An Expanding World."

I wish to advise that Rej Allinson, VK2MP, passed away on Friday October 11th, 2002. I understand that Rej was in hospital preparing for surgery, but was overpowered by a serious illness before the operation could take place. Rej was well known amongst the VHF fraternity in South Eastern Australia. His presence during the regular aircraft enhancement Skeds will be sadly missed ... Ian, VK1BG.

I'll leave you with this thought.. "All of the animals, except man, know that the principal business of life is to enjoy it"

Will's Page

Will McGhie VK6UU

21 Waterloo Cr Lesmurdie 6076 will2@iinet.net.au

Modified Sine Wave Inverters

I have spent much time installing amateur radio gear in my recently purchased 4by4 along with a 240 volt inverter. What better than to have amateur radio HF on board. When heading bush! The 240 volt inverter is to run the odd electrical items like battery chargers etc. One of the local electrical retailers was throwing out a 300 watt "modified Sine wave" inverter at half its original price, too good to miss. I tried out the inverter it worked well. However the results with a television were not as I had hoped. The picture had horizontal lines and the sound a most annoying buzz. Modified Sine wave means not a sine wave, but just what was the waveform like? Placing a CRO across the 240 volt output produced the accompanying drawing showing the very "square" wave nature of the modified Sine wave and a peak voltage of 350 volts.

As you can see the waveform is not the usual square wave but a pulse with lots of zero volts. It could be said this waveform is a little closer to a Sine wave than the full duty cycle square wave but it sure requires a good imagination.

I tried placing a high voltage capacitor across the 240-volt output, to see if it would round off the modified Sine wave but this had no effect. A friend suggested running the inverter output through a one to one power transformer, but this also did nothing. I tried several televisions and they all had the same lines on the vision. The interference was not severe but annoying. Perhaps extra filtering in the television power supply might solve the problem but I did not want to fiddle around.

The reason for the change from the original 100% "square wave" to the narrower "square wave" may be to do

with power supplies in some equipment requiring the higher peak voltage in a Sine wave as compared to the original "square wave". The peak voltage in a Sine wave is 340 volt and this reflects in regulated DC power supplies as a higher average voltage across filter capacitors. The original square wave inverters had a peak voltage of 240 volt and this means a lower voltage out of the rectifier that is applied to the filter capacitors that don't now have a higher peak voltage to charge up to. The lower voltage then applied to any regulator could be too low for the regulator to function properly. The modified Sine wave inverter has a peak voltage of 350 volt, the same as a Sine wave. The narrower pulse produces an overall power close to a true Sine wave.

Pure Sine Wave

With my interest in inverters whetted I purchased a Pure Sine Wave inverter and decided on a 150 W one at around \$300, considerably more than the modified Sine wave inverter but a good investment for retirement. On a trip away to Windy Harbour on the Western Australian south coast, where there is no mains ac, this inverter worked well until it was plugged into a couple of normal 240 V mains fluorescent tubes. The inverter failed and refused to operate again. I suspected that for some reason the fluoros had killed the inverter, so on returning home I re-read the instructions. No mention of any problems with fluoros. It was replaced under warranty and I decided to upgrade, for a little extra, to a 300 W pure Sine Wave model. I tested this extensively including placing a normal 4 foot 240 V fluoro across the inverter. All worked well until I placed a second fluoro, when this inverter failed also! It too was replaced under warranty. I explained what had happened and my

belief that fluoros were killing the inverters. The fluoros at Windy Harbour were not the same as those at back home. This ruled out some unexplained problem with a particular fluoro.

The store manager (Jaycar) set up this third replacement inverter on the shop counter and we had up to five different fluoros working well from it. Perhaps it was just bad luck but I did not believe it. I arranged to bring my fluoros into the store the next day and do the test while the manager was watching. Sure enough on placing the second fluoro into circuit the inverter died! The manager wrote me out a replacement document and said he would get back to me.

Back home I nervously placed one fluoro across the modified sine wave inverter and all worked okay. A second fluoro worked but only for a couple of minutes and then the inverter failed, but not completely; it worked after the fluoros were disconnected. Repeating the load test gave the same results.

I have thought of one possible reason for the problem. Mains operated fluorescent tubes are inductive and require a power factor correction capacitor of around $3\mu\text{F}$ to restore the power factor back to one. When 240 volt is first applied to a fluoro, the fluoro tube is not effectively in circuit until it strikes. However during this period the power factor correction capacitor is in circuit as it is connected directly across the mains. Maybe the inverter cannot run into a highly capacitive load, which adds up to $6\mu\text{F}$ with two fluoros connected. Why the five fluoros worked at the store I don't know. Perhaps they did not have power factor correction capacitors.

Have any readers had similar problems with Pure Sine Wave inverters running 240 volt fluorescent tubes, if so let me know? I will let you know the outcome with the electronics store.

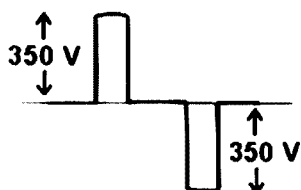

MODIFIED SINE WAVE

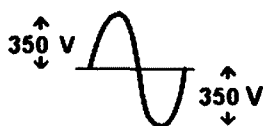

TRUE SINE WAVE 240V RMS

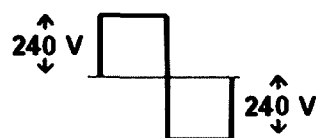

SQUARE WAVE

Over to you

Novice Cram Course - A Review?

Well who decided to give the task of reviewing Ron Bertrand's product to C. Low, B. Edmonds & C. Taylor for heavens sake? AR October 2002

A bit like asking the Holden Dealer Team to review the new Ford Falcon! How could they contain themselves? The 'review' ends up at the very least 'picky', if not downright 'catty' and is a poor bit of biased journalism. It's interesting that the editor admits to 'bringing the comments together' which is probably code for a 'strong edit' and one can only guess what was left out!

I had the good fortune to meet Ron Bertrand many years ago when attempting to exit from my CB boom roots into Amateur Radio. I did not do any of his courses but know many who did and there are not too many who know him who would doubt his total dedication to amateur radio. He is the sort of bloke who will always help and encourage would-be hams to become licensed.

For my NAOCP theory, I used a small book from Tandy called "From 5 watts to 1000". It did not cover the whole

NAOCP syllabus, but I went into that exam knowing every word of that book and passed with 92%. Upgrading was a similar exercise in cramming. In those days before the exams became multi choice, the theory exam was an essay type with, I think, 12 questions and you had to write essay answers to 6 out of the 12. I simply looked at as many past exam papers as possible and learned all about those questions that recurred, succeeding at my second attempt. Now you can pontificate and call me a 'black box operator' if you like, even an 'ex-CBer', but I am still active and still enjoy operating. I didn't want to be a radio engineer! I wanted to operate ham radio and that exam and the CW had stood between me and that goal. How I made it is less important to me than the fact that I did.

Now I'm very aware that the three reviewers have also been very dedicated to the ongoing education of amateurs over a long period of time and do a fantastic job. But surely their aim should be to encourage all potential amateurs to qualify for a licence in any way

possible. Potential amateurs like the CB operator who picked up AR at the newsagent and wrote an interesting letter "Why Amateur Radio is dying" - AR October 2002. If their review of Ron's course has 'turned off' just one potential amateur who could have succeeded with Ron's course, then that's one who may never try again.

At the end of the day, we need more licensees who are actually going to operate on the bands - "Use 'em or lose 'em" - and while Ron would want his students to understand their subject, his primary object is to get more people licensed. By all reports, over the years, he's done a damn good job and this product, being PC based, sounds the goods since we are losing potential hams to other communication formats particularly PCs.

One of my mentors told me long ago, that if you can't say something good about someone, you should say nothing!

Neil Cornish VK2KCN
neilcorp@kooee.com.au

On air behaviour

On a recent Saturday afternoon a friend and I were evaluating his antenna as we talked on the lower end of the 40 metre band. Ross VK1UN/2 was the station I was talking to and even though he only had low power signals were very strong.

Suddenly a voice arrived on the frequency uttering that I was causing interference with the statement "your signal is broad and way over driven" this caused me to examine all the settings which appeared normal. Ross and I persisted on the frequency and the voice again interjected "you should get back to the chicken band" at which I requested a call sign.

The call sign was supplied (from the East Coast of Australia) and given the circumstances Ross and I decided to try another band anyway. When I returned to the frequency it was obvious that a net was to happen very close to the frequency we had been using, probably

half a kilohertz away or so. Conditions on the day were enhanced; later other stations confirmed that no detectable problem could be found with my transmission during a two hour or so contact.

I read the timely comments by The Federal WIA president regarding on air behavior, this event has again encouraged me to consider selling the few pieces of amateur equipment I own and forgetting the hobby.

What if any is the significance of a Six Metre DXCC anyway, let alone 24 years on air since leaving High School!

This hobby may be seen by those whom administer it as an anachronism!

Of course this is the minority of situations that occurs, my faith has been restored by common sense operation a little in the meantime!

73 de Neville VK2QF / VK2ANZ,
(ex 4W/VK2QF).
6m DXCC #289.

PLAN AHEAD

for

May 2003

WIA

**Federal
Convention**



MDRC

**Hamfest
Glen Waverley**

HAMADS

FOR SALE NSW

- **FT-757GX II** S/n OD 4206987 \$600. **FT-212 RH** S/n 9G-330232 \$275. VK2DJM AH 2030hrs. Firm. Phone 02 6686 8742.
- **Packet equipment.** 1200/4800 Tiny 2s radios Pakratt MBX232, cables, diode matrix, books. David VK2BDT, Goulburn. If interested phone 02 4821 5036
- **Valve tester Taylor Model Windsor 45C** (ex-PMG) Complete with book and valve chart and 100s of new and secondhand valves \$275. Reg Rundle, Greenwell Point NSW. Phone 02 4447 1493. run@shoal.net.au
- **Antenna Hustler 5BTV** HF trap vert (unused) \$300; **Hustler 90-MTK** 30m kit for **5BTV** (unused) \$70; 100 m coax cable **DSE RGS8CU** 50 ohm (unused) \$70; 100 m cable **H/D 26/030 red/blk** (unused) \$80; **3-way coaxial antenna switch, Southern Star D-S206** \$15. Cyril formerly VK2ACQ Phone 02 9701 4312 (leave message if unattended)
- **BOOK: "Radiotelegraph and Radiotelephone Codes, Prowords and Abbreviations"** 3rd Edition (236 pages), 610 gm, 1.5 lbs, now available. Probably the World's best compilation of this info now available. Q,X,Z Codes, 142 Phonetics, 24 Morse, 8 Needle codes. Myer, Phillips, 10, 11, 12, 13 and other codes. Much other info, abbreviations, procedures and methods. AU\$25 + P&P. Post calc from Postcode 2480. Internet: <http://www.nor.com.au/community/sarc/phonetic.htm>. John Alcorn, VK2JWA, QTHR, Phone 02 6621 5217, vk2jwa@sarc.org.au
- **Power Supply 13.8v (adjustable) 60 amp** continuous choke input filter weighs 25 kg \$200 ono VK2ZHR. Phone 02 4930 7671

WANTED NSW

- **Receiver, general coverage**, for amateur radio minded high school student. Must be reasonable priced. Reply Peter VK2DBI, QTHR. Phone 02 6367 5095
- **Kenwood SW-2000 SWR meter** with SWC-3 remote coupler VK2KL, QTHR. AH Phone 02 6584 2997, BH 0408 818 442
- **Yaesu FRG-100 communications receiver** in good condition with power supply and manual, if possible. John VK2GQK, QTHR. Phone/fax: 02 6568 3323, email: jwallvk2@tsn.cc

FOR SALE VIC

- **Yaesu VX5 H/H triband** as new, comes with new spare Lithium-ion battery, Sp/mic, charger, filtered DC power adaptor, carry case ADMS-IE software and more. Ser no 9K160317, \$600. **Yaesu VX1 H/H** micro dual band, comes with new spare Lithium-ion battery, filtered DC power adaptor, carry case, 30 watt linear. As new, \$300. Ted Filuk, VK3KTF, 3 Hare Court, Bacchus Marsh 3340. Phone 03 5367 4439
- **Kenwood transceiver TS-440S**, very good, in original box, serial no 7051799, with automatic tuner unit and user manual, \$650. Brian VK3WP QTHR. Phone 03 9723 6110, email kendersbee@yahoo.com
- **Dec'd estate: Kenwood HF transceiver TS-43X**, pwr supply **PS-430**, Auto antenna tuner **AT-260**, speaker **SP-430** and mike (hand and desk) \$1,800 ono. **Yaesu eonun receiver FRG-7700**, tuner **FRT-7700** & converter **FRV-7700** \$350 ono. Yaesu transceiver (**FT-211 & FT-411**) \$150 each ono. Bruce. Phone 03 9722 2310, henriette2@optusnet.com.au.

WANTED VIC

- **Service manual and instruction manual for Kenwood TS-130S**. All costs met. Stephen VK3JY, QTHR. Phone 03 9836 3841
- **Technical service book for Kenwood TS-820S or TS-520** VK3CFF, QTHR. Phone 03 5338 1927
- **FT-790 Yaesu 70cm** all mode portable transceiver. Must be in good working order. Contact Ian VK3AQU AH Phone 03 57 511 631, or email lorian@netc.net.au
- **Kenwood R-820 Receiver**, reasonable condition. Ron VK3OM, QTHR, Phone (03) 59443019

FOR SALE QLD

- Quantity **'QST'** from 1926 onwards to approx 1952 save breaks for WW2. Similarly **'73'** and **'CQ'** plus other mags. Must clear lot, moving into residential homes. Sidney Grantham VK4SG, 36/17 Mile Rocks Road, Oxley Qld.
- **Ceramic Roller inductors, ceramic variable capacitors, VHF AVO valve characteristic meter MK4** with valve data manual and handbook, **HP CRO camera**. John VK4AAF Phone 07 4928 6573
- **Two (2) TS-120S**, one good and one for parts. One **TS-120V** and remote VFO, both good. Reply to VK4DV QTHR. Phone 07 4928 5537

WANTED QLD

- Ex army **WWII TX/RX typo 208 set** manuf. by Radio Corp. Melb c 1942/3. Also **Kingsley AR7 power supply** 12/240V. Ray VK4FH, PO Box 5263, Daisy Hill 4127. Phone 07 3299 3819, fax 07 3299 3821
- **Barlow Wadley XCR-30 receiver** in good condition. Top dollars paid. Ray, VK4ZKI QTHR. Phone 0418 708 315, email ivins@gil.com.au
- **Plessey ICs** SL610, SL621, SL622, SL630, SL640, SL641. L Schmidt, VK4JZ, 62 Laguna St, Boreen Point 4565, phone 07 5485 3324
- **Cavities wanted**, two for 2 metres. Phone 07 5578 2293 or email: smokey2@winshop.com.au, VK4KD.

WANTED SA

- **Large power transformer**, 385 volts CT 385 volts 100 mA or more, filament 5 volts and 6.3 volts. Terminal board essential. NOT loose wires. VK5ZLC QTHR
- **To restore Army Landrover Series III** fitted for radio we need: for **Radio Set AN/GRC-160**: amplifier power supply group OA-3633, mounting MT-1029, cable CX-4720. And for **Radio Set AN/GRC-106A**: amplifier AM-3349, mounting MT-3140, headset H-227/U, key telegraph KY-116/U and copy of manual TM 11-5820-520-35. Harro VK5HK, QTHR. Phone 08 8323 9622

WANTED WA

- **9MHz HC-49 crystal**, prefer Kenwood part L77-0981-05. VK6ABS, QTHR. Phone 08 9075 4136

About hamads....

- Hamads may be submitted by *email* or on the *form on the reverse of your current Amateur Radio address flysheet*. Please print carefully, especially where case or numerals are critical.
- Please submit separate forms for For Sale and Wanted items, and be sure to include your name, address and telephone number (including STD code) if you do not use the flysheet.
- Eight lines (forty words) per issue free to all WIA members, ninth and tenth lines for name and address. Commercial rates apply for non-members.
- Deceased estates Hamads will be published in full, even if the ad is not fully radio equipment.
- WIA policy recommends that the serial number of all equipment for sale should be included.
- QTHR means the address is correct in the current WIA Call Book.
- Ordinary Hamads from members who are deemed to be in general electronics retail and wholesale distributive trades should be certified as referring only to private articles not being re-sold for merchandising purposes.
- Commercial advertising (Trade Hamads) are pre-payable at \$25.00 for four lines (twenty words), plus \$2.25 per line (or part thereof), with a minimum charge of \$25.00. Cheques are to be made out to: WIA Hamads.
- Copy should be typed or printed clearly, and be received by the deadlines shown on page 1 of each issue of Amateur Radio, at:

Email: newsletters@ozemail.com.au

Fax: 03 9756 7031

Postal: Newsletters Unlimited, PO Box 431, Monbulk Vic 3793

FOR SALE NT

• **Kenwood YK-88CN-1 CW narrow filter**, 8830 kHz cf, 270 Hz bw, \$30. **ICOM OPC-689** microphone adapter cable, 8 pin modular to 8 pin standard microphone, new in unopened original packaging, suits ICOM IC-706 (others?), \$30. JJ, VK8JJ, Phone 08 8953 0065, vk8jj@ozemail.com.au

WANTED NT

• **Icom IC-4A or IC-04A 70cm FM**, handheld in working order. Battery condition not important. **Icom IC-706 Mark I**, early model preferred, in working order. Accessories not important. Jeff VK8GF, QTHR. Phone 08 8952 1016 AH, emailvk8gf@austarnet.com.au

MISCELLANEOUS

• The WIA QSL Collection (now Federal) requires QSLs. All types welcome, especially rare DX pictorial cards, special issue. Please contact the Hon Curator, Ken Matchett VK3TL, 4 Sunrise Hill Road, Montrose Vic 3765, tel. (03) 9728 5350

TRADERS
Advertise in 
03 9756 7797

TRADE ADS

PSK-31, SSTV, RTTY SOUNDBOARD INTERFACES

Fully isolated, ready to plug in.
<http://www.G3LIV.CO.UK>,
 johnny@melvin.com, G3LIV QTHR.

AMIDON FERROMAGNETIC CORES:

For all RF/electronic applications.
 See our website for complete data on all cores including prices.

RJ & US Imports,
 PO Box 431, Kiama NSW 2533.

A 3.5" PC disk containing all data is available for \$5.00 incl. post.

www.catchnet.com.au/~rjandusimports

Agencies at: Active Electronics, Tas; Truscotts, Electronic World, Melbourne; TTS Systems, Tyabb; Tower Communications, Perth; Haven Electronics, Nowra.

HF, VHF, UHF ANTENNAS & ACCESSORIES

Alum towers, guys etc. Diamond VSWR/PWR meters. HD copper ant wire & insulators. TX tubes & pwr transistors. Quality coax cables & connectors. Free advice & catalogue.
 ATN Antennas Ph 03 5492 2224 Fax 03 54922666, email atnant@ruralnet.net.au

THE WIA BOOKSHOP

DISCOUNTS FOR WIA MEMBERS

ARRL

RSGB

EDUCATIONAL

CALLBOOKS

COMPREHENSIVE RANGE

109 Wigram Street, Parramatta, New South Wales, Australia.

PO Box 432, Harris Park, NSW, Australia 2150.

Phone: +61 2 9689-2417

Facsimile: +61 2 9633-1525

Toll free in New South Wales outside Sydney: 1800 817-644

Office Open 11am - 2pm Tuesdays & Thursdays Email: vk2wi@ozemail.com.au

We take mail, phone, email and fax orders

How to submit material to Amateur Radio Electronically:

- Text:** Microsoft Word, Text or RTF file, *no graphics embedded.*
- Diagrams:** 300 dpi jpeg (preferred), tiff or pdf (last resort!)
- Photos:** 300 dpi jpeg, tiff or eps. Light coloured background, but beware of flash shadows. If submitting for cover, send 600 dpi jpeg, preferably portrait rather than landscape orientation.
- Email to:** edarmag@chariot.net.au

Hard copy:

- Text:** Preferably typed or word processed, one and a half spacing. If handwritten, must be clear
- Diagrams:** Clear black lines and labelling, for either scanning or redrawing by Amateur Radio
- Photos:** Light coloured background, but beware of flash shadows. When photographing equipment remember that it will be reproduced in black and white so aim for contrasting colour *tonings*, e.g. yellow and blue will scan as white or light grey, but red will come up black. For cover photos portrait orientation is preferred over landscape.
- Send to:** The Editor, *Amateur Radio*, 34 Hawker Crescent, Elizabeth East SA 5112

ADVERTISERS INDEX

Com-an-tena.....	24
Connektron.....	33
G & C Communications.....	27
Icom.....	OBC
Strictly Ham.....	8
TTS.....	16
WIA Call Book.....	IFC

<http://www.hamsearch.com>

a not-for-profit site that is a search engine for hams

TRADE PRACTICES ACT

It is impossible for us to ensure that the advertisements submitted for publication comply with the Trade Practices Act 1974. Therefore, advertisers and advertising agents will appreciate the absolute need for themselves to ensure that the provisions of the Act are strictly complied with.

VICTORIAN CONSUMER AFFAIRS ACT

All advertisers are advised that advertisements containing only a PO Box number as the address cannot be accepted without the addition of the business address of the box-holder or seller of the goods.

"Hey, Old Timer..."

If you have been licensed for more than 25 years you are invited to join the



Radio Amateurs Old Timers Club Australia

or if you have been licensed for less than 25 but more than ten years, you are invited to become an Associate Member of the RAOTC.

In either case a \$5 joining fee plus \$8.00 for one year or \$15.00 for two years gets you two interesting OTN Journals a year plus good fellowship.

Write to

RAOTC,
 3/237 Bluff Road
 Sandringham VIC 3191

or call Arthur VK3VQ on 03 9598 4262 or Allan VK3AMD on 03 9570 4810, for an application form.

Email your hamad

Then we just cut and paste

You proof it, you retain control

newsletters@ozemail.com.au



Division Directory

The Amateur Radio Service exists for the purpose of self training, intercommunication and technical investigation. It is carried out by amateurs who are duly authorised people interested in radio technique solely with a personal aim and without pecuniary interest.

The Wireless Institute of Australia represents the interests of all radio amateurs throughout Australia. National representation is handled by the executive office under council direction. There is one councillor for each of the seven Divisions. This directory lists all the Divisional offices, broadcast schedules and subscription rates. All enquiries should be directed to your local Division.

Broadcast schedules All frequencies MHz. All times are local.

VK1 Division Australian Capital Territory,
GPO Box 600, Canberra ACT 2601
President Gilbert Hughes
Secretary Peter Kloppenburg
Treasurer Linden S Orr

VK1GH
VK1CPK
VK1LSO

VK1WI: 3.590 LSB, 146.950 FM each Thursday evening from 8.00pm local time. The broadcast text is available on packet, on Internet [aus.radio.amateur.misc](http://www.aus.radio.amateur.misc) news group, and on the VK1 Home Page <http://www.vk1.wia.ampr.org>

Annual Membership Fees. Full \$80.00 Pensioner or student \$71.00. Without *Amateur Radio* \$48.00

VK2 Division New South Wales
109 Wigram St, Parramatta NSW
(PO Box 432, Harris Park, 2150)
(Office hours Tue, Thurs, Fri 1100-1400)
Phone 02 9689 2417

Web: <http://www.wiansw.org.au>
Freecall 1800 817 644
e-mail: vk2wi@ozemail.com.au
Fax 02 9633 1525

President Terry Davies
Secretary Owen Holmwood
Treasurer Chris Minahan

VK2KDK
VK2AEJ
VK2EJ

VK2WI transmits every Sunday at 1000 hrs and 1930 hrs on some or all of the following frequencies (MHz): 1.845, 3.595, 7.146, 10.125, 14.170, 18.120, 21.170, 24.950, 28.320, 29.170, 52.150, 52.525, 144.150, 147.000, 432.150, 438.525, 1273.500. Plus many country regions on 2m and 70cm repeaters. Highlights are included in VK2AWX Newcastle news Monday 1930hrs. on 3.593, 10 metres and local repeaters. The text of the bulletins is available on the Divisional website and packet radio. Continuous slow morse transmissions are provided on 3.699 and 144.850.

Annual Membership Fees. Full \$80.00 Pensioner or student \$63.00. Without *Amateur Radio* \$50.00

VK3 Division Victoria
40G Victory Boulevard Ashburton VIC 3147
(Office hours Tue 10.00 -2.30)
Phone 03 9885 9261

Web: <http://www.viavic.org.au>
Fax 03 9885 9298
e-mail: viavic@viavic.org.au

President Jim Linton
Secretary John Brown
Treasurer Barry Wilton

VK3PC
VK3JJB
VK3XV

VK3BWI broadcasts on the 1st Sunday of the month at 20.00hrs Primary frequencies, 3.615 DSB, 7.085 LSB, and FM(R)s VK3RML 146.700, VK3RMM 147.250, VK3RWG 147.225, and 70 cm FM(R)s VK3ROU 438.225, and VK3RMU 438.075. Major news under call VK3ZWI on Victorian packet BBS and WIA VIC Web Site.

Annual Membership Fees. Full \$83.00 Pensioner or student \$67.00. Without *Amateur Radio* \$51.00

VK4 Division Queensland
PO Box 199, Wavell Heights, Old. 4012
Phone 07 3221 9377
e-mail: office@wiaq.powerup.com.au
Fax 07 3266 4929

Web: <http://www.wia.org.au/vk4>

President Ewan McLeod
Secretary Bob Cumming
Treasurer Bill McDermott

VK4ERM
VK4YBN
VK4AZM

VK4WIA broadcasts on 1.825 MHz SSB, 3.605 MHz SSB, 7.118 MHz SSB, 10.135 MHz SSB, 14.342 MHz SSB, 21.175 MHz SSB, 28.400 MHz SSB, 29.660 MHz FM (rptr), 147.000 MHz, and 438.525 MHz (in the Brisbane region, and on regional VHF/UHF repeaters) at 0900 hrs K every Sunday morning. QNEWS is repeated Monday evenings, at 19.30 hrs K, on 3.605 MHz SSB and 147.000 MHz FM. On Sunday evenings, at 18.45 hrs K on 3.605SSB and 147.000 FM, a repeat of the previous week's edition of QNEWS is broadcast. Broadcast news in text form on packet is available under WIAQ@VKNET. QNEWS Text and real audio files available from the web site

Annual Membership Fees. Full \$95.00 Pensioner or student \$81.00. Without *Amateur Radio* \$69.00

VK5 Division South Australia and Northern Territory
(GPO Box 1234 Adelaide SA 5001)
Phone 08 8294 2992

web: <http://www.sant.wia.org.au>
email: peter.reichelt@bigpond.com

President Trevor Quick
Secretary Peter Reichelt
Treasurer Trevor Quick

VK5ATQ
VK5APR
VK5ATQ

VK5WI: 1843 kHz AM, 3.550 MHz LSB, 7.095 AM, 14.175 USB, 28.470 USB, 53.100 FM, 147.000 FM Adelaide, 146.800 FM Mildura, 146.900 FM South East, 146.925 FM Central North, 438.475 FM Adelaide North, ATV Ch 35 579.250 Adelaide. (NT) 3.555 LSB, 7.065 LSB, 10.125 USB, 146.700 FM, 0900 hrs Sunday. The repeat of the broadcast occurs Monday Nights at 1930hrs on 3585kHz and 146.675 MHz FM. The broadcast is available in 'RealAudio' format from the website at www.sant.wia.org.au Broadcast Page area.

Annual Membership Fees. Full \$88.00 Pensioner or student \$73.00. Without *Amateur Radio* \$58.00

VK6 Division Western Australia
PO Box 10 West Perth WA 6872
Phone 08 9351 8873

Web: <http://www.vk6wia.org>
e-mail: vk6wia@iinet.net.au

President Neil Penfold
Secretary Christine Bastin
Treasurer Bruce Hedland-Thomas

VK6NE
VK6ZLZ
VK6OO

VK6WIA: 146.700 FM(R) Perth at 0930hrs Sunday relayed on 1.865, 3.564, 7.075, 10.125, 14.116, 14.175, 21.185, 29.120 FM, 50.150 and 438.525 MHz. Country relays 3.582, 147.200 (R) Cataby, 147.350 (R) Busselton, 146.900 (R) Mt William (Bunbury), 147.000 (R) Katanning and 147.250 (R) Mt Saddleback. Broadcast repeated on 146.700 at 1900 hrs Sunday relayed on 1.865, 3.564 and 438.525 MHz : country relays on 146.900, 147.000, 147.200, 147.250 and 147.350 MHz. Also in "Real Audio" format from the VK6 WIA website

Annual Membership Fees. Full \$71.00 Pensioner or student \$65.00. Without *Amateur Radio* \$39.00

VK7 Division Tasmania
PO Box 371 Hobart TAS 7001
Phone 03 6234 3553 (BH)

Web: <http://www.lased.edu.au/tasonline/vk7wia>
also through <http://www.wia.org.au/vk7>
email: batesjw@netspace.net.au

President Mike Jenner
Secretary John Bates
Treasurer John Bates

VK7FB
VK7RT
VK7RT

VK7WI: 146.700 MHz FM (VK7RHT) at 0930 hrs Sunday relayed on 147.000 (VK7RAA), 146.725 (VK7RNE), 146.625 (VK7RMD), 3.570, 7.090, 14.130, 52.100, 144.150 (Hobart), repeated Tues 3.590 at 1930 hrs.

Annual Membership Fees. Full \$90.00 Pensioner or student \$77.00. Without *Amateur Radio* \$57.00

VK8 Northern Territory is part of the VK5 Division and relays broadcasts from VK5 as shown, received on 14 or 28 MHz. The broadcast is downloaded via the Internet.

Hams at Home

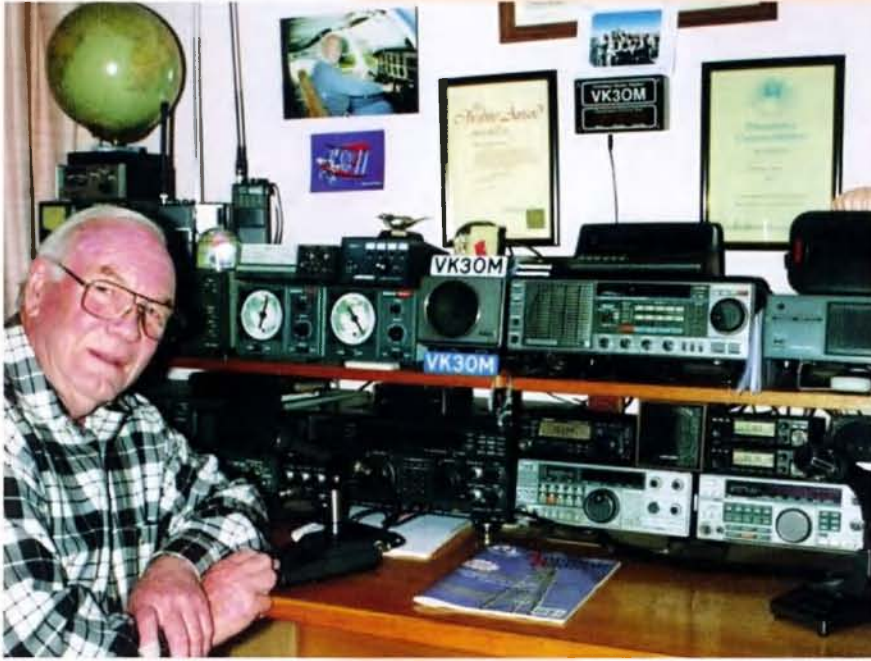

VK3OM Ron Fisher's shack. A well laid out installation. Ron is a member of the Amateur radio Publications Committee and has many years' service supporting the production of Amateur Radio Magazine. Ron's knowledge of Amateur radio equipment is also much in demand. Ron is proficient with a camera and many of his photographs have been used in the magazine.

VK3IO Ron Tremayne at home in Cockatoo. Ron as you can see likes open wire feeders. The picture shows his Kenwood TS690S, the open wire antenna relay switching matrix and some of the Link Coupled Open Wire feeder ATUs. There are 18 altogether (two per HF band) and they match to two 160 metre, Top Band, dipoles. This extreme solution saves retuning when changing bands.

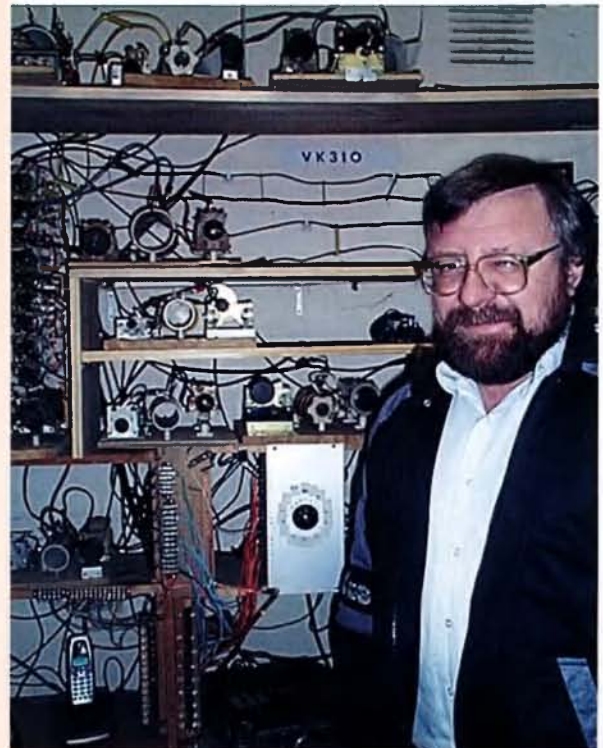

ICOM'S GREAT CHAMPIONS



IC-756PROII

NO FILTERS REQUIRED

Sharp & soft IF filter shape • Improved 3rd IMD & wide dynamic range • One-touch record/play Digital voice memory • Extended 1/4 Tuning step & BPF functions for SSB-D mode • 32-bit floating-point DSP and 24-bit AD/DA converter • SSB/CW synchronous tuning • 4.9-inch color TFT LCD



IC-718 A compact HF all band transceiver.

A superior performer with simple, straightforward operation with keypad • Optional AF DSP capabilities, including noise reduction & auto notch function • It's versatile, compact & loaded with features.



IC-910H The new dimension in the VHF/UHF world!

Tri band multimode transceiver • 2M -100W, 70CM - 75W, (optional 23CM, 10W) • 9600bps packet operation • Satellite communication Reverse/normal tracking doppler shift compensation CIV capability for PC control • Optional 2.4G down convertor.



IC-706MKIIG HF • VHF UHF

The amazing evolution of the legendary 706.

Now includes 70cm @ 20W and 50W, on 2m Standard feature dsp • Built in sub tone encoder & decoder Tone scan • Mosfet PA • You get base station performance and features in a mobile rig sized package.



IC-T90A A new 5W Triband handheld

VHF/UHF FM 2M, 6M, & 70CM
Wideband receive 495 KHz - 1 GHz
555 Alphanumeric memories • 13 Scan modes
DTCS & CTCSS encode & decode
DTMF encoder (10 memories)
Wide/narrow transmit capability.



ICOM

Clearly Ahead

2 YR WARRANTY

find your nearest ICOM dealer at

www.icom.net.au or (03) 9387 0666

The magazine for **AUSTRALIAN** Amateurs



December 2002

January 2003

Volume 70 No 12



Amateur Radio

\$ 5.95

Holiday Projects

An Update on the **Double Tuned Crystal Set**
by Felix Scerri VK4FUQ

plus

2

Drew Diamond VK3XU projects

- ◆ A Temperature-controlled Crystal Frequency Calibrator
- ◆ Uses for a Dip Oscillator

Measuring echoes and propagation on the HF bands
Part 1

International Call Signs
Quick reference table

Season's Greetings



connektron

STRICTLY HAM

COM-AN-TENA **ICOM**
G. & C. COMMUNICATIONS



Callbook 2003

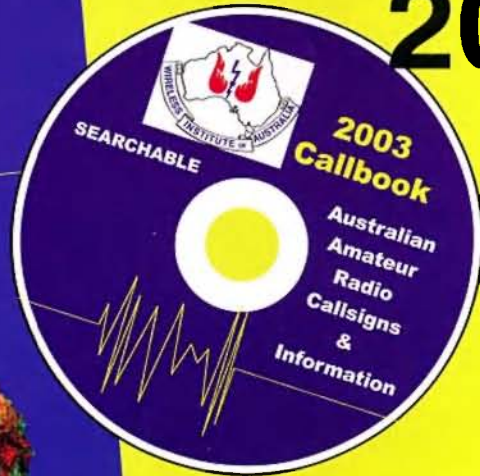
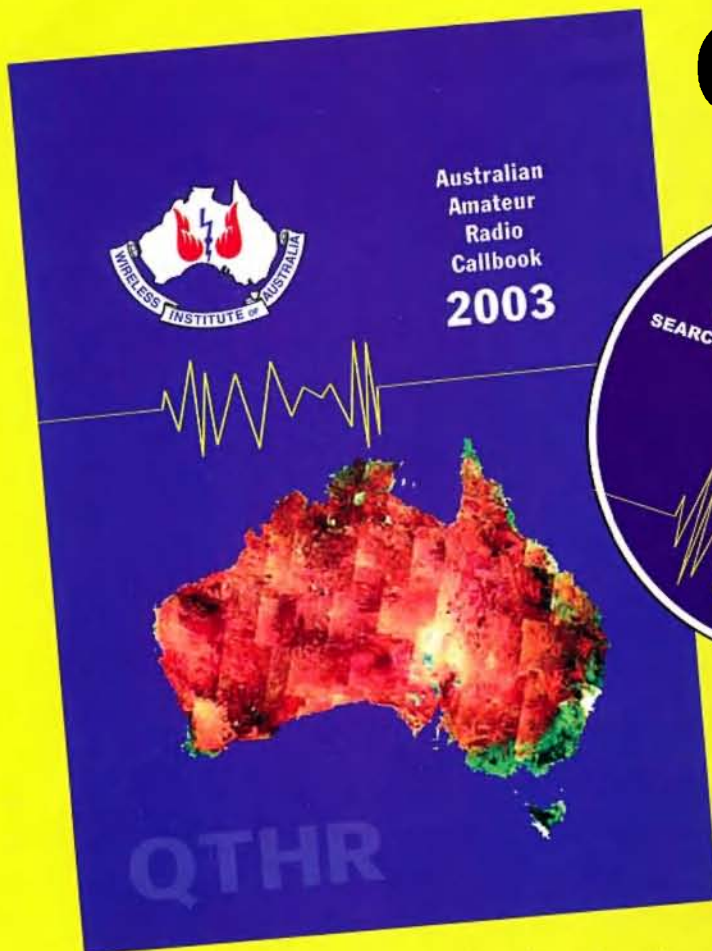

**TWO FOR
THE PRICE
OF ONE.**

This year we are offering the full Callbook/Handbook as a handsome **BOUND COPY** that would grace any shack or bookcase **AND** as a **FULLY SEARCHABLE DISC**

Both publications contain all Australian callsigns by callsign order in easy-read format and about 60 pages all about beacons, packets, rules and regulations, repeaters, frequencies and bands and much other useful information all in one convenient unit.

☀ And as a special bonus on the disc alone, Greater Circle information.

ABOUT SEARCHING ON THE DISC

The material in the disc is distilled into Acrobat files. Which means that any word in the disc can be found by using the Acrobat Reader's >SEARCH>.

Example. Say you wanted to know who in your area had an amateur callsign/licence.

Easy — put in your postcode, do a search and there are your choices. (we have included Acrobat Reader)

And about that two for the price of one offer.

WIA, through its Divisions and other outlets is making the set, full book and even fuller disc, available for a delivered price that compares extremely favourably with the 2001 price of the book alone.

Contact your division to place your order now. Details on page 16.



Amateur Radio

Volume 70
Number 12
December 2002
January 2003

The Journal of the Wireless
Institute of Australia
ISSN 0002-6859

Editorial

Editor: Colwyn Low VK5UE
edarmag@chariot.net.au

Technical Editor: Peter Gibson VK3AZL

Publications Committee Members

Ron Fisher VK3OM
Don Jackson VK3DBB
Evan Jarman VK3ANI
Bill Rice VK3ABP
Gill Sones VK3AUI
Bill Roper VK3BR

Advertising

Mrs June Fox,
Tel: (03) 9528 5962

Hamads

"Hamads" Newsletters Unlimited
PO Box 431, Monbulk Vic 3793
Fax: 03 9756 7031
e-mail: newsletters@ozemail.com.au

Office

10/229 Balaclava Road
Caulfield, Victoria
Telephone (03) 9528 5962
Facsimile (03) 9523 8191

Business Hours 9:30am to 3:00pm weekdays

Postal

The Editor AR
34 Hawker Crescent
Elizabeth East
South Australia 5112
Email edarmag@chariot.net.au

Production

Newsletters Unlimited 03 9756 7797

Printer

Streamline Press, Melbourne (03) 9417 2766

Postal Service

IMS (03) 9291 5888

Production Deadlines

Advertising booking and articles for
publication 10th of preceding month.

Hamads and advertising material deadline
18th day of preceding month

The contents of Amateur Radio are Copyright
Wireless Institute of Australia © 2002

General

Amateur Radio In Pakistan	17
<i>Brenda Edmonds VK3KT</i>	
Table of Allocation of International Call Sign Series	25
Low Level Entrance Licence	51
<i>Brenda Edmonds VK3KT</i>	
Book Review: <i>The Dick Smith Way</i> by Ike Bain	51
<i>by Peter Parker VK3YE</i>	

Technical

Some uses for a Dip Oscillator	4
<i>Drew Diamond VK3XU</i>	
Modifications and Enhancements for the Double Tuned Crystal Set	9
<i>Felix Scerri VK4FUQ</i>	
Measuring echoes and propagation on the HF bands Part 1	10
<i>By H. de Waard (PA0ZX) and J.G.C. Niehaus (PA0PA)</i>	
A temperature-controlled crystal frequency calibrator	18
<i>Drew Diamond VK3XU</i>	
Build an electronics set	23
<i>Peter Parker VK3YE</i>	
Elevated Feed Antenna (Technical Abstracts)	29
<i>Gill Sones VK3AUI</i>	
External GPS Antenna (Technical Abstracts)	30
<i>Gill Sones VK3AUI</i>	
Simple CW Filter (Technical Abstracts)	31
<i>Gill Sones VK3AUI</i>	

Columns

Advertisers' Index	55	HF Predictions	58
ALARA	38	How's DX?	52
AMSAT	40	Intruder Watch	55
Contests	45	Over to you	7, 28, 44, 81
Club News	27	OSL page	32
WIA Division News		Spotlight on SWLing	39
VK1 Notes	34	Sunspots	33
VK3 Notes	35	Technical Abstracts	27, 30, 31
VK6 Notes	36	VHF/UHF - An Expanding World	58
VK7 Notes	37	WIA Comment	3
Editor's Comment	2	WIA Division Directory	84
Hamads	82	WIA Federal Directory	2
Ham Shack Computers	43	Will's Page	80

Our Cover this month

The antenna system is VK5LP's. As you will have read unfortunately Eric is no longer able to maintain the system due to continual bird attacks. The closing of Eric's VHF/UHF station is a great loss to the Australian VHF and UHF community.

Contributions to Amateur Radio

Amateur Radio is a forum for WIA members' amateur radio experiments, experiences opinions and news. Manuscripts with drawings and or photos are always welcome and will be considered for publication. Articles on disc or email are especially welcome. The WIA cannot be responsible for loss or damage to any material. A pamphlet, How to write for Amateur Radio is available from the Federal Office on receipt of a stamped self-addressed envelope.

Back Issues

Back issues are available directly from the WIA Federal Office (until stocks are exhausted), at \$4.00 each (including postage within Australia) to members.

Photostat copies

When back issues are no longer available, photocopies of articles are available to members at \$2.50 each (plus an additional \$2 for each additional issue in which the article appears).

Disclaimer

The opinions expressed in this publication do not necessarily reflect the official view of the WIA and the WIA cannot be held responsible for incorrect information published.

Amateur Radio Service

A radiocommunication service for the purpose of self-training, intercommunication and technical investigation carried out by amateurs; that is, by duly authorised persons interested in radio technique solely with a personal aim and without pecuniary interest.

Wireless Institute of Australia

The world's first and oldest
National Radio Society
Founded 1910

Representing
The Australian Amateur Radio Service

Member of the
International Amateur Radio Union

Registered Federal Office of the WIA

10/229 Balclava Road
Caulfield North Vic 3161

Tel: (03) 9526 5982 Fax: (03) 9523 8191
<http://www.wia.org.au>

All mail to
PO Box 2175 Caulfield Junction VIC 3161

Business hours: 9.30am-3pm weekdays

Federal Secretary

Pater Naish VK2BPN

Federal Office staff

June Fox Bookkeeper
Rita Trebilco VK3IF Examinations Officer

Council

President	Ernest Hocking	VK1LK
VK1 Federal Councillor	Gilbert Hughes	VK1GH
VK2 Federal Councillor	Barry White	VK2AAB
VK3 Federal Councillor	Jim Linton	VK3PC
VK4 Federal Councillor	David Jones	VK4OF
VK5 Federal Councillor	David Box	VK5OV
VK6 Federal Councillor	Will McGhie	VK8UU
VK7 Federal Councillor	Phil Corby	VK7ZAX

Executive

Brenda Edmonds VK3KT
David Pilley VK2AYD
Don Wilschafski VK4BY

Federal Coordinators

AMSAT	Graham Ratcliff	VK5AGR
ARDF	Jack Bramham	VK3WWW
Awards	Mal Johnson	VK8LC
Contests	Ian Godall	VK3VP
Education	Ron Smith	VK4AGS
FTAC	John Martin	VK3KWA
Historian	John Edmonds	VK3AFU
IARU	Neil Penfold	VK6NE
Intruder Watch	Harry Anderson	VK8HA
International Travel Hoat	John Millar	VK3DJM
ITU Conference and study group	Gilbert Hughes	VK1GH
QSL Manager (VKs, VKs)	Neil Penfold	VK6NE
Videotape	VK2 Division	
Web	Joe Burford	VK5UJ
WICEN	John Weir	VK3ZRV

ACA Liaison Team

Glen Dunstan VK4DU (Corresponding)
Gilbert Hughes VK1GH
Keith Malcolm VK1ZKM
Peter Nalah VK2BPN

Editorial Comment

Colwyn Low VK5UE

2002 – a significant year for AR

Well we have reached the end of another year. This has been a significant year for AR as it went on the newsstands and seems to be selling quite well.

I extend to all our members and readers my Best Wishes for a Happy Christmas and a Prosperous New Year. I also hope some of the true meaning of Christmas penetrates the thinking and actions of those who control our destinies.

We Amateurs have done a lot this year in experimenting with new modes, with competing in contests, with keeping in contact with old mates on our regular nets and with helping the community through WICEN. Some of us have been called out to help the emergency services with communications in the bush fires that have occurred in VK2 already this season. These volunteers deserve the thanks of all the community.

There has been a lot of discussion on new licence levels and the possible dilution of our qualifications. I think we have to recognise that there will always be at least two levels of licencing one to ease new people into the Amateur Service and one which recognises the knowledge to build operate and maintain a modern Amateur station. This latter should be kept at a level which enables holders to be given recognition and credit in qualifications required for employment in the electronics and communications industry.

Now for something to think about

over the Christmas break. Would the WIA be more effective if we all joined the Wireless Institute of Australia and then made application to join a local Branch. The local Branch could then be as large as a State or as small as a Club. The current State Divisions, which run as companies, could keep the companies as affiliated organisations and distribute costs and income according to a predetermined agreement.

Just in closing, I read with interest Will's article on inverters (AR Nov 2002 page 52). Then the threat of power outages this hot summer triggered the thought that I had many Ah of 12 V and a fan or water cooler needed about a 100 watt to run. So I bought a 150 watt inverter on special for just over \$80. It runs the fan OK, bit slow to run up but it settles down. Then I realised I had a solar panel that gets to 18 V in full sun at about 1 A. This then would be the top up charger. So if the power fails we will still have some cooling. See all that gear we need for Field Day operation is really useful after all.

I had hoped this would be my last Editorial, but as a replacement Editor has not been found I will continue in the position into 2003. However I do not wish to be Editor this time next year. So have a few thoughts as to who else might make a fist of Editor AR and talk to them about it.

Have a great time over the Christmas break. I hope all your presents are really useful. We will be back with the February 2003 issue hopefully available late January.

Colwyn VK5UE

PLAN AHEAD

December/January
Ross Hull VHF Contest ★
between December 26, 2002 ★
and January 12, 2003. ★
(Details AR Nov page 43) ★
Summer VHF/UHF ★
Field Day
11, 12 January (details page 47)

February
Gosford Field Day
VK3GH Hamfest,
Healesville
23 February
Central Coast Field Day,
Wyong
23 February

Ernest Hocking VK1LK
email: president@wia.org.au
or via PO Box 691, Dickson, ACT 2602

Recent Events

I'll begin this month's notes by reflecting on the recent VK1 technical conference "OneTech02". This was my third technical conference this year and already I had a very high expectation of what I might find. However turning up on the day the first thing I noticed was the outside broadcast TV studio belonging to the Gladesville Amateur Radio Club. I had been promised that the session would be recorded but seeing the incredible effort put in by the Gladesville team can only make you sit up and pay attention to just what amateur radio operators can achieve when they work together. It didn't stop there though. Somehow the organiser Peter Ellis VK1KEP had persuaded representatives from the Australian National University to talk about their Bush LAN project, the Department of Defence and their HF modernisation project, as well as representatives of the IEEE and a very enthusiastic group of amateurs all happy to talk and discuss their experiences and experiments. And to show that amateur radio can still attract the big names we even had a lunchtime appearance from Dick Smith where he took part in a panel discussion about the future direction of the hobby. Well done Peter and all the VK1 team for organising such a spectacular day.

Yes there was a common theme - it was all about radio - but what a range of diverse aspects of the hobby. We had talks about using fluorescent light tubes as a 2m plasma antenna, computer enthusiasts talked about using Linux to drive amateur radio projects, and a number of people talked about how we can work with others to assist in using our experience to assist in Community Wireless LAN projects. Is amateur radio a dying hobby I hear you ask? Well these technical conferences have convinced me that amateur radio is very much alive and kicking - maybe it's taking a different form from that of previous years - but the same enthusiasm and pioneering spirit that captured the imagination of earlier generations is very much alive. I look forward to seeing the videotapes

that were produced during the weekend and hopefully they can be made available to all amateurs across Australia so that they can see for themselves the enthusiasm of the weekend's activities.

Reflecting on my impressions of these various events has convinced me that we owe it to the next generation of amateur radio enthusiasts to do everything that we can to bring to their attention the merits of the hobby. Furthermore we need to make entry into the hobby appropriate to modern needs and relevant to the sorts of activities that a new generation of amateurs will undertake as part of the hobby.

End of Year

December brings in the end of the WIA year and brings many of us to reflect on what has happened over the last twelve months. I know that I have not achieved many of the goals that I have set myself at the beginning of the year. I had hoped that we could have made much more progress in the two areas of restructuring the WIA and moving forward on a new foundation licence. However just because some of the goals have not been met does not mean that significant progress has not been made in

progressing this work. Where we have put in the effort this year, I suspect that we will reap the benefits in the next year. So I believe that 2003 will be a very significant year for amateur radio in Australia.

Personally this last year has been extremely busy in terms of work and WIA activities. However I can honestly say that the rewards have by far and away exceeded the effort put in. Just today I exchanged emails with a newly licensed amateur - I'm not sure who was happier with his success: him or me. Somehow knowing that the efforts of each and every member of the amateur radio community contributes something towards the hobby, tells me that we can be assured of a very vigorous future.

By the time this copy of AR reaches you, we will be well into planning the start of 2003 and I look forward to being able to update you on a range of initiatives that we have planned for the year.

I will bring this month's note to a close and wish you all 73 and the very best for 2003. I look forward to hearing from you as always on any amateur radio matters.

Ernest Hocking VK1LK

CHRISTMAS/NEW YEAR BREAK for WIA Federal Secretariat

The Melbourne secretariat of WIA Federal will close for the Christmas-New Year break on Friday 20th December 2002 and re-open on Tuesday, 28th January 2003.

The WIA Exam Service advises that amateur examination papers for marking and orders for exam material required over the holidays, must be received in Melbourne by Monday, 9th December to ensure posting before Christmas.

Any material or orders received after that date cannot be guaranteed to be dealt with before the break and may have to wait until the Exam Service re-opens.

Some uses for a Dip Oscillator

Drew Diamond, VK3XU,
45 Gatters Road,
Wonga Park, 3115.

The keen radio experimenter who owns, and knows how to employ a dip oscillator has a strong ally. Let me illustrate here just some of the more usual applications for this most versatile device.

It seems that some models of 'modern' solid-state dippers are rather difficult to use, in that it may be difficult to observe the meter needle deflection, and this is perhaps why some amateurs have become indifferent to the technique. Admittedly, older style valve dippers were (or are) generally more sensitive to the dipping phenomenon. However, recent work with 'Kalitron' oscillators (Refs 2, 3 and 4), which have improved sensitivity, has helped to put the GDO back into the amateur's toolbox.

A key application is in finding the resonant frequency of lumped (coil and capacitor) tuned circuits. Photo 1

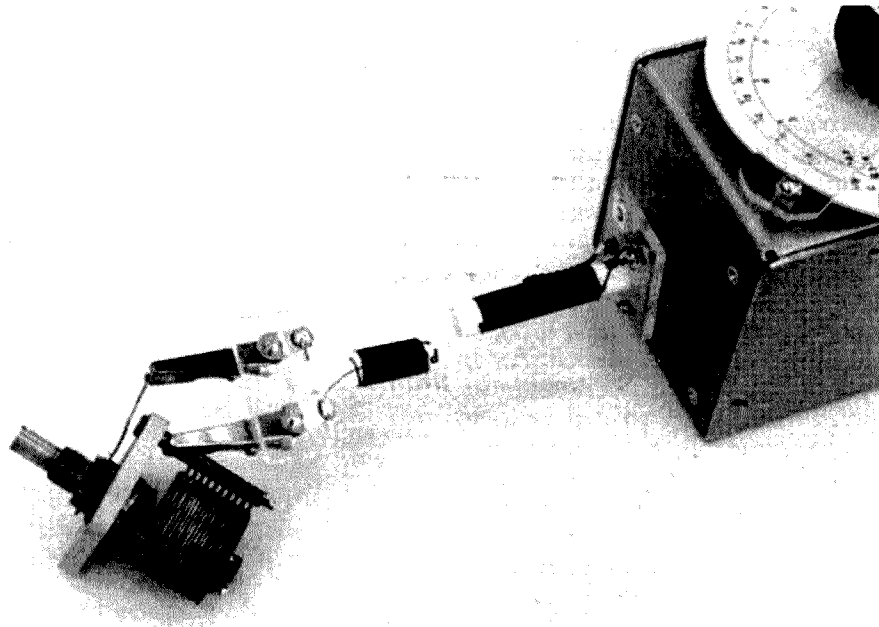

Photo 1. Dipping a plain solenoid coil

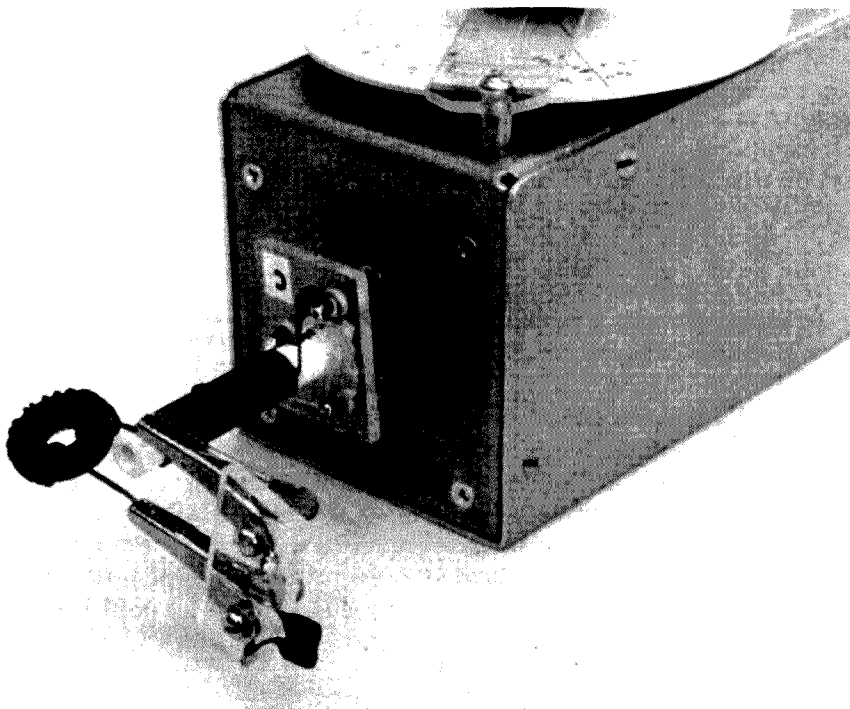

Photo 2. Dipping a toroidal coil

illustrates how the coil of the oscillating dipper is coupled to the coil of a passive (not energized) circuit. The coils may be end-on, as shown, or side-by-side, depending upon physical constraints. For best results, the passive circuit should be free from the loading effects of any bias resistors, and the inputs and outputs of active devices-, which should be disconnected from the 'hot' side of the tuned circuit. For high impedance input devices, such as FETs and cold valves/tubes, loading is not usually a problem. The dipper's frequency is then varied about the estimated frequency of the passive circuit until a 'dip' in meter reading is observed. Use the least amount of coupling (greatest distance) consistent with obtaining an observable dip. The resonant frequency of the passive circuit is then read from the dipper's frequency dial.

For toroidal coils, the dipper's coil is inserted between the connecting leads of the toroid, which effectively forms a one-turn loop, as shown in Photo 2.

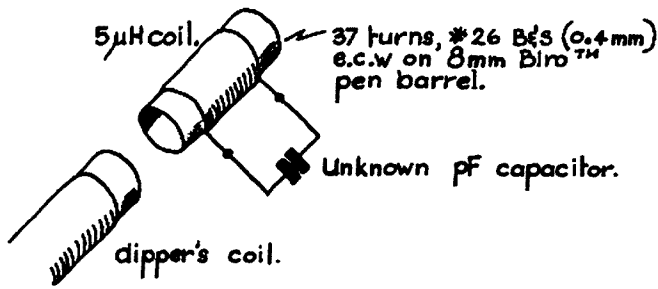

Fig. 1a

To find the value of an unknown pF capacitor :-

$$C_{pF} = \frac{25330}{f_{MHz}^2 \times L_{\mu H}}$$

e.g.; dip found at 7.1 MHz ;

$$C_{pF} = \frac{25330}{7.1^2 \times 5_{\mu H}}$$

$$= 100.5 \text{ rounded to}$$

$$= 100 \text{ pF}$$

Figure 1a



Fig. 1b

Drawn: D.C.D.

To find the value of an unknown μ H coil (or inductance):-

$$L_{\mu H} = \frac{25330}{f_{MHz}^2 \times C_{pF}}$$

e.g. dip found at 30 MHz ;

$$L_{\mu H} = \frac{25330}{30^2 \times 100 \text{ pF}}$$

$$= 0.28 \mu H \text{ rounded to}$$

$$= 0.3 \mu H (300 \text{ nH}).$$

Figure 1b

One of the handiest applications is in finding the value of microHenry coils and pF capacitors at radio frequencies. Pictured in Photo 3 are a 5 microHenry 'standard' inductor, and a 100 pF silver mica capacitor. These are each fitted upon a small rectangle of Perspex (acrylic), or other low-loss material, with crocodile clips attached for the connection of the unknown component. Details of the 5 μ H coil are shown in Fig. 1a. Photo 1 illustrates how an unknown variable capacitor is first 'dipped' with the standard coil, and Photo 2 shows the 100 pF standard capacitor being used to 'dip' a toroidal coil. Fig. 1a also explains how the value of an unknown capacitor may be calculated. The method is particularly useful in finding the minimum and maximum values of variable capacitors (which are seldom clearly marked), and Fig 1b shows how

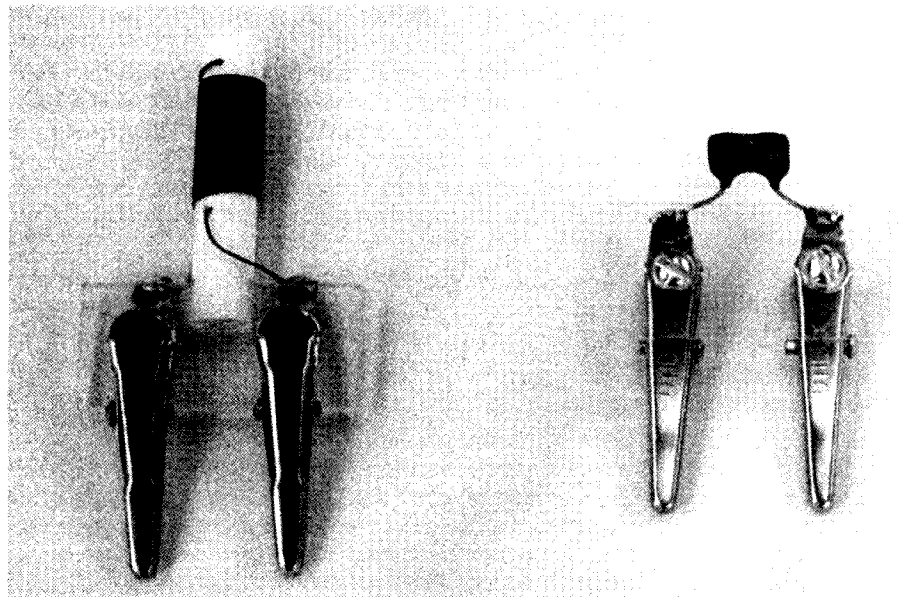

Photo 3. 5 μ H coil and 100pF 'standards'

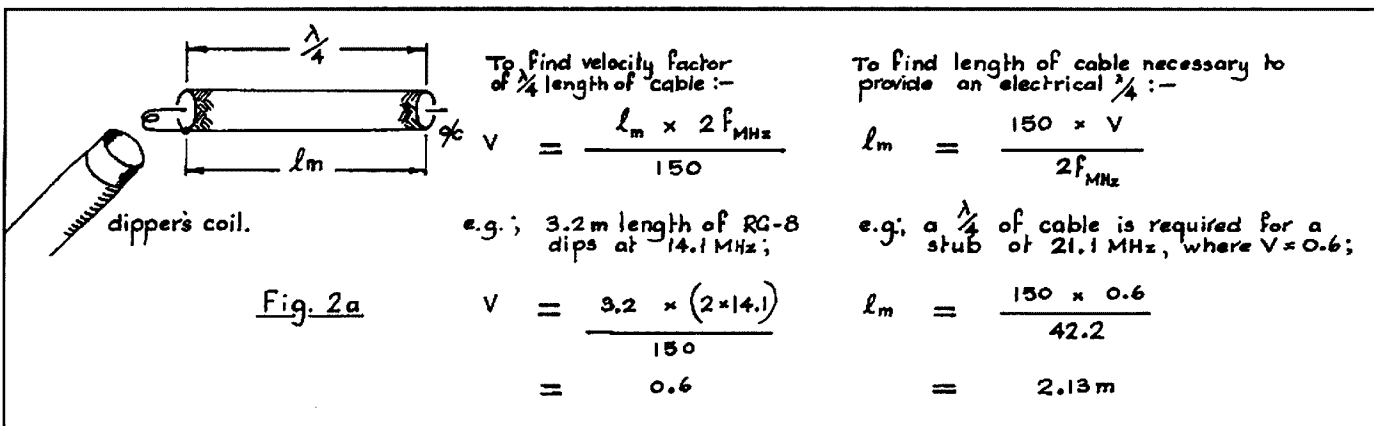

Figure 2a

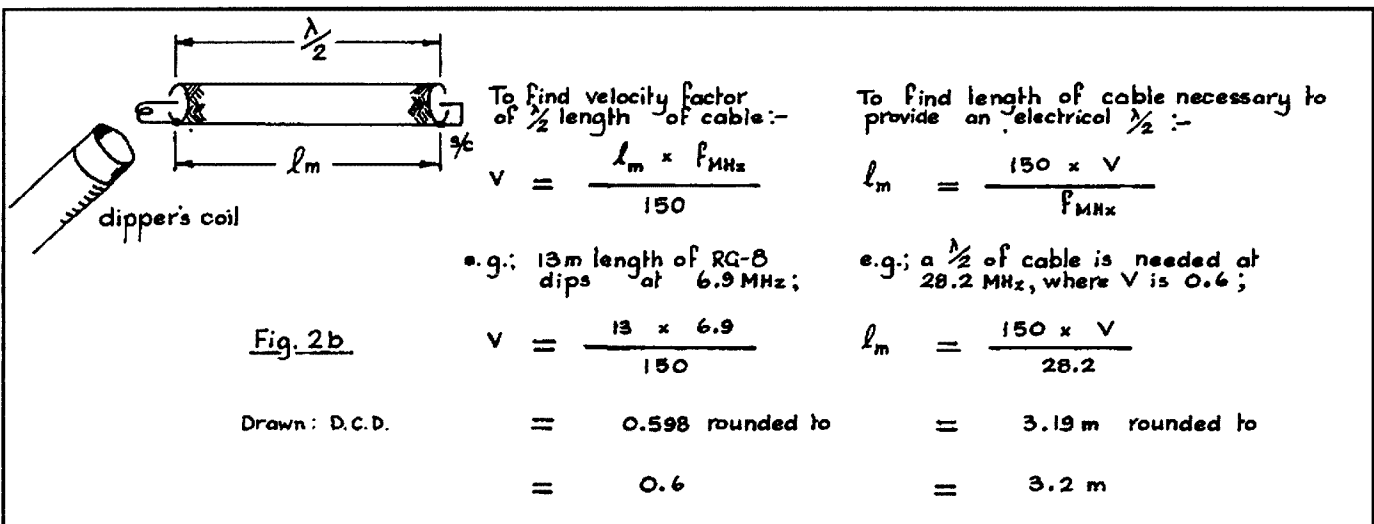

Figure 2b

the inductance of an unknown coil may be determined.

There are instances in antenna work where it is necessary to know the velocity factor of a certain type of coaxial cable in order to make exact electrical lengths of line, and so radio handbooks generally list generic velocity factors for various cable types. We should be careful however, as the actual velocity

factor may be quite different from that specified. In my experience, it is much better to calculate, and then actually confirm the electrical length. To measure the electrical length of a quarter-wave line (coaxial or twin) the far end is left open-circuit (o/c) which will therefore reflect a short-circuit back to the link-coil at the measuring end. A two-turn hook-up wire link may be soldered to a

suitable connector, as pictured in Photo 4, which shows how the dipper may be coupled to your coax line. Also see Fig. 2a. As the dipper's frequency is varied upwards (from a frequency that is estimated to be well below the resonant frequency [fr] of the line), a distinct dip will be observed as the dipper is swept through fr. Reduce coupling as necessary to obtain a just discernible dip (thus obtaining best frequency accuracy). It will be found that the line under test is quite a good radiator, allowing the dipper's signal to be heard on the station receiver, which may be used to obtain a more exact reading of the actual fr.

Electrical half-wavelengths may be obtained in a similar manner, except now the far end must have a short-circuit (s/c) applied- perhaps by using a crocodile clip or similar. The method and formula are shown in Fig. 2b.

Our dipper may be used to find the fr of dipoles and other low-impedance feed-point radiators. Preferably, the measurement must be made with the antenna in-situ. However, as this is

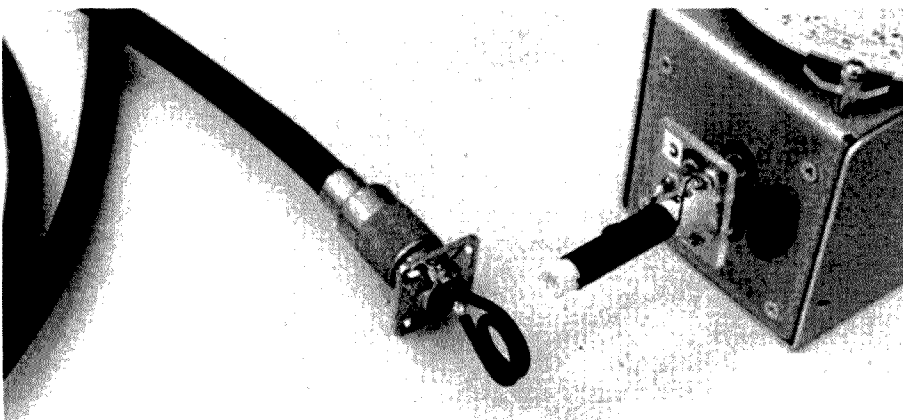

Photo 4. Dipping a length of coax line

generally only possible with ground-plane and similar types, quite good results may be obtained with the antenna wire simply raised off ground and away from conducting objects as far as reasonably possible- perhaps strung between convenient supports such as trees or posts. A set of wooden steps may be used to gain access to the feed point. Any feed-line must be disconnected during the measurement. Photo 5 shows how the dipper is coupled through a short one-turn wire loop, which is attached with crocodile clips to the feed-point. Because antennas usually behave as low Q tuned circuits, quite close coupling is usually required to obtain a dip. The centre of the Kalitron's coil (Ref. 2) is at zero RF potential, and so the link may be placed in the middle of the dipper's coil as shown.

If your dipper does not already have a crystal test function, quartz crystals may be checked for frequency and activity. Connect a two-turn link coil across the crystal's pins, then close couple the dipper to the link coil. A prominent dip should occur as the dipper is swept across the crystal's frequency. A more precise measurement of the crystal frequency may be had by tuning for the dipper's signal on the station receiver. Interestingly, it should be found that the dipper's frequency would pull into that of the crystal, and become "crystal-locked".

Finally, our dipper makes a handy signal source for receiver, transmitter and other tests. A two or three-turn link coil looped over the middle of the dipper's coil will provide a signal (in the case of the Kalitron of Ref. 2) of about 1 mW in 50 ohm. For a crystal-locked source, simply couple your crystal as described above.

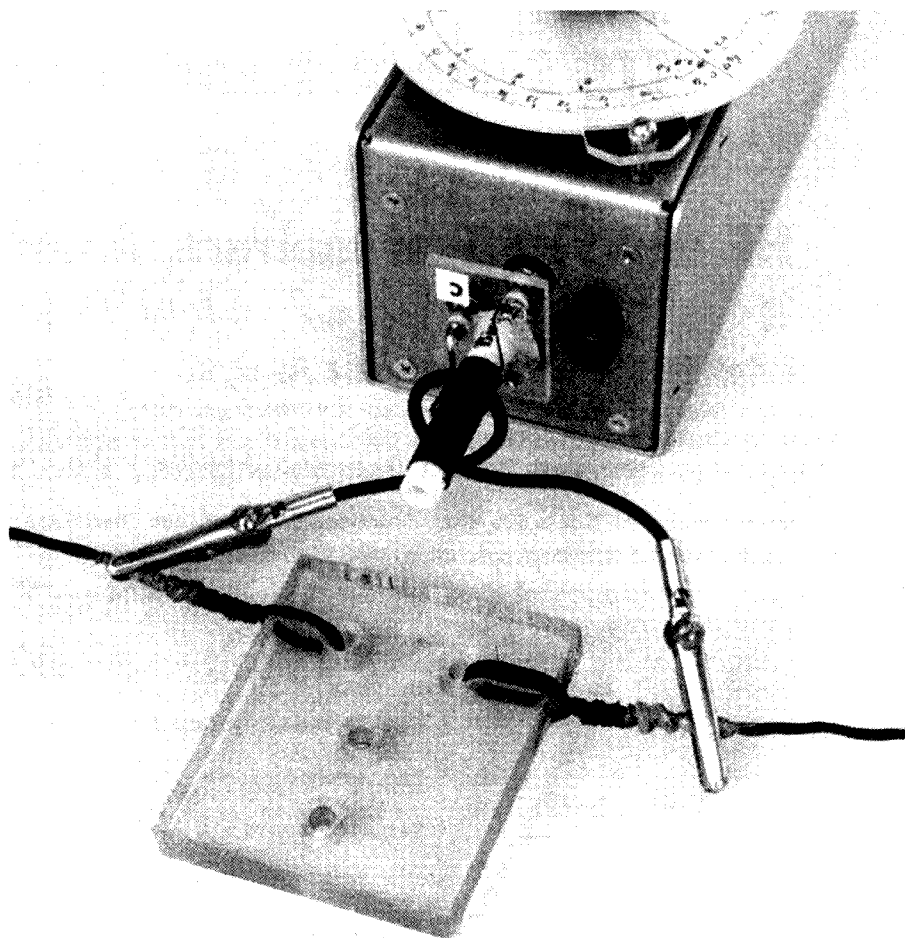

Photo 5. Coupling to a dipole antenna

References and Suggested Further Reading

1. Servicing with Dip Meters; John Lenk, Foulsham-Sams.
2. "A 'Kalitron' Gate Dip Oscillator/Crystal Checker"; D. Diamond, AR, to be published 2003.
3. "The G3WPO FET Dip Oscillator Mk2"; A. Bailey, G3WPO, RadCom, Apr. '87.

4. Test Equipment for the Radio Amateur, C. Smith, G4FZH, RSGB, pp 33 - 41.
5. "The Grid Dip Oscillator"; J. Buchanan, K8WPI, CQ, Feb. 2000.
6. "What Can You Do With a Dip Meter?"; QST, May 2002.

Computer links

Hello, I've recently returned to Australia after working overseas for 4 and a bit years.

I've found the changes in the AR-escape quite marked.

Packet Radio, which was rapidly growing when I left, appears to have stalled and now be dropping in popularity. The small group of people running packet wormholes through the Internet have in many cases disappeared and taken with them the potential for attracting young computer

hobbyists into amateur radio.

I've also noticed a dramatic rise in the use of 2.4 GHz by 802.11b wireless computer LANs. My personal observations are of quite large groups (hundreds) of computer hobbyists in at least two of our major cities (Sydney and Melbourne) now linking their computers with this technology. Several young lads in my area have sought advice on, and successfully constructed helical antennas for use on 2.4GHz and now that I know what to look for, I've identified

Over to you

several more, just looking out the train windows on the way to work. This growth appears to be similar in many aspects to the CB Radio hobbyists of 30 years ago.

Left alone, this network is likely to continue growing. I wonder if it may be opportune for Amateur Radio clubs to seek out these people in their areas and offer to help them with the RF side of their hobby, to hopefully catch some spillover into amateur radio?

David Henderson VK2KWY

HF and VHF Transceivers, Autotuners and Kits

New !!

Autek Research RF/Antenna Analyst.

An accurate antenna/network analyzer that measures VSWR, Impedance, Inductance, Capacitance and Reactance.

True signed reactance readings on the VA1. Is the reactance component inductive or capacitive?

Three models covering 1.6 Mhz to 500 Mhz. Low Cost, Low Power and Small Size!

Comprehensive instruction manual describing many RF measurement techniques.

All in a pocket-sized instrument.

Call for data sheets and more details



TEN-TEC Jupiter HF DSP Transceiver

- Easy-to-read LCD main panel display.
- Multi-function meter provides bar graph and digital readout of signal strength, TX power and SWR.
- Band sweep function
- 34 built-in receive filters—300 to 8000 Hz.
- Seven selectable main tuning rates

Get Kitted Out "It goes better on something you made yourself"



Z11 QRP Auto Tuner Kit



HF Receiver Kit



AT11-MP Auto Tuner Kit

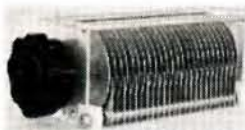

H.V. Variable Capacitor Kit



Dummy Load Kit



RT11 Remote Auto Tuner Kit



10-2M Transverter Kit

Soon from Ten-Tec.
The Orion HF 32 bit DSP
Transceiver and the Argonaut
V QRP IF-DSP Transceiver.



We have RF Cables, Connectors and Baluns

★ All kits include easy-to-follow step by step assembly instructions.

You supply the soldering iron and basic tools!!!

All kit products can be supplied fully assembled and tested.

Service and Support for all
Ten-Tec and LDG equipment

We stock Amidon Iron Powder and Ferrite Cores — Call for an application guide

Phone 03 59774808. Fax 03 59774801 info@ttssystems.com.au

Modifications and Enhancements for the Double Tuned Crystal Set

Felix Scerri VK4FUQ

Since the original article, which appeared on page 8 of the March 2002 edition of AR, was drafted, several modifications have been worked out that improve the general performance in weak signal areas. These modifications now follow.

Firstly, the tuning coils

Higher "Q" coils will benefit performance by increasing the available level of signal voltage to the detector (improving efficiency) and tightening selectivity. If "Litz" Wire with a high number of strands is available, very efficient coils will result with attendant benefits. If "Litz" wire is unobtainable, then a novel winding technique I have developed will improve coil "Q" and efficiency. I have found that a bifilar winding, instead of a simple single wire winding is much more efficient. I used a bifilar winding composed of two 0.25 mm winding wires in lieu of the 0.315 mm single wire winding. Both these approaches result in improved coil efficiency. However, there is a slight downside to this. As a simple consequence of increased "Q", the audio bandwidth will narrow somewhat. It will be necessary to reduce the spacing between coils a little, to compensate for this, by slightly overcoupling the two tuned circuits.

Secondly, the detector

Now things get interesting. The unfortunate but widespread use of heavy "processing" by AM broadcast stations can cause serious diode detector distortion, especially under low signal level conditions. Such is the case in our local area. I've looked long and hard at this serious problem, and come up with an interesting solution in the form of an "active" detector. Basically the problem stems from insufficient voltage injection into the diode. I have developed a hybrid diode/FET detector that has superior performance over a simple diode

detector. The circuit is essentially a germanium diode directly coupled into a simple FET source follower buffer stage. Due to very high impedance diode "load", a high impedance is reflected into the tuned circuit through the diode, resulting in very light "loading" and as a consequence, more efficient use of available signal voltage, reducing detector distortion. Compared to a simple diode detector, this active diode/FET detector has much higher audio output and considerably less distortion. It does require a 9V battery, but that's a small price to pay for greatly improved detector performance. I am told the basic circuit resembles a now forgotten valve circuit, but I've not seen a solid state version before.

One final modification

Although the diode/FET detector offers improved performance, in our local area, some distortion remained, and a complete solution was found by adding an untuned FET RF preamp immediately in front of the diode/FET detector. The 10 or so dB gain provided by the preamp has completely removed the last traces of detector distortion. It may or may not be required, depending on local conditions. So there you are, a number of modifications for improved performance. Local conditions will dictate which ones are required.

73s from Felix VK4FUQ.

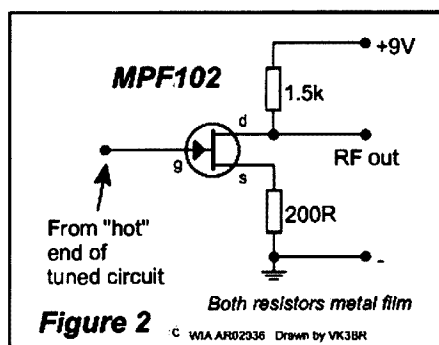
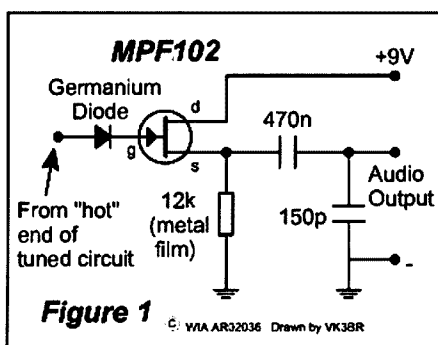

PLAN AHEAD

**John Moyle
Field Day** ★
★
15, 16 March ★
★

**Urunga
Field Day**
19, 20 April

Measuring echoes and propagation on the HF bands

Part 1

By H. de Waard (PA0ZX) and J.G.C. Niehaus (PA0FA)
Translated by Pleter Kloppenburg (VK1CPK) from VERON's
'Electron' of December '93

The Electron editors consider themselves fortunate to offer an article on a subject that many are interested in, but with which few have occupied themselves. In short, another facet of our hobby. The article is in two parts

Life on earth depends on the rays of the sun, and the sun continues to make our lives agreeable in many different ways. Without it, all life would soon disappear.

The formation of ionised layers at great heights (more than 50 km) through ultraviolet rays from the sun seems a small issue compared with everything else that happens in the universe. However, because of this, for example, long-distance communications have become possible.

For us Amateurs this is a fountain of inexhaustible joy, but also in general terms the possibility of reflection of

radio waves by the ionosphere, despite the growing importance of satellite communications, remains of great importance.

In 1901, Marconi succeeded in establishing communications over a long distance between England and Newfoundland. In 1902, Heaviside and Kennelly postulated independently of each other the assumption that this was possible because radio waves at great heights are reflected by ionised layers. In 1925, Appleton proved the existence of ionised layers and determined the height of the important F-layer by

measuring the delay of echoes of electromagnetic pulses. Since that time, echo measurements have become a standard method in research of the ionosphere.

A later practical application of using the ionosphere as a reflector for pulsed signals is the "Radar over the horizon". We Amateurs had to put up with these long-distance radars in the USSR of gigantic output powers in the form of "Woodpeckers" on our HF bands.

A conscious use of echoes via the ionosphere has never been an important issue in Amateur circles. This is not surprising; it is easy to believe that, apart from professional interest, not much can be achieved with it. Even so, Amateurs have experimented with this a long time ago. In QST of March 1952 (Ref 3), is a comprehensive article from W6QYT and W6POH in which the results are described of echo measurements in the 20-metre band. These were carried out in professional surroundings, namely at the University of Stanford, and with a peak power of 800 watt. This was probably not conducive to further home-conducted experiments.

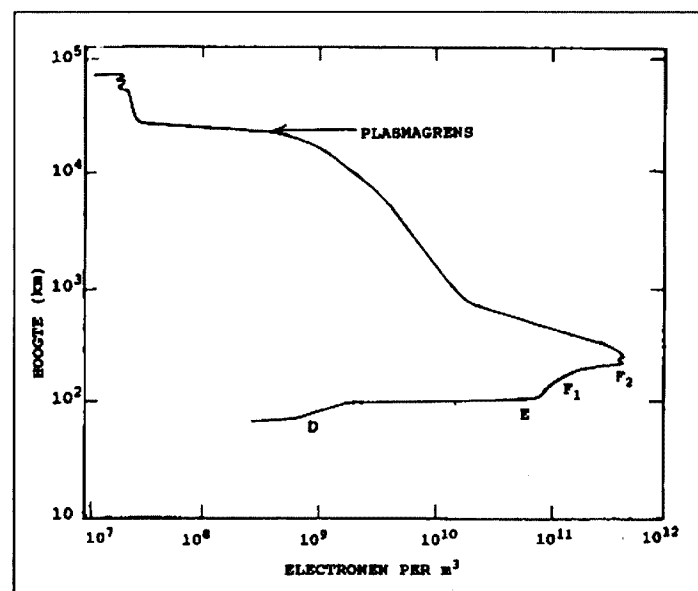

Figure 1: Height versus Electrons per m^3 . Progress of ionisation density of the air above the earth's surface. The curve shows the concentration of free electrons depending on height, during the day, near low latitudes and during low solar activity. The height of the different layers (D, E, F_1 and F_2) of the ionosphere is also indicated.

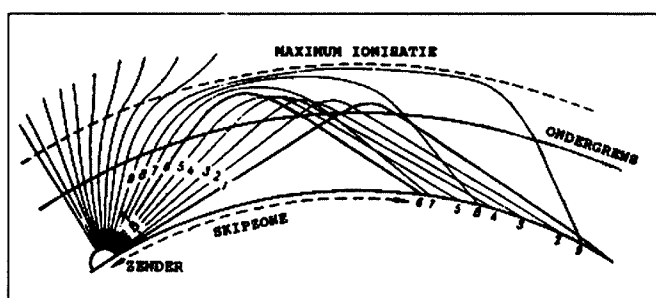

Figure 2: Schematic reproduction of the paths of electromagnetic waves that bounce once between the ionosphere and Earth, for different take-off angles θ (Ref 6).

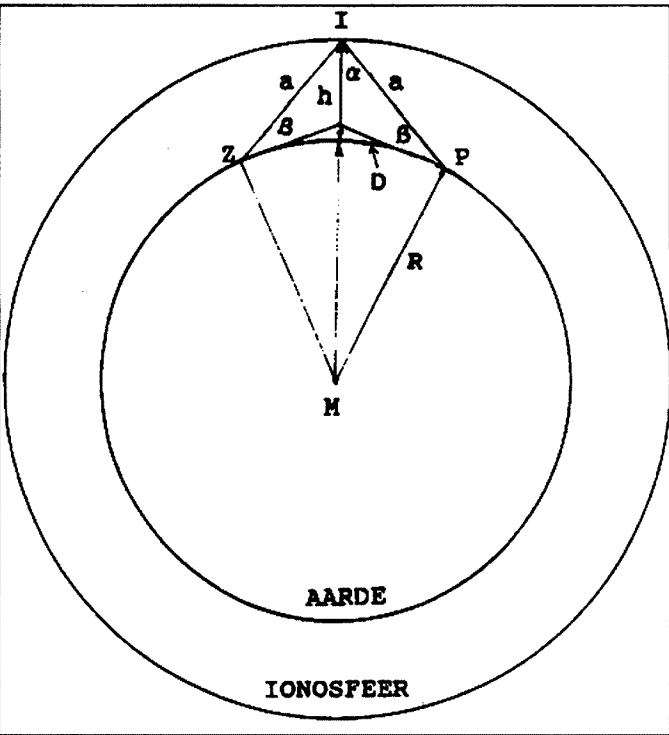

Figure 3: Diagram to aid in the calculation of algebraic magnitudes from measured echo delays. Z = Place of transmitter, I = Place of reflection in the ionosphere (the gradual bending of the wave is replaced by a sudden reflection, which is correct, provided a correction is made in the value of h, the height at which the reflection occurs), P = point of reflection against earth after one hop, a = distance between Z and I = distance between I and P. This distance follows direct from the measured echo delay t_e : $a = (1/4)c/t_e$ ($c = 300,000$ km/s is the speed of light), R = earth radius, D = length of hop, h = effective height of reflection sphere with respect to earth sphere, b = take-off angle, $\alpha =$ acute angle of the electromagnetic wave in the ionosphere. Using the measured value of a, and the given values of h and R, all the other magnitudes in the figure can be determined.

Nearly every PA operator, especially if he uses a beam, and probably a linear amplifier, is made aware of the existence of echoes via the ionosphere when he makes DX contacts. When he, together with another PA operator or a West European operator that he cannot receive directly, is in communication with a DX station that for both of them lies in approximately the same direction, for example the United States, he will often observe that the other European station is very readable. But when he turns his beam in the direction of the other European station, that signal disappears, provided that the distance between the European stations is at least 50 km. For a long time, this phenomenon has been called "Back-scatter". For this reason there exists, the widely held belief, but faulty assumption, that this scatter occurs in the ionosphere.

In December of 1991, the writers of this article, whose QTHs are about 40 km from each other, decided to use a pulsed signal to determine the distance at which Scatter appears. One station (PA0ZX) transmitted the pulses, and the other station (PA0FA) received the direct signal as well as that

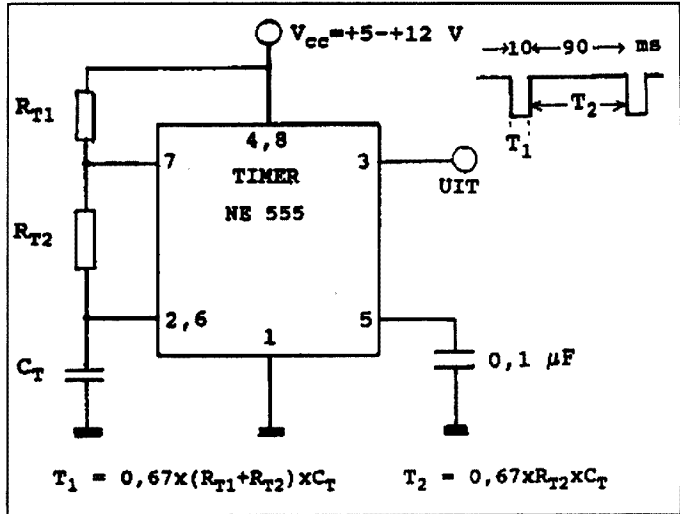

Figure 4: Pulser, based on NE-555 (PA0FA)
 For $T_1 = 10$ ms (make) and $T_2 = 90$ ms (rest), use values of $R_{T1} = 70$ kW and $R_{T2} = 18$ kW, $C_T = 1$ mF
 For $T_1 = 10$ ms and $T_2 = 190$ ms, $R_{T1} = 42.3$ kW, $R_{T2} = 3.3$ kW, $C_T = 4.7$ mF.
 Use 10-turn potentiometers for the given pulse duration for R_{T1} and R_{T2} , for example 100 kW and 20 kW.
 V_{CC} is not critical; it must be of a value that ensures effective keying of the transmitter. Sometimes the correct pulse voltage can be obtained from the transceiver documentation. Check the pulse length after adjustment of V_{CC} .

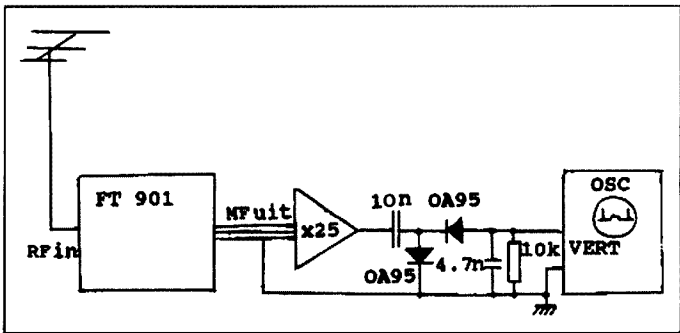

Figure 5: Interface between IF output FT-901 and oscilloscope (PA0ZX)

delayed by the ionosphere. In radar technology, this is called the bistatic method, which means separate locations for transmitter and receiver. Further research resulted in the development of a monostatic method, whereby transmitter and receiver are in the same place, and which can even be combined in a transceiver. This method is described under the heading "Monostatic long distance radar"; a cheap propagation monitor for the HF bands.

The results of the research invite us to continue with further development, and other Amateurs are warmly invited, to join us. An important conclusion from the research is that the returned signals have nothing to do with ionospheric backscatter but that they are caused by reflection from the earth's surface and especially from sea waves and steep mountains, while the ionosphere acts normally as a nearly ideal mirror for to-and-fro radio waves. From measurements of the delay of echoes, the distance of the reflecting objects can be determined. You speak, therefore, of "echoes via the ionosphere", not of "scatter through the ionosphere". The

latter is wrong. This conclusion is not new; earlier echo measurements had led to this conclusion a long time ago. Even before the coming of weather satellites, an ionospheric radar system existed in

the United States that measured the direction and height of waves in the Atlantic Ocean. With that, the development and movements of hurricanes could be observed (ref 4).

Propagation of radio waves between earth and ionosphere.

Much is written about this matter, some in amateur accessible literature. We shall mention, therefore, only those aspects that are necessary for a good understanding for what follows.

The ionosphere stretches out between heights of 50 to more than 10,000 km above the earth. The region is penetrated by the rays, which the sun transmits in the far ultra-violet. Under the low pressure these rays release electrons from the molecules that are present there (mainly nitrogen and oxygen molecules), and the rays are thus eventually absorbed. This process is called ionisation, hence the name ionosphere. Closer to the earth, the only rays remaining are ultra-violet, close to the visible light spectrum and capable of frying us red or brown but unable to ionise air. Because some far ultra-violet wavelengths are absorbed better than others a certain layering of ionisation builds up and the strength of each is height dependent. Distinguished according to height are the D-layer (about 80 km), the E-layer (about 100 km), the F_1 -layer (about 200 km), and the F_2 -layer (about 300 km). The heights of these layers and the density of the free electrons per cubic metre are roughly indicated in Figure 1. Whether these layers can reflect the penetrating radio waves depends very much on solar activity, the frequency of the waves, and on the time of day and the year.

The most important layer for DX traffic is the F-layer and most often the F_1 -layer. It is with this layer that we are concerned in this article. The bending of the electromagnetic wave in the layer is mainly caused by the presence of free electrons. We can compare this in some respects to the bending of light in glass or water, with the major difference being that the change in direction of the wave in the ionosphere is gradual and not sudden, as is the case with air and glass. Moreover, in the ionosphere the ability to bend waves, aka refractive index, is smaller than one, while that for light in a transparent material is always greater than one. We shall not go further into the physics background in this article, but to observe that in Nineteenth Century physics it was possible to

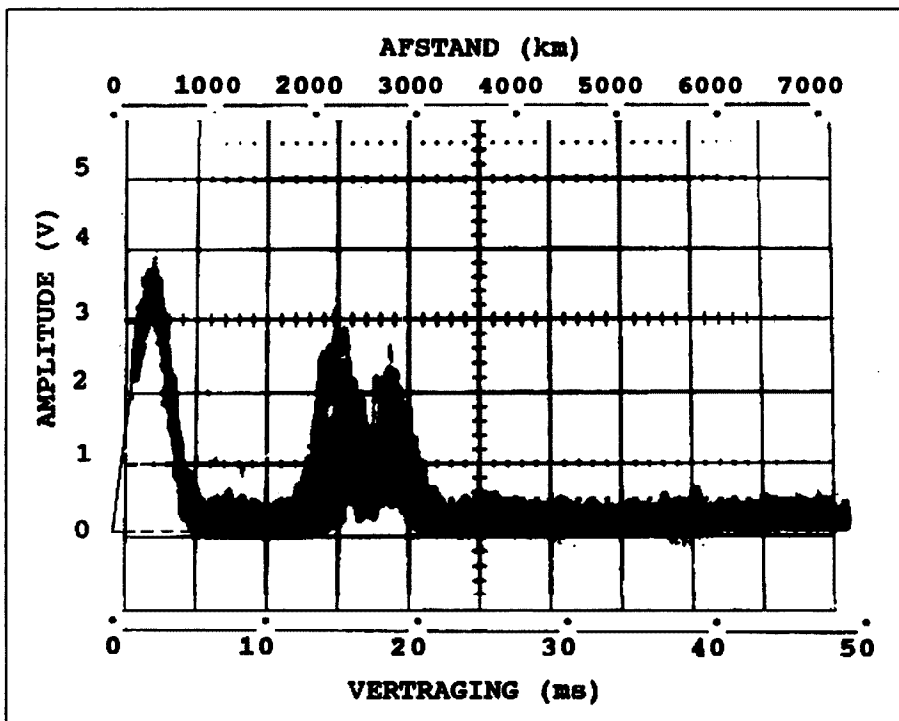

Figure 6: Amplitude versus Delay. One of the earliest echo photographs, recorded on 24-12-91 at 14:45 UTC. Frequency 28.96 MHz, IF bandwidth 3 kHz, beam heading 270°. Below the figure the pulse delay t_E , above the figure the one-way covered distance of the wave ($2a = (1/2)c/t_E$). Recorded with Polaroid camera (shutter open for about 20 sweeps). Further details in the text.

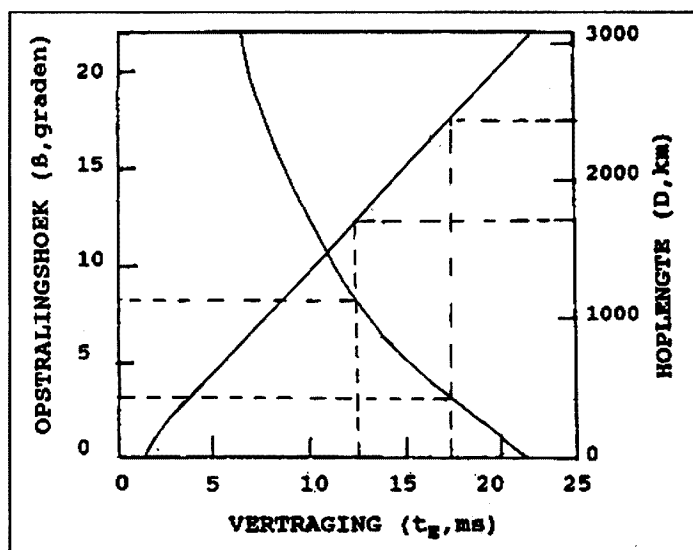

Figure 7: Take-off angle versus Delay versus Hop length. Calculated values of take-off angle β and hop distance D , as a function of the echo delay t_E , by an effective ionosphere height $h = 200$ km. The results of the measurement are drawn with broken lines in the figure.

calculate the bending of waves in ionised gases, long before the existence of the ionosphere was proved through measurements. In Figure 2 (due to Al'pert) (Ref 6) are shown calculated tracks of waves that propagate through the ionosphere are shown.

We see that these waves are always bent back in the direction of the earth's surface. In the figure, wavelength and ionisation density are chosen such, that waves (numbered 1 to 9) with a sufficiently low take-off angle b return to the earth's surface. With an increase in angle b , the wave begins to be bent more strongly with increasing height until we see a wave (number 9) that keeps going horizontally over a great distance just below the height of maximum ionisation (the Pedersen wave, after the discoverer). When the angle b becomes even larger, the wave proceeds, after an initial bending in a horizontal direction, right through the maximum of ionisation, and above that bends upwards and disappears parallel to its original direction into space. As can be seen in Figure 2, the distance that can be bridged in one hop depends mainly on the take-off angle of the wave. The longest distance that can be bridged (with the exception of the Pedersen-wave) is with a wave with a 0° take-off angle, the shortest with wave number 6, a rather large angle. A zone is created around the transmitter within which the transmitter cannot be received, the so-called skipzone and beyond that a zone where the transmitter, after one reflection by the ionosphere, produces a strong signal. In principle, some scattering shall always occur by ionospheric action, but this scattered wave is so weak that it can hardly be observed with ordinary equipment.

The notion that plays an important role in the practical calculations of the possibility of communication via the ionosphere, is the highest frequency, whereby a wave with a small take-off angle b is just reflected by the ionosphere. This frequency is called the Maximum Usable Frequency (MUF). The greater the take-off angle, the lower the frequency whereby reflection occurs. With a take-off angle of 90° , i.e. straight up, the frequency of the wave that is just reflected by the ionosphere is the lowest, and called the critical frequency f_c . For many years it has been routinely measured in many places around the

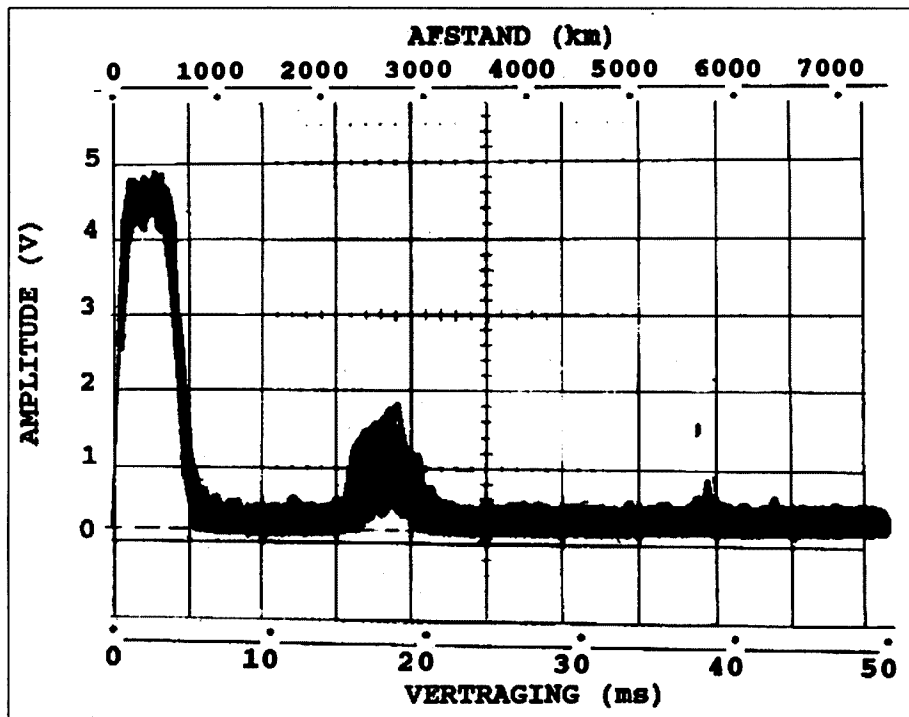

Figure 8: Amplitude versus Delay. Echo from Southerly direction, probably from the Atlas Mountains in Morocco, North Africa, at a distance of 2200 ± 100 km. Recorded on 29-12-91 at 13:15 UTC. Frequency 28.96 MHz, IF bandwidth 3 kHz, beam heading 180°

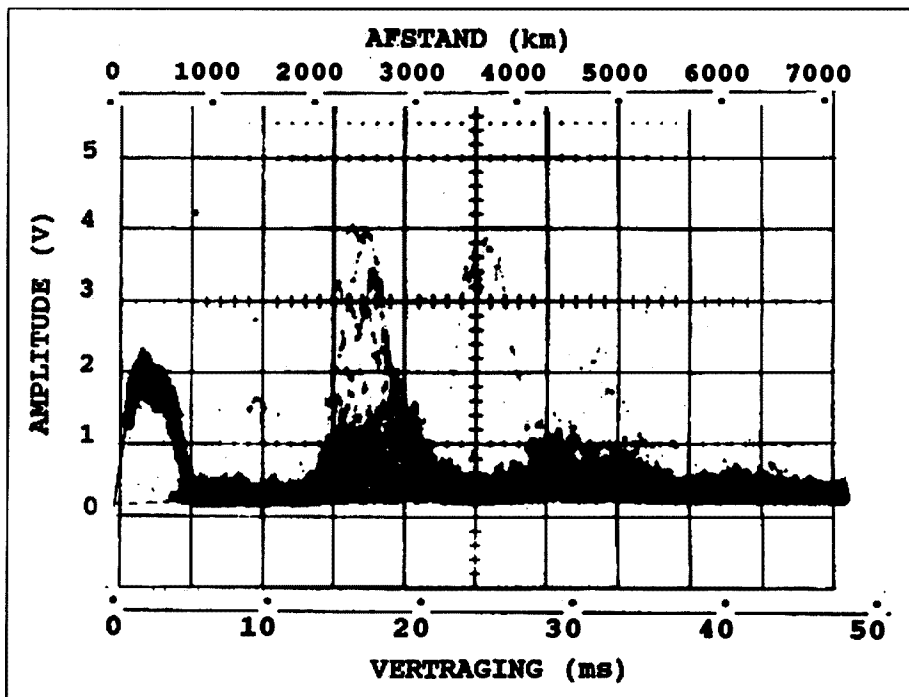

Figure 9: Amplitude versus Delay. (Triple?) Double echoes from the ocean, recorded on 29-12-91 at 13:30 UTC. Frequency 28.96 MHz, Beam heading 280° . Other details as for Figure 6.

world. A relation exists between the MUF and f_c as follows:

$$F_{MUF} = f_c / \cos a \quad (1)$$

where a is the angle at which the wave approaches the ionosphere (indicated in

Figure 3). This angle can be calculated from the take-off angle and the height h where the reflection occurs. Of importance to us is the maximum frequency whereby a wave hits the

ionosphere with a small angle and is still reflected by it, because that is what we use when making long distance connections. For $h = 200$ km and a realistic take-off angle, $b = 8^\circ$, a is 72° , $f_{MUF} = 3.2 \times f_c$.

The critical frequency depends on the degree of ionisation of the ionosphere, which is determined by the sun's activity and the time of day (at night, f_c is reduced by a factor of two or three). During a period of maximum solar activity the critical frequency can increase to $f_c = 13$ MHz, thus f_{MUF} is 40 MHz, and the 10-metre band is wide open.

There are two important possibilities for propagation across distances much greater than single-hop. In the first place through multiple hops, in the second place through a wave which propagates over a long distance inside the ionosphere (the Pedersen-wave). The first possibility shows itself when we make contacts with Amateurs in the United States, the second when comparatively reliable contacts are made with Amateurs in Australia and New Zealand.

Echo measurements with a "bistatic radar".

The appearance of echo signals during DX-contacts, as a consequence of which stations in the same area (but not within reach of each other) can receive one another with signal strength of S3-S7 when their beams are pointing in the same direction, led us to the question of where those echoes actually come from. Because the answer "Ionospheric Scatter" that experts gave us in the first instance wasn't very convincing, we decided to conduct a test. The distance between our QTHs (Gieten - Groningen) is about 30 km and was therefore favourable, because the signal strength of the direct received signal and the echo signal (when the band is open) were comparable; with pointing angles of 270° for both stations, it was about S-7. We found that the sound had a hollow ring to it, as in an empty room with hard surface walls. Within a few days PA0FA had made up a pulser (Figure 4) that could be plugged into the Key-input of his transceiver (ICOM IC765), PA0ZX connected the IF-output of his Yaesu FT901 via an IC amplifier to a detector (Figure 5), which turned the received

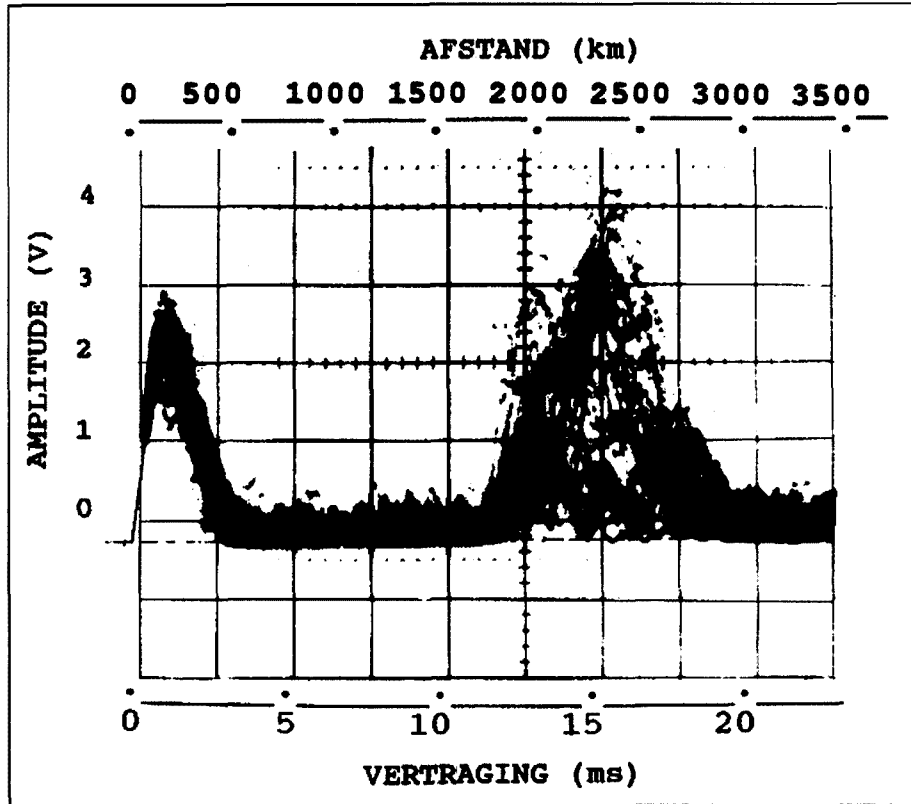

Figure 10: Amplitude versus Delay. First echo from the ocean, on a smaller time scale. Recorded on 16-1-92 at 11:40 UTC. Frequency 28.96 MHz, IF bandwidth 2 kHz, Beam heading 285° . Other details as for Figure 6.

CW signal from PA0FA (with a pulse duration of 1 ... 5 ms and pulse period 50 ... 200 ms) into a row of positive-going pulses that were applied to a scope with a calibrated timebase. Directly received pulses trigger the scope. Usually, the timebase is set for 5 ms per major division on the scale. The IF bandwidth of the receiver can be varied from 1 to 4 kHz.

We used a Polaroid camera to record the scope display, and manually operated the shutter at speeds of between 0.5 ... 1 second, so that with a pulse frequency of 20 Hz (50ms period), 10 ... 20 successive sweeps were recorded on the film. One of the first results, when pulses were transmitted on the 10-metre band (on 28.96 MHz) is shown in Figure 6. The direct pulse is on the extreme left with a half-height width of 3 ms and a rise time of about 2 ms. Further to the right we see echo pulses with a delay of between 12 ... 17 ms, thus with a spread in time of 5 ms, and also with large fluctuations in amplitude. When you look at the scope screen in real time, you'll notice a very turbulent display. Because the

propagation speed of the wave is 300,000 km/s (the speed of light), one millisecond of delay corresponds with the wave covering a distance of 300 km. Therefore, a delay of 12 ... 17 ms corresponds with a distance of 3600 ... 5100 km. Because the wave travels to and fro, the actual distances between antenna and obstacle is half of this, that is 1800 ... 2550 km. The distance scale is annotated on the top edge of the screen. In Figure 2 there are two obstacles that could cause these echoes: the ionosphere at point 1, at distance a , and the earth at point P, at distance $2a$. Calculations reveal that a distance $a = 1800$ km even with a take-off angle of $b = 0^\circ$ would correspond with a height $h = 400$ km, but at such a height there is no reflection. We must therefore conclude that we see an echo from the earth's surface. The first possibility occurs after one hop near point P. The to-and-fro distance covered by the wave between the ionosphere and the earth's surface is then $2a$. That is longer than the distance measured over the earth's surface. Using Figure 3 and the Pythagorean theorem you can calculate

that when the wave is at height $h = 200$ km (F_1 -layer) it is reflected and the hop distance is $D = 1700 \dots 2200$ km. For the measured value of $2a$ and the given value $h = 200$ km we can also calculate the take-off angle of the wave of which reflected signals are observed, these lie between 3° and 8° . In Figure 7 are the results shown graphically of the calculations of take-off angle and hop distance as a function of the measured delay. Those calculated values are indicated with broken lines.

It is interesting to observe that from the maximum take-off angle at which echoes are still received, and the height of the ionosphere, an estimate follows also for the critical frequency f_c in comparing (1) with $b = 8^\circ$ and $h = 200$ km, you'll find from Figure 3 with Pythagoras: $a = 74^\circ$ and then from comparison (1): $f_c = f_{MUF}$ and $\cos a = 28.96 \times 0.28 = 8.1$ MHz. The inaccuracy of the measurement of the echo delay and the uncertainty of the value of h , lead to an error of about ± 1 MHz in this value of the critical frequency.

From where do these fluctuating echoes exactly come from? We saw from the large variations in time delay that they come from an area of substantial dimensions: about $2200 \dots 1700 = 500$ km deep in the direction of the wave. The half-power beam width angle of our beams are about 30° , and this provides, at a distance of 2000 km, a width of 1000 km perpendicular to the direction of the wave. For the chosen beam heading of 270° , the center of this area lies approximately at 27° North and 46° West, which is in the North-Atlantic Ocean, about 900 km North of the Azores.

If the ocean were flat in the area from which the wave is reflected, the wave would continue in a southwesterly direction and begin a second hop. On the surface of the ocean exist large and small waves; these have a changing angle with the horizontal surface. At various places and times, these angles become great enough to reflect the radio

waves back into the direction from which they came. This effect is put to good use by radar systems that locate and track hurricanes, as described by Villard in QST (Ref 4). With such a system, even windspeed and force can be determined in a large number of places in areas of the ocean. The echo signal is always at least four S-points weaker than one that is returned after one hop (think of the signal strength of stations in Spain). This means, that, with ocean reflections, only about 1% of the electromagnetic energy (-20 dB) returns to us.

Now back to our own measurements. In December 1991 and January 1992, we made a large number of records of received echoes. Often in the 10-metre band, but also in the 15- and 20-metre band. A few special ones are reproduced here as follows. In Figure 8 we see a reflection from a Southerly direction (beam headings PA0FA and PA0ZX are both 180°) of pulses transmitted on 28.96 MHz. These reflections are 'quieter' and of shorter duration than reflections from the ocean. From the echo delay (15.5 ± 0.7 ms) we see a hop-distance of $D = 2200 \pm 100$ km, in Southerly direction. When we look in the atlas, we see the Atlas Mountains in Morocco, North Africa, which stretches out in an East-West direction. One high peak in these mountains lies 2275 km South of Groningen (latitude difference 53 North - 32.5 North = 20.5). The reflection disappears when the beam is turned 30° .

In Figure 9, the beams are turned again to the West with a heading of 280° , a frequency of 28.96 MHz, and an IF bandwidth of 3 kHz. Here, adjacent to the first reflection (12 - 20 ms) we see the second one distinctly (24 - 32 ms) and possibly something of a third one (38 - ?). The second reflection at distance $D = 3400$ to 4600 km corresponds with two hops, the third one would agree with three hops, but this one lies deeply in the noise. In Part 2 we shall see how making the IF bandwidth much smaller,

results in an improvement in the signal to noise ratio and late arriving reflections becoming more visible.

We have observed that the structure in time and amplitude of the echo signal varies strongly from day to day. Not seldom there are two peaks visible on the scope with steep wavefronts in the right direction (perpendicular on the transmit direction) as shown in Figure 6. These two peaks are separated by about 600 km. In addition, the difference in amplitude between the two peaks can vary strongly from day to day. While these in Figure 6 are a maximum of 0.8, in Figure 10 the variation is nearly 1.5. This could be caused by the amount of disturbance on the ocean surface, but also because of variations in the received signal strength because of changes in atmospheric conditions between PA0FA and PA0ZX

Postscript

This article was published earlier in *Electron* of September 1993, but with incorrect captions of the figures. Part 2 was published in *Electron* of October 1993

References

- 1 D. Rollema, *Electron*, Vol. 37 (1982) Page 562
- 2 D. Rollema, *Electron*, Vol. 40 (1985) Page 61
- 3 Instantaneous Prediction of Radio Transmission Paths, QST March 1952, page 11
- 4 Over-the-Horizon or Ionospheric Radar, QST, April 1980, page 39
- 5 Encyclopaedia Britannica, 1973/74 Vol. 9 page 813
6. Radio wave propagation and the ionosphere. Ya. L. Al'pert (Consultants Bureau, New York, 1963) page 316.
- 7 L.c. ref. 6, page 308

Other references:

Long-Delayed Echoes ... Radio's "Flying Saucer" Effect, QST May 1969, page 38

ar

email address for contributions:

edarmag@chariot.net.au

Snail mail address for contributions:

**The Editor
Amateur Radio
34 Hawker Crescent
Elizabeth East SA 5112**

Andrews Communication Systems

ESTABLISHED 1976

ACN 001 968 752

NEW! ALINCO DR-620E Dual-Band Remote Mobile



Made in Japan quality

- ★ 2m & 70cm, 50W/35W, 200ch mem.
- ★ Dual In-Band Receive; V/U, V/V, U/U
- ★ AM Aircraft & FM Broadcast band receive
- ★ Large alphanumeric display. Not full duplex
- ★ Optional 9600/1200 bps packet operation
- ★ Optional direct GPS input for APRS
- ★ Optional DIGITAL voice communication
- ★ CTCSS & DCS & TCXO & Cloning feature

NEW LOWER PRICING

ALINCO DX-70TH



Made in Japan quality

HF+ 6m 100W ALL-MODE MOBILE

COMPACT REMOTABLE TRANSCEIVER HAS EXCELLENT RECEIVER, HIGH QUALITY TRANSMIT AUDIO, CTCSS PLUS 4 I.F. FILTERS

\$1399

- ★ DR-605EA TWINBAND ...\$799
- ★ DJ-V5EA WIDE Rx DUALBAND ...\$499
- ★ DR-435E UHF 35W MOBILE ...\$649
- ★ DR-135T 2m 50W MOBILE ...\$399
- ★ DJ-X2000 HI-TECH SCANNER ...\$899
- ★ DJ-X10 ALL-MODE SCANNER ...\$749
- ★ DJ-X3 SMALL H/H SCANNER ...\$349
- ★ DJ-X2 TINY H/H SCANNER ...\$349

ALINCO RADIOS ARE MADE IN JAPAN!
3-YEAR FACTORY-BACKED WARRANTY!
FIRST & BEST ALINCO IMPORTER!

★ Tokyo Hy-Power Made in Japan

WORLD'S BEST AMATEUR LINEAR AMPS

Factory direct importer: www.thp.co.jp

ICOM

Made in Japan



IC-706HF HF

2-year warranty

+ 6m, + 2m + 70m ALL MODE COMPACT TRANCEIVER **\$2199**

OUTSTANDING PERFORMANCE
PLENTY OF ICOM AVAILABLE—CALL

KENWOOD



CALL FOR BEST PRICES

TELESCOPES

HIGH QUALITY
BEST PRICES IN AUSTRALIA



REFRACTORS

60mm \$99, 70mm \$179
80mm \$299, 90mm \$429, 102mm \$749

REFLECTORS

76mm \$99, 114mm \$149, 130mm \$299
150mm \$499, 200mm \$999. Dob's, too!

FACTORY DIRECT IMPORTER!

New Style BINOCULARS

- 5 x 30 ...\$19 Breakthrough Pricing!
- 10 x 25RC ...\$29 Guaranteed Hi-quality!
- 12 x 32RC ...\$39 Factory Direct Importer!
- 10 x 50RC ...\$49 Why pay more?

PROUDLY MADE IN AUSTRALIA—**GME ELECTROPHONE**

- ★ TX-3400\$429
- ★ TX-3200\$329
- ★ TX-4400\$429
- ★ TX-6000\$479

TWO-YEAR WARRANTY
EXCELLENT QUALITY

MOST EXC. COND.

USED

WARRANTY INC. (ex. o/P)

- | | |
|---|---|
| <p>—ICOM—</p> <p>IC-746 ...\$2399</p> <p>IC-756 ...\$2499</p> <p>IC-2100H ...\$299</p> <p>IC-575A ...\$599</p> <p>IC-910H ...\$2499</p> <p>IC-735 HF ...\$699</p> <p>—KENWOOD—</p> <p>TS-690S/AT \$1349</p> <p>TS-520 exc ...\$349</p> <p>TM-241A 2m \$249</p> <p>IF-232C ...\$59</p> <p>—MFJ—</p> <p>Preselector1040B \$179</p> <p>80/40m, NEW \$299</p> <p>NOISE BRIDGE \$129</p> <p>TUNER 948 ...\$219</p> <p>—AOR—</p> <p>AR-8200II, mint \$799</p> <p>AR-3000A, mint \$1100</p> <p>—THP—</p> <p>HL-82V 2M ...\$199</p> <p>HL-45U UHF ...\$299</p> <p>HL-60U UHF ...\$349</p> <p>HL-166V 6M ...\$299</p> <p>NICAD PACKS ...Call</p> | <p>—CODAN—</p> <p>8528 + ANT ..\$1499</p> <p>8528 +P/S ..\$1399</p> <p>—MIDLAND—</p> <p>70.265.48B ..\$299</p> <p>—ANDREWS—</p> <p>DX-1600A ..\$2999</p> <p>DX-1600V2 ..\$4500</p> <p>SPEAKER-MICS...call</p> <p>SLA Batteries -\$25ea</p> <p>—NEW—</p> <p>COAX SWITCH \$19</p> <p>PATCH LEAD ...\$5</p> <p>SWR METER ...\$15</p> <p>MUCH MORE IN STOCK...Call</p> <ul style="list-style-type: none"> ★ DIAMOND ANTENNAS ★ UNIDEN UHF CBs & SCANNERS ★ VOICECRAFT MICROPHONES ★ GARMIN GPS ★ AOR SCANNERS ★ YUPITERU SCAN. |
|---|---|

SCOOP PURCHASE!

BP-196H NiMH BATTERY PACKS **\$79** ea
for IC-40S, etc
1,500mA/h, 9.6V (not \$160)

MFJ TUNERS from ..\$249
ANALYSERS IN STOCK
ANTENNAS IN STOCK
SOUND CARDS IN STOCK
MASSIVE RANGE

UHF CBs



CALL (02) 9636-9060 or 9688-4301 or FAX 9688-1995

SHOP 8, 41—51 BATHURST ST, GREYSTANES, NSW 2145 Near Great Western Highway

Why pay more? MAIL ORDER TO PO BOX 240, PENDLE HILL, NSW 2145

Some items indent. Prices subject to change without notice - limited stock, some items. E & OE Newsletters Unlimited AAR/12/02

★ <http://www.andrewscom.com.au> ★ email: lee.andrews1@bigpond.com ★ all technical questions answered

Amateur Radio in Pakistan

Brenda Edmonds VK3KT

In June 2000 I had the opportunity to spend some time in Pakistan as a guest of the Principal of the Wahid Public School in Islamabad. June is the middle of summer in Pakistan, leading up to the monsoonal season in August-September. The weather was mostly very hot, temperatures up to 40 degrees C, with the land looking extremely dry and reservoirs very low. However any irrigated areas were very lush, and crops planted could almost be watched growing. I was surprised to see many of the roads lined with eucalyptus trees.

I had met with amateur operators from Pakistan during my visit to the IARU Region 3 Conference in Singapore in 1994, and had corresponded intermittently since then with my hostess and with AP2MY, Yunus Chaudhry, who is Secretary of the Pakistan Amateur Radio Society (PARS). Yunus was to spend a lot of time with me and contributed significantly towards my comfort and well-being during my stay. Through his arrangements, I met with AP2NK, Nasir Khan the President of PARS, AP2HA, Hasnat Bugvi the Treasurer and the society's patron AP2AGJ, Amir Gulistan Janjua and spent much time discussing matters of mutual interest.

A feature of my visit was my invitation to attend the Annual General Meeting of Pakistan Amateur Radio Society. This was held on the morning of the second Sunday of my visit (the date having been arranged to suit my itinerary). It was attended by about 40 amateurs, from areas around Islamabad and more distant parts of Pakistan. There are only about 170 licenced amateurs in Pakistan and an almost equal number of SWLs, but as the country covers about 800,000 square kilometres not all areas were able to be represented.

The meeting started with a reading from the Koran (Pakistan is predominantly Islamic), followed by the annual report prepared by the Secretary. This was followed by the customary annual reports and discussion of these. As there was no change of office-bearers there was no election, and the meeting proceeded to discussion of matters arising from the reports or raised from the floor. Luckily for me, most of the proceedings were in English. I was formally welcomed to the Society, and invited to address the meeting. I presented the society with some educational materials, badges and one

of our 75th Anniversary medallions. After the meeting concluded all were invited to partake of an elaborate lunch, when I was able to talk briefly with some of the members.

Matters, which seemed to be of concern to PARS, were the low growth rate of the hobby and the poor acceptance of amateur radio by the authorities. They have plans for WICEN-type activities, but are being told "Now we all have mobile phones we do not need radios" Finances, of course, are a continuing problem. The society did not feel able to send a delegate to the IARU Region 3 Conference in Beijing or Darwin.

Yunus also took me to visit the clubroom of PARS which is established in part of the Wahid Public School. The school has a small radio group in training, which also uses the facilities

there. Unfortunately I was not able to follow up the course details or speak to the students as we were there in vacation time.

On the social side, I met many of the relatives of my hostess, and was taken to see the local sights. The mountains, of course, were most impressive; especially the dwellings scattered over the hillsides among the trees. I found some of the roads a bit hair-raising, (not that I did any driving) but the traffic whilst intense was well-mannered and co-operative, one toot on the horn and the vehicle ahead pulled over to allow us to pass.

In all, it was a memorable trip and a great way to avoid some of the Melbourne winter. It is good to know that amateur radio is alive and well in Pakistan.

ar



PARS rooms (up top)



Yunus AP2MY at station in PARS rooms

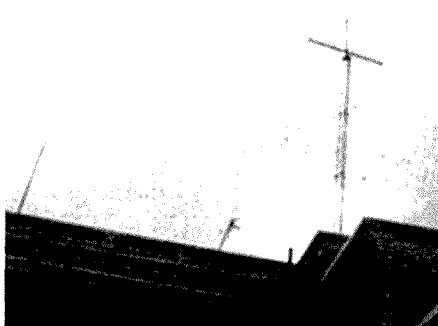

AP2AGJ antenna



From left: AP2HA, AP2NK, VKEKT, AP2AGJ, AP2MY

A temperature-controlled crystal frequency calibrator

Drew Diamond, VK3XU,
45 Gatters Road,
Wonga Park, 3115

Apart from a legal requirement that our transmissions shall be confined to permitted amateur bands, operating prowess is greatly improved when we have an accurate knowledge of our transmitting and receiving frequencies. An increased need for exactness is driven largely by band-planning requirements, and by new modes, which demand high stability and narrow operating bandwidths. Technical satisfaction may also be a factor.

Contemporary radio transceivers provide the user with a digital display of operating frequency to a (generally) high degree of resolution- typically 1 or 10 Hz. However, such impressive displays may cause some complacency. To make full use of the precision offered, it is essential that the internal frequency reference (and hence the display accuracy) be checked regularly against some acceptable "standard" of accuracy.

For the last 30 or so years, Australian radio workers have had access to our own local time and frequency service; VNG. The history of VNG could be made the subject of a "Yes Minister" story – always the poor orphan kicked from pillar to post. By the time you read this,

unless some extraordinary reprieve has occurred, we must somehow get along without a local (and therefore) reliable, accurate, simple to use, free-to-air time and frequency service.

Generally, we are not as interested in accurate time as we are in frequency. Time information, to fair accuracy, is available from the telephone network, the GPS system, the Internet and from short-wave services such as WWV and WWVH. Paradoxically for this age, local radio broadcast stations do not always send a time-signal (six pips, the start of the sixth being the hour) because they can no longer be guaranteed to be accurate.

There are three perceived free sources of accurate radio frequency:

- (1) AM broadcast transmitters. My local stations (near Melbourne), when compared against VNG, were found to be surprisingly accurate. In particular, the ABC transmitters on 621 and 774 kHz, with their well "aged" ovened crystals, were consistently within +/- 1 Hz of VNG. Of the dozen or so stations in ground-wave range, only one was found to be more than 3 Hz off nominal frequency. These would make fair (but not guaranteed) "consensus" references when taken as a whole. But consider; a combined reference and measuring error of (say) 2 Hz at 1 MHz would be 28 Hz at 14 MHz and 864 Hz at 70 cm. Is this good enough for the work in hand? Only you can tell.
- (2) The Channel 9 TV network is believed to be locked into a rubidium frequency standard. Therefore the off-air 15625 Hz horizontal oscillator signal from a TV receiver may be used as a local reference to which a local oscillator may be locked (as described in Ref. 6). Whilst not intending to detract from this bright scheme, it is perhaps a little more elaborate than the average amateur requires. Incidentally, for rough calibration work, the 448th harmonic of the horizontal oscillator radiated from a nearby TV set gives a pretty good checkpoint at 7.000 MHz.



Photo 1. Crystal Frequency Calibrator

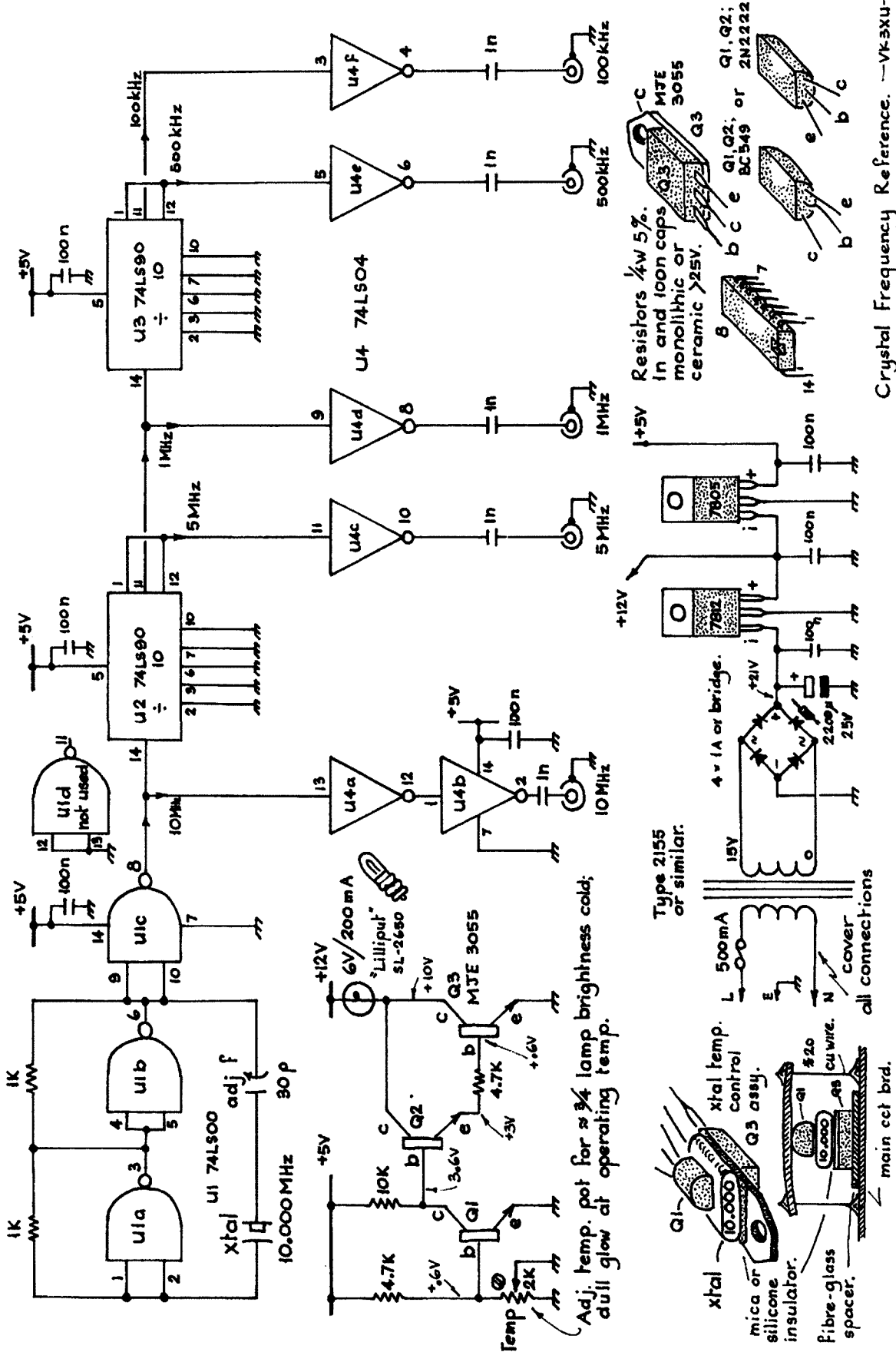

Fig. 1

Figure 1

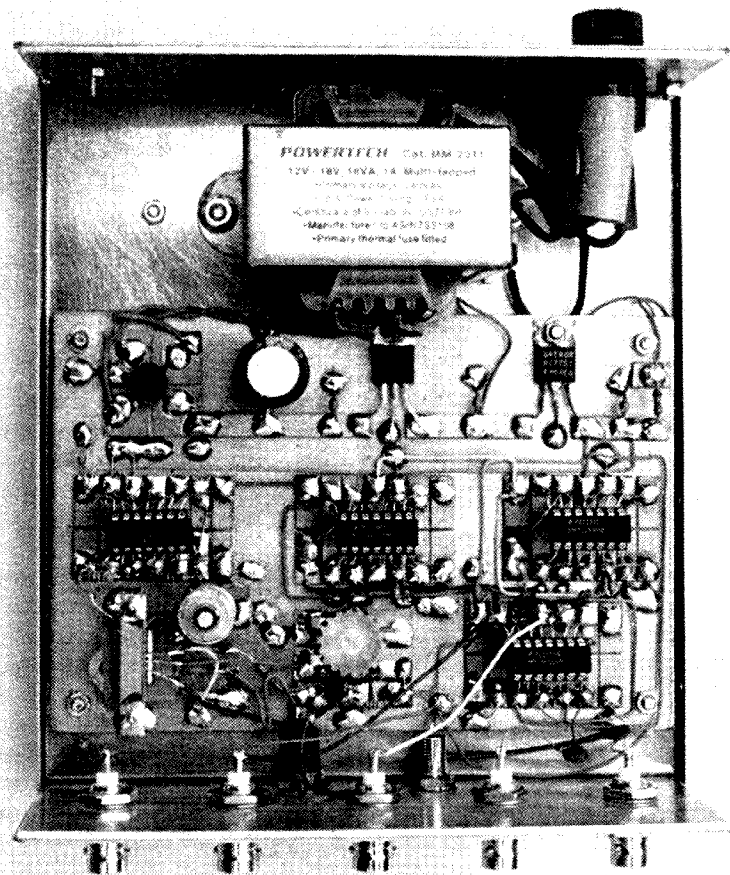

Photo 2. Internal view showing Paddyboard layout

(3) Short-wave time and frequency signals. WWV and/or WWVH are usually audible here late afternoons and well into the evening on 5, 10 and 15 MHz. With care, these transmissions provide adequate accuracy and reliability for amateur work. The main problem is phase fluctuations caused by multipathing (Ref 7). However, very acceptable accuracy can be achieved if these signals are used over a period of time. More later.

One of the simplest and most popular methods is to maintain a whole-number crystal, such as 10, 5, 4 or 1 MHz in a "crystal-calibrator" configuration (see Refs 1, 2 and 3 for typical circuits), and digital dividers to provide convenient ratios. In this model, a 10 MHz crystal is used to supply individual outputs at 10, 5, 1 MHz, 500 kHz and 100 kHz, harmonics of which are useable to at least 70 cm. To check a receive frequency accuracy at 432.1 MHz for instance, the 100 kHz output will furnish a signal of good strength against which the

receiver's oscillator (or internal reference) may be adjusted for correctness.

A local crystal calibrator reference finds application in checking the accuracy of frequency displays and dials, oscilloscope time-bases, and in providing convenient signals for receiver calibration and alignment work. Instruments such as frequency counters may be checked for accuracy, and adjusted accordingly. By incorporating (optional) temperature control of the crystal, precise checks may be made during times when the primary radio reference is unavailable.

Circuit

An ordinary off-the-shelf 10 MHz crystal is maintained in oscillation by two NAND gates of a 74LS00 logic chip U1a and b. The signal is buffered by U1c and applied to the first of two 74LS90 divide-by-ten chips, U2 and U3, to provide signals at 5, 1 MHz, and 500 and 100 kHz. Additional buffering of the 10 MHz and derived signals is provided by

individual inverters of U4. Outputs are capacitively coupled to the output connectors to ensure a rich high-frequency harmonic content for radio work, and to provide the output buffers with a degree of protection from accidental shorts and external voltage sources.

The optional crystal temperature controller is closely based on Ian Pogson's clever simple circuit (Refs. 4 and 5). I hesitate to call mine an oven, for it was found in practice that in order to obtain close temperature control, a thermally insulated crystal enclosure was not necessary. As fully explained in Ref. 3, a less than ideal (i.e. cheap) crystal, if held at some temperature which is perhaps 10 degrees C higher than any expected ambient will provide a very satisfactory degree of stability.

The crystal's case is heated by being attached to an MJE-3055 (or similar) power transistor in a simple feed-back arrangement. Transistor Q1 is thermally coupled to the opposite side of the crystal, and is heated also. With an increase in temperature, the effective resistance of Q1 is reduced, therefore its collector voltage moves towards chassis potential, thus sourcing less current into the base of Q2, which in turn reduces base current in Q3, whose collector current (hence dissipation = temperature) is reduced accordingly. A "Lilliput" 6.3 V/200 mA pea-lamp is connected in series with the collector of Q3 to give a visual indication of operating temperature; bright glow when "warming up", dull when operating temperature is reached.

Regulated dc supplies of +12 V and +5 V are provided by 7812 and 7805 regulator chips powered by a conventional transformer and bridge configuration.

Construction

If the greater stability offered by the temperature controller is not required, the mains power supply may simply be omitted, and U1 - U4 powered by four AA cells (6V). Include a series 1A diode to protect against accidental wrong polarity.

All components, including the power supply bridge (or diodes) and regulator chips are accommodated upon a plain circuit board measuring 100 x 150 mm. Wiring style is not particularly critical, although a meld of 'Paddyboard' (see

Ref. 8) and 'ugly' is recommended (Photo 2) for reliable high-frequency operation. The four Schottky (LS) chips are fitted into 14-pin DIL sockets, each of which is attached with fine tinned copper wires upon a segmented 40 x 25 mm circuit-board substrate. They may be super-glued or soldered upon the copper side of the main board. Single-strand telephone or wire-wrap wire (also available from Jaycar; WH-3032) is ideal for interconnecting the chips, +5V supply line, and other low-voltage connections. Include a 100 nF ceramic or monolithic by-pass at the +5 V supply rail pin of each chip.

A metal case or box is suggested. That shown in Photo 1 measures 175 x 155 x 65 mm, which is a HB-5446 from Jaycar. But any similarly sized enclosure should do. Not a lot of internal heat is generated, so vent holes are not mandatory. The aluminium component of the HB5446 base is rather thin, and so a snug fitting strengthening member has been added to the prototype. The cover should have a hole to accept a plastic tweaking tool

for adjustment of the crystal trim capacitor.

Connections on the mains (primary) side of the power transformer must be adequately covered to prevent accidental contact. For best long-term stability (and ready availability), it is recommended that the calibrator be run continuously. A mains switch is therefore not required.

Photo 3 shows a suggested method of assembling the temperature controller. It is made like a sandwich, starting with a rectangle of plain fibre-glass circuit board, then power transistor Q3 (heat flag upwards), TO220 silicone or mica insulator, crystal, transistor Q1, then the whole assembly held together with a small rectangle of circuit board attached to the main board with tinned wires, as pictured in Fig. 1. The crystal may lie along the power transistor, or at right angles (Photo 3) to suit your board layout. Q2, 2k trim-pot and remaining controller components may be wired upon a 9-land pad-board substrate.

Adjustment and Operation

Do a thorough parts placement and wiring accuracy check. Pay particular attention to polarised components—diodes, regulators, transistors and electrolytic. With all the digital chips removed; apply mains power and measure your +12 and +5 V supplies. Switch off and insert U1. If an oscilloscope is available, power up and apply the 'scope probe to pin 8 of U1 and observe a 10 MHz square waveform of about 4 V p-p. No 'scope? Listen for the 10 MHz signal on a nearby receiver. You may need to touch a screwdriver blade to pin 8 to radiate a signal.

Remove power and insert the remaining digital chips. Power on, and again using a 'scope, observe a waveform at each output connector—the 10, 5 and 1 MHz should be fairly square in shape, but the 500 kHz and 100 kHz will be "integrated" (spikey-rich in harmonics). If no 'scope, apply (say) the 100 kHz

continued next page

G. & C. COMMUNICATIONS

Authorised dealer for

✓Kenwood ✓Icom ✓Barrett RFDS ✓GME Electrophone ✓Uniden ✓RF Industries

TE-33 3 element tri-band yagi antenna

The most popular tribander. Storm proved in the Pacific islands.

Excellent performance. wide bandwidth, high gain, low SWR, high F/B ratio. Marine grade S/S h/ware. 6063T83 aluminium tube and specially machined heavy duty aluminium brackets.

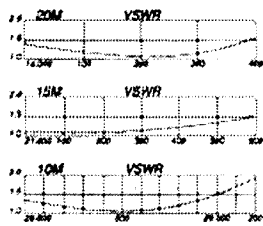
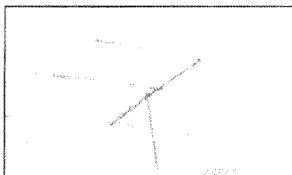

World famous names in HF and VHF Amateur Transceivers

27 Mhz and UHF CB Radios

HF and UHF LINEAR AMPLIFIERS

FULL RANGE OF EMTRON HF ANTENNAS

WE MOVED !

But only just down the road to

207 High Street

(The South Gippsland Highway)

Cranbourne

In our new, centre of town facility we have more room, more stock, and can deliver even better service.

We now stock Pioneer, Kenwood AND Clarion car audio.

We have a drive-in bay where we can fully fit any of your mobile communication needs!

Drop in, say G'day

Australia-wide orders welcome. Payment by credit card, cheque or money order

207 High St. Cranbourne 3977

Ph: 03 5996 3298 Fax: 03 5995 0184

Email: gccomm@netspace.net.au

www.netspace.net.au/~gccomm



Photo 3. Crystal temperature control assembly

signal to your receiver's input and observe a mark every 100 kHz across the dial. Check the other outputs accordingly. When using (say) the 1 MHz signal- you may also hear the 500 kHz and 100 kHz marks, but at smaller strength.

From a cold start, adjust the temp. pot through its range and observe that the lamp may be varied from full bright to nil, then set the pot for about 3/4 maximum brightness. You can test the controller's operation by briefly touching a hot soldering iron tip to the plastic case of Q1; the lamp should quickly dim. Removal of the iron should cause the lamp to gradually brighten again. After some 5 minutes operation, the lamp should dim to an orange glow, indicating that the crystal is up to operating temperature. If a thermometer is available- apply the sensor to the crystal case, where a temperature of about 50 or 55 degrees C should be indicated.

The signal may usually be introduced into a HF transceiver's input by wrapping a few turns of hook-up wire (from the calibrator's output connector) around the outer braid of the antenna coax, thus no damage can be caused to the calibrator if the transmitter is accidentally keyed on. Fit the cover, and allow the crystal to reach operating temperature. Tune to the standard broadcast signal on 5, 10 or 15 MHz, initially in AM mode. Select the 5 or 10 MHz signal from your calibrator. Now, with an audible note of sufficient

loudness, carefully adjust the crystal trim cap for zero-beat. A better method is to tune the broadcast signal on SSB, for a note of perhaps 800 or 1000 Hz, then adjust the trim cap for zero "burble" (like tuning a piano string). Be on guard for the modulation tone on the broadcast signal. At about 20 seconds before the minute there is a silent period (except for ticks), which is more ideal.

Let the calibrator run continuously, and gradually, day by day, re-check the setting of the trim cap, and so sneak up on a final setting. Over time, the calibrator should settle down, and achieve a day to day accuracy, which is very close, for all practical purposes, to that of the broadcast signal as received. With care, an accuracy of significantly better than one part in one million should be possible from here. No frequency hysteresis has been observed for the prototype. That is, if power is removed (typically overnight), the crystal frequency returns to the same value as before when operating temperature is reached.

Conclusion

For technical and operational reasons, radio operators and experimenters ought to accurately know transmitting and receiving frequencies. Therefore, a transceiver's internal frequency reference should be regularly checked against a standard of known exactness. A simple and cheap method is to use free-to-air broadcast frequency standards

as primary reference. It has been shown that the signal frequency generated by an ordinary temperature-controlled 10 MHz crystal, when carefully adjusted against the primary reference over a period of time, may be used with a high degree of confidence to make accurate checks on radio frequency generating and measuring equipment at any time of the day.

Parts

No rare or special components are required- all are collectively available from our usual electronics suppliers, including Altronics, Dick Smith Electronics and Jaycar. For best frequency stability, an air-spaced 25 or 30 pF "beehive" style trim cap is recommended. These are available from Electronic World (039723 3860- will answer mail orders).

References and Further Reading

1. "A Simple Secondary Frequency Standard"; Brumbaugh, KB4ZGC, 73, Mar. '96.
2. "A Crystal Calibrator and Signal Source"; Diamond, AR, Oct. '87.
3. Test Equipment for the Radio Amateur; Smith, G4FZH, RSGB Publications.
4. "A Simple Temperature Controlled Crystal Oven"; Pogson, VK2AZN, E.A., Apr. '87.
5. "Omega-derived Frequency Standard"; Pogson, VK2AZN, E.A., May '87.
6. "TV-derived Time and Frequency Standard"; Jim Rowe, E.A. Oct '89 and Oct/Nov '93.
7. Frequency and Time Standards; Application Note 52; Hewlett Packard Co.
8. "'Paddyboard" Circuit Construction"; Diamond, AR, Feb. '95.

ar

Amateur Radio

By subscription with your WIA membership,
or now in your newspaper

Build an electronics set your springboard into practical electronics

Peter Parker VK3YE
12/8 Walnut St, Carnegie, Vic, 3163
<http://www.alphalink.com.au/~parkerp/>

Fifteen or twenty years ago many people got their start in electronics with an electronics set. These sets included a selection of components wired to springs, all mounted on a plastic or cardboard base. Soldering was not required; connections were made by linking the springs with hook-up wire. Construction details for dozens of projects were provided, with sirens, Morse oscillators, flashing lights, crystal sets, timers and simple AM transmitters being popular.

These spring-based sets are still available and represent good value. However there is much to be said for building your own from scratch. It is not hard and parts are readily available. All that's missing is the instruction book. However suitable beginner circuits are available from those old '101 project' books or off the web, so it's easy to make your own instruction manual. The benefit of this is that you are no longer doing 'electronics by numbers' and are instead learning how to handle components, read their values and construct projects straight from the circuit. As a result you gain more skills and increased personal involvement.

Assembly

Photo One shows how the electronics set is constructed. The components and springs are mounted on a plastic pet litter container. Another litter container, screwed to the other, forms the base. The result is a high base with a compartment for wires, earphones and circuit diagrams.

The choice of parts is up to the builder. The selection chosen will depend on the constructor's interests and whether the board is to be used for fun, education or prototyping. If the latter, a solderless breadboard or several IC sockets could be added to allow the use of extra components not included on the board. The parts list provided was used in the prototype and should prove sufficient for most purposes.

Possibly the most important part of the project is the springs. Calculate the number required carefully; there is nothing worse with having all components, but having insufficient springs to complete the project. The springs used came from DSE and are

sold as accessories for their 'Funway One' kits.

Make a layout plan based on the size of your litter containers and the components at hand. Do not try to cram too much into too small a space; it is suggested that springs be at least 20 mm apart to prevent short-circuits.

The springs are passed through 3mm holes drilled in the base of the litter container. Because they are very tight, many torn fingernails will result if an attempt is made to find an end of the spring and push it through the hole. Instead use a small flat bladed screwdriver to do the job. When the end of the spring is through the hole, turn the spring until you have screwed about one quarter of the spring through the hole. This is a menial and time-consuming job, so is best spread over several days.

Next to each spring drill a small hole for each component lead. A 1.5mm drill bit is suitable. Ensure that the spacing is suitable for each component, particularly for transistors, LEDs and the relay.

Insert the components and loop the leads to connect with the underside of their respective springs. Use tinned copper wire to extend connections from the relay, meter, battery holder, power switch, potentiometers, ferrite rod taps and tuning capacitors to their respective

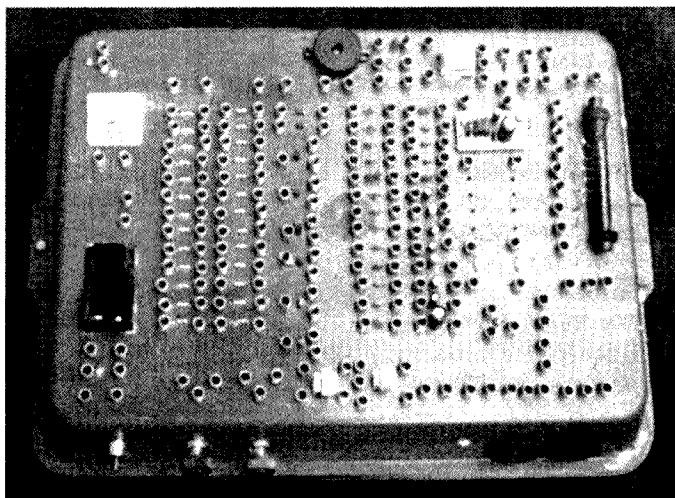

Photo: Completed Electronics Set

springs. Two grommets are threaded over the ferrite rod to provide some separation between it and the plastic board.

With all electronic circuits correct polarity is important. This board is no exception. For the battery, meter, buzzer, electrolytic capacitors, LEDs and solar panels, make your connections so the positive connection is always the right hand terminal. For the transistors, make the connections like how the schematic symbol is normally drawn. For instance, have the base at 9 o'clock, the collector at 1 o'clock and the emitter at 5 o'clock. Similarly, orient the FET so the gate is at 9, the drain is at 1 and the source is at 5 o'clock.

Note the reference to the 'Champ' audio amplifier kit in the parts list. This is a low-cost audio amplifier module based on the LM386. This module was included because it is commonly available and cheap. Also the printed circuit board overcomes the difficulty of mounting small ICs on the litter

container. Of course to include this part of the project, you will need to know how to solder. If you can't solder this simple amplifier kit is a good starting point to learn.

Parts List

Resistors

Fixed: (5%, $\frac{1}{4}$ watt): 47, 100, 220, 470 (x2), 1k (x2), 2.2k (x2), 4.7k (x2), 10k (x2), 22k (x2), 47k (x2), 100k (x2), 220k (x2), 470k (x2), 1M (x2)

Variable: 10k, 100k

Capacitors

Disc ceramic: 22 (x2), 47, 100 (x3), 220, 470 pF, 0.001 (x3), 0.0022, 0.0047, 0.01 (x2), 0.022 (x2), 0.047, 0.1 (x2), 0.22 uF

Electrolytic: 1, 3.3, 10 (x2), 47, 100, 220 uF

Variable: 60/160 pF (x2)

Semiconductors

Diodes: OA95 (x2), 1N914 (x2)

Transistors: BC547 (x3), BC557 (x2), MPF102

ICs: MK484

LEDs: Red, Yellow, Green

Light dependent resistor

0.45 volt solar cells (x2)

Miscellaneous

1k-8ohm & 3k-3k audio transformers, 8 ohm speaker, crystal earpiece, SPDT relay, piezo buzzer, ferrite rod (80 turns, taps every 10 turns), earphone socket, 250 uA meter, 'Champ' audio amp module, SPDT switch, battery holder for 9v battery, springs, hook-up wire with tinned ends

Some starter circuits

With the board now complete, the fun can begin! The circuits in Figure One, though bare-bones in their simplicity, have been found to work on the prototype board.

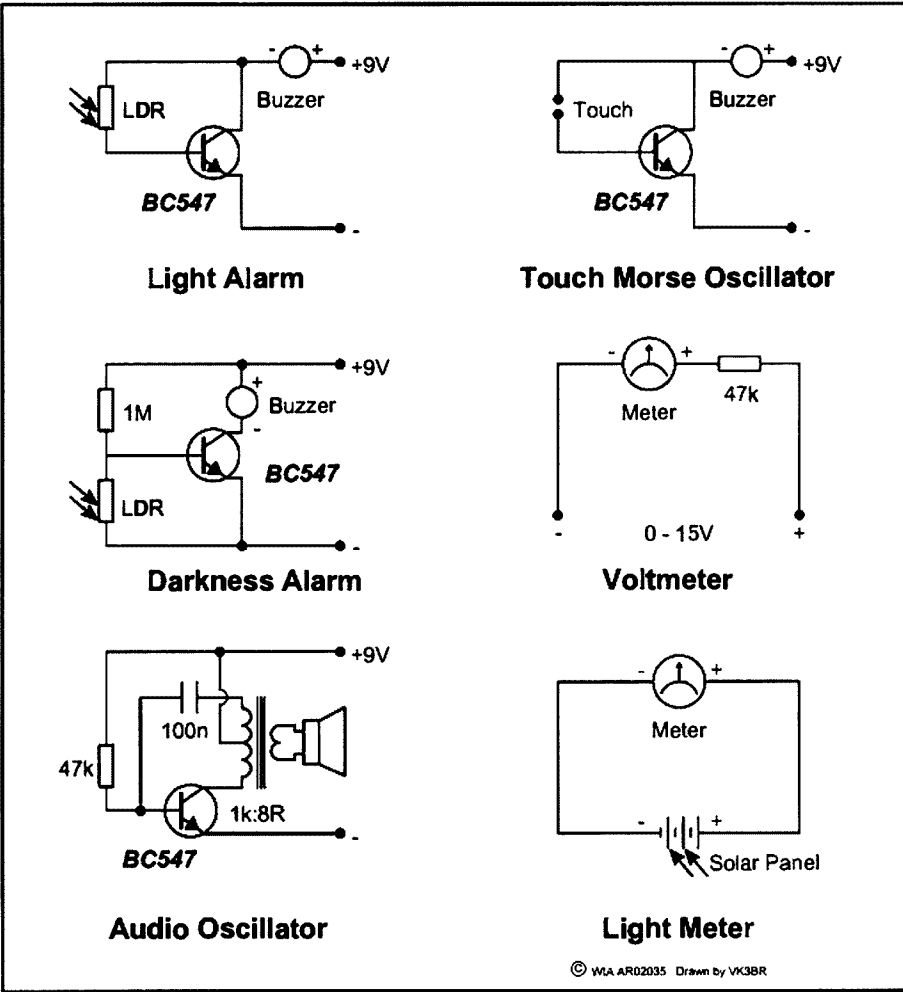

Figure One:

Conclusion

An old-style electronics set has been described. It will prove useful for prototyping, education and entertainment. It particularly lends itself as a club project or training aid as there

are no parts to get lost. Also the use of available parts means that students can easily duplicate projects developed on this board at home, further adding to the board's educational value.

Over to you

Mainland problems

My XYL and I have just returned from one of our annual trips up north and with our 2 metre rig in the car were looking to use IRLP to talk back to our 670 node here on the Tasmanian Northwest Coast.

Node list at the ready! PROBLEMS – are these mainland nodes on 144 or 432?

Is trial and error the only way to find out? Talking to many mobile hams it

would seem that 2 metres is the predominant rig used in travellers' cars but it would seem most IRLP nodes on the mainland are on 70cm. It would be VERY useful to have a frequency list for our Australian nodes or, better still, a standard band use. A check of the call-book shows 50% more 2 metre repeaters than 70cm. One comment was "We don't want to clutter up our 2 metre repeaters" – LAUGH – who has tried to get ANYONE to answer you on most repeaters?

Surely we are not the only ones to have experienced this problem. Any comments folks?

Ron Churcher, VK7RN.

"It's a great pity that Mr Cornish VK2KCN (OTU, P 53 November issue) doesn't abide by the credo so ably expressed by his mentors and noted in the last paragraph of his letter to you"

Having got that off my chest, Regards

Don Jackson VK3DBB

Table of Allocation of International Call Sign Series

<http://life.itu.ch/radioclub/rr/ap42.htm>

* Series allocated to an international organization.

** In response to Resolution 99 (Minneapolis, 1998) of the Plenipotentiary Conference

(See Article 19) <http://life.itu.ch/radioclub/rr/art19.htm>

Printed with Permission of the ITU

Call Sign Series	Allocated to	Call Sign Series	Allocated to	Call Sign Series	Allocated to
AAA-ALZ	United States of America	GAA-GZZ	United Kingdom of Great Britain and Northern Ireland	OAA-OZZ	Denmark
AMA-AOZ	Spain	HAA-HAZ	Hungary (Republic of)	PAA-PIZ	Netherlands (Kingdom of the)
APA-ASZ	Pakistan (Islamic Republic of)	HBA-HBZ	Switzerland (Confederation of)	PJA-PJZ	Netherlands (Kingdom of the) - Netherlands Antilles
ATA-AWZ	India (Republic of)	HCA-HDZ	Ecuador	PKA-POZ	Indonesia (Republic of)
AXA-AXZ	Australia	HEA-HEZ	Switzerland (Confederation of)	PPA-PYZ	Brazil (Federative Republic of)
AYA-AZZ	Argentine Republic	HFA-HFZ	Poland (Republic of)	PZA-PZZ	Suriname (Republic of)
A2A-A2Z	Botswana (Republic of)	HGA-HGZ	Hungary (Republic of)	P2A-P2Z	Papua New Guinea
A3A-A3Z	Tonga (Kingdom of)	HHA-HHZ	Haiti (Republic of)	P3A-P3Z	Cyprus (Republic of)
A4A-A4Z	Oman (Sultanate of)	HIA-HIZ	Dominican Republic	P4A-P4Z	Netherlands (Kingdom of the) - Aruba
A5A-A5Z	Bhutan (Kingdom of)	HJA-HKZ	Colombia (Republic of)	P5A-P9Z	Democratic People's Republic of Korea
A6A-A6Z	United Arab Emirates	HLA-HLZ	Korea (Republic of)	RAA-RZZ	Russian Federation
A7A-A7Z	Qatar (State of)	HMA-HMZ	Democratic People's Republic of Korea	SAA-SMZ	Sweden
A8A-A8Z	Liberia (Republic of)	HNA-HNZ	Iraq (Republic of)	SNA-SRZ	Poland (Republic of)
A9A-A9Z	Bahrain (State of)	HOA-HPZ	Panama (Republic of)	SSA-SSM	Egypt (Arab Republic of)
BAA-BZZ	China (People's Republic of)	HQA-HRZ	Honduras (Republic of)	SSN-STZ	Sudan (Republic of the)
CAA-CEZ	Chile	HSA-HSZ	Thailand	SUA-SUZ	Egypt (Arab Republic of)
CFA-CKZ	Canada	HTA-HTZ	Nicaragua	SVA-SZZ	Greece
CLA-CMZ	Cuba	HUA-HUZ	El Salvador (Republic of)	S2A-S3Z	Bangladesh (People's Republic of)
CNA-CNZ	Morocco (Kingdom of)	HVA-HVZ	Vatican City State	S5A-S5Z	Slovenia (Republic of)
COA-COZ	Cuba	HWA-HWZ	France	S6A-S6Z	Singapore (Republic of)
CPA-CPZ	Bolivia (Republic of)	HZA-HZZ	Saudi Arabia (Kingdom of)	S7A-S7Z	Seychelles (Republic of)
CQA-CUZ	Portugal	H2A-H2Z	Cyprus (Republic of)	S8A-S8Z	South Africa (Republic of)
CVA-CXZ	Uruguay (Eastern Republic of)	H3A-H3Z	Panama (Republic of)	S9A-S9Z	Sao Tome and Principe (Democratic Republic of)
CYA-CZZ	Canada	H4A-H4Z	Solomon Islands	TAA-TCZ	Turkey
C2A-C2Z	Nauru (Republic of)	H6A-H7Z	Nicaragua	TDA-TDZ	Guatemala (Republic of)
C3A-C3Z	Andorra (Principality of)	H8A-H9Z	Panama (Republic of)	TEA-TEZ	Costa Rica
C4A-C4Z	Cyprus (Republic of)	IAA-IZZ	Italy	TFA-TFZ	Iceland
C5A-C5Z	Gambia (Republic of the)	JAA-JSZ	Japan	TGA-TGZ	Guatemala (Republic of)
C6A-C6Z	Bahamas (Commonwealth of the)	JTA-JVZ	Mongolia	THA-THZ	France
C7A-C7Z	World Meteorological Organization	JWA-JXZ	Jordan	TIA-TIZ	Costa Rica
C8A-C9Z	Mozambique (Republic of)	JYA-JYZ	Jordan (Hashemite Kingdom of)	TJA-TJZ	Cameroon (Republic of)
DAA-DRZ	Germany (Federal Republic of)	JZA-JZZ	Indonesia (Republic of)	TKA-TKZ	France
DSA-DTZ	Korea (Republic of)	J2A-J2Z	Djibouti (Republic of)	TLA-TLZ	Central African Republic
DUA-DZZ	Philippines (Republic of the)	J3A-J3Z	Grenada	TMA-TMZ	France
D2A-D3Z	Angola (Republic of)	J4A-J4Z	Greece	TNA-TNZ	Congo (Republic of the)
D4A-D4Z	Cape Verde (Republic of)	J5A-J5Z	Guinea-Bissau (Republic of)	TOA-TOZ	France
D5A-D5Z	Liberia (Republic of)	J6A-J6Z	Saint Lucia	TRA-TRZ	Gabonese Republic
D6A-D6Z	Comoros (Islamic Federal Republic of the)	J7A-J7Z	Dominica (Commonwealth of)	TSA-TSZ	Tunisia
D7A-D9Z	Korea (Republic of)	J8A-J8Z	Saint Vincent and the Grenadines	TTA-TTZ	Chad (Republic of)
EAA-EHZ	Spain	KAA-KZZ	United States of America	TUA-TUZ	Côte d'Ivoire (Republic of)
E1A-E1Z	Ireland	LAA-LNZ	Norway	TVA-TXZ	France
EKA-EKZ	Armenia (Republic of)	LOA-LWZ	Argentine Republic	TYA-TYZ	Benin (Republic of)
ELA-ELZ	Liberia (Republic of)	LXA-LXZ	Luxembourg	TZA-TZZ	Mali (Republic of)
EMA-EOZ	Ukraine	LYA-LYZ	Lithuania (Republic of)	T2A-T2Z	Tuvalu
EPA-EQZ	Iran (Islamic Republic of)	LZA-LZZ	Bulgaria (Republic of)	T3A-T3Z	Kiribati (Republic of)
ERA-ERZ	Moldova (Republic of)	L2A-L9Z	Argentine Republic	T4A-T4Z	Cuba
ESA-ESZ	Estonia (Republic of)	MAA-MZZ	United Kingdom of Great Britain and Northern Ireland	T5A-T5Z	Somali Democratic Republic
ETA-ETZ	Ethiopia (Federal Democratic Republic of)	NAA-NZZ	United States of America	T6A-T6Z	Afghanistan (Islamic State of)
EUA-EWZ	Belarus (Republic of)	OAA-OCZ	Peru	T7A-T7Z	San Marino (Republic of)
EXA-EXZ	Kyrgyz Republic	ODA-ODZ	Lebanon	T8A-T8Z	Palau (Republic of)
EYA-EYZ	Tajikistan (Republic of)	OEA-OEZ	Austria	T9A-T9Z	Bosnia and Herzegovina (Republic of)
EZA-EZZ	Turkmenistan	OFA-OFZ	Finland	UAA-UIZ	Russian Federation
E2A-E2Z	Thailand	OKA-OLZ	Czech Republic	UJA-UMZ	Uzbekistan (Republic of)
E3A-E3Z	Eritrea	OMA-OMZ	Slovak Republic	UNA-UQZ	Kazakhstan (Republic of)
** E4A-E4Z	Palestinian Authority	ONA-OTZ	Belgium	URA-UZZ	Ukraine
FAA-FZZ	France			VAA-VGZ	Canada

Table of Allocation of International Call Sign Series (continued)

Call Sign Series	Allocated to	Call Sign Series	Allocated to	Call Sign Series	Allocated to
VHA-VNZ	Australia	ZNA-ZOZ	United Kingdom of Great Britain and Northern Ireland	5UA-5UZ	Niger (Republic of the)
VOA-VOZ	Canada	ZPA-ZPZ	Paraguay (Republic of)	5VA-5VZ	Togo (Republic of)
VPA-VQZ	United Kingdom of Great Britain and Northern Ireland	ZQA-ZOZ	United Kingdom of Great Britain and Northern Ireland	5WA-5WZ	Western Samoa (Independent State of)
VRA-VRZ	China (People's Republic of) - Honkong	ZRA-ZUZ	South Africa (Republic of)	5XA-5XZ	Uganda (Republic of)
VSA-VSZ	United Kingdom of Great Britain and Northern Ireland	ZVA-ZZZ	Brazil (Federative Republic of)	5YA-5ZZ	Kenya (Republic of)
VTA-VWZ	India (Republic of)	ZZA-ZZZ	Zimbabwe (Republic of)	6AA-6BZ	Egypt (Arab Republic of)
VXA-VYZ	Canada	Z3A-Z3Z	The Former Yugoslav Republic of Macedonia	6CA-6CZ	Syrian Arab Republic
VZA-VZZ	Australia	2AA-2ZZ	United Kingdom of Great Britain and Northern Ireland	6DA-6JZ	Mexico
V2A-V2Z	Antigua and Barbuda	3AA-3AZ	Monaco (Principality of)	6KA-6NZ	Korea (Republic of)
V3A-V3Z	Belize	3BA-3BZ	Mauritius (Republic of)	6OA-6OZ	Somali Democratic Republic
V4A-V4Z	Saint Kitts and Nevis	3CA-3CZ	Equatorial Guinea (Republic of)	6PA-6SZ	Pakistan (Islamic Republic of)
V5A-V5Z	Namibia (Republic of)	3DA-3DM	Swaziland (Kingdom of)	6TA-6UZ	Sudan (Republic of the)
V6A-V6Z	Micronesia (Federated States of)	3DN-3DZ	Fiji (Republic of)	6VA-6WZ	Senegal (Republic of)
V7A-V7Z	Marshall Islands (Republic of the)	3EA-3FZ	Panama (Republic of)	6XA-6XZ	Madagascar (Republic of)
V8A-V8Z	Brunei Darussalam	3GA-3GZ	Chile	6YA-6YZ	Jamaica
WAA-WZZ	United States of America	3HA-3UZ	China (People's Republic of)	6ZA-6ZZ	Liberia (Republic of)
XAA-XIZ	Mexico	3VA-3VZ	Tunisia	7AA-7IZ	Indonesia (Republic of)
XJA-XOZ	Canada	3WA-3WZ	Viet Nam (Socialist Republic of)	7JA-7NZ	Japan
XPA-XPZ	Denmark	3XA-3XZ	Guinea (Republic of)	7OA-7OZ	Yemen (Republic of)
XQA-XRZ	Chile	3YA-3YZ	Norway	7PA-7PZ	Lesotho (Kingdom of)
XSA-XSZ	China (People's Republic of)	3ZA-3ZZ	Poland (Republic of)	7QA-7OZ	Malawi
XTA-XTZ	Burkina Faso	4AA-4CZ	Mexico	7RA-7RZ	Algeria (People's Democratic Republic of)
XUA-XUZ	Cambodia (Kingdom of)	4DA-4IZ	Philippines (Republic of the)	7SA-7SZ	Sweden
XVA-XVZ	Viet Nam (Socialist Republic of)	4JA-4KZ	Azerbaijani Republic	7TA-7YZ	Algeria (People's Democratic Republic of)
XWA-XWZ	Lao People's Democratic Republic	4LA-4LZ	Georgia (Republic of)	7ZA-7ZZ	Saudi Arabia (Kingdom of)
XXA-XXZ	Portugal	4MA-4MZ	Venezuela (Republic of)	8AA-8IZ	Indonesia (Republic of)
XYA-XZZ	Myanmar (Union of)	4NA-4OZ	Yugoslavia (Federal Republic of)	8JA-8NZ	Japan
YAA-YAZ	Afghanistan (Islamic State of)	4PA-4SZ	Sri Lanka (Democratic Socialist Republic of)	8OA-8OZ	Botswana (Republic of)
YBA-YHZ	Indonesia (Republic of)	4TA-4TZ	Peru	8PA-8PZ	Barbados
YIA-YIZ	Iraq (Republic of)	* 4UA-4UZ	United Nations	8QA-8OZ	Maldives (Republic of)
YJA-YJZ	Vanuatu (Republic of)	* 4VA-4VZ	Haiti (Republic of)	8RA-8RZ	Guyana
YKA-YKZ	Syrian Arab Republic	* 4WA-4WZ	United Nations	8SA-8SZ	Sweden
YLA-YLZ	Latvia (Republic of)	4XA-4XZ	Israel (State of)	8TA-8YZ	India (Republic of)
YMA-YMZ	Turkey	* 4YA-4YZ	International Civil Aviation Organization	8ZA-8ZZ	Saudi Arabia (Kingdom of)
YNA-YNZ	Nicaragua	4ZA-4ZZ	Israel (State of)	9AA-9AZ	Croatia (Republic of)
YOA-YRZ	Romania	5AA-5AZ	Libya (Socialist People's Libyan Arab Jamahiriya)	9BA-9DZ	Iran (Islamic Republic of)
YSA-YSZ	El Salvador (Republic of)	5BA-5BZ	Cyprus (Republic of)	9EA-9FZ	Ethiopia (Federal Democratic Republic of)
YTA-YUZ	Yugoslavia (Federal Republic of)	5CA-5GZ	Morocco (Kingdom of)	9GA-9GZ	Ghana
YVA-YYZ	Venezuela (Republic of)	5HA-5IZ	Tanzania (United Republic of)	9HA-9HZ	Malta
YZA-YZZ	Yugoslavia (Federal Republic of)	5JA-5KZ	Colombia (Republic of)	9IA-9JZ	Zambia (Republic of)
Y2A-Y9Z	Germany (Federal Republic of)	5LA-5MZ	Liberia (Republic of)	9KA-9KZ	Kuwait (State of)
ZAA-ZAZ	Albania (Republic of)	5NA-5OZ	Nigeria (Federal Republic of)	9LA-9LZ	Sierra Leone
ZBA-ZJZ	United Kingdom of Great Britain and Northern Ireland	5PA-5QZ	Denmark	9MA-9MZ	Malaysia
ZKA-ZMZ	New Zealand	5RA-5SZ	Madagascar (Republic of)	9NA-9NZ	Nepal
		5TA-5TZ	Mauritania (Islamic Republic of)	9OA-9TZ	Democratic Republic of the Congo

Amateur Radio

cheaper if you are a member of the Wireless Institute of Australia!

Why search for Amateur Radio Magazine on the news stands when you could receive a copy at your own home anywhere in Australia?

Please contact us at the WIA - Western Australian Division - WIA

Or see page 64

There are three grades of membership:

1. Full Member - with AR Magazine \$71.00 per year
2. Pensioner or Student with AR Magazine \$65.00 per year
3. Full member - without AR Magazine \$39.00 per year

Bankcard, MasterCard or Visa

Application forms are available by post or from:

<http://www.wia.org.au/vk6>

Roy VK6XV on 08-9246-3642 or Christine VK6ZLZ on 08-9351-8873

Email: vk6@wia.org.au or vk6membership@wia.org.au

Post to WIA WA PO Box 10, West Perth WA 8872

Gipland Gate Radio and Electronics Club

AOCP/NAOCP Classes for 2003

From **March 17 - 2003**, a **Radio Class** will be conducted by the Club at the **Cranbourne Scout Hall on Monday nights**

The course will take people through the fundamentals of radio and electronics theory. At the end of the course participants will be ready to attempt the exams necessary to obtain an Amateur Radio Operators license.

There are **TWO** points of entry into the course. **STAGE 1** will suit those with no previous experience. On one night per week, over **9** weeks participants will learn the fundamentals of electricity and semiconductors. **STAGE 2**, which also lasts for **9** sessions, focuses on radio &

communications topics, with transmitters, receivers, antennas etc. It will suit those with a background in electronics who wish to know more about radio topics or those with a Novice radio license who would like to upgrade to the full license standard.

The fee for the full course is \$172 which includes Club membership for the 2003-2004 year. Those who wish to participate in the second stage only, pay \$115. The classes will be from 7:00pm to 9:30pm on Monday nights. A \$20

deposit is needed with the application to secure a position.

A \$15 discount will apply to Juniors & Pension card holders.

Immediately following the course, an examination will be held at the same venue, for the full range of Novice theory, Full theory and Regulations topics.

For more information contact Ian Jackson, the Class Coordinator, on 5625 2545 or visit the GGREC website on www.ggrec.org.au.

Goulburn and Southern Highlands Amateur Radio Society Inc

Following the winding up of the Southern Highlands Amateur Radio Club, the Goulburn Amateur Radio Society has changed its name.

The club is now called the Goulburn and Southern Highlands Amateur Radio Society, and is seeking to build a viable social and technical forum for amateurs in the Goulburn and Southern Highlands areas of NSW.

A recent mail out of our newsletter to all amateurs in the Goulburn and Southern Highlands areas has been

successful with 12 new members joining the society, and a number of others indicating their interest.

At recent meetings members heard presentations by VK2CSS on his life as a marine radio officer, and from VK2XCD and VK2AIJ on experiments with a 40 meter full wave sloping loop antenna on its fundamental and harmonic frequencies.

A number of interesting presentations are planned for coming months, and the

next edition of our newsletter is due in December.

Our club net is at 9:00 pm local time, each Sunday night on 3.615 MHz, and all are welcome.

If you are interested in joining, and have not received a newsletter and application form, call the secretary Chris, VK2XCD, on 4822 4753, or write to the Goulburn and Southern Highlands Amateur Radio Society, PO Box 341, Goulburn 2580.

Chris Devery VK2XCD
Secretary

PO Box 341 Goulburn 2580

Midland Amateur Radio Club Inc.

Powercor donates computers to MARC

Victoria's largest electricity distributor, Powercor Australia Ltd has kindly donated computer equipment to the Midland Amateur Radio Club in Bendigo.

This valuable donation of computer equipment will enable the upgrade of the Packet Bulletin Board system run by Gordon VK3AH from his Heathcote QTH, and will enable other projects to

be undertaken in the future.

The photo shows the computer being donated by Des Henderson of Powercor to the local packet bulletin board Sysop Gordon VK3AH.



Adelaide Hills Amateur Radio Society

The October meeting of AHARS was a "Show and Tell" evening, which, as usual, was very interesting.

We were shown a 6 metre transmitter of extraordinary robustness demonstrated by Graham VK5ZFZ, who will again be supplying the materials

and instructions for a construction night to conclude the year's meetings, in November.

Jim VK5JST brought along a new power supply to which he gave the 'file' test. He ran a wire up and down a bastard cut file, which produced much spark

power but did no damage to the power supply itself.

Steve VK5AIM had another portable device to show. This was a simple device to anchor a portable aerial in any weather conditions at all. Phil VK5NN

Continued on page 26

Winners at the Easter Urunga Convention 2002

Saturday

Event	First	Second
80 m hunt	VK2URK	VK3YDF
2 m Pedestrian hunt	3YDF	2YMW.
Junior event:		
80 m and 2 m	Karen O'Brien	Kelly O'Brien.
2 m	Mobile	3YDF 2KKT.
2 m	Talk in	2FA 3YDF

Saturday night consisted of rag chewing, cartoon classics and supper.

Lucky door prizes raffles and competitions were competed for and won, the weather was good except for a brief shower on Sunday afternoon where some competitors got a little damp. Everyone appeared to enjoy themselves. The Prizes were presented at the end of the day and many of the visitors stayed on to enjoy dinner together.

The committee is now working on the lead up to the 2003 Convention (April 19/20th) and hopes that the competition will be thick and strong for the events next year.

The juniors appear to have had a ball with Brian VK2BI in

Sunday

Scramble	2FA
Junior events: on 80 m and 2 m	Mitchell Guest Sarah Piper
Last Junior event	Caitlin Williams Mitchell Guest
2 m Mobile	2DGT 3YDF
2 m Pedestrian	3YDF 2KKT
2 m Pedestrian Talk in	3YDF
Overall winner	3YDF
Jack Gerrard Award	3YDF
Senior amateur.	VK2UC, Lismore
Longest distance travelled.	3YDF and 3YMG

charge of their events. A lot of the juniors will soon be able to compete in the open events. Thank you Brian for your assistance at the "Urunga Do".

73 from the Committee at Urunga.

B.J.Slarke VK2ZCO.

AHARS

Continued from page 25

also had aerials to show. These were the car aerials for all the HF bands he has used for many years. He was not sure how well they would go with a modern, all-electronic car but had a few basic modifications to the mounting arrangements that make it possible to use HF on any band regardless of the complexity of the car's system. He did suggest that if you wish to operate 40 or

80 metres while travelling along you devise an elastic arrangement from the tip of the antenna to the car. Heavy rubber bands are cheap and suitable.

Rob VK5RG showed some digital signal processing equipment that has applications to CW and other modes of operation.

The demonstration that won the prize for the night was the set of cross-field antennas made up by Lloyd VK5BR. Using the principles first described over

100 years ago he made up a 20 metre, 40 metre and 15 metre antenna using plastic sewer pipe and empty fruit or jam tins. Wires from the tins inside the pipes were linked in the right patterns to give these cross-field effects and were the only thing to be seen outside the pipes.

The antennas were each only a little more than a metre long and could be hung under the verandah or in a tree when in use and taken inside until needed again. This idea could be a very practical way to continue to enjoy your amateur radio in a retirement village or housing complex which will not allow masts or towers to be erected.

AHARS is fortunate to have so many clever experimenters in its ranks that there were actually too many 'show and tell' items to fit into one evening. Hopefully those who missed out this time will be able to show their items of interest next time.

The President and committee of AHARS send Seasons' Greetings to members and to all other amateurs. Anyone visiting Adelaide on the third Thursday of the month is welcome to visit our meeting held at the Blackwood High School. Please contact Geoff VK5TY or Alby VK5TAW for more details

Over to you

The Future of Amateur Radio

The answer to your question (Oct. editorial) "What is Amateur radio today?" is at the top left hand corner of the editorial page; it is now as it was at the beginning.

Amateur radio is about setting up a radio station to transmit and receive on the ITU frequencies authorised for that purpose. "There is nothing - absolutely nothing - half so much worth doing as simply messing about in a radio shack". (Apologies to Kenneth Grahame).

In or out of it doesn't matter. Whether you get "on air" with phone, CW,

computer aided or with some newer mode doesn't matter; you're always busy and you never do anything in particular and when you've done it there's always something else to do and you can do it if you like.

Editors and presidents come and go and each has a turn at worrying or predicting the future. Rest easy chaps, the future will be as Ratty as we can make it. We would rather not have you predict and establish your own preference.

Lindsay Lawless VK3ANJ

ar

Technical Abstracts

Gil Sones VK3AU
30 Moore Street, Box Hill South Vic 3128

Elevated Feed Antenna

An antenna for 160 metres and 80 metres suitable for a moderately sized yard was described in the Antennas column of Peter Dodd G3LDO in Rad Com July 2002. The antenna was designed by Colin Draper G3TSK. The antenna is an elevated feed design with a buried counterpoise and uses a loading coil to give resonance on 160 metres. The feed is with 50 ohm coax which makes it simple to use.

The antenna is shown in Fig 1. The counterpoise is made of insulated wire and is buried. The end of the counterpoise can be a fairly high RF potential and it should be taped at the end with insulating tape. The counterpoise is buried just below the ground to avoid tripping over it and to allow mowing the lawn.

The loading coil inductance is approximately 150 microhenries and is wound on a 21.5 mm diameter round former. The former is 250 mm long and the winding is 240 mm long. The four turns at the high end are spread over 10 mm and the three turns at the low end, nearest to the feedpoint, are spread over 6 mm. The winding is 292 turns of 21 or 22 SWG enamelled copper wire over a length of 240 mm with the main body of the winding close wound and the end turns spaced as described. The winding

is coated with shellac and then wrapped with stretch rubber tape. While Shellac is still available you may find it easier to obtain clear lacquer for the coating.

The 68 foot (20.73 m) length should be adjusted for resonance on 80 metres and the end 12 ft 10 in (3.93m) length should be adjusted for 160 metre resonance. Resonance is found with a Dip Meter coupled to a two turn link at the feed point. The feed point impedance and hence the SWR can be adjusted by altering the length of the counterpoise. The original antenna could be adjusted for a low SWR allowing use of 50 ohm coaxial feed without the use of an ATU. The coaxial feed line should be coiled several times at ground level to choke off any antenna current which may be present on the feedline outer.

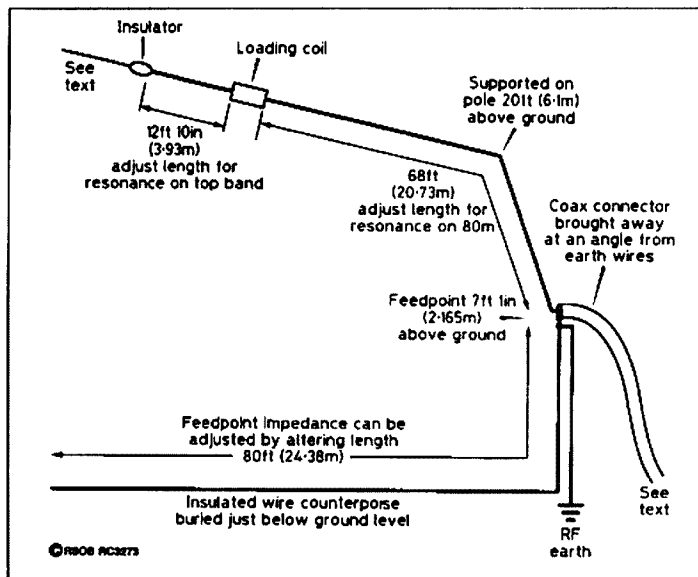

Fig 1. Elevated Feed Antenna.

Australian Made ANTENNAS

"Setting a New Standard" COM-AN-TENA

(Formerly a j and j coman)

6 Muir Court
CHELSEA HEIGHTS 3196

All new 5/8 vertical 16 radials	\$145
Dual drive 26-30 5 ele yagi beam	\$305
4 ele 10-11m yagi beam	\$262
5-6-&7 ele high gain antennas 11m	\$call
3 ele delta loop 10-11m	\$320
11m 5/8 vertical/4-1/4 wave radials	\$170
Duoband 10-15 3 ele each band	\$356
Log-periodic 7 ele 13-30 MHz 7.7m boom	\$890
Tri-band 5 ele HB35C s/steel fix	\$730
3 ele 20m computer opt	\$390
3 ele 15m computer opt	\$285
M B Vert Auto switch 10-80m	\$310
40m linear loaded 2 ele beam	\$580
6m 5 ele compt opt beam	\$259
6m 7 ele compt opt beam	\$355
10 ele high performance 2m	\$135
17 ele high performance 70cm	\$119
2m vert 2-5/8 co-linear 4 rad	\$ 96

Guyed Masts

21 metres 13 metres

Winch-up & tilt-over. Aluminium and stainless steel three-sided construction. Auto-brake winches

Free Standing Masts

9.5 metres

New Baluns

1-1 to 16-1 to 3kW



Our Masts meet Australian Standards. We supply all the computations and data you will need for a permit.

03 9773 3271

Mob: 0419 542 437

Andy VK3IV

Technical Abstracts

External GPS Antenna

While GPS may not be amateur radio it is used extensively by amateurs. GPS is used by APRS operators and is also used to determine operating locations for grid squares and for calculating the distances covered by contacts as well as other uses by amateurs. The hand held unit is often sufficient but sometimes an external antenna is useful such as when in a vehicle. The external antenna can be positioned so as to receive the satellites and the GPS can be positioned to suit the operator.

In QST October 2002 Mark Kesauer N7KKQ described a cheap homebrew external antenna for a GPS receiver. The antenna is housed in a radome made from a cream cheese container and uses a turnstile configuration. The turnstile dipoles are positioned a quarter wave above a ground plane made from tinplate or thin brass placed in the lid of the cream cheese container. The cream cheese container then fits over the antenna and acts as a radome.

The dipoles are supported on a parallel plate transmission line made out of PCB laminate which holds them a quarter wave above the ground plane. The transmission line is made from two pieces of 0.062 inch glass epoxy FR-4 or G10 single sided PCB laminate material glued together. The pieces are 0.25 inches wide and 2 inches long and when glued together form a 50 ohm line. The pieces of glass epoxy single sided laminate are shown in Fig 2 and Fig 3. The side which connects to the coaxial feed line inner is shown in Fig 2 and requires the foil to be etched or cut as shown. The dimensions are reasonably critical as this is a transmission line with the cut away part forming a microwave turn. You could etch the pattern or you could use a sharp knife or a Dremel tool to produce the simple pattern. The two pieces are stuck back to back with glue such as epoxy or superglue and form a transmission line. You could make them slightly oversize and then after glueing them together you could file them to the final dimensions.

The antenna construction is shown in Fig 4. The parallel transmission line post supports the turnstile elements above

the ground plane. The transmission line post is soldered to the ground plane and the dipoles made of copper wire are soldered to the transmission line at the top which is a quarter wave above the ground plane. The ground plane which is 4 inches in diameter is cut from tinplate or thin brass and is fitted into the lid of the cream cheese container. The author used what looked like a Kraft Philadelphia Cream Cheese container. The silk screened label can be removed using automotive rubbing compound.

The dipoles are made from 14 gauge wire. Two 4 inch lengths of wire are bent into right angles at their exact centres. They are soldered to the opposite sides of the transmission line post at the 1.78 inch point so as to form two dipoles at right angles to each other with the ends of one dipole drooping down towards

the ground plane at a 45 degree angle and the other dipole horizontal and parallel to the ground plane. The ends of the horizontal wires are trimmed to be 1.51 inches from the centre junction. The drooping 45 degree wires are trimmed to be 1.82 inches long from the centre junction. The ends of the drooping dipole should be about 0.5 inch above the ground plane.

The dipoles are cut so that the horizontal dipole centre impedances and phasing are right for circular polarisation and give an omnidirectional pattern. The feed is a self phased quadrature type which uses the dipoles tuning to provide both phasing and matching. The antenna matching can be tweaked by watching the GPS display and then bending the dipole ends up and

continued next page

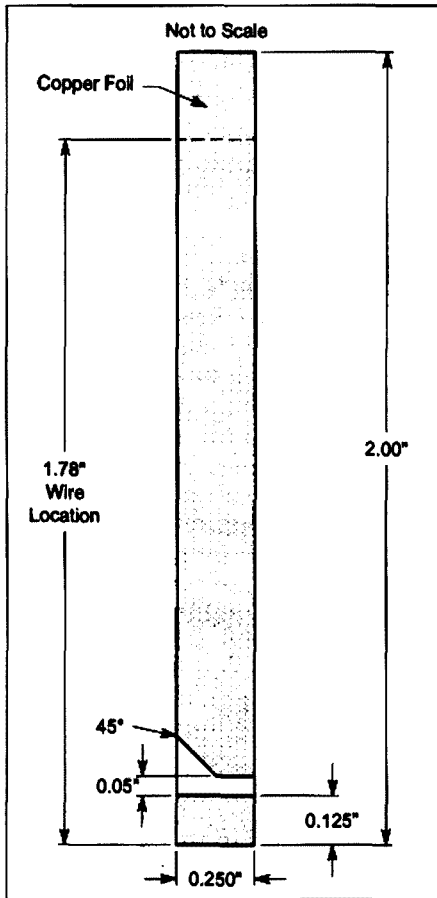

Fig 2. Active Side of Transmission Line.

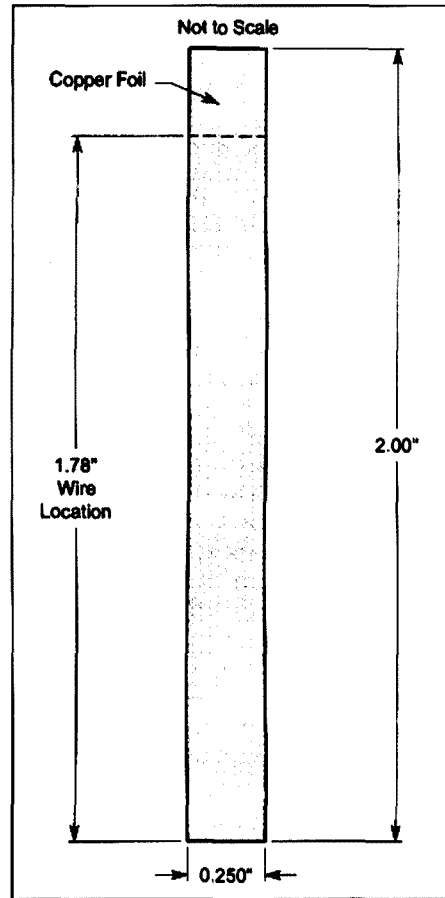

Fig 3. Ground Side of Transmission Line.

Simple CW Filter

A simple audio filter for CW reception was described by Fraser Robertson G4BJM in Rad Com August 2002. The filter is a simple series filter which helps to clean up the audio by attenuating noise above and below the frequency of the beat note.

The basic circuit is shown in fig 5. The inductor is a 47 mH one in the TOKO 10RB series. It is available in the UK from Farnell , part no 143-680, and RS , part no 228-365. Locally both Farnell and RS seem to use the same numbers and have similar stock.

A more complex design with a 700 Hz centre frequency and providing an alternative treble cut filter is shown in Fig 6.

The capacitors used are polyester types and should be readily available.

Both filters are designed to drive headphones. The author used cheap walkman style headphones which were of 32 ohm impedance. When these were connected in parallel they presented a 16 ohm impedance.

Mention was made of some rigs which provide a true stereo output from the headphone jack with main and sub receiver chains being fed to left and right outputs. If you have such a receiver then you will have to make arrangements accordingly and not just parallel them up. You could make two filters or just connect to the one you want to listen to.

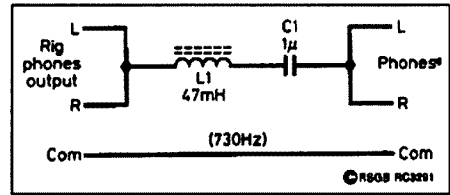

Fig 5. Simple Two Component CW Filter.

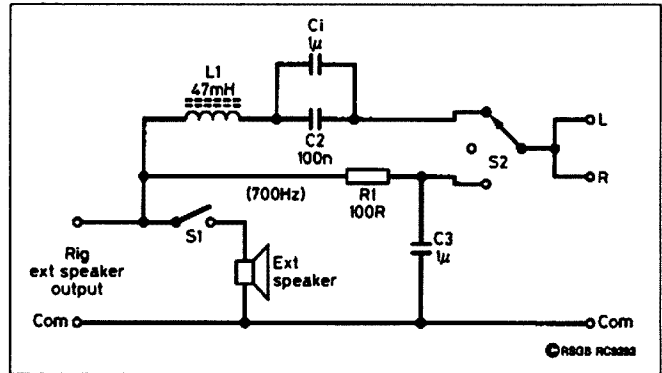

Fig 6. Deluxe Filter.

External GPS Antenna (continued)

down slightly to get the best signal.

The feed line used is small diameter 50 ohm Coax. At the GPS operating frequency of 1.57542 GHz the coaxial cable loss is high and so the minimum length necessary should be used. The connector used should suit the GPS receiver and should be of good quality.

Some GPS receivers have provision for disconnecting the internal antenna and using an external active antenna which is powered via the coax. This design does not draw any current and so the switching used needs to be triggered by connecting a suitable resistor between the coax inner and outer . A resistor between 1 and 5 kohm should be suitable.

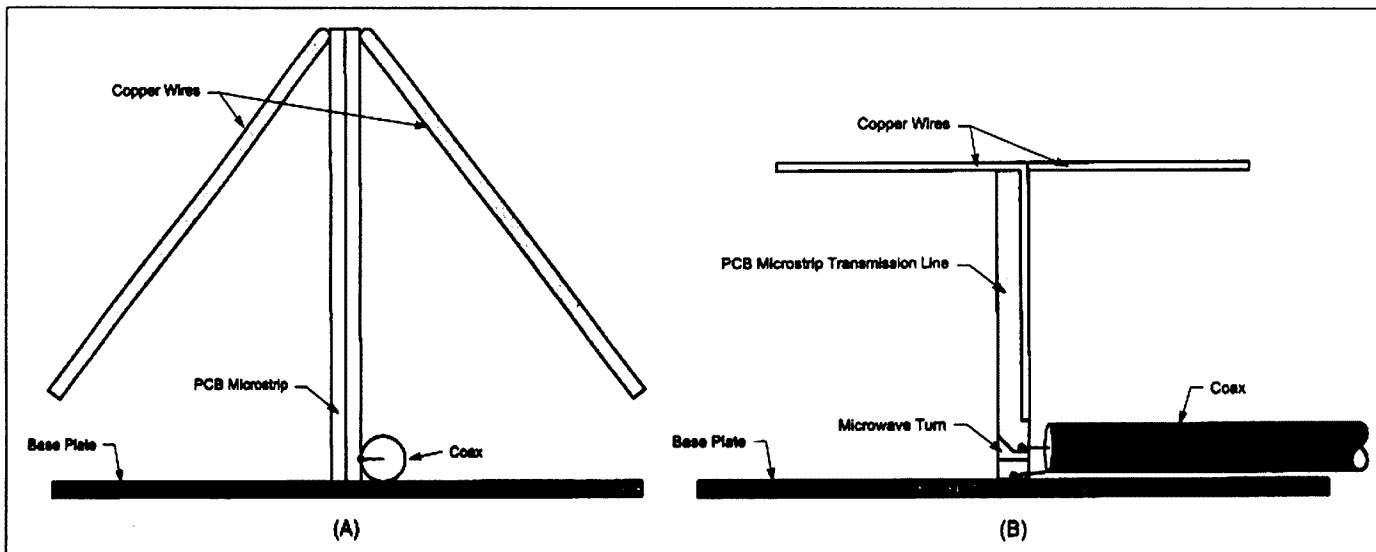

Fig 4. Side (A) and Front (B) views of Antenna showing Parallel Plate Transmission Lines and Dipoles.

QSL page

Ken Matchett VK3TL

A Truly Historic Event

2MT

It has been a very long time indeed since an amateur call-sign has been issued without any indication of the country of origin. In the days of spark, of course, and long before the official issue of internationally recognized call-sign prefixes it was common practice to use call-signs without prefixes, the only indication of the source of the transmission being the name of the country on the QSL card. Such cards might have printed on them 'Chile 3CR', 'French Station 8CO', the letters used often indicating the operator's initials.

The call-sign 2MT was used by Marconi's Wireless Telegraph Company. The station ran from February 1922 to January 1923, its main purpose being to advertise to the public the wonder of the recently invented means of communication 'Wireless'. Marconi's first successful attempt at long distance transmission was made on 12 December 1901, when a Morse signal was sent from Poldhu Point (the furthest suitable point in south-west England) across the Atlantic to Signal Hill, St John, Newfoundland. When, through the

crackling noises in the receiver, the letter 'S' was received the whole history of communication changed within a moment. (The letter "S" was chosen to be sent since it was felt that the sending of any dashes might tax the transmitter!!)

Although the call 2MT at the time was a commercial call-sign rather than an experimental one, this same call-sign was issued in 2001 to the Chelmsford Amateur Radio Society to celebrate the 100th anniversary of this historic occasion.

Recent transmissions were carried out from the original Marconi New Street factory in Chelmsford, the location of the 1922 transmitter. Staff of the Marconi firm Mobile Limited also played a part in this historic event.

The front of the QSL shows Marconi himself in front of the receiver installed at Signal Hill, Newfoundland just after the successful Trans-Atlantic transmission. Also shown is the Marconi New Street factory as it is today. On the right (top) is shown the original '2 emma toc' transmitter, the 'Writtle Hut' (middle) from where the first regular public broadcasts were made and (bottom) the huge antenna array at Poldhu, Cornwall used to transmit the historic Trans-Atlantic message. (Bigger is better - don't worry too much about resonance!!)



<http://www.wia.org.au>

**check out the
WIA webpage
today!**

WANTED

American QSL cards

We aim to collect all 3,100 or so QSL cards of all the American counties of the 50 States of the USA.

Can you help the WIA National QSL Collection along?

Postage refunded but please first telephone Ken VK3TL, Hon. Curator on 03 9728 5350.

Hon. Curator: Ken Matchett VK3TL
4 Sunrise Hill Road, Montrose Vic. 3765
Tel: (03) 9728 5350

DFOBK

Apart from the prefix DJ0, other Federal Republic of Germany call-signs bearing the numeral zero may be regarded as special issue calls. This one is no exception since it was issued to Club station OV Backnang in order to celebrate the Trans-Atlantic transmission. Call signs DK0ANT and DF0ANB were also issued to radio clubs in Backnang and Offenburg associated with the firm Marconi Communications. It shows a rather younger Marconi than that portrayed on the first QSL. (Marconi was 27 years old at the time of the historic transmission.) The cleverly designed QSL also shows a map indicating the locations of both the transmitting and receiving stations.

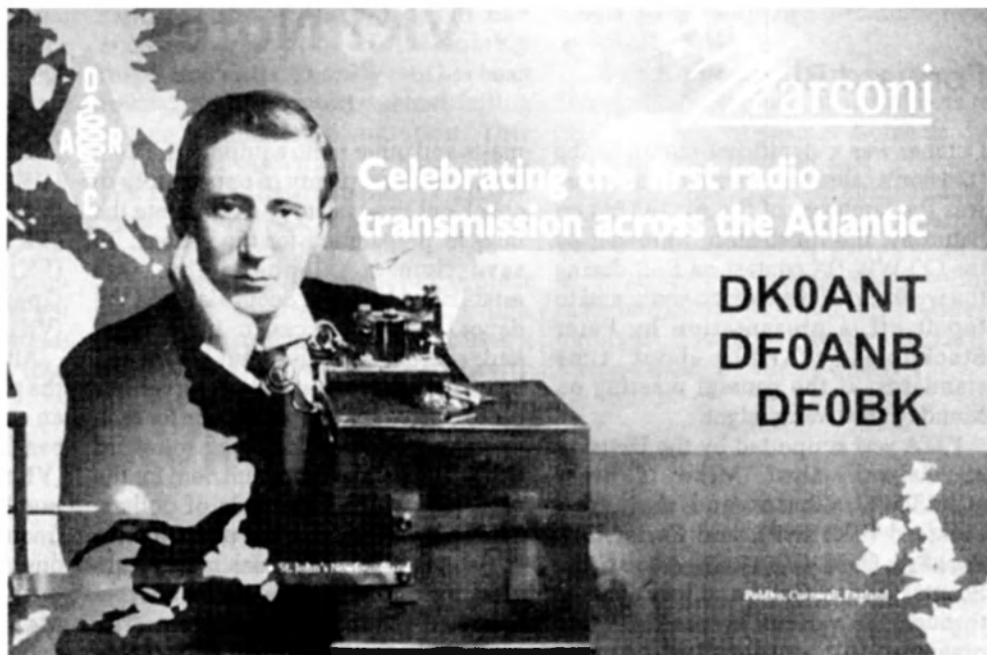

Readers may find further information leading up to this historical event in the

article entitled 'Pioneer of the Story of Radio - Guglielmo Marconi' by Wolf

Harranth OE1WHC, which appeared in the September 1999 edition of AR.

ar

Sunspot Numbers

Monthly Sunspot Average Oct 2002: 97.3
Annual Sunspot Average Apr 2002: 110.4

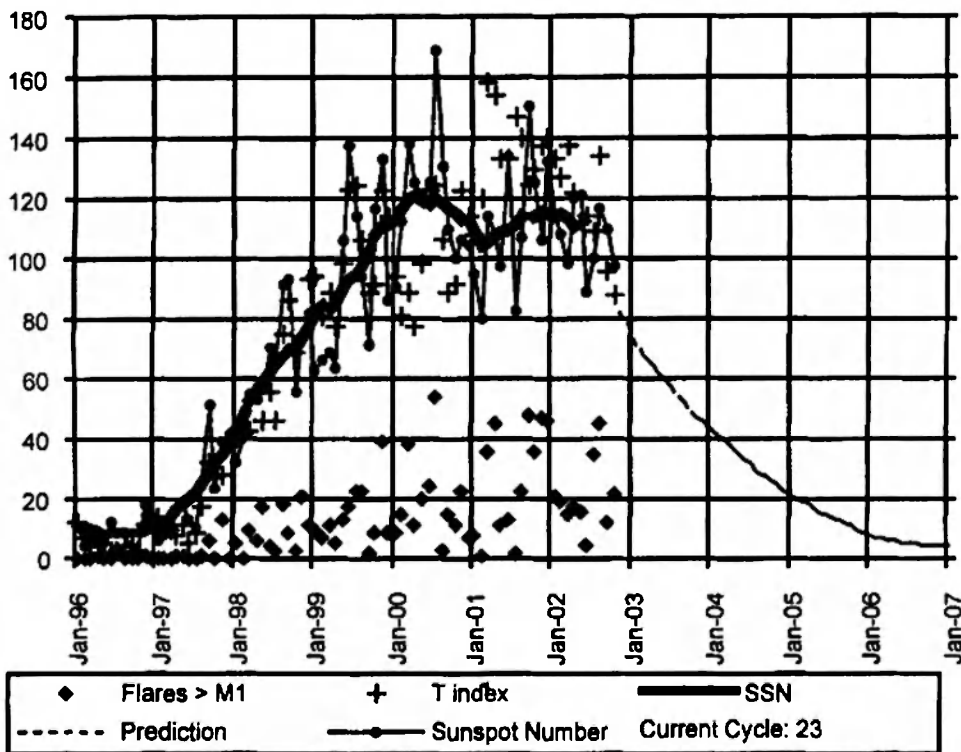

Drawn from monthly data provided by the Ionospheric Prediction Service

The Central Coast Field Day

for

**RADIO
AMATEURS
AND
ENTHUSIASTS,
COMPUTER
AND
ELECTRONIC
HOBBYISTS**

**Sunday 23rd
February, 2003**

**Wyong
Racecourse.
Gates open
8.30 am**

VK1 Notes

Forward Bias

Peter Kloppenburg VK1CPK

October was a significant month in the Division's calendar of events. First, there was the Jamboree of the Air (JOTA) on Saturday, the nineteenth, followed by the CQ WW DX contest on SSB during the weekend of the twenty-sixth, and to top it off, a presentation by Peter Stackpole (VK1RX), about time standards, at the general meeting on Monday, the twenty-eighth.

JOTA was supported by the Division at Calwell thru Mike Thurgar (VK1TMT), Charnwood thru Neil Pickford (VK1KNP), and Farrer thru Richard Gard (VK1RG). About 250 Scouts, Guides, Cubs, and Joeys passed through the various events that were organised in these localities. Among other presentations, there were talks about old and new radios, the use of VHF and UHF in communications, and Citizen Band (CB) radio. Assistant Scout Leader, Richard Gard (VK1RG), and other licensed amateur radio operators demonstrated how to use transmitters and receivers on the HF bands. Sitting in front of a desk microphone, Scouts and Guides made radio contacts with other Scouts in Mumbai, Kazakhstan, and Alice Springs.

The Scout movement in Canberra had invited local politicians to observe JOTA activities first-hand, and to assist with burying a time capsule. Bill Wood, Minister for Urban affairs, made a short speech and turned the first sod. This particular event signified the fact that Scout Hall was built 30 years ago when the branch was known as 1st Farrer.

With a fridge full of food and drinks, three tower-mounted beams, four roof-mounted verticals, and an assortment of long-wire and dipole antennas, the CQ WW DX Contest got underway at the Parks & Garden Depot hamshack in Farrer, under the baton of Olaf Moon (VK1JDX) on Saturday, October 26, 2002.

Much preparation for this event had been made a few weeks earlier, even before JOTA started on 19 October. In fact, JOTA was the forerunner of the contest because the Division had committed itself to support JOTA in word and deed by setting up antenna

masts and other radio equipment. There was, therefore, plenty of opportunity to check out the system and eliminate the bugs in preparation for the contest. To save time, a telephone line was established between Scout Hall and the depot to provide access to the Internet and, consequently, find out where and by whom QSOs were made. A server was used to drive six computers, one for each operator station in the depot to record QSO data. Radio equipment, lent for the occasion, worth thousands of dollars, linear amplifiers, and low pass filters to keep harmonics out of each other's hair, were used to cover the six bands that Olaf had planned for the event. The operator stations required kilometers of coax cable, mains power extensions, and dozens of mike-equipped headsets. It was, therefore, relatively quiet in the depot, and visitors were able to talk to each other in a normal level of voice. The result of all this effort was impressive: 380 QSOs were made across four bands being 10, 15, 20, and 40 metres. Given that this was the first contest run from the divisional hamshack, there was much success in the accumulation of points, new CQ Zones and countries, including 85 countries on 20 metres, 48 on 15 metres, 12 on 10 metres, plus three on 40 metres. 32 zones were achieved of the 40 around the globe. The final, and adequate, score was 212,000 points, in the section known as M2, or multi-two i.e. two transceivers, any number of operators, all HF bands with the exception of the WARC bands.

Olaf is planning to use the hamshack again next year and participate in the CQ WW WPX (Prefix) contest 29/30 March. However, between now and then, a few changes will be made in and around the hamshack to increase contest efficiency. A big thank-you goes to Phil (VK1ZPL), Phil (VK1DX), and Chris (VK1DO) for lending transceivers, and other valuable equipment for the occasion.

The following amateurs worked hard and spend much time, or provided encouragement, to make the contest a success: Olaf (VK1JDX), Kerry

(VK1KRF), Tex (VK1TX), Peter (VK1KEP), Russell (VK1JRM), Bob (VK7KOB), Richard (VK1RG), Mike (VK1MJ), Chris (VK1DO), Lyle (VK1XLW), Gilbert (VK1GH), Brad (CB Operator), Ian (VK1ZCW), Phil (VK1DX), Phil (VK1ZPL).

Although John Harrison had to share the prize of 20,000 pounds for designing an accurate clock that could be used at sea in June 1773, Peter Stackpole (VK1RX/VK2RU) spend the same number in cents to design and build a frequency standard, with an output of one pulse per second, for experimental purposes. At the general meeting on Monday, October 28, 2002, Peter demonstrated his standard in front of 28 members of the WIA at Scout Hall. Peter explained how difficult it was to determine the standard's accuracy and stability over time. He had spend much of his time building a number of crystal controlled oscillators, comparing their accuracy and stability with WWWW, local ABC TV stations, and VNG at 2.5 MHz. All of these frequency sources had lower accuracy and stability than he required. Peter said that propagation delays were the main source of their instability over time. Eventually, he received a circuit for a frequency standard from Brook Sheares in the US that uses the GPS satellite as a standard of accuracy and stability. The design of this circuit provides for a much higher level of control of the crystal oscillator frequency, by the use of timing pulses from the GPS satellite. These pulses are used by a comparator to measure the difference between the pulses from the GPS and those produced by Peter's standard. Output from the comparator steers the Voltage Controlled Crystal Oscillator (VXO) to the correct frequency. The standard contains a VXO at 24 MHz, and an assortment of integrated circuits, including dividers, multipliers, and counters. Taking his home-built standard to the National Measurement Laboratory (CSIRO) in Lindfield, Sydney, for comparison measurement, short-term accuracy averaged at a frequency offset of 5 parts

in 10^{11} . For those who are curious about this expression, the following definition is quoted *: Frequency offset is the amount by which a frequency lies above or below a reference frequency. For example, if a frequency measures 1.000 001 MHz when compared against a reference frequency of 1.000 000 MHz, then its fractional frequency offset is 1 Hz/1 MHz or 1 part in 10^6 .

* Hewlett Packard - Frequency and Time Standards - Application Note 52.

Falling ice-sheets, hail, and vandalism resulted in punctures of the repeater hut roof on Mt Ginini. However, a new roof has gone up by the time you read this.

Luckily, no water damage had occurred to any of the radio equipment inside the hut, because the roof damage was reported almost as soon as it had occurred during one of the monthly inspection visits. The new roof has been re-designed to protect against falling objects and water penetration. This project was carried out by Alan Hawes (VK1WX), Gilbert Hughes (VK1GH), Paul Elliot (VK1TEE), and Phil Longworth (VK1ZPL).

Another recent divisional project worthy of mention is the 70 cm link upgrade in Wagga. The repeater uses a Motorola MSF-5000, a 4 x 4" cavity

duplexer, and an RFI pre-amp. Transmitter output is 438.025 MHz at 70 watts, and receiver sensitivity is 0.15 mvolt for a 10-dB signal-to-noise ratio at 433.025 MHz.

Ex-CB operator, Bob Baker, has donated a trailer-load of radio parts to the Division. Interested? Come to the next Trash & Treasure sale. The next Trash & Treasure sale will be on Sunday, January 19, 2003 at the Parks & Garden Depot, Longerenong St. Farrer, starting at 12 noon. The next general meeting will be held at 8.00 pm, on Monday, January 27, 2003 at Scout Hall, Longeronong St. Farrer. Cheers.

VK3 Notes

By Jim Linton VK3PC

WIA Victoria web site: www.wiavic.org.au
email: wiavic@wiavic.org.au

Seasons greetings

The WIA Victoria Council extends its best wishes for the festive season, and a happy New Year – in this combined December and January issue of the VK3 Notes.

As we reflect on the influences and achievements in our lives over the past 12 months I am sure that it will be easy for most of us to see how rapidly our world can change.

The hobby of amateur radio is changing too. The predictions of years ago behind the slogan of "use it or lose it" are becoming a reality with the ACA earmarking 420-430MHz for public service and emergency services.

The WIA has responded to that situation by reshaping the 70cm band plan for the remaining spectrum of 430-450MHz.

While the ACA sees the lower 10MHz of the 70cm band being suited for other uses, the remaining Amateur Service secondary allocation 430-450MHz, shared with, among others, the Defence Department which has Primary status, seems not to be under such a threat.

The ACA has also earmarked 403-420MHz, which has 27,000 existing licences, to dovetail with 420-430MHz for a proposal globally harmonised emergency services band.

There are other winds of change for the Amateur Service. The Electromagnetic Radiation (EMR) regulations, put on hold by the ACA in 2002, will become a reality in 2003.

The World Radiocommunications Conference in June 2003 (WRC03) will

be a watershed for the Amateur Service with significant changes certain to be adopted. Among these are the International Amateur Radio Union backed removal of the mandatory requirement for Morse code tests in amateur licensing.

There are others which are widely reported elsewhere, so no need to go into great detail here. What is interesting is that although the Morse code requirement is likely to end, it seems certain that VK radio amateurs will not benefit from it until early 2004.

WIA Victoria initially thought that such a delay could not be justified. However, in discussion with an ACA Senior Manager recently, it was learnt that the ACA had to wait the six months until the decisions of WRC03 are ratified.

The ACA will not implement WRC03 decisions until after that process is completed. It has a reputation within the Asia-Pacific region to adhere to ITU decisions, and for that reason is not willing to take what could be seen by Australia's neighbours as a premature or unilateral decision.

WIA Victoria understands the ACA's position. Unless there is a significant precedent set by other nations to remove the Morse code requirement ahead of the ratification of WRC03 decisions, then the existing VK no-code licensees will face a six month wait.

The year 2003 also includes the IARU Region 3 meeting in Taiwan to be attended by delegates of the region's radio societies including the WIA.

WIA Victoria Elmer Hall of Fame

Many of today's radio amateurs can attribute their involvement and enjoyment in the hobby to an Elmer.

The term "Elmer" describes experienced and knowledgeable individuals who are a mentor or teacher that encourages prospective radio amateurs, or the less experienced operator.

WIA Victoria encourages Elmering and through its Hall of Fame, pays tribute to Elmers, both past and present, who have assisted in the creation and imparted their knowledge to VK3 radio amateurs.

The first inductees to the Elmer Hall of Fame are:

- Craig McMillan VK3CRA (SK)
- Bill Trenwith VK3ATW (SK)
- Peter McDonald VK3DI
- Roy Haynes VK3RU
- Reg Whiting VK3MZ (SK)
- Fred Swainston VK3DAC
- Eric Jamieson VK5LP
- Ron Daniels VK3AEO
- Kevin McGrath VK3EQM
- Greg Williams VK3VT
- Howard Ryder VK3ZJT (SK)
- Neil Trainor VK3IJ
- Len Vermuelen VK3COD (SK)

The Elmer Hall of Fame includes citations for each of the inductees. It can be found at www.wiavic.org.au/news/elmer/

To make a written nomination by mail or email wiavic@wiavic.org.au and please put "Elmer" in the subject line.

WIA Victoria AGM

Advance notice is given that the annual general meeting for 2002 will be held on Thursday, 22 May 2003. A formal notice will be issued to members as required by the articles of association.

At the AGM the three year term of office for the WIA Victoria Council concludes. Nominations are invited for the 2003-2006 Council and they will close at noon on Friday 21 February 2003. Nominations will only be accepted on forms available from the Secretary.

It is important to remember that the WIA Victoria office will close at noon on Tuesday 17 December 2002 and re-open on Tuesday 4 February 2003.

During the holiday break office-bearers will be busy preparing the annual financial and other statements,

and dealing with the auditors.

The WIA Victoria office number 9885 9261 will provide emergency telephone contact numbers. Fax facilities at the office will not be available at the office during the holiday period.

During the closure applications for membership and similar incoming mail will be processed. Apart from the Christmas, Boxing Day and New Year holidays, and the week in between them, urgent email will also be handled.

The final VK3BWI broadcast for the year is at 8.00 pm on Sunday 3 December. The broadcast will resume on Sunday 2 February 2003. Any material for the broadcast should be sent by post, or email to wiavic@wiavic.org.au

Callbook 2003

The latest edition of the Australian Radio Amateur Callbook is due to be available in early December.

The publisher advises that it is to include a free searchable CD which will have all of the data contained in the printed version, plus printable material such as greater circle information.

The Callbook has listings of 15,000 amateur stations, plus reference material - band plans, repeater and beacon list, DXCC countries list, and WIA exam team leaders.

The price for the Callbook/CD combined package is:

Members (Collected) \$20.00

Members (1 book mailed) \$23.50
(Extra postage for additional books)

Mail orders will be despatched as soon as Callbook stocks arrive.

VK6 Notes

Compiled by Chris Thomson VK6TNC.

Email VK6NOTES@wia.org.au

This has been a busy month in WA with the hosting of Hamfest and SEANET 2002, which were very successful. A debriefing meeting had not been held as this magazine went to press, so look forward to all the highlights in an upcoming issue.

Congratulations to all that participated in the Remembrance Day Contest and put VK6 well and truly back on the map.

The following stations are Certificate winners VK6AFW, ANC, CSW, JIP, VZ, ZBP and SZ. SZ is a Scout station based in Kalgoorlie, and was driven by VK6ZX Bill Main and VK6KYL Dianne Main.

Final planning is well underway for the 2003 training programme. Neil 6BDO will be at the blackboard. The course, running from January to December, contains modules for both Novice and Full Call theory, Regulations and Morse code. The WIA will subsidise this course to encourage newcomers to the hobby. The Courses are to be held at the Lynwood Scout Hall, which is situated in the Whaleback Golf course.

As a further inducement for newcomers, Council members agreed to keep the debate on a Foundation Licence alive. A working party has been formed to propose a new model for consideration. This grade of licence should offer people with an interest in radio an easy stepping stone to the world of amateur radio and all that it offers. Why use packet on CB when you can use packet on the International Space Station?

The Internet has produced almost instant communications, but at a cost. Instead of a local call to your ISP why not leave a radio on with your favourite frequency being monitored. Share this information with your friends and a

radio net will appear on a regular basis instead of forwarded emails being the primary source of communications between regular contacts. I am sure your ISP will not go broke but the amateur bands will hopefully flourish with increased traffic.

Our President, Neil VK6NE has been approached by an Amateur operator in the northern suburbs whose mast has been the subject of complaint from neighbours. He has been requested to attend a "Mediation Meeting" a new approach regarding Local Councils. Some new housing estates in Perth do not allow a TV antenna to be visible from the roadside or satellite dishes for pay-tv. Hopefully this mediation process will introduce some common sense into the argument.

VK6SIG (Royal Signals Amateur Radio Society, Western Australia) has returned to the West after a 3 month trip away. The station was heard as VK6SIG/1,2,3,4 & 5 from 14 locations including the Cape York Peninsular and Thursday Island.

Malcolm, VK6LC, operated VK6SIG/p on CW and SSB during his holidays July to September 2002.

Any operators, and Clubs, outside the Perth metro area are encouraged to contact me regarding information for inclusion in this column.

"Hey, Old Timer..."



If you have been licensed for more than 25 years you are invited to join the

Radio Amateurs Old Timers Club Australia

or if you have been licensed for less than 25 but more than ten years, you are invited to become an Associate Member of the RAOTC. In either case a \$5.00 joining fee plus \$8.00 for one year or \$15.00 for two years gets you two interesting OTN Journals a year plus good fellowship.

Write to

RAOTC,
3/237 Bluff Road
Sandringham VIC 3191

or call Arthur VK3VQ on 03 9598 4262 or Allan VK3AMD on 03 9570 4610, for an application form.

VK7 Notes

QRM

For more years than some of us can add up (actually over thirty) the "Sewing Circle" has been held every evening between 5 and 6pm, EST or EAST. You get no prizes for guessing why some wit christened the get-together the Sewing circle. The big "Do" for the year is the November Sewing Circle Barbecue, for years held at the ranch of Bill VK7AAW at Sorell. Bill has shifted house and this year the venue was the village of Orielson at the home of Ken, VK7DY, and XYL Wendy. Voted a huge success, 71 attended - 38 amateurs from around the State and one, VK3FIM, Peter from the island up north. VK7DY generously donated a smoked Christmas ham to be

raffled for our repeater funds - won by Devonport's VK7AY, Don. Don tells me it's frozen till he finds out the best way to cook it! Among the events was the presentation of the "Sewing Circle" annual trophy for outstanding support for the Circle by a participating member during the year. Murray, VK7MRY, was the deserving winner.

Rex, VK7MO ventured up Mt Wellington for the VHF/UHF field day. After setting up his gear half an hour before starting time, he gave a quick CQ call for a check on 144.1 and received responses from five VK2's with the best distance being VK2ZCV at Coffs

Harbour. Following this a check on 432 produced VK2DVZ in Taree and two Sydney stations.

As predicted by Murphy's law, propagation to VK2 dropped away as soon as the field day started. However Rex made 50 contacts in the field day, most to VK3 on 144, 432, and 1296. Three VK3's and one VK7 were the 1296 contacts. Great work Rex.

The Novice "Cram Courses" are proving a boon to our efforts to get new Licences. Eight aspirants on the North West coast are scheduled to take their exams in mid-December.

Cheers for now, Ron VK7RN.

Healesville Amateur Radio Group Inc. C/o P.O. Box 346, Healesville, Vic, 3777

VK3GH **HAMFEST** VK3GHA

Sunday 23rd February 10am to 2pm
Healesville Memorial Hall

Maroondah Highway, Healesville (Melways 278 C1)

Sales

of pre-loved
Ham equipment,
components &
computer gear

**For booking of trestles and further information:
Gavin VK3TLN 5968 8482 Carol 5962 6098
or email to gpt@celestial.com.au**

Cable and Connectors

Belden

- RG58C/U Belden 8259 @ \$0.90 per metre
- RG213/U Belden 8267 @ \$4.45 per metre
- RG8/U Belden 9913 Low Loss @ \$5.15 per metre
- RG8/U Belden 9913F7 High Flex Low Loss @ \$5.55 per metre
- RG8/U - RF400 Belden 7810 Low Loss Sweep Tested to 6000MHz @ \$6.30 per metre

LINK

- RG58: B80-006 UHF connector (M) @ \$7.65 each
- RG8/213: B80-001 UHF connector (M) @ \$8.80 each
- RG213: B30-001 N connector (M) @ \$9.10 each
- RG8: B30-041 N connector(M) @ \$14.00 each

connektron Pty Ltd

ABN 19 413 484 007

email sales@connektron.com.au or Phone (03) 9761-5220

connektron Pty Ltd, 45 - 49 Merrindale Drive, Croydon South, Victoria 3036

www.connektron.com.au

* All prices include GST

* Minimum order value \$50 payable by Visa, Mastercard, Bankcard or Money Order

* Packing and Delivery \$15 within Australia (Outside Australia P.O.A.)

ALARA

Christine Taylor VK5CTY

vk5cty@vk5tty or geencee@picknowl.com.au

Season's Greetings to everyone

Dear OMs,

Here is a suggestion for you to get for your ALARA YL for Christmas. All the YLs who attended the ALARAMEET in Murray Bridge now have a black and yellow badge with their name and callsign (if they have one) on it. Mine is shown here so you can see what they



The ALARA Individual Badge

look like. Everyone was thrilled that they will now be able to wear their own badge at all sorts of functions.

Dear YLs,

Why not buy your own ALARA badge and be able to show your affiliation wherever you go?

The cost is only \$5.50 plus postage (they will fit in an ordinary envelope) and the people who make them are very quick so there could still be time before Christmas and there certainly will be time before the next issue of AR comes out.

My address is correct in the callbook.

After the ALARAMEET

Yes, life goes on after the MEET. Several of the ZL visitors stayed to attend state luncheons. In VK5 we had Eileen ZL1BRX and Jill ZL2BHJ as well as Tina VK5TMC, Jean VK5TSX, Maria VK5BMT, Meg VK5YG and Christine VK5CTY.

At the Melba Café in Melbourne they had Lee-Anne ZL2TLO and Jill ZL2DBO as well as Bron VK3DYF, Gwen VK3DYL, Mavis VK3KS, Jessie VK3VAN and Robyn VK3WX.

It was lovely to extend the friendship beyond the weekend in Murray Bridge.



The YLs at the ALARAMEET

Friendship is what it is all about.

Now everyone has gone home but the joy continues through emails and letters as well as talking on air.

Things to do



Lord Howe Island

It is now too late for your logs from the ALARA Contest. I hope you remembered in time. There is still time to send your log to Gwen VK3DYL for the special QSL card for Lord Howe Island or one of the Cook Islands. Keep her busy!

The YLs on Lord Howe sent a very nice card with Raija to wish us all well in Murray Bridge. The photo on the left lets you see what the beautiful island looks like, in case you never have a chance to visit it.

Local publicity for ALARA

We were very pleased to have a reporter and photographer from the Murray Valley Standard come to our gathering on the Saturday afternoon. An item appeared in the next issue of the local paper with a photograph of the two local YLs, Meg VK5YG and Jennifer VK5ANW, with Jean VK5TSX (the State Rep and ALARA Co-ordinator for the MEET) and the two most distant DX visitors, Raija SM0HNV and Walli DJ6US.

No matter what information one supplies to the local newspaper people they do not always follow it up so this was very satisfactory.

Now the locals understand what all those cars with black and yellow ribbons on them were all about!

Notoriety in the most unexpected places

The National Archives in Canberra issue a small booklet three times a year. In it they stories of people who have made their mark in Australian history are retold. In the May 2002 edition (number 20 of the series) the story of Austine, the first VK3YL is told. To quote, "When other young women in the 30s were learning to twirl their strings of beads, pose with long cigarette holders and practise their Charleston, Mary Austine Marshall was teaching herself how to build and operate a wireless set"

The article follows Austine from that time through her enlistment in the Reserve of the Royal Australian Air Force in 1934, the first and only female to do so, to her career as an Aircraftsman (sic) in the Reserve, to her application to join RAAF. This seems to be the first time those in authority realise that Austine was a female. She was immediately discharged from the service, depriving the RAAF of a wireless operator of exceptional skill, purely on the grounds of her sex. What a fuss that would cause today!

Thanks to Bron VK3DYF for passing on to me that interesting copy of "Momento". We are proud that the contribution made by YL operators is seen as important enough to be acknowledged in a national publication such as this.

Listening in to a troubled world

The US semi-clandestine Arabic station, "R. Sawa" is being heard here at 2100Z on a variety of channels, playing popular Arabic and American music. I am hearing it well on 11905 and 11895. It has a news bulletin at 45 minutes past the hour. This station, as previously reported, is on MW from Cyprus and Kuwait plus FM outlets in the Gulf and Amman in Jordan. This station apparently is a co-production of the VOA/RFE.

I recently obtained my copy of "Passport to World Band Radio 2003" and again it has been indispensable but not infallible. This year they have highlighted broadcasting from the Horn of Africa. I was surprised to read about the involvement of Sam Voron, VK2BVS, with some activities in Somaliland. Sam and I used to have a regular sked going back to the Australian Third Party Network (APTN) in the late seventies and early eighties. I had lost touch with him.

PWBR 20003 seems to have been underwritten by Grundig, as they have extensively advertised in this edition. I use the blue pages in the rear of the book to assist in the identification of broadcasters but as I noted earlier it is far from infallible, as are the contact addresses elsewhere. I obtained my copy of this 592 page edition direct from the publishers for \$24.95 US from Passport 2003, IBS Ltd., Box 300, Perm's Park PA 18943 USA or check out their website at www.passband.com.

In mid October, the FCC in America decided to adopt IBOC as their platform

for digital audio broadcasting. IBOC stands for In Band On Channel and is a commercial development of the Ubiquity Company. Basically the digital signal is transmitted in adjacent sidebands to the standard DSB or FM signal. Broadcasts have already commenced using IBOC on MW from WOR in New York on 710 kHz and the hash has been noted interfering with stations on adjacent channels. For that precise reason, IBOC on MW is only permitted to operate in daylight hours. It is very unusual that broadcasting has already commenced despite the absence of any commercial receivers or software. Analysts expect this to become available later in 2003-4.

The Europeans and the rest of the World have decided on DRM or Digital Radio Mondiale as their preferred platform. This mode is supposed to be on Long, Medium and Shortwave. DRM Test transmissions have been going on for some years on shortwave and regular broadcasting is supposed to start in 2003. MW testing has been in Berlin. I believe that selected monitors could obtain software to run off your soundcard for approximately \$160 US but I am unsure how many were interested at that price.

A separate platform for VHF/UHF, known as DAB or Eureka 147 was also chosen by the EBU and has been in use there. Again suitable receivers are presently expensive, compared to the existing analogue models. Australia has been conducting consumer trials of DAB in the L-Band in the Sydney

metropolitan region. Also it has been decided here that DRM will only be used in the shortwave range and that IBOC and DRM will not be on MW. DRM and DAB were political decisions, primarily in Europe, whilst IBOC has been commercially developed in the USA. Whether any of these digital modes will become a reality does depend on the commercial manufacturing of receivers. All three systems are incompatible!

One wag commented that there was no appreciable difference between DAB and the existing analogue FM as the programming choices were limited from both platforms. The major plus is that DAB/ DRM can add text-based information to complement the program. The existing analogue FM does have a system known as RDS with text such as traffic and weather alerts. You may have noted this facility on imported FM sets from Europe

I have personal reservations that IBOC and DAB will be around in 10 years time. DRM also is questionable as many broadcasters wonder about the viability of shortwave with declining listenership. DRM could work but you must remember that the largest audience for shortwave is not in Europe, America or even Australia but in Africa and Asia. A DRM receiver will be out of their price range compared to a much cheaper analogue model.

Well that is all for this month. All the compliments of the Season to you and hope that conditions during 2003 will continue to be fruitful.

73 de VK7RH

ALARA continued

JOTA

Frank VK2AKG took the opportunity in Murray Bridge to find out who would be likely to be running a JOTA station in a couple of weeks. I hope his groups made many contacts.

Mary VK5AMD, this year only had a group of young boys (she called them "sprouts" which is very appropriate, I

think) who camped in tents on their property and enjoyed talking to other scouts as well as experimenting with some of the 'toys' Mary has made or had her 'children' make over the years. I am sure they had a great time.

Jeanne VK5JQ and OM Keith VK5OQ were up at Woodside in the Adelaide

Hills again this year. They have two children, both involved in scouts and enjoy all the activities as a family.

No doubt there were several other YLs and families involved in JOTA but these are the only ones from whom I have any information.

AMSAT

Bill Magnusson VK3JT

New AO-40 Control Stations take up duties

Colin Hurst VK5HI and Paul Williamson VP9MU have recently been included in the band of AO-40 controllers.

This will ease the burden on the other stations, particularly Graham VK5AGR who has been travelling and snowed under at work since returning to VK and James G3RUH who has been juggling his time between controller duties and house renovations. Colin has been mainly involved in attitude determination and has been putting his considerable programming skills to work in this area. It looks as though, at the time of writing, the attitude has been

successfully moved to settings which should be able to be maintained in stable condition for some time ensuring good squint angles at perigee and therefore virtually optimum operating conditions. Now would be a good time to set up your station to cope with AO-40. Check out the AMSAT web site and in particular Steve, VK5ASF's very popular FAQ site at <http://hamgate.apana.org.au/AO-40FAQ.htm>

Brief Glitch in UO-22 Operations

UO-22 gave us all quite a scare recently when it suddenly disappeared from our computer screens. Its transmitter had shut down and it was a day or so before Chris Jackson was able to announce on the bulletin board that it would require some investigation to determine the exact cause. The investigation is still underway as I write this column and

Chris has appealed to European stations in particular to refrain from uplinking so that the command station can complete the job. Hopefully UO-22 will be returned to full service before too long. Lots of people have come to rely on this, the first and now last of the original 9600 baud digital birds.

Useful Archive on the AMSAT web site

Satellite operators are reminded that the day to day "goings-on" on the AMSAT-BB bulletin board are archived at the AMSAT web-site.

The archive is very well done with message "threads" organised in an orderly fashion to make it easy to follow the threads. Often you find that a particularly interesting topic will come up as a result of an inquiry from a newcomer. By following a message

thread right through some very useful hints and operating tips can be gleaned. Be warned however that a great number of BB users "shoot from the hip" and often it is wise to go towards the end of a particular thread to get the best information.

Phase 3D/AMSAT OSCAR 40/AO-40

Launched: November 16, 2000 aboard an Ariane 5 launcher from Kourou, French Guiana.

Status: The U/V/L-1/L-2 to S-2/K passband is active at various times.

Uplink:

V-band 145.840 - 145.990 MHz CW/LSB

U-band 435.550 - 435.800 MHz CW/LSB

L1-band 1269.250 - 1269.500 MHz CW/LSB

L2-band 1268.325 - 1268.575 MHz CW/LSB

Downlink:

S-band 2401.225 - 2401.475 MHz CW/USB

K-band 24,048.010 - 24,048.060 MHz CW/USB

AO-40 experimental transponder operation started on May 05, 2001 at

approximately 08:00 UTC when the U-band and L1-band uplinks were connected to the S-2 transmitter passband downlink via the Matrix switch. The passband times have been shifted to MA 50-170 and the ALON/ALAT has been updated. ALAT has already been lowered considerably, accounting for the improved signals. As mentioned earlier, Colin VK5HI is the controller most involved in setting the attitude and checking for accuracy. Graham VK5AGR announced as this column was being prepared that the attitude had been made very favourable and is likely to remain so for some time.

The AMSAT group in Australia.

The National Co-ordinator of AMSAT-VK is Graham Ratcliff VK5AGR. No formal application is necessary for membership and no membership fees apply. Graham maintains an email mailing list for breaking news and such things as software releases. Members use the AMSAT-Australia HF net as a forum.

AMSAT-Australia HF net.

The net meets formally on the second Sunday evening of the month. In winter (end of March until the end of October) the net meets on 3.685 MHz at 1000utc with early check-ins at 0945utc. In summer (end of October until end of March) the net meets on 7.068 MHz at 0900utc with early check-ins at 0845utc. All communication regarding AMSAT-Australia matters can be addressed to:

AMSAT-VK,

GPO Box 2141,

Adelaide, SA. 5001.

Graham's email address is:

vk5agr@amsat.org

Half-Yearly Update Summary of Operational Amateur Radio Satellites

Since this is a combined December and January issue of AR magazine I will include the normal six-monthly summary of operational satellites.

For the sake of brevity, I will not include satellites, which are spasmodically operational or have been inactive for some time. Full information on all amateur radio satellites, operational or defunct is available on the AMSAT web site.

Scott, NX7U has a program that automatically calculates Uplink S/N against a supplied Nova for Windows orbital listing.

Download at: http://members.cox.net/nx7u/ao40/ao40v20_AutoSNR.zip

The popular "AO-40 FAQ", compiled by Steve, VK5ASF is now available at: <http://www.amsat.org>

Ground stations capturing telemetry from AO-40 are asked to send a copy of the data to the AO-40 archive at: ao40-archive@amsat.org. To keep up to date with the very latest transponder-operating schedule visit: <http://www.amsat-dl.org/journal/adlj-p3d.htm>

International Space Station/ARISS

Worldwide packet uplink: 145.990 MHz FM
Region 1 voice uplink: 145.200 MHz FM
Region 2/3 voice uplink: 144.490 MHz FM
Worldwide downlink: 145.800 MHz FM
TNC callsign: RS0ISS

The ARISS initial station was launched September 2000 aboard shuttle Atlantis. ARISS is made up of delegates from several major, national Amateur Radio organizations, including AMSAT.

Status: Operational. Numerous contacts have been made with the ISS Crew.

Alain, IZ6BYY and Claudio, IK1SLD

wish to announce the opening of the ISS Fan Club.

The ISS Fan Club is a free no-profit organization. The first 100 subscribers will receive by mail a nice picture of ISS Crew #1 signed by Sergei Krikalev and Yuri Gidzenko at the ISS Forum 2001 in Berlin. The official ISS Fan Club website is at: <http://www.issfanclub.com> ISS packet activity has resumed. If you wish to peruse packet operation with ISS a good discussion on its use is available at: <http://www.rac.ca/arispak2.htm> ARISS school contacts have resumed with the Expedition 5 crew of mission

commander/U.S. astronaut Peggy Whitson, KC5ZTD, and Russian cosmonauts Valery Korzun, RZ3FK and Sergei Treschev, RZ3FU. An archive of school contacts can be found at: <http://www.msnbc.com/news/505064.asp> Before planning to make real-time contact with the ISS crew, consult their daily schedule of activity which can be found on the web at: <http://spaceflight.nasa.gov/station/timelines/>

The callsigns used on ISS are as follows:

U.S. callsign: NA1ISS

AMSAT OSCAR 7 AO-7

Uplink:
145.850 to 145.950 MHz CW/USB Mode A
432.125 to 432.175 MHz CW/LSB Mode B

Downlink:
29.400 to 29.500 MHz CW/USB Mode A
145.975 to 145.925 MHz CW/USB Mode B

Beacon:
29.502 MHz, 145.972 MHz, 435.1 MHz,
2304.1 MHz

Launched:
November 15, 1974 by a Delta 2310 from Vandenberg Air Force Base, Lompoc, California.

Status: Semi-operational in sunlight. After being declared dead 21 years ago in mid 1981 due to battery failure, AO-7 has miraculously sprung back to life and was first detected by Pat Gowen, G3IOR on

June 21, 2002 at 1728 UTC. Jan King, W3GEY reports AO-7 is running off the solar panels only. It will only be on when in sunlight and off in eclipse. Therefore, AO-7 will reset each orbit and may not turn on each time. On July 11, 2002 AO-7 was successfully commanded for the first time since it was declared dead 21 years ago. Commands were sent and accepted to change the CW beacon code speed. Command investigation continues. So far, 11 different commands have been accepted by AO-7. Tim, K3TZ has written a program to decode AO-07 telemetry. The program can be downloaded at:

http://www.qsl.net/k3tz/files/K3TZ_AO-07_Telemetry_Decoder_0.5.zip

OSCAR 10 AO-10

Uplink:
435.030 to 435.180 MHz CW/LSB

Downlink:
145.975 to 145.825 MHz CW/USB

Beacon:
145.810 MHz (unmodulated carrier)

Launched:
June 16, 1983 by an Ariane launcher from Kourou, French Guiana.

Status: Semi-operational AO-10 has been locked into a Mode-B, 70-cm uplink and 2-meter downlink for several years but the old "war-horse" refuses to die and continues to give remarkably good service to the amateur radio community.

UoSAT-Oscar-14 UO-14

Uplink:
145.975 MHz FM

Downlink:
435.070 MHz FM

Launched: January 22, 1990 by an Ariane launcher from Kourou, French Guiana.

Status: Operational, mode J. Can often be worked with minimal gear.

Radio Sport RS-15

Uplink:
145.858 to 145.898 MHz CW/USB

Downlink:
29.354 to 29.394 MHz CW/USB

Beacon:
29.352 MHz (intermittent)

Launched: December 26, 1994 from the Baikonur Cosmodrome.

Status: Semi-operational, mode A, using a 2 meter uplink and a 10 meter downlink. This satellite still represents a great way to "get your feet wet" in amateur radio satellites

JAS-1b FO-20

Uplink:
145.90 to 146.00 MHz CW/LSB

Downlink:
435.80 to 435.90 MHz CW/USB

Launched:
February 07, 1990 by an H1 launcher from the Tanegashima Space Center in Japan.

Status: Operational. FO-20 is in mode JA continuously. Tak, JA2PKI, reported FO-20 control station operators believe that the UVC (Under Voltage Controller) now is regulating the transponder. The controller monitors battery voltage and tries to protect the batteries from over discharge.

Have you heard this week's Divisional Broadcast? See page 64 for times and frequencies.

UoSAT OSCAR-11

Downlink:

145.826 MHz FM (1200-baud AFSK)

Mode-S Beacon:

2401.500 MHz

Launched:

March 1, 1984 by a Delta-Thor rocket from Vandenberg Air Force Base in California.

Status: Semi-operational. OSCAR-11 is currently operating in a default mode, controlled by the watchdog timer. The satellite transmits continuous ASCII telemetry for about eight days on 145.826 MHz, followed by about 14 days of silence. However the mode-S

beacon on 2401.5 MHz is ON continuously. At the present time, ground control are unable to command the satellite due to low temperatures affecting the command decoder. They will attempt to command the satellite when the command decoder temperature has risen to 15C. UO-11 is an old-timer. It is not a communication satellite, having just downlink capability but still has a solid following among the education fraternity who after almost 20 years still use its telemetry signals on a daily basis.

ITAMSAT IO-26

Uplink:

145.875 145.900 145.925 145.950 MHz FM (1200-baud)

Downlink:

435.822 MHz SSB

Broadcast Callsign: ITMSAT-11

BBS: ITMSAT-12

Launched: September 26, 1993 by an Ariane launcher from Kourou, French Guiana.

Status: Semi-operational, the digipeater function is on and open for APRS users.

PCSAT NO-44

Uplink/downlink:

145.827 MHz 1200 baud AX-25 AFSK via PCSAT-1

Aux/Uplink:

435.250 MHz 9600 baud via PCSAT-2 (off)

APRS Downlink: 144.390 MHz (Region 2)

Launched: September 30, 2001 aboard an Athena-1 rocket from the Kodiak, Alaska launch complex.

Status: Operational. PCSat is a 1200-baud APRS digipeater designed for use by stations using hand-held or mobile transceivers. Downlinks feed a central web site < <http://pcsat.aprs.org> >. The APRS-equipped PCSat was built by midshipmen from the U.S. Naval Academy under the guidance of Bob Bruninga, WB4APR. A new version of Bob's telemetry decoding and operating program, PCSAT.EXE can be obtained at: <ftp://tapr.org/dosstuff/APRSdos/pcsat017.zip>

JAS-2 FO-29

Launched: August 17, 1996, by an H-2 launcher from the Tanegashima Space Center in Japan.

Status: Operational

Voice/CW Mode JA

Uplink:

145.90 to 146.00 MHz CW/LSB

Downlink:

435.80 to 435.90 MHz CW/USB

Digital Mode JD

Uplink:

145.850 145.870 145.910 MHz FM

Downlink:

435.910 MHz 1200-baud BPSK or 9600-baud FSK

Callsign: 8J1JCS

Digitaltalker: 435.910 MHz

<http://www.ne.jp/asahi/hamradio/j9pel/>

PACSAT AO-16

Uplink:

145.90 145.92 145.94 145.96 MHz FM (using 1200-baud Manchester FSK)

Downlink:

437.025 MHz SSB (RC-BPSK 1200-baud PSK)

Mode-S Beacon:

2401.1428 MHz

Broadcast Callsign: PACSAT-11

BBS: PACSAT-12

Launched: January 22, 1990 by an Ariane launcher from Kourou, French Guiana. *Status:* Semi-operational, the digipeater command is on.

UOSAT UO-22

Uplink:

145.900 MHz FM 9600-baud FSK

Downlink:

435.120 MHz FM

Broadcast Callsign: UOSAT5-11

BBS: UOSAT5-12

Launched: July 17, 1991 by an Ariane launcher from Kourou, French Guiana. *Status:* Operational and still carrying a good deal of international packet radio traffic through its "satgate" stations worldwide.

TIUNGSAT-1 MO-46

Uplink:

145.850 or 145.925 MHz 9600-baud FSK

Downlink:

437.325 MHz

Broadcast callsign: MYSAT3-11

BBS: MYSAT3-12

Launched: September 26, 2000 aboard a converted Soviet ballistic missile from the Baikonur Cosmodrome.

Status: Operational at 38k4-baud FSK with new imaging taking place fairly regularly.

SO-41 SAUDISAT-1A

Uplink:

145.850 MHz

Downlink:

436.775 MHz

Broadcast Callsign: SASAT1-11

BBS: SASAT1-12

Launched: September 26, 2000 aboard a converted Soviet ballistic missile from the Baikonur Cosmodrome.

Status: Operational but intermittent. SO-41's downlink RF power is 1-watt with left-hand circular polarization. The uplink antenna (located on top of the spacecraft) is linear in polarization.

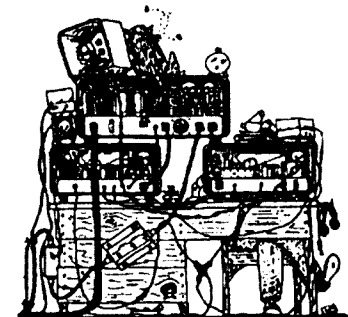

Part 21

Learning Morse Code

Morse Code has been the premier radio communications mode since the dawn of Amateur Radio. Even today, Morse is used extensively for long distance communication in conditions when most other wider bandwidth modes fail. However, some narrow band digital modes may have the edge in effectiveness, but the sheer simplicity of Morse Code means that it will remain popular in the Amateur Radio fraternity for many years to come. Learning Morse Code can be daunting for some but with the right motivation and a desire to succeed, it can be fascinating and fun to learn in a very short time. Modern computers, with free software can help in the learning process, particularly for people lacking access to a local radio club or an AR friend to assist with practice sessions. For first timers aiming at a full call licence, or the old timer wanting to brush up on some Morse practice - Computer Aided Instruction (CAI) is the answer.

Books and Publications

Over the last 50 years, dozens of good books have been written, some with tapes and CD's each claiming to be the best method to learn Morse Code. In the worlds military, Morse still remains an important skill for communicators even though modern data signals are used for regular traffic. Finding the right method to learn the code has remained illusive. However, a good book is a great start in studying the alphabet and numerals, followed by punctuation and Morse procedures. Remember that Morse is just a coded language with 26 letters and 10 numerals, and very easily learned to the level of precision needed to pass the Morse test for your full-unrestricted callsign.

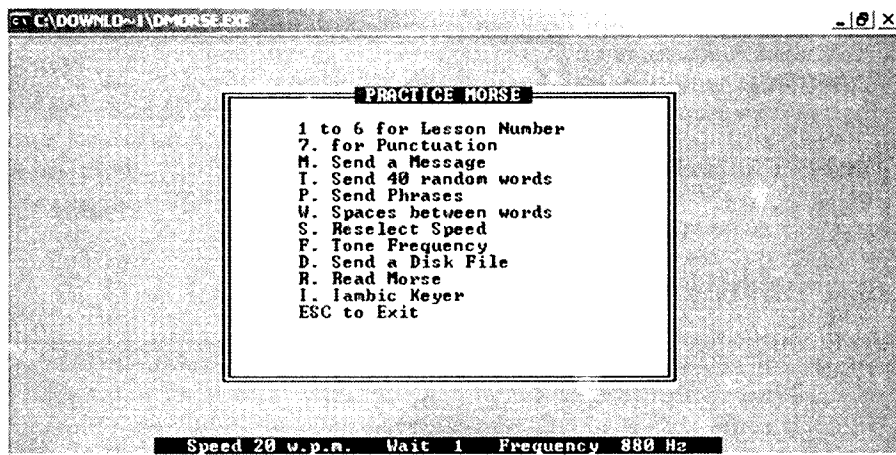

Start with a copy of your society callbook and study the Morse letters and numerals first.

For the ultimate reading material try "The Art and Skill of Radio-Telegraphy" by NOHFF (1) that deals with the history, learning processes, and application of Morse Code in detail. The book is available via online ordering in both hard and soft covers, or free download in Adobe Acrobat (pdf at 990kb) format, and well worth the effort for newcomers or veterans alike.

One classic booklet by Margaret Mills, G3ACC "Morse Code for Radio Amateurs" published by the RSGB in 1964 was the ultimate at the time. However, better methods have evolved now computers have become the central focus in modern Amateur Radio Shacks.

Morse Learning Software

With expansion of the Internet, and the assertiveness of RA software authors worldwide, there is a myriad of software available free for the asking online. Two Morse CAI programs have stood the test of time and very popular:

1. **DMorse** (61kb) by G0MDO (2) is a very effective DOS program for use on all computers including an old XT without a sound card. It will also run on the latest 2Gb, Windows XP machines with all the trimmings as well. DMorse uses the built-in computer loudspeaker and runs Morse at any speed between 5 through 50 words per minute. The DMorse Menu layout shown above offers most attributes needed to learn the Code - and remarkably simple to use.

The Art and Skill of Radio-Telegraphy

A manual for learning, using, mastering and enjoying the International Morse Code as a means of communication

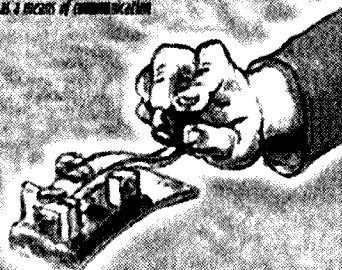

William G. Pierpont NOHFF

2. CW Player is the popular Morse learning program (CAI) that's stable on all Windows-based operating systems and a delight to use. It even keys your transmitter, writes practice files, runs from 5-50 WPM, sends common Q-code signals, offers random letters, numerals, punctuations, gives call signs and practice QSO procedures and much more! The software is downloaded from the Internet as cwplayer.zip (322kb) and self-extracting into a new folder. Simply run CWPLAYER.EXE from a desktop shortcut and the following screen is presented:

Just looking at the above menu for CW Player is exciting enough. "Click" on

each of the letters and the character is played to your computer speakers. This will help you learn the code very quickly by repeating the letters until the sound becomes automatic. Type in some text in the upper left window and the characters are played immediately. Try the QUIZ that offers a score out of 100 when characters are displayed. You get three seconds to respond with the correct answer! Common Q-codes is another option which helps in quick recognition of regularly used Q-codes on air. Look for the practice QSO options, read a simple text file for practice sessions. CW Player will tell you when you are wrong - and ask you to try again until mastery has been gained. Start with the speed set to 5-WPM and work up

through 12-WPM until proficiency has been gained. You can even write your own practice lessons and run each until you feel comfortable. For newcomers starting from scratch, at least 12-WPM should be reached with 100% proficiency within about six weeks.

For Contesters wishing to brush up with their speed reading problems, CW Player is ideal. By adding some background QRM, especially from a running contest, use the output from your station receiver added to the sound output of CW Player for some "real world" contest practice. For determined operators speeds of 25-WPM can easily be achieved under "contest" conditions commonly heard on the HF bands these days. CW Player will also play French and German languages for operators studying other languages or just want to rag chew with other European operators!

Ham Tip No. 21: Use CW Player to make Morse practice files for friends. It's much easier than recording audiotapes!

Ham Shack Computers, Part 22 next month "Computer Calibration" - a free program to properly test and calibrate your computer and screen display. This "must-have" free software called VGATEST.EXE will be available for download on the Ham Shack Computers Web Site.

- (1) "The Art and Skill of Radio-Telegraphy" by N0HFF at: <http://raes.ab.ca/book.html>
- (2) DMorse software at: <http://www.rafars.freemove.co.uk>
- (3) CW Player software at: <http://perso.club-internet.fr/f10rl/>
- (4) Ham Shack Computers Web: <http://www2.tpg.com.au/users/vk6pg>
73s de Alan VK6PG

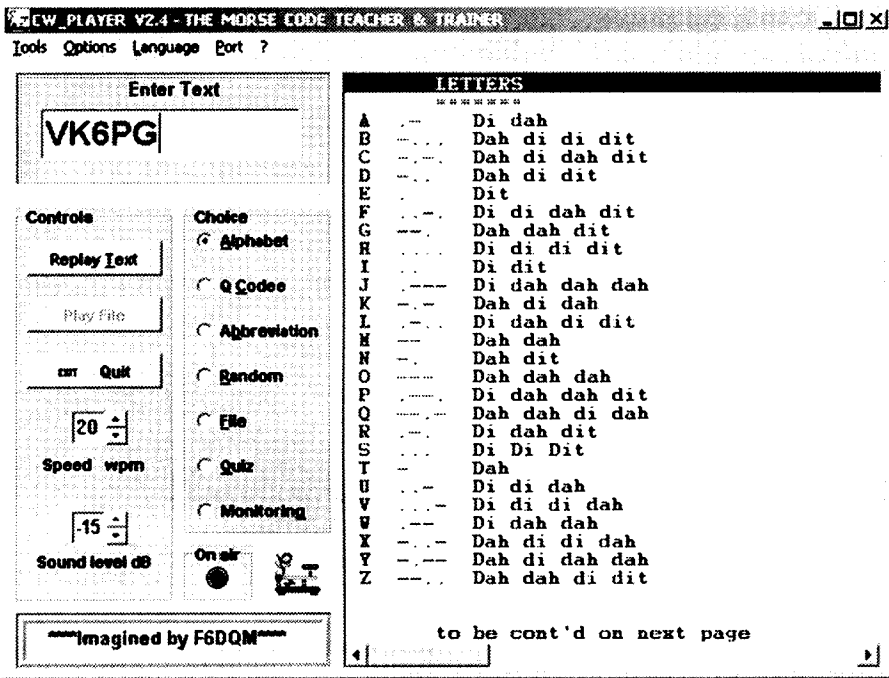

Bad operating habits

I had just finished installing a new antenna. The CQ WW contest seemed to be the ideal opportunity to see how good it is. Everybody who came back to me gave me the same report - 59 even if they were only 4&4 or so with me. I asked one station who gave me the customary 59, what my REAL report was "5 and 3" he replied.

What is the point of giving a dishonest report? Even in the heat of a contest, and I have operated in many

of them, it does not take much time to glance at your S meter. Some stations thanked me for giving THEM a real report.

I was also horrified by some of the language. One operator, unfortunately a VK, told a W operator to "move his arse off this frequency, I have been here all day." Also heard "that shows that cretins can own radios." There was also some outright swearing and profanity. This sort of behaviour is not confined to

contests either, just listen to some of the DX nets or Dxpeditons.

If amateur radio is to survive we have to lift our game. If spectrum administrators heard some of the stuff that pollutes our bands they would almost certainly decide that the large amount of spectrum we occupy could be put to better use. They would probably be right!

Wayne Melrose VK4WDM
melrosew@optusnet.com.au

Contest Calendar December 2002 to February 2003

Dec 6-8	ARRL 160 Metres Contest	(CW)	
Dec 14/15	ARRL 10 Metres Contest	(CW/SSB)	
Dec 21	OK DX RTTY Contest		
Dec 26- Jan 13	Ross Hull Memorial VHF Contest	(Nov 02)	
Dec 28	RAC Canada Winter Contest	(CW/SSB)	
Dec 28/29	Original QRP Contest	(CW)	
Dec 28/29	Stew Perry Top Band Distance Challenge	(CW)	
Jan 4/5	ARRL RTTY Roundup		
Jan 11/12	VHF+ Summer Field Day	(CW/SSB)	(Dec 02)
Jan 19	HA DX Contest	(CW)	
Jan 24-26	CQ 160 Metres Contest	(CW)	
Jan 25/26	Ref DX Contest	(CW)	
Feb 8/9	CQ WW RTTY WPX Contest		
Feb 8	Asia-Pacific Sprint 40-20 m	(CW)	
Feb 8/9	PACC Contest	(CW/SSB)	
Feb 8/9	RSGB 160 Metres Contest	(CW)	
Feb 15/16	ARRL International DX Contest	(CW)	
Feb 21/23	CQ WW 160 Metres	(SSB)	
Feb 22/23	REF Contest	(SSB)	
Feb 22/23	UBA DX Contest	(CW)	

Greetings to all readers...

As I start these notes we have just had the first leg of this year's Oceania DX Contest. I am pleased to report that the participation from DX stations was good as far as I could hear, including possibly an unusual station in P93 North Korea operating on 40 metres with a 4-element beam.

Recently I wrote on the technique of seeking new multipliers in order to boost the total score. This I was interested to hear many stations doing, including some of our own "big guns". I admit that I did so myself as much as I could.

However, it also came to me that when one is a low-powered station as I am, then it is possible to hear DX stations but not get back to them. If not very careful, this could lead to dejection and an early finish to one's participation. PLEASE DO NOT DO THIS!

In this situation, the time-honoured practice of working as many stations as possible (even when these are locals) is still quite valid. I was not at all unhappy with my small number of contacts by world standards. I used my skills and

my station as well as I could. This, I believe, is what we should all aim for, not just in a DX contest, but in all contests — and in Life in general.

Novice Contest

Over recent years there has been a sharp decline in participation in the Novice Contest, to the point where the Westlakes Amateur Radio Club Inc. has decided to cease its sponsorship of this event. The results listed below are, therefore, the last that we shall see for this Contest.

This is very sad, but I take this opportunity to say a sincere thank you to the Club for its support over many years.

Finally

At the end of these notes notice is given of a new contest activity from South Africa. You may be interested to try this one, but please be aware that it will be on the same weekend as the Summer VHF Field Day.

As we reach the end of another year, thank you all for your interest and participation in contests in 2002. I hope that you will continue next year, even to the point of trying some new modes and associated contests.

73 and good contesting,

Ian Godsil VK3VP

Results Digital Mode Contest 2002

1st	VK3BGH	1,890 points
2nd	HP8AJT	385
3rd	OK1VSL	51
4th	VK4TJ	48
5th	VK3DY	24
6th	VK4FAD	6

On behalf of the CW Operators' QRP Club I thank all those who took part in this inaugural contest and sent their logs.

I found it most interesting that three of the six above logs were operators who were trying the digital mode for the first time. Now here is an excellent opportunity for many of the rest of us to do the same next year.

Graeme VK3BGH reported that the bands were open, but little activity outside 20 metres. Graeme has also offered to help organise next year's event.

Thanks to you all.

73 and good digital moding.

Ian Godsil VK3VP

Results ANARTS RTTY Contest 2002

from Jim VK2BQS and Colin VK2CTD

(VKs only — Place\Call\Points\Award)

Category A

5	VK2KM	19,816,776	5th World, 2nd OC, 1st VK2
6	VK4UC	17,577,864	6th World, 1st VK4
48	VK6GOM	5,204,750	1st VK6
156	VK2BQS	561,495	2nd VK2
159	VK2CTD	530,400	3rd VK2

Category B

2	VK4WPX	14,694,912	1st OC, 1st VK4
---	--------	------------	-----------------

Comments: 240 logs were received this year, a record for our contest. However, the number of VK stations taking part was disappointing again this year.

Checking and processing of the logs revealed that there are many new stations taking part using Sound Card programs in lieu of traditional Terminal Units. I hope that this trend continues and brings many more contestants to the various RTTY contests. MMTTY seems to be the favoured software in use. However, there were problems, eg 20 logs with no calculation carried out at all.

The new programs operating through Sound Cards generated the majority of logs received with lack of data of some kind. Whether there is a problem with the Contest Log section of these programs is not yet clear.

Whilst email logs are fine and warmly welcomed, once again this year I received a variety of file formats, despite asking for Plain Text files.

Thanks to all for taking part. Next year's contest will be on 14/15 June, 2003.

Amateur Radio

— an essential in every shack!

Results Novice Contest 2002

from Westlakes Amateur Radio Club

1st	Terry VK2KTD	SSB	111 points
2nd	Chris VK2LCD	SSB	71
3rd	Ian VK3JS	CW	50
4th	Chris VK2MQX	CW	42

Keith Howard Trophy for Novice with highest SSB score to
Chris Meagher VK2LCD

Clive Burns Memorial Trophy for Novice with highest CW score
to Chris Thompson VK2MQX

Results Oceania DX Contest 2001

(VKs only)

Continent: Oceania

Australia

VK4EMM **	Single-Op All	3180192
VK2APK	Single-Op All	2184630
VK4UW	Single-Op All	879795
VK5GN #	Single-Op All	538734
VK4TT	Single-Op All	509270
VK2PS	Single-Op All	255448
VK2QF	Single-Op All	211792
VK4BUI	Single-Op All	65462
VK3JS	Single-Op All	47460
VK3IO	Single-Op All	13489
VK3TZ *^	Single-Op 80M	1080
VK2AYD *^	Single-Op 20M	217994
VK3AMD	Checklog	50

Continent: OCEANIA

Australia

VK5GN *^#	Single-Op All	2874143
VK2CZ	Single-Op All	1440504
VK2APG	Single-Op All	1109801
VK2FHN	Single-Op All	987012
VK3TZ	Single-Op All	938202
VK4EMM	Single-Op All	709956
VK1JDX	Single-Op All	368220
VK1MJ	Single-Op All	253580
VK3IO	Single-Op All	215644
VK4BAY	Single-Op All	28792
VK7JAB #	Single-Op All	348
VK7LUV	Single-Op All	126
VK2APK *^	Single-Op 20M	252215
VK3YE	Single-Op 20M	7242
VK2VZQ *^	Single-Op 15M	167692
VK4DMP	Single-Op 15M	141040
VK2XZ *^	Single-Op 10M	1847100
VK4NEF	Single-Op 10M	290088
VK4EJ	Single-Op 10M	35757
VK4WIL *	Multi-One	568980
(VK4SN VK4CEJ)		
VK3AMD	Checklog	39
VK3VP	Checklog	0

Good to see our usual "big guns" continuing their successes, but not forgetting those others in the list with very creditable scores. (Oh, and don't overlook the Wooden Spooner above! Trouble in the log checking program.)

On behalf of the organising committee, thank you to everyone. Hope I worked you in this year's event.

Ian VK3VP

Rules Summer VHF-UHF Field Day 2003

from John Martin (VK3KWA), Contest Manager

The Summer VHF-UHF Field Day will take place on the weekend of January 11 and 12, 2003.

The rules are the same as for the Spring Field Day in November 2002. The only change from previous years is the trial run of a 6 hour multi-operator section. Hopefully this will allow more stations to go out in the field, and if it is successful it can become a permanent part of the Field Day. Please include any comments on this or any other aspect of the Field Day with your log.

Dates

Saturday and Sunday January 11 and 12, 2003.

Duration in all call areas other than VK6:

0100 UTC Saturday to 0100 UTC Sunday.

Duration in VK6 only:

0400 UTC Saturday to 0400 UTC Sunday.

Sections

- A: Portable station, single operator, 24 hours.
- B: Portable station, single operator, 6 hours.
- C: Portable station, multiple operator, 24 hours.
- D: Portable station, multiple operator, 6 hours.
- E: Home station, 24 hours.

Single operator stations may enter both Section A and Section B. If the winner of Section A has also entered Section B, his log will be excluded from Section B. The same applies to the winner of Section C if the station has also entered Section D.

General Rules

A station is portable only if all of its equipment is transported to a place which is not the normal location of any amateur station. Operation may be from any location, or from more than one location. You may work stations within your own locator square. Repeater, satellite and crossband contacts are not permitted.

One callsign per station. If two operators set up a joint station with shared equipment, they may choose to enter Section A or B as separate stations under their own callsigns, or Section C or D under a single callsign. If they enter Section A or B, they may not claim contacts with each other. Stations with more than two operators must enter Section C or D. Operators of stations in Section C or D may not make any contest exchanges using callsigns other than the club or group callsign.

No contest operation is allowed below 50.150 MHz. Recognised DX calling frequencies must not be used for any contest activity. Suggested procedure is to call on .150 on each band, and QSY up if necessary.

Contest Exchange

RS (or RST) reports, a serial number, and your four digit Maidenhead locator.

Repeat Contacts

Stations may be worked again on each band after three hours. If the station is moved to a new location in a different locator square, repeat contacts may be made immediately. If the station moves back into the previous locator square, the three hour limit still applies to stations worked from that square.

Scoring

For each band, score 10 points for each locator square in which your station operates, plus 10 points for each locator square worked, plus 1 point per contact. Multiply the total by the band multiplier as follows:

6 m	2 m	70 cm	23 cm	Higher
x 1	x 3	x 5	x 8	x 10

Then total the scores for all bands.

Logs

Logs should cover the entire operating period and include the following for each contact: UTC time, frequency, station worked, serial numbers and locator numbers exchanged, points claimed.

Cover Sheet

The cover sheet should contain the names and callsigns of all operators; postal address; station location and Maidenhead locator; the section(s) entered; the scoring table; and a signed declaration that the contest manager's decision will be accepted as final.

Please use the following format for your scoring table. In this example the operator has operated from one locator and worked four locators on each band:

Band	Locators Activated	+	Locators Worked	+	QSOs (1 pt each)	x	Multiplier	=	Band Total
6 m	10	+	40	+	40	x	1	=	90
2 m	10	+	40	+	30	x	3	=	240
70 cm	10	+	40	+	20	x	5	=	350
Overall Total									= 680

A sample cover sheet has been posted on the VK-VHF e-mail reflector, and copies can also be obtained from the e-mail address given below.

Entries

Paper logs may be posted to the Manager, VHF-UHF Field Day, 3 Vernal Avenue, Mitcham, Vic 3132. Electronic logs can be e-mailed to jmartin@xcel.net.au. The following log formats are acceptable: ASCII text, MS Office RTF, DOC, XLS or MDB. If you use Office 2000, please save the files in Office 97 format.

Logs must be received by Monday, February 3, 2003. Early logs would be appreciated.

ALARA Contest Results 2002

It was a disappointing year this time, with fewer participants from VK, though our DX members kept up their usual effort. The conditions were quite reasonable both evenings, and some members managed contacts during the daylight hours as well.

I heard quite a few giving numbers, BUT NO LOGS came in from many of them!

We did have a bit of confusion regarding the email address this year, but there were 6 logs that arrived by that means. That should all be behind us in the future, as ALARA now has its own e-mail address for the Contest.

Everybody should be able to use this one: alaracontest@wia.org.au

Our thanks to WIA for this service.

Again this year two members put in a wonderful effort to take out the top honours – namely Gwen VK3DYL and Bev ZL1OS. It's probably time for others to give these two girls a challenge! Susan VK7LUV was our top Novice, while Pat VK3OZ again earned the Florence McKenzie trophy for CW. Again Mavis VK3KS made the effort to give contacts on CW – thank you very much, Mavis. As this was the third time Pat had won the trophy, we anticipated the results and presented her with the actual trophy at the recent ALARAmeet in Murray Bridge. Our top OM this year was Chris VK2LCD, and it was great to hear him giving the girls the numbers – keep up the good work, Chris!

The change of date has been definitely for the better, so we will be keeping to that schedule – next year's Contest will be held on August 30th/31st, 2003 over the same time period.

I will look forward to working many more of you next year – I hope!!

33, Marilyn VK3DMS, Contest Manager

2003 Hunting Lions In The Air Contest

The 32st annual Hunting Lions in the Air contest will take place on the weekend January 11 – 12, 2003.

Objective: "To create and foster a spirit of international understanding and cooperation" among radio amateurs and Lions through world-wide radio communication. The contest is to commemorate the birthday of the founder of Lionism, Melvin Jones, born at Ft. Thomas, Arizona USA on January 13, 1879.

Websites:

<http://www.sarl.org.za/public/contests/lionita.htm>
and

<http://www.geocities.com/lions410b/>

Operators interested in additional information regarding this contest should write to the Contest Committee at:

The HLITA Contest Committee

Lions Club of Midrand

PO Box 1548

Halfway House 1685 South Africa

or via email to:

rad.handfield-jones@pixie.co.za

22ND ALARA CONTEST RESULTS

24/25th August, 2002

Gwen VK3DYL	758	Top score overall, Top score VK YL, Top phone score, Top VK3 ALARA member
Susan VK7LUV	256	Top VK Novice, Top VK7 ALARA member
Bev ZL1OS	215	Top DX YL, Top ZL ALARA member
Chris VK2LCD	206	Top VK OM
Marilyn VK3DMS	182	CHECK LOG
Celia ZL1ALK	163	
Christine VK5CTY	152	Top VK5 ALARA member
Robyn VK3WX	140	
Steve VK5AIM	138	
Dot VK2DB	131	Top VK2 ALARA member
Alan VK7JAB	127	
Bron VK3DYF	122	
Lynnette ZL1LL	108	
Elizabeth VE7YL	97	Top VE ALARA member
Justin VK7TW	68	
Pat VK3OZ	62	Top VK YL CW Florence McKenzie Trophy
Rosemary ZL1RO	57	
Margaret VK4AOE	55	Top VK4 ALARA member
Elizabeth VE7TLK	25	
Mavis VK3KS	20	
Evelyne F5RPB	16	Top European ALARA member

SUMMARY:

VK ALARA members	10 (Includes 1 check log)
DX ALARA members	7
VK OMs	4
Total logs	21

THE WIA NSW BOOKSHOP

<http://www.wiansw.org.au/bookshop/index.htm>

email: bookshop@wiansw.org.au

QST QST QST

109 Wigram Street, Parramatta, New South Wales, Australia.

PO Box 432, Harris Park, NSW, Australia 2150.

Phone: +61 2 9689-2417 Facsimile: +61 2 9633-1525

Toll free in New South Wales outside Sydney: 1800 817-644

Office Open 11am–2pm Tuesdays & Thursdays

Email: vk2wi@ozemail.com.au

"We endeavour to provide a range of technical books of interest to the Radio Amateur as well as electronics enthusiasts, at competitive prices. Special discounts are offered to WIA members. We are the only bookshop of this type in Australia."

**Comprehensive Range • Antennas • Equipment
Construction and Design • Historical • ARRL and RSGB
Publications • Educational**

Order by mail, fax or email

Knowledge should not be unaffordable

Remembrance Day Contest 2002 — VK6 Division Wins!

From 6th place last year to 1st place in 2002, the VK6 Division has pulled out all stops to bring the trophy home to the West.

As a member of the VK6 Division, I can say that there was tremendous enthusiasm and a strong desire to put in a winning effort this year. Congratulations to all who participated and made the win possible.

Winning the RD Contest is all about

participation. VK6 had the highest number of submitted logs of all the divisions this year. It seems proper that effort should be rewarded.

Once again, the task of checking logs and collating results was made very easy by the high standards of submitted logs.

I believe that this is due to the good understanding of the rules and the increased use of computers for contest logging.

Here now are the results for the contest.

RESULTS

Divisional Scores

Table 1 shows the placing of each division along with their overall Improvement Factors.

Table 1: Divisional Ladder

1 st	VK6	1.136
2 nd	VK4	0.993
3 rd	VK7	0.920
4 th	VK5/8	0.822
5 th	VK2	0.585
6 th	VK3	0.532
7 th	VK1	0.462

The total scores in both HF and VHF are shown in Table 2.

Table 2: Divisional Scores

Div'n	HF	VHF
VK1	270	118
VK2	2643	84
VK3	2601	2218
VK4	2903	1490
VK5/8	3204	1367
VK6	2437	5060
VK7	1274	986

For those who wish to know how the final score for each division is calculated, I have included the following live example of how it is done. I will use the VK3 Division's figures in the calculations.

First is the calculation of Benchmarks for VK3 for 2001 RD Contest.

2001 Benchmarks. (As published in 2000 results and 2001 rules)

HF 3852
VHF 8727

2001 Scores. (As published in 2001 results)

HF 2286
VHF 2174

Formula:

$$2002 \text{ Benchmark} = (0.25 \times 2001 \text{ Score}) + (0.75 \times 2001 \text{ Benchmark})$$

Calculations:

HF

$$2002 \text{ Benchmark} = (0.25 \times 2286) + (0.75 \times 3852)$$

$$2002 \text{ Benchmark} = 571.5 + 2889$$

$$2002 \text{ Benchmark} = 3461$$

VHF

$$2002 \text{ Benchmark} = (0.25 \times 2174) + (0.75 \times 8727)$$

$$2002 \text{ Benchmark} = 543.5 + 6545.25$$

$$2002 \text{ Benchmark} = 7089$$

Those 2 benchmark figures are the scores the division needs to beat to register a positive improvement factor in each section of the contest.

Now to calculate the final score, let's use the points that the VK3 division scored in HF and VHF this year.

Formula:

$$\text{Improvement Factor} = \frac{2002 \text{ Points}}{2002 \text{ Benchmark}}$$

Calculations:

HF

$$2601 / 3461 = 0.752$$

VHF

$$2218 / 7089 = 0.313$$

The two improvement factors are now averaged to give the division's final result.

Formula:

$$\text{Overall Score} = (\text{HF Improvement} + \text{VHF Improvement}) / 2$$

Calculation:

$$\text{Overall Score} = (0.752 + 0.313) / 2$$

$$\text{Overall Score} = 1.065 / 2$$

$$\text{Overall Score} = 0.533$$

Here now, are the Benchmark figures for the year 2003. This table will also appear in the rules for 2003. As above,

the formula for determining these values is:

$$2003 \text{ Benchmark} = (0.25 \times 2002 \text{ Score}) + (0.75 \times 2002 \text{ Benchmark})$$

Table 3: 2003 Benchmarks

Div'n	HF	VHF
VK1	615	189
VK2	3950	132
VK3	3246	5871
VK4	3509	1302
VK5/8	3572	1662
VK6	2390	4315
VK7	1565	935

The following table shows the total number of logs received over the last 3 years. * Denotes winning division.

Table 4: Logs

Div'n	2000	2001	2002
VK1	9	15	8
VK2	41	41*	25
VK3	137	57	57
VK4	78*	40	53
VK5/8	46	51	54
VK6	59	47	72*
VK7	41	24	27
Total	411	275	296

Individual Scores

The individual scores for entrants are listed below. Certificate winners are denoted by an asterisk (*) and the top Australian scores in each section by a hash (#). Multi operator certificate winners are denoted by (M). Certificates will be issued to the top operators in each division. Where a multi operator station holds the top score, a certificate will also be issued to the top scoring single operator in that section. Where a single operator station holds top place, only that station will receive a certificate.

VK1	GH 82	FNQ 225	BWH 225	ADI 128	SJJ 49
HF Phone	BCZ 76	FJ 180	ATU 214	GW 111	RO 49
ZX 102*	EK 73	KKN 142	YX 150	JP 110	ARO 48
DW 41	BJA 70	WIT 134	XY 112	BRN 88	CRO 48
EY 33	DBQ 60	BTW 90	SIG 84	AB 71	SIX 48
HF CW	AMW 53	ZA 82	KMC 81	SAR 70	AF 39
LK 62*	FH 50	ZJ 67	FD 80	TS 41	KTN 38
	AQ 41	TE 64	NN 69	PX 35	XV 33
	US 41	PF 61	TW 55	AR 30	MM 28
	JSS 40	MC 44	AFZ 50	ED 18	KCC 27
HF Open	DCP 34	KJD 41	BCZ 46	KH 14	RZ 21
AI 32*	ABP 33	PJ 40	AJW 45	HK 13	HTW 20
VHF Phone	DY 30	ARS 32	RV 42	KG 11	HK 18
ZX 55*	XH 30	ILD 30	PC 34	APK 10	AB 17
EY 32	SS 28	EV 27	OQ 28	NU 8	
DW 31	BSR 27	BSH 25	ZQ 28	KAD 2	VK7
	VQ 27	DV 25	LL 24	SAA 2	HF Phone
	DET 23	ESK 21	KDK 23	SH 2	VH 296*
VK2	RS 23	FXL 21	8AA/3 17	HF CW	CK 251
HF Phone	AKT/4 18	WIF 21	SE 15	AFW 182*	RN 204
XT 227*	ATN 17	LO 20	NF 13	AJ 100	TW 203
BDT 117	NA 13	PAL 10	RK 11	AF 62	KC 70
LCD 81	AAJ 12	HF CW	QV 10	WT 34	HK 43
ASU 56	HF CW	BUI 190*#	VH 9	PM 28	KH 35
EDB 33	AMD 42*	COZ 92	AIM 8	HF Open	NDO 35
IRP 30	KS 40	LP 20	GRC 8	VZ 278*	PP 33
YW 27	HF Open	HF Open	LZ 4	VZ 278*	JGD 31
BJK 20	JS 294*	LT 277*	8AA/2 2	TQ 232	RM 30
IGS 20	BML 227	GZ 200	HF CW	NGW 88	KBE 20
RL 10	VB 100	TJ 58	8HA 114*	RZ 21	BM 13
HF CW	YE 39	ZZ 49	BGL 92	VHF Phone	NGC 10
OI 170*	VHF Phone	VHF Phone	UM 8	ANC 401*#M	VHF Phone
BHO 160	JK 278*	AML 265*	HF Open	JIP 401*#	ZIF 259*
EL 132	BJA 209	AA 184	BRC 521*#M	ZBP 401*#	KRW 114
PS 114	KBD 197	3CE/4 147	WO 88*	NGW 307	HTW 102
GR 88	HAY 164	NBP 127	UE 68	HGR 306	TW 101
KM 68	ACR 146	ZBV 117	RG 62	RRG 199	JGD 95
PH 44	DBQ 123	EV 76	VHF Phone	BDO 197	RM 88
RJ 40	GH 110	ZA 66	ZSR 272*	CSW 193	VH 54
HF Open	AQ 100	PAL 64	BRC 237	SAR 186	NDO 51
AYD 458*	KTO 100	PJ 59	XY 120	APK 185	FB 50
BO 370	US 100	4LO 47	HKT 116	ZKO 163	EB 26
YN 198	ZUG 100	ZZ 42	MX 101	AD 154	JK 25
DPD 144	XJU 74	ZM 39	ZKK 86	JP 139	PP 19
EAH 36	EX 51	WIT 38	GRC 84	MIN 127	HGO 2
VHF Phone	DYL 39	ZT 36	AIM 56	AR 123	Overseas
LCD 41*	AUI 36	JUS 35	KMC 56	YF 121	Section
BDT 40	TTX 34	DO 30	PC 55	KAD 94	HF Phone
JHN 3	XP 30	FNQ 28	RV 38	SAA 94	P29KFS 154*
VK3	TFE 15	BAY 25	SE 38	SH 94	ZL3DW 76
HF Phone	VHF Open	DFZ 25	AVQ 27	NU 89	ZL2ADN 64
SY 249*	JS 137*#	WJ 22	LZ 26	SWA 87	HF CW
AHY 183	YE 106	ZJ 14	QP 19	TRA 85	ZL4GU 48*
KTO 157	VP 69	WIF 4	ADE 18	EH 82	HF Open
BGH 108	VK4	VK5/8	YX 18	XC 70	ZL2ALJ 259*
ADW 91	HF Phone	HF Phone	VK6	ZIC 66	
ACR 85	DO 369*	CRS 501*#M	HF Phone	TS 60	
JK 85	BAY 246	BP 263*	SZ 476*#M	FJA 52	
			CSW 172*	KG 51	
				WT 50	

It has been pleasing to see a small increase in overall activity in the contest this year. Some of us have been participants for many years and even decades. Many of the old timers are still participating and putting in good scores. The reason is very simple. The RD is "The Friendly Contest" and that is what

keeps people coming back each year. The spirit of the RD is mateship and it is as strong as ever. I'll close this year with a note from Al Carter, VK4LT. Al scored 277 points in the HF Open section for the VK4 Division. He has also earned a certificate for his efforts.

"Being in my 86th year, I reckon this is my final effort but have always had fun in this contest since its inception. Pity I had visitors for the last 6 hours of contest. 73, Al."

Thanks Al, thanks everyone.

73, Alek. VK6APK

ar

Low Level Entrance Licence

Brenda Edmonds VK3KT

I have been asked to make a few comments about the proposal for a low-level entry licence.

If the mandatory Morse code competence requirement is revoked at next year's WRC, we will, in effect, be left with only two levels of licence, the Unrestricted and the Novice. That would seem to be an appropriate time to introduce another level, lower than the current Novice, as a way of operating legally whilst learning. The UK has successfully added this level, as have several other countries.

Details of bands, power, and Licence conditions remain to be negotiated, but if we have in principle support for the proposal we can start the planning.

First, if we are to have a three level system, let us invent some new names for them, even if we have to call them Levels 1, 2 and 3. Please note I am not advocating a decrease in the standard of the current licences, but a system, which allows some hands-on activity at an earlier stage.

The benefits of a lower entry seem to me to be the chance to build on the short interest span of the current young people who are conditioned against making a long-term commitment to study. If they can actually get on air after a few hours

of work, preferably under some level of guidance from an experienced operator, we have a chance to nurture them along to higher achievements. Those of us who have been involved in running classes all agree that most of the dropping out occurs in the first six weeks or so of the classes, - the time when all the boring basic stuff is being covered. (I started one of my classes at the height of the CB boom on the Antennas section. Great idea.)

Another factor, which has influenced me to support this proposal, is the number of amateurs who have told me "If there were a lower level entry, my wife (daughter, son) would have a go." I have long advocated a recruitment plan aimed at the female half of the population, and this may be the way to advance this idea. I recently reread an article I wrote in the early 90s noting the benefits gained by a multi-licensed household. Whilst communication technology has overtaken us and almost everyone now has a mobile phone, there is still a place for radio, - and there are still some areas where mobile phones do not work. For short distances 2 metre or 70 cm simple

is ideal, -"I'm at the station, come and get me" or "I'm coming up the hill, where do I park?" are some of the frequently used phrases in our family. I have resisted pressure to get myself a mobile phone on the basis that I have a radio in the car and so have access to help in times of need. It has saved me considerable inconvenience on several occasions. It is also useful (and fun) when travelling with two or more cars in convoy. On the basis of our family experience, I would advocate the new licensees have access to either 2 metres or 70 cm as well as some HF.

How do you feel about this idea? Let your Divisional Council know your views on the proposal, on the level of examination required, the mentoring required and the privileges to be offered.

The ACA has said that a number of the regulations and conditions may need to be changed after WRC 2003, and they prefer to have one major revision rather than do a patchwork of changes. So we should have this proposal ready for submission fairly soon. Think about it.

ar

Book review

by Peter Parker VK3YE

The Dick Smith Way by Ike Bain

Written by a radio amateur (VK2AIG) and former general manager of Dick Smith Electronics, *The Dick Smith Way* is a mix of corporate history, anecdotes and ideas for business success.

The chapters covering the growth of Dick Smith Electronics, from its beginnings as a car radio shop, will be of most interest to *Amateur Radio* readers. Most entertaining is the account of a horror week of radio installations, which probably convinced him that electronics retailing was less risky than installations, particularly with inexperienced employees. The car radio shop was sold, the electronics store was upgraded and the company grew. As they say, the rest is history!

Other chapters discuss the establishment of Australian Geographic, the man himself and why he has been successful. Part Two provides observations on business management, including sales and marketing, publicity, honesty, managing people, negotiating, communicating and more, as learned by the author from Dick Smith. It is not all serious, though, with many amusing photos, cartoons and early

advertisements (mainly from magazines and catalogues) spread throughout the book.

The Dick Smith Way is highly recommended to anyone who is curious about what makes the man tick, wishes to pick up some business hints from an Australian success or just wants a good read. It is published by McGraw-Hill Australia and costs \$24.95.

ar

How's DX?

Ross Christie, VK3WAC

19 Browns Road, Montrose 3765, Vic.

Email vk3wac@aol.com

Where did the Resolutions go?

Wall, another year almost gone and as the famous Beatles song asks 'What have we done?' For once I can say that I stuck to most (though not all) of my 2002 New Years resolutions.

I did manage to do some serious homebrewing and did manage to rebuild my TL922 linear amplifier, but I have not yet put it into proper service. The 240V mains supply into the shack needs to be beefed up and upgraded before it can be operated safely (without causing 'key clicks' in the shack lighting, hi!). My promise to the XYL to go through my extensive junk box (well at least one of them) and throw some of it out has finally come to pass this last couple of weeks. Mind you, not much ended up being consigned to the garbage truck, its amazing what you forget you have secreted away. I did spend a considerable time on a homebrew project. My TL922 will need an ATU to match it to my various antennas. My junk box did not contain any suitable

high-voltage variable capacitors so I had to manufacture them using 1mm thick aluminium sheet for the rotors and stators, 6mm thick Perspex for the ends and inch brass rod for the control shaft. After much cutting, filing and tapping the finished capacitors look quite good and are very smooth in operation, providing a 25 – 360pf swing with a DC breakdown voltage of 3.5kV. The inductor is wound on a perplex tube 10 inches long (250mm) and 3 inches (75mm) in diameter using 4mm diameter enameled copper wire and nicely tapped with a large HV ceramic switch. But! Fulfilling all these New Year resolutions has limited the amount of actual time spent in the shack operating, and this brings me to my 2003 New Year resolution. Yes, this year I will

spend more time in the shack actually operating my rig, TL922 and ATU and working even more interesting and exotic DX!

So, I'll take this opportunity to encourage you to make an effort to get on the air and do some operating in the New Year. Whether it is chatting on the local repeater, beaconing on APRS from around state or country, participating in a contest/s, working DX on SSB, Dxpeditioning, sending pictures around the globe on SSTV, typing on a keyboard to a distant computer using PSK31 or simply bashing the key in a quick exchange of details around the world. No matter what your interest is in amateur radio, enjoy it and make use of it. May you, and your family, have a very Merry Christmas and a safe and Happy

The DX

6W, SENEGAL. Jean-Marc, F8IXZ is heading to the Djoudj National Park in Northern Senegal, near the border with Mauritania. He will be staying there from the 14th until the 22nd of December. Jean-Marc says he will be using the callsign 6W/F8IXZ if the authorities refuse his application for a normal 6W call. He is planning to be active on 40 – 10 metres including the WARC bands using mainly CW. His equipment comprises an FT847 and a C5RV antenna. If possible he may also be QRV as 6W1/F8IXZ from Dakar at the beginning and end of his visit. QSL via home call. [TNX F8IXZ and 425 DX News]

7Q, MALAWI. Joe, G3MRC is currently active as 7Q7BP and will be on air for the next six months or so. He has been heard, and spotted on DX clusters, recently on 20 and 10 metres using CW. He is most active on 14021 kHz after 0400Z and on 28025 kHz after 1830Z. QSL is via C3MRC, Brian J. Poole, 18 Grosvenor Avenue, Kidderminster, Worcs, DY10 1SS, England. [TNX G3MRC and OPDX]

8Q7, MALDIVES. Juergen, DL8LE is travelling to The Maldives (AS-013) for

a well-earned holiday. He is planning to be active from the 17th of Nov until the 3rd of Dec on all bands 80 – 10 metres mainly CW but will try and get some SSB, RTTY and PSK31 activity going as well. QSL via home call either direct or via the bureau. [TNX DL8LE and 425 DX News]

8R, GUYANA. Lenny, K5OVC says that there is a new YL operator in Guyana. Her name is Bevon and her callsign is 8R1YL and she has lost no time in hitting the airwaves. Recently she has been on air operating under the tutelage of Desmond, 8R1AK on 24960 kHz at around 1915Z. There have been other YL operators QRV from Guyana in the past, Gaynell, 8R1/KD4GMV (April '97) and Iris, W6QL/8R1 (Dec '81) but Bevon is the very first YL national to be licensed. No QSL route was given but perhaps one will be established soon. [TNX K5OVC and The Daily DX]

9K, KUWAIT. Bob, 9K2ZZ, was active recently on 10m and 20m this past week. He favours 28004 kHz around 1300Z, 14003 kHz around 2145Z and 14200 kHz at around 0315Z. He took part in the recent CQWW DX SSB Contest as a

Single Op/Single Band (10m) entry and clocked up a score of 3802 QSOs with 154 countries. QSL is via W8CNL, Ray McClure, 5 McKenzie Circle, North Augusta, S.C. 29841-4319. [TNX 9K2ZZ and OPDX]

9L, SIERRA LEONE. Andy Chadwick, G3AB (ex G4ZVJ) will be in Freetown, Sierra Leone from the 7th of Nov for at least a month. He is planning to be QRV as 9L1AB on all bands 160-6 metres using mainly CW. QSL is via G3AB, Andy Chadwick, 5 Thorpe Chase, Ripon, North Yorkshire HG4 1UA, England. Updates on his schedule will be posted on <http://www.g3ab.net/9l1ab.htm> [TNX G3AB and 425 DX News]

EL, LIBERIA. Antoine, F6FNU says that Mario (ex EY8TM) has moved to Monrovia, Liberia and will be based there for approximately 3 years. Mario has been issued with a licence and the callsign EL2TM, however he is still waiting on the arrival of his equipment. QSL is via F6FNU. [TNX F6FNU and 425 DX News]

FR, REUNION ISLAND. Fred, F5IRO has been transferred to Reunion Island

(AF-016) and will be there until at least Jan 2003. He has been issued the call FR5KH/J, and expects to be able to get in a visit to Juan de Nova (AF-012) from time to time. QSL via F6FNU. [TNX F5IRO, La Gazette du DX and 425 DX News]

FT, AMSTERDAM ISLAND. Caroline, F4DOT is now active as FT1ZK from Amsterdam Island. She only has permission to operate on 6 metres but is on air everyday on 50110 kHz. She will try and organise for a beacon to be set up on 50086 kHz. QSL via F5JCB. [TNX OZ6OM and 425 DX News]

GM, SCOTLAND. Richard, G0GN is moving to Barra Island in the Outer Hebrides (EU-010) for around a year or so. He is very keen on QRP operation and will be haunting all the usual QRP frequencies. Richard has been issued with the call MM3BRR and will be using this on air for the duration of his stay. [TNX GM3VLB and 425 DX News]

P40, ARUBA. Ken, K6TA, will be operating from here as P40TA in the ARRL 160m Contest (Dec 6th - 8th). Kay, K6KO will be joining him for a combined effort in the ARRL 10m Contest (Dec 14th / 15th) signing as P40K. Ken will be on the island from the 3rd until the 17th of Dec. QSL route for both operations is via WM6A. [TNX K6TA and OPDX]

S2, BANGLADESH. JF1EQA, Koichiro Takeda is currently working in Dhaka, Bangladesh and has recently been issued with the call S21YY. He has been heard on air recently on 15m using CW and RTTY. QSL via JF1EQA. [TNX JF1EQA and The Daily DX]

S2, BANGLADESH. KX7YT, John will be active as S21YV on 10, 15 and 20 metres using SSB and PSK31 from Dhaka, Bangladesh from the 8th of Nov until the 4th of Dec. His equipment will consist of an IC-706 and an AT-180 tuner to vertical and wire yagi antennas. John says he will be returning to Dhaka in February 2003 and again in October. QSL to his home call KX7YT, via the buro or direct. [TNX KX7YT and The Daily DX]

ST, SUDAN. William (ZS5WC, ST0F) is currently in Sudan and will be there until at least Christmas. He has a web site is at <http://www.qsl.net/st0f/> where you can check his details etc. QSL via ZS4TX. [TNX The Daily DX]

TJ, CAMEROON. Rumour has it that Christian (ex-TT8DX) will be travelling

to Cameroon in mid November and will be there until the end of the year. No other details re callsigns, bands or modes were mentioned, but keep an ear open on the bands and check propagation to this part of the world and you may get lucky. QSL via F5OGL. [TNX OPDX]

TN, CONGO. Paul, ON7UR arrived in late October and will be here for an unknown length of time. He has applied for a licence and call but none has been issued as yet. QSL via ON4ACA. [TNX OPDX]

TT, CHAD. Pascal, F5PTM, is currently in the city of Djamena and operating as TT8ZZ, possibly until December. Activity will be on all bands 80 - 10 metres using SSB and CW. He has recently been pretty active on 15, 12 and 10 metres using CW, usually between 1200-1700Z. Watch around 21016, 24910 and 28024 kHz. QSL is via F5PTM. [TNX F5PTM and OPDX]

V3, BELIZE. Joe Pontek, K8JP is returning to Belize and expects to arrive back around mid to late November and will stay until April 2003. He has been issued the call V31JP and will be QRV on 160 - 6 metres using mainly CW, with some SSB and possibly some RTTY too. QSL direct to KA9WON. [TNX K8JP and 425 DX News]

V73, MARSHALL ISLANDS. Bruce, AC4G is planning a trip back to the Marshall Islands. Listen for him signing as V73CW beginning in early Dec. QSL via AC4G. [TNX AC4G and The Daily DX]

VP5, TURKS and CAICOS ISLANDS. VP5/W6XK and VP5/N6EE will be on from the VP5B contest station in the Turks & Caicos over the period of the 1st until the 7th of January 2003, including the ARRL RTTY Roundup, using the callsign VP5NN. For short periods before and after the RTTY contest the pair will be operating RTTY on all bands, and CW and SSB on the WARC and low bands. QSL via their home calls and QSL VP5NN via NN6NN. [TNX NN6NN and The Daily DX]

XT2, BURKINA FASO. Dani, EA4ATI is currently in Houde where he expects to spend the next six months. He has been issued with a licence and the call XT2ATI and has been active on 20 and 10 metres. Keep an ear tuned to 14208 and 28495 after 2130Z or 1400Z. Dani has been using simple dipole antennas but has plans in hand to install a triband minibeam. QSL via EA4YK only. [TNX

EA4YK and 425 DX News]

YJ, VANUATU. Masahiro, JH3IUU will be in Vanuatu until March or May 2003. He is operating as YJ8MN using CW on the 20, 15 and 10 metre bands. QSL to Mashiro Nada, PMB005, Port Vila, Republic of Vanuatu. Or to Mashiro Nada, 3-15-39 Nishishizu Sakura, Chiba, Japan 285-0845. [TNX JH3IUU and The Daily DX]

IOTA Activity

Hiro, JA6WFM/HR3, is planning to be active from Cayo Cochino (NA-160). He expects to be in Honduras until at least December. No details of bands, modes or times were mentioned. QSL is via JA6VU. [TNX JA6WFM and The daily DX]

Steve, G0UIH, who is the manager of the RSGB's IOTA website (rsgbiota.org) will be back in Australia operating as VK2LAY/p from the 22nd of Nov until the 15th of Dec. He plans to operate from the following IOTA locations; OC-142 (Lady Elliot Island) from the 2nd until the 5th of Dec, OC-172 (Fitzroy Island) from the 6th until the 9th of Dec, OC-137 (North Stradbroke Island) from the 11th until the 12th of Dec. Steve also hopes to have the chance to put in some time from OC-171 for a couple of days but all depends on the final plans. He will be running 100 watts and dipoles for 20, 17 and 15 metres. Listen for him on or around 14260, 18145 and 21260 kHz SSB only. QSL is via G0UIH, either direct or through the RSGB bureau. Any queries to rsgbiota@aol.com [TNX G0UIH and 425 DX News]

A group of Argentinian operators from the Bahia Blanca DX Group will be active from Gama Island (SA-022) on the 6th until the 9th of December. Listen out for LW3DKC/D, LW4DRH/D, LW4DRV/D, LW8DMK/D, LW9EAG/D, LU4ETN/D, LU6EPR/D, LU6DRD/D, LU7DSY/D, LU8DWR/D, LU8EBK/D, LU8ECF/D, LU8EBJ/D, LU8EXN/D and LU9ESD/D on all bands. QSL via LY7DSY, Carlos Almiron, P.O.Box 709, 8000 Bahia Blanca, Argentina. [TNX LU8DWR and 425 DX News]

PY0, BRAZIL. Tony, PY8IT will be active as PY0FT from Fernando de Noronha (SA-003) on 8th until the 10th of December. He is planning to concentrate on the RTTY, PSK31 and SSTV modes. QSL via JA1ELY. [TNX NG3K and 425 DX News]

Special Events

ZS, SOUTH AFRICA. A total eclipse of the sun will take place on the 4th of December. It will be visible, from the Northern and North Eastern regions of Limpopo Province, South Africa. The eclipse will begin at approximately 0500z and will end two and a half hours later, depending on the viewing location. To mark the event a group of operators from ZS5 and ZS6 will air the special event call ZS6SOL from the 30th of November until the 7th of December. We are all invited to share the experience with them on 40, 20 and 15 metres (try around 7075, 14200 and 21155 kHz) depending on band conditions. QSL is via ZS5WI either direct to P.O. Box 1064, Eshowe 3815, South Africa (enclosing a stamped, self addressed envelope with your card) or via the bureau. [TNX OPDX Bulletin]

8N, OGASAWARA. The special event station 8N1OGA continues to be very active on the bands, commemorating the 75th anniversary of the Japan Amateur Radio League (JARL). The station will be on air until the end of January 2003. Recent activity has taken place on 160, 80, 30 and 12 metres. All QSL cards will be dispatched via the bureau unless you QSL direct to JA1MRM. A log search feature and more details about the station, and JARL in general, can be found on the web site at <http://www.fivenine.com/8n1oga/eng/>

Round up

LX, LUXEMBOURG. This one will really count. Please 'MAKE A QSO!' An international group of amateurs will be operating as LX0LT from the 30th of Nov until the 8th of Dec. The special station LX0LT will be on the air to help in collecting donations for scientific research against genetic illnesses. The team has confirmed sponsors who will donate 4 US cents per QSO. Their goal is to reach 20,000 QSO's in one week. The station will be active 24 hours a day all that week using SSB, CW, RTTY and PSK. Robert, LX1RQ says "The hams around the world have only one thing to do..... contact LX0LT on all bands (WARC included). We hope that we will be able to reach our goal of 20.000 QSOs." QSL is to LX1RQ direct or via the LX Bureau. The group also has a web site at <http://www.qsl.net/lx0lt> [TNX LX1RQ and OPDX]

8F, MEXICO. The special event station

6F1LM will continue to be active on weekends only through until the end of the year. The station commemorates the 70th Anniversary of Federacion Mexicana de Radio Experimentadores (FMRE). Activity is on CW and the Digital Modes (RTTY, PSK31, MFSK). 6F1LM will be operated on various bands and modes by a number of different Mexican hams and radio clubs during the rest of the year. Have a listen particularly around 7003, 10107, 14085, 14012, 18071 and 21015 kHz. A special QSL card with this very rare prefix will be sent to each and every contact made in January 2003. If you want to send them your QSL card please do so VIA THE BUREAU ONLY. You don't need to send them your card to receive their QSL card, however they will appreciate it very much if you do send them one. BUT PLEASE QSL ONLY VIA BUREAU. Please DO NOT send SASE, IRCs or Green Stamps, simply send it via the bureau and save yourself some money.

ANTARCTIC QSLs: A nice Antarctic QSL Gallery can be found on the web site of the French bulletin "Les Nouvelles DX" at <http://lesnouvellesdx.free.fr/> [TNX F5NOD]

4S7BRG, Mario is now moving permanently to Sri Lanka. His HB9BRM QSL route will no longer be valid. All QSLs should now go to via the 4S bureau or to his qrz.com address. [TNX 4S7BRG and The Daily DX]

ZS6DX, Rudi will be using the special callsign ZS02AM to mark the "Africa Militair" airshow and arms exhibit at Waterkloof Airbase in Pretoria, South Africa. The call is valid for 12 months so Rudi says he will try to use it again later in the year. A special QSL has been printed for the occasion. QSL via ZS6DX direct or via the bureau. [TNX ZS6DX and The Daily DX]

A news item from the ARRL reports "Top ARRL officials say they are still optimistic about a new ham band around 5 MHz. ARRL general counsel W3KD, Chris Imlay, says ARRL is working with the U.S. government to work out the impasse. Imlay has indicated something less than the originally requested 150 kHz and something less than the requested 1,500 watt power output limit might be what will 'fly,' in the end." The UK and the US have both issued 'special notices of variation' or official permission for limited use of a band of frequencies around 5 MHz. Is anyone (WIA or private individual) lobbying for

access to this new band for VK amateurs?

A disconcerting report from The Daily DX magazine regarding a German team (using the callsign H8A) being requested to cease operations after only a short period of operation has emerged from Central America. Apparently "the group were intending to enter the CQ/RJ WW RTTY contest with the special call but the 'written and signed license' was cancelled a few hours before the contest when some Panamanian ham(s) complained to authorities about it. The group of German operators used the call HP1XVH instead and for the rest of their stay on Contadora Island. All QSL's should be to DL6MYL. Operators DJ7AA, Wil; HP1XVH, Gunter; DL5LYM, Tom and DL4LQM, Dimo plan to have a lot more to say about the callsign problem after the dust settles. This same sort of thing has happened in other Central American countries, resident hams objecting to operations by 'outsiders'. The last I heard, even Mexico had some restriction or outright prohibition on permission for non-Mexicans to operate in contests." If I remember correctly, last year a group of UK amateurs were similarly treated in Mexico. One wonders where the spirit of amateur radio has gone when this sort of thing happens. Surely we should all be trying to expand the number of reciprocal licence agreements between countries instead of limiting them!

A new website called "THE DXER'S RANKERS" has been commissioned by Mako, 7N2UTO. It is a special collection of websites that should prove useful to DXers as well as bulletin board service that will accept image files and "reverse link ranking" (perhaps someone can explain that one to me?) The website can be found at:

<http://isweb31.infoseek.co.jp/sports/rankers/>

Sources

Thanks to the following people and organisations for the information in DX Notes. 7N2UTO, DL4LQM, ZS6DX, 4S7BRG, F5NOD, 6F1LM, LX1RQ, JA1MRM, ZS5WI, PY8IT, LU8DWR, G0UIH, JA6WFM, EA4YK, NN6NN, AC4G, K8JP, F5PTM, F5OGL, ZS5WC, KX7YT, JF1EQA, K6TA, OZ6OM, F5IRO, F6FNU, G3AB, 9K2ZZ, K5OVC, DL8LE, G3MRC, F8IXZ, La Gazette du DX, 425 DX News, OPDX (BARF80), The Daily DX, RSGB and The ARRL.

ar

International Amateur Radio Union. Region 3

Monitoring Systems News

This month also, we have innumerable reports on Indonesians, the data stations and the regular Havana gurgle from Cuba, CODAR sea state Radar, the several multi channel data stations, the usual fundamental and the several harmonics/spurious products from Radio Pyongyang are continuing unabated. Unless, all possible pressure is brought on the known intruders, the condition continues to remain bad and may tend to worsen if we fail to complain and follow-up with reminders.

This month's news carries the three monthly reports from JARL, which were long pending and the readers can assimilate the statistics from the JA area.

In the Newsletter of IARU Region 2, of October 2002, the Regional Monitoring systems Coordinator OM Martin Potter, VE3OAT, has brought out in the most clear and lucid style, the need for a Monitoring system in every National Society. I want to share it with all of you, as it is very *urgently required* in many of the National Societies of Region 3.

An active monitoring system - why?

Some National Amateur Radio societies have a corps of volunteer monitors who regularly monitor the Amateur bands, looking for intruders and other sources of interference. Some national societies have monitoring systems which are dormant, and which become active only when a serious problem is reported by other Amateurs or organizations. Some national societies have no monitoring system at all. Here are two advantages of an active monitoring system:

1. The monitors of an active monitoring system are experienced and are able to quickly determine the necessary technical information about new intruders, often comparing results by e-mail, and sometimes identifying the source of interference within a few hours of the first report.

2. Active monitors can develop expertise that will assist your national telecommunications administration in identifying sources of interference, thus becoming a credit to your national society

How does an active monitoring system do this?

Here are some of the ways:

1. The monitors of an active monitoring system regularly tune across the Amateur bands, looking for non-Amateur stations and becoming familiar with the different intruders found there, both digital and analog.
2. Active monitors become familiar with the problems of direction finding (DF) and can properly assess amateur direction finding results, noting the limitations due to propagation and equipment and extracting the best interpretation from ambiguous data.
3. Active monitors learn to measure radio frequencies accurately and precisely, often providing important information to assist in signal identification.

Does your national society have an active monitoring system?

News from other Regions:

Region 1:

Ron Roden, G4GKO, IARU Region 1 Monitoring System Coordinator comments in his October report as follows:

"Merlin Communications are an organization that have contract responsibility for the operation and maintenance of the BBC's World Service transmitters and it would be remiss of

me if I did not record our thanks for their ready cooperation and assistance when a problem of harmful interference to the Amateur Service is brought to their attention.

"On two occasions in the past year a particular combination of transmitter/antenna at their transmitter site in Rampisham [southwestern England] was causing harmful interference across the 20 metre band and on both occasions immediately after being advised, a speedy change of transmitter was effected to clear the problem.

"Quite recently the Region 2 IARUMS Coordinator advised me that a transmitter located on Ascension Island and used by the BBC relay station beaming to Africa had harmonics appearing in the 20 metre exclusive amateur band in Region 2 [on 14320 kHz]. Once again Merlin were most helpful and I have been advised that the problem is presently under investigation and may be also the result of a particular combination of transmitter/antenna. Merlin expects the problem to be cleared very shortly."

Region 2:

The following intruders were notable in Region 2 during September:

7000 kHz J3E,U YL repeating in French "Test de Matis" with days of week and months of year.

14057.25 NON (A3E) Carrier with 100 hertz (and harmonics) hum modulation.

14250 A3E Radio Pyongyang, DPR Korea, harmonic of 2850 kHz.

14320 A3E B r i t i s h Broadcasting Corp. (BBC) World Service, harmonic from 7160 kHz.

10, 12 m A3E, J3E Many "CB type" pirate radio operators.

Compiled by:
B.L.Manohar "Arasu"
Regional Monitoring Systems Coordinator

Adelaide-Accra 242 **Brisbane-Auckland 123**

First F 0-5 Short 14682 km

First F7-12 1E0 Short 2291 km

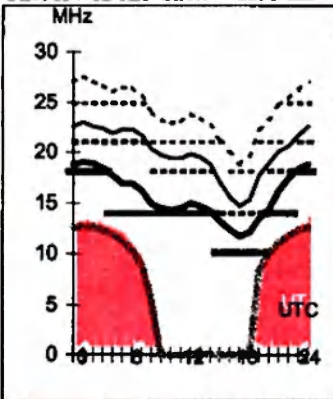
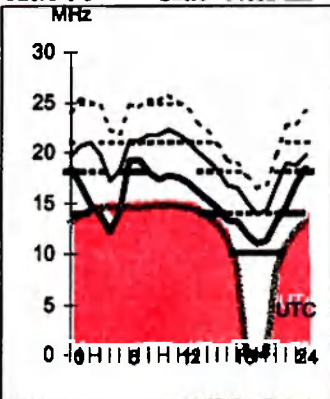

December 2002

T Index: 89
Jan 2003: 87

Legend
UD
E-MUF
OWE
F-MUF
ALE
>10%
30%
>80%
Time scale

HF Predictions

by **Even Jarman VK3ANI**
34 Alandale Court Blackburn Vic 3130

These graphs show the predicted diurnal variation of key frequencies for the nominated circuits. These frequencies as identified in the legend are:-

- Upper Decile (F-layer)
- F-layer Maximum Usable Frequency
- E-layer Maximum Usable Frequency
- Optimum Working Frequency (F-layer)
- Absorption Limiting Frequency (D region)

Shown hourly are the highest frequency amateur bands in ranges between these key frequencies, when usable. The path, propagation mode and Australian terminal bearing are also given for each circuit. These predictions were made with the Ionospheric Prediction Service program: ASAPS Version 4

Adelaide-Moscow 318 **Brisbane-London 147**

First F 0-5 Short 13807 km

First F 0-5 Long 23498 km

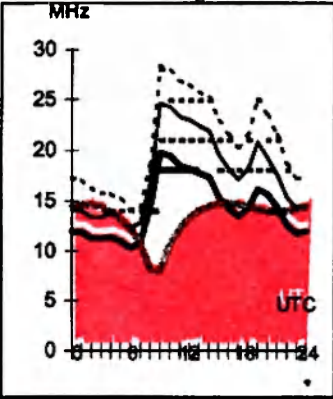
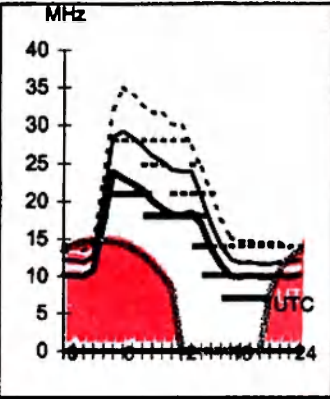

Canberra-Capetown 219 **Darwin-Invercargill 144**

Second 4F4-12 4I Short 10779 km

First 2F5-10 2R0 Short 5159 km

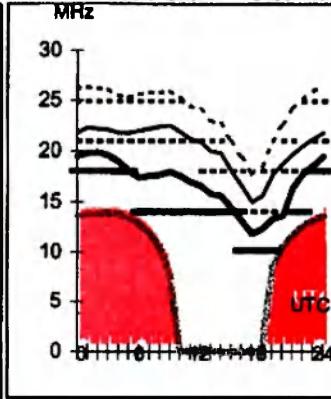
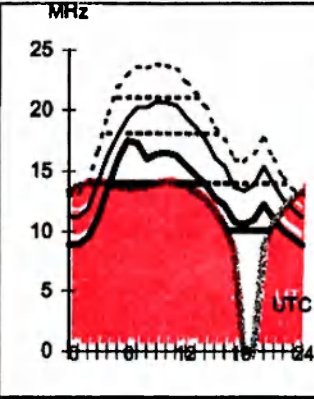

Adelaide-Ottawa 58 **Brisbane-London 327**

First F 0-5 Short 16901 km

First F 0-5 Short 16526 km

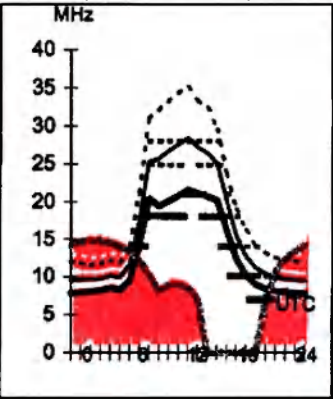
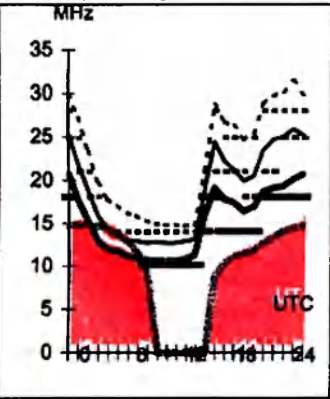

Canberra-Los Angeles 62 **Darwin-Paris 322**

First F 0-5 Short 12309 km

First F 0-5 Short 13816 km

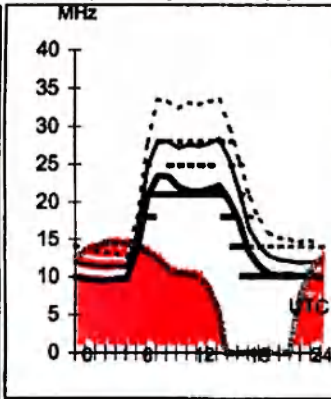
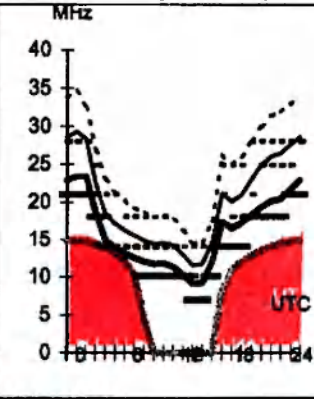

Adelaide-Vancouver 49 **Brisbane-Manila 320**

First F 0-5 Short 13421 km

First 2F3-9 2E0 Short 5811 km

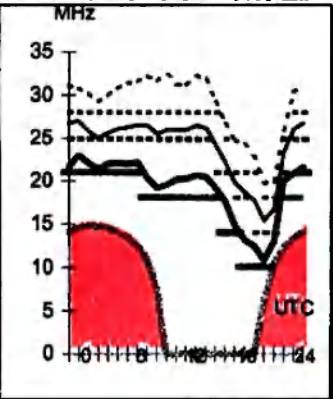
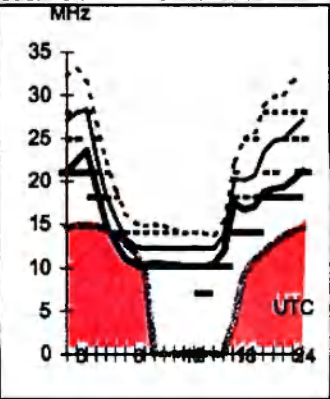

Canberra-Wellington 115 **Darwin-Tokyo 10**

First F7-12 1E0 Short 2324 km

Second 3F11-19 Short 5436 km

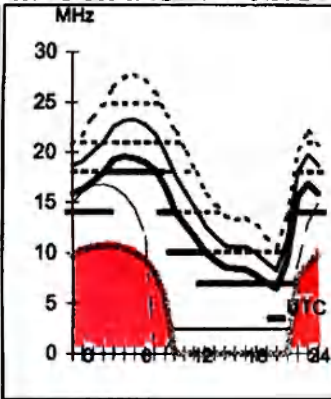
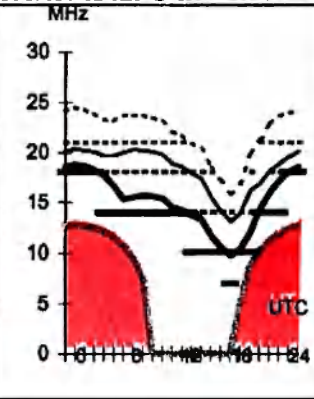

Hobart-London 123 **Melbourne-Lusaka 241** **Perth-Johannesburg 248** **Sydney-Auckland 106**

First F 0-5 Long 22620 km Second 4F4-10 4f Short 11153 km First 3F4-10 3E0 Short 8315 km First 1F8-14 1E0 Short 2159 km

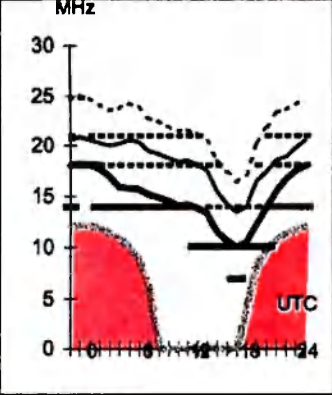
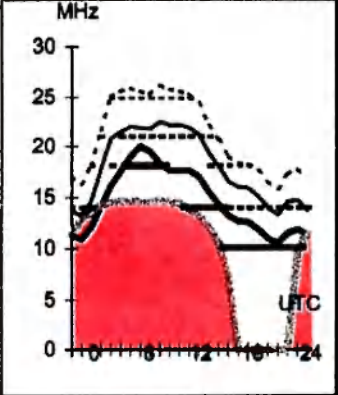
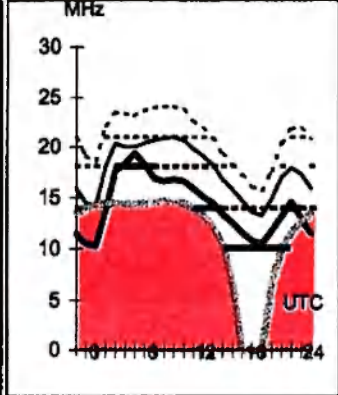
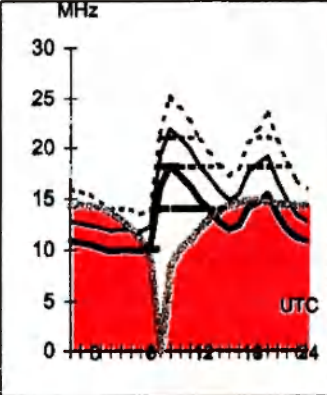

Hobart-London 303 **Melbourne-Miami 94** **Perth-Rio de Janeiro 203** **Sydney-Barbados 199**

First F 0-5 Short 17404 km First F 0-5 Short 15584 km First F 0-5 Short 13523 km First F 0-5 Short 16155 km

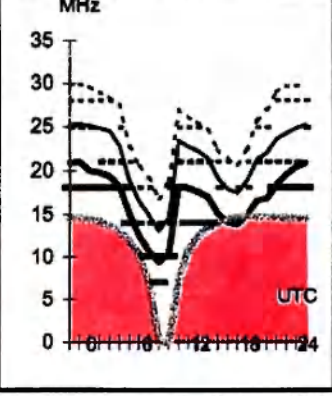
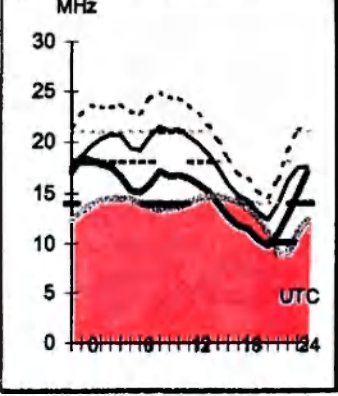
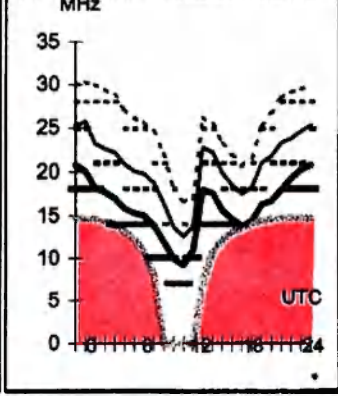
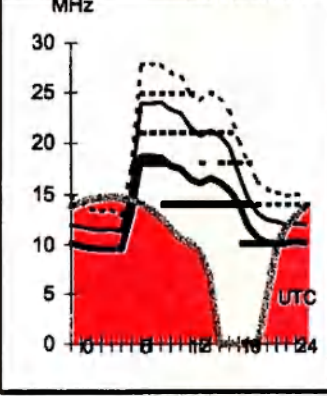

Hobart-Montevideo 161 **Melbourne-Nairobi 258** **Perth-Rome 123** **Sydney-New Delhi 302**

Second 4F7-9 4E(Short 11044 km Second 4F3-9 4E(Short 11501 km First F 0-5 Long 26684 km Second 4F5-11 4f Short 10416 km

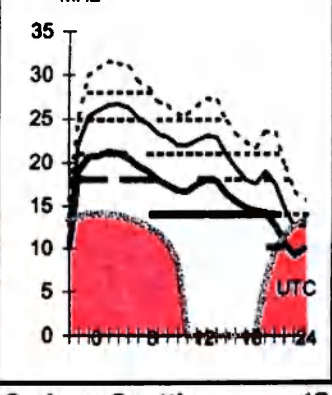
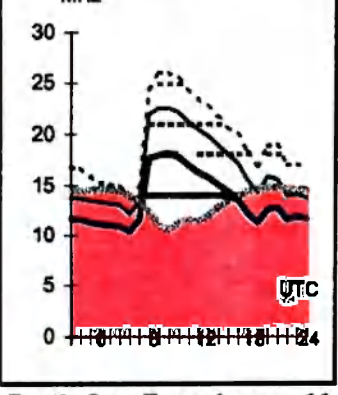
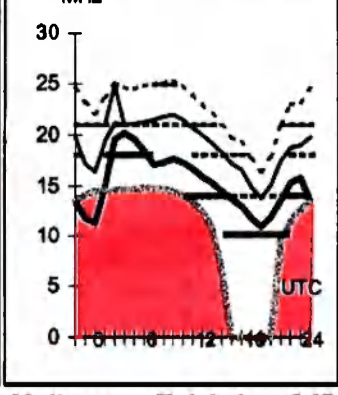
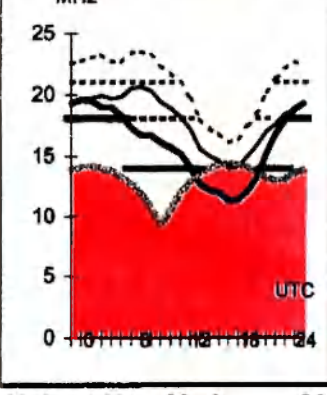

Hobart-New York 80 **Melbourne-Tel Aviv 267** **Perth-San Francisco -66** **Sydney-Seattle 47**

First F 0-5 Short 16609 km First F 0-5 Short 13766 km First F 0-5 Short 14743 km First F 0-5 Short 12470 km

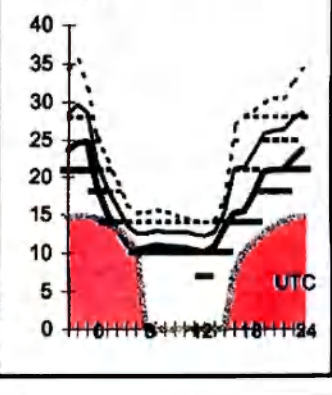
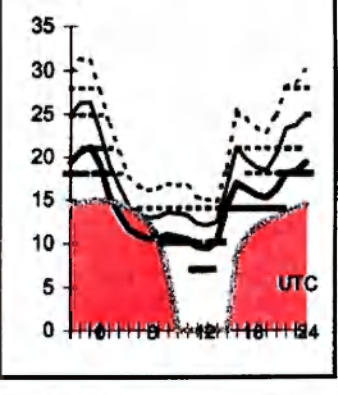
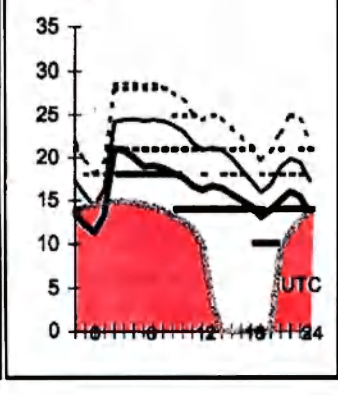
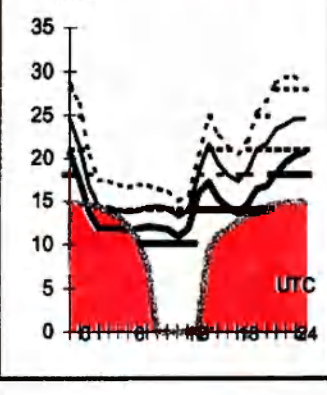

VHF - UHF.. AN EXPANDING WORLD

David K Minchin VK5KK

Postal: 10 Harvey Cres, Salisbury Heights, SA, 5109

E-mail: tecknolt@ozemail.com.au

Web page: <http://members.ozemail.com.au/~tecknolt>

Phone: 0403 368 066 AH only

All times are in UTC.

The Future of 420 - 450 MHz

Andrew Davis VK1DA reports ... in the 1974 WIA Federal Convention the VK3 Division reported that discussions with the authorities of the day had indicated that there would be a difficulty with retaining amateur access to the 420/450 band in the long term.

The VK3 delegates strongly recommended that the WIA commence considering negotiating for a small segment of the band as an amateur exclusive allocation, in exchange for either continued secondary status or even lower status in the rest of the band, or even in exchange for giving up claims to much of the band.

There seems to still be a naive notion among some, that the bands in the post war Regulation handbook will stay that way forever.

It is up to those interested in this band to state their concerns and be realistic about their demands. The others who don't care won't even notice it getting

wiped off the list.

So what is the basic minimum band requirement? In terms of preferred sole use, shared use and occasional use.

I suggest the following ideas merit discussion. (Note: I'm not saying the following is the final word, I'm inviting and encouraging considered thought).

1. We should decide on a band segment that meets most needs, allowing amateurs to retain international compatibility for moon bounce and satellite segment compatibility. I suggest 430 to 440 would be a pretty good segment to go for as a starting point.
2. If the "Low power interference devices" and baby hand held radios are going to remain at 433, which seems inevitable, the repeater inputs have to move.
3. Forget TV in this band.
4. There are many more repeater users than DX operators and perhaps this

is when we start valuing each other's usage and numbers.

5. The WIA is the logical body to coordinate a campaign and a submission to the ACA. Whatever our individual misgivings about the past, united we stand, divided we lose our privileges.

This paper has just been placed on the ACA website regarding 420-430 MHz: <http://www.aca.gov.au/licence/accredit/420-430bands.htm> Note the comment though re need for more than the 10 MHz for emergency services.

It has been highlighted in this column previously (for the last 28 years!) that we need to seriously plan our fall back position on the 420 - 450 MHz (lets call it the 432 MHz band). Andrew's comments are a sound position to start from. Whatever is planned should treat all users of this band in a fair manner.

50 MHz

Bruce VK2EM reports ... we had a reasonable opening into Hawaii yesterday (Friday 22-11-02) on 6 metres. I worked NH6YK for 53 x2, KH6SX for 52 x2 both in BK29. I also heard NH7RO at 57 but he couldn't verify my signal due to bad QRN at his end. I also heard Brian VK2UBF in Bulli and Wayne VK2TQP near Coff's Harbour working a few so the opening covered quite a bit of the NSW coast ... Bruce VK2EM

Bevan VK4CXQ reports ... Activity

report from Townsville mid Oct to mid November on 6 metres. From 15 Oct to 26th most activity was from Japan with the occasional signal from China. On 27th EU opened a little with 9A, LZ, YU, and IT as well as a few stations from Ukraine. It was a bit quiet until 2 Nov when ZK1, HW1 and 9N7 were worked. 7 Nov worked HV0A, and Bulgaria, Italy and Croatia. 8 Nov QSO with K8T, YA4, some more EU stations, A45 and EX8. 13 Nov EU opened a bit more with

Ukraine, lots of DLs and SPs and some OKs, S5, ON, Italy and France. 51 QSO's in about 2 hours. Not as many QSO's as this time last year.

Have finally made the DX100 club on 6 (100 countries worked), now the hard work begins trying to get the QSL cards. Hope it doesn't take as long as the QSO's (2 years & 9 months) ... Bevan VK4CXQ

Congratulations Bevan on the 100 Countries on 50 MHz!!

144 MHz and above

Peter VK3YE has been touring VK6, he reports ... Equipment: FT-817 transceiver. Antenna: 2-el yagi for 2m (made from rabbits ears indoor TV antenna - pulls apart to form a dipole for train mobile work and as will be mentioned later is surprisingly good on 70cm). A rush job built on the day before

departure. On 6m the antenna was a random wire tuned up on the 160m - 6m L-match (as previously described in AR magazine). Battery: 8xC NiCad (thus power out would be approx 3-4w and not the rig's full rated 5w). Here are a few highlights:

12/10/2002 Portable from Kellerberrin Hill (200km east of Perth, other side of Darling Scarp). 2m: Worked VK8HK, VK6ZWZ, VK6KZ and VK6TQ all in Perth. VK6KAT Donnybrook to the south heard bits of me (he was 43). Power 3-4w to a hand-held 2-el yagi (a small mast would have made a huge improvement).

Could hear VK6RPH beacon on 2m.

70cm: Didn't think we'd do any good here, as I had no antenna for 70cm. I removed the reflector, holding on to the dipole bit. It didn't retract small enough for 70cm so kept it as a 144MHz dipole (3/2 on 70cm). Put the dipole on the end of the squid pole giving a bit of extra height (about 3m above the ground - the constraint being the feedline length). Signals were weaker but worked VK6KZ & ZWZ on SSB and 6HK on CW.

A very successful experiment given the distance and the extremely poor

antenna at this end. That was the only SSB/CW operating but did some more beacon listening later ... Peter VK3YE/6

Neil VK2EI reports on a recent tropo opening to New Zealand ... had a listen fairly late last evening (8/11/2002) and could hear some ZL beacons. Called CQ ZL but guess all good Kiwis were probably in bed!

8/1100Z ZL1VHW Hamilton 144.256 51, ZL1VHF Auckland 144.240 31, ZL2VHT New Plymouth 145.220 Nil (Later confirmed not operational), 1135Z

ZL1VHW Hamilton 144.256 52, 1322Z ZL1VHW Hamilton 144.256 31, 1845Z ZL1VHW Hamilton 144.256 31

Worked: 2015Z ZL2WSP New Plymouth Stuart 52 53, 2113Z ZL2TAL New Plymouth Ray 41 41, 2335Z ZL1TPH/P Brynderwyn Steve 51 53/5, and 2335Z ZL1TPH/P Brynderwyn Steve 54 55

Steve asked me to advise he will be at the Brynderwyn site for the next 4 hours or so and also has 70cm and 23cm systems operational. He has also alerted other ZL's ... Neil VK2EI QF68km

Microwave News: 5.7 GHz ATV News

Barry, VK5BQ reports on microwave ATV activity ... You may be interested to know that I have been able to get a signal from Stansbury, across St Vincent's Gulf to Maitland, VK5AO, in Adelaide on 5.8 GHz.

The mind boggling thing is that Maitland has received my ATV signal on just a 5.8 GHz chaparral feed tied on to a pole 30 feet up his tower. There is no dish at this time. The received signal strength varies from nothing to P5. The

main problem is that his converter and Sat. RX are also up the tower, the sun is belting the daylights out of the converters oscillator and causing frequency drift, or that's what we think.

Not bad for a distance of over 86 km being received on just a waveguide feed. For the sake of this historical event and I think it would be a first, the recorded time was 11.10 AM Tues, Nov 5, 2002 witnessed by the following personalities. VK5JD, VK5RO, VK5KGS

and VK5ZDG. I tried with Don but his setup wasn't successful. The witnesses observed the event via relays on 2.4 GHz and 1250 MHz.

The final amplifier seems to be going ok with the power supplies and protection circuits, with about 4 watts output. I can now operate on three ATV bands simultaneously with separately controlled antennae (1250, 2400, and 5800) and also receive only on 10 GHz. ... Barry VK5BQ

Microwave News: 2.4 & 5.7 GHz Unlicensed Data Links

Is this pushing the limit of unlicensed activity on two of our "allocated" amateur bands? The following comes from the USA ... Hans Werner-Braun, a researcher at the San Diego Supercomputer Centre and principal investigator for the San Diego County High Performance Wireless Research and Education Network (HPWREN), plans and develops wireless circuits that routinely span miles, including HPWREN's current distance-record holder, a 72-mile (115km) hop installed last month from San Diego to San Clemente Island.

Although standard 802.11b WLAN gear operating in the unlicensed 2.4-GHz frequency serves as the baseline hardware for the new network, Werner-Braun said that HPWREN, backed by grants from the National Science Foundation, uses far-from-routine hardware configurations to serve rural San Diego County.

The link to San Clemente Island — used to carry data from a seismograph, data logger and Global Positioning System receiver — runs with the

maximum 1-watt power output allowed by the Federal Communications Commission for 2.4-GHz equipment, Werner-Braun said. At both ends of the link, HPWREN technicians installed high-gain, 2-ft (600mm). Parabolic antennas to provide an additional boost to the signal.

Low costs, ease of installation and no hassles with protracted FCC licence proceedings are the hallmarks of HPWREN, which uses equipment operating in both the 2.4- and 5-GHz bands to provide broadband data service to scientific installations, schools and Indian reservations scattered throughout 10,000 square miles of rural San Diego and southern Riverside counties in California.

"There's no other viable choice" for high-speed access for scientific installations such as the Palomar Observatory besides HPWREN, which can easily, quickly and cheaply install wireless connections to backbone nodes on mountains such as Alliance Peak, Toro Peak and Monument Peak, he added.

The backbone nodes operate at a data rate of 45M bit/sec. in the same unlicensed 5-GHz frequency bands used by 802.11a WLAN equipment, with high-gain, 8-ft (2.4m). Antennas pushing the distance from feet to miles, Werner-Braun said.

Greg Ennis, technical director for the Wi-Fi Alliance, said that although wireless point-to-point bridging is "relatively routine," Braun's long shots are unusual. Whereas eight to 10 miles is common, Ennis said, a 72-mile (115km), 2.4-GHz link pushes the technology to its limits. .. from US Computerworld magazine, November 2002.

continued next page

**Support the
advertisers who
support
Amateur
Radio**

Will's Page

Will McGhie VK6UU
21 Waterloo Cr Lesmurdie 6076
will2@iinet.net.au

Inverters Update

Last month's column chronicled the problems with using 12 volt to 240-volt inverters to power 240-volt fluorescent tubes. If more than two fluoros were placed across the inverter output the inverter failed and would not work again. The store where I purchased them was most helpful (Jaycar) and all up replaced 3 failed inverters, before it was agreed that the pure sine wave inverter would not run more than one 240-volt fluoro.

Contact with Jaycar's technical division agreed that there did indeed appear to be a problem and most likely it was the inability of the inverter to handle a capacitive load that the fluoro tubes introduced before they strike.

At this time there is no solution to the problem but it may be a warning will be included with this brand of inverters not to use them on fluorescent tubes that contain power factor correction capacitors. Just how you would know which fluoros do and don't contain capacitors without pulling them apart is impossible to know.

The modified sine wave inverter also had similar problems when powering fluorescent tubes but did not suffer catastrophic failure and would work again when turned off and on again. I have not contacted the store yet (Dick Smith) but will do so when I have time.

Time

While on the issue of time, and one of the reasons while the column is so short this month, is time wasted trying to figure out my internet connection. For the past week or so I have been suffering more than usual dropouts. Ringing the help desk always turns up yet another change to the settings and usually all works fairly well. However this time it was impossible to even connect to my ISP. Ringing the help desk resulted in the phone just ringing out. Luckily I have my original Pentium 100 still in operating order so I tried connecting to my ISP and it too would not go beyond the modem hand shaking. The

conclusion was that the ISP had serious problems and the help desk had either been abandoned or was wilting under the load of calls. Sure enough several hours later all seemed to work, even though I was being kicked off after a short time.

Hopefully I will be able to connect long enough to email this to the editor.



VHF-UHF..An Expanding World continued

PLL locking of Microwave local oscillators

A few years ago I published & kitted a PLL to lock microwave oscillators against a known stable reference oscillator. My design was based on WA6CGR's design in the 1994 Microwave update. Nearly 100 KK048 kits have been circulated around the globe in the last few years but of late some of the IC's have become a bit hard to get. For those looking for a newer design to get better microwave oscillator stability then have a look at Luis' (CT1DMK) posting about the ref_lock: <http://w3ref.cfn.ist.utl.pt/cupido/>. This is the same info published in his 3/2002 Dubus article.

Basically, you need to convert your existing xtal LO into a VCXO by adding

varactors in the same manner as the KK048. The CT1DMK board will let you lock several popular microwave LO freqs to a 10 MHz external reference.

One suitable reference would be the Z3801 GPS receiver for those who like to be within a few parts-per-billion accuracy. For more info on these GPS disciplined oscillators, look here...

http://www.realhamradio.com/GPS_Frequency_Standard.htm they probably won't maintain lock whilst moving, but they have "Smartclock" technology built in, which will probably track out your oven oscillator drift for most of a weekend.

With JT44 and a better stability oscillator, normal extended tropo

propagation, we should be able to get another 10 dB performance over CW using a good pair of ears. JT 44 requires 600 Hz accuracy. Luis' chip includes many popular freqs already burned in, requiring a simple jumper wire installation. ... Bill W3IY

In closing

Christmas 2002 is upon us! Merry Christmas and Happy New Year to you all ... see you in the Summer Field day! I'll leave you with this thought... "No one can be completely relaxed ... like a wind up clock no person can function without some tension"

73s David VK5KK

ar

The RS 20 Power Supply

The following letter was received from the author Jim Tregellas VK5JST. The cautionary note was published with the original article to emphasise that the power supply was not a continuously rated one and if it was used at 20 amp continuously serious problems could arise. The magazine needed to make potential constructors aware of this. Hopefully with the information below readers can provide themselves with a very useful power supply for their SSB rig at a reasonable cost. The use with an SSB rig was specifically stated in the heading. There was no problem with the design of the circuit. In fact it is quite ingenious.

Editor VK5UE

Dear Colwyn,

Thank you for publishing my article on the RS20 power supply, but I have to say that I was both surprised and very annoyed to find the extraordinary caution attached to the end of it. In this caution, the reviewers seem to imply that the design is seriously lacking, and that fundamentally I don't know what I'm doing. Well, I can assure you that I do. The article says quite clearly and I quote "The heatsink size and power supply design have been optimised for SSB operation (regular peaks to 20 amps NOT the continuous drain of 20 amps) which happens in FM and AM operation". Your reviewers seem to have totally missed this point, and if they have, maybe some readers will too. So, to re-state it, **THIS SUPPLY IS INTENDED TO POWER SSB TRANSCEIVERS WHICH DRAW 20 AMPS PEAK CURRENT.** This description applies to many transceivers on the market, most of which put out around 100 watts PEP on SSB and 40-50 watts on AM and have **AVERAGE** current drains in the 8 to 10 amp region during transmit.

If a Cautionary Note was necessary (and it appears it was) then this is what it should have said loudly, instead of rabbiting on about wires with 7.5 amp ratings.

On this latter point, the reviewers got it exactly right. In fact, the supply has been carefully designed in line with standard commercial practice for articles which handle music or speech. If items

such as mass marketed high fidelity amplifiers are carefully examined, the heatsinks and power transformers will be found to be rated at around 25 to 35 per cent of peak output. This practice is totally justified as typical music and speech both have very low average power levels with the occasional high peak (organ music and rap are possible exceptions). And if you look at commercially made 1500 watt SSB RF linears as used by many of the amateur fraternity overseas, you will be very lucky to find one with a mains transformer continuously rated at more than 600 watts. But if you want to make a supply which will supply 20 amps continuously for FM or AM, simply follow the instructions which were clearly given in the paragraph "ADDING MORE MUSCLE". Wind the secondary with wire having a cross sectional area of around 5 square millimetres, use some heavy stud mounted diodes on a good sized heat sink, and beef up the heatsink on which the power transistors are mounted (or simply increase the airflow over the existing sink which is very close to continuous requirements anyway).

Coming now to some of the other points your reviewers raise, one of which is rectifier peak current limiting. First, let me state that rectifier bridges with ratings of more than 35 amp are neither readily available or cheap (check your Jaycar or DSE catalogue) and that when you go to buy your stud mounted diodes for the continuously rated beastie you want to build, you WILL make sucking noises. In the case of a rectifier bridge with a 475 amp single surge rating as used in this design, and a rectifier/filter capacitor system which delivers a dc output of 20 volts, a quick calculation will show that around 40 milliohm of total secondary resistance is necessary to meet this specification. This resistance has to come mainly from the secondary winding because the typical primary resistance of 1.5 ohm when reflected through the 18 to 240 volt turns ratio, only contributes around 8 milliohm. So the secondary resistance has to be around 30 milliohm when the loss resistance of the diodes and electrolytics are taken into account. If you calculate the resistance of 6.5 metres

of 2.5 square mm copper wire as used in this design, it comes out to almost exactly this figure which is very fortuitous as this wire is also easily obtained. Unfortunately many designs published using 35 amp bridges ignore these unhappy facts and use transformers with very much lower resistances. The inevitable results are premature rectifier failures, which can be very interesting if they happen to go short circuit and apply raw AC to the filter capacitors. With regard to the suggestion that surge limiting can be effected by placing a resistance in series with the primary winding, this sounds reasonable until it is realised that the 5.5 ohm which would be necessary in this design would be dissipating around 16 watts under no load conditions due to the primary magnetising current of 1.7 amps which is typical of microwave transformers. A red hot 20 watt resistor sitting out in the open with the 240 volt mains on it doesn't seem all that practical to me and the decision was therefore made to use the secondary for current limiting purposes where magnetising current is not a consideration.

Finally, a couple of practical points which may be of use to readers who are interested in the design of high current 13.8 volt supplies. Rectifier turn on surge currents can be easily measured in the following way. Terminate the secondary of the transformer you intend using in a one milliohm resistor (about 150 mm of 7 X 0.69mm copper wire) and monitor the voltage across it with a scope. Drive the primary winding from another transformer with a secondary output of around 10-20 volts RMS @ 1 amp minimum. The peak currents in the one milliohm resistor can then be easily measured with the scope and are then scaled up by the factor 240/20 to give the current which your rectifier must tolerate. Last, the outer copper sheath of an old piece of RG-8U or RG-213 with its 200 or so fine conductors has a cross sectional area of almost exactly 6 square mm. and when flattened and covered with heavy masking tape makes ideal secondary wire for a continuously rated 20 amp supply or a 35 amp SSB supply.

Jim Tregellas VK5JST

HAMADS

FOR SALE NSW

- **Transceiver, AWA BS15A**, 240V FM base station on 77 MHz with two speaker/phones. s/n 8R62094 \$95. Contact Tony VK2BBJ Phone 02 4360 2234
- **Short Wave Magazines**, Dec 1980, Jan 1981 - Feb 1982 those relating to using 4CX250/4CX350 valves, **Eimac data sheet** for 4CX350A and 4CX350F and **Care and Feeding of Power Grid Tubes by Varlan (1978)**. All free. Will not separate. Geoff VK2KPK, Phone 02 6845 4203 or (preferred) email gperrin@well-com.net.au
- **BOOK: "Radiotelegraph and Radiotelephone Codes, Prowords and Abbreviations" 3rd Edition (236pages)**, 610 gm, 1.5 lbs, now available. Probably the World's best compilation of this info now available. Q,X,Z Codes, 142 Phonetics, 24 Morse, 8 Needle codes, Myer, Phillips, 10, 11, 12, 13 and other codes. Much other info, abbreviations, procedures and methods. AU\$25 + P&P. (in Australia \$7.50) Internet: <http://www.nor.com.au/community/sarc/phonetic.htm> John Alcorn, VK2JWA, QTHR, Phone +61 2 6621 5217 vk2jwa@sarc.org.au

WANTED NSW

- **Atlas model 210X** in good working order, also **Eddystone EC-10** same condition. Ray VK2AWQ Phone 02 6494 1347
- Copy of manual **Marconi Universal Bridge TF 2700** serial 53978/093. Stanley Dogger VK2KSD QTHR
- **Meter shunts 14R8 and 166R6** for vintage University 1000.OPV. M M Dogger, 116 Tunnel Road, Stokers Siding 2484
- **Interrogation Code plug-in module for IFF/ATC test set model 198A**. Ex RAAF/USAF. Phone 02 9791 0366 or toynmul@pip.com.au QTHR VK2ACV.

- **Geloso G4/218 general coverage receiver** and **STC AMR300 general coverage receiver**. Buy or swap. Ray VK2AWQ ph 02 6494 1347

FOR SALE VIC

- **Yaesu FT-1000** 200W Tcwr w/desk mike & spkr \$2000 ono. **Kenwood AT-230 ATU** \$200. **Nally Tower** \$800. **HB35C 5-el ant** \$250. **Daiwa rotator** \$200. **Icom IC-2A 2m FM** \$100. **Azden 2m FM Tcwr & power supply** \$100. **Kenwood headphones** \$30. **Coax 4 posn switch** \$30. **LP filter** \$25. Laurie VK3DPD QTHR Phone 03 9818 6009
- **Ideal QTH no QRN modern 18.5 sq home**, fabulous expansive views 7 3/4 acre property, seven mins to highway, shopping, railway station. Ample water, storage shedding, includes Nally Tower. See website <http://members.dodo.com.au/~dorcass/> Tom Straughair VK3ABV QTHR
- **Valves** from a deceased estate. Best offer for the lot by the end of the month. 4- QQE06/40s, 2- QQE03/20s 6- 866s, 7- 807s, 6- 2E26s, 1- 6146, 2- 811As, 3- 832s, 3- 813s, 2- QB3-300s with bases, 3- 4X150s, 1 vacuum capacitor 50mmf 7.5kv. QTHR email: dotbob@i-o.net.au or phone 03 5156 7654. Bob Neal VK3ZAN.
- **Siemens teleprinter with tape perforator** and reader, working and in good condition. It's heavy, so you arrange the transport. \$60 ono. Norm VK3JAL Phone 03 5456 3122 QTHR. Email: normguy@malleenet.net.au
- **Kenwood TS-690S/AT** original condition with optional ATU HF 100W/6 m 50 W Original Packing/Manual & Hand Mic, Ser no 30800247 \$1200. Ernie VK3DET Phone 03 5342 0383 ernie@giant.net.au
- **Icom IC-490a 70cm** all mode 10 W. Original condition ser no 01549 \$350. Ernie VK3DET 03 5342 0383 ernie@giant.net.au
- **Silver-Mica capacitors**, pack of mixed values and types about 120 pieces, \$10 incl post (to most places) Terry VK3ZXY QTHR Phone 03 9592 3514, email vk3zxy@leithy.com

- Give away to a good home: AR from 1989 to 1999. Near complete, approx 100 journals. Address not yet in callbook. Phone 03 5975 0306 (Morningson) Vic. Laurie VK3BV.
- **Antenna, Hustler 4-BTV trap vertical**. 80, 40, 20, 15 & 10 metre bands, with radials and manual. \$220 Peter VK3FIM Phone 03 9802 9475 or email pmccallum@telstra.com
- **Equipment Rack** - 19 inch free standing 6ft 6 in high \$70. Bill VK3ZWO phone 03 9598 6304

FOR SALE QLD

- **Realistic DX-300** gen coverage receiver, EC \$220. **MJF-1214** multimode computer interface and handbook, mint \$120. Wayne VK4WDM Phone 07 4722 5770. Email melrosew@optusnet.com.au
- I have approx 160 **old AR magazines**, from DEC 1946 til DEC 1961. About 20 missing from complete set from that era. Condition various from good to some water damage. Will sell, swap or give away to highest bidder! Phone or email to negotiate. Reg VK4CMB Phone 07 3630 4472, email: jonesreg@bigpond.com
- **One set of mobile whips made by G-WHIP** of UK, never used and in perfect condition. 80-10m. One **COM-ANTENNA all band vertical**, in good condition. VK4DV QTHR or phone 07 4928 5537
- **ICOM IC-706MK2G with built-in DSP**, all bands 160m - 70cm, all modes, original packaging and manual, as new in mint condition, \$1850. Contact: Carsten VK4OA QTHR Phone 07 3264 6443. Mobile: 0419 966 111. Email: pedersen@powerup.com.au

WANTED QLD

- **Drake SPR-4** or similar Drake gen coverage receiver. **IC-502 6 m** transceiver. **Carolina window 160-10 m antenna**. All must be GWO. Wayne VK4WDM Phone 07 4722 5770. Email melrosew@optusnet.com.au
- **For Townsville RAAF museum: Copy of book "A Saga of Achievement, the story of RAAF radio"** by E R Hall, circa 1970s. Donations of other books, equipment, parts etc always very welcome. Please don't dispose of anything military until you check with us. Your trash may be our treasure! Wayne VK4WDM Phone 07 4722 5770. Email melrosew@optusnet.com.au
- **Manuals (or copies), service manuals preferred**, for the following equipment: **HP Power-Meter** model 431B. **Airmec Modulation Meter** type 409. **Airmec Sig Generator** type 407. **Dawe Strobflash** type 12006. **AWA AT oscillator** type A57321. All costs refunded, Gwen VK4CB QTHR Phone 07 3202 7137.
- **Ex army Tx/Rx type 128** manpack used late 1940s/early 1950s. Also after battery box and 6 volt vibrator power supply and hand generator for this set. Ray VK4FH Phone 07 3299 3819. Fax 07 3299 3821, PO Box 5263 Daisy Hill Qld 4127.

FOR SALE SA

- **Yaesu FT707** base mobile transceiver with WARG bands and handbook \$400. Phone 08 8738 0000 QTHR

WANTED SA

- **Wanted operation manual for Yaesu FT-770RH 70cm Transceiver**, also wanted a **2m/70cm Duplexer** Phone 08 8365 9640 or email: ilikepizza@bigpond.com

About hamads....

- Hamads may be submitted by **email** or on the **form on the reverse of your current Amateur Radio address flysheet**. Please print carefully, especially where case or numerals are critical.
- Please submit separate forms for For Sale and Wanted items, and be sure to include your name, address and telephone number (including STD code) if you do not use the flysheet.
- Eight lines (forty words) per Issue free to all WIA members, ninth and tenth lines for name and address. Commercial rates apply for non-members.
- Deceased estates Hamads will be published in full, even if the ad is not fully radio equipment.
- WIA policy recommends that the serial number of all equipment for sale should be included.
- QTHR means the address is correct in the current WIA Call Book.
- Ordinary Hamads from members who are deemed to be in general electronics retail and wholesale distributive trades should be certified as referring only to private articles not being re-sold for merchandising purposes.
- Commercial advertising (Trade Hamads) are pre-payable at \$25.00 for four lines (twenty words), plus \$2.25 per line (or part thereof), with a minimum charge of \$25.00. Cheques are to be made out to: WIA Hamads.
- Copy should be typed or printed clearly, and be received by the deadlines shown on page 1 of each issue of Amateur Radio, at:

Email: newsletters@ozemail.com.au

Fax: 03 9756 7031

Postal: Newsletters Unlimited, PO Box 431, Monbulk Vic 3793

• (1) Heathkit QRP transceiver type HW-9. (2) Documentation on HF transceiver manufacturers and their products. Granger Associates and Weston Electronics. Malcolm Haskard VK5BA QTHR Phone/Fax 08 8280 7192, email: mhaskard@charlot.net.au

• EA for September 1990 as the VHF Power Match Mk2 Project Power Match Reflecto Meter Head from 1971. this is an SWR bridge for both VHF and UHF. VK5ZLC QTHR 08 8294 6908

WANTED TAS

• For Aust. Wireless Sat 101:- (1) 6 pin line connectors for the power supply and set; (2) 2 pin plug for PS; (3) 2 pin line mounting connectors for PS and set; (4) 2 pin plug for battery case. Phil VK7ZAX QTHR Phone 03 6372 5158

MISCELLANEOUS

• The WIA QSL Collection (now Federal) requires QSLs. All types welcome, especially rare DX pictorial cards, special issue. Please contact the Hon Curator, Ken Matchett VK3TL, 4 Sunrise Hill Road, Montrose Vic 3765, tel. (03) 9728 5350

TRADE ADS

PSK-31, SSTV, RTTY SOUNDBOARD INTERFACES

Fully isolated, ready to plug in. <http://www.G3LIV.CO.UK>, johnny@melvin.com, G3LIV QTHR.

AMIDON FERROMAGNETIC CORES:

For all RF/electronic applications.

See our website for complete data on all cores including prices.

RJ & US Imports, PO Box 431, Kiama NSW 2533.

A 3.5" PC disk containing all data is available for \$5.00 incl. post.

www.catchnet.com.au/~rjandusimports

Agencies at: Active Electronics, Tas; Truscotts, Electronic World, Melbourne; TTS Systems, Tyabb; Tower Communications, Perth; Haven Electronics, Nowra.

HF, VHF, UHF ANTENNAS & ACCESSORIES

Alum towers, guys etc. Diamond VSWR/PWR meters. HD copper ant wire & insulators. TX tubes & pwr transistors. Quality coax cables & connectors. Free advice & catalogue. ATN Antennas Ph 03 5492 2224 Fax 03 5492 2666, email atnant@ruralnet.net.au

ADVERTISERS INDEX

Com-an-tena.....	24
Connektron.....	37
G & C Communications.....	29
Icom.....	OBC
TTS.....	8
Andrews.....	16
WIA Call Book.....	IFC

For Sale By Tender

Two Way Radio Equipment and Miscellaneous Items

The following items form part of the deceased estate of Mr John Richard Smethurst (VK3TJ) formerly of 90 Raglan Street, Daylesford. These items are offered for sale by tender. All tenders should be addressed to;

Ms Tennille Rodd
State Trustees
168 Exhibition Street
MELBOURNE 3000
Email: tlr@statetrustees.com.au

number. Tenders close Friday December 20, 2002.

Further information or inspection of the items can be arranged by telephoning David Verner on 0428 510 404. The items are stored in Maldon, Victoria.

Tenders should clearly indicate the tenderers name, address, daytime contact telephone

Item No.	Make	Model	Description	Item No.	Make	Model	Description
Two Way Radio Equipment							
1	National Panasonic	GX500M	5 Band Receiver (FM, MW, Marine, SW1, SW2)	25	Philips	FM-620	UHF Transceiver with mobile antennae
2	Okerblock	SWR-200	SWR Meters (x2)	26	MFJ	MFJ-1118	Deluxe high current, DC switched 5 outlet power board 35A
3	Kenwood	MC-85	Desktop Microphone (Two way Radio)	27	Philips	FM-828/25W	Unknown equipment
4	Plessey		Mobile Radio Extension Speaker	28	Philips	3502 399 0	Unknown equipment
5	Arlac	PS353	Regulated 13.8V Power Supply	29	Tech	Model TE-25	Unknown test equipment
6	Minipa		Panel DC Voltmeter	30	Sylvania	JAN 6148W	Valve - New
7	Banchar Inc	YA-1	Low Pass Filter 1.8-30Mhz	31	Matsushita	S2001	Valves (x2) - New
8	Radio Shack	22-305	RF Frequency Counter	32	Mullard	12B7A	Valves (x3) - New
9	Kanwood	SP-23	Extension Speaker	33	Mullard	BY74	Valve - New
10	Kantronica		Packet Radio Modem	Computer Equipment			
11	Kantronica	Communicator 3	Packet Radio Modem HF, VHF	34	Hewlett Packard	Kayak KA	Personal Computer Pentium 11 processor 4Gb Hard Drive, NEC Multisync M600 monitor. Colour Printer
12	Tokyo Hy-Power	KanPlus	144Mhz All power mode amplifier	35	Lexmark	Z22	Laser Printer
13	Reallistic	HL-88V	20-9148A Scanning Receiver	36	Canon	LBP-8 Mk111	Laser Printer
14	DSE	Pro-2026	VHF Wattmeter	37	Colorado	Model 360	Internal Tape Drive
15	Barlow Wadley	XCR-30 MK2	Receiver	38	Multimedia	MS-898	1000W Super Sub Woofer
16	Kenwood	TS-790A	144/430/1200Mhz All mode Triband Transceiver	39			Computer Desk with Hutch
17	Kenwood	VFO-820	Remote VFO	Miscellaneous Equipment			
18	DSE	Cat D-3800	3-15V Regulated Power Supply 26A	40	Garmin	GPS 38	Personal GPS Navigator
19	Trio	TS-820S	SSB Transceiver	41	Nokia	3210	Mobile Telephone
20	DSE		13.8V Rack mounted Power Supply 1.5kA	42	Pentax	P30N	35mm SLR Camera, 28-70mm zoom lens
21	MFJ	MFJ-889C	Versa Tuner V, 3 kW Series Roller Tuner	43	Pentax	SFX	35mm SLR Camera, 35-70mm zoom lens
22	Phillips	FM-900	Transceiver, with mobile antennae	44	Sigma		70-210mm zoom lens
23	Uniden	Pro-160C	Transceiver, with mobile antennae	45	Sigma		Lens 65mm Filters - UV, Polarizing with 52mm adapters
24	Yessu	FT-1600M	Transceiver, with mobile antennae, 146,450-147,260,161,025, 163,675MHz	46	Brother	Fax 470	Phone, Fax, Copier

TRADERS
Advertise in **AR**
03 9756 7797

TRADE PRACTICES ACT
It is impossible for us to ensure that the advertisements submitted for publication comply with the Trade Practices Act 1974. Therefore, advertisers and advertising agents will appreciate the absolute need for themselves to ensure that the provisions of the Act are strictly complied with.

VICTORIAN CONSUMER AFFAIRS ACT
All advertisers are advised that advertisements containing only a PO Box number as the address cannot be accepted without the addition of the business address of the box-holder or seller of the goods.



Division Directory

The Amateur Radio Service exists for the purpose of self training, intercommunication and technical investigation. It is carried out by amateurs who are duly authorised people interested in radio technique solely with a personal aim and without pecuniary interest.

The Wireless Institute of Australia represents the interests of all radio amateurs throughout Australia. National representation is handled by the executive office under council direction. There is one councillor for each of the seven Divisions. This directory lists all the Divisional offices, broadcast schedules and subscription rates. All enquiries should be directed to your local Division.

Broadcast schedules All frequencies MHz. All times are local.

VK1 Division Australian Capital Territory,
GPO Box 600, Canberra ACT 2601
President Gilbert Hughes
Secretary Peter Kloppenburg
Treasurer Linden S Orr

VK1GH
VK1CPK
VK1LSO

VK1WI: 3.590 LSB, 146.950 FM each Thursday evening from 8.00pm local time. The broadcast text is available on packet, on Internet [aus.radio.amateur.misc](http://www.aus.radio.amateur.misc) news group, and on the VK1 Home Page <http://www.vk1.wia.ampr.org>

Annual Membership Fees. Full \$80.00 Pensioner or student \$71.00. Without *Amateur Radio* \$48.00

VK2 Division New South Wales
109 Wigram St, Parramatta NSW
(PO Box 432, Harris Park, 2150)
(Office hours Tue., Thu., Fri., 1100 to 1400 hrs.)
Phone 02 9689 2417
Web: <http://www.wiansw.org.au>
Freecall 1800 817 644
e-mail: vk2wi@ozemail.com.au
Fax 02 9633 1525

President Terry Davies
Secretary Owen Holmwood
Treasurer Chris Minahan

VK2KDK
VK2AEJ
VK2EJ

VK2WI transmits every Sunday at 1000 hrs and 1930 hrs on some or all of the following frequencies (MHz): 1.845, 3.595, 7.146, 10.125, 14.170, 18.120, 21.170, 24.950, 28.320, 29.170, 52.150, 52.525, 144.150, 147.000, 432.150, 438.525, 1273.500. Plus many country regions on 2m and 70cm repeaters. Highlights are included in VK2AWX Newcastle news Monday 1930hrs. on 3.593, 10 metres and local repeaters. The text of the bulletins is available on the Divisional website and packet radio. Continuous slow morse transmissions are provided on 3.699 and 145.650. VK2RSY beacons on 10m, 6m, 2m, 70cm and 23cm. Packet on 144.850.

Annual Membership Fees. Full \$80.00 Pensioner or student \$63.00. Without *Amateur Radio* \$50.00

VK3 Division Victoria
40G Victory Boulevard Ashburton VIC 3147
(Office hours Tue 10.00 -2.30)
Phone 03 9885 9261
Web: <http://www.wiavic.org.au>
Fax 03 9885 9298

e-mail: wiavic@wiavic.org.au
President Jim Linton
Secretary John Brown
Treasurer Barry Wilton

VK3PC
VK3JJB
VK3XV

VK3BWI broadcasts on the 1st Sunday of the month at 20.00hrs Primary frequencies, 3.615 DSB, 7.085 LSB, and FM(R)s VK3RML 146.700, VK3RMM 147.250, VK3RWG 147.225, and 70 cm FM(R)s VK3ROU 438.225, and VK3RMU 438.075. Major news under call VK3ZWI on Victorian packet BBS and WIA VIC Web Site.

Annual Membership Fees. Full \$83.00 Pensioner or student \$67.00. Without *Amateur Radio* \$51.00

VK4 Division Queensland
PO Box 199, Wavell Heights, Qld. 4012
Phone 07 3221 9377
e-mail: office@wiaq.powersup.com.au
Fax 07 3266 4929

Web: <http://www.wia.org.au/vk4>
President Ewan McLeod
Secretary Bob Cumming
Treasurer Bill McDermott

VK4ERM
VK4YBN
VK4AZM

VK4WIA broadcasts on 1.825 MHz SSB, 3.605 MHz SSB, 7.118 MHz SSB, 10.135 MHz SSB, 14.342 MHz SSB, 21.175 MHz SSB, 28.400 MHz SSB, 29.660 MHz FM (rptr), 147.000 MHz, and 438.525 MHz (in the Brisbane region, and on regional VHF/UHF repeaters) at 0900 hrs K every Sunday morning. QNEWS is repeated Monday evenings, at 19.30 hrs K, on 3.605 MHz SSB and 147.000 MHz FM. On Sunday evenings, at 18.45 hrs K on 3.605SSB and 147.000 FM, a repeat of the previous week's edition of QNEWS is broadcast. Broadcast news in text form on packet is available under WIAQ@VKNET. QNEWS Text and real audio files available from the web site

Annual Membership Fees. Full \$95.00 Pensioner or student \$81.00. Without *Amateur Radio* \$69.00

VK5 Division South Australia and Northern Territory
(GPO Box 1234 Adelaide SA 5001)
Phone 08 8294 2992
web: <http://www.sant.wia.org.au>

email: peter.reichelt@bigpond.com
President Trevor Quick
Secretary Peter Reichelt
Treasurer Trevor Quick

VK5ATQ
VK5APR
VK5ATQ

VK5WI: 1843 kHz AM, 3.550 MHz LSB, 7.095 AM, 14.175 USB, 28.470 USB, 53.100 FM, 147.000 FM Adelaide, 146.800 FM Mildura, 146.900 FM South East, 146.925 FM Central North, 438.475 FM Adelaide North, ATV Ch 35 579.250 Adelaide. (NT) 3.555 LSB, 7.065 LSB, 10.125 USB, 146.700 FM, 0900 hrs Sunday. The repeat of the broadcast occurs Monday Nights at 1930hrs on 3585kHz and 146.675 MHz FM. The broadcast is available in 'Realaudio' format from the website at www.sant.wia.org.au Broadcast Page area.

Annual Membership Fees. Full \$88.00 Pensioner or student \$73.00. Without *Amateur Radio* \$58.00

VK6 Division Western Australia
PO Box 10 West Perth WA 6872
Phone 08 9351 8873
Web: <http://www.wia.org.au/vk6>

e-mail: vk6@wia.org.au
President Neil Penfold
Secretary Roy Watkins
Treasurer Bruce Hedland-Thomas

VK6NE
VK6XV
VK6QO

VK6WIA: 146.700 FM(R) Perth at 0930hrs Sunday relayed on 1.865, 3.564, 7.075, 10.125, 14.116, 14.175, 21.185, 29.120 FM, 50.150 and 438.525 MHz, Country relays 3.582, 147.200 (R) Cataby, 147.350 (R) Busselton, 146.900 (R) Mt William (Bunbury), 147.000 (R) Katanning and 147.250 (R) Mt Saddleback. Broadcast repeated on 146.700 at 1900 hrs Sunday relayed on 1.865, 3.564 and 438.525 MHz : country relays on 146.900, 147.000, 147.200, 147.250 and 147.350 MHz. Also in "Real Audio" format from the VK6 WIA website

Annual Membership Fees. Full \$71.00 Pensioner or student \$65.00. Without *Amateur Radio* \$39.00

VK7 Division Tasmania
PO Box 371 Hobart TAS 7001
Phone 03 6234 3553 (BH)
Web: <http://www.tased.edu.au/tasonline/vk7wia>
also through <http://www.wia.org.au/vk7>

email: batesjw@netspace.net.au
President Mike Jenner
Secretary John Bates
Treasurer John Bates

VK7FB
VK7RT
VK7RT

VK7WI: 146.700 MHz FM (VK7RHT) at 0930 hrs Sunday relayed on 147.000 (VK7RAA), 146.725 (VK7RNE), 146.625 (VK7RMD), 3.570, 7.090, 14.130, 52.100, 144.150 (Hobart), repeated Tues 3.590 at 1930 hrs.

Annual Membership Fees. Full \$90.00 Pensioner or student \$77.00. Without *Amateur Radio* \$57.00

VK8 Northern Territory is part of the VK5 Division and relays broadcasts from VK5 as shown, received on 14 or 28 MHz. The broadcast is downloaded via the Internet.

Is JOTA dying?

by Scotty (G. Scott) VK2KE



JOTI in action – Albury Girl Guides

I have been active in providing ham radio to scouts and guides since the 1970s and I feel there is a clear waning in activity on the HF and the VHF bands.

Last weekend, 19/20 October, we set up a station at the Albury Guides hall and noticed that the HF bands had very few signals from JOTA stations. We had contacts with stations in OLD and WA on 20 metres.

Scanning 40 metres and 80 metres regularly we noticed a distinct lack of stations.

We for the last years have set up an alternative activity- a JOTI (Jamboree on the Internet) station via the auspices of John VK2YUE and his son David who is an IT expert.

What we have noted is that the JOTI is very popular with the kids as they have computers and Internet at school and probably at home too, so the trend is to go for the JOTI in preference to JOTA on the radio waves.

For quite a few years now, Ian VK2KE and I have set up HF radio and 2 metres for the kids to be able to have JOTA contacts on 80, 40, 20 and the 2 metre bands.

We use a vertical on 2 metres and it gets out well as it is on the roof of the Albury Council building (with permission!).

We hang the HF inverted vees and G5RV off the roof too using a pulley attached to the roof so we can raise and lower antennas from the ground.

For HF we used my TS 180s and on 2 metres, an FM transceiver to use via the Big Ben repeater on 147 MHz and on simplex on 146.5 MHz.

We had a reasonable number of contacts on 20 metres, nil on 40 metres, nil on 80 metres and the 2 metre rig was used via the repeater and on simplex 146.5 to Camp Nelson out west of Albury on the Howlong road.

In the past we had plenty of 40 and 80 m contacts so where have all the operators gone?

Regularly scanning across the 20,40 and 80 metre bands showed very little activity on 40 and 80, which quite surprised us. As in the past these bands have been full of stations working each other in JOTA.

Ian and I have accepted that the JOTI is becoming a strong trend with the kids to be on the Internet, as it is the go thing to do.

We accept this and recognise it is probably natural progress, however, we feel that there is still a place for radio but with few stations on air to work, we found it difficult to get good contacts.

So what we now recommend is to ask operators to get on air and support the kids in their area to provide experience with ham radio as an alternative to merely going on the Internet with JOTI only.

As another test, we are considering using SSTV on HF to allow the kids to transmit a picture of themselves to the station they are working so that each kid can see the person they are talking to at the other end.

We are now actively looking for stations who would be prepared to do this next October for JOTA so we can liven up the contacts on air for the kids and so they can see it's more than voice that we can provide on our bands.

We've got a year to do the planning so let's give it a go and try to make HF radio QSOs more stimulating for the kids in JOTA.

It's our window of opportunity to encourage more young operators into our great hobby!

Any operators who'd like to take part in this experiment are invited to contact me on email gscott@albury.net.au to discuss the idea further or to write to me via PO box 385 Albury NSW 2640

There is an issue of security and privacy in relation transmitting images of kids over the air and on the Internet but the parents will, by and large give approval once they understand what we are doing and the normal precautions we can take.

I look forward to hearing from a good number of operators, who will take part in this aspect of ham radio and JOTA,

73,

Scotty VK2KE

ICOM'S GREAT CHAMPIONS



**NO
FILTERS
REQUIRED**

IC-7400 (746 PRO)

- Sharp & soft IF filter shape
- 100W HF /6m /2m
- Digital twin PBT
- DSP
- SSB / CW synchronous tuning
- Built in antenna tuner
- RTTY demod / decoder
- Digital RF speech processor
- Microphone equaliser.



IC-910H The new dimension in the VHF/UHF world!

- Tri band multimode transceiver
- 2M - 100W, 70CM - 75W, (optional 23CM, 10W)
- 9600bps packet operation
- Satellite communication Reverse/normal tracking doppler shift compensation
- CIV capability for PC control
- Optional 2.4G down converter.



IC-718 A compact HF all band transceiver.

- A superior performer with simple, straightforward operation with keypad
- Optional AF DSP capabilities, including noise reduction & auto notch function
- It's versatile, compact & loaded with features.

IC-T90A A new 5W Triband handheld

- VHF/UHF FM 2M, 6M, & 70CM
- Wideband receive 495 KHz - 1 GHz
- 555 Alphanumeric memories
- 13 Scan modes
- DTCSS & CTCSS encode & decode
- DTMF encoder (10 memories)
- Wide/narrow transmit capability.

NEW



IC-706MKIIG HF • VHF UHF

The amazing evolution of the legendary 706.

- Now includes 70cm @ 20W and 50W on 2m
- Standard feature dsp
- Built in sub tone encoder & decoder
- Tone scan
- MosFET PA
- You get base station performance and features in a mobile rig sized package.

ICOM
Clearly Ahead

2 YR WARRANTY

find your nearest ICOM dealer at

www.icom.net.au or (03) 9387 0666